

# HI-FI *Music* AT HOME

JUNE 1957      PRICE 50¢  
MILTON B. SLEEPER, Publisher



devoted to hi-fi music from records, tape & FM radio

WorldRadioHistory

# NOW..

you're actually  
**BACK STAGE**  
at the making  
of a hi-fi  
record!

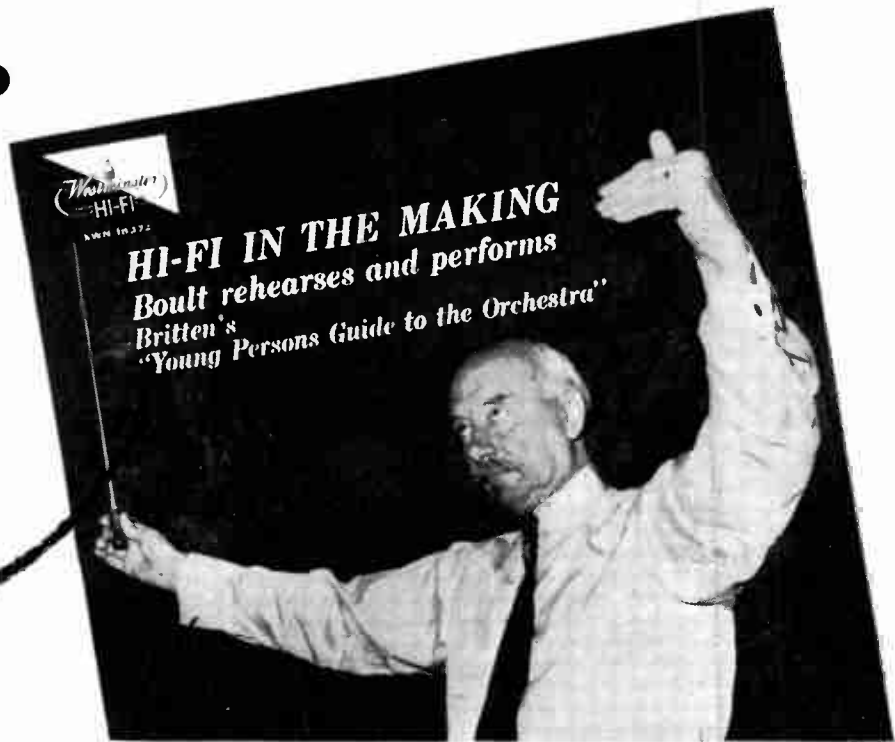

**SURPRISE!** the most **THRILLING** surprise in all your hi-fi listening!

The conductor didn't know. Nor did the orchestra. Nor the musical director. Unknown to all of them, Westminster's engineers taped part of a rehearsal — that vital part when, tempi and phrasing and all else established, the *high fidelity* is put into the music making. And presented that tape, a surprise gift, to the director.

But this was too good to keep private! Immediately on hearing it, Sir Adrian and the musical director decided it *must* be produced — for every listener, everywhere, with a beginner's curiosity or a professional's interest in what makes hi-fi high. And

here it is, un-edited and un-cut: one side of this unique record.

The other side? The finished product: Britten's "*Young Person's Guide to the Orchestra*" — as brilliant and sharply-defined a work as high fidelity has yet produced. Every individual instrument, every orchestral voice in sonic and dynamic display that thrills, dazzles, delights the hi-fi ear.

There is but one way to know how hi-fi is made: *hear it*. There is but one way to hear it "in the raw": *get it*. It's called

**HI-FI IN THE MAKING...XWN 18372**

*Challenge!*

Listen to this making of "hi-fi", then hear the result of such making, with — BACH! If you think of hi-fi as a phenomenon of sound alone, we challenge you to hear Westminster's new panorthophonic recordings of Bach in "Natural Balance"... to hear hi-fi sound wedded to high fidelity music. We challenge you to listen and COMPARE, with any Bach record, anywhere! See Westminster ad in April issues of Schwann and Long Player catalogs for complete list.



*"You'll Have The Best  
in Hi-Fi Sound with  
a Jensen Speaker System!"*

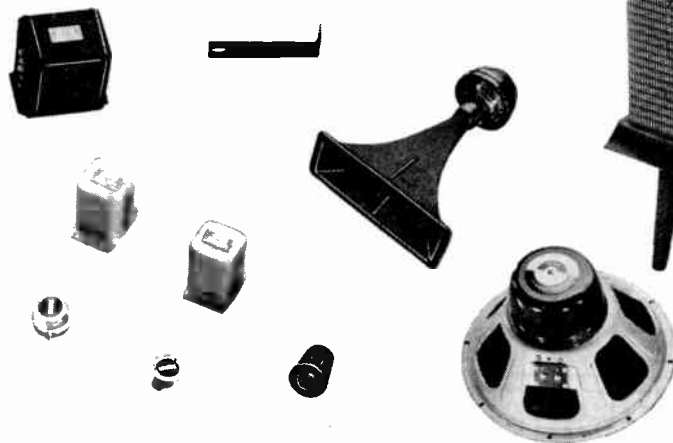

## ADD YOUR OWN TOUCH TO HI-FI...and SAVE!

You'll enjoy hi-fi music doubly when you put together your own easy-to-assemble Jensen speaker kit . . . and you don't need a work shop. The acoustically correct Jensen-designed Cabinet enclosure kit and the famous Jensen loudspeaker kit can be assembled right in your living room without any messy woodworking or wood finishing. Everything is accurately pre-cut and *pre-finished* with a professional furniture finish in your choice of mahogany or korina blonde. You'll have the same fine matched speaker components used in Jensen's factory assembled complete high fidelity reproducers—and at far less cost, too!

Send 50¢ for your copy of Manual 1060 for full information about selecting and building Jensen speaker systems.

System Type	"Woofer" Size	Equivalent Jensen Reproducer	Jensen Speaker Kit		Type	Cabinet Kits			
			Model	Price		Basic Cabinet Kit	Price	Dress Kit	Price
3-Way	15"	Imperial	KT-31	\$184.50	Corner* Horn	K-101	\$89.00	P-201	\$54.00
3-Way	15"	Triplex	KT-32	169.50	Corner* Bass-Ultraflex	K-103	48.00	P-203	39.00
3-Way	15"	Triplex	KT-32	169.50	Low Boy Bass-Ultraflex	K-105	48.00	P-205	39.00
2-Way†	15"	—	KT-21	99.50	Corner* Bass-Ultraflex	K-103	48.00	P-203	39.00
2-Way†	15"	—	KT-21	99.50	Low Boy Bass-Ultraflex	K-105	48.00	P-205	39.00
2-Way†	12"	Concerto	KT-22	73.00	Corner* Bass-Ultraflex	K-107	39.00	P-207	36.00
2-Way†	12"	Concerto	KT-22	73.00	Low Boy Bass-Ultraflex	K-109	39.00	P-209	36.00
2-Way†	8"	Contemporary	KDU-10	24.75	Corner* Bass-Ultraflex	K-111	23.00	P-211	25.00
2-Way	8"	Duette Treasure Chest	KDU-10	24.75	Duette	K-113	18.00	P-213	21.00

\* Gives excellent results against sidewall. Bass-Ultraflex is a Jensen trademark.

† Cabinet provides for expansion to 3-way system at any time with Jensen KTX-1 Range Extender Supertweeter Kit, price \$43.75.

‡ Available in Mahogany or Korina Blonde.

BURTON BROWNE ADVERTISING

# Jensen

MANUFACTURING COMPANY  
6601 SOUTH LARAMIE AVE., CHICAGO 38, ILLINOIS

Division of The Muter Co.—In Conodo: Copper Wire Products, Ltd., Toronto

JENSEN LOUDSPEAKERS . . . WORLD'S QUALITY STANDARD FOR MORE THAN A QUARTER CENTURY

May-June 1957



4 Speeds — plus the reproduction qualities of the world's finest record players... in this compact, revolutionary

# GARRARD

model **T** mark II  
single play unit

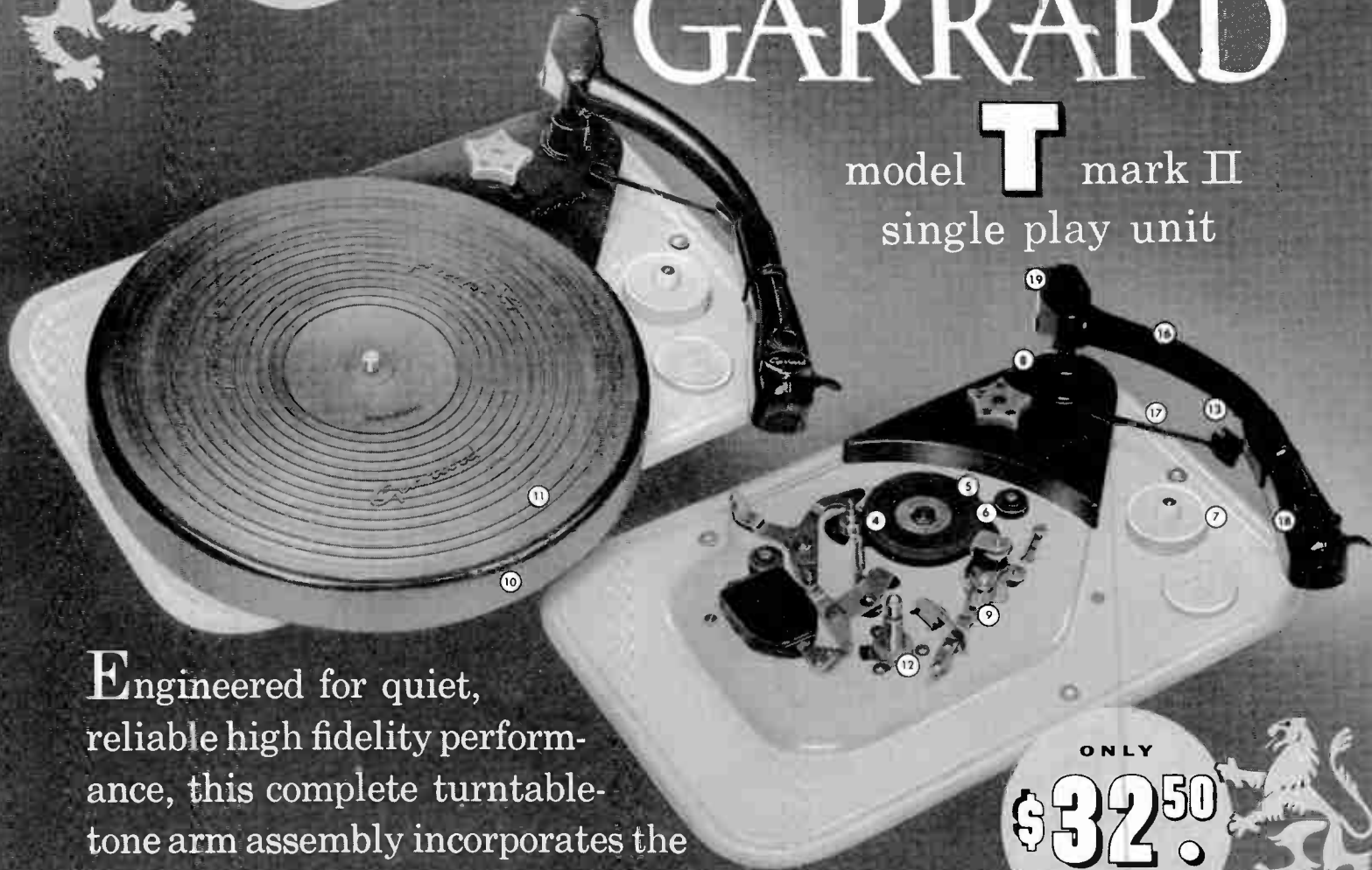

Engineered for quiet, reliable high fidelity performance, this complete turntable-tone arm assembly incorporates the latest Garrard advancements... at a modest price...

ONLY  
**\$32.50**

Slightly higher west of Rockies

**1 4-Pole Shaded "Induction Surge" Motor:** Heavy duty, with minimum of vibration or rumble! Smoothest, quietest, most powerful type available. No hum, even when used with sensitive pickups. Self-aligning Oilite bearings top and bottom.

**2 Exclusive, Dynamically-Balanced Rotar:** Super-finished and individually weighted by exclusive Garrard equipment for true speed.

**3 Live Rubber "Cani-Poise" Motor Mounts:** Floating power! Motor isolated and damped by exclusive tension/compression shock absorbers.

**4 Perfected True-Turret Drive:** All 4 speeds operate directly off motor on a single turret, eliminating vibration and insuring even speed. Perfect results now possible without belts.

**5 Oversized "Soft Tread" Idler Traction Wheel:** Surrounded by 3/4" wide live rubber, presents long-arc heavy traction surface. Guarantees unflinching speed, without inducing wows, flutter or vibration.

**6 Self-Neutralizing Pull-Away Idler Wheel Mount:** Keeps idler perfectly round and "true"... no thump... no rumble. Automatically disengages in any shut-off position.

**7 45 RPM Adaptor:** Rests on unit plate—ready for instant use.

**8 Exclusive "Finger-Form" Star Switch:** Convenient, instantaneous 4-speed selector.

**9 Exclusive, Sensi-matic Trip:** Permits perfect operation even with tone arm set at lowest tracking pressures. Safe, gentle, quiet and positive.

**10 Heavy Steel Precision Turntable:** A full inch high! Shields motor; eliminates possible hum caused by stray magnetic fields. Flywheel action to compensate for any voltage variation in drive motor.

**11 Genuine Rubber Turntable Traction Mat:** Special tread... no abrasive action on record grooves.

**12 Noiseless Main Spindle:** Rotates on specially designed bearing.

**13 Automatic Start and Stop:** Move tone arm to start; shuts off at end of record.

**14 Shielded Condenser-Resistor Network:** Pioneered by Garrard. No startling "plap" noise through speaker when player shuts off.

**15 Heavy-Steel Unit Plate:** A husky, rigid support for entire mechanism.

**16 True-tangent Tone Arm of Aluminum:** Provides rigidity with low mass and light weight. The finest material for this use... similar to professional arms. End socket pivots to permit perpendicular stylus alignment.

**17 Convertible Tone Arm "Softi-Rest":** Supports tone arm—ready for play... simple snap locks it for safety in carrying.

**18 Interchangeable Plug-In Heads:** Accommodate users' personal choice of magnetic, ceramic or crystal cartridges; turnover, twist or simple plug-in types.

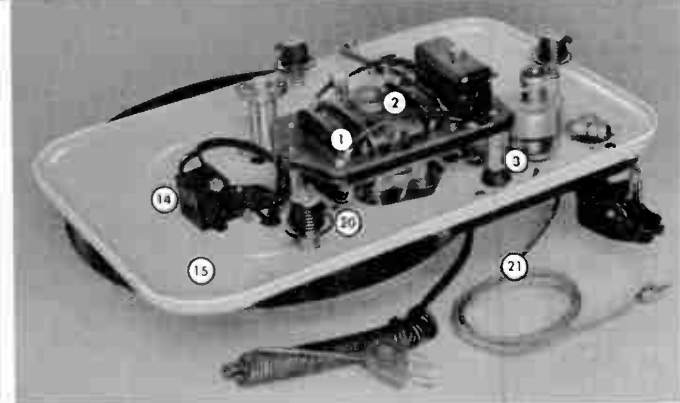

**19 Accessible Stylus Pressure Adjustment:** Knurled knob on back of tone arm sets pressure instantly and maintains it... easy to use regardless of where player is situated in cabinet.

**20 Exclusive "Snap Mount" Spring Assembly:** Permits instant mounting and can easily be levelled from top of unit.

**21 Complete UL-Approved Wiring...** Ready for Plug-In! 6-ft. UL-approved electrical line cord; and pickup cable, terminating in standard jack. No soldering or tools required for connecting.

**Service and Replacement Parts:** Garrard record players hold their pre-eminent position in the American market by the finest service and parts facilities available in the industry... the guarantee and facilities of the BIC group.

**Minimum Cabinet Dimensions:**  
Left to right: 14 3/4"    Front to rear: 12 1/2"  
Above Motor Board: 3"  
Below Motor Board: 2 1/4"

**MAIL THIS COUPON FOR HIGH FIDELITY PLAN BOOK AND DEALERS' NAMES:**

Garrard Sales Corp., Port Washington, N.Y. Dept. GE-37  
Please send High Fidelity Plan Book

Name \_\_\_\_\_  
Address \_\_\_\_\_  
City \_\_\_\_\_ Zone \_\_\_\_\_ State \_\_\_\_\_

Now, there's a Garrard for every high fidelity system



# HI-FI Music AT HOME



THE COMPLETE GUIDE TO HI-FI REPRODUCTION FROM RECORDS, TAPE AND FM RADIO

**Publisher:**  
Milton B. Sleeper

**Music Editor**  
James Lyons

**Editorial Assistant**  
Shirley Fleming

**Cover Design**  
Elli Zappert

**Art Director**  
Ray Robertson

**Production Manager**  
Mary Yiatis

**Photography**  
William Leftwich

**Circulation**  
Myrna Sossne

**Contributors to this issue**

Ward Batsford	James Lyons
Jean Bowen	George L. Mayer
Oliver Daniel	Ruby Mercer
Warren De Matte	David H. Miller
Leonard Feather	Fred Reynolds
Shirley Fleming	Irmgard Seefried
P. Glanville-Hicks	Max Serbin
Edward Jablonski	Abraham Skulsky
Alfred Kaine	Walter Stegman
Thomas Kelly	Saul Taishoff
Ben Kemper	Milton Sleeper
Ezra Laderman	Harold Taplin
C. J. Luten	Marguerite Tazelaar

HI-FI MUSIC AT HOME® is published bimonthly by Sleeper Publications, Inc., Hi-Fi House, 105 E. 35th St. at Park Ave., New York 16. Telephone: MUrray Hill 4-6789. THIS OFFICE IS CLOSED FROM THURSDAY NIGHT TO MONDAY MORNING. Editorial, advertising, and circulation departments are located at the address above. HI-FI MUSIC AT HOME is not connected or associated with any other magazine.

Subscription rates are \$5.00 per year (7 issues including the Hi-Fi Yearbook issue) or \$10.00 for 3 years (21 issues including 3 Hi-Fi Yearbook issues). Single copies 50¢ except for the Hi-Fi Yearbook issue which is \$2.00. Outside the USA, Canada, and the Pan American Postal Union, rates are \$6.00 per year, or \$13.00 for 3 years. Copies are mailed on the 10th of January, March, May, July, September, October, and November. Allow time for delivery by second class mail.

Editorial contributions and interesting photographs are welcome, and will be paid for upon publication. No responsibility can be accepted for unsolicited manuscripts, and they will not be returned unless they are accompanied by return postage.

Entered as second class matter at New York City, and additional entry at Concord, N. H., under the Act of March 3, 1879. Printed in the U. S. A. by Rumford Press, Concord, N. H.

The cover design and contents of HI-FI MUSIC AT HOME® are fully protected by copyrights, and must not be reproduced in any manner or form. Quotations are not permitted without specific authorization in writing from the Publisher.

\* Registered U. S. Patent Office

Copyright 1957 by Sleeper Publications

**Sleeper Publications, Inc.**  
105 E. 35th St., at Park Ave., N. Y. 16, N. Y.

**Milton B. Sleeper, President and Treasurer**  
**Ethel V. Sleeper, Secretary**  
**Charles B. Graham, Eastern Advertising Mgr.**

## C O N T E N T S

VOLUME 4 . . . NUMBER 2 . . . MAY-JUNE, 1957

### SPECIAL FEATURES

Editorial: New Impetus to Tape Recording . . . . . 23  
The Hi and the Fi . . . . . 25

### MUSIC

The Katzenjammer Kids—Ben Kemper . . . . . 26  
Crew-Cut Composer—Elmer Bernstein . . . . . 28  
Guide to Record Collecting—Irmgard Seefried . . . . . 30  
Library for Listening—Marguerite Tazelaar . . . . . 31  
Hi-Fi Tapes—Reviews and Ratings . . . . . 32  
Collectors' Corner . . . . . 34  
Record Reviews and Ratings . . . . . 35

Hi-Fi Records—Reviews and Ratings

Orchestral Music . . . . . 35	Keyboard . . . . . 42
Concertos . . . . . 38	Miscellany . . . . . 43
Chamber Music . . . . . 39	Folk Music . . . . . 43
Opera . . . . . 40	Jazz . . . . . 44
Vocal . . . . . 41	Popular Albums . . . . . 45
Stage & Screen Music . . . . . 46	

### EQUIPMENT

Listening in Comfort—Thomas A. Kelly . . . . . 46  
Readers' Roundtable . . . . . 50  
"Inside Information" on Commended Designs . . . . . 51  
Where to Buy Hi-Fi in Boston and Chicago . . . . . 62

### INSTALLATIONS

Planning a Stereo System, Part 4—Milton B. Sleeper . . . . . 50

### DEPARTMENTS

Records, Tape, and FM Radio . . . . . 4  
Advertisers Index . . . . . 67  
Buy Hi-Fi Here . . . . . 67  
Buy, Sell, and Swap Department . . . . . 68  
Information & Subscription Service . . . . . Facing 68

**COVER** If you read the magazine section of *The New York Times*, or if you get Esso's reports to stockholders, you have already seen some of Miss Elli Zappert's work. It was she who produced this month's cover. Hi-fi enthusiasts are inclined to discount distaff capacity to appreciate fine reproduction from records, tapes, and FM. But we think that Miss Zappert conceived a very graphic and understanding representation of hi-fi music at home. And, in justice to her, we should add that this cover was entirely her own idea.



ask **F. R. O'Sheen**  
**ABOUT TAPE AND  
 TAPE RECORDING!**



F. R. O'SHEEN, the resident leprechaun of Irish FERRO-SHEEN recording tape, answers in this column the month's most interesting question sent to him by readers of this publication on the subject of tape recording or tape. All other questions received are answered by F. R. O'Sheen through the mail. When you send in your question, make sure you enclose a stamped, self-addressed envelope.

Q. How should I store my already recorded tapes to ensure maximum life?  
 Warren Nardin, Oyster Bay, N. Y.

A. Tape recording is less than a decade old, so that no hard-and-fast rules about tape storage can be considered absolutely proven. However, it is common sense in view of the physics and chemistry of recording tape to observe the following precautions: (1) store the tape in some kind of tightly shut container; (2) store it away from all stray magnetic fields (power transformers, loudspeakers, etc.); (3) store in a cool but not cold room (60 to 70°F.); (4) avoid storage in an excessively dry room (relative humidity from 40 to 60% is ideal); (5) make sure the tape is not over-recorded, otherwise it may "print through."



watch for  
**F. R. O'Sheen**  
 ON EVERY BOX OF

**irish**  
 BRAND  
**FERRO-SHEEN Recording Tape**

Address your questions to F. R. O'Sheen  
**ORRADIO Industries, Inc.**  
 OPELIKA, ALABAMA  
 Export: Morhan Exporting Corp., New York, N. Y.  
 Canada: Atlas Radio Corp., Ltd., Toronto



# RECORDS TAPE AND FM RADIO

## Hi-Fi Shows

Dates are now being set for fall and winter shows. The list below will be supplemented in future issues as fast as information is received.

CHICAGO, Palmer House, Sept. 13-15.

CINCINNATI, Sheraton-Gibson Hotel, Sept. 20-23.

BOSTON, Hotel Touraine, Oct. 18-20.

MIAMI, McAllister Hotel, Oct. 18-20.

NEW YORK, New York Trade Show Building, Oct. 9-12.

PORTLAND, ORE., Multnomah Hotel, Nov. 1-3.

SEATTLE, New Washington Hotel, Nov. 8-10.

ST. LOUIS, Statler Hotel, Nov. 22-24.

## To Stack or Stagger

Sooner or later, equipment manufacturers and recorded tape producers must choose between stacked and staggered heads. There are arguments for and against each, but the strongest arguments seem to be for a single standard. A letter from Steffen Electro Art Company of Milwaukee contains this comment: "We don't want to argue about the technical differences between the two, although stacked tapes are easier to edit. As dealers, we have two main reasons to think this industry must standardize on stacked stereo: 1) we like to keep our customers happy; 2) we want to avoid keeping a double inventory of recorded tapes. Therefore, we decided some time ago that we would not stock staggered tape, nor staggered recorders or kits". — We'd like to have more views on this subject.

## Isn't There a Better Way?

CBS has made a sharp reduction in nighttime radio rates, because fewer people are listening to their stations in the evening. We wish they would put on programs that would attract such audiences that they would be justified in increasing the rates.

## Italian Hi-Fi Equipment

Components from Societa per Azioni Ge-  
*Continued on page 13*

the Ultimate

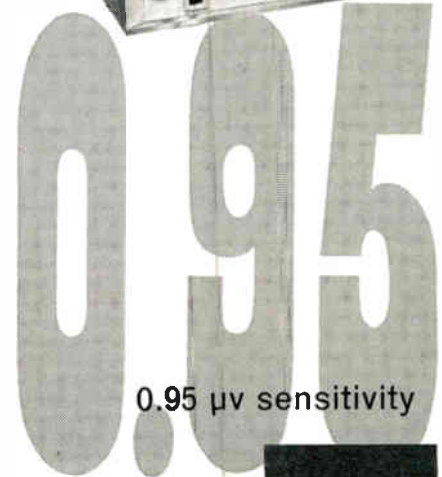

0.95  $\mu$ v sensitivity

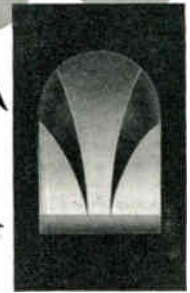

"Feather-Ray" Tuning Eye

**Sherwood**  
**TUNERS**

Indeed the Ultimate! Under one micro-volt sensitivity for 20 db FM quieting increases station range to over 100 miles with the newly engineered Sherwood tuners. Other important features include the new "Feather-Ray" tuning eye, a local-distance switch to suppress cross-modulation images, AFC switch, fly-wheel tuning.

MODEL S-2000 FM-AM Tuner...\$139.50 net  
 MODEL S-3000 FM only Tuner...\$99.50 net

Write for literature—Dept. M-5

**Sherwood**  
 Electronic Laboratories, Inc.

2802 West Cullom Avenue, Chicago 18, Illinois



The "complete high fidelity home music center."



*Hi-Fi Music at Home*



**LOVE ME IF YOU WANT TO.** New album by Nilla Pizzi, "Queen of Italian Song." Her exciting, pulsing voice has the gift of transforming the simplest love song into an unforgettable experience!

**THE EYES OF LOVE.** The eyes have it, as Hugo Winterhalter and His Orch. build a shimmering haze of musical romance. "Smoke Gets in Your Eyes," "There's Danger in Your Eyes, Cherie," "I Only Have Eyes for You," "With My Eyes Wide Open I'm Dreaming," and others.

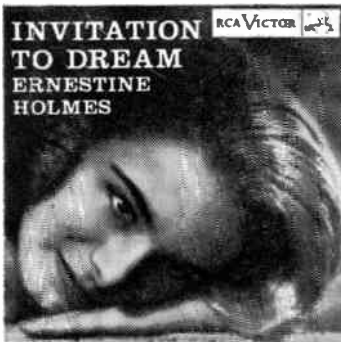

**INVITATION TO DREAM.** Background music for your fondest daydreams. Ernestine Holmes weaves the spell at the pipe organ, as she plays "Invitation to Dream," "Yesterdays," "Street of Dreams," "The Song Is You," others.

**BAREFOOT BALLADS.** National Barn Dance headliners Homer and Jethro, in a fresh assortment of hilarious country comedy tunes. Includes "Cigareetes, Whusky and Wild, Wild Women," "The West Virginy Hills," "I'll Go Chasin' Women."



**HOT, HAPPY AND HONKY.** Second album by Del Wood, the "Down Yonder" gal, and even greater than her first! Sensational sound, as the Grand Ole Opry piano star beats out "Tennessee Waltz," "Sentimental Journey," "Beer Barrel Polka," and other favorites.

**DREAMY HANS.** At the piano—Hans Sommer. A lyrical free-flowing style that creates hands-across-the-table intimacy out of melodies like "In the Still of the Night," "Lover," "Deep Purple," "Over the Rainbow."

# NEW SENSATIONS IN SOUND FOR MAY from **RCA VICTOR**

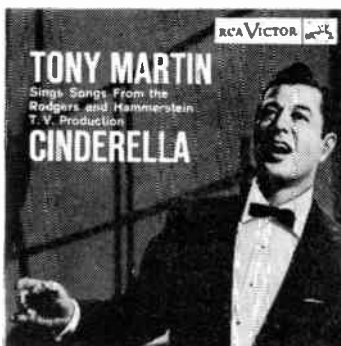

*New Orthophonic High Fidelity.*

Only **\$1.29\*** each 45 EP record;

Long Play **\$3.98** each

**CINDERELLA.** An unbeatable combination! The voice of Tony Martin, the orchestra of Henri René, and the songs of Rodgers and Hammerstein from their TV production, "Cinderella." On 45 EP only.

**THE GENE AUSTIN STORY.** Gene Austin, the idol of the '20's, shows how it's done with "The Sweetheart of Sigma Chi," "Sleepy Time Gal," "My Blue Heaven," "She's Funny That Way," "Ramona," and "I'm in the Mood for Love." On 45 EP only.



**Big Album Cover Photo Contest!**

Win Valuable Prizes! See your photograph on an RCA Victor album cover! Full details at any RCA Victor record dealer or Canon camera store. Nationally Advertised Prices

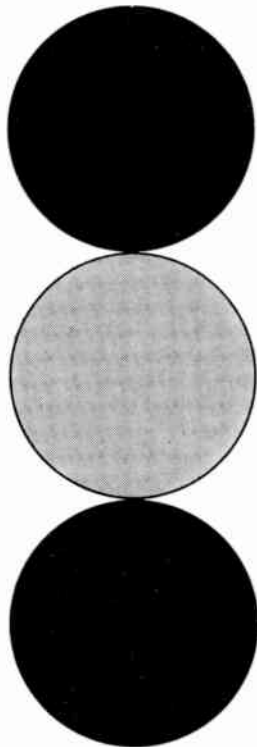

# the **FINEST** on **TAPE!**

**SHIPMENT FROM STOCK  
THE SAME DAY**  
at lowest prices available

**RECOMMENDED TAPES** for Superb Listening.  
Recorded tapes in all Popular Brands.  
Monaural - Stereophonic

**BLANK TAPES** for Highest Quality Recording.

**TAPE EQUIPMENT** - All Quality Hi-Fi Components

**COMPLETE LINE AMPEX STEREO SYSTEMS.**  
Audio and Professional

### **FIRST ANNIVERSARY**

Tape House is the first and only source devoted exclusively to supplying Tapes (both blank and recorded) and Tape Recording Equipment.

In ordering by mail it is possible for you to have selections when you want them — without delays or back ordering. All Tapes delivered **POSTAGE FREE** in original manufacturers package unopened. **WE PAY THE POSTAGE.**

**WHEN ORDERING** specify Tapes by name and number. If stereophonic, specify In-Line or Staggered Heads. Enclose check or money order. Sorry, No C.O.D.'s.



new dimensions in sound

*The Tape House*

228 Crissey Street  
P.O. Box 150, Geneva, Ill.

### **MAIL THIS COUPON NOW:**

Please send me your free catalog of tapes, prices and recommended "Best of the Year."

name \_\_\_\_\_

address \_\_\_\_\_

city \_\_\_\_\_ zone \_\_\_\_\_ state \_\_\_\_\_



## SPECIFICATIONS

### ALL VIKING DECKS

frequency response: 30 to 14,000 cps plus, at 7½ ips. 40 to 7,000 cps plus, at 3½ ips.

signal-to-noise: 50 db or better.

flutter: 0.2 percent average.

long term speed regulation: ½ of 1.0 percent.

tape speed: 7½ ips (3½ ips available by changing belt to smaller groove on motor pulley).

maximum reel size: 7"

record/playback head characteristics: track width .090 inch. Gap width .00015 inch. Impedance 2000 ohms at 1000 cycles. Double coil hum bucking winding. Mu-metal shielded. Output 2.5 mv.

recommended bias current: .8 ma. at 68 kc.

erase head characteristics: track width .125 inch, double gap (each .005 inch), Inductance 53 mh. at 1 kc, erase 60 db at 68 kc.



Ultra-linear transport . . . flutter and wow completely below audibility.

Short-gap record and/or playback heads for extended range . . . Double-coil (hum-bucking) record and playback heads for minimum hum. Double-gap erase heads for *dead quiet* erase.

The finest of bearings, and the ultimate in machining tolerances in capstan and drive members — *where precision counts.*

Rugged simplicity for enduring performance.

Physically independent amplifier components for increased flexibility and minimized hum pick-up

Very high erase-bias oscillator frequency permits extended range recording without bias intermodulation.

NARTB equalization. Physical separation of mechanical and amplifier components, plus clean design, eliminates need for roll-off of lower (*hum*) frequencies.

## SPECIFICATIONS

### RP61 SERIES PREAMPLIFIERS

frequency response, playback: 30 to 14,000 cps ± 2 db.

frequency response, record-playback cycles: 30 to 12,000 cps ± 3 db.

distortion (tapes recorded 12 db below saturation): less than 2% within specified frequency range.

internal signal-to-noise ratio: 60 db minimum all units.

equalization: modified NARTB



Ask your dealer for a Viking recording and playback demonstration before you buy any other recorder.



**Viking** OF MINNEAPOLIS

9600 Aldrich Avenue South, Minneapolis 20, Minnesota

EXPORT DIVISION: 23 Warren Street, New York City 7, New York  
Cable: SIMONTRICE, NEW YORK (All Codes)

recording channel gain: low level input. Requires .002 volt rms at 400 cycles for recording level 8 db below saturation. (High level input, .3 volts rms.)

playback channel gain: 55 db.

recording inputs: high impedance microphone (62 db overall gain) and high impedance radio or phono input (32 db gain).

bias frequency: 68 kc.

output: 1 volt, high impedance.

tube complement: 1-12AX7, 1-12AU7A, 1-12AV7, 1-6X4, 1-6E5 Indicator.

## Basic to Better Listening

# Electro-Voice®

### *E-V Coaxial Integrated Full-Range Speakers*

In this exclusive E-V development, the specialized woofer provides maximum bass reproduction; the small, rigid, lightweight cone delivers the high frequencies. The mechanical cross-over gives you a smooth transition in proper phase with perfect balance.

**SP8B** Radax Super-Eight 8" Coaxial speaker. Frequency Response, 50 — 13,000 cps. 20 watts program material; 40 watts peak. Net,.....\$29.50.

**SP12B** Radax 12" Coaxial speaker. Frequency response, 30 — 13,000 cps. 20 watts program material, 40 watts peak. Net,.....\$33.00.

**SP15B** Radax 15" Coaxial speaker. Frequency response, 30 — 13,000 cps. 20 watts program material, 40 watts peak. Net,.....\$43.00.

**SP15** Radax Super-Fifteen 15" Coaxial speaker. Frequency response, 30 — 13,000 cps. 30 watts program material, 60 watts peak. Net,.....\$85.00.

### *E-V Patrician IV 4-Way Speaker System*

These are the components of the integrated 4-way system in the Electro-Voice Patrician. It is the finest loudspeaker system obtainable. Net, \$393.00.

**18WK** 18" low-frequency driver. Essentially flat response up to 600 cps. 30 watts program material, 60 watts peak. Net,.....\$115.00.

**118** mid-bass assembly, employs two 828HF driver and A8419 horn units as compression-type indirect radiators for faithful reproduction. Net,.....\$78.00.

**T25A** treble driver with 6HD Diffraction horn, gives you the important "presence" range, 600 — 3500 cps. Net,.....\$80.00.

**T35** Super-Sonax very-high-frequency driver. Reproduces the range above 3500 cps to beyond the range of hearing with no measurable distortion. Net, \$33.00

**X2635** crossover network. Divides amplifier power into four separate sections, eliminating harmonic and inter-modulation distortion. Net,.....\$75.00.

*There IS a difference in high fidelity. You can hear it. You can see it. The difference is Electro-Voice 'listenearing,' the unique E-V approach to audio engineering which assures you the finest of reproduction.*

Basic to your high-fidelity system are the E-V speakers and enclosures shown here. Which-ever combinations you choose, you'll know there's no finer choice than Electro-Voice.

### *E-V 'Listeneered' High-Fidelity Speaker Enclosures*

**BARONET** direct-radiator folded-horn corner enclosure for 8" speakers and separate systems. Mahogany, Net, \$44.00. Limed Oak, Net, \$47.00. Walnut, Net,.....\$49.35.

**ARISTOCRAT** direct-radiator folded-horn corner enclosure for 12" speakers and separate two- and three-way systems. Mahogany, Net, \$69.00. Limed Oak, Net, \$76.00, Walnut, Net,.....\$79.80.

**EMPIRE** enclosure for 15" speakers and separate two- and three-way systems, available factory installed. Enclosure only, Mahogany, Net, \$85.00. Limed Oak, Net, \$91.00, Walnut, Net,.....\$95.55.

**REGENCY** folded-horn enclosure for 15" speakers and separate two- and three-way systems. Enclosure only, Mahogany, Net, \$127.50. Limed Oak, Net, \$137.00, Walnut, Net, \$143.85.

**CENTURION** corner folded-horn enclosure and complete 117, 4-way speaker system. Sold only with system installed. Mahogany, Net, \$325.00. Limed Oak, Net, \$335.00, Walnut Net,.....\$343.80.

**GEORGIAN** corner folded-horn enclosure and 105, four-way speaker system. Sold only with system installed. Mahogany, Net, \$525.00. Limed Oak, Net, \$545.00. Walnut, Net,.....\$573.00.

**PATRICIAN** corner folded-horn enclosure and 103C, 4-way speaker system. Sold only with system installed. Mahogany, Net, \$865.00. Limed Oak, Net, \$885.00. Walnut, Net,.....\$958.00.

### *Plus 7 Ready-to-assemble Speaker Enclosure Kits*

# Electro-Voice

ELECTRO-VOICE, INC. • BUCHANAN, MICHIGAN  
Export: 13 East 40th Street, New York 16, U.S.A., Cables: ARLAB

# Electro-Voice



## HIGH-FIDELITY SPEAKERS AND ENCLOSURES

### BARONET



SP8B



### ARISTOCRAT



SP12B



### EMPIRE



SP15B



### REGENCY



SP15



### CENTURION



Model 117 Driver Components Package  
(15 BWK LF Driver Illus.)



### GEORGIAN



MODEL 105 Driver Components Package  
(15WK LF Driver Illus.)



### PATRICIAN

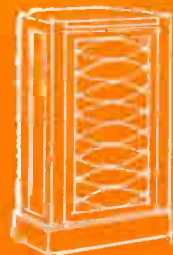

18WK

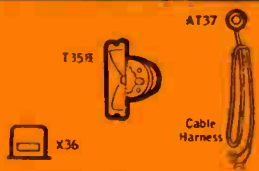

BB1 - \$34.50



BB2 - \$46.50

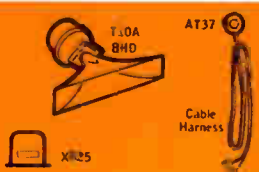

BB3 - \$83.50

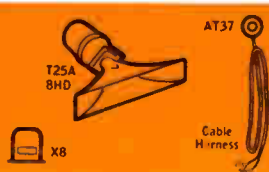

BB4 - \$112.00

WorldRadioHistory



25A and 6HD



T35



828HF and A8419



X2635

# AMPRO<sup>®</sup> TAPE RECORDER

PUSH-BUTTON CONTROL!

STARTS...

STOPS...

REVERSES...

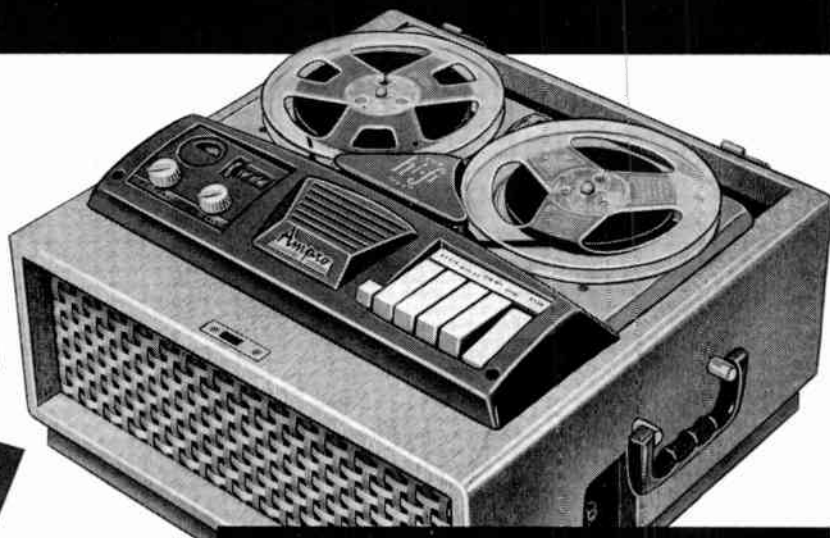

*Instantly!*

Thanks to 100% solenoid control, only Ampro gives you instant Start, Stop and Reverse in either direct or remote operation. The Ampro's immediate response to Push-Button Control offers unmatched accuracy and recording performance impossible in mechanically driven tape recorders. Solenoid controls make many operations easier and more perfect. You can dub in corrections or erase unwanted material easily and accurately. Because of its split-second operation, you can easily record sound effects or portions of music or speech from records for special effects. The Ampro Hi-Fi solenoid operation permits exclusive use of a forward-reverse foot control and a stop-start microphone for operating and controlling the unit from a distance . . . highly beneficial in recording, dictating and transcribing. There is no danger of spilling the tape! Mechanism shuts off automatically at the end of the reel.

### *True High Fidelity*

Ampro Hi-Fi features one of the finest amplifying systems ever incorporated in a tape recorder, providing true high fidelity reproduction from 40 to 15,000 cycles per second. The lowest notes of the string bass to the highest notes of the violin are well within its duplicating range.

Contributing to Ampro's "live performance" sound is a crossover network system which combines two electronically balanced speakers, achieving matchless realism through perfect tonal separation. The lower frequencies are reproduced by a 6 x 9 inch elliptical Alnico-5 "woofer" and the higher frequencies by a 3 1/2" round Alnico-5 "tweeter."

### PLUS THESE FEATURES

- A smooth-running high torque AC motor gives absolute minimum "wow" and "flutter" (less than 0.3% RMS at 7 1/2 i.p.s. and 0.4% RMS at 3 3/4 i.p.s.). Signal to Noise Ratio is 45 decibels.
- Automatic Selection Locator
- Automatic Tape Transport Shut-off
- Two-speed Operation, 3.75 and 7.5 i.p.s.
- Electronic Recording Level Eye
- Fast Forward Key —72 i.p.s.
- Fast Rewind Key —120 i.p.s.
- Amplifier By-pass for High Fidelity Systems

Ampro Hi-Fi Two Speed Recorder . . . . \$249.95

Ampro Hi-Fi with built-in radio tuner . . . 284.45

Ampro Matching Console Speaker . . . . 69.95

Graflex dealers offer convenient Graflex Easy Payment Plan. Pay 10% down . . . monthly payments as low as \$13.50.

Write Dept. HF-57 Graflex, Inc., Rochester 8, N.Y.

*Prices include federal tax where applicable and are subject to change without notice.*



70th Anniversary—1887-1957

**GRAFLEX** *Prize-Winning Cameras and Equipment*





**h.h. Scott**



- Green Dot Controls
- 22 Watts Undistorted Power Output
- 5 Position Record Equalizer
- Tape, Tuner and TV Inputs
- Handsome Styling
- Matches all Scott Tuners
- Separate Rumble Filter
- Separate Scratch Filter
- Volume-Loudness Switch
- Separate Loudness Control
- 2 Magnetic Inputs With Selector Switch On Front

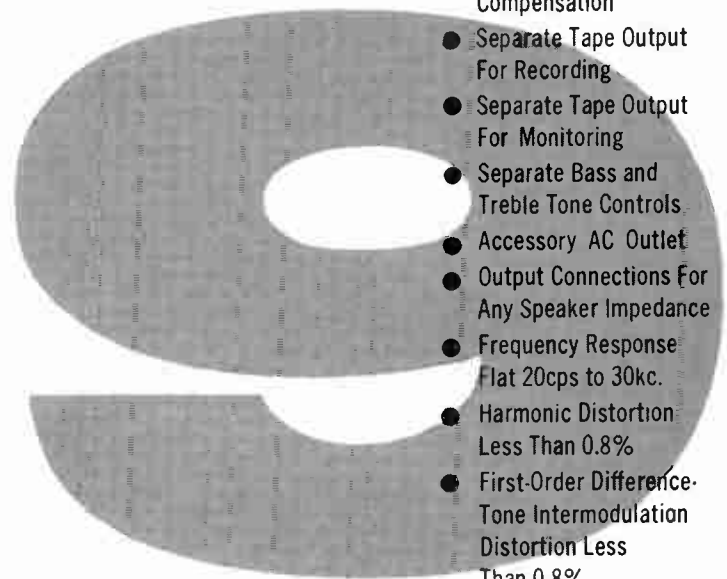
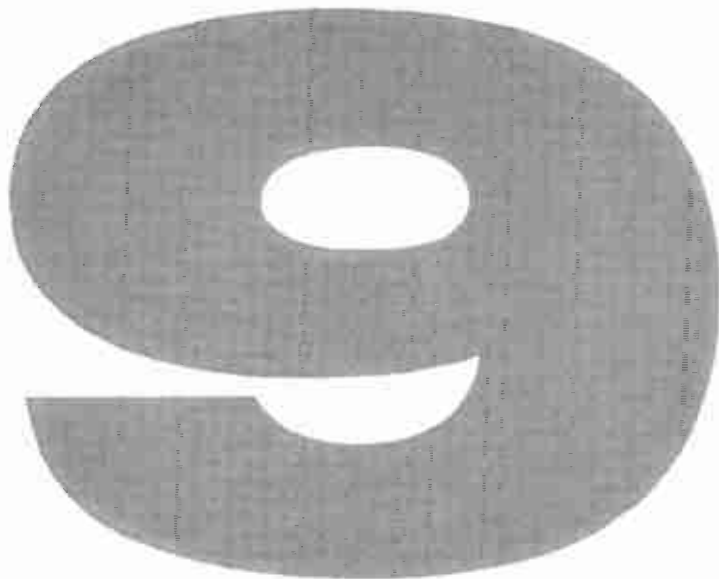

- NARTB Tape Playback Compensation
- Separate Tape Output For Recording
- Separate Tape Output For Monitoring
- Separate Bass and Treble Tone Controls
- Accessory AC Outlet
- Output Connections For Any Speaker Impedance
- Frequency Response Flat 20cps to 30kc.
- Harmonic Distortion Less Than 0.8%
- First-Order Difference-Tone Intermodulation Distortion Less Than 0.8%

*Reasons why the H. H. Scott '99' Complete Amplifier is your **BEST BUY** at \$99<sup>95</sup>*

*All prices slightly higher west of Rockies.*

*There are hundreds of reasons for buying H. H. Scott components. They're easy to install, easy to connect and easy to play. They're packed with years ahead features that defy obsolescence. They're backed by award-winning engineering. Prove Scott superiority for yourself . . . listen to H. H. Scott amplifiers, tuners and turntables at your nearest high fidelity dealer.*

- Separate Level Control To Match Any Cartridge
- Hum Level: 80db below Full Output
- Easy To Connect
- Beautiful Accessory Mahogany Case
- Compact, Only 15½"x5"x12½"
- Easy to Panel Mount
- Completely Fused To Protect Amplifier
- Crystal Input With Compensation.
- Heavy Duty, Conservatively Designed Power Transformer
- Only The Best Parts Used—Mica-Filled Tube Sockets, Plastic-Sealed Condensers
- Self-Balancing Phase Inverter
- Clean Symmetrical Clipping



H. H. Scott, Inc., 385 Putnam Avenue, Cambridge, Mass.  
 Export Dept.: Telesco International Corp., 36 West 40th St., N. Y. 17, N. Y.

Rush me your new catalog M-5 showing the complete H. H. Scott line for 1957, including question and answer section explaining hi-fi.

Name .....

Address .....

City ..... State ..... WorldRadioHistory

# COMPARE!

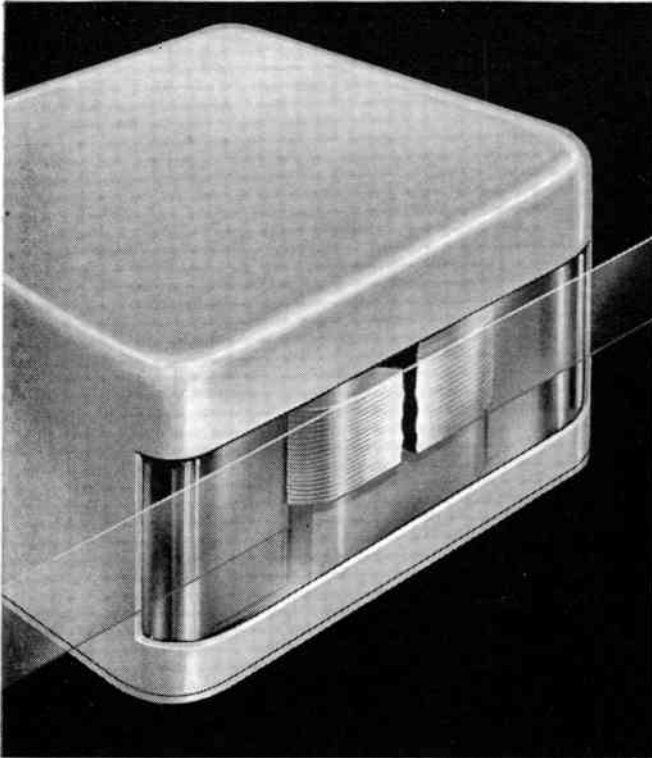

Picture of a recorder head's contact surface, with critical center gap eroded and enlarged by the wearing action of conventional magnetic tape.

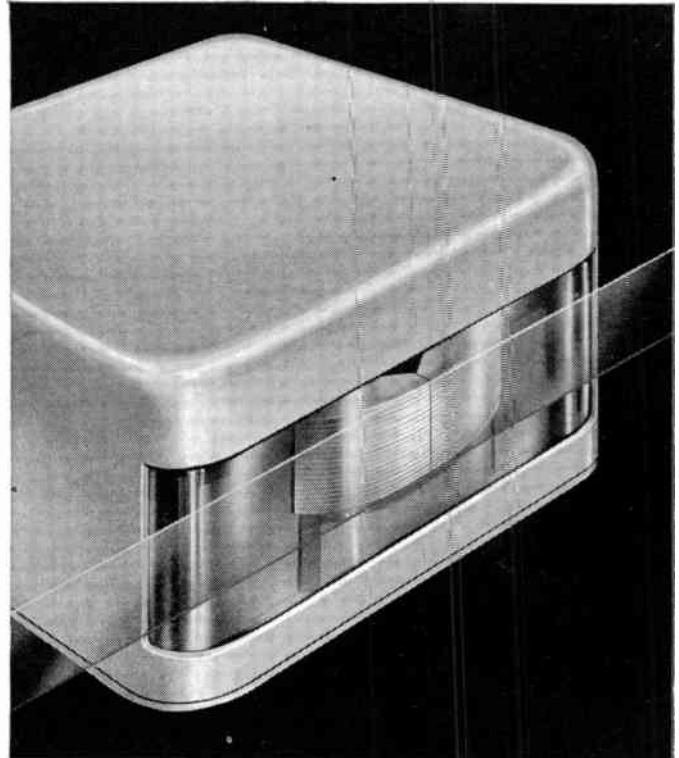

Same type head, same period of use. But see how silicone lubricated "Scotch" Brand Magnetic Tape has saved the head from wear—assuring perfect response!

## Read how "Scotch" Brand's built-in dry lubrication reduces recorder abrasion

Know what's the most vulnerable part of your recorder? It's the sensitive magnetic head—the tiny, precision-made part where lack of proper lubrication can cause annoying wow, flutter and harmful friction.

Compare the two magnetic heads magnified above. See for yourself what lack of proper lubrication can do. Like the heads in your recorder, each head is made with an almost invisible quarter mil gap over which tape passes. At left, abrasive action by conventional tape has worn down the head

.0025 of an inch. (Small, yes, but enough to cause a frequency drop of a full octave!) Now, look how "Scotch" Brand Magnetic Tape has saved the head on the right. No wear. . . so no loss of sound.

Only "Scotch" Brand Magnetic Tapes perform this critical lubricating job for you. Exclusive silicone lubrication process (dry lubrication) lets tape glide smoothly, safely over the magnetic heads. And this famous safety feature lasts the life of the tape. Treat your machine to a reel soon.

Free Tape Tips—write Dept. OF-57.

### ONLY "SCOTCH" BRAND HAS SILICONE LUBRICATION



#190 Extra playing time    #150 Extra strength    #120 Higher output    #111 True economy



Your guarantee of quality

The term "SCOTCH" and the plaid design are registered trademarks for Magnetic Tape made in U.S.A. by MINNESOTA MINING AND MFG. CO., St. Paul 6, Minn. Export Sales Office: 99 Park Avenue, New York 16, N. Y. © 3M Co., 1957



PHONOTAPES INC., producer of the world's largest catalogue of recorded monaural tapes, announces its first great stereophonic release. Stereo by PHONOTAPES—perfectly balanced two-channel recording, providing distortion-free reproduction of the entire musical range. **THIS IS STEREO!**

*Exclusive:* Test tone at the beginning of each reel for setting channels at equal levels.

\* **LISZT: Piano Concerto No. 1 in E-flat**  
Alfred Brendel (piano) & Pro Musica Symphony, Vienna. Michael Gielen, cond.  
S-701 .....\$11.95

\* **LISZT: Piano Concerto No. 2 in A Major**  
Alfred Brendel (piano) & Pro Musica Symphony, Vienna. Michael Gielen, cond.  
S-702 .....\$11.95

\* **TCHAIKOVSKY IN STEREO!**  
Symphonic fantasy of great themes by Tchaikovsky.  
Pro Musica Symphony, Vienna. Heinz Sandauer, cond. S-703 .....\$11.95

\* **ENESCO: Roumanian Rhapsody No. 1**  
Bamberg Symphony, Jonel Perlea, cond.  
S-501 .....\$ 7.95

\* A Vox Recording

- AVAILABLE STACKED OR STAGGERED
- 7½ SPEED
- GRADE-1 BLUE AUDIOTAPE
- INDIVIDUALLY DESIGNED ALBUMS



**PHONOTAPES INC.**  
248 West 49th St., New York 19, N. Y.

**RECORDS, TAPE, AND FM**

*Continued from page 4*

loso, of Milan will be offered soon through American Geloso Electronics, Inc., Manchester, N. H. John Geloso came to the U. S. as an immigrant boy, but by 1925 he had become chief engineer of Pilot Radio Corporation. Just before the last war, he returned to Italy, where he set up a plant to make radio equipment. Through good fortune and great ability, he built a business which now employs over 3,000 people in seven factories. It will be interesting to see the Geloso products that will be made available here.

Thomas A. Kelly

From a note commenting on the article entitled "Hi-Fi in Twenty Minutes" which appeared in our March-April issue: "Who would enjoy assembling a hi-fi system in twenty minutes? Music is an art, art is creative, so one should use some creativeness in the design and assembling of an instrument to bring music within one's reach. *Cbacun à son gout.*" You'll understand Mr. Kelly's approach to hi-fi when you read his article and see the pictures of his installation in this issue.

Betcha Five Dollars

Kool cigarettes commercials, labeled as coming from various parts of the Country, are all made in one place — in New York, judging from the voices!

Flying Up from Rio

The redoubtable Albert J. Franck, whose erstwhile International Records Agency was a blessing for collectors in the old days, has an LP of *Anhangüera* by the Brazilian composer Hekel Tavares as performed and recorded down Rio way. Tavares is represented in the domestic catalogues only by a piano concerto (on London) that is not, reportedly, among his better works.

Golden Taste, Tin Ear

Caption for photo of Leonard Bernstein in *Holiday*: "High Fidelity has arrived in the portable phonograph too. Composer-conductor Leonard Bernstein, on a Martha's Vineyard vacation with Mrs. Bernstein, finds the Fi of his [portable] plenty Hi for his sensitive ear."

FM Broadcasting

In Los Angeles, six applications have been filed for the three FM broadcast channels still available. In Washington, D. C., all FM channels assigned to that area are in use.

Have you Thought of This?

More films are being released to television, but if you think that the movie industry has stopped fighting TV, it may not have dawned on you that wide-screen pictures can't be transmitted on TV. Reason is that TV is tied to a width-to-height ratio of 4

*Concluded on page 66*

*entirely NEW type*  
**test record**



**the ONLY ONE**  
using actual  
musical pitches

The usual mathematical frequencies (ie 1000 cycles) are not musical pitches. The Series 60 uses actual scale tones to test your playback over entire chromatic range of 8 octaves—1 beyond the piano.

**the ONLY ONE**  
based on the  
established facts of  
human hearing

(FLETCHER-MUNSON CURVE)

Normal human hearing is not "even." Fletcher-Munson research has defined the exact variations at each pitch level. Side A of the Series 60 is adjusted so each tone will sound with equal loudness to the ear over the entire range. (Side B recorded flat.)

the new **COOK Series 60**  
**Chromatic Scale Test Record**

the only one which tests  
**BY EAR ALONE** for:

- frequency response
- transients (new tone burst device)
- room acoustics
- speaker hangover tones
- false resonances (spkr. enclosure)
- comparative loudness levels
- Absolute Pitch reference (stroboscopic label)

**12"—33-1/3 rpm—\$4.98**  
**With Informative Booklet**

At Your Dealer Now or send direct

**COOK Labs**

101 Second Street, Stamford, Conn.

Please send:

- Chromatic Scale Test Record
- New 1957 catalog
- (other).....

NAME .....

ADDRESS .....

\$4.98 enclosed

Bill me.



**AT CONVENTIONS**

**IN BOMBERS**



**UNIVERSITY ACHIEVEMENT**  
**... as the largest supplier**  
**of loudspeakers to the**  
**military and industry...**  
**WHAT IT MEANS TO YOU**



**IN MINES**

**IN SUBMARINES**







**ON NAVAL VESSELS**

... it means that just "know-how" and mere claims count very little in the *making* of quality speakers. University achievements speak for themselves.

... it means that the high precision techniques and specialized engineering skill acquired in meeting the exacting requirements of military and industrial reproducers are applied to the design and production of high-fidelity speakers.

... it means that University's meticulous system of quality control guarantees that all speakers of a given type be identical in every minute detail. A speaker is rejected at the slightest variation from rigid specifications.

... it means that the immense resources of the University organization make it possible to offer the highest quality speaker possessing unique and exclusive University features ... at the lowest possible price.

... more than all this, it means that the integrity of University, into which the U. S. government and the greatest industrial names have put their confidence, is your guarantee of a superior product.

**Yes, University sounds better, because it is better.**



**IN TANKS**

**These self-contained units are just a few of a very complete selection of quality wide-range and thru-axial speakers and components to meet every size and budget requirement**



**Model 315**

A 15" 3-way Super-Diffaxial speaker. Employs the deluxe multi-sectional "Diffusicone" element and 6½ lbs. of Alnico 5 magnet. Response to beyond audibility. Exceptional power capacity of 50 watts. 8-16 ohms. \$132.00 User net.



**Model 6303**

A 15" 3-way Diffaxial speaker. Employs the deluxe multi-sectional "Diffusicone" element and extra heavy 2 lbs. of Alnico 5 Gold Dot magnet. Response to beyond audibility. 30 watt power handling capacity. 8-16 ohms. \$80.10 User net.



**Diffusicone -15**

A 15" 2-way Diffaxial speaker. Employs the deluxe multi-sectional "Diffusicone" element and heavy 24 oz. all-Alnico 5 Magnet. 30 watt power handling capacity. 8-16 ohms. \$45.00 User net.



**Model 312**

A 12" 3-way Super-Diffaxial speaker. Employs deluxe multi-sectional "Diffusicone" element and extra heavy woofer Alnico 5 Gold Dot magnet. Handles 25 watts, 8-16 ohms. \$64.50 User net.



**Diffusicone -12**

A 12" 2-way Diffaxial speaker. Employs deluxe multi-sectional "Diffusicone" element and extra heavy 24 oz. all-Alnico 5 magnet. Unusual 30 watt power handling capacity. 8-16 ohms. \$33.00 User net.



**Model UXC-123**

A 12" 3-way Diffaxial speaker. Employs the standard uni-sectional "Diffusicone" element. Response encompasses full musical reproduction range. Handles 25 watts, 8-16 ohms. \$59.50 User net.



**Model UXC-122**

A 12" 2-way Diffaxial speaker. Standard uni-sectional "Diffusicone" element. Super-sensitive Alnico 5 magnet of shallow design for application flexibility. 25 watt capacity, takes those heavy transients with ease. 8-16 ohms. \$29.75 User net.



**Model 308**

An 8" 3-way Diffaxial speaker. Employs the deluxe multi-sectional "Diffusicone" element and is the only small integrated 3-way speaker on the market. Performance is unbelievable for its size. Handles 25 watts, 8-16 ohms. \$37.50 User net.



**Diffusicone -8**

An 8" 2-way Diffaxial speaker. Employs deluxe multi-sectional "Diffusicone" element. Exceptional sensitivity and 25 watt power capacity makes this an outstanding performer for its size. 8-16 ohms. \$23.50 User net.

UNIVERSITY LOUDSPEAKERS, Inc., 80 So. Kensington Ave., White Plains, N. Y.



LISTEN... *University sounds better*



# Bogen

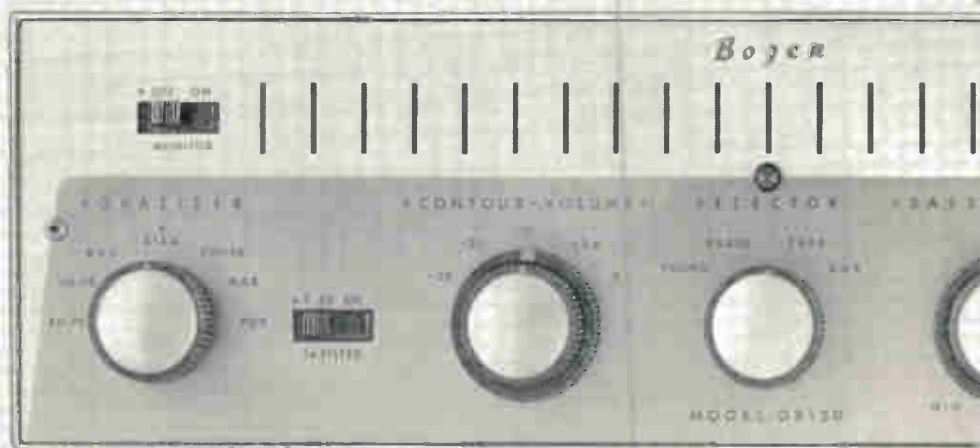

## DB130 35 WATT AMPLIFIER

*Glance at the "specifications and controls" or at the control panel in the photo. It's obvious that our engineering department (largest in the high-fidelity industry) hasn't spared itself on the DB130. Many experts consider this the finest "full-control" amplifier ever built. Spin those knobs and flick those switches at your nearest Bogen Sound Salon. You'll get the hi-fi thrill of your life.*

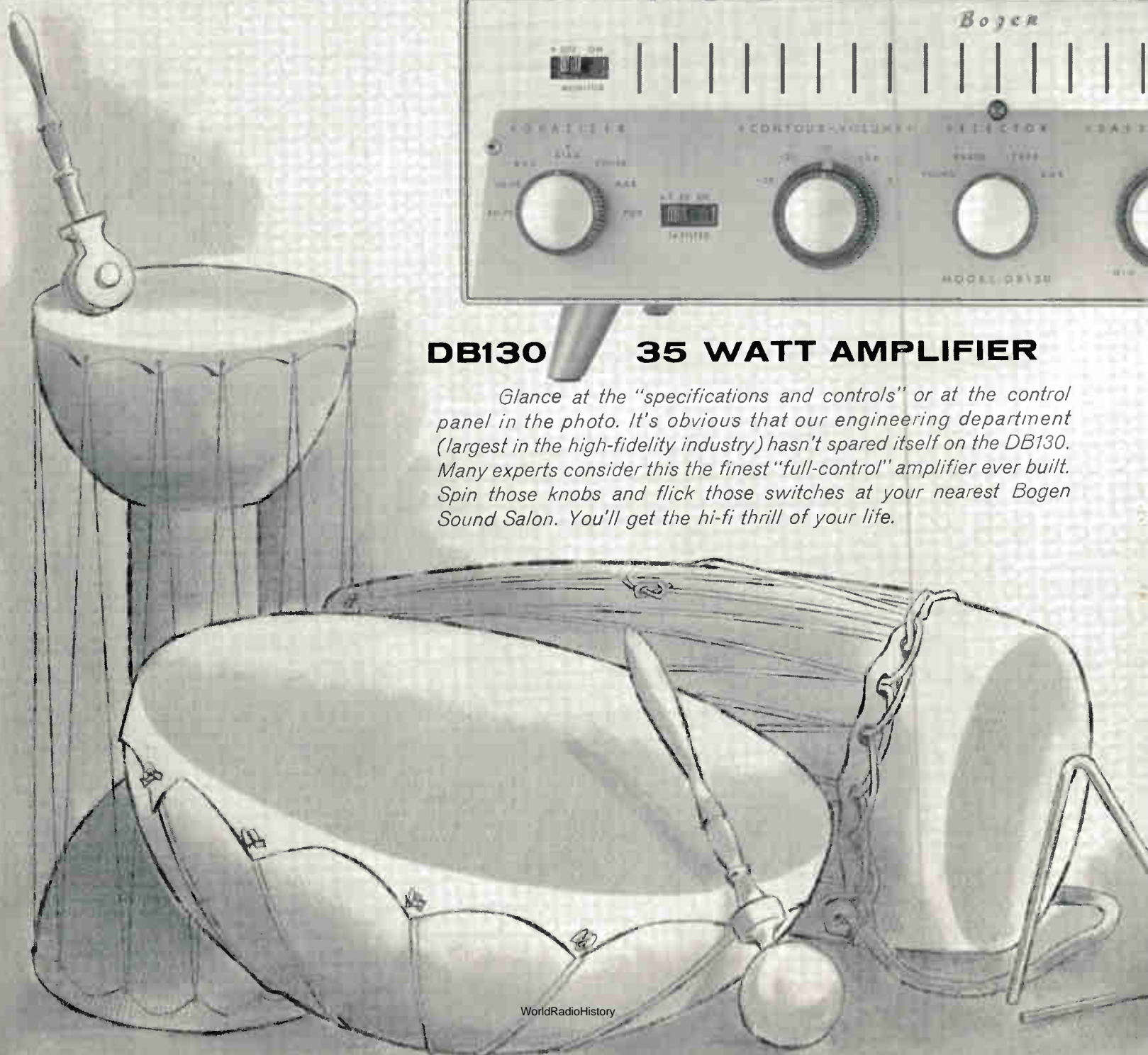

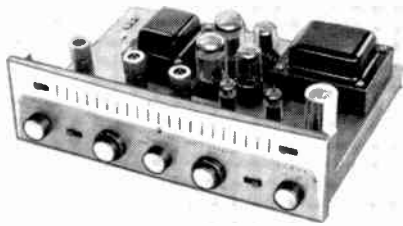

*because it sounds better ...*

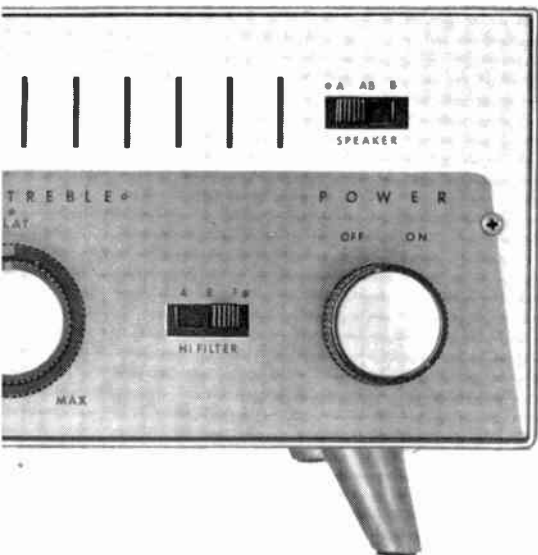

POWER: 35 WATTS. PEAK: 100 WATTS • FREQUENCY RESPONSE: 15-30000 CPS WITHIN 0.5 DB • DISTORTION: 0.3% AT 35 WATTS • INPUTS: LOW MAGNETIC. HIGH MAGNETIC. HI-FI CRYSTAL. TUNER. TAPE. AUXILIARY (2) • OUTPUTS: SPEAKER(S). TAPE • CONTROLS: POWER (ON-OFF). CONTINUOUSLY VARIABLE BASS AND TREBLE. SEPARATE CONTINUOUSLY VARIABLE LOUDNESS CONTROL SELECTOR. INPUT SELECTOR (PHONO. RADIO. TAPE. AUX.) 7-POSITION RECORD EQUALIZER. INFINITE DAMPING CONTROL. LO FILTER (FLAT. 50C. 100C). HI FILTER (FLAT. 8KC. 4KC). SPEAKER SELECTOR SWITCH (A. AB. B.) TAPE MONITOR (ON-OFF). AUX ADJUSTER. HUM ADJUSTER • CHASSIS: \$115.00 • BLONDE OR MAHOGANY-FINISHED ENCLOSURE: \$7.50

**Bogen**  
HIGH FIDELITY

A UNITRONICS CORPORATION AFFILIATE

## what the 'sound men' say...

"The growth of Hollywood Electronics is directly related to the growth of the industry, and reflects the company we keep. We have deliberately aligned ourselves with the solid, progressive factories in our industry—with those who contribute more than just a product to sell.

"All the Bogen products offer the customer honest value, from the modestly-priced "starter" model HF10A amplifier for the neophyte to the unique and superb model R775 tuner to please the seasoned connoisseur.

"In addition to Bogen's achievements in product design and styling, we consider that Les Bogen's book 'Understanding High Fidelity' represents a major contribution to the growth of the industry. This interesting and informative book has aided hundreds of our customers to intelligently select their Hi Fidelity equipment."

*Harry Shaffer, Hollywood Electronics, Hollywood, Calif.*  
Harry is one of the real pioneers in high fidelity component sales, having spent the last 13 years in providing top-grade sales and service to West Coast audiophiles.

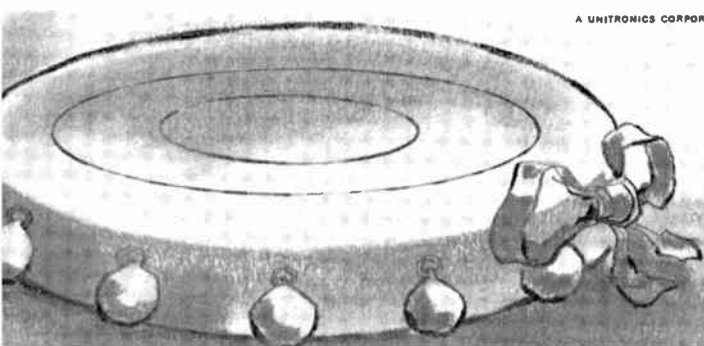

Read "Understanding High Fidelity," informative 56-page book by L. H. Bogen. Send 25¢ to David Bogen Co., Inc., Box 500, Paramus, N. J.

WorldRadioHistory

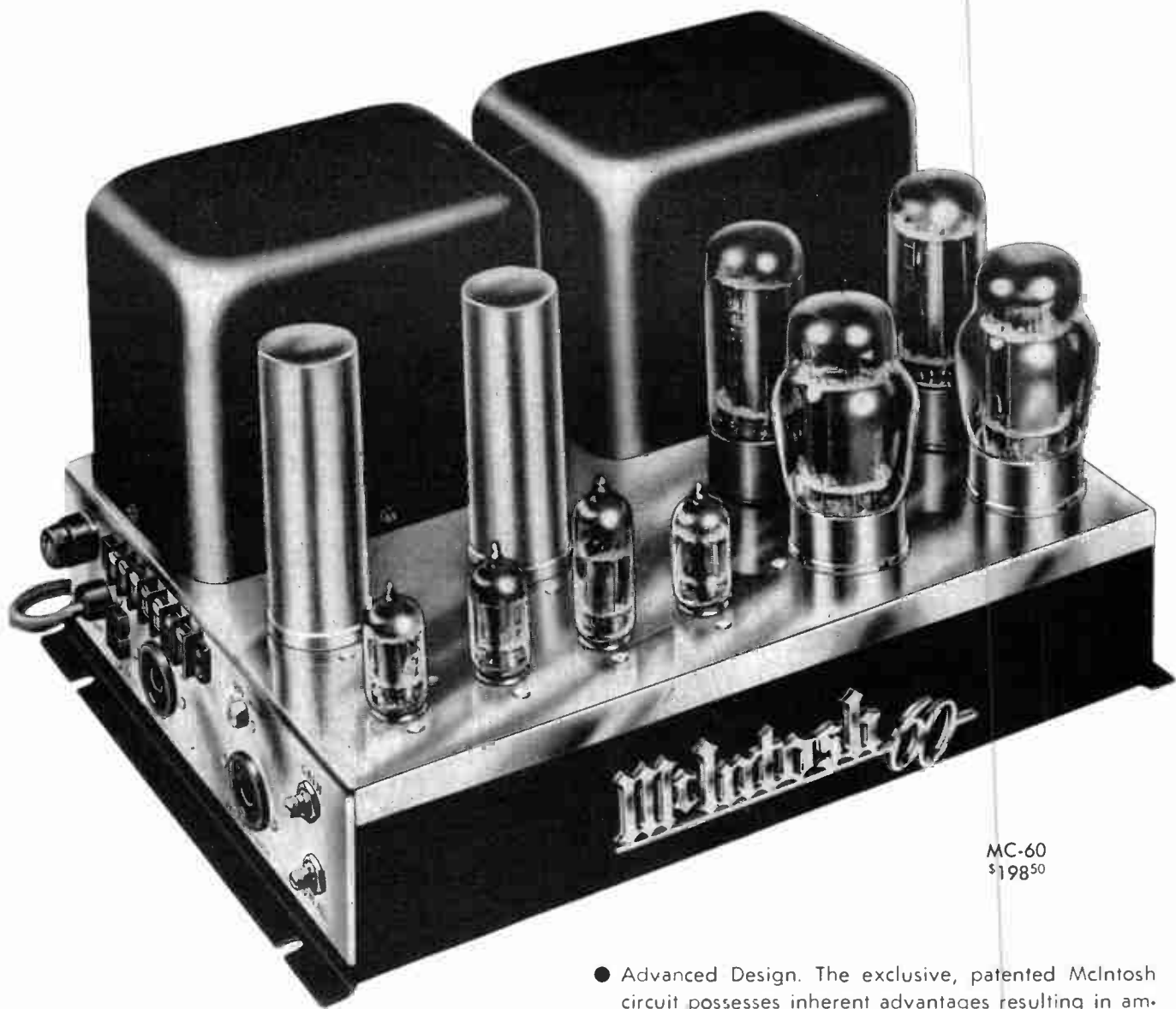

MC-60  
\$198<sup>50</sup>

*matchless  
perfection....*

- Advanced Design. The exclusive, patented McIntosh circuit possesses inherent advantages resulting in amplification within .4% of theoretical perfection.
- Purity of Signal. Low Harmonic distortion of  $\frac{1}{3}$  of 1%, from 20 to 20,000 c.p.s.;  $\frac{1}{2}$  of 1% Intermodulation Distortion if instantaneous peak power is below 120 watts. **No Lost Instruments!**
- Adequate Power Reserve. 60 watts continuous, 120 watts peak to meet the power demands of natural sounds under any room conditions.
- Designed Stability for clean bass, long dependable life.
- Highest Efficiency means less heat dissipation, less power consumption for greater output.
- Unexcelled Performance **guaranteed**. Your protection for quality sound.

*See your Franchised McIntosh  
dealer or write for detailed specifications.*

# McIntosh

LABORATORY, INC.

4 Chambers St., Binghamton, N. Y.

EXPORT DIVISION: 25 WARREN ST., NEW YORK 7, N. Y.  
CABLE: SIMONTRICE, NEW YORK



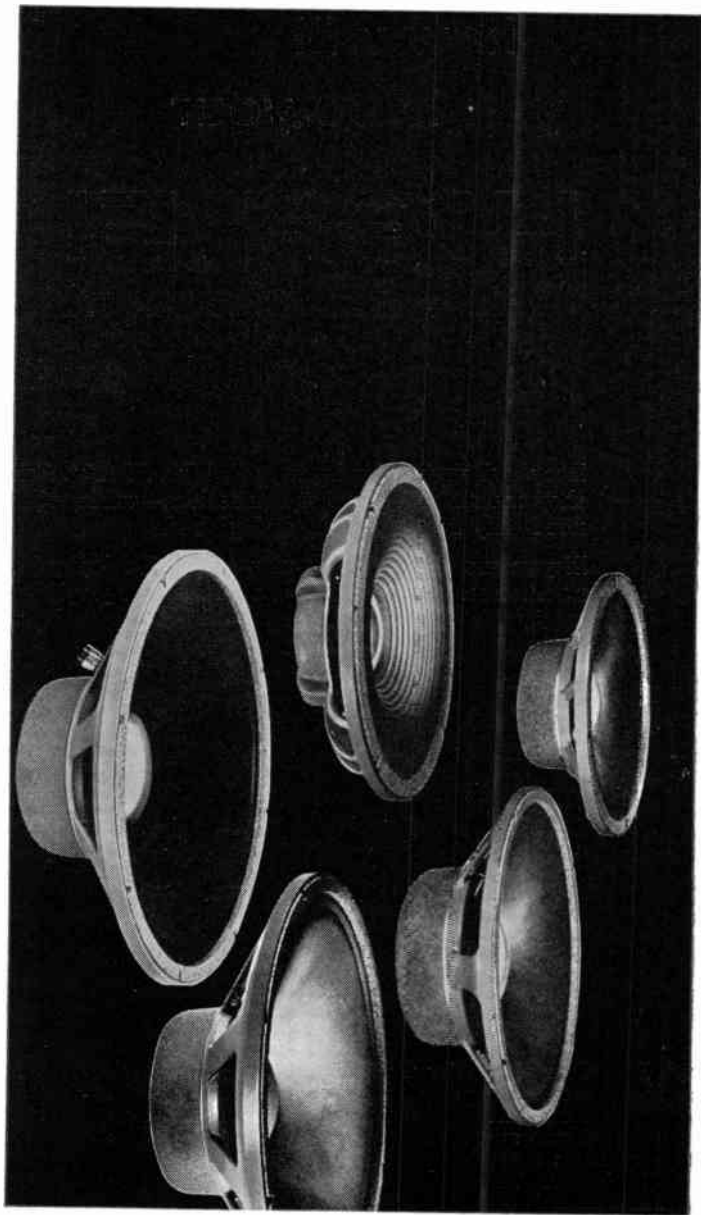

## ALL THAT IT TAKES TO MAKE A SPEAKER GREAT

A great loudspeaker preserves the essence of high fidelity. This essence is the accurate reproduction of complex sound waves of varying magnitudes without distortion. What you hear is lifelike reproduction. It is achieved by thorough acoustical research and engineering, excellent basic design, precision manufacture and assembly, meticulous attention to detail.

JBL Signature Loudspeakers are built around the four-inch voice coil. The coil is made of wire ribbon wound on its narrower edge. Frames are rigid castings. Magnetic circuitry is designed to make maximum use of magnet materials, to eschew superfluous metal, and to avoid stray magnetic fields.

Added to these more obvious differences in JBL Signature Speaker construction are the constant refining of each minute detail, the unflagging, meticulous care with which the precision parts are assembled. These are details you cannot see, but they are most important to what you hear.

These are the reasons why JBL Signature Loudspeakers are the most efficient to be found anywhere. These are the reasons why JBL Signature Speakers cover the audio spectrum with such outstanding smoothness...why they make of "every note a perfect quote." Excellent design, painstaking care—these are what it takes to make a speaker great. There is no short cut.

For free catalog and technical bulletins describing JBL Signature Loudspeakers, write to James B. Lansing Sound, Inc. 2439 Fletcher Drive, Los Angeles 39, California.

*"JBL" means James B. Lansing Sound, Inc.*

how will  
you have your



# HIGH FIDELITY

... components or consoles?

**Pilot** offers you the same  
superb quality in both

People show two preferences in high fidelity. Some select individual components which they install and connect themselves—while others prefer self-contained consoles that need only be plugged in and played.

If you are among those who enjoy the 'doing' as much as the listening, you will find no finer components than the tuners and amplifiers offered by Pilot. Or, if you favor the easy, 'plug-in-and-use' convenience of a console, you will find an exciting message in the story of Pilot Component-Consoles.



*Pilot High Fidelity* COMPONENTS

Today's Pilot Tuners and Amplifiers are the most advanced in circuit design and engineering. They cover all design types to permit the greatest flexibility in planning a system: tuners with built-in phono and tape preamps, for use with basic power amplifiers; and basic tuners for use with preamp-equipped amplifiers. The choice of combination is one of personal preference.

Pilot Tuners and Amplifiers are also the most modern in styling and appearance. They are housed in attractive metal enclosures, finished in brushed brass, and trimmed in contrasting burgundy. Pilot high fidelity components make handsome matched pairs when used on tables and open shelves.

Pilot high fidelity components are easily interconnected, and can be used with all makes of record changers, turntables, tape recorders, and speaker systems. All Pilot Tuners feature the new Beacon Tuning Indicator for easy, accurate station selection. This insures the precise tuning necessary for distortion-free FM reception.

Cathode follower circuits are included to permit the use of long amplifier connecting cables without degrading frequency response. The preamps provide equalization for tape heads as well as tape recorders and records. There are separate bass and treble controls, and separate loudness and volume controls. Hum-free DC voltage is used on the preamp tube heaters. Every essential quality feature has been included to assure flawless high fidelity performance.

Pilot Tuners are priced from \$79.50 to \$189.50 Amplifiers from \$49.50 to \$165.00.



*Pilot High Fidelity* COMPONENT-CONSOLES

You can now enjoy the proven, superior performance of high fidelity components without having to assemble, connect, and install your own system. For, with a Pilot Component-Console, you have a custom made component system, installed in a handsome cabinet. And you can identify each of the components—the Pilot Tuner, Pilot Amplifier, Garrard Changer, Magnetic Cartridge, 3-Way Speaker System—components you would select, or be advised to select if you were planning your own installation.

But the performance of the finest components can be impaired through the use of cabinets with internal resonances and wall vibration. Pilot therefore turned its top engineering skill to the task of designing a cabinet with the necessary sturdiness and rigidity to permit all of the components to be operated in a single console.

Even the speaker system is completely closed off in a heavy-walled, acoustically-padded infinite baffle. And inside this enclosure there are four loudspeakers to cover the entire audible frequency range: a 12" woofer; a 6" mid-range reproducer in its own vented, acoustically insulated baffle; and two 3" tweeters.

Pilot has achieved a wonderful, new approach to high fidelity for the home—by combining component quality with console convenience—superb high fidelity performance in a single cabinet.

ENSEMBLE 1035 FM-AM Radio-Phonograph (illustrated) in cordovan mahogany \$415; in cherry or blond mahogany \$425. Other models from \$178 to \$605.

Select the PILOT Dealer nearest you for a thrilling high fidelity demonstration

For complete literature, write to Dept. LF-3

**Pilot**

**RADIO CORP.** Long Island City 1, N. Y.



Prices slightly higher west of Rockies





*Milton Sleeper discusses*

## MUSIC IN YOUR HOME

THE NBC program "Recollections at Thirty"<sup>1</sup> has given more impetus to tape recording and tape collecting than anything that has happened for a long time. This is the program made up from NBC's library of nearly 300,000 transcriptions of radio broadcasts — both music and public events — since 1933.

Dating back long before the advent of tape, these are 78-rpm. disc transcriptions. Transferred now to tape for the "Recollections" program, the needle-scratch has been reduced, though with some loss of audio frequency range. Nevertheless, the drama of the landing and burning of the Hindenburg and Sir Winston Churchills' announcement of England's declaration of war against Germany have lost none of their spine-tingling qualities. And while it may be nostalgia, Arthur Godfrey and Frank Sinatra suffer by comparison with Major Bowes and Rudy Vallee!

Of course, the quality of those old 78's makes one wish that the recordings could have been made on tape. But tapes of "Recollections" made off the air now are gems that make priceless additions to private tape libraries.

What is it about taped broadcasts that gives them the capacity to recall the past so vividly, and makes people and events so much more real than photographs? Look at a picture of General MacArthur. Well, it looks *like* him. Then put on a tape of his speech when he said: "Old soldiers never die." Why, that *is* General McArthur! A picture of the Hindenburg shows a dirigible on fire, but when you hear Herb Morrison's description of her coming into the tower, his disbelief in what he saw when fire broke out, and the emotion in his voice as, almost sobbing, he told of bodies falling from the ship to the ground — that is drama that puts you at the scene of what seems to take place right while you listen!

Think what it would mean today if you could have taped Caruso's voice during the height of his career. It wasn't possible then, but now you can tape the singing of Maria Callas and Renata Tebaldi on broadcasts from the Met.

The possibilities of a tape machine are soon exhausted if it is only used to practice speech-making or to record and play back voices at parties. After all, the importance of tape depends on what's recorded on it, and most program material available around the house is of limited value

after it has been played back once or twice. This explains the number of perfectly good tape machines that are tucked away in attics and storage closets — just because the owners tired of taping inconsequential things, and didn't realize that they have an inexhaustible supply of the finest entertainment to record from their radio receivers!

From letters and discussions with our readers, we find there is a prevailing impression that the loudspeaker is cut off when a tape machine is being used to record off the air or, at best, the program can be heard only with headphones if the machine has a monitor connection. That is true when conventional radio sets are used, but preamps and amplifiers designed for use in hi-fi systems have connections so arranged that broadcasts can be taped without interference with loudspeaker reproduction.

Also, records can be copied on tape in the same manner. Many people who are building fine record libraries play each new record just once to make a tape copy and, thereafter, use the tape. John McAllister, of Viking, told us of a different reason for following this practice. His seven children enjoy music as much as he does, but he doesn't want to risk his records in their hands. Instead, he tapes each new record, and lets the children use the tapes. If one is damaged, he just runs off another copy for them!

Latest new idea for those who have stereo equipment is taping stereo broadcasts off the air. And this activity is spreading as more and more stereo programs are being carried by FM-AM stations, or by two FM stations in the same area.

Many special applications are contributing to the increased use of tape, but the great impetus has come from the realization that radio broadcasts are a continuing source of material for building tape collections of music and events worth hearing again and again, acquiring more significance with the passing of time.

SINCE the announcement of the Hi-Fi Music Commendation Seal, we have had numerous inquiries asking if the Seal indicates confirmation of manufacturers' specifications. The answer is No. The Commendation Seal is not, and is not intended to be the summarization of a testing-laboratory report.

The factors with which we are concerned are design, workmanship, facilities provided, performance, and price for, to our readers, these are all prime considerations.

<sup>1</sup> The story of this program was told in "Do You Remember" by Shirley Fleming, HI-FI MUSIC, November-December 1956.

everyone's acclaiming the *extraordinary new*



**\$59.85**

incl. 1 mil diamond stylus!

# *Fluxvalve-Unipoise* pickup-arm

WITH ITS OWN BUILT-IN CARTRIDGE CONTAINING AN EASILY REPLACEABLE STYLUS...ALL STYLUS SIZES ARE AVAILABLE INCLUDING THE EXCLUSIVE 1/2 MIL

The all-knowing, the cognoscenti, music critics and record-playing enthusiasts have accorded the Fluxvalve-Unipoise Arm an acceptance never before seen in the history of Hi-Fi equipment. Here is the ultimate arm-cartridge for perfect tracking... for minimum stylus wear... for maximum record life and for optimum performance... there's nothing like it... nothing to compare.

The Fluxvalve-Unipoise Arm, latest development in record-playing arm-cartridge combinations, embodies all the features exclusive to the Fluxvalve... and at the remarkably low price of \$59.85 for the arm-cartridge combination - including 1 mil diamond stylus!

*This combination of features is exclusive with the Fluxvalve-Unipoise:*

- Very high compliance
- Very low tracking force, 2-4 grams
- Resonance-free, flat frequency response to 30kc
- Distortion-free dynamic tracking
- All stylus sizes, including 1/2 mil
- Maximum stylus life
- Minimum record wear
- Feather-weight, airframe design
- Single friction-free pivot bearing
- High output
- Easily replaceable styli

*Ultra-dynamic styling to match ultra-dynamic performance!*



**PICKERING & CO., INC.** OCEANSIDE, N. Y.

Professional Audio Components

*"For those who can hear the difference"*

EXPORT: AD. AURIEMA, INC., 89 BROAD ST., NEW YORK / CANADA: CHARLES W. POINTON LTD., 6 ALCINA AVE., TORONTO

Enjoy a demonstration at your hi-fi sound studio... you'll hear the difference. For the dealer nearest you or for literature write Dept. X-16



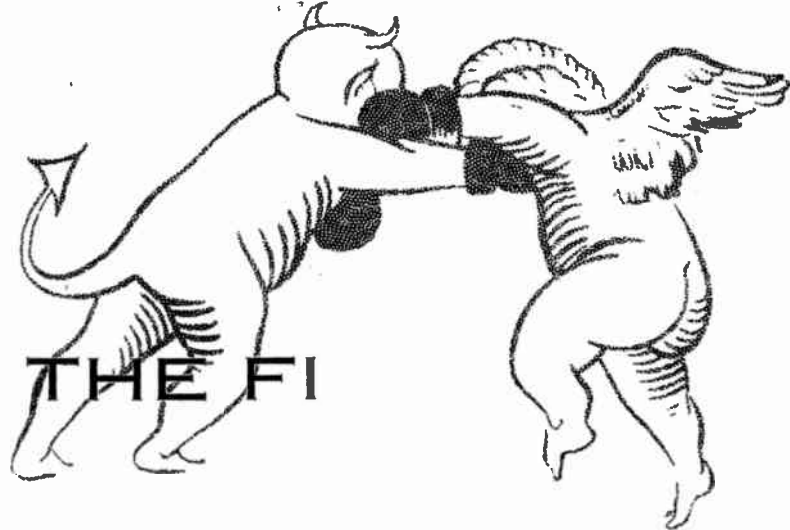

## THE HI AND THE FI

**H**IGH FIDELITY music can be heard in the most unlikely places. In the sports pages of *The New York Times* not so long ago there was a story about an LP library — all classical — that reposes in the Madison Square Garden office of Harry Markson, managing director of the International Boxing Club.

"If you should mention a name like Artur Rubinstein", the item read, "someone would want to know how many times he had been knocked out and who managed him." So the secret of Harry Markson is well kept around the premises, especially by those few cronies to whom The Ring means more than the fight game.

**L**AST TIME a gremlin somehow misplaced our formal introduction of Ruby Mercer, the charming "Miss" who is "Mr. and Mrs. Opera" to thousands of Sunday morning radio listeners in the New York City area, and who is known far beyond that provincial center for her five years on the Mutual network.

Ruby is a native of Athens, Ohio, who became a leading soprano at the Metropolitan Opera and then, after a couple of seasons, decided that she might like talking and writing about it. She did, as it turned out, and still does.

Her interest in FM radio (the weekly WNYC broadcasts are heard on both AM and FM) has taken her far afield. This summer, for the third year in a row, she will be America's delegate to the 22-nation meeting out of which will come the *Prix Italia* awards — the highest honor in European broadcasting.

**B**BRITISH RADIO's proudest achievement has been the Third Programme of the BBC — principal purveyor of music and other aspects of culture to all of England.

Of late, however, television has been making inroads on the previously solid encroachment of this most famous of the adult offerings on the world's networks.

Americans find it difficult to understand the English custom as to radio listening. Namely, it must be paid for, albeit nominally, by each and every owner of a receiver. Hence, no advertising. Hence, also,

the rule of the majority. And the majority, or so it seems, wants more television — even if that would mean less radio.

Dyneley Hussey, in *The Listener*, submits an eloquent dissent: In "no foreseeable future", he writes, "can television usurp the place of sound radio as a purveyor of music. There is neither the time nor the space on the screen for the adequate presentation of full-length opera, while there is no particular advantage in being able to see a concert in progress, provided one can hear it well."

That last proviso, alas, is not always observed. And it might not be untoward for the elders of the Society for the Protection of the Third Programme to address themselves to the problem of sound quality while they are tilting with the Philistines. In music, the sound's the thing.

**A**T PRESS TIME the spring had brought at least two notable developments in the steady encroachment of tape on the recorded musical scene.

For one, Phonotapes-Sonore has added stereo. For another, Mercury at long last has entered the field.

Phonotapes, moreover, has acquired the rights to a new and promising catalogue — Monitor's — which already contains some of the most exciting performances ever made in Eastern Europe. This in addition to the cream of Vox and Folkways lists.

Interestingly, too, Phonotapes is planning to issue certain tape recordings even before they are made available on LP's. Thus far the industry has kept it the other way around. But if Hollywood and TV can coexist, why not discs and tape?

Apparently that is the thinking behind Mercury's long awaited decision, which will be good news to all. This label far-sightedly began recording everything on stereo (triple-track if you please) as early as 1955, so that there will be no dearth of material "in the can" to draw from.

Mercury was in the vanguard of hi-fi pioneers and, thanks initially to our own David Hall (who has since departed the label), came farther faster toward sonic perfection than any other in the business operating domestically. The first batch of

Mercury tapes — to be released on stereo and monaural simultaneously — will be eagerly awaited by trade and public alike. The actual availability date is slightly indefinite, but it will be only weeks away when you read this.

RCA Victor's tape program proceeds apace on all fronts, except that it is confined to in-line or stacked releases (as distinguished from staggered ones, which are the only type accommodated on certain machines). Of course, RCA's stereo equipment line has lent impetus to its production of tapes. As yet, none of the other majors is committed to releasing tapes, and the word from them — Columbia, Decca, and London — is that tape is not in their immediate future.

Despite this air of watchful waiting, certain of the important independents, so called, have taken the step recently. Urania, for example, having come back swinging into the LP market only a few months ago, now is going all out with an ambitious campaign to win its share of the tape market. Certainly the Urania catalogue has plenty to offer.

First and last, needless to add, Sonotape has been the pace-setter. Its plans are simply stated — more of the same. That is to say, the best sound to be had, on the whole, and always a little better than before.

What with all this and the steady proliferation of small labels burgeoning via Livingston (Boston, Lyrichord, Esoteric, and the like), the prognosis for tape as of mid-1957 would seem to be sanguine in the extreme.

**M**EMO TO ALL: In congress assembled, the august music critics of New York this year named Carlisle Floyd's opera, "Susanna", as the best new work they had encountered in a season heavy with premières. Having attended two performances, the undersigned concurs heartily and urges the trade to consider "Susanna" as a recording proposition. It's really a wonderful opera — head and shoulders above many to be had at your corner store. That the composer is an American should not prevail against it. — J. L.



*A perfect recording is the product of team work and hard work. The more there is of the former, the less evidence of the latter. These photographs were taken during recording sessions directed by the A and R men whom the author identifies as the Katzenjammer Kids.*

*Upper left: Heifetz, Rubenstein, Dick Mohr, and Pirigorsky take a break during a chamber music session*

*Above: Conductors Fiedler and Munch comprise a critical audience of two as they listen to a playback*

*Left: Jack Pfeiffer follows the score and listens in the control room to a recording by Anna Dorfman*

*Lower left: Rise Stevens, Jan Peerce, Fritz Reiner, and Dick Mohr decide a moot point in the recording of music from the opera "Carmen"*

*Below: If you know Dimitri Mitropoulos and Marian Anderson, you know they were equally pleased with the tape playback they were hearing*



# The Katzenjammer Kids...

Seems as If Musical Directors Have More Fun and Trouble Than Anyone — By Ben Kemper

JASCHA HEIFETZ was returning to RCA Victor's Hollywood studio after dinner with Jack Pfeiffer, musical director of the Red Seal Division, to complete the recording of Lalo's *Symphonic Espagnole*. The sessions had been going well that day, but there was trouble ahead. As they walked into the building both men remarked on the heavy fog bank that had rolled in and settled down since their break two hours earlier. The musicians were waiting. Heifetz picked up his violin, warmed up for a few seconds, and took his place before the microphone. Pfeiffer said from the control room: "All right, we'll start now with the last movement". The red light went on, and Heifetz's unmistakable tone soared through the big studio.

When the "take" was over, the violinist joined the musical director to listen to the playback. They were aghast at the sound from the speaker that assaulted their ears. The quality was as different from what they had played so successfully that afternoon as the contrast between the clear California sky earlier and the low overcast which now hid it. To quote Pfeiffer, the tonal texture had the quality of a "waterlogged, salt-embedded ship's rope being dragged across a sawdust floor".

With the chief engineer, Pfeiffer rearranged the microphone setup for another try. Once more the Heifetz artistry, not to mention the orchestra's, was obscured by deadening, grainy reproduction on the playback. Then Pfeiffer ordered the entire ensemble farther front on the stage. Still little or no improvement. New microphone placements were set up. They even changed the room temperature, and Heifetz was asked to play from a small pedestal. For two hours Pfeiffer dug into his bag of recording tricks. But to no avail. The outside fog had permeated the inside atmosphere so thickly that it posed an insurmountable hazard.

Bowing to the elements and the frayed tempers, Heifetz finally called a halt and suggested that they give up until the sun returned to shine upon their efforts, and dried out the studio! He and Pfeiffer repaired to a coffee shop across the street. Exhausted and discouraged by the frustration, Pfeiffer slumped against the counter and stared wearily off into space, muttering disconsolate comments on the vagaries of recording.

Heifetz at this moment reached into his wallet, produced a small card and, with a totally blank expression, handed it to Pfeiffer. Bordered in black were the neatly printed words: "Your remarks have touched my heart. Never before have I met anyone with more troubles than you. Please accept this token of my sincerest sympathy."

Pfeiffer still carries this card with him in his wallet, both as a reminder of his occupational hazards of recording and as evidence of the unsuspected Heifetz humor. Next day they finished the *Symphonic Espagnole* with ease.

Such adventures are not at all unusual in the hectic rounds of a recording company's musical director. Victor has two such men, Pfeiffer and Richard Mohr. Both operate out of New York City, where they have adjoining offices at the 24th Street headquarters.

Mohr and Pfeiffer are the youthful high priests of the hi-fi vanguard. Following through the decisions of vice president George Marek and Red Seal A & R Manager Alan Kayes, their schedule encompasses some 150 albums a year, and their activities take them to such far-flung recording outposts as San Francisco, Los Angeles, Chicago and Dallas — and also to nearby Boston and Lakeville, Connecticut.

Both are of quiet mien and studious appearance.



Arthur Rubinstein joined William Miltenburg and Jack Pfeiffer in the control room to hear the playback of a tape recording he had just made

Mohr, for whom Stokowski once inscribed a picture "to a recording angel", has the more chameleon-like personality of the two. His facile moods range from those of a dashing man about town to that of a droll wise old owl, from a dignified, mid-western pedagogue to a buffoon and mimic of hilarious and devastatingly satiric talents.

Pfeiffer is of a somewhat more retiring nature and his tall good looks suggest a leading man in an Italian art movie or perhaps a German student version of the late Guido Cantelli. He, too, is the possessor of a sly wit.

Both men are ultimately responsible for the physical execution of the actual recordings. The problems of assigning repertoire, obtaining decisions from the artists involved, packaging the releases — those are the spheres of Marek and Kayes. Co-ordinating the engineering department with the artistic requirements, and meeting schedules and deadlines — these are the responsibilities of the musical directors. When the many records in an entire month's release are safely in under the line, they feel like the captains of a convoy who have brought *Continued on page 58*

# crew-cut composer

## ELMER BERNSTEIN CONDUCTS HIS OWN SOUNDTRACK OF CECIL B. DeMILLE'S PRODUCTION "THE TEN COMMANDMENTS"

"Serious" composer-conductor Elmer Bernstein was a minor musical figure until the theme from his biting, powerful soundtrack score for the searing movie of a dope addict, "Man with the Golden Arm" cleaved its way into the list of popular best-sellers. Paramount's producer-director Cecil B. DeMille, wrestling with the making of his mammoth Biblical epic "The Ten Commandments" heard the score, recognized the talent.

He had him compose characteristic themes for Moses (Charlton Heston) and Pharaoh Rameses II (Yul Brynner), recreating one of the most dramatic episodes known to man — the saga of Moses in Egypt.

He did not begin his study of music until the age of ten. He gravitated toward the piano, concertized to some extent, but found his real capacity to be that of a composer. During the past two decades — he is now thirty-four — he has written chamber music, song cycles, a suite for orchestra which was broadcast to Europe by the U. S. Information Service.

Crew-cut and left-handed, he is fond of Bach — *St. Matthew Passion* is one of his favorites — but if the DeMille tradition holds, Bernstein's score, both as a part of the movie and as a disc from Dot Records, will be heard by more millions than the music composed by the old master.







Left: On the sound stage, overhead lights are not used during a recording session, in order that the conductor can see the film as he fits the music to the scenes with split-second timing. A spot is turned on Bernstein so that his 72 musicians can follow him. In this picture, the screen shows Charlton Heston, as Moses, when he raised his arms in benediction, making his last speech to the children of Israel



Right: Producer-director Cecil B. DeMille visits Bernstein to learn how his work is progressing



Left: DeMille gestures vigorously to explain to Bernstein the type of beat called for in a particular scene. He is accompanied by an assistant, Doris Turner, who notes his every word, and by Roy Fjastad, head of Paramount's music department

Right: Conductor Bernstein and producer DeMille debate their views as secretary Turner and department head Fjastad stand by



Left: In preparation for scoring the soundtrack of "The Ten Commandments", Bernstein, on the podium at rear center, explains to his musicians some of the effects he wants to achieve, and they make notes on their parts

Right: The musicians are given a ten-minute break while he discusses a problem with orchestral manager Phil Kahgan and musical boss Fjastad. At the left, orchestrators Leo Shuken and Lucien Cailliet have opinions, too, about the music



Left: Before each recording session, Bernstein checks the score and plans the music he will need

Right, above: "Conductor" Bernstein has to wait while "composer" Bernstein works out a phrase at the piano

Right, below: The musicians have gone home, but Bernstein lingers on, still hearing the music that he has conducted



## IRMGARD SEEFRIED

Suggests a basic Wolf library

Few singers of our time have penetrated so deeply as Miss Seefried into the lyric genius of Hugo Wolf (1860-1903), from whose incomparable songs she selects a group of characteristic masterworks especially appropriate for the listener unfamiliar with this special repertory.

Notes and Comments by Max Serbin

# Guide to Record Collecting

THE DISTINGUISHED soprano Irmgard Seefried, like so many ranking lieder artists before her, frequently addresses herself to the interpretative challenge of Hugo Wolf's songs. She has recorded twenty-two of them on Decca DL-9743. Among the women who have essayed this repertory on records, Miss Seefried clearly is outstanding. Among the men, several stand out. Dietrich Fischer-Dieskau has done sixteen of the songs on His Master's Voice ALP-1143 and fifteen on Decca DL-9632, Gérard Souzay eight on London LL-1476, Alfred Poell fourteen on Westminster WL-5048, Heinrich Schlusnus nine in all on Decca DL-9620/2, and Hans Hotter eleven on Angel 35067. There is also a Wolf record by Bruce Boyce (London/L'Oiseau-Lyre OL-50026) and a scattering of songs on various recital LP's by lesser known singers. All but the last-listed of these discs can be recommended in whole or in part. And the duplication problem is practically non-existent as to works by this composer.

In the brief survey that follows, the Wolf songs singled out as favorites by Miss Seefried are woven into a discussion of those general aspects of style that insure a unique place in the vocal literature for the art of this highly individual composer. Her selection assembles ten works. Here they are with the recommended recordings:

Seefried, Decca DL-9743

1. *Auch kleine Dinge*
2. *Schweig einmal still*
3. *Wir haben beide lange*
4. *Mir ward gesagt*
5. *Du sagst Mir*
6. *Mein Liebster ist*

Hotter, Angel 35057

7. *Prometheus*

Poell, Westminster WL-5048

8. *Abscheid*

Schlusnus, Decca DL-9620

9. *Denk es, o Seele*
10. *Verborgenheit*

The foregoing is a representative sampling. Like almost any other conceivable grouping of Wolf songs it depicts a whole tone-world unto itself: replete with love, hatred, exaltation, and resignation; in short, humanity expressed in the space of a few bars. This defines the art of Hugo Wolf.

We are now in a period of increasing musical sophistication, it has been said, and no one can deny that composers so disparate as Monteverdi and Bartók are reaching out to an ever growing audience. However, with the larger appreciation of the very early and the very modern has come a vastly enlarged emphasis on the "unusual" — percussive sounds, rumbles, whistles, and such gimcracks. Timbre is at a premium, and the orchestra (the loudest noise) reigns supreme.

Consequently, of all the musical forms only the art song, or lied, has managed to remain relatively unpopular through the era of LP. Many a devotee of Mahler's *Eighth* or the Berlioz *Requiem* still limits his familiarity with Schubert's songs to the perennial *Serenade*. A half-century after his death, Wolf remains a solitary, even an aloof figure. And this despite the undeniable fact that he carried the art song to its highest consummation. For he did not merely set poetry to music. Rather, he re-created poetry in music — with infinite delicacy, subtlety, restraint, and the most scrupulous attention to mood.

The usual course of development for a composer is from an eclectic style — that is to say youthful and immature — to the artistic ripeness that is supposed to come in middle age and to take on more and more character as creative influences are "grown out of" and absorbed into a truly personal idiom. A sharp break in stylistic growth is usually not apparent, although what is to be heard in any one work almost inevitably has been foreshadowed before. This process is perhaps perfectly exemplified by Beethoven.

But the musical development of Hugo Wolf was far more complex. He was in the habit of setting several poems by a single poet before passing on to the writings of another — and whenever he did, his style changed abruptly. Hearing the tiny but precious *Auch kleine Dinge* from the "Italienisches Liederbuch" as sung by Miss Seefried, one would infer that Wolf was a composer of somewhat Schubertian felicities — the music is cameo-like, unaffected. But compare this with the gigantic *Prometheus* as sung by Hotter, which is complex, tortured, reminding one harmonically of Wagner and otherwise of late Beethoven. It is difficult to believe that these two songs flowed from the same pen.

The "Italienisches Liederbuch" is written in Wolf's so-called Italian style. The settings, like the poems themselves, are short, economical, and intense — what the English critic Ernest Newman calls "a blend of profundity and compression". In these German translations of Italian folk poems the women are by turns mocking, gay, or desolate. Typical of the sequence, and also done by Miss Seefried, is the masterful *Schweig einmal still*, in which the woman sarcastically tells her lover to stop his "odious babbling" while a perfect little fantasia on the familiar bray of a donkey is worked out on the piano. Wolf's manner of handling a text is of supreme interest throughout the Italian songs. He sometimes maintains a rigid quietude while the vocal line moves step-wise within a narrow range — as in *Wir haben beide lange Zeit*. Miss Seefried includes from the same collection the arresting *Mir ward gesagt* and *Du sagst Mir*, the latter of which is a striking expression of a woman's scorn for the pretensions of an admirer.

In the imposing figure of Goethe, Wolf faced a poet whose wisdom and philosophy were so profound and yet so concentrated that one or two stanzas could well summarize an entire universe of experience. In

*Continued on page 54*

# Library for Listening

Outdoor Concerts in the  
Heart of New York City  
Draw Local and Visiting  
Devotees — By Marguerite Tazelaar

tendance has jumped from about 100 in 1948 to an average of 1,000 in 1956. Fan mail, too, has increased to substantial proportions.

One man from the Mid-west wrote to the library this spring requesting programs to be played in July, when he expected to take his vacation in New York. Like so many other correspondents, he also asked when the annual Caruso concert was to be held. This memorial to Caruso, first held on August 2, 1951 (the 30th anniversary of his death) drew 5,000 rapt listeners. It has been repeated each year since. Another memorial held annually honors George Gershwin; this one, too, always attracts thousands. So does the children's program.

Mozart, Beethoven, and Bach, in that order, lead in the public's favor. The summer concerts are built entirely on requests sent in by listeners, except that the music programmed is exclusively classical. Requests for popular song numbers or jazz rarely come in and, since it is hard enough to fill demands as it is, these are politely but firmly passed over. "The Magic Flute", "Marriage of Figaro", and



Mozart, Beethoven, and Bach are the composers whose works are in most demand for the New York Public Library's concerts, played from records

ONE HOT JULY DAY some years ago, occupants of the benches in New York City's Bryant Park were roused from their reveries by snatches of Mozart and Beethoven floating across the open square behind the Public Library at Fifth Avenue and 42nd Street. Suddenly dispelled was the cacophony of a thousand taxis, and trucks, and the scurrying noonday crowds. The lovely music seemed like the strains of a lyre — a sound not commonly encountered in Manhattan's busy midtown. In the park, daydreaming vagabonds turned in surprise to look for the invisible orchestra; the gnarled faces of elderly men and women softened under the spell of the soaring symphony; even astonished sparrows stopped their ceaseless chatter.

The date was July 19, 1948, when the library inaugurated its recorded outdoor concerts. On June 19, 1957, the opening concert of the tenth season will be given. The programs now attract so many people, particularly out-of-town visitors, that the series has been extended from June through the middle of September, instead of running from mid-July to late August as originally planned. Daily at-

"Don Giovanni" are particular favorites, with Beethoven's *Fifth* and Bach's cantatas and organ works following closely. Berlioz' *Requiem*, which takes two hours to play, is a "must" each season.

The idea for these noon concerts took shape when heads of the Library's music division decided that the public was not receiving adequate benefits from its extremely valuable collection of records. Now totalling over 25,000 discs, this treasury of the world's greatest music was accumulated slowly. It represents donations by individuals and record companies and bequests from estates or patrons. Some items go back as far as 1903 or even before; for example, there are numerous early recordings by Suzanne Adams, Marcella Sembrich, Schumann-Heink and Eduoard de Reszke that would fetch high prices from collectors. These are kept under careful supervision in a secluded corner of the stacks.

Monthly recorded concerts in the Library's lecture-room already were a fixture when someone — nobody remembers who — suggested moving them out of doors. The intermediate step was an indoor *Continued on page 54*

# Tape Reviews and Ratings

For Names of Reviewers and Explanation of Ratings, See the Record Review Section

**BACH: Violin Concertos** A  
 Reinhold Barchet, Will Beh, violinists; B  
 Pro Musica String Orchestra, Stuttgart, under Walther Davisson B  
 7½ ips. Double Track  
 Phonotapes-Sonore (Vox) PM-154

Barchet



Barchet is the soloist in the A minor and E major and he is joined by Beh in the D minor Double Concerto. There is nothing fancy about the playing; soloists and conductor go about their business most professionally and the music is given every opportunity to speak for itself without interference. In these healthy, direct pieces, this approach is salutary and the result is a tape of real consequence. The sound of the solo violins and the string instruments of the orchestra is captured very effectively, although the supporting function of the harpsichord continuo is accomplished with more than necessary reticence. WDM

**BEETHOVEN: Symphony No. 8;** A-A  
**Overture — Consecration of the** B-B  
**House** A-A  
 Philharmonic Symphony Orchestra of London and Vienna State Opera Orchestra under Hermann Scherchen  
 7½ ips. Double Track  
 Sonotape (Westminster) SW-1049

Scherchen



On disc the Scherchen Eighth is the most exciting, sonically, of any. On tape it is performed even more so. Musically, I find it less congenial than most, somewhat wanting as to the inherent humor of the work. But this conductor is ever serious, and he is entitled to stress those aspects of the score that seems to him controlling. The inclusion of Beethoven's unjustly neglected, deliciously Handelian overture lends added appeal to this issue. I have always felt that Toscanini drove it too hard, prevented it from singing. Scherchen doesn't let in much air, either, but he is less tense about it. Again, glorious sound. JL

**BRAHMS: Symphony No. 2 in D,** A  
**Op. 73** A  
 Frankfurt Opera Orchestra under Carl A  
 Bamberger  
 7½ ips. Stereo  
 Concert Hall Society CHT/BN-23

Brahms



The orchestra is not one of the great ones, but it certainly makes a brave showing in this tape. Bamberger evidently is a conductor who can drive or lead men to give him what he wants and the Frankfurters go all out for him. He sets a lively pace; this is not languorous Brahms. The playing possesses a vigor that demands a firm baton hand, but it does not become coarse. This is a sunny performance of the composer's sunniest symphony, abetted by a stereo process that dissects the orchestration nicely and with remarkable clarity, yet maintains its essential integrated texture. WDM

**BRITTEN: Serenade, Op. 31** A-B-B  
**CHAVEZ: Toccata for Percussion** A  
**FARBERMAN: Evolution** A  
 Various artists  
 7½ ips. Double Track  
 Livingston (Boston) BO 7-2

Britten



This omnibus assembles what is probably the least miscible assortment of music to be encountered in the tape catalogues. For all their disparity these are good works, to be sure, and they are very well performed. In the dulcet Britten delight the tenor is David Lloyd, who will do in lieu of another Peter Pears; the sterling horn soloist is James Stagliano. Other members of the Boston Symphony collaborate here and elsewhere, including composer Harold

Farberman, whose *Evolution* will be welcomed especially by fellow percussionists in need of a vehicle with which to move stage front once in a while. The sound throughout is superb. JL

**"Gershwin by George"** C  
 George Greeley, pianist, with B  
 percussion ensemble A  
 7½ ips. Stereo  
 Jemo JTT-1-S

Gershwin



Here we have a selection not of the best but of the best-known Gershwin, in commercial, rather predictable arrangements, slickly performed. Thus, since no other aspects interest, let us consider the technical. The sound, but for some print-through caused by very high recorded levels, is excellent. And there lies an apparent contradiction, for a fair portion of this stereo recording is solo piano! Jemo apparently has adopted a solution to the stereo solo piano recording which others tried with considerable success: one microphone at the pianist's right, the other down at the far end of the instrument. Result: the effect of being right at the keyboard. RLK

**GRIEG: Lyric Suite; Norwegian** B  
**Dances; Holberg Suite; Wedding** A  
**Day at Trolldhaugen** A  
 Bamberg Symphony Orchestra under  
 Edouard van Remoortel  
 7½ ips. Double Track  
 Phonotapes-Sonore (Vox) PM-146

Remoorte



These are the highly praised performances that established Remoortel's reputation when they were released on Vox disc PL-9840. Hearing them on tape confirms the judgment that he worked a minor miracle with the Bamberg Symphony. The quality of the playing hardly can be bettered, while the interpretations penetrate into the very spirit of the music. It is little cause for wonder that the young conductor has not yet repeated the success of this program; he certainly set himself a high standard. However, he has our good wishes and we have a splendid tape. WDM

**MENDELSSOHN: Symphony No. 3** A  
**in A, Op. 56 "Scotch"** B  
 Netherlands Philharmonic Orchestra A  
 under Walter Goehr  
 7½ ips. Stereo  
 Concert Hall Society CHTB/N-25

Goehr



The *Scotch* is a musical representation of the moods and impressions engendered in an extremely sensitive artist by a foreign land which excited his imagination. In it, Mendelssohn expresses his admiration of the strength of the Scottish character and his awe of the Scottish scene. It is a romantic work, which makes it difficult to interpret with conviction in this era. Goehr achieves a degree of lyricism, although some of the broadness and sweep that can be moulded by stronger hands eludes him. The clarity of the recording adds depth and power to the reading. WDM

**MOZART: 10 Overtures** A-B  
 Pro Musica Symphony Orchestra, B  
 Vienna, under Jonel Perlea B  
 7½ ips. Double Track  
 Phonotapes-Sonore (Vox) PM-155

Perlea



So many overtures one after the other make the old 78s almost attractive. The rigidity of the LP and tape format does not permit convenient pleasurable listening of short compositions. This is the area of classical music for



which the programatically flexible 45 rpm. Extended Play record is much better suited. As a panoramic survey of the development of the operatic overture in the Mozartean scheme, this tape serves a purpose; it also satisfies the passion for completeness. Perlea's readings are competent, but not particularly imaginative. Very good sound. WDM

**MOZART: Symphony No. 39 in E Flat, K.543** A  
 B  
 Netherlands Philharmonic Orchestra A  
 under Walter Goehr  
 7½ ips. Stereo  
 Concert Hall Society CHT/BN-26



Mozart

Mozart's great E flat has come in for a considerable amount of recording attention recently. It is a deceptive symphony; it refuses to play itself, yet will not bend to wilful direction. It is music within the technical abilities of the Netherlands Philharmonic and, inasmuch as Goehr is not the kind of conductor who indulges his individualism unduly, there is little with which to cavil in this performance. Of course, stereo is ideal for Mozart; the transparency is made further transparent, without the destruction of relationship and interdependence. This tape is one of the most successful in the Concert Hall series. WDM

**RAVEL: Mother Goose Suite; Introduction and Allegro** A  
 B  
 Pasdeloups Orchestra and Paris Chamber Orchestra under Louis Martin A  
 7½ ips. Stereo  
 Concert Hall Society CHT/BN-24



Ravel

These compositions are among the most sensitive from Ravel's pen. The Suite is melodious and colorful and filled with the imagination demanded by its literary associations. The Introduction and Allegro for Harp and Strings shimmers and whispers. Such subtlety is grist for the stereophonic mill. Martin leads both pieces with the assurance that comes from understanding and experience. The playing is expert; as a matter of simple justice, the harpist deserves lobel recognition. The recording has picked up every nuance and variation of tonal color. A fascinating tape. WDM

**SCHUBERT: Symphony No. 8 in B minor "Unfinished"** A-B  
 C-C  
**SIBELIUS: Finlandia** C-C  
 Florence May Festival Orchestra (?)  
 under Vittorio Gui (?)  
 7½ ips. Stereo  
 Audiosphere 701-BN



Schubert

Every now and then a producer of records or tapes does something to keep the critics on their toes. The titling and notes connected with this tape are a case in point. Bold type proclaims "The Florence May Festival Series". The body of the notes is concerned with the history of the Florence May Festival, its orchestra, Gui's relationship to both, and an appreciation of his conductorial genius. Yet there is not one specific statement this tape presents in fact the Florence May Festival Orchestra or that the conductor is in fact Gui. What gives? The playing is inclined to roughness and the recording is rather coarse. WDM

**R. STRAUSS: Dance of the Seven Veils from "Salome"; Final Scene from "Elektra"** A  
 A  
 A  
 Inge Borkh, soprano; Chicago Symphony Orchestra under Fritz Reiner  
 7½ ips. Stereo  
 RCA Victor CCS-23



Reiner

These performances constitute half the contents of LM-6047, a two-disc miscellany (another excerpt from "Salome", a suite from "Bourgeois Gentleman") reviewed in the opera section four issues ago. Miss Borkh's portrayal is positively electric, if somewhat cooler than others remembered, and Reiner's virtuosos provide a marvel of surcharged Straussian splendors. Predictably, the sound represents an improvement over that on LP, and the latter is extraordinary enough. All things considered, it really is a pity that more of "Elektra" was not vouchsafed us — preferably all of it, because a complete one has been needed for years now. JL

**TCHAIKOVSKY: The Nutcracker (abridged)** A  
 A  
 A  
 Philharmonic Symphony Orchestra of London under Artur Rodzinski  
 7½ ips. Stereo  
 Sonotape (Westminster) SWB-9002



Rodzinski

As an unreconstructed balletomane I cannot wholeheartedly endorse any truncation of the music contrived for Ivanov's choreographic masterpiece, but in all fairness it must be admitted that the score out of context rather invites the blue pencil. This version runs something over three quarters of an

hour and assembles fourteen separate sections (including all those in the familiar concert suite), presented, however, in the correct balletic order. Rodzinski limns the enchanting pages with loving care; his forces are admirably responsive; the sound is perfect. Poor program notes. JL

**Opera Ballets**  
 Pro Musica Symphony Orchestra, B  
 Vienna, and Württemberg State B  
 Orchestra, Stuttgart, under Jone. B  
 Perlea  
 7½ ips. Double Track  
 Phonotapes-Sonore (Vox) PM-156



Bizet

To the swank members of the Jockey Club of Paris, the ballet used to be the better part of opera. Of course, today's audience is not likely to riot if a new opera does not include a dance divertissement, but then, we live in extraordinary times. This tape includes ballet music from Faust, La Gioconda, Samson and Delilah, Aida and Djamilah. The last, by Bizet, is based on an oriental subject. All of these items are easy to listen to and Perlea keeps them moving in lively fashion. The melodies are attractive and uncomplicated and the taping is expert. WDM

**Black Watch Pipe and Drum Tunes** B  
 Black Watch Royal Highland B  
 Regiment Band B  
 7½ ips. Double Track  
 Phonotapes-Sonore Cameo (Folkways) PMC-1009



This is the stuff that separates the men from the boys. If your system (mental, physical and tape-reproducing) can take regimental bagpipes and drums played for all they are worth and recorded on location, this is your meat. The Royal Highlanders march as they play. The coming and going of the kilted perambulators and the shouted commands that set them in motion are captured by the microphone with impressive realism, the music swelling and ebbing effectively. Folkways taped this program during actual exercises in an armory, so that the quality of the sound suffers somewhat from excessive echo. WDM

**In the Spanish Mood** B  
 Varieton Concert Orchestra B  
 under Fred Hausdoerfer A  
 7½ ips. Stereo  
 Concert Hall Society CHT/BN-27



The program consists of *España* and *Estudiantina* by Waldteufel, the *Spanish Dance No. 5* by Granados and five *Spanish Dances* by Moszkowski. At first blush, it seems like painting the lily to tape these in stereo. However, second thoughts are less negative. Granted that none of this music is important, much of it nevertheless has a vitality that has enabled it to survive when thousands of more ostentatiously serious compositions have long since been retired. Be that as it may, the orchestra, with which I am not familiar, plays well, and the conductor, whom I do not know, has a flair. WDM

**Josh White Comes a-Visitin'** A  
 Josh White A  
 7½ ips. Stereo A  
 Livingston T-1085-BN



White

This is a winner. Josh does eight rhythmic numbers, accompanied by drums, organ or piano and bass, plus a vocal trio consisting of Beverly White, William White and Sam Gary. Among the songs are *Bonbons*, *Chocolate* and *Chewing Gum*, *She's Too Much for Me*, *Evil-Hearted Me* and *Go Away from My Window*. Josh is in fine voice and he sings with taste and enviable musicianship. The performances are notable for their vitality; there is a definite urge to tap toes along with the music. The taping is so vivid, the feeling of presence so real, that the reason for the title of this collection is obvious; Josh does come a-visitin' right in your own home. WDM

**String Band Music of New Orleans** B  
 Six and Seven-Eighths String Band B  
 7½ ips. Double Track B  
 Phonotapes-Sonore Cameo (Folkways) PMC-1008

Mandolin, steel guitar, guitar, and bass comprise the 6⅞ String Band of New Orleans. What the name signifies I do not know; perhaps this is the way the leader remembers the size of his hat. The members of the group are amateurs and they play nice, bouncy jazz as nostalgic in style as the sentiments of some of the half-dozen songs on this low-priced tape. A little singing is done by someone with more enthusiasm than voice. In the main, it is a steely sound that comes out, but this is a steel-stringed aggregation, although the bass is properly gutty. The players evidently enjoy themselves and the enjoyment is contagious. WDM



# COLLECTORS' CORNER

**B**IMONTHLY BESTS were, as usual, anything but easy to isolate. The Brahms *First* of Markevitch on Decca, for example, is just as extraordinary in its way as the Vaughan Williams *Fourth* of Mitropoulos on Columbia, the cover of which is shown above. But one or another of them had to be displaced by the collection of *Danzas* by Juan Morel Campos just issued on the Balseiro label.

As you read this, the first annual Casals Festival in Puerto Rico is drawing to a close. Among the artists participating is pianist Jesús María Sanromá, who is that island's most distinguished musical ambassador. His lifelong advocacy in behalf of Campos undoubtedly will approach fruition as a consequence of the international gala that has brought the world of music to their homeland. It's about time.

For its ingeniously calculated topical interest, then, as well as for its surfeit of unsuspected artistic values, our spotlight beams brightest upon this splendid homage to an unaccountably forgotten composer who was, after all, one of our own.

If you cannot obtain the set through normal dealer channels, address Casa Balseiro, Inc., 204 San José St., San Juan, Puerto Rico.

**M**USIC PUBLISHERS are not given to value judgments as to the manner in which any work in their catalogues is performed. Their aim is circulation, and they are properly concerned mostly with renting parts, collecting fees, and otherwise respecting the prerogatives that belong to the conductor or, these days, to the music director of every recording company.

So that our "through-channels" request for a statement from Igor Stravinsky in answer to the letter from Kurt List of Westminster-Sonotape (March-April issue, page 15) has thus far (1) been received by

Boosey & Hawkes, Stravinsky's longtime "official" publisher; (2) forwarded to G. Schirmer, American agent for the English publisher still holding rights to this early work, and (3) forwarded in turn to J. & W. Chester, Ltd., in London, which house actually brought out *L'Histoire du soldat* back in the twenties. No statement yet.

Meantime our reviewer, Ward Botsford, would like to be heard:

"Dr. List takes exception to my criticism of Sonotape's *L'Histoire* by saying that I was 'apparently ignorant of the following: Stravinsky himself not only approved this concert version without spoken parts, but recorded it twice, as did Leonard Bernstein.'

"I believe Dr. List is in error. Whether Stravinsky ever approved a wordless version of the complete score *sans* dialogue is a moot point, but he certainly did not record it at any time, nor did Bernstein. What they did record is the concert suite. [Of these the only one extant is the composer's second recording on Columbia ML-4964 — Ed.]

"This suite does not include any of the following sections: *Musique de 3<sup>ème</sup> Scene*, *Marche du Soldat*, *Petit Choral*, and *Couplet du Diable*. In fact, no purely instrumental recording other than Sonotape's ever has included them since they were not intended for instrumental performance in lieu of actors.

"The timing of Stravinsky's Columbia recording is 24:51, while that of the Sonotape is 32:25. This alone should indicate that there is a considerable discrepancy between the versions involved. I am sure that Dr. List, who is a thorough musician, knew all this but simply forgot, as the best of us will on occasion."

**A**NOTHER HONOR for our own Herman Neuman, who would make us happier

if he would contribute to these pages a bit more often. Herman has become the first musician ever to receive the gold medal award of the National Arts Club. It was bestowed in recognition of his contribution to "greater international understanding through the world tongue of music", via his weekly "Hands Across the Sea" program on WNYC-FM and AM, New York.

**P**UBLICITY BLURBS are part of a reviewer's daily chores. They have to be read, although most of them are badly written, a waste of everyone's time, and not infrequently full of misinformation. Worst of all, they are humorless in their hyperbole.

As evidence that there are exceptions, and also to show that this mass of stuff does get a once-over, we thought you'd enjoy the following tid-bit from Columbia's press department.

In advance of the recent Epic issue of Prokofiev's "The Love for Three Oranges" arrived the usual stack of biographies and a synopsis of the opera. Atop the latter was the title. Beneath it, in parentheses, was this subtitle: "Who Got Caught in the Orange-Crush?"

Purely apocryphal, naturally. But a smile and a thank-you to Bea Baron of Debbie Ishlon's staff, who is plainly entitled to insert little tests like this every now and then to ascertain what every copywriter longs to know. In the case of Columbia's press releases, yes, they are perused — and with more pleasure than some.

**C**OLLECTORS should be looking forward to the forthcoming Decca recital by pianist Frederick Marvin. It will be devoted altogether to newly-discovered works by that amazingly prophetic iconoclast of the 18th century, Padre Antonio Soler (1729-83).

Marvin has long since established his prowess as a keyboard marksman and his surpassing good taste as an interpreter. Now he has demonstrated, in addition, a penchant for scholarship that is uncommon among virtuosi to put the best light on it. He actually took up residence at the monastery in Spain where Soler spent the better part of his creative life. And it was there that he collected the other fascinating sonatas and assorted pieces presently being recorded.

**I**N A NOTE that accompanied the recent and most welcome reissue of Artur Schnabel's complete Beethoven sonatas, vice president George R. Marek of RCA remarked that the \$80 album is "fortunately released at a time of general prosperity".

The efficacy of this market analysis notwithstanding, George had better see to it that the thirteen discs are soon released singly. Indignant mail reaching Hi-Fi Music indicates that there are more poor collectors than rich ones, although that should surprise nobody.

# Record Reviews and Ratings

BOARD OF REVIEWERS: Ward Botsford • Jean Bowen • Eugene Bruck • Oliver Daniel • Warren DeMotte • Leonard Feather • Shirley Fleming • Charles Graham • David Hall • Peggy Glanville-Hicks • Allen Hughes • Edward Jablonski • Alfred Kaine • Richard L. Kaye • Ezra Laderman • C. J. Luten • James Lyons • George Louis Mayer • Ruby Mercer • David H. Miller • Robert Prestegard • David Randolph • Richard RePass • Fred Reynolds • Abraham Skulsky • Sheldon Soffer • Walter Stegman • Saul Tishoff

## ORCHESTRAL MUSIC

**BALAKIREV: Symphony No. 1 in C** **A**  
Royal Philharmonic Orchestra under  
Sir Thomas Beecham **A**  
Angel 35399 12" **A**

Beecham



Quite aside from its service in the public interest, Angel's making this sturdy period piece generally available is due note for thus insuring to posterity the otherwise unsung contribution of the Maharajah of Mysore to the musical scene. It was he who picked up the tab for Angel's Philharmonia in the old days, and what he wanted to hear were works by such as Medtner and Balakirev — pursuant to which well-heeled whimsy that orchestra once recorded the present symphony under Karajan. His Mysorean Majesty is not mentioned by annotator Victor Seroff, but Beecham elicits a performance worthy of the most royal delectation. **JL**

**BEETHOVEN: Symphony No. 5 in** **A-A**  
**C minor, Op. 67; Overture, The** **A-B**  
**Consecration of the House** **A-A**  
Philharmonia Orchestra under Otto  
Klemperer  
Angel 35329 12"

Klemperer



A really superior recording — still rare enough to warrant comment — illuminates superb playing by the Philharmonia and exemplary leadership by Klemperer in the most popular of Beethoven's symphonies. All things considered, there has never been a finer version on records. Unfortunately, however, the wonderful and somewhat neglected *Consecration of the House* does not fare so well. This is due to the excessively slow tempo adopted by Klemperer that robs the fugue of much of its power. **CJL**

**BEETHOVEN: Symphony No. 9 in D** **A**  
**minor, Op. 125 ("Choral")** **B**  
Stuttgart Philharmonic under Isaie Dis-  
enhaus; F. Wachmann, soprano; M.  
Bence, contralto; F. Wunderlich  
tenor; O. Von Rohr, bass  
Period SPL-306 12"

Beethoven



If it's a bargain *Ninth* you're after, this is it. For \$1.98 you get the entire symphony compressed into one record with no great damage. The performance is satisfactory, on condition that you turn the volume control to a higher

level than normal. Disenhaus, who is a Belgian conductor in his early thirties, leads with vigor and interprets straightforwardly. The slow movement is the least well done, while the Scherzo is too fast for my taste. Neither orchestra nor quartet can be called outstanding, but they do their job with perfect understanding of the work. For this price it is quite an achievement. **AS**

**BERLIOZ: Harold in Italy** **A**  
Heinz Kirchner, solo violist, with the Ber-  
lin Philharmonic Orchestra under Igor  
Markevitch **A**  
Decca DL-9841 12" **A**

Berlioz



With the exception of a rather too slow opening, Markevitch paints Berlioz's scenes in vivid colors. All is energy and no-nonsense; confidence strides through every movement and introspection gives way to decisiveness and articulation. This holds true for the solo viola as well. It is not particularly poetic, but entirely adequate. There is some fine playing by individual members of the orchestra, and the famous English horn solo in the third movement is a delight. The dynamic range between *piano* and *forte* is immense and may cause unavoidable knob-turning on some machines, but you can't say the effect isn't acutely two-dimensional, at least. **SF**

**BRAHMS: Symphony No. 1 in C** **A**  
**minor, Op. 68** **A**  
Symphony of the Air under Igor Marke-  
vitch **A**  
Decca DL-9907 12"

Markevitch



Not even the finest of many fine Markevitch records quite prepared me for this phenomenal demonstration of conducting genius. Indeed, having seen him in the flesh recently I had begun to suspect that he was somewhat overrated. And yet no one could listen to this umpteenth version of the great C minor and fail to recognize that it is in every way a remarkable achievement. The finale is mannered and otherwise an anti-climax, true, but the other movements are without a peer in their massively inexorable and ever stylish unfoldment. Aware of the hyperbole involved, I must insist nevertheless that this is the only *First* worth comparing to Toscanini's. **JL**

**CASELLA: La Gioia — Suite Simfonica** **A-B**  
**RESPIGHI: The Pines of Rome** **A-A**  
Orchestra of the Accademia di Santa  
Cecilia, Rome, under Fernando Pre-  
vitali **A-A**  
London LL-1575 12"

Casella



### RATINGS OF CLASSICAL MUSIC

The following explanation of the Record Ratings which accompany the Record Reviews is given so that you will understand exactly the significance of the three letters which appear at the left of each review.

#### COMPOSITION (Top Letter)

##### A: Outstanding

Indicates that the composition is one of the composer's best works, or that it is outstanding in a particular class of music. Assignment of this rating is an unqualified recommendation.

##### B: Important

This rating is but slightly below the A rank.

##### C: Worthy

A composition which may merit representation in a library of the composer's works, or in a collection of that particular music.

#### PERFORMANCE (Middle Letter)

##### A: Outstanding

Indicates a superb performance. Assignment of this rating is an unqualified recommendation.

##### B: Excellent

A noteworthy performance, subject only to minor criticism.

##### C: Satisfactory

A performance not without flaws, yet deserving public notice.

#### RECORDING QUALITY (Bottom Letter)

##### A: Outstanding Realism

Representing the highest present attainments in acoustic and recording techniques.

##### B: Excellent Quality

Slightly below A rating because of minor faults in the acoustics or recording, or because the noise is considered somewhat above the minimum currently obtainable.

##### C: Acceptable Quality

Representing the current average of the better LP records.

##### R: Indicates a re-issue.

**Important Note:** Records which are rated below C as to the composition, artist or orchestra, or recording quality are not ordinarily reviewed here. However, the omission of a record does not mean that it was rejected, as it may not have been submitted to HI-FI MUSIC AT HOME for review.

This is the first time that we encounter the name of Previtalli on records. He is evidently among the foremost Italian conductors, and of course the orchestra he leads is one of the better known ensembles of Europe. Casella's "La Gira" should be a very effective ballet, judging from this first recording of the concert suite. Dating from 1923 it has, naturally, a strong Stravinsky influence, but the extensive use of Italian folk material and the very effective scoring lends the work an individuality of its own. Respighi's famous tone picture is made notable by Previtalli's musical interpretation, in contrast to others who tend to overdo its bombast. AS

**CHARPENTIER: Impressions d'Italie** C  
L'Orchestre de la Société des Concerts A  
du Conservatoire de Paris under Al- A  
bert Wolff  
London LL-1511 12''



Charpentier

How dreadfully faded this music sounds today. It's of a kind with Massenet's *Scènes pittoresques* and Richard Strauss' *Aus Italien* — a pale painting of another era. This aside, Albert Wolff does an admirable job of conducting and the Paris Conservatory orchestra is rich in sonority. However, Angel also has a fine issue of the work with Louis Fourestier conducting the Orchestre du Théâtre National de l'Opéra. The latter, although not so well recorded, does offer the advantage of a dividend in the form of Louis Aubert's very charming *La Habanera*. WB

**CHAVEZ: Sinfonia No. 5** A-B  
**BEN-HAIM: Concerto Grosso** B-B  
M-G-M String Orchestra under Izler B-B  
Solomon  
M-G-M E-3423 12''



Solomon

Chavez' *Sinfonia* is a first-rate work, strong in its materials and dramatic in expression. Indian elements, which are not so obvious here as in some of his earlier works, are nevertheless fully integrated in his rhythmic language. Chavez' present main concern seems to be the invention of new sounds for the string choir. Always, however, this inventiveness is subordinate to dramatic urgency. Ben-Haim's *Cancerta* is less satisfactory. It is one of the composer's earlier works, and his style had not yet integrated and taken on its individual characteristic. Performance and sound are somewhat dry. AS

**CHOPIN: Les Sylphides** C-A  
**DUKAS: La Péri** C-C  
Hallé Orchestra under George Weldon B-B  
Mercury MG-50117 12''



Weldon

It is ironic that Dukas' first-rate score has never found a permanent home in any ballet company despite the efforts of several prominent choreographers, while the flimsily orchestrated piano pieces of Chopin have served as a staple for companies good and bad. This coupling invites comparison of their respective musical values. Weldon's performances sacrifice atmosphere for clarity and crispness. Contrasts are not sharply defined and rhythmic accents are not sufficiently energetic. Also, *La Péri* is performed without the brass fanfare Dukas later added to the score. Honest performances, but certainly not definitive. GLM

**COPLAND: Appalachian Spring** A-B  
(Complete); *Billy the Kid (Suite)* A-A  
Philadelphia Orchestra under Eugene A-A  
Ormandy  
Columbia ML-5157 12''



Copland

Copland's prize-winning score for Graham's *Appalachian Spring* was originally composed for thirteen instruments. The complete work was not expanded for full orchestra until 1954 for a performance by Ormandy. This is its first complete recording. The section not included in the suite is the tense but musically episodic solo for the bride as she anticipates motherhood. Ormandy and the Philadelphians are at their best. The delightful *Billy*, introduced at Chicago in 1938 and not in New York in 1939 as stated in the notes, was a happy choice for the second side. Both readings are dramatic, with the dance impulse given its full due. GLM

**DEBUSSY: La Mer** A  
**RAVEL: La Valse; Valses nobles** A to C  
*et sentimentales* B  
St. Louis Symphony Orchestra under  
Vladimir Golschmann  
Columbia ML-5155 12''



Golschmann

It is in the charming and subtly moving *Valses nobles et sentimentales* that Golschmann discovers most that is rewarding. His conceptions here have a suave elegance and a light consistency that are perfect for these glowing vignettes. *La Valse*, however, lacks the utter abandon and dramatic irony to be found in Munch's first recording of this work for Victor. Of this *La Mer*, all that one can say is that the waves were rather subdued that day, and what the wind had to say to them wasn't very exciting. The sound is quite good. AK

**DVOŘÁK: Serenade for Strings, Op. 22;** B-A  
**Serenade for Winds, Cellos,** B-B  
**and Double Basses, Op. 44** B-B  
Arthur Winograd String Orchestra and  
M-G-M Chamber Orchestra under  
Arthur Winograd  
M-G-M E-3489 12''



Winograd

Three years separate the composition of these two works. Both are beautiful, full of the warmth, good humor, and expressiveness of Dvořák's best music. The later piece has more to offer than the earlier, — more color, more inventiveness, even more melody. Winograd's performances are well balanced and expert, although he does not achieve the plasticity in the *String Serenade* that Lehmann did on Decca. Also Haas (Decca again) was able to achieve more subtle contrasts in the *Wind Serenade*. However, the Winograd readings are not too far behind and the coupling of both works on a single disc is an attraction in itself. WDM

**DVOŘÁK: Slavonic Dances,** A  
Opp. 46, 72 B  
Vienna State Opera Orchestra under B  
Mario Rossi  
Vanguard VRS-495 12''



Rossi

For the budget minded this is quite an issue. Previously all companies have taken at least three sides for these magical works. Urania, in fact, took four. Vanguard has been able to effect its economy at some loss in fidelity, a diminution in level, and by leaving out repeats. By and large Rossi leads a good rendition, unmarked by any special understanding of the idiom but also unmarked by excesses. For those who care, regardless of price, let us sing anew in praise of Vaclav Talich and the Czech Philharmonic, whose Urania version is one of the great sets of all time. WB

**GLAZUNOV: The Seasons — Ballet,** B  
Op. 67 B  
L'Orchestre de la Société des Concerts A  
du Conservatoire de Paris under  
Albert Wolff  
London LL-1504 12''



Glazunov

Although written at the turn of the century, "The Seasons" is steeped in the traditions of nineteenth-century French ballet. Wolff, happily, seems content to leave it a period piece and makes no attempt to bring it up to date. What he does is to give it a brilliant and at times iridescent playing on its own terms. The orchestration is elaborate but the texture never becomes ponderous. Its romantic melodies soar and the accompanying orchestral fill jangles and shimmers brightly. Constantly shifting dynamics breathe vigor into the score and climaxes are exciting without being forced. London has provided excellent sound. GLM

**HAYDN: Symphony No. 94** A  
("Surprise") A  
**MOZART: Serenade, Eine kleine** A  
*Nachtmusik, K. 525*  
N. W. D. R. Symphony Orchestra under  
Hans Schmidt-Isserstedt  
Capitol P-18022 12''



Schmidt-Isserstedt

Rich performances of these much-recorded works. Schmidt-Isserstedt's style is close to Bruno Walter's — the same relaxed, loving devotion to the classical line. His orchestra is still in its infancy, but it is a crack ensemble by any standards. Others have done Mozart and Haydn with more vigor and brilliance, but few with such warmth. If you are looking for excitement, you won't find it here — just sweet, lyrical music-making. Isn't that the way it should be in these works? The recording is not so full-bodied as Capitol's domestic issues, but it has a warmth which matches the interpretations. DHM

**HAYDN: Symphony No. 99 in E Flat;** A  
**Symphony No. 102 in B Flat** A  
Vienna State Opera Orchestra under A  
Mogens Wöldike  
Vanguard VRS-491 12''



Wöldike



Unlike his young friend Mozart, Haydn was held in the greatest esteem and handsomely rewarded for his work. A glance at these scores will more than confirm that his fame is justly deserved. Wölkke's love for this music is obvious in his sturdy, sensitive performances of the *E Flat*, with its harmonic surprises (suspended ninths in the horn passages) and enchanting minuet, and the brilliant *B Flat*, with its haunting adagio and uncanny canon writing (first movement). If the other symphonies of this series (VRS-492/93) are played with the same insight, I would recommend them wholeheartedly. AK

**HOVHANESS: Saint Vartan** A  
**Symphony, Op. 80** A  
 M-G-M Chamber Orchestra under A  
 Carlos Surinach  
 M-G-M E-3453 12''



Hovhannessian

This is one of Hovhannessian's most extensive and important works. The composer's art is fully summarized in it, although calling it a symphony is equivocal. There is no such thing as thematic development or formalistic allegiance in this music. The work consists of twenty-four seemingly unrelated pieces, each one a unit in itself with its own sonic, harmonic, and rhythmic material. The means employed are as varied as possible from both the technical and the expressive viewpoints. The whole impresses as a product of genuine creativity which, although ignoring Western traditions, has a definite place in music's general development. AS

**MOZART: Symphony No. 41 in C** A  
 ("Jupiter"), K.551 C  
 Philharmonic Symphony Orchestra of B  
 London under Erich Leinsdorf  
 Westminster W-LAB 7022 12''



Leinsdorf

Somehow the insight into Mozart's writing that has been so characteristic of Leinsdorf's recordings has eluded him here. A breathless first movement is played with such propulsion as to preclude any delicacy of phrasing or subtlety of color. It is indeed a tribute to the excellent orchestra that all of the notes and ornamentations remain cleanly played. There is a more relaxed *andante*, where the music is allowed to sing forth, but all too soon a heavy-footed, thumped-out and accelerated *minuetto* is upon us. The witty closing *allegro* is neatly played, if not given any great character. I'll stick by Bruno Walter. Clear, colorless sound. AK

**MAHLER: Symphony No. 4** A  
 Teresa Stich-Randall, soprano; The B  
 Hague Philharmonic Orchestra under A  
 Willem van Otterloo  
 Epic LC-3304 12''



Stich-Randall

A new recording of a Mahler symphony is always welcome, especially when the source is Holland, thanks to Willem Mengelberg a country second to none in its devotion to this important composer. However, the Dutch capital can boast neither an orchestra nor a conductor equal to those of the nation's largest city, Amsterdam, and the Concertgebouw and van Beinum already have to their credit a fine performance on London. Invidious comparisons aside, van Otterloo tends to sluggishness and is also occasionally willful. Stich-Randall sings neatly in the finale, but I could not detect much expression behind her careful articulation of the notes. ST

**NORDOFF: Winter Symphony** B-B  
**MULLER-ZURICH: Concerto for** A-B  
**Cello and Orchestra, Op. 55** A-A  
 Louisville Orchestra under Robert  
 Whitney; Grace Whitney, cellist  
 Louisville LOU 57-1 12''



Whitney

Nordoff's work is neoromantic and its main element is melody. The composer does have a lyric gift, but whether this is enough to manufacture a symphony is doubtful. While this one is expertly written there is an absolute lack of individuality in it. Only the second movement has definite charm; it bears a French characteristic. Muller's concerto is not much better. It is neoclassical in conception and the motoric element of early Hindemith is very easily detected. Somehow or other a theme from one of Janáček's operas got into the last movement. What it does there is a mystery. AS

**RESPIGHI: Feste Romane; Rossini-** B-A  
**ana** B-A  
 Philharmonic Promenade Orchestra A-A  
 under Sir Adrian Boult  
 Westminster XWN-1B240 12''



Boult

It sometimes seems that there were two Respighis, the composer of tasteless orchestral monstrosities and the tasteful arranger of other men's music. *Feste Romane* is of a piece with *Pines of Rome*, only more so. It is bombastic in the extreme. *Rossiniana* is a gay bouquet of melodic posies based on some long lost piano pieces by Rossini. The prime exponent of the *Feste* was, of course, Tascanini, and his interpretation is not approached by Boult's. However, Westminster's recording is far superior to Victor's, and in music of this type sound is of the essence. WDM

**ROGERS: Leaves from the Tale of C-C-B**  
**Pinocchio** A-A-A  
**HANSON: Fantasy Variations on a A-A-A**  
**Theme of Youth**  
**TRIGGS: The Bright Land**  
 Soloists; Eastman-Rochester Symphony  
 Orchestra under Howard Hanson  
 Mercury MG-50114 12''



Hanson

It gives me no pleasure at all to be forced to say that I found most of this music dreadfully boring. It is conservative, well made, and vacuous of musical idea. Only the Triggs is intermittently interesting. The Rogers, with a badly chosen selection from Collodi's masterpiece, is ripe with sound effects. The Hanson, for strings and piano, was written for the centenary of Northwestern University. The Triggs is a quiet and melancholy picture of the Western lands. Naturally, considering the source, all are well performed and recorded. WB

**SAINT-SAËNS: Le Rouet d'Omphale,** A to B  
**Op. 31; Phæton, Op. 39; Danse** A  
**macabre, Op. 40; La jeunesse** A  
**d'Hercule, Op. 50**  
 Philharmonic-Symphony Orchestra of  
 New York under Dimitri Mitropoulos  
 Columbia ML-5154 12''



Saint-Saëns

This is music for which Mitropoulos has a decided flair. Played with vivid coloration, wonderful excitement, and real conviction, these performances easily outclass those of Fougère (on Angel), whose disc is the only other on LP programming the four symphonic poems together. The unpredictable Philharmonic really responds with admirable articulation and spirit. Columbia engineers provide aural qualities to match the evocative interpretations. AK

**SIBELIUS: Symphony No. 1 in E** B  
**minor, Op. 39** A  
 Philharmonia Orchestra under Paul A  
 Kletzki  
 Angel 35313 12''



Kletzki

The two earliest Sibelius symphonies have shown a lot of vitality despite allegations of their debt to Tchaikovsky. The *First* is almost sixty years old and firmly established in the standard symphonic repertoire; only the *Second* among the Finnish master's seven achieves more frequent performance. Kletzki does not emphasize the romanticism of the work. Without ignoring its lyricism, he plays up its vigor and directness. However, this symphony does have passages that are a temptation to the sound-conscious and the conductor goes along with the recording engineer in providing a hi-fi feast. WDM

**R. STRAUSS: Sinfonia Domestica,** B  
**Op. 53** A  
 Saxon State Orchestra, Dresden, under A  
 Franz Konwitschny  
 Decca DL-9904 12''



R. Strauss

Of course this is not Strauss's greatest work in the genre but, still and all, a day in the life of the Strauss family is far from being dull. Since the late Clemens Krauss gave us a beautiful recording of this piece with the Vienna Philharmonic the present reading may be in the nature of an embarrassment of riches. This is a most expert reading. Konwitschny, too, has the advantage of a really fine orchestra at his beck and call. By this token a choice between the two recordings becomes virtually impossible, although the new one has an edge as to sound, which is very reverberant but also very good. WB

**STRAVINSKY: Firebird Suite** A-B  
**KODÁLY: Mátyás Suite** A-A  
 Concertgebouw Orchestra of Amster- A-A  
 dam under Eduard Van Beinum  
 Epic LC-3290 12''



Beinum

Beinum and his men combine stunning virtuosity with a sensitivity for shading, phrasing, and orchestral color which is thrilling to hear. Ansermet's *Firebird* has long been considered practically definitive, but this one is formidable

competition indeed. Kodály's score is probably more suited to a Cinema-Scope production than anything else. It is colorful in its own way, however, and this rendition almost makes it sound like a masterpiece. It combines all the vitality and excitement of Toscanini and Ormandy, but lends the score more imagination. The recording is clear and full-bodied. **DHM**

**SURINACH: Sinfonietta Flamenca** A-B  
**TURINA: Sinfonia Sevillana** A-A  
 Philharmonia Orchestra of Hamburg A-A  
 under Arthur Winograd  
 M-G-M E-3435 12"



Surinach

Freely improvised rhythms are usually associated with Flamenco music. Surinach has obviously tried to stylize this element; hence, much of the essential nature is lost. This LP premiere is far from disappointing, however. The music is colorful, inventive, and brilliantly orchestrated. The Turina is a pleasant, if somewhat inconsequential work. It draws from the neoclassic Spanish style, in contrast to the Surinach, which is highly personal folklorism. The recording is superb, and the performances seem to do full justice to the rich sonorities and sharp contrasts of both scores. **DHM**

**VAUGHAN WILLIAMS: Symphony** A  
 in F minor A  
 Philharmonic-Symphony Orchestra of A  
 New York under Dimitri Mitropoulos  
 Columbia ML-5158 12"



Vaughan Williams

Using Beethoven's Ninth as his point of departure VW gave us one of the truly great symphonies of our times, and here it is magnificently interpreted. Columbia's engineers have captured every note of this taut, brooding, violent masterpiece in a fine aural perspective which brings out the lucid, meaningful, dynamic shaping of the work by Mitropoulos. It is said that this fourth in VW's symphonic series predicted World War II, an opinion with which the composer is not in concurrence. Whatever the ultimate motivation there is no denying that this is a major expression of a powerful mind. **EJ**

**WAGNER: "Die Meistersinger"** A  
 — Preludes to Acts I and III, Dance B  
 of the Apprentices, Procession of A  
 the Mastersingers; "Lohengrin"  
 — Prelude to Act I  
 London Philharmonic Orchestra under  
 Artur Rodzinski  
 Westminster W-LAB 7028 12" Wagner



This is great music beautifully recorded; but performed, it seems to me, somewhat indifferently. The "Meistersinger" Prelude is taken at a rapid tempo which will probably not suit all tastes. Rodzinski seems to lack the breadth and exultation which make this music some of the finest in all of operatic literature. The other selections fare much better in this respect, although a bit more warmth would do no harm, especially in the "Meistersinger" Act III, and the "Lohengrin." At any rate, Beecham and Toscanini seem to realize the music to a greater degree. The recording is probably as close as a present-day disc can come to tape. **DHM**

**CONCERTOS**

**BRAHMS: Piano Concerto No. 2 in B** A  
 flat, Op. 83 B  
 Alexander Uninsky, pianist; The Hague B  
 Philharmonic Orchestra under Wil-  
 lem van Otterloo  
 Epic LC-3303 12"



Uninsky

Although this performance is not the successor to that venerable one by Horowitz and Toscanini by which all others must be judged, it still is a more satisfying effort than the recently issued Serkin-Ormandy version. Uninsky has a firm technical grasp on this papa of all bone-breakers. Also, he phrases beautifully and has a sensitive way of coloring a melodic line. Conductor and soloist seem to be on one stylistic plane, whereas Ormandy and Serkin seemed at interpretative odds. What is lacking here is the sense of drama that the late Maestro and his brilliant son-in-law so well realized. Clear sound, but the orchestra sounds a bit distant. **AK**

**BRAHMS: Concerto for Violin and** A  
 Orchestra, in D, Op. 77 A  
 Leonid Kogan, violinist; Paris Conserva- A  
 toire Orchestra under Charles Bruck  
 Angel 35412 12"



Kogan

Somebody said once that good things come in threes. That was before the Brahms Concerto reached the recording rooms, for now good performances of this work, like the "Pinafore" Admiral's kin, can be reckoned up by dozens. Not many months ago the Francescatti version was cited here as just about the last word on the subject. It seems to me that it still is, but the scales teeter toward the balancing point. Kogan plays with an almost savage rhythmic drive, and a fine command of tone and "breathing". The orchestra keeps step with him all the way, and Bruck demonstrates a keen sense of climax. One can't ask for much more. **SF**

**BRUCH: Violin Concerto in G minor,** A-A  
 Opus 26 A-A  
**WIENIAWSKI: Violin Concerto in D** A-A  
 minor, Opus 22  
 Mischa Elman, violinist; London Phil-  
 harmonic Orchestra under Sir Adrian  
 Boult  
 London LL-1486 12"



Elman

A fiddler's holiday, these concertos provide melody upon lush melody and the performer needs but match their heart-on-sleeve Romanticism with his own. Elman is peculiarly equipped to do this and superlatively well. The famed Elman tone is predestined for the melodic splendors of this music and the Elman manner for its unabashed virtuosity. Incredibly, although he has ridden these battle-scarred war-horses for half a century, he still plays them with the ardor and conviction of youthful discovery. Ah, such wonderful extraversion! Sir Adrian and his men offer hearty collaboration as do London's engineers. **WDM**

**CHOPIN: Piano Concerto No. 2 in F** A to B  
 minor, Op. 21; 6 solo pieces A  
 Vladimir Ashkenazy; pianist; Warsaw C  
 Philharmonic Orchestra under Zdzi-  
 slaw Gorzynski  
 Angel 35403 12"



Ashkenazy

Of the Russian pianists one has heard on records, Ashkenazy must be singled out for the quality of his poetic playing. Second prize winner of the 1955 Chopin Contest in Warsaw (this album was produced at that time) and winner of the 1956 Brussels Contest, Ashkenazy is not yet 20 years old. But he is already something of a master, with a marked affinity for playing Chopin. His work has an openheartedness that reminds one of Rubinstein and a quicksilver nuance used for poetic purposes not too unlike that of Hofmann. The recording Ashkenazy received is rather poor, but his playing is well worth your time. Go west, young man—if you can. **CJL**

**DVOŘÁK: Cello Concerto in B mi-** A-B  
 nor, Op. 104 A  
**TCHAIKOVSKY: Variations on a** A  
 Rococo Theme, Op. 33  
 Gaspar Cassadó, cellist; Pro Musica  
 Orchestra under Jonel Perlea  
 Vox PL-9360 12"



Cassadó

When Brahms saw the manuscript of this work he exclaimed: "Why on earth didn't I know that one could write a violoncello concerto like this? If I had only known, I would have written one long ago!" His enthusiasm is easy to share. This is a large work in spirit and execution. Its middle movement is profoundly beautiful, the two outside ones almost symphonic in subject and orchestration. Cassadó, making his Vox debut, gives the part everything from melancholy to aggressive brilliance. Tchaikovsky's agreeable set of variations, on a peculiarly uncelloistic theme, presents the instrument in a series of progressively more ambitious appearances. **SF**

**HOVHANESS: Concerto for Viola** A-A-A  
 and Strings, Op. 93 A  
**HINDEMITH: Music of Mourning** A  
**PARTOS: Yiskor ("In Memoriam")**  
 Emanuel Vardi, violist; M-G-M String  
 Orchestra under Izler Salomon  
 M-G-M E3432 12"



Vardi

M-G-M unites a remarkable quorum of viola composers: a New Englander who has turned to Asia for musical direction; a German long resident in America; a Hungarian who went to Palestine to become one of Israel's leading composers. They meet on common ground, for the music they have written for this step-child among solo instruments is of a high order—thoughtful and moving. The newest of the works is perhaps the most impressive; Hovhaness' way with a modal, chant-like melodic line, set in a wonderful variety of textures, opens vistas within a string orchestra seldom encountered. Emanuel Vardi is an intense, skillful, and feeling violist. **SF**

LISZT: Concerto No. 1 in E Flat;  
Concerto No. 2 in A  
Andor Foldes, pianist; Berlin Philharmonic  
Orchestra under Leopold Ludwig  
Decca DL-9888 12''

A-B  
B-A  
A-A



Foldes

These warhorses are dear to the heart of the virtuoso pianist. Played with a regard for their romanticism and drama, they have enough sinew and muscle to make an impression on even a modern audience of musical sophisticates. Foldes mounts the steeds and gallops them up and down the keyboard in a cheery display of virtuosity and ardor. The E Flat is very well done, if not with quite the poise of Rubinstein's recent rendition. The A Major has fewer competitors and this performance has more sweep than any of them. Decca's recording has depth and good balance. Paired this way, this is the disk to own.

WDM

MEDELSSOHN: Concerto No. 1 in G minor, Op. 25; Concerto No. 2 in D minor, Op. 40  
Peter Katin, pianist; London Symphony Orchestra under Anthony Collins  
London LL-1453 12''

B-B  
B-B  
B-B



Mendelssohn

It is unfortunate that these concerti seldom appear on anything but conservatory programs, for there is much in each that is really fine writing. Both, especially the lesser known D minor, have a beautiful, lyric songfulness. If Katin has not yet the poetic vocabulary that he shows signs of attaining, neither was Mendelssohn to write his "Elijah," or his Reformation Symphony for a good many years. The abundant technical skill of the youthful Briton is apparent, as is his feeling for the composer. All in all, neat, tasteful performances. Collins provides firm, well-balanced support.

AK

MOZART: Clarinet Concerto in A, K. 622; Quintet for Clarinet and Strings in A, K. 581  
Benny Goodman, clarinetist; Boston Symphony Orchestra under Charles Munch; Boston Symphony String Quartet  
Rca Victor LM 2073 12''

A-A  
A-A  
A-A



Goodman

When Goodman recorded the Quintet in 1938 it was in the nature of a stunt and displayed Goodman in a far from favorable light musically. Today the picture is altogether different. Gone are the wooden intonation and stiffer interpretation. Obviously he has profited by his lessons with Bellison and Kell. Simply stated, these are the best performances available. The best ever are still those by Kell on 78's. His LP's are unfortunately marked by the excessive vibrato which he has affected of late.

WB

MOZART: Violin Concerto No. 5 in A ("Turkish")  
BACH: Violin Concerto No. 1 in A minor  
Nathan Milstein, violinist; Festival Orchestra under Harry Blech  
Capitol P-8362 12''

A-A  
A  
A



Milstein

It is a perilous distance from the brain to the hands when a performer sets out to re-create a piece of music. One of the remarkable things about Milstein is that the way appears to be absolutely without black, bump, or detour; the most delicate turn of mind finds instant fulfillment in left hand and bow. And this performer's turn of mind is such that a five-note scale passage can sound like a gift from the gods. The Mozart concerto is the last of the five that the composer wrote, all at the age of nineteen, and contains a number of charming surprises. The magnificent Bach makes a good companion work.

SF

RACHMANINOV: Concerto No. 1  
SAINT-SAËNS: Piano Concerto No. 5  
Sviatoslav Richter, pianist; Soviet orchestras under Kurt Sanderling and Kiril Kondrashin respectively  
Monitor MC-2004 12''

B-A  
A-A  
C-C



Richter

Richter is a great pianist and make no mistake. Around the Steinway Building, management headquarters of the concert business, his name has become a gambit for small-talk conversation with virtuosi just back from European tours. Not even the elder Oistrakh, a priori, excited such unrestrained enthusiasm. This new Monitor disc leaves no doubt as to the grounds for such atypical cordiality. Richter simply cannot be too highly praised. His performance of the bone-breaking Rachmaninov is a marvel of artistry and second to none save, possibly, that of the composer himself. In the Saint-Saëns he has no competition. Accompaniments and sonics suffice.

JL

SCHUMANN: Cello Concerto in A minor  
TCHAIKOVSKY: Variations on a Roco Theme  
Pierre Fournier, cellist; Philharmonia Orchestra under Sir Malcolm Sargent  
Angel 35397 12''

B-B  
B-B  
B



P. Fournier

The Schumann work traditionally is given the cold eye by cellists, but a sympathetic performer can draw attention to the best that is in it. In this case, the slow movement reaches out most persuasively to the listener and is likely to linger most warmly in the ear. If the rest of the work is frequently uninspired it nevertheless holds one's attention. The Variations, born of Tchaikovsky's love of Mozart, grow more appealing with each hearing, due possibly to the very Tchaikovskyan orchestration — inventive, vital and bright. Fournier's performances are entirely competent, yet without much individual stamp.

SF

R. STRAUSS: Burleske  
FRANCAIX: Concertino  
HONEGGER: Concertino  
Margrit Weber, pianist; Berlin Radio Symphony Orchestra under Ferenc Fricsay  
Decca DL-9900 12''

A-B-A  
A-A-A  
A-A-A



Fricsay

While each of these works has been recorded previously, this is the first time that they are issued together. The idea is very sensible, for their common characteristics are lightheartedness and transparency in texture. One does not have to insist upon the easygoing qualities of the Strauss; neither upon the amusing mannerisms of the Francaix. Honegger's Concertino is one of his rare works by which he really had a right to be part of "Les Six". In fact it is the only instance in which he uses jazz elements in a very subtle manner. The performances are absolutely outstanding.

AS

TELEMANN: Concerto for Viola in G  
MOZART: Divertimento, K.136; Eine kleine Nachtmusik, K.525  
GABRIELI: Two Canzone  
Heinz Kirchner, violist; Stuttgart Chamber Orchestra under Karl Münchinger  
London LL-1321 12''

A  
A  
A



Telemann

If all collections of short works were half as well programmed as this one, how unbegrudging would be their purchase! The familiar Mozart Serenade is done in a leisurely fashion, with a little less electricity than in some versions; the Divertimento is clearly focused and bright. The too-rarely-heard Viola Concerto of Telemann (probably the first of its kind) is very well played by Heinz Kirchner. Gabrieli's Canzone for Double String Orchestra bring to mind his counterparts for brass choirs, and they are just as absorbing to listen to. Altogether, a delightful record. The sound matches the programming in quality.

SF

## CHAMBER MUSIC

BRAHMS: Sonata No. 1 in G, Op. 78; Sonata No. 2 in A, Op. 100  
Aaron Rosand, violinist; Eileen Flisser, pianist  
Vox PL 10,090 12''

A-A  
A  
A



Rosand

What is the sixth sense that tells a musician how to do more than the composer is able to indicate on the page — that turns a competent performer into a creative one? No one can say, but almost anyone can hear it in operation, and there is no difficulty in recognizing it here. Comparisons are odious, but they are the stuff reviews are made of: Rosand seems to me to possess this sense, in relation to Brahms, to a slightly lesser degree than Stern, and a bit more abundantly than Leonid Kogan (see Sept.-Oct. 1956). Rosand emulates Stern's attention to the architectural aspects, and almost equals his telling way with individual phrases.

SF

COWELL: Set of Five  
IVES: Violin Sonata No. 4  
HOVHANNES: Kirghiz Suite  
Anahid and Maro Ajemian, violinist and pianist; Elden Bailey, percussion (in the Cowell)  
M-G-M E-3454 12''

A-B-B  
A-A-A  
A-A-A



Cowell

Cowell's Set of Five is a fascinating piece. The contrasting elements of

unimaginative melodic materials, which derive obviously from Bach, Beethoven, and others, and those of the composer's original and imaginative sonic world (by means of various groups of percussion instruments) result in a work with an eerie atmosphere of its own from which, however, humor is not absent. The other works are much less engaging. Ives' Sonata is pure Americana without any of the composer's prophetic originalities. The medium of violin and piano does not seem to fit Hovhaness. Performances and sound are excellent. AS

**FAURÉ: Sonata in A, Op. 13** A-A  
**FRANCK: Sonata for Violin and Piano** A  
 B  
 Lola Bobesco, violinist; Jacques Genty, pianist  
 London LL-1549 12"



Fauré

From the abundant flow and sweep of Fauré's Sonata to the rugged terrain of Franck's is a step of some length, and one which Lola Bobesco proves she can take with ease. She maneuvers the sailing melodies of Fauré with the grace and confidence of a weathered seafarer, and projects the boldness of the companion work with an equal breadth. Her tone is on the small and wiry side, without much variety, but for some reason this does not hinder her musical communication. The pianist keeps apace, and shows to particular advantage in the Franck. The recorded sound is adequate. SF

**SCHUBERT: Fantasy in C, Op. 159** A-A  
**SCHUMANN: Sonata No. 1 in A minor, Op. 105** B  
 B  
 Anahid and Maro Ajemian, violinist and pianist  
 M-G-M E-3383 12"



Schubert

The unbroken length of Schubert's Fantasy combined with the melancholy of Schumann's A minor Sonata add up to a pretty rigorous program, from where I sit. Perhaps the session would have communicated more if the violin half of the Ajemian team and the recording engineers had managed, between them, to produce a more pleasing sound. But Miss Ajemian's high notes come at you like a hypodermic needle; whether she is entirely responsible is difficult to say. It is evident, however, that she has not the sheer beauty of tone to spin out the legato Schubert line in the manner to which it is accustomed. SF

**SMETANA: Quartet No. 1 in E minor, ("From My Life")** A-A  
**BORODIN: Quartet No. 2 in D** A  
 Endres Quartet  
 Vox PL-10190 12"



Borodin

If you have ever been curious about the kind of quartet writing accomplished by composers who are not famous primarily for their music in that exacting field, this record provides rewarding information. The Endres Quartet performs with a kind of vigorous understanding these two most dissimilar works: the Smetana, with its "unquartetish" reliance on solo melody with accompaniment, and Borodin's tight-woven and conscientiously organized four-voice conversation, which achieves a beauty in the slow movement that is surely a high water mark in quartet composition. A fine pair of works off the beaten track, and well worth the excursion. SF

**R. STRAUSS: Cello Sonata in F, Op. 6** A-A  
**BRAHMS: Cello Sonata in E minor, Op. 38** A  
 Joseph Schuster, cellist; Friedrich Wuehrer, pianist  
 Vox PL-9910 12"



Schuster

Strauss keeps events moving quickly in each movement through the ramifications of classical plot, by turns dramatic, mellow, coy, and humorous. He knows his business well, and with your eyes closed you might guess Beethoven in the Allegro. The Brahms is dark-hued and brooding; the cello has some fine moments of lamentation, and in a typical veering toward counterpoint in the finale the piano moves to center stage. Both performers deserve the position, for they collaborate in excellent style. Schuster in particular is impressive — he sails into the high registers with poise and, what is more, good pitch. SF

**VITALI: Chaconne** A-A-A  
**CASTELNUOVO-TEDESCO: "The Lark"** A-A-A  
 A  
**FAURÉ: Sonata No. 1 in A, Op. 13**  
 Jascha Heifetz, violinist; Richard Ellsasser, organist; Emanuel Bay and Brooks Smith, pianists  
 RCA Victor LM-2074 12"



Heifetz

If there is another point on the compass of violin-writing besides the three singled out here, I cannot think of it. With Vitali, the practice of a pure "string style" which aimed at making the instrument sound well and did not shun an idiomatic sequence or two in order to do it; secondly, the concept of such a composer as Fauré, emphasizing the singing, vocal capabilities of the violin; and, complementing these, it's use in a pictorial, almost programmatic sense (not unknown to Vivaldi, of course) to depict a bird that fairly darts into vision. All three different, yet all thoroughly violinistic. Performances top-notch. SF

## OPERA

**CORNELIUS: The Barber of Bagdad** C  
 Oskar Czerwenka, Gerhard Unger, Elisabeth Schwarzkopf, Grace Hoffman, Nicolai Gedda; Philharmonia Orchestra and Chorus under Erich Leinsdorf  
 Angel set 3553 B/L 2-12"



Schwarzkopf

Few operatic performances on stage or off can boast such an outstanding all-star cast as this one of an altogether delightful work. The Barber himself (bass Czerwenka) sings with ease throughout his wide range whether in dramatic or patter phrases; his final scene in Act I is a *tour de force*. The notable second-act trio as sung by Miss Schwarzkopf, Gedda, and Czerwenka, is a high point among the many achieved by all — most frequently by Leinsdorf. The Mottl overture included at the end only serves to point up the fine re-creative work done by Max Hasse on the original score. RM

**ROUSSEAU: Le Devin du Village** C  
 Janine Micheau, Nicolai Gedda, Michel Roux; Louis de Froment Chamber Orchestra under Louis de Froment  
 Angel 35421 1-12"



Froment

If this pastoral work had received such an expert performance on all counts and at all times as it does in this album, it seems unlikely that any pressure could have forced its deletion from the French operatic repertoire as old-fashioned, in spite of the fact that it does echo the era of the composer. Cast, ensemble, and orchestra combine to make this one of the most delectable recordings on the market. It would be querulous quibbling to mention the fact that the bass has a tendency to flat at times, or that the sopranos in the ensemble to sound rather tentative. On the whole, a delight. RM

**SMETANA: The Battered Bride** A  
 Vilma Bukovetz, Miro Grajnik, Latko Koroshetz, Yanez Lipushchek, Yekoslav Yanko; Choir and Orchestra of the Slovenian National Opera under Dimitri Gebré  
 Epic set SC-6020 3-12"



Smetana

An authentic and spirited performance, well balanced and alive in quality, of this favorite Czechoslovakian folk opera. Gebré conducts with verve and a special sympathy for the national quality of the rhythms and melodies. It is a change for our ears to hear the role of Vasek sung in a lyric rather than farcical manner or the marriage contract scene given a *marcato* treatment; or for the hero, Jenik, to emerge as a dramatic tenor. The singing is enjoyable, in general, with bass Koroshetz being especially good as the marriage broker. The best recording of this work to date. RM

**R. STRAUSS: Salome: Final Scene** B-A-A  
**BEETHOVEN: Ah, perfido** A-A-A  
**WEBER: Oberon — Ozean, du Ungeheuer** A-A-A  
 Inge Borkh, soprano; Vienna Philharmonic Orchestra under Josef Krips  
 London LL-1536 12"



Borkh

Apart from her presence in the complete *Turandot*, it appears to be the fate of Inge Borkh to be heard on records only in excerpted miscellany. A while back she was featured in a Richard Strauss grab-bag from RCA. Here she duplicates the big scene from "Salome" which was heard in the previous collection. In addition, we hear Beethoven's early, dull concert aria and Weber's late and far from dull apostrophe to that old devil sea. Miss Borkh again proves herself excellent in every respect, so good that I must repeat my prayer on behalf of a complete *Elektra*. We need one badly. Please, London ST

**STRAVINSKY: The Soldier's Tale** A  
 (L'Histoire du soldat — in English)  
 Robert Helpmann, Terence Longdon, Anthony Nicholls; Ensemble under John Pritchard  
 RCA Victor LM-2079 12"



Stravinsky

A first-rate presentation of Stravinsky's masterwork in its originally conceived theatrical version, in which the elements of music, drama, and speech each contribute to the overall dramatic poignancy. This recorded performance is the one which was given at the Edinburgh Festival in 1954 in the very effective English translation by Michael Flanders and Kitty Black. A deep understanding of this extraordinary work is apparent on the part of all the participants. The music itself is well played, but without the incisive rhythm and bite of Stravinsky's own performance of the Suite. AS

**TCHAIKOVSKY: Eugene Onegin** A  
Soloists, Chorus, and Orchestra of the Belgrade National Opera under Oscar Danon A  
London set XLLA-41 3-12"



Tchaikovsky

The Yugoslavs make the most of this melodic cornucopia with stylish characterizations, generally fine singing, and admirable orchestral support. The vocalism of Valeria Heybalova (Tatiana) is unsteady, but she is warm and appealing; there is a minimum of Slavic vibrato and hardness. Not so Dushan Popovich, who lends little refinement to the title role. Drago Startz (Lensky) is outstanding, but Miro Changalovich is a most acceptable Gremin. And one Biserka Tzyveych (what a name for a singer!) is an effective Olga. Over-all there is a right "feeling" about the performance that offsets its faults. WS

**VERDI: Aida** A  
Herva Nelli, Eva Gustafson, Richard Tucker, Giuseppe Valdengo, Norman Scott, Dennis Harbour; Chorus and NBC Symphony Orchestra under Arturo Toscanini B  
RCA Victor set LM-6132 3-12"

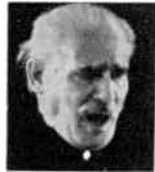

Toscanini

The opera in which the unknown young Italian cellist made his sensational debut as an operatic conductor in 1886 is the one with which he makes this posthumous bow on records as the most famed musician of our time. He always demanded perfection not only from himself and his musicians, but from singers as well. This recording represents one of the fortunate instances in which everyone concerned rose to new heights. As a faithful reproduction of the memorable broadcasts of March and April, 1949, this album is a valuable item in the musical legacy left us by the late Maestro. RM

**VERDI: Un Ballo in Maschera** B  
Giuseppe di Stefano, Tito Gobbi, Maria Callas, Fedora Barbieri, others; Chorus and Orchestra of La Scala under Antonio Votto B  
Angel set 3557 3-12"



Callas

The surprise here is the exceptionally fine singing of Di Stefano as Riccardo, which seems tailor-made for his talents. Fedora Barbieri, too, is in particularly good voice here as the fortune-teller Ulrica. Although Miss Callas exhibits her customary artistry as Amelia, there is evident strain and a disturbing vibrato in her upper tones. Baritone Gobbi negotiates some of his top notes with effort also, but he gives a moving interpretation of the familiar *Eri Tu* aria. The choruses, when not distorted by faulty engineering, are on a par with the fine performance of the orchestra. RM

**VERDI: Il Trovatore** A  
Maria Meneghini Callas, Giuseppe di Stefano, Fedora Barbieri, others; Orchestra and Chorus of La Scala under Herbert von Karajan B  
Angel set 3554 3-12" (5 sides)



Karajan

Comparison is inevitable with the earlier and superb two-record RCA Victor Album: Miss Callas is at her vocal best (as was Miss Milanov); Di Stefano is excellent as Manrico (though less thrilling than Jussi Bjoerling); Panerai is good (but no match for Leonard Warren); Miss Barbieri, the Azucena in both performances, is superior in this new release. The chorus and orchestra are magnificent under the baton of Herr von Karajan (Renato Cellini's conducting is good but less dramatic), and particularly effective due to the higher recording level than is usual on Angel. RM

**VERDI: Otello** A  
Nicolo Fusati, Apollo Granforte, Maria Carbone, Tamara Beltacchi, Piero Giardi, La Scala Chorus and Orchestra under Carlo Sabajno C  
RCA Camden set CCL-101 3-12"



Verdi

The main appeal of this recording, reclaimed from the 1930's, is its popular price. The best performance is given by Granforte as Iago. This is true both

interpretatively and vocally. The tenor Fusati is less successful as Otello. Maria Carbone, most comfortable in piano passages, is at her best in the final scene. Today's microphone-wise recordings can boast better balance as a rule, with truer fidelity and greater clarity, but they often lack the in-effectually realistic effect of a live stage presentation which is one of the attributes of this revived entry. RM

**WAGNER: The Flying Dutchman** B  
Hermann Uhde, Astrid Varnay, Ludwig Weber, Rudolf Lustig; Bayreuth Festival Chorus and Orchestra under Joseph Keilberth C  
London set XLLA-42 3-12"



Varnay

An adequate performance of the "Dutchman" is yet to be recorded. Neither this version, which bears the Bayreuth imprimatur, nor the previous Decca effort is representative of average prewar Wagnerian standards of today's best. Indeed, by all accounts, this same 1956 production fared considerably better when conducted by Knappertsbusch and when the Dutchman was Hotter. Keilberth inspires no one much, and Uhde has been far more impressive on other occasions. Varnay is miscast, I believe; Santa wants more flexibility and a lighter touch. Even Weber is a bit under par. The important choral portions are, however, beautifully sung. CJL

**De los Angeles in Opera** A-B  
(Arias from Otello, Ernani, La Wally, others) A-B  
Victoria de los Angeles, soprano; Orchestra of the Rome Opera House under Giuseppe Morelli B  
RCA Victor LM-1920 12"



De los Angeles

De los Angeles has a lyric soprano voice of velvety richness at the bottom and extreme brightness at the top, in addition to an admirable technique that enables her to deal successfully with scale passages that well might daunt a lighter voice. Her conception of the music here recorded gives first attention to musical rather than dramatic meaning. As a result, arias such as the one from "Cenerentola" that make points primarily musical are indeed convincing, while those (such as the Mefistofele aria) that demand a feeling for character or situation seem to miss the point. Sound is good throughout. JB

**Jan Peerce in Opera** A-B  
Jan Peerce, tenor; various orchestras B  
RCA Victor LM-2055 12"



Peerce

Peerce's dependability and thoughtful musicianship, revealed throughout a long operatic and recording career, are here summarized in a disc that is made up of highlights from his previous endeavors. A robust voice and a serious mind are his assets, and one cannot easily put a finger upon his liabilities. These lie generally in the realm of those intangibles that generate excitement — perhaps a quality of sensuous beauty that is lacking in the voice itself, perhaps an inability to abandon the self in a sweeping phrase or a moment of dramatic intensity. A skilled craftsman-artist, rather than an intuitive one, is at work. Very good sound. JB

**Famous Operatic Arias** A-B  
Roberta Peters, soprano; Rome Opera House Orchestra under Vincenzo Bellezza and Jonel Perlea B  
RCA Victor LM-2031 12"



Peters

Gilda, Lakmé and other coloratura characters receive the attention of Miss Peters on this disc. To them she gives her brilliant voice, breathtaking agility and pure intonation. In addition, a dispassionately correct and thoughtful reading is hers, as well as carefully cultivated diction. What is missing is abandon and warmth and a firm conviction about the meaning of all those scales. That they can be more than pleasant sound has been abundantly shown in the past; it remains for this gifted singer to discover what can be done with them. Then she will become not the phenomenon she was, or the dependable routinist she now is, but an artist. JB

## VOCAL MUSIC

**BACH: 9 Cantatas** A  
Gunthild Weber, soprano; Helmut Krebs, tenor; Herman Schey, bass; others, various choruses and orchestras under Fritz Lehmann A to C  
Decca Archive ARC-3063/7 5-12"



Bach



All of these performances were made available previously by Decca, but in that distant time when the label's domestic pressings were not yet up to industry standards. It is a joy, therefore, to welcome these sonically smooth Deutsche Grammophon imports. The contents, in numerical order: "Wie schön leuchtet der Morgenstern" with "Christ lag in Todesbanden", "Ich hatte viel Bekümmernis", "Es erhub sich ein Streit" with "Gott, der Herr, ist Sonn' und Schild", "Brich dem Hungrigen dein Brot" with "Herr, gehe nicht ins Gericht", and "Vergnügte Ruh, beliebte Seelenlust" with "Meine Seele rühmt unpreist". JL

**KRIEGER: Neue Arien (12 songs)** A  
Margot Guillaume, soprano; Hans-Peter Egel, alto; Johannes Feyera- A  
bend, tenor; Fritz Harlan, baritone; Kammermusikreis Scheck (cham- A  
ber-music ensemble); Fritz Neumeyer, harpsichordist and director  
Decca Archive ARC-3055 12''

Archive has produced a real treasure with this recording. Adam Krieger (1634-1666), musician and poet, is said to have been the first composer of the German solo-lied to combine words and music with satisfying unity, and these twelve songs (which bear no resemblance to what we think of as lieder today) indicate that he was truly inspired. Some are solos, others call for combinations of voices; all feature instrumental interludes between stanzas. The performances are beautiful, blending stylistic and expressive elements in just the right proportions for 20th-century ears. The Baroque era never seemed lovelier. AH

**E. MARTIN: Sacred Mass for the Kings of France** A-A  
A-A  
**LOTTI: Crucifixus** R-R  
Soloists, Les Chanteurs de Saint-Eustache under R. P. Emile Martin  
Concord 4001 12''



On the Ultraphonic Label you will find the same performances of both the Mass and the brief *Crucifixus* identified as the work of Antonio Lotti (1667-1740). Upon its première a few years ago the Mass was attributed to the even earlier Estienne Moulinié, a *ballet de cour* composer employed by Louis XIII's brother. The truth of the matter is that the Mass was written by Révérend Père Emile Martin, who conducts it here. He "unearthed" it for the 1951 gala commemorating the 2000th anniversary of the founding of Paris, and it was acclaimed a masterpiece. When the musicologist Félix Raugel accused him of fraud, he readily confessed. The hoax in no way diminishes the worthiness of the Mass, which is a superbly sonorous evocation of the splendors associated with that galaxy of musical geniuses who founded the French tradition. JL

**SCHUMANN: 8 Songs** A  
**SCHUBERT: 5 Songs** A to B  
Kirsten Flagstad, soprano; Edwin A  
McArthur, pianist  
London LL-1546 12''



Flagstad

Flagstad's voice remains — she is in her sixties — quite incredibly beautiful. To be sure, the top (F sharp and above) has not the control of old, but what is lost in vocal sureness is more than compensated for in the wealth of meaning and nobility of delivery found in such as Schumann's *Meine Rose* and Schubert's *Des Mädchens Klage* (what songs!). I find her conception and coloring a bit heavy in *Der Nussbaum* and *Die Soldatenbraut*. McArthur's accompaniments are rather ordinary. The sound is clear and realistic. AK

## KEYBOARD MUSIC

**BARTÓK: Allegro barbaro, 8 Roumanian Folk Dances, Suite Op. 14, 9 Piano pieces, 3 Burlesques** A to C  
B  
A  
Edith Farnadi, pianist  
Westminster XWN-18217 12''



Bartók

Since Bartók has been canonized it is almost heretical to suggest that his each and every work was not writ with quills dipped in holy water. Some of these pieces are quite dull; in fact, none of them is the stuff of which Bartók's present adulation has grown. For collectors of Bartók this disc will be of interest, but more academically than esthetically. Miss Farnadi plays the pieces well enough, but they never seem to get off the ground. There is none of that elusive quality called inspiration. Soundwise the recording is very good. OD

**BEETHOVEN: Piano Sonatas, Op. 109, Op. 110, Op. 111.** A  
Friedrich Wüher, pianist A  
Vox PL-9900 12''



Wüher

Wüher has captured the plasticity, the romantic pulse within the logistics of a Classical mind in the last Beethoven Sonatas. He treats all three with great breadth, yet never neglects the minutest detail as he sweeps along in a torrent of sound. It is quite a musical experience to listen to these works at one sitting. The emotional impact of a profound creator emerging from the sound-track is an inspiration to those of us who walk in his shadow. There is a glow to the recorded sound that turns even the most stark registration into a balanced sonority. EL

**BEETHOVEN: Sonatas in C minor, Op. 111; F minor, Op. 57 ("Appassionata")** A-A  
B-B  
A-A  
Ernst Levy, pianist  
Unicom UNLP-1034 12''



Levy

Levy's playing has a ruggedness that becomes the Op. 111 very well. He is a sensitive artist, lyrical and forceful, and shows a fine sense of form, so important in the variations of the second movement. Had Levy approached the *Appassionata* as he did the C minor, the worst that might be said about his performance would be that it lacks verve. Unfortunately, he adds exclamation points in lieu of tension and the flow of the music is broken without its drama being heightened. The excellence of the recording is a virtue compounded of M.I.T. acoustics and the skill of engineer Pefer Bartók. WDM

**BRAHMS: Variations and Fugue on a Theme by Handel; Intermezzo in E flat minor; Rhapsody No. 2 in G minor** A-A-B  
B-B-C  
A-A-A  
Witold Malcuzyński, pianist  
Angel 35349 12''



Malcuzyński

Malcuzyński is one of the most erratic pianists of the day. Each part of his equipment is just as apt to surprise as to dismay on any given occasion. He is in good form in the Brahms-Handel variations and favored by the best recording this work has yet received. But he is overcareful and his playing thereby misses some of the impulsiveness requisite to a number of the variations. Some wayward rhythm and unaccountable changes of pace disturb the flow of the two remaining pieces. The Rhapsody is more afflicted in this respect than the Intermezzo. Excellent piano tone will make this recording a favorite among hi-fi fans. CJI

**CAMPOS: 50 Dances** A  
Jesús María Sanromá, pianist A  
Balseiro set BLE-3000 4-12'' A  
Sanromá



This limited edition is being released in conjunction with the centenary of the birth of Juan Morel Campos, the pre-eminent Puerto Rican composer whose fame — unaccountably on all evidence — seems to have died with him in 1896. The redoubtable Sanromá once recorded a sampling of this collection for RCA Victor, but that shellac album is long since extinct. Subsequently he drew on the same corpus for an LP (LSM-2) issued for export by the same label. Now, just in time for the Casals Festival, the San Juan entrepreneur Juan Ramón Balseiro has assembled eight sides of these delicious miniatures, newly taped under ideal studio conditions in New York. "Chu-Chu" tosses them off with the aplomb that is part of his superior artistry, the latter being magnified by his special affection for these testaments of the cultural tradition to which he is heir. JL

**CHERUBINI: 6 Piano Sonatas** B  
Vera Franceschi, pianist B  
Westminster XWN-18276 12'' A  
Franceschi



Luigi Cherubini wrote all six of these sonatas in 1800, when he was twenty years old. Each is in two movements. Considering the craftsmanship shown in these pieces by the young composer, it is surprising that he never again wrote a piano sonata (he lived to be an octogenarian). Miss Franceschi plays with Classic poise and polish that barely avoid the point of primness. Her negotiation of the rococo embellishments which abound is nicely accomplished and her tone is pleasant and well recorded. WDM

**DEBUSSY: Préludes (Book 1)** A  
Guiomar Novaes, pianist B  
Vox 10,180 12'' A  
Novaes



With the passing of Walter Gieseking, one finds a gap that cannot be filled. The piano music of Debussy was his province in our time. That much said, one can report that Novaes is one of the few contemporary pianists skilled enough to draw from the *Préludes* sufficient color. Her playing, indeed, will give much pleasure. But less than ideal is her rhythm. She brings to this music a kind of freedom that is more appropriate for the nineteenth-century Romantic literature in which she has won fame than it is for these remarkable works, which require a greater measure of Classic restraint. **CJL**

**FRANCK: Chorales, Nos. 1 in E, 2 in B minor, 3 in A minor** **A**  
**VIVALDI-BACH: Concerto No. 2 in A minor (BWV 593)** **A**  
 Jeanne Demessieux, organist  
 London LL-1433 12"



Demessieux

Both as to music and performance, this recording should not be missed. Demessieux is an organist whose colorful, expressive registrations and virtually flawless technique seem to be equally fine in either the Classical or Romantic schools of playing. A great deal of credit must go to the instrument at Victoria Hall, Geneva, which is rich and mellow in the Franck and clear and distinct in the Bach. The only flaw is that some of the pedal notes are slow to speak. This organ is of the larger variety, but the music is not lost in a mass of echo. A recording notable for its balance and clarity. **DHM**

**MENDELSSOHN: Songs Without Words (complete)** **A to B**  
**B to C**  
 Ania Dorfmann, pianist **A**  
 Victor LM-6128 12"



Dorfmann

This is music which is mainly Italian in form but German in spirit. The line and phrasing are constructed as if to be sung by the voice rather than instrumentally. The one thing that this music is decidedly not, either in style or structure, is Chopinesque. Unfortunately, it is just this approach with its nuances and rubati in mid-phrase, that Dorfmann employs. All the works are conceived within a small frame as is her tone, the greater success being with those more subdued in feeling such as Op. 19, No. 6 (*Venetianisches Gondellied*), Op. 30, Nos. 4 and 5, and Op. 38, No. 3. There are more inherent rhythmic contrasts and dynamic colorations than are here discovered. Fine piano sound. **AK**

**RAVEL: Mother Goose, La Valse, Bolero** **A to B**  
**B to C**  
**DEBUSSY: Nuages, Fêtes** **B**  
 Ferrante and Teicher, duo-pianists  
 Westminster XWN-18219 12"



Debussy

Despite the fact that the transcriptions are Ravel's own, any sensible person must know that nothing less than a full orchestra can supply the colors, shading and percussion that these scores demand. At best, any two-piano renditions tend to be pale facsimiles. Here they are far less. Replete with abundant liberties, and played like a dainty Chopin trifle, the entire point of *La Valse* is missed. *Nuages* has all the subtlety of the *Third Man Theme*. Only *Ma Mère L'oye* fares a bit better, but what happens to *Fêtes* and the *Bolero* is better left unsaid. The reproduction is well balanced and clear. **AK**

**Iturbi Treasures** **B-C**  
 José Iturbi, pianist **A-B**  
 Angel 35347 12" **A**  
 Iturbi



Seven pieces make up this hoard. The Chopin *A Flat Polonaise* and Debussy's *Clair de lune* are the most familiar and they are played with dash in the first and sighs in the second. A Granados *Allegro de Concerto* is a digital display piece that demands only agility. Mozart's *Fantasia in D minor, K. 397*, is a reminder of Iturbi's affinity for Classicism, while two Schubert *Moments musicaux* permit him moments of romantic tenderness. The most interesting item is the *Funeral March* from a Sonata by Filip Lazar which Iturbi introduced here in 1931, five years before the composer's death. Its mood and integrity cause one to regret the omission of the other movements. **WDM**

## FOLK MUSIC

**The Rising of the Moon** **A**  
**The Lark in the Morning** **A**  
 Joan, Liam, Tom, and Patrick Clancy; Sarah and Tommy Makem; others **A**  
 Tradition TLP-1006, -1004 each 12"



Welcome to yet another brave new folk music label, and good luck to it. Tradition's initial list is ambitiously diversified. I liked very much these two programs of Irish material, much of it new to records. As the album titles imply, the first is a miscellany of the ringing rebellion songs that are still heard in all the pubs of Erin, the second a collection of songs and dances from the far counties. The participants are of course themselves sons and daughters of the old sod, so that there can be no questioning the authenticity of anything. The singing is not uniformly good, but no matter. The quality of sound, happily, is first-class throughout. **JL**

**Richard Dyer-Bennet** **A**  
 Dyer-Bennet DYB-1000, -2000 2-12" **A**  
**A**



Folk music is not any particular kind of music, but the quality of all music in its essential expressive nature. Hence the staying power of folk songs and ballads, for they contain a maximum — in the simplest and most direct terms — of the fundamental and the timeless, along with a minimum of the more conscious embellishments. Those gathered here are a revelation in minstrelsy. How easy it is in handling such material to make errors of taste, such as a slip in the addition of accompaniment or of a harmonic progression (even by implication) not of the proper era or alien to the melody. Balladeer Dyer-Bennet does not err. His guitar playing emanates naturally from whatever song he sings. His vocal style, his taking of liberties within a discipline, is in an old and fine tradition. Superb recordings. **PG-H**

**Odetta Sings Ballads and Blues** **A**  
 Tradition TLP-1010 12" **A**  
**A**  
 Odetta



"Spectacular" is the first word that occurs to one on hearing Odetta. And yet this adjective suggests something calculated for effect, achieved with technique, whereas Odetta's singing is just the opposite — earthy, hugely robust, terribly moving, essentially evocative of life as it is lived. The voice seems to have infinite resources of volume and timbre, so that *If I Had a Ribbon Bow* is a million miles away from the tone and manner of *Easy Rider*, for instance. I am not saying that hers is a freak voice, only that it is an all-encompassing one. Odetta is really terrific. **PG-H**

## MISCELLANY

**Brass and Percussion** **A-C**  
 Morton Gould and his Symphonic Band **A**  
 RCA Victor LM-2080 12" **A-C**  
 Gould



Besides eight of John Philip's best jingoisms we have Bagley's wheezing but still lively *National Emblem* and other marches by Goldman and Gould himself. I especially liked Gould's own arrangement of the *Battle Hymn of the Republic*. The renditions are all de luxe without ever being slick; the orchestra really is excellent. Mostly the engineering is excellent — recorded in Manhattan Center? — but a trick effect in Sousa's *On Parade* is a disaster of the first magnitude. Otherwise a very entertaining disc. **WB**

**'ere's 'olloway** **A**  
 Stanley Holloway with the Loverly Quartet and an orchestra under Arthur Lief **A**  
 Columbia ML-5162 12" **A**



Holloway

The English music hall of pre-World War I days is brought to hi-fi life on this record. The songs that pleased the gallery gods of London are given a lively go by Holloway and his associates. There is a lot of Cockney humor — and corn — in the material, which consists of seventeen items, including such titles as *My Ward! You Do Look Queer!* (which did not mean then what it might mean now), *I Live in Trafalgar Square*, *I'm Shy*, *Mary Ellen*, *I'm Shy* and *Eving's Dorg 'Ospital*. Holloway sings with attractive expressiveness; he has a wonderful sense of timing and his enunciation is predicated on the proposition that the words must be heard — and understood. A pleasant hour. **WDM**

**Music To Awaken the Ballroom**  
Beast  
The Brute Force Steelband  
Cook 1048 12"

B  
A  
A



I'm really crazy about this incredibly mellow type of music, and it is very easy to recommend to your attentions this steelband recording, just as I have the others in this same pattern that Emory Cook has released. For this disc, the mighty Brute Force band — the best of all the Antigua steelbands — plays *Say Si Si, Take Me, Take Me, Teach Me Tonight, Meringo Jenny, Take Her to Jamaica Where the Rum Comes From, Beastly Meringue, Now Is the Hour, Carnival, Pierconela, Perfidio, Man Smart, Woman Smarter, Steelband Invention, Gloria, Green Faced Man, and Go March*. Lovely music, all of it and so colorful. FR

**New Jazz Conceptions**  
Bill Evans  
Riverside RLP 12-223

A  
A  
B



Evans is a 27-year-old pianist first prominent last year with the Tony Scott quartet. He swings, has a modern conception, is a composer of merit (this LP includes four originals), and will undoubtedly develop a fully mature style and personality. On several tracks Paul Motian's overloud drumming mitigates the enjoyment; Teddy Kotick's firm bass, however, provides a solid anchor. Tunes include Shearing's *Conception*, Dameron's *Our Delight*, Ellington's *I Got It Bad*. Evans is the freshest addition to Riverside's illustrious piano roll of honor, which covers all territory from Scott Joplin through Thelonious Monk, a span of more than a half-century. LF

## JAZZ

**Hi-Fi Suite**  
Feather-Hyman Orchestra  
M-G-M E-3494

A  
A  
A



Feather

Now, our own Leonard Feather has not gone and got himself a band. It's just a name for the virtuosic pickup group he assembled with Dick Hyman to record their music. And "must" music it is for all aficionados of the woofer and the tweeter, not to speak of those who are interested in exploring the jazz esthetic without regard for semantic extra-musicalities. The latter may be inferred (but they are better heard) in the several subtitles, which include *Feedback, Bass-Reflex, Reverberation, Squawker, Flutter, and Wow*. The gimmicky aspects notwithstanding, this is worth your attention. JL

**A String of Swingin' Pearls**  
(Vault Treasures from the Swing Thirties)  
RCA Victor LPM-1373 12"

A  
A  
R



Teagarden

Pure gold. Sixteen items by various groups dating from the 1930's, all but two enlisting something smaller than standard swing band (four rhythm and saxes, five brass). Included are such rarities as two numbers by Casa Loma arranger Gene Gifford, a pair of Wingy Manones with tenor man Chu Berry (try *Limehouse Blues*), four shots of Bud Freeman's Chicagoland friends (hear *The Eel*) and Bunny Berigan (miraculously on seven numbers including the Fletcher Henderson arrangement of *Blue Lou*). Also present and swinging are Jack Teagarden, Frankie Trumbauer, B. Goodman, Max Kaminsky, D. McDonough et al. These are real collectors' pieces — an education for the novice, joy for connoisseurs. CG

**Tenor Conclave**  
Hank Mobley, Al Cohn, John Coltrane,  
Zoot Sims  
Prestige 7074

B  
A  
B



Cohn

Don't let the production slips bother you (the tunes *Bob's Boys* and *Tenor Conclave* are switched on label credits, and the cover design and photos are something short of professional); the important factor is the music, and if you dig tenor saxes, here's where you can dig deep. Coltrane has the biggest sound, Zoot the littlest, but all four are expert modernists and the accompanying rhythm section leaves no room for improvement (Red Garland, piano; Paul Chambers, bass; Art Taylor, drums). Eight shorter tracks would have been preferable to these four extra-long items. Ira Gitler's program notes are succinctly informative. LF

**J. R. Monterose**  
(with Ira Sullivan, Horace Silver, Wilbur Ware, Philly Joe Jones)  
Blue Note 1536

B  
B  
A



Silver

Another of the Detroit jazz flock, Monterose teams with trumpeter Ira Sullivan in a modern quintet session, hard-swinging and persuasive. Monterose and Sullivan compensate in technique and ideas what they may lack in tonal finesse; moreover, they are backed by a singularly felicitous rhythm section, with Silver playing his customarily personal piano, a fine new Chicago bassist named Wilbur Ware, and the outspoken Jones on drums. Each track runs a little too long, but there is quality to match the quantity in most of the six originals heard. LF

**Streamline**  
The Rolf Kuhn Quartet  
Vanguard VRS-8510

B  
A  
A



Kuhn

Prediction: Kuhn will win this year's *Down Beat* critics' poll as the best new clarinetist. There really isn't much competition for this German newcomer's fluent, warm-toned modern style, clearly patterned after Buddy DeFranco. For his debut in this country, he was backed by the excellent trio heard on this LP, with a sparkling new pianist, Ronnell Bright, plus Joe Benjamin, bass and Bill Clark, drums. Among the selections are several originals and such standards as *Laura, Street of Dreams* and *Love Is Here to Stay*. LF

**Sweets**  
Harry Edison and His Orchestra  
Clef MG C-717

B  
A  
A



Kessel

Edison's horn has graced a variety of jazz and popular bandstands; his obligatos frequently adorn Sinatra's LPs, Rosemary Clooney's TV shows and other commercial California ventures. Here, happily, the session and the style are his own and his companions are worthy members of an all-star sextet under his leadership: Ben Webster, tenor saxophone; Barney Kessel, guitar; Jimmy Rowles, piano; Alvin Stoller, drums; Joe Mondragon, bass. This is unpretentious, mainstream jazz, using as its material a few simple originals and three standards. LF

**Styles of Jazz Series**  
Various Artists  
Jazztone J-1240/1252

A  
A  
R



Rushing

### RATINGS OF JAZZ AND POPULAR RECORDS AND TAPE

It must be obvious to everyone that popular music, jazz, and music of the theatre and motion picture, cannot be rated in the same manner as classical music, save for the audio quality of the records. Therefore, the following explanation is given so that you will fully understand the significance of the three letters which appear at the left of reviews of popular, jazz, theatre and motion picture albums:

#### COMPOSITION (Top Letter)

##### A: Extraordinary

Indicates that the collection is of superior character, both from a standpoint of material and programming. Assignment of this rating means an unqualified recommendation.

##### B: Good

In general the collection is excellent, but additions or substitutions might have made the work more attractive and more lustingly enjoyable.

##### C: Satisfactory

A collection that is highlighted by only a few numbers, yet the over-all is quite acceptable. This might often apply to collections that have a limited appeal, yet are important to those who specialize in specific types of music. It might often apply to collections of historic importance where the artistic performance is the primary factor.

#### PERFORMANCE (Middle Letter)

##### A: Extraordinary

Indicates a superior performance throughout the collection. Assignment of this rating means an unqualified recommendation.

##### B: Good

In general the performance is excellent, save that there are minor imperfections or breaches of artistry.

##### C: Satisfactory

To a limited extent and purposes an enjoyable recording, yet one that does not qualify for B rating.

#### RECORDING QUALITY (Bottom Letter)

A, B, C: The same as for classical recordings.  
R: Indicates a re-issue.

One of the most ambitious projects undertaken in jazz this year is the reissue of a flock of LPs by this mail-order outfit. George Simon deserves special kudos for his editing and remastering of material that goes all the way back to the Original Dixieland Jazz Band, whose 1917 *Livery Stable Blues* is on *Early Jazz Greats* (J-1249) featuring a dozen stars of the early rhythmic decades. Other highlights are the sets by Lionel Hampton (1246), Fats Waller (1247), Jimmy Rushing (1244) and the *West Coast Jazz* anthology (1243). There's a special "any three for \$2.98" sales gimmick that makes that Jazztone Society even more worth joining. The covers are a remarkable improvement on the monstrosities with which Jazztone enveloped its releases in an earlier incarnation. **LF**

## POPULAR

**Cosa Lomo in Hi-Fi** **A**  
 Glen Gray's Casa Lomo Orchestra **A**  
 Capitol W-747 12" **B**  
 Gray



A group of crack west coast musicians re-create 14 famous numbers of the original great Casa Loma Orchestra, and they do it in style and performance entirely in keeping with tradition. The arrangements hew to the originals, while the playing on the whole is crisp, rounded, and swinging. The ballads — *Memories of You, I Cried for You, Sunrise Serenade, Just an Old Manuscript, Sleepy Time Gal, For You*, and *Smoke Rings* — shine even more richly than before, and Kenny Sergent is back to sing *I Cried for You* and that wonderful *For You*. The killer-dillers, such as *No Name Jive, Maniac's Ball*, and *Casa Loma Stamp*, sure sound swell in the new sound. **FR**

**Let Me Love You: Portia Sings the** **A to C**  
**Songs of Bart Howard** **A**  
 Portia Nelson and orchestra under **A**  
 Ralph Burns  
 New Sound NS-3003 12" **A**  
 Nelson



Miss Nelson possesses one of the most beautiful voices extant, sensitive, cultured, exquisitely controlled, warm and pure. This set deploys a dozen songs by young composer-pianist Bart Howard, whose forte is the fashioning of an unforgettable melody but only now and then. I find him wanting in the lyric department, though no doubt his words are right for the boîtes where the smart young things hang out, but this kind of poetry cracks easily, like the stems of champagne glasses. Still, listen to the haunting melodies of *Beautiful Women, If You Leave Paris*, and the superb *Year After Year*: fine song writing. But most of all, supremely creative singing. **EJ**

**The Johnny Ever Greens** **A**  
 Sue Allen, Eddie Robertson, Jud Conlon **A to B**  
 Rhythmaires, Russell Garcia orchestra **A**  
 ABC-Paramount ABC-147 12" **A**  
 Green



Ignore the coy title of this album and explore the riches of 16 songs composed by Johnny Green, whose career as composer, alas, has been diverted by a successful career in Hollywood, where he is now General Music Director of Metro-Goldwyn-Meyer. Some fine old "standards" are included: *Body and Soul, Out Of Nowhere, I Cover The Waterfront, Coquette, I'm Yours*, and *Hello My Lover Goodbye* and lesser known gems like *Who Do You Think You Are?, I Wanna Be Loved, The Trembling of a Leaf, and Easy Come Easy Go*. Fine contributions by Sue Allen, Eddie Robertson and the Rhythmaires. **EJ**

**The Voice of Audrey Morris** **B**  
 Audrey Morris **B**  
 Bethlehem BCP-6010 12" **A**  
 Morris



Miss Morris is an off-beat singer — kind of, if you want a description, a combination of Peggy Lee and Jeri Southern. She's a singer who sings melody without giving too much heed to the meaning of lyrics — at any rate, she doesn't put lyrics over like a good many people I could mention, and that's too bad. I think maybe that if I listened to her a great deal I'd tire of her rather easily. However, Audrey has two striking advantages on this record — excellent audio and some brilliant arrangements by Marty Paich, who is very, very good indeed. Included in the collection is an off-beat Porter song titled, *You Irritate Me So*, which Miss Morris certainly should have left to Lena Horne. **FR**

**Day by Day** **A**  
 Doris Day **A**  
 Columbia CL-942 12" **B**  
 Day



Miss Doris, backed splendidly by Paul Weston and his orchestra, presents a fine collection of melodies — *The Song Is You, Hello, My Lover, Goodbye, But Not for Me, I Remember You, I Hadn't Anyone Till You, But Beautiful, Autumn Leaves, Don't Take Your Love from Me, There Will Never Be Another You, Gone with the Wind, The Gypsy in My Soul, and Day by Day*. I think La Day has never done a song sloppily or half-heartedly, and she seems to have exercised a special amount of fondness on this folio of evergreens. Guitarist Barney Kessel and saxophonist Ted Nash contribute some excellent solo work within Weston's nifty orchestra. **FR**

## STAGE AND SCREEN

**Can't We Be Friends** **A**  
 Jane Powell and orchestra conducted by Buddy Bregman **A**  
 Verve MGV-2023 12" **A**

An excellent collection of show and film songs beautifully and intelligently sung by a grown-up Jane Powell, no longer an insipid child soprano of the cinema but a rich-voiced woman, by turn belting or tender, with a knack for getting the meaning out of a lyric without compromising a song's musical values. The songs include Arlen's *For Every Man There's A Woman* and *Hooray for Love*, one of Irving Berlin's best, *Let's Face The Music*, Martin and Blones's *Ev'ry Time*, Kern's *In Love In Vain*, Burke and Van Huesen's *Imagination*. One of our finest composers, Kay Swift — whose songs should be better known — supplies the song that titles the album. **EJ**

**Noel Coward in New York** **B**  
 Noel Coward with orchestra and **A**  
 piano by Peter Matz **B**  
 Columbia ML-5163 12" **A**  
 Matz



Some like coffee, some like tea, but if absinthe is your dish, so is Noel Coward, the most civilized, disdainful, observer of the human comedy. Coward the sociologist is brought to the fore in this album; his observations are served in devastating patter with impeccable nuance and crushing aplomb, viz. such as *Why Must The Show Go On, What's Going to Happen to the Tots, Louisa*, and the song in which Coward reveals his true unregimented colours, *I Wonder What Happened to Him*. Brilliant young pianist-arranger-conductor Peter Matz (who has worked before with Coward, and Marlene Dietrich, Harold Arlen) furnishes perfect accompaniment. **EJ**

**Ella Fitzgerald Sings The Rodgers and Hart Song Book** **A**  
 Ella Fitzgerald and orchestra under Buddy Bregman **B**  
 Verve Set MGV 4002-2 12" **A**

Over 30 selections from the scores of Rodgers and Hart ranging from one of their earliest songs, *Manhattan*, from the 1925 "Garrick Gaieties" to their last full score "By Jupiter" (1942) represented by *Ev'rything I've Got*. Miss Fitzgerald's wonderful musicianship is always in evidence (backed by the generally unobtrusive Bregman arrangements): smooth phrasing, lovely tone, faultless intonation, rhythmic precision. But one half of every Rodgers and Hart song is in the brilliant lyric. Miss Fitzgerald's preoccupation with musical effects sometimes misses a little of the point, but this is to quibble of almost nothing considering overall excellence. **EJ**

**WEILL: Johnny Johnson** **A**  
 Burgess Meredith, Hiram Sherman, Eve- **A**  
 lyn Lear, Scott Merrill, Jane Con- **B**  
 nell, Lotte Lenya, others; orchestra  
 under Samuel Matlowky; choral  
 director Joseph Liebling  
 M-G-M- E-3447 12" **A**  
 Weill



Enterprising M-G-M continues its laudable series of recordings of the works of Kurt Weill. Here is his first American musical, libretto by Paul Green, dating from 1936. The play's theme (contra war) did not contribute to its popularity, but it is Weill's music that makes this an important release. Some of the bitterness of postwar Germany permeates the music, but on the whole Weill mastered the American idiom remarkably well. Performances are uniformly good, with especially commendable ones from Burgess Meredith in the haunting *Johnny's Song*, Bob Shaver's *Cowboy Song*, Scott Merrill's *Capt. Valentine's Tango*; and, too, there is the incomparable Lenya. **EJ**



*The author listens to his music in a sea-going atmosphere*

# *Listening in Comfort*

By THOMAS A. KELLY



*From his comfortable chair, the tuner is within easy reach at the left, the preamp and tape machine at the right. A push-button actuates the changer*



**T**HE ONLY WAY to improve on having the best seat in a concert hall would be to add a remote control with which you could order whatever performances you want by the orchestra or artist suited to your listening mood. That is exactly what I undertook to do when I installed my hi-fi system.

I put the loudspeaker in one corner, and my favorite chair diagonally across the room. Then I laid out a plan for the equipment, the controls, and the cabinetwork that would make it possible for me to be the favored member of the audience and, at the same time, manager-impresario of my private concert hall!

It was not possible, however, to achieve such end results with cabinets available in completed or kit form. I wanted to look at the dials on the preamp and to adjust the radio tuner from a normal sitting position, and to start and stop the record-changer or reject a record with equal ease. That just wouldn't be possible with the preamp and tuner mounted in the conventional, horizontal position unless they were up at eye level, and in that case they would take up more space than I was willing to allot to them.

The answer was to mount them vertically, so the controls would be in plain sight, close to my chair, with each cabinet occupying only a thin slice of space where it could be spared most conveniently.

The accompanying photographs show how this was done, and how neatly the idea worked out. I made simple floor stands for the preamp and tuner so they would fit snugly against the arms of my chair. To provide ventilation, three slots were cut on the outer side of each cabinet. With the wide feet and the weight of the components, the cabinets stand firmly, with no danger of tipping over.

Friends who have seen this method of mounting have asked: "Is it all right to do it that way? I thought the units had to be down flat." And then they add: "I'm surprised that this hasn't been done before!" Well, it has been my experience that something new almost always happens when function is put before convention, and usually it is an improvement.

It was no trick to build the cabinet for the changer and amplifier, but the operation of the reject lever had me stopped until I found a solenoid magnet with a flexible cable. You can see this on the front of the changer base.

You can get the details of the system from the block diagram. All the AC power comes in at the preamp. No. 1 is the on-off switch, and 2 is a switched outlet. No. 3 is an AC switch for the changer motor, and 4 is the push-button in the AC solenoid circuit. The VU meter leads come off at 5 and run to the amplifier. No. 6 is the reject solenoid. Connections to the fluorescent light and changer motor are made at 7 and 8, while 9 is the lead from the pickup. Leads circled on the diagram are shielded.

The tape machine is an important part of this system. One of my hobbies is collecting tapes of music and special events broadcast by radio. Also, I tape records no longer available in the stores when my friends are kind enough to let me play them once. Since the machine is not secured to the stand that holds it, I can disconnect the wires and carry it away for outside recordings. *Concluded on page 54*

May-June 1957



*Above: The speaker is diagonally opposite the system controls. Below: Reject lever on the changer is actuated by a solenoid and flexible cable*



*Below: By mounting the preamp and tuner vertically, the controls are put at eye level, and space occupied by these units is reduced to a minimum*

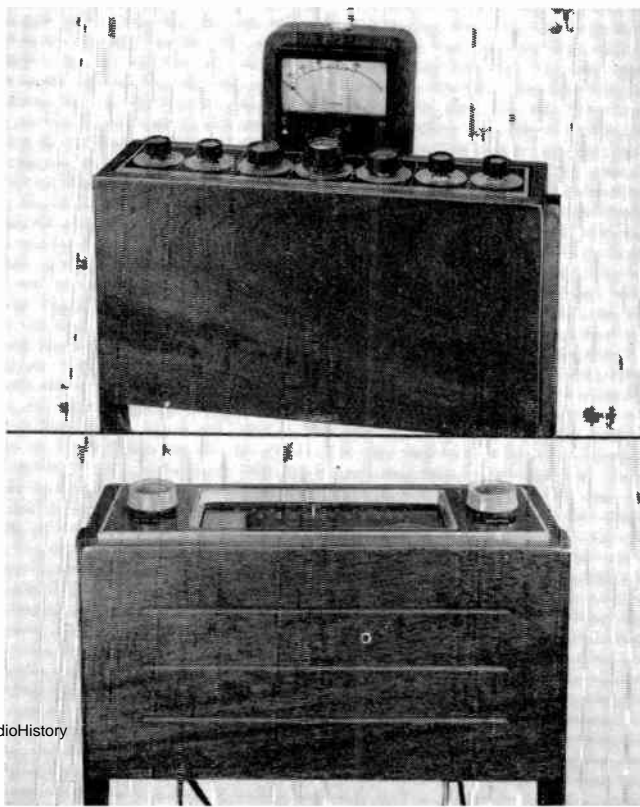

# PLANNING A STEREO SYSTEM

## Part 4: Designing the Cabinets for a Stereo Installation — *By Milton B. Sleeper*

**T**HE COST of adding stereo tape reproduction to a good hi-fi radio or phonograph installation is surprisingly small, particularly if you have a spare amplifier and speaker on hand. But whatever the cost, you can be certain of a big return from your investment.

For the purpose of this series on stereo tape equipment, a rather elaborate installation will be described and illustrated with photographs taken in the course of construction. It has been designed to incorporate all the features that comprise a complete radio-phonograph-tape system, from which you can select those suited to your particular requirements, and modify them to fit your needs. As a means of identification, let us call this the "Hi-Fi Music Stereo System".

The equipment to be included provides for stereo and monaural playback, stereo and monaural recording, tape copying from radio and records, and radio and record reproduction. You probably have some of the components needed already, so that you can assemble an equivalent system, even though you use other units.

### Cabinets for the "Hi-Fi Music System"

The cabinets, of somewhat elaborate construction, might

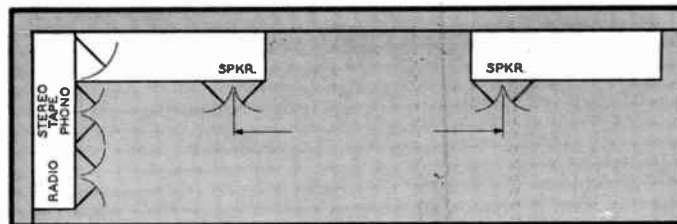

Fig. 3. Plan of a stereo system using the cabinets shown in Figs. 4 and 5

be called a "papa-and-mamma" design, representing a man's technical thinking combined with his wife's ideas as to attractive appearance. This might seem difficult of achievement, for the "papa" position was unalterable opposition to any sacrifice of performance, and the "mamma" position was held with equally firm insistence that 1) all equipment must be hidden behind doors when not in use, and 2) the finished job must not detract from, but must add to, the appearance of the room. Here are all the potentially tragic elements of a head-on collision, but this project has worked out amicably, with no doors slammed or tears shed!

Fig. 3 is a plan view of the cabinets. As you will see from subsequent illustrations, there is a fireplace between the speakers, flanked by windows. Speakers in conventional enclosures could have been used, but there was a need for additional storage space in the room. Hence the long cabinets, just window sill height.

On the wall at the left, there was no window to limit the height of the equipment cabinet. That was an important design consideration because it had been agreed that all the controls must be at eye level from a standing position — no sitting on the floor to change records, no bend-

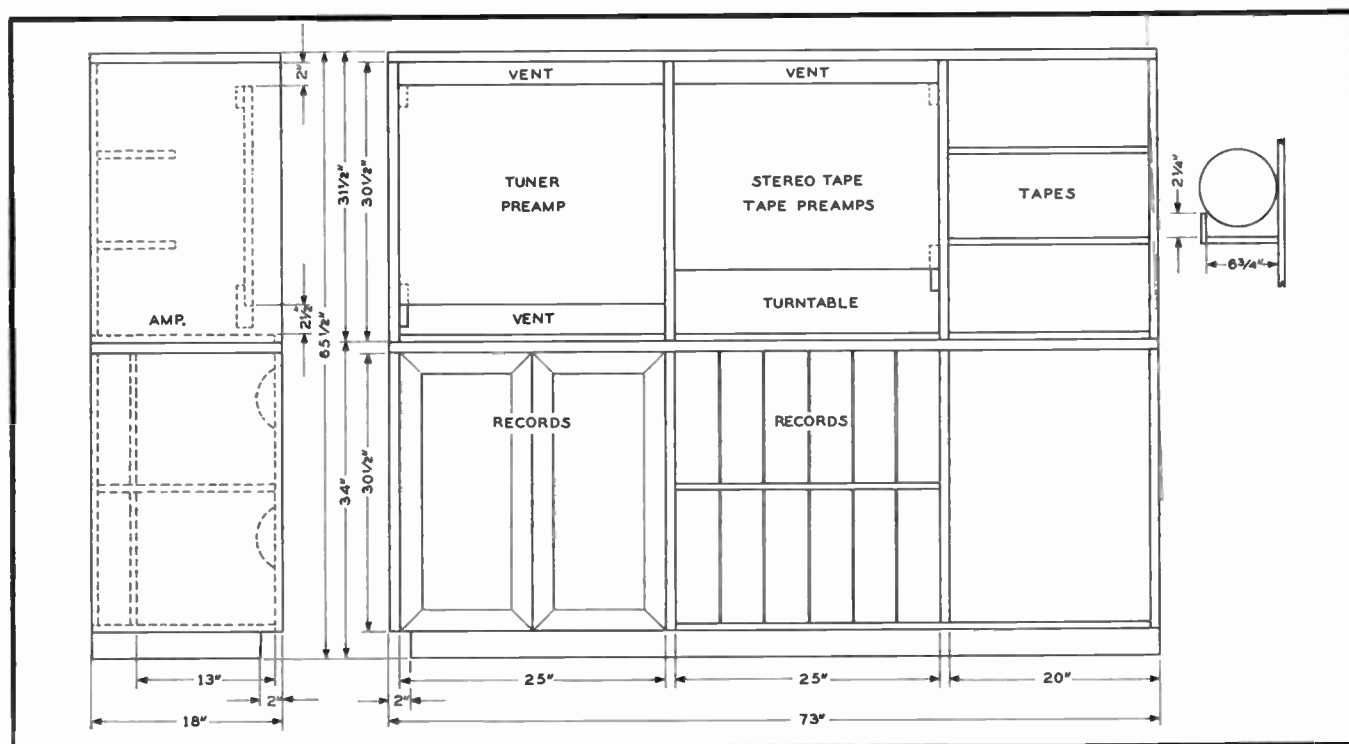

Fig. 4. All equipment, excepting the amplifiers, are mounted on the inner hinged panels. Tape compartment has a single door; all others, double doors

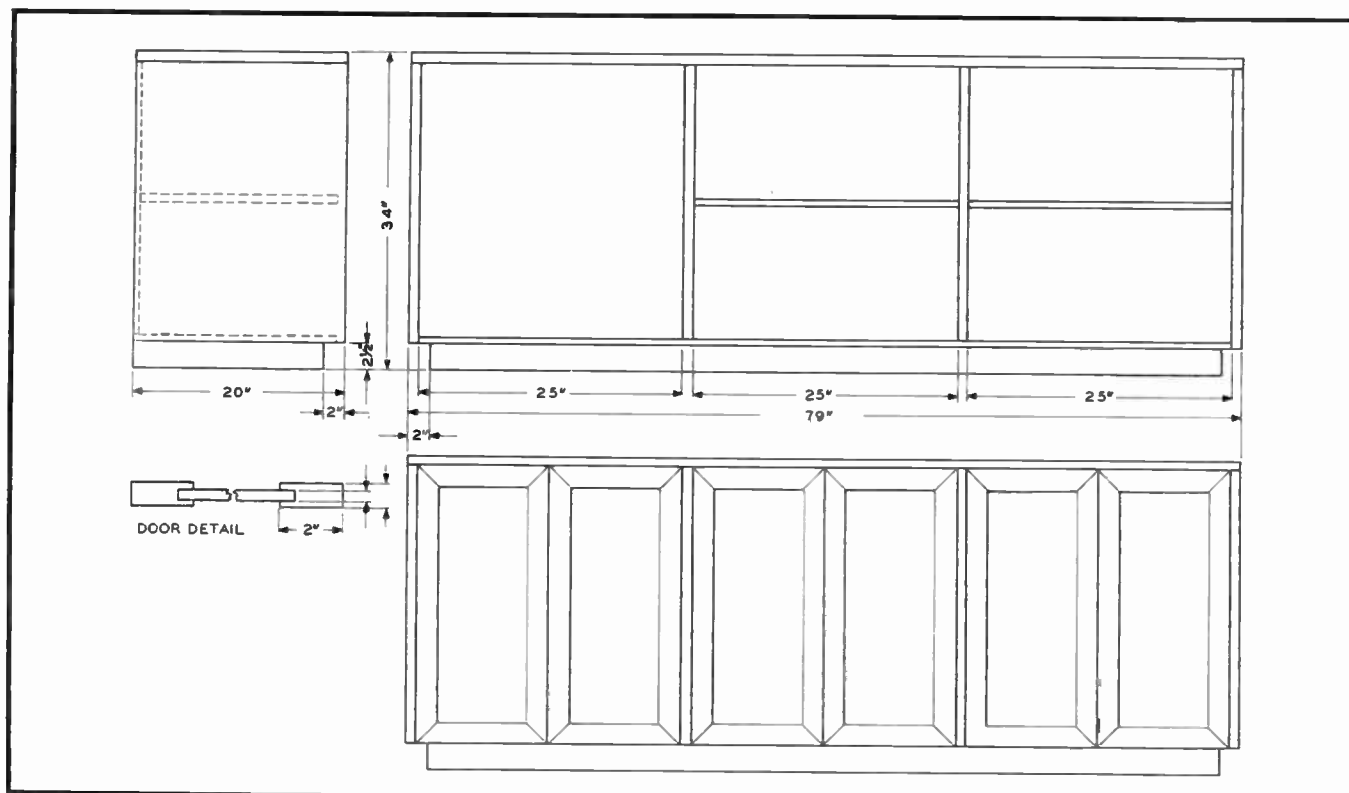

Fig. 5. Cabinet for the right-hand speaker has extra storage space. The left-hand cabinet is similar in design, with the speaker at the right

ing down to read the tuner dial or adjust the preamp. The tape deck might have been set horizontally at table height, but it was finally decided that it and the associated preamps, too, must be at a convenient elevation.

#### Details of the Cabinets

Figs. 4 and 5 are drawings of the equipment and speaker cabinets, with overall dimensions. They might or might not suit your needs, but if you are planning something of this sort, they offer a starting point.

Manufacturers' claims to the contrary notwithstanding, the most expensive grades of plywood may warp. So do solid woods. Hence the decision to make the doors of  $\frac{3}{4}$ -in. solid wood frames, mitred and glued, with  $\frac{1}{4}$ -in. plywood panels set in as shown by the detail in Fig. 5. The panels were not glued to the frames, however, so that they would be free to move slightly with any expansion or contraction.

In Fig. 5 there are front views with and without the doors, and an end view. Space was allowed for a Bozak 302-A speaker system and enclosure, with a 12-in. woofer, 6-in. mid-range speaker, and two tweeters. Remaining space at the right of the speaker section was planned for storage, and has no part in the hi-fi system.

The cabinet for the left side is similar in design except that the speaker is on the right.

Total distance between the centers of the speakers is 10 ft. Before these cabinets were designed, experiments were made to determine the optimum separation. Of course, no two rooms are acoustically alike, but in this case the distance was not critical, nor was there any hole-in-the-middle effect, even on choral music, at center-to-center separation up to 12 ft.

As for the equipment cabinet, Fig. 4: having decided on the height at which the units would be mounted, the cabinet pretty much designed itself. The lower section at the right could only be left empty, since the speaker cabinet runs up against it, as you will see in Fig. 3. The space above, logically, is best suited to tape storage. Since it is only 20 ins. wide, one door is indicated rather than two. The detail shows how additional 7-in. reels can be carried on door shelves.

The other two lower sections can be used to best advantage for record storage. Only one pair of doors is shown in Fig. 4, in order to indicate the interior construction. There is a false back behind the record compartments. Without it, the records would roll back out of reach. That rear space is not wasted, however. As you will see later on, it is used for the AC sockets and power wiring to the various components.

On the left end of the cabinet at the rear, openings were cut for an AC receptacle to bring in the power, and a main switch and pilot light, where all the power can be cut off.

Since it was required that no equipment be in evidence when the doors are closed, inside, hinged panels were indicated for mounting the components so that they could be swung out at any time. The equipment panel must be cut short at the top and bottom for ventilation. At the right, the panel was cut high enough for convenient access to the turntable. Blocks must be provided, as shown in Fig. 4, to carry the load when the panels are pushed back in place.

So, you see, the requirements of appearance and function actually dictated the arrangement and design of the equipment cabinet.

Parts 5 and 6 will include photographs of this system, from the beginning to the complete installation of the equipment.

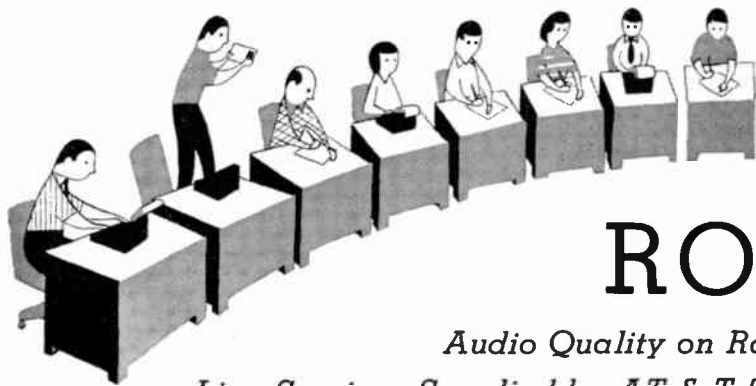

# READERS' ROUNDTABLE

*Audio Quality on Radio vs. TV Networks — Four Different Line Services Supplied by AT & T for Networking — Next Topic Is Stereo*

**O**UR Roundtable discussion of audio quality from radio broadcast stations has developed considerable heat. Some letters even registered temperatures too high to be handled by the printing presses which produce this Magazine! Many were severely critical of the stations as to unskilled operation, inferior equipment, and low-quality telephone lines.

From our careful reading of the letters, there emerged two points on which there were confusion and lack of specific information. These were 1) the higher audio quality on television as compared to radio, and 2) the telephone lines used for radio networks. Accordingly, we called on AT&T to get the answers. Here is what we learned:

## Lines Used for TV Sound

We know, of course, that special facilities are supplied by the Telephone Company to the television networks. Since pictures and sound are carried on a single TV channel, the impression prevails generally that they are carried together over wide-band telephone lines or the radio relay system. It is assumed that the use of these wide-band facilities explains the superior quality of sound on TV as compared to radio broadcasting.

AT & T says this is not the case. The sound is carried on the same Class A lines as are supplied to radio stations. Such lines are equalized to handle 100 to 5,000 cycles.

Why do listeners feel, then, that there is better quality on TV than radio? There are several possible reasons. TV studio equipment is new and of the best quality available. Some of the microphones and audio consoles used by radio stations are long past retirement age. While the sound tracks of old movies are generally awful, new filmed shows use tape for the sound track. Thus the original audio quality is better than that of radio stations which use obsolete pickups, turntables, and amplifiers for phonograph records. Compression amplifiers used by AM stations introduce a substantial amount of distortion. Finally, it is possible that some listeners are comparing TV sound, which is transmitted on

FM, with reception from AM stations, or FM from FM-AM stations where FM is treated as a stepchild.

## Lines Used by Radio Stations

There is much more to be said about telephone lines for radio broadcasting. Four different services are available. These are:

Class C	200 to 3,500 cycles
Class A	100 to 5,000 cycles
Class AA	50 to 8,000 cycles
Class AAA	50 to 15,000 cycles

Class C is a regular telephone subscriber line, such as is used for making news reports or contest calls on radio programs. Class A is used for network operations. These lines are rented by the month, at a cost of \$4.50 per mile for 8 hours use per day. There are also Class B lines. Most of us have assumed that these are inferior in audio capabilities to Class A lines, but that is not the case. Class B lines also handle 100 to 5,000 cycles. The "B" merely indicates that they are for occasional use, rented at the rate of 15¢ per mile per hour.

At the end of the last war, anticipating a demand for lines to carry wider frequency bands, the Telephone Company planned a Class AAA network for FM stations, and published a map of such facilities. It never materialized. The Telephone Company said there was no demand for Class AAA service, and the broadcasters claimed that the rates were too high.

Last fall, rates were reduced on AA and AAA lines, but still there were no takers. Monthly rates are:

Class A	\$4.50 per mile
Class AA	6.00 per mile
Class AAA	7.50 per mile

Rates for occasional use are:

Class B	15¢ per hour per mile
Class BB	22¢ per hour per mile
Class BBB	28¢ per hour per mile

There should be a substantial improvement in audio quality from a Class AA line over Class A. However, AM radio cannot benefit from such a change, for AM receiving sets are deliberately designed to pass nothing above 5,000 cycles in the IF stages. And few owners of AM stations

with FM affiliates are making efforts to attract FM listeners. Consequently, they see no reason for increasing the cost of network operation, nor will they unless and until they are affected by competition from independent hi-fi FM stations. As for the TV operators, their concern is with their TV competitors, and they do not want their AM or FM stations to reduce their TV audiences!

## Better Audio Quality Ahead

From the foregoing, you can see why broadcasters are annoyed by the increasing number of complaints coming in from listeners who have acquired hi-fi tastes. Most stations look upon this growing group as audio nuts. They haven't time to bother with listeners who think they know more about program quality than broadcast engineers who have had years and years of professional experience.

But the complaints are increasing in number, and hi-fi enthusiasts are not easily discouraged. They know that some FM stations (mostly those without AM affiliates) are doing full justice to the quality available on LP's and tape. If some can, why shouldn't the others, particularly the network stations? This attitude is reflected in letters from those taking part in our Round-table discussion of radio program quality.

## Stereo Next on the Agenda

The article entitled "Let's Steer Stereo Straight" which appeared in our March-April issue stirred up comments and discussion that brought to light some interesting points of view. We'll go into this subject in the Readers' Roundtable next issue. Meanwhile, we have instructed our reviewers of recorded tapes to listen with particular attention for fake-stereo effects. It may be no more than a completely unfounded rumor (and we hope that is the case), but we have been hearing about tapes offered as being "stereo" that were made from monaural records, with the second track made by one of the various pseudo-stereo methods. This would be misrepresentation.



*You Can't Judge a Book By Its Cover,  
nor Hi-Fi Equipment By Its  
Outward Appearance. Here Are  
Photographs Showing the Actual  
Inside Construction of New Components*

# "INSIDE INFORMATION"



The Hi-Fi Music Commendation Seal, which bears the inscription "A Commended Design in Its Price Class", has been awarded to the specific models described and illustrated in this department.

In making these awards, five factors are considered. They are: mechanical design, electrical design, workmanship, performance, and facilities provided. These factors are then related to the retail price.

Thus, designation as "A Commended Design in Its Price Class" represents a composite of the various points which must be taken into account in the selection of hi-fi equipment.

It should be clearly understood that the Commendation Seal is not a confirmation of the manufacturer's specifications. However, when we have received such confirmation from an independent engineering laboratory, this is so stated in the discussion of the equipment, and the name of the laboratory is given for purposes of identification.

Viking stacked stereo tape deck FF75SR, preamp RP61, slave preamp RP61S. These units comprise a complete stereo playback and stereo recording system, except for the amplifiers, speakers, and mikes. The photographs show two views of the deck, front and rear of the slave preamp, rear of the preamp, and the inside construction. Connections can be made in a minute's time. No wow or flutter was observed from a

Sonotape stereo test tape on steady tones.

All driving functions are performed by one motor, stabilized by a heavy, belt-driven flywheel. Only difficulty encountered was when the control was in the REWIND position and, instead of moving it to STOP, it was pushed on to FORWARD, but that was careless operation.

Controls on the preamp and second-channel slave preamp are, left to right,

record level, equalization, playback-record switch, level indicator, and playback level. At the rear are jacks for low-level and high-level mike inputs. By changing the connections, two-track monaural tapes can be played. There is an erase head for one track recording, but not for stereo recording. Prices: FF75SR stacked stereo tape deck \$113.00; RP61 and RP61S preamps \$77.50 each.

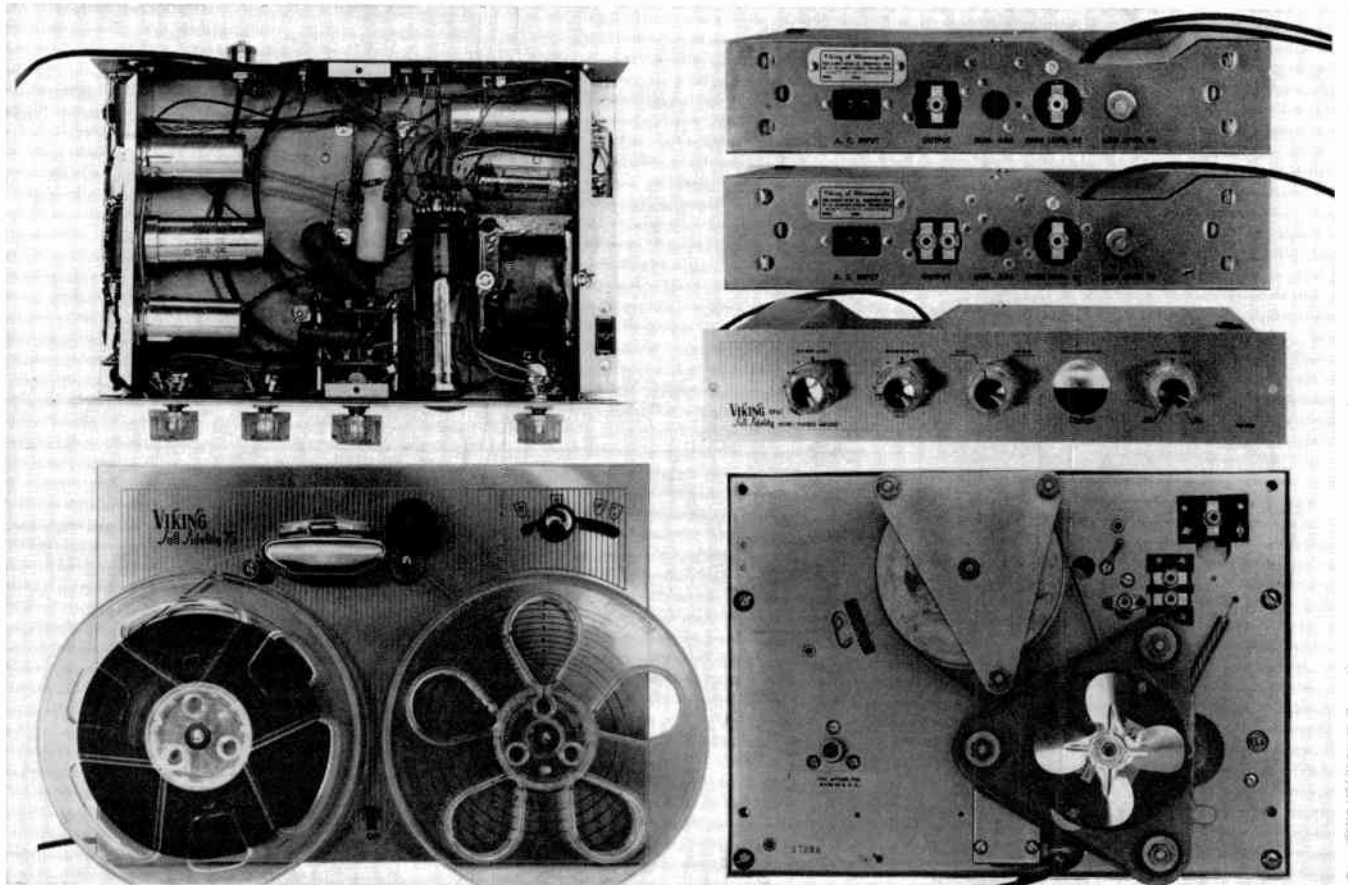



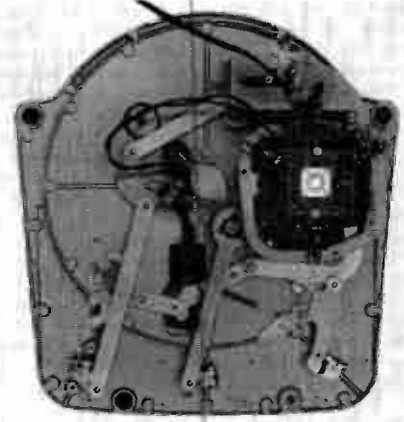

**Garrard 301 turntable.** [Manufacturer's specifications confirmed by Audio Instrument Co., Inc.] Operating at 33, 45, and 78 rpm., with a vernier speed adjustment, the speed-change lever is locked when the start-stop lever is in the running position. As the lever is moved to Stop, a felt brake shoe, left in the detail photograph, is brought against the rim of the turntable. Also, the idler disc is moved back from the

rim of the turntable and the 3-step pulley which drives it. The motor is spring-mounted to minimize the transmission of vibration. Shock mountings are provided for the base, to isolate any external vibration.

This turntable is supplied as shown, or with an ebony-finished wood base 5 ins. high, 20 $\frac{3}{4}$  wide, and 15 $\frac{1}{2}$  deep. This allows ample space for mounting the tone

arm. The Garrard 301 is made in England. Price \$89.00; base \$24.00.

**Bogen R775 FM-AM tuner and preamp.** Top-price tuner in the Bogen line, this model has controls and connections which make it unusually flexible.

At the rear, left to right, are: level

control for the Aux input; main and tape output jacks; Aux input for any audio source of about 1 volt, such as a tape recorder; crystal pickup input; and inputs for high-level and low-level magnetic pick-

ups. There are connections for 75 and 300-ohm and built-in FM antennas, and a loop-stick and outdoor AM antenna.

Front controls are: switched low-band filter; 7-position equalizer; volume and

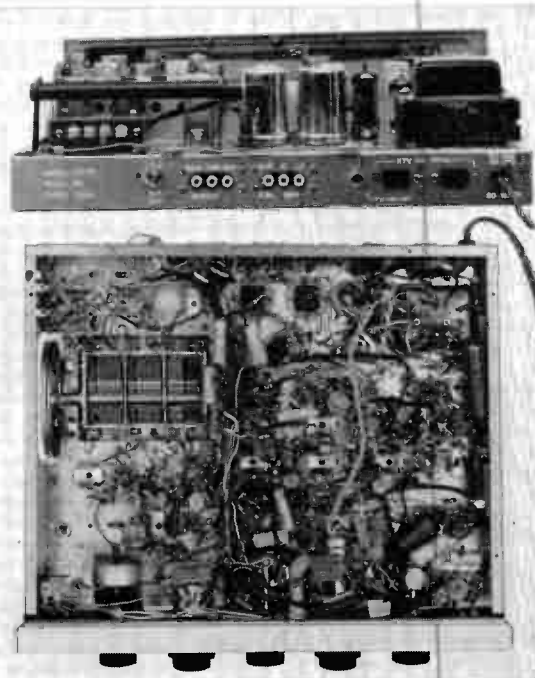
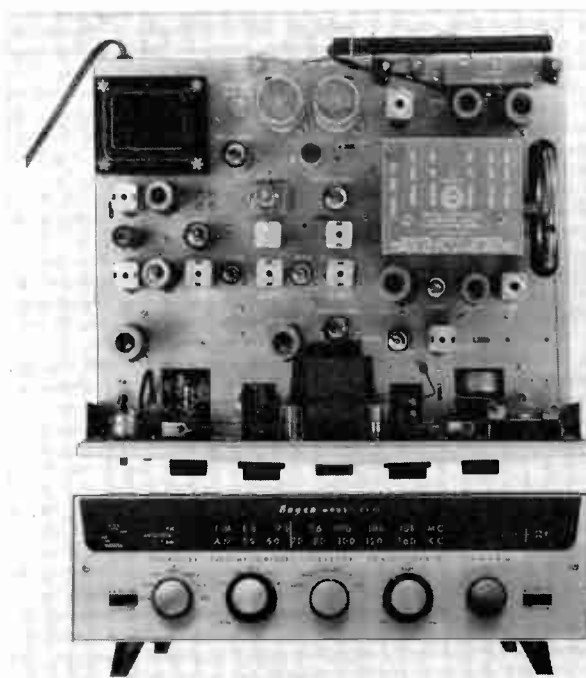

contour; selector for wide and narrow-band AM, phonograph, FM and the auxiliary input; bass and treble; tuning; and a switched high-band filter. The tuning meter works on both FM and AM.

An interesting feature is the Auto-Lock on FM. This automatically disables the AFC when changing stations. Once a station has been selected, the AFC is cut in to prevent drift, and a signal light comes

on. There is also an adjustable squelch, to reduce noise between stations.

Chassis measures 15 ins. wide, 4 $\frac{1}{4}$  high, 12 deep. Furnished with or without a metal cabinet. Price \$249.50; cabinet \$8.00.

**Weathers MT-1 tone arm and MM-1 or MM-5 pickup system.** Mechanical, electrical, and eye-appeal features have been incorporated in this new model. In the Weathers pickup, no work is done to generate current. Only a tiny vane, serving as a condenser plate, varies the tuning of an FM circuit. Thus the pickup is not affected by magnetic fields, or the proximity of a steel turntable.

The base of the tone arm is shock-mounted, and carries the arm on a viscous-damped pivot that does not require adjust-

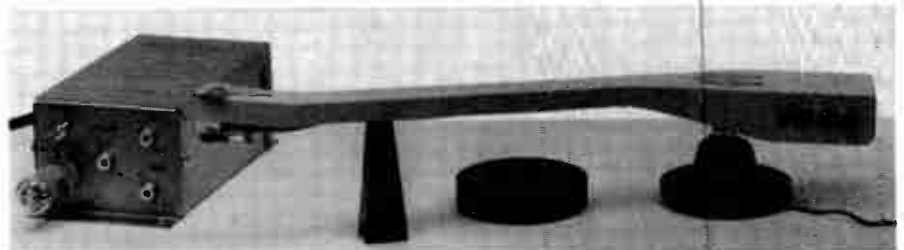

ment. Stylus force is adjustable from a screw at the rear of the arm. The brush on the pickup takes up about 1 gram, with

only 1 to 1 $\frac{1}{2}$  grams pressure on the stylus.

Only operating adjustment is the tuning adjustment on the oscillator unit, and this

is done by ear. The length of the lead from the pickup to the oscillator must not be changed, as this is a tuned transmission,

and is adjusted to the correct length at the factory.

Price, MM-1 white tone arm and pickup

with diamond stylus, complete, \$92.10; MM-1 black tone arm, sapphire stylus, complete, \$74.20.

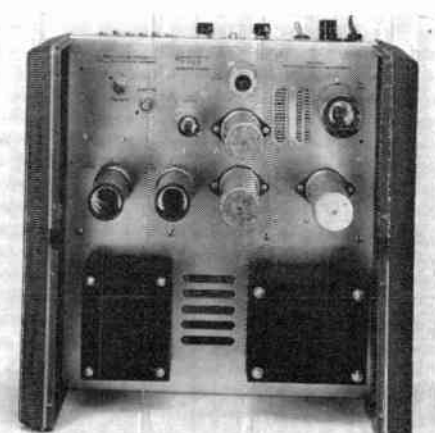
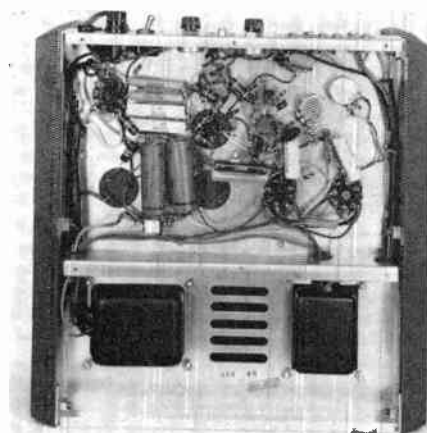

Scott model 240 amplifier. Heavy construction, with die-cast end plates, characterizes this unit, rated by the manufacturer at 40 watts output. The case is finished in brown, with gold-color front panel and ventilating cover plate.

As the front view shows, there is an AC outlet and fuse at the left, an AC switch and pilot light, input level control, input jacks for .5 and 1.5 volts, damping factor control, and speaker connections for 4, 8, and 16 ohms, and 70-volt public address systems. On the top of the chassis a precision balance adjustment is provided for the phase inverter circuit, although this is a self-balancing type, and a hum output adjustment. Tubes used are two 12AX7's, two 6CA7's, and a 5U4 rectifier. Tube types are marked on the chassis at each socket.

The 1.5-volt input jack is intended particularly for use with the Scott 121 equalizer-preamp, or the 331 FM-AM tuner. Special purpose of the level control is to work in conjunction with the loudness control on those instruments. The damping control is calibrated from 1 to 15, but at settings above 8, the G and O speaker terminals should be connected together.

Views of the top and bottom show the construction, shielding, and provisions for ventilation. Overall dimensions of the case are 12 $\frac{1}{4}$  ins. wide, 6 $\frac{3}{4}$  high, by 12 $\frac{7}{8}$  deep. Price \$99.50.

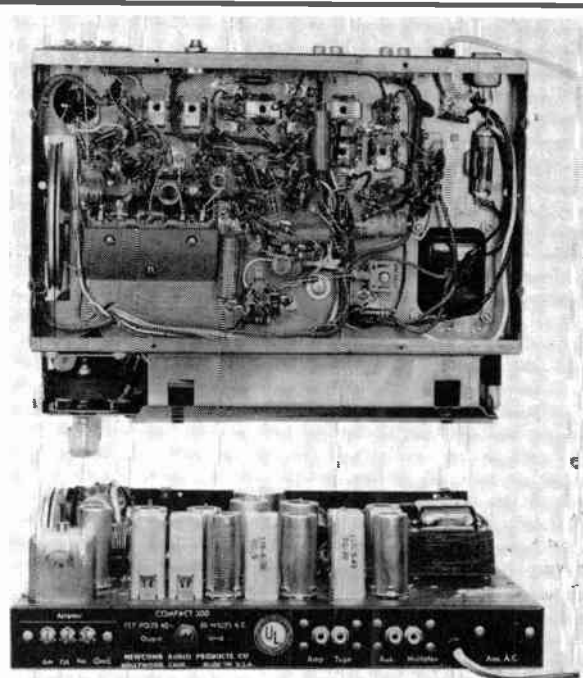
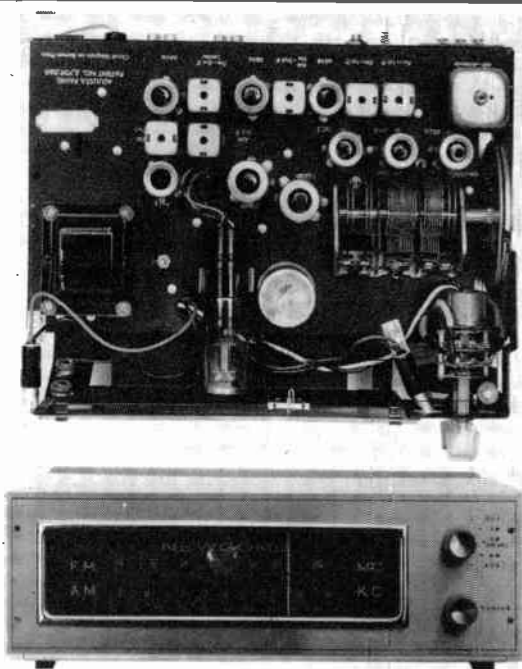

Newcomb model 200 FM-AM tuner. In outward appearance, the gold-finished metal case is suited to table-top use, although special provisions are made so that the chassis can be moved forward for mounting on a wood panel up to  $\frac{3}{4}$  in. thick. Since this tuner is designed for use with a separate preamp and amplifier (it matches the appearance of the Newcomb 1020 preamp-amplifier) it has only a tuning control and a switch for AC power on-off, FM-AFC, FM, AM, and an auxiliary source, such as the output of a recorder.

At the rear are terminals for FM and AM antennas; an output level control to prevent overloading the preamp; output jack to go to the preamp; output jack to go to the input of a tape recorder for taping off the air; jack for the auxiliary input mentioned above; jack for plugging in a multiplex adapter when such broadcasting is on the air; and an AC outlet connected through the front-of-panel on-off switch.

A cathode follower output is provided so that the tuner can be located up to 200

ft. from the preamp. Radiation on FM is certified to be under FCC specifications. The tuning eye works on both FM and AM. Overall dimensions of the case are 12 $\frac{5}{8}$  ins. wide, 4 high, by 9 $\frac{1}{4}$  deep. Price \$169.50.

#### PREVIOUS AWARDS

The first Commendation Seal awards were announced in the March-April issue of Hi-Fi Music. Copies are still available, if you would like to keep a complete file of these awards.

## LISTENING IN COMFORT

Continued from page 47

I have a real appreciation of machines of all kinds, and a great interest in them. But I believe that they are designed and installed correctly only when they serve most effectively the convenience of those who use them. Accordingly, I think you will find, if you study the pictures of this system, that each part was installed in such a way that it does not require added effort on my part to use it. More thought at the planning stage makes subsequent operation a lot easier.

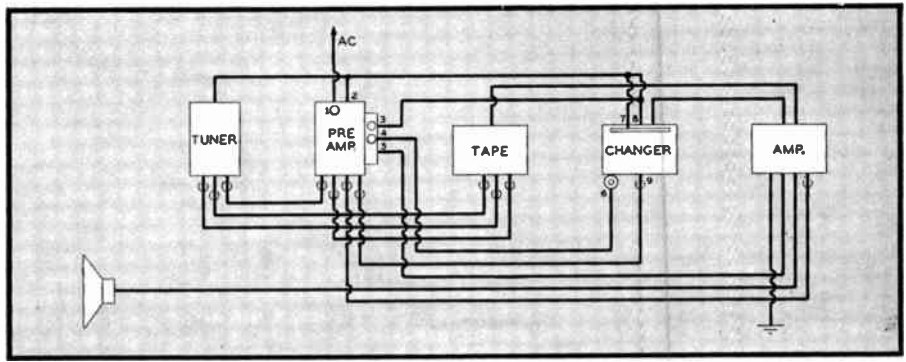

All the equipment in this hi-fi system can be controlled at the preamplifier or tuner

## LIBRARY FOR LISTENING

Continued from page 31

series of recorded programs from noon to two o'clock for the pleasure of workers in the neighborhood. They became extremely popular, filling the lecture-room to overflowing. At a staff meeting one day, it was pointed out that if the concerts were to be given in the rear of the Library in Bryant Park, weather permitting, people could enjoy the sunshine and the music at the same time. A permit was obtained from the Park Department and so the free noonday concerts got underway.

Lanny Ross, the well-known singer, donated necessary funds for the first season and set the precedent of having an outstanding musical figure make a personal appearance at the initial concert each season. Those who have followed Ross in voluntary appearances have included Benny Goodman (with the New Music String Quartet), Richard Tucker of the Metropolitan, and Robert McFerrin and Stephen Douglas among other singers. Ross will be back this year to signalize the anniversary.

Unless it rains, the two-hour programs are offered Monday through Friday in the shade of the park's old trees and the shadow of midtown skyscrapers.

The library concert *aficionados* are of all ages, but the majority, oddly enough, are in their twenties — secretaries, clerks, and young executives — and more young men attend than young women. Some stay for a single movement of a symphony, others for the entire work. Among the modern composers in demand are Prokofiev, Holst, Copland, Vaughan Williams, Horatio Parker, and Arnold Schönberg.

By the end of the first season, it was apparent that the public's interest in the library concerts justified continuing them. The problem was to find a sponsor to cover the costs. One of the chief items was the salary for an operator to attend the turntables, check the pickups, select the records from the stacks, and help in the arrangement of programs.

By 1949 the Dime Savings Bank, located at 40th Street and the Avenue of the Americas, had come to the rescue as sponsor. It has remained so ever since. Requests for musical selections may be left with an at-

tendant at the bank or at the music division of the library. And a great many of the requests come by mail.

Philip L. Miller, who has been on the Library staff for nearly three decades, is in charge of the concerts and plans the programs. As a student at the Juilliard School of Music, Mr. Miller had studied to become a professional singer. In order to defray expenses, he worked nights in the Library. He says he just stayed on, and has never regretted it. He is first assistant to Carleton Sprague Smith, head of the Library's Music Division.

While the noon concerts are designed for the public, particularly a working public relaxing at lunch time, many music students and professionals attend them. Out-of-town visitors also watch the announcements. One man told Mr. Miller that he had traveled from Buffalo for the sole purpose of hearing an Emma Eames program. The former Metropolitan singer had been one of his idols. Geraldine Farrar fans also come from long distances when her records are scheduled.

These Bryant Park concerts really are unique. A young music teacher, returning from study abroad, wrote to Mr. Miller that she had traveled throughout Europe on musical tours and had found nothing like these free programs. Music students and librarians from other cities have written to say that they always include the concerts on their visits to New York, and many of them, too, write ahead for the programs.

Now retired after many years on the New York Herald Tribune, *Marguerite Tazelaar has turned free-lance writer. And she is frequently a grateful member of the audience at the Bryant Park Concerts.*

## RECORD COLLECTING

Continued from page 30

*Prometheus*, Goethe achieved the very summit of German heroic poetry. Wolf, not a whit behind, brought his genius to its most colossal manifestation to create what is probably the greatest song of its kind in all the literature. The only current recording of this masterpiece is that of Horner, unfortunately done with piano accompaniment instead of the orchestra called for in the original score. (The old Friedrich

Schorr shellac recording, made under the auspices of the Hugo Wolf Society in the thirties, is the last word to date on this song.) With *Prometheus* must be mentioned two other gigantic poems — *Ganymede* and *Grenzen der Menschheit* — the three of them representing a peak of achievement, indeed, for both Goethe and Wolf. While *Prometheus* is majestic, defiant of Zeus, *Ganymede* is at the opposite pole — lyrical, nature-loving, and at one with the universe. And *Grenzen* can be summed up without exaggeration as 'philosophy in music'.

Another song worth mentioning among so many distinctive ones is *Mein Liebster ist so klein*, which is recorded by Miss Seefried. In it the Italian woman heaps wrath on her boy friend for being so small that he could sweep her room with his hair. His insignificance is suggested by a piddling figure on the piano, while the accompaniment's occasional ascending and descending suggests someone's stooping down to a person of diminutive stature.

In Eduard Mörike, Wolf found a poet who expressed the folk qualities of the South German. From this artistic union came the famous *Verborgenheit*, the somber *Denk es, o Seele*, and that most fantastic of Wolf's gems, *Abschied*, which concludes with a magnificent satire on all Viennese waltzes.

Not to be overlooked are the songs of the "Spanisches Liederbuch". There is an odd character about them and they have a mentality all their own. Most of them exude a peculiar miasma of self-flagellating mysticism mixed with a curious sense of urgency. This is partly accomplished through dissonant harmonies of extreme poignancy, and the total effect reminds the listener of Spanish Baroque sculpture. The people portrayed in these songs are by turns feverish, bitter, and ecstatic, and they exist under high pressure. Alas, the Spanish songs on LP are inadequately realized.

With the "Michelangelo Songs" Wolf reached the end of his musical fruitfulness — at the tragically early age of thirty-seven. From then on, he was hopelessly insane. In these three works his style was subtly elemental. Of the set, *Alles endet was ensteht* is especially noteworthy. In the composer's own words, it is of a "staggering, truly an-

Concluded on page 58

# "We're building a HEATHKIT<sup>®</sup>..."

BECAUSE IT'S SUCH GREAT FUN... AND BECAUSE WE GET SO MUCH MORE FOR OUR MONEY!"

Every day more and more people (just like you) are finding out why it's smart to "do-it-yourself" and save by building HEATHKIT high fidelity components. These people have discovered that they get high-quality electronic equipment at approximately one-half the usual cost by dealing directly with the manufacturer, and by doing their own assembly work. It's real fun—and it's real easy too! You don't need a fancy work shop, special tools or special knowledge to put a Heathkit together. You just assemble the individual parts according to complete step-by-step instructions and large picture-diagrams. Anyone can do it!

## Heathkit Model SS-1 Speaker System Kit

This high fidelity speaker system is designed to operate by itself, or with the range extending unit listed below. It covers the frequency range of 50 to 12,000 CPS within  $\pm 5$  db. Two high-quality Jensen speakers are employed. Impedance is 16 ohms, and power rating is 25 watts. Can be built in just one evening. **\$39<sup>95</sup>**  
Shpg. Wt. 30 lbs.



\$4.00 dwn.  
\$3.36 mo.

## Heathkit Model SS-1B Speaker System Kit

This high fidelity speaker system kit extends the range of the model SS-1 described above. It employs a 15" woofer and a super-tweeter to provide additional bass and treble response. Combined frequency response of both speaker systems is  $\pm 5$  db from 35 to 16,000 CPS. Impedance is 16 ohms, and power is 35 watts. Attractive styling matches SS-1. Shpg. Wt. **\$99<sup>95</sup>**  
80 lbs.

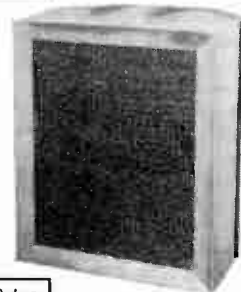

\$10.00 dwn.  
\$8.40 mo.

## HEATHKIT

### "LEGATO" SPEAKER SYSTEM KIT

Months of painstaking engineering by Heath and Altec-Lansing engineers has culminated in the design of the Legato, featuring "CP" (critical phasing) and "LB" (level balance). The result is a *new kind* of high fidelity sound, to satisfy even the most critical audio requirements. Two high-quality 15" theater-type speakers and a high-frequency driver with sectoral horn combine to cover 25 to 20,000 cycles without peaks or valleys. "CP" and "LB" assure you of the smooth, flat audio response so essential to faithful reproduction. Choice of two beautiful cabinet styles below.

#### "Legato" Traditional Model HH-1-T

Styled in classic lines to blend with period furniture of all types. Doors attractively paneled. African mahogany for dark finishes unless you specify imported white birch for light finishes. Shpg. Wt. 246 lbs. **\$345<sup>00</sup>**



\$34.50 dwn.  
\$28.98 mo.

#### "Legato" Contemporary Model HH-1-C

This fine cabinet features straightforward design to blend with your modern furnishings. Slim, tapered struts run vertically across the grille cloth to produce a strikingly attractive shadowline. Wood parts are pre-cut and pre-drilled for simple assembly. Supplied in African mahogany for dark finishes unless you specify imported white birch for light finishes. Shpg. Wt. **\$325<sup>00</sup>**  
231 lbs.



\$32.50 dwn.  
\$27.30 mo.

## HEATH COMPANY

A Subsidiary of Daystrom, Inc.

BENTON HARBOR 5, MICHIGAN

# Make yours a **HEATHKIT**<sup>®</sup>

**It's Easy (and fun) to Plan Your Own Hi-Fi Installation  
By Choosing the Heathkit Components  
That Best Suit Your Particular Needs.**

As the world's largest manufacturer of electronic equipment in kit form, Heath Company can provide you with a maximum variety of units from which to choose. You can select just the amplifier you need from five different models, ranging in power from 7 watts to 25 watts, some with preamplifiers, and some requiring a separate preamplifier. You can pick your speaker system from four outstanding high fidelity units ranging in price from only \$39.95 to \$345.00. You can even select a fine Heathkit FM or AM Tuner! Should there be a question in your mind about the requirements of an audio system, or about planning your particular hi-fi installation, don't hesitate to contact us. We will be pleased to assist you.

### **MATCHING CABINETS . . .**

The Heath AM Tuner, FM Tuner and Preamplifier are housed in matching satin-gold finished cabinets to blend with any room decorating scheme. Can be stacked one over the other to create a central control unit for the complete high fidelity system.

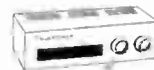

MODEL FM-3A



MODEL BC-1

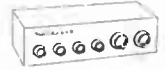

MODEL WA-P2



### **PRE-ALIGNED TUNERS . . .**

A unique feature of the Heathkit AM and FM Tuners is the fact that both units are pre-aligned. A signal generator is not necessary! IF and ratio transformers are pretuned at the factory, and some front-end components are preassembled and pretuned. Another "extra" to assure you of easy kit assembly.



## **HEATH COMPANY**

A Subsidiary of Daystrom, Inc.  
BENTON HARBOR 5, MICHIGAN

**EASY TIME PAYMENTS . . .** We invite you to take advantage of the Heath Time Payment Plan on any order amounting to \$90.00 or more. Just 10% down and the balance in twelve monthly payments. **WRITE FOR COMPLETE DETAILS.**





# HIGH FIDELITY SYSTEM

**1 HEATHKIT HIGH FIDELITY FM TUNER KIT** Features AGC and stabilized, temperature-compensated oscillator. Sensitivity is 10 microvolts for 20 db of quieting. Modern circuit covers standard FM band from 88 to 108 mc. Employs ratio detector for efficient hi-fi performance. Power supply is built in. Illuminated slide rule dial for easy tuning. Housed in compact satin-gold enamel cabinet. Features prealigned transformers and front end tuning unit. Shpg. Wt. 7 lbs.

MODEL FM-3A Incl. Excise Tax (with cab.) **\$25<sup>95</sup>**  
\$2.60 dwn., \$2.18 mo.

**2 HEATHKIT BROADBAND AM TUNER KIT** This fine AM Tuner was designed especially for use in high fidelity applications, and features broad bandwidth, high sensitivity and good selectivity. Employs special detector circuit using crystal diodes for minimum signal distortion, even at high levels. Covers 550 to 1600 kc. RF and IF coils are prealigned. Power supply is built in. Housed in attractive satin-gold enamel cabinet. Shpg. Wt. 8 lbs.

MODEL BC-1 Incl. Excise Tax (with cab.) **\$25<sup>95</sup>**  
\$2.60 dwn., \$2.18 mo.

**3 HEATHKIT HIGH FIDELITY PREAMPLIFIER KIT** This preamplifier meets or exceeds specifications for even the most rigorous high fidelity applications. It provides a total of 5 inputs, each with individual level controls. Hum and noise are extremely low, with special balance control for absolute minimum hum level. Tone controls provide 18 db boost and 12 db cut at 50 cps, and 15 db boost and 20 db cut at 15,000 cps. Four-position turn-over and four-position rolloff controls for "LP", "RIAA", "AES", and "early 78" equalization. Derives power from main amplifier, requiring only 6.3 VAC at 1A and 300 VDC at 10MA. Beautiful satin-gold enamel finish. Shpg. Wt. 7 lbs.

MODEL WA-P2 (with cab.) **\$19<sup>75</sup>**  
\$1.98 dwn., \$1.66 mo.

**4 HEATHKIT ADVANCED-DESIGN HI-FI AMPLIFIER KIT** This fine 25-watt high fidelity amplifier employs KT66 output tubes by Genalex and a Peerless output transformer for top performance. Frequency response  $\pm 1$  db from 5 to 160,000 cps at 1 watt. Harmonic distortion less than 1% at 25 watts, an IM distortion less than 1% at 20 watts. Hum and noise are 99 db below 25 watts. Output impedance is 4, 8 or 16 ohms. Extremely stable circuit with "extra" features.

MODEL W-5: Consists of W-5M plus WA-P2 Preamplifier **\$59<sup>75</sup>** \$5.98 dwn., \$5.02 mo.  
Shpg. Wt. 38 lbs. \$79.50 \$7.95 dwn., \$6.68 mo.  
Express only

**5 HEATHKIT DUAL-CHASSIS HI-FI AMPLIFIER KIT** This 20-watt Williamson-type amplifier employs the famous Acrosound model TO-300 output transformer, and uses 5881 tubes. Frequency response is  $\pm 1$  db from 6 cps to 150 kc at 1 watt. Harmonic distortion less than 1% at 21 watts, and IM distortion less than 1.3% at 20 watts. Output impedance is 4, 8 or 16 ohms. Hum and noise are 88 db below 20 watts.

MODEL W-3: Consists of W-3M plus WA-P2 Preamplifier **\$49<sup>75</sup>** \$4.98 dwn., \$4.18 mo.  
Shpg. Wt. 37 lbs. \$69.50 \$6.95 dwn., \$5.84 mo.  
Express only

**6 HEATHKIT SINGLE-CHASSIS HI-FI AMPLIFIER KIT** This 20-watt Williamson-type amplifier combines high performance with economy. Employs Chicago-Standard output transformer and 5881 tubes. Frequency response  $\pm 1$  db from 10 cps to 100 kc at 1 watt. Harmonic distortion less than 1.5% and IM distortion less than 2.7% at full output. Output 4, 8 or 16 ohms. Hum and noise—95 db below 20 watts.

MODEL W-4A: Consists of W-4AM plus WA-P2 Preamplifier **\$39<sup>75</sup>** \$3.98 dwn., \$3.34 mo.  
Shpg. Wt. 35 lbs. \$59.50 \$5.95 dwn., \$5.00 mo.  
Express only

**7 HEATHKIT 20-WATT HIGH FIDELITY AMPLIFIER KIT** Features full 20 watt output using push-pull 6L6 tubes. Built-in preamplifier provides four separate inputs. Separate bass and treble controls. Output transformer tapped at 4, 8, 16 and 500 ohms. Designed for home use, but also fine for public address work. Response is  $\pm 1$  db from 20 to 20,000 cps. Harmonic distortion less than 1% at 3 db below rated output. Shpg. Wt. 23 lbs.

MODEL A-9B **\$35<sup>50</sup>**  
\$3.55 dwn., \$2.98 mo.

**8 HEATHKIT ELECTRONIC CROSS-OVER KIT** This device separates high and low frequencies electronically, so they may be fed through two separate amplifiers driving separate speakers. Eliminates the need for conventional cross-over. Selectable cross-over frequencies are 100, 200, 400, 700, 1200, 2000 and 3500 cps. Separate level controls for high and low frequency channels. Attenuation 12 db per octave. Shpg. Wt. 6 lbs.

MODEL XO-1 **\$18<sup>95</sup>** \$1.90 dwn., \$1.59 mo.

**9 HEATHKIT 7-WATT ECONOMY AMPLIFIER KIT** Qualifies for high fidelity even though more limited in power than other Heathkit models. Frequency response is  $\pm 1\frac{1}{2}$  db from 20 to 20,000 cps. Push-pull output and separate bass and treble tone controls. Good high fidelity at minimum cost. Uses special tapped-screen output transformer.

MODEL A-7E: Same as A-7D except one more tube added for extra preamplification, two inputs, RIAA compensation and extra gain. **\$17<sup>95</sup>** \$1.80 dwn., \$1.51 mo.  
MODEL A-7D  
Shpg. Wt. 10 lbs. \$19.95 \$2.00 dwn., \$1.68 mo.  
Incl. Excise Tax Shpg. Wt. 10 lbs.

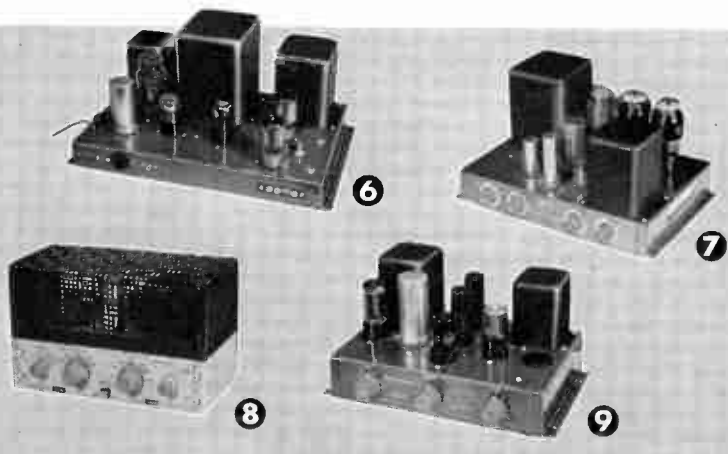

Write for Free Catalog

**HOW TO ORDER**  
Just identify kit by model number and send order to address below. Write for further details if you wish to budget your purchase on the HEATH TIME PAYMENT PLAN.

**HEATH COMPANY**  
A Subsidiary of Daystrom, Inc.  
BENTON HARBOR 5, MICHIGAN  
Please send Free HEATHKIT catalog.

Name \_\_\_\_\_  
Address \_\_\_\_\_  
City & Zone \_\_\_\_\_ State \_\_\_\_\_

Twelve Years of Superiority

# The Altec 604 Duplex®

Since its introduction in 1945 the Altec 604 coaxial loudspeaker has been considered the finest single frame loudspeaker in the world. *The 604 Duplex* has become the quality listening standard in the majority of recording studios and broadcast stations. And, since the beginning of the home high fidelity market, it has led the field in popular acceptance. More than 95% of all the 604 Duplexes built are still in service today.

The reasons for the marked superiority of the speaker are surprisingly simple. Conceived originally as a professional quality standard, the 604 was designed in a straight-forward manner and at the time of its introduction incorporated many features new to the industry. Continuing research has resulted in the constant improvement of this speaker, but it is interesting to note that the basic design features have not yet been changed; the 604 remains superior and many of the features built into the 604 more than 12 years ago are now being promoted in the high fidelity industry as "new developments" and "industry firsts."

Let's examine the 604C Duplex in detail, analyzing the design features which have made it famous.

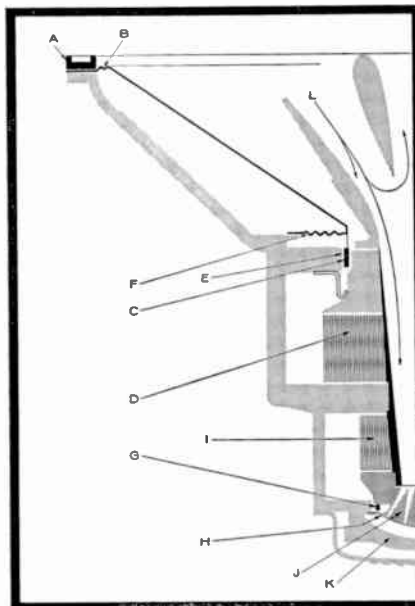

#### BASS SECTION

(a) The outer edge of the loudspeaker cone is clamped between the cast frame and rigid cast clamping ring, instead of the more common glued construction. This clamping ring permits more accurate centering of the cone and assures its accurate location over a long period. (b) The compliance section of the cone is provided with a viscous anti-reflecting compliance damping to absorb sound waves which would introduce distortion if permitted to reflect back down the cone. (c) The three inch voice-coil is made of 95 turns of ribbon copper wire, wound on edge to provide greater speaker efficiency. The ribbon is .0033" thick and .024" wide and is coated with two .00025" layers of insulation for protection against electrical shorting between turns of the coil. (d) A 4.4 pound Alnico V ring magnet provides high efficiency and precise control over the movement of the speaker cone. (e) The deep voice-coil gap sides provide a long path of homogeneous flux density permitting greater cone excursion (.75") while maintaining the voice-coil in a constant flux field. The use of a shallow gap would mean that the voice-coil would move to areas of varying flux density with resulting distortion. (f) The woven annular compliance spider and damped cone compliance (b) permit free cone excursion for a maximum natural cone resonance of 40 cycles while at the same time controlling the cone movement to avoid acoustic self resonances.

#### TREBLE SECTION

(g) The 1.75 inch voice-coil consists of 37 turns of double insulated edge wound aluminum ribbon .0023" thick and .014" wide for maximum efficiency. (h) The domed diaphragm is made of an exclusive fatigue resistant aluminum alloy for long life and high rigidity. To provide the lowest possible mass an integral tangential compliance is formed of the same material. (i) A 1.2 pound Alnico V ring magnet physically separated from the low frequency structure. (j) A dust-annular phasing plug automatically machined to assure complete production accuracy. (k) A mechano-acoustic loading cap to provide proper back loading of the aluminum diaphragm. (l) A true exponential throat ending in six exponential horns grouped in a 2x3 multicellular configuration to provide a 40° by 90° distribution pattern. It should be noted that the exponential horn both in its sectoral and multicellular shapes is still the only type of high frequency horn which has proved acceptable in professional use.

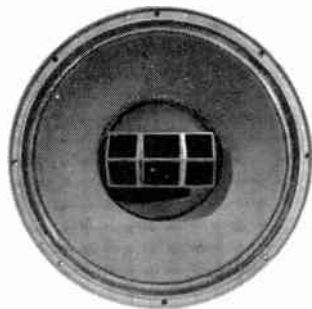

The 604C including network \$165.00

As you can see, the Altec 604 Duplex was a truly revolutionary development 12 years ago and today, with its many improvements, still displays a marked degree of engineering superiority and a performance throughout the entire range from 30 to 22,000 cycles noticeably superior to that of any other single frame loudspeaker.

If you are not as yet acquainted with the superb performance of Altec Duplex loudspeakers, ask your dealer for a listening comparison with *any* other units. We are sure you will hear the superiority that has made the Duplex famous for 12 years.



Dept. 5M  
1515 S. Manchester Ave., Anaheim, Calif.  
161 Sixth Avenue, New York 13, New York

## RECORD COLLECTING

Continued from page 54

tique simplicity". Nothing more despairing has been written in the lied form.

One's admiration for Wolf's songs cannot but grow and grow upon deeper acquaintance. In variety of conception, in the discovery for each poem of a searching and true musical analysis, Wolf has never been surpassed, even by such masters as Schubert, Schumann, and Brahms.

*Max Serbin is a well known New York choral conductor and instrumentalist of especially wide interests. The latter include most notably the art song and (very) early music, to both of which specialized pursuits he has given much of his avocational time throughout a busy practical career.*

## KATZENJAMMER KIDS

Continued from page 27

their fleet to harbor through the multitudinous hazards of mine-imperiled waters.

Victor's repertoire has its inception at a regular routine meeting of Marek, Kayes, and "the boys", as Dick and Jack are affectionately called by the major portion of the personnel. Mohr and Pfeiffer invariably leave these meetings with a heavy load of notes. Immediately there issues from their office a steady stream of work authorizations, complicated schedules, and timing blueprints with copies to all concerned. Every facet of the assignments is now in their hands.

Each handles separately every recording session to which he has been assigned. They also interchange their artists, with one handling Munch and the Boston Symphony for one session and the other for another. A few of the artists also prefer to work with one of the boys exclusively. The musical directors join hands on the major assignments that involve both soloists and orchestra.

Once the red light goes on in the recording studio, Pfeiffer's job is, as he puts it, "getting the best possible performance in a relaxed atmosphere most conducive to its perfection".

To this Mohr adds that "it is the task of collaborating with the artist and with the recording engineer; to reconcile their differences, if any, and to produce a record of the artist's best performance coupled with the best sound engineering".

Mohr looks on the Berlioz "Damnation of Faust" with Munch and the Boston Symphony as perhaps the most difficult of all the recordings he has ever handled, because of its length and because of its demands upon the singers and the chorus as well as orchestra. Reiner's abridged "Salome" and "Elektra" he found challenging because of the music's tremendous dynamics.

Pfeiffer finds that possibly his greatest challenge lies in his work with the engineers in adapting the sound to the demands of a solo piano when recording works by

Concluded on page 60

Hi-Fi Music at Home

# why the Collaro

## RC-456

is today's outstanding  
**HIGH FIDELITY RECORD CHANGER**



**Minimum  
Noise and  
Distortion**

Balanced, heavy 4-pole motor . . .  
balanced pulley and coupler reduce  
rumble to an inaudible minimum.  
Automatic muting switch and R/C  
network eliminate 'clicks.'

**Accurate  
Speed & Pitch**

Collaro quality control limits for the  
RC-456 are .25% wow and flutter  
. . . unmatched by any other  
record changer.

**Jam-Proof**

Collaro safety-clutch prevents  
damage even if tone-arm is held  
or moved during change cycle.

**Four Speeds**

Plays all 78, 45 and 33 1/3 rpm  
records . . . plus new types designed  
for 16 2/3 rpm speed.

**Automatic  
Intermix**

Plays 7, 10 and 12-inch records  
stacked in any order —  
automatically.

**Manual  
Operation**

For playing records individually or  
for selecting and playing specific  
bands and parts of a record.

**Simple  
Installation**

Prewired power and audio connections  
eliminate soldering. Pre-cut  
mounting board available.

### ...Plus

- ★ Rapid change cycle independent of record speed.
- ★ Automatic 'shut-off' after last record.
- ★ Simple, one-knob speed selection.
- ★ Gentle, straight-spindle record handling.
- ★ Interchangeable, plug-in cartridge shells.
- ★ Heavy, rim-weighted turntable for flywheel action.
- ★ Automatic idler-disengage prevents idler flats.

At leading sound dealers, or write Dept. XE-5

**ROCKBAR CORPORATION** • 650 Halstead Avenue, Mamaroneck, N. Y.



# AR-2

The AR-1 acoustic suspension\* speaker system is now widely recognized as reproducing the cleanest, most extended, and most uniform bass at the present state of the art. It is employed as a reference testing standard, as a broadcast and recording studio monitor, as an acoustical laboratory test instrument, and in thousands of music lovers' homes.

The AR-2, our second model, is a two-way speaker system (10 in. acoustic suspension woofer and newly developed tweeter assembly), in a cabinet slightly smaller than that of the AR-1—13½"x24"x11¾". It is suitable for use with any high quality amplifier which supplies 10 or more clean watts over the entire audio range.

# AR-2

The price of the AR-2 in hardwood veneer is \$96.00, compared to the AR-1's \$185.00. Nevertheless we invite you to judge it directly, at your sound dealer's, against conventional bass-reflex or horn systems. The design sacrifices in the AR-2, comparatively small, have mainly to do with giving up some of the AR-1's performance in the nether low-frequency regions, performance which is most costly to come by. The AR-2 can radiate a clean, relatively full signal at 30 cycles.

The AR-2 speaker was designed as the standard for medium-cost high fidelity systems. Our tests have shown it to be so far ahead of its price class that we think it will come to be regarded as such a standard within its first year.

# AR-2

Literature, including complete performance specifications, available on request from:

**ACOUSTIC RESEARCH, INC.**  
24 Thorndike St., Cambridge 41, Mass.

\* Pat. pending and copr., Acoustic Research, Inc.

## KATZEN-JAMMER KIDS

Continued from page 58

composers such as Mozart, Domenico Scarlatti, or the elder Bach: "The intimate quality called for in Mozart, or the necessity of fitting the sound to the quality of Bach so that the polyphonic character of the voices is articulate, demands painstaking care and consideration."

The variables which can be used to obtain this balance include, according to Pfeiffer, proper microphone placement so that the various sections of the instrument are balanced; the beam direction of the microphone; the padding or flat arrangement around the piano to direct the sound and the frequency response of the channel used in connection with the mike.

As for their individual choices, Mohr holds out for the music he personally likes such as the Verdi "Il Trovatore" with Milanov and Warren; Monteux's *Pathétique* with the Boston Symphony; Reiner's *Also Sprach Zarathustra* and the Munch *Daphnis et Chloé*.

Pfeiffer classifies *The Well-Tempered Clavier* of Wanda Landowska among the outstanding achievements of his experience. "I feel very strongly about this work", he says, "because we spent four years on it and labored so hard to make this the definitive recording. I am steeped in every detail and feel very proud of my association with it."

In the spacious confines of Manhattan Center, in the garishly rococo and resplendent Webster Hall, or in the simpler quarters of studios 1 or 2 at 24th Street, these perfectionists are preserving performances that will serve as study models for many years. Once the repertoire meetings are finalized and the paper work completed, the artists' appearances scheduled, the hall reserved, the musicians called and the equipment unloaded and adjusted, then the world which the boys rule as music impresarios is that of the red light, the words "Quiet Please", the hushed footsteps, and rapt concentration.

Following the scores at their separate sessions, the faces of the musical directors and the artists who come into the control room to listen to "takes" are bathed in the light from a small student lamp on the directors' desk which is often the sole illumination in the vast caverns of the studio. The lights and shadows in the deeply engrossed faces of the artists — sometimes half covered in a shawl or towel to avoid drafts — have overtones of Giotto or Daumier. Through it all, cutting across the shadows and maze of cables, microphones, and flats is the voice of Dick or Jack saying to the musicians and engineers, "Let's try it again, please", or "We're satisfied with that one, if you are."

Pfeiffer is a graduate of the University of Arizona where he was a music major, studying oboe and piano. When he joined the Navy he was assigned to electronics

which he liked so much he studied electrical engineering when he returned to civilian life. Pfeiffer was assigned to the design and development division of RCA as an engineer in 1949, then was shifted to the quality control division of the 24th Street studio. He was transferred to the A & R department in 1950 because of his combination of music and engineering experience.

Mohr was born in Springfield, Ohio, studied music and journalism at a local college, later became a reporter and finally music critic on the *Columbus Dispatch*. He came with Victor in 1944 as editor of the now long defunct *Victor Record Review*. He was appointed assistant musical director in 1946, then took over the reins the following year and was joined by Pfeiffer four years later.

Neither Dick nor Jack ever originally conceived of themselves in the positions which they now occupy. Pfeiffer always thought of himself as an engineer with musical leanings; Mohr was a writer and editor who expected to remain such. They profess to be completely absorbed in their work, even to the extent that much of their spare time is spent in listening both to Victor records and those of the competition. Each, also, is prone to retreat from society to some extent in what leisure hours are left after those they spend both officially and unofficially with the artists.

Mohr lives in an East Sixties apartment furnished with custom-built French Provincial fruitwood furniture, a scattering of marble-topped tables, and drapes of Thai-bok Siamese fabrics. He is an omnivorous reader of Dickens and also interests himself in Etruscan art and the Renaissance. In a spacious modern apartment overlooking the upper Hudson, Pfeiffer refreshes himself by working out problems in probability, theory, and calculus and also by studying for his Master's degree in engineering, the achievement of which will fulfill a long-cherished ambition. He also has a distinctive touch at the piano.

"One of the greatest qualities of a musical director," according to Morton Gould, "lies in his art of saying something critical in the nicest possible way so that not until days later has the artist realized how gently he has been guided in what — at that time, for him — was the right direction. And by then the artist is freer to see their suggestions in the proper perspective. He must also create an atmosphere that enables the artist to function to the fullest extent within the confines of the recording machinery." So, in addition to all the other requirements, a musical director must have the ultimate capabilities of a diplomat!

During his years as RCA publicist, Ben Kemper became intimately acquainted with the subjects of this account, so that he was able to write about their activities from first-hand knowledge. The author is also an alumnus of *Paramount Pictures* and the *New York Daily News*.

FIRST NIGHT FRESHNESS . . . forever . . .

The Newcomb Compact 200 AM-FM Tuner will reawaken your first wonder at the miracle of radio, will recall your first thrilling taste of high fidelity sound. The excitement of a first performance awaits you when first you light the dial.

And the newness will not wear off. Highly refined circuitry, temperature controlled oscillators, automatic frequency control give the Newcomb Compact 200 unrivalled, enduring stability. And from its very great sensitivity you derive the same masterful satisfaction you enjoy when operating any fine instrument or highly powered vehicle.

Free of novel gadgets and ornaments, the Compact 200 is designed for listeners of the highest taste who require a tuner for the lasting enjoyment of broadcast music. Styled for the drawing room, the panel is the color of golden satin; the case—a shade of champagne dusted with gold. Within is concentrated all of the quality, precision, and perfection that twenty years devotion to the amplification and control of sound has taught us how to achieve.

**NEWCOMB** . . . since 1937, Hollywood's leading producer of precision instruments for the control and amplification of sound—high fidelity components, record and transcription players for professionals, radios, public address systems.

For complete details write: Newcomb Audio Products Co., Dept. MH5  
6824 Lexington Avenue, Hollywood 38, California.

Export Department:  
431 Fifth Avenue, New York 16, New York





**avoid  
a costly  
mistake**

*in your  
high fidelity system*



**send for this new  
REK-O-KUT booklet**  
*colorfully illustrates...  
factually describes... the  
important advantages of  
playing your records on a  
precision turntable!*

**FREE — SEND COUPON TODAY!**

NAME \_\_\_\_\_  
ADDRESS \_\_\_\_\_  
CITY \_\_\_\_\_ ZONE \_\_\_\_\_ STATE \_\_\_\_\_

**REK-O-KUT COMPANY, INC.**  
38-01 Queens Blvd.  
Long Island City 1, N. Y. TN

## Where to Buy Hi-Fi in the Chicago Area

A New Directory of Dealers Handling  
Hi-Fi Equipment, Records & Tapes,  
and a List of the FM radio stations



This listing of hi-fi specialists has been compiled with great care, to make it as accurate and complete as possible. Where no details are shown, the dealer failed to respond to our request for information.

### ILLINOIS

#### Aurora

**HI-FI RECORD SHOP**, 47 Fox St. 6-8021  
Hi-fi equipment, tape, stereo, recorded tapes,  
custom installations, records, service  
Ask for John Cook, Harold Sharpe

**MAINLINE SUPPLY CO.**

#### Blue Island

**Delta Distributors**

#### Broadview

**HI-FI UNLIMITED**, 1305 W. Roosevelt Rd. 1 mile west  
of V.A. Hospital FI 5-1800  
Hi-fi equipment, stereo, recorded tapes, custom  
installations, records, service  
Ask for Bob Lewis, John Griffin

#### Chicago

**Ades Sound Service**

**Alan Radio & Appliance Co.**

**ALLIED RADIO CORP.**, 100 N. Western Ave.  
HA 1-6800

Hi-fi equipment, records, tape, recorded  
tapes, stereo  
Ask for Fred Pohn

**B. Andrews & Co.**

**Atlas Music Co.**

**Arpio Soles, Inc.**

**Atronic Corp.**

**BACKGROUND MUSIC**, 2122 N. Western  
AR 6-5005

Hi-fi equipment, stereo, custom installations,  
service

Ask for Roger Aiman

**Bennett Bros., Inc.**

**Boom Electric Co.**

**J. G. BOWMAN CO.**, 517 E. 75 St. TR 4-8070  
Hi-fi equipment, custom installations, tape, service  
Ask for Harold Wickland, Jack Kawall

**Caller's Sound Service**

**Chauncey's, Inc.**

**Chicago Electronic Distributors**

**Cloyton Radio Parts**

**Continental Corp.**

**CUSTOM ELECTRONICS**, 5019 Blackstone  
LI 8-0606

Hi-fi equipment, tape, custom installations, service  
Ask for Richard Faby, Joe Foucoul

**DeHAAN HI-FI**, 9680 Evergreen Plaza PR 9-4610  
Hi-fi equipment, records, tape, stereo, recorded  
tapes, custom installations

Ask for Jim DeHaan, Ted Lindgren

**De Luxe Music Shop**

**The Disc**

**ELECTRONIC EXPEDITERS**, 2909 W. Devon  
RO 4-8640

Hi-fi equipment, records, tape, stereo, recorded  
tapes, custom installations, service  
Ask for Dove Berns, Dick Williams, Fred Friedler

**EVERGREEN ALLIED HIGH FIDELITY**, 2025 W.  
93th St. BE 8-1067

Hi-fi equipment, records, tape, re-  
corded tape, stereo  
Ask for Marvin Sklansky

**Functional Music Co.**

**GREEN MILL RADIO**, 145 W. 111th St. PU 5-9840  
Hi-fi equipment, tape

Ask for Herman, Nick

**HI-FI INC.**, 10309 S. Western Ave. PR 9-3323

Hi-fi equipment, tape, stereo, recorded tapes,  
custom installations, service, records  
Ask for N. Coulter

**Hudson-Ross, Inc.**

**Irving Joseph, Inc.**

**LISHON'S**, 175 W. Washington St. CE 6-3073

Records, tape, recorded tapes  
Ask for Hank Lishon, Joe Reed

**LISHON'S**, 43 E. Oak St. WH 4-1077

Records, tape, recorded tape  
Ask for Mark Stern, Frank Woods

**Little Al's**

**Lowes Radio Co.**

**Lukko Soles Corp.**

**LUND CO.**, 5236 S. Blackstone Ave. MU 4-3300  
Hi-fi equipment, custom installations, service

Ask for Harry Lund, Bene Bakes

**Lyon & Healy, Inc.**

**Main Street Book Store**

**Marquette Record Shop**

**The Mostow Co.**

**Merquip Co.**

**Musichron Corp.**

**MUSICRAFT, INC.**, 48 Oak St. DE 7-4150

Hi-fi equipment, tape, stereo, recorded  
tapes, service, records

**ARTHUR NAGEL, INC.**, 918 E. 55th St. BU 8-5050

Hi-fi equipment, tape, custom installations  
Ask for Art, Joe

**Nation Wide Radio Co.**

**R. W. Neill Co.**

**NEWARK ELECTRIC CO.**, 223 W. Madison St.  
ST 2-2944

Hi-fi equipment, tape, custom installations, stereo  
Ask for David Dinoh, Marvin Birchfield

**PLUSSER RADIO**, 2543½ E. 75th St. SA 1-0830

Hi-fi equipment, tape, stereo, custom installations,  
service  
Ask for Mr. Plusser

**Radio Parts Dist. Inc.**

**Radio Parts Co.**

**The Record Center**

**ROSE RADIO**, 159 W. Madison DE 2-2737

Records, tape, stereo recorded tapes, service  
Ask for Merrill Rose, Al Schuchter

**SCHWARTZ BROS HI-FI**, 1215 E. 63 St. PL 2-4316

Hi-fi equipment, tape, stereo, custom installa-  
tions, service  
Ask for Gene, Ted Schwartz

**Star Electronic Dist. Inc.**

**Stebbins Sound Service**

**Stolz-Wicks, Inc.**

*Hi-Fi Music at Home*

Three Dimension Co.  
 TRI-PAR RADIO COMPANY, 119 N. Wells St.  
 AU 3-2585

Hi-fi equipment, stereo, tape, recorded tapes,  
 custom installation, service  
 Ask for Mr. Stanley J. Hersch

Universal Audio Equipment Inc.  
**VOICE AND VISION, INC., Walton & Rush**  
 WH 3-1166

Hi-fi equipment, hi-fi records, tape, re-  
 corded tapes, stereo  
 Ask for Norman Foss

The Walker Jamieson Co., Inc.  
 White Sound Corp.  
 Woodlawn Appliances

**Decatur**  
 Loughane & Company

**Dixon**  
 Illinois Appliance Co.

**Elmhurst**  
 Malone Electronics, Inc.

**Evanston**  
**ALLIED HIGH FIDELITY STORES, 602 Davis St.**  
 SH 3-6233

Hi-fi equipment, hi-fi records, tape, re-  
 corded tapes, stereo  
 Ask for Robert Livin

LISHON'S, 163 Sherman, off Fountain Sq.  
 DA 8-8860

Records, tape, recorded tapes  
 Ask for Haskell Gordon, Tom Ferguson

**Highland Park**  
 GRANT & GRANT, 208 Central Ave. ID 2-7222

Hi-fi equipment, tape, records, recorded tapes  
 custom installations, service  
 Ask for C. W. or L. I. Grant

GRANT & GRANT HI-FI, 708 Central at Green Bay  
 ID 2-7222

Hi-fi equipment, records, stereo, tape, recorded  
 tapes, custom installations, service  
 Ask for Chuck Grant

Lishon's Inc.

**Hinsdale**  
 Village Music Shop

**Joliet**  
 Mainline Supply Co.

**Kankakee**  
 Radio Doctors Supply House

**La Salle**  
 Warren Radio Co.

**Libertyville**  
 MASTER ELECTRONICS & TV, Rt. 59-A, 1/2 mi. E. of  
 Rt. 21 LI 2-3261

Hi-fi equipment, stereo, recorded tapes, custom  
 installations, service  
 Ask for Rudy, Marian Bruna

**Oak Park**  
 HIGH FIDELITY HOUSE, 1127 Westgate,  
 near Harlem & Lake VI 8-5664

Hi-fi equipment, tape, records, stereo, custom  
 installations, service  
 Ask for Mr. Weis

LYON & HEALY, 125 N. Marion St. EU 3-2200  
 Records, tape, service

OAK PARK RECORDS, 1020 Lake St.  
 near Lake St. Theatre EU 6-1384  
 Records, tape, recorded tapes, hi-fi equipment  
 Ask for Ted Seifert

**WEST SUBURBAN ALLIED HIGH FIDELITY**  
 7055 W. North Avenue  
 ES 9-4281, EU 6-6812

Hi-fi equipment, hi-fi records, tape, re-  
 corded tapes, stereo  
 Ask for Alex Americus

Geo. Wallach & Assoc.

TRI-PAR RADIO COMPANY, 218 Madison Ave.  
 CO 1-8442

Hi-fi equipment, stereo, tape, recorded tapes,  
 custom installation, service  
 Ask for Ed Temu



# Save on Famous knight Hi-Fi

THE VERY FINEST FOR LESS:

Knight Custom components are built to ALLIED's  
 own special high standards to deliver outstanding  
 musical quality with distinguished appearance  
 at money-saving minimum cost. Each unit is  
 unconditionally guaranteed for one full year.



## Top Value knight Hi-Fi Components



ONLY  
**\$94<sup>50</sup>**

**Deluxe 24-Watt Amplifier.** "Space-Saver"  
 design; response,  $\pm 0.75$  db, 20-40,000  
 cps; 12-position compensation; variable  
 damping; loudness control; rumble filter;  
 tape head input; hum balance. U.L. Ap-  
 proved. Shpg. wt., 30 lbs. Net . . . \$94.50



ONLY  
**\$99<sup>50</sup>**

**Deluxe Basic FM-AM Tuner.** Matches De-  
 Luxe amplifier; AFC; tuning meter; tuned  
 RF on FM and AM; FM discriminator;  
 2 cathode followers; exceptional sensitiv-  
 ity. FCC Approved Radiation; U.L. Ap-  
 proved. Shpg. wt., 17 lbs. Net . . . \$99.50



ONLY  
**\$64<sup>50</sup>**

**"Bantam" 12-Watt Amplifier.** Response,  
 $\pm 0.5$  db, 20-20,000 cps; 3-position com-  
 pensation; variable damping; loudness  
 control; built-in preamp; tape head input;  
 7 inputs; "Space-Saver" design. U.L. Ap-  
 proved. Shpg. wt., 18 lbs. Net . . . \$64.50



ONLY  
**\$74<sup>50</sup>**

**"Bantam" Basic FM-AM Tuner.** Matches  
 "Bantam" Amplifier; AFC; FM limiter  
 and discriminator; output level control;  
 RF stage; high sensitivity; temperature-  
 compensated oscillator. FCC Approved  
 Radiation; U.L. App. 13 lbs. Net . . . \$74.50



ONLY  
**\$104<sup>95</sup>**

**"Uni-Fi" Tuner-Amplifier Combination.**  
 Single chassis construction; complete FM-  
 AM Tuner, Preamplifier and Amplifier all  
 in one; compact,  $4\frac{1}{4} \times 15 \times 10\frac{1}{2}$ ; 10-watt  
 amplifier has every advanced feature;  
 FCC Radiation Approved.

"Uni-Fi" chassis only. 17 lbs. Net. \$104.95  
 "Uni-Fi" complete in "Space-Saver" cabi-  
 net. 21 lbs. Net. . . . . \$109.95



### LOW-COST knight PHONO SYSTEM

ONLY  
**\$174<sup>50</sup>** Top value in a fine Hi-Fi  
 music system. You save  
 \$18.32 over cost of individual  
 components. No cabinets required. In-  
 cludes Knight "Bantam" amplifier; E-V  
 Baronet Speaker System (specify limed  
 oak or mahogany finish); Webcor 1632-  
 27B Changer with G.E. RPX-050A Tri-  
 ple Play Cartridge (dual sapphire styli).  
 Easy installation. Shpg. wt., 67 lbs.  
 94 PA 600. Complete System . . . \$174.50



ONLY  
**\$44<sup>50</sup>**

**Preamp-Equalizer.** Lowest-cost  
 self-powered preamplifier. 3-  
 position compensation; rumble  
 switch; loudness switch;  $\pm 1$  db,  
 30-30,000 cps. U.L. Approved.  
 Shpg. wt., 8 lbs. Net . . . . \$44.50

ALL PRICES NET, F.O.B. CHICAGO



**FREE**  
**ALLIED'S 1957**  
**356-PAGE CATALOG**

Send for this value-  
 packed catalog fea-  
 turing the world's largest selection of  
 Hi-Fi components and systems, as well  
 as everything in Electronics.

Write for your copy today.

## ALLIED RADIO

America's Hi-Fi Center

OUR  
 36th  
 YEAR

ALLIED RADIO CORP., Dept. 76-E-7  
 100 N. Western Ave., Chicago 80, Ill.

Ship the following KNIGHT Hi-Fi equipment \_\_\_\_\_

\_\_\_\_\_ \$ \_\_\_\_\_ enclosed

Send FREE 356-page ALLIED 1957 Catalog

Name \_\_\_\_\_

Address \_\_\_\_\_

City \_\_\_\_\_

Zone \_\_\_\_\_ State \_\_\_\_\_

**Riverdale**  
**AUDIO DISTRIBUTORS**, 14218 S. Indiana Ave.  
 RI 4543  
 Hi-fi equipment, records, recorded tapes, custom installations, service  
 Ask for Bill Thompson

**Rockford**  
 H & H Electronic Supply Inc.  
 J & M RADIO & TV, 1133 Railroad Ave. 8-3729  
 Hi-fi equipment, stereo, recorded tapes  
 Ask for Robert Carpenter  
 Mid-West Associates, Inc.  
 THE RECORD SHOP, 318 N. Main St.  
 39132, 43015  
 Hi-fi equipment, tape, stereo, recorded tapes, custom installation, service  
 Ask for George Nielsen, Clyde Person  
 Superior Radio Parts Co.

**Waukegan**  
 Badger Electronic Parts Co.

**Wilmette**  
 Suburban Appl. & Electric Co.

**INDIANA**

**Gary**  
 COSMOPOLITAN RADIO, 524 Washington St.  
 TU 5-0551  
 Hi-fi equipment, tape, stereo, recorded tapes, custom installations, service  
 Ask for Dan Garci, E. Gonzalez

WILSON ELEC. APPL. CO., 804 Broadway  
 TU 5-7557  
 Hi-fi equipment, records, stereo, recorded tapes, custom installations, service  
 Ask for Marcus Blumenthal, Bill Holtzman

**Hammond**  
 Broadwin Television & Radio Co.

**Valparaiso**  
 JESS BOWMAN ASSOCIATES, 257 W. Lincolnway  
 Hi-fi equipment, tape 34381

**WISCONSIN**  
**Milwaukee**  
 Audio Engineering Co.  
 A & F Electro Mart  
 BADGER SOUND CO., 2216 N. 38th St. HI 4-3830  
 Hi-fi stereo equipment, tapes, service, custom installations  
 Electronic Expeditors  
**THE HI-FI CENTER, INC.**, 4236 W. Capitol Dr. at Sherman Blvd. UP 1-2113  
 Hi-fi equipment, records, tape, stereo, recorded tapes, custom installations, service  
 Ask for James Goodwillie, Gordon Lew, Warren Keats  
 Marsh Radio Supply Co.

RADIO PARTS CO., 940 N. 27th St. WE 3-5131  
 Hi-fi equipment, tape, stereo, recorded tapes  
 Ask for Mr. Dresfus, E. Behagen  
 ROEHL-REITH, 2224 W. Meinecke Ave FR 4-1700  
 Hi-fi equipment, tape, recorded tapes, custom installations, service, records  
 Ask for M. W. Bolansky, H. Reith  
 WACK SALES CO., 3131 W. North Ave. HI 2-3442  
 Records, tape, stereo, recorded tapes, hi-fi equipment, service  
 Ask for Wally, Stella Wack  
 WISCONSIN SOUND EQUIPMENT, 2733 W. North Ave. DI 2-2144  
 Hi-fi equipment, tape, stereo, recorded tapes, custom installations, service  
 Ask for Roy Van Brunt, Lloyd Selfe

**FM RADIO STATIONS IN THE CHICAGO AREA**

Call Letters	Frequency	Location	Call Letters	Frequency	Location
WBBM	96.3	Chicago, Ill.	WEPB	88.1	Elkhart, Ind.
WBEZ	91.5	Chicago, Ill.	WNUR	89.3	Elkhart, Ind.
WEAW	105.1	Chicago, Ill.	WNIC	91.1	Elkhart, Ind.
WEFM	99.5	Chicago, Ill.	WBEZ	91.5	Elkhart, Ind.
WEHS	97.9	Chicago, Ill.	WJOB	92.3	Elkhart, Ind.
WENR	94.7	Chicago, Ill.	WFJL	93.1	Elkhart, Ind.
WEPS	88.1	Chicago, Ill.	WENR	94.7	Elkhart, Ind.
WFJL	93.1	Chicago, Ill.	WBBM	96.3	Elkhart, Ind.
WFMF	100.3	Chicago, Ill.	WNIB	97.1	Elkhart, Ind.
WFMT	98.7	Chicago, Ill.	WROK	97.5	Elkhart, Ind.
WHFS	101.3	Chicago, Ill.	WEHS	97.9	Elkhart, Ind.
WJOB	92.3	Chicago, Ill.	WFMT	98.7	Elkhart, Ind.
WLEY	105.9	Chicago, Ill.	WNIB	97.1	Elkhart, Ind.
WMAQ	101.1	Chicago, Ill.	WSEB	104.3	Elkhart, Ind.
WNIB	97.1	Chicago, Ill.	WTRC	100.7	Elkhart, Ind.
WNIC	91.1	Chicago, Ill.			
WNUR	89.3	Chicago, Ill.			
WOPA	102.3	Chicago, Ill.			
WROK	97.5	Chicago, Ill.			
WSEL	104.3	Chicago, Ill.			
WTRC	100.7	Chicago, Ill.			

**Where to Buy  
 Hi-Fi  
 in the Boston Area**

A New Directory of Dealers Handling Hi-Fi Equipment, Records & Tapes, and a List of the FM radio stations

This listing of hi-fi specialists has been compiled with great care, to make it as accurate and complete as possible. Where no details are shown, the dealer failed to respond to our request for information.

**MAINE**

**Portland**  
 CRESSEY & ALLEN, 517 Congress St. SP 3-8131  
 Records, tape, recorded tapes, stereo, service  
 Ask for Louis Smith, Mrs. Ethel Clark

**MASSACHUSETTS**

**Boston**  
 BOOK CLEARING HOUSE, 423 Boylston St. CO 7-1600  
 Records, recorded tapes  
 BOSTON MUSIC CO., 116 Boylston St. HA 6-5100  
 Records, tape, recorded tapes  
 Ask for Mr. Morris  
 CRAMER ELECTRONICS, INC., 811 Boylston St. CO 7-4700  
 Hi-fi equipment, tape, stereo  
 Ask for Arthur Pettingill, Ernest Sochin



DeMAMBRO RADIO, 1095 Commonwealth Ave. AL 4-9000  
 Hi-fi equipment, tape, stereo, recorded tapes, custom installations  
 Ask for Al Robinson, Pat Thompson  
 Louis M. Herman Co.  
 KREY'S, 60 Boylston St. HA 6-3395  
 Records, tape, recorded tapes  
**LISTENING POST, INC.**  
 161 Newbury St. near Copley Sq. CO 7-7530  
 Hi-fi equipment, tape, recorded tapes, stereo, custom installations, service  
 Ask for Ted Songer, John Ring, Gene Hirshberg  
 Mosher Music Company  
**RADIO SHACK CORP.**  
 167 Washington St., near Faneuil Hall LA 3-3700  
 Hi-fi equipment, stereo, tape, records, recorded tapes, custom installations  
 Ask for Vallmer Hetherington, Ed Seeley

RADIO WIRE TV (Lafayette)  
 110 Federal St., near South Station HU 2-7850  
 Hi-fi equipment, stereo, tape, records, recorded tapes, custom installations, service  
 Ask for Bob Kelley, Joseph Levine

SAGER ELECT. SUPPLY, 201 Congress, up one flight from Telephone Co. LI 2-2281  
 Hi-fi equipment, tape, stereo  
 Ask for Dick Blake, Ed Delaney  
 Yankee Electronics

**Brookline**  
**LOWE ASSOCIATES**, 65 Kent St., nr. Harvard & Washington Sts. AS 7-3135  
 Hi-fi equipment, tape, records, stereo, custom installations, service  
 Ask for Mr. Arkin, Mr. Demarkies  
**STEDMAN RADIO LABS.**, 360 Boylston St., near Brookline Village LO 6-5882  
 Hi-fi equipment, tape, custom installations, service  
 Ask for Dick Stedman

**Cambridge**  
 T. L. Eastern Co.  
 Hi-Fi Lab Electronic Supply  
 Minute Main Radio

**Fall River**  
 E. A. Ross & Co.

**Framingham**  
 Hi-Fi Studios

**Gloucester**  
 Sylvester Ahola

**Hyannis**  
 CAPE COD SOUND SERVICE HY 4261  
 Hi-fi equipment, tape, recorded tapes, stereo, custom installations, service

**Lawrence**  
 YOUNG & YOUNG, 198 Broadway MU 7-7171  
 Hi-fi equipment, tape, recorded tapes, stereo  
 Ask for Rob. Robideaux, Harold Cookson

**New Bedford**

**C. E. BECKMAN CO.**  
11-35 Commercial St. near State Pier  
WY 6-8201  
Hi-fi equipment, tape, stereo, recorded tapes  
Ask for P. W. Gifford, M. J. Szulik, G. Brazil  
**MUSIC BOX, 1088 Acushnet Ave.** WY 6-0111  
Records, tape, recorded tapes  
Ask for Frank Preiss, Monny Germaine

**Norwood**

Louis M. Herman Co.

**Springfield**

**SPRINGFIELD RADIO, 405 Dwight St., near Post Office** RE 2-3411  
Hi-fi equipment, tape, recorded tapes, service  
Ask for B. J. Carpenter

**SPRINGFIELD SOUND, 772 Worthington St. opposite Skipton's Dairy** RE 3-5391  
Hi-fi equipment, stereo, recorded tapes, custom installations, hi-fi & tape recorder service  
Ask for Mr. Houck, Mr. Jones

**SOUNDCO ELECTRONIC, 147 Dwight St.** RE 9-3847

Hi-fi equipment, tape, stereo  
Ask for Robert Cizek

**CUSTOM AUDIO LAB HI-FI CENTER, 999 Worthington St. near Armory St.** RE 9-7989  
Hi-fi equipment, stereo, recorded tapes, custom installations, service  
Ask for Louis Del Padre

**Taunton**

David B. Dean & Co.

**Waltham**

**LINEAR ELECTRONICS, 109 Hammond St.** TW 4-7300

Hi-fi equipment, tape  
Ask for Ed Kantorski, Bernie Nelson

**Wellesley**

**MUSIC BOX, INC., 58 Central St.** WE 5-5100  
Hi-fi equipment, stereo, recorded tapes, records, custom installations, service  
Ask for Bill Bell, Don, Carolyn Davis

**Worcester**

DeMambro Radio Supply

Denholm & McKay Company  
Marcel Plonte  
Walters Company, Inc.

**NEW HAMPSHIRE**

**Concord**

**EVANS RADIO, Route 3A Bow Jct.** CA 5-3358  
3 miles south of Concord  
Hi-fi equipment, stereo, recorded tapes, custom installations, service  
Ask for Jack Wright

**Dover**

American Radio Corp.

**Keene**

Melody Shop Inc.  
DeMambro Radio Supply Co.

**Manchester**

Worthen Laboratories  
DeMambro Radio Supply Co.

**Portsmouth**

Bert Sessions Music

**RHODE ISLAND**

**Pawtucket**

**SUPREME RADIO, 310 Main St.** PA 5-5350  
Records, tape, recorded tapes, stereo, service  
Ask for P. Hushner, E. Natalizia

**Providence**

**AUDIONICS COMPANY, 790 N. Main St.** DE 1-4242

Hi-fi equipment, records, tape, stereo, recorded tapes, custom installations, service  
Ask for Frank Parker, Al Litwin, Ed Wentworth

**BEACON SHOPS INC., 821 N. Main St.** UN 1-7500  
near N. Burial Ground  
Records, recorded tapes  
Ask for Al, Frank, Rube, Don

William Dandreta & Company

**DeMAMBRO RADIO, 90 Broadway** JA 1-5600  
Hi-fi equipment, tape, custom installations, service  
Ask for George Wells, Alfred Marifino

**W. H. EDWARDS CO., 94 Broadway** GA 1-6158  
Hi-fi equipment, tape, custom installations, service  
Ask for E. Gervais

**FM RADIO STATIONS IN THE BOSTON AREA**

Call Letters	Frequency	Call Letters	Frequency	Call Letters	Frequency
WBET	97.7	WERS	88.9	WERS	88.9
WBMS	97.3	WGBH	89.7	WGBH	89.7
WBUR	90.9	WBUR	90.9	WBUR	90.9
WCOP	100.7	WHR	91.9	WHR	91.9
WCRB	102.5	WPRO	92.3	WPRO	92.3
WEEI	103.3	WHYN	93.1	WHYN	93.1
WERS	88.9	WOCB	94.3	WOCB	94.3
WGBH	89.7	WHDH	94.5	WHDH	94.5
WHDH	94.5	WMAS	94.7	WMAS	94.7
WHSR	91.9	WPFM	95.5	WPFM	95.5
WHYN	93.1	WPJB	105.1	WPJB	105.1
WKBR	95.7	WPRO	92.3	WPRO	92.3
WLLH	99.5	WTMH	101.5	WTMH	101.5
WMAS	94.7	WTAG	96.1	WTAG	96.1
WNAC	98.5	WXHR	96.9	WXHR	96.9
WNBH	98.1	WBSM	97.3	WBSM	97.3
WOCB	94.3	WBET	97.7	WBET	97.7
WPFM	95.5	WNBH	98.1	WNBH	98.1
WOTW	106.3	WNAC	98.5	WNAC	98.5
WPJB	105.1	WLLH	99.5	WLLH	99.5
WPRO	92.3	WOCB	94.3	WOCB	94.3
WTAG	96.1	WHDH	94.5	WHDH	94.5
WXHR	96.9	WMAS	94.7	WMAS	94.7
WTMH	101.5	WPFM	95.5	WPFM	95.5
WTSV	106.1	WPJB	105.1	WPJB	105.1
WWON	106.3	WPRO	92.3	WPRO	92.3
		WTMH	101.5	WTMH	101.5
		WTSV	106.1	WTSV	106.1
		WWON	106.3	WWON	106.3

**HI-FI DEALERS IN OTHER CITIES**

"Where to Buy Hi-Fi" Directories appearing in HI-FI MUSIC will cover the 12 principal retail areas of the U. S. Following is the schedule: July-August issue, Cleveland and San Francisco; September, Washington and Los Angeles; November-December, New York and Detroit; January-February, Pittsburgh and Minneapolis-St. Paul; March-April, Philadelphia and St. Louis.

Write today for free information on the ESL-BJ Super 90 to Electro-Sonic Laboratories, Inc. Dept. M-35-54 Thirty-sixth Street - Long Island City 6, N. Y.



THE ALL-NEW

SUPER 90

**THE WORLD'S MOST ADVANCED PHONO ARM**

For the discriminating ear  
true FM fidelity is achieved

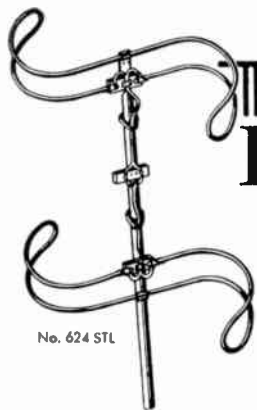

No. 624 STL

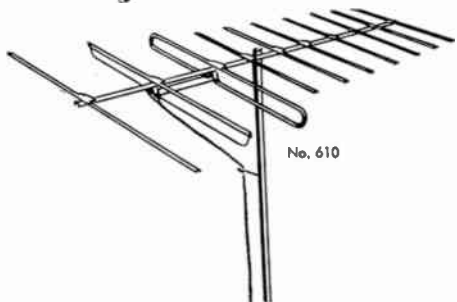

No. 610

with  
**TACO**  
FM antennas

An outdoor antenna is a necessity for the strong FM signal required to recreate all the subtle variations of great music composition.

If you like your music with the realism of a fine orchestra, a world-renowned conductor and the technical faithfulness of FM transmission, more than just an FM tuner is needed. These distinguished TACO FM antennas are an essential part of the true Hi-Fi installation, wherever located. Stacked or single, these streamlined antennas assure the "presence" looked for by the most critical Hi-Fi enthusiast whether in town or country.

The TACO No. 610 twin-driven, 10 element Yagi-type FM antenna (illustrated) offers the finest in FM reproduction over the greatest transmission distances. Completely assembled, the antenna is mechanically balanced for rotator use.

The TACO No. 624STL (illustrated) is an omnidirectional FM antenna with S-type folded dipole; ideal for FM reception up to 35 miles. Available also as single antenna.

FOR FURTHER INFORMATION ON THESE AND OTHER FM ANTENNAS WRITE TO: TECHNICAL APPLIANCE CORPORATION, SHERBURNE, N. Y.

## The GRAY professional HI FI Turntable

The Gray Heavy Duty High Fidelity Turntable is so outstanding that many of the major radio stations have purchased units for their "on the air programming."

Professional Disc Jockeys, who know the necessity for wow- and rumble-free turntables, also demand Gray.

You can be safely guided by the experience of true experts in buying a turntable for your own use. Follow the professionals, and you'll agree on Gray.



See your authorized Gray High Fidelity Dealer.

### Check these features!

Choice of Hysteresis Synchronous or Induction type motor. Cabinet available in 4 Fabrilite colors and 3 wood finishes • Sahara Beige or Satin Black mounting plate • Wow and rumble superior to NARTB professional standards • Speeds 33.33 RPM, 45 RPM and 78.26 RPM • Famous Gray viscous-damped 108C Tone Arm for "floating action." Write for complete technical literature.

**GRAY** RESEARCH & DEVELOPMENT CO., INC.  
MANCHESTER, CONNECTICUT

Subsidiary of The Gray Manufacturing Company

EXPORT DIVISION: Rocke International Corp., 13 E. 40th St., New York 16, N. Y.  
Cables: ARLAB

## RECORDS, TAPE, AND FM

Continued from page 13

to 3. So you'll still go to the theatre if you want to see wide-screen pictures. And remember that established industry standards are changed by the pressure of competition — almost never for sheer product improvement.

### Banana Boat Song

Must be a product of Tin Pan Alley. Where they grow, people never speak of a "bunch" of bananas. It's a "stem".

### Speaker Size

The first loudspeakers were made with a horn mounted on a modified version of a single headphone. The output was small because the little metal diaphragm moved only a few thousands of an inch. Sound output was first increased not by increasing the excursion of the diaphragm, but by changing to the use of a paper cone, as much as 3 ft. in diameter on some models. Then came the dynamic speaker, using a magnet, and working with a voice coil mounted on a smaller cone. Sound output was increased, however, because of the greater excursion of the cone.

While the output of a cone, or piston, is proportional to its area, it is also proportional to the square of the movement. Thus, if the distance the cone moves is doubled, the sound output is increased four times. This explains the trend toward the use of 8-in. speakers designed for greater cone excursion since, theoretically at least, there is no loss of output.

### New Setup

About July 1, Ampex will have a new subsidiary, Ampex Audio, Inc., operating in a new plant of 40,000 square feet at Sunnyvale, Calif. Located at Keifer and Lawrence Station Roads, this will be a complete manufacturing facility employing about 250 people to handle the engineering, production, and marketing of Ampex hi-fi equipment for consumer use. Phillip L. Gundy, a vice president of the parent company and now manager of the audio division, has been elected president of Ampex Audio, Inc.

### Add This New Word

From the Klipsch reservation at Hope, Ark. (where men are men and wow! what sounds they make) a note by John Eargle refers to "phonogenic" sound as being that which is worth recording. It's the first time we have encountered the word. It's most appropriate, and it should come into common use.

### Back to Normalcy

The NAB (National Association of Broadcasters) under the influence of TV fever, changed its name to NARTB (National Association of Radio & Television Broadcasters). But now that they have decided that radio is here to stay, the name is being changed back to NAB.



**ALLIED RADIO CORP.**  
100 N. Western Ave., Chicago 80, Ill.  
**EVERGREEN ALLIED HIGH FIDELITY, INC.**  
2025 W. 95th St., Chicago 43, Ill.  
**VOICE AND VISION, INC.**  
921 N. Rush St., Chicago 11, Ill.  
**ALLIED HIGH FIDELITY STORES, INC.**  
602 Davis St., Evanston, Ill.  
**WEST SUBURBAN ALLIED HIGH FIDELITY, INC.**  
7055 W. North Ave., Oak Park, Ill.



High gain Broadband Yagi for max. sensitivity to both 72 and 300 ohm tuner input. Designed for fringe FM.  
**APPARATUS DEVELOPMENT CO.**  
FM Dept. Wethersfield 9, Connecticut

**EVERYTHING IN HIGH FIDELITY . . .**  
from pickup to speaker. Try and compare your choice of hi-fi components on the "AUDIOMAT" in ASCO's air-conditioned demonstration studio.  
**ASCO SOUND CORPORATION**  
115 W. 45th St., 3rd floor, New York 36, N. Y.  
Write for free catalog, or phone Jdson 2-1750

**AUDIO EXCHANGE**  
The Trading Organization in the HI-FI FIELD

Write department MH-1 for free catalog of used, fully-guaranteed equipment  
159-19 Hillside Ave., Jamaica 32, N. Y. AXtel 7-7577  
367 Mamaroneck Ave., White Plains WH 8-3380

**STEREOPHONIC TAPES**

Now in stock (all of them) send 30 cents for tape catalog. Latest stereo equipment lists and details of stereo conversion kits. See our ad on next page.

**BOSLEY HI FI AND STEREOPHONIC**  
316 N. Glendale Ave., Glendale 6, Calif.

**LISTEN TO POLICE & FIRE CALLS**

Complete Registry of police and fire radio stations in the U. S., showing location, call letters, and frequencies—Postpaid, \$4.00

**COMMUNICATION ENGINEERING BOOKS**  
Radio Hill, Monterey, Massachusetts

**PROFESSIONAL RECORDING SERVICE**

Tapes made, copied, masters cut, processed, pressings made — short runs our specialty — all AMPEX 300's Telefunken & Altec, HYDROFEED Lathes, monofusion presses. Components Corporation, 106 Main St., Denville, N. J. Phone: Rockaway 9-0290

**CRAWFORD'S OF BEVERLY HILLS**

Records and tapes of all labels  
Pioneers in radio and hi-fi since 1922  
Manufacturers of Telemusic  
Operators of KCBH-FM 98.7 mc.  
456 N. Rodeo Drive—BR2-3231

**IN CANADA —**

There's one place where you can find — and hear — all your high-fidelity equipment needs. We carry a complete stock . . . come in, or write in, for a chat, a look, and a listen.

**ELECTRO-VOICE SOUND SYSTEMS**  
141 Dundas St., West, TORONTO



**Makes Record Collectors HAPPY!**

Table-size wrought iron music-center holds 250 albums in 12 compartments! Top holds largest Hi-Fi set. Sturdy, 30" h., 22" w., 17" d. Please remit \$14.95, or charge Diner's Club acct. Shipping chgs. collect.

© LESLIE CREATIONS, Dept. 6  
Lafayette Hill, Pa.

**INDEX of ADVERTISERS**

Acoustic Research, Inc.	64
Allied High Fidelity Studios	67
Allied Radio Corp.	63
Altec Lansing Corp.	62
Apparatus Development Co.	67
Asco Sound Corp.	67
Audio Exchange	67
Bogen Co., David . . . 18, 19, Inside Back Cover	
Book Department	68
Bosley Hi-Fi & Stereo	67, 68
Bozak Speakers	16
British Industries	2
Canterbury Hotel	68
Collaro	59
Components Corporation	67
Cook Laboratories	13
Crawford's of Beverly Hills	67
Electro Sonic Laboratories	65
Electro-Voice, Inc.	8, 9
Fidelity Music, Inc.	67
Garrard Changers	2
Graflex, Inc.	10
Gray Research & Development Co.	66
Heath Company	55, 56, 57
Hollywood Electronics	67
Jensen Mfg. Co.	1
Klipsch Associates	68
Lansing Sound, Inc., J. B.	21
Leslie Creations	67
McIntosh Laboratory, Inc.	20
Minnesota Mining & Mfg. Co.	12
Newcomb Audio Products Co.	61
Orradio Industries, Inc.	4
Phonotapes, Inc.	13
Pickering & Co., Inc.	24
Pilot Radio Corp.	22
RCA Victor Records	5
Rek-O-Kut Company	62
Robins Industries Corp.	67
Rockbar Corporation	59
Scott, Inc., Herman Hasmer	11
Sherwood Electronics Lab.	4
Stephens Tru-Sonic Inc.	Back Cover
The Tape House	6
Technical Appliance Corp.	66
University Loudspeakers	14, 15
Viking of Minneapolis	7
Weathers Industries	17
Westminster Recording Co., Inc.	
Inside Front Cover	
Wholesale Supply Co.	67

**HOLLYWOOD ELECTRONICS**

"HI-FI COMPONENTS EXCLUSIVELY"

Since 1944

7460 MELROSE AVE., L. A. 46. WEB 3-8208

FINE RECORDS . . . FINE SOUND EQUIPMENT . . . FINE TAPES . . . FINE FM RADIOS

**FIDELITY MUSIC, INC.**

Fifty-one O'Farrell San Francisco 8  
Home of KEAR-FM YUkon 2-1982

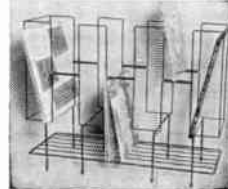

**IF YOU LIKE TO COLLECT RECORDS**

Wrought iron cabinet holds 200 albums in 10 compartments. Sturdy, 25" x 22" x 10". Please remit \$9.95, or charge Diner's Club acct. Shipping chgs. collect.

© LESLIE CREATIONS  
Dept. 6, Lafayette Hill, Pa.

**GIBSON GIRL TAPE SPLICERS**



splices in a wink!  
NO SCISSORS!  
NO RAZOR BLADES!  
Diagonal cuts tape ends and trims splice edges.  
At Your Dealers  
ROBINS INDUSTRIES CORP. Bayside 61, N. Y.

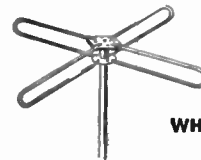

**FM RECEIVING ANTENNAS**

Standard and Special Designs  
**WHOLESALE SUPPLY CO.**  
Lunenburg, Mass.

**HI-FI MUSIC PROGRAM EDITIONS**

Special program editions of HI-FI MUSIC Magazine are now published for:

- KCBH-FM Beverly Hills
- WCRB AM-FM Boston
- WBAI-FM New York City
- WTMH-FM, WFMQ-FM Providence-Hartford
- WASH-FM Washington

If you are a subscriber living in the service area of one of these stations, and are not getting the program edition for that station, tell us, and it will be sent to you in the future, without extra charge. Address.

**HI-FI MUSIC MAGAZINE**

Program Department

105 E. 35th Street at Park Avenue  
New York 16, N. Y.



## For the Ultimate in HIGH FIDELITY



WRITE for this new 1957 free booklet. It explains how loudspeaker systems designed by Paul W. Klipsch utilize the corner walls of your room to give you full range reproduction of music — with *fidelity*.

**KLIPSCH AND ASSOCIATES**  
POST OFFICE DRAWER 98  
HOPE, ARKANSAS

CREATORS OF  
THE  
AUTHENTIC

**Klipschorn**  
CORNER HORN  
LOUDSPEAKER SYSTEM

### RECOMMENDED BOOKS for Hi-Fi Enthusiasts

**EDWIN HOWARD ARMSTRONG**  
By Lawrence Lessing

The fascinating biography of the extraordinary man who invented the regenerative and superheterodyne circuits, and the revolutionary system of FM broadcasting. \$5.00 plus 25¢ mailing.

**LOUDSPEAKERS**  
By G. A. Briggs

A most interesting book on a most important subject, by one of the leading authorities on speakers, enclosures, and installations. Written for beginners, full of information for experts, too. \$1.95 plus 15¢ mailing

**HIGH FIDELITY, THE WHY  
AND HOW FOR AMATEURS**  
By G. A. Briggs

A book planned to answer in simple terms the questions most often asked about the different hi-fi components, listening tests, and room acoustics, by England's top authority. \$2.95 plus 20¢ mailing.

**BOOK SERVICE DEPT.**  
**HI-FI MUSIC MAGAZINE**  
105 E. 35th St. at Park Ave., New York 16

Overlooking the Fenway  
**Boston, Mass.**  
Attractive, comfortable, homelike rooms, suites and kitchenettes—near Kenmore Square and Boston University Modern, fireproof building. from \$6 double

**FAMILY PLAN**  
Special rates for permanent guests.

**Hotel CANTERBURY**  
14 Charlestown West, Boston, Mass.

## BUY, SELL or SWAP

The opportunity to buy, sell, or swap items of equipment or records through the use of this department is made available as a service to readers of MUSIC at HOME without charge.

Copy should be limited to 35 words. Items are not accepted from business firms. The Publisher reserves the right to reject copy which, in his opinion does not conform with the standards of this Magazine. No box numbers, please.

**SELL:** One GE UPX-003A phono preamplifier with rectifier for 115-V. 50/60-cycle supply in original carton never used \$7.00. W. I. Stemwell, 7610 Nancemond St., Springfield, Va.

**SELL:** Lafayette FM-tuner model KT-100 completely wired, with cage, but needs alignment. Cost \$40, will sell for \$20. Donald J. Bonetti, 2738 Cruger Ave., New York 67, N. Y.

**SELL:** B-J tone arm, excellent condition, \$11.75. Edwin Kaplan, 421 W. Main St., Huntington, L. I. N. Y.

**SELL:** Stromberg-Carlson 402 tuner, Stromberg-Carlson 420 amplifier, University 6201, V-M record player with base, GE cartridge with diamond needle. Louis Friedman, 210 Cedar Lane, Teaneck, N. J.

**SELL:** University 308 triaxial speaker. Brand new. Price \$25 (list \$38). I will pay mailing charges. Emmanuel Peluso, 171 Meserole St., Brooklyn 6, N. Y.

**SELL:** IBM electric typewriter, pica type, \$150; Garrard RC-98-4 record changer, 4-speed, new condition, \$60; cascade 2-speed disc recorder-radio-phonograph, \$50. Donald P. Bagren, 417 North Winnebago, Rockford, Ill.

**SELL:** Fisher 80-C master audio control, new condition, \$85; Webster 50-watt audio amplifier, \$50; RCA-Victor 45-rpm record changer, amplifier, \$25; Timex magnetic recorder, \$25. V. R. Hein, 418 Gregory, Rockford, Ill.

**SELL:** Webcor 121 changer with GE magnetic cartridge, like new, \$24; Need hi-fi equipment cabinet and good speaker at reasonable price. John P. McCullen, 3050 Bainbridge Ave., Bronx 67, N. Y.

**SELL:** Electro-Voice A20CL amplifier, six months old, perfect condition \$65. Frank H. Simon, 120 Auburn St., Paterson, N. J. Evenings LA 3-4128.

**SELL:** Concertone 1501D tape recorder, case, amplifier, speaker, dual track, 7 1/2, 15 ips. Excellent condition \$175. Pentron T-90 like new \$95. FOB. List of other items available. V. Maycher, 168 Williams Ave., Hasbrouck Hts., N. J.

**SELL:** Two Electro-Voice 18-in. woofers, \$110 for the pair. Pat McEvoy, 583 Eagle Ave., Bronx, N. Y.

**SELL:** Ampro model 757 tape recorder. Two speed, complete with mike and 11 7-in. reels of tape. Perfect condition. Best offer over \$100.00. Ed Harbur, 304 E. 89th St., New York 28, N. Y.

**SELL:** Have RPJ-013A, RPJ-004, and RPJ-003 GE styli guaranteed new, unused. \$8 each. Also new Rek-O-Kut 120 arm and Fluxvalve cartridge. Best offer. B. C. Pevehouse, 1930 22nd Ave., San Francisco 16, Calif.

**BUY:** Ampex tape recorders, any type, especially stereo. Cash or trade for new equipment. Also late models Presto Berlant, Magnecorder. S. A. Cisler, 424 Bucknell Dr., San Mateo, Calif.

**SELL:** Ampex 401A, excellent, \$650; Jensen 18-in. auditorium woofer, Stephens E-15 multi-cellular tweeter, 2 mid-range drivers, ideal for E-V Patrician kit, \$95. **BUY:** Rek-O-Kut TR-12-H recording turntable; National Criterion tuner. C. F. Tuma, 13201 Miles Ave., Cleveland 5, Ohio.

## ALL STEREO TAPES NOW IN STOCK

(Send \$2.00 per tape with order (balance C.O.D.). See catalog for selections and prices.

### STEREO CONVERSION KITS

CONVERT YOUR RECORDER  
TO PLAY STEREO

Stereo Kit for V.M. Pentron and Bell Recorders (Staggered).....\$ 16.95  
Stereo Kit for most other recorders (Stacked)..... 68.00  
Stereo Kit for Concertone and Ampex .. 98.00  
Stereophonic Dual Pre-amplifier with balance controls ..... 48.00  
Stereophonic 2 channel Amplifier..... 149.95  
Viking Playing Deck, Stacked and Staggered..... 106.00  
10,000 Cycle Tweeter Crossover..... 16.00  
(Send 25% with Kit or Amplifier orders, Balance C.O.D.)

Send 30 cents for tape catalog and latest stereo reports

We ship anywhere. We pay the freight.  
All correspondence answered.

### Bosley Hi Fi & Stereo

316 N. Glendale Ave., Glendale 6, Calif.  
OPEN EVERY NIGHT UNTIL MIDNITE

### NOTICE TO SUBSCRIBERS

If you change your address, be sure to give us your old address, as well as the new one

**SELL:** Airline 3-speed portable record changer, \$25; Weston Master III exposure meter, \$25; 3-way portable radio, \$10; General Electric RPX-050 cartridge, \$5. All new condition. Mrs. Carolyn Barger, 3007 Rice Ave., Rockford, Ill.

**SWAP or SELL:** Popular Electronics No. 1-25 (Oct. '54-Oct. '56) Radio-TV News Apr. '53, June '53 through Oct. '54 (in loose-leaf binder) Nov. '54 through Jan. '57. Donald Bisbee, 685 S. Roys, Columbus 4, Ohio.

**SELL:** Thorens CB33N manual record player with arm, non-ferrous brass turntable, mahogany base, Recoton 500SD cartridge, diamond and sapphire styli. Excellent condition. \$45. Original cost \$85. A. S. Kushen, 63-61 99th St., Forest Hills, N. Y. TW 6-3192.

**BUY:** Private collector wants to buy, borrow, or rent tapes of operas sung in English (NBC-TV operas and others). Ralph F. Cameron, 38-30 Douglaston Pkwy, Douglaston 63, N. Y. Bayside 4-0954.

**SELL:** Rek-O-Kut T12-RH recording turntable, feed-screw, lathe, cutter, db meter. Perfect condition guaranteed. \$100 postpaid; Details on request. Howard Sterling, Oaks Road, New Hope, Pa.

**SELL:** Brociner Mark 10 amplifier \$53; Miraphon XM110A manual player with base and GE cartridge RPX061A \$45. Still under warranty, original cartons. Jayson Hyun, M.D., Pathology Dept., Albany Medical College, Albany, N. Y.

**SELL:** Wharfedale Super 10/CSB \$27; Fairchild 215A cartridge, diamond, 20 hours \$10; Brociner-Fairchild high-gain phono output transformer \$8; GE RPX041 cartridge \$5. Recently checked and guaranteed. William Elliot, 45 Sicketon Rd., Pearl River, N. Y.

**SELL:** Heath audio test instruments. Satisfaction guaranteed or money back. Send stamped, addressed envelope for list. J. E. Bilane, 109 Normandy Village, Union, N. J.

**SELL:** Used Stephens microphone systems, excellent condition, C-1 \$239, C-2 \$139. Complete or any part. T. W. Coulter, 5337 Pagewood Lane, Houston 19, Tex.



**BUSINESS REPLY CARD**  
FIRST CLASS PERMIT NO. 4609, SEC. 34.9, P. L. & R., NEW YORK, N. Y.



**HI-FI MUSIC MAGAZINE**  
105 E. 35th St. at Park Ave.  
New York 16, N. Y.

# READERS' SERVICE DEPARTMENT

For your convenience, a postage-free card is provided below which you can use to obtain catalogs and literature. Your requests will be forwarded promptly to the individual companies. To assure prompt service, follow these instructions carefully:

1. Fill out the coupons in ink, and PRINT your name and address.
2. Because the coupons are sent to different companies, you must put your name and address on each one.
3. No postage is required if the card is mailed in the U. S. or possessions. Postage is required only from countries outside the U. S.
4. Use this service to keep up-to-date on the latest record and tape releases, and the newest hi-fi equipment and accessories.



**BE SURE TO PRINT YOUR NAME & ADDRESS ON EACH INFORMATION-REQUEST COUPON**

Please send complete information about.....  
 Manufactured by.....described in HI-FI MUSIC  
 My Name..... Street.....  
 City.....Zone.....State.....

Please send complete information about.....  
 Manufactured by.....described in HI-FI MUSIC  
 My Name..... Street.....  
 City.....Zone.....State.....

Please send complete information about.....  
 Manufactured by.....described in HI-FI MUSIC  
 My Name..... Street.....  
 City.....Zone.....State.....

Please send complete information about.....  
 Manufactured by.....described in HI-FI MUSIC  
 My Name..... Street.....  
 City.....Zone.....State.....

Please send complete information about.....  
 Manufactured by.....described in HI-FI MUSIC  
 My Name..... WorldRadioHistory Street.....  
 City.....Zone.....State.....

**SUBSCRIPTION with EXTRA HI-FI YEARBOOK ISSUE**

- \$10.00 Three years (21 issues) including 3 big \$2.00 Hi-Fi Yearbook issues. SAVE \$5
- \$5.00 One year (7 issues) including 1 big \$2.00 Hi-Fi Yearbook issue

**SPECIAL PROGRAM EDITION for STATION.....**

If you are within the service area of one of the stations for which we publish a Special Program Edition, fill in the station call letters above. Then the Program Edition will be sent to you without extra charge. The list of Program Editions is published in each issue of HI-FI MUSIC Magazine.

**SUBSCRIPTION without the EXTRA HI-FI YEARBOOK ISSUES**

- \$6.00 Three year (18 issues) SAVE \$3.
- \$3.00 One year (6 issues)
- My remittance is enclosed
- Will pay on receipt of bill

NAME.....

ADDRESS.....



# SUBSCRIPTIONS

As you will see from the subscription order card above, you may order the Full Edition of 7 issues per year, including the special \$2.00 Hi-Fi Yearbook Issue published in October; or the Bi-monthly Edition of 6 issues per year.

In either case, if you live within the service area of a station for which we published a Program Guide, you may have the Program Edition without extra charge. Stations for which Program Editions are available are listed in each issue of HI-FI MUSIC.

## HI-FI YEARBOOK ISSUE

We strongly recommend that you order the Full Edition, so that you will be sure to have the Hi-Fi Yearbook Issue. This is a special number published in October, containing a directory of the whole hi-fi industry and a who's who of the men in it, an up-to-date listing of FM stations, and a wealth of information on records, tape, and hi-fi equipment and installations not available elsewhere.

## GROUP SUBSCRIPTIONS

Group subscriptions to the Full Edition (7 Issues) are shown below. Remittance must accompany a group subscription order.

- 2 1-year subs. \$9.00
- 3 1-year subs. 12.50
- 4 1-year subs. \$16.00
- 5 1-year subs. 19.50

More than 5 1-year subs. \$3.75 each

## BACK ISSUES

A few copies in mint condition are available from the first issue, March-April 1953. Price is still 50c each. Please remit with your order.



**BUSINESS REPLY CARD**  
FIRST CLASS PERMIT NO. 4609, SEC. 34.9, P. L. & R., NEW YORK, N. Y.



**HI-FI MUSIC MAGAZINE**  
105 E. 35th St. at Park Ave.  
New York 16, N. Y.

Subscription Card

records, tape & FM radio

Information Card

# STEREO!

STEREOPHONIC TAPE PLAYBACK is now within the reach of every budget—thanks to the mighty BOGEN ST10 Stereo Tape Amplifier and 2-Channel Preamp. Until now, using a stereo tape deck meant buying a separate preamp for your second channel—and an additional amplifier as well . . . and a lot of work balancing two sets of controls.

But not any more . . . because Bogen has developed the ST10. It saves you trouble—and a lot of money. Here's why:

First, the ST10 preamplifies both of your stereo signals for you (the gain control acts on both channels simultaneously, automatically assuring balanced stereophonic playback). Then one preamplifier feeds your present hi-fi system, while the second preamp feeds the ST10's built-in 10-watt amplifier for your second speaker. This one amazing wonder-unit does it all—and all for the incredibly low price of \$52.50 in chassis form, or \$59.50 for the ST10G with cage and legs, as illustrated.

Write for ST10 literature (include a quarter and we'll also send you our 56-page *Understanding High Fidelity*), or better yet, see your hi-fi specialist. Dept. 7Q, David Bogen Co., Inc., Post Office Box 500, Paramus, New Jersey.

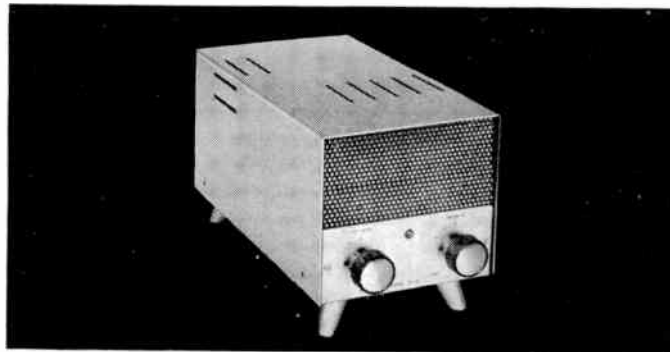

**Bogen**  
HIGH FIDELITY

*because it sounds better...*  
A UNITRONICS CORPORATION AFFILIATE







**1=2**

With engineering magic by the originators of coaxial speakers, two voice coils in one 12" speaker cover the entire audio range without distortion. Complete, compact and requiring comparatively little enclosure space, the 122 AX Coaxial Speaker System reflects TRU-SONIC quality engineering and materials. \$83.00



*Listen... you'll always hear more from:*

**STEPHENS TRU-SONIC INC.**

8538 Warner Drive, Culver City, California

Cable Address: MORHANEX • Export Address: 458 Broadway, New York 13