

# Music

## AT HOME

THE GUIDE TO HI-FI REPRODUCTION FROM RECORDS, TAPE, AND FM RADIO



**MUSIC**

**EQUIPMENT**

**INSTALLATION**

**OPERATION**

*Published by*  
**MILTON B. SLEEPER**

# WHAT'S **NEW** IN TAPE RECORDING

- *immune to temperature*
- *impervious to moisture*
- *practically unbreakable*

## audiotape

on **Mylar\*** polyester film

Manufactured by AUDIO DEVICES, 444 Madison Ave., New York

\*DuPont trademark

◀ Here's a professional magnetic sound recording tape that offers a new high in *permanence* and durability. It can be used and stored under the most extreme conditions of temperature and humidity without any ill effects. For all practical purposes, it is virtually *unbreakable*. Now available on 1, 1½ and 2 mil Mylar\*, in standard sizes from 600 to 2,500 ft. Write for Bulletin No. 201.

type **EP\*** audiotape

\* **EXTRA PRECISION** magnetic recording tape for telemetering, electronic computers and other specialized applications

manufactured by  
**AUDIO DEVICES, Inc.**  
444 Madison Ave., New York 22, N. Y.

▶ The new EP Audiotape provides the *extra precision* that is so important to *dependable* magnetic data recording and reproduction. It is especially produced to meet the most exacting requirements for uniformity and freedom from microscopic imperfections. Available in ¼" to 2" widths, 1,225 to 5,000 feet. Write for Bulletin No. 207.

**color**

the new dimension in  
**audiotape**  
recording

◀ Audiotape, now available on green, blue or brown plastic base — and Audiotape reels in red, yellow, green, blue and clear plastic — provide *instant identification* that can simplify your cueing, filing, recording and playback problems. Write for Bulletin No. 209.

## AUDIO DEVICES, Inc.

Dept. A7, 444 Madison Ave., New York 22, N. Y.

Export Dept., 13 East 40th St., New York 16, N. Y., Cables "ARLAB"





# THERE'S NO SPEAKER SYSTEM LIKE IT...

*the*  
**deMARS**  
*Loudspeaker system*

**AUTHENTIC BASS REPRODUCTION  
AND GENUINE CONCERT HALL QUALITY  
IN A COMPACT DIRECT  
RADIATION SPEAKER SYSTEM.**

"I have developed a new loudspeaker system incorporating the "Styrocone" speaker, capable of reproducing the sounds of musical instruments from the lowest bass notes through the entire tonal spectrum, into the highest frequencies. This unit is distinguished by naturalness of sound reproduction and resulting excellence of musical definition, which permits listening at concert volume without fatigue. These characteristics are obtained in a unit so compact that it is eminently suitable and practical for home use."

*Paul A. de Mars*

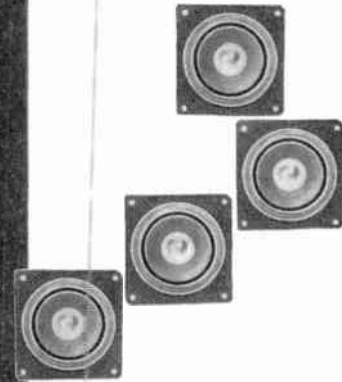

**Model S  
Basic System  
\$250\***

**Model SC  
Corner Style  
\$450\***



Basic system is mounted on wooden baffle board 22" x 32".

Enclosures are custom-built of finest, genuine solid furniture woods, all hand-finished in mahogany, walnut, or blonde, to your preference.

\*FOB Lawrence, Mass.

**Model SW  
Wall Style  
\$450\***



**deMARS ENGINEERING & MFG. CO. · 360 Merrimac Street · Lawrence, Mass.**

<p><b>Q. What is the deMars speaker system?</b></p> <p><b>A.</b> A multi-cone system with a single voice coil mechanism, supported by an array of very high frequency direct radiators.</p>	<p><b>Q. What kind of loudspeaker system is the deMars?</b></p> <p><b>A.</b> It is a direct radiation system as distinguished from acoustic coupling devices, such as horn types or acoustically baffled systems.</p>
<p><b>Q. How does the deMars system achieve better reproduction?</b></p> <p><b>A.</b> Through the multi-cone principle, which presents the optimum vibrating surface for each area of frequencies over the tonal spectrum.</p>	<p><b>Q. Why was this new type of direct radiation system required?</b></p> <p><b>A.</b> To obtain authentic bass response in the home within acceptable sized enclosures, and independent of location in the living room.</p>
<p><b>Q. What distinguishes the deMars system from all others?</b></p> <p><b>A.</b> It incorporates a new device, called the "Styrocone", which enlarges the vibrating surface beyond that of any other single multi-cone type unit known today... much larger than any other direct radiation system on the market.</p>	<p><b>Q. What is the advantage of a direct radiation system, such as the deMars?</b></p> <p><b>A.</b> It performs better than other types of speakers, except when they are coupled with horns or baffles of prodigious size... and, it is much more flexible and practical for economical installation.</p>

**Q. What is the opinion of the critics?**

**A.** The new deMars system has been tested under many and varied room conditions. Critics have been unanimous in their enthusiasm.

**Q. Is the deMars system available, and what does it cost?**

**A.** Yes... It is available now, in three models, each built under Mr. deMars' personal direction. The basic system comes pre-assembled and mounted... can be installed quickly and without difficulty by simply connecting 2 wires.

**— MAIL COUPON TODAY —**

deMars Engineering & Manufacturing Co.  
360 Merrimac Street,  
Lawrence, Mass.

Gentlemen:

Enclosed is my check  — money order  — for style.....

Send me your illustrated literature on the deMars Speaker System.

Send information as to where I can hear the deMars Speaker System.

Name \_\_\_\_\_

Address \_\_\_\_\_

City \_\_\_\_\_ Zone \_\_\_\_\_ State \_\_\_\_\_

MH-3

# Incomparable...



**CHECK CRAFTSMANSHIP, FEATURES,  
PRICE AND SERVICE . . .**

and you will understand clearly why this is  
the world's No. 1 high-fidelity record changer.

**"RIGHTS" and "WRONGS"**  
of record changer design  
(important in protecting your records).

**RIGHT:**

Garrard Precision Pusher Platform . . .  
the only record changing device that insures  
positive, gentle handling of records with standard  
center holes.



**WRONG:**

"Overhead Bridges" (as on ordinary changers)  
. . . which may damage or dislodge records  
accidentally.

**RIGHT:**

Garrard removable and interchangeable  
spindles . . . Easily inserted; accommodate all  
records, all sizes, as they were made to be  
played; pull out instantly to facilitate removal of  
records from turntable.



**WRONG:**

Fixed Spindles (as on ordinary changers) . . .  
which require ripping records upwards over  
metallic spindle projections after playing.

**Other Garrard features include:** 4 pole motor  
—no rumble, no induced hum • heavy drive shaft  
—no wows, no waves • weighted turntable—  
flywheel action, constant speed • muting switch  
—silence between records • silent automatic  
stop—shuts off after last record; no disturbing  
"plop". • easy stylus weight adjustment—pro-  
tects long-playing records • balanced-mounted  
tone arm—true tangent tracking • universal shell  
—fits all popular high fidelity cartridges

**GARRARD**  
*"Triumph"*

## World's Finest Record Changer

Mail coupon today for a complimentary  
copy of "Sound Craftsmanship", 16 pages,  
illustrating and describing the products  
WorldRadioHistory in the British Industries Group.

Garrard Sales Corp., Dept. MH-5  
164 Duane Street  
New York 13, N. Y.

Please send literature to:

Name \_\_\_\_\_

Address \_\_\_\_\_

City \_\_\_\_\_ Zone \_\_\_\_\_ State \_\_\_\_\_

# Music AT HOME

THE GUIDE TO HI-FI REPRODUCTION FROM RECORDS, TAPE AND FM RADIO



Photo by William Leftwich

**Publisher:**

Milton B. Sleeper

**Music Editor**

David Hall

**Art Director**

Walter Buehr

**Photography**

William Leftwich

**Editorial Assistants**

Mary Snow  
Ethel V. Sleeper

**Contributors to this issue**

Walter F. Buehr  
Anita de Mars  
Walter Jones  
E. J. Marcus  
Fred Reynolds  
Jonathan Schiller

**Sleeper Publications, Inc.**

207 East 37th Street, New York 16, N. Y.

Milton B. Sleeper, *President*

James I. Benjamin  
*Vice President, Business Manager*

MUSIC AT HOME is published bimonthly by Sleeper Publications, Inc., Hi-Fi House, 207 East 37th Street, New York 16, N. Y. Telephone: Oxford 7-0542. Editorial, advertising, and circulation departments are located at the address above. MUSIC AT HOME is not connected or associated with any other magazine.

Subscription rates are \$3.00 per year (6 issues) or \$6.00 for 3 years (18 issues). Single copies, 50¢. Outside the USA, Canada, and the Pan American Postal Union, add \$1.00 per year for postage. Copies are mailed on the 1st of January, March, May, July, September, and November. Allow time for delivery by second class mail.

Editorial contributions and interesting photographs are welcome, and will be paid for immediately they are scheduled for publication. No responsibility can be accepted for unsolicited manuscripts unless they are accompanied by return postage.

Application for entry as second class matter pending at New York City, and additional entry at Concord, N. H., under the Act of March 3, 1879. Printed in the U.S.A. by Rumford Press, Concord, N. H.

The cover design and contents of MUSIC AT HOME are fully protected by copyrights, and must not be reproduced in any manner or form. Quotations are not permitted without specific authorization in writing from the Publisher.

## Vol. 1, No. 2 • CONTENTS • May-June, 1954

### SPECIAL FEATURE

WNYC: 30 Years of Progress—Jonathan Schiller . . . . . 16

### MUSIC

The Hi-Fi Concert Society . . . . . 19  
 Beethoven, Handel, Mozart, Haydn . . . . . 20  
 Wagner, Schubert, Bach . . . . . 21  
 All-Beethoven Program . . . . . 22  
 Paganini, Liszt, Sibelius . . . . . 23  
 All-Bizet Program . . . . . 24  
 Tristan & Isolde . . . . . 25  
 All-Stravinsky Program . . . . . 26  
 Jazz Music Session . . . . . 27  
 Importance of Records—David Hall . . . . . 32  
 Your LP Record Shopping Guide . . . . . 40

### EQUIPMENT

Diamonds for Styli—E. J. Marcus . . . . . 28  
 Preamp-Amplifier with Printed Circuits . . . . . 31  
 Take Your Music with You . . . . . 47

### INSTALLATION

An Adjustable Network—Walter Jones . . . . . 34  
 Hi-Fi without Disorder—Walter F. Buehr . . . . . 37  
 Step-by-Step Plan for Beginners—Milton B. Sleeper . . . . . 44

### OPERATION and USE

It's Fun to Practice with a Tape Recorder—Anita de Mars . . . . . 13  
 A Card Index for Your Records . . . . . 46

### DEPARTMENTS

Records, Tape, and FM Radio . . . . . 4  
 Ideas for You . . . . . 7  
 Directory of Hi-Fi Record & Equipment Dealers . . . . . 50

**COVER PHOTO:** Walter Buehr is an artist-designer and a hi-fi enthusiast in his own right. Mrs. Buehr, a fashion artist, contributes the modifying influence of the woman's point of view. This photograph was taken in the Buehrs' East 35th Street studio in New York City.



Now  
the  
first  
tuner  
especially  
designed  
for  
magnificent  
new  
binaural  
reception

THE MODEL RJ48 TUNER  
BY

**browning** "Top name in Tuners"



The Browning Model RJ-48 Tuner is especially designed for binaural reception. In addition to binaural reception of AM and FM simultaneously, the RJ-48 is a versatile tuner for use either for AM or for FM reception. Also it may be used for reception of two different broadcasts (one AM, one FM) when speakers are located in different rooms. Thus the RJ-48 provides for all your high fidelity tuning requirements, now and in the future. Outlets for recorders are provided in both AM and FM circuits. Designed and manufactured by Browning to the highest Browning standards of quality and performance, the RJ-48 is truly the ultimate in high fidelity tuners.



Other Browning tuners include the RV-31 FM Tuner and the RJ-42 for either FM or AM. Both employ the famous Browning basic circuits. Both are recognized as outstanding for quality in true high fidelity reception.

For further details write 757 Main St.

**BROWNING LABORATORIES, INC., WINCHESTER, MASS.**  
Copyright 1954 Browning Laboratories, Inc.



## Records, Tape, and FM Radio

### Readers' Letters

Magazines get some letters that are hard to answer, but manufacturers get their share, too. For example, Stromberg-Carlson received a request for a piece of a television cabinet from a lady who wanted to get an idea as to how it would look in her living room!

### Pro Musica Antiqua

If you are interested in medieval, renaissance, and baroque music, you are probably familiar with the Primavera Singers and Players of the New York Pro Musica Antiqua which, in concerts and on records, has been reviving so successfully the neglected musical treasures of the periods identified by such names as Leonardi, Michelangelo, Chaucer, Dante, and Shakespeare.

At Lenox, Mass., directly following the Berkshire Music Festival, the pro Musica Antiqua will present five programs of instrumental and vocal music from the Middle Ages and the Renaissance. The instruments will include viols, recorders, and the harpsichord. On one program, Rey de la Torre will play a set of Spanish lutes. Among the singers will be Russell Oberlin, a countertenor or male alto, a type of voice widely cultivated in early times, but very rare today. Information about the Festival and accommodations at Lenox can be obtained from Roy Rappaport, Avaloch Inn, Lenox, Mass. The time is August 21 to 29.

### Standards of Performance

Dr. Hans Wolf's article in our March-April issue stirred up varied comments expressing agreement with his views on recording techniques. Certainly he made a worthwhile contribution to information on the subject of accurate recording. But it's beginning to appear that the more we learn about the factors involved at the reproducing end, the farther we are from arriving at a basis for setting up audio standards.

David Hall in this issue refers to recordings of music which *demand attention*. This implies listening to the music itself, rather than to the individual bits of sounds of which it is comprised. Like Anita de Mars' children who are so preoccupied with the physical process of operating a piano that they cannot listen critically to the sounds they produce, we have audio enthusiasts who are so concerned with the instantaneous performance of hi-fi systems that they do not hear the composition being played.

(Continued on page 6)

*Music at Home*

devotion of  
the craftsman  
for the  
object  
he creates

photograph by irvin kershner of 18th century pandurina in the erich lachmann collection of historical stringed musical instruments reproduced with permission of the allan hancock foundation and the university of southern california

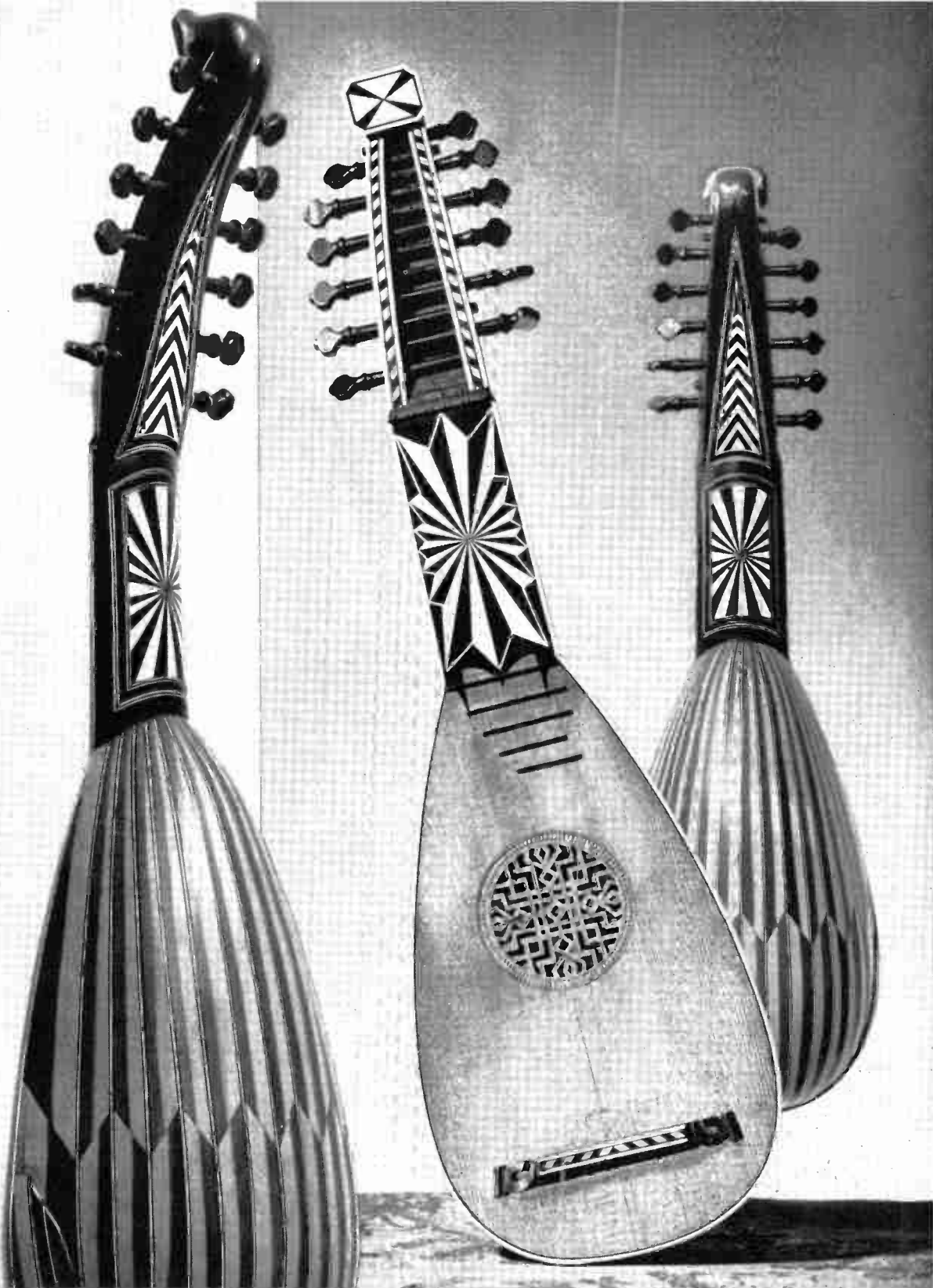

is shown by the infinite care taken with minute details. Fedele Barnia fashioned this pandurina in Venice in 1765. The pains he took to cut and fit his bits of cedarwood, ivory and ebony are immediately apparent to the eye. Immediately apparent to the ear is the care taken by Jim Lansing craftsmen in forming and assembling Signature Speakers and enclosures. The objective of all concerned in the fabrication of this outstanding sound reproduction equipment is to make every note a perfect quote.



*A modern work of devoted craftsmanship.* This is the Jim Lansing Rear-loaded Corner Horn, model number 34, with the DOO1 2-unit, 2-way system including fifteen inch low frequency unit, cross-over network, and high frequency unit with the one and only Koustical Lens. Widely used also with 15" or 12" General Purpose Signature Speakers.

JAMES B. LANSING SOUND, INC. • 2439 Fletcher Drive, Los Angeles 39, California

# Brilliant Response

...for **PROFESSIONAL**  
or **HOME SYSTEMS**

RCA's new, extended-range speaker, SL-12—a true, high-fidelity, 12-inch speaker priced under \$25. 8 ohms, 10 watts, 50 to 16,000 cycles



For brilliance and realism—for crisp, clear reproduction—listen to RCA's High-Fidelity speaker, Type SL-12.

You'll find it hard to believe such honest reproduction—such brilliant presence—can be achieved with a speaker priced so low. It's truly professional

reproduction at a price the hobbyist can well afford.

Hear it . . . see it . . . price it . . . and compare it with other speakers costing considerably more. Listen to all the professional-grade RCA Intermatched High-Fidelity components at your local RCA ELECTRONICS DISTRIBUTOR'S.

FOR UNEQUALLED PERFORMANCE AT ANY PRICE



RCA's famed LC-1A speaker, with acoustical domes for ideal sound distribution.

DeLuxe RCA 20-watt amplifier intermatched for perfect performance with all RCA components.

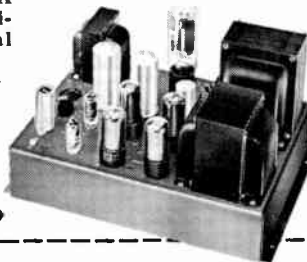

—professional-grade components of

RCA INTERMATCHED  
**High Fidelity**

Radio Corporation of America, Dept. E237 Building 15-1, Camden, N. J.  
Please send me information on:

- RCA Intermatched High-Fidelity components
- RCA's complete High-Fidelity "Victrola"® phonographs

Name \_\_\_\_\_

Address \_\_\_\_\_

City \_\_\_\_\_ Zone \_\_\_\_\_ State \_\_\_\_\_



**RADIO CORPORATION of AMERICA**

## Records, Tape & FM

(Continued from page 4)

Others, however, are capable of becoming so engrossed in the music that they supply from their imagination any deficiencies of reproduction. If the manufacturers of high-fidelity equipment discover that angle, they may answer critics by saying: "You are supposed to concentrate on the music. Then you won't know that there is anything wrong with the instrument!"

This comment isn't intended to confuse the issue of performance standards. However, it does indicate the complex nature of such an undertaking, since some consideration must be given to the mental attitude of individual listeners.

If and when standards are agreed upon by the members of any group whose conclusions will be generally accepted, it may be decided that ratings should be made on specific systems, operated under controlled conditions, rather than on components.

There would be some definite advantages to such a solution. It would enable each dealer to install a top-rated system so that his customers could hear what would be *The Finest*. Such a system would probably be too costly for most people, but it would serve as a standard of comparison in deciding on somewhat lower-priced units. Also, beginners who want to spend as little as possible at the start could plan for future changes that would enable them to build toward the ultimate in audio quality. Maybe this is an interim plan that dealers can put into use right now.

### New York Audio Fair

October 14 to 17 will mark the 6th Audio Fair in New York City, to be held again at Hotel New Yorker, 8th Avenue and 34th Street. Called Audiorama 1954, it will be the largest affair of its kind in the United States, occupying four floors this year. The Show will be open to the public without admission charge, except for 27 rooms of professional audio exhibits on the 8th floor. An admission charge of \$1.50 for that area will entitle visitors to attend all the technical sessions of the Audio Engineering Society which will be held at the Hotel New Yorker during the Show. In the past, the Audio Fair has ended on Saturday afternoon. This year it will run from 1:00 P.M. to 10:00 P.M. on Thursday to Saturday, and to 6:00 P.M. on Sunday.

### FM Receiving Equipment

History discloses the fact that, in many cases, widespread use of an invention does not develop until after the death of the inventor. Apparently that is to be the case with FM broadcasting. In recent months, more new FM tuners have been brought out, more advertising on FM has appeared, and more people have bought FM equipment than in any previous six-months period. You will see a summary of all FM

(Concluded on page 59)





# IDEAS for YOU

THE PURPOSE of this Department is to call attention to new products of interest to our readers. No attempt is made to rate performance of equipment shown, as that is not considered to be a proper function of this Magazine. Detailed specifications and descriptive literature can be obtained on request by writing the manufacturers. Music AT HOME will appreciate your mentioning this Magazine.

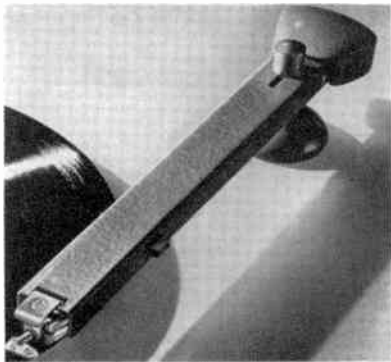

### Pickup Arm

To reduce the mounting space required for its model 190 arm, Pickering has brought out a redesign, identified as model 190D, making it possible to mount a turntable and the arm on a motor board 17 by 17 ins. It is intended particularly for playing LP records. *Pickering & Company, Oceanside, Long Island, N. Y.*

### Miniature Audio Transformers

A wide range of audio transformers is now available in cylindrical cases 1 $\frac{1}{2}$  ins. high by 1 $\frac{3}{32}$  ins. in diameter, fitted with pins to plug into a standard octal tube socket. They offer some interesting opportunities for designing very compact audio equipment. *Microtran Co., 2117 Mott Ave., Far Rockaway, N. Y.*

### Belt-Driven Turntable

A turntable designed to please the most rumble-minded listeners is now available from Components Corp. The turntable itself is a 25-lb. steel casting, topped by a cork pad to eliminate any effect on magnetic pickups. An expanding spring spindle locates records accurately. The motor is of the induction type, designed for continuous duty. Other features include damped shock mounts, levelling adjustments, and 3-speed drive. *Components Corp., Denville, N. J.*

(Continued on page 8)

May-June 1954

## at ALLIED high-fidelity is not expensive



the *Golden Knight*

### 24-WATT DELUXE HI-FI AMPLIFIER

±0.75 db, 20 to 40,000 CPS

**THE FINEST FOR LESS.** A tremendous value designed for optimum performance in limited-budget home music systems. Features very wide response with extremely low distortion (harmonic, less than 1% at rated output; intermodulation, less than 0.5% at normal listening level); low hum and noise (80 db below rated output); plenty of reserve power; selector switch for proper loading of G.E., Pickering or Audak cartridges; Equalizer Switch for accurate playback of all records; bass and treble controls; inputs for magnetic phono, mike, tuner, auxiliary (crystal phono, tape, TV, etc.). Chassis finished in satin-gold. 8 x 14 x 9" deep. Complete with connectors, instructions, shaft extenders and separate lucite panel. For 110-130 v., 50-60 cy. A.C. Shpg. wt., 30 lbs. Guaranteed for one full year! Detailed specification sheet available on request.



### GOLDEN KNIGHT HI-FI MUSIC SYSTEMS

**PHONO SYSTEM.** A super value, true high fidelity phono system, complete with color-coded cables and plugs for easy custom installation. Includes "Golden Knight" Amplifier; Electro-Voice SP-12B 12" Radax Speaker; famous Garrard RC-80 3-speed record changer, and G.E. RPX-050 triple-play magnetic cartridge with dual-tip sapphire stylus. For 110-120 v., 60 cycle AC. 60 lbs.

94 SX 127. Net, only ..... \$161.75

**FM-AM-PHONO SYSTEM.** As above, but includes new Knight 727 High-Fidelity FM-AM Tuner. Shpg. wt., 76 lbs.

94 SX 128. Net, only ..... \$214.50

93 SX 321. Net, only ..... \$79.50

NEW  
LOW COST  
HI-FI  
TUNER

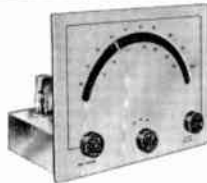

### HARMAN-KARDON FM-AM TUNER

An amazing value with every fine feature of costly deluxe units: Automatic frequency control for simple, accurate, drift-free tuning; Foster-Seeley discriminator circuit and low noise, grounded-grid triode front-end; FM sensitivity—8 microvolts for 30 db quieting; AM sensitivity—100 microvolts with built-in antenna; response—± 0.5 db, 20 to 20,000 cps; audio distortion—less than 1% at rated output; hum level—65 db below rated output. 7 tube circuit; built-in AM antenna; outdoor antenna connection; input for crystal phono; auxiliary AC outlet. Brushed copper panel. Size: 8" h, 11" w, 7" d. Complete with tubes. For 110-120 v., 60 cycle AC. Shpg. wt., 5 lbs.

99 SX 081. Net ..... \$49.50

SAVE!  
Build Your Own  
HI-FI  
AMPLIFIER



### KNIGHT 10-WATT HI-FI AMPLIFIER KIT

It's easy to assemble this fine fidelity amplifier. High gain characteristics; 1/2 volt drives amplifier to 10 watts output. Response, ± 1 db, 30-30,000 cps at 10 watts. Harmonic distortion, less than 0.5% at 10 watts; intermodulation, less than 1.5% at 10 watts. Separate bass and treble controls. Input for crystal phono or tuner. Matches 8 ohm speakers. Chassis will accommodate preamp kit (below) for use with magnetic cartridges. Kit is complete with tubes, all parts, punched chassis. Easy to build from clear pictorial instructions. Size: 7 x 13 x 6". For 110-120 v., 50-60 cy. AC. Shpg. wt., 14 lbs.

83 SX 234. Net ..... \$21.95

83 S 235. Equalized Preamp Kit. 6SL7 tube and all parts ready for wiring into amplifier chassis above. Shpg. wt., 1 lb. Net ..... \$2.95

### Free 268-Page Catalog

Write today for ALLIED'S complete guide to the world's largest selection of High-Fidelity home music systems, amplifiers, tuners, speakers, changers, recorders and accessories. If it's anything in Hi-Fi it's in stock at ALLIED.

**ALLIED RADIO**  
Everything in High-Fidelity



ALLIED RADIO CORP., Dept. 76-E-4  
100 N. Western Ave., Chicago 80, Ill.

Send FREE 1954 Catalog.

Ship the following .....  
..... \$..... enclosed.

Name .....

Address .....

City ..... Zone ..... State .....

Thousands of engineers and audio enthusiasts have improved Hi-Fi performance with DUBBINGS' tests.

Here is what Audio Experts are saying about our latest development:

**HAROLD D. WEILER**, author of "Hi-Fidelity Simplified" in his forthcoming book states:

"The Dubbings' Test Tapes are an absolute must for anyone interested in obtaining and maintaining peak performance from his tape recorder."

**ROBERT J. MARSHALL**, Chief Engineer, Fairchild Recording Equipment Co.:

"Dubbings' new Test Tapes are welcome companions to that company's series of fine Test Records. . . . Getting all the important tests on a single test is a tribute to advanced engineering know-how."

*the first and only comprehensive*

ON ONE REEL — ALL MAJOR TESTS FOR PERFECT ADJUSTMENT OF:

WOW AND FLUTTER

HEAD ALIGNMENT

FREQUENCY RESPONSE

30 to 7,500 cps at 7½ ips  
30 to 15,000 cps at 15 ips

SIGNAL LEVEL

SIGNAL TO NOISE RATIO

TAPE SPEED

A complete instruction book, "Tape Recorder Maintenance", is enclosed



*no costly voltmeter needed . . . the simplified D-500 TEST LEVEL INDICATOR is noted for accuracy (use with both test tape and records) . . . only \$3.95*

the accepted standard in audio tests

**DUBBINGS' TEST RECORDS**

**BROER WITH CONFIDENCE . . . UNCONDITIONAL MONEY BACK GUARANTEE**

Enclosed find  CHECK  MONEY ORDER

NAME \_\_\_\_\_

ADDRESS \_\_\_\_\_

CITY \_\_\_\_\_ ZONE \_\_\_\_\_ STATE \_\_\_\_\_

**The DUBBINGS CO., Inc. Dept. 45 KM**  
41-10 45th St., L.I.C. 4, N. Y.

Quantity Amt.

D-110 5" Reel 7½ ips @ \$12.50

INTRODUCTORY TILL MAY 15 @ \$10.95 \$ \_\_\_\_\_

D-111 7" Reel 15 ips @ \$17.50

INTRODUCTORY TILL MAY 15 @ \$15.95 \_\_\_\_\_

D-500 TEST INDICATOR @ \$3.95 \_\_\_\_\_

D-100 TEST RECORD @ \$3.50 \_\_\_\_\_

D-101 TEST RECORD @ \$4.95 \_\_\_\_\_

Postage & Handling \$ .50

Please Print TOTAL \$ \_\_\_\_\_

**D-100 TEST RECORD**

"Measure of Your Phonograph's Performance." The test record for:

FREQUENCY RESPONSE RUMBLE AND HUM WOW AND FLUTTER TRACKING STYLUS COMPLIANCE

**D-101 TEST RECORD**

"Measure of Your Phonograph's Equalization." The only record with each of these response curves:

COLUMBIA LP AES NARTB  
RCA's "New Orthophonic"

*individually recorded on REEVES SOUNDCRAFT LIFETIME professional tape!*

*a long-awaited aid for tape recordists*  
**DUBBINGS'**

*"The Measure of Your Tape Recorder's Performance"*

**TEST TAPE**

D-110, 5" REEL 7½ IPS

D-111, 7" REEL 15 IPS

**Ideas For You**

*(Continued from page 7)*



**Adjustable Speaker Enclosure**

The enclosure illustrated here is so constructed that it can be used as a folded horn, infinite baffle, or bass reflex cabinet, according to the manufacturer. A sealed compartment is provided at the top for tweeters, a mid-range speaker, and crossover networks. The lower section takes a 12 or 15-in. woofer. This arrangement is planned so that an original one-speaker installation can be expanded at a later date. Wood is finished in blond oak or mahogany. *Angle Genesee Corp., 111 Norris Drive, Rochester 10, N. Y.*



**Preamplifier-Equalizer**

The unit shown here is designed to provide high quality performance with considerably simplified controls. A special feature is an adjustment at the rear, intended to give an overall matching with the room acoustics. This control is difficult to describe briefly, but it is worth looking into at your dealer's store. There are 7 input channels, each with its own level control. *Fairchild Recording Equipment Co., 154th St. and 7th Ave., Whitestone, N. Y.*



**Condenser Microphone**

For those who refuse to be satisfied with any but the condenser type of microphone, here is a new design which, in a case 1½ ins. in diameter and 6 ins. long, contains stretched-diaphragm mike and a pream-

*(Continued on page 57)*

*Music at Home*



*The Best Costs Less When You Buy*

# THE FISHER

## Custom Audio Components

■ If you are buying 'for keeps' buy the best *first!* Buy FISHER, *quality leader* for seventeen years. Engineered for the professional, functionally designed for home use. "Of the very best!"—*High Fidelity*.

### FM-AM TUNER, Model 70-RT

Features extreme sensitivity, low distortion and low hum. Armstrong system, *adjustable* FM-AFC and AM selectivity. Preamplifier-equalizer, 2 inputs, 2 cathode follower outputs. Six controls. Self-powered. \$184.50

### FM-AM TUNER, Model 50-R

Same features as 70-RT above, but designed for use with external preamplifier-equalizer such as 50-C. Hum level better than 100 db below 2 volts output. Fully shielded and shock-mounted. Self-powered. \$164.50

### MASTER AUDIO CONTROL, Series 50-C

16 choices of record equalization, plus separate bass and treble tone controls, loudness balance control. Five inputs and input level controls, two cathode follower outputs. Chassis only, \$89.50 · With cabinet, \$97.50

### 25-WATT AMPLIFIER, Model 70-A

50-watts peak! More *clean* watts per dollar. Less than 1/2% distortion at 25 watts (0.05% at 10 watts.) Response  $\pm 0.1$  db, 20-20,000 cycles; 1 db, 10 to 50,000 cycles. Hum and noise virtually non-measurable! \$99.50

### 50-WATT AMPLIFIER, Model 50-A

100-watts peak! World's *finest* all-triode amplifier. Uniform within 1 db, 5 to 100,000 cycles. Hum and noise 96 db below full output. IM distortion below 2% at 50 watts. Highest quality components thruout. \$159.50

### SPEAKER ENCLOSURE, Series 50

NEW! Regardless of the speaker or enclosure you are now using, the "50" Horn will revolutionize its performance. For use with 12" or 15" speaker systems. 50-HM (Mahogany) \$129.50 · 50-HB (Blonde) \$134.50

### PREAMPLIFIER-EQUALIZER, Model 50-PR

*Professional* phono equalization facilities at low cost! Independent switches for LF turn-over and HF roll-off. Output lead up to 50 feet. Can accommodate any low-level, magnetic pickup. Self-powered. \$22.95

### HI-LO FILTER SYSTEM, Model 50-F

Does what ordinary *tone* controls cannot do, for it suppresses all types of noise with an *absolute minimum* loss of tonal range. High impedance input; cathode follower output. Use with any equipment. \$29.95

*Prices slightly higher west of the Rockies*

WRITE TODAY FOR COMPLETE SPECIFICATIONS

FISHER RADIO CORPORATION · 37 EAST 47th STREET · NEW YORK, N. Y.



# MUSIC for YOUR HOME

**D**URING the past two months, the wordy Battle of the Frequencies has been stepped up to a furious pace. But it has been notable only for the completely inconclusive results from all the foot-pounds of energy expended in talking and writing about standards of reproduction quality.

From all this discussion there is one contribution that is noteworthy because of the source, and because it offers a new and erudite angle of attack. Here is R. F. Goldman, writing in the first issue of the *Juilliard Review*:

"Each age has intellectual and artistic battles that are in some ways peculiar to itself but that are, in other ways, permanent. . . . The mediocre and the witless are always with us. A serious idea of art, and even a serious view of education, are preoccupations of a buffeted minority. . . . Belief must be strong: belief in seriousness, belief that the greatest achievements of the human imagination are represented by the Mozart Symphony in itself and not by a High-Fidelity technique for reproducing it. The Mozart Symphony exists, continues, and represents what is best in human experience; it is this that is serious, this that symbolizes our values. It is this idea and this thing that matter and that would continue to matter even if all electronics were to disappear from man's knowledge.

" . . . In the abundance of distraction, the belief in quantity, the levelling for mass consumption of the great and trivial, the task of acquiring discrimination, of maintaining a sense of that which expresses the finest consciousness of man, has become much more difficult. The machines — radio, film, and phonograph — seem to make art accessible and easy; they affect music in a special way, and reduce it, in a sense, to a species of useful noise. It would be false to say that music does not have a useful place in society today; it exists, if for nothing else, to feed these machines, and to prevent silence. For these machines the great and the trivial serve equally as fuel; but who would say that Beethoven does not deserve somewhat better than to be heard as an accompaniment to conversation, or as a salesman for vermouth?"<sup>1</sup>

**T**HUS Mr. Goldman makes a major contribution of new considerations, and adds fuel to the fires of discussion which burn so brightly at every meeting of hi-fi enthusiasts, or of those whose enjoyment of music has prompted them to become interested in the entertainment offered by records, tape, and FM radio.

It must be recognized that Mr. Goldman writes from the point of view of a teacher. Hence his preoccupation with developing appreciation of music. It might be said that no one knows better than he that just as it takes a

<sup>1</sup> Mr. Goldman's complete text, which is well worthy of serious consideration, will be found in the *Juilliard Review*, January, 1954, published by the Juilliard School of Music, 120 Claremont Avenue, New York 27. Price is 50¢ per copy.

thousand students to produce one musician, so he cannot expect more than one listener in a thousand to join in his protest against a conversational accompaniment to the music of Beethoven.

That would be only a quick and unappreciative way, however, to dispose of the scholarly and provocative ideas contained in Mr. Goldman's text.

Whatever else may be said of music, it is an intellectual product expressed by mechanical means. Thus the mind that conceives the music and the minds that conceive the means for its expression compliment one another, even though they may not meet on any ground of mutual interest, understanding, or purpose.

The invention of the phonograph and radio broadcasting, however imperfect they were, nevertheless enabled countless thousands of people to gain their first knowledge of the music previously denied them. Should musicians or teachers then discount the efforts of those who created these devices, and the work of those who strive to improve them? Lack of respect and appreciation of Beethoven may be represented by inattention, but is there no gain at all in homes where he is invited to accompany conversation?

**M**R. GOLDMAN's comment on that point prompts one to wonder if he has had an opportunity to hear the fine quality of reproduction that is available from the best records, tape, and FM radio. The statement was made on this page in the last issue of *MUSIC AT HOME*: ". . . when you listen to hi-fi, you can no more carry on a conversation than you would want to in a concert hall, or to play cards at the theatre."

And that brings up a second point which is given so little consideration and requires so much. Just as the people who never had an opportunity to hear the works of the great composers contented themselves with their folk-songs, so people who have not listened to fine reproduction are satisfied with their table-model phonographs and AM radios.

People can never gain a full appreciation of Beethoven's music until they hear it with the quality of reproduction that compels them to silence. And they will continue to buy third-rate instruments in response to advertising that promises 50 to 15,000 cycles until they have heard enough music from truly fine equipment to recognize the difference.



New integrated **3-WAY** reproducers for finest Hi-Fi performance

# NEW E-V TRIAXIAL

15" and 12"  
REPRODUCERS



For the first time, an integrated 3-way system that combines the famous E-V Super Sonax, Radax Propagator, and large bass cone with heavy magnet in one compact concentric assembly, at lowest cost ever!

All the magic of high fidelity reproduction is now easily yours! E-V concentric Triaxial design gets the most specialized driving media for each portion of the audio spectrum. Phenomenal bass response, full-bodied mid-range and silky-smooth upper octaves to the highest audible frequencies provide an unusual musical balance without masking effects or imposed distortions. No larger than ordinary quality speakers, the E-V Triaxial can be installed in direct radiator type cabinets or in E-V recommended folded horn enclosures.

## E-V ENGINEERED FEATURES

- Exclusive E-V Concentric Mounting Insures Full Range, Complete Room Coverage
- Augmented, Balanced Bass Response with Smoothest, Extended "Silky" Highs
- Carefully Tailored Mid-Range Characteristic Provides Realism and "Presence"
- Adjustable Brilliance Control for Remote Mounting Allows Matching to Room Acoustics
- Response  $\pm 5$  db, 30-15,000 cps in Recommended Enclosures
- Full  $\frac{1}{2}$  Section M-Derived Crossover Network Minimizes Distortion Products
- Edgewise Wound Voice Coil Design Affords 18% More Efficiency
- Heavy Magnet Structures; Die-Cast Frame Assembly

**Model 15TRX.** Diam. 15 $\frac{1}{4}$ ". Depth 9 $\frac{3}{4}$ ". Magnet 5 $\frac{3}{4}$  lbs. Net wt. 44 lbs. Imp. 16 ohms. List Price, \$225.00. **Audiophile Net, \$135.00**

**Model 12TRX.** Diam. 12 $\frac{1}{2}$ ". Depth 8". Magnet 3 $\frac{1}{2}$  lbs. Net wt. 38 lbs. Imp. 16 ohms. List Price, \$190.00. **Audiophile Net, \$114.00**

Includes X-36-1 crossover network and AT-37 brilliance control.



Recommended E-V Folded Horn Enclosures  
E-V REGENCY for Model 15TRX



E-V ARISTOCRAT for Model 12TRX

WRITE FOR BULLETIN NO. 204 MH

# Electro-Voice

BUCHANAN, MICHIGAN

Export: 13 E. 40th St., N.Y. 16, U.S.A. Cables: Arlab

Quality is an elusive thing. Engineers measure it . . . copywriters glorify it . . . salesmen describe it. But the final test is actual performance. If a product is the best in its field, those who know quality will accept no other.

That is the story of Pickering's new 260 Turnover Cartridge.

Introduced only months ago, it is already a leader among magnetic cartridges. It has won that position because it is the nearest thing to perfection yet produced. Here are the combined advantages it offers:

## The nearest Thing to Perfection

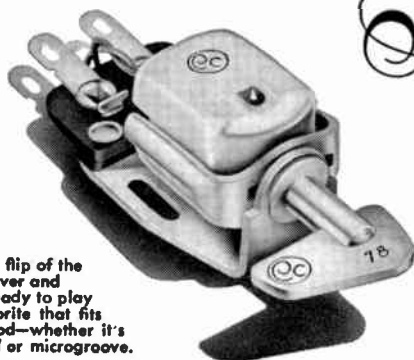

A simple flip of the handy lever and you're ready to play any favorite that fits your mood—whether it's standard or microgroove.

1. HIGHER OUTPUT—Better overall signal-to-noise ratio.
2. LOWER OVERALL DISTORTION—Less intermodulation distortion with wider frequency response.
3. MINIMUM TRACKING FORCE—Lowest practical tracking force for both microgroove and standard recordings.
4. HIGHER COMPLIANCE—Compliance of moving elements is the highest practical, consistent with best-quality transcription arms and changers.
5. LOWER MOVING MASS—Lowest of any comparable magnetic cartridge.
6. TWO DIAMOND STYLI—For longer record and stylus life and greatest economy.

These design features have real meaning to those who understand that quality reproduction depends on components which meet professional standards. If you want the best that high fidelity can offer, ask your dealer to demonstrate the new 260 Turnover Cartridge. You, too, will hear the difference!

**PICKERING** and company incorporated • Oceanside, L. I., New York



PICKERING PROFESSIONAL AUDIO COMPONENTS

*“For those who can hear the difference”*

. . . Demonstrated and sold by Leading Radio Parts Distributors everywhere. For the one nearest you and for detailed literature, write Dept. X-4





*The author, who uses a Revere tape recorder to add interest and effectiveness to piano practice, listens with her pupils to the playback of a duet. She explains: "This is the only way they can hear their own mistakes."*

*It's Fun to Practice with a*

## **TAPE RECORDER**

*By ANITA deMARS*

*May-June 1954*

**D**O YOU HAVE a boy or girl studying the piano, the violin, the clarinet, or the trumpet? Have you wondered how in the world your child can make such awful sounds, particularly on the last three? Or how Sue and Jim can possibly go on with the same mistakes on that piano, over and over and over? Is there something wrong with the child? Or the teacher? Are you almost at the point of thinking the instrument is defective!

But the real reason is that the young musician is so busy making those sounds that he doesn't even hear them. The involvement of the child with his fingers, his feet, arms, back, and breath leaves no attention for the ears which he hasn't been taught to use consciously, either in school or at home. And music is an art for the ear alone. His teacher probably imitates him in an effort to make him *hear* what he does, but his reaction to her rendition is always, "I didn't play it that way!"

Today we have the perfect way of getting around that problem: It's a tape recorder for the young musician's use at home. Music schools are using them in their studios with great success, but if you live outside a large city, your boy or girl probably studies with a teacher who comes to your home, and can hardly be expected to transport even the portable type of tape recorder through a day's travelling from house to house. So the answer for your young musician is a tape recorder of his or her own, to use with and without his teacher!

A recorder, turned on for his practise period, eliminates all arguments as to whether he actually practised or just played for his own amusement, and whether or not he worked a full half-hour! Most of your problems as a parent of the not-too-studious boy or girl will disappear at once! A small recorder, run at  $7\frac{1}{2}$ -inch tape speed, is inexpensive and simple to operate. The student himself can turn it on

*Children learn quickly to operate the simple controls of a tape recorder. Being able to hear the playback gives practicing a new, exciting significance*





*When there's trouble with a particular passage, it helps the young student to have his mother play it back to him at once. This reveals mistakes he cannot hear while he is playing himself, and avoids the repetition of the same mistakes which, then, are more difficult to overcome*

when he starts to practise, and it will record for 30 minutes on one side of the tape. At the end of that time, he will be more than glad to sit down and listen to what he has done.

He may argue that he did not bang the keys like that at the end of the first ten minutes! He may like to think that the stumbling, inaccurate rendition of *The Merry Farmer* is not at all like the beautiful playing he thought he did. But the machine is adamant. It will not answer back or get upset as Mother might, and in his little heart he knows the tape plays back to him exactly what he has done.

The availability of a recorder will provide an important element of social activity for the youngsters, too. Your children's friends will spend whole afternoons playing for the tape and sitting in rapt attention as it plays back the music they created. You'll surely agree that there is no more wholesome occupation for them than learning to play an instrument and enjoying music in groups where friendships are made on the basis of mutual participation in an art.

Very real benefits derived from this new miracle are the development of the capacity to listen, the training of the student's critical sense, and the information provided by hearing what he did after he did it. For the advanced

student in the beginning artist class, the use of the tape recorder is a must, a short cut which can eliminate months of struggle and work. Listening to the recording of what he has played, he can study his own music as intelligently as he would another's.

The tape mirrors accurately the technical achievements, the dynamics, the interpretation for which the advanced student works so hard and often unsuccessfully between lessons with his teacher. Recently in a New York studio, a young pianist, working on the Warsaw Concerto, found himself in trouble with one of the involved rhythm passages. All his counting, tapping, beating it out didn't seem to help because, when he played it, it sounded right to him. Still, his teacher insisted it was not accurate. Finally they brought in the tape recorder. Immediately the student recognized his fault, and then was able to remedy it at once. This very simple procedure quickly solved what might have been an insurmountable problem.

Today's portable recorders are inexpensive and so fool-proof that they can be operated by any boy or girl. To be sure, some of these machines fall short of professional standards of tone quality, but for the benefit of the young music student, a moderately-priced machine delivers ade-

*Concluded on page 64*



*Seymour N. Siegel, director of WNYC, is justly proud of the decorations on the wall behind his desk. One is from the French Government, and the other from the Netherlands, both given to Mr. Siegel for his work in promoting international understanding through radio broadcasting. With him in this picture is program director Bernard R. Buck*



Photographs by Emil J. Ostheimer

# WNYC: 30 YEARS of PROGRESS

*From an instrument of political propaganda to an independent medium of service and culture*

By JONATHAN SCHILLER

SINCE its inauguration on July 8, 1924, New York's municipal radio station has written a remarkable record into the history of radio broadcasting. Despite the inauspicious circumstances of its establishment, FM-AM station WNYC has progressed during the past 30 years to the point where it is performing an outstanding public service. In fact, it is generally considered to have contributed more to enriching the cultural standards of its extremely large and loyal audience than any other single station in this Country or abroad, with the exception of the British Broadcasting Company's Third Program, and the Italian radio system which is almost on a par with it.

## Establishment of New York's WNYC

The idea of establishing a municipally-owned station was originated by Grover A. Whalen who, in the early 20's, was New York's official city greeter and Commissioner of the Department of Plants and Structures in the Hylan administration. An election was coming up, and perhaps with the thought in mind that radio broadcasting might be a useful political instrument for Mr. Hylan and his party, Grover Whalen discussed the proposition with the Mayor and Maurice Connolly, then Borough President of Queens.

The latter introduced a resolution at a meeting of the Board of Estimate and Apportionment calling for a committee to study the possibility of establishing a station to



*Don Gillis, who was the producer of the Toscanini-NBC Symphony broadcasts, is also a composer, conductor, author, and commentator. He has a weekly program on WNYC called "This Is American Music". His Alice in Orchestralia, an original work he recorded in Italy, was released recently*

be owned and operated by the City. In his speech to the Board, Mr. Connolly set forth as the purpose of the station: ". . . carrying to the people useful knowledge and healthful entertainment in the form of broadcasts of music and such lectures as may be found to be most desirable." While no basic change has been made in this statement of purpose, the interpretation and application has evolved from what might be called service to politicians to what has truly become service to the public.

When funds were made available for the station, a hassle ensued with the equipment manufacturers which was finally resolved by the purchase of a second hand 1,000-watt Westinghouse transmitter built originally for demonstration and publicity purposes at the Brazilian Centennial Exposition in Rio de Janeiro.

### Radio for Political Propaganda

It was evident from the beginning that those who had advocated the operation of a station to disseminate useful knowledge and healthful entertainment were actually thinking in terms of political propaganda. The local press was severely critical of the Hylan administration at that time, and members of Mr. Hylan's party used the station to explain and justify the Mayor's "good works." This created a storm of public disapproval, and the Citizens Union took the matter to court. After some litigation, the court decided that the municipal radio station, supported by the taxpayer's money, could not be used as a political instrument on behalf of the City's administration.

Hylan was not re-elected, and in 1925 he was succeeded by the late Jimmy Walker. Although he was not overly enthusiastic about WNYC, he made it known that, reports to the contrary notwithstanding, he would continue the station after taking office. Despite that statement, Albert Goldman, Commissioner of Plants and Structures in the Walker administration, proposed that a poll of the voters be taken to determine whether or not the station should be kept on the air. The poll was never taken, however, and the operation of WNYC was continued without further serious threat of interruption until, about a year ago, Lazarus Joseph, City Comptroller under Mayor Impelliteri, advocated closing the station as a measure of economy. By that time, WNYC and WNYC-FM had become so well and favorably known to listeners throughout the Metropolitan New York area that, the day after Mr. Joseph made his ill-advised statement, he found so many letters of protest piled up at the door of his office that he dropped the matter then and there.

### Programming for Public Service

When Fiorello La Guardia took office as Mayor, he asked Seymour N. Siegel to look into the possibility of discontinuing WNYC. That was in 1934. Mr. Siegel, however, became so interested in the potential of a municipally-owned radio station as a means of rendering an important public service that he not only aroused Mayor La Guardia's enthusiasm for the idea, but he took over as director of the station, a post which he still holds!



*Above: David Randolph's "Music for the Connoisseur" is a weekly WNYC feature, also carried by some 70 member stations of the NAEB. The David Randolph Singers record for Westminster. Below: Assistant program director A. Alan Levin, with two of the numerous Ampex machines used for tape programs*

Mayor La Guardia, who loved music himself, gave whole-hearted support to the development of WNYC. Herman Neuman, music supervisor of the station, loves to tell about the occasions when the Little Flower, after announcing to his office staff that he was going out to lunch alone, would slip up to the station library, take down an album of classical music, and disappear into a small studio where he listened to records for an hour or more. Under



his encouragement, more and more emphasis was put on programs dealing with the arts, and with music particularly. And as the programs improved, the listening audience grew rapidly.

In 1941, an FM transmitter, operating on 93.9 mc., was added. The AM transmitter was originally licensed to operate only until sundown, because it interfered at night with a Minneapolis station. FM made it possible to continue operation during the evening hours. Then, in 1942, the FCC extended the AM time to 10:00 p.m. The FM transmitter, now up to 20,000 watts, runs from 6:00 a.m. to 3:00 a.m., except on weekends when it starts at 6:55 a.m.

In 1947, during William O'Dwyer's administration the operation of WNYC was removed from the jurisdiction of the Department of Public Works, and was attached directly to the Mayor's office. With this new status, increased funds were provided for new equipment and additional personnel.

WNYC-FM-AM is said to have the third largest audience in the metropolitan New York area, and is generally considered the No. 1 good music station. At the present time, live and recorded music make up over 50% of the program hours.

Back in the early days, however, music was confined to those periods when the station was not carrying political speeches and propaganda. Many of the musical programs were short piano recitals played and announced by Herman Neuman. Then, as now, he was able to lure to the downtown studios atop the Municipal Building many of the great artists. Amateurs and little-known professionals have been helped in their careers by the opportunity of performing for the WNYC audience.

There has never been any appropriation to pay for records or live talent. So, when Dr. Neuman started the Masterworks Hour, the first radio program of its kind, he borrowed records from the very large collection of a Brooklyn lawyer. Later, he arranged with the Gramophone Shop to obtain the records needed for each day's broadcast.

But one day, one of the shellac records was broken! This created a major crisis, for there were no funds with which to replace it. Thereupon, Mr. Siegel got in touch with General Sarnoff of RCA, and explained the circumstances. The General was most sympathetic. He called the RCA Victor plant and arranged to have 20,000 records shipped immediately to WNYC. Dr. Frank Stanton of CBS was equally cooperative. Since that time, Victor and Columbia have sent review copies of their new releases to the station, and today WNYC has one of the finest record libraries in the City.

The Masterworks Hour, still going strong, has been increased by popular demand to an hour and a half in length. Other regular musical features have been added. "While the City Sleeps," heard from midnight to 3:00 a.m., has a surprisingly large audience.

Discussions of recorded music, with excerpts from the records, are presented by such authorities as David Randolph and Edward Tatnall Canby. Don Gillis, producer of the NBC Symphony, does a Sunday evening program on America's music. These men donate their services.

*(Concluded on page 63)*



*Back in 1924, mechanical phonographs, left, were set up to play directly into the microphone. There was no air conditioning, and in the summer the mike picked up street noises coming through the studio windows*



*Above: Musical director Herman Neuman, left, and his assistant, Alex Richardson, in the WNYC record library. Below: another of the early studios. Note the draped walls and the fancy wicker microphone stand*

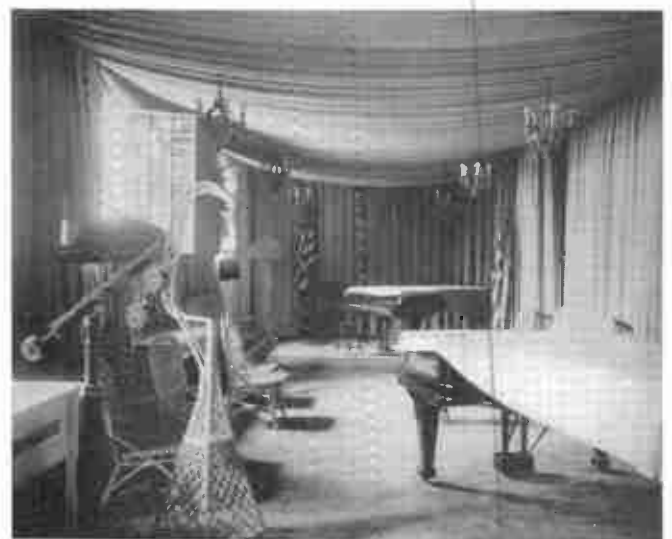



# THE HI-FI CONCERT SOCIETY

*Why not share your enjoyment of recorded music with your friends and neighbors in an informal Hi-Fi Concert Society for group listening and music discussion? Here is a plan for you*

THE IDEA of planned programs of recorded music, first proposed in the last issue of *MUSIC AT HOME*, has created immediate and enthusiastic response from our readers. A typical comment: "There are so many advantages in this that the amazing thing about it is that it wasn't proposed years ago!" A summary of opinions expressed by readers adds up in this way:

It is surprising to find how much more enjoyment there is in listening to a planned grouping of related selections, and how much more the music means when records are played in that way. This is the most effective way to build a mood for listening in an appreciative, understanding way, whatever type of music comprises the program.

A number of readers remarked that they couldn't imagine why they had not thought of it before. For example: "If I went to a concert, and they picked out selections in the haphazard way I have always played my records, I'd walk out and ask the manager to refund my money!"

Others wrote that in the past, they have listened to records separately one by one. Now they find the music on each record has greatly added significance when the individual records are heard as parts of a series of complimentary compositions. The planned programs are proving to afford particular advantages to those seriously interested in developing their appreciation of music.

All this is perfectly obvious, of course. And there's nothing new about it. The technique has been used as long as there have been concerts, and musical experts to plan them. Radio concerts of recorded music date back to the beginning of broadcasting. No wonder that people who have hi-fi equipment acclaim the idea of planned music at home, and exclaim over the fact that, with all that is being written about records, no one has thought of arranging records in concert form before!

## New Plans Already under Way

Encouraged by the reception of this idea, we have undertaken to make it still more interesting and worthwhile. To that end, we enlisted the assistance of Miss Anita de Mars as musical director of the programs. This is a field in which she has had great experience. To use her expression, she was a "builder" of musical programs at CBS in Chicago for ten years, and program manager of WABF (FM) New York in the early days of that station when it ranked at the top for fine music. Now, she is teaching courses in radio and TV operations and writing at Finch College. She is also well-known in New York as an accompanist, and is much sought after as a piano teacher, although she takes only a very limited number of students.

At our first discussion of the recorded concerts with Miss de Mars, she said, "This is the biggest, most exciting contribution to listening pleasure that any publication has ever made. You've really got something here. But it's only a start." Then she proceeded to explain how the presentation of the programs should be improved.

"Let's encourage people to form listening groups among their friends and neighbors. There are times, of course, when one wants to play records just for oneself, but there is so much to be gained from group listening, and the discussion of music. Let's encourage our readers to carry out the idea of organizing their own informal Hi-Fi Concert Societies, and let's arrange the programs in *MUSIC AT HOME* in the form of real concert programs."

Group listening answers the one objection raised against planned programs by those who said they didn't have the records called for, and that it was too expensive to buy them. Actually, the programs offer an excellent plan for building a fine collection. However, with group listening, it may be possible to collect the records specified from among those taking part. Or, if records must be bought, the purchasing can be parceled out so that no one will have to stand the expense of more than one record.

The explanatory introduction and the program notes which you will see in the pages following were also suggested by Miss de Mars. The latter, she insisted, should serve as record reviews, but written to be informative, and definitely not in the intellectually snobbish gobbledegook style affected by some reviews. To that, one of our group contributed the comment that he was under the impression that a great many reviews are written to impress other reviewers, rather than to inform the readers. Be that as it may, we shall try to make the program notes useful and easy to understand.

## Programs Presented in This Issue

The eight Music-at-Home Programs offered in this issue offer a wide variety as to composers and types of music. Three are made up of selections by composers whose works are often heard together in public concerts. Then there are three devoted to single composers, namely, Beethoven, Bizet, and Stravinsky, in addition to one opera performance, and an out-and-out jazz session planned by guest director Frederick Reynolds.

Whether you try just one of these concerts or all of them, whether you listen alone or in the company of your friends, Miss de Mars and our Editorial Board would like to have your comments and suggestions about further improvements that can be made in these Music-at-Home Programs. Your opinions will be most welcome.

# THE HI-FI CONCERT SOCIETY

PRESENTS the 1st MUSIC-at-HOME PROGRAM:

## Beethoven, Handel, Mozart, Haydn

Thursday, May 6, 1954

ANITA de MARS, Musical Director

TO BE HEARD AT HOME

1. **Beethoven**—Symphony No. 5 in C Minor, Opus 67—Bruno Walter and the New York Philharmonic Symphony Orchestra  
**Columbia ML-4790**
2. **Handel**—Dettingen Te Deum—Richard Bales and National Gallery Orchestra, Chancel Choir, and soloists **WCFM LP-6**
3. **Mozart**—Aria—Eleanor Steber **Columbia ML-4694**
4. **Haydn**—The Creation—Krauss and the Vienna Philharmonic Orchestra and soloists **Haydn Society 2005**

### INTRODUCTION

**D**IGGING around in the musical past of the month of May, it is intriguing to find that, on May 6, 1872, Theodore Thomas gave his inaugural concert at the first Cincinnati May Music Festival. This evening's program is a duplicate of that important occasion in the history of music in America.

As a little ten-year-old German boy, Theodore Thomas came to this Country in 1845, a fiddle tucked under his arm, and his heart filled with a driving urge to play and conduct. Beginning as his own concert manager, "Master T. T. — a Prodigy" played until he was old enough to conduct. His career brought to America a wealth of fine music that is part of our standard repertory today.

He travelled from coast to coast with his orchestra, inspiring each city to organize its own group of musicians. He started the famous Cincinnati May Music Festivals. He gave summer concerts in New York's Terrace Garden, and at Central Park Garden, and he conducted the New York Philharmonic.

His programs were designed to give his audiences both the familiar music they loved, and new music which they neither knew or liked. His summer concerts were a musical education to a Country that knew only the brass band concerts before his time.

In 1890, Thomas was invited to Chicago to organize their symphony orchestra, and he stayed as its conductor

until he died in 1905 at the age of 70.

### PROGRAM NOTES

1. The *Beethoven Fifth* has become so well known that even the programs of the New York Philharmonic Symphony have very little to say about it that is not repetitious. It is the famous Victory symphony, with the familiar four-note opening. There are more than a dozen recordings of it, representing nearly every major orchestra and conductor.

Therecording by the New York Philharmonic Symphony is suggested here. If you don't own an LP of the *Fifth*, look through the catalog at your record shop and choose the one you like best.

2. Handel's *Dettingen Te Deum* was written to celebrate the victory of the British over the French in the Battle of Dettingen, a village in Bavaria where the British had triumphed over an almost successful French ambush. The year was 1743. *Te Deum* is an ancient Latin prayer of thanks, and Handel based this composition on the hymn of St. Ambrose of Milan. He divided it into eighteen parts to be sung by solo voices and chorus with orchestra.

On this WCFM disk you will hear Katherine Hansel soprano, Rachel Koerner alto, George Barritt tenor, Harold Ronk baritone, and the National Gallery Orchestra of Washington, D. C., conducted by Richard Bales. The spectacular first trumpet part is played by Lloyd Geisler. Theodore Schaefer

conducts the Chancel Choir of the National Presbyterian Church in Washington.

3. An aria is a solo song from an opera or an oratorio. On this Columbia record, Eleanor Steber has recorded seven arias from various Mozart works. Steber is a nationally-known soprano, and one of the leading stars of the Metropolitan Opera. Any one of these arias will fit into the program at this point. You may want to use several of them. They are all delightful.

4. For those who are not familiar with this type of work, an oratorio is a religious work written for soloists, chorus, and orchestra, to be performed on stage without action, costumes, or scenery. It is pure music without theatre of any kind. George Frederick Handel was, of course, the most famous composer of oratorios. His *Messiah* has become required music for Christmas in our time. Inspired by his genius, Josef Haydn wrote two oratorios which have also taken their place among great music: *The Seasons* and the one on this evening's program, *The Creation*. The text for this music was adapted from the Book of Genesis and from Milton's "Paradise Lost." Obviously, it is the story of the creation of the world. The Haydn Society made this excellent disk with Conductor Krauss and the Vienna Philharmonic Orchestra and soloists.

# THE HI-FI CONCERT SOCIETY

PRESENTS the 2nd MUSIC-at-HOME PROGRAM:

## Wagner, Schubert, Bach

Thursday, May 13, 1954

ANITA de MARS, Musical Director

TO BE HEARD AT HOME

1. **Wagner**—Overture to the Flying Dutchman—Knappertsbusch and Vienna Philharmonic Orchestra **London LL 800**
2. **Schubert**—Fantasy (Der Wanderer) arranged by Liszt—Grant Johannesen, pianist **Concert Hall CH 1176**
3. **Bach**—Magnificat—Ferdinand Leitner and the Ausbach Bach Festival Orchestra with chorus and soloists **Decca DL 9557**

### INTRODUCTION

THEODORE THOMAS experienced one of the greatest thrills in his life on May 13, 1862, when he conducted his own orchestra in its first concert. The place was Irving Hall in New York City. There were several innovations on this occasion: an American orchestra used the harp and the English horn, and Wagner's *Flying Dutchman Overture* and the *Schubert-Liszt Fantasy* were heard for the first time in this Country.

Thirteen years later, May 13, 1875, at the Cincinnati May Music Festival again, Thomas introduced Bach's *Magnificat*.

You will enjoy these three works on this evening's program.

### PROGRAM NOTES

1. The easiest way to describe Wagner's *Overture to the Flying Dutchman* is to tell the story of the opera for which it was written. Wagner wrote his own libretto, inspired by Henrich Heine's legend of the sea, which tells of a Dutch captain, trying to sail around the Cape of Good Hope, who was beset by storms which seemed determined to prevent his success. He swore a sacrilegious oath to accomplish it if it took him all of eternity. As a consequence, his ghostly ship with its captain and crew were doomed to sail the seas until he could find a wife who loved him. In the opera,

the ghostly Dutchman boards the ship of a Norwegian sea captain, asks for the hand of his daughter, pays the captain handsomely, and gets his consent. However, the stipulation is that the lady must love him, and of that the Dutchman cannot be sure. Finally he leaves her and sails off in his ghost ship. The poor girl has really loved him, and she throws herself into the sea. This proof of her devotion frees the Flying Dutchman from the curse.

In the *Overture*, Wagner portrays the crashing, roaring sea as the gales whistle over it. The spirit of the ocean comes from the eerie woodwinds. Through it all runs the love theme of the girl, Senta.

2. Franz Schubert wrote this *Fantasy—Der Wanderer*—in 1822 as his opus 15, and Liszt made an arrangement of it. The brilliancy of Liszt added to the poignancy of Schubert are played beautifully on this Concert Hall LP by the young pianist, Grant Johannesen.

3. The *Magnificat* is one of Johann Sebastian Bach's famous religious works, written in 1823. It is the song of the movements, which is not long for such a work. In true oratorio fashion, it is done with four solo voices, chorus, and orchestra. The movements are based upon the words of Mary:

1. My soul doth magnify the Lord.

2. And my spirit doth rejoice in God, my savior.

3. For He hath regarded the low estate of His handmaiden; for behold, all generations shall call Me blessed.

4. For He that is mighty hath done to Me great things; and holy is His name.

5. And its mercy is on them that fear Him from generation to generation.

6. He hath shewed strength with His arms, He hath scattered the proud in the imagination of their hearts.

7. He hath put down the mighty from their seats, and exalted them of low degree.

8. He hath filled the hungry with good things; and the rich he hath sent empty away.

9. He hath holpen His servant Israel, in remembrance of His mercy.

10. As He spake to our fathers, to Abraham, and to His seed forever,

11. Glory be to the Father, the Son, and to the Holy Ghost, as it was in the beginning, is now and ever shall be, world without end.

Amen.

On this LP, Decca has presented soprano Marta Schilling, alto Gertrude Pitzinger, tenor Heinz Marten, bass Gerhard Gröschel, the Rudolph Lamy Choral Society and Ferdinand Leitner with the Ausbach Bach Festival Orchestra in a recording that calls for a fine hi-fi system.



# THE HI-FI CONCERT SOCIETY

PRESENTS the 3rd MUSIC-at-HOME PROGRAM:

## All-Beethoven Program

Thursday, May 20, 1954

ANITA de MARS, Musical Director

TO BE HEARD AT HOME

1. **Beethoven**—Egmont Overture—Van Beinum and the London Philharmonic Orchestra **London LL 357**
2. **Beethoven**—Bagatelles—Grant Johannesen, pianist **Concert Hall CHS 1199**
3. **Beethoven**—Symphony No. 9, Op. 125—Toscanini and the N. Y. Philharmonic Symphony Orchestra **Victor LM 6009**

### INTRODUCTION

THE great Beethoven *Ninth Choral Symphony* was brought to America on May 20, 1846. The young New York Philharmonic was only four years old at that time, and to perform this huge work was quite an achievement. Beethoven took six years to write it for orchestra, chorale, and solo voices. The words are those of Johann von Schiller's great poem, *Ode to Joy*:

Joy of flame, celestial fashioned,  
Daughter of Elysium,  
By that holy fire in passion  
To thy sanctuary we come.  
Thine the spell that reunited  
Those estranged by custom dread.  
Every man a brother plighted  
Where thy gentle wings are spread.<sup>1</sup>

In honor of the first playing of this great work, it is featured on this program, together with two other Beethoven compositions which should be in

<sup>1</sup>English translation by courtesy of the N. Y. Public Library.

every library of classical music records.

### PROGRAM NOTES

1. Beethoven wrote a number of overtures from which it is difficult to make a selection. The *Egmont* on this evening's program is a very familiar one — a good opener for this Hi-Fi Concert. Also on this disk are other familiar overtures: *Consecration*, *Coriolan*, *Fidelio*, and the third of his three *Leonore Overtures*, all played by Van Beinum and the London Philharmonic Orchestra. You will want to hear them all, but to keep this program in compact form, the *Egmont* is sufficient for this occasion.

2. The word *bagatelle* means "trifle" — something of little importance. Beethoven may have considered his *Bagatelles* trifles, but they are among his most charming works. Perhaps he meant they were trifling in length — twenty-six of them are played on this Concert Hall LP by Grant Johannesen, pianist. Play as many as you and your guests want to

hear. You will enjoy all of them, and you will find them admirable to precede the final, featured composition of this program.

3. You have your choice of ten LP's when you shop for the Beethoven *Ninth*. It has been recorded by Columbia, Victor, London, Westminster, and Royal. The one listed this evening is the performance taped at Carnegie Hall on March 31, and April 1, 1952. Toscanini had rejected four previous attempts by RCA Victor to tape the *Ninth Symphony*, but when he heard this performance on tape, he judged it to be the best possible recording that could be made of this famous composition, and declared that he was "almost satisfied with it". On this LP you will hear soprano Eileen Farrell in her first association with the Maestro, tenor Jan Peerce, mezzo Nan Merriman, baritone Norman Scott, and the Robert Shaw Chorale with the New York Philharmonic-Symphony Orchestra, all under the baton of Toscanini.

# THE HI-FI CONCERT SOCIETY

PRESENTS the 4th MUSIC-at-HOME PROGRAM:

## Paganini, Liszt, Sibelius

Thursday, May 27, 1954

ANITA de MARS, Musical Director

TO BE HEARD AT HOME

1. **Paganini**—Caprices, Opus 1—Michael Rabin  
**Columbia ML 2168**
2. **Liszt**—Hungarian Rhapsody No. 1—Arthur Fiedler and the Boston Pops Orchestra  
**Victor LRM 7002**
3. **Sibelius**—Swan of Tuonela—Ormandy and the Philadelphia Orchestra  
**Columbia AAL 9**
4. **Sibelius**—Finlandia Overture, Op. 27, No. 7—Toscanini with the NBC Symphony  
**Victor LRM 7005**

### INTRODUCTION

**O**DDLY enough, three events marked by this date suggest the selection of works by Paganini, Liszt, and Sibelius which combine to make up a particularly interesting program for this 4th Hi-Fi Concert on records.

After a mad life of virtuoso playing and many love affairs, the great violinist Nicolo Paganini died at Nice on May 27, 1840. The word picture Oscar Thompson paints of this artist is "tall, lean, pale, and cadaverous of face, with black hair and eyes and shaggy brows." This appearance, added to his fiery temperament, had an almost hypnotic effect upon his audiences, and he exploited his great technical facility to the utmost. He was very jealous of it, so much so that he refused to publish his compositions during his lifetime lest other violinists learn some of his secrets. Among those he did publish were the 24 unaccompanied *Caprices*.

Another event of May 27: Theodore Thomas and his orchestra, again in New York's Central Park Gardens in 1875, gave the first American performance of Liszt's Hungarian Rhapsody No. 1 in an orchestral version.

On May 27, 1914, Jean Sibelius arrived in the United States to conduct at the Litchfield County Choral Festival

in Norfolk, Connecticut. The program included the American premiere of his own *Swan of Tuonela*. To this has been added for tonight his *Finlandia Overture*.

### PROGRAM NOTES

1. Into these *Caprices*, Paganini wrote every possible difficulty for the violinist. Only a performer of phenomenal talent can play them as young Michael Rabin does. He is considered one of the great talents today. You can hear the technique of Paganini himself in this disk which Michael Rabin made at the age of thirteen — his first recording. There are eleven of the twenty-four caprices — all short delightful bits — on the record, including the No. 24 which was the basis of Brahms' *Variations on a Theme of Paganini* and Rachmaninoff's *Rhapsody on a Theme of Paganini*. Mr. Rabin made his debut in Carnegie Hall in 1950 and attended the Juilliard School of Music. Perhaps you heard him in the MGM picture "Rhapsody."

2. Franz Liszt's *Hungarian Rhapsodies* are almost too famous to need discussion. Between 1851 and 1856 he wrote twenty of them. Arthur Fiedler and the Boston Pops Orchestra do full justice to this Rhapsody No. 1 in their usual

exuberant style. The Boston Pops Orchestra players are Boston Symphony men, the difference between the two organizations being one of style and type of program, not of quality. The Pops Orchestra plays the more popular style of good music, leaving the deeply classical playing to the Boston Symphony.

3. On Sibelius' score of *The Swan of Tuonela*, we find these words: "Tuonela is the land of death, Hell of Finnish mythology, surrounded by a large river with black waters and rapid current on which the Swan floats majestically singing." This is beautiful music. Listen for the exquisitely melodious Swan song that the composer has written into the English horn part.

4. *The Finlandia Overture* by Sibelius is also on the back of the *Swan of Tuonela*. However, the Victor LRM 7005 we have listed is a new Toscanini disk which includes Ponchielli's *Dance of the Hours*, Rossini's *Dance from William Tell*, and Sibelius' *Finlandia Overture*. Although Sibelius said that the melodies he used in the overture were original, they are nevertheless so very Finnish as to seem almost like the folk music of Finland, and the overture has a national feeling as a consequence.

# THE HI-FI CONCERT SOCIETY

PRESENTS the 5th MUSIC-at-HOME PROGRAM:

## An All-Bizet Program

Thursday, June 3, 1954

ANITA de MARS, Musical Director

TO BE HEARD AT HOME

1. **Bizet**—Card Song from *Carmen*—Rise Stevens  
**Victor LM 1749**
2. **Bizet**—C'est Toi from *Carmen*—Rise Stevens & Jan Peerce  
**Victor LRM 7011**
3. **Bizet**—Flower Song from *Carmen*—Jussi Bjoerling  
**Victor LM 105**
4. **Bizet**—Chanson du Toreador from *Carmen*—Robert Merrill  
**Victor LM 1007**
5. **Bizet**—Fair Maid of Perth—Beecham and the Royal Philharmonic Orchestra  
**Columbia ML 2133**
6. **Bizet**—L'Arlesienne Suite No. 2—Sargent and Halle Orchestra  
**Entre RL 3051**

### INTRODUCTION

WE ALL KNOW the composer Georges Bizet particularly for his incidental music to Daudet's play, *L'Arlesienne*, and his *Fair Maid of Perth*, and for one of the most popular operas ever written — *Carmen*. The opera was not the immediate and drastic failure we are sometimes told it was. It was given 37 times in the season of 1875 at the Opéra Comique. That doesn't sound like failure! On June 3, while *Carmen* was enjoying its 23rd performance, Georges Bizet passed away.

But *Carmen* went on around the world. She arrived in New York at the old Academy of Music on 14th Street in 1878. Five years later, the Metropolitan Opera House was built, and *Carmen* came back for a fine performance in the Met's first season in its new home. The sinuous and alluring *Carmen* was Emma Calvé who created the role in America.

The succeeding selections were chosen

because they further exemplify Bizet's art and style which have won such enduring affection for his music. All these compositions should be together in any library where his work is represented.

### PROGRAM NOTES

1 to 4. The first four selections of this program are arias from *Carmen*. If you like opera, you know these singers well: they are all at the Metropolitan and are known everywhere through their recordings. The four arias listed are familiar ones. If you would like to modify this program in order to hear the entire opera of *Carmen*, with Albanese and Jan Peerce in the leading roles, then substitute the Victor LM 6102.

5. Bizet's *Fair Maid of Perth* was inspired by Sir Walter Scott's novel of the same name written in 1828. It is the love story of the most beautiful girl in Perth, of course. Perth was a city on the northeast coast of Scotland near

Dundee. The time of this story was during the reign of Robert III, when men fought to the death for what they wanted. In Bizet's music, there are five sections: *Prelude*, *Serenade No. 1*, *March*, *Serenade No. 2*, and *Dance Bohemienne*, very beautifully done by Sir Thomas and the Royal Philharmonic. On the other side of this record is *Over the Hills and Far Away* by the British composer, Frederick Delius.

6. There are two *L'Arlesienne Suites* — 27 numbers in all — which Bizet dashed off, so to speak, as incidental music to a play of the same name by Daudet. They became some of his best-loved music. In his orchestration he introduced the saxophone, a fairly new instrument which was not generally accepted in 1872!

The *Suites* have the same intriguing charm that all Bizet's music has — a quality of rhythm and harmony and melody peculiar to him.



# THE HI-FI CONCERT SOCIETY

PRESENTS the 6th MUSIC-at-HOME PROGRAM:

## A Complete Opera—Tristan & Isolde

Thursday, June 10, 1954

ANITA de MARS, Musical Director

TO BE HEARD AT HOME

1. **Richard Wagner**—Tristan and Isolde—Flagstad, Suthaus,  
and Thebom **Victor LM 6700**

### INTRODUCTION

WHEN Hans von Buelow conducted the first performance of Wagner's *Tristan and Isolde* in Munich, 99 years ago today, the opera audience heard what was to them a new and different kind of music. The Vienna Court had previously planned to give the new work but, after 77 rehearsals, they pronounced it "unperformable." Wagner had moved to Vienna to supervise the rehearsals and found himself without funds when the performance was cancelled.

With the help of friends, he got to Munich, and there *Tristan and Isolde* was finally performed the following year. Wagner wrote the text, as usual, and there is little doubt that his friend Mathilde Wesendonk was his inspiration. In a letter to her, he said: "That I wrote *Tristan* I thank you from the depths of my soul forever and ever."

### PROGRAM NOTES

This is one of the Victor Book of Opera series, recorded by Kirsten Flagstad soprano, Ludwig Suthaus tenor, Blanche Thebom mezzo, Josef Greindl bass, Dietrich Fischer-Dieskau baritone, Rudolph Schock tenor, Edgar Evans tenor, and Rhoderick Davies baritone. The Chorus of the Royal Opera House and the Philharmonia Orchestra of Covent Garden are under the direction of Wilhelm Furtwangler.

The story of this three-act opera will make the music more interesting to you, if you are not already familiar with it. It is based on the old Celtic story of *Tristram and Isolt*. In his own manner, Wagner departed from the legend and from the poem of the 13th century which he used as his authority.

Before the actual opera begins, the story goes that Isolde had known the

Cornish Knight Tristan under the name of Tantris when he was brought to her, wounded and ill, after a battle. She had cared for him, nursed him back to life, and then discovered he had killed her kinsman, Morold. Attempting to avenge Morold's death, she tries to kill Tantris with his own sword, but when he looks upon her with love, she returns it and cannot kill him.

However, at the opening of the opera, Isolde is a passenger aboard Tristan's ship, on her way to Cornwall to be married to Tristan's uncle, King Mark. She sends her maid Brangaena to summon Tristan to speak with her. He is at the helm of the ship and refuses to leave it. She is furious at the indignity and decides to kill him and die with him. She tells Brangaena of his past infidelity and commands her to bring a poisoned drink for him when he comes. She does so, and when he has drunk half of it, Isolde seizes it from his hand and finishes it.

However, Brangaena has brought a love potion, and the first act ends with Tristan and Isolde madly in love as Tristan's ship lands at Cornwall and is boarded by King Mark's men who take Isolde to her husband-to-be.

Act II is laid in the garden of King Mark's palace. Isolde has married the king, but her love for Tristan continues and they meet in the garden at night, guarded by Brangaena who stands on the tower, watching for the dawn and the return of King Mark and Sir Melot who have gone on a night hunting trip.

She warns of their approach, but her warning falls on unheeding ears. King Mark is led to the rendezvous by Sir Melot and surprises them together. The King's reaction is one of sorrow that his beloved nephew and heir could have so betrayed him. Tristan decides he must leave Cornwall and re-

turn to his homeland. He kisses Isolde goodbye. The infuriated Melot draws his sword. Tristan seizes the sword of his henchman Kurvenal and attacks Melot who mortally wounds him.

Act III is laid in Tristan's home in Brittany, where Kurvenal has taken him. He lies hovering in delirium between life and death, thinking only of Isolde and wondering why she does not come to him. In the background the shepherd who is watching for her pipes a mournful tune. Suddenly the tune becomes joyful, announcing Isolde's ship. Tristan struggles to rise, cannot, and dies in Isolde's arms as she reaches him. She falls upon him as Kurvenal sees a second ship bringing Brangaena, King Mark, and Sir Melot. Expecting them to attack, Kurvenal attempts to defend the castle and is killed.

But King Mark has come, not to avenge but to forgive Tristan and Isolde and to make it possible for them to be together always. Then, from the feet of the dead Tristan, Isolde rises and sings the magnificent *Liebsteod*. Her death at its end unites her with Tristan forever.

The *Liebsteod* has become one of the most beloved arias in all opera, possibly because it is one of Wagner's greatest achievements, but also because the singing of it requires an artist of great stature, usually guaranteeing a magnificent performance. Kirsten Flagstad has been the greatest Isolde of contemporary times, and LM 6700 brings her right into your living room.

Urania has also made a recording of *Tristan and Isolde*, URLP 202. The artists are Margarete Baumer, Ludwig Suthaus, Erna Westenberger, Gottlob Frick, Karl Wolfram, and Theodor Horand with the Chorus of Mitteldeutsche Rundfunk and the Gewandhaus Orchestra of Leipzig conducted by Franz Konwitschny.

# THE HI-FI CONCERT SOCIETY

PRESENTS the 7th MUSIC-at-HOME PROGRAM:

## An All-Stravinsky Program

Thursday, June 17, 1954

ANITA de MARS, Musical Director

TO BE HEARD AT HOME

1. **Stravinsky**—Fireworks—Stravinsky and the N. Y. Philharmonic Symphony Orchestra **Columbia ML 4398**
2. **Stravinsky**—Petrouchka—Ernest Ansermet and l'Orchestre de la Suisse Romande **London LL130**
3. **Stravinsky**—Concerto for Two Pianos—Vronsky and Babin **Columbia ML 4157**
4. **Stravinsky**—Octet for Wind Instruments—Leonard Bernstein and Boston Symphony **Victor LM 1078**

### INTRODUCTION

IGOR STRAVINSKY'S seventy-second birthday comes on June 17th, making it an appropriate date for a Hi-Fi Concert of his music. You either like Stravinsky, or you don't. There is no happy medium about it.

He patterned his early composition after the style of his teacher, Rimsky-Korsakoff, but as the great Diaghilev of the Ballet Russe became more and more an influence in his career, Stravinsky developed something all his own. His instrumentations are unique: female voices and three clarinets; solo and chorus voices with four pianos and seven percussion instruments. A combination of seven instruments — clarinet and bassoon, trumpet and trombone, violin and double bass (each pair representing the soprano and bass of its group) with assorted percussion instruments — provide an emphatic rhythm for his *l'Histoire du Soldat*.

This all-Stravinsky program begins with an early composition, *Fireworks*, written on the occasion of the wedding of Rimsky-Korsakoff's daughter on Stravinsky's 26th birthday, June 17, 1908.

### PROGRAM NOTES

1. At the wedding of Rimsky-Korsakoff's daughter to his pupil, Maximilian Steinberg, there was a spectacular and colorful fireworks display. For the occasion, Stravinsky wrote a fantasy for orchestra, *Fireworks*. He took a four-measure tune as a basis for this short and exhilarating piece in which, if your imagination is keen enough, you can hear and almost see the fireworks. Stravinsky himself conducts the N. Y. Philharmonic Symphony on this Columbia LP which also includes *Ode*, a chant in three parts for orchestra; *The Russian Maiden's Song* played by Szigeti; *Ebony Concerto* in which Stravinsky conducts Woody Herman's Orchestra; *Norwegian Moods* and *Circus Polka*, by the New York Philharmonic Symphony with Stravinsky conducting. A very entertaining LP to have among your records of modern music.

2. *Petrouchka* was the second ballet that Stravinsky wrote for Diaghilev. It is Stravinsky at his imaginative best as he portrays the puppet Petrouchka who suffers from unjust persecutions, and tries to make his life more palatable

by wooing the Ballerina. The Ballerina's lover kills him, and his ghost comes back to haunt those who have injured him. Another LP of Stravinsky conducting this work is Columbia's ML 4157.

3. Stravinsky is among those few composers who have written concertos without including an orchestra, and here is one for two pianos. Both pianos are of equal importance in this work, and it is difficult to determine which one has the melody at a given moment! This is especially so since the recording artists are Vronsky and Babin, who started out separately to study piano with Arthur Schnabel, met in his studio, married each other, and stepped into their concert careers together! Their collaboration with the composer's intention makes this *Concerto for Two Pianos* worth owning.

4. The instrumentation of the *Octet* is typical Stravinsky! You will hear a flute, a clarinet, first and second bassoon, first and second trumpet, and first and second trombone, with Leonard Bernstein conducting. The combination makes this LP intriguing.

# THE HI-FI CONCERT SOCIETY

PRESENTS the 8th MUSIC-at-HOME PROGRAM:

## A Real Jazz Session

Thursday, June 24, 1954

FRED REYNOLDS, Guest Director

TO BE HEARD AT HOME

- |   |   |
|---|---|
| 1. <b>Syncopated Chamber Music</b> , Vols. 1 and 2—Red Nichols & his Five Pennies<br><b>Audiophile AP-7 &amp; 8</b> | 5. <b>Hot Mallets</b> —Lionel Hampton and his orchestra<br><b>RCA Victor LP LJM1000</b>                                     |
| 2. <b>Barney Kessel</b><br><b>Contemporary LP C2508</b>   | 6. <b>Gallery of Irving Berlin Songs</b> —Dave Pell Octet<br><b>Trend LP TL 1003</b>  |
| 3. <b>Benny Goodman Plays Fletcher Henderson</b> —Benny Goodman and his Orchestra<br><b>Columbia LP GL524</b>       | 7. <b>Jam Session Coast-To-Coast</b> —Eddie Condon's All-Stars and the Rampart Street Paraders<br><b>Columbia LP CL 547</b> |
| 4. <b>Barbara Carroll Trio</b> —Barbara Carroll<br><b>RCA Victor LP LJM1001</b>                                     |   |

### INTRODUCTION

JAZZ is a wonderful word used to describe any kind of music where improvisation takes place. Today, that music can be hot or cool, it can be New Orleans style, Chicago style, modern, bop, or what have you, performed by a trio, a 14-piece band, or a singer, and it's all called jazz. To avoid those sometimes furious arguments as to whether this is right or wrong, let's say that jazz boils down to the age-old Fats Wallerism; A woman once asked the great one to define rhythm. Beaming up at her, Fats replied, "Lady, if you got to ask, then you ain't got it."

### PROGRAM NOTES

1. The jazz world has been basking in the refulgence of the "Red" Nichols cornet for 30 years. This solid, square-jawed little man with the look of a perennial college senior has pushed the valves down the way he liked and has blown the way he wanted all that time. The Pennies of today, like those of years previous, are a warm, friendly band that plays with polish, finesse, and taste. Audiophile is the finest hi-fi record I have ever heard. It's the production of E. D. Nunn, Saukville, Wisconsin. Distribution is purposely limited, so you may have to write direct to Mr. Nunn. In the Pennies, besides Nichols, are Joe Rushton, Matty Matlock, King Jackson, Nick Fatool, and Stan Wrightsman, and some of the songs are *Three*

*Blind Mice*, *Easter Parade*, *Candlelights*, *Tin Roof Blues*, and *Corky*.

2. Barney Kessel and his guitar are showcased in a galaxy of eight numbers, at least five of which are splendid. These are *Tenderly*, *Squeeze Me*, *I Let a Song Go Out of My Heart*, *Salute to Charlie Christian*, and *What Is There to Say?* Kessel is terrific, and at hi-fi his guitar is wired right to your speaker. The rhythm of drummer Shelly Manne, pianist Arnold Ross, and bassist Harry Babasin is precisely right, and sometimes very exciting. Bud Shank is masterful on both alto sax and flute.

3. Fletcher Henderson does the arrangements for the greatest swing band of all time. This is a collection of some of Benny Goodman's most popular releases of '39 and the early '40's, including *Stealin' Apples*, *Somebody Stole My Gal*, *Night and Day*, and *Just You, Just Me*. There are three new recordings made in '52 expressly for this album, all featuring the singing of Goodman's first and finest vocalist, Helen Ward. Reissues of of course, but excellent quality.

4. Here are April showers by a May flower named Barbara Carroll. Her work at the piano is as graceful as a gazelle, as mellow as a martini, and with just as much kick. Her style is strictly her own, blending a seeming endless variety of moods, a soaring brightness, a delicate lightness, and a

happy modernity that is at once both complex and rarely respectful of the melody. The songs are some of Miss Carroll's favorites.

5. This is a rare collection of records that Lionel Hampton cut with small, marvelous jazz bands from 1937-1939. Just to mention a few of the greats who are with Hamp: Cootie Williams, Ziggy Elman, J. C. Higginbotham, Johnny Hodges, Coleman Hawkins, Chu Berry, Buster Bailey, Jess Stacy, Charlie Christian, and Cozy Cole. Swing's the thing here, and the 12 re-issues, re-recorded at an astonishing level of quality, all swing splendidly.

6. The Dave Pell Octet is a streamlined offensive unit from the brilliant Les Brown band. For the record: eight unusual Irving Berlin tunes are played in modern jazz style that is both refined and elegant, to arrangements by Shorty Rogers and Wes Hensel. The work is thoroughly hi-fi.

7. Here is a most informal, happy, meeting of two groups of Dixieland-minded jazzmen, reproduced with top audio quality. From the East are Eddie Condon's All-Stars, and that means such torpedo merchants as Wild Bill Davison, Edmond Hall, Lou McGarity, and Peanuts Hucko. From the West come the Rampart Street Paraders, Eddie Miller, Matty Matlock, Abe Lincoln, and other playmates.





# Diamonds for Styli

by E. J. Marcus

*The diamond for your stylus was first dislodged from Mother Nature's care in a South African mine, such as the one shown here*

*Many people take it for granted that diamond styli are intended only for use by the superperfectionist fraternity. The diamond stylus costs less to use because it lasts so long*

QUITE NATURALLY, we associate music with relaxation. That calls for enjoying music under conditions which provide the maximum degree of comfort with the minimum amount of effort. In the case of recorded music, that explains why, after half a century, the phonograph disc has retained its popularity. It occupies very little space, stores easily, and most important of all, is easy to handle.

The only real disadvantage it had in the past was shortness of playing time, and the interruption of long classical selections. This shortcoming has, of course, been overcome by the long-playing record. Modern recording techniques employing master tape, hot-stylus cutting, variable pitch recording, and improved plastic materials now make it possible to capture the entire sound spectrum in correct balance, with the background noise reduced to the point of being almost inaudible.

And you will experience fine results provided you maintain your reproducing equipment in good condition. Of all the components of the phonograph playback system, the phonograph needle or, as it is more properly termed, the stylus, is most susceptible to wear and deterioration. This creates a problem because the tip of a stylus is so small that the degree of wear cannot be seen readily, even when it is sufficient to cause damage to the records.

## No Stylus is Permanent

Did anyone ever tell you that you had a "permanent" or "lifetime" stylus in your phonograph? Correction please! There is no such thing. The only stylus that approaches permanence is the diamond, and even diamonds will wear out in time. All must be changed eventually, but some last much longer than others. The diamond is the only stylus material which can be depended on to last beyond 24 hours of use. As a matter of fact a diamond stylus should last for about 1,000 hours of actual playing time. The significance of this fact is that after 24 hours use with a stylus tip other than a diamond, the finest hi-fi equipment will not deliver hi-fi performance.

## Stylus Tip Should Be Ball-Shaped

A record groove is a V shaped channel, spiraling inward on the disc, and is covered with myriads of side-to-side sound wiggles every inch of the way. And, by the way, it takes a lot of distance — nearly one mile of groove length — to cover one LP record!

Many people think that a phonograph stylus has a sharp point. Actually it is ball-shaped, as is shown in the accompanying drawing, and in the enlarged photograph



*Sorting the day's output of a diamond mine. Many of the tiny pieces, too small for use in jewelry, are ground for styli in the U. S. A.*

of a perfect diamond stylus. Contrary to the prevailing impression, the music is not recorded at the bottom of the groove, but only on the sides. There are some records still in use, principally for commercial purposes, that have the recording at the bottom of the groove. They are called *hill-and-dale* records. But all those now sold to the public are *lateral* records. Obviously, if the stylus is to move sidewise, it should not touch the bottom of the groove! If it does, the result from the loudspeaker is heavy needle scratch.

As long as the ball shape is maintained on the stylus tip everything goes along beautifully. But, the pressure on the tiny area of the stylus tip amounts to several tons per square inch. Pressure, friction from rapid movement, and the high temperatures generated tend to wear flats on the sides of the stylus. Eventually, then, instead of riding the sides of the groove walls where the music is recorded, the stylus sinks down into the bottom of the groove where there is plenty of annoying noise, but no music.

The flats worn on the stylus bridge across the waves of the groove, causing distortion. At the juncture of curved surface and the flats a sharp crescent or cutting edge develops which can cause severe damage to the groove. Since the tip of stylus is under continual attack by the forces of abrasion, while any one section of the moving groove is affected only momentarily, it is the stylus which wears out first,

not the record. But once the cutting edges become sharp and large, permanent groove damage is inevitable.

### Normal Useful Life of a Stylus

It is technically correct, therefore, to say that the performance of any record-playing equipment, whether it is a simple table-model phonograph or an elaborate installation, can be no better than the condition of the stylus. Not so many years ago, steel needles were used almost universally. It was then standard practice to put in a new needle after each playing of a 4-minute record. Later, the period of use was extended by the introduction of osmium and sapphire styli. They have not, however, met the requirements of LP records.

Various technical reports published in current books and magazines rate the sapphire type as having a useable life up to 75 plays on LP records. For LP records, most authorities do not recommend osmium styli.

This brings up a matter of economics to which each person must give careful consideration. The relatively high price of LP records makes it necessary to avoid damage resulting from the use of worn styli, whatever type is used.

The material of which a stylus is made has no effect on reproduction

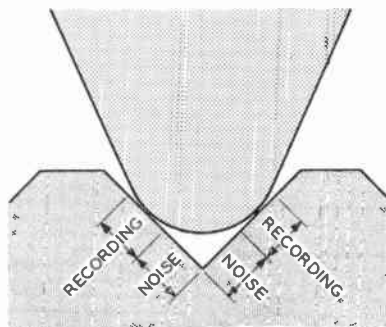

*See how the stylus is ground to ride on the sides of the groove where the music is recorded, and not on the bottom*

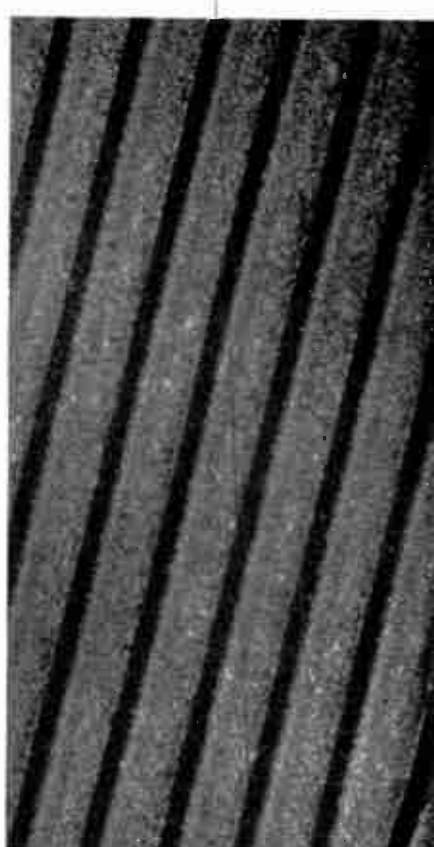
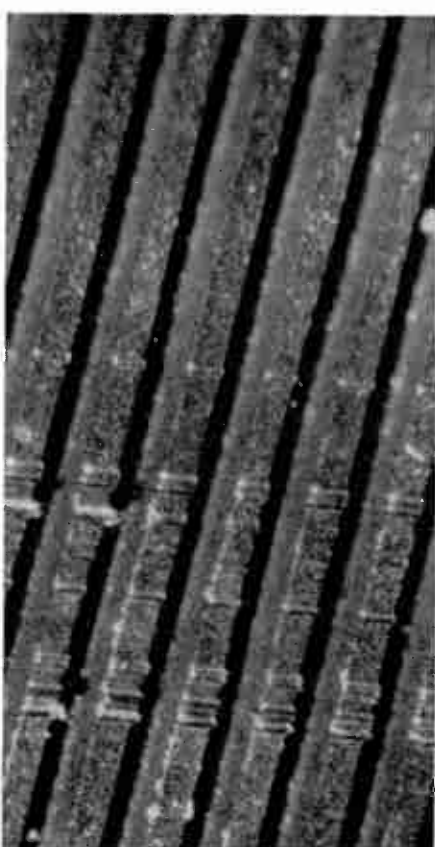
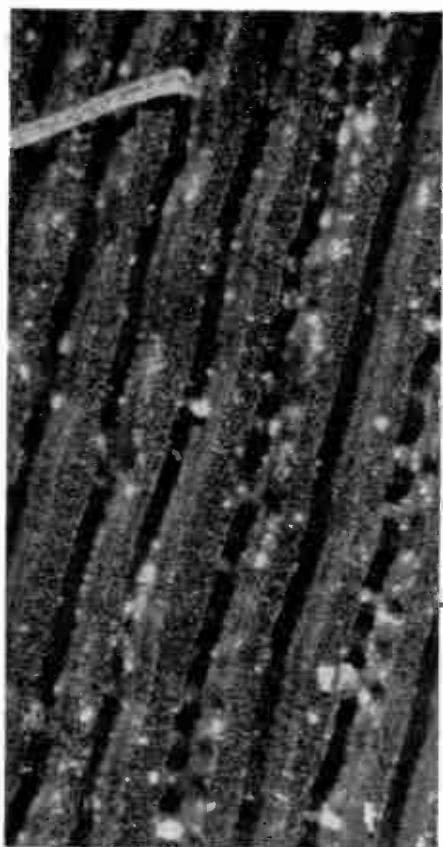

*Microphotos of grooves without modulation. Left to right: 1. Test record damaged by worn stylus. Note chips at top, and dust in grooves. 2. The scratches are not deep enough to reach sides of the grooves. 3. Test record was not recored by perfect stylus*

quality. The shape and polish of the point are the essential features. Consequently, there is no objection to using any kind of a properly made stylus *provided* you put in a new one before it wears down enough to damage your records and to affect the tone.

The objection lies in the cost and inconvenience of replacements necessary when short-lived styli are used. So the advantages of the diamond lie in dollars-and-cents economy, and the protection of records against damage which results from forgetting to keep track of the number of times a short-lived stylus has been used.

In that connection, it should be noted that, while a diamond stylus is subject to wear, it wears down so slowly that even when, upon inspection, there is evidence of slight wear, it will continue to give perfect service for many more hours of use, allowing ample time for getting a

replacement long before the diamond stylus can have any adverse effect on the records, or give any audible evidence of deterioration.

### Diamond Styli Use

The Muzak Corporation has accumulated data on diamond stylus life which is of interest. Muzak uses equipment for playback which one would rarely, if ever, find outside a professional studio: a massive pick-up weighing 150 grams, with the arm adjusted to 32.5 grams pickup weight. This compares with the 15 to 20 grams weight of tone arms ordinarily used in hi-fi installations, with 6 to 8 grams pickup weight. Stylus pressure and mass are definite factors, of course, in stylus and record wear. Here is some interesting data

*(Continued on page 59)*

*Microphotos of styli. Left to right: 1. Perfect diamond stylus. 2. A sapphire stylus starts to wear down quickly. 3. When a sapphire wears to this extent, it will destroy an LP in one playing. 4. Osmium wears so quickly it is not generally recommended for LP's*

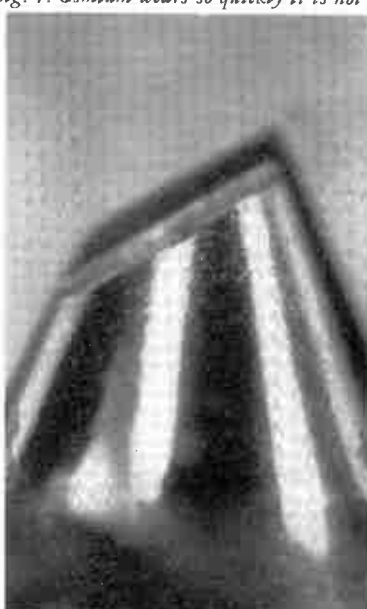
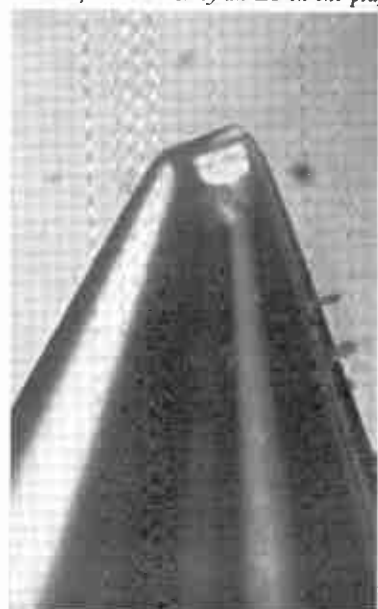
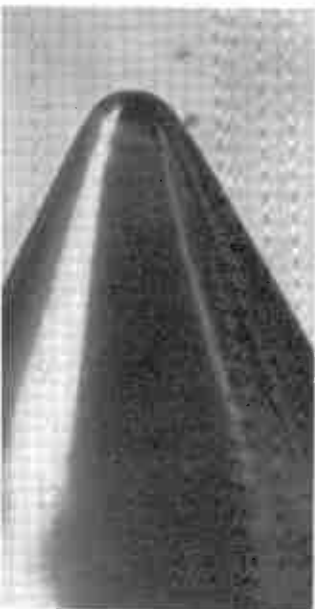



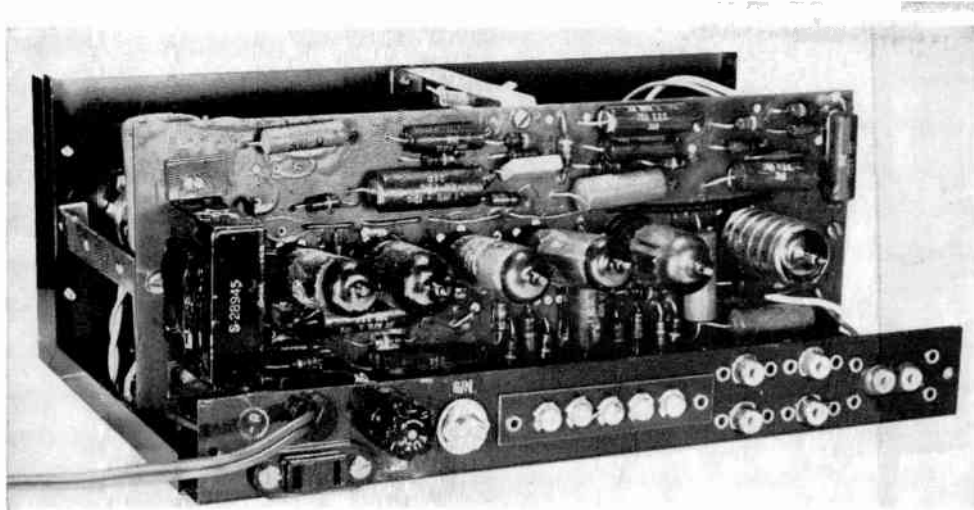

*The Brociner preamplifier and 12-watt amplifier, as seen from the rear with the cover removed. Practically all connections for this instrument are printed on the front side of the phenolic panel which carries the tubes. The terminal strip fits into an opening in the rear of the metal cover*

## *Preamplifier-Amplifier with Printed Circuits*

CONSIDERABLE interest attaches to the design of the Brociner preamplifier and 12-watt amplifier illustrated on this page because of its printed-circuit design and resulting construction.

Basically, printed circuits employ one of several methods to deposit copper or silver connections on an insulating panel, or to etch away the copper from a solid sheet, leaving only the connections required. Printed circuits were originally developed for military equipment, not to reduce manufacturing costs but to increase dependability of operation.

In practice, as experience has been gained with this method, it has won favor because it eliminates so many possibilities of errors in assembling, and poorly-soldered joints which may not show up in factory inspection tests,

but prove to be defective later, when the equipment is in use.

The illustrations at the foot of this page show one side of the main components panel which carries the printed copper circuits, and the reverse side with the components in place. Leads from the capacitors and resistors are run through holes and are then cut off so that they extend slightly on the other side. Socket terminals are so arranged that they are in direct mechanical contact with the copper plating. The photograph below shows how the copper runs up to the holes where the sockets are inserted.

When all the parts are in place on the panel and the leads cut off at the right length on the opposite side, the panel is held over a large, rectangular soldering pot, and lowered just to the surface of the molten solder. In this

*(Concluded on page 62)*

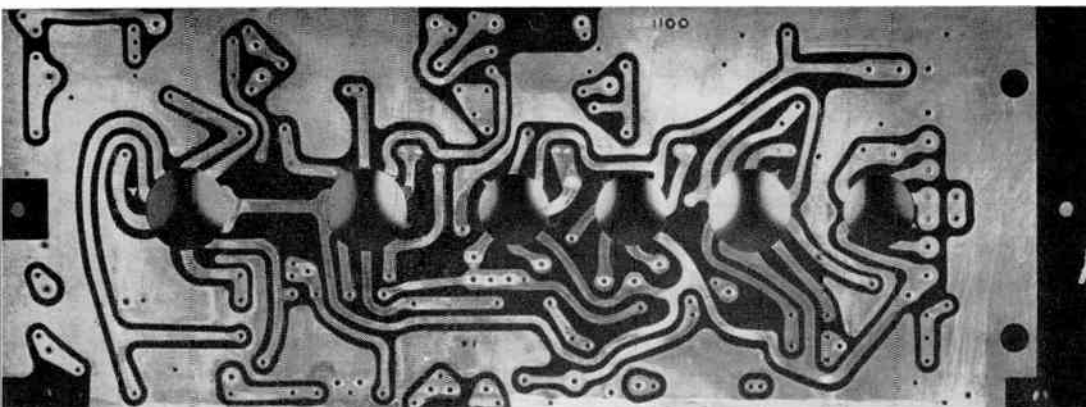

*Left: The insulating plate with the copper "printed" on it, and the eyelets inserted in holes where wires are to come through to be soldered later. As much copper as possible is left on the panel to serve as shielding. At this point, the panel is ready for mounting the components on the other side*

*Right: Rear of the panel, with all the components in place after the opposite side has been immersed in solder, thereby soldering all the leads which run through the panel, and the socket terminals at one time*

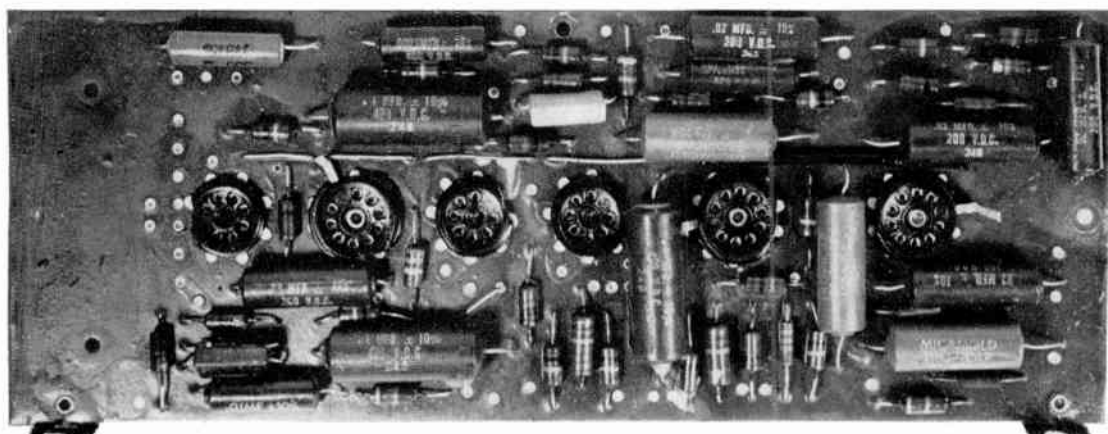

# IMPORTANCE of RECORDS

*Improved records and the growing demand for them are bringing about major changes in the musical world, and in the habits and attitudes of people who enjoy listening to music. Here are the reasons*

By DAVID HALL

UNTIL actual sound is produced, musical composition does not exist." In this aphorism coined by England's Ralph Vaughan Williams is set forth the essential, historical, and cultural justification for the existence of recorded music.

The notation from which an orchestra or a solo artist plays a symphony or concerto offers at best an *approximate* indication of the manner in which the composer thinks the music should be performed in order to produce the total complex of sound which he had in mind at the time of composition. Yet, without musicians to play from the notation which the composer has put down on his manuscript, the notation remains just that — lifeless symbols that have vitality only through actual performance by human beings.

## A New Tool for Composers

Unlike a printed book, the symbols of which can be transformed into living experience through the mind and heart of any literate individual, musical notation is not susceptible of being transformed into mental sound images in the same fashion. True, there are some few exceptionally skilled musicians who can peruse a symphonic score and derive from it both intellectual and emotional impact; but it is reasonable to assume that even this experience is not fully comparable to an actual hearing of the symphony in performance.

The fact remains that creative art, whether in the form of music, literature, painting or sculpture, is in essence a form of communication between the creative artist and those who experience his artwork. This communication may take place on the broadest level, as in the *Ode to Joy* finale of Beethoven's Ninth Symphony or the impressive historical-social frescos by the 20th century Mexican muralists, Orozco and Rivera. Or this communication may exist only on a quite erudite and sophisticated level, as in T. S. Eliot's poetic sequence *Four Quartets*, or *The Musical Offering* of J. S. Bach.

Beyond these boundaries of the broadly popular, on the one hand, and the narrowly esoteric on the other, there are the treacherous areas wherein the would-be creative artist finds himself dealing in public-square propaganda or in materials that possess emotional and intellectual validity only for the small circle of his own colleagues.

The creative artist, be he composer,

painter, sculptor, or writer, works in terms of human experience — experience which more often than not is closely related to human aspiration or frustration, as well as to the peculiar experiences of identification or of fear that we human beings feel in the presence of nature. In music alone, a host of celebrated works built around these basic themes can be called to mind — Beethoven's *Eroica Symphony*, Tchaikovsky's *Parbétique*, Debussy's *La Mer*, and *Tapiola* by Sibelius.

Music, among all the arts, is most particularly an affair of the emotions in its expressive aspects — if only because the rise and fall of melody, as well as the throb of its rhythms are so closely related to those of the human body itself. It would be an unperceptive listener indeed who could not one day sense in certain of the more intensely lyric episodes of the Brahms symphonies a rhythmic undercurrent which parallels almost exactly the beating of the human heart.

Yet, this same art of music demands of one who would exploit its medium for artistic creation the most exacting intellectual discipline and craftsmanship. Of all workers in art, it is only the composer who can almost never work directly in his medium for the immediate and permanent experience of the art lover. The painter works directly on canvas, the writer on paper, the sculptor employs stone, wood, or plaster. The composer, however, must laboriously jot down intrinsically meaningless symbols on staved musical manuscript paper. If it is a keyboard work, then he can play it back to himself or have a pianist friend do it for him; but if it is a chamber or orchestral work, then separate performing parts must be extracted from the original score, and only after considerable rehearsal by a group of musicians or a whole symphony orchestra is it possible for the composer (or the public, for that matter) to experience in sound an approximation of his original, creative concept.

Thanks to the perfection of the magnetic tape recorder in our own day, a composer who is also proficient at some solo instrument can now work to a limited degree directly in sound — *i.e.*, to record his improvisations directly on tape. Presumably it would even be possible for the composer to improve and polish his original conception through the use of tape editing technique, and then commit the finished product to notation on manuscript paper

for subsequent publication in printed form. Also, the edited tape could be processed to a phonograph disc, and the new composition made available to the public as *originally conceived at the time of its composition!*

## Importance of the Phonograph

In order to flourish, music and the other arts must have a receptive audience eager to experience both the permanent masterpieces that form the basis of its past, as well as the newly-created works that will carry its main stream toward the future.

As of 1954, the growth of the musical literature on long playing records, together with the enormous advances in musical recording techniques and the general economic availability of good-quality reproducing machines for home use — these have brought about a set of conditions which could make the phonograph record the *most powerful stimulus ever known toward the growth of music as an art*, both in terms of a large and enthusiastically receptive audience, and in terms of composers able and willing to fulfill the demands of that audience for new musical creations. While the achievement of this near-utopian state of affairs may take a generation or more, the fact still remains that the conditions now exist which bring such an achievement within the realm of possibility.

The development of the long-playing microgroove record and its large-scale introduction to the public in late 1948 went hand-in-hand with the perfection of magnetic tape as a medium for the making of master recordings. The result has been not only to make available relatively uninterrupted recorded performances of symphonies and other large musical works on unbreakable and relatively noise-free discs, but also to bring the purchase price of a recorded symphony into line with that of a fine book.

Likewise, the use of magnetic tape for master recording to be processed to long-playing discs has both created the demand for and made feasible the recording of operas and other extended musical works on a scale never before possible with the 78-rpm, 4-minute discs that were standard for phonograph recordings from the turn of the century.

The first five years of the long playing record has witnessed an expansion of the disc repertoire of concert music unparalleled in history. Most of the standard symphonic, chamber, keyboard, and vocal

repertoire has been covered several times over; but far more important has been the incredible expansion into areas of pre-classic and contemporary music virtually unknown to even sophisticated music lovers. With nearly 200 record companies active in the field instead of the former dozen-odd, we find the scores of such half-forgotten 19th century composers as Spöhr and Conradin Kreutzer being ransacked in the hope that there will be something novel and interesting to offer a concert record buying public now grown numerically to proportions far exceeding that of the attendance at live concerts.

Today, American listeners who do not or cannot go to public concerts and recitals are hearing important music of the past and present, to say nothing of brilliantly gifted performing artists, through long-playing records. Vivaldi's oratorio *Juditha Triumphans* (Period 533), most of the middle-period symphonies of Haydn (Haydn Society), Alban Berg's last opera *Lulu* (Columbia SL121) comprise a few of the striking instances of major repertoire new to American listeners, while pianist Paul Badura-Skoda, conductor Ferenc Fricsay, and 'cellist Janos Starker are only a few of the major younger talents whose attainments have been introduced to these shores via recordings.

Now a turning point has come wherein the success of a live concert performance has become of less relative significance in determining whether a particular composition or artist shall be recorded; while the notably successful introduction of a previously unheard musical work or performer via phonograph records *now creates a potent demand for hearing that work or performer in person.*

While it is perfectly true that the vast majority of concert records presently purchased in America comprise the tried and true masterpieces of the 18th & 19th centuries, played by artists of international renown, it is also true that the lesser-known artists of unusual gifts are gaining ground on their famous colleagues with fantastic rapidity; and the same thing is happening at a somewhat slower pace with the less familiar musical repertoire ranging from the liturgical music of the 12th century to the chamber, operatic, and orchestral works of our own day.

Less than 200 years ago, music lovers stood very little chance of hearing the masterpieces of an earlier period. More likely than not they would be listening to the latest concerto by Bach, Telemann, Mozart, or Haydn. Quite possibly the music would have been written especially for the occasion.

Within the last century, which has seen the establishment of the public concert as an entrenched institution, and the rise of the instrumental or vocal artist as a virtuoso entertainer, the concert hall and the opera house have become museums where exhibits are more or less restricted to a selected series of fifty standard master-

pieces from the 18th, 19th and early 20th centuries. The same observation holds true for live musical performance over the major radio and television networks. The effect on audiences, performers, and composers of this state of affairs has been far from healthy. Listeners have become lazy-minded; performers have become bored, corrupted in their artistry, or both; composers have lacked real incentive for significant creation, since there was such small hope of substantial public demand for their work, let alone economic compensation.

What has been happening in the realm of recorded music, however, truly presages a revolution in the making. A new audience is being created, unprecedentedly vast in numbers and with new listening habits. These people are eager to hear and to decide for themselves what music and which performing artists they want to hear in their homes and, subsequently, at public performances. Herein lies the long-term significance of recorded music in its present stage of development. The world literature of art-music from its very beginnings through our own day and on into the indefinite future is no longer to be in bondage to written or printed notation, decipherable only by professional musicians or musicologists. For all who have ears to hear, this vast heritage has now been and will continue to be endowed with a powerful existence of its own as living sound on records.

### The Exploration of Music

Given reasonably adequate listening facilities, the discovery and exploration of the musical literature through recordings can be a wonderfully gratifying and stimulating experience for novice and trained musician alike.

The growth of this literature in the form of LP discs has been such as to make full and complete discovery and exploration entirely possible; for though there still remain a few major gaps, there is no doubt that these will be filled quickly enough.

The problem facing any music lover seriously interested in building a record library resolves itself to *how fast and how far*. The *how fast* is determined to a large extent by his budget limitations, unless he has access to the facilities of a record lending library. The *how far* depends to a large degree on his musical background and taste, his incentives, and his intellectual capacity.

Certain peculiarities inherent in the experience of listening to music on records should be carefully borne in mind by anyone attempting to build a library for his home on any kind of planned basis. A concert-hall listening experience is a vivid but evanescent affair that carries with it visual as well as auditory impact, to say nothing of the entire complex of psychological rapport that comes of joy shared

with one's fellow human beings, and the aura of intense communication between the concert artist and his audience under conditions of inspired performance. A recording, unlike a live concert or a radio broadcast, has something in common with a book, painting, a fine piece of ceramic art or sculpture: it is something to be *lived with* and to be experienced time and again in the many varied aspects that it may assume upon each successive hearing. Like a painting or a book, a recording may function as delightful entertainment after the fashion of topnotch jazz, musical comedy, colorful modern ballet, or a Mozart divertimento; or it may serve as an intense reminder of the most profound human values, being perhaps the *St. Matthew Passion* of Bach, the *Eroica* Symphony of Beethoven, or the *Fantasia on a Theme of Thomas Tallis* by Ralph Vaughan Williams.

Human values being what they are, it is only natural that the entertainment aspect of recorded music should occupy a more important place in the home than the more serious side. On the other hand, the greater masterpieces of music by such composers as Palestrina, Bach, Beethoven, Brahms, Tchaikovsky, or Vaughan Williams *are not to be trifled with for purposes of casual listening*. The most important and serious works of these and other masters demand undivided attention; and the occasions for hearing them, particularly in the home, should be reserved for such times as they can be given the attention and response which they so truly deserve.

It is significant that most of the really outstanding musical creators — Josquin des Près, Lassus, Monteverdi, Bach, Handel, Mozart, Haydn, Beethoven, Schubert, Brahms, Debussy, Ravel, Bartók, Sibelius, and Prokofieff — were able to turn out masterpieces in the lighter vein as well as in the grand and serious manner. Nor is mere bigness of form or numbers of executants demanded any indication of the intrinsic merit of a musical work. The best of Schubert's small piano pieces and songs far surpass the impact and perfection of all but a few of his very last piano sonatas, string quartets, and symphonies. Instances of this kind can be multiplied throughout the length and breadth of the musical literature.

This brings us to another major aspect of music as it is heard on records, namely, the limited lasting qualities of all but *the very finest music properly performed and reproduced*. The fact that a recording may be listened to repeatedly at will and *as sheer aural experience without visual distraction* places in effect an added burden of responsibility on the music itself, as well as on the performing artist, the recording engineers, and the reproducing equipment.

---

NOTE: The second and concluding part of Mr. Hall's discussion of recorded music, dealing with various aspects of selecting records, will appear in the July-August issue.

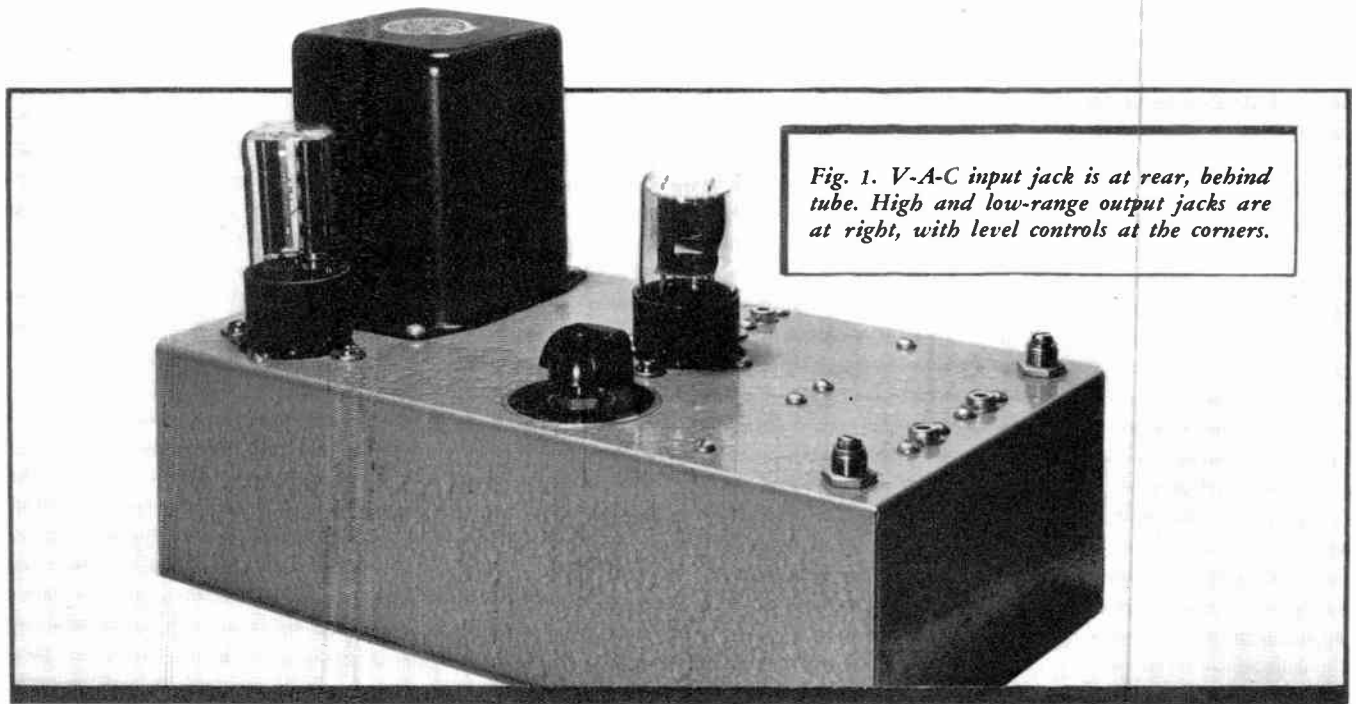

# AN ADJUSTABLE NETWORK

By WALTER JONES

**Q**UITE LOGICALLY, the audio perfectionist inquires: "How can I be sure that the crossover frequency, or frequencies, that I select for my speaker system will be the best for my speakers, the enclosures I use, the room where I install them, and the particular locations where I put them?"

Anyone who has had experience with different types of systems installed under widely varying conditions of room size and shape, furnishings, wall and ceiling materials, and floor coverings knows that the selection of specific crossover frequencies cannot be related to those factors with any degree of certainty. No one can claim that his decision is more than a well-informed guess.

Sound waves do very strange things, some of the strangest of which result from the fact that they do not do the same things at different frequencies. Or perhaps it would be more accurate to say that the effects of a given set of conditions changes with the frequency of the sound waves.

You can actually see this for yourself if you have a General Radio type 1555-A sound-survey meter. It is a pocket-size instrument, with self-contained batteries, a microphone to pick up the sound, and a meter to

show what the microphone hears. Some very interesting experiments can be made, for example, by playing a frequency test record, picking it up with the sound survey meter in different parts of the room, and then going through the same routine after the position of the upper-range or mid-range speaker has been changed slightly.

This is a striking way to demonstrate the fact that the whole room is actually a part of the speaker system. A simple test can be made by clapping your hands, and listening for echoes. You may find that, from one position, the room is very dead, and from another surprisingly live. Usually, the dead spot is the best location for a speaker, since the creation of echoes produces undesired effects if they return in the direction of the speaker.

All this adds up to the fact that optimum crossover frequencies can be determined only by experiment, after the speaker system is installed. Even then, it may be found that results can be improved by moving the mid-range speaker and tweeter to another part of the room, and changing one or both of the crossover frequencies.

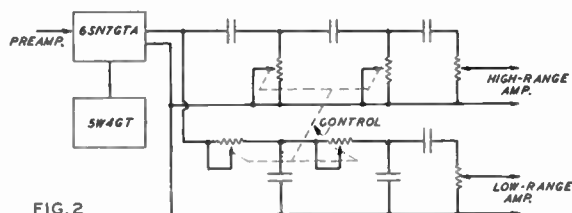

FIG. 2

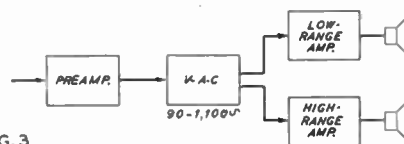

FIG. 3

Fig. 2. Variable Audio Crossover control uses 4 variable resistors for shifting the crossover to any point from 90 to 1,100 or 600 to 8,000 cycles. Fig. 3. V-A-C outputs feed high and low frequencies to separate amplifiers and speakers

## The V-A-C Control

Fixed networks are so expensive that it is hardly practical



to assemble a series that can be switched in one at a time, until the best crossover frequency has been found. It is cheaper, and much more satisfactory, if you have an extra amplifier available, to build a variable audio crossover control.

The idea of using a control of this sort was translated into practical circuitry for the General Apparatus Company by Roy Allison. The unit, shown in Fig. 1, was given the name of V-A-C or Variable Audio Crossover control. Although the control was planned originally for use in Air-Coupler installations, it can be used to improve the performance of any speaker system, whatever types of speakers and enclosures are used.

The V-A-C is a resistance-capacitance type of filter, as indicated in Fig. 2, in which four variable resistors, ganged on a single shaft, vary the crossover point continuously over a substantial range. It has the advantage of operating at a very low power level, since it is connected after the preamplifier. This is shown in Fig. 3. Therefore, the low-range and high-range outputs must be connected to separate amplifiers which, in turn, drive the low and high-range speakers.

Figs. 4 and 5 show the V-A-C in assembled form. The knob on the top of the chassis controls the crossover fre-

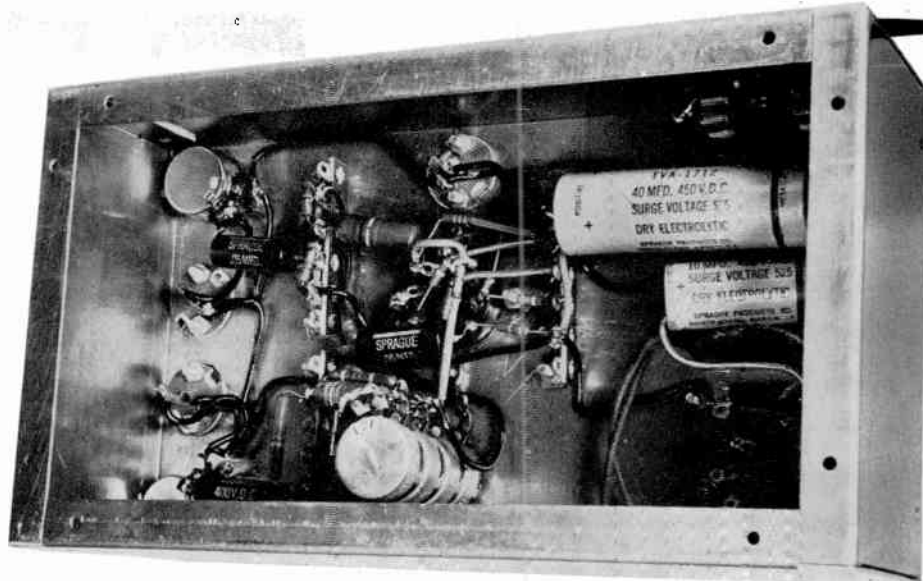

Fig. 4. Under side of V-A-C unit, showing output jacks and level controls at left

quency. A calibration curve is supplied with each kit of V-A-C parts. Typical settings for the control are:

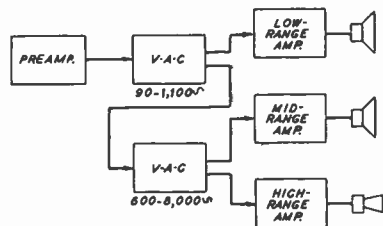

FIG. 6

Fig. 6. This system uses low and high-range V-A-C's to provide crossover adjustments between woofer and mid-range speaker, and between mid-range speaker and tweeter

quency. A calibration curve is supplied with each kit of V-A-C parts. Typical settings for the control are:

DIAL SETTING	CROSSOVER FREQUENCY
0	90 Cycles
27	100
43	125
55	150
62	175
70	200
84	300
92	400
96	500
104	1,000

There is also a high-range unit intended as the second network in a three-speaker system, Fig. 6, which provides adjustment from 800 to 6,000 cycles.

### Advantages of the V-A-C

No loss is introduced in the low-power output circuit from the preamplifier. Instead, the V-A-C delivers a voltage gain of about 6 times. This

means a corresponding reduction of the gain required from the amplifiers for a given audio output, and the use of a lower output per amplifier.

When a single amplifier is used, there is, necessarily, a certain loss introduced by the fixed network. That loss must be overcome by increasing the output of the amplifier which, in turn, means somewhat higher distortion. Using the V-A-C Control, the amplifiers can be operated at reduced output since they work directly into the speakers and do not have to make up for the loss due to fixed network circuits.

Of course, intermodulation distortion is reduced by the use of the V-A-C, since each amplifier is fed only a part of the audio frequency band. This is in contrast to systems using fixed networks, in which one amplifier must handle all frequencies, for the separation occurs after final amplification.

Fig. 2 shows a potentiometer across each output circuit of the V-A-C. These adjustments serve two purposes. First, they are a means of achieving a proper balance of gain in the preamplifier, V-A-C, and the power amplifiers, so that each stage will be operating conservatively. Second, they can be used to adjust the individual speakers for overall system balance.

Fig. 5. Wiring of the V-A-C is simple and direct, requiring not more than 2 hours time. Note arrangement of the four stacked variable resistors of the crossover control

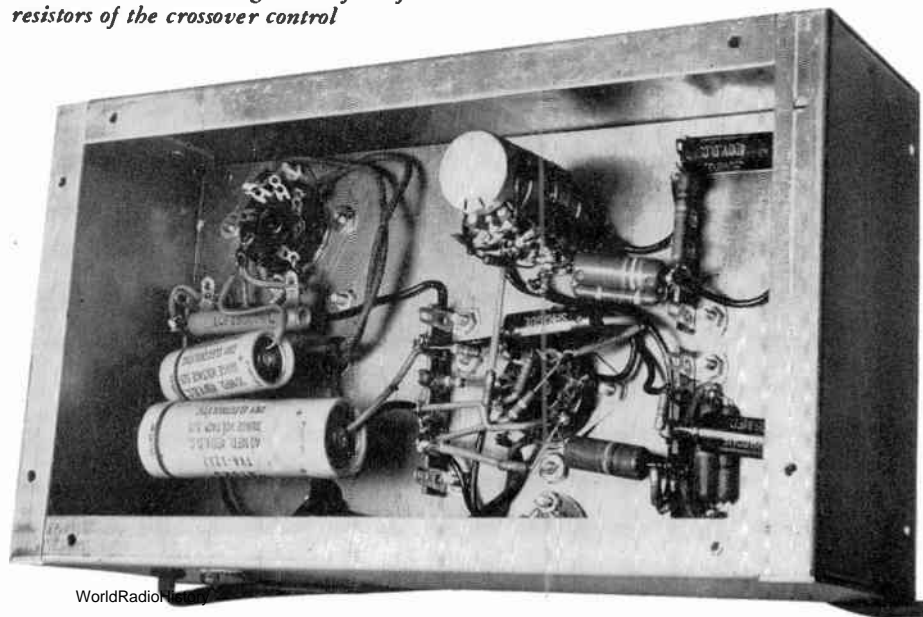

## Installing V-A-C Controls

It is a simple matter to install one or two V-A-C Controls in a new system, or to substitute them for fixed networks in an existing installation. The V-A-C has a high-impedance input (470,000 ohms) so that it can be used with any standard preamplifier. Each of the two V-A-C outputs is of high impedance also, suitable to feed any of the standard power amplifiers. Putting the V-A-C after the preamplifier does not affect the operation of the latter in any way.

There are three ways in which the V-A-C can be used. You may start with the first, and wind up with the third:

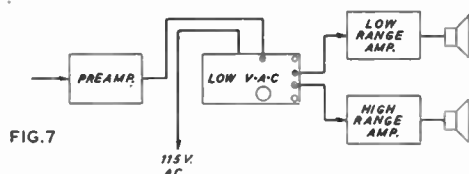

FIG. 7

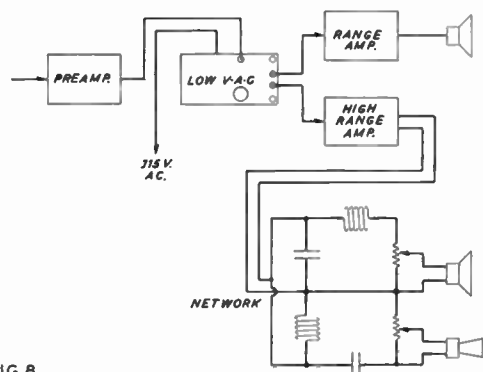

FIG. 8

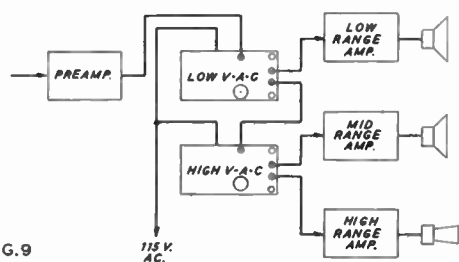

FIG. 9

*Figs. 7, 8, 9. Methods of using V-A-C controls in systems employing two or three amplifiers and speakers*

1. The simplest system is comprised of a bass speaker, a coaxial speaker for the middle and high ranges, a low-range V-A-C Control by which the crossover can be adjusted from 90 to 1,100 cycles, and two amplifiers. One amplifier, for the bass speaker, should be of 15 or 20 to 50 watts output, and the other of 10 to 20 watts.

2. In the system just described, the coaxial speaker can be replaced with a mid-range speaker and a tweeter merely by adding a fixed network.

3. If you are a super-critical listener, you will eventually want a bass speaker, mid-range speaker, and a tweeter, with a low-range V-A-C adjustable from 90 to 1,100 cycles, and a high-range V-A-C, adjustable from 800 to 6,000 cycles. In addition to the two amplifiers listed above, you will need one more for the tweeter.

You can take your choice from these three combinations according to your own requirements, and the amount you want to invest in your installation. The shift from a fixed network to the V-A-C is highly recommended. It is amazing to hear what a difference it makes when you vary the crossover point, and get it exactly where it should be for your installation and the acoustics of your living room.

## Connections and Location

If you have one of the standard preamplifiers, the V-A-C can be located at any reasonable distance from the preamplifier. However, the leads from the V-A-C to the power amplifier should not be more than 10 ft. long.

The pin jacks provided for making input and output connections to the V-A-C can be seen in Fig. 1. Use shielded wire for the three leads, soldering the wire to the center pin on the plug, and the shield to the outside sleeve. Be sure to solder these joints, and do the job very carefully. Don't rely on temporary connections, because they are sure to become intermittent or entirely open.

**No. 1 V-A-C SYSTEM:** Fig. 7 shows the complete circuit for a two-speaker system. The wiring is so simple that it can be finished in a matter of minutes, after the units have been put in place. It is not necessary to use amplifiers of any particular power output ratings, but if they are different in power and quality, the better one should be used to drive the bass speaker. Output power is less important in this system because the total load of the speakers is divided between two amplifiers.

**No. 2 V-A-C SYSTEM:** If you want to use a mid-range speaker and tweeter, and you haven't a third amplifier, you may want to use a fixed network as shown in Fig. 8. A cross-over frequency of 2,200 or 4,400 should be used to divide the mid-range speaker and tweeter.

Putting cost against performance, this is an excellent system. The V-A-C provides a variable crossover between the low and mid-range speakers where it is important to have such an adjustment. The fixed network is used where the crossover frequency is less critical. However, the volume levels of the mid-range speaker and tweeter can be adjusted individually. That offers a distinct advantage over the coaxial speaker employed in the No. 1 system, in that it is possible to balance the total system precisely.

**No. 3 V-A-C SYSTEM:** When you have become acquainted with the improvement in reproduction that one V-A-C affords, you will probably want to go all the way, and use two of these controls with three amplifiers. The circuit is given in Fig. 9. There are no complications involved in making an installation of this sort, beyond the care required in making connections between the shielded cable and the pin plugs. If there is noticeable hum from any speaker, it can probably be eliminated by moving or separating the shielded wires, or by a slight change in the grouping of the amplifiers. If the amplifiers are high-quality types, however, it should be possible to put them together as a single unit.

The complete flexibility of this system is indicated by the fact that the crossover between the low and mid-range speakers can be varied continuously (*Continued on page 61*)



*Putting a hi-fi system, except for the speaker, in this chest required no change in its outward appearance*

## HI-FI *without* DISORDER

*Is it possible to install an audio system in your home without altering the plan of furnishings and decorations? Here is an emphatically affirmative answer from an artist-designer who is also a hi-fi music enthusiast*

By **WALTER F. BUEHR**

PERHAPS pictures of hi-fi home installations make you think: "I wish we could have a really fine system at our house. I'm afraid there is no way to arrange the equipment, though, without completely disrupting the arrangement of our furniture, and our plan of decoration. I guess we'll have to wait until we build a new house, so we can plan for hi-fi right from the start."

If your thinking runs along that line, some simple suggestions may help you. First, and most important of all: Forget about the installations that other people have made in homes totally different from yours. Your tastes, your furniture, and your decorations

are totally unlike anyone else's. That is why installations in other people's homes won't do at all in yours.

However, you will find it surprisingly easy to work out a suitable plan once you confine your thinking to the arrangement, furnishings, and decorations that are available to you in *your* home.

Because no two rooms are alike, it is not possible to make generalizations that can be adapted to all conditions. Nevertheless, the accompanying illustrations show, in a practical way, that it is possible to install hi-fi equipment in any room without making more than minor changes.

For example, the illustration on page 37 was drawn from the cover of *House Beautiful* for February, 1954. The only modification is the top of the chest, which is hinged to give access to a record changer, and a preamplifier and tuner mounted with their panels horizontal. It would also be necessary to cut openings through to the closet space for the preamplifier and tuner chassis. There is room below for the amplifier. Except for the hinged top, there is no change in the appearance of the original picture!

The drawing on this page was made from a photograph published in the March, 1954 issue of *Living for Young*

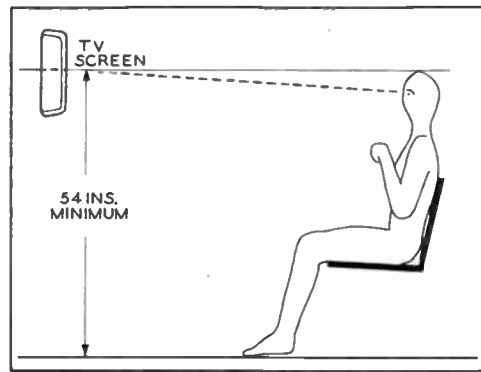

*Minimum height of TV tube for viewing comfort*

*Homemakers*, showing a storage wall used as a room-divider. A rearrangement of the original design provides for a large record storage cabinet, phonograph, combination preamplifier and amplifier, speaker cabinet, TV set, FM tuner, and a tape recorder!

Incidentally, if you are going to include a TV set in your installation, note the essential dimension of height from the floor to the TV tube, given in the small sketch. When you look at movies in a

theatre or television at home, you should be able to lean back in your chairs with your chin up, not on your chest.

The original of the living room picture on page 39 also appeared in the March, 1954 issue of *Living for Young Homemakers*. Only the bookcase and cupboards were changed. Two top shelves were closed to take the loudspeaker. Then the shelves were modified for the tuner, amplifier, and record storage. The drawer at the center is deep enough to accommodate a turntable. These slight modifications have in no way disturbed the traditional decor of the room!

Perhaps you would like to have music outdoors this summer, but you don't want to move equipment you have

*Concluded on page 62*

*This storage wall or room-divider houses a complete audio installation and provides record storage, with other space accessible from opposite side*

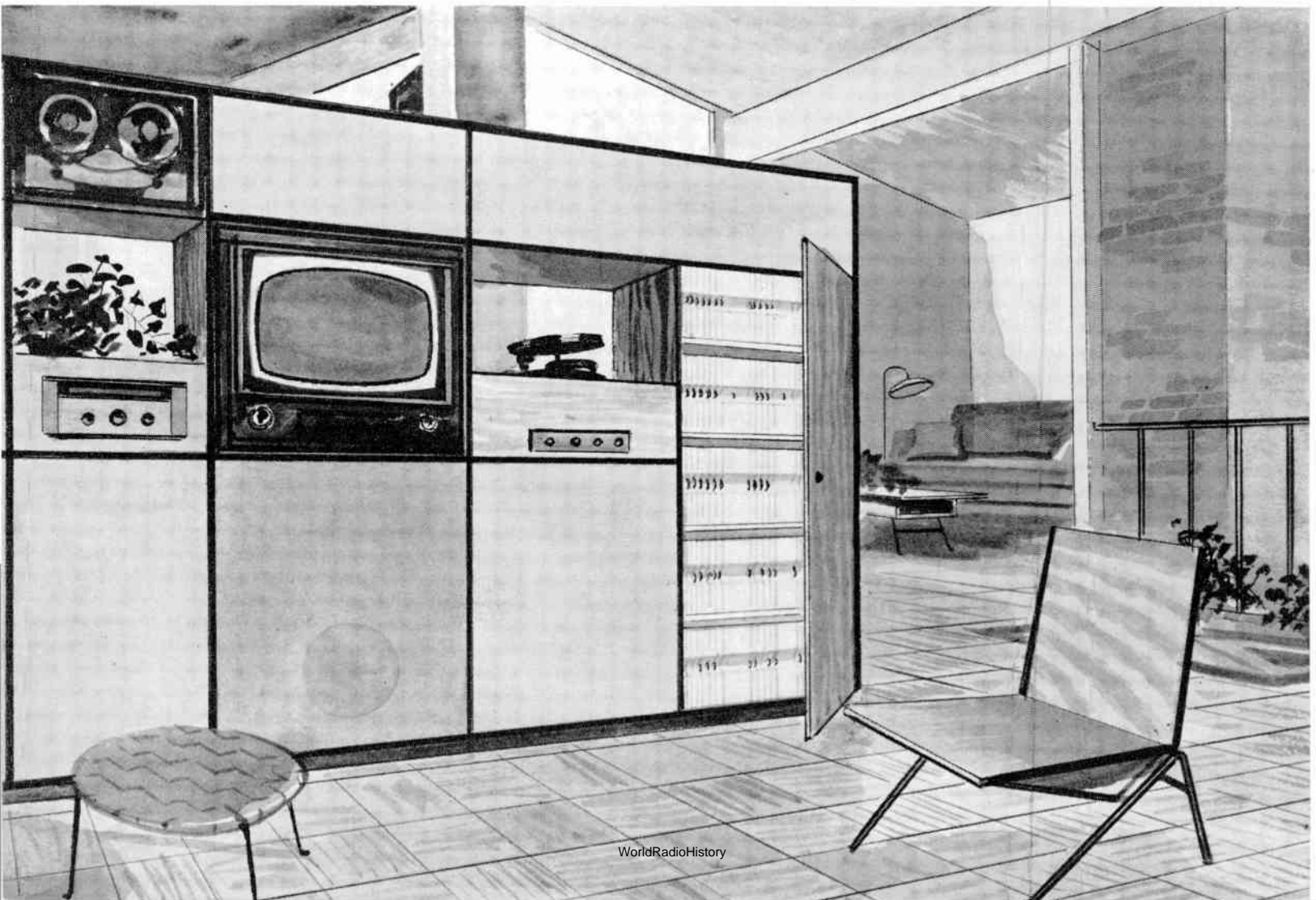



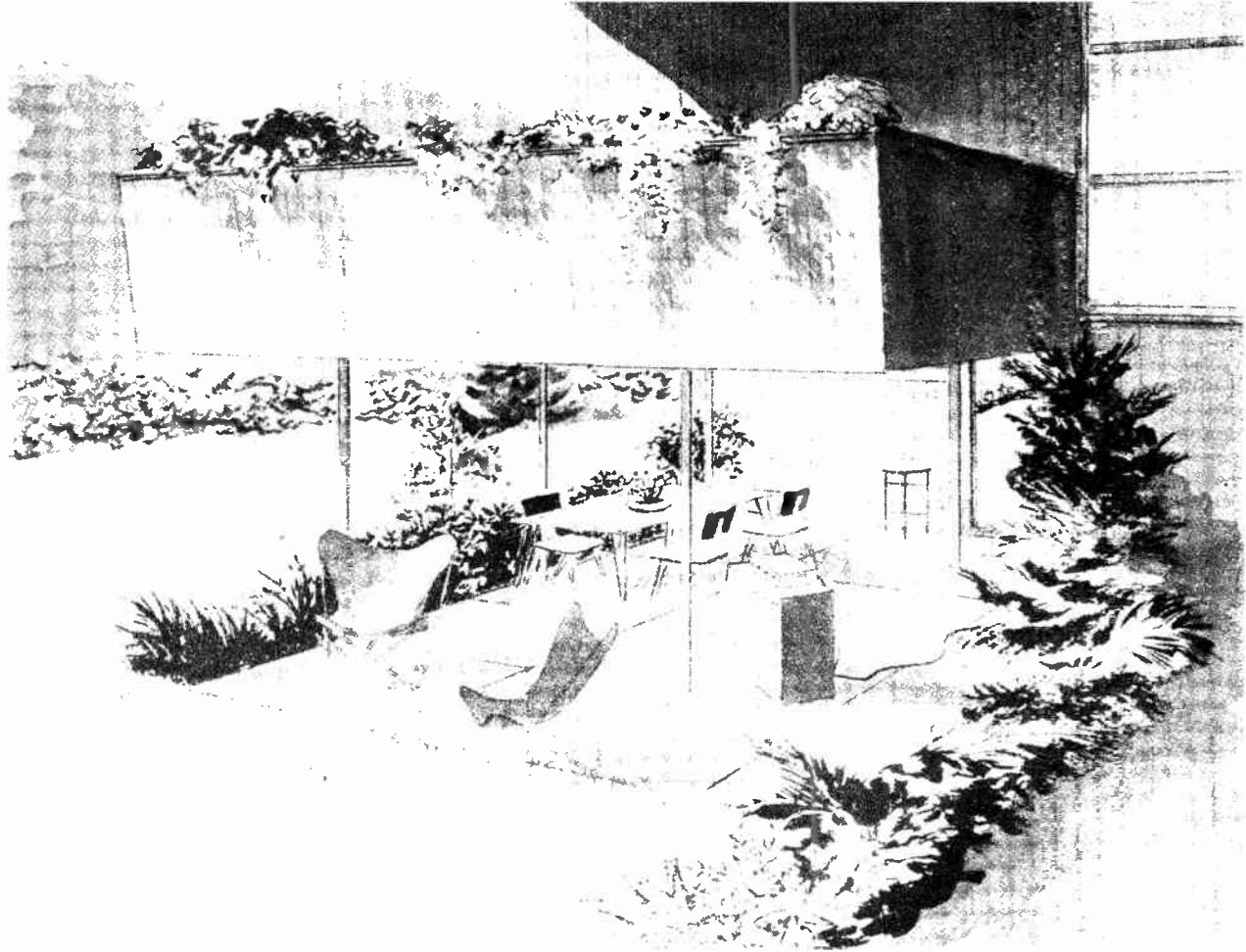

It is easy to provide most outdoors for living. During a plain Christmas without the expense your apartment makes just use a few trees and plants to create a complete and speaks in your house in pairs. Then you can be your records and change in the house when they are set.

The one special thing made in the traditional decorative scheme of this room was to enclose the two upper shelves for mounting the loudspeakers.

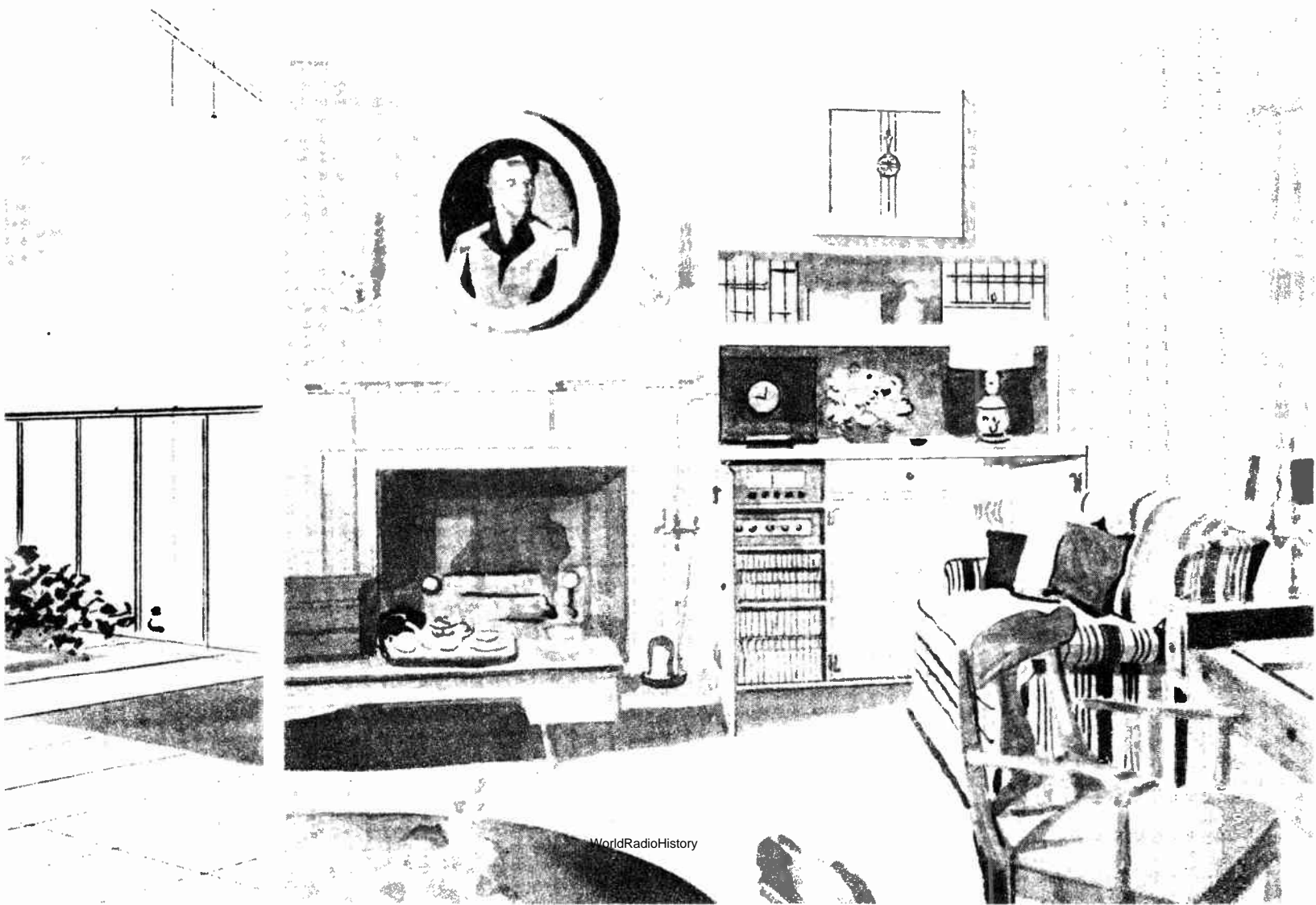

# YOUR L-P RECORD SHOPPING GUIDE

The bimonthly list of new L-P releases, divided under nine classification headings. An asterisk indicates a premier recording

## ORCHESTRAL MUSIC

- Alfven:** Midsummer Vigil—Swedish Rhapsody; Covent Garden Royal Opera Orchestra under John Hollingworth **12" MGM E3082**
- \***Amirov:** Caucasian Dances; Leipzig Radio Symphony Orchestra under Hermann Abendroth **12" Urania 7117**
- \***Arensky:** Silhouettes, Op. 23; Berlin Radio Symphony Orchestra under Felix Lederer **12" Urania 7117**  
Variations on a Theme by Tchaikovsky, Op. 35a; Leipzig Radio Symphony Orchestra under Gerhard Pfluger **12" Urania 7117**
- Bach:** Suite No. 1 in C Major; Radio Berlin Chamber Orchestra under Herbert Haarth **12" Urania 7-33**  
Suite No. 2 in B Minor; Suite No. 3 in D Major; Stuttgart Chamber Orchestra under Karl Munchinger **12" London LL848**
- Barbar:** Adagio for Strings; Concert Arts Orchestra under Vladimir Golschmann **12" Capitol P 8245**
- Box:** Coronation March 1953; London Symphony Orchestra under Sir Malcolm Sargent **10" London LD9046**
- Beethoven:** Symphony No. 1 in C Major, Op. 21; Symphony No. 5 in C Minor, Op. 67; N. Y. Philharmonic-Symphony Orchestra under Bruno Walter **12" Columbia ML4790**  
Symphony No. 5 in C Minor, Op. 67 Amsterdam Concertgebouw Orchestra under Erich Kleiber **12" London LL912**  
Symphony No. 6 in F Major, Op. 68; ("Pastoral"); Vienna Philharmonic Orchestra under Wilhelm Furtwängler **12" His Master's Voice LHMV1066**  
Amsterdam Concertgebouw Orchestra under Erich Kleiber **12" London LL916**  
Symphony No. 6 in F Major, Op. 68 ("Pastoral"); Royal Philharmonic Orchestra under Sir Thomas Beecham **12" Columbia ML4828**  
"Jena" Symphony in C Major; Leipzig Radio Symphony Orchestra under Rolf Kleinert **12" Urania 7114**
- Berlioz:** Symphonie Fantastique, Op. 14; London Symphony Orchestra under Hermann Scherchen **12" Westminster 5268**
- Bizet:** Carmen—Orchestral Scenario; Andre Kostelanetz Orchestra **12" Columbia ML4826**  
Fair Maid of Perth—Suite; Jeux d'enfants; Paris Conservatory Orchestra under Eduard Lindenberg **12" London LL871**
- Borodin:** In the Steppes of Central Asia; Prince Igor—Polovstian Dances; N. Y. Philharmonic-Symphony Orchestra under Dimitri Mitropoulos **12" Columbia ML4815**
- \***Boyce:** The Shepherd's Lottery; Allegro String Orchestra under John Bath **10" Allegro 4011**
- Brahms:** Academic Festival Overture; Tragic Overture; Amsterdam Concertgebouw Orchestra under Eduard van Beinum **10" London LD9038**  
Hungarian Dances (selected); NWDR Symphony Orchestra under Hans Schmidt-Isserstedt **10" London LD9071**  
Symphony No. 2 in D Major, Op. 73; Vienna Philharmonic Orchestra under Carl Schuricht **12" London LL867**  
Symphony No. 2 in D Major, Op. 73; Philadelphia Orchestra under Eugene Ormandy **12" Columbia ML4827**  
Tragic Overture, Op. 81; N. Y. Philharmonic-Symphony Orchestra under Bruno Walter **12" Columbia ML4814**  
Variations on a Theme of Haydn, Op. 56a; N. Y. Philharmonic-Symphony Orchestra under Bruno Walter **12" Columbia ML4814**
- Bruckner:** Symphony No. 4 in E-Flat ("Romantic"); Hague Philharmonic Orchestra under Willem van Otterloo **2 12" Epic 5C6001**
- \***Coplet:** Masque of the Red Death; Concert Arts Orchestra under Felix Slatkin **12" Capitol P8255**
- \***Cosella:** Italia, Op. 11; Radio Berlin Symphony Orchestra under Rolf Kleinert **12" Urania 7118**  
Serenade for Small Orchestra; Radio Leipzig Symphony Orchestra under Herbert Kegel **12" Urania 7118**
- Chabrier:** Espana Rapsodie; Lamoureux Orchestra under Jean Fournet **12" Epic 3028**  
Espana Rapsodie; Suisse Roumante Orchestra under Ernest Ansermet **10" London LD9039**
- Gwendoline Overture; Lamoureux Orchestra under Jean Fournet **12" Epic 3028**
- Marche Joyeuse; Lamoureux Orchestra under Jean Fournet **12" Epic 3028**
- Le Roi Malgre Lui—Gete Polonaise; Lamoureux Orchestra under Jean Fournet **12" Epic 3028**
- Suite Pastorale; Lamoureux Orchestra under Jean Fournet **12" Epic 3028**
- Suite Pastorale; Paris Conservatory Orchestra under Eduard Lindenberg **12" London LL871**
- Copland:** Quiet City; Concert Arts Orchestra under Vladimir Golschmann **12" Capitol P8245**
- \***Creston:** 2 Choric Dances; Concert Arts Orchestra under Vladimir Golschmann **12" Capitol P8245**  
\*Symphony No. 2, Op. 35; Symphony No. 3, Op. 48; National Symphony Orchestra under Howard Mitchell **12" Westminster 5272**
- Delibes:** Coppelia—Ballet Music; Sylvia Ballet Music; Lamoureux Orchestra under Jean Fournet **12" Epic 3030**
- Delius:** On Hearing the First Cuckoo in Spring; The Walk to the Paradise Garden; London Symphony Orchestra under Anthony Collins **10" London LD9067**
- Diamond:** Rounds for Strings; Concert Arts Orchestra under Vladimir Golschmann **12" Capitol P8245**
- Dvorak:** Slavonic Dances (selections); Cleveland Orchestra under George Szell **12" Columbia ML4785**
- de Falla:** The 3-Cornered Hat—3 Dances; St. Louis Symphony Orchestra under Vladimir Golschmann **12" Capitol P8257**
- Frank:** Psyche—Symphonic Poem; Amsterdam Concertgebouw Orchestra under Eduard van Beinum **10" London LD9081**
- \***Glazounov:** Scenes de Ballet; Concert Waltzes; Bolshoi Theater Symphony Orchestra under Alexander Guak **12" Period 596**
- Gounod:** Faust—Ballet Music Lamoureux Orchestra under Jean Fournet **12" Epic 3030**
- Grieg:** Lyric Suite, Op. 54; Danish National Orchestra of the State Radio under Erik Tuxen **10" London L5849**
- Haydn:** Symphony No. 44 in E Minor ("Mourning"); Symphony No. 48 in C Major ("Maria Theresa") Danish St. Radio Symph. **12" London LL844**  
Symphony No. 53 in D Major ("L'Imperiale"); Vienna Symphony Orchestra under Paul Sacher **12" Epic LC3038**  
\*Symphony No. 67 in F Major; Vienna Symphony Orchestra under Paul Sacher **12" Epic LC3038**  
Symphony No. 96 in D Major ("Miracle"); Symphony No. 97 in C Major Amsterdam Concertegouw Orchestra under Eduard van Beinum **12" London LL854**  
Symphony No. 102 in B-flat; N. Y. Philharmonic-Symphony Orchestra under Bruno Walter **12" Columbia ML4814**
- Hindemith:** Concert Music for Strings and Brass; Mathis der Maler; Philadelphia Orchestra under Eugene Ormandy **12" Columbia ML4816**
- d'Indy:** Istar—Symphonic Variations; Colonne Concerts Orchestra under Georges Sebastian **12" Urania 7115**
- Ippolitov-Ivanov:** Caucasian Sketches; N. Y. Philharmonic-Symphony Orchestra under Dimitri Mitropoulos **12" Columbia ML4815**
- Liadov:** 8 Russian Folksongs; Bolshoi Theater Orchestra under Anatol Kondrashin **12" A-440 AC1204**
- Liszt:** Symphonic Poems—Les Preludes; The Battle of the Huns; Mazeppa; Orpheus; London Philharmonic Orchestra **12" Westminster 5269**  
Les Preludes—Symphonic Poem; Hague Philharmonic Orchestra under Willem van Otterloo **12" Epic LC3032**
- \***Martini:** Intermezzo; Louisville Orchestra under Robert Whitney **12" Columbia ML4859**
- Mendelssohn:** The Destruction of Doftanas; Radio Berlin Symphony Orchestra under Rolf Kleinert **12" Urania 7114**
- \***Milhaud:** Kentuckiana; Louisville Orchestra under Robert Whitney **12" Columbia ML4859**  
Symphony No. 1; Columbia Broadcasting Symphony under Darius Milhaud **12" Columbia ML4784**
- Mozart:** Symphony No. 35 in D Major (K. 385) ("Haffner"); Symphony No. 41 in C Major (K. 551) ("Jupiter"); Pittsburgh Symphony Orchestra under William Steinberg **12" Capitol P8242**

\***Neilsen**: Maskarade—Dance of the Cockerels; Covent Garden Royal Opera Orchestra under John Hollingsworth 12" **MGM E3082**  
**Prokofieff**: Chout—Ballet Suite No. 1, Op. 21; St. Louis Symphony Orchestra under Vladimir Golschmann 12" **Capitol P8257**  
**Rabaud**: Marouf—Ballet Music; Lamoureux Orchestra under Jean Fournet 12" **Epic 3030**  
**Rameau**: Suite for Strings; Allegro String Orchestra under John Bath 10" **Allegro 4011**  
**Ravel**: Pavane pour une infante défunte; Suisse Romande Orchestra under Ernest Ansermet 10" **London LD9039**  
**Rimsky-Korsakov**: Capriccio Espagnol, Op. 34; Philadelphia Orchestra under Eugene Ormandy 12" **Columbia ML5846**  
 \*Invisible City of Kitezh—Suite; Bavarian Radio Symphony Orchestra under Kurt Graunke 12" **Urania 7115**  
**Schubert**: Symphony No. 4 in C Minor ("Tragic"); Symphony No. 5 in B-flat; London Philharmonic Orchestra under Dean Dixon 12" **Westminster 5274**  
**Schumann**: Symphony No. 1 in B-flat, Op. 38 ("Spring"); The Cleveland Orchestra under Erich Leinsdorf 12" **Columbia ML4794**  
 Symphony No. 2 in C Major, Op. 61; The Cleveland Orchestra under George Szell 12" **Columbia 4817**  
 Symphony No. 4 in D Minor, Op. 120; The Cleveland Orchestra under George Szell 12" **Columbia ML4794**  
**Sibelius**: Romance in C for Strings; Covent Garden Royal Opera Orchestra under John Hollingsworth 12" **MGM E3082**  
**Smetana**: My Fatherland—The Moldau & From Bohemia's Meadows and Forests; N. Y. Philharmonic-Symphony Orchestra under George Szell 12" **Columbia ML4785**  
**R. Strauss**: Le Bourgeois Gentilhomme—Suite; Don Juan—Symphonic Poem, Op. 20; Pittsburgh Symphony Orchestra under Fritz Reiner 12" **Columbia ML4800**  
 Don Juan—Symphonic Poem, Op. 20; Amsterdam Concertgebouw Orchestra under Eugen Jochum 12" **Epic LC3032**  
 \*Symphony for Winds; MGM Chamber Orchestra under Izler Solomon 12" **MGM E3097**  
 Till Eulenspiegel's Merry Pranks—Symphonic Poem, Op. 28; The Cleveland Orchestra under George Szell 12" **Columbia ML4800**  
 Till Eulenspiegel's Merry Pranks—Symphonic Poem, Op. 28; Amsterdam Concertgebouw Orchestra under Eugen Jochum 12" **Epic LC3032**  
**Stravinsky**: Pulcinella (complete ballet) The Cleveland Orchestra with Soloists under Igor Stravinsky 12" **Columbia ML4830**  
 Le Sacre du Printemps; Minneapolis Symphony Orchestra under Antal Dorati 12" **Mercury MG50030**  
 Le Sacre du Printemps; Pittsburgh Symphony Orchestra under William Steinberg 12" **Capitol P8254**  
**Svendson**: Carnival in Paris, Op. 9; Covent Garden Royal Opera Orchestra under John Hollingsworth 12" **MGM E3082**  
**Tchaikovsky**: Capriccio Italien, Op. 45; Philadelphia Orchestra under Eugene Ormandy 12" **Columbia ML4856**  
 Symphony No. 5 in E Minor, Op. 64; Leopold Stokowski Symphony Orchestra 12" **Victor LM1780**  
**Vaughan Williams**: Fantasia on a Theme of Tallis; English Folksong Suite; London Philharmonic Promenade Orchestra under Sir Adrian Boult 12" **Westminster 5270**  
 \*Norfolk Rhapsody; Fantasia on Greensleeves; London Philharmonic Promenade Orchestra under Sir Adrian Boult 12" **Westminster 5270**  
**Wagner**: Polonia Overture; Radio Berlin Symphony Orchestra under Adolf Fritz Guhl 12" **Urania 7116**  
 \*Symphony in C Radio Leipzig Symphony Orchestra under Gerhard Pflüger 12" **Urania 7116**

## WORKS FOR ORCHESTRA, CHORUS, AND SOLOISTS

**Bach**: Christmas Oratoria (complete); Detmold Academy Chorus, Soloists and Orchestra under Kurt Thomas 2 12" **Oiseau Lyre 50001/3**  
**Blow**: Venus and Adonis; Soloists, Chorus and Orchestra under Anthony Lewis 12" **Oiseau Lyre 50004**  
**Beethoven**: Missa Solemnis in D, Op. 123; Robert Shaw Chorale with Soloists and NBC Symphony Orchestra under Arturo Toscanini 2 12" **Victor LM6013**  
**Benevoli**: Festival Mass; Salzburg Cathedral Choir and Vienna Symphony Orchestra under Joseph Messner 12" **Epic 3035**  
**Berlioz**: L'Enfance du Christ (complete oratorio); Little Orchestra Society, Choral Art Society, Soloists under Thomas Scherman 2 12" **Columbia SL199**  
**Charpentier, M. A.**: "Assumpta est Maria" Mass and Symphony; Jeunesse Musicales de France Chorus, Orchestra and Soloists under Louis Martini 12" **Vox PL8440**  
**Delius**: A Mass of Life; London Philharmonic Choir with Soloists and Royal Philharmonic Orchestra under Sir Thomas Beecham 2 12" **Columbia SL197**  
**Foss**: A Parable of Death; Louisville Orchestra with Soloists under Robert Whitney 12" **Columbia ML4859**  
**Handel**: Messiah (complete recording); London Philharmonic Choir with Soloists and London Symphony Orchestra under Hermann Scherchen 3 12" **Westminster WAL308**  
**Haydn**: The Creation (complete oratorio) Berlin Radio Soloists, Chorus and Orchestra under Helmut Koch 2 12" **Urania 235**

\***McDonald**: Builders of America; Columbia Symphony Orchestra and Chorus with Claude Rains (narrator) under Harold McDonald 10" **Columbia ML2220**  
**Monteverdi**: Vespers of the Blessed Virgin (1610); London Singers with Soloists and Chamber Ensemble under Anthony Lewis 2 12" **Oiseau Lyre 50021/2**  
**Mozart**: Bastien and Bastienne (complete Opera); Vienna Symphony Orchestra with Soloists 12" **Columbia ML4385**  
**Pergolesi**: Salve Regina; Patricia Neway (soprano) with the Allegro Chamber Music Society 10" **Allegro 4019**  
**Stravinsky**: Les Noces; Dresden State Opera Chorus, Soloists and Orchestra under Schrieber 10" **Allegro 4010**

## ORCHESTRA AND SOLOIST

**de Falla**: Nights in the Gardens of Spain Guiomar Novaes with the Vienna Pro Musica Symphony Orchestra under Hans Swarowsky 12" **Vox PL8520**  
**McDonald**: From Childhood—Wuite for Harp and Orchestra; Ann Mason Stockton with the Concert Arts Orchestra under Felix Slatkin 12" **Capitol P8255**  
**R. Strauss**: Don Quixote—Symphonic Poem, Op. 35; Boston Symphony Orchestra under Charles Munch with Gregor Piatigorsky (cello) 12" **Victor LM1781**

## CHAMBER MUSIC

### Trios

**Beethoven**: Wind Trio in E-flat, Op. 87; "La ci Darem" Variations; Octet Rondo in E-flat Kamesch, Kautsky, Hadoumouky 12" **Westminster 5262**  
**Chopin**: Trio in G Minor, Op. 8; Trio di Bolzano 12" **Vox PL8480**  
**Mozart**: Trios—E Major (K.542); C Major (K.548); Paul Badura-Skoda (piano) Jean Fournier (violin), Antonio Janigro (cello) 12" **Westminster 5267**  
**Schumann**: Trio in F Major, Op. 80; Trio di Bolzano 12" **Vox PL8480**

### Quartet

**Beethoven**: 16 String Quartets & Grosse Fuge; Vegg Quartet 10 12" **Haydn Society HSQ-N,O,P**  
**Boccherini**: Quartets—A Major, Op. 39, No. 3; E-flat, Op. 58, No. 3; New Italian Quartet 12" **Angel 35062**  
**Creston**: Quartet, Op. 8; Hollywood Quartet 12" **Capitol P8260**  
**Dvorak**: Piano Quartet in E-flat, Op. 87; Galimir Quartet 12" **Stradivari 619**  
**Fine**: Quartet (1952); Juilliard Quartet 12" **Columbia ML4843**  
**Haydn**: Quartet in G Minor, Op. 74, No. 3 ("Horseman"); Roma Quartet 12" **Urania 7-20**  
**Imbrie**: Quartet in B-flat; Juilliard Quartet 12" **Columbia ML4844**  
**Kirchner**: Quartet No. 1; American Art Quartet 12" **Columbia ML4843**  
**Kreisler**: Quartet in A Minor; Stuyvesant Quartet 12" **Philharmonia 107**  
**Mennin**: Quartet No. 2; Juilliard Quartet 12" **Columbia ML4844**  
**Mozart**: Quartet in G Major (K.387); Quartet in D Minor (K.421); New Italian Quartet 12" **Angel 35063**  
 Quartet in D Major (K.499); Quartet in D Major (K.575); Juilliard Quartet 12" **Columbia ML4863**  
**Paganini**: Quartet in E Major; Stuyvesant Quartet 12" **Philharmonia 107**  
**Palmer**: Quartet for Piano and Strings; John Kirkpatrick and the Walden Quartet 12" **Columbia ML4842**  
**Turina**: La Oracion del Torero; Hollywood Quartet 12" **Capitol P8260**  
**Verdi**: Quartet in E Minor; Roma Quartet 12" **Urania 7-20**  
**Wolf**: Italian Serenade; Hollywood Quartet 12" **Capitol P8260**

### Quintets

**Beethoven**: Quintet in E-flat, Op. 16; Rudolf Serkin (piano) and the Philadelphia Woodwind Quintet 12" **Columbia ML4834**  
**Dvorak**: Quintet in E-flat, Op. 97; Budapest Quartet and Milton Katims 12" **Columbia ML4799**  
**Mozart**: Quintet in C Major (K.515); Barylli Quartet (augmented) 12" **Westminster 5271**  
 Quintet in E-flat for Piano and Winds (K.452); Rudolf Serkin with the Philadelphia Woodwind Quintet 12" **Columbia ML4834**

### Sextets

**Brahms**: String Sextet in G Major, Op. 36; Vienna Konzerthaus Quartet (augmented) 12" **Westminster 5263**  
**Hill**: Sextet for Piano and Winds; Lillian Kallir with the N. Y. Woodwind Quintet 12" **Columbia ML4846**  
**Poulenc**: Sextet for Piano and Winds; Lurie & Fine Arts Ensemble 12" **Capitol P8258**

## Miscellaneous Groups

\***Berger**: Duo for 'cello and Piano; Quartet for Winds; Bernard Greenhouse, Fairfield Wind Ensemble 12" **Columbia ML4846**  
**Bowles**: Music for a Farce; David Glazer (clarinet), Herbert Mueller (trumpet), Elden Bailey (percussion), William Masselos (piano) 12" **Columbia ML4845**

- Hindemith:** Kleine Kammermusik, Op. 24, No. 2; Fine Arts Wind Ensemble  
12" **Capitol P8258**
- \***d'Indy:** Suite in Olden Style for 2 Flutes, Trumpet and Strings; Julius Baker, Claude Monteux; Harry Glantz and the Guillet Quartet 12" **MGM E3096**
- Mozart:** Divertimento in B-flat (K.287); Vienna State Opera Orchestra under Felix Prohaska 12" **Vanguard 441**  
Divertimento in D Major (K.334); Vienna Konzerthaus Quartet with Horns 12" **Westminster 5276**
- \***Pezel:** 17th Century Tower and Festive Music; Brass Ensemble under Gunther Schuller 12" **EMS7**
- Saint-Saëns:** Septet for Piano, Trumpet and Strings; Menahem Pressler, Harry Glantz and the Guillet Quartet with Philip Sklar 12" **MGM E3096**

## CONCERTOS

- Bach:** 2-Violin Concerto in D Minor Krebbers, Olof and Hague Philharmonic Orchestra under Willem van Otterloo 12" **Epic LC3036**
- Bartok:** Piano Concerto No. 2; Rhapsody for Piano and Orchestra; Andor Foldes with the Lamoureux Orchestra under Eugene Bigot 12" **Vox 8220**  
Piano Concerto No. 3; Leonard Pennario with the St. Louis Symphony Orchestra under Vladimir Golschmann 12" **Capitol P8253**  
Julius Katchen with the Suisse Romande Orchestra under Ernest Ansermet 12" **London LL945**
- Beethoven:** Piano Concerto No. 1 in C Major, Op. 15 Friedrich Wührer with the Vienna Pro Musica Symphony Orchestra under Hans Swarowsky 12" **Vox PL8400**  
Piano Concerto No. 1 in C Major, Op. 15; Wilhelm Backaus with the Vienna Philharmonic Orchestra under Clemens Krauss 12" **London LL879**  
2 Romances for Violin and Orchestra, Op. 40 & 50; Krebbers, Hague Philharmonic Orchestra under William van Otterloo 12" **Epic LC3036**
- \***Berg:** Violin Concerto; Louis Krasner with the Cleveland Orchestra under Artur Rodzinski 12" **Columbia ML4857**
- Brahms:** Piano Concerto No. 1 in D Minor, Op. 15; Rudolf Serkin with the Cleveland Orchestra under George Szell 12" **Columbia ML4829**  
Violin Concerto in D Major, Op. 77; Julian Olevsky with the National Symphony Orchestra under Howard Mitchell 12" **Westminster 5273**
- Debussy:** Rhapsody for Saxophone and Orchestra; Marcel Mulé with the Paris Philharmonic Orchestra under Manuel Rosenthal 12" **Capitol L8231**
- Grieg:** Piano Concerto in A Minor, Op. 16; Guiomar Novaes with the Vienna Pro Musica Orchestra under Hans Swarowsky 12" **Vox PL8520**
- Handel:** Concert Grossi, Op. 6—Nos. 11 & 12; Boyd Neel Orchestra 10" **London L5870**
- Ibert:** Saxophone Concertino; Marcel Mulé with the Paris Philharmonic Orchestra under Manuel Rosenthal 12" **Capitol L8231**
- \***Khochaturian:** 'Cello Concerto; Wilhelm Posegga with the Radio Leipzig Symphony Orchestra under Rudolf Kempe 12" **Urania 7119**
- \***Korngold:** Violin Concerto in D Major, op. 35; Jascha Heifetz with the Los Angeles Philharmonic Orchestra under Alfred Wallenstein 12" **Victor LM1782**
- \***Lambert:** Concerto for Piano and Nine Instruments; Menahem Pressler with Chamber Ensemble under Theodore Bloomfield 12" **MGM E3081**
- \***Milhaud:** Concertino d'Automne; Arthur Gold and Robert Fildale with chamber ensemble (2 pianos) 12" **Columbia ML4854**
- Mozart:** Flute Concertos—G Major (K.313); D Major (K.314) Barwahser, Vienna Symphony Orchestra, Pritchard 12" **Epic LC3033**  
Flute and Harp Concerto in C Major (K.299); Pro Musica Chamber Orchestra of Vienna 12" **Vox PL8550**  
\*Piano Concerto in F Major (K.413); Vivian Rivkin with the Vienna State Opera Orchestra under Dean Dixon 12" **Westminster 5244**  
Piano Concerto in C Major (K.467); Robert Casadesus with the N. Y. Philharmonic-Symphony Orchestra under Charles Munch 12" **Columbia ML4791**  
Piano Concerto in E-flat (K.482); Vivian Rivkin with the Vienna State Opera Orchestra under Dean Dixon 12" **Westminster 5244**  
Piano Concerto in B-flat (K.595); Robert Casadesus with the N. Y. Philharmonic-Symphony Orchestra under John Barbiralli 12" **Columbia ML4791**
- Pergolesi:** Concertinos for String Orchestra—No. 5 in E-flat; No. 2 in G Major; No. 6 in B-flat; No. 3 in A Major; Lamoureux Chamber Orchestra under Pierre Colombo 12" **Oiseau Lyre 50010**
- Prokofieff:** Piano Concerto No. 3 in G Major, Op. 26; Leonard Pennario, the St. Louis Symphony Orchestra under Vladimir Golschmann 12" **Capitol P8253**
- \***Schoenberg:** Violin Concerto; Louis Krasner with the N. Y. Philharmonic-Symphony Orchestra under Dimitri Mitropoulos 12" **Columbia ML4857**
- Shostakovich:** Piano Concerto; Margot Pinter with the Radio Berlin Symphony Orchestra under Günter Wand 12" **Urania 7119**
- \***Vivaldi:** La Stravaganza—12 Concerti Grossi, Op. 4; Stuttgart Pro Musica String Orchestra under Rolf Reinhardt 3 12" **Vox DL103**

## OPERA

- Gilbert and Sullivan:** The Sorcerer (complete recording); D'Oyly Carte Opera Co. 2 12" **London LL885/6**  
The Gondoliers; Iolanthe—Highlights; D'Oyly Carte Opera Co. 12" **London 11784**

- Giordano:** Andrea Chenier. (complete opera); Gigli and others, Chorus, Orchestra of LaScala, Milan under Oliviero de Fabritiis 2 12" **Victor LCT6014**
- Gounod:** Faust (complete opera); Victoria de los Angeles, Nicolai Gedda, Boris Christoff and others with Chorus and Orchestra of the Paris Opera under Andre Cluytens 4 12" **Victor LM6400**
- Massenet:** Werther (complete opera); Ferruccio Tagliavini; Pio Tassinari and others with the Radio Italiana Chorus and Orchestra under Francesco Molinari-Pradelli 3 12" **Cetra 1245**
- Puccini:** Arias from Mme. Butterfly & La Boheme; Renata Tebaldi (soprano) 12" **London LD9053**
- \***Rachmaninoff:** Aleko (complete opera); Bolshoi Theater Soloists, Chorus and Orchestra 12" **Concert Hall CHS1309**
- \***Rimsky-Korsakov:** Sadko (complete opera); Bolshoi Theater Soloists, chorus and Orchestra 3 12" **Concert Society CHS1307**
- R. Strauss:** Elektra—Final Scene; Soloists and Chorus with the Royal Philharmonic Orchestra under Sir Thomas Beecham 12" **Victor LCT1135**
- \***Wagner:** Der Ring des Nibelungen—Das Rheingold; Die Walküre; Siegfried; Die Götterdämmerung (complete recording); Dresden State Opera Co., Schreiber 19 12" **Allegro 3125/43**

## SONATAS

- Bach:** Sonatas for Flute; Philip Koplan with Erwin Bodky (harpsichord) and others 2 10" **Allegro 4003/4**  
Sonatas for Viola da Gamba and Harpsichord—A Major, F Major, F Minor; Hermann Busch (cello) and Edith Weiss-Mann 12" **Allegro 3087**
- Beethoven:** Violin Sonatas—A Major, Op. 12, No. 2; E-flat, Op. 12, No. 3; Op. 47 ("Kreutzer"); Jean Fournier with GINETTE Doyen (piano) 2 12" **Westminster 5247, 5275**  
Violin Sonatas—C Minor, Op. 30, No. 2; G Major, Op. 30, No. 3; Zino Francescatti with Robert Casadesus at the piano 12" **Columbia ML4861**
- Brahms:** 'Cello Sonata No. 1 in E Minor, Op. 38; No. 2 in F Major, Op. 99; Janos Starker with Abba Bogin at the piano 12" **Period 593**
- \***Cowell:** Violin Sonata No. 1; Joseph Szigetzi with Carlo Bussotti at the piano 12" **Columbia ML4841**
- \***Dello Joia:** Variations and Capriccio; Patricia Travers (violin) with Norman Dello Joia at the piano 12" **Columbia ML4845**
- Franck:** Violin Sonata in A Major; Jascha Heifetz and Artur Rubinstein (piano) 12" **Victor LCT1122**
- Handel:** 6 Sonatas for Violin and Figured Bass; Alexander Schneider with Ralph Kirkpatrick (harpsichord) and Frank Miller (cello) 12" **Columbia ML4787**
- \***Harris:** Violin Sonata; Joseph Gingold and Joanna Harris (piano) 12" **Columbia ML4842**
- Mendelssohn:** 'Cello Sonatas—B-flat, Op. 45; D Major, Op. 58; Nicolai and Joanna Graudan 12" **Vox PL8500**
- Mozart:** Violin Sonatas—G Major (K. 301), E Minor (K. 304), B-flat (K. 378), G Major (K. 379); Amsterdam Duo 12" **Epic LC3034**
- Shostakovich:** 'Cello Sonata, Op. 40; Emanuel Blabec with Franz Hollatshchek at the piano 10" **London LD9075**
- Strauss R.:** Violin Sonata in E-flat, Op. 18; Jascha Heifetz with Arpad Sandor at the piano 12" **Victor LCT1122**

## PIANO

- Bach:** Anna Magdalena Bach Notebook, Keyboard Pieces; Lili Kraus (piano) 12" **Educo 3001**  
Capriccio on the Departure of a Beloved Brother, Lili Kraus (piano) 12" **Educo 3001**  
6 Partitas for Clavier; Rosalyn Tureck (piano) 3 12" **Royal 3 1415/7**
- \***Barber:** Souvenirs, Op. 28; Arthur Gold and Robert Fildale (2-pianos) 12" **Columbia ML4855**
- Bartok:** For Children—Vols. 1 & 2; Tibor Kozma (piano) 2 12" **Bartok 919/20**  
\*Roumanian Christmas Carols; Bagatelles; Roumanian Dances; Tibor Kozma (piano) 12" **Bartok 918**
- Beethoven:** Piano Sonatas—C Minor, Op. 13; G Minor, Op. 49, No. 1; G Major, Op. 49, No. 2; Lili Kraus 12" **Educo 3006**  
Piano Sonatas—C Minor, Op. 13 ("Pathétique"); C-sharp Minor, Op. 27, No. 2 ("Moonlight"); F Minor, Op. 57 ("Appassionata"); Paul Badura-Skoda 12" **Westminster 5184**
- \***Berners:** Piano Music—3 Little Funeral Marches, etc.; Menahem Pressler (piano) 12" **MGM3081**
- Brahms:** Piano Sonata in F Minor, Op. 5; Paul Badura-Skoda 12" **Westminster 5245**  
Piano Pieces, Op. 76 & Op. 117; Carl Friedberg 12" **Zodiac 1001**  
Rhapsodies (piano), Op. 79; Wilhelm Kempff 10" **London LD9048**  
\*Scherzo in E-flat Minor, Op. 4; Carl Friedberg (piano) 12" **Zodiac 1001**  
Piano Pieces, Op. 118; Sonata in F-sharp Minor, Op. 2; Joseph Battista 12" **MGM 3056**
- Chopin:** Barcarolle in F-sharp, Op. 60; Leonard Pennario (piano) 12" **Capitol H8246**
- Debussy:** Estampes; Images Sets I & II; Pour le Piano; Claudio Arrau (piano) 12" **Columbia ML4786**
- Granados:** Goyescas—Piano Suite; Jose Falgarona 12" **Vox PL8580**
- Liszt:** Mephisto Waltz; Leonard Pennario (piano) 10" **Capitol H8246**



**Mendelssohn:** Songs without Words (Vol. 2); Ginette Doyen (piano) 12" Westminster 5246  
 Songs without Words (Vol. 3); Ginette Doyen (piano) 12" Westminster 5279  
 \***Nielsen:** Chaconne, Op. 32; France Ellegaard (piano) 10" London LD9065  
**Schubert:** Wanderer Fantasy, Op. 15; Karl Ulrich Schnabel 12" WCFM 17  
 Piano Sonatas—D Major, Op. 53; G Major, Op. 78; Webster Aitken 2 12" EMS 108/9  
 Piano Sonata in B-flat (Post.); Clara Haskil 12" Epic LC3130  
 \***Schumann:** Bunte Blätter, Op. 99; Clara Haskil 12" Epic LC3130  
 Fantasia in C Major, Op. 17; Etudes Symphoniques; Op. 13; Yves Nat (piano) 12" Haydn Society 87  
 Kinderscenen, Op. 15; Carl Friedberg (piano) 12" Zodiac 1001  
 Piano Sonata No. 2 in G Minor, Op. 22; Humoreske, Op. 20; George Demus 12" Westminster 5264  
 \***Villa-Lobos:** Rudepoema; Children's Doll Suite; The 3 Marias; Jacques Abrams (piano) 12" EMS 10

## DUO-PIANO MUSIC

\***Haieff:** Sonata for 2 Pianos; Arthur Gold and Robert Fizdale 12" Columbia ML4855  
**Hindemith:** 4-Hand Piano Sonata; Arthur Gold and Robert Fizdale 12" Columbia ML4853  
 \***Poulenc:** 4-Hand Piano Sonata; Arthur Gold and Robert Fizdale 12" Columbia ML4854  
 \***Rieti:** Suite Champetre (1948); Arthur Gold and Robert Fizdale (2 pianos) 12" Columbia ML4853  
 \***Shapero:** 4-Hand Piano Sonata; Harold Shapero and Leo Smit 12" Columbia ML4841  
**Stravinsky:** Concerto for 2 Solo Pianos; Arthur Gold and Robert Fizdale 12" Columbia ML4853

## ORGAN

**Bach:** 6 Trio Sonatas; Robert Noehren (organ) 10" Allegro 3093, 10" Allegro 4002  
 \***Guilmant:** Organ Sonata No. 1 in D Minor; Richard Ellsasser 12" MGM 3078  
 \***Liszt:** Fantasia and Fugue on BACH; Gloria and Credo; E. Power Biggs (organ) 12" Columbia ML4820  
**Reubke:** Sonata on the 94th Psalm; E. Power Biggs (organ) 12" Columbia ML4820  
 'Sonata on the 94th Psalm; Richard Ellsasser (organ) 12" MGM E3078  
 \***Mendelssohn:** Organ Sonatas No. 1, 3, 6; Prelude and Fugue in C Minor; John Eggington 12" Oiseau Lyre 50013  
 \***Sessions:** 4 Chorale-Preludes; Marilyn Mason (organ) 12" Esoteric 522  
 \***Thomson:** Variations on Sunday School Tunes; Marilyn Mason (organ) 12" Esoteric 522

## HARPSICHORD

**Bach:** Italian Concerto; Edith Weiss-Mann (harpsichord) 12" Allegro 3087  
 English Suites—No. 5 in E Minor & No. 6 in D Minor; Alice Ehlers (harpsichord) 12" Allegro 3094  
**Beethoven:** Bagatelles, Op. 126; Flute Variations; Richard Dirksen (piano), Wallace Mann (flute) 2 12" Esoteric 525/6  
**Debussy:** Syrinx; Jean-Pierre Rampal (flute) 12" Educo 4001  
 \***Purcell:** Suites for Harpsichord Nos. 1 to 8; Isabelle Nef 12" Oiseau Lyre 50011

## ART AND FOLK SONGS

**Bartok:** Ady Songs; Hungarian Folk Songs; Nina Valery (soprano) with Rudolf Goehr at the piano 10" Allegro 4020  
**Beethoven:** Gellert Songs, Op. 48; Ralph Herbert (baritone) with piano 10" Allegro 4022  
 \***Bowles:** Scenes d'Anabase; William Hess (tenor), Josef Marx (bass), William Masselos (piano) 12" Columbia ML4845  
**Brahms:** 4 Serious Songs; William Warfield (baritone) with Otter Herz at the piano 12" Columbia ML4860

**Chopin:** Polish Songs, Op. 74; Doda Conrad (bass) with piano 12" Vox PL8310  
**Faure:** La bonne chanson—Song-Cycle, Op. 61; Hughes Cuenod (tenor) with piano 12" Westminster 5278  
**Gounod:** Biondina—Song-Cycle; Hughes Cuenod (tenor) with piano 12" Westminster 5278  
**Hindemith:** Das Marienleben—Song-Cycle; Jennie Tourel (mezzo-soprano) and George Reeves (piano) 2 12" Columbia SL196  
**Mahler:** Kindertotenlieder—Song-Cycle; Hermann Schey with the Hague Philharmonic Orchestra under Willem van Otterloo 2 12" Epic SC6001  
**Moussorgsky:** Songs and Dances of Death; Heinz Rehfuß (baritone) with piano 10" London LD9070  
**Schumann:** Dichterliebe—Song-Cycle, Op. 48; Frauenliebe und Leben—Song-Cycle, Op. 42; Lotte Lehmann (soprano) and Bruno Walter (piano) 12" Columbia ML4788  
 Liederkreis—Song-Cycle, Op. 39; William Warfield (baritone) with Otto Herz (piano) 12" Columbia ML4860  
**R. Strauss:** 4 Last Songs; Lisa della Casa (soprano) with the Vienna Philharmonic Orchestra under Karl Böhm 10" London LD9072

**African and Afro-American Drums** 2 12" Folkways 502  
**African Coast** 12" Riverside 4003  
**Allegro String Orchestra** 12" Allegro 3100  
**Ameni Islands** 12" Folkways 448  
**Basque** 10" Folkways 830  
**Greece** 10" Folkways 814  
**Haiti—Creole** 10" Folkways 833  
**Heath, Gordon and Lee Payant:** Songs of the Abbaye (with guitar) Elektra EKL-19  
**Israeli Folk Dances, Vol. 2** 10" Israel 6  
**Jewish Freilach** 10" Folkways 809  
**Jewish—Mort Freeman** 10" Tikva 11  
**Jewish, Vol. 2** 10" Folkways 827  
**Morriñas da Miña Terra** 10" Montilla 7  
**Paley, Tom:** Folksongs from the Southern Appalachian Mountains (with guitar and 5-string banjo) Elektra EKL-12  
**Spain and Portugal** 10" Montilla 3  
**Terry, Sonny:** Folk Blues (with his Mouth Harp) Elektra EKL-14  
**Terry, Sonny and Alec Stewart:** City Blues Elektra EKL-15  
**Voodoo Priestess** 10" Monogram 816  
**Warner, Frank:** Songs and Ballads of America's Wars (with guitar and mountain Banjo) Elektra EKL-13  
**Wilder, Dick:** Pirate Songs and Ballads (with guitar) Elektra EKL-18

## SPOKEN WORD AND DOCUMENTARY

**Drunkard** 12" Audio Drama 3075  
**Rain, White Cargo** 12" Audio Masterpiece 1215  
**Shakespeare:** Hamlet, John Barrymore 12" Audio Rarities 2201  
 Macbeth, John Barrymore 12" Audio Rarities 2202  
 Merry Wives of Windsor 12" Royale 1426  
 Richard III, John Barrymore 12" Audio Rarities 2203  
 Twelfth Night, John Barrymore 12" Audio Rarities 2204  
 John Barrymore Reads Shakespeare 12" Audio Rarities 2280  
**Stratford-on-Avon** 12" Royale 1440  
**Uncle Tom's Cabin** 12" Audio Drama 3080  
**Coronation Ceremony** 12" Allegro 3084  
**Anthology of Rhetoric** 12" B&B 4  
**Bach Ornamentation—Lanning** 12" B&B 5  
**Birth of a Baby** 10" Capitol H-480  
**Florella LaGuardia** 12" Audio Rarities 2310  
**Graded Series** 10" Polly 1  
**Musiquiz** 12" Per. 600  
**Poems & Songs of the Sea** 12" Audio Masterpiece 1220  
**Sounds of the American Southwest** 12" Folkways X-1220

## TEST RECORDS

**FFRR Frequency** 12" London LL-738  
**Frequency & Intermodulation** 10" Cook 10-A  
**High Fidelity Demonstration** 12" Urania 7084

## EDDIE CONDON'S JAZZ MUSIC

Whether or not you enjoy jazz, and most particularly if you do, be sure to read Eddie Condon's article on this subject in the May issue of *Holiday Magazine*. It is the first exposition on the nature and origin of jazz and the men who play it that has been written by anyone qualified by personal participation in this area of music. In his article, Eddie Condon debunks some of the notions developed by devotees who insist on making of jazz something that it isn't at all, provides answers to questions

that many enthusiasts have wanted to ask, and explains things about the music that will add interest to hearing it.

Long before you finish the article, you will start looking for the address of what Eddie Condon calls his "saloon" if for no other reason than the feeling that it would be fun to visit a place run by a man who could write such an engaging piece. *Holiday* doesn't give the address, but it is 47 West 3rd Street, New York City, and if you want to make a reservation by phone, call Gramercy 5-8639.



Fig. 7. This Webcor model is one of the tape recorders admirably suited for off-the-air recording

## Step-by-step Plan for Hi-Fi Beginners

PART 2 — By MILTON B. SLEEPER

**A**FTER the tuner, amplifier, and speaker have been installed according to the information given in Part 1 of this series, the logical second step is the addition of a tape recorder.<sup>1</sup> The reason is that, in addition to the almost endless variety of uses for a tape machine, it provides the most interesting and least expensive way to build a library of recorded music. Also, and this is becoming a very popular hobby, it is a means of making documentary recordings of important historical events heard by radio.

### Musical and Documentary Tapes

You can make up your own music library on tape from off-the-air recordings at about one-half the cost of LP records. That is, an hour's music recorded on a two-track machine costs approximately \$3.00 for a 7-in. reel. Using an FM receiver, the audio quality from tapes of network shows may not be quite up to that of the best LP's, but tapes of live-talent shows originating locally should be as good or better.

Frequently it is necessary to buy records with selections you don't want, in order to get something you want to hear. When you use tape, you record only the music you want to keep. And by splicing short tapes together, you can make up reels containing selections of particular orchestras, artists, or types of music provided, of course, you use only one track.

A new and growing hobby is that of making documentary

<sup>1</sup>The installation of a changer and a turntable, and the addition of a preamplifier for magnetic pickups will be described in Part 3.

tapes of special events that have historical interest. Today, for example, tapes of Sir Winston Churchill's wartime broadcasts would be priceless collectors' items. Apparently, few tapes were made of General McArthur's famous address, and they are virtually impossible to obtain. Tapes of Toscanini's last concert are considered to have value because of the break in the program. Because a 7-in. reel runs for 30 minutes on one track at  $7\frac{1}{2}$  ips, the timing is just right for recording plays, shows, and concerts which feature notable talent.

### How to Connect the Recorder

It's a simple matter to connect a tape machine for off-the-air recording. For the purpose of this explanation, a Webcor model 2010 recorder is illustrated because it has all the circuits and controls necessary, and sufficient amplification to work directly from the Pilot FM tuner shown in Part 1. Other recorders can be used, of course, if they are designed for this particular purpose.

You will need a No. 2901 input cord and a No. 2902 output cord for making connections to the recorder, and two pin plugs for plugging the cords into the tuner. Figs. 8 and 9 show the receptacles for the input and output cords respectively. The input cable must be run to the AUDIO OUTPUT jack, Fig. 11, at the rear of the tuner chassis, and the output cable to the PHONO INPUT on the tuner, also shown in Fig. 11. The cables are not furnished with pin plugs. You must solder them on yourself. Note that the cable wire encased in plastic insulation goes to the pin, and the other wire to the sleeve.

This arrangement is employed in order to use the switch at the center of the tuner panel in the FM position for recording, and the PHONO position for playback through the amplifier and speaker in the recorder. When you want to hear your tapes through your own amplifier and speaker, you will have to disconnect the recorder from the AUDIO OUTPUT on the tuner, and plug in your amplifier. One other adjustment must be made. There is a switch on the tuner chassis, Fig. 10, that cuts one stage of amplification in or out. For recording purposes, the switch should be at the IN position. That is all the preparation necessary for recording FM programs.

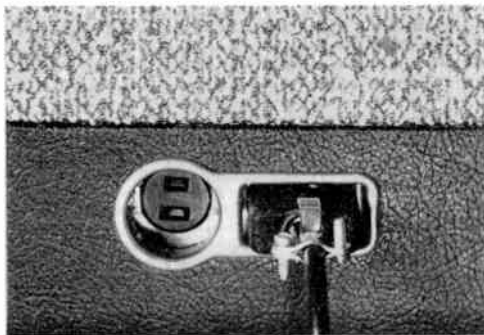

Fig. 8. Input connection to the recorder from the tuner output

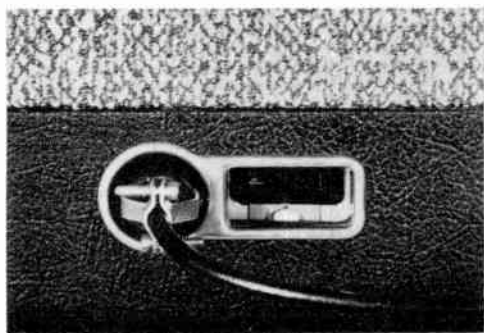

Fig. 9. Output from the recorder to the phono input of the tuner

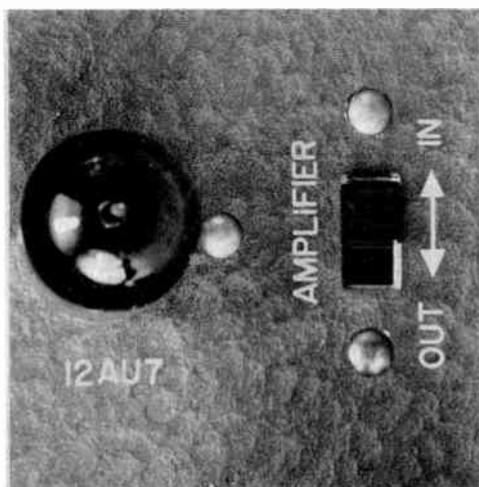

Fig. 10. Switch cuts in one stage of amplification on the tuner

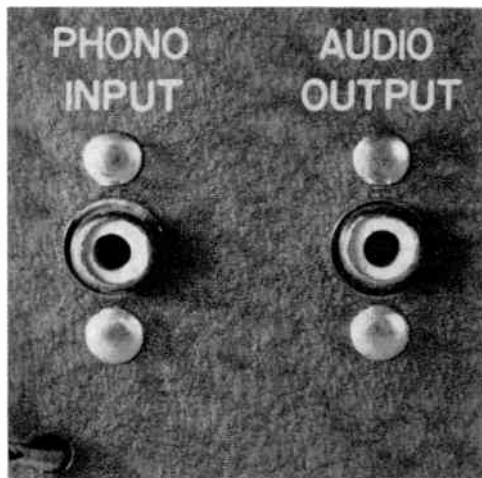

Fig. 11. Input and output connections at rear of tuner chassis

## Operating the Recorder

It is not necessary to repeat here the directions for threading the tape and operating the machine, but some notes from experience may be helpful. First of all, it is important to make some experimental recordings in order to determine the proper settings for the volume controls on the tuner and recorder. Be sure they are both on the low side, to avoid distortion from overmodulation.

If you put the switch at the left front of the recorder in the No. 4 position, you will be able to hear the program as it is being recorded. To start the tape to record, it is only necessary to press down the button and knob at the right rear, and turn it in the direction the tape is to travel. Ordinarily, the empty reel is put on the right hand spindle. When the right hand reel is full, it is not necessary to change it over to the left. Just push down the control knob and turn it to the left. That will reverse the direction of the tape, and also shift the recording head to the other track. This is a great convenience, particularly if the change must be made in the middle of a program, for the action is almost instantaneous. Or, if there is a break in the program near the end of the first track, the change can be made right then.

Two other notes are in order. 1) Be sure that the speed adjustment is set at  $7\frac{1}{2}$  ips. The control is a slotted button with an arrow. 2) When you have played a tape, take off the reel *before* you rewind it. That is standard professional practice. The reason is that the tape is wound more evenly at the slow speed. At the high rewind speed, some of the layers are exposed, and may be damaged.

Your first attempt at off-the-air recording may not be completely successful, but you'll very quickly master the controls, so you remember which must be turned and where, and the volume control settings that will give clean, clear quality. At least, your early mistakes will only cost the loss of some program material, since you can use the tape over and over for practice.

When you have mastered the recording technique, you will want to tackle the job of editing your tapes to combine related material on single reels. In the process, you will develop a new and very worthwhile interest in radio program material, and in collecting tapes that are not only entertaining to play, but are of historic value.

## Notes on Professional Equipment

Tape recorders are generally classified as being intended for home or professional use. The basic difference is that the former record two tracks on  $\frac{1}{4}$ -in. tape, while the latter record only one track. The audio quality can be made as high on two-track recording but, obviously, it is not possible to cut and patch one track without destroying the other.

In practice, professional, one-track recorders are designed to higher standards of audio quality and are, in consequence, more expensive. While home recorders operate at  $3\frac{3}{4}$  and  $7\frac{1}{2}$  ips, professional models are ordinarily designed for  $7\frac{1}{2}$  and 15 ips. The lower speed is used for speech, and the higher for music. Tape cost runs higher for one-track recording at 15 ips, since a 7-in. reel runs for about 15 minutes, and a 10-in. reel for 30 minutes.

You will probably start with one of the less expensive machines, and they are entirely adequate to take you to the point of being a serious tape collector. As your hobby becomes known to others, you will be offered opportunities to make recordings of all kinds, from marriage ceremonies to church music, and private jazz sessions to foreign language folk songs.

Then, inevitably, you will want to graduate to a professional type of recorder, both to get the higher audio quality provided by 15 ips, and to make everything on one-track tape which can be edited. That will be the time to go over all your two-track tapes to sort out what is important for recording on your new machine, and to reuse all the remaining tapes. Meanwhile, number your tapes, and keep a careful record of what is on each one. It may save you hours of listening later to find out just what is on unidentified reels. You can't tell just by looking at them!

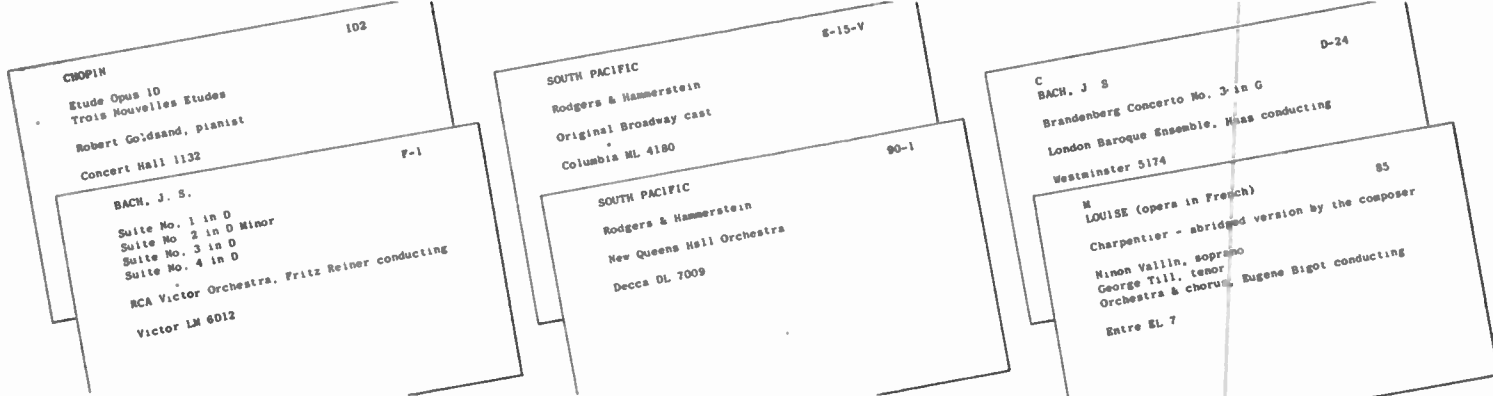

## A Card Index for Your Records

Do you have a card file for your record library? If not, this is a worthwhile undertaking that will repay you amply for the effort you put into it. This refers, of course, to a carefully-planned reference index such as broadcast stations have for their record libraries. If you have only 25 to 50 records now, this is the best time to start it, because it will be easy. And if your collection runs into the hundreds, although the work involved will be considerable, an index is a must if you are to get the most entertainment from your records.

One of the reasons you need a file of this sort is the pleasure and satisfaction you can get from being able to select the music you have available to fit any particular mood or occasion. You'd like a symphony concert with one or two soloists? With the aid of your card file you can plan one quickly. You'd enjoy an evening of opera music tonight? Or you have friends coming who will prefer some of the old, standard favorites? Look in that card file and see who is available to play or sing for you.

As you work out your index thoughtfully and thoroughly, you'll become conscious of gaps in your collection, or that, without realizing it, you have been buying one type of music almost to the exclusion of others which you enjoy equally. Thus the index will help to guide you in choosing new records, and building a still finer collection.

### Methods of Indexing and Filing

Depending on the amount of time you want to put into your file, you can use any one of several methods of indexing, or you can use two or more methods for cross-indexing. That is, you may choose to classify your records by:

- |              |                           |
|--------------|---------------------------|
| 1. Composers | 3. Types of music         |
| 2. Artists   | 4. Titles of compositions |

You may want to go into additional details for certain groups, using a special index to show conductors, orchestras, and performances with or without vocal parts. You may even want to build a file showing new recordings and rerecordings, or the names of recording companies.

Then you must decide on a method of arranging your records. That is, you may want to file them on your shelves according to:

- |                         |                               |
|-------------------------|-------------------------------|
| 1. Composers            | 3. Types of music             |
| 2. Manufacturers' names | 4. The succession of purchase |

Probably you will find method 3 or 4 to be the most practical and easiest to handle, particularly if you are going to use two or more card indexes for cross reference.

### Examples of Index Cards

If you decide to file your records in groups by types of music, it will be necessary to assign a letter to each type, followed by an identifying number. Be sure to label and number *both* the record and the jacket. This will avoid confusion, and make it easier to get each record back into the jacket where it belongs. But if you are going to file your records in succession of purchase, it is only necessary to mark them in numerical order. Examples of these methods are indicated in Fig. 1, showing the information typed on cards 3 by 5 ins.

In some cases, you may have two records of the same music, but one will be vocal, while the other is instrumental. You can show this on your cards by adding a -I or a -V to the identifying number. This is shown in Fig. 2.

When you take a card out of your file, you must be sure to put it back where it belongs. That is particularly important if you have two or more files for cross reference. And there is also the possibility that someone else, not entirely familiar with your system, may use your files from time to time. Therefore, it is important to indicate in which file each card belongs by identifying letters, such as C for composers file and M for music or composition file, as shown in Fig. 3.

### Information on the Cards

How much detail should be provided on each card? The sample cards shown here represent the minimum. The minimum varies considerably, however, from record to record, and you must decide as you make up each card what you consider essential information. To make each card of greatest use for future reference, try to think what you will want to know about a record in the future when you may have forgotten the details as to what is on it.





*Good music attracts good company. Put the two together, and you can be sure of having fun this summer. Of all the items you might take with you, a simple, inexpensive source of music will contribute most to making your vacation a success. Now is the time to select a factory-built instrument, or to assemble the necessary components.*

## TAKE YOUR MUSIC *with* YOU!

Most of us used to think that music was something to be enjoyed indoors, during the stay-at-home months. Probably the music festivals have helped us to change our thinking on that point, although they are public performances that are not available at the turn of a switch, nor can they be enjoyed from a hammock swung between trees at the side of a lake.

Music can contribute so much to a vacation, whether it is only for two weeks or all summer. But whether it is for dancing, for serious listening, or just for fun, vacation music must be available in convenient form, so that it can be enjoyed with the least effort. That brings up the subject of record-playing equipment of designs that can be carried by hand, or at least transported by automobile.

There are various arrangements of equipment for vacation use that will provide excellent quality, and at the same time meet these essential requirements:



*Fig. 1. This portable Rek-O-Kut instrument has additional connections for a radio and a microphone to be used with the built-in loudspeaker*

1. The equipment must be of rugged design, so as to stand up under rougher handling than if it were installed permanently at home.

2. This rules out anything that is affected by dampness, particularly if it is to be used near salt water. Remember that servicemen and replacement parts are hard to find at most vacation spots. And things that give trouble are more nuisance than they are worth when you go away for the specific purpose of having fun.

3. Simple, light-weight construction is important. You may prefer to sacrifice tone to gain small size and portability. In that respect, there are advantages in breaking down the equipment into units that can be handled separately, instead of putting them all in one large, heavy cabinet assembly.

4. If you are going to take some of your best LP's, get a case that can be used to carry them safely to the place where you are going, and to protect them after you have arrived. For pop music, better take EP's or 78's.

### Factory-Built Record-Players

There is a wide choice of portable record-players, complete with turntables or changers, amplifiers, and speakers, ready to plug into 115 volts AC. These range from relatively inexpensive instruments of rather limited audio quality to those with all the performance good engineering can provide within the space and weight limits of portability.

Such an instrument is the Rek-O-Kut Recitalist, shown in Fig. 1. This unit has a 3-speed turntable and reluctance

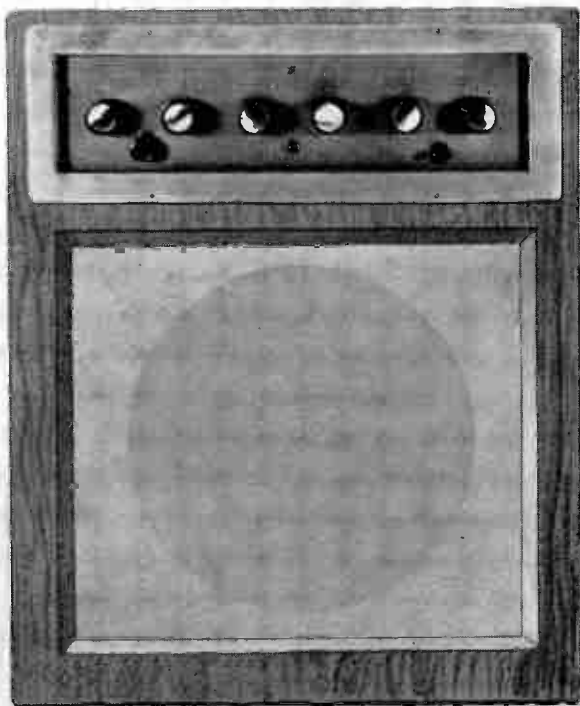

Fig. 2. Excellent record quality can be obtained from this combination of a Scott 99 and a 12-in. speaker in a plain plywood enclosure

pickup, equalizer, separate volume controls for records or radio and microphone, and input connections for a microphone and a radio set. There is a loudspeaker in the cover, and a jack where a separate speaker can be plugged in if desired.

If you want to take your music with you in the form of a factory-built portable, compare the different types and consider the factors of price, weight, size, and audio out-



Fig. 3. You may prefer this arrangement of the preamp-amplifier and a Presto turntable, with the two wood cases fastened together

put. In the end, you will probably decide to spend a little extra to be sure you will be satisfied with the tone and volume. Bear in mind that what seems loud enough indoors may sound thin and weak out in the open, particularly when you want music for dancing. And remember the possibility that some one will forget the equipment and leave it out in the rain. That misfortune has been known to occur!

### Equipment You Can Make up Yourself

If you want to go a little overboard for quality and output, you may prefer to make up your own equipment. Fig. 2 shows a Scott model 99 preamplifier and amplifier mounted in a simple enclosure for a 12-in. speaker. The enclosure measures 25 ins. high, 20½ ins. wide, and is 18 ins. deep.

It should be noted that this preamp-amplifier does not have holes for fastening it in place. However, it can be secured firmly by wood blocks at the rear corners of the case. The blocks should be fastened to the case with screws, so they can be removed when necessary.

To make the construction as simple as possible, grille cloth is stretched across the front of the cabinet, held in place by plain molding available at any lumber yard. Plywood ¾ ins. thick can be used to keep down the weight of the enclosure, provided you use nails and glue to fasten the pieces together. If there is any tendency for the cabinet to vibrate, this can be corrected with one or two braces across the back, but you will probably find that the shelf and the weight of the amplifier will make the enclosure solid enough.

A combination turntable and the preamp-amplifier,

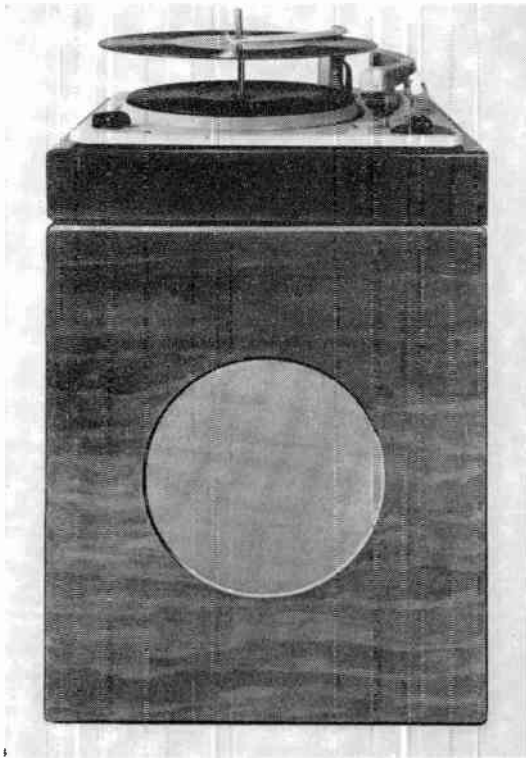

Fig. 4. Complete installation of inexpensive design, using a 10-in. speaker, Collaro changer, and amplifier in the bottom of the enclosure

Fig. 3, makes a unit that is small and easy to transport. The Presto turntable is available in a covered cabinet which can be fastened to a box containing the Scott amplifier. If you have an amplifier of this type in your permanent hi-fi system, you can disconnect it readily, slip it into this portable arrangement, and carry it off for use in the country. You'll find such a unit very handy if you have a speaker set up permanently at your summer home.

Still less expensive is the combination shown in Fig. 4. The enclosure is a plywood box 20 ins. high, 16 ins. wide, by 13 ins. deep, fitted with a 10-in. speaker. There are several good ones of that size, and fairly light in weight. Dimensions of the enclosure are just right to fit the base of the Collaro record-changer. Any trouble due to vibration transferred from the cabinet to the changer can be overcome by putting a sheet of foam rubber or  $\frac{1}{2}$ -in. Celotex under the changer.

If you are willing to forego the use of a preamp, you can mount a plain amplifier on the bottom of the cabinet, and connect it to the switch on the changer so that it will be cut off by the changer switch. Or a switch and pilot light controlling both the changer and amplifier can be mounted on the cabinet.

Without a preamplifier you will need a crystal or ceramic cartridge in order to get higher output. Figs. 5, 6, and 7 show the details of the Collaro pickup head, and the method of mounting an Electro-Voice ceramic cartridge in it. The ceramic type is safe to use at summer homes near the ocean, or on the shore of a lake.

Fig. 5 shows the head as it is furnished originally with the hardware for mounting virtually any type of magnetic, crystal, or ceramic pickup. In Fig. 6, the Electro-Voice ceramic pickup is fastened to the mounting, ready to put in the head, where it is held by a flat-head screw threaded into the metal plate. Fig. 7 shows the cartridge in place. Leads from the pins in the head must be soldered to those on the cartridge. This operation must be carried out with great care, using a hot iron that will melt the solder quickly, before excessive heat can be transferred to the cartridge by the pins.

One more point to consider about taking your music with you on your vacation: People always gather where there's music. And if you want company, you'll have plenty if you buy or build a record player that you can take along wherever you go this summer.

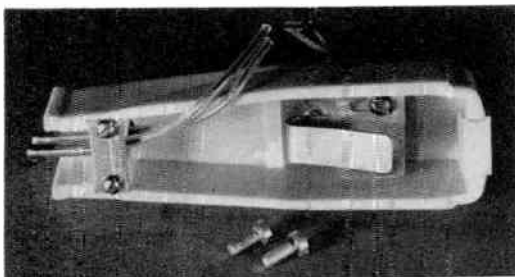

Fig. 5, left: Head of the Collaro tone arm has all the hardware necessary for mounting any conventional type of pickup

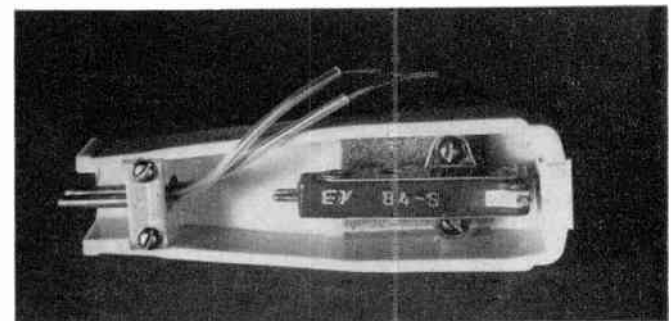
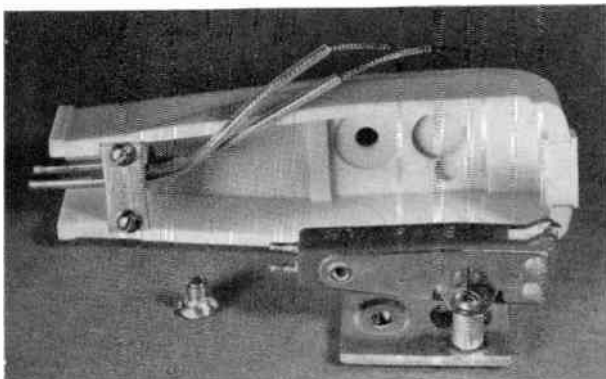

Fig. 6, left: The Electro-Voice ceramic cartridge fastened to the mounting plate. One screw holds it in the head. Fig. 7, above: Assembled plug-in head, ready for soldering the leads

# Directory of Hi-Fi Record & Equipment Dealers

## ALASKA

**Bethel**  
Charlie's Radio Shop, Box 717  
Fairbanks  
Arctic Radio & Record Shop, 520 2nd Ave.

## ARIZONA

**Bisbee**  
The Music Box, Box 340  
**Phoenix**  
Elco Elec. Comm. Co., 202 E. Filmore St.  
Western Radio & Engrg., 1921 E. Washington

## CALIFORNIA

**Berkeley**  
The Audio Shop, 1645 Hopkins St.  
Berkeley Custom Electronics, 2302 Roosevelt  
U. C. Corner, 2350 Telegraph Ave.  
**Beverly Hills**  
Crawfords of Beverly Hills, 456 N. Rodeo Dr.  
**Burbank**  
Valley Electronic Supply Co., 1302 W. Magnolia  
**Glendale**  
The Bartholomews Music, 522 N. Brand Blvd.  
**Hollywood**  
California Sound Prods., Inc., 7264 Melrose  
Pacific Radio Exchange, 1407 Cahuenga Blvd.  
Precision Electronics, 7518 Melrose Ave.  
Rhapsody Record Shop, 1723 N. Highland Ave.  
**Kentfield**  
Catania Sound, 926A Sir Francis Drake  
**Long Beach**  
Custom Sound, 3687 Atlantic Ave.  
Penny-Owsley Music Co., 4334 Atlantic Ave.  
Scott Radio Supply, 266 Alamitas Ave.  
**Los Angeles**  
Arco Electronics, Inc., 103 W. Vermont Ave.  
Fairfax Radio & Elec. Co., 4527 W. Adams Blvd.  
Federated Purchaser, 911 S. Grand Ave.  
Figart's Sound Un-Ltd., 6320 Commodore Sloat  
Gateway to Music, 3089 Wilshire Blvd.  
Henry Radio Co., 11240 W. Olympic Blvd.  
Hollywood Electronics, 7460 Melrose Ave.  
Kierulff Sound Corp., 820 W. Olympic Blvd.  
Magnetic Recorders Co., 7120 Melrose Ave.  
Penny-Owsley Music Co., 3330 Wilshire Blvd.  
Radio Equip. Dist. Co., 1340 S. Olive St.  
Radio Products Sales, Inc., 1501 S. Hill St.  
Recorders Distributing Co., 7115 Melrose Ave.  
Shelley Radio Co., Inc., 2008 Westwood Blvd.  
Universal Radio Sup. Co., 1729 S. Los Angeles  
Weingarten Electronics, 7556 Melrose  
**Menlo Park**  
High Fidelity Unlimited, 935 El Camino Real  
**Oakland**  
Elmar Electronics, Inc., 140 11th St.  
Olin S. Grove, 2904 Telegraph Ave.  
E. C. Wenger Co., 1450 Harrison St.  
**Pasadena**  
Dow Radio, Inc., 1759 E. Colorado St.  
High-Fidelity House, 536 S. Fair Oaks  
The Turntable, 457 E. Green St.  
**Sacramento**  
The Sound Shoppe, Inc., 1910 16th St.  
Tower Record Mart, 1518 Broadway  
**San Diego**  
E. F. Brierley Co., 3781 Fifth Ave.  
**San Francisco**  
Hal Cox Custom Music, 2598 Lombard St.  
Eber Electronics, 160 10th St.  
The Hi-Fi Shop, 3525 California St.  
San Francisco Radio & Sup., 1282 Market St.  
Television Radio Supply Co., 408 Market St.  
West Coast Radio & Elec., 409 Market St.  
Zack Radio Supply Co., 1424 Market St.  
**San Jose**  
T. J. Guiffre Co., 34 N. 3rd St.  
Paramount Sound Co., 343 W. San Carlos  
Peninsula Telev. & Radio Sup., 881 S. 1st St.

**San Luis Obispo**  
Allen's Sight & Sound, 856 Monterey  
**San Pedro**  
Bower's Music, 810 S. Gaffey  
**San Rafael**  
E. B. Abbott Co., 345 Francisco Blvd.  
Marin Music Co., 1331 4th  
**Santa Barbara**  
The Gramophone Shop, 9 E. Canon Perdido  
**Thermal**  
Custom Classics, 82-321 Ave. 56  
**Van Nuys**  
House of Sight & Sound, 14513 Victory Blvd.  
**Whittier**  
Lovell's Radio-TV Section, 175 N. Greenleaf

## COLORADO

**Denver**  
Chas. E. Wells Music Co., 1629 California St.  
**Grand Junction**  
Clark-Steen Music Co.

## CONNECTICUT

**Danbury**  
Heims Music Store, Inc., 268 Main St.  
Shelter Rock Telev., 33 Shelter Rock Rd.  
**Danielson**  
Oliver's Music & Appliance, 31 Main St.  
**Hartford**  
Nathan Margolis Shop, 23 High St.  
Moses Radio Electric Co., 54 Flower St.  
**Naugatuck**  
Conn's Music Shop, 88 Church St.  
**New Haven**  
Dale Electronics Distr., 150 James St.  
David Dean Smith, Inc., 262 Elm St.  
Loomis Temple of Music, 101 Orange St.  
**New London**  
Aikens Electric Supply Co., 428 Bank St.  
**Waterbury**  
The Mattatuck Music Co., 82 E. Main St.  
**Westport**  
Music Systems of Westport, Inc., Post Road  
Reed Sound Studios, Boston Post Road

## DELAWARE

**Wilmington**  
D & M Radio Sales & Service, 215 W. 4th St.  
Radio Elec. Serv. Co. of Pa., 3rd & Tatnall  
Wilmington Elec. Spec. Co., 405 Delaware Ave.

## DISTRICT OF COLUMBIA

**Washington**  
Discount Record Shop, 1327 Conn. Ave., NW  
Electronic Wholesalers, 2345 Sherman Ave., NW  
Hollywood Record Shop, 1706 Columbia Rd., NW  
John Learmont, 1625 Wisconsin Ave., NW  
Shrader Custom Sound, 2803 M St., NW

## FLORIDA

**Coral Gables**  
Hi-Fi Sound Hdqtrs., 1809 Ponce de Leon Blvd.  
**Daytona**  
Moore-Bivens Co., Inc., 220 Seabreeze Blvd.  
**Jacksonville**  
Southeast Audio Co., 930 W. Adams St.  
**Melbourne**  
McHose Electronics, New Haven Ave.  
**Miami**  
Flagler Radio Co., Inc., 1068 W. Flagler St.  
Voice, Inc., 3662 Coral Way  
**St. Petersburg**  
Better Listening Studio, 24 Beach Dr. North  
**Sarasota**  
Radio Center, 302 S. Orange Ave.

## GEORGIA

**Atlanta**  
Baker Fidelity Corp., 429 Peachtree St., NE  
Buckhead Telev. Serv. Center, 3181 Peachtree  
High Fidelity SSS, 606 Peachtree St., NE  
**Augusta**  
Prestwood Electronic Co., 1445 Greene St.

## ILLINOIS

**Champaign**  
The New Sound, 35 E. Springfield Ave.  
**Chicago**  
Allied Radio Corp., 111 N. Campbell  
Arpio Sales, Inc., 4305 N. Lincoln Ave.  
Audio Arts Assoc., 1323 S. Michigan Ave.  
Audio Workshop, Inc., 725 S. LaSalle St.  
Chicago Electronics Distr., 420 E. 87th St.  
Columbia Sound Engineers, 2702 W. Diversey  
Crittenton's TV & App., 4740 N. Broadway  
De Haan Camera Co., 1655 W. 79th St.  
Lowe's Radio Co., 1233 E. 55th St.  
The Lukko Sales Corp., 5024 Irving Park Blvd.  
Marquette Records, 3215 W. 63rd St.  
Newark Electric Co., 223 W. Madison  
Olson Radio Wholesale, 623 W. Randolph St.  
Voice & Vision, 53 E. Walton St.  
**Decatur**  
York Radio & Telev. Corp., 801 N. Broadway  
**Hinsdale**  
Village Music Shop, 18 First St.  
**Mattoon**  
Kuehne Mfg. Corp.

## INDIANA

**Columbus**  
Ernie's Record Shop, 910 25th St.  
**Indianapolis**  
Graham Elec. Supply, Inc., 102 S. Penna St.  
**Lafayette**  
Golden Ear, 610 Main St.

## IOWA

**Council Bluffs**  
World Radio Laboratories, West Broadway

## KANSAS

**Emporia**  
Phil Woodbury Hi-Fi Sound  
**Kansas City**  
Morrell Electronics, 820 Roswell Ave.  
**Wichita**  
The Bennett Music House, 206 E. Douglas

## KENTUCKY

**Covington**  
Customcrafters, Inc., 1028 Russell St.  
**Louisville**  
Lewis Radio & Sound, 266 W. Liberty Ave.

## LOUISIANA

**Baton Rouge**  
Louisiana Radio & Telev., 1645 Plank Rd.  
Ogden Park Record Shop, 618 N. 3rd St.  
**Lake Charles**  
Zypien's Record Shop & Music Center  
**New Orleans**  
Custom Electronics, 813 Chartres St.

## MAINE

**Portland**  
Bartlett Radio Co., 8 Longfellow St.



# G. A. SPECIALTIES for hi-fi music systems

To help you make sure that you select the correct networks for finest performance from your particular speaker system, the following information is presented on two and three-speaker types, using either G.A. fixed networks or the new G.A. Variable Audio Crossover Controls.

## G.A. FIXED NETWORKS

**High-Quality Performance:** The circuit designs and components furnished for G.A. networks represent the very best audio engineering practice. They provide these essentials of true high-fidelity performance: 1) Selectivity giving 12 db droop per octave. 2) Losses are held to a minimum by the use of air cores and No. 16 wire. 3) Inductance values are extremely accurate, and coils are unconditionally guaranteed against shorted turns. 4) Individual level controls permit exact balancing of the speakers.

General Apparatus Company is probably the largest manufacturer of high-precision network inductors. G.A. quality control assures you of the finest performance, at prices which reflect economies due to quantity production.

**Two-Speaker Systems:** First, decide on the crossover frequency you want, and check the impedance of the *low-range* speaker.

Select the network you require from the Table, according to the impedance of the *low-range* speaker. It is not necessary that both speakers be of the same impedance, but one should not be more than twice the impedance of the other. With an Air-Coupler for the bass, a crossover of 175 cycles is generally used, or 350 cycles if the bass speaker is in a conventional cabinet.

**Three-Speaker Systems:** Two networks are required for three-speaker systems. Network A should have the same impedance as the bass speaker, and network B, the same impedance as the mid-range speaker. Usually a crossover of 1,100 or 2,200 cycles is chosen for network B.

Impedance of low-frequency speaker	Crossover Frequency	Order by 2 Coils	Price Only	Price Complete*
16 ohms.....	4,400	No. 1A	\$ 5.75	\$ 9.50
	2,200	1	7.00	11.50
	1,100	2	7.00	12.00
	350	4	12.00	17.50
	175	5	20.00	24.00
8 ohms.....	2,200	6A	5.75	9.70
	1,100	6	7.00	12.00
	350	8	12.00	17.50
	175	9	20.00	24.00
	85	10	20.00	26.50
4 ohms.....	275	12	7.00	15.00
	175	13	12.00	19.00

\* Complete networks include necessary capacitors and level controls. Be sure to indicate whether you want just the coils or the complete network.

**Network Circuits:** Complete information is supplied with each G.A. network. Connections are so simple that the components can be hooked up in a few minutes. If you are in doubt about the correct network for your particular system, send 10¢ for the G.A. Network Data Sheet.

## G.A. V-A-C CONTROLS

The Variable Audio Crossover Control is an exclusive G.A. development. Types for two and three-speaker systems permit the adjustment of the crossover at any point between 90 and 1,100 cycles (Type A) or 900 to 11,000 cycles (Type B).

Thus it is possible to determine the optimum point, or points, *after your speaker system has been installed*. If, at any time, you want to experiment with other speakers, you can shift to any other crossover by merely resetting the calibrated control knob.

**Completely Flexible Controls:** The V-A-C is a tube-operated device, complete with its own power supply. In addition to the calibrated control knob, there are individual adjustments for setting the level of each speaker independently of the other. Over-all volume can be regulated from the preamplifier. Since the V-A-C has a possible gain of 5, power amplifiers can be operated at minimum distortion. No measurable distortion is introduced by the V-A-C.

**V-A-C Control for Two Speakers:** The V-A-C can be used with any standard preamplifier and power amplifiers. Use an amplifier of 20 to 50 watts for the low-range, and 10 to 20 watts for the high-range. Order V-A-C Control Type A.

**V-A-C Controls for Three Speakers:** Using a combination of Type A and B Controls, with three speakers, the crossover points can be varied from 90 to 1,100 cycles, and from 900 to 11,000 cycles. The high-range amplifier should be of 5 to 10 watts.

This is the ideal speaker system, permitting unequalled flexibility of control, delivering the finest performance that money can buy. Order V-A-C Types A and B.

**V-A-C Prices, Deliveries:** The V-A-C is supplied in kit form, including all components, a handsomely-finished aluminum chassis 10 by 5½ by 3 ins., one 6SN7GT and one 5W4GT, and an instruction book with picture wiring diagrams and step-by-step instructions. As far as possible, deliveries are made from stock. Price, Type A or Type B, \$39.95, plus 75¢ mailing.

**V-A-C Instruction Book:** The V-A-C Instruction Book is available at \$1.00 postpaid. You may deduct that amount later from the price of a V-A-C.

## NEW AIR-COUPLER PRICES

Air-Coupler installations, now numbered in the thousands, are rated by the most critical audio enthusiasts as the finest enclosures for bass reproduction for 2-speaker and 3-speaker systems. Moreover, the Air-Coupler, with a high-quality 12-in. speaker, is the least expensive means of obtaining full bass reproduction down to 28 cycles.

**Unequalled Bass Reproduction:** Unlike conventional speakers, it is not necessary to turn up the volume in order to hear the full bass. With an Air-Coupler, you can turn down the volume to bare audibility and still hear the bass in true proportion. Dimensions of enclosure, 72 by 16 by 6 ins.

**New, Lower Prices:** Effective May 1st, the price of the knocked-down Air-Coupler, with the opening cut for a 12-in. speaker, is reduced to \$29.50, and the assembled Air-Coupler, ready for mounting the speaker, is reduced to \$39.50. Immediate delivery from stock.

## deMARS STYROCONE SPEAKERS

G.A. offers the deMars Styrocone Speaker with the guarantee that it will give more accurate reproduction than any other cabinet speaker or folded horn design selling under \$750. This is not an idle claim, but a guarantee based on actual A-B tests. It provides extended bass range, smooth performance in the middle range, and clean, clear treble quality.

**The Styrocone Design:** The remarkable accuracy of reproduction obtained from the deMars speaker is due to 1) the use of a vibrating surface 20 by 20 ins., equal to the cone area of five 12-in. speakers, 2) the concentric-coupling construction of the vibrating surface, and 3) use of four separate direct radiators for wide-angle distribution of high frequencies.

deMars Styrocone speakers are available in wall or corner cabinets, or the Styrocone speaker with 4 tweeters and network can be purchased unmounted. All cabinets are *solid* mahogany, finished in colors of red mahogany, walnut brown, or blond.

**Prices of deMars Speakers:** G.A. can make immediate shipment of deMars Styrocone speakers. The price for the wall or corner cabinet, in the finish you select, is \$450, subject to the guarantee above. The Styrocone speaker, networks, and 4 tweeters unmounted are \$250 complete.

# GENERAL APPARATUS COMPANY

219 MAIN STREET, SHEFFIELD, MASSACHUSETTS Tel.: 9-8475

May-June 1954

51

## MARYLAND

Annapolis  
Albright's, Custom Music Dept., 78 Maryland Ave.  
Baltimore  
American Distri. Co., 2 N. Howard St.  
American Telev. Co., 1200 N. Fulton Ave.  
Customcraft Studios of Park Radio & TV,  
323 N. Charles St.  
Custom Music Systems, 2326 N. Charles St.  
General Radio Service, 3 S. Howard St.  
Music House, 5855 York Rd.  
Park Radio & Telev. Co., 323 N. Charles St.  
Radio Elec. Serv. Co., 5 N. Howard St.  
Reed's Record Shops, Inc., 768 Washington St.  
Wholesale Radio Parts Co., 308 W. Redwood St.

## MASSACHUSETTS

Boston  
DeMambo Radio Supply Co.,  
1095 Commonwealth  
The Listening Post, 161 Newbury St.  
A. Marks & Co., 77 Summer St.  
Moshier Music Co., 181 Tremont St.  
Radio Shack Corp., 167 Washington St.  
Radio Wire Telev. Inc., 110 Federal St.  
Yankee Electronics, 257 Huntington Ave.  
Cambridge  
Sheldon Distr. Co., 800 Massachusetts Ave.  
Fall River  
E. A. Ross & Co., 341 Columbia St.  
Lunenburg

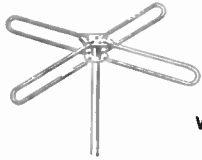

### FM RECEIVING ANTENNAS

Standard and  
Special Designs  
WHOLESALE SUPPLY CO.  
Lunenburg, Mass.

Melrose  
Melody Ranch Music Shoppes  
New Bedford  
E. A. Ross & Co., 1663 Purchase St.  
Pittsfield  
Pittsfield Radio Co., 41 West St.  
Springfield  
Freedman Custom Audio Lab., 1225 Main St.  
Regent Sales, Inc., 236 Chestnut St.  
Soundco Electronic Supply Co., 47 Dwight St.  
Taunton  
David B. Dean & Co., 85 Cohasset St.  
Waltham  
Dorrington Press, 233 Riverview Ave.  
  
**MICHIGAN**  
Ann Arbor  
Ann Arbor Music Shop, Inc., 300 S. Thayer  
Purchase Radio Supply, 605 Church St.  
Birmingham  
MacCullen & Dean, 409 E. Maple Ave.  
Detroit  
Audio House, Inc., 19771 Conan  
Communicating Systems Co., 16261 Hartwell Ave.  
The Glen Music Shop, 14127 Gratiot  
Grinnel Brothers, 1515 Woodward Ave.  
Haco Distributing Co., 9730 Burnette  
K. L. A. Labs., Inc., 7422 Woodward Ave.  
Knight Distributing Co., 8300 Fenkell Ave.  
Modern Record Shop, 15356 Livernois  
Reno Radio Co., 1314 Broadway  
Ferndale  
Erickson's Electronics, 23525 Woodward  
Flint  
Flint Home Furnishing Co., 121-127 Kearsley W  
Jensen, Inc., 501 N. Saginaw St.  
Grand Rapids  
Radio Parts, Inc., 720 Division Ave., S.  
Lansing  
Tape Recording Industries, 3335 E. Michigan  
Laurium  
Northwest Radio of Mich., 435 Tamarack St.

Livonia  
Hi-Fi Records & Systems, 31685 Plymouth  
Sault Ste. Marie  
John P. LeBlanc, 321 E. Spruce St.

## MINNESOTA

Minneapolis  
Anderson's Gifts & Records, 44 W. 66th  
Lew Bonn Co., 1211 LaSalle Ave.  
Disc & Needle Record Shops, 1439 W. Lake  
Electronic Center, Inc., 107 3rd Ave. N.  
St. Paul  
Gopher Electronics Co., 370 Minnesota St.

## MISSOURI

Independence  
Don Cook's Electronic Equip., 1020 W. Truman Rd.  
Kansas City  
Barnard's, 4724 Broadway  
Springfield  
Barry Reed Radio & Supply Co., 805 Boonville

### NOTICE TO DEALERS

Listings in this Directory are available without charge to hi-fi record and equipment dealers as a service to our readers. If you operate a hi-fi record or equipment store, and do not find your company listed, please write to the Directory Editor, MUSIC at HOME Magazine, 207 E. 37th Street, New York City 16. Information for qualifying for a listing in this Directory will be sent to you at once.

## NEBRASKA

Lincoln  
Program Service Co., 1213 M St.  
Omaha  
Moss Recording Studios, 1910 California St.

## NEW HAMPSHIRE

Manchester  
DeMambo Radio Supply Co., 1308 Elm St.  
Radio Service Lab., 670 Chestnut St.

## NEW JERSEY

Camden  
Radio Electric Serv. Co., 513-15 Cooper St.  
East Orange  
Creative Audio Associates, 150 S. Harrison St.  
Custom Music Systems, 225 N. 18th St.  
International Distr. Co., 185 Central Ave.  
Montclair  
Perdue Radio Co., 8 S. Park St.  
Morristown  
M & M Telev. Co., Inc., 7 Maple Ave.  
Newark  
Federated Purchaser, Inc., 114 Hudson St.  
Hudson Radio Co., 35 William St.  
Radio Wire Telev., Inc., 24 Central Ave.  
New Brunswick  
William Radio Supply Co., 265 Woodbridge Ave.  
Paramus  
Music Age, Inc., Route 4  
Paterson  
TV & Electronics Co., 152 Paterson St.  
Plainfield  
Union Television Parts Co., 403 Watchung Ave.  
Princeton  
Princeton Listening Post, 164 Nassau St.  
Princeton Music Center  
Princeton University Store  
Ridgefield  
Melody Shop, 181 Main St.  
Trenton  
People's Radio, 558 N. Clinton Ave.

## NEW MEXICO

Albuquerque  
Sound Engineering & Equip., 601½ Yale Blvd. SE

## NEW YORK

Albany  
Bell-Tone Sound Corp., 11 N. Pearl St.  
Fort Orange Radio Distr. Co., 904 Broadway  
Hi-Fidelity Centre, Home Savings Bldg.  
Ofisonde, Inc., 380 Clinton Ave.  
Astoria  
Howard Music Co., 31-89 Steinway St.  
Bayshore  
Long Island Elec. Sup. Corp., 226 E. Main St.  
Bellmore  
Rand Radio & TV, 223 Bedford Ave.  
Binghamton  
Audio Service Co., 145 State St.  
Stack Electronics, Inc., 4 E. Clinton St.  
Brooklyn  
BenRay Electronics Corp., 485 Coney Island Ave.  
Brooklyn Hi-Fi Sound Center, 2128 Caton Ave.  
Green Radio Distr., 472 Sutter Ave.  
Buffalo  
F. M. Sound Equipment Corp., 254 Genesee St.  
Radio Equipment Corp., 147-151 Genesee St.  
Flushing  
S. Friedland, 140-24 Franklin Ave.  
Glen Falls  
Ray Distributing Co., 284 Glen St.  
Hempstead  
Island Radio Distributor, Inc., 412 Fulton Ave.  
Jamaica  
Peerless Radio Dist., Inc., 92-32 Merrick Rd.  
Long Island City  
Electronic Supply Corp., 4108 Greenpoint Ave.  
Mt. Vernon  
Morwin Music Center, 9 Gramerton Ave.  
New York  
Alro Radio & Music Shop, 222 W. 50th St.  
Arrow Electronics, 65 Cortland St.  
Asco Sound Corp., 115 W. 45th St.  
Bennett Radio, 565 3rd Ave.  
Bryce Appliance & Record Shop, 110 W. 40th St.  
Custom Television Co., 1947 Broadway  
Dorosin Distributing Corp., 149 W. 13th St.  
Electronic Workshop Sales, 26 W. 8th St.  
Elgot Sales Corp., 859 Madison Ave.  
Federated Purchaser, Inc., 66 Day St.  
Fischer Distributing Co., 18 Duane St.  
Goody Audio, 235 W. 49th St.  
Grand Central Radio, 124 E. 44th St.  
Harvey Radio Co., Inc., 103 W. 43rd St.  
Haynes-Griffin Ltd., 420 Madison Ave.  
Heins & Bolet Co., 68 Cortland St.  
Hudson Radio Co., 48 W. 48th St.  
Hudson Radio Co., 212 Fulton St.  
Int'l Audio & Record Exchange, 1101 Lexington  
Leonard Radio, Inc., 69 Cortland St.  
Magic Vue Television Corp., 323 E. 13th St.  
Midway Radio & TV Corp., 60 W. 45th St.  
Milo Radio & Electronic Corp., 200 Greenwich St.  
Music Masters Records, 53 W. 47th St.  
Niagara-Concord Corp., 55 Vesey St.  
Pro-Sound Corp., 175 5th Ave.  
Radio Row Electronics Corp., 172 Greenwich St.  
Radio Wire Telev., Inc., 100 Sixth Ave.  
Stan-Burn Co., 1697 Broadway  
Sun Radio & Elec. Co., Inc., 650 6th Ave.  
Terminal Radio Corp., 85 Cortland  
Thalia Hi-Fi Audio Co., 250 W. 95 St.  
Rochester  
Craig Audio Laboratory, 12 Vine St.  
Jerry Fink Co., 358 Averill Ave.  
Masline Radio & Elec. Equip. Co.,  
192-196 Clinton Ave., N.  
Music Lovers Shoppe, 370 E. Main St.  
Raslyn Hill  
Segen Electronics, Inc., 118 Glen Cove Rd.  
Scarsdale  
Garth Radio, Inc., 74 Garth Rd.



## Which Records are HI-FI?

You spent a lot of money and a lot of energy  
to get true-to-life performance on your hi-fi set.  
You can only be sure of getting it with records  
that are specifically made for hi-fi reproduction.

Of the thousands upon thousands of records  
available, which ARE hi-fi records?

There's one place . . . and one place only . . .  
where you can find the answer:

### \*The HARRISON HIGH FIDELITY RECORD CATALOG

It's complete, concise, compiled for easy  
reference.

Ask your neighborhood record shop for  
The Harrison High Fidelity Record Catalog  
(or write to Harrison Catalogs, 274  
Madison Ave., New York 16, New York,  
enclosing 10c for handling) . . . then you  
can be sure of 100% hi-fi enjoyment!

\*By the Publishers of Record Retailing • The Opera  
Catalog • The Children's Catalog • The EP 45 RPM  
Catalog • The Convention Daily of the National  
Association of Music Merchants.

# PRECEDENT

# *fabulous!*

► Here, at last, is a new FM tuner by perfectionists for perfectionists! PRECEDENT sets the pace among all tuners with its distinct superiority on every worthwhile performance feature.

► Radio Engineering Laboratories receivers are in use at all monitoring stations of the Federal Communications Commission, and by virtually every FM station and network. PRECEDENT actually exceeds the legendary performance of earlier REL receivers, while introducing new advantages for home use.

► Write today to discover why such superlative performance and beauty make PRECEDENT the world's most wanted FM tuner.

## **RADIO ENGINEERING LABORATORIES • INC.**

36-40 Thirty-seventh Street • Long Island City 1, N. Y.



## **Hi-Fi Record and Equipment Dealers**

Schenectady  
Concert-Craft, Inc., 1138 Waverly Place  
Syracuse  
W. E. Berndt, 655 S. Warren St.  
White Plains  
High Fidelity Center, 367 Mamaroneck Ave.  
Woodmere  
Long Island Radio & TV, Inc., 942 Broadway  
Yonkers  
Elradco, 529 S. Broadway  
Westlab, 1587 Central Ave.

### **NORTH CAROLINA**

Chapel Hill  
Abernathy's, 205-207 E. Franklin St.  
Charlotte  
Joe Little Record Shop, 115 S. Church  
Music, Inc., 212 N. Independence  
Morganton  
Thomas Music Shop  
Raleigh  
Southeastern Radio & Supply Co., 411 Hillsboro  
Winston-Salem  
Long Engineering Co., 31-33 Burke St.

### **OHIO**

Akron  
Electronic Engineering Co., 362 W. Bowery St.  
Main TV Supply Co., 1013 N. Main St.  
Canton  
Burroughs Radio Co., 711 Second St., NW  
Cincinnati  
Customcrafters Audio, Inc., 2259 Gilbert Ave.  
Rex Dale, 4114 Francis Ave.  
Steinberg's, Inc., 633 Walnut St.  
Cleveland  
Counterpoint, Inc., 20971 Westgate  
Custom Classics, 13421 Euclid Ave.  
Pioneer Radio Supply Co., 2115 Prospect Ave.  
The Progress Radio Supply Co.,  
413-415 Huron Rd.  
Publix Book Mart, 930 Prospect Ave.  
Radio & Electronics Parts Corp., 3235 Prospect  
Columbus  
Anderson's High Fidelity Sound Center,  
2244 Neil Avenue  
Electronic Supply Corp., 134 E. Long St.  
Whitehead Radio Co., 118-124 S. Long St.  
Toledo  
Sweeny Sound, Inc., 1758 Sylvania Ave.  
Warren Radio Co., 1002 Adams St.

### **OREGON**

Eugene  
Abar Radio & Television, 298 W. Broadway  
Portland  
Appliance Wholesalers, 600 NW 14th Ave.  
Salem  
Cecil Farnes & Co., 428 Court St.  
The Salem Record Shop, Oregon Bldg.

### **PENNSYLVANIA**

Allentown  
Federated Purchaser, Inc., 1115 Hamilton St.  
Norman D. Steedle Co., 1005 N. 19th St.  
Harrisburg  
D & H Distributing Co., 2535 Montgomery Ave.  
Hazleton  
S. J. Pensock, 136 N. Wyoming  
Lancaster  
John H. Troup Music House, 38 W. King  
Merion  
Hi-Fidelity Sound Corp., 368 Montgomery Ave.



## Hi-Fi Record and Equipment Dealers

Philadelphia

in the PHILADELPHIA area

YOUR COMPLETE SUPPLIER IS **Radio Electric SERVICE CO. OF PENNA., INC.**

HI-FI & COMMERCIAL SOUND STUDIO  
709 Arch Street, Philadelphia 6, Pennsylvania  
Phone: LOmbard 3-7390

Allied Appliance Parts, Inc., 3640 Elder St.  
Almo Radio Co., 412 N. 6th St.  
Audio Electro Co., 4923 N. Broad St.  
Danby Radio Corp., 19 S. 21st St.  
Friends, 106 N. 6th St.  
Lectronics, City Line Center  
Penn Electronic Parts Co., 5303 Frankford Ave.  
Radio 437 Store, 437 Market St.  
The Radio & Television Shop, 7205 Lincoln Dr.  
Radio Electric Serv. Co. of Penna., 7th & Arch  
The Record Shop, 251 S. 15th St.  
Walker Radio Serv. & Sales, 3rd & Fern Sts.

Reading

George D. Barbey Co., 2nd & Penn Sts.

Roslyn

High-Fidelity Music Center, 1373-83 Easton Rd.

York

York Radio & Refrigeration, 263 W. Market St.

### RHODE ISLAND

Providence

DeMambro Radio Supply Co., 90 Broadway

### SOUTH CAROLINA

Charleston

Radio Laboratories, 215 King St.

Greenville

Arthur Rixon & Son, 209 W. Washington St.

### TENNESSEE

Memphis

Electronic Supply, Inc., 1100 Union Ave.  
Ferguson's Record Shop, 173 South Cooper St.

Nashville

D. N. Distributing Co., 105 8th Ave. N.  
Electra Distributing Co., 1914 W. End Ave.

Oak Ridge

The Music Box, 5 Broadway, Box 225

### TEXAS

Amarillo

West Texas Radio Supply, 1026 W. 6th

Dallas

Crabtree's Wholesale Radio, 2608 Ross St.  
Ernstrom's Record Shop, 4356 Lovers Lane

Denison

Logan's Music Shop

Fort Worth

Audio Associates, 2804 Race St.

Houston

Audio Center, Inc., 1633 Westheimer  
Busacker Elec. Equip., Co., 1721 Waugh Dr.  
Business Music, Inc., 403 Cotton Blvd.  
Gulf Coast Electronics, 1110 Winbern St.  
Southwest Record Sales, 4710 Caroline  
Sterling Radio Prods., Co., 1616 McKinney Ave.  
The Wrye Co., 2045 Welsh St.

San Antonio

Electronics, Inc., 512 Broadway  
Texas TV Stores, 506 W. Hildebrand Ave.

Wharton

Sound Haven, Box 668

### UTAH

Salt Lake City

O'Loughlin's Radio Supply, 113 E. 3rd South St.



## You are FRONT ROW CENTER...

### with FAIRCHILD's High Compliance Diamond Cartridge

Now—you hear for yourself—new brilliancy in recorded sound reproduction made possible by the Fairchild Series 215. This remarkable high-compliance cartridge brings amazing life like quality to the most delicate nuances of recorded sound and eliminates completely listening fatigue caused by tracking distortion. *Compare.* You'll select Fairchild professional quality at

ONLY \$37.50

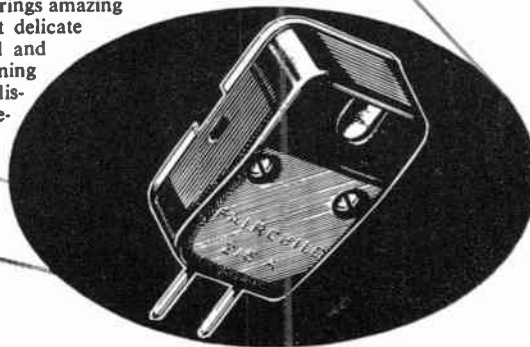

### with FAIRCHILD's Plug-in Type Transcription Arm

Only by eliminating the adverse effects of arm resonance can records sound their best. Fairchild's new transcription arm allows the cartridge alone to lift all of the tone color from high-fidelity recordings. Dual pivoting plus a precision engineered offset provide continuous mid-groove tracking. And an automatic built-in arm rest safeguards the stylus. Any standard cartridge slides into this professional quality Series 280. An exceptional value at

\$29.50

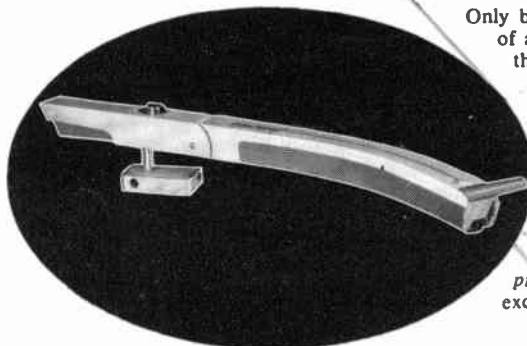

### with FAIRCHILD's Balanced-Bar Preamplifier-Equalizer

Imagine—tailoring your high fidelity system to your listening room characteristics. It's all possible with Fairchild's new Model 240 Balanced-Bar Preamplifier-Equalizer. This exclusive feature results in simplicity of operation, yet allows full professional flexibility of control for the unusual record. Complete record compensation and gain controls. Four dual-triode tubes plus built-in rectifier. And, just as important, decorator styling keyed to today's living. Net to users,

\$98.50



SEE YOUR AUDIO DEALER or for free folder write:

**FAIRCHILD RECORDING EQUIPMENT**

156th STREET & 7th AVE., WHITESTONE, L. I., N. Y.

# Tested

## AGAIN and AGAIN

45 times by factory experts to provide and insure consistent HIGH FIDELITY PERFORMANCE

### Only craftsmen

does this . . . each and every tuner must perform with less than 1/2% intermodulation distortion at 100% frequency modulation when tested from antenna to audio output.

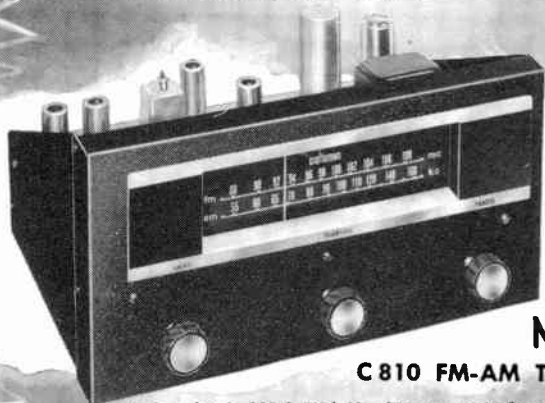

**New!**

#### C 810 FM-AM Tuner

A new basic High Fidelity Tuner with flat audio output response. Featuring: Sensitive FM, 4 $\mu$ v for 30 db quieting. Automatic Frequency Control (no drift) on FM simplifies tuning. Frequency response,  $\pm 1/2$ db, 20 to 20,000 cps. Distortion — FM, 1/3% at 100% modulation. Cathode-follower audio output for remote installations.



#### New C 800A FM-AM Tuner

(same as C 810 with additional features)

Built-in phono preamplifier and record equalizer. Front-panel selected equalization for AES, LP or EUROpean recording characteristics. Double-shadow tuning eye. Bass and treble controls continuously variable up to 15 db attenuation or boost.



**Craftsmen CA1 Assembly**—a complete HiFi home music system. Ready to install with all cables, hardware, escutcheons and detailed plans. \$275 net.



Get new booklet on High Fidelity by DEEMS TAYLOR. Ask your Supplier or write to us . . . enclose 10c to cover handling and mailing.

Department M5

THE RADIO **craftsmen** INCORPORATED

4403 North Ravenswood Ave., Chicago 40, Ill.

## Hi-Fi Record and Equipment Dealers

### VIRGINIA

Alexandria  
John Learmont, 202 King St.  
Charlottesville  
Virginia Radio Supply Co., 715 Henry Ave.  
Norfolk  
Electronic Engineering Co., 316 W. Olney Rd.  
The Music Center, 123 College Place  
Radio Sales & Service, 416 Monticello Ave.  
Petersburg  
Electronic Supply Co., Inc., 13 E. Washington  
Richmond  
Audio Workshop, 5813 Crestwood Ave.

### WASHINGTON

Puyallup  
Music Shop, 111 W. Main St.  
Seattle  
High Fidelity Hi-Fi Hdqtrs., 603 Broadway N.  
Radio Products Sales Co., 1214 First Ave.  
Seattle Radio Supply Co., 2117 Second Ave.  
Spokane  
E. M. Johnson Co., W. 615 First Ave.  
Twentieth Century Sales, W. 1021 First Ave.  
Tacoma  
Wm. T. Raymond & Associates  
17 Oak Park Dr., SW

### WEST VIRGINIA

Wheeling  
James M. Black & Sons, 952 Market St.

### WISCONSIN

Appleton  
Valley Radio Distr., 418 Appleton St. N.  
Delavan  
Larson's Electric Shop, 110 Walworth Ave.  
Milwaukee  
Marsh Radio Supply Co., 838 N. 4th St.  
Photoart Visual Service, 840 N. Plankinton Ave.  
Television Parts, Inc., 714 W. State St.

### ALBERTA

Lethbridge  
Leister's, Paramount Theatre Bldg.

### ONTARIO

Hamilton  
Hurst's Record Bar, 233 Ottawa St. N.  
Toronto

### IN CANADA—

There's one place where you can find — and hear — all your high-fidelity equipment needs. We carry a complete stock . . . come in, or write in, for a chat, a look, and a listen.

**ELECTRO-VOICE**  
SOUND SYSTEMS  
141 Dundas St., West, TORONTO

Custom Sound & Vision, Ltd., 390 Eglinton West  
Electro-Voice Sound Systems, 141 Dundas St., West  
Roher's Book Shop, 15 Bloor St., West

### SASKATCHEWAN

Regina  
National Musical Supply Co., 1780 Hamilton St.

### CUBA

Havana, Vedado  
"California" Alta Fidelidad, LaRompo 23Y "P"

## Ideas For You

(Continued from page 8)

plifier. Identified as model CM-2001, it is rated as flat within 3 db from 30 to 15,000 cycles. It is omnidirectional, blast-proof, and unaffected by moisture. *Frank L. Capps & Co., Inc., 20 Addison Place, Valley Stream, N. Y.*

### Tape Splicer

To speed the work of splicing tape, and to make it easier for those who have trouble making smooth joints, Yale has brought a splicer which first cuts a diagonal joint and then, while the two parts of the tape are held in place by spring fingers, trims the splicing tape neatly in such a way that the joint will pass through the recorder mechanism smoothly. Standard model is for 1/4-in. tape. *Yale Industries Corp., 82-09 251st Street, Bellerose 26, N. Y.*



### Portable Tape Recorder

This 8-lb. tape recorder, operating from dry cells, is designed to operate continuously for 25 hours. The electric motor is equipped with a fly-ball governor to maintain constant speed during the life of the batteries. Tubes are sub-miniature types. Up to 4 hours of recording can be made with a 5-in. reel of tape, at 1 5/16 ips. *Amplifier Corp. of America, 398 Broadway, New York 13*

### Audio Equipment Catalog

A general catalog No. 44BA has been issued by Shure Brothers. Illustrations and design data are presented on all types of microphones and accessories, crystal pickups and needles, tape and wire recording heads, and crystal and ceramic pickup cartridges. There are also replacement charts for the recording heads and cartridges. *Shure Brothers, Inc., 225 W. Huron St., Chicago 10*

### Private Ear for TV

Hoffman TV sets are now equipped with Spacephone connections so that children can listen to their TV shows with headphones! A special plug is provided for as many as four children listening together. Other phones are available for the hard-of-hearing. *Hoffman Radio Corp., Los Angeles, Calif.*

(Concluded on page 58)

May-June 1954

# “Diamond needles prove best by actual scientific test and measurement”

— Harold D. Weiler

## DIAMOND NEEDLES



new      after 38 hours of playing      after 87 hours of playing      after 1538 hours of playing

Note: This needle shows less wear than the sapphire after 38 hours of playing shown below.

## SAPPHIRE NEEDLES



new      after 3 1/2 hours of playing      after 17 hours of playing      after 38 hours of playing

“The preceding tests have proved conclusively the superiority of the diamond tipped stylus from the standpoint of economy, preservation of records, and the quality of reproduction over a given period of time.”

Published as a public service by

# TETRAD

World's Largest Producer of Diamond Styli  
Supplier to Manufacturers of Pick-Up Cartridges and Phonographs

62 St. Mary Street, Yonkers 2, New York

Tests, statements, and photographs reprinted from “The Wear and Care of Records and Styli” by Harold D. Weiler. Published by Climax Publishing Co., 17 East 48th Street, New York 17, N. Y. We recommend this authoritative book on proper record care written in understandable, non-technical language. It contains information vital for the protection of your valuable records. Available at your local dealer.

## WANTED for PUBLICATION: PHOTOS of INTERESTING HI-FI INSTALLATIONS

MUSIC AT HOME Magazine will pay \$10.00 each for acceptable photographs of amateur and professional hi-fi installations made in private homes or public places. Here are the simple rules:

1. Photos must be clear, sharp, undistorted. Glossy prints are required, 8 by 10 ins.
2. Include photos of any special features or details of construction. Each picture must be accompanied by a brief description of the equipment, and the name of the individual or company by whom the installation was made. The pictures will be so identified.
3. For each photo used, MUSIC AT HOME will pay \$10.00 promptly on publication. Acceptable photos not used at once may be held over for a subsequent issue. Published photos will not be returned. Those which are not acceptable will be returned only if they are accompanied by return postage. MUSIC AT HOME will not be responsible for loss or damage to photographs submitted.

## MUSIC at HOME

Hi-Fi House, 207 East 37th Street, New York 16, N. Y.

## Ideas For You

(Continued from page 57)

### Dynamic Noise Suppressor

A new 4-tube unit is designed to suppress rumble, record scratch, and hiss in wide-range music systems. One control adjusts the degree of noise suppression, while the other selects the cutoff frequency at 20, 12, and 6 kc. A fourth position cuts in the rumble suppressor only. The dynamic action restricts the bandwidth only during soft passages when the ear is relatively insensitive to extremely low and high frequencies, and opening the band to the full width during loud passages when the music masks the rumble or hiss. *H. H. Scott, Inc., 385 Putnam Ave., Cambridge 39, Mass.*

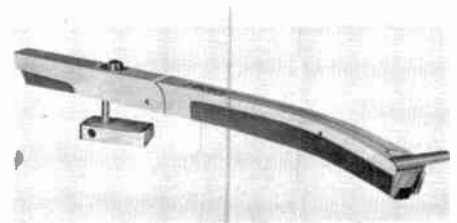

### Transcription Tone Arm

The professional-type plug-in arm shown above takes any standard cartridge. This new design features dual pivoting to assure tracking on LP's, elimination of resonance effects due to the arm, and an automatic built-in rest to protect the cartridge and stylus. *Fairchild Recording Equipment Co., 156th and 7th Ave., Whitestone N. Y.*

### Pre-Recorded Tape

Because high-quality recordings on tape are more expensive than LP discs, the question is coming up as to the advantages represented by the higher cost of the tapes. Here are the essential differences:

1. A wider audio range is recorded on fine tapes than on commercial discs. Reproduction of the full range from such tapes requires, of course, corresponding excellence in the recorder and reproducing equipment.

2. A wider dynamic range (volume) can be recorded on tape. Because the background noise is so low on tape, it is not necessary to boost the soft passages artificially, and the tape can take the full volume on loud passages. The higher noise on discs, and the need of limiting the lateral swing of the stylus call for boosting the low level and reducing the high level of music on discs.

3. Handled properly, audio quality does not deteriorate on tape as the result of repeated use. Discs, on the other hand, are subject to added wear each time they are played. A tape should not give audible evidence of wear after it has been played 1,000 times.

4. In general, a tape is less liable to be damaged accidentally. Even if it is broken, a tape can be mended, but a scratched record must be thrown away.

# The NEW



# BROOK

## MODEL 22A

*Is Creating A Sensation!*

- so dramatically different, it's a new concept in amplifier design.
- so functionally compact, it simplifies any installation.
- so exceptionally attractive, it captivates at first glance.

**• But, FOREMOST, so genuine in HIGH QUALITY AUDIO PERFORMANCE, despite its unprecedented low cost.**

SEE and HEAR the New Model 22A at your local dealer's Sound Department soon. A listening treat awaits you. Write today for free technical information.

10-watt single-chassis power and pre-amplifier combination  
Dept. MH-4

34 DeHART PLACE **BROOK ELECTRONICS, INC.** ELIZABETH 2, N.J.  
*First in the High-Quality Audio Field Since 1934*



## Records, Tape & FM

(Continued from page 6)

tuners in the July-August issue of *MUSIC AT HOME*. It's an appropriate time, because summer static is a special reason for FM reception.

### Uses for Tape Recorders

Some of the recording artists have done very interesting tricks with tape recorders by recording several times on the same tape. It can't be done on standard equipment for, when a tape is run through a second time, anything previously recorded is wiped off. Maybe you know already how it is done. But if you don't, you will find out in a very interesting article in the next issue, explaining how standard recorders can be modified for this particular purpose. As far as we know, this is the first time this information, originally a professional secret, has been published.

### Diamond Styli

(Continued from page 30)

obtained in the course of conversations with E. F. Hembrooke, chief engineer of the Muzak Corporation and G. W. Bilgam, assistant director of equipment and engineering. This material, incidentally, was carefully checked by Mr. Bilgam for its accuracy, and is dated March 31, 1953.

The first portion is an extract from the "Muzak Equipment and Engineering Bulletin," binder number F-1 File — 3, 181 dated November 25, 1949.

"It has been found, after extended tests made by the Equipment and Engineering Department, that the average life expectancy of the diamond stylus in the D-93306 and 9A reproducers is approximately 750 hours of reproducing service. No figures are available on the sapphire, but the useful life here will be much shorter, since the sapphire is very soft in comparison with the diamond."

The purpose of testing materials used by the Muzak Corporation is to determine:

1. Which materials will give the finest trouble-free performance under conditions of continued use
2. Which materials are best from the economic standpoint
3. What recommendations should be made to Muzak personnel and to its franchised organizations.

The same kind of careful study is given to all components of equipment used in order to maintain the high quality of music associated with the name Muzak. In the case of diamond playback styli, a very careful and precise study was made and records kept of all test conditions to determine just how long diamond styli could be played before distortion and/or excessive record wear occurred.

A large library of recordings is maintained by each Muzak franchise holder. Obviously, the protection and preservation

(Continued on page 60)

# AXIETTE

MADE IN ENGLAND

High

**FIDELITY**  
OF SOUND

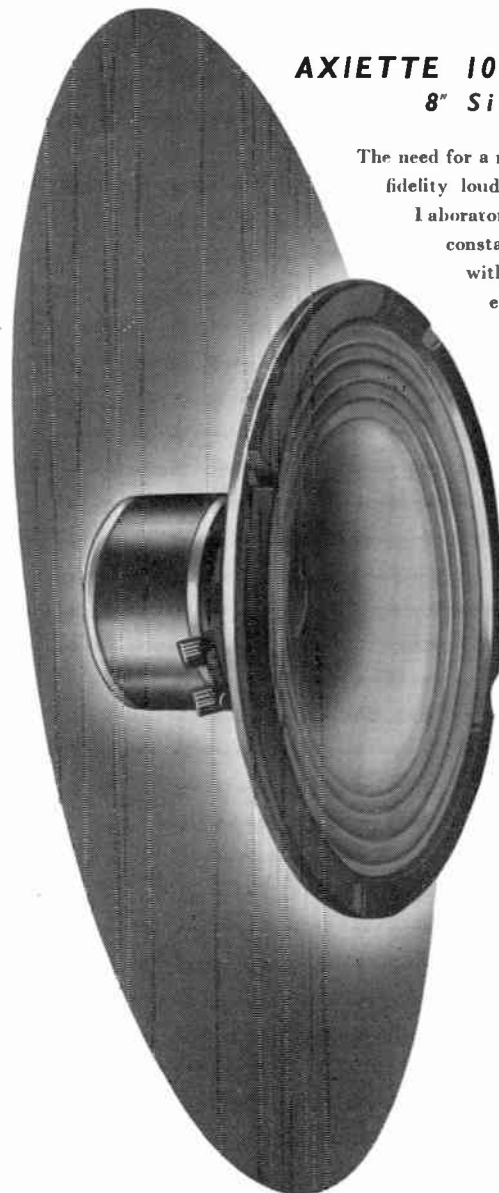

## AXIETTE 101

### 8" Single Cone Loudspeaker

The need for a reasonably-priced and medium sized high-fidelity loudspeaker has been met by the Research Laboratories of Goodmans Industries who are constantly in touch and, indeed, in sympathy with the requirements of the high-fidelity enthusiast. To a certain extent this demand can be related to the present-day restrictions on living space and the fact that enthusiasts are seeking a loudspeaker which, when suitably housed, will occupy the minimum of space, and yet still faithfully reproduce their particular choice of music.

From the start it was decided that the new loudspeaker would be housed on an 8 in. chassis and to set a really new trend, a special hyperbolic cone was designed.

#### SPECIFICATION

Frequency Range	40-15,000 cps
Fundamental Resonance	65 cps (nominal)
Voice Coil Diameter	1 in. (2.5 cms.)
Voice Coil Impedance	15 ohms.
Flux Density	13,500 gauss
Total Flux	51,200 Maxwells
Maximum Power Handling	5 watts peak A.C.
Overall Diameter	8½ in. (20.63 cms.)
Overall Depth	3½ in. (10 cms.)
Baffle Hole Diameter	7 in. (17.8 cms.)
Mounting Holes	4 slots ½ in. (9.5 mms.) x ¼ in. (5.5 mms.) equipaced on a 7½ in. (19.36 cms.) P.C.D.
Nett Weight	3½ lbs. (1.47 kgs.)
Finish	Grey Rivelling Enamel

**AUDIOPHILE NETT PRICE \$21.30**

Exclusively Distributed by:—

EAST

GOODY AUDIO CENTER INC.  
235, West 49th Street  
NEW YORK 19, N. Y.

SOUTH & SOUTH-WEST  
HIGH FIDELITY SSS  
606, Peachtree Street N.E.  
ATLANTA, GA.

WEST

HOLLYWOOD ELECTRONICS  
7460, Melrose Avenue  
LOS ANGELES 46, CAL.

CANADIAN SALES OFFICE  
A. C. SIMMONDS & SONS LTD.  
100, Merton Street  
TORONTO 12



# GOODMANS

GOODMANS INDUSTRIES LTD., AXIOM WORKS, WEMBLEY, MIDDLESEX, ENGLAND

The  
Best  
Seats  
in the  
House...



You  
hear it  
all —  
as though  
you were  
there ...  
when  
you use  
a

MODEL 206AX

## Stephens TRU-SONIC SPEAKER

Regarded as the international standard in high fidelity sound equipment, STEPHENS speaker systems are used throughout the world by the most discriminating listeners.

It's a SOUND PRINCIPLE  
when you say

**STEPHENS**  
TRU-SONIC

MANUFACTURING  
CORPORATION

8538 Warner Drive • Culver City, Calif.

## Diamond Styli

(Continued from page 59)

of these costly transcriptions is an important economic consideration. The reports states that:

"Vertical [hill-and-dale] transcriptions taken from our library were employed, covering a great variety of selections. These recordings were played at  $33\frac{1}{3}$  rpm, and consisted of both filled and unfilled vinylite. No notes were made of proportion of clear vinylite records played to vinylite with filler. A log book is always maintained of each selection played and duration of playing. This log is accurate to within a few seconds of playing time."

A summary of the results stated that "Two thirds of the diamonds tested lasted about 750 hours, plus or minus a few hours. The remaining third lasted up to 1,800 hours. In fact some of the diamonds at 1,700 to 1,800 hours had only slight wear flats.

"When used on our playback equipment previously described, we recommend changing the diamond stylus after 750 hours to avoid distortion and restriction of frequency range. We do not use or supply styli of any material other than diamond due to the short lifetime and/or fragility of these other materials. After a short period of use the inadequacy of other stylus materials results in poor response, frequent servicing and replacement, and excessive groove damage."

If the operating data gathered by Muzak engineers is translated into the corresponding number of times LP records would be played, taking 20 minutes as the average for the usual assortment of 10 and 12-in. records, then two-thirds of the diamond styli would have been good for 2,250 playings, and one-third of the diamonds would be good up to 5,400 playings or more. Reduced to cost per record when the stylus is replaced promptly as soon as it is worn to the point of possible damage to the grooves, this data indicates that the expense of using sapphire styli is about 6 times or more that of the diamond.

Frankly, because Muzak employs hill-and-dale records, with such heavy tone arms and pickups, it is not possible to make a direct comparison with stylus wear encountered with the lateral records and lightweight equipment used in home hi-fi installations. However, it is safe to assume even greater life for diamonds under average conditions of home use.

The fact of this saving may come as a surprise to those who have considered the diamond stylus an extravagance indulged in only by the super-perfectionist kind of audio enthusiast, but the great increase in demand for diamonds, according to the hi-fi equipment dealers, is coming from budget-minded people who want to save money and, at the same time, provide maximum protection for their investments in LP records.

*As you know...*

**YOUR HI-FI  
RECORDING SYSTEM  
IS ONLY AS GOOD  
AS YOUR MICROPHONE!**

*These important features  
are the reasons why the*

**SHURE GRADIENT<sup>1</sup> "300"**

**HIGHER FIDELITY MICROPHONE**

is used by leading recording artists and Hi-Fi enthusiasts for consistently superlative reproduction:

- ✓ **REDUCES REVERBERATION** and pick-up of unwanted noises by 66%!
- ✓ **SMOOTH FREQUENCY RESPONSE** —40-15,000 c.p.s.
- ✓ **BI-DIRECTIONAL PICKUP PATTERN** —enables you to arrange the artists around microphone to obtain the best balance between the different musical components.
- ✓ **VOICE-MUSIC SWITCH**—for utmost flexibility in achieving highest quality recordings.
- ✓ **HIGH OUTPUT**—eliminates hum problems—by allowing recorder to be operated at normal gain settings.
- ✓ **MULTI-IMPEDANCE SWITCH** for LOW, MEDIUM or HIGH IMPEDANCE—provides added flexibility.

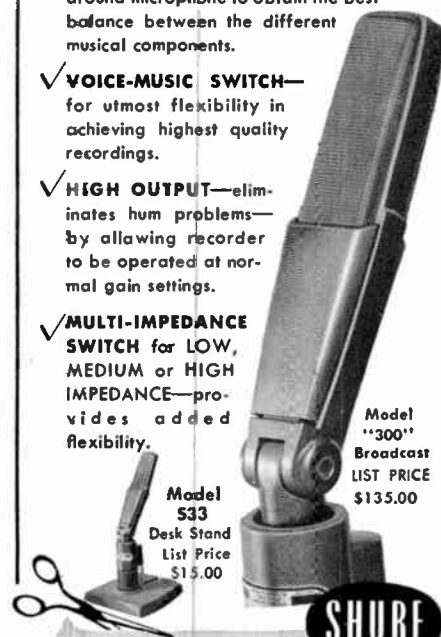

Model  
S33  
Desk Stand  
List Price  
\$15.00

Model  
"300"  
Broadcast  
LIST PRICE  
\$135.00

**SHURE BROTHERS, Inc.**  
Microphones and Acoustic Devices  
225 West Huron St., Chicago 10, Illinois  
Cable Address: SHUREMICRO

Please send me FREE Microphone Catalog  
77A and list of Shure Distributors in my  
locality.

Name \_\_\_\_\_

Address \_\_\_\_\_

City \_\_\_\_\_ State \_\_\_\_\_

MHG-5

## V-A-C

(Continued from page 36)

from 90 to 1,100 cycles, and between the mid and high-range speakers from 800 to 6,000 cycles. In addition, the level of each speaker can be adjusted without affecting the other two. Special care must be taken to determine the optimum crossover points, and in setting the levels, for the performance of the whole system will depend on the thoroughness with which this work is done.

It is entirely practical to use one of the standard binaural amplifiers such as the Newcomb 3D-12 in place of two separate units, if you choose to do so. These are simply two independent amplifiers on one chassis.

### Balancing a V-A-C System

There are three separate factors to consider in balancing a system using V-A-C controls. First, the amount of amplification contributed by the preamplifier, the V-A-C, and the power amplifier must be so distributed that each unit does only its proportionate share of the work. Second, the speaker levels must be so balanced that no one part of the range is over-emphasized. Third, the crossover points must be determined according to the characteristics of the speakers and their enclosures, and the acoustics of the room where they are installed.

You can get an approximate balance by setting the gain control on your preamplifier about  $\frac{1}{3}$  of the way up from minimum, and the control on the mid-range amplifier at about the same point. Then set the volume from the mid-range speaker to normal listening level by adjusting the corresponding control on the V-A-C. Work the three controls back and forth until you have normal speaker volume, with each control at about the same relative position between minimum and maximum.

If you are using two V-A-C's, set the upper-range output level control on the low-range V-A-C down a little, remembering that extra amplification will be added in the high-range unit. Then, without changing the preamplifier, get a balance between the V-A-C controls and those on the low-range and high-range amplifiers. Unless this is done, you may find that too much of the amplification is being done in the preamplifier, or the power amplifiers, in which case one part of the system will be operating at a higher point of distortion than is necessary. After these preliminary adjustments are made, the individual speaker levels must be checked again for exact reproduction balance of the system. This can be done at the V-A-C or the amplifier controls.

Final adjustment of the system, and the most interesting part, calls for setting the crossover frequency point, or points. There are no rules to follow. You must rely on

(Concluded on page 62)

*Let your own Ear  
be the Engineer!*

then you'll choose

**PILOT**

RADIO CORPORATION

**Hi-fi**

New improved Williamson type Amplifier using famous KT-66 tubes. Power Output: 10 watts — less than 0.1% distortion, 25 watts — less than 0.3% distortion, maximum output — 30 watts. Frequency Response  $\pm$  1DB 15 to 50,000 cycles. Hum Level 90 DB below 10 watts. Speaker output impedance 8 and 16 ohms. Tube complement 6SN7GT, 6SN7GT (2), KT-66 (2) Push-Pull Power Amplifier, 5U4G Rectifier.

7½" high x 4¾" wide x 14" long

AA-904 PILOTONE  
30 watt AMPLIFIER



\$89.50

"THE STANDARD OF EXCELLENCE"

Write for free brochure M-2



**PILOT** Radio Corp. • 37-06 36th St., Long Island City, N. Y.

*You have to  
**HEAR it to believe it!***



Full symphonic level  
high-fidelity sound from the  
amazing BARUCH-LANG corner loudspeaker system.

- The phenomenal BARUCH-LANG high fidelity corner loudspeaker system is the successful result of research at one of the leading university acoustic laboratories to achieve high quality, wide-range response in a compact, low-cost unit.
- Complete, ready for connection to any amplifier, radio, or television set, this amazingly efficient speaker system is ideal not only as the main high-fidelity speaker in your living room, but also as a second or third speaker placed at other points in your home. Designed exclusively for corner installation, this unit is only 13½" high and 19¾" across the front.
- Only from KLOSS INDUSTRIES, the original manufacturer of this famous, nationally advertised speaker, can you buy direct and thus save dealer markup. Kloss Industries offers you an unconditional 10 day refund guarantee in order that you may listen to the KLOSS BARUCH-LANG system in your own home without obligation.

**\$22.00**

Shipped by express only, shipping charges collect. Weight 14 lbs. C.O.D. if you wish.

Specify birch or mahogany moulding, 4 or 16 ohms impedance.

**KLOSS  
INDUSTRIES**

10 Arrow Street, Cambridge 38, Mass. Dept. 2

**Freed-Eisemann**  
ONE OF THE GREAT NAMES IN RADIO SINCE 1922

Pioneers and specialists in AM and FM, the name Freed-Eisemann has provided the highest quality performance in radio and television. This experience over the years assures you of the highest standards of sound reproduction... guarantees High-Fidelity!

The new Freed-Eisemann single chassis hi-fi unit is based upon the most advanced concepts of the art. No 'one' assembly can match its excellence!

Beautifully styled, the Freed-Eisemann chassis may recline on an open shelf or table or may be readily dismantled for console installation. Complete, ready to operate, by merely connecting a High-Fidelity speaker.



Fine AM-FM Tuner of superior performance



High Fidelity 10 watt amplifier of low distortion response and wide frequency range.

**... on one chassis**  
for ease of installation and operation



... a product of

Freed Electronics & Controls Corp. • 200 Hudson St. • New York 13, N. Y.

**Hi fi**

- AM and FM circuits designed for maximum gain at minimum noise level to meet fringe area reception requirements.
- Automatic frequency controlled FM terminating in a Foster-Seely limiter-discriminator.
- Built-in pre-amplifier for variable reluctance - phono pick-ups.

- Tuned RF on both AM and FM for maximum sensitivity and selectivity.
- Audio frequency Response: 20 cycles to 20,000 ± 1db. at full output.
- Audio output 10 watts at less than 1.5% distortion.
- Record compensation—Treble and Bass Controls.
- Jack for Tape Recorder.
- Electronic Tuning Eye.

Write Department M-5 for illustrated literature

V-A-C

(Continued from page 61)

your own judgement! Each time you shift the crossover, you will probably want to change the level controls. You'll simply have to work them back and forth until you are satisfied. Two suggestions may be helpful: If the controls are near the speakers, get someone to make the adjustments for you, while you sit in the part of the room where you do most of your listening. And don't try to complete the adjustments immediately. Recheck them from day to day, over a period of a week or more. It's a tricky job to achieve perfect balance of the crossover points and the volume levels. When you are finally satisfied that everything is just right, look at the calibration and see what crossover frequencies you are using. You may be surprised to find that they are very different from those you would have chosen for fixed-frequency networks!

### Hi-Fi without Disorder

(Continued from page 38)

installed permanently. That is easy, too, if you carry out the idea shown in the fourth sketch, drawn from a picture in *Better Homes & Gardens* for February, 1954. You can build a simple enclosure for an extra speaker. Then get a 10-watt amplifier and connect it to the preamplifier and record-changer in the house. Load up your changer with LP's and you'll have all the music you want for a whole afternoon or evening without getting up from your chair! When the speaker and amplifier are not in use, put them indoors, or protect them with a waterproof cover.

Now, reexamine the situation in your home to see how, with the very minimum changes, you can install a complete system. You may be surprised to find that it's easier than you thought!

### Preamp-Amplifier

(Continued from page 31)

single operation all the metal parts are coated with solder thereby making secure joints between the printed copper and the wires. All this happens so quickly that the insulating plate and the components are unaffected by heat from the molten solder. In fact, less heat is transferred to the components than when the individual connections are soldered manually, with an iron.

As for the instrument itself, it employs three 12AX7 tubes, with two 6AQ5's for the output, and a 6X4 rectifier. Power rating of 12 watts is based on less than 1% harmonic distortion. The switch-controlled input has connections for phonograph, tape, radio, and TV, and there is complete control of equalization, treble, and bass. There is a take-off jack for tape recording, and speaker output connections for 4, 8, and 16 ohms. Dimensions are 4½ ins. high, 10¾ ins. long, and 8 ins. deep from the front panel to the jacks at the rear.

## Amplifier SENSATION OF THE YEAR

# the H. H. SCOTT "99"



\$99.95 net

"best amplifier for the money I've ever owned"

Other owners say: (owner's comments on returned guarantee tags)

"amazed at its performance—idea of fully encasing the amplifier is brilliant—a group of twelve persons, upon hearing this amplifier, judged it the best dollar for dollar buy on the market — more than satisfied — I am sure every owner is as proud as I am of his 99-A amplifier."

FREE BOOKLET

#### An Expert Says:

"the little Scott, amusingly designed to resemble a control unit alone, has few rivals in the feature of flexibility, regardless of price."

C. G. Burke, NEW TRENDS IN AUDIO  
"Saturday Review" Dec. 26, 1953

HERMON HOSMER SCOTT, INC., 385 PUTNAM AVENUE, CAMBRIDGE 39, MASSACHUSETTS



# WNYC-FM-AM

(Continued from page 18)

Live programs at present range anywhere from a short recital by some comparatively unknown artist to the splendid weekly series of concerts from the Library of Congress in Washington, the Juilliard School, or the Frick collection.

An interesting series which has been revived recently occurs Sunday afternoons at 3:00 P.M. It is called "Speaking of Music." On each program, a leading figure from the world of music — a performer, conductor, critic, or manager — gives an impromptu talk based on his experiences, and introduces his favorite recordings (usually his own, if he is a performer).

Perhaps the outstanding accomplishment of Mr. Siegel's stewardship is the work he has done to organize an international exchange of cultural programs between this country and Europe. In March, 1953, the National Association of Educational Broadcasters, a tape network of 127 radio stations mostly operated by colleges and universities, inaugurated a series of cultural programs recorded abroad mostly in France and Italy. From France comes a drama series of classic French plays done in French by members of the world famous Comédie-Française in Paris, a series of programs on contemporary French music in which leading French composers comment upon their own music, and a series of half-hour programs on the life and works of Balzac and Hugo. Italy is furnishing a series of opera performances from La Scala, and chamber concerts of 18th century choral and orchestral music.

In return, the NAEB makes available to foreign networks some of its public service programs, such as the twelve-part "Jeffersonian Heritage" starring Claude Rains, and "The Ways of Mankind," an exploration of the origin and development of cultures, customs, and folkways throughout the world.

There are certain lessons to be learned from the success of New York City's radio station. The first is that WNYC's operation has proven that it is possible to have a good radio station run by municipal funds without political interference. And there is a very wide audience for this kind of radio. The enormous amount of mail the station receives constantly, the number of awards it has won over the years, and the continued loyalty of its hundreds of thousands of constant listeners give the lie to the premise of commercial radio executives that radio audiences are comprised of people who qualify intellectually as 14-year-olds.

Over the past 30 years WNYC has demonstrated that in the New York area, with its many broadcast outlets, there is room for a radio station which refuses to compromise with the highest cultural standards.

May-June 1954

*Let your own Ear  
be the Engineer!*

then you'll choose

**PILOT**

RADIO CORPORATION

**Hi-fi**

10 tubes, with two stage pre-amplifier equalized according to LP NAB, AES and foreign recording standards selected by Switch. Three magnetic phono and crystal and AUX. inputs. Two stage audio amplifier with cathode follower output. Sensitivity on FM-AM 10 MV. Audio frequency response  $\pm 1/2$ DB, 20 to 20,000 cps. Hum level 80DB below one volt with hum balancing adjustment provided. Controls: Volume, Equalizer, Treble, AM-FM-PHONO-AUX, Bass, Tuning and AFC on-off. Built-in antennas for FM and AM.

AF-824 AM-FM PILOTUNER

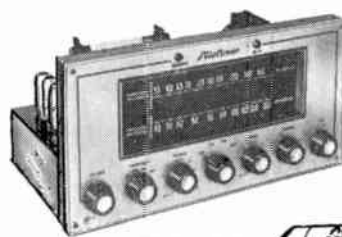

\$119.50



Write for free brochure M-2

**PILOT** Radio Corp. • 37-06 36th St., Long Island City, N. Y.

*Every Sound heard right!*

OTHER  
MODELS  
FROM  
\$345.00



MODEL 1502  
\$445.00



*Concertone* lets you hear them all

"... just like being there..."

**THE ONLY TAPE RECORDER UNDER \$1000 WITH ALL THESE PROFESSIONAL FEATURES:**

- Separate playback head permits monitoring direct from tape while recording.
- Uses 10½ inch professional reels without extension arms.
- Three motors for superb tape motion.

**DESIGNED SPECIFICALLY FOR CUSTOM SOUND SYSTEMS**

Get complete details now. See your Audio Distributor or write for Bulletin Number 2MJ05.



**Berlant Associates**

4917 W. Jefferson Boulevard Los Angeles 16, California



# Music Lovers:

## BULLETIN

### BROCINER PREAMPLIFIERS

Rated by  
**Mr. C. G. BURKE,**  
Author of *The Saturday Review*  
*Home Book of Recorded Music*  
and *Sound Reproduction,*  
among those

**"In a Class Apart  
From All the Others  
in Their Flexible  
Resourcefulness"**



complete  
**AUDIO  
CONTROL  
CENTER**

\$99†

24 RECORD-PLAYBACK CHARACTERISTICS to match every possible record. UNIVERSAL PICK-UP COMPENSATION to accommodate all makes of high quality pick-ups. TREBLE CUT-OFF FILTER... a professional range selector to give you the best possible results from imperfect as well as flawless program material. ADJUSTABLE LOUDNESS CONTROL... a true level compensator easily adjustable for all requirements... and other features too numerous to mention, presented in complete, factual form in our bulletins.

†Without cabinet.

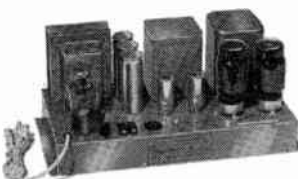

**A POWER  
AMPLIFIER**

Worthy of  
the name!

\$129

30 WATTS\* at 1% intermodulation. ULTRA-LINEAR CIRCUIT using the famous Acro TO-300 output transformer. KT86 OUTPUT TUBES. 20 db feedback over 4 stages. Engineered for easy installation.

\*Equivalent sine wave power.

Prices slightly higher on West Coast



AVAILABLE  
AT BETTER  
HIGH FIDELITY  
DISTRIBUTORS.

LITERATURE ON REQUEST

**BROCINER ELECTRONICS LABORATORY**

344B East 32nd Street • New York 16, N. Y.

## Practicing with a Tape Recorder

(Continued from page 15)

quate performance. The tape costs almost nothing because it can be used over and over. When a tape is used with the machine in the RECORD position, whatever was recorded previously is automatically erased. However, teachers recommend that students keep sample tapes of their playing, and store them away to be played back from time to time in order to show the degree of progress. Many times, students who have become discouraged are spurred to new efforts by hearing that they have actually improved far more than they realized.

With each tape recorder there is a book of directions which answers all the questions, and tells just where to put what. It would be wise to retire to a comfortable chair and read it through before you attempt to operate the equipment. Then return to your recorder and identify each of the parts mentioned in your book. Remember that in operating any machinery, easy does it. If your procedure is correct, the equipment will work easily. If you must struggle and force it, something is wrong somewhere, and further reading of the directions is indicated. It is important to familiarize yourself with the operation before you attempt to teach the children how to run it.

When you have learned how to make it go, take a little time to find the best location for the microphone. Sound is reflected from walls or absorbed in rugs and draperies, and the microphone is affected by both conditions. If the walls of your room are "live" — that is, bare of draperies, tapestries, deadening material of any kind — the sound will bounce from wall to wall and enter the mike from several directions. This is not all bad. In fact, you may find it an advantage, provided the mike is placed some distance from the instrument.

If your room is heavily draped and carpeted, the music will record without the accompanying overtones that you get in the live room, and your mike must be placed closer to the source of your music.

Study the instructions for setting the volume control. Be careful to keep the volume down, both on pickup and playback, to the point where the recorder will not be overloaded. Clear, clean quality at low level is far more useful to the musician than loud, distorted reproduction.

With the assistance of your young musician, try out your microphone in several locations as he plays. Record a bit and play it back until you like what you hear on the recording. Finally, when you are thoroughly familiar with your tape recorder, teach the youngsters how to handle it. You'll be delighted to see how useful and important it will become to them.

Over  
500,000  
record  
collectors  
read

"Schwann's  
long playing  
record  
catalog"  
every month  
before  
buying.

are you one  
of them?

Available  
at your  
record dealer  
now.

Pick up your  
copy today.

**schwann**  
long  
playing  
record  
catalog

131 Clarendon St., Boston 16, Mass.

AN EAR TO PERFORMANCE • AN EYE TO VALUE

**harman kardon**

# Festival®

COMBINED DELUXE HIGH FIDELITY TUNER,  
PRE-AMPLIFIER AND AMPLIFIER

MODEL D-1000



SUPERLATIVE AM-FM TUNER. PRE-AMPLIFIER. 20 WATT ULTRA-LINEAR WILLIAMSON AMPLIFIER

## A Brilliant New Conception!

More than a fine tuner; more than a superb amplifier — the Festival groups all the critical electronic elements of a deluxe high fidelity system on one compact, controlled chassis — for flawless performance.

**SIMPLEST POSSIBLE INSTALLATION**  
Decorator-styled copper escutcheon with black knobs.

**PRECISION FLY-WHEEL TUNING**  
Edge-lighted, functionally-styled, slide rule dial

**EXCLUSIVE 6 POSITION DYNAMIC LOUDNESS CONTOUR CONTROL**  
Automatically adjusts sound at any volume — high or low — to match your own hearing!

**20 WATT ULTRA LINEAR "WILLIAMSON" AMPLIFIER**  
Response flat within 1/2 db 20-20,000 cycles

**BUILT-IN PRE-AMPLIFIER**  
Full record equalization for magnetic, crystal or ceramic cartridges.

**SUPERIOR AUTOMATIC FREQUENCY CONTROL**  
AFC Defeat combined with tuning knob.

Incomparable performance!  
**PRICED ECONOMICALLY**  
**\$ 189.50** NET  
Zone 2 \$193.50

**SEPARATE AM AND FM FRONT ENDS**  
Armstrong FM system with Foster-Seeley Discriminator.

**harman - kardon, inc.**  
52 West Houston Street • New York 13, N. Y.

MAIL THIS COUPON TODAY FOR LITERATURE

Harman-Kardon, Inc., Dept. MH-5  
52 West Houston Street, New York 13, N. Y.

Name.....

Address.....

City..... Zone..... State.....

**ULTIMATELY,  
EVERY PERSON WHO OWNS OR PLANS TO OWN  
A FINE HOME MUSIC SYSTEM MUST FACE THIS QUESTION:**

**“Shall I buy a Turntable  
or a Record Changer?”**

*The following statement represents the point of view of one of America's leading manufacturers of professional recording and playback equipment.*

The choice between record changer and turntable is, for the most part, entirely personal to the user. It depends upon what he wants. If it is merely the physical comfort of hearing hours and hours of just music, without manual intervention, then the choice would be a record changer. On the other hand, if it is his desire to enjoy the utmost in sound quality, then a quality turntable is certainly indicated. In broadcast studios, for example, where reproduction quality is of prime importance, turntables are used exclusively.

#### *The Record Changer*

The record changer is an extremely clever device, and much ingenuity has gone into its complex mechanism. It originated in the days when 78 rpm was the only popular record speed, and the playing time of a 12-inch record was only about 4 minutes per side. A complete 40 minute musical composition required at least 10 sides or 5 records. The record changer made it possible for these records to be played automatically, without the need for getting up every three or four minutes to change records.

#### *The Long Playing Record*

The long-playing, microgroove record has changed all of this. Each side of a

12-inch long-playing record disc provides about 25 minutes of music. The same 40 minute composition now requires only two sides of a 33 $\frac{1}{4}$ rpm 12-inch record. The long-playing record has also brought tremendous improvements in the quality of recorded sound. As a result, the older 78s are rapidly becoming obsolete among serious music lovers.

#### *The High Quality Turntable*

The turntable is basically a simple device. A manufacturer who desires to create a high quality instrument can devote all of his engineering skill to the one important function of the turntable: its rotating motion. A Rek-O-Kut turntable, for example, offers the closest approach to perfect motion; with virtually no rumble, wow, flutter, or other mechanical distortion.

There are other important advantages to the turntable. Once the angle between the stylus and record is established, it remains constant for all time. In the case of the record changer, this angle varies, depending upon the number of records stacked underneath the record 'in play'.

A turntable has a 'live' spindle, meaning that it rotates with the table and the record. The spindle of most changers remain stationary so that

there is an element of wear introduced whereby the spindle hole of the record may become enlarged, and cause off-center wow. Similar wear can result as the record is dropped, and it slides down the long spindle.

A third advantage peculiar to Rek-O-Kut is that the turntable itself is machined from aluminum castings. Aluminum is unaffected by magnetism, and therefore, the turntable exerts no 'pull' when used with a magnetic cartridge. With steel and other magnetic materials, the magnetic pull may actually cause the stylus to 'ride the groove' with a pressure considerably greater than recommended.

#### *Conclusion*

High fidelity is rapidly becoming a part of our home life. This is expressive of the typically American desire for the enjoyment of finer things. As specialists in the field of professional sound reproduction, and having served this field for years, we welcome the fact that this wonderful experience is now being adopted in the American home.

Rek-O-Kut precision turntables are among the finest in the world. Every detail of their construction is carefully engineered to provide the finest quality record reproduction. Whether you now own or plan to own a music system, we urge you seriously to consider one of the several Rek-O-Kut turntables. You will find that it makes all the difference in the world.

*Literature on Request*

Export Division: MORHAN EXPORTING CORP.  
458 Broadway, New York 13, N. Y.  
Cable: MORHANEX  
In Canada: ATLAS RADIO CORP., Ltd.  
560 King Street, W., Toronto 28.



## **THE REK-O-KUT COMPANY**

*Makers of Fine Recording and Playback Equipment  
Engineered for the Studio • Designed for the Home*

Dept. LE-16, 38-01 Queens Boulevard, Long Island City 1, New York