

Audiofan

**THE MAGAZINE
FOR THE
HI-FI ENTHUSIAST**

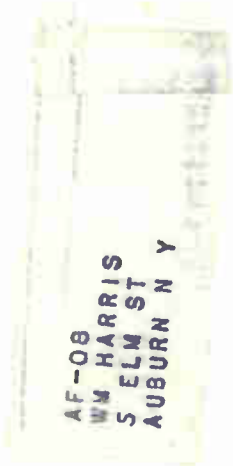

AUGUST 1966 Vol. 2 No. 8 FIFTY CENTS

**Speakers
for
Sunlight,
Moonlight
&
Underwater
Fun**



**FM STEREO'S HIGH FIDELITY ANCHOR
STORECASTING**
Page 6

YOUR SUBSCRIPTION IS SPONSORED BY

BARNETT BROS.

(PLEASE SEE OUR ADVERTISEMENT INSIDE BACK COVER)

Space-age Scott FET design improves AM as dramatically as it does FM



New Scott 382 Receiver lets you hear more stations, more clearly! 65-watts/Space-age FET circuits* in both AM and FM/Only \$339⁹⁵

Scott engineers are constantly on the search for new developments to continually improve a near-perfect product.

After experiencing the miraculous improvements FET's brought to FM, Scott engineers applied amazing new FET circuitry to Wide-Range AM. The result — the new 382 AM/FM stereo receiver — incorporating, for the first time anywhere, a Field Effect Transistor AM circuit along with Scott's astonishing FET FM front end. Introduction of this new model marks the first real improvement in AM circuitry design in more than a decade.

AM Comes of Age

Recent improvements in AM broadcasting equipment, plus the Federal Communication Commission's decision to split AM and FM programming, have given audiophiles renewed interest in superior AM reception. Introduction of the new 382 now brings Scott FET sound to the exciting news, sports, current events and music broadcasts available only on the AM band.

Scott AM Has Advanced FET Circuits

Advanced Scott 382 circuitry incorporates Automatic Variable Bandwidth, a unique feature which automatically adjusts tuner bandwidth to the quality of the incoming signal. The bandwidth automatically narrows for best reception of weak, distant stations, blocking out noise and interference. When tuned to stronger stations, the bandwidth automatically broadens, providing full frequency wide-range reception. In addition, the new Scott Automatic Gain Control circuit, which increases tuner sensitivity when incoming signal decreases, also increases resistance to cross modulation as the signal gets stronger.

Field Effect Transistor FM Lets You Hear More Stations, More Clearly

The 382 utilizes revolutionary new Field Effect Transistor circuitry for maximum FM sensitivity with virtually no cross modulation, no drift, no more problems caused by changing tube characteristics. Scott led the industry in being first to use this important advance in solid-state design.

Scott's all silicon IF strip provides three stages of true IF amplification for strong as well as weak signals plus three additional stages of IF limiting action, giving optimum selectivity and stereo separation.

Direct-Coupled Silicon Output Amplifier Section

Output and driver transformers, major causes of diminished power and distortion, are eliminated from Scott's radically new direct-coupled solid-state amplifier design . . . allowing more power over a wider frequency range, with virtually no distortion.

The 382 includes these popular features found in the most expensive Scott components: Tape Monitor switching, Speaker switching with provision for remote speaker selection, switched front panel stereo headphone output, front panel stereo balance switch, separate-channel clutched bass, treble, and volume controls, fully automatic stereo switching with indicator, and precision tuning meter.

382 Specifications: Usable sensitivity, 2.5 μ v; Harmonic distortion, 0.8%; Drift, 0.02%; Frequency response, 18-25,000 cps \pm 1 db; Music Power rating per channel (4 ohms), 32½ watts; Cross Modulation Rejection, 85 db; Stereo separation, 35 db; Capture ratio, 6.0 db; Selectivity, 40 db. Price \$339.95.

* Patent Pending

Scott . . . where innovation is a tradition



H. H. Scott, Inc., 111 Powdermill Road, Maynard, Mass. Dept. 39-08 Export: Scott International, Maynard, Mass.
Prices and specifications subject to change without notice. Prices slightly higher west of Rockies.



EDITORIAL

hands across hi-fi land

It's an unusual high fidelity equipment enthusiast who goes it alone and achieves the most good music reproduction he could get for his money.

There are a variety of ways in which audiofans obtain hi-fi assists. Reading publications devoted to hi-fi equipment no doubt plays the greatest role in keeping audio devotees abreast of new developments and methodology in the land of hi-fi.

Visits to hi-fi component dealers to examine and listen to new equipment also contributes to the ever-growing knowledge of audiofans, as does attending high fidelity music shows in which many audio problems are resolved by company representatives.

Some audiofans are luckier than others. They have a group of friends who share their hi-fi stereo interests. Thus, they can share audio experiences, compare notes on who tried what with which. But what about the hi-fi enthusiast who started his hobby without the benefit of some friends? He certainly misses out on much information, not to mention the pleasure of exchanging information with a group of people who enjoy the same hobby he does.

If you're interested in such people-to-people contact, why not consider joining a local audio club or, perhaps, making efforts to form one? If you're technically inclined, you might be interested in joining a society, such as the Audio Engineering Society. You need not be an engineer to do so, you know. It is possible to become an "associate member" if you have an interest in audio but do not have the education and/or professional experience in audio engineering required to become a full member. An Associate can enjoy all the privileges of the Society—regular meetings, field trips, audio engineering journal, etc.—except voting, holding office or chairmanships. Dues are low: \$8.00 per year. For more information on this, contact the AES headquarters at 60 E. 42nd St., New York, N. Y. 10017.

And if you're interested in joining a local audio club but can't locate one, let us know. We might be able to direct you to an active one or, if enough audiofans in a locale express such interests, start the ball rolling on forming an audio club.

THE EDITORS

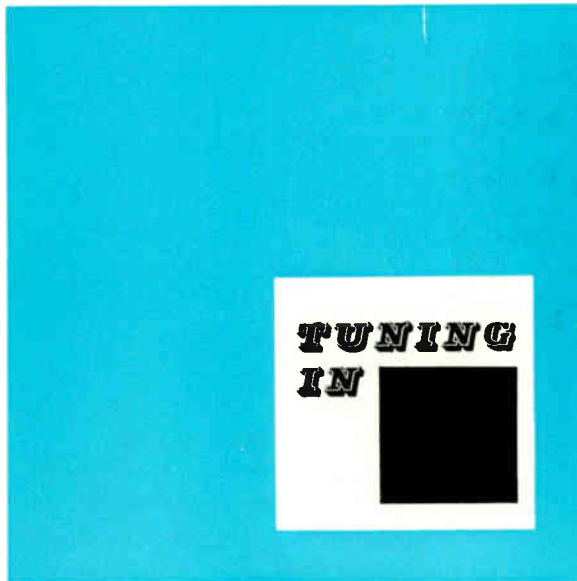

- Did you listen (and watch) the Grammy Award show on network TV? The recording awards were certainly interesting, but since sound quality as well as musical performance was the prime reason for the awards, isn't it a shame that TV receiver sound circuits are so inadequate? You can't tell the good sound from the bad sound. Wish TV manufacturers would incorporate a cathode follower with a pin-jack in their receivers so hi-fiers could easily pick off an audio broadcast and feed it into their hi-fi systems.
- Now you can talk under water. A waterproof electronic megaphone, called *Hydratalk*, has been developed for underwater chatting. Guess you have to take a deep breath of oxygen before expelling those bubbly verbal gems.
- Tape cartridge standards have been set by a few West German home electronic manufacturers; U.S. standards for 4-track and 8-track tape cartridges are expected to be announced soon, with the Electronic Industries Association feverishly working on them. Unlike American manufacturers, The West Germans, who produce 2-track and 4-track cartridges, consider 4-tracks to be the maximum channel system for good fidelity.
- A non-woven, textile wiper for computer tapes and electronic equipment has been introduced by the Pellon Corporation. Because of its lint-free and static-free characteristics, the new wiper is said to pick up splicing splinters on computer tapes without depositing foreign material or creating static. Will the company enter the consumer market for audio tapes?
- "Toot-Toot," sounds Kinematix' new electronic "Two Tooter" for automobile horns. The device uses a tiny transistorized unit to convert sounds of paired auto horns to a rhythmic alternation of individual high and low notes. Gee, Dad, that's a Wurlitzer.
- RCA expands its line of Stereo 8 tape cartridges to other recording labels. Its initial releases of non-RCA labels will include Kapp, Scepter and Wand. (Those last two names don't ring any bells with us.)
- Stereo FM radio stations plead for stereo single records. Introducing new recording numbers, the life-blood of many disk jockeys, is wanting in the stereo department. The single selection records are all in mono. Stereo FM stations cry that they need the singles in stereo while they're a hit to be competitive with non-stereo stations. At present they have to wait until a record album, that is, an LP is issued which includes the artist and the particular hit.
- Japan awards its "Taisho" award to Vladimir Horowitz for his "An Historic Return—Horowitz at Carnegie Hall." The recipient is chosen by Japan's leading music critics.
- A new product, the "Sonuswitch," allows you to turn on and off any electrical appliance with the clap of your hands. You can hook it up to any appliance that might interfere with your hi-fi listening, such as an air conditioner, fan, or your offspring's rock-and-roll playing equipment. This assumes that you're wearing headphones, of course. Otherwise sound from speakers would shut off the system.

Popular Science Magazine June 1966 Review of New ACOUSTECH ADD-A-KIT

PERSONAL-USE REPORT:

Kit Makes Super Hi-Fi Solid-State Amplifier

By RONALD M. BENREY

The Acoustech XI is a kit-built all-transistor amplifier that will outperform most factory-assembled rigs you can buy today. Its frequency response extends well past the upper and lower measuring limits of my test instruments. Distortion, even at the maximum power output of 35 watts per channel, is virtually inaudible.

I listened to the amplifier drive both low-efficiency AR-3 acoustic-suspension speakers and high-efficiency Jensen 600-XLs. The sound from both types of speakers was remarkably clear and brilliant, an indication of excellent transient response.

The basic power-amplifier kit costs \$130; the add-on preamp module \$90. They are made by Acoustech, Inc., 139 Main St., Cambridge, Mass.



Components and hardware are packaged in numbered plastic bags (like one shown above) that are stapled to a fuzzy-surfaced, solder-resistant cloth. You open one bag at a time to carry out a group of instructions.



The cloth makes an excellent work surface since small bits of hardware and tiny electronic parts won't roll or slide off it. Tricky-to-wire parts of the circuitry come pre-assembled on plug-in printed-circuit boards.



Step 1. Kit is designed so you can stop after wiring the easy-to-assemble power-amplifier stages, if you already own a hi-fi preamplifier. Construction time: about five hours.

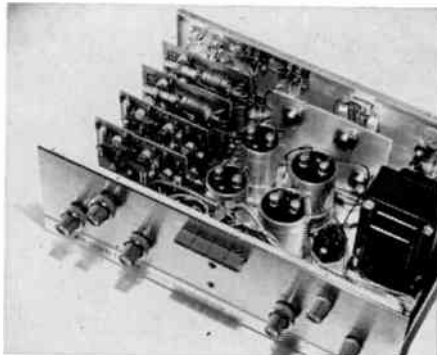

Step 2. You can add on the preamplifier and control circuitry when you build the power amplifier, or do it at a later date. The conversion takes about 12 hours, most of it spent in wiring the complex selector switches.

Letters

Send your audio questions, problems, comments and suggestions to the

Editor,
AUDIOFAN
25 West 45th St.
New York, N.Y. 11036

I like Harry

DEAR AUDIOFAN:

Keep it [AUDIOFAN] just the way it is—unless you reinstate “Harry, The Hi-Fi Repairman.” I did enjoy it.

Robert B. Withrow
Hawthorne, Calif.

Anybody else miss Harry?—Ed.

Background music view

DEAR AUDIOFAN:

You asked for it when you invited readers' views on background music (June AUDIOFAN editorial, “The Background Music Merry-Go-Round”). I believe that California decision on FM multiplex transmission of background music was wrong. Naturally the FM station won . . . so many politicians own outright or have pieces of FM stations . . . Who shoots Santa Claus? You would do a good deed if you would publish a diagram for the purpose of altering an ordinary FM chassis to catch background signals. I have an old Pilot FM tuner bought in 1947 which I would like to modify to receive background music. Let me know what parts I need and where to place them.

Carl T. F. Newman
Bronx, N.Y.

It would take some doing to alter a monophonic FM tuner to receive background music. The “Storecasting” programs ride piggyback on the FM multiplex signal, so you would first have to have a stereo tuner. See this issue's article, starting on page 6, for more information the subject.
—Ed.

ACOUSTECH

ACOUSTECH, INC. div. KOSS/Rek-O-Kut,
Dept. AF-8 139 Main Street, Cambridge,
Mass. 02142

IMPETUS: 2 VIA BERNA • LUGANO, SWITZERLAND



At the touch of your finger...
the cueing control
built into the
Garrard LAB 80
gently and precisely
raises and lowers
the tone arm...

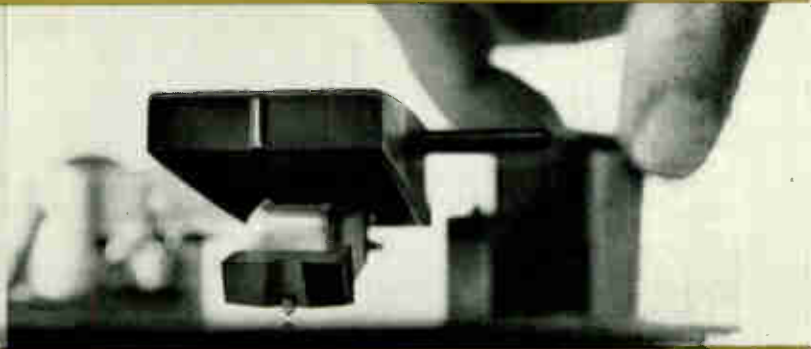

1. To play a single record, you simply move the arm into position over the first groove then, touch the cueing control . . . the arm gently lowers onto the record.

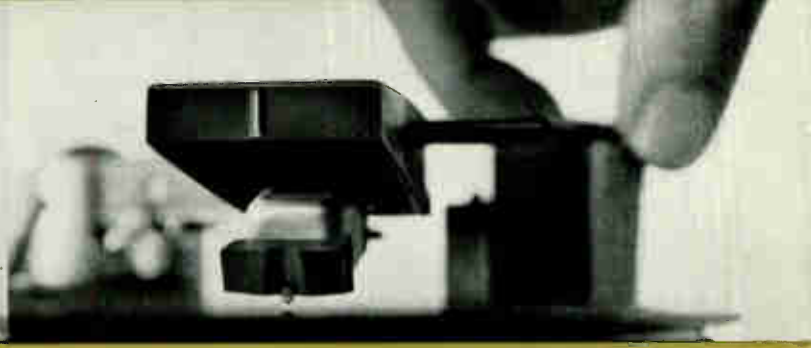

2. To interrupt the music, touch the Manual tab -the arm gently rises then, touch the cueing control . . . the music will resume at the very same groove.

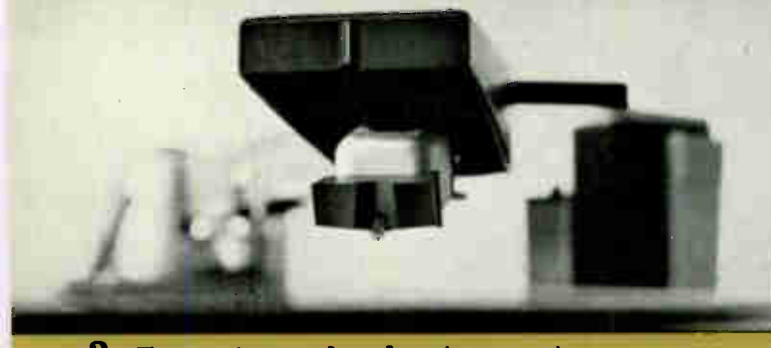

3. To cue to any band or to repeat a passage, place the tone arm over the desired groove then, touch the cueing control . . . the arm gently lowers to the exact groove.

Garrard incorporated this unique cueing control into the Lab 80 for your convenience...to add to your listening pleasure...and for the safety of your sensitive stereo records and vulnerable stereo stylus. The Lab 80 cueing control is simple to operate, easily accessible from any angle, and com-

pletely foolproof. It works beautifully whether you're playing a single record or a stack of eight.
 For complimentary copy of our 32-page Comparator Guide describing all the advanced features of the Lab 80, write to Garrard, Dept. GK-2096, Westbury, New York 11590.

Garrard[®]
 WORLD'S FINEST

August 1966
Vol. 2, No. 8



Features

- page7 ■ Storecasting—FM stereo's high fidelity anchor
page10 ■ Speakers for sunlight, moonlight, and underwater fun
page12 ■ How Hollywood's sound recordists do it
page14 ■ Profile of an Audiofan
page18 ■ Conducting phono cartridge comparisons in home hi-fi stereo systems
page24 ■ Build a component shelf
page29 ■ FM listings—Northern California

Departments

- page1 ■ Editorial
page2 ■ Tuning in
page3 ■ Letters to the editor
page17 ■ Hold on to high fidelity
page23 ■ Audio club news
page26 ■ What's going on
page30 ■ The technical quality of records and tapes

Executive Editor—Anthony Lord

Editor—Arthur P. Salsberg

Contributing Editors—Edwin S. Bergamini

John Cornell

Leonard Feldman

John Heston

Robert Long

Alex Rosner

Designer—Herbert M. Rosenthal

Illustrator—Charles F. Dreyer

Circulation—Etta Eisman

Production—Wm. Geo. Rave

Advertising—

New York:

S. Kenneth Nelson, V.P.

25 W. 45th St.

New York, N.Y. 10036

LT 1-8840

Chicago:

Stuart J. Osten

333 No. Michigan Ave.

Chicago, Ill. 60601

DE 2-3507

West Coast Regional Manager

Stanley Sherman

6290 Sunset Blvd. (Suite 1612)

Los Angeles, Calif. 90028

466-8321



AUDIOFAN—Volume 2, No. 8 Copyright © 1966 by St. Regis Publications, Inc. Published monthly by St. Regis Publications, Inc., 25 W. 45th St., New York, N. Y. 10036. Publishers: J. T. Schwartz and L. D. Solomon. Controlled circulation postage paid at Englewood, New Jersey. Change of address notices must give old, as well as new, address. Attach address label from recent issue. Allow sixty days for processing by the mailing house. Printed in U.S.A.

**FM
STEREO'S
HIGH FIDELITY
ANCHOR**

STORECASTING

by Leonard Feldman

**As good as FM multiplex is today,
it could have been better.
An expert tells why.**



If you were told that your precious FM band is being used to send secret messages to a chosen few, how would you react? If you suddenly learned that the all-too-narrow band of frequencies from 88 to 108 MHz (surrounded on both sides by the TV colossus) is also swarming with insipid lo-fi background music, would you rush to the nearest office of the FBI?

The fact of the matter is that your attempts to fulfill your patriotic duty would all be in vain. Ever since 1955, certain FM stations have led a schizophrenic existence. By sanction of the Federal Communications Commission (FCC), they are permitted to supply "private subscriber" music to restaurants, factories, bowling alleys and the like while at the same time engaging in their primary function of transmitting "free," commercially-sponsored music and programming for the general public.

How SCA Got Started

It must be stated, in all fairness, that back in 1955 when the FCC issued its Subsidiary Communications Authorization (SCA) there was good and sufficient reason for the edict. In the early 1950's the great pre-war promise of FM Radio just was not coming to pass. People in the trade recognized the merits of FM—its full-fidelity and noise free performance. The public at large, however, was becoming enamored of TV and little or no audience was available to appreciate the noble efforts of some 600 FM stations then in existence. Broadcasters, like any other businessmen, must make a profit, idealism notwithstanding. An avalanche of station failures ensued, till finally FM broadcasting seemed about to suffer a total premature death.

It was under these circumstances that many stations sought a second source of income. They availed themselves of the genius of the late Major Armstrong. Many years before he had demonstrated the feasibility of transmitting two simultaneous programs over one FM transmitter—the auxiliary program riding "piggy-back" upon the primary program in a system called "multiplexing."

For the technically curious, the bandwidth diagram of Fig. 1 will help explain how this seeming defiance of the laws of nature is made possible.

As you may know, in conventional FM transmission a station broadcasting at a frequency of 100 MHz actually shifts frequency in accordance with the "loudness" of the program material to be transmitted. That is, when loud passages are transmitted, the station frequency may vary $\pm 75\text{KHz}$ about its center frequency. Unlike AM broadcasting, the *amplitude* of the carrier wave remains constant.

The number of times that the frequency shifts back and forth about its center determines the audio tone to be broadcast. Thus, a loud whistle

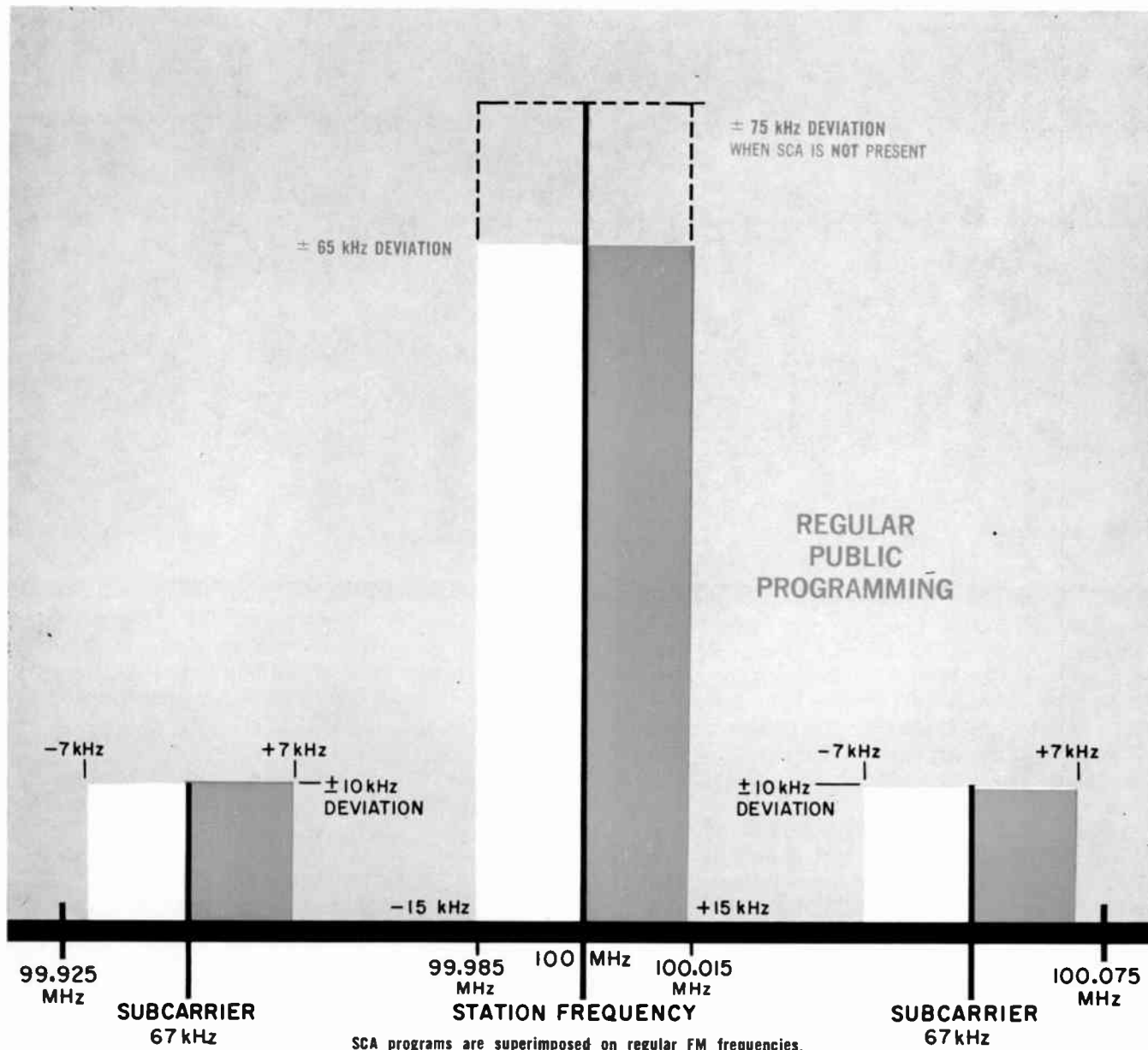

at 1000 Hz would require that the station frequency move back and forth 1000 times per second, ± 75 kHz about its center. So much for conventional FM.

Fig. 1 shows the program frequency distribution for regular programming. Since the highest frequency to be transmitted is limited to 15,000 Hz, the frequency distribution will extend ± 15 kHz about the center frequency. Now, there is nothing to prevent the broadcaster from also sending out a super-audible tone at, say, 67 kHz. Furthermore, this inaudible tone may itself be treated as a carrier wave. That is, it in turn can be FM-modulated about the center point of 67 kHz for, say ± 7 or 8 kHz, by a separate and distinct secondary program source such as music or speech. Since the demodulated frequencies of this secondary program, as received by a public FM receiver, will therefore range from a low of 59 or 60 kHz to a high of

74 or 75 kHz you are unable to hear any part of this programming. Of course the maximum "deviation" or excursion of the carrier is still limited to ± 75 kHz, so the broadcaster of FM and SCA must back off on his public program deviation somewhat, but this is hardly noticeable in monophonic programming.

The Stereo Conflict

Why not live and let live, you say? Who cares if some stations are making extra profits—if anything this should permit them to put on better programming for the general public.

All too true until one considers FM Stereo. You may recall that back in 1960, when the FCC was deliberating over which proposed system of FM stereo broadcasting to approve, that there were *two* favored systems under consideration up to the last moment. The one which, by the FCC's own admission, was capable of

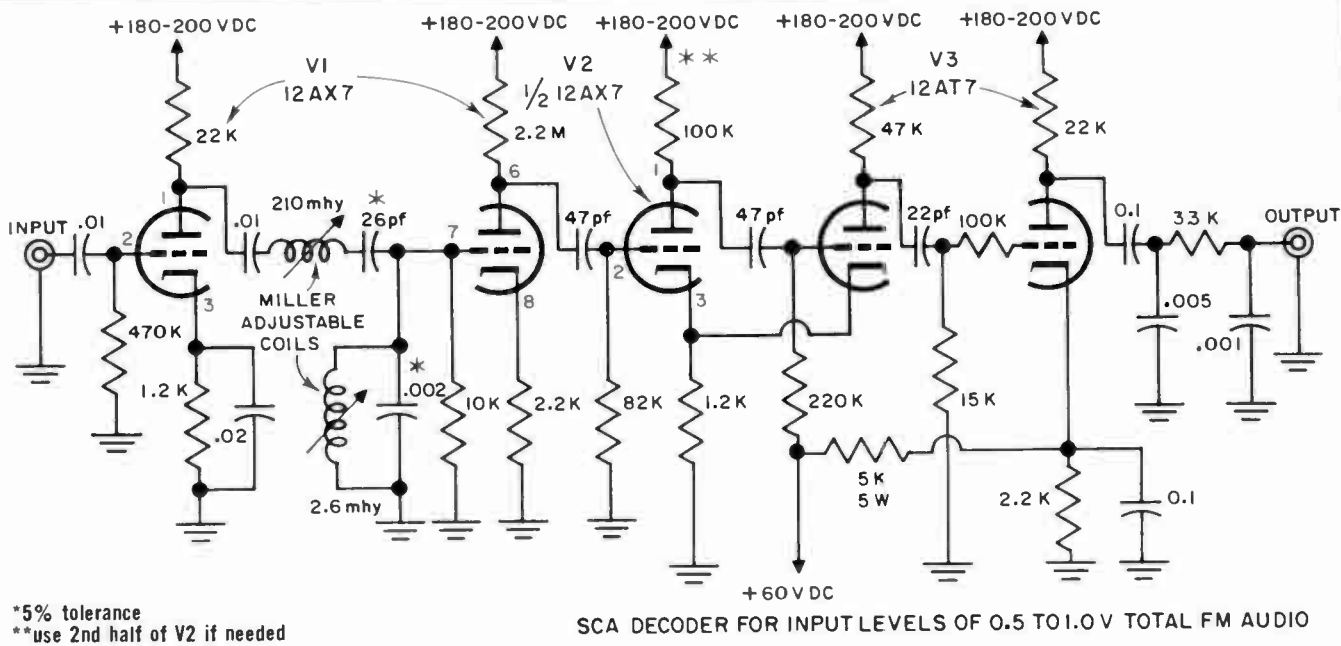

better STEREO performance was *rejected* by the FCC. You see, this superior stereo FM system, proposed by Murray G. Crosby, its inventor, did not provide enough room for both stereo and private subscriber SCA. By this time some 170 stations were finding their SCA operations quite profitable. The rest is history. The alternate system, proposed by giants GE and Zenith (which *did* permit simultaneous stereo and SCA), was approved despite the fact that it suffers from inferior signal-to-noise ratios (as any convert to stereo FM can testify) and thereby decreases the effective range of stereo reception by a significant percentage.

SCA to Stereo Cross-Talk

As if that were not bad enough, early producers of FM Stereo receivers and adapters learned quickly that stations broadcasting both SCA and Stereo make much more stringent demands upon the design of the receiving equipment. You see, the stereo frequencies involved in the transmission of FM Stereo range all the way from 50 Hz up to 53KHz. That upper limit of 53KHz is not very far removed from the lower frequencies used in background music transmission (59 or 60KHz). Unless precise and elaborate filters are used, the stereo listener will hear an annoying "whooshing" sound whenever he attempts to tune in an FM Stereo station that happens to be earning a little extra money with SCA at the same time.

Home Background Music

Some audiófans of a more technical bent decided to "join 'em rather than fight 'em" and proceeded to build their own SCA decoders, so that they could at least "enjoy" this background music in their own homes. There seemed noth-

ing wrong in this pursuit, since the FCC rules governing this type of transmission state that such programming may not be received by anyone who uses it for commercial gain without paying the monthly rental fee to the station involved.

Eventually, a few manufacturers decided to sell such decoders (or even complete receivers).



A typical SCA decoder for input levels of 0.5V to 1V total FM audio is shown at left, with a standard power supply for it at right. If more gain is needed, the second half of V2, which is a 12AX7 vacuum tube, could be used in an added stage shown at the extreme right.

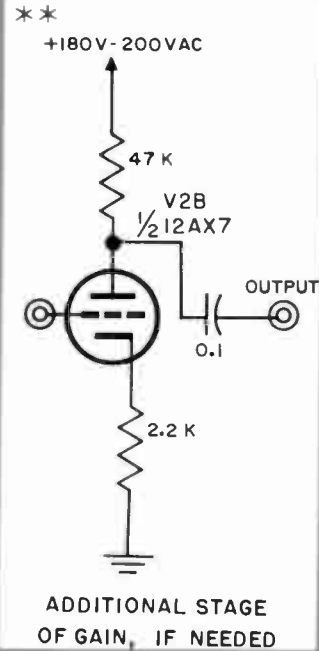
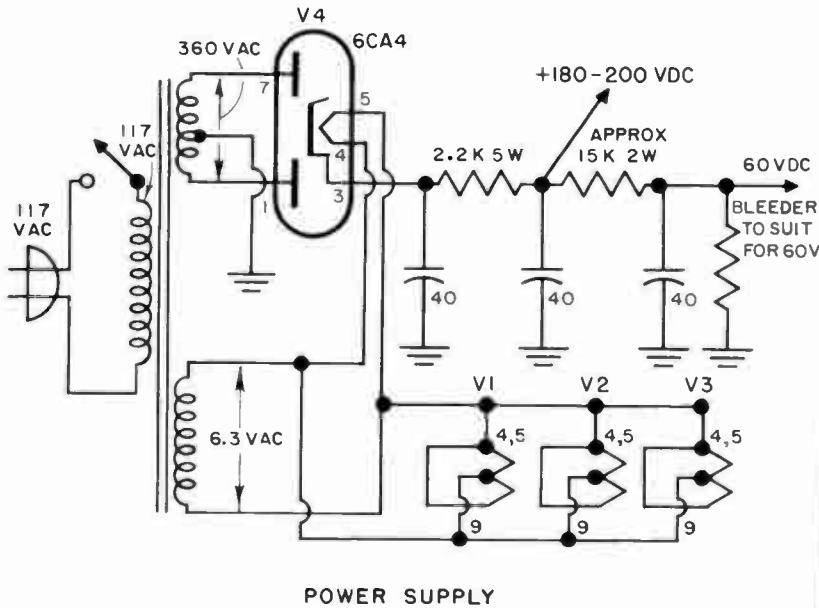

No sooner did this practice get under way than a law-suit was brought by the background music interests against one such manufacturer. Incredibly, the court ruled in favor of the background music interests and the manufacturer was penalized and ordered to cease and desist from further manufacture and distribution of these special decoders and receivers!

Frankly, some months ago AUDIOFAN magazine was preparing to publish a do-it-yourself construction article on building a home SCA adapter, replete with the required warning about not venturing out of your home music room with it (all doctors and dentists take particular note!), but now—well, we'll wait and see how it all comes out in appeals court



Entertainment center of the future

Here's an experimental dream entertainment center created by Canada's Dominion Electrohome Industries. Called "Circa 75," ostensibly to mean around the year 1975, it consists of a circular cabinet with a wide variety of round dials, function pushbuttons, and lighting indicators. Aside from a wide variety of hi-fi stereo equipment, such exotic gear as a video phone (a small-screen TV receiver is integrated into the "dream" system) and color video taping are featured. Also featured as part of the system are companion chairs with built-in speaker systems in the "head wings" for personal listening, and remote control mode selectors.

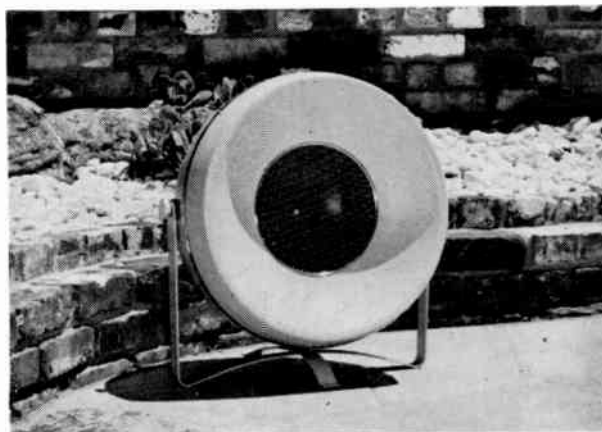

Speakers for Sunlight, Moonlight & Underwater Fun

Outdoor speakers, unlike indoor speakers, are designed to withstand rain, snow, and some rough handling. Bozak's Bard, above, and Electro-Voice's Sonocaster, below, are examples of this speaker system strain.



You can take any loud-speaker system(s) and place it outdoors. But the open air setting doesn't make it an outdoor speaker. To qualify for this adjective, it must be weatherproof, if not waterproof.

The elements can play havoc with a speaker system not designed to stand up to it. (You'd be surprised what heavy rainfall does to wood veneer.) That's why a host of speaker manufacturers produce speaker systems specifically made for outdoor use and, in some cases, for underwater use.

A popular outdoor speaker today is the Bozak B-1000 *Bard* (\$79.50), a weatherproof hemispherical-shaped system that stands on the floor or hooks onto an object. Electro-Voice has a number of portable, outdoor types. The company's weatherproof *Sonocaster I* consists of a molded, crackproof enclosure with a handle and hangup bracket (\$25). It weighs only 6¾ lbs. A similar, though heavier model, named just plain *Sonocaster*, has a wider frequency response, weighs 8 lbs. (\$36). Other speakers in E-V's line include two outdoor extension types, the *Musicaster* and the *Musicaster II*. The former one has an 8" speaker,



Sound travels even better under water than in air, but you require special speakers to achieve good performance and longevity.

weighs 31½ lbs. (\$60). The Musi-caster II adds a VHF driver and is a bit heftier (\$81). Both are housed in weatherproof, 1 piece aluminum diecast enclosures.

There are other speakers suited for outdoor use, though they are more on the professional side, generally for commercial applications. Companies that have such speakers include Electro-Voice, Jensen, and University.

Let's not exclude underwater speakers here. Sound travels particularly well under water. There's a limit to the depth in which underwater speakers can be immersed without losing considerable fidelity, of course, because water pressure prevents the cone from moving back and forth properly. But 8 feet and sometimes beyond this depth has often proved satisfactory. Among the companies making available underwater speakers are Electro-Voice, Pioneer, and University. No doubt, you've observed some other companies, such as Hartley, demonstrating at hi-fi shows how their speakers operate under water. Such speakers may be used on land and at sea, so to speak.

You'll probably need more power outdoors than indoors because the wide open spaces soak up considerable sound. Bass response falls off outdoors, too. But the same holds true for live orchestras playing in outdoor concerts, so don't let it concern you. Just relax in a lounge chair and enjoy hi-fi outdoors while you're getting that summer tan, or dance outdoors to wide-frequency music on a balmy evening, or thrill to the sound of music underwater (don't relax too much here or some gurgles will be added).

Your outdoor speakers can be used in a number of ways: connected to your indoor hi-fi system, hooked into a portable radio to substitute for a tiny built-in one, or as part of a portable phono system. And nothing stops you from using outdoor speakers indoors when frigid weather arrives.

HOW DO IT HOLLYWOOD SOUND RECORDISTS

by Hart Sweeney

 "Judgment is the single most important attribute of the art of sound recording," according to Franklin Milton, Head of the Sound Recording Department at MGM. And he should certainly know. He has won Academy Awards for his contributions to *Ben Hur* and *How the West Was Won*. More important, his influence upon the state of the art in supervising some 75 to 110 employees in the production of sound for 200 theatrical feature films and several hundred television and other productions, has long since won him the respect and accolades of his contemporaries.

Judgment, as Milton defines it, is a combination of learning from experience and having the courage and patience to experiment. "The person who is willing and able to do these things," says Milton, "can, for all practical purposes, become as skilled as he wishes at the art of recording sound.

"This includes everyone from the amateur who gets pleasure out of recording and playing back interesting sounds (music or otherwise) to the professional, or would-be professional, who wants to make his hobby into a profession.

"Both fields—amateur and professional sound recording—are growing. Also, practitioners are improving their skills all the time. This is obvious from the increasing quantity and quality of mail I receive from people who want to know how we did something, or how they can get a job," said Milton.

Much of the mail that comes across Milton's desk is very encouraging, he finds. It is from people who want to learn from his experience. Some of it, however, is less encouraging.

"Some of the mail just comes from people looking for an easy

way to solve their own tape recording challenges. You can learn from what other people have done. However, you cannot substitute this knowledge for trying yourself," said Milton.

"This is where experience and experimentation come in.

"You learn tape recording techniques from experience, by reading books about basic recording methods, by exchanging ideas with other tape enthusiasts.

"You also learn from experimentation—trying something different—even though the previous method might have worked all right. We at MGM do this all of the time.

"Perhaps the one basic lesson that we have learned at MGM is that there is no substitute for quality. Our judgment teaches us that we can do much to add to the creative value of our product if the original and subsequent materials and equipment used for recording are of high quality. Not everyone, of course, can always afford to purchase the most expensive recording equipment. However, we have found that much can be done to upgrade recording quality merely by sticking to brand name, instead of white box, magnetic recording materials.

"These materials not only provide better original sound, but also allow the individual to exercise more creative judgment, since he will have more to work with," Milton continued.

"For example, better magnetic tapes will provide more dynamic range. This means, that you could, by way of illustration, record music at a concert and later, in playback or re-recording, move the volume of the music higher or lower, and thus, over or under other recorded sounds.

"This control of dynamic range actually permits the sound recording artist to increase his cre-

ativity by allowing him more leeway in recording in areas where he cannot control outside noises.

"I think that the amateurs who experiment with dynamic range will be pleasantly surprised. By experimenting, and trying different things, he will be able to improve his judgment, and therefore enhance his capabilities.

"This is exactly the way we improve our own techniques in a Hollywood studio. For example, we once ran into a reverberation problem while recording sound for the television series, *Mr. Novak*. Unlike the theatrical film, each technical chief working on a television show is pretty much on his own. Because of tight schedules, there generally is no time for the producer or director to redo something he doesn't like.

"In our case, this means that it is up to us to exercise judgment which will produce something good the first time around. On the *Mr. Novak* series we recorded sound both on location and in the studio for later dubbing.

"The location sound is most often obtained at the high school where the show was photographed. However, because of the unique hall structure at this high school, we found that there was a reverberation quality in all voices recorded on location. This quality was, at first, almost impossible to match. Yet, we did have to dub a certain amount of dialogue to match the scenes photographed at the school.

"After a process of trial and error, we learned that, by recording dialogue to be dubbed in a room whose walls were padded with mattresses, we were able to exactly match the quality of the original reverberation.

"The amateur can apply this lesson to his own work. If the tapes that he is working with are of sufficient dynamic range potential, and if they record the same way everytime, he can greatly

Gordon MacRae during a Hollywood recording session.



influence final sound quality by the environment he works in.

"This, of course, takes determination, and a willingness to stick to it. However, the amateur who tries, I believe, will find that he can accomplish things that he didn't dream of before.

"I can think of one excellent case in point. How many ama-

teurs have ever tried to mix sound? Not many. Yet, the questions that I most commonly receive are in regard to how we accomplished effects that were actually the result of mixing.

"For example, in George Stevens' *The Greatest Story Ever Told*, we mixed 63 different sounds in order to accomplish a

single effect. It was actually very simple. The scene: The temptation scene. The Devil kicked a rock which bounded and reverberated from the top to the bottom of a canyon. Yet, through the medium of sound, we feel that we were able to build a crescendo of dramatic impact. I would
(Continued on page 28)

PROFILE OF AN AUDIOFAN

More hi-fiers respond to
AUDIOFAN's invitation to
send in photos of their
stereo systems

apartment dweller beats space problem

 John H. Beaumont, a West-Side New York City apartment dweller, tells us that he enjoys looking at the "dream" hi-fi stereo systems featured in AUDIOFAN, but sadly observes: "... most of us don't have an extra room that is needed for such installations, not to mention the neighbors' feelings if one was to turn on a room full of equipment and speakers."

Thanks, John. You've summed up the reasons why AUDIOFAN is interested in all types of hi-fi installations, not only the "dream"

setups. So let's hear from the rest of you audiofans, even though your rigs are not pretentious ones.

John Beaumont was faced with the typical room space problems besetting most apartment dwellers. "One can always find an 8 foot long cabinet," he notes, "but the problem becomes where to put it . . . who can afford 8 feet of space in a small New York apartment?"

The only space he had available was in an entry hall, and a limited amount of space at that. You might think that this is an in-

convenient location, but our hi-fier says, "Not really. A New York apartment is small enough that the entry hall is not more than a few steps from you favorite easy chair."

He finally conquered his space problem by locating an antique breakfront just the right size to fit into the space requirements of his apartment, yet large enough to install all of his equipment with room left for record and tape storage. As you can see in the photos, he accomplished this neatly by

(Continued on page 28)

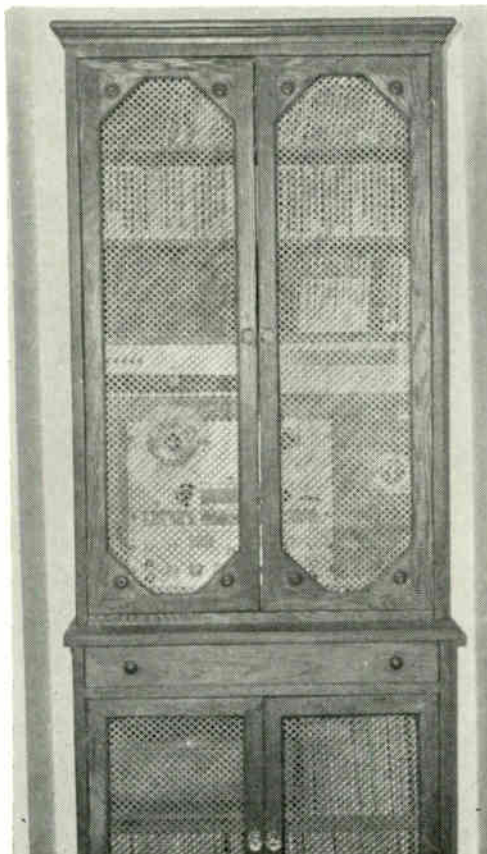

An antique breakfront, converted into an equipment cabinet, provides a functional, easy-on-the-eyes solution to an apartment dweller's space problems. Speaker systems are located in the living room, naturally.

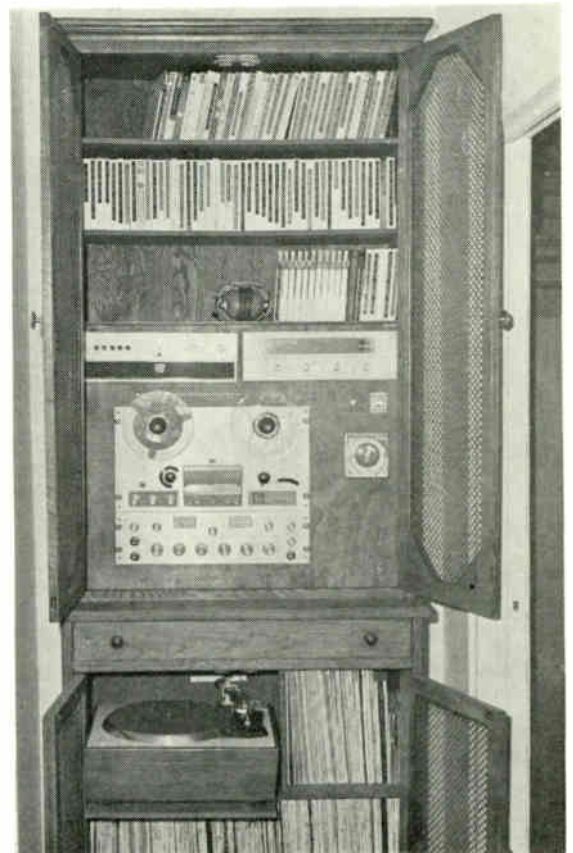

SHARE YOUR HI-FI INSTALLATION . . .

AUDIOFAN MAGAZINE will pay \$10 for photos or hi-fi component arrangements it uses. Simple snapshots will do, together with a few words on how you found the best spot in the room. This isn't a contest. It doesn't matter whether your hi-fi stereo system is big or small, elaborate, or simple. So let's hear from you.

Send material to

AUDIOFAN MAGAZINE
25 West 45th Street, New York, N.Y. 10036

builds own speaker cabinet

 In his very first attempt at cabinet making, Maron Horonzak of St. Louis, Mo. sure picked a dilly—James B. Lansing's wall-to-wall Paragon system.

This effort was made after 10 years of hi-fi interest, in which audiofan Horonzak went through at least six complete hi-fi component systems. ". . . This will not be my last," he said. "A four channel system will probably be my next project."

He bought detailed construc-

tion drawings from J.B.L. and followed the instructions step by step. How much time did the giant undertaking require? "Five months, working three days per week," advises our brave hi-fier. This included rubbing five coats of danish oil into the walnut. *(Mr. Horonzak knows of at least 7 more Paragon cabinets that were built in the St. Louis area and wonders how many more were built elsewhere. So if anyone else has built one, let us know and we'll relay the information to him.*

Who knows, maybe there's a Paragon construction club in the offing.—Ed.) "Carving the front legs took one day each [temporary blocks supported the cabinet in the front until legs were completed] and painted them flat black," he reported.

The complete complement of J.B.L. speakers were installed in the cabinet—2 model LE-15A woofers, 2 model 375 drivers, a model 075 tweeters, models LX5 and N7000 crossovers. After these were installed, final walnut dress

The Jim Lansing Paragon speaker system shown here was built by audiofan Horonzak from detailed construction plans obtained from the manufacturer. The closet-installed low frequency speakers at its right can be switched in to reinforce deep, deep bass notes whenever this is desirable. (See overleaf page for photos showing cabinet construction stages and other hi-fi stereo components.)

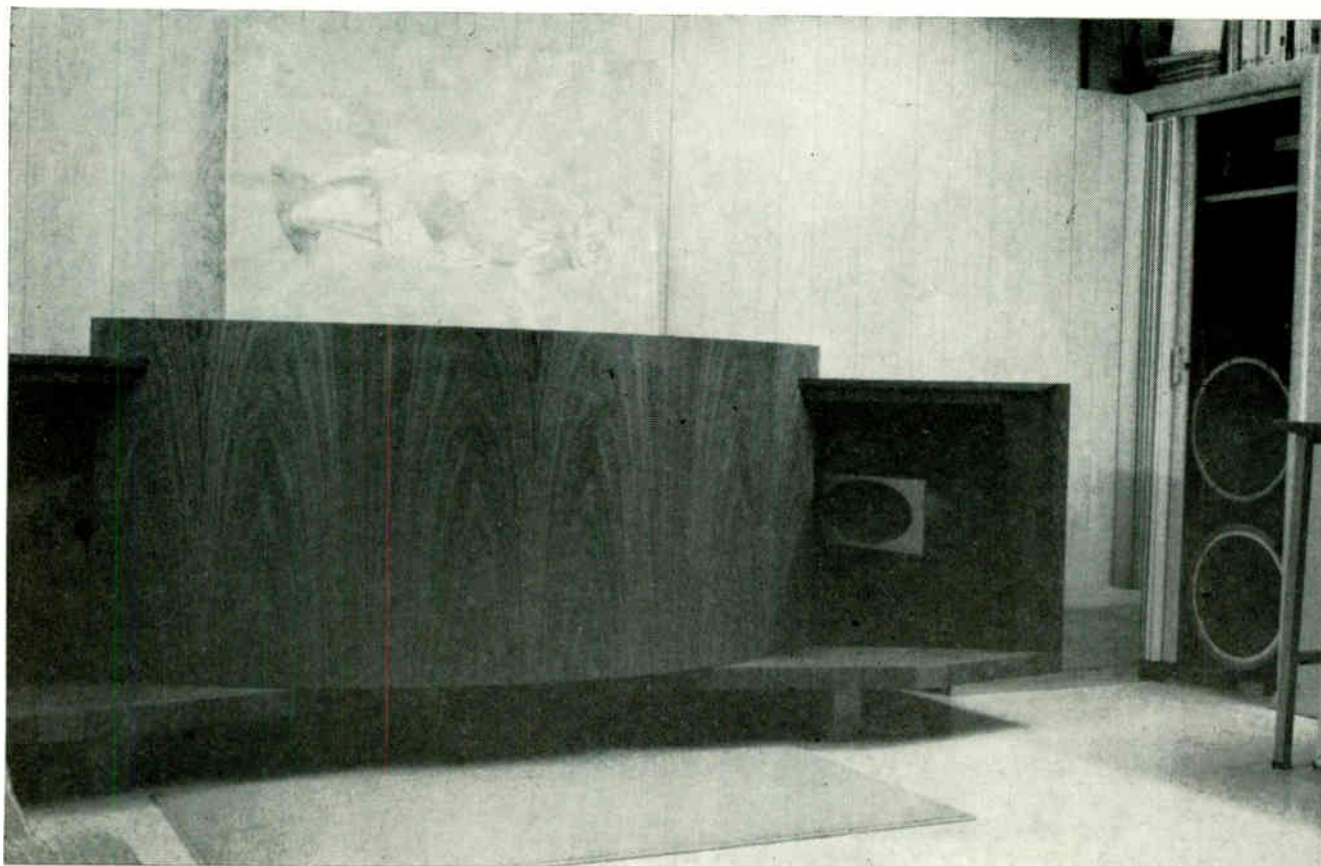

was completed; the lower skirt assembly and the curved panels were lowered into place.

The remainder of Horonzak's hi-fi stereo system consists of the following components:

- 1 Marantz Model 7C stereo preamplifier
- 1 Marantz Model 7T stereo preamplifier

- 1 Marantz Model 10B FM multiplex tuner
- 1 J.B.L. Stereo Energizer amplifier
- 1 Crown Model 300 Tape Player
- 1 A-R Manual Turntable
- 2 Magnetic phono cartridges with elliptical styli (Grado BE and Shure M55E)

In addition to the above, he installed a supplementary bass speaker and passive radiator in a closet (see photo) to enhance the ultra low end of his new Paragon. "It can be switched in or out of the circuit as I see fit," says Horonzak, whose main occupation, Industrial Art, no doubt prepared him for his present undertakings.

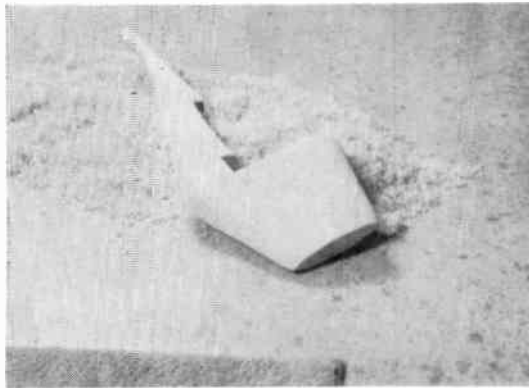

One of the hand-carved legs of the large enclosure is shown here on a pile of wood shavings. Each leg took one day to carve out. Legs were finished in flat black paint.

Left and right top sections of the speaker system's enclosure are pictured here before assembly. The slots are for the refractor panel.

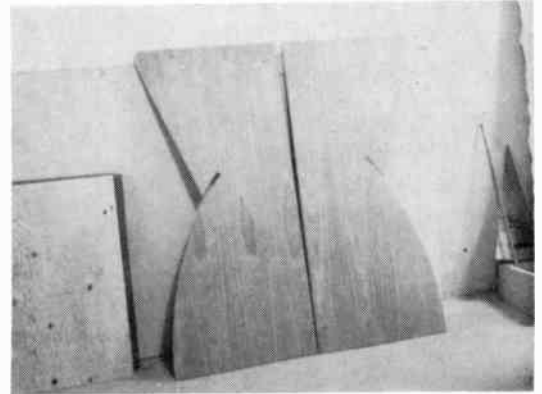

Audiofan Builds own Speaker Cabinet

(Continued from previous page)



Going back in time, here's a photo of the Paragon enclosure before top sections and the refractor panel were added.

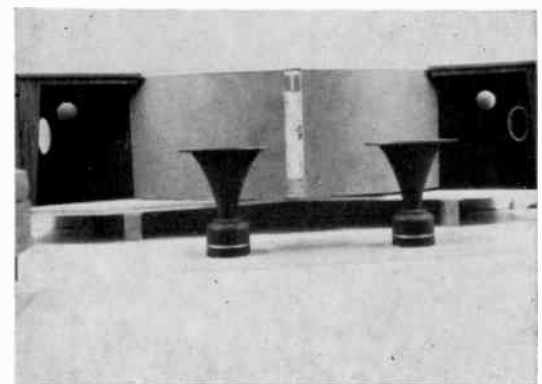

Here is the almost-completed stereo speaker cabinet ready for speaker installation. (The finished unit is shown on the preceding page.)

Components are situated on wood shelves, supported by metal brackets and metal wall strips (see Construction Projects). They include a JBL "energizer" stereo power amplifier, two Marantz stereo preamps, McIntosh FM stereo tuner, A-R manual turntable and tone arm, and a Crown tape transport. A television receiver beneath the shelves rounds out the entertainment center.



**SIMPLE
CHECK-UPS
THAT KEEP
YOUR
SYSTEM
TIP-TOP
HOLD
ON TO
HIGH
FIDELITY**



*A continuing series of
maintenance and service tips
on hi-fi system components.*

AUDIOFAN
AUGUST
1966
PAGE 17

wire—the electronic staff of life

With all the advances made in the field of electronics, common electrical wire still plays an important role. To the hi-fier, this is particularly apparent because he's usually hooking up one piece of equipment to another. This might be a length of coaxial shielded wire between a turntable's pickup and a preamplifier input; lamp wire between a power amplifier's output terminals and a speaker; twin lead wire or coaxial cable between an antenna and the radio frequency input of a tuner; right down to power line wire which plugs into a wall outlet.

Any one of these wires are capable of affecting your hi-fi system's performance.

The power line one could be an electric shock hazard if its insulation becomes bare over the years. It could also lead to a higher level of hum if the plug is inserted into the outlet in one position rather than the reverse position. You can test this by comparing the level of hum when the plug is reversed. Try this without source material, of course, and place your ear fairly close to the speaker while maintaining the volume control in a normal position. You don't want to turn the gain all the way up because you could damage a speaker this way. The ideal situation is to have equipment with three-prong plugs. Some European equipment is made this way. Unfortunately, most American homes do not have three-prong outlet boxes. You could use an adapter, naturally, which has a wire lead with a spade terminal for the third wire. The lead is attached under a screw that secures the outlet panel to the outlet box. But this presumes that the outlet box is grounded to a water pipe or some similar earthing. Many aren't.

Most people use ordinary lamp wire to connect speaker systems to power amplifiers. This is fine if the wire is large enough, and if it doesn't become an antenna of sorts as it is routed around a room. Most lamp wire is #18 gauge, which is a mite too small for best results. If you're going to use 10 feet or more of speaker lead wire, #16 wire should be used; better still, use #14. If the wire is too small, you're putting more resistance in series with the speaker's voice coil which, in turn, is in series with the amplifier output. This could affect the damping factor built into the amplifier.

During nice weather, it's a good idea to check out your FM antenna. It takes quite a beating during the winter season. Perhaps your antenna wire is flapping in the wind and has to be secured with standoffs? Maybe it's so old that moisture is causing a partial short between leads? The only solution here is to install new twin lead or coaxial lead wire.

A-B test procedure
gives
accurate results

conducting phono cartridge comparisons in home hi-fi stereo systems

by Alex Rosner



A-B comparisons of hi-fi equipment—that is, playing source material over one component (A) and quickly switching over to another component (B) of the same type to compare its performance with the first one—offer a valuable way to evaluate them accurately. After all, the final test of hi-fi equipment is how it sounds to you and other people!

Such realistic evaluations are especially reliable for a hi-fi system's transducers — components such as phono cartridges (our subject) and speakers that transfer mechanical action into electrical action, or vice-versa.

This is due to the lack of accepted measurement and rating standards for transducers.

Preference testing of cartridges, however, has many pitfalls. Removing them requires careful planning, time-consuming preparation and exact execution. Attention to detail is imperative to avoid making a comparison invalid due to a small, apparently unimportant aspect of it.

The way to compare two of

anything is to make them do the same thing and observe the results. The first problem is to “do the same thing.” The second problem is getting results that eliminate chance. Let us first examine how phono cartridges can be made to “do the same thing.”

In a typical high fidelity system, the output of a phono cartridge that is mounted in a turntable's tone arm is connected to the input(s) of a preamplifier which, in turn, feeds amplifiers that drive the speakers.

If the preamplifier has an additional switch-selected input for accepting a second cartridge, it would seem simple to connect two cartridges, each mounted in its own arm and turntable, or even a common turntable, play the same record, switch the pre-amp input selector back and forth, and listen for the difference. A panel of listeners could vote on the results and conclusions could be drawn.

But even though the cartridges are alternately being fed to the same circuit, are they really “doing the same thing”?

Multiple tone arms mounted on a turntable sets the stage for stereo phono cartridge comparison tests.



Suppose cartridge A has a slightly higher output than cartridge B. Will the listeners be able to compensate for the resulting loudness difference? Can this difference be eliminated by changing the volume control setting each time the input selector switch is thrown? It's all very unlikely. If both cartridges are similar in quality—that is, if one is not very good and the other very bad—most listeners will favor the one that sounds louder. Some listeners, on the other hand, who are aware of the tendency to favor the louder cartridge, will feel that since cartridge A is louder and does not seem that much better than cartridge B, cartridge B must be better than cartridge A. It becomes evident that we must somehow balance the output signal levels of both cartridges.

balancing signal levels

There are many ways to balance signal levels. One way is to play a test record with a steady test tone, measure the output of the preamp with an AC VTVM

and note its readings. Then repeat the procedure, switching to the other cartridge. We might then change the volume control setting and mark the panel so that every time we switch over to a second component (while playing an orchestral selection, let's say) we would change the volume control too.

The disadvantage of this technique is that even with careful marking of the panel, moving the volume control to exactly the same spot each time is exceedingly difficult, if not impossible. At normal listening levels, a very small displacement of the control from the mark will change the sound level appreciably. Besides, few stereo volume controls track so closely that a small mechanical rotation will yield the same change in both channels.

A step-type volume control, found on some preamps, would be fine, but suppose the difference between the cartridges being compared falls somewhere *between* the steps? You might think, too, that preamps sporting individual input level controls

would offer an excellent means of level compensation with the turn of built-in potentiometers. But these controls often affect the frequency responses of inputs, depending on what position they are in. So to be fair to both cartridges, the effect of level controls in the circuit should be removed by turning them all the way up.

Having eliminated the most obvious ways of balancing input levels, we now come to a practical solution, as shown in Fig. 1. This technique will work on preamps or integrated control amplifiers which have tape monitor switching facilities. (These are incorporated in most modern units.) The parts required are two (for stereo) 100,000 ohm potentiometers, four short lengths of shielded cables with phono plugs at one end (other ends get soldered to the pots), four phono plug-to-dual jack adaptors, plus the use of either an AC VTVM or a set of VU meters with drive amplifiers (described in last month's *AUDIOFAN*).

(Continued on next page)

An unmodified preamp selects, amplifies and frequency-compensates (in accordance with record industry standards) an incoming phono cartridge signal. It makes available two kinds of outputs. The signal level of one of these, intended to feed a separate power amplifier, is not only dependent upon the output level of the phono cartridge connected to the preamp, but is also dependent upon the preamp volume and tone

control setting. This output is the preamp AUDIO OUTPUT. The other preamp output (or set of outputs for stereo) is internally tapped off prior to the volume and tone control circuits and its level, therefore, depends solely on the input source signal—the phono cartridge, in our case. This is the preamp RECORD OUTPUT.

During normal play operation, with the tape monitor switch in

the INPUT position, as shown in Fig. 2A, the preamp selector switch chooses which inputs the signals are to go through to become available at both outputs. But with the tape monitor switch thrown to the TAPE position, as shown in Fig. 2b, the AUDIO OUTPUT no longer makes available the signal selected by the preamp selector switch. Instead, the AUDIO OUTPUT now pre-

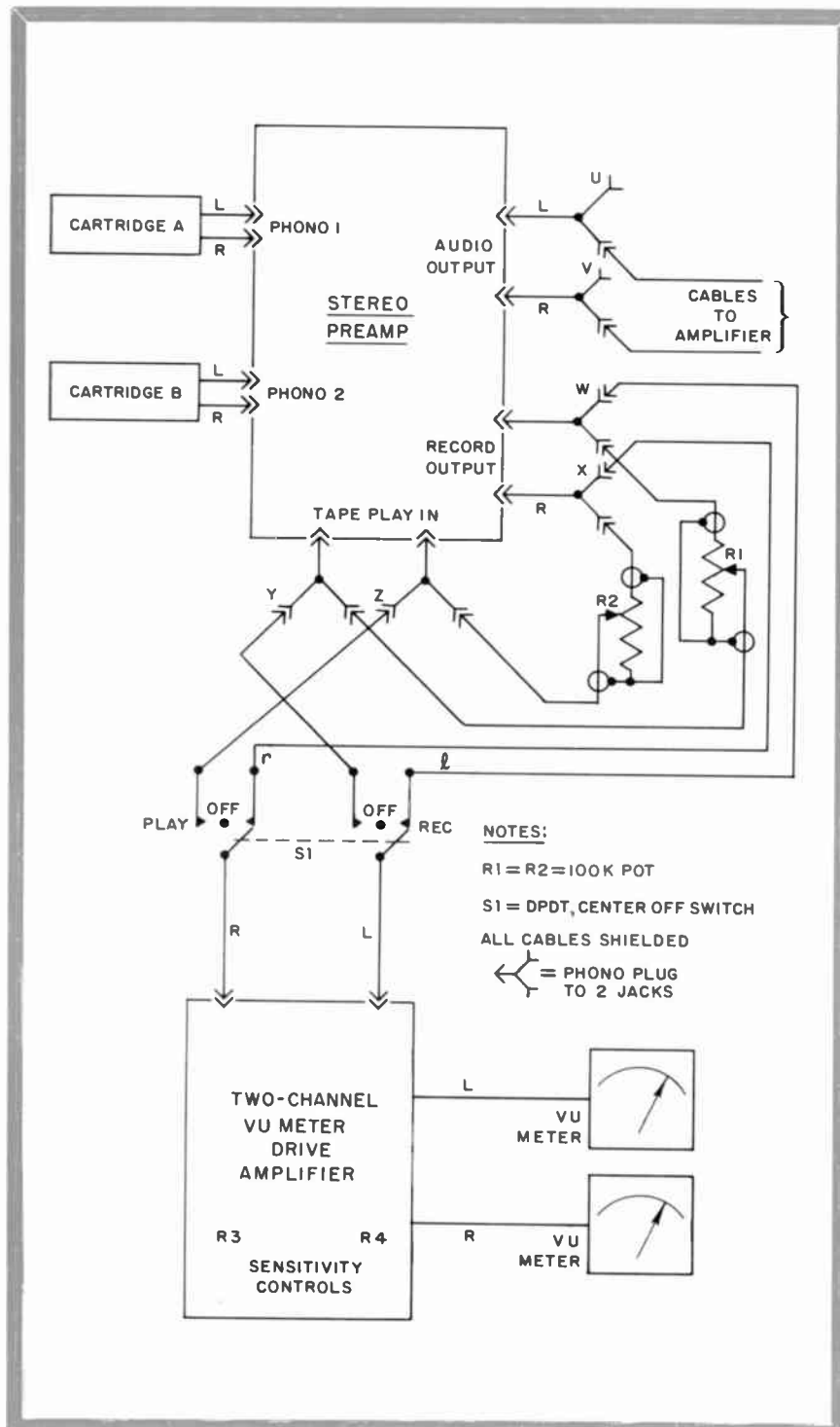

Parts/Equipment List

- 2 100,000 ohm potentiometers
- 4 short lengths of shielded cables with phono plugs at one end
- 4 phono plug-to-dual jack adaptors
- 1 AC VTVM or VU meter with drive amplifiers
- 1 Test record (see text)
- 2 Tone arms or two turntables with tone arms
- 1 DPDT, center-off switch

Fig. 1—When you're comparing input sources—in this case, phono cartridges—it's imperative that output levels are balanced. Otherwise the louder sounding cartridge might be chosen as the better one. External wiring which plugs into a preamp is shown here for this purpose. (See parts/equipment list.)

sents whatever input is connected to the preamp's PLAY TAPE input, while the RECORD OUTPUT maintains whatever input has been selected by the preamp input selector switch (as before). It is this feature of the preamp that can be taken advantage of in balancing input source levels, though we have nothing to do here with tape recorders.

After connecting the 100,000

ohm pots (R1 and R2) shown in Fig. 1, the setup is used as follows: Connect the phono cartridge with the higher output voltage to the PHONO 1 inputs, while the other cartridge is connected to PHONO 2 inputs. With R1 and R2 turned all the way up and the preamp selector switch in PHONO 1 position, switching the tape monitor switch should have no effect. That is, the signal

from the preamp's AUDIO OUTPUT, which drives the power amplifiers, will be the same whether the tape monitor switch is in the INPUT position or in the TAPE position. (Without R1 and R2 connected, there would be no sound at all in the TAPE position.) It should be noted at this time that care must be used in connecting and disconnecting preamplifier inputs and outputs:

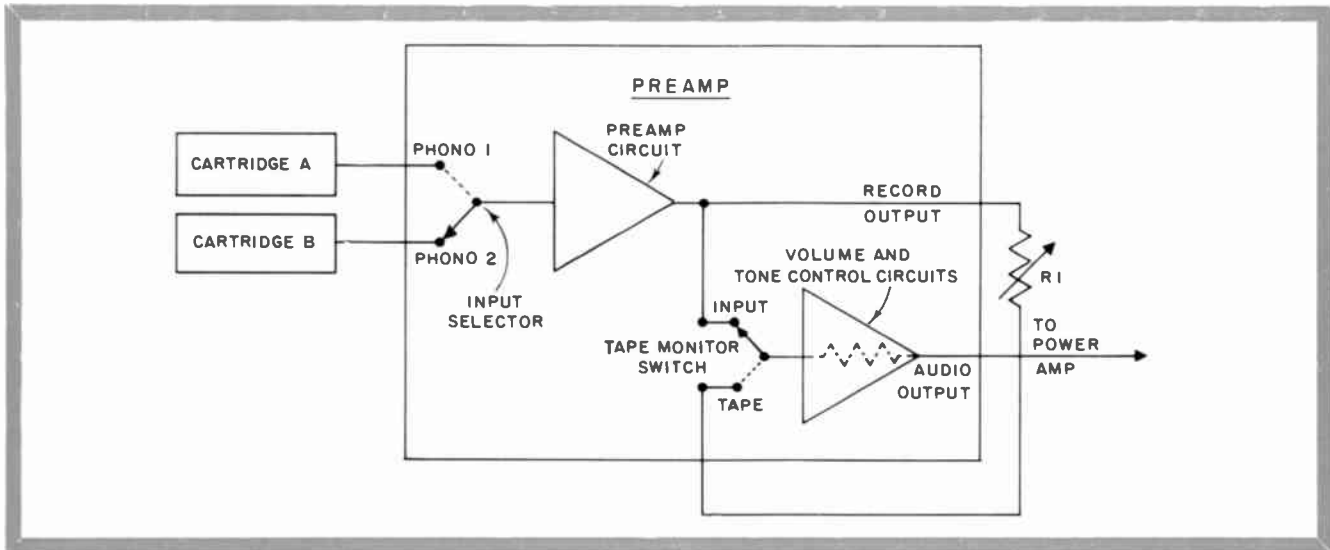
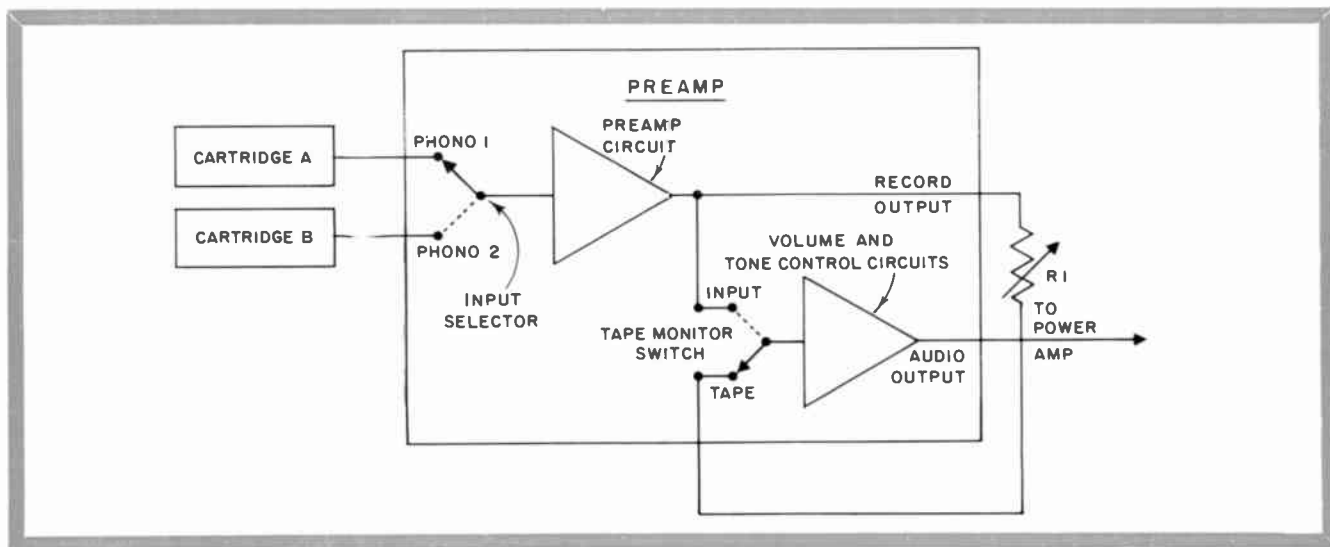

Fig. 2A—With the preamplifier's selector switched to phono 2 and the tape monitor switch in the input position, you can see that the signal flow of a stereo channel (the other channel uses the same setup) is not affected by potentiometer R1. It goes straight through to the power amplifier because the tape monitor switch position creates an open circuit.

Fig. 2B—With the selector in phono 1 position and the tape monitor switch in the tape position, however, the audio signal from cartridge A has to travel through R1 before it can go to the power amplifier. Thus, its level depends on the setting of the potentiometer, which should be adjusted so that the output of cartridge A equals the output of cartridge B.



Cartridge comparisons in home systems

(Continued from previous page)

power amplifiers must be shut off, otherwise popping transients may cause speaker damage.

Playing a record with PHONO 1 will demonstrate that no level change takes place when throwing the tape monitor switch to TAPE. But now let us lower R1 and R2 about half way and listen. It will be noted that the sound level, just as the preamp AUDIO OUTPUT level, will drop when throwing the tape monitor switch from INPUT into TAPE position. The task now, using PHONO 1 (cartridge A) and the tape monitor switch in the TAPE position, is to set R1 and R2 to yield a preamp AUDIO OUTPUT that will be equal to the preamp AUDIO OUTPUT when both PHONO 2 (Cartridge B) is selected and the tape monitor switch is in the INPUT position (R1 and R2 out of the circuit). Once R1 and R2 are adjusted to reduce the stronger of the two inputs (PHONO 1, in this case) the switching action for comparisons is merely PHONO 2 and INPUT for cartridge B and PHONO 1 and TAPE for cartridge A.

Because of the nature of preamp cathode-follower circuitry, R1 and R2 will have no ill effects on frequency response or distortion as will input level controls or input level adaptors. Furthermore, both pairs of input signals are traveling through exactly the same equalization and amplification stages, which beats using separate preamps, even if available. If it is more convenient, remote volume controls of the type that connect to the same points as R1 and R2 are tied to can be used in place of R1 and R2 since they operate on the same principle. An example of this type of control is the Fisher Model RK-1.

There are two ways of accurately setting R1 and R2, each of which can be done using either an AC VTVM or the amplifier-driven VU meters described in last month's issue. One way in-

volves measuring at the preamp's AUDIO OUTPUT, while the other way requires measuring at both the preamp RECORD OUTPUT and TAPE PLAY input. Using a vacuum tube voltmeter (VTVM), the first step is to play a stereo test record with stereo cartridge B, one channel at a time. A suitable disk for this purpose is Vanguard's *Stereolab Test Record VSD-100*. After connecting the VTVM to point U of Fig. 1, set the preamp volume for a comfortable listening volume, setting the VTVM's measurement range so that an indication on the scale appears on some convenient mark just past the center of the meter scale. Play the same tracks with cartridge A (tape monitor switch in TAPE) and adjust R1 and R2 to give the identical meter indications as when playing cartridge B. Since both pots were full up until now, adjustment will consist of turning them down, one channel at a time.

In the event that either cartridge is suspected of having an unreasonable peak at the test frequency, adjustment of R1 and R2 should be made at several frequencies, or a frequency response check should be made on both cartridges (you can use the same disk for this) and the difference averaged out. In most cases, an AUDIO OUTPUT level equalized at 1000 cycles should be fair enough.

For frequent comparisons, and where several cartridges are to be compared (two at a time), the VTVM method becomes awkward to use. The VU meter method is much preferred. If you built last month's *Construction Project*—a VU meter drive amplifier with sensitivity adjustment controls—you're all set. If the VU meters and VU drive amplifier controls are panel mounted, this method becomes even more effective.

The hookup, shown in Fig. 1, requires switch S1 to look at either sides of R1 and R2. A three position, illuminated Switchcraft "Leverlite" model 25312L or

27312L switch works out well here. Illumination current for it as well as for the VU meters can be furnished by the filament transformer of the VU meter drive amplifier.

With S1 in the REC position, play a 1000 Hz standard level test tone with cartridge B and adjust R3 and R4 for a 0 VU indication. Switch over to cartridge A (PHONO 1, tape monitor switch to TAPE) and throw S1 to PLAY. The VU meter will now read more than 0 VU, possibly even pinning its pointer against the stop (which should be avoided for more than a few seconds). Adjust R1 and R2 for 0 VU on each meter. The inputs are now balanced.

Play an orchestral selection using cartridge A with preamp controls in the positions just set. Notice the action of the VU meters. Now repeat the musical passage using cartridge B this time (input selector to PHONO 2, tape monitor to INPUT) and switch S1 to the REC position. The VU meters will swing just about the same way. But at this point the swing of the VU meters is irrelevant and they may be shut off by throwing S1 to its center position. What is important is that the difference in cartridge output levels has been eliminated.

errors can falsify results

If two similar tone arms are mounted on one turntable, their cartridges will be up to one half of a disk revolution apart in relation to each other. By careful cueing, their styli can be placed in the same groove. At 33-1/3 rpm, it means a time difference of less than one second—a small enough delay to allow alternately hearing a portion of recorded music with both cartridges.

During a recent cartridge comparison session, an observer expressed concern about the possibility of the stylus plastically deforming the record groove so that the second stylus is at a disadvantage when arriving at the "scene of the crime" only a second later—

AUDIO CLUB NEWS

possibly an inadequate amount of time for complete self-restoration of the groove. It could also be argued that the leading stylus not only gets surrounded with grit that it digs out of the grooves, but cleans the groove for the following stylus, in which case the second cartridge benefits. If you used two turntables, two arms, and duplicates of the same disk, a different small imbalance might be suggested.

Regardless how little the above factors influence performance of either cartridge, just worrying about them is reason enough to eliminate them. So, sometime during the tests, simply interchange cartridges in their respective arms. This is a good idea for other reasons as well—such as the possibility of a difference in tone arm cable capacitance and variations between the preamp phono input resistors, as well as the difference in tone arm performance (who would ever buy two identical tone arms?) In other words, remove all the doubt you can.

Having expended all this effort to eliminate the most likely causes of error in performing phono cartridge A-B comparisons, it remains for us to explore some of the less tangible, but still significant, factors that can bias a test. The audio system through which the cartridges are to be played must be of high quality, naturally. Otherwise such things as speaker response peaks can compensate for a cartridge's deficiency, yielding misleading data.

Even with smooth speakers, the listening room could mask one cartridge's faults while highlighting the other's assets; or the converse could occur. Hopefully, this imbalance will not be significant enough to upset the findings. Having reasonably assured ourselves that the cartridges will now "do the same thing," we must now minimize chance as a factor in comparison results.

live audience test

An effective procedure is to request each of five people to bring



Don Springer (photo above), bearded new chairman of the Stereophonic Club of Southern California (he

was formerly treasurer), observes that membership attendance picked up as soon as Spring-time arrived. So after a period in which monthly meetings were held in members' homes, meetings are again being held in the spacious quarters of the Pasadena Athletic Club building.

Acoustic Research informs us that they'd be happy to receive visits from audio club groups for tours of inspection of the AR plant located at 24 Thorndike St., Cambridge, Mass. Visitors will be able to view speaker and turntable production and test procedures. If you've never seen an anechoic chamber, here's your chance. Contact AR's Gerald Landau to make arrangements for a visit. He promises coffee and pastries in addition to hi-fi.

one record which they consider suitable for the occasion. The operator performing the test has no vote and must refrain from comments.

The turntables, VU meters (if they're on) and controls must be out of the listening panel's view and cartridges should be interchanged between arms by the operator as often as possible. Cartridge switching should be done without informing the panel, since an astute listener will quickly learn which cartridge is ahead in time on the record, which might bias his judgement on the next record. In other words, with each record, no one should know which cartridge is tied to which input. Cartridges can be assigned a number, which should be known only to the operator.

Each panel member can take his turn in directing the operator to switch over during the listening tests. This may be done by holding up one or two fingers; visible to everyone, but not as

disturbing as voice commands might be. To test the judging reliability of a given panel, tests should be repeated (but in different order). Results should generally be the same.

An effective check of the method as well as the panel is to perform an A-B comparison between identical cartridges. Aside from output level differences, which can be eliminated with R1 and R2, two same-model and same-make phono cartridges should be close enough so that an A-B comparison will result in a split panel. It's best if all votes are in writing.

Since the hi-fi stereo system, including the room used for comparisons, is not perfect nor standard, conclusions drawn regarding one cartridge over another (especially where differences are slight) will specifically apply only to the cartridges used in the test system. Test results may or may not apply to the cartridge's

(Continued on page 28)

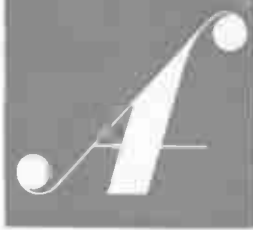

Lumber Cutting Guide

PLYWOOD SIZES

PART A	$\frac{5}{8}$ x $34\frac{1}{2}$ x $14\frac{1}{2}$
PART B	$\frac{5}{8}$ x $34\frac{1}{2}$ x $15\frac{5}{8}$
PARTS C & D	$\frac{5}{8}$ x $15\frac{5}{8}$ x $7\text{-}9/16$
PART E	$\frac{5}{8}$ x 34 x $7\text{-}3/16$
$\frac{3}{4}$ " STOCK SIZES	
PART F	$\frac{3}{4}$ x 34 x $1\frac{1}{8}$
PART G	$\frac{3}{4}$ x $33\frac{1}{2}$ x $1\frac{1}{8}$

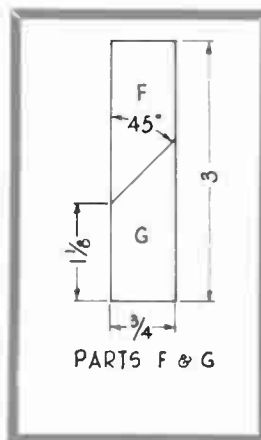
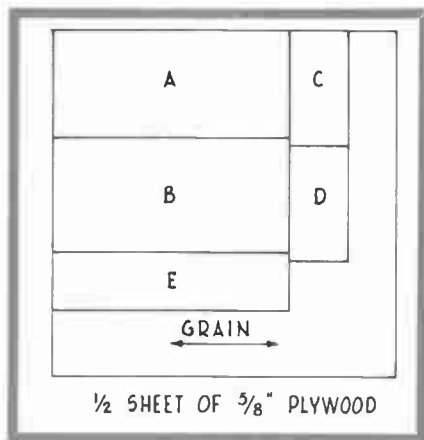

If you're short of floor space to house hi-fi stereo equipment, don't despair—turn to the walls. For example, you can build an all-in-one component shelf which mounts as a whole unit on a wall, as shown directly below (with plans at left). Alternate wall units include wood shelves with brackets or a closet "shadow box" with shelves, both of which are illustrated below.

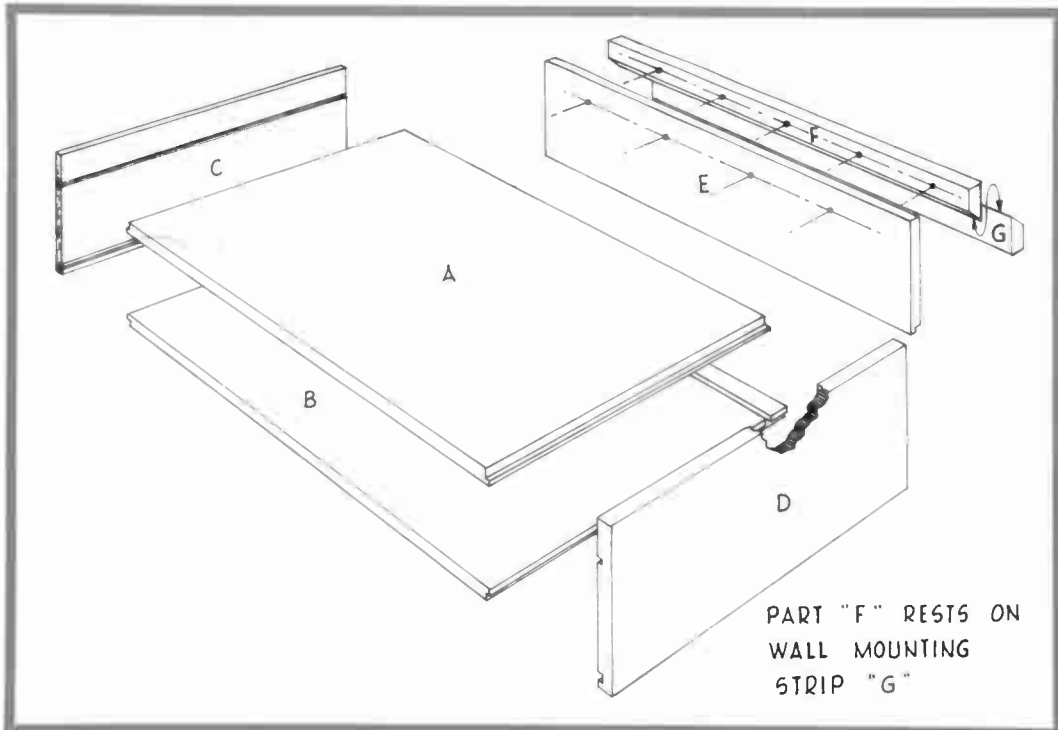

CONSTRUCTION PROJECTS

Build a component shelf



If you're ever at a loss for floor space in your home to accommodate high fidelity stereo components, look to the walls. Shelves can save the day!

You can buy fancy oiled walnut shelves and wood brackets from a store that specializes in these products, installing them yourself or paying for professional installation. If you're even slightly handy with tools, you can make your own. This might be a shelf system that uses metal bracket strips and metal brackets with pine wood shelves cut to size for you at a lumber yard. You would do well to examine one of your closets, too, in the event you are able to give up some space. We're not talking about placing equipment inside a closet. Rather, we're suggesting the possibility of cutting out a large panel from the closet door and building a shadow box with shelves, as shown in a photo here. Then, again, you might wish to make a more elaborate (and more attractive) shelf that doesn't look like "component shelving." This would be a unitized shelf that mounts as a whole unit on the wall.

The latter component shelf is not as difficult to build as you might imagine. In fact, a free brochure of complete instructions for building a wall-mounted shelf

of this type is available from Acoustic Research, Inc. The plans are designed to accommodate specific equipment, but there's no reason why you couldn't modify them to meet any other component requirements. The plans also include provisions for some storage space.

AR's plans call for a 34½" long x 14½" deep plywood component shelf, but this can be changed to whatever measurements you need. You'll note from the partial plans shown here that the shelf doesn't require brackets. The unit hooks over a single strip of wood that can be attached to a wall with stud beams behind it. (These vertical wood beams are generally spaced about 16" apart; just tap the wall lightly with a hammer until a hollow sound is replaced by a more solid vibration. The wood beam should lie directly behind the tapping point where this "solid" sound occurs.)

If you don't have a saw with a dado head to cut grooves, most lumber yards will route out the wood for a nominal charge. In case you've never visited a lumber yard, most cater to do-it-yourselfers and, therefore, are very happy to arm you with the information you need to complete a project. So just because you're a neophyte carpenter, there's no need to be bashful about visiting a lumber yard.

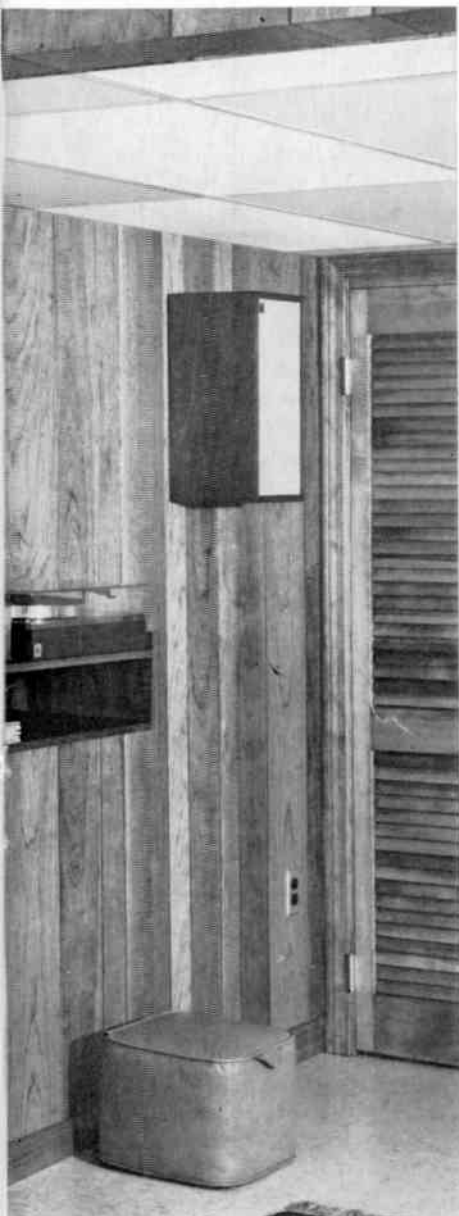

WHAT'S GOING ON

SPEAKER SYSTEMS

JENSEN Here's a departure for Jensen. A brand new line of console furniture speaker systems with three distinct stylings: Mediterranean (shown), Contemporary, and Early American. But don't think that it's all outside. The new "1200 XL" series packs seven speakers into a four-way speaker system. And what speakers! Each enclosure has four 15-inch woofers with a combined magnet weight of 14.4 lbs., a compression-driver horn loaded midrange, a compression-driver horn super-tweeter, and a direct radiating ultra-tweeter. Total magnet weight is 17½ lbs. Specs include a frequency range of 15 to 25,000 Hz; crossover frequencies at 500 Hz, 4000 Hz, and 10,000 Hz; power rating of 100 watts; impedance is eight ohms. Mid-frequency and high-frequency balance controls are located on the rear of the cabinet. The attractive cabinets measure 40" wide x 30½" high x 22¾" deep,



so you need a bit of floor space for them, but no more than required by other console speakers of its kind. A speaker system weighs in at about 240 lbs., so the floor boards have to withstand some 480 lbs. for stereo. The cabinet pictured here uses select distressed pecan veneer. Three horizontal sections with thin, dark shadow lines at the top and bottom, plus a large center area in a textured gray tone make up the grille. The center section is divided vertically into three sections, each highlighted by silk-screened pattern designs. \$895 each. (For honey you pay money.)

MARTIN A new bookshelf speaker system from a new company, that's the model M-390. The \$39.95 unit measures 18" wide x 10" high x 9" deep in a ¾" thick, hand-rubbed walnut cabinet. The manufacturer says it uses a new damping technique and "infinite baffle loading" to achieve a response range of 40 to 18,000 Hz with amplifier power of 5 watts

to 25 watts (it's obviously a fairly efficient system). Impedance is eight ohms. The speaker components themselves consist of an eight inch extended range woofer and a three inch closed-back tweeter. Grille fabric colors are available in a choice of cloud white, indigo, tangerine, and sienna.

ELECTRO-VOICE Of course, most of the newly introduced speaker systems are not titans. Electro-Voice, who has more than a few giants in its stable, demonstrated its new E-V FIVE bookshelf speaker system at the '66 West Coast hi-fi shows. The FIVE features two loudspeakers: a 10", high compliance woofer which utilizes the acoustic suspension principle, and a 3½" cone-type tweeter with viscous damping to enhance highs. The unit incorporates an electrical crossover network and a continuously variable level control. Frequency response

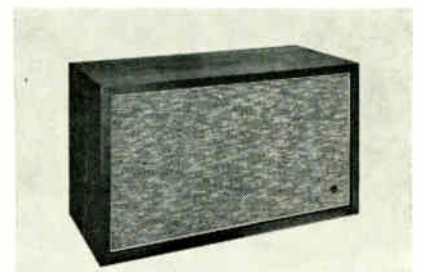

is 30 to 17,000 Hz; power rating is 60 watts peak, 30 watts program material; impedance is eight ohms. Dimensions of the enclosure, finished on all four sides with hand-rubbed, oiled walnut, are: 21¾" wide, 10¾" deep, 12¼" high. Priced at \$88.00.

receivers

SHERWOOD Here's Sherwood's big baby, the new model S-8800 FM stereo receiver rated at 130 watts music power at 4 ohms and 100 watts at 8 ohms. The all-silicon unit incorporates the same FM tuner circuitry used in the company's model S-3300. Thus, they share $1.6\mu\text{v}$ (IHF) sensitivity. A dual automatic gain control system maintains proper selectivity. The FM section also features noise-gated FM stereo/mono switching, an automatic stereo indicator light, and a zero center FM tuning meter. The receiver's amplifier's specs include: IM dis-

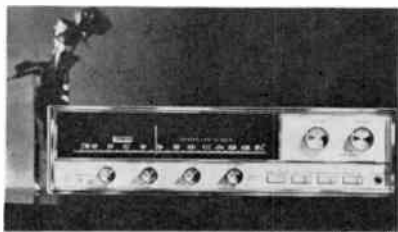

tortion, 0.1% at 10 watts or less; power bandwidth, 12 to 35,000 Hz at 1% distortion. Some FM specs include: signal-to-noise ratio, 70 dB; capture ratio, 2.2 dB. The unit has a full complement of front panel facilities, as you might expect. Among them are a front-panel stereo headphone jack, rocker switches for tape monitor, noise filter, loudness contour control, and speaker switching, as well as FM interchannel hush and preamp gain adjustments. The 40 silicon transistor, 14 silicon diode and rectifier S-8800 is priced at \$359.50 or the chassis and \$368.50 in a walnut-grained leatherette case.

1966 coming events

SEPTEMBER 28-OCTOBER 2 (Wednesday-Sunday)

New York High Fidelity Show

TRADE SHOW BUILDING (500 8th Ave.), NEW YORK, N.Y.



Now you see it! Now you don't! That's Toujay Designs' X-26 stereo cabinet. It features speaker cabinets on each end which can be rotated about 180° , and are acoustically isolated from hi-fi gear installed in the equipment section. The 100" long x 18" deep x 28" top-loading cabinet is designed to accommodate an amplifier, tuner, record turntable, and tape deck, as well as having record and tape storage provisions. (There's a storage rack for 40 reels of tape, and two sliding record storage racks, each holding up to 100 record albums.)

The cabinet wood is $\frac{3}{4}$ " oiled walnut with a rosewood top mounted on "invisible" tension hinges which can be adjusted to lift open the top at any desirable angle. The speaker cabinets are mounted on swivel bases, allowing users to aim stereo sound in almost any direction. When not in use, the speaker cabinets can be revolved so that they are flush with the cabinet face, as shown here.



NOW FREE!

STEREO INFORMATION

FM Station Directory

The directory lists 1571 FM stations in the United States and Canada. All the stations broadcasting in stereo are listed.

Test Reports

Test reports full of facts. The test reports were made by independent laboratories. Tests cover tuners, preamps, power amp/preamps. Read the facts from test experts.

Big 36-Page Catalog

You get a 36 page catalog. It tells you about tuners, power amplifiers, preamplifiers, pre-amp/power amplifier combination and tuner preamps.

ALL FREE

McIntosh

PLEASE SEND ME YOUR CATALOG
McIntosh Laboratory, Inc.

16 Chambers St. Binghamton, N. Y. 13903

NAME

STREET

CITY

STATE ZIP

HOW HOLLYWOOD DOES IT!

(Continued from page 13)
recommend that the serious amateur see this film—and listen to this scene.

"Then, he should go home and try mixing sound himself. All he really needs is a good device for recording, and another for playback. He should also work with the best possible recording materials for copying both original and re-recorded sound. There is a difference between the characteristics of even name brand types, as most amateurs should know.

"Beginning with these prerequisites, all the amateur really has to do is sharpen his judgment via the route of experience and experiment. He can record one sound and then play it back while he is recording a second original sound. Actually, at MGM we usually mix as many as nine

sounds at one time. The amateur, with proper equipment, can, in time, teach himself to do this.

"In fact, it is my feeling," Milton continued, "that sound recording is going to become an increasingly sophisticated hobby. For our wide film motion pictures today, we record original music on five tape channels instead of one or two. It is very possible that this type of technique will eventually be available to the amateur who wishes to improve his skills," Milton concluded.

How good can the amateur become? How far can he go? These are the questions that I asked MGM's Frank Milton. I hope that his testimony has shed some light on the fact that the amateur can become as good as he wishes, and can go as far as he wants if he goes about it seriously.

APARTMENT DWELLER BEATS SPACE PROBLEM

(Continued from page 14)
taking up space in the height of the room rather than the width. The speaker systems (KLH 6's) are located in the living room, of course, placed 8 feet apart on one side of the listening area.

Here's a rundown of the hi-fi stereo equipment in his cabinet:

Top Section

Fisher X-101-C Stereo Control Amplifier
Fisher FM-50-B FM Multiplex Tuner
Fisher K-10 Spacexpander
Magnetic 1024, 4-track Stereo Tape Transport, Record and Playback Amplifiers
33 Shelves for Magnetic Tape

storage (one of the shelves holds a pair of Koss Pro-4 stereo headphones)
Rotron Whisper Fan

Bottom Section

Fairchild 412-1 Manual Turntable
Grado Lab Series Tone Arm with Empire 880P Cartridge
1½ shelves for record storage
Center drawer for audio cleaning supplies and miscellaneous equipment
John Beaumont adds that setting up his hi-fi stereo system in this manner leaves his living room uncluttered, as most women feel it should be.

COMPARING CARTRIDGES

(Continued from page 23)
use in other systems, of course. It is conceivable, for example, that in a properly conducted test, cartridge A is considered better than cartridge B by a 4 to 1 margin. It seems cartridge B lacks sheen and sounds duller than cartridge A.

Now let's take the cartridges to another test location in someone else's house and perform an equal-

ly fair test. It is possible that in this system, which has different speakers and a more acoustically live environment, cartridge B will win, with cartridge A appearing to be too bright. To make matters worse, different records can make different cartridges sound better (in the panel's opinion) than others. That's when the fun begins . . .

FM LISTINGS IN YOUR STATE



part III

Northern California

In response to many reader requests for FM broadcast listings beyond local reception areas, **AUDIOFAN** presents such information from time to time. If you'd like to have your state covered (a New York FM listing was printed last September), let us know. An asterisk next to a broadcast frequency indicates some FM stereo. The fast-changing pace set by FM stations—installing multiplex, new stations, etc.—makes it impossible to present an absolutely accurate list. Should you note any omissions, commissions or typographical errors, please let us know and we will alert readers to these changes in future issues.

Northern Cities

Alameda
92.7 KJAZ

Angwin
88.1 KANG

Arcata
90.5 KHSC

Auburn
101.1 KAFI

Berkeley
89.3 KPFB
94.1 KPFA
102.9 KPAT-FM

Bishop
100.7 WISB-FM

Fremont
*104.9 KHYD

Hayward
101.7 KTUX

La Sierra
89.7 KSDA

Los Altos
89.7 KFJC
97.7 KP6M

Marysville
99.9 KRFD

Modesto
103.3 KBEE-FM
104.1 KTRB-FM

Oakland
98.1 KAFE

Redding
92.9 KCER

Sacramento
92.5 KFBK-FM
96.1 KCRA-FM
* 96.9 KSFM
98.5 KXRO
100.5 KEBR
*105.1 KHIO
106.5 KJML
107.9 KXOA-FM

San Francisco
88.5 KXXK
90.3 KSFX
91.7 KALW
93.3 KYA-FM
* 94.9 KSFR
95.7 KKHI-FM
96.5 KRON-FM
97.3 KEAR
* 98.1 KABL
98.9 KCBS-FM
99.7 KNBR-FM
*101.3 KPEN
102.1 KDFC
103.7 KGO-FM
*104.5 KFOG
*105.3 KBRG-FM
106.1 KFRC-FM

San Jose
90.7 KSJS
* 92.3 KSJO-FM
98.5 KRPM
*100.3 KEEN-FM
106.5 KPLX

San Mateo
90.9 KCSM
107.7 KUFY

San Rafael
100.9 KTIM-FM

Santa Clara
105.7 KREP

Santa Cruz
99.1 KSCO-FM

Stockton
91.3 KUOP
107.3 KSTN-FM

Turlock
* 92.9 KHOM

Ukiah
93.5 KUKI-FM

Walnut Creek
* 92.1 KWME

Woodland
*102.5 KATT

Compare these Sherwood features and specs! **ALL-SILICON** reliability. Noise-threshold-gated automatic FM Stereo/mono switching. FM stereo light, zero-center tuning meter, FM interchannel hush adjustment, front-panel stereo headphone jack, rocker-action switches for tape monitor, noise filter, speaker disconnect and loudness contour. 100 watts music power (8 ohms) @ 0.3% harm distortion. IM distortion 0.1% @ 10 watts or less. Power bandwidth 12-35,000 cps. Phono sens. 1.6 mv. Hum and noise (phono) -70 db. FM sens. (1HF) 1.6 μ v for 30 db quieting. FM signal-to-noise: 70 db. Size: 18½ x 4½ x 14 in. dp.

Sherwood Specs Speak For Themselves

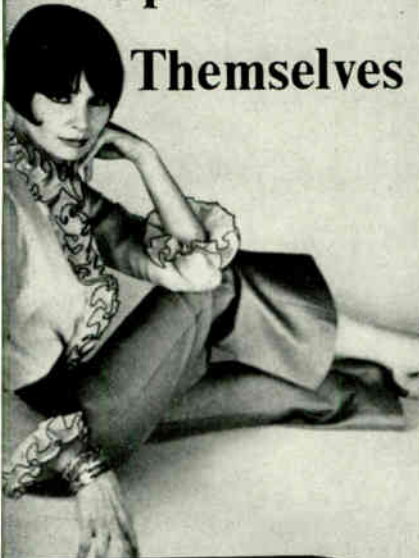

S-8800 100-W. FM Receiver
Chassis: \$359.50 Wal. Cab. \$9.00

No other FM receiver but Sherwood's new Model S-8800 has a pacesetter 1.6 μ v FM sensitivity, a remarkable 0.1% distortion rating and a 100-watt stereo output with **ALL-SILICON** reliability for the most true-to-life sound reproduction. Your proof of this reliability is our 3-year warranty—the industry's longest. How can Sherwood offer this warranty? Only because we said "No!" to germanium or nuvistor hybrid designs, and insisted on **ALL-SILICON** solid-state reliability.

Sherwood

Sherwood Electronic Laboratories, Inc.,
4300 North California Avenue,
Chicago, Illinois 60618 Dept. F-8



the technical quality of records and tapes

Reviews are concerned with audio reproduction qualities of recordings, not musical performance by Robert Long

Ramuz/Stravinsky: *L'Histoire du Soldat* (Markevich/Cocteau/Us-tinov/etc.) Philips PHS900-046; Britten: Noye's Fludde (Brannigan/Anthony/etc.) London OS 25331; Colette/Ravel: *L'Enfant et les Sortilèges* (Maazel/Col-lard/Rehfuss/etc.) DGG (re-viewed from Ampex 7-1/2 ips tape version, DGP 8970); Anon.: *The Play of Daniel* (Greenberg/New York Pro Musica) Decca DL 79402; Weill: Johnny Johnson (Meredith/Lear/Lenya/etc.) Hel-iodor HS 25024.



Miscellaneous though this list looks, all the recordings in it have an element in common: they are dramatic pieces that, by virtue of their unusual and naive approach, pose fresh problems to the engineers assigned to record them.

Every professional audio engineer today must have a pretty good idea how he would go about setting up a typical Italian or German opera for a stereo recording. Reams of copy have appeared in the music magazines about how the principals are moved about, much as they would be on the stage of an opera house and how the chorus was tried here and there, mikes were changed, isolation panels switched around until "that perfect perspective" was achieved.

So we have developed a sort of "recorded opera house sound" that operatic recordings, with varying degrees of success, all apply today. The ninety-man orchestra must sound big, but transparent enough to get some of the soprano's diction. The tenor must sound as though he has a big

enough voice to fill Madison Square Garden without losing the sheen of his *mezza voce*.

What is the engineer to do with these pieces, then? Standard operatic techniques simply do not fit this music.

A real pioneering effort was *The Play of Daniel*. In the late Fifties, when this recording was made, hardly anyone had heard a medieval music drama. Even the instruments were unfamiliar. How should it sound on disc? The Decca engineers had to start from scratch. They chose an acoustic considerably less live and spacious than was at that time more or less standard in church music. Treating the instruments like chamber music (fairly close-to for lots of sharp detail without bit, massed effects), they wove the voices right into the texture.

All of this is fine from the point of view of recreating the actual sound of a performance. (I was fortunate enough to have many opportunities to hear *Daniel*, live, from many vantage points; and the coloring of this reproduction certainly retains much of the bloom of the original.)

In spacial terms, however, it is not nearly so successful. Sounds represented as elsewhere than front and center are too often blurred—even muddy. And no consistent pattern of space is developed. A couple of retakes even failed to duplicate the miking of the originals, with the effect that the singer is suddenly jolted to a new part of the picture. Since the staging of the original depended heavily on processions, this is a great pity. The recording

is, by contrast, basically static; antiphonal rather than dynamic elements provide what sense of space it has.

Noye is a very different affair. At least in terms of the recording. (Both are medieval biblical dramas, with only Britten's music for *Noye* being modern.) The live acoustics of the church in which *Noye* was recorded have been very nicely controlled by London's engineers; and through it moves a cast that genuinely seems to be going and coming. (They actually turn their backs on the mikes when they're going, for instance, producing that telltale damping of the upper frequencies.)

It is curious that both *Daniel* and *Noye* contain exceptionally well-recorded bells, always an engineer problem because of their transients. So alike are the respective sounds, that I would almost be willing to swear that the Aldeburgh bells, like those of the pro music, come from the White-chapel founders.

Although the recording is marked, "recorded at the XIVth Aldeburgh Festival," this does not seem to be an "actual performance" job—if it is, London was lucky enough to find an audience with not a cough in a carload, as the saying goes. Still, the feeling is very much that of an actual performance. Perhaps one reason is that some of the many children involved (some 80% of the vocal and instrumental forces involved) sometimes exhibit considerably less than ideal intonation. If you are very sensitive to this sort of thing, it may be sufficient to turn you away from the recording without further ado. If the hair on the back of your neck doesn't rise at such things, however, you may find the wide-eyed charm of the proceedings.

For children's ears, rather than their voices, is Ravel's unique *L'Enfant et les Sortilèges*. And yet, this piece is, in a sense, the most sophisticated of the group. It uses the most elaborate orchestra, it makes the greatest demands on the singers, and it exacts the greatest feats of imagination of both listener and engineer. When

the same soprano must successively sing as the fire on the hearth, an enchanted princess out of a fairy tale, and a squirrel from the garden, it's pretty obvious that standard techniques just won't do.

Maazel's performance, however, is one that relies on the sensuous beauty of Ravel's writing for much of its effect. And the engineers have taken their cue from him. Listen, for instance to the way the woodwind effects are set against the deep strings at the beginning of Part Two. Stereo separation is used more to preserve a limpid clarity in the complex and delicate textures of the writing than it is as a tool to build an impression of movement and interaction between the many characters. In these terms, even the old (and long since deleted) Columbia version under Leibowitz was more to the point.

Nonetheless, there is real magic in the DGG/Maazel approach. If you want to hear and savor everything that's going on musically (if not dramatically), this recording is superb. I wish, how-

ever, that I had been reviewing from the discs, rather than the tape. Ampex has seen fit to issue the opera back-to-back with *L'Heure espagnole*, requiring the use of double-play tape to fit the whole thing on. On standard play, perhaps there would have been less problem with print-through to intrude on these delicate details.

Turning from *L'Enfant* to *Johnny Johnson* is, however, a question of going from the almost-sublime to the near-ridiculous. Weill's piece falls, both in time and in scoring, somewhere between the *Threepenny Opera* and *Lady in the Dark* and combines the harshness of the one with the sentiment of the other. The way in which it is put on disc is utterly undistinguished. No attempt is made at preserving the story line (it is a full-length musical comedy—the record contains excerpts); there is no variety of perspective outside that written into the music; miking is not clean; detail is not there; the sound is often harsh; and the

(Continued on page 32)

this leprechaun will charm you



It's incredible what happens when you put a few boxes of Irish Tape on your counter. Your wife becomes prettier. Business booms. Friends call you lucky—but you'll know the Irish Leprechaun was working for you. (Great tape and at popular prices too!)

WITH
ferro-sheen®
PROCESS



Hurry!
Get happier. Write
for the free catalog describing
complete Irish line.

IRISH MAGNETIC RECORDING TAPE

MORHAN NATIONAL SALES CO., INC.

458 Broadway, New York, N.Y. 10013



Up- grade your sound !

Whatever your receiver or amplifier is capable of doing, EMI loudspeakers have a unique way of making it sound better.

Perhaps it's the ease with which EMI loudspeakers project sound. So smooth and natural, it seems to float on the air in all its concert hall glory. Filling the room.

Or perhaps, it's the deep bass, the incomparable realistic midrange and the full, silky highs.

Or it could be the subtle detailing of their transient perfect response that catches you unawares.

So, for better sound from your receiver or amplifier, come on up to EMI loudspeakers.

There's an EMI loudspeaker to meet any requirement and budget. From \$49.95* to \$395.00*



*Slightly higher in South and West

EMI / SCOPE

Scope Electronics Corporation
470 Park Avenue South
New York, New York 10016
Also available in Canada.

(Continued from previous page)
"stereo" indication is a joke.

That sounds pretty bad. But the recording was made (in mono) in the Fifties by MGM, so it can't all be blamed on Heliodor. Lacking an original MGM pressing of *Johnny Johnson*, I got out a copy of their *Three-penny Opera*. It reminded me in all its unattractiveness how really harsh and dry those recordings were. If *Johnny Johnson* was typical, Heliodor must be congratulated on putting some bloom back into the desert, just as MGM must be congratulated for the enterprising spirit that enlisted Burgess Meredith in the cast. Unfortunately, nobody got around to bringing to life the offbeat dramatic values of this "Great Musical" (as the liner calls it).

To round out our group of offbeat dramas, there is a recording that has only recently been added to the tape catalog, although it was recorded in 1962. Stravinsky's *L'Histoire du Soldat* carries the notation "to be read, played, and danced." In other words, there is in the basic concept of the piece a non-audio element—one that can't be recorded.

The familiar chamber piece for seven instrumentalists is only one of three elements that were intended, as Stravinsky originally conceived the work, to be separate, independent, mutually illuminating. Since we can't be expected to *hear* the dance element in a recording, Philips has seen fit to give some of the narrator's lines to the actors and introduce via stereo more activity on stage that might otherwise have been assigned to them. The narrator, particularly, seems to hop about in rather arbitrary fashion.

When HMV recorded the piece some years back (in mono) at Glyndebourne with Robert Helpman, they saw placed voices in the foreground, telling the tale, and allow the septet to act as accompaniment, robbing it to a certain extent of its role as independent agent. In stereo, Philips does not need to do this. The instrumentalists can be heard in excellent detail (notice the violin

which is almost an actor in its own right), with a fairly close-to-acoustic, without obscuring speech. In fact, it is all so clean and neat that the proceedings seem, if anything, a little bloodless. If only there were a touch of distortion in the peaks, one feels, perhaps it would help them mature into climaxes.

And yet, there are few real climaxes in this mordant piece. The cool approach to the sound seems altogether appropriate in a work that is sardonic rather than passion. It is all the more to be deplored that the text in the accompanying booklet follows the original score (?) rather than the altered version as recorded.

If we think back to the days when Goddard Lieberson was experimenting with the introduction of radio techniques into his recordings of *Porgy and Bess* and *Conversation Piece*, it seems hard to believe that, by 1966, we could not pick out a group of dramatic recordings, each representing a pioneering effort in its way. Thus, this group of recordings seems somewhat less successful than they might otherwise. It's true that, with the exception of *Johnny Johnson*, all of them do a fine job of simply reproducing most of the sounds that were produced in front of the microphones. But in terms of a continuum of sound, we should have a right to expect, in the mid-fifties, more successful productions than are represented here. Only *Noye's Fludde* seems really adequate in this respect.

Two of the recordings may be excused on the grounds that they derive from the Fifties. But one of them, *Daniel*, easily keeps up with the bulk of its current rivals. With the aid of D. H. Auden's poetic narrative in the program notes, the impact of the drama as such can be very forceful. If the same can't really be said for either *L'Histoire* or *L'Enfant*, it is partly the fault of poor program notes. But it is above all a commentary on the fact that although stereo may have progressed technically in the last few years, the recording industry is not making as imaginative use of its medium as it could.

Dear Audiofan:

Over the years, we've verified our feelings that hi-fi enthusiasts aren't strange hermit types, as some low-fi neighbors would have you believe. Many good AUDIOFAN customers volunteered that they talked to many people regularly about hi-fi equipment as part of their hobby.

We also observe that many customers submit interesting suggestions concerning advancements they would like to see made in future high fidelity equipment. Some customers pushed for wireless remote control; others had more striking suggestions, such as switchable tone controls in "tape out" position to give the user command over the character of signal being recorded. And much, much more.

This is all to the good because, as you communicate your feelings to us, we pass them along to the manufacturers who make the hi-fi equipment we sell and you buy.

We cordially invite you to come in to our store to chat about features you'd like to see incorporated into hi-fi gear. And if you haven't visited us for a while, we think you'll be pleasantly surprised at how many useful new features have already been added to equipment.

Soundest regards,

BARNETT BROS.

Hi-Fi • Commercial Sound
Main Store
932 Arch Street
Philadelphia, Pa. 19107
WAlnut 5-9780

You call it tiny.
We call it progress!



 This is the new E-V 1177. An FM stereo tuner and 50 watt stereo amplifier. All in one neat package.

Don't let its calm exterior fool you. The inside is packed with action. Solid-state circuitry born of our lengthy experience in aerospace electronics. Nothing wasted. Every ounce contributes to superb sound reproduction.

You can tackle the biggest musical sounds on record with the 1177. It's more than equal to the challenge.

When teamed with a pair of famed Electro-Voice speakers, you've achieved a matched high fidelity system of rare excellence. And the E-V approach to high fidelity design makes installation easy and operation effortless.

Oh. One other thing about the E-V 1177. The price. It's right in line with the size. Small. Just \$280.00, including the walnut-paneled case. See your E-V dealer for a demonstration. Or write for our complete high fidelity catalog. *It's big!*

ELECTRO-VOICE, INC., Dept. 864AF
604 Cecil Street, Buchanan, Michigan 49107

Electro-Voice