

TAPE RECORDING

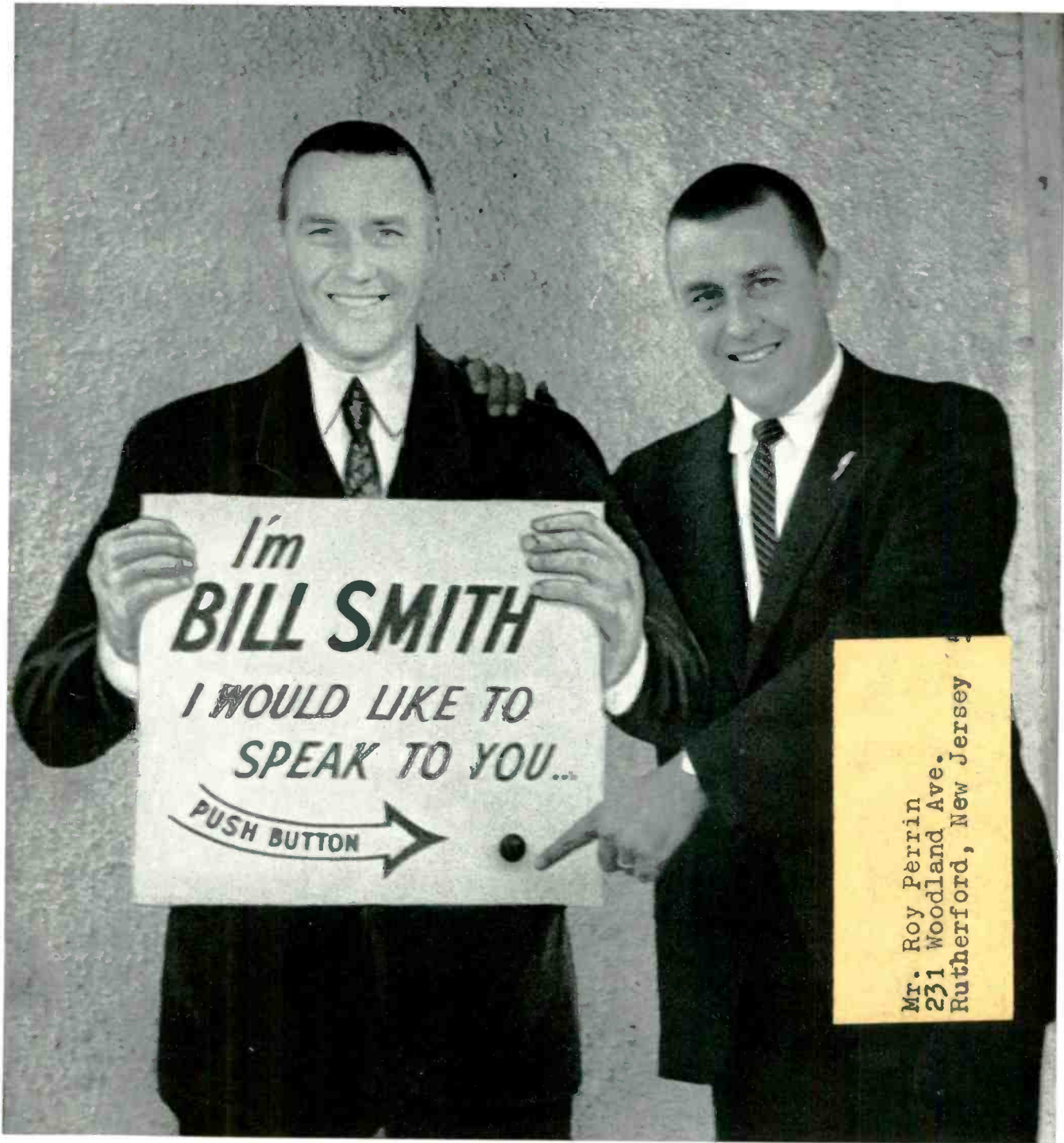

Tape Aids Political Campaign—See Page 30

11/19/62

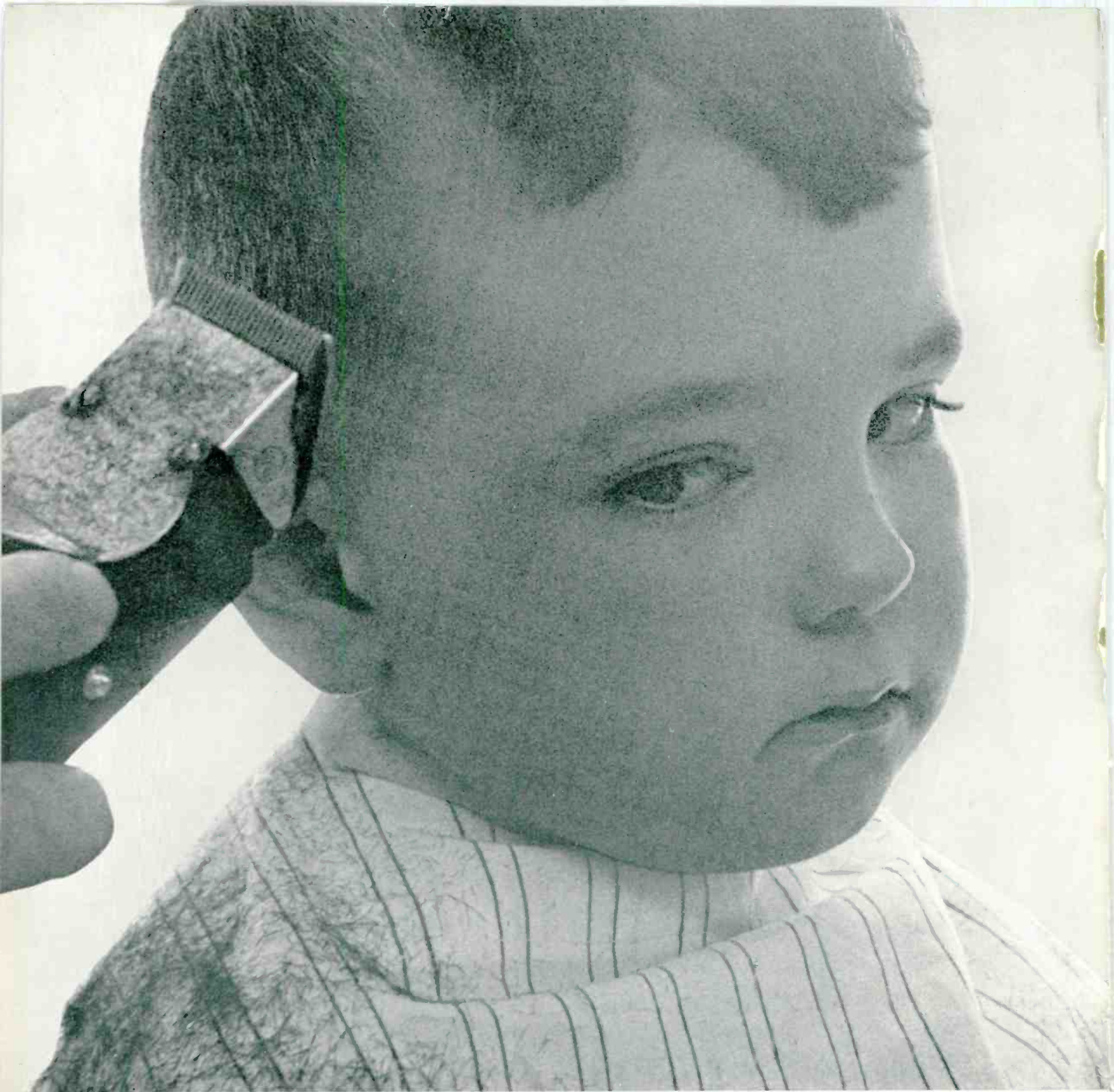

bzzzz

When a very small boy has his hair cut, the clippers make a harsh buzz—a nervous, exciting sound. Yet the same machine gives off only a dull hum when it's used on a man.

The unfortunate part is that once you've heard the dull hum, you never get to hear that exciting buzz again. No matter what. Even Audiotape can't record it.

Audiotape can (and does) take care of everything else that adds to listening enjoyment. It gives you clarity and range, freedom from noise and distortion and unequalled uniformity, reel after reel. All you have to supply is the point of view. Audiotape does the rest, and does it superbly.

Whether you're taping a barbershop quartet or a hundred-voice choir, there's an Audiotape exactly suited to your needs. From Audio Devices, for 25 years a leader in the manufacture of sound recording media—Audiodiscs*, Audiofilm* and . . .



audiotape TRADE MARK
"it speaks for itself"

AUDIO DEVICES INC., 444 Madison Ave., New York 22, N.Y.
Offices in Los Angeles • Chicago • Washington, D. C.

*TRADE MARK

In every way, this new V·M tape recorder gives you more . . .

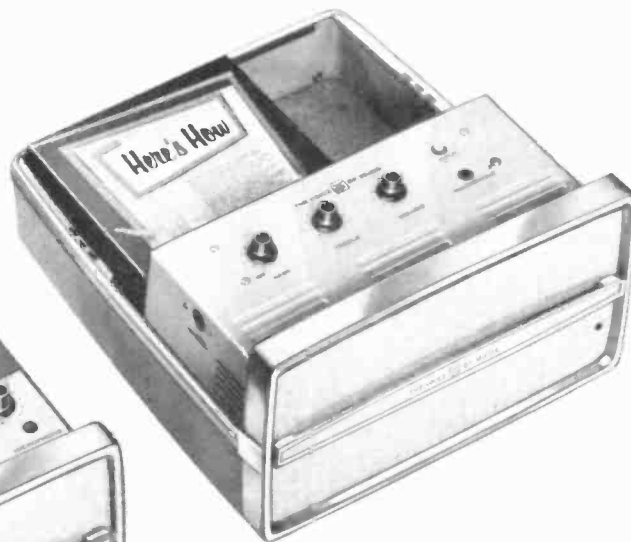

More of the things that count . . . for less money. That's V·M's promise to you in the new Model 735 tape recorder . . . a more highly developed version of the famous V·M Model 730, recently hailed by a leading tape recording authority as producing sound equal to that produced by some tape recorders costing three times as much. Here are the features that make this new unit a very superior tape recorder buy:

EXCLUSIVE V·M 'ADD+A+TRACK'® FEATURE lets you record on one tape track, then add voices or musical accompaniment on a separate track on the same tape *while listening* to the first. When you play back, you hear both tracks simultaneously. Imagine what that means: play or sing with your favorite bands; practice music or a language; polish up a speech; or, just have fun. (You can re-record the second track as often as you wish without disturbing the first.)

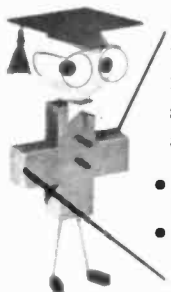

- Records three speeds—7½, 3¾ and the new tape-saving 1¾ ips speed.
- True high-fidelity amplifier-speaker system brings out the quality of your tapes.
- Stereophonic playback is yours with addition of the style matching Model 136 auxiliary amplifier speaker. You'll be thrilled by the brilliance provided by this two unit stereo playback.
- Can be used with an automatic slide projector synchronizer such as V·M Model 1412.

There's a V·M dealer close to you. Why not stop in and try this versatile new V·M recorder, and discover why it offers you so much more value for your investment.

THE VOICE  OF MUSIC®

the most
noise-free
recordings
you have
ever
heard

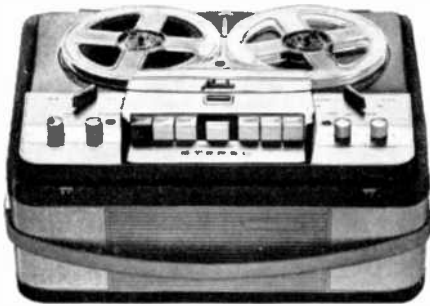

will be made on the new all-transistorized Norelco Continental '401' Stereo Tape Recorder, the only recorder using the newly developed AC107 transistors in its two preamplifiers. The AC107 is the only transistor specifically designed for magnetic tape head preamplifiers utilizing specially purified germanium to achieve the extraordinary low noise figure of 3 db, measured over the entire audio band (rather than the usual single frequency). This noise figure remains stable over large collector-emitter voltage swings and despite large variations in source resistance.

Hear the new transistorized Norelco Continental '401' • 4-track stereo/mono record and playback • 4 speeds: 7½, 3¾, 1½ and the new 4th speed of ¾ ips which provides 32 hours of recording on a single 7" reel • fully self-contained with dynamic stereo microphone, two speakers (one in the removable cover for stereo separation), dual preamps and dual recording and playback amplifiers • self-contained PA system • mixing facilities • can also play through external hi-fi system • multiplay facilities.

Specifications: Frequency response: 60-16,000 cps at 7½ ips. Head gap: 0.00012". Signal-to-noise ratio: better than 40 db. Wow and flutter: less than 0.4% at 7½ ips. Recording level indicator: one-meter type. Program indicator: built-in, 4-digit adjustable. Inputs: for stereo microphone (1 two-channel); for phono, radio or tuner (2). Foot pedal facilities: (1). Outputs: for external speakers (2), for external amplifiers (1 two-channel); headphone (1). Recording standby. Transistor complement: AC 107 (4), OC75 (6), OC74 (2), OC44 (2), 2N1314 (2), OC79 (1). Line voltage: 117 volts AC at 60 cycles. Power consumption: 55 watts. Dimensions: 16¼" x 15¼" x 8¾". Weight: 43 lbs. Accessories: Monitoring headset and dual microphone adapter.

For a pleasant demonstration, visit your favorite hi-fi dealer. Write for Brochure D-11. North American Philips Company, Inc., High Fidelity Products Division, 230 Duffy Avenue, Hicksville, Long Island, New York.

Norelco

In Canada and throughout the free world, Norelco is known as 'the Philips.'

TAPE RECORDING

VOL. 9 No. 12

NOVEMBER 1962

MARK MOONEY, JR.
Editor and Publisher

JOHN L. ALLEN
Circulation Manager

JEAN COVER
Assistant Editor

ROBERT W. LAPHAM
Art Director

JAMES H. MILLS, SR.
Technical Consultant

ANTHONY J. MORIN, JR.
National Advertising Manager
274 Madison Ave., New York 16, N. Y.

IN THIS ISSUE

LET YOUR RECORDER GO HI-FI	John W. Berridge	20
GETTING THE MOST FROM YOUR MAGNETIC SOUND PROJECTOR	Robert Van Der Velde	25
AVAILABLE CHRISTMAS TAPES	Jean Cover	29
COUSINO AUDIO-ANNOUNCER		30
NEW TAPES		6
CROSSTALK		10
INDUSTRY NEWS		11
TAPESPENDENTS WANTED		12
TAPE CLUB NEWS		14
CONTEST WINNERS		16
LETTERS		17
NEW PRODUCTS		18
TAPE IN EDUCATION		19
NEW PRODUCT REPORT: Wollensak 1580 Stereo Recorder		32

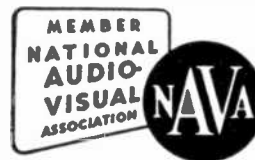

TAPE RECORDING is published monthly by Mooney-Rowan Publications, Inc., 101 Balto.-Annapolis Blvd., Severna Park, Md. (501-647-1800). Entered as second class matter January 7, 1954 at the Postoffice Severna Park, Md. under the Act of March 3, 1879. National Advertising Representative: J. V. Associates, 274 Madison Ave., New York 16, N. Y. (212-679-0030). Subscriptions, U. S. and Possessions, Canada and Mexico \$5.75 for one year, all others add \$1.00 a year. Two years \$7.00. Contents copyrighted by Mooney-Rowan Publications, Inc., 1962. Printed in U. S. A.

POSTMASTER—Send all address labels clipped from undeliverable copies with Form 3579 to Tape Recording, 101 Balto.-Annapolis Blvd., Severna Park, Md.



SOUND TALK

...from the world's most experienced manufacturer of recording tapes



Let's face it...

4-track stereo does challenge tape quality!

SCOTCH® BRAND RECORDING TAPES MEET THE CHALLENGE WITH OXIDE "POWER," HIGH DIMENSIONAL UNIFORMITY!

New 4-track stereo, with dramatic improvements in sound reproduction and tape economy, puts tape quality to the test—makes the exceptional quality of "SCOTCH" BRAND Recording Tapes more important than ever. For example . . .

Narrow, quarter-width tracks mean that oxides must work harder, and the high-potency oxides in "SCOTCH" Recording Tapes do just that—permit thinner, more flexible coatings that make intimate head-to-tape contact a certainty.

With 4-track equipment, tiny variations in tape thickness (unnoticed in previous recording systems) may be magnified into level variations, distortion, other sound failures. "SCOTCH" Recording Tapes meet this demand with microscopic precision of both coating and backing thickness

—assure identical full-frequency response with wide dynamic range inch after inch, reel after reel. Width, too, is held to a close tolerance to assure proper track alignment. And exclusive Silicone lubrication provides lifetime protection against wear for delicate 4-track heads. To make the most of 4-track stereo (two- and full-track recording, too), insist on the tape that's the performance standard of the recording industry... "SCOTCH" BRAND.



Free: Send for Sound Talk Bulletin No. 19— "Handling and storage of Magnetic Tape." For your copy, write Magnetic Products Division, Dept. MDF-112, 3M Company, St. Paul 6, Minnesota.

SCOTCH® AND THE PLAID DESIGN ARE REGISTERED TRADEMARKS OF MINNESOTA MINING & MANUFACTURING CO. ST. PAUL 6 MINN. EXPORT, 99 PARK AVE. NEW YORK, CANADA LONDON ONTARIO © 1962, 3M CO.

Magnetic Products Division **3M** COMPANY

NEW TAPES

★—Fair

★★—Good

★★★—Very Good

★★★★—Excellent

CLASSICAL

Reviewed by Robert E. Benson



Music ★★★★★
 Performance ★★★★★
 Fidelity ★★★★★
 Stereo Effect ★★★★★

BEETHOVEN: Nine Symphonies (complete)
 Royal Philharmonic Orchestra; Beecham Choral Society and Soloists conducted by Rene Leibowitz

Reader's Digest (Five Reel Album)

4-track, 7½ ips

\$42.50, approximately 5 hrs. 11 mins.

This new tape release is extraordinary in so many ways it must be drawn to the attention of all who collect tapes. This handsome new boxed set of five seven-inch reels contains all nine Beethoven symphonies played by the Royal Philharmonic Orchestra conducted by René Leibowitz. Soloists in the *Symphony No. 9* are Inge Borkh, soprano; Ruth Siewert, contralto; Richard Lewis, tenor and Ludwig Weber, bass, assisted by the Beecham Choral Society.

The first reel contains the *Symphony No. 1 in C, Op. 21* and the *Symphony No. 2 in D, Op. 36*. The second reel contains the "Eroica" Symphony, the *Symphony No. 3 in E Flat, Op. 55*, with the reel turnover coming between the second and third movements. The third reel contains the *Symphony No. 4 in B Flat, Op. 60* and the *Symphony No. 5 in C Minor, Op. 67*, and reel four couples the *Symphony No. 6 in F, Op. 68*, the "Pastorale" symphony with the *Symphony No. 7 in A, Op. 92*. The final reel contains the *Symphony No. 8 in F, Op. 93* and the "Choral" symphony, the *Symphony No. 9 in D Minor, Op. 125*, with the tape turnover occurring after the first movement of the *Symphony No. 9*.

From a performance standpoint, there are many different and equally valid viewpoints on the interpretation of Beethoven symphonies, ranging from the intellectual approach of Klemperer to the dynamic one of Toscanini. Leibowitz, who is best-known for his work with the modern repertory, tends towards faster tempi for the Beethoven symphonies than most conductors. The First, Second, Fourth and Eighth symphonies as recorded here are the equal of any other currently available recordings. The "Eroica" is highly individual but stunning in its impact, and the Seventh is positively thrilling with its glorious French horns and whirlwind tempi.

The *Symphony No. 9* is the ultimate test for any conductor, and Leibowitz proves his musicianship with a thoroughly integrated performance reaching an enormous climax. The Scherzo is electrifying in its exuberance. All of the soloists are superb, with

the possible exception of Weber, who is now at the end of a long and distinguished career, and the Beecham Choral Society's contribution is all one could ask. Throughout, the Royal Philharmonic plays with incredible virtuosity and élan. One could point out numerous examples of extraordinary playing—the spectacular precision of the strings in the finales of the earlier symphonies, the magnificence of the horns in the *Symphony No. 7*, or the exquisitely phrased woodwind solos in all nine symphonies. The only example of less-than-perfect ensemble is at the beginning of the *Symphony No. 7*, where an ascending scale in the strings is not quite together.

So far as the recorded sound is concerned, it is sensational, with all the resonance one could ask for, combined with extreme clarity, revealing every detail of orchestral texture, and with everything in its correct perspective. From the delicate opening of the *Symphony No. 4* to the massed sonorities of the *Symphony No. 9*, everything sounds just right, with smooth strings, solid bass and glistening percussion. The tape processing is immaculate, with virtually no tape hiss, and I found no traces whatever of cross-talk.

This set was recorded by RCA Victor Custom Records for the Reader's Digest, and is available only through the mail. For information, write the Reader's Digest, Pleasantville, New York. For subscribers to the magazine the cost of the set is \$39.75.



Music ★★★★★
 Performance ★★★★★
 Fidelity ★★★
 Stereo Effect ★★★★★

WAGNER: The Flying Dutchman (complete opera)

George London, baritone (The Dutchman); Leonie Rysanek, soprano (Senta); Giorgio Tozzi, bass (Daland); Karl Liebl, tenor (Erik); Richard Lewis, tenor (Steersman); Rosalind Elias, mezzo-soprano (Mary), with the Orchestra and Chorus of the Royal Opera House, Covent Garden; Antal Dorati, cond.

RCA FTC 8003 (two reels)

4-track, 7½ ips

\$21.95... 2 hrs. 22 mins.

This is a highly commendable enterprise, with a top-notch cast and fine sound. Dorati is in firm control here, and orchestral playing is uniformly excellent. George London's portrayal of the title role is solid, strong and sensitive, with a supporting cast any opera house would be proud to present. It is a pleasure to hear Leonie Rysanek sounding well; her recordings rarely do justice to her big voice, and even in this new release her voice is sometimes muffled and distorted.

Victor's stereo is very fine; I rather imagine hi-fi enthusiasts will replay many

times the anchor-dropping episode in Act I. Resonance is in abundance here, but the production cannot be whole-heartedly recommended as there is occasional distortion in loud passages, apparently caused by tape overloading. These moments are not too frequent, but they are there, and could have been avoided by careful processing.



Music ★★★★★
 Performance ★★★
 Fidelity ★★
 Stereo Effect ★★★

OPERATIC CHORUSES (Carmen, The Tales of Hoffman, Faust, Nabucco, Otello, Il Trovatore, Lohengrin, Rigoleto, Die Meistersinger, Mignon, Cavalleria Rusticana and Die Meistersinger)

Robert Shaw Chorale with the RCA Victor Orchestra

RCA FTC 2072

4-track, 7½ ips

\$8.95... 46 mins.

The Robert Shaw Chorale is certainly a remarkable chorus, strong in all areas, and so versatile their repertory ranges from Bach to Broadway hits. Here they give vigorous accounts of generally familiar operatic choruses. If only our opera houses could boast a chorus like this!

Sound is very clear but sadly lacking in the resonant sound of a hall. Too bad RCA doesn't see fit to record the Robert Shaw Chorale as they sound in a good auditorium.

POPULAR

LONDON PHASE 4 PLUS I.M. 20 C.R.

When London introduced their "Phase 4 Stereo" last year, it marked a definite improvement in the art of sound recording over their former methods. Basically, it consisted of ten microphone channels fed through a ten channel-mixer to four recording tracks, then to the two tracks of the master tape. All of this resulted in better control of separation and movement, as well as quality and realism of sound.

Unfortunately, the engineers attempted to emphasize directionality by the introduction of excessive percussion effects, notably bongos, to the detriment of the musical selections.

(This process was reviewed here in Dec. 1961 issue.)

The newest additions to the series are now called "Phase 4 Plus I.M. 20 C.R.", which means "Plus Individually Monitored 20 Channel Recording". That London's engineers have accomplished something of value is evident when listening to the tapes reviewed here. More emphasis is placed on music rather than sound effect gimmicks, and bongos are used sparingly.

With these new advances in the Phase 4 methods, we hope that the imagination,

MORE TRICKS AND TREATS WITH VERSATILE TARZIAN TAPE

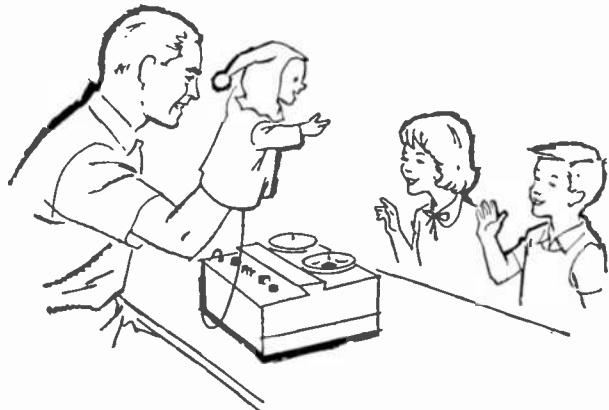

A Puppet Named Mike

How do you get microphone-shy youngsters to talk freely? Try slipping the microphone inside a hand puppet. While the child talks to the puppet, you will be recording every word on long-lasting Tarzian Tape.

Home Grown Memory Machine

Everyone has important but infrequently-used notes that seem to disappear just when needed—special recipes, handy-man ideas, appliance maintenance instructions. Record them on an easy-to-find reel of Tarzian Tape. Presto—the information is as close as your tape recorder, for computer-like “information retrieval” in your own home.

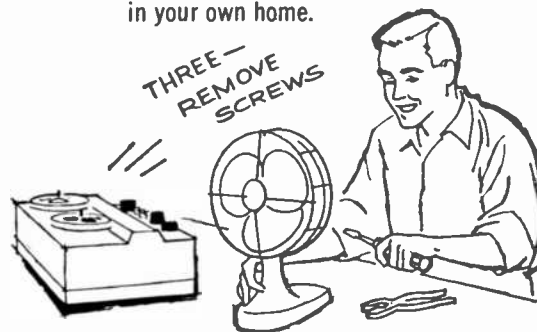

This Free Tarzian Booklet,

“The Care and Feeding of Tape Recorders,” is available from your tape dealer—or write to the address below. It contains 32 pages of additional ideas for the use and maintenance of your tape equipment. And for hours of entertaining and practical recording, ask for Tarzian Tape—either acetate or Mylar* base, on 3, 5, or 7-inch reels. Compare its sound reproduction to that of any other tape on the market.

Discover for yourself that, while Tarzian Tape’s price is competitive, its quality is unchallenged.



Talking Monkeys

Tape recorders and Tarzian Tape pep up your movie and slide shows just as Rodgers worked with Hammerstein—good separately, outstanding together. In addition to straight commentary and music, other voices and sounds can be taped from radio and TV for use as needed—traffic, machinery, applause, and so on. For something different, try filming house pets or zoo animals—then synchronize, on tape, the voices of family and friends to match the animal’s movements or expressions.

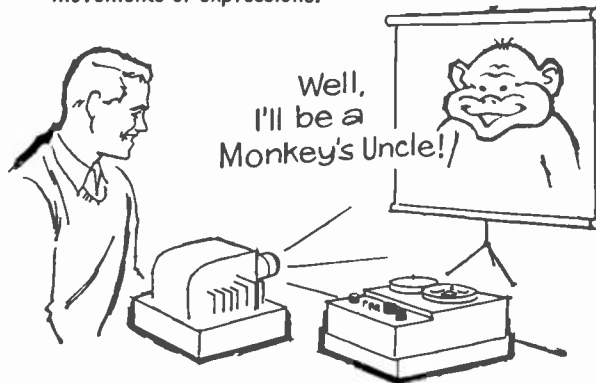

*DuPont trademark for polyester film

SARKES TARZIAN, Inc.

World's Leading Manufacturers of TV and FM Tuners • Closed Circuit TV Systems • Broadcast Equipment • Air Trimmers • FM Radios • Magnetic Recording Tape • Semiconductor Devices
MAGNETIC TAPE DIVISION • BLOOMINGTON, INDIANA
Export: Ad Auriema, Inc., N.Y.

versatility, and real ability of the recording engineers, arrangers, and others will be devoted to outdoing each other in making their tape recordings real, authentic and breathtakingly full of presence.—*F. N. West*



Music ★★★
Performance ★★★
Fidelity ★★★★★
Stereo Effect ★★★★★

AVEC MOI A PARIS

Side 1: Comme Ci, Comme Ca, La Vie En Rose, Pigalle, My Man, Under Paris Skies, La Valse Apache.

Side 2: Poor People of Paris, Domino, Mademoiselle de Paris, Under The Bridges of Paris, C'est Si Bon, I Love Paris.

Maurice Larcange and his Accordions.

LONDON LPL 74013

4-track, 7 1/2 ips

\$7.95...31:30 mins.

Maurice Larcange is a young Frenchman who knows his way around Paris with an accordion. For this musical Phase 4 Tour, he has assembled an Orchestra replete with harp, vibraphone, strings, musette and accordions, that exudes the gay spirit of Paris with every note. All of the popular, well liked tunes of that colorful city are given his own special treatment, which he fits to the mood, whether it be happy or sad, and all too soon the trip is ended.

This recording takes full advantage of stereo, with some sharp left and right speaker work by the accordions.—*F. N. West*



Music ★★★
Performance ★★★
Fidelity ★★★★★
Stereo Effect ★★★★★

ITALY

Side 1: Mattinata, Arrivederci Roma, The Echo Told Me A Lie, Roman Guitar, Come Back To Sorrento, La Danza.

Side 2: Vieni Sul Mar, Ciao, Ciao, Bambino, Marie, An Mari, O Sole Mio, Anema E Core, Carnival of Venice.

Roger Laredo and his Orchestra

LONDON LPL 74014

4-track, 7 1/2 ips

\$7.95...32:25 mins.

With Italy, a land of rich musical background, it is only natural that the melodies of that country would benefit from the Phase 4 process.

Roger Laredo has combined many of the old time standards, such as "O Sole Mio," "Mattinata", and "Roman Guitar", with some of the contemporary favorites to produce a beautiful musical picture.

Arrangements and recording are fine with intelligent renditions helping to maintain interest throughout.—*F. N. West*

DANCE AGAIN

Side 1: Patricia, Tropical Merengue, Tea For Two, Miami Beach Rhumba, Cocktails For Two, I Came, I Saw, I Conga'd.

Side 2: Cherry Pink and Apple Blossom



Music ★★★
Performance ★★★★★
Fidelity ★★★★★
Stereo Effect ★★★★★

White, The Wedding Samba, Mambo Number Five, Blue Tango, When The Moon Comes Over The Mountain—Cha Cha, Colonel Bogey.

Edmundo Ros and his Orchestra

LONDON LPL 74015

4-track, 7 1/2 ips

\$7.95...28 mins.

It's hard to determine if Phase 4 was made for Ros, or Ros for Phase 4. Either way, it's refreshing to find this process used to its best advantage on these Latin rhythms.

Ros already had the tingles, bells, and bongos, so consequently, Phase 4 complements his music very well. The engineers went all out to record the music, and succeeded with a tape so clear, so dynamic, so full of presence, that stereo really comes to life. All this without missing a single frequency in their recording.

This is Edmundo Ros at his best.—*F. N. West*



Music ★★★★★
Performance ★★★★★
Fidelity ★★★★★
Stereo Effect ★★★★★

SPAIN

Side 1: Valencia, Ay, Ay, Malaguena, Bullerías, Ritual Fire Dance, Sevillanas.

Side 2: Granada, Estrellita, Macarenas, Carmen Suite.

Stanley Black and his Orchestra

LONDON LPL 74016

4-track, 7 1/2 ips

\$7.95...37:55 mins.

Phase 4 really comes into its own with this vivid and colorful tape featuring all-time Spanish favorites, such as Malaguena, Ritual Fire Dance, Estrellita and others.

Here too, a new Stanley Black emerges. His music, although the familiar piano is absent, is original, sparkling, well balanced and exciting. No doubt some of this dual personality can be attributed to the new Phase 4 process, although Stanley Black had established himself firmly in the music world long before its inception.

Now, with a full symphony orchestra at his command, Stanley Black has produced a brilliant tape that is a tribute to his superb talents as a musician. It is also one that will put your hi-fi equipment through a grueling test.—*F. N. West*



Music ★★★
Performance ★★★★★
Fidelity ★★★★★
Stereo Effect ★★★★★

BIG BAND BASH

Side 1: Hindustan, A-Tisket-a-Tasket, I

Don't Know Why, Capuccina, Hernando's Hideaway, Cherokee.

Side 2: Harlem Nocturne, Sabre Dance, In a Persian Market, Clopin-Clopant, Out of Nowhere.

Ted Heath and His Music

LONDON LPL 74017

4-track, 7 1/2 ips

\$7.95...29:55 mins.

A demonstration of what Phase 4 can do for the Big Band Sound of Ted Heath can be had by playing this new release.

The Band is composed of a group of able musicians, each apparently capable of solo work, and once in a while Ted gives them a chance. But when the signal is "Let's Go", they all strike out in different directions, and strangely enough, they seem to finish on the correct note.

In "Sabre Dance", they go native with Tom-Toms, and give out with some fast and furious rhythm, all of which are signs of Ted's musicianship.

Very brilliantly recorded, with every advantage taken of stereo, this tape is one for all Ted Heath fans.—*F. N. West*



Music ★★★
Performance ★★★
Fidelity ★★★★★
Stereo Effect ★★★★★

RONNIE ALDRICH and his TWO PIANOS

Side 1: Liebestraum, Reverie, Story of A Starry Night, Till The End of Time, Story of Three Loves, Full Moon and Empty Arms.

Side 2: Stranger in Paradise, Clair de Lune, Baubles, Bangles, and Beads, Theme from "Goodbye Again", Tonight We Love, I'm Always Chasing Rainbows.

Ronnie Aldrich

LONDON LPL 74018

4-track, 7 1/2 ips

\$7.95...34:15 mins.

The electronic wizardry of Phase 4 has been used to good advantage in this album, in which Ronnie Aldrich plays two pianos and does it beautifully.

Piano music, especially when it abounds in long, sustained notes or chords, presents the supreme test, both to recording and reproducing equipment. There are times when the piano leaves a little to be desired, but Aldrich's style is so informal and gentle, that the tape provides decidedly pleasant listening. The accompaniment by a rhythm section is acceptable in the pop tunes he plays, but becomes incongruous when applied to classics such as "Liebestraum", "Reverie", and "Clair de Lune".

Quality and stereo are excellent.—*F. N. West*



Music ★★★
Performance ★★★
Fidelity ★★★★★
Stereo Effect ★★★★★

TEMPTATION

Side 1: Temptation, Blues In The Night,

Love For Sale, Daddy, Laura, Bess, You Is My Woman.

Side 2: Maria, St. Louis Blues, Chloe, Satin Doll, Whatever Lola Wants, Jezebel.

John Keating Orchestra and Singers
LONDON LPL 74019

4-track, 7 1/2 ips
\$7.95... 39:50 mins.

This combination of orchestra and singers arranged by John Keating, is unique, if only from the standpoint of the theme; he attempts to portray moods and fascinations predicated upon the women represented in the song or title.

The combination of a fine orchestra, good voices, imaginative arrangements, and Phase 4 technique, make this tape quite listenable.

Fidelity and presence are outstanding.—*F. N. West*



Music ★★
Performance ★★★
Fidelity ★★★★★
Stereo Effect ★★★★★

HAWAIIAN SWING

Side 1: Blue Hawaii, Hawaiian War Chant, Moon of Manakoor, Pagan Love Song, Bali Ha'i, "Hawaiian Eye" Theme.

Side 2: Sweet Leilani, Now is The Hour, Aloha Oe, On the Beach at Waikiki, My Little Grass Shack, "Adventures In Paradise" Theme.

Werner Muller and his Orchestra
LONDON LPL 74021

4-track, 7 1/2 ips
\$7.95... 31:45 mins.

As an example of sensational sound effects possible with Phase 4 recording, "Hawaiian Swing" is a good choice.

But, if you expect to hear the beautiful, dreamy melodies for which Hawaii is famous, played as you would normally hear them, you are in for a surprise.

Werner Muller and his 80 piece orchestra play the lovely music of the Islands with a swinging beat, and they swing so far at times, that it is hard to believe this is a Hawaiian music tape.

Technically, the Phase 4 method enhances the sound. Musically, this tape is mostly rock and roll gone Hawaiian.—*F. N. West*



Music ★★★
Performance ★★★
Fidelity ★★★★★
Stereo Effect ★★★★★

HIT THEMES FROM FOREIGN FILMS

Side 1: "La Dolce Vita" Theme, "La Strada" Theme, "La Ronde de L'Amour", "Romande D'Amour", "Black Orpheus" Theme, "Never On Sunday".

Side 2: "Saturday Night and Sunday Morning", "Adieu Tristesse", "Anna", "Nadia's Theme", "Scotland the Brave", "The Rising of the Moon".

International All Stars
LONDON LPL 74020

4-track, 7 1/2 ips
\$7.95... 32:50 mins.

Most of the foreign films shown in this country lately have a musical score or theme that has helped contribute to their success. While most of these numbers have been recorded by other orchestras, the International All Stars Orchestra appears on the London label with a brilliantly recorded, very listenable album of unusual foreign film music.

Played with animation and feeling, the catchy tempos with their original arrangements are enhanced by Phase 4, and recorded with full stereo effect and wide dynamic range.—*F. N. West*

CAPSULE REVIEWS:

CLASSICAL

RCA VICTOR FTC 2125, ARTUR RUBINSTEIN AT CARNEGIE HALL, \$8.95, 52 min Twentieth century piano music consisting of four works of Debussy, four *Mazurkas* of Szymanowski, 12 *Vision fugitives* of Prokofieff, and the *Doll Suite* of Villa-Lobos, recorded during live concerts the latter part of 1961. Superlative performances of generally unfamiliar music, recorded with natural piano sound before an unusually quiet audience.

RCA FTC 2097, PROKOFIEV: Love for Three Oranges Suite, CHOPIN: Les Sylphides, Boston Pops Orchestra conducted by Arthur Fiedler, \$8.95, 46 min. Vigorous performances of these favorites, recorded with a definitely constricted dynamic range and "boxed-in" sound quality.

RCA FTC 2075, MILHAUD: *Suite Provencale La Creation du Monde*, Charles Munch conducting the Boston Symphony Orchestra, \$8.95, 33 min. The *Suite Provencale* is an intriguing collection of folk airs from the 18th Century, while *The Creation of the World* was one of the first successful uses of Jazz in serious music. Performances here are excellent, but recorded sound is not; it is tinny, brash, lacking in natural bass and restricted in dynamic range.

VANGUARD VTC 1648, "THE VIRTUOSO HORN": The Four Horn Concertos of Mozart played by Albert Linder with the Vienna State Opera Orchestra conducted by Hans Swarowsky, \$7.95, 55 min. Superb performance by Linder, with fine sound from Vanguard. Definitely a best buy in four-track tape, with almost an hour's playing time.

AND HE SAID—

"I want a couple of blank tapes but please . . . this time without all those hums!"

. . . .

"Erasing is part of editing; but what do you call it when there's nothing left at the end?"

. . . .

"Whadda you got good in four track tape that's good for a hi-fi?"

. . . .

"No, I don't remember the name of the speaker but my wife was just crazy about the blond enclosure and I thought . . ."

NEW!

low cost solution for superior tapes

- Cuts Background Noise
- Focuses on Your Voice



ONLY
\$35⁰⁰ list
including stand adaptor (stand extra)

SHURE UNIPLEX

unidirectional ceramic microphone

Most low cost microphones pick up sound indiscriminately—from all around the room . . . the result is tapes with too much "room echo" and ambient noise. Unidirectional microphones (which pick up sound mainly from the front while suppressing unwanted sound coming from the sides and rear) were too high priced for many users. Now! Shure has incorporated its world-famous "Uni-phase" network (found in our most expensive unidirectional dynamic microphones) into this low cost, probe-type ceramic microphone that makes it possible for you to get professional results at a minimum investment. Ask for a demonstration at your microphone or sound system dealer's . . . you'll hear how it can improve all your tapes . . . especially stereo!

50 to 7000 cps response. Can be hand held, or stand mounted. Response at rear down 15db from front. High impedance.

Literature:
SHURE BROTHERS' INC.
222 Hartrey Ave.
Evanston, Ill., Dept. TR-K

CROSTALK

from the Editors

MANY OF US do not think of a tape recorder as a charitable instrument but it most certainly is. We had this brought forcibly to our attention recently when we were asked to address a group whose sole purpose was recording for the blind.

* * * * *

IN THESE DAYS of huge charitable foundations and Government handouts the feeling of individual satisfaction that comes from a charitable act has been taken away. With the tape recorder it can be put back.

* * * * *

WE WERE IMPRESSED with the sincerity and dedication of the group to whom we spoke. Composed mostly of women, many of who were becoming acquainted with tape recorders for the first time, they met to share experiences, to solve common problems and to learn how to do an even better job.

* * * * *

SOME OF THE questions raised were on the amusing side—such as what do you read when the author starts using four-letter words in some of the modern literature? Others were more serious. What reading speed does a blind person prefer? In recordings made by a group, should one voice be used throughout or is it permissible to have a number of different readers.

* * * * *

QUESTIONS OF the best technique to use with a microphone, the differences that room acoustics make on a recording, what kind of tape to use and similar, more or less technical questions were also raised.

* * * * *

WHILE THERE IS plenty of "classical" material available in the Library of Congress Division for the Blind, most of it is on records. The blind are as much interested in topical events as a sighted person and they are just as much interested in the latest books and magazine articles as any one of us.

* * * * *

IT IS THIS type of material that brings the tape recorder to the fore. Using tape, a large number of readers may be used who can read an assigned book on their own time and as their time permits. The finished tape may then be duplicated and distributed.

* * * * *

BUT EVEN on an individual basis, your own recorder can be put to work. There are sure to be blind people in your own city or area who would deeply appreciate any reading you might be able to do for them. The latest magazines, and similar material, especially magazines or articles on topics of especial interest to the person would be of great value and benefit.

* * * * *

IF YOU DO not know the whereabouts of a blind person, your local Workshop for the Blind will be able to help you find one. As with the group to whom we spoke, the reading of material for the blind may also be made into a group project with the recorder set up in some central place and with readers scheduled at various times. Some of the tape correspondence clubs have divisions for the blind within their memberships and you might be able to help out there.

* * * * *

WE CAN THINK of no finer use for a tape recorder, nor can we think of anything that will produce greater personal satisfaction in having made a gift of yourself rather than contributing to an organized charity, the recipients of which you never know.

INDUSTRY NEWS

CITROEN ELECTRONICS has appointed 52 authorized repair stations to provide service and replacement parts on the company's 550 and 660 recorders. Additional stations are rapidly being set up according to Eugene Freeman, president, to complete the national picture. Service and parts for the company's portable recorders will soon be available in every retail area.

They have also announced that Ponder & Best, Inc., of Hollywood, Cal., has been appointed distributor for their tape recorders. Ponder & Best are long time specialists in hi-fi, electronics and photo equipment.

REEVES SOUNDCRAFT has announced that all existing sales records for a single month have been broken. Hazard E. Reeves, president of the firm made the announcement. For the month of August, he said, sales were \$753,000 despite the fact that August is traditionally a slow month. Sales were more than \$1,300,000 for the corresponding period of last year and Mr. Reeves predicts sales of at least \$12 million in 1963.

PENTRON ELECTRONICS CORPORATION has announced that a new profit mark has been set for their fiscal year ending June 30. Sales were up over \$4,000,000 from the previous year. Formerly a tape recorder manufacturer, the company now makes a broad line of products and has acquired a number of allied firms to diversify its operations.

AMPEX has announced a one year warranty covering all Ampex Audio tape recorders, decks and related equipment. The new parts warranty, which replaces the customary 90 day warranty, covers the entire Ampex product line. Customers who have purchased equipment since May 1, 1962 and who have registered their warranty may obtain coverage by making a request directly to the factory. Upon receipt of the unit's model number, serial number and date of purchase, a warranty card will be issued. Tubes and tape which carry their own manufacturer's warranty are not included in the program. Ampex 1200 series recorders used in commercial applications are limited to 90 day coverage.

3M has announced a long-play version of the "Scotch" brand sandwich tape which has had wide acceptance by language labs and other heavy duty applications. The oxide is covered with a microscopically thin plastic layer which keeps the oxide from ever touching the head or guides of recorders. The plastic coating, which is 50 micro-inches thick does not impair sound qualities. The plastic film is so thin that sound is faithfully recorded and reproduced.

FERRODYNAMICS, Lodi, N. J. has made available magnetic tape accessory kits in specially designed plastic attache carrying cases. The kit for standard recorders contains two empty 3" reels, two 3 1/4" empty reels, two 5" empty reels, two 7" empty reels and two 7" reels each containing 1,200 feet of acetate tape, and a tape splicer, a roll of splicing tape, a marking pencil, two reels of leader tape, a strobe

tape, six tape clips and a booklet on how to make good recordings. The suggested list price is \$13.95.

The kit for the miniature recorders contains the splicer, pencil, clips, etc. of the larger kit and has three 3" reels, two empty 3 1/4" reels, one 3" and one 3 1/4" reel of recording tape. The suggested price of this is \$8.95.

NEW YORK HI-FI show was a big success according to Raymond Pepe, president of the Institute of High Fidelity Manufacturers, sponsors of the show.

The attendance was about 32,000 of which 26,000 were paid admissions.

Next year's Hi-Fi Show in New York will be held from September 9 to 14th, giving one more day than this year's show.

ROBERTS ELECTRONICS has introduced three new tape recorders all featuring sound-on-sound or sound-with-sound possibilities. The model 455 priced at \$599.95 has three motors, three heads 20 watts of music power with transistorized amplifiers, and solenoid action.

ROTRON MANUFACTURING COMPANY, Woodstock, N. Y. has brought out a fan designed to cool audio components, TV etc. The unit is priced at \$14.85 and requires only 7 watts of operating current. It is very quiet in operation and is designed for various types of cabinet mounting.

STANCIL HOFFMAN, Hollywood, Cal., has brought out a new series of communications recorders for police and fire departments and a new tape duplicator designed for schools and colleges which consists of a master reproducer and three slaves. Cost of the unit is \$4,500.

MRIA sponsored 1963 San Francisco High Fidelity Show will be held in the Cow Palace March 6 through 10th. The announcement was made by James Logan, Show Director.

This year will feature "good looks go with good sound" and the show will be put on jointly with a decorator's show under the auspices of the San Francisco Chapter of the National Society of Interior Designers.

Mr. Logan said, "For the past two years the high fidelity event was held in conjunction with our Bay Area home show but this year we are moving inside the California home, with special emphasis on interior design."

ELECTRO-VOICE, Buchanan, Michigan has brought out a line of quality tape recording microphones which it had on exhibition at the New York Hi-Fi show. The models range from \$7.50 to \$200 and include E-V Models 655C, 664, 623, 615, 729, 719 and 712.

PICKWICK INTERNATIONAL, a recorder manufacturer has entered the recorded tape field with a low priced recorded stereo tape. The tape will have a suggested price of \$3.99 and contains 25 numbers recorded at 7 1/2 IPS. The next release will feature Christmas music.

TAPE RECORDING IN EUROPE

Some of the most interesting developments in tape recording are taking place in old-established factories and laboratories in Europe. The fullest information about them appears regularly in TAPE Recording Magazine, published in London, England, since February 1957.

TAPE Recording Magazine was the first and is today the foremost publication in Europe in this field.

It will enable you to enjoy a unique world-view of what tape recording engineers and scientists and European amateur enthusiasts are doing.

For a one-year postal subscription send \$3.50 to —

TAPE

RECORDING MAGAZINE

7 Tudor St., London, EC4, England



"A complete recording studio in itself," says Dick Van Dyke—star of Columbia's forthcoming musical "Bye Bye Birdie" and his own CBS TV show.

New ROBERTS '1057' STEREO TAPE RECORDER

Has 4-track stereo and monaural record/play • Sound-on-sound multiple recording in stereo, sound-with-sound (teacher/student feature), sound-over-sound mixing • Dual stereo speakers • Dual stereo power amplifiers • 4 stereo headset outputs • Automatic shutoff • 3 3/4 & 7 1/2 ips tape speeds **\$339.95**

ROBERTS ELECTRONICS, INC., Dept. TR-12-T
5978 Bowcroft St., Los Angeles 16, Calif.
Please send me: Roberts Stereo Tape Instruction Manual containing stereo and monaural applications. I enclose 25¢ (cash, stamps) for postage and handling.
 The name of my nearest dealer.

Name _____
Address _____
City _____ Zone _____ State _____

TAPESPENDENTS WANTED

This listing is for those seeking tape correspondents, looking for swaps of tapes, etc. and it is a free service for our readers. If you wish your name listed send us the following information on a post card: 1-Name, 2-Mailing Address, 3-Kind of recorder, speed and number of tracks, 4-Subjects on which you want to tapespond or items for which you are looking, 5-Indicate whether you are an adult or teenager. Listing will run two months and then be dropped to make way for new listings. Address your postcard to: TAPESPENDENTS WANTED, Tape Recording Magazine, 101 Baltimore-Annapolis Blvd., Severna Park, Md.

Tape Recording magazine assumes no responsibility for any inquiries between people listed in this column which are not answered.

Spencer M. Berger, 65 Laurel Rd., Hamden 11, Conn.; Recorder: Wollensak T-1515-4, 7 1/2 & 3 3/4 ips, 2 & 4 track; Interest: Wants any material (standard phonograph records excepted with Ted Lewis; John, Lionel, or Ethel Barrymore; Leopold Stokowski; Adult (45).

Emerson Evans, 1444 S. 14th East, Salt Lake City 5, Utah; Recorders: 2 Roberts, 1 Ekotape, 2 tracks, 3 3/4, 7 1/2, 15 ips; Interests: Unusual sounds, tape recording and mixing, gay-nineties songs and piano music, 1900-1930 history. Want to tape with someone over 40 from New York City, San Francisco, New Orleans, Texas, Quebec, Baltimore, Maine, Vermont or New Hampshire—just tape, all tapes answered; Adult, Advertising Artist.

Ernest Centofante, 3085 Adams Way, Santa Clara, Calif.; Recorder: Sony 101, 3 3/4 and 7 1/2 ips, 2 track; Interest: Tapespondence in English anywhere outside U. S. & British Empire; Adult.

LCDR John W. Beale, SC, USN, Command and Staff Course, Naval War College, Newport, Rhode Island; Recorder: Norelco 400, 1 1/8, 3 3/4, 7 1/2 ips, 4 track mono/stereo; Adult.

Warren L. Wallis, 1355 Continental Drive, Daytona Beach, Florida; Recorders: V-M and Silvertone, all speeds, two tracks; Interest: Want tape contacts in Caribbean; Adult (36).

Leif G. Brush, 234 N. Austin Blvd., Oak Park, Illinois; Recorders: Ampex 601, Roberts 192FT, 7 1/2 ips, full track; Interests: First Day Covers, old-time radio voices—network local. Want 1945 or earlier network station breaks of Red, Blue, CBS, Mutual and CBC, Dominion networks. Chimes included in Red, Blue breaks: "This is NBC—The National Broadcasting Company, bing-bong-bing," etc. Also: Complete Blue Coal spon. Shadow half-hour; Kix spon. Lone Ranger half-hour; Bayer spon. American Album of Familiar Music. (Felix Knight, Donald Dame—announced by George Ansbro). Offer: Nautilus arrival in Portland Harbor, Eng., '58—no charge; Adult.

Bill Surmik, 103 N. McKinley Ave., Endicott, N. Y.; Recorder: RCA 8-TR-3, 7 1/2, 3 3/4 ips; Interests: Talk and write Czech and English. Interested in Czechoslovakian polkas, Waltzes and Csardas (Bohemian-Slovak). I tape this kind of music for radio, 30 min. tapes, at 7 1/2 ips speed. Maybe I can find someone who does this kind of work. Would like to find information—how to get some tapes and records made in Czechoslovakia.

Tom A. McIntire, 501 Wright St., Wilmington, N. C.; Recorders: Concord 880 and Norelco, 1 1/8, 3 3/4 & 7 1/2 ips, 4 track record/playback, 2 track playback; Interest: Want to exchange classical music tapes. Send your "want" list—I'll send you mine. Have some stereo, lots of mono; Adult.

Stephen Edward Buggie, 2421 Garfield Avenue South, Minneapolis 5, Minn.; Recorders: Norelco 400, Wilcox-Gay 5M, 15/16, 1 1/8, 3 3/4, 7 1/2, 15 ips; Interests: Electronic sound effects, world politics, science fiction, unusual people, Spanish language study, various types of "Language Laboratories," round robin tapes, 8mm movies, hi-fi, travel, records (stereo), I would like to get a 7 1/2 ips, 4 track stereo recording of a boomerang, also different cuckoo clocks in stereo as well as other sounds. Interested in promoting new young tape club, International Voices of Youth; Mature Teenager (16).

PFC Robert P. Rice, RA12611579, Box 194, U.S.A.R.S.C.A.T./D.I.C.S., A.P.O. 90, San Francisco, Calif.; Recorder: Fujiya-corder, 2 track, 3 3/4, 7 1/2 ips; Interest: Old recordings Edison through 1930, particularly the 20's; also railroad sound effects, would like to hear from fellow railfans; Age 21, single.

Irwyn S. Greif, 2231 Batchelder Street, Brooklyn 29, N. Y.; Recorder: Telectro SR-441, dual track, 1 1/8, 3 3/4, 7 1/2 ips; Interests: Flying saucer research, occult research, E.S.P. research and development. My desire is to gather together all psychically sensitive people into one group to develop higher E.S.P. and psychic sensitivities. I have 8 years background in psychic field. I wish to use tape correspondence as a worldwide communications setup; Adult (32), married.

John W. Howe, 84 Sproat, Detroit, Mich.; Recorders: Wollensak T1616, 3 3/4, 7 1/2 ips, monaural or stereo; Telectro, 3 3/4, 7 1/2 ips, monaural; Interests: Music, all kinds, but especially organ, honky tonk piano, pre-recorded tapes. Folk-voice taped programs; any Dick Kenny series, spot recording sound effects; world tapesponding exchanges; Adult.

Edmund Perry, 7 Raposa St., South Dartmouth, Mass.; Recorder: Realistic, 3 3/4 & 7 1/2 ips, dual track; Interests: Controversial discussions, psychic phenomena, adult comedy, travel, etc. Interested in anything and everything, but prefer the unusual and different sounds; Adult (36).

Dod. Wilcox, 731 East 73rd St., Los Angeles 1, Calif.; Recorder: Telectro Stereo Master, 3 speeds, dual track, 4 track, record/play stereo; Interests: Play real swinging organ, use sound on sound and percussion for blues and R & R, play all kinds of music. Arrange and compose. Hoping to form own trio for recording. Will answer all interested in music, or exchange ideas; Adult (single).

John P. Baker, 217 Sturgeon St., Springfield, Ohio; Recorder: Telectro Model 999, 1 1/8, 3 3/4, 7 1/2 ips, dual track, stereo and mono playback; Interests: Philately, travel, good music, science fiction, writing, books, recording techniques, general tapespondence; Adult.

Skip Gorman (wife, Jake), 493 Lovell, Mill Valley, California; Recorder: Wollensak, 3 3/4, 7 1/2 ips, dual track; Interests: Writing (all aspects), jazz, sports car racing, authors, abstruse thinking, Yeats, Eliot, cooking; Adult (26).

F. O. Chumbley, 1929 College, Springfield, Missouri; Recorder: Pentron, 3 3/4, 7 1/2 ips, monaural, two track; Interests: Have tape, will talk. Wish to exchange English tapes with anyone, any country; Adult (58).

Harold A. Miller, D.D.S., 1121 Edgewater Drive, Orlando, Florida; Recorder: Norelco 100, 1 1/8 ips, 2 track, monaural; Interests: Want to contact dentists here and abroad. Interested in dentistry, travel; also wish to tapespond with trailer dealers in the U. S.; Adult.

William W. Lau, 512 W. Lehigh Ave., Philadelphia 33, Pa.; Recorder: Realistic, 2 speed, 4 track; Interests: Fiction, news events; Adult (33).

Gloria-Ann Pauly, 42 West 65 St., New York 23, N. Y.; Recorders: Wollensak, 4 track, 3 3/4, 7 1/2 ips; Pentron, 2 track, 3 3/4, 7 1/2 ips; Interests: Folk songs and trivia from Tom Lehrer to

Segouia Bagpipes, military & marching music; Adult (30).

Ellys Lund, 35 Division St., New Rochelle, N. Y.; Recorder: Webcor, 7 1/2, 3 3/4, 1 1/8 ips, 2 tracks; Interests: Spanish and English, any cultural subjects, travel, music, foreign customs, story, geography, medicine, religion; Adult.

John R. Furney, 9024 53rd St., Seattle 18, Wash.; Recorder: Norelco C. 400, 2 or 4 track, 1 1/8, 3 3/4, 7 1/2 ips; Interests: Anyone interested in talking about our Century 21 World's Fair, music, photography. Would like to exchange tapes with anyone, anywhere, on any subject; Adult.

Manley D. Hinshaw, 1420 Aldrich Ave., No., Minneapolis 11, Minn.; Recorder: Reverse, dual track, 3 3/4, 7 1/2 ips; Interest: Exchange of humorous monologues and dialogues; Adult.

Paul Sheldon, 6 Rollins St., Concord, New Hampshire; Recorder: V-M 720, 3 3/4 & 7 1/2 ips, dual track; Interests: Conversation, music, publishing, and anything I can re-record and pass on to shut-ins. Guaranteed answer to all tapes in English; Adult.

Al Keller, 2738 Colonial Ave., Merrick, New York; Recorder: Magnecordette 101, 2 track, stereo/mono, record/playback, 3 3/4 and 7 1/2 ips; Interests: Swing music of the 30's and 40's; Jazz music of all kinds; Hi-fidelity equipment; Adult (33).

F. Lockie (Miss), 4, Maryfield Place, Bonnyrigg, Midlothian, Nr. Edinburgh Scotland, U.K.; did not list recorder; Interests: Wishes to tapespond with a young lady of her own age around 29 yrs. in Texas or Wyoming. Does not wish to tapespond with any religious sects such as Jehovah Witnesses, etc. Likes reading, music (light classical), swimming, tapesponding, country life, photography and travel. Wishes tapespondence with females only.

P. A. Moss & S. Roberts, 4 Queen St., Coggeshall, Nr. Colchester, Essex, England; Only two track, 3 3/4 ips, 5 1/4" spools; Interest: We are looking for a couple the same as ourselves aged between 19 to 25 years. Our ages are 19 and 21, we are unmarried and our interests are dancing, records and general.

Earl Linder, 2521 N.W. 23 St., Miami, Fla.; Recorder: Norelco #400, 4 track, 1 1/8, 3 3/4, 7 1/2 ips; Interest: Exchange data on True Science, True History, in relation to the Scriptures as originally written; Adult.

Ray Sholders, 209 Helms Ave., Swedesboro, N. J.; Recorder: V-M 720, 3 3/4 & 7 1/2 ips, 4 track monaural with stereo playback; Interests: Big band stereo tapes, general topics on hunting, fishing, boating, camping in other parts of the country.

Stuart Albert, 31 Lott Ave., Brooklyn 12, N. Y.; Recorder: Wollensak 1515-4, 3 3/4 or 7 1/2 ips, 2 or 4 track; Interests: Electronics, stereo, hi-fi, jazz, drums and music in general. I am an electronics technician going for engineering. I will talk to anybody, any place; Adult.

Steve Barker, 306 Rutherford St., Athens, Ga.; Recorder: V-M Tape-O-Matic 722, 3 3/4 & 7 1/2 ips, 4 track (dual and full track), stereo; Interests: Classical and popular music; hypnotism, tape letters, historical events, electronics, stereo. I am particularly interested in science-fiction and sound effects. Answer all; Teenager.

Elaine Burnett (Miss), 201 Derby Ave., Louisville 18, Kentucky; Recorder: V-M Tape-O-Matic, Model 710, 3 3/4 & 7 1/2 ips, dual track; Interests: Flamenco music, 35 mm slide photography, travel, stereo, pre-recorded tapes, oriental music, boating, Corvette sport cars; Age 20 (single).

Steve Friedman (Spike), 714 Crestview Place, Walla Walla, Wash.; Recorder: monaural, two track, Reverse, with 3 3/4 ips only; Interests: "Tapeals" wanted interested in exchanging and returning tapes and ideas on sleep learning, new and old R'n'R; hypnotism. Would preferably like to hear from male or female in this general area; Teenager.

Franzel C. Buck, 146 Duke of Gloucester Street, Annapolis, Maryland; Recorder: mono-stereo, 3 3/4 & 7 1/2 ips, 2 and 4 track; Interests: Anthroposophy, designing, general interests (English and German)—will answer all tapes.

Ron Bisset, 45 Adderley Terr., Dunedin, New Zealand; Recorder: Telefunken M24, 7 1/2 and 3 3/4 ips at half track; Interests: Radio programs and commercials, color slides, and general tapespondents; Adult (24), married, recording studio manager.

Gene Wahrman, 952 No. Ardmore, Hollywood 29, Calif.; Recorder: Roberts, 4 track, stereo, 3 3/4 & 7 1/2 ips; Interests: Light classical music; I would like to exchange copies from pre-recorded stereo tapes; looking for stereo tape of "Show Boat" motion picture; Adult (27).

Elmer H. Fuehr, 4113 Evergreen Rd., Pittsburgh 14, Penna.; Recorder: Pentron NL-3, 3 3/4 and 7 1/2, dual track, 2 track stereo, will have 4 track recorder soon; Interests: High fidelity, 35 mm photography, citizen band radio, 6 and 2 meter amateur radio, travel, current events high school teaching degree in social science. Interested in these subjects and philosophy; Adult (38), single.

Robert Hodges, 435 Diversey, Chicago 14, Ill.; Recorder: Viking 75, 2 track, 7 1/2 and 3 3/4 ips; Interests: Would like to find tapes of Susanah Foster on Lux Radio theatre broadcast, early forties—"Phantom of the Opera," and early movie sound tracks; also Helen Traubel Met broadcasts and radio; Adult (33).

Thomas A. Roker, Jr., 31-07 49th Street, Woodside 77, N. Y.; Recorders: Philco, V-M 711, 7 1/2 & 3 3/4 ips, 2 track, stereo; Ekotape tape deck 346, 7 1/2 & 3 3/4 ips, 2 and 4 track stereo; Eicor 115, 7 1/2 ips, dual track; Interests: Modern jazz and classical music; would like to tapespond with those interested with the aspects of tape recording and beginners in tapesponding interested in improving their techniques. I am also looking for copies of any dynamic classical organ works; Adult (35).

Syd Finley, Jr., 939 H Street N.W., Wash. 1, D. C.; Recorder: Telefunken & Grundig, 1 1/8, 3 3/4 & 7 1/2 ips, dual track; Interests: Motorcycles, sports cars, women and music; Adult, single.

Barbara Confino, 1561 Sheridan Avenue, Bx. 57, N. Y.; Recorder: Revere T-2000, mono, 2 track, 2 speeds; Interest: I would like to trade opera tapes; Adult.

Dr. Harold Kahn, 444 Superior St., Toledo 4, Ohio; Recorder: Norelco 400, 1 1/8, 3 3/4 & 7 1/2 ips, 4 track; Interest: Jewish and Yiddish music, old and new; Adult (45).

Dave A. Amaral, 38553 Logan Drive, Fremont, Calif.; Recorders: V-M 714, V-M 722, Ampex 601-2; Interests: 1939-40 records by Sons of the Ozarks on RCA Bluebird, 1942 records by Rusty Draper on coast, Draper air-checks, tapespondent in field of radio or television broadcasting wanted; Adult (25).

Walter O'Malley, 7722 So. Austin Ave., Oak Lawn, Ill.; Recorder: Webcor Royalite, two track, 1 1/8, 3 3/4 and 7 1/2 ips; Interests: Irish and Scotch music, comedy satire; Adult (31).

Richard M. Semerak, 4327 So. Sacramento Ave., Chicago 32, Ill.; Recorders: Viking Model 86 and Webcor, 2 and 4 track, full track, 3 3/4 and 7 1/2 ips; Interests: Japanese folk and popular music, opera, dance bands, general folk music and classical music. Interested in tape of Yukiji Asaoka singing "Sayonara" on the Dinah Shore show of Dec. 25, 1960 and Izumi Yukimura singing Japanese folk song on Victor Borge show of Oct. 6, 1960; Adult.

Robert J. Linden, 610 Knoll Drive, Lansdale, Penna.; Recorder: Wollensak, 3 3/4 & 7 1/2 ips; Interest: Want to hear from Reading Railroad ramble trip tapes either aboard train or on ground recordings; Adult.

William Swisher, 409 Taylor Street, Sandusky, Ohio; Recorders: Webcor 2711, dual track, 3 3/4 & 7 1/2 ips; and V-M 730, dual track, 1 1/8, 3 3/4 & 7 1/2 ips; Interests: Would like to swap tapes of

78 rpm records by Glenn Miller and his orchestra, and tapes of David Brinkley prior to 1961; Teenager (16).

Audrey C. Monroe, 116 Drake Ave., South San Francisco, Calif.; Recorder: Sony 300 Stereorecorder, 3 3/4 or 7 1/2 ips, monaural, 2 or 4 track; Interests: Magic, fishing, organ music, photography, plus old fashioned every day "chit-chat"; Adult.

Frank X. Micallef, 101, Stuart Street, Gzira, Malta; Recorder: Norelco 400, 7 1/2, 3 3/4 & 1 1/8 ips, 4 track, stereo; Interests: Wants tape pals from USA, Germany, France, Italy, North Africa, and Japan. Most types of music mono or stereo, folk music, but no pop songs. Peculiar humor, hilarious or serious conversations on most human activities except sports. Italian opera. Unusual and 'queer' music. I also seek lady tape friends around 30 years old, international FM broadcasts. I have much musical and spoken word material (in English) to offer. Sound effects. I have spent the last 22 years in England, Germany, Egypt, Libya, Israel, Ceylon, Singapore. Express myself best in English although I am familiar with a few other tongues of the countries I have lived in; Adult (38).

Merrill A. Maynard, P. O. Box 4, Taunton, Mass. Several Recorders: monaural, dual track, 3 3/4 ips; Interest: Operate a lending library for Catholic listeners, send tape for list, or if you are interested in serving as a volunteer reader; Adult (43).

Edmund K. Krause, 571 Edgemont Ave., Lansdale, Penna.; Recorder: Fujiya FL-77, two track, monaural, 3 3/4 & 7 1/2 ips; Interests: Historical shrines, Archeology, nature study, tapes of bird calls, and also of general conversation; Adult.

Victor Wise, 1331 Teller Ave., Bx. 56, N. Y.; Recorder: Concertone 505-4, 4 track (stereo-mono), 2 and 4 track playback, also half track mono; Interests: Classical, Jazz (all types) music; would especially like to exchange ideas on broadcasting techniques in announcing, sound effects, general conversation, D.J. Shows; Adult (22).

Bob Franzenburg, 8 Gutheil Lane, Great Neck, L. I., N. Y.; Recorder: Webcor "Regent Cornet," stereo, 1/4 track and 1/2 track, 1 1/8, 3 3/4 & 7 1/2 ips; "Technicorder" battery operated, half track, 1 1/8 & 3 3/4 ips; Interests: Would like to write to people about sleep learning and exchange self-help recordings on the subject with them. Also: Anyone having a tape recording of TV's production of "Meet Me In St. Louis" starring Tab Hunter, etc. I would like to have all musical songs. Also: I have many "candid" conversations of great interest, if you collect such conversations of people's gossip, arguments, fights or just plain interest—will exchange mine for yours . . . got some gems! Battery miniature hidden recorder does the trick; Teenager (19).

Jack M. Walters, Box 302, Plant City, Florida; Recorder: Silvertone Model 9047, 3 3/4 or 7 1/2 ips, stereo playback; Interests: Music of all types, postmark collecting, also post cards—interested in exchange of both. Also general topics of conversation; Adult (27), male.

David G. Hillier, 13 Haig Road, Grand Falls, Newfoundland, Canada; Recorder: Phillips (Norelco) 400, 1 1/8, 3 3/4 & 7 1/2 ips, 2 and 4 track stereo and monaural; Interests: Music (except Dixieland and R' & R'), travel, general conversation, languages—French and German (just learning), sports; Adult (24).

Edward Greenberg, 15869 Cherrylawn, Detroit 38, Mich.; Recorder: Bell RT 65-B, 1 1/8, 3 3/4 & 7 1/2 ips, dual track, monophonic; Interests: Rock n' Roll and a variety of popular and classical music, tape recording, hi-fi, science fiction, space, and tape conversation. Will answer all tapes, especially want to tape to other teens; Teenager (15).

NOTE: We have a backlog of names on file which we must hold until we have space to publish them. We are publishing each name in two issues as stated in our heading. Please be patient until your name is used.



**PORTABLE...
PROFESSIONAL...
PRECISION-MADE!**

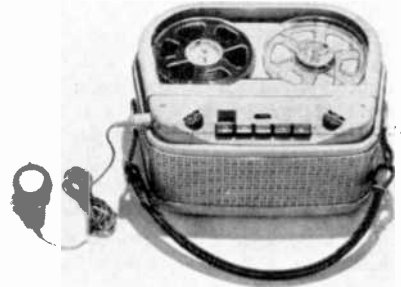

BUTOBA is a precision tape recorder, quality-engineered and hand-crafted by skilled West German technicians, offering performance and features never before found in portable recorders!

UNEQUALLED FEATURES:

4 hrs. recording or play-back on 5 inch reels
 • Exceptionally fast forward and rewind
 • Instant start and stop
 • 2 motors with transistorized electronic speed control
 • Separate volume and tone controls
 • Built-in push-pull amplifier and 5" x 7" heavy-duty speaker
 • Tape position indicator
 • 40 hrs. operation from 8 ordinary flashlight batteries
 • Fully transistorized, battery or A/C operated.

SPECIFICATIONS:

Response: 50—13,000 cps @ 3 3/4 ips,
 60—6,000 cps @ 1 1/8 ips • Half track • Flutter and wow: Max. .2% @ 3 3/4 ips • Mike input—200 ohms; line input 100K ohms • Compact
 • Lightweight • Complete with dynamic mike
 • Full line of accessories available.

BOOKLET FREE!

"25 WAYS TO USE YOUR TAPE RECORDER" and color folder. Yours for the asking. Write...

STANFORD INTERNATIONAL
 569 Laurel Street • San Carlos, Calif.
 Telephone: 591-0339

TAPE CLUB NEWS

Interviewed On Radio



Harry and Marjorie Matthews, founders of World Tape Pals, board a plane for Los Angeles to appear on Radio Station KFI on behalf of WTP.

Harry and Marjorie Matthews, were interviewed about World Tape Pals over the Night Owl Program Radio Station KFI, on Sept. 15, and interviewed for a story in the Los Angeles *Herald Examiner* the following Sunday.

Tape Helps Renew Old Friendship

It was wonderful to read of the story which developed as a result of tape correspondence in the Universal Tape Network club. Club member Rudolphe R. Roberge received a tape from blind John Cote of Berlin, N. H., saying that his friend, Jean-Paul Guilbeault, also blind, had contacted him and he would appreciate it if Mr. Roberge would look him up since they both lived in the same vicinity.

Mr. Roberge took his recorder to the home of Mr. Guilbeault and had him voice a tape for Mr. Cote. At the time, Mr. Guilbeault was an unemployed organist.

Upon receipt of the tape, Mr. Cote taped a reply inviting Mr. Guilbeault to come to Berlin. Mr. Cote obtained a house for Mr. Guilbeault and his mother, and he arranged for him to be the organist for his church, the Veterans of Foreign Wars Auditorium and a roller skating rink.

Thus, through the medium of tape exchange, two old friends were brought together, and one was able to help the other find a new life and employment.

New Additions

We are adding a new foreign club to our roster, Stereo Tape Club (Africa Division). This club has 66 members, is engaged in building a tape library which already contains 75 tapes, and it has one main committee, the Executive Committee, which handles most of the club's business. Other committees are established as the need arises.

Anyone interested in this African club is invited to write to P. J. Kruger, the club secretary for information.

We are also listing another new club in our roster this issue — International Voices of Youth. This club was founded by a group of teenagers in California and it now has members in six countries, representing five continents and in eleven states of the United States. It was established to provide a tape club with a program aimed at the interests of teenagers and young people the world over. There is no

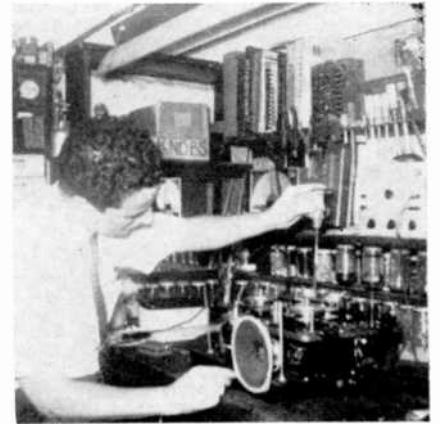

Ralph Holder, general secretary of The Society of Tape Hobbyists, is also chairman of the club's technical department. Here he is making adjustments on a fellow members tape recorder. This photo was taken in the Audio-Lab where all the Society's electronic problems are solved.

age limit, however, the only requirement being a sincere interest in the activities of young people the world over.

Membership in this club is two dollars per year which includes a subscription to the club publication "Playback", as well as directory supplements.

Still another new addition to the roster is Cartridge Correspondence Club. This club now has 68 members; its president is Duane Davidson, vice-president is Jasper Toalson, and sect.-treas. is George C. Ekmalian. Anyone who has a cartridge recorder and is interested in joining may contact the sect.-treas. at the address listed below.

The club has designed and is having built a special tape cartridge mailer which will hold the cartridge and its box intact.

JOIN A CLUB

TAPE RECORDING Magazine assumes no responsibility for the management or operation of the clubs listed. This directory of clubs is maintained as a service to our readers. Please write directly to the club in which you are interested regarding membership or other matters.

Please enclose self addressed, stamped envelope when writing to the clubs.

AMATEUR TAPE EXCHANGE ASSOCIATION
Ernest Rawlings, President
5411 Borage Street
Cartierville, Montreal 9, P. Q., Canada

AMERICAN TAPE EXCHANGE
Clarence J. Rutledge, Director
1422 No. 45th Street
East St. Louis, Illinois

CARTRIDGE CORRESPONDENCE CLUB
George C. Ekmalian, Sect.-Treas.
45 Haumont Terr.
Springfield, Mass.

CATHOLIC TAPE RECORDERS OF AMERICA, INTERNATIONAL
Jerome W. Clarrocchi, Secretary
26 South Mount Vernon Avenue
Uniontown, Pennsylvania

CLUB DU RUBAN SONORE
J. A. Freddy Masson, Secretary
Grosse Ile, Cte, Montmagny,
P. Que., Canada

INDIANA RECORDING CLUB
Mazie Coffman, Secretary
4770 E. 39th St.
Indianapolis 18, Indiana

INTERNATIONAL VOICES OF YOUTH
P. O. Box 3041-T
San Mateo, California

MAGNETO-VOX CLUB
J. M. Roussel, Secretary
7915 Des Erables
Montreal 35, Que., Canada

ORGAN MUSIC ENTHUSIASTS
Carl Williams, Secretary
152 Cilzbe Avenue
Amsterdam, New York

STEREO INTERNATIONAL
O. B. Sloat, Director
1067 Flatbush Avenue
Brooklyn 26, N. Y.

TAPEWORMS INTERNATIONAL TAPE RECORDING CLUB
Marion Chism, Co-ordinator
129 South Broad Street
Carlinville, Illinois

THE SOCIETY OF TAPE HOBBYISTS
Ralph Holder, General Secretary
116-06 139th Street
South Ozone Park 36, N. Y.

THE VOICESPONDENCE CLUB
Charles Owen, Secretary
Noel, Virginia

UNION MONDIALE DES VOIX FRANCAISES
Emile Garin, Secretary
c/o Romance Languages—Rm. 1617
Cathedral of Learning
University of Pittsburgh
Pittsburgh 13, Pa.

UNIVERSAL TAPE NETWORK
Larry Duhamel, President
R. F. D. #1, Main St.
East Douglas, Mass.

WORLD TAPE PALS, Inc.
Marjorie Matthews, Secretary
P. O. Box 9211, Dallas 15, Texas

OVERSEAS

AUSTRALIAN TAPE RECORDISTS ASSOC.
Bob Nardi, Hon. Sec./Treas.
P. O. Box 67, Eastwood,
New South Wales,
Australia

ENGLISH SPEAKING TAPE RESPONDENTS' ASSOCIATION
Robert Ellis, Secretary and Treasurer
Schoolhouse, Whitsons By Duns
Berwickshire, Scotland

INTERNATIONAL TAPE FELLOWSHIP
Fred Rimmer, Overseas Rep.
21 Mount Pleasant
Sutton-in-Ashfield
Nottinghamshire, England

STEREO TAPE CLUB
P. J. Kruger, Secretary
3 Clan Building
181 Main Road
Diep River
Capetown, South Africa

THE NEW ZEALAND TAPE RECORDING CLUB
Kenneth M. Tutford
P. O. Box 7060
Auckland, W. I., New Zealand



NO MORE blurrec, distorted sound



ALWAYS perfect reproduction like this

YOU CAN TAPE IT WITH YOU ANYWHERE...

Play/record with the 6-lb.

Model 660

CEC portable tape recorder

Like a picture, irreplaceable *sounds* can be recorded "out of focus". Answer is the CEC professional Model 660. Six pounds light, fully portable. Runs on six penlight batteries, AC or in your car. Capture the sounds you want anywhere—anytime—keep them forever. Covers widest frequency range with professional-type microphone. That means you record what you hear—and what you want to keep. Send 25¢ for booklet on how a portable tape recorder can work and play with you 24 hours a day! Name of your nearest CEC dealer will be included.



CITROEN ELECTRONICS Dept. TR 112
729 N. Highland Avenue, Los Angeles 38, California

- CEC Booklet containing ingenious suggestions on how to get the most from a tape recorder at work or play. I enclose 25¢ (coin, stamps) for postage and handling.
- Name of nearest CEC dealer.

Name.....

Address.....

City..... Zone..... State.....

SAXITONE RECORDING TAPE
 Oxide guaranteed not to rub off or squeak—or money back. Compare ours with other "Bargain" tape. You'll find it's more than just "price" when you deal with us. We are original pioneers in the tape recorder business and our reputation means everything to us.

600' acetate (plastic), 5 inch...	.75
600' MYLAR 5 inch reel.....	.95
900' MYLAR (Polyester), 5 inch...	.99
1200' MYLAR, 1/2 mil., 5 inch reel	1.10
1200' Acetate (plastic), 7 inch...	1.19
1200' MYLAR, 1 1/2 mil., (strong)	1.29
1800' acetate (plastic), 7 inch...	1.79
1800' MYLAR 1mil. thick, 7 inch...	1.99
2400' MYLAR, untemalised, 7 inch	2.99
2400' MYLAR, temalised, 7 inch	2.99

(Large Cases, Ex on Lower) Plus Postage

SAVE 30% 4-track stereo music on tape

NORELCO SPEAKERS
 Famous AD3800M, twin cone 8" (73-19,000 cycles) comparable net 9.99 now 4.95, 2 for 9.00, plus postage. **OTHER Norelco models at BIG DISCOUNTS.** Specifications on entire Norelco line set on request.

SAXITONE TAPE SALES
 div. Commission Electronics, Inc.
 1776 Columbia Rd., Wash., D.C.



OWN THIS MACHINE RECORDING FOR US PART TIME

For complete Literature Packet and Tape send \$1 (refundable) if sincerely interested. Many territories still open but closing fast!

ARTISTIC RECORDING SYSTEMS
 Box 3774, Oak Park, Mich.

AUDIO unlimited
 Specializes in **SAVING YOU MONEY**

- ✓ FACTORY FRESH COMPONENTS
- ✓ LOWEST POSSIBLE QUOTATIONS
- ✓ FAST DELIVERY

We are **FRANCHISED** for most Hi-Fi lines. Orders **SHIPPED PROMPTLY** from our large stock. **RECORDING TAPE at LOWEST PRICES.** **FREE STEREO CATALOG.**
 715-T Second Ave. (Nr. 38th) New York 16, N. Y. **Visit Our Showroom**

RENT 
STEREO TAPES

- Over 2500 different, 4-track & 2-track
- No deposit on tapes rented
- Postpaid 2 to 5 day delivery (48 States)

FREE BROCHURE **stereo-parti**
 811-N CENTINELA, INGLEWOOD, CALIF

TAPE RECORDERS—HOW THEY WORK
 by Charles G. Westcott and Richard F. Dubbe

This book is based on the principle that to get the most from a recorder, one must first understand thoroughly how it works.
 5 1/2" x 8 1/2", 177 pp., paper bound, illustrated

\$2.75

Order your copy from:
TAPE RECORDING
 Severna Park, Md.

"WHY MY RECORDER IS IMPORTANT TO ME" CONTEST

WIN A REEL OF TAPE. Tell us in your own words why your recorder is important to you, not why it could be important to someone else. Entries will be judged on the basis of their usefulness to others and on the uniqueness of the recorder use. No entries will be returned. Address your entry to: Important Recorder Contest, Tape Recording Magazine, Severna Park, Md.

Dear Sir,

Being a wedding photographer, my recorder is important to me not only in recording weddings, but a great asset to me in the darkroom. When shooting a large wedding group, for example a group of 15 people, you will find when printing the photos of the group that the skin tones will vary a great deal because of the different skin tones of the people and also because of light fall off when the photo was taken. A good group shot will have all skin tones the same and not having the girls light and the men appear dark.

To correct this condition you burn in certain faces and hold certain faces back. Once you have obtained the correct exposure for *each face* you can dictate this data into your tape recorder and when making each print, play the tape back and you have a perfect print. I've used this idea for years and it works wonderful.—George Lillie, Cedar Rapids, Iowa

Gentlemen:

My recorders, two of them, known to you as Norelco, are important to me for the following reasons.

1. That I am able to record for the personal enjoyment of myself and friends, and maintain a library of things of great importance, such as the speeches of Her Majesty the Queen, President Eisenhower, President Kennedy, General Viscount Alexander; General Montgomery; Church Bells in various parts of the world; Church Ceremonies of high importance, such as the Enthronement of the Archbishop of Canterbury; and Ordination ceremonies of the Episcopal and Roman Catholic Churches; Musical programmes and Operatic performances as well as Light Operatic works, which are not available on recordings. Then too, I am able to record meetings of extreme importance thus being enabled to verify or disprove any arguments arising therefrom. In each and every instance previously related, they are of items which can never be reproduced excepting through the medium of the recorded tape and thus to me, are priceless.

2. Then too, I am enabled to record speeches given at various functions, both of my own, of others, and in my own instance, Speeches covering Historical research THUS being enabled, at the flick of a switch to reproduce for the entertainment or education of others.

3. My Tape Recorder is important to me because it fills a position, on account of its portability, that nothing else can, because I can record for posterity, items, which, but for the tape recording, would be lost forever.—Wm. H. Talbot, Manitoba, Canada

Gentlemen:

Being one of your subscribers, I cannot resist the temptation to tell you how much I enjoy your fine magazine. I especially enjoy your sections of "Letters" and "Why my recorder is important to me." Among the questions are many that I once had myself when I was struggling along learning the rough fundamentals. I don't mean to infer that I'm a professional yet, but I couldn't experiment with recording for six years without learning something.

I would like to contribute something to your column on the various things people use recorders for. I record steam ship whistles. Being located up here in the St. Lawrence river where there are many large ships, it is quite easy to make fine quality recordings of their whistles. I use a little bit different equipment than most fellows. First I bought a really good mike, a Shure 556S with multiple impedance so that I can use it with my recorder alone (which is high impedance) or I sometimes use it in the low impedance position, with a transistor pre-amp. When using the low impedance set-up I have a 100' three conductor cable so that I can setup at a long distance from the source of sound. This is the set-up I use when recording weddings, or programs in large auditoriums. Of course I record quite a considerable amount from F M. I find that it is much easier to record from F M than A M, as the quality is better and then too, the recorder doesn't "fight" with the F M tuner as it does with the A M radio. I still get the biggest thrill from my ship whistles though. I play them back through a 50 watt amplifier and a 15 inch loudspeaker which really makes them sound real. We have many large ships up here and some of them have become almost like old friends . . . we recognize them by their whistles. I use my recorder a great deal and would enjoy hearing from other fellows who share my hobby. I find that I have become very fussy about my recordings . . . I like to end up with a pure signal, free of clicks and blops, and with good fidelity and no background noise. This isn't always easy to accomplish, but it is fun trying. Some things that sounded good to me a few years ago, no longer please me, because I notice imperfections that I once missed altogether.

I fear that I have already written too much, but I hope someone will enjoy reading these words. I would be glad to send some of my "whistles" to any one who will write me for them. I wish you people the best of luck and success with your fine magazine.—Leonard F. Blanchard, Clayton, N. Y.

LETTERS

Excerpts from readers' letters, including questions and answers, will be used in this column.

Address all correspondence to: The Editor: TAPE RECORDING, Severna Park, Maryland

Wants To Know

- Q—Why do the tape companies continue to make their albums on Acetate tape, when it is so fragile, and only has a shelf life of 2 years against Mylar with the strength and a shelf life of 10 years?
- Q—Why can't the recording companies on 4 track balance their tapes one side to the other viz: London LPK-70025 Side 1, (time 41:17) Side 2. (time 29:30) Quiet a blank SPACE. Are they bound to louse up something good??
- Q—What earthly good do these big hub reels do except to make somebody think he's getting something he ain't. People who are not used to handling same will take a 7" reel and try to wind in on one of these big hub jobs with what a mess. I take them off and throw the big hub reel as far as possible with a few kind words to go with it.—
E. J. T., Fort Worth.

We think you'll find the shelf-life of acetate to be considerably more than two years. We have recorded tapes ten years old and they are perfectly good. Regarding the balance between two tracks, we don't know why they can't do it. Perhaps they felt the piece on side one should not be broken. Somehow the tape industry seems to have got stuck on the 7" reel as the standard figuring the 7" box will make the best display in a dealer's store, the big hub reel is meant for recorded tape only and we agree that it is quite an unpleasant surprise to use an empty one by mistake and find all the tape from a 7" regular hub reel just won't go on it.

Tape Magazine

To the Editor:

I have been a subscriber to TAPE RECORDING Magazine over five years and look forward eagerly each month to read about the latest in this fascinating tape recording field.

Concerning new uses of tape recording I would like to mention something of interest which, I believe, has not as yet come to your attention.

For about two years, in the United Kingdom and the past year in the United States and Canada there has been in circulation a recorded tape magazine named "Folk Voice" devoted to folk-country music and containing program material submitted by subscribers and recording artists.

"Folk Voice" is published every two months and is available at the low cost of \$1.00 for six bi-monthly issues. The recording is on a five inch reel at 3¾ speed and permits a full hour of enjoyable listening.

The editors and their associates, who are also members of various tape clubs pro-

duce "Folk Voice" as a hobby and it is not a commercial endeavor in any way.

Perhaps you can bring "Folk Voice" to the attention of your readers. Anyone wishing to learn more about "Folk Voice" can have full information on request.—*Herbert C. Wolf, U. S. Representative, Folk Voice, 2427 Seymour Avenue, Bronx 69, New York.*

HOW TO GET THE MOST OUT OF TAPE RECORDING

by Lee Sheridan

This book is aimed at the new recordist, who has yet to discover the hundred and one unusual, interesting and profitable uses to which a tape recorder can be put . . . with patience, a little imagination, and a few accessories.

6" x 9", 128 pp., paper bound, illustrated
ONLY \$1.25

Order from: Book Dept.,
Mooney-Rowan Pub., Inc.
Severna Park, Md.

"No Echo"

Why Burgess Magnetic Recording Tape is 8 ways better:

Lower print-through — Revolutionary Burgess dispersion processes greatly reduce possibility of magnetic transfer from layer to layer. "NO ECHO" with Burgess tape — after months of storage.

Greater tensile strength — new Burgess processes and formulas make Burgess tape "tough" tape. Tensile strength is important wherever tape is given rough handling, as in schools and colleges.

Higher frequency response, greater sensitivity — Burgess uses only acicular oxide particles (and disperses them evenly) to achieve finer sensitivity and top frequency response. Burgess wide bias latitude produces professional results on all types of recorders.

Lower noise level — New dispersion techniques eliminates "clumps" of oxide on Burgess tape. You get a lower noise level and eliminate "hissing" or "popping".

Freedom from flake-off — New Burgess precoat formula eliminates flake-off, cuts the amount of head-cleaning necessary, and gives constant true-tone qualities.

Consistent satisfaction — Burgess' new processes, monitored by rigid quality control, assure the user that Burgess tape is uniform from reel to reel. You get the same high reproduction quality today, tomorrow or next month.

Superior built-in lubricant — Enables tape to glide smoothly, without friction or squeaking over recorder head and guides. Prolongs the life of tape recorder heads.

Erases clean — Burgess tape erases clean and evenly on home recorders. No bulk eraser needed!

No other line of Magnetic Tapes offers you such
VERSATILITY, ADAPTABILITY
to your needs, or gives you all the advantages cited above

BURGESS BATTERY COMPANY

DIVISION OF SERVEL INC.

MAGNETIC TAPE DIVISION

FREEMONT ILLINOIS NIAGARA FALLS, CANADA



NEW PRODUCTS

PORTABLE LEARNING LAB



Bell & Howell Company, 7100 McCormick Road, Chicago 45, Illinois, is marketing the Model 777 Specialist tape recorder which can convert a classroom into an electronic learning lab. Up to 30 of these two-channel recorders can be interconnected, permitting users to "Talk To," "Play To," "Listen To," or "Record" to or from any or all of the other connected machines. Features a stereophonic half-track record/playback head and a dual half-track erase head. A 5 watt amplifier and a 2 tube preamplifier with overall frequency response of plus or minus 6 db from 100 to 10,000 cps at 7½ ips provide power sufficient for a 30 machine system. 5¼" speaker is baffled and permanently mounted on the side of the case. Has speeds of 3¾ and 7½ ips. Has pause control; tape controls include 5 pushbuttons, fast drop in loading, and a resettable program indicator for quick location of a selection. High-impedance microphone input permits recording with microphone. Hand microphone is supplied. Two earphone outputs make machine usable by either a teacher or a student or by both simultaneously. Write to manufacturer for additional information.

AUTOMOBILE TAPE RECORDER HANGER



The wide use of Citroen Electronics portable tape recorders by business and professional men while they are driving has led to the development of a convenient car bracket for the company's portable tape recorders. Hanger fits both the Models 550 and 660 which operate off batteries or, with an adaptor, off the

cigarette lighter of the car. Designed so that it fits snugly on the car window without scraping or marring the car finish or interior, the bracket is made of stippled black metal. It can be used on any make or model car and won't rattle when the car is in motion. Bracket can also be used to hang tape recorder in the office or at home. The cost is \$3.50—write to Citroen Electronics Corp., 729 N. Highland Avenue, Los Angeles 38, Calif., for information.

NEW AMERICAN MIKE



The American Microphone Mfg. Co., 400 South Wyman Street, Rockford, Illinois, is marketing an all purpose dynamic unidirectional microphone designed for extended frequency response of 70 to 15,000 cps. This microphone, Model D55, will favor sound arriving on its axis originating in front, and will reject sound arriving from the rear. Impedance may be easily changed from a low of 50 ohms to medium of 150 ohms to a high of 40,000 ohms by changing wire. It weighs only 11 ounces, and comes equipped with an 18 foot, two-conductor shielded cable. The instrument is available in Satin Black anodized or Roman Gold finish lathe machined aluminum case and with an optional "On/Off" switch. For further information, write directly to the American Microphone Mfg. Co.

AUDIO ROBOT



Royce Electronic Development, Inc., P. O. Box 321, Valley Stream, N. Y., is producing the Audio Robot which controls the on/off switch of any monophonic or stereo hi fi component or console music

system from an extension or remote speaker. The basic system consists of the Robot Control which is installed at the main hi fi system, and a Remote Control unit which is installed in a room where an extension speaker is located. As many as five units may be used with one Robot Control, permitting independent control of the hi fi's electric power from six different locations. These devices can be installed by anyone in minutes with the aid of a screw driver. Complete information and specs may be obtained by writing to Dept. P, above address.

ROBERTS 192



Roberts Electronics, Inc., 5920 Bowcroft Street, Los Angeles 16, Calif. has available their Model 192, full or half track recorder with hi/lo impedance input switching and 8/600 ohm balanced control. According to the manufacturer, it has a precision balanced hysteresis-synchronous motor to speed stabilized flywheel/capstan tape drive and assure absolutely true reproduction of voice pitch and sound. Wow and flutter are less than 0.18% RMS. Has interlocking controls and a pause lever. Operates in horizontal or vertical position; accommodates up to 2400 feet of tape; has speeds of 7½ or 3¾ ips. The cost is \$349.50. Write to manufacturer for more information.

FM MULTIPLEX ADAPTER

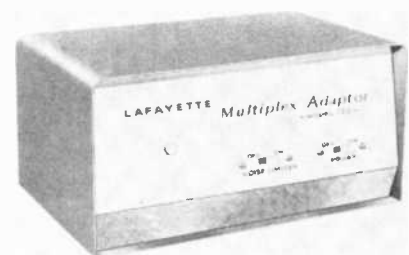

Lafayette Radio Electronics Corp., 111 Jericho Turnpike, Syosset, L.I., N.Y. is marketing an FM Multiplex adapter kit, KT-220, for \$19.50. Designed to operate with any quality wide-band FM or FM/AM tuner supplied with or without multiplex jacks, it is easy to build and connect to an existing tuner. Coils are prealigned, only minimum adjustments are necessary. It is self-powered and may be remotely connected to a tuner. Separation is 30 db at 400 cps; distortion is below 1%. Noise limiter slide switch, on-off power slide switch with pilot light, separation control. Front panel is finished in beige and ivory trim with contrasting beige and brown cabinet.

TAPE IN EDUCATION

From an address by Dr. Wm. J. Smither, Director of the Language Laboratory, Tulane University, given to MRIA.

DURING the past four years the number of language laboratories in the United States has increased from fewer than 400 to more than 4,000, the Educational Facilities Laboratories has said in describing the "leaping growth" of the language labs.

If these more than 4,000 labs average 30 positions each, and each position serves 25 students (as do ours at Tulane), it can be estimated that some 3,000,000 students were learning languages with the aid of magnetic tape during this past spring semester.

These figures are certain signs of a revolution.

But this revolution is more than figures. It is more than the magnetic tape, without which the revolution probably would have failed.

It is a concept.

To those of us brought up in the once-cloistered calm who had attained the ivory tower of the language teaching profession, the change has been shattering. Friendships were broken as many professors adopted extreme avant garde positions. Others fell victim to secret fears of inadequacy as lifetimes of sincere dedication were called into question and brusquely superseded by new concepts of teacher-student relationships.

The man who leaned on the tape was called at best a traitor to the humanities, one who would replace an intellectual pursuit with mere mechanics of communication. In reply we have argued that our objectives are not to replace but to add to language a measure of technical skill that will make the intellectual pursuit even more meaningful.

Although the battle is by no means over, the outcome is no longer in doubt.

It began during World War II when the emergency need for foreign language skills on a large scale produced the hasty shotgun marriage of descriptive linguistics to foreign language teaching.

The anthropologists for decades had been calmly analyzing and learning outlandish languages with an admirably rational, scientific method that had little in common with traditional Greek and Latin grammatical concepts and absolutely no room for individual prejudices on the subject. Language for them was a physical sound phenomenon, a system of meaningful contrasts in sound. This wartime union began to come apart at the seams when economic stress set in after the war. The colleges, not the Armed Forces, had to foot the bill.

Applied descriptive linguistics required native voices, "informants," who were human beings needing food, salaries. Every class needed two teachers, and the conventional three hours per week were far from enough. You needed more like three or four times that, so that the cost was not merely doubled, it was multiplied by six or more. The old 78 rpm disks were tried but were no adequate substitute for the informant. Their frequency response was poor, and editing and cuing were cumbersome.

The postwar magnetic tape recorder offered a solution to some of the money problems and made available an unlimited range of native-voice "informants." Through the early fifties we made solid theoretical headway but material progress was slow. In 1951 Tulane set up 12 positions and two tape recorders. In 1957 we installed 60 positions. We now have 80, served by about 100 recorders and have plans for more.

How do we teach with the things? We don't know the best answers yet; we're learning all the time. Sputnik put the Federal Government back into the picture with the NDEA, which made possible research into many aspects of the problem of second language teaching in the United States that the colleges alone could not afford to conduct. Tulane in 1960 began a three-year project under a contract with the U.S. Office of Education to experiment in French and Spanish with a "re-structuring" of the foreign language curriculum in college.

We have several objectives. As an overall aim we are trying to turn out four-year majors who will meet rigid, newly-established national norms of professional qualifications for foreign language teachers.

At the same time—one of our limited aims—we are testing the comparative efficacy of wholly monitored and partially monitored laboratory work in the elementary year. As a midway objective we are trying to turn out students at the end of the second college year who can compete with native students at the University of Paris and the University of Madrid on reasonably equal terms.

This year students who began in our project in September, 1960, will soon begin to prove part of our success or failure. By the end of the second year, then, whether they go to Europe or not, the students must have a near-native grasp of the four skills: hearing, speaking, reading, and writing.

Along with this they must have, too, a degree of cultural acclimatization.

Our first year objective tells more about how we are trying to use your machines: total or partial monitoring—must the tape be controlled constantly by the teacher, or can machine and student get along most of the time?

To try to get the answers, we have every year, in both French and Spanish, parallel experimental sections. One meets with tape and teacher in a lab 9 hours per week; the other meets 4 hours in monitored lab session and spends another 5 hours on the tapes without the teacher. All other factors are identical.

Through testing in 3 skills the 9 and 4 contact-hour sections are compared statistically with each other, and with all other French or Spanish classes at Tulane and Newcomb.

(To be continued next month)

Make TAPE RECORDING A Reading Habit

Stop having to borrow a neighbor's copy, or going by a local shop or newsstand to pick up a copy of Tape Recording Magazine. You can have 12 issues a year conveniently delivered to your door, by simply filling out the coupon below and returning it to us.

Every issue contains informative, interesting articles written just for tape recording enthusiasts, in addition to regular features, including:

- Tape Reviews
- Crosstalk
- New Products
- Tape in Education
- Industry News
- Tapespondents Wanted
- Shop or Swap
- Tape Club News

When you invest in Tape Recording, you do so without any risk, since we have always maintained a "money-back guarantee" policy should you not be satisfied with your investment.

2 Years \$7.00
1 Year \$3.75

Fill out the coupon today. If your checkbook isn't handy, we'll be glad to bill you later.

TAPE RECORDING Severna Park, Md.

Please enter or renew my subscription as indicated below:

- 2 years \$7.00
 1 year \$3.75
 Payment enclosed. Bill me later.

Name

Address

CityZoneState

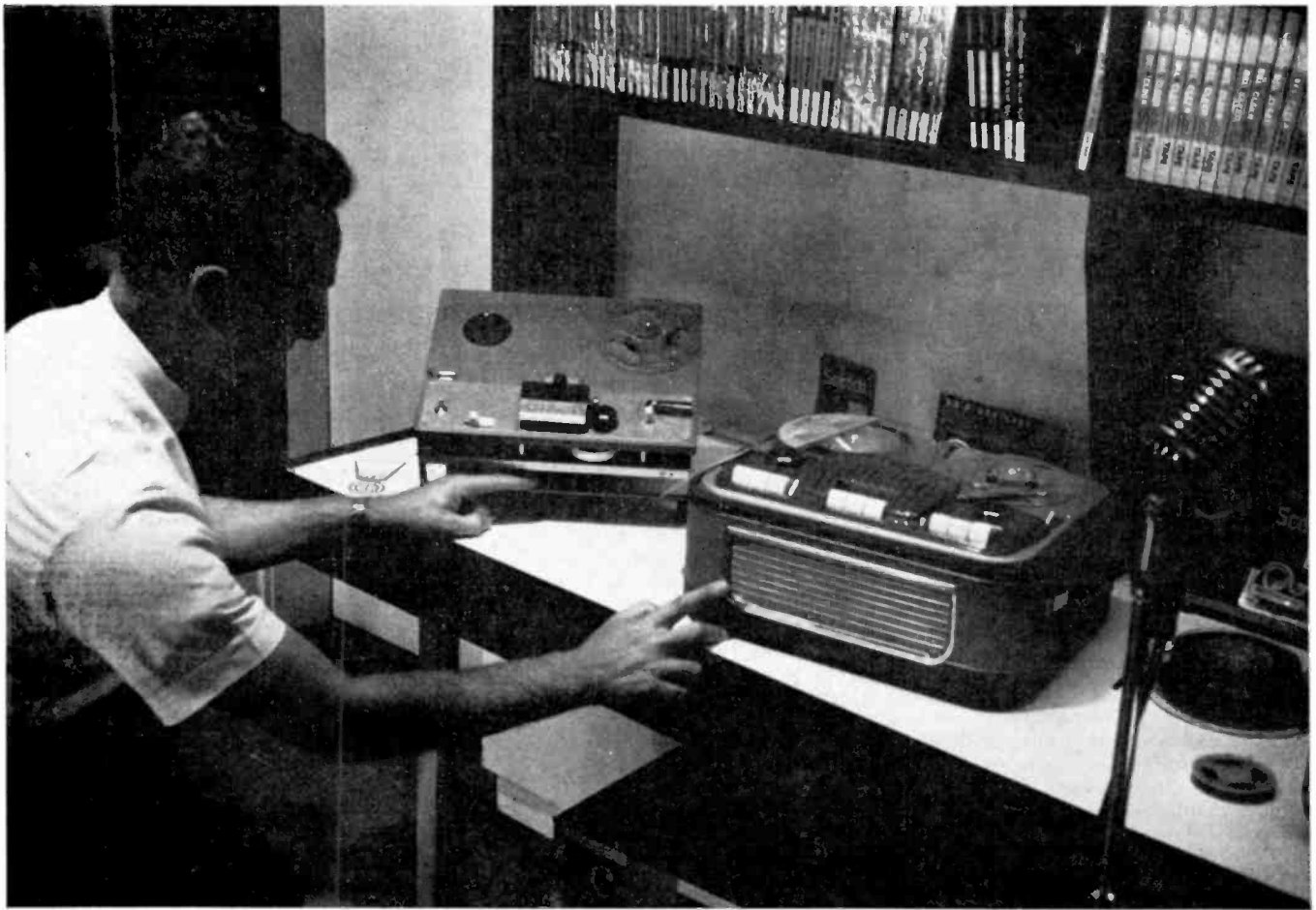

Scott Bernstein of Bay-Bloor Radio in Toronto demonstrates to a customer the difference between a deck and a full recorder. The Sony deck on the left contains no electronics whatever, the Phillips '400' containing all facilities within the one case.

Let Your Recorder Go Hi-Fi

by John W. Berridge

... connect your recorder into component circuitry.

PLAYING back thru high-quality speakers can add much to the fun of recording from TV or radio. Here's how a recorder can be connected into Hi-Fi circuitry.

A recorder by itself can be a whale of a lot of fun (as well as being a possible source of income) but sooner or later most of us want to hear what our recordings sound like "on a good system." Let's face it, the internal speakers in machines aren't the best and anyway they're only really intended as a compromise. Then there's that rare record a friend has brought over, or maybe a recording of the first telecast from TELSTAR, or a favorite piece over the QXR network, all of which you'd like to keep. How do you go about coupling up the recorder?

FOR PLAYBACK ONLY

Let's start with the tail end first and add record facilities later. And before I go into any sort of comment about connections, let me point out that there are two ways of ap-

proaching the question of adding tape to high-quality reproducing equipment (or vice-versa if you happen to have bought the recorder first). You can connect your present portable recorder into your other gear and all you'll need will be a couple of extra connecting cables. The one disadvantage with this arrangement is that it looks downright untidy and very temporary (unless you're a whiz at building things into furniture). However, you can hike it out and take it with you elsewhere.

The other alternative is to integrate a deck into the rest of the equipment. This again requires some wood butchery but surprisingly little (if you can cut a large rectangular hole, you're in—if you can't then you've almost certainly got a friend or neighbor who can and will). Since the manufacturers of decks give more than adequate instructions I won't go into details here. The drawback to a deck is that once you have it installed you're limited to using it in your own home. Balanced against this is the practical certainty

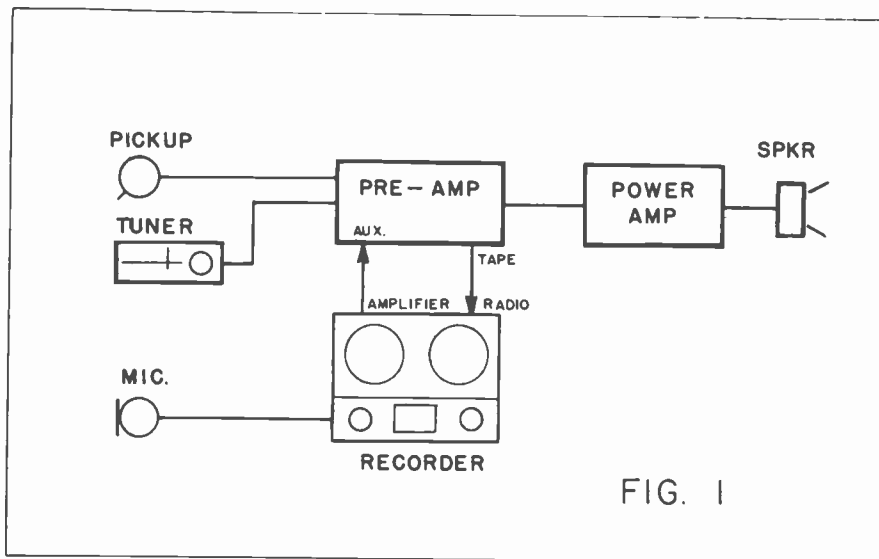

Block schematic of the connections involved in adding a "portable" recorder into a Hi-Fi set-up.

FIG. 1

that you'll pay a lot less for a deck and electronics than you would for a complete recorder, mainly because you'd be omitting the monitor amplifier, speaker and carrying case (which you wouldn't need anyway). Whichever tape system you use is up to you and I'll proceed along parallel lines of thought from here. By the way, when I talk about a "portable" recorder I mean any machine you can pick up and carry, whether it weighs five or fifty pounds, A.C. or battery powered.

There are three ways to connect a tape recorder into other equipment for playback. The first is at low level by connecting the playback head directly into the TAPE HEAD input of a hi-fi preamp. Now with a portable you can't do this since there's no direct connection on the back of the chassis and unless you want to add one (which isn't worth it I can assure you) forget this method. With a deck it works excellently since you need buy only the deck itself which comes equipped with at least a playback head. This is the best arrangement if you have a preamp with a tape head input (which includes most but not all of the more recent models).

The second way is to connect the output of the playback electronics to one of possibly two or three high-level inputs on the preamp. These latter generally have one marked simply TAPE among them but if there isn't you

could use one marked AUX (AUX 1 if there's more than one) or TUNER or even TV if these aren't already used for their labelled purposes. They're all basically the same. The appropriate output on a portable is usually marked AMPLIFIER and it's only necessary to interconnect the two with a suitable cable. With a deck, it becomes necessary to buy a record/playback amplifier and connect its PLAYBACK output (or just plain OUTPUT) to the preamp, a somewhat wasteful procedure if you've already got a tape head input.

The third way is to connect the SPKR. output of the recorder direct to a high-quality speaker and enclosure. This may be fine with a portable if you only want to play tapes, but the quality of the power stages on most recorders is not particularly good (even on expensive machinery it's largely intended for monitor purposes) and if you already have a good power amplifier (i) it would be the better sounding of the two and (ii) why waste time re-connecting the speaker every time you changed over from tape to disc? With a deck this won't work anyway since the electronics don't come equipped with a power stage with which to drive a speaker.

So, to add a portable into the listening set-up, connect the AMPLIFIER output into any one of the high-level inputs of the hi-fi preamp. To add a deck, connect the playback head direct to the TAPE HEAD input of the preamp,

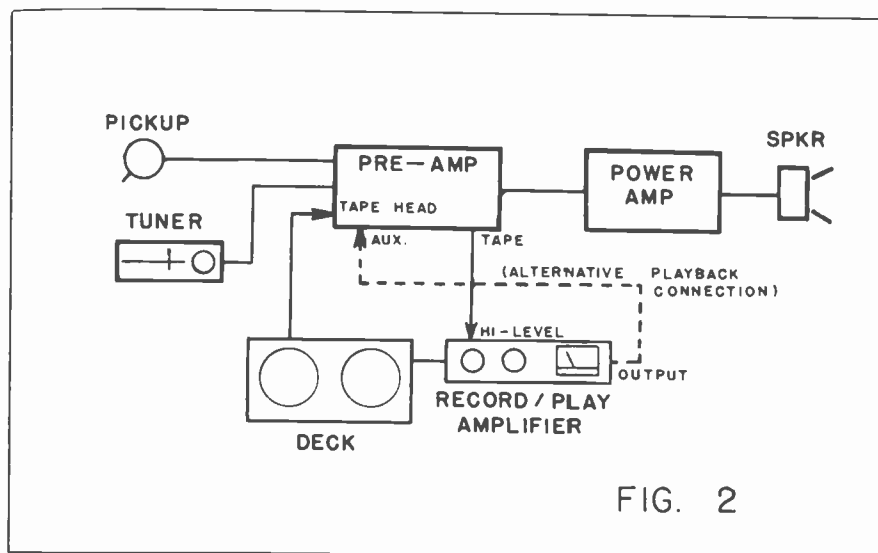

Schematic of the connections required to add a simple tape deck into the set-up. If playback only is proposed then eliminate the record/playback amplifier together with any connections to it. Power connections are not shown here or in Fig. 1.

FIG. 2

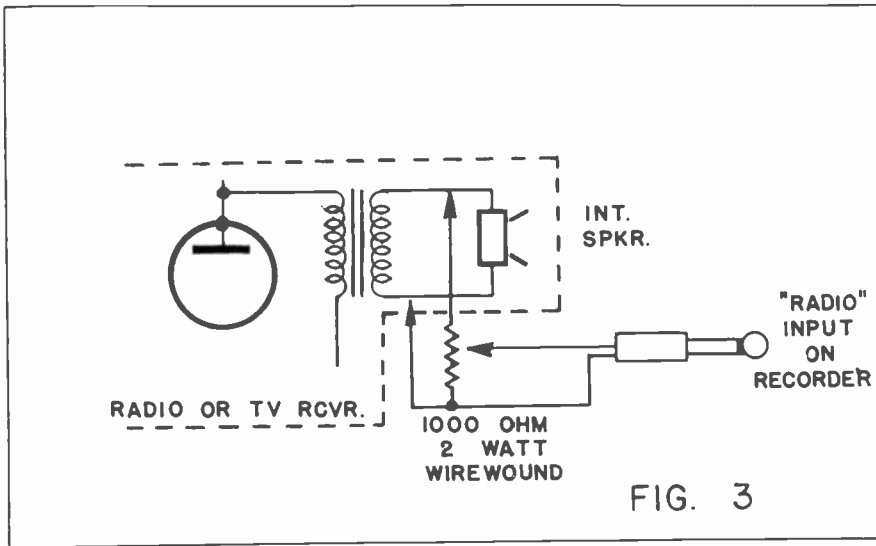

FIG. 3

Adding the 1000 ohm pot'r is desirable if you want to connect directly to the speaker of a radio or TV receiver. This isn't very good since the internal speaker acts as a microphone picking up room noise.

or, failing that, include a record/playback amplifier with your purchase and connect its output to any one of the preamps high-level inputs. It's that simple.

ADDING RECORD FACILITIES

It isn't very long before you find out that mere playback of tapes just plain isn't enough. Pre-recorded tapes are still pretty expensive, and whatever anyone may say they're still not as convenient to use as the corresponding discs. Furthermore, unless you have a regular source of recordings, these are about the only tapes you're likely to hear. It won't take much to convince you of the advantages of having full record facilities as well. I've made mention a couple of times already of adding a RECORD/playback amplifier to a deck, not to belittle in any way the excellent playback-only amps turned out by Viking, Nortronics and others. It's simply that for little more you can have the whole works, and in a wider range of choice too. Viking probably has a greater variety of decks, heads and assorted electronics than anyone, Knight's record/playback unit has separated record and play facilities for maximum versatility, and Eico's deck and electronics are fully transistorized with a performance many reviewers claim equals that of broadcast gear twice as costly. You have lots to choose from, you see.

Connecting up the record facilities is even easier than patching up the playback ditto. There are exactly two types of input to a recorder (be it portable or deck), low-level and high. The low-level input is for the microphone, period, the high (usually labelled RADIO) for phono preamp output, tuner, radio or TV receiver. You can select between mike and radio inputs with a selector switch on most recorders, and there's an increasing tendency to incorporate mixing facilities between the two. Connecting the mike is no problem, it's covered in the instruction book (if it isn't already self-evident), the RADIO input is what I'll cover here.

Now there's one method of connection that most manufacturers condone by implication. It takes the form of an accessory cable with a plug to fit the radio input on one end and a pair of alligator clips on the other, and please note that the following is my own personal opinion and not necessarily that of this magazine's editorial staff. What you're supposed to do is to clip the leads to the terminals of the speaker in a radio, TV set or whatever. As this cable comes it doesn't work very well for three reasons. First, even with the speaker still in circuit as a load, the signal level at this point is much too high for the recorder to handle successfully. Second, the speaker doubles as a fairly strong and poor quality microphone, picking up the room noise

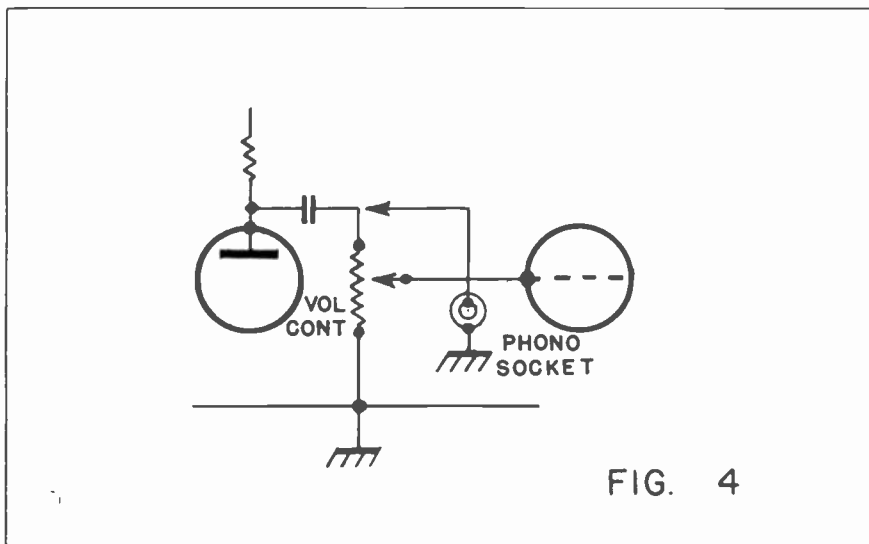
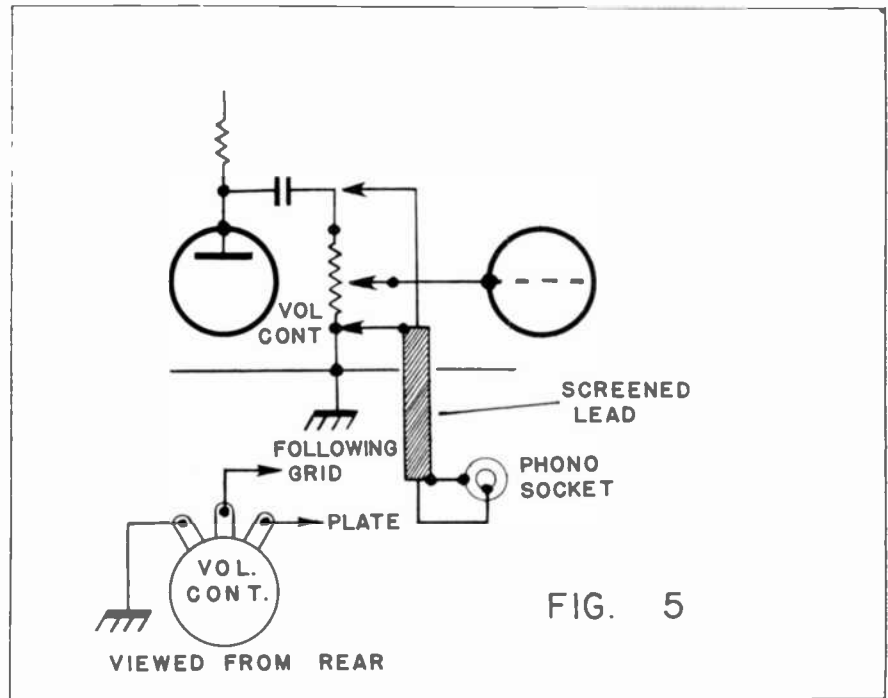

FIG. 4

Adding an extra HIGH LEVEL output to the phono preamp is no harder than drilling one hole for the phono socket and soldering one length of wire.

Tacking a HIGH LEVEL output onto the insulated back of a radio or TV set means using a length of screened lead rather than plain wire. The volume control is also shown as it appears from the back of the front panel and connections can be worked out by the reader accordingly.



(including the signal), distorting it and then feeding this onto your recording. Third, it's a darned nuisance to haul the back off something, screw it back, and then do it all over again just to retrieve the cable. To me the end result is twice as bad as just holding the mike in front of the speaker. The latter isn't the best, granted, but at least the undistorted room sound can be tolerated as part of the atmosphere of the recording. If you MUST connect across the speaker, Fig. 3 will show how it can be done but don't expect good quality from this arrangement.

A portable will have this high-level input labelled RADIO, and deck electronics call it Hi-LEVEL (or something similar). Essentially they're the same thing, both requiring a high-impedance signal of around one-half volt to give good recording. That statement's a generalization of course, but our only problem is to obtain the right kind of output. The problem is basically simpler with a deck since you're almost certain to be using said deck with high fidel-

ity gear, and nearly all phono preamps have a separate output to match a tape recorder input. It's just a question of connecting the two together. The arrangement is the same with a portable in this respect, with the added consideration that you'll have to thread the cable thru the furniture somewhere so that you can just lay the tape machine on top of the cabinet and connect it up without too much bother. That second output may be labelled TAPE, OUTPUT TO RECORDER, TAPE INPUT or one or two other designations. Whatever it's called, all it is essentially is a second output in parallel with the main output to the power amplifier. If, of course, you have your preamp and power section integrated on one chassis, it'll be the only output as such (the speaker output takes the form of a terminal strip not a phono socket).

Stereo. Everything I've outlined here applies equally to stereo with just a couple of extra things to remember. The second channel is merely a duplicate of the first, they're



On this H. H. Scott integrated preamp/amplifier the PLAYBACK sockets (marked "A" and "B" for the two stereo channels) accept the outputs of tape heads direct and the TAPE RECORDER sockets feed a high level signal to the two respective RADIO inputs, or the HI-LEVEL inputs of a tape deck amplifier. AMPLIFIER outputs of a complete recorder could be fed either into the EXTRA or TUNER inputs on this particular piece of equipment.

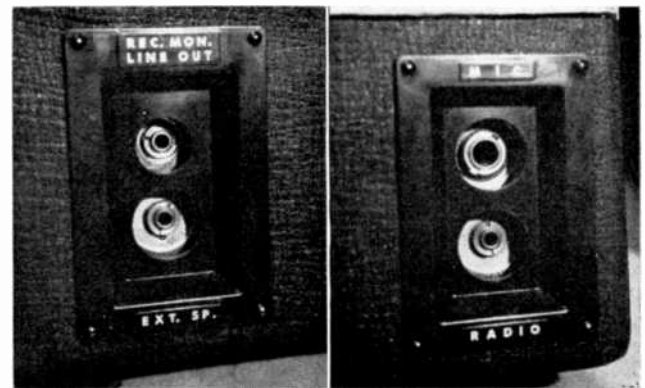

Left: The EXT. SP. socket is intended to drive an external speaker directly without any other amplification. The REC. MON. LINE OUT socket would thus be used to feed a signal into the AUX. input of a phono preamp for playback of tapes. Right: The MIC. socket is a standard phone jack on this recorder whereas the RADIO socket is a miniature type. This eliminates possible errors and the RADIO input is used to take a signal from a phono preamp for recording purposes.



The Sony 521 has an AUX. INPUT to take a high level signal from a phono preamp for recording purposes and the LINE OUT sockets would feed an AUX. input on the same preamp for playback purposes. An added feature of this machine is a pair of MONITOR sockets so that the owner can use stereo headphones or external speakers for monitoring during an outside recording session.

identical in all respects except that one is labelled LEFT, the other RIGHT. Don't get your left and right connections mixed up, and if you make up your own cables, be certain that they're soldered the same way, otherwise you'll end up with the two channels out-of-phase (something that's hard to spot but irritating to listen to).

Suppose you HAVEN'T got a tape output on your preamp? Well you can always use the main output while you record and do without the main speaker system, but this deprives you of the monitor facilities offered by same. The best thing to do is to add an appropriate high-level output, a simple task as shown by Fig. 4. All you need is a panel-mounting phono socket and a length of hook-up wire. Drill a hole in the back of the chassis (carefully, please!!) close to the main output and bolt the phono socket in place. Then connect the central terminal of the socket to the CLOCKWISE tag of the three on the volume controls as you look at it from behind. That's all there is to it and this means that you can control your recording and listening levels entirely separately of each other. A suitable phono socket would be the Switchcraft 3501 FR, which has the securing nut on the outside of the chassis for easier tightening. For stereo, of course, you'd need two sockets, one for each channel, but I doubt whether you'll find a stereo preamp without tape outputs already fitted. All that's then necessary is to cable up this socket (s) with the RADIO or HI-LEVEL input (s) of the recorder or deck.

This completes the connections necessary to add record and tape playback facilities to a Hi-Fi system, but there are a couple of other points worth mentioning. The first

is that addition of the high-level output described in the last paragraph can also be applied to a TV set or all-wave receiver to enable it to be fed either into one of the auxiliary inputs of the phono preamp or directly into the recorder itself. Here there may be an added complication. As previously described, the ground return for the high-level signal is thru the chassis itself, but on a radio or TV set you may have to mount the phono socket on the fibreboard back for want of a better place. In this case, instead of using the hook-up wire, use a length of shielded wire. Unravel the shielding for about 1½" at both ends, twist it into a pigtail and tin it to make a lead for soldering. The center conductor joins the center terminal of the socket with the clockwise tag of the volume control as before. The shielding joins the outside terminal of the socket to the ANTI-clockwise tag of the volume control (see Fig. 5). And for Heaven's sake, don't grope around inside a TV set while it's turned on!!! Unplug it to be on the safe side.

Finally a brief comment about connecting cables. You won't save time, money or anything else by making them up yourself, not these days. Buy the ready-made ones, it's so much simpler all round. Switchcraft has a real treasure trove of cables, connectors and who knows what else. If you write for their Catalog A-401 (they advertise in these pages), you'll get it with every single goodie fully illustrated, and there are other outfits getting into this market too. See what your local dealer has to offer.

A single evening's effort will double the fun and pleasure you get from tape recording. Why don't you try going HI-FI?

COMING — TENTH ANNIVERSARY ISSUE

We will be celebrating the start of our tenth year of publishing with our December issue. This edition will feature a history of tape recording for the last ten years, as well as a peek into what the next ten years will bring.

Getting the Most From Your Magnetic Sound Projector

by Robert L. Van Der Velde

... well prepared and synchronized sound and film professionalizes home movies.

REALIZING that nothing can render that professional touch to their home movies like the addition of a sound track, amateur photographers for years have been contriving complicated Rube Goldberg contraptions to synchronize their tape recorders with their motion picture projectors. Aware of this, manufacturers of photographic equipment began to develop a simple, yet effective means of putting sound on film which would be within the average advanced amateur's budget. The result, introduced a few years ago, was the magnetic sound projector.

While several excellent projectors of this type are now on the market, little material has been published on their use. Since their inception my wife and I have used magnetic projectors to add sound to our films, both commercially and for our own amusement. But many were the times we felt like chucking the whole apparatus through the living room picture window. Problem after problem arose—and the solutions were never in the instruction booklets. So new was the process that we had no criterion for diagnosing our difficulties.

Through painful trial and error, not to mention countless letters to various manufacturers' research departments, we finally evolved a fool-proof method for recording sound tracks of acceptable if not theatrical quality.

In theory, a magnetic sound projector is a combination motion picture projector and tape recorder, all housed in one nifty little package. A magnetic striping, very similar to the tape used in home recording equipment, is laminated onto one edge of the developed film. As with a tape recorder, the projector can be stopped or started instantly. It can be run either in forward or reverse motion, and the striping can be erased and used over again as often as desired. The entire record-playback and erase head assembly, which is no bigger than a fingertip, can usually be swung out of the way or removed to convert the projector into the more customary optical sound type.

The projector we are now using has two input jacks, which means we can simultaneously patch in two channels—one for narration and another for musical background or sound effects. An earphone can be patched into the rear of the machine to monitor both inputs while mixing.

Despite advertisements to the contrary, you cannot produce acceptable sound tracks by sitting down next to your



The author uses a Bell & Howell 302 magnetic projector to rerecord from a Revere tape recorder. The tape is kept in synchronization with the instant start-stop button. Note earphone for monitoring.

projector and narrating a film as you screen it. Your sound track will pick up an annoying amount of projector roar. In order to eliminate this disturbing background noise the projector must be completely isolated from the microphone.

This is a situation similar to one which plagued Hollywood during the early days of talkies. While modern studio cameras are now "blimped" against sound, those early cameras were often so noisy that they all but drowned out the actors' voices, especially during the shooting of close-ups. The disturbance was eliminated by encasing both camera and operator in a soundproof box resembling a phone booth on wheels.

Borrowing an old but still effective trick from Hollywood, you can isolate your magnetic projector by building a soundproof box for it or, even easier, simply by placing it in another room and projecting through a doorway into the room where the microphone and narrator are located.

Unfortunately, this means you will need a fantastically long microphone cable, equally long patch cords from your phonograph or tape recorder supplying background music, and a veritable staff to handle all the equipment spread throughout two rooms.

The worst drawback to this system, however, is the fact that you are recording both the narrator and music at the same time. If the narrator makes one small mistake near the end of a musical number, you will have to go all the way back to the beginning of the number and start over again. Otherwise a noticeable break in the music will occur.

It is obvious that the narration and background music must be recorded separately, then mixed onto the finished sound track later in order to obtain quality results.

Consequently, we are right back to the original problem

of synchronizing tape recorder with motion picture projector. One may wonder then what advantage there is to using a magnetic projector at all. The advantage is that once the recording has been dubbed onto the film in synchronization it will never get out of sync. Furthermore, the operator will not be burdened with tape recorder or complicated special equipment every time he wishes to show his film.

The system we use to sync our sound tracks with our films is simplicity itself. We first view our film while recording an ad-libbed, rough narration on our tape recorder. This recording is full of annoying projector roar, but that is unimportant. Its sole purpose is to serve as a guide for timing the typewritten script.

The script is typed from the taped notes much as a stenographer works from a dictating machine. It is polished off into good grammar as it is typed. Then the script is again checked for time against the projected film and any necessary changes made.

The secret to this timing is to have less script than film. That is, there should be plenty of dead spots in the narration where the picture alone is telling the story. Actually, this is only good motion picture technique, for the script should merely supplement the picture—not explain obvious action.

We usually mark these pauses on the script with a red line. The announcer then knows when to pause during the reading, for he does not view the film while recording is in process. An announcer from a local radio station has narrated most of our films to date. It took him a little while to catch on to our system, but he now knows that every time he sees a red line in the script he must pause for exactly two seconds before continuing. We have found, incidentally, that it is a good idea to show him the film first so that he is fairly familiar with the subject material.

The recording is made in any quiet room without the projector running. The two-second pauses at intervals on the tape are not necessarily the same length of time on the screen. Some of them are as long as a minute. When the narration on tape is rerecorded onto the magnetic sound stripe on the film, the tape recorder is merely stopped until the picture again catches up to the tape. We have found the Revere T-1100 tape recorder excellent for this sort of work, since it has an instant stop-start button. This recorder does not make an annoying click when turned on or off with this button. Many recorders do make this clicking sound and are unsuitable for rerecording by this method.

Using the same method, we turned out, purely as an experiment, a picture in lip sync sound. First the actor (there was only one) ran through his lines. We recorded the sound on our tape recorder without the camera running. The tape was then played back. The actor mouthed his lines while we filmed his actions. The camera was speeded up slightly, which meant that when projected the action would be just a bit too slow for the recording. As the sound was dubbed onto the magnetic film track the tape recorder was stopped briefly at the end of sentences or whenever there was a pause between words until the picture caught up to the sound. With a bit of practice remarkably good results can be obtained in this manner.

Another manner of producing lip sync films with your magnetic projector uses a method often employed by major studios. With your projector running silently (either in a sound-proof box with a window or beamed through a doorway from another room), have your actors speak their lines

into the microphone as they watch their previously filmed actions on the screen. Almost every feature picture employs this post recording technique somewhere in the film. Distant scenes, or long-shots, which include dialogue are seldom recorded when filmed, usually because the microphone would have to be placed too far away from the actors to be kept out of the picture.

Most musical numbers are prerecorded on tape in a studio under ideal conditions. The tape is later played back so that the singer can mouth his words during actual filming. Better sound quality is obtained that way.

Don't be surprised if your actors have some trouble synchronizing their voices to their pictures during post recording. It is a knack calling for considerable practice and talent. Most professional sound technicians usually post record only two or three sentences at a time. An endless loop of film is run again and again through a projector while the actor practices. When a successful recording is made another loop is formed for the next few sentences and the process repeated. It is an involved and difficult technique and, because so little can be recorded at a time, often results in rather stilted dialogue. Consequently, it is used only when absolutely necessary.

A knowledge of professional motion picture recording practices, while not a necessity, is certainly an aid to any amateur who takes his movie work seriously. For that reason, a word or two about "how Hollywood does it" might be worthwhile.

Almost all Hollywood motion pictures today are filmed by a technique known as the double system of filming. This means that the picture is shot on a silent camera while a tape recorder nearby is running separately. Sound cameras, that is, cameras which reproduce both sound and picture right on the film, are used only for newsreel or television work where time is of the essence. The camera is yet to be invented that can reproduce both sound and picture with equal fidelity.

The cameras used in Hollywood today are basically not too different from the more expensive models of home movie outfits. They are different in that they are driven by synchronous motors instead of spring winds, use film of larger widths, are encased in soundproof blimps, have more gadgets on them and cost about the same as a medium priced home in a good neighborhood.

Hollywood's tape recorders are also similar to home equipment. But they, like the cameras, are powered by synchronous motors which drive them at a constant speed. And these motors make lip sync motion pictures possible.

If both camera and tape recorder are driven at an exact and constant speed during filming and recording, and the results are projected and played back at the same speed, they obviously must be in synchronization. Yes, synchronous motors are available for some of the more expensive 16 mm home movie cameras such as the Bolex and Eastman Kodak Cine Special. These motors cost about \$500. However, none are available for your home tape recorder.

If such motors were available they would be worthless, for in time tape stretches and soon reaches the point where it takes considerably longer to play back than it did when first recorded. The only solution to this is to use sprocketed tape as do the major Hollywood studios. And then you are getting into astronomically priced professional motion picture equipment.

The primary reason that you cannot produce synchronous

sound movies with home equipment, however, is because—even if your tape does not stretch—you can never film or project your footage or record and play back your tape at the same speed. The spring wind on your camera is neither accurate nor constant, and the electrical current powering your tape recorder and projector flows through the instruments with uneven pulses, continually changing the speed of both.

That is why, when rerecording from tape onto magnetically striped film, you must have more film per second than sound. You can stop the tape until the pulses of electrical current that are erratically powering the projector are no longer of importance.

You can use a similar method for dubbing in sound effects with your magnetic projector. On tape, record all the effects you are going to need for your entire film. Space them about a second apart. During rerecording stop your tape recorder immediately after each sound and do not start it again until about one second before the next. You can have several tape recorders patched into your projector at the same time. Since there is no magnetic projector on the market with more than two input jacks, you will need a multi-channel mixer if you wish to use more than two tape recorders simultaneously. You will seldom use more than three—one for narration, one for sound effects and one for background music.

When using more than one tape recorder at a time you will need some method of monitoring your efforts. If your projector is equipped with a monitoring jack into which an earphone can be inserted, you have no problem. If it is not, you will need a mixer with such a jack and a headphone set. This is an absolute necessity for multi-channel recording. Otherwise, you may find that the music has drowned out the narrator's voice.

Eastman Kodak Company's projector has what is called a "built-in mixer." First the music is recorded on a portion of the magnetic track. Then the narration is recorded on the remaining unused portion of sound striping. The level has been pre-set by the manufacturer so that the music will remain soft and at about half the volume of the voice. The disadvantage, however, is that it is virtually impossible with this system to have the music swell up to full volume during pauses in the narration.

Whether you are contemplating an ambitious production with lip sync sound or simply want to add a narration to those last few reels you shot of the kids, you will probably run into more or less the same difficulties we encountered.

Our first experience with magnetic sound was disheartening. The projector succeeded only in ripping the magnetic striping right off the film. Assuming the film had not been properly magna-striped in the first place, we had it restriped by another laboratory. (The process is amazingly inexpensive—only a little more than two cents a foot.)

The restriping did not help a bit. Again the projector scraped the magnetic track from the film. We wrote to the manufacturer's research department, and were surprised to find that they had been suffering from the same trouble. The method they finally developed to prevent this trouble has never been published, to my knowledge, and I have often wondered how many people have abandoned the use of magnetic sound because they could not solve this problem.

It seems that newly magna-striped motion picture film does not have as smooth a surface as magnetic tape. Millions of tiny points of iron oxide protrude from the sur-

face and can easily be caught on the edges of the projector's magnetic heads, thus stripping the magnetic oxide from the film. For best results, these tiny points must be removed before the striping is permitted to pass over the magnetic heads. This operation is easily performed by running the film through the projector three times with the magnetic heads removed or swung out of the way. A polishing action will take place in the aperture gate of the projector. Therefore, the projector should be stopped periodically during the procedure and any sound stripe material that may have adhered to the back aperture plate at the lamp house should be removed. Never use a metallic object for this, for it is apt to scratch the highly polished surface of the plate. Use a rag, and moisten it with alcohol if necessary to remove stubborn bits.

To be on the safe side, run your film three more times through the projector, but now with the magnetic heads in place. As before, stop the projector from time to time to clean it, but pay particular attention to the heads.

The necessity of this polishing operation cannot be overstressed. It is without a doubt the most singularly important step toward a successful recording. Magnetic projectors do not use pressure pads to hold the striping tightly against the heads; they use a rubber roller, which exerts much more force than the pressure pads found in tape recorders. Consequently, an exceptionally smooth surface on the striping is needed.

Another problem which nearly brought on the screaming meemies was the poor quality of sound which would occur now and then for no apparent reason. We wrote to the manufacturer and were cautioned never to use a feed reel of more than 400-foot capacity when recording. The projector, we were told, cannot build up an even speed quickly when it must pull the heavy weight of large reels.

This diagnosis proved to be correct. We had been running 2,000-foot reels, which were far too heavy to be used during recording. We switched to 400-foot reels, and there was a marked improvement. Even with these reels, however, some build-up time is needed before the projector is running at full speed. The effect is not noticeable on speech but is obvious when certain sounds are recorded immediately after the projector has been started. We ran into particular difficulty with the sound of a cathedral bell which came at the beginning of a sequence. There is really no solution to this problem, however, other than to avoid such sounds until the projector has had time to build up speed. But knowing the limitations of one's equipment is as important as knowing its capabilities.

You can, incidentally, use larger reels during play-back and, if you wish, wind one 400-foot reel after another onto a large take-up reel when recording.

Professional motion picture producers never project their original footage, for a slight scratch on the film can make it worthless. Following the professional's method on any serious filming, we always have duplicate prints made. We have our 16 mm prints made on single perforated stock so that a full width magnetic stripe can be applied. A half-width magnetic striping can be applied to double perforated stock, but the fidelity is not quite as good.

We have found also that a balance striping on the opposite edge of the film is necessary. Without it, film will not stack properly on reels and is apt to slip off the projector's sound drum. All of our footage is shot and projected at 24 frame-per-second sound speed, which is, of

course, a necessity if one wishes to sell it.

As you progress with your magnetically recorded films you will become more discriminating in your choice of sound effects. With most amateurs the tendency at first is to overload their films with sound. In a narrated picture such as a travelogue it is not necessary to have every automobile horn honk, every horse whinney or every door slam. Sound effects should be used only where they are expected by the audience—that is, where the *lack* of a sound would be disturbing—or to install or enhance the atmosphere you are attempting to create on film.

If, for example, in the middle of a sound film a close-up of a steaming boat whistle were to flash on the screen, the sound would certainly be expected to accompany it. On the other hand, a picture of a hansom cab in Central Park would not necessarily be helped by adding every beat of the horse's hoofs on the sound track. However, if your objective were to depict the lonely sadness of the same hansom cab as it disappeared into the distance on a deserted foggy night, then the sound of the hoofs clapping on the pavement and echoing through the streets would enhance the atmosphere of the scene.

Study the motion pictures shown at your local theater or on your television screen. Notice how certain sounds have been added purely for atmospheric effect. As the Western hero riding slowly across the plains, approaches a distant ranch, the far-off sounds of dogs barking and roosters crowing are heard in the background. And how often have you jumped with a start when an elevated train roared overhead just as the private eye was about to burst into the tenement house where the murderer lurked?

These are exaggerated examples which you will probably never use in home movies, but you can use the same principle to create mood with sound. New York Harbor at night may be a beautiful sight with the moon reflecting on the water and perhaps a giant liner gliding past, lights blazing from every porthole. Add a soundtrack of spooky harbor sounds and you have more than beauty; you have beauty plus mystery. A mood has been created with sound.

The addition of these sounds need not be an expensive proposition. If your picture is not going to be used commercially there is no need for you to pay anything at all for sound effects. You can record them from your television set. Be sure to patch directly from your TV set into your tape recorder. Do not attempt recording from TV with a microphone. We have our set permanently patched into our recorder so that the latter can be started instantly to catch any sound that may appear valuable. Within several months you should be able to build an extensive sound effects library containing most of the basic sounds you'll ever need. Others you can buy. The average price for a sound effect record, which is usually recorded at 78 rpm, is two dollars. Florman & Babb, Inc., 68 W. 45th St., New York 36, N. Y., has a wide selection available. They are licensed for public performance without additional permission or royalty payments.

When recording sound effects onto film, be sure to take into consideration the distance at which your subject was filmed. You would naturally increase the volume as a train roared into the lens and decrease it as the train disappeared from view. By the same token, the sound should be louder on close-ups than on long-shots. If you switch from a wide angle shot of the train to a telephoto shot of the driving

wheels you must also increase the volume. Although you have not moved the camera closer you have moved the audience closer through your choice of lenses.

Certain sounds will not give the illusion of distance simply by being recorded or played back at a lower level. A recording of an automobile at a distance does not sound at all the same as a recording of an automobile close up played back at low volume.

In recent years sound as a transition device in motion pictures has come into vogue. Two completely different scenes (usually close-ups) are tied together by a similar sound. The classic example of sound used in this manner was created by Alfred Hitchcock for a British thriller. As the lady victim was about to be murdered the camera zoomed in to a close-up of her face. Just as she was about to scream a train flashed on the screen accompanied by the ear-splitting screech of a British train whistle.

Precision timing must be employed when using sound for transition effects; otherwise the device may be ineffective or even ridiculous. The ear does not act as quickly as the eye, consequently the audible transition must precede the visual one by a fraction of a second. An example of bad timing when using sound for a transition device could be seen in "The Fly." Having discovered a body horribly mutilated by machinery in his plant, a night watchman backs off in terror, opening his mouth to scream. Instead of a blood-curdling yell, the audience hears the ring of a telephone. Although the shot of the watchman is quickly followed by a close-up of a telephone, the transition is not fast enough and the audience has already started to giggle. It is accepted practice to compensate for the slower reaction time of the ear as compared to the eye by beginning the sound for a new scene slightly before the scene appears on the screen, but it must be done with discretion. It is subtleties such as this which separate the good films from the bad, and in this respect the serious amateur can turn out work as good as, if not better than, Hollywood.

Magnetic motion picture projectors have brought the sound stage into the living room. Eastman Kodak, Bell & Howell, Victor Animatograph and RCA and others now manufacture projectors of this type. An attachment is now on the market which can be used to convert any 16 mm or 8 mm silent projector to a magnetic sound projector.

Perhaps we are pushing our luck a bit, but we are now experimenting with stereophonic sound on film. That balance striping on the opposite edge of the film was too enticing. By attaching a magnetic conversion unit to a magnetic projector, we have been able to adapt the balance striping to a second channel for binaural sound. The unit must be installed backwards since the opposite film edge is used. It is either considerably ahead or behind the sound drum, depending on whether it is installed on the feed reel arm or the take-up reel arm, but its position in relation to the other sound head makes no difference as both channels are recorded and played back at the same time. The principle employed is similar to that of staggered head binaural tape recorders.

We feel that we have come a long way since we started pioneering with this new type of sound five years ago. The going has not always been easy—it never is with a product still in its infancy. But the results have been rewarding.

Magnetic striping is certainly the most economical and convenient method available today for adding a soundtrack to home movies.

AVAILABLE CHRISTMAS TAPES

All of these tapes should be available through local dealers who can obtain them from area distributors or directly from manufacturers.

- BEL CANTO** (All 4 track)
 Christmas Carols—DST-25148
 Billy Vaughn
 Price: \$7.95
 Christmas in the Old World—PT-600-036
 Phillips
 Price: \$7.95
 Christmas With the Lennon Sisters—DST-25343
 Price: \$7.95
 Handel's Messiah (Excerpts)—ST-181
 London Philharmonic Choir & London Philharmonic Orchestra
 Price: \$6.95
 Merry Christmas—DST-25232
 The Mills Brothers
 Price: \$7.95
 Merry Christmas—ST-183
 Robert Rheims Organ & Chimes
 Price: \$6.95
 Organ and Chimes—DST-25225
 Dr. Kendall & Dr. Wright
 Price: \$7.95
 Robert Rheims Corraliers—ST-184
 Price: \$6.95
 Season's Greetings—LT-Not given
 Felix Slatkin
 Price: \$7.95
 Silent Night—DST-25397
 Lawrence Welk
 Price: \$7.95
 White Christmas—DST-25222
 Pat Boone
 Price: \$7.95
- CAPITOL RECORDS, INC.**
 Hallelujah!—Capitol ZP-8529 (4 track)
 Handel: Hallelujah (The Messiah); Steffe: Glory Glory Hallelujah; Hopkins: We Three Kings of Orient Are; Worgan: Christ The Lord Is Risen Today; Adams: The Bells of St. Mary; Newman: Hallelujah, Palm Sunday (The Robe), 23rd Psalm (David and Bathsheba); Luther: A Mighty Fortress Is Our God; Traditional: Little David Play On Your Harp, Deck The Hall; Malotte: The Lord's Prayer; Sibelius: Chorale (Finlandia).
 Hollywood Bowl Symphony Orch.; Alfred Newman, conductor.
 Price: \$7.98
 Poulenc: Gloria For Soprano, Choir & Orchestra—Angel ZS-35953 (4 track)
 Rosanna Carteri, Soprano; French Radio & Television Chorus; Yvonne Gouverne, director; French National Radio & Television Orchestra; Georges Pretre, conductor.
 Poulenc: Concerto For Organ, Strings & Timpani
 Maurice Durufle, Organist; French National Radio & Television Orchestra; Georges Pretre, conductor.
 Price: \$7.98
 The House of the Lord—ZP-8365
 Roger Wagner Chorale
 Price: \$7.98
 Spirituals by Tennessee Ernie Ford—ZT-818
 Price: \$6.98

LIVINGSTON AUDIO PRODUCTS CORP.

- An Album of Christmas Favorites—1108F (2 track)—4CR-1108D (4 track)
 Jingle Bells, Chestnuts Roasting On An Open Fire, Winter Wonderland, Sleigh Ride, Toyland, Rudolph, The Red Nosed Reindeer, White Christmas, Joy To The World, O Little Town Of Bethlehem, The First Noel, It Came Upon A Midnight Clear, Hark, The Herald Angels Sing, Silent Night, O Holy Night, O Come All Ye Faithful.
 Tom and Jerry Vincent at the Piano and Hammond Organ.
 Price: \$9.95 (2 track)
 \$7.95 (4 track)

RCA VICTOR (All 4 track)

- Christmas Hymns and Carols, Vol. 1—FTC-2026
 O Come, All Ye Faithful, The First Nowell, O Little Town of Bethlehem, O Come, O Come Emanuel, Away in a Manger, etc.
 Robert Shaw Chorale
 Price: \$8.95
 Christmas Hymns by George Beverly Shea—FTP-1031
 Away in a Manger, O Holy Night, Thou Didst Leave Thy Throne, Sleep Precious Babe, The Birthday of a King, etc.
 George Beverly Shea
 Price: \$7.95

- Christmas Joy—FTP-1032
 Jingle Bells, The First Noel, White Christmas, Good King Wenceslas, Rudolph the Red-Nosed Reindeer, etc.
 Melachrino Strings and Orchestra
 Price: \$7.95

- Christmas Sound Spectacular—FTP-1029
 Silver Bells, Rudolph the Red-Nosed Reindeer, etc.
 John Klein at the Carillon Americana with Orchestra and Chorus
 Price: \$7.95

- Lanza Sings Christmas Carols—FTC-2025
 The First Noel, O Come, All Ye Faithful, Away in a Manger, We Three Kings of Orient Are, O Little Town of Bethlehem, etc.
 Mario Lanza
 Price: \$8.95

- Pops Christmas Party—FTC-2022
 A Christmas Festival, Joy to the World, Deck the Halls, Good King Wenceslas, God Rest Ye Merry, Gentlemen, etc.
 Arthur Fiedler, Boston Pops Orch.
 Price: \$8.95

- Season's Greetings from Perry Como FTP-1030
 Winter Wonderland, Christmas Song, Rudolph the Red-Nosed Reindeer, etc.
 Perry Como; Mitchell Ayres Orchestra; Ray Charles Singers
 Price: \$7.95

UNITED STEREO TAPES (All 4 track) KAPP

- Christmas Time—KT-41019
 Silent Night, The First Noel, Hark, the Herald Angels Sing, etc.
 Roger Williams with the Concert Grand Orchestra, directed by Frank

- Hunter and Marty Gold
 Price: \$7.95

- LONDON**
 Christmas Carols—LPM-70036
 Good King Wenceslas, O Tannenbaum, Hark, the Herald Angels Sing, etc.
 Mantovani
 Price: \$6.95

- Christmas Offering—LPM-70049
 Silent Night, Hark, the Herald Angels Sing, We Three Kings, O Holy Night, etc.
 Leontyne Price; Vienna Philharmonic & Chorus
 Price: \$6.95

- Christmas Organ & Chimes—LPM-70037
 Charles Smart at the Organ and James Blades at the Chimes
 Price: \$6.95

- Handel's Messiah (Complete)—R-80077
 Joan Sutherland; London Symphony and Chorus
 Price: \$21.95 (two reels)

- Songs of Praise—M-70048
 Nearer My God To Thee, Little Brown Church in the Vale, Abide With Me, Rock of Ages, etc.
 Mantovani
 Price: \$6.95

- MEDALLION**
 Sound of Christmas—Deck The Halls—MST-47012
 The Medallion Orchestra and Chorus, directed by Paul Krance
 Price: \$7.95

- RICHMOND**
 Music For A Merry Christmas—RCE-45014
 Away in a Manger, Once in Royal David's City, Good Christian Men Rejoice, etc.
 Frank Chacksfield and His Orchestra
 Price: \$4.95

- Children's Christmas Album—RCE-45015
 Christmas Alphabet, I Saw Mommy Kissing Santa Claus, The Holly and the Ivy, etc.
 Cyril Stapleton and His Orchestra with Children's Chorus
 Price: \$4.95

- WARNER BROS.**
 The Twenty-Two Best Loved Christmas Piano Concertos—WST-1338
 Joy To The World, We'll Dress the House, All On A Christmas Morning, White Christmas, Jingle Bells, etc.
 George Greeley, guest pianist, Warner Bros. Orchestra
 Price: \$7.95

- Happy Holiday—WST-1341
 Happy Holiday, Wassail Song, Have Yourself a Merry Little Christmas, etc.
 Wally Stott, his Orchestra and Chorus
 Price: \$7.95

- WESTMINSTER**
 Handel's Messiah—WTW-134
 Herman Scherchen conducting the Vienna Academy Chorus & Vienna State Opera Orchestra, Pierrette Alarie, soprano; Nan Merriman, alto; Leopold Simoneau, tenor; Richard Standen, bass
 Price: \$23.95 (two reels)

COUSINO AUDIO-ANNOUNCER

S T A **F** I K S T E D

. . . continuous play device has provision for automatic shut-off by means of metallic tabs attached to tape.

THE Cousino Audio-Announcer is a new cartridge type automatic repeater unit which features automatic stop at any point if a foil tab is placed on the tape. It may also be rigged to play continuously if desired.

The cartridge is the Cousino Echo-Matic, one of the first of such cartridges to be developed. It holds up to 30 minutes at $3\frac{3}{4}$ ips in the larger size or down to as little as 40 seconds in the small size.

The cartridge employs specially lubricated tape which is wound on a hub and pulled from the center as it is wound up on the outside. The slight drag as the tape moves away from the center position is enough to cause the hub to turn and wind up the tape after it passed across the heads. Tape motion is provided by a capstan and roller drive.

The new unit has a die cast tape deck which not only makes for longer wear and accurate assembly but also makes the unit lower in price. The Echo-Matic cartridge driving unit in a case, but without electronics, is only \$75.00. The same unit with a transistor preamp capable of driving a headset is \$99.75 and the complete unit with the Powermatic speaker, which is also transistorized, and delivers two watts of power, is \$134.75. The manufacturer is the Cousino Electronics Corporation, 1941 Franklin Avenue, Toledo 2, Ohio.

As with any machine which we test, we like to test it under actual working conditions. With a hot local political campaign underway in our area, we designed and built the likeness of the candidate shown on the cover of the magazine and on the facing page.

The figure was made of Homosote board and painted realistically. The face was a photo. It was held upright by a box on the base and it was in this box that the Audio-Announcer was placed. This protected it from prying fingers.

Rather than use the push button start control which is a part of the Powermatic amplifier-speaker, a micro-switch was rigged with a push button that fed through the board to the corner of the sign that was held by the figure.

Since the control circuit is 110 volts the switch was also boxed in to prevent children or inquisitive adults from coming in contact with it. This was connected to a five pronged plug, using contacts 3 and 4 and this in turn was plugged into the Powermatic speaker control receptacle.

The tape bearing the election message was recorded on a regular recorder and then dubbed, after editing to some of the special graphite-lubricated tape which was then fed into the cartridge. A metallic tab was placed on the tape at the end of the speech.

The figure was placed in an area that had good traffic and did yeoman duty in delivering the candidate's message to prospective voters.

No difficulty was encountered with it at any stage, either in production or in operation. The voice was well reproduced with satisfactory definition and with a minimum of wow and flutter.

The mechanism worked well under actual working conditions and it stopped on cue every time.

This unit can be used in "audiomating" many kinds of displays. The 110 volt receptacle in the Powermatic speak-

The Cousino Audio-Announcer (left) has a die cast tape deck which provides superior wearing qualities and makes possible a lower price. The matching Power-Matic speaker (right) has an all transistor power amplifier built into the baffled speaker housing. It also has an 110 volt outlet for powering moving displays and a control receptacle. The speaker becomes the lid for the Audio-Announcer to make a complete and compact package. A push button is also incorporated for starting.



er unit can be used to power displays.

The Audio-Announcer can be started by means of a push button located on the speaker baffle, or it can be triggered by a foot mat, photo electric cell or other device that will close the necessary connection. The device must be capable of carrying 110 volts, however.

The transistor amplifier and pre-amp require no warmup time or standby operation. They go into action instantly and when in the off position are not consuming current, as do vacuum tube amplifiers.

The pre-amp is incorporated in the Audio-Announcer case and is of sufficient power to drive earphones or a telephone handset. In addition to its use for display purposes, it may be used for safety warning messages or in instructing assembly workers in step by step procedures. In the latter case, only a headphone is needed so that nearby persons would not be disturbed.

The unit may also be fed into background music distribution systems, PA or intercom systems and will also serve as a language laboratory sound source.

Exhibits in museums and zoos, etc. can also be explained to the visitors by means of the Powermatic speaker or a headset.

In fact, in any application where repetitive messages are needed this unit should serve very well indeed.

The dimensions of the unit are $5\frac{7}{8}$ " wide x 9" deep x $5\frac{3}{8}$ " high and the weight is 9 pounds. It operates on regular 110 volt current and has a wide tolerance to current fluctuations, operating satisfactorily from 105 to 120 volts. Power requirements when operating are 20 watts. Since the unit is transistorized, no standby power is required, as is the case with vacuum tube units.

The audio response is from 80 to 10,000 cycles per second at the standard operating speed of $3\frac{3}{4}$ ips. Models



Left: the complete figure and Bill Smith, the candidate for election. The Audio Announcer was mounted in a box which formed the base of the figure, as is shown at right. A brief message from the candidate was put on the tape.

may be had which operate at $1\frac{1}{8}$ ips if more playing time per cartridge is necessary. Tapes for the cartridges may be recorded in a regular recorder and inserted in the cartridge.

When the recording is made, the oxide side of the tape is toward the head and when it is placed in the cartridge, the oxide side must be on the outside since the head is positioned on the opposite side in comparison with a regular recorder. When the tape is turned over, the recorded track will then be on the bottom, which is the proper way for it to be in the cartridge.

Cartridges may be changed simply by sliding out the one in the unit and replacing it with another. The cartridge is so constructed that the tape is protected by being lifted out of the way when it is removed.

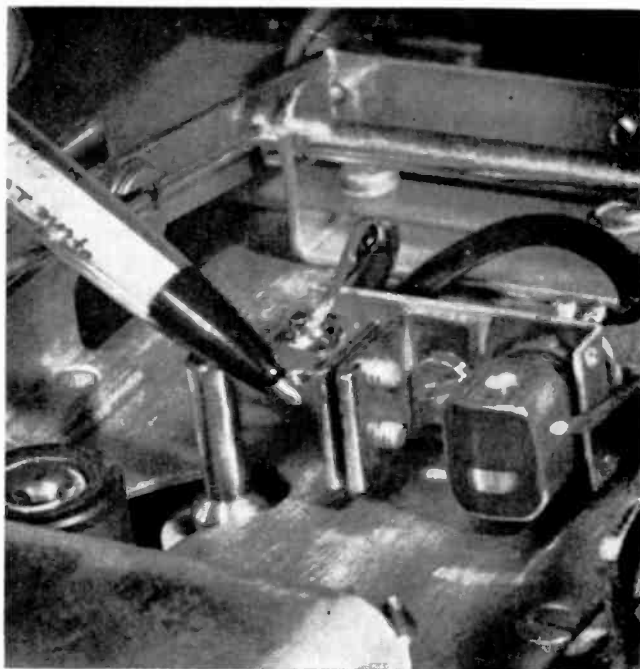
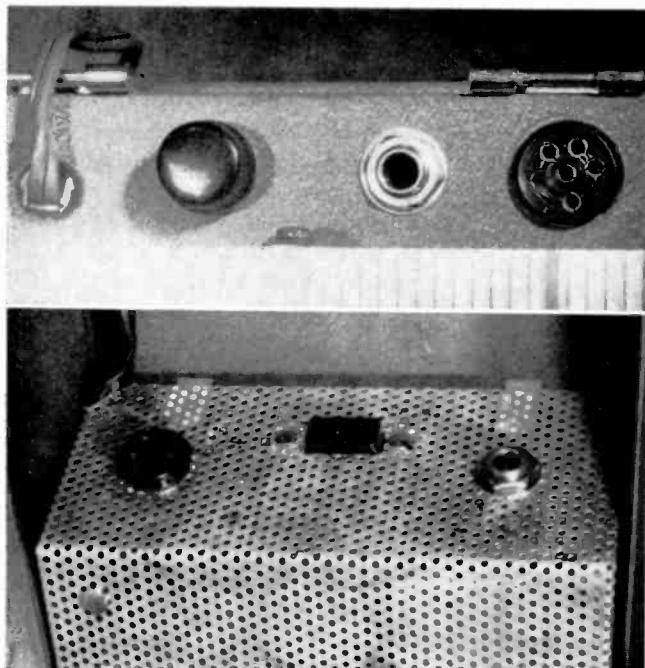

Upper left: controls on the Audio-Announcer are at a minimum. Black knob controls on/off and volume, jack takes plug for earphones or for driving power amplifier and five prong outlet has both audio and control circuits. Lower left: speaker has 110 volt outlet for powering displays in addition to output jack and control receptacle. Right: automatic shutoff is achieved when piece of foil on tape crosses contacts indicated by pencil.

NEW PRODUCTS

STA **OK** STED



WOLLENSAK STEREO RECORDER

... features full stereo record and playback plus ability to record one channel while playing another

THE Wollensak 1580 stereo tape recorder is really two recorders in one case, yet the weight of this compact unit is only 26 lbs. In size it is but 6½" x 10¼" x 13¾".

Roller tabs are used for the electronic controls which offer 12 possible positions. You can record on both channels simultaneously or separately, either in mono or stereo. Both channels may likewise be played together or separately. You can record on one channel while playing the other, providing sound-with-sound or play one channel while using the other as a PA, such as might be useful in square dance calling. You can use both chan-

nels for stereo P.A. with an output of 11 watts each or use both amplifiers together to provide 22 watts of power for PA.

One thing we especially like about this recorder, in addition to its unquestioned versatility was the fact that it is completely self-contained. Both power amplifiers *and speakers* are in the case, which means you can put a stereo tape on the machine and play it without hooking up to anything else.

Of course the stereo separation is only the width of the case but by putting the recorder in a room corner so that the sound is bounced off the walls, a better effect can be obtained. Of

Product: Wollensak Stereo Recorder Model 1580

Manufacturer: Revere Camera Company, 320 E. 21st St., Chicago, Ill.

Price: Less than \$379.00

course, the recorder may be hooked up to external speakers for proper stereo separation. It is nice to have everything in one case.

The machine will record both 2 and 4 track stereo tapes or record 2 or 4 track mono tapes. Proper positioning of the head for this is by means of a knurled wheel on the head cover. This Track Selector Dial has three positions: "A" is used for recording and playing 4 track stereo or parts 1 and 2 of 4 track mono. Position "B" is used for recording parts 3 and 4 of four track mono. The "2 Track" position is used for recording and playing 2 track stereo and mono. Since the erase head in the machine is a quarter track erase, virgin tape, or tape which has been erased completely with a bulk eraser or by running it through the recorder in both directions in the 4-track mode, in erase, should be used.

The end-of-tape cut-off switch which is just below the feed reel has a latch on it. After the tape is threaded the pin should be moved forward to rest against the tape. After the end of the tape passes through, the pin will fall forward and cut off the power. It must be moved back manually into open position. When using the recorder for PA purposes, the pin should be pulled back until it latches where it will remain.

The recorder also has an instant stop lever on the right hand side of the case on the top. Pressing this lever stops the tape motion and releasing it permits the tape to move again. The start and stop is noiseless and does not produce clicks on the tape.

Record level is indicated by neon bulb indicators which show normal and distort. These apply only in recording although they also flash on playback and may be used to balance stereo channels.

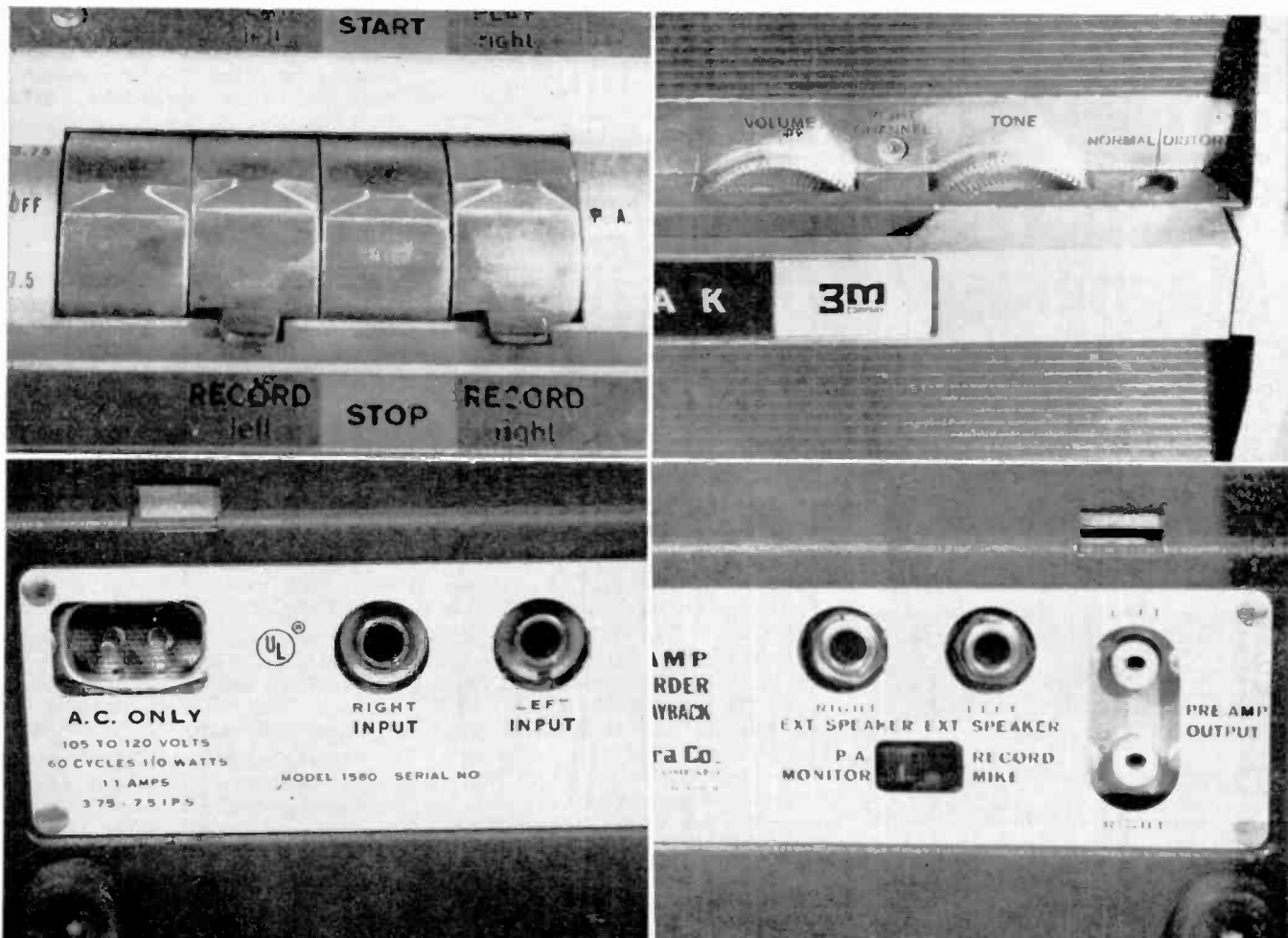

Upper left: central tape motion controls. Levers are in off position when placed as shown; they move forward or back. Speed control is at left, play/record left channel next (including safety interlock) start and stop lever and record/play and PA on lever at right. Upper right: volume and tone controls for right channel and record level indicator. These controls are duplicated for left channel. Lower left: on rear of case are: AC cord connection, and right and left stereo inputs. Lower right: external speaker connections and pre-amp outputs. Switch below external speaker jacks is for PA and Monitor and record.

Two speeds $3\frac{3}{4}$ and $7\frac{1}{2}$ ips are available on the recorder and are obtained by positioning the first tab roller at the desired speed.

The mike input is high impedance and will accept most ceramic, dynamic, magnetic or crystal mikes with a rating of 57-to-14 db. Two mikes are furnished with the recorder. Also furnished are a reel of tape and an empty reel, 2 audio cables, 2 hi-fi attachment cables, 2 attachment cords, power cord, spare pressure pads and a slip over case to protect the recorder when carrying it.

The radio-phono input takes a standard phone plug and will handle up to 1 volt at 1 megohm resistance.

All controls are readily accessible and easily operated. End-of-tape cutoff switch is below left reel, counter is at left, and fast forward and rewind sliding level at right. Center levers control speed, record/play and start and stop. Controls on lower panel are tone and volume, with separate controls for each channel.

Frequency response at the slower speed is 40 to 13,000 cps and at the high speed 40 to 18,000 which is more than adequate for any tape use. Our check showed the quality to be excellent.

Because this machine is so versatile

it is mandatory that the instruction book be carefully and thoroughly read.

The craftsmanship of the recorder is excellent and we believe it is worthy of your consideration. The lightweight all metal case is attractive and should fit with any decor.

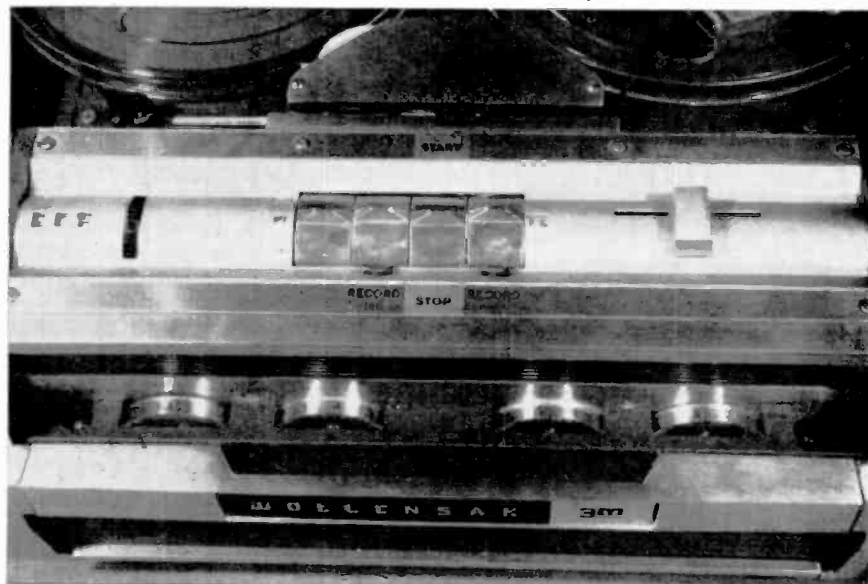

Assure 100%
**COMPLETE
ERASURE**
of Recorded Tape
ON THE REEL



with the
Magneraser[®]

— the Original and still the best!

Quickly erases a reel of magnetic tape or sound film of any size or type. Erasure is 100% complete even on severely overloaded tape. Lowers background noise level of unused tape 3 to 6 db. Also demagnetizes record-playback and erase heads. Only \$18.00. Two-Year Guarantee. Available at your dealer's or write to:

AMPLIFIER CORP. of AMERICA
An Affiliate of the Keystone Camera Co., Inc.
398 Broadway, New York 13, N. Y. • WO 6-2929

SAVE MONEY **HI-FI COMPONENTS**
TAPE RECORDERS
SLEEP LEARN KITS

MERITAPE Low cost, high quality recording tape, in boxes or cans.

DRESSNER FREE 1963 CATALOG
1523 JERICHO TPKE.
NEW HYDE PARK 18, N.Y.

BUILD A SOUND STORY LIBRARY

These unusual, different 3" reels of recorded tapes are already a library in sound. Each is authentic and original. More will fallow from time to time. Why not start your collection today—choose from these listed below.

\$100 EACH
pastpaid

- #1—General examples and excerpts of Tape Recorder Music, Dr. Vladimir A. Ussachevsky; plus, Sounds of New York City, Tany Schwartz
- #2—The Contact Microphone, Kenneth Miller—A hilarious tape that demonstrates creative production.
- #3—Beat Recording, O. Nadlehs—The cats who swing this crazy tape are real-reel beat.
- #4—Africa, Frank Weston — Authentic sounds recorded in the wilds of Africa.
- #5—Portuguese Fada, Jahn H. Lerch—Fadas are songs of fate, typical throughout Portugal.
- #6—Tape Travelogue—Yucatan, Mexico, Russell B. Maxey
- #7—B & O Locomotive 25—Interview with engineer and authentic sounds of this old-timer.

All tapes are dual track and all except #7 are 7½ ips. #7 is 3¾ ips. Order from: Sound Story Dept., Mooney-Rowan Pub., Inc., Severna Park, Md.

SHOP OR SWAP

Advertising in this section is open to both amateur and commercial ads. TAPE RECORDING does not guarantee any offer advertising in this column and all swaps, etc., are strictly between individuals.

RATES: Commercial ads, \$3.00 per word. Individual ad, non-commercial, \$.05 a word.

In figuring the number of words in your advertisement, be sure to include your name and address. Count each abbreviation, initial, single figure or group of figures as a word. Hyphenated words count as two words. The name of your city, local postal zone and state count as two words. Maximum caps first four words. Proofs are not submitted on classified ads.

Remittance in full must accompany copy. No exceptions permitted. Ads will be inserted in next available issue. Please print or type your copy to avoid error. Address ad to: Shop or Swap, Tape Recording Magazine, Severna Park, Md.

HI-FI RECORDS MADE from your tape. Finest professional quality. All speeds-sizes. Prompt service. For prices write MBS Recording Studios, 228 S. Wabash-Chicago.

PENTRON N13S TAPE RECORDER, 4 speakers, 2 track stereo, 2 speeds. Good condition. Quick sale for \$75. Send money order to Simon S. Spielman, Box 295, Far Rockway 91, N. Y.

FEW UNUSED BRUSH boxed magnetic heads. Half track playback models BK1090, BK1091, \$5 each. Full track record BK-1250, playback BK1251 and erase BK-1252, \$10 each. Half track stereo BK-1072 playback and BK1072S2773 record, \$10 each. Shipped C.O.D. Write A. Carsten, Box 218, Solana Beach, California.

USED 3M RECORDING TAPE (1½mil acetate) 1,200 x 7" dia. reels, 6 reels \$5.50; 12 reels \$10, postpaid in U. S. only; TV-Time, 7 Orchard Parkway, White Plains, N. Y.

SWING ERA BANDS Taped Air Checks. Collectors Items, Box 322, Glen Head, New York.

USED MYLAR TAPES—150 reels on hand. 1,800 foot, \$1.10 each. For order of 40 or more—99¢ each. Postage prepaid in U. S. B. Freeman, 800 W. 87th St., Kansas City 14, Mo.

SELL: Minifon P55 Miniature 4 hour portable recorder, complete with tie clip mike, standard mike, AC power supply, auto connecting cord, shoulder holster, telephone pickup and batteries. Excellent condition, cost \$390.—want \$125. Frank Collins, Bldg. 117, U. S. Naval Academy, Annapolis, Maryland.

PROFESSIONAL RECORDING EQUIPMENT: 2 Electro Voice 667, 3—666's, 2 Phillips EL6040; 2—315 Berliant Mixers, 50 ohm input, 600 ohm output; Concertone 22ST Recorder. F. Kenny, 1322 Troy St., Dayton 4, Ohio.

STEREO TAPES—I will gladly purchase for you any of the many discontinued, factory sealed 2 and 4 track stereo tapes available in New York and I will add on

SCRIPT READING FUN . . .

"The Truth Will Out"

An old-fashioned mellerdrama.

6 Complete scripts **\$198**

pastpaid

Order your set today
TAPE RECORDING
Severna Park, Md.

a small additional charge to get some tapes for myself. Price \$3.00 to \$4.00 postpaid including my charge (lower in quantity). Please send for list. Charles Sokol, 1241—59 St., Brooklyn 19, New York.

ELECTRIC TROLLEY CAR SOUNDS still needed as per my advertisement Tape Recording, September issue, page 34. Fred Reynolds, 544 Clarkson St., Denver 18, Colo.

WANTED: COMPLETE DISC CUTTING equipment. State condition and price. Dan Lee, 3167 E. Green Street, Pasadena, California.

TAPEX COMEDY CLUB—SAE for information. Box 1361, Gardena, California.

WRITE SONGS—but can't write them down? I'll transcribe, harmonize from your tape vocal to music manuscript. Send tape, lyrics, \$9.95 each. Ted Maters, 226 Paris SE, Grand Rapids, Michigan.

WANTED: MIDGET MOHAWK tape recorder—give price, condition, first letter. Nick T. Leiker, 532 S. Market, Wichita, Kansas.

LP'S MADE FROM TAPES: 12"—45 minutes \$5.95, add 50¢ total postage. Other sizes and speeds, write Artistic Sound, Box 3774, Oak Park, Mich.

CHRISTIAN TAPE LIBRARY—Gospel singing, organ music, good Gospel sermons. Undenominational. Also write about rental of slide show to Samuel Fry, Box 500, Selinsgrove, Pa.

4 TRACK STEREO RECORDERS. Slightly used. \$297.50 Viking Stereo Compact RMQ \$150.00; \$595.00 #505 Concertone \$399.00; \$297.50 Viking 86 Stereo Compact \$209.00; \$399.50 Norelco "400" \$189.00; \$399.50 #2207 Webcor \$189.00; \$87.70 Sony Stereo Tape Deck \$57.00; \$139.95 Concord #107 \$59.00; \$99.95 Phono Trix Mark 3 \$49.00; \$99.95 Columbia C-690 \$49.00. WIFI, Box 3022, Philadelphia 50, Pa.

LEARN WHILE ASLEEP, hypnotize with your recorder, phonograph or amazing Electronic Educator endless tape recorder. Free catalog lists over 300 unusual tapes, records, equipment for experimenters. Sleep-Learning Research Association, Box 24-TR, Olympia, Washington.

WRITE for our low quotation on components, recorders. Hi-Fidelity Supply, 2817-JC Third, N. Y. C. 55.

TRUE SCIENCE, TRUE HISTORY, Bible confirmed. Recordings, 2521 N.W. 23 St., Miami.

RENT STEREO TAPES—Over 2,500 different—all major labels—free catalog. Stereo-Parti, 811-F Centinela Ave., Inglewood 3, Calif.

COMPONENTS, TAPE RECORDERS

Write for our low quotes on your choice of components. Save more on "pikes." All factory sealed. Send for "Monthly Specials" bulletin.

HI-FI RECORDING TAPE
Splice Free (except 2400') freq. resp. 20—20,000 cps. 15 day money back guarantee.

1200' 7" acetate	1.29	12-23	24+
1800' 7" acetate	1.79	1.17	.99
1800' 7" mylar	1.95	1.59	1.40
2400' 7" mylar	2.89	1.85	1.83
2400' 7" tensitized mylar	2.99	2.59	2.45
	2.99	2.95	2.90

Can Be Assorted. Add 15¢ Postage Per Reel

10¢ for 24+ Lots.

125-C East 88 St., New York 28, N.Y.

CARSTON Studios

TAPEBOOKS AND OTHER TAPES

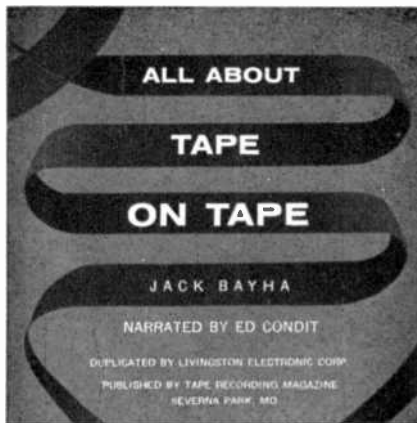

ALL ABOUT TAPE— ON TAPE

Will give you the information you need about tape recording in sound, not in the written word.

... authored by Jack Bayha ... a book to which you listen ... the first book specifically designed and produced on tape instead of the printed page. ... Now you can actually HEAR what good recording, over-recording, wow, flutter, distortion, wrong mike placement, etc., sound like. A test section allows you to adjust the head of your recorder for best results. Chapters include: How

a Tape Recorder Works, A Demonstrated Glossary, Recorder Operation, Home Recording, Field Recording Low Impedance, Microphones, Recorder Maintenance and Testing. ... Playing time of the Tapebook is one hour. Accompanying each reel is a 28 page booklet containing 80 illustrations to supplement the spoken word. It is unique, enjoyable and instructive.

7½ IPS, 7" Reel, Dual Track
\$6.95

3¾ IPS, 5" Reel, Dual Track
\$5.95

Including a 28 page manual of illustrations

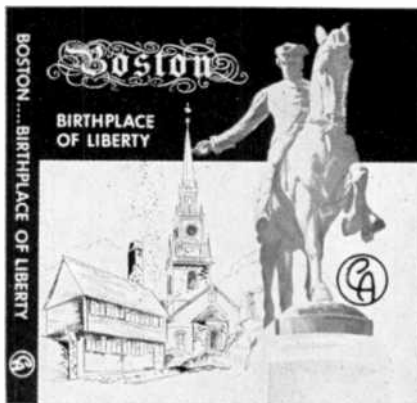

BOSTON

A full 57 minute tour of one of America's most famous and historic cities. You visit in sound Boston Common, the Park Street Church, Kings Chapel, Old South Meeting and Faneuil Hall, the Cradle of Liberty. Hear the worship service at Old North Church in the belfry of which Paul Revere hung his famous lanterns and also hear the Vicar of Old North tell about the clear glass windows, kept clean so your forebearers could see the need outside, as well as the beauty inside. Every sound, every voice is authentic. Dual track, 7½ ips. **\$695**

HOW TO STAY ALIVE ON THE HIGHWAY

This tape may save your life. Contains the actual voices of nearly 40 auto drivers, victims and survivors of highway accidents, police and traffic officials. Portions were secretly recorded in court rooms, on the highway and in police stations over a period of three years. A must for driver education programs. Dramatic, forceful—something you won't forget.

\$795

ADD-THE-MELODY TAPE

Twelve old favorite tunes for you to sing along with. Specially recorded with the melody missing so you can sing or play with the tape then, on playback hear both parts together. Suitable for use on any recorder with the ability to play the lower track while recording on the upper. Can be recorded again and again without harm to the Hammond Organ accompaniment by Hack Swain. You can get a million dollars worth of pleasure from this tape. **\$995**

HOW'S YOUR HEARING?

Periodic hearing tests are important because unlike most other ailments, a hearing loss gives little positive warning. Tape contains 33 tone pairs to test your musical discrimination, 75 word pairs to test speech discrimination and 30 minutes of music by the famous Lenny Herman orchestra for screen testing of hearing. Full 7" reel, 7½ ips and booklet giving full directions for use of the tape. **\$995**

New! TAPE RECORDS Monaural Music

3" reels, 3¾ ips, full track

Only \$1.00 each postpaid

- 1—Cha Cha Cha—Tito Puente—Oye Me Mama, Sope de Pinchon, El Miche
- 2—Dinner-Dance—Fred Martin Radio Orchestra—Let's Dance, Somewhere over the Rainbow, Women are No Angels
- 3—Jazz—Dickie Thompson Quartet—Love for Sale, Blues in My Heart
- 4—Jazz—Dickie Thompson Quartet—Laura—What is This Thing Called Love
- 5—Jazz—Dickie Thompson Quartet—Misty, Satin Doll
- 6—Dinner-Dance—Jose Melis—Tonight, Am I Blue, White Cliffs of Dover
- 7—Dinner-Dance—Fred Martin Radio Orchestra—Flamingo, Song of India, Symphony
- 8—Dinner-Dance—Fred Martin Radio Orchestra—I've Got Plenty of Nothin', Ebttide, Autumn Leaves
- 9—Dinner-Dance—Fred Martin Radio Orchestra—Fiddle Faddle, Blue Tango, Serenata
- 10—Hammond Organ—Bill Thompson—Touch of Your Hand, I Won't Dance, Smoke Gets in Your Eyes

TAPEBOOK DEPARTMENT TAPE RECORDING MAGAZINE Severna Park, Md.

Please send me the following:

- All About Tape on Tape, 7½ ips.\$6.95
- All About Tape on Tape, 3¾ ips.\$5.95
- Boston, Birthplace of Liberty.\$6.95
- How to Stay Alive on the Highway.\$7.95
- Add-the-Melody Tape, 7½ ips.\$9.95
- How's Your Hearing.\$9.95
- MONAURAL MUSIC TAPES.each \$1.00

(circle numbers desired)

1 2 3 4 5 6 7 8 9 10

NAME

ADDRESS

CITY ZONE STATE



Perhaps two years from now the quality of this tape may be duplicated...perhaps never! **Soundcraft Golden Tone—a physically perfect tape...a musically perfect sound.** A bold claim? Yes. Warranted? Yes. Here's why. Golden Tone is a very special tape...

designed just for those who demand the finest performance from today's advanced recorders. Unless you have the discerning ear and the exacting equipment which ordinary tapes can't satisfy, there is no reason for you to buy Golden Tone.

A special magnetically-active FA-4 oxide formulation increases Golden Tone's high frequency output by 25%. Its signal-to-noise ratio is 7 db better than other brands, to give your recordings **the greatest dynamic range possible with a tape.** Precision-slit Golden Tone is free of edge burrs and skew. These physical defects can be cruelly exposed by the narrower tracks in 4-track recording. Microscopic burrs prevent the tracks on the edge of the tape from making intimate head contact, resulting in loss of "highs."

Skew another hidden defect, produces cross-talk and loss of recording level. Golden Tone's oxide formulation and base are balanced to prevent cupping or curling, an effect which can also prevent tape to head intimacy. Golden Tone's oxide surface is Micropolished. This patented Soundcraft process removes any surface irregularity prevents drop-outs, protects high frequency response and minimizes head wear.

From this physically perfect tape, comes musically perfect sound. Golden Tone costs more, but it is worth more. It is produced in small quantities with infinite care and rigid quality control. It is the world's finest tape for those who demand the ultimate in sound reproduction. Offered for the first time anywhere—a long play Golden Tone tape on 1 mil Mylar*, TENSILIZED by DuPont—will not stretch or break. Also on ½ mil "Mylar" and 1½ mil Acetate Bases.



GOLDEN TONE BY REEVES SOUNDCRAFT CORP.

*DuPont T.M.