

July 1990

\$5.00 £2.00

STUDIO SOUND

AND BROADCAST ENGINEERING

A LINK HOUSE MAGAZINE

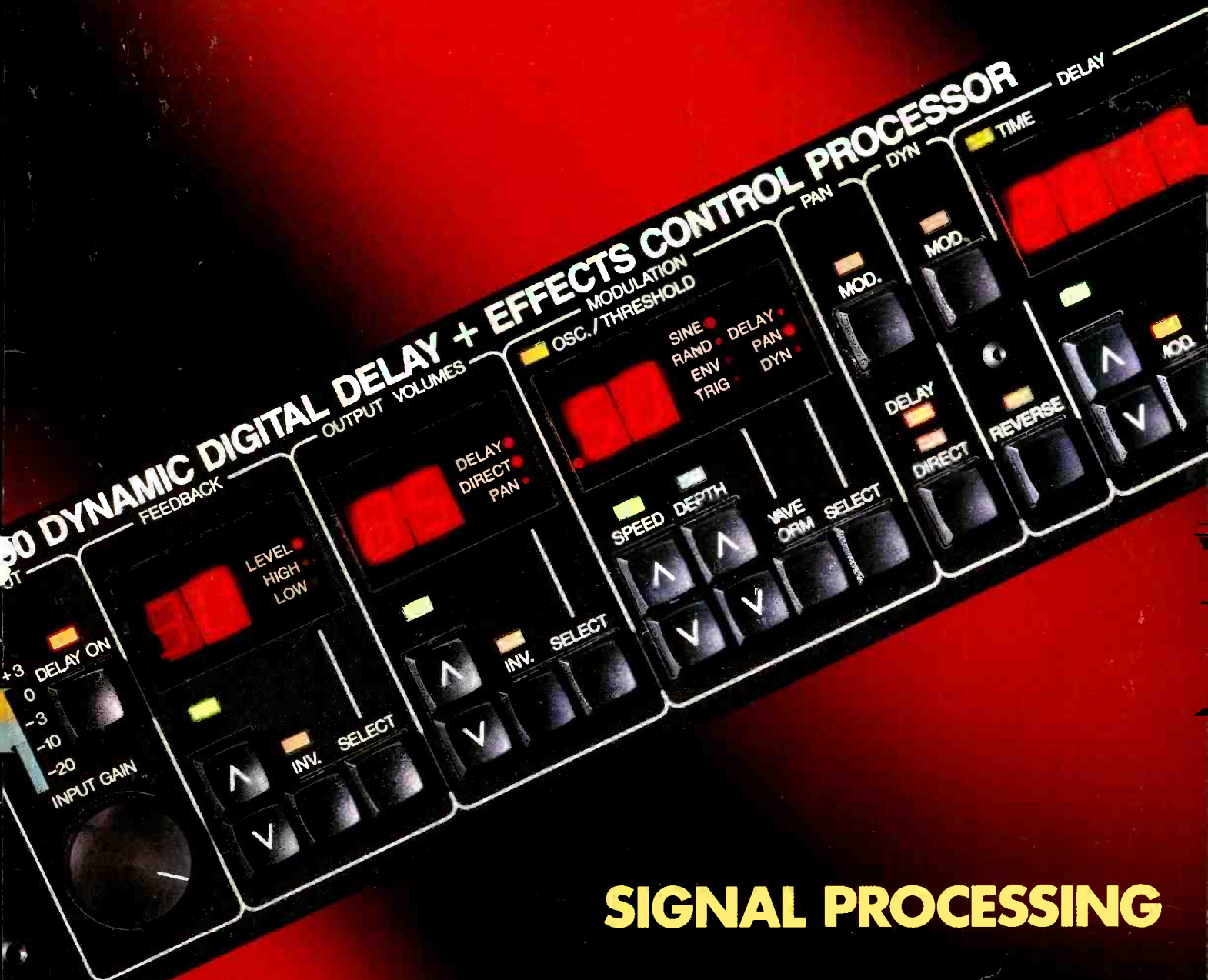

SIGNAL PROCESSING



All in one.



INTRODUCING A WHOLE NEW CONCEPT: THE POSTPRO™ SD.

Presenting the smart alternative to multi-manufacturer component sampling and hard disk recording systems: New England Digital's PostPro SD. For the first time, random access performance is uninhibited by multi-manufacturer incompatibilities. With the PostPro SD, you get all the editing power of Direct-to-Disk™ recording, plus a fully integrated Synclavier® sound module. Switching between music and effects, sound design and editing, recording and sequencing is truly seamless, truly transparent. The PostPro SD is the first hard disk recorder/editor that lets you go beyond cutting sounds: it allows you to create them. There's also another very important PostPro SD feature: our Total Commitment support package. It means our commitment to you extends beyond technology to offering financing alternatives, training, responsive service and regular software updates.



Synclavier and the New England Digital logo are registered trademarks. Direct-to-Disk and PostPro are trademarks, and Total Commitment and The smart move are service marks of New England Digital Corporation. © 1990 New England Digital UK, Ltd., Elsinore House, 77 Fulham Palace Road, Hammersmith, London W6 8JA. Tel: (44) (0)-81-741-8811

STUDIO SOUND

AND BROADCAST ENGINEERING



Sojin grand piano at Black Barn studios, Surrey, UK

Editorial: Julian Mitchell's cynicism subsides at the feat of One World, One Voice	5
News: Events, news, moves and comment from inside and outside the recording industry	13
Telekinoradiotechnika 90: A report from the Moscow show by Terry Nelson	18
Products: Information on new products, developments, upgrades and software updates	21
No Optical Illusion: James Betteridge gives an overview of the new Akai DD-1000 magneto-optical disk recording system	29
Black Barn: Patrick Stapley takes a trip to the Surrey countryside in the UK	33
Effects: A guide to new effects units for audio enhancement that have been introduced over the last 18 months	37
Equalisers: A list and short description of new equalisers that have been introduced over the last 18 months	38
Business: Precision and ethics of Bruel & Kjaer, Dance Music Awards. by Barry Fox	43
Perspective: US columnist Martin Polon laments the plight of those who would buy music	44
Evaluating Audio Op Amps: Part one of Ben Duncan's series looks at the history and background of op amps	50
Why Do Equalisers Sound Different?: Michael Gerzon offers some food for thought	58
tc 2290: Dave Foister gives an operational report on the latest upgrade from tc electronics for this processor	68

SIDE BY SIDE

Pinewood Studios Sound Department launches Britain's first Solid State Logic SL5000 M Series film post-production system in Theatre One. The console features a G Series studio computer with Instant Reset™.



By adopting Pinewood's unique tried and tested technique of using dubbing Theatres One and Two at the same time you can reduce your post production schedule without losing quality.

Theatres One and Two are identical in size, side by side under the same roof, and both now feature 60 input-32 output automated stereo mixing consoles, with programmable panning, Dolby SR and four 35mm multitrack recorders.

To complete your film, Pinewood's state of the art transfer facility will make your soundtrack negatives with in-house care and precision.

Technology with technique: the Pinewood way to a better result – sooner.

 **PINEWOOD
STUDIOS**



Iver, Bucks, England SL0 0NH
Tel: (0753) 656301

Solid State Logic
AUDIO PRODUCTION SYSTEMS FOR FILMS

Begbroke, Oxford, England OX5 1RU
Tel: (0865) 842300

STUDIO SOUND

AND BROADCAST ENGINEERING

July 1990
Volume 32 Number 7
ISSN 0144 5944

EDITORIAL

Editor: Keith Spencer-Allen
Assistant Editor: Julian Mitchell
Co-ordinating Editor: Ann Lowe
Production Assistant: Dawn Boulthwood
Secretary: Elaine Sweeney
Consultant: Sam Wise
Columnists: Barry Fox, Martin Polon (US)
Regular Contributors:
Janet Angus David Hastilow
James Betteridge Mike Lethby
Mike Collins David Mellor
Ben Duncan Terry Nelson
Dave Foister Francis Rumsey
Neil Grant Patrick Stapley
Yasmin Hashmi

ADVERTISEMENTS

Advertisement Manager: Steve Grice
Display Sales: Phil Salmon
Copy Controller: Sarah Stanmore
Advertisement Production: Mark Trainer
Secretary: Lianne Davey

CIRCULATION

Circulation and Development Manager:
Colin Enderson
Controlled Circulation Manager:
Maria Udy
Enquiries: See classified advertisement

Director: Doug Shuard
Publisher: Steve Haysom

EDITORIAL & ADVERTISING OFFICES
Link House, Dingwall Avenue, Croydon CR9 2TA,
UK. Tel: 081-686 2599. Telex: 947709. E-mail:
78:DGS1071. ESI: STUDIO SOUND-UK/US.
Fax: 081-760 5154-0973.

AMERICAN OFFICE

Publishing Services Manager: Fred Vega
Studio Sound, 2 Park Avenue, 18th Floor,
New York, NY 10016, USA. Tel: (212) 779-1212.
Fax: (212) 213-3484.

JAPAN & FAR EAST AGENT

Contact: Mikio Tsuchiya, Media Sales Japan Inc,
Tamuracho Bldg 3 3 14, Shimbashi, Minato-Ku,
Tokyo, Japan. Tel: (03) 504-1925. Telex: J25666.
Fax: (03) 595-1709.

© Link House Publications plc 1990 all
rights reserved

Printed in England by Lawrence-Allen
(Colour Printers) Ltd, Gloucester Street,
Weston-super-Mare, Avon BS23 1TB



A LINK HOUSE
PUBLICATION

Studio Sound and Broadcast Engineering
incorporates Sound International and Best
Instrumental

Studio Sound is published on the third Friday of
the month preceding the cover date. The
magazine is available on a rigidly controlled
requested basis, only to qualified personnel (see
classified advertisement for terms)



MEMBER OF THE AUDIT
BUREAU OF CIRCULATIONS



Total average net circulation of 19,169 per issue
during 1989.
UK: 5,272. Overseas: 13,897.
(ABC audited)

Cynicism takes a holiday

As an American reporter kept repeating to herself at the recent One World, One Voice press launch when reacting to the preview of that programme, "Awesome, truly awesome!" She was no doubt impressed, as we all were, by the production she had witnessed on two large Trinitron monitors set up in one of the large rehearsal rooms at Nomis recording studios, West London. I was no less impressed but being on the reserved side of 'awesome', and being British, I limited my delight to genuine, though silent, admiration for the people involved in the project.

For those of you who haven't heard of the One World, One Voice project and album, the idea was to create awareness of the plight of the earth through music. In practice that meant recording 300 musicians worldwide and filming them as they performed. The music was composed as they went along by the majority of the artists and then mixed at Nomis while the film was being edited at Carlton TV, also in London.

The idea was visionary indeed and the motivation involved was of the highest calibre. But unfortunately whenever well meaning pop stars come up with ideas like this the result can be creatively compromised and usually suffered for the betterment of man and the world, etc. So it was with a touch of cynicism that I sat down at Nomis for the preview, happily it was unfounded. Even if the music and film hadn't worked the project would have been remembered for rekindling the spirit of Live Aid across the world. For the first time since then a single programme was broadcast simultaneously to nearly 40 countries and to an estimated audience of 500 million people.

As with all truly great things there is a certain amount of reflected all-round goodness. The interest that One World has generated must have permeated down to all the cultures that were pinpointed in the film. This should have had a perpetuating effect and secured the popularity of the culture's music and customs, for the time being anyway. Witness the power of a pointed camera and a held microphone. Even the cultures that were missed by the One World team must've had a morale booster because Western documentary makers are like buses: there'll be another one along in a minute. Another big plus must have been the amount of cross-fertilisation of ideas and discovery of different instruments that went on. Who could forget the sight of an African musician dressed in tribal garb of loin cloth, multicoloured beads and head-dress, playing an electric guitar in true axeman style while flanked by his, more traditionally, trumpet playing pals?

Could it be that this kind of world awareness project has become the guardian of the world's musical cultures? That's not such a giant responsibility as it may seem. If nothing else the programmes make great TV and now equally stirring soundtracks. There is a wealth of documentary potential out there and TV producers could be pleasing their programme commissioners and at the same time shedding light on problems on a worldwide scale. Is there a darker question to consider, however? Could these very same programmes dilute and sanitise these third world cultures so much with their increasing publicity that their impact on a worldwide scale diminishes?

As in 1985 when Live Aid and Band Aid made music making respectable and proved its power, One World, One Voice has used that power to whip-up much needed awareness of immediate world problems. However, while we admire the skill and vision of the people who have put this project together, we should awe at the technology that made it possible to record over 300 musicians on all kinds of formats digital and analogue, mix them all together, edit them at the same time as the film, travel the equivalent of twice round the world to get them and still come out with something meaningful all in just 89 days. Truly awesome!

Julian Mitchell

Cover: tc electronic 2290. Photography by Tony Petch

WHEN YOU WANT SOMETHING BETTER

D&R's Dayner series offers more inputs in less space than any other console. Up to 56 input modules (112 mix inputs) in less than 1.85 m. Ideal for space limited control rooms and MIDI oriented studios.

Yet despite its compactness, the Dayner is long on features. Split EQ, Floating Subgroup System, 8 aux send busses and digital quality specs are just a few.

Whether you have 8, 16, 24, or 32 tracks and the most elaborate MIDI set up, the Dayner is all the recording mixer you'll need for years to come.

If you prefer the traditional split format, the innovative in-line format or both, your Dayner can be custom configured to fit your particular needs in just minutes.

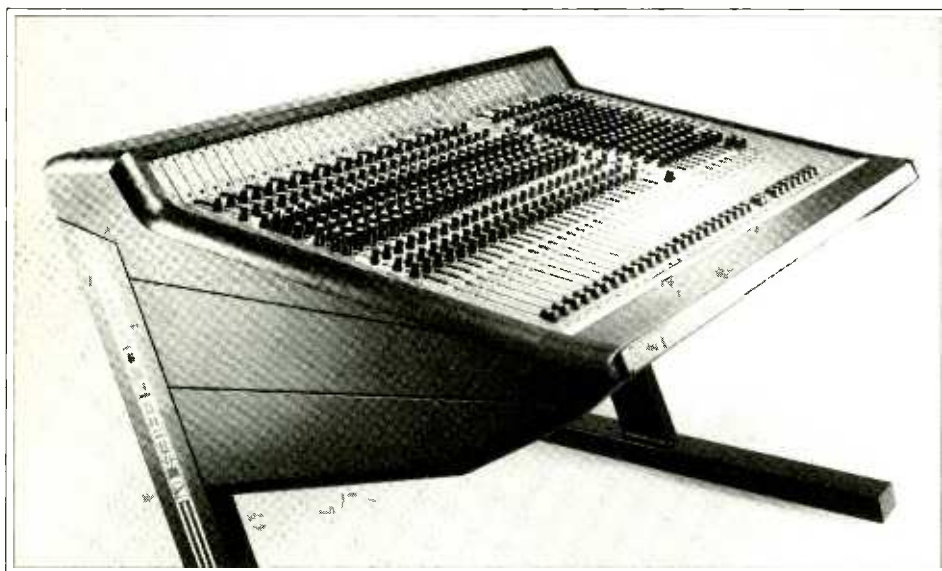

Dayner 42 studio console

D&R Electronica b.v.
rijnkade 15B
1382 GS WEESP
the Netherlands
Phone: --31 2940 18014*
Fax: --31 2940 16987

D&R USA
Montgomery TX 77356
Rt. 3 Box 184-A.
USA
Phone: (409) 588-3411
Fax: (409) 588-3299

Check out the DAYNER

D&R

TOTAL CONTROL

AUSTRALIA, AUDIO&RECORDING, 2019 Sydney, 36-38 Daphne St Botany, Phone: (02) 6669935. **AUSTRIA**, KÜNL & WURZER, A 4020 Linz, Waldeggstrasse 68, Phone: 732668125. **BELGIUM**, D&R Electronica b.v., 1382 GS WEESP, Holland, Phone: 0031-2940-18014. **CANADA**, J-MAR, M4H 1E9 Ontario, 6 Banigan Drive, Toronto, Phone: 4164219080. **DENMARK**, P.S.S. DK 2400 Kobenhavn, Gortelvej 4, Phone: (01) 821582. **EGYPT**, Alpha Audio, 6 Mahmoud Hafez St suite 905, Safir square, Heliopolis, Phone: 245 6199. **FINLAND**, S.L.O. OY, 01301 Vantaa 30, P.O. Box 88 Sahkometsa, Phone: 908381. **FRANCE**, METTLER AUDIO, 75009 Paris, 1-3-5 Blvd de Clichy, Phone: 148782911. **GERMANY**, J. Isler GmbH, Paul-Ehrlichstrasse 28-30, D-6074 Rödermark, Phone 06074-94086. **GREECE**, Omikron, 20 Salomou Street 147, Athens 106-82, Phone: 3631066. **HONGKONG**, JOLLY SOUND Ltd, Tower B, RM 1214-1215, Hunghom comm, centre 37-39, Ma Tau Wei Rd KLN H.K., Phone: 36202025. **ICELAND**, RADIO STOFAN HF, 130 Reykjavik, P.O. Box:10340, Phone: 354-1673737. **ISLD. CANARIAS**, MUSIC ACCORD, S. Cruz de Tenerife Puerta Causeco 35, Phone: 22-289506. **ITALY North**, Musica-In S.R.L., Corso di Porta Romana 132, 20122 Milan, Phone: 02-5488171, **ITALY South**, Synchrom, S.r.l., Via Fabio Massimo 34 00192 Rome, Phone: 6-3581296. **NEW ZEALAND**, Accusound NZ Ltd, Auckland 3, Linwood industrial park, unit12, 43A Linwood Avenue, Phone: (09) 8150258. **NORWAY**, VEDUM ELEKTRONIKK, N-1381 Heggedal, Aamotveien 2, Phone: 2798990. **PORTUGAL**, JORSOM AUDIO VISUAL, 1000 Lisboa, Rue Eca de Queiroz 20-3 Phone: 19562850. **SPAIN**, Audio Sintesis, 08007 Barcelona S. Ronda Universidad W,19, Phone: (93) 4171340-212891. **SWE- DEN**, ALLBA LJUD AB, Gelbgjutarevägen 4, 17148 Solna, Phone:087300280. **SWITZERLAND**, ISLER AG, 8048 Zurich, Badenerstrasse 808-810, Phone: 14321444. **U.K.**, Palm Audio Systems, 16/17 Caroline street, B3 1 TR Birmingham, Phone: 0212001771. **VENEZUELA**, SOUND AND POW- ER, 1070 Caracas, P.O. box 76766, Phone: 2223201.

International Broadcasting Convention

IBC90 will as in previous years, offer an ambitious Technical Programme covering all aspects of broadcast engineering and related subjects. Enhanced and High Definition television is expected to feature prominently in the papers, along with the problems of implementing new standards and services and their interaction with existing facilities.

The IBC Exhibition will reflect the leading edge of Broadcasting Technology, with the world's top manufacturers demonstrating their latest products. Also represented will be the increasing number of smaller specialist companies who play a vital role in the industry.

A comprehensive Social Programme will be arranged.

The prestigious IBC Award for IBC90 will be presented at the Champagne Reception during the Convention.

SEPTEMBER 21st - 25th 1990

**BRIGHTON
UNITED KINGDOM**

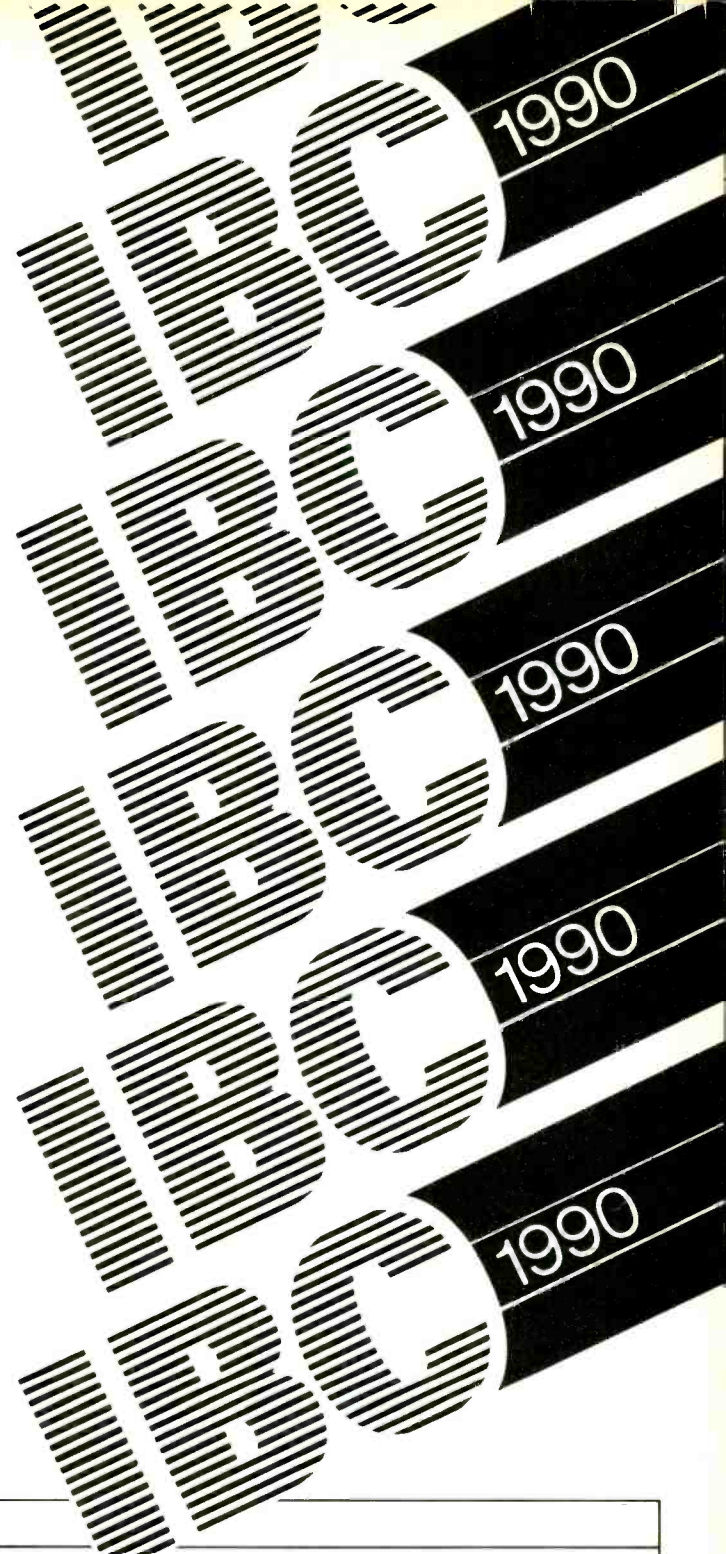

EXHIBITION REGISTRATION FORM

To Register in advance please complete this form OR attach a business card, valid for one person only.

SURNAME										TITLE									
FIRST NAME																			
NAME OF ORGANISATION																			
ADDRESS																			
COUNTRY										POSTCODE									
TELEPHONE										TELEX									
FAX																			

- Attendance, please tick appropriate box(s)
- | | |
|--|---|
| <input type="checkbox"/> Friday 21, September | <input type="checkbox"/> Saturday 22, September |
| <input type="checkbox"/> Sunday 23, September | <input type="checkbox"/> Monday 24, September |
| <input type="checkbox"/> Tuesday 25, September | <input type="checkbox"/> All five days |

COST

VAT NO 240-3420-16

£12.00 per day (including £1.56 VAT),
£40.00 for 5 days (including £5.22 VAT).
Payment must accompany this form and be sent to:-
IBC Secretariat, Savoy Place, London, WC2R 0BL.

HEARD BY MILLIONS BUT SELDOM SEEN

ducer

STUDIO QUALITY CONTACT CONDENSER MICROPHONES

- 42Hz to 22KHz Frequency response
- Superb clarity - true acoustic sound
- Complete isolation
- Easy to use
- More than 5000 systems in use world wide
- Abience-Free Stereo

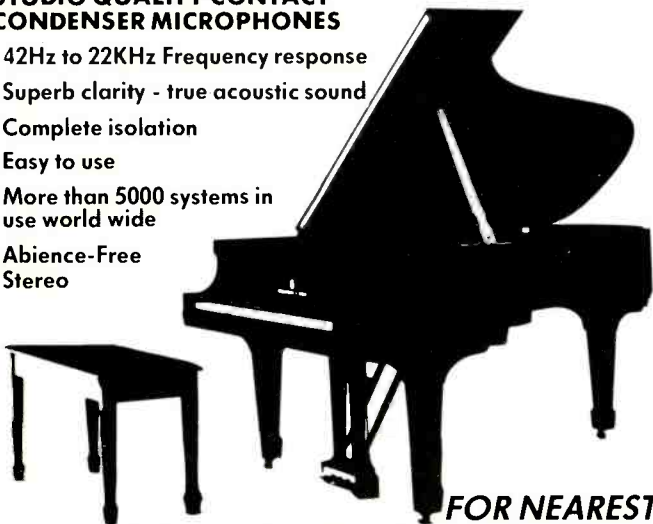

FOR NEAREST
DEALER/DISTRIBUTOR CONTACT:-

UK + EUROPE
A.M.G.

USA
C - T AUDIO

CANADA

Call 0428 58775
Fax 0428 58438
Int + 428 58775

Call 1 - 800 C - T Audio
Fax 407 738 0319
Int + 0101 407 738 0622

West Call 416 360 5940
Fax 416 362 2477
East Call 604 222 8190
Fax 604 222 9884

PROBABLY THE SMALLEST PG ON THE MARKET!

- * Housed in Std 26pin camera plug.
- * Crystal controlled.
- * Stability better than 1/2 frame / Hr
- * Full CCIR / RS170 sync waveform.
- * 625/50 and 525/60 versions.
- * generates component colour black.
- * Powered from VTR.
- * Internal voltage stabiliser.

The PG Plug is designed to enable sound recordists to use a portable video recorder, such as the BWV 35, as a sound only machine to record effects or "atmos" tracks. It generates a suitable black signal to enable the servo systems to function correctly.



DT Electronics Limited, 1st Floor, Bridge Block,
1, Cophall House, Station Square,
Coventry CV1 2FZ, England.
Tel: (0203) 525466 Fax: (0203) 525468

PG PLUG

YAMAHA AD2X

19 BIT 2 CHANNEL A/D CONVERTER

THE NEW STANDARD



INNOVATIVE UNPARALLELED PRECISION

Yamaha's innovative 'digital floating' technology is applied to these advanced, high-rate, 1-bit delta-sigma convertors. Its unprecedented conversion precision delivers 19-bits of Digital Audio. For CD Mastering, 2-track and MTR digital recordings, enhanced DAT performance, Digital Mastering, A to D Mastering transfers, editing and measurement operations, the AD2X substantially improves on the 'quality limiting factor' in all of these processes.

FEATURES

Automatic and manual self calibration.
Internal bit shift for data delay compensation 20-bit output word length.
Yamaha output formats.
AES/EBU, CD/DAT and word clock in/out.
Switchable sampling frequency and emphasis.
Electronically Balanced Analog input.

SPECIFICATION

Conversion:	19-Bits Digital Floating 64 times oversampled A/D
THD:	less than 0.005% (nominal level) less than 0.0018% (max level)
Dynamic Range:	Greater than 110 dB
Hum & Noise:	less than - 90dB
Sampling Frequency:	48/44.1 KHz

YAMAHA DIGITAL AUDIO SYSTEMS

YAMAHA KEMBLE MUSIC (UK) LTD · PRO AUDIO DIVISION · MOUNT AVENUE · BLETCHLEY · MILTON KEYNES · MK1 1JE · TEL: (0908) 371771

ANNIVERSAIRE
25
ANNIVERSARY
25



MIDEM

THE MUSIC SHOW

MORE BUSINESS, MORE PARTICIPANTS, MORE NEW EVENTS,
MORE CELEBRATIONS, MORE MUSIC.

NOW IN ITS 25TH GLITTERING STAR STUDDED YEAR

PALAIS DES FESTIVALS, CANNES, FRANCE.

20-24 JANUARY 1991

CONTACT

PETER RHODES, MIDEM, METROPOLIS HOUSE, 22 PERCY STREET, LONDON W1P 9FF.
TEL: 071-528 0086, FAX: 071-528 0949, TELEX: 920173

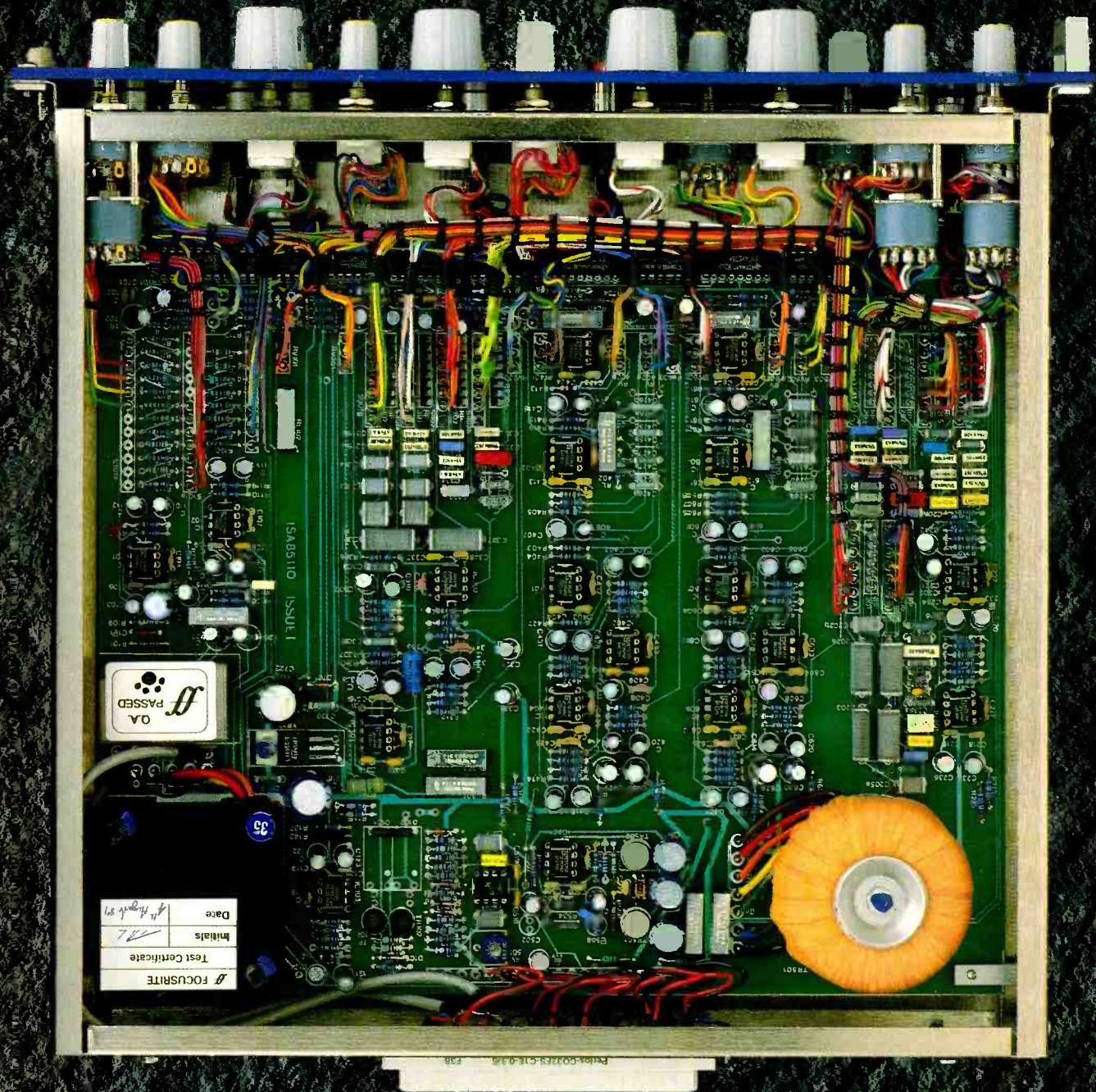

PASSSED
QA

Test Certificate
FOCUSRITE

Date	
Initials	<i>[Handwritten Signature]</i>

35

ISABEILLO
ISSUE 1

“Digital probably
won’t surpass
Focusrite’s
analogue quality
within the next
fifteen years”.



NOTHING SHORT OF EXCELLENCE

FOCUSRITE AUDIO ENGINEERING LIMITED,
UNIT 2, BOURNE END BUSINESS CENTRE, CORES END ROAD, BOURNE END, BUCKS SL8 5AS, ENGLAND
TELEPHONE ++ 44 (0)628 819456 FAX ++ 44 (0)628 819443

AUSTRALIA GREATER UNION VILLAGE TECHNOLOGY (02) 550 5488 **BENELUX** TEM (02) 466 5010
CANADA IMAGINATIVE MARKETING (514) 685 2046 **DENMARK** SLT (01) 713 344
FRANCE SCV (1) 48 63 22 11 **GERMANY** THUM & MAHR (49) 2173 78060
ITALY AUDIO EQUIPMENT (39) 2000312 **JAPAN** TIMELOD (0468) 73 6226 **NORWAY** LYDROMMET
(02) 11 4085 **SWEDEN** TAL & TON (031) 803 620 **USA** SONIC IMAGE (312) 653 4544

On the left is what amounts to a work of art in analogue.

For within this hand-crafted maze of circuitry lies perhaps the finest audio signal path ever created.

The work bears the imprint of its legendary designer, complete with his experience and emotions, since it represents the embodiment of the attributes that he considers paramount.

It was the product of an almost fanatical devotion to the mathematical calculation of component values – as well as their specification – and some of the solutions it contains don’t exactly conform to the norm. For instance, circuits are isolated from each another by the copious use of buffering, and all inputs and outputs are transformer isolated. The actual circuit topology is rather unusual too.

Of the hours spent in development, perhaps the most critical involved auditioning by some of the finest ears in the business; a test, incidentally, that we’d like you to do as well.

The result is a sound that is unique to Focusrite; a warm, musical sound with no side effects at all; a sound that can be found in our module products which are used extensively in major recording studios today.

But what of the future?

While maintaining the integrity of our audio paths, we have now developed the Focusrite Studio Console. We believe that the innovations within this new evolution make it the ultimate expression of analogue recording console design. And it will set new standards of performance that will last for many years to come.

A ROOM OF MY OWN: MIKE HEDGES

Mike Hedges, a producer with some of the most influential albums of the last decade to his credit (including work with Siouxsie & The Banshees and The Cure) is now firmly committed to working with the Akai Digital Audio Multi-track (A-DAM) in his set-up. At his "home" studio in North West London, Mike has 28 tracks at his disposal, combining an early 70s 16 track analogue machine and a DR1200, of which he has become a firm fan over the last year.

Mike Hedges first saw A-DAM at the AES show, and his interest was stimulated enough to contact Akai to arrange a test of the machine. "Within 24 hours of working with it, I knew that A-DAM would be right for me. It fitted in exactly with what I was looking for—a digital machine with the precision I needed, which is very good value for money. I wouldn't say it's cheap—it's an expensive machine, and it does an expensive job—but relative to other digital machines it's extremely good value."

As well as being a good investment from a financial point of view, the machine had a number of features which made it a very attractive proposition. "Drop-ins and drop-outs are fantastic, especially if we're multi-tracking backing vocals and things like that: we can do that on twelve tracks absolutely cleanly. For instance, you can drop in and out in the middle of words without any difficulty, it's so precise. A lot of people think the Mitsubishi is unbeatable, and it is very good for dropping-in and out, as is the Sony, but this matches them easily—it's perfect. How can you get better than that?"

Things have not been entirely plain sailing, however: Mike had some early problems



Mike Hedges at "home" with his EMI desk (formerly installed at Abbey Road) and Akai A-DAM system.

with some of the tape on the market, which highlighted some software deficiencies now resolved by Akai. "In the early days, when I first started using the machine, we did have problems with the first tape we bought: we had drop out problems, and there were a lot of errors being displayed. It wasn't a problem, it just showed that there were errors. Then, the software of the time would cause the machine to stop recording. The new software no longer does that: if there is an error, the machine doesn't drop out of Record, it merely corrects it.

The other thing we did was to change to Maxell tape, and we haven't had a problem since, which has been about seven or eight months, and has been really reliable. In fact, since I've been using the new software, I've used the old tapes for demos. The transport

is excellent—really fast and precise—and the whole system has been extremely reliable. I've had no real problems at all."

Working in a quite unique way which incorporates the use of both digital and analogue multi-tracking for different aspects of the music, Mike is in a position to judge the merits of both formats in a more objective way than probably anybody else in his field. But working with two formats means that synchronicity has to be exact; this is another A-DAM advantage. After getting the required sound on analogue—perhaps its a rhythm section with a 60s feel—Mike can either synchronise the two machines for mixing directly, or, as often happens, he bounces everything off the 16 track, ending up with a sub-master

on the DR1200, in order to do a 12 track mix.

It's not only Mike that is convinced about A-DAM. In the first twelve months since its launch, over 600 systems have been sold world-wide with over 44 sold in the UK alone. As well as Mike, UK users include Dave Stewart, Michael Kamen and Ricky Wilde—whose sister Kim recently completed a new album on A-DAM. Around the world, top artists and producers such as Nile Rodgers, Stevie Wonder, Bob Seger, Madonna and Hans Zimmer are also using the system.

A twelve track A-DAM digital multi-track recording system costs £15,695 and can be expanded to 24 or 36 tracks. For more information on A-DAM contact Akai Digital Division on 081-897 6388.

Valley International statement

Norman Baker, President of Valley International Inc, has confirmed that his company filed for reorganisation under the provisions of Chapter 11 of the Federal Bankruptcy Code on February 13th, 1990. Baker explained, "This action became necessary to preserve claims which our company has against a contract manufacturer of Valley products and to protect new suppliers until this conflict can be resolved."

According to Baker, "Valley entered into an agreement with the supplier to begin delivery of a substantial portion of the Valley product line effective July, 1988. The supplier failed to deliver the goods on time and in the quantities agreed upon. These actions forced Valley to fall behind in its deliveries and interrupted product flow. After several attempts to remedy this problem, Valley was forced to seek

alternative sources of supply. Ironically, these unfortunate circumstances have served to heighten demand for our products. We now have three independent sources manufacturing and delivering products to us so that we can catch up on existing orders and quickly return to normal delivery times."

Baker further stated, "During this very difficult time we have been overwhelmed by the supportive attitude of our loyal customers, dealers, distributors, representatives and vendors. Having now found an effective method to remedy our past problems, I look forward to achieving smooth and predictable product deliveries in the very near future and furthering our reputation in the industry by delivering new products and technologies for the recording, broadcast and live sound industries."

Exhibitions and conventions

July 17th to 22nd British Music Fair, Olympia 2, London, UK.

August 19th to 22nd Video Expo '90, Palacio Das Convencoes do Anhembi, Sao Paulo, Brazil. Contact: (UK) Alison Carew-Cox. Tel: 021-45 9600. Fax: 021-456 1785.

September 9th to 12th 90 Light and Sound Show, Olympia 2, London, UK. Contact: 3D Services. Tel: 081-569 9742.

September 21st to 25th International Broadcasting Convention, Metropole Conference Centre, Brighton, UK. Contact: IEE Secretariat. Tel: 071-240 1871.

September 21st to 25th AES 89th Convention, Los Angeles Convention Center and Los Angeles Hilton, Los Angeles, CA, USA. Contact: AES USA. Tel: (212) 661-8528.

October 3rd to 9th Photokina,

Cologne Fair Grounds, Cologne, West Germany.

October 4th Sound Broadcasting Equipment Show, Albany Hotel, Birmingham, UK.

October 13th to 17th SMPTE, Los Angeles, CA, USA.

November 15th to 17th InterBEE, Nippon Exhibition Centre, Japan.

1991

February 19th to 22nd AES 90th Convention, Palais des Congres, Paris, France. Contact: AES Exhibition Director Herman A O Wilms, Zevenbunderslaan 142/9-B-1190 Brussels, Belgium. Tel: (2) 345 7971. Fax: (2) 345 3419.

April 15th to 18th NAB, Las Vegas.

June 13th to 18th International Television Symposium, Centre de Congrès, Montreux, Switzerland.

News from the AES

Our next evening meeting will be on Tuesday July 10th, when Bob Stuart, Technical Director of Boothroyd Stuart Meridian, will be presenting a wide range of material in his talk **High-quality Digital Audio**. Starting from first principles he will review the accepted position relating subjective and objective performance of nearly linear analogue electronics. The lecture will then review digital audio systems concentrating on defects which are both inherent and unintentional due to engineering.

Many aspects of digital audio will be covered including conversion, transmission, storage, CD, DSP and coding. At each point he intends to show and explain subjective results from the first principles of electronics and psychoacoustics. Obviously a discussion of high quality presumes that digital systems vary and therefore there will be some references and contributions to the 'Great Debate', particularly relating these problems to recent findings and thinking of psychoacousticians.

The lecture will conclude with an objective specification which may come close to defining a perceptually perfect audio chain. The lecture will be illustrated with some demonstrations.

This lecture will be held at the IBA, 70 Brompton Road, London SW1 starting at 7.00pm, with coffee at 6.30pm. As with our other monthly meetings, members and visitors are most welcome to attend. To help future planning, the dates, speakers and titles of our future monthly meetings are listed below (more

details will be available on each nearer the time).

September 11th
BBC Control Room at BH
George Legg

October 9th
AGM & Annual Dinner

November 13th
Digital Audio in Professional Video Recorders
John Watkinson

December 11th
Room & Loudspeaker Correction using Digital Equalisation
Peter Craven

A number of new books have appeared which will be of interest to many in the audio business.

● John Watkinson has followed up his highly acclaimed book **The Art of Digital Audio** with the companion **The Art of Digital Video** (£42.50). He has also written a book entitled **Coding for Digital Recording** (£15.95).

● John Borwick has added to his book **Loudspeakers and Headphones** with a book looking at the other end of the audio chain **Microphone Technology and Techniques** (£25.00). After his book **Stereo Sound for Television**, Francis Rumsey has now written one on the very topical subject **Tapeless Recording** (£14.95).

For further details on any of the above or information on joining the AES, please contact: **Heather Lane, AES British Section, Lent Rise Road, Burnham, Slough SL1 7NY, UK. Tel: 0628 663725. Fax: 0628 667002.**

Agencies

● Amber Technology have announced their appointment as Australian distributor of Otari recording products. Amber Technology, PO Box 942, Brookvale, NSW 2100. Tel: (02) 975 1211. Fax: (02) 975 1368.

● Protape, retailers of magnetic media and associated hardware, have announced their appointment as sole UK distributor of **BNS Professional Loudspeakers**. Protape, Jadwin House, 205/211 Kentish Town Road, London NW5 7EJ. Tel: 071-267 9336. Fax: 071-485 1154.

● Canford Audio have been appointed sole UK and French agents for **MB** products. The MB range includes both detachable and non-

detachable capsule studio condensers, ultra-linear measurement, and boundary layer mics. Canford Audio, Washington, Tyne & Wear NE38 0BW. Tel: 091 417 0057.

● Italian sound reinforcement equipment manufacturers **db Technologies**, based near Bologna, Italy, have appointed two new distributors.

Austria: Bauer Sound, Davidgasse 79, Vienna A-1100, Austria. Tel: (222) 601 17. Fax: (222) 602 2859.
Greece: Prophile SA, 3G Theatoka Street, GR-546 21 Thessaloniki, Greece. Tel: (31) 260 922. Fax: (31) 223 254.

New scheme for radio frequencies

The Dept of Trade and Industry's Radiocommunications Agency in the UK have announced a new scheme to co-ordinate the licensing of radio frequencies used by independent film, TV and radio production companies. The new scheme will be operated by ASP Frequency Management Ltd, acting as agent for the DTI. They will be responsible for co-ordination and licensing of use of a small amount of radio spectrum needed by the entertainments industry for devices including radio microphones, remote sound and vision links and

radio talkback links.

The scheme has been introduced in response to current and expected demand from independent programme makers and will provide them with access to the radio spectrum for perhaps the first time. Information sheets outlining the general principles of the scheme and scheme application forms are available from ASP Frequency Management, Edgcott House, Lawn Hill, Edgcott, Aylesbury, Bucks HP18 0QW, UK.

Contracts

● **tc electronic** have sold four 1128 graphic equalisers to BBC Radio 2 to preset the EQ on all of the 20 presenters.

● Clinton recording studios, New York, have installed a new **Studer Dyaxis** digital audio production system equipped with three 320 Mbyte hard disk drives providing just over 1½ hrs of stereo audio storage.

● Airport Studios in Milan, Italy, have recently completed an acoustic and equipment upgrade. New equipment includes an **Amek Mozart** 56-channel desk, **Otari 900 PD** digital multitrack, and **Studer A820** analogue multitrack with **Dolby SR**. The control has been acoustically improved and more space provided. A MIDI room and audio-for-video facilities are also included.

● **Audiomaster**, a new digital recording facility in Washington DC, USA, have installed over 90 ft² of the **Systems Development Group's Art Diffuser**, one of the largest applications of their acoustic treatment product in the US.

● **Industrial Acoustics Company** (IAC) of Staines, Middlesex, has been awarded a contract by Bovis Construction to design, manufacture, supply and install 14 voiceover studios for ITN's new headquarters in Grays Inn Road, WC1, London.

● The Power Station, New York, have taken delivery of an **SSL**

SL 4000 G series console with 80 inputs and **G** series computer automation. The console will be installed in the facility's new audio-for-video mixing suite.

● **Digital Audio Research** have recently delivered seven more **SoundStation II** systems to customers and new distributors. Included are DAR's French distributor 3M; BBC Belfast; and Madrid studio Eurosonic who have ordered a 16-channel unit with **WordFit** ADR software.

● Sonoland, one of Madrid's music recording studios, have opened Studio B, a new **Recording Architecture** designed facility. The control room is a carbon copy of Studio A's control room designed by Recording Architecture in 1987.

● Recent orders for the **Soundtracs Quartz** console include Paul Carrack, lead singer of Mike and the Mechanics; and Noel Ram of Ram Productions, London, for installation in the new production suite.

● The Audio Outpost post-production studios have recently opened in London's West End with two rooms based around the **WaveFrame AudioFrame** digital audio system. UK distributors Stirling Audio Systems, have supplied two **AudioFrames** for the new rooms, together with two **DDA S** series consoles and a range of outboard equipment including **Lexicon 480Ls**.

In brief

● London, UK: PRS have announced that the PRS John Lennon Awards will now only be open to students at Salford College of Technology. The awards, which are to be donated by the PRS to honour the memory of John Lennon, will be made to students who prove outstanding on Salford's Popular Music and Recording Courses.

● **Begbroke, UK: Solid State Logic**, in response to an increasing number of demands for operational demonstrations of **ScreenSound** digital audio-for-video system, have introduced a 20-minute training video, which guides the viewer around the **ScreenSound's** features and facilities.

● London, UK: **Recording Architecture**, the recording studio design and acoustic consultancy group, has been listed as a consultancy under the Department of Trade and Industry's Design Initiative. The Design Initiative is able to make grants to clients of listed consultancies in order to contribute to consultancy work.

● Hollywood, CA, USA: **Full Sail Center for the Recording Arts** have just opened their first West Coast branch in Hollywood. The new Full Sail Center, Full Sail West, is based at Margarita Mix, a new five-studio complex in Hollywood. One of

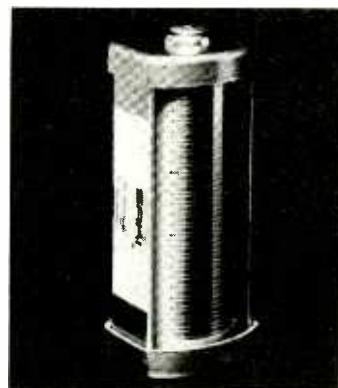

Saki Magnetics replacement record head for Studer 24-track recorders

the five new studios is completely equipped with an **NED Synclavier** and **PostPro** workstation.

● London, UK: **Metropolis Studios'** three new rooms, designed and built by Eastlake, will feature a new Focusrite console as well as new Neve and SSL consoles.

● Calabasas, CA, USA: **Saki Magnetics** are now offering immediate delivery of their factory equivalent record and playback heads for use with Studer A-80 and A-800 series 24-track studio recorders. The Saki heads are made of longlife Permalloy to meet Studer electrical and mechanical specifications and are interchangeable with original heads with no wiring modifications.

People

● **Scarlett Studios**, London, have announced the promotion of Sandy Dworniak and Sharon Lord to the position of studio managers at Power Plant and Maison Rouge studios. Scarlett Group have also announced the appointment of Colin Fairley as general manager studios and production.

● **DDA's** sales and technical support team has been strengthened by the arrival of Chris Gibbs, who had extensive training in the RAF. Gibbs joins DDA from Neve.

● **Robbie Piddington** has been appointed area sales manager by pro-audio distributor **Michael Stevens & Partners**. Piddington was formerly area sales manager with Hayden Labs.

● **Glyn Baxter** has been appointed UK head of professional audio sales and marketing at **Celestion**. Baxter comes from Audio Fidelity plc.

● **Bill Whitlock** has been named president of **Jensen Transformers**.

He was Deane Jensen's business associate during the 2 years before Jensen's death. It was Jensen's wish that Whitlock assume presidency of the company.

● **Hagai Gefen**, president of **Gefen Systems**, Woodland Hills, CA, has announced the appointment of Jon Beachdell to the position of vice-president, sales and marketing.

● **Quested Monitoring Systems** have announced the appointment of Terry MaQuaide as production manager as a direct result of an increase in export sales.

● **Nick Bowdery** has joined the pro-audio sales team at **Sony Broadcast** as sales engineer. Bowdery comes from the BBC.

● **Clive Green & Co**, manufacturer of **Cadac** theatre consoles, has appointed Philip Jones as senior digital development manager. Jones comes from 6 years with Audio Kinetics.

CREATIVE STANDARDS



The AMS range of digital processors is designed to deliver creative audio solutions.

From the same family of products as the AudioFile, the world's leading hard disc editor and the SoundField surround sound microphone, their pedigree is guaranteed.

Happily these digital processors are now so widely used, they have become standards in more ways than one. Perhaps that's because we apply only one standard ... excellence.

- (A) TimeFlex Digital Audio Time Compressor/Expander
- (B) S-DMX Digital Audio Delay and Pitch Changer
- (C) RMX 16 Digital Reverberator
- (D) A/V Sync Auto Compensating Audio-for-Video Delay



For information and literature contact...

AMS Industries plc
 Billington Road, Burnley BB11 5ES, UK
 Tel: (0282) 57011 Fax: (0282) 39542

AMS Industries Inc
 1180 Holm Road, Suite C, Petaluma, CA 94954, USA
 Tel: (707) 762 4840 Fax: (707) 762 4811

Media

14 The Markham Centre, Station Road,
 Theale, Berkshire RG7 4PE,
 United Kingdom.
 Telephone: (0734) 303800
 Fax: (0734) 323121
 (IDD +44 734)
 Telex: 858893 FLETEL G

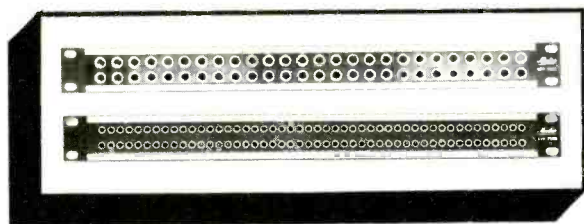

APP SERIES

Audio Patch Panels

- Wide range of 20, 24, 26 Ways with 1/4" BPO Jacks
- 2 or 3 Rows of 1/4" BPO Jacks, in 2 U Height
- High Density version has 2 Rows of 1/4" BPO Jacks in 1 U Height
- 2 Rows of 48 and 52 Ways of Bantam Jacks in 1 U Height
- Stereo Spacing of Jacks as standard
- Can be supplied Connectorised with choice of Rear Connector
- Combined Audio+Video Format also available

Media

14 The Markham Centre, Station Road,
 Theale, Berkshire RG7 4PE,
 United Kingdom.
 Telephone: (0734) 303800
 Fax: (0734) 323121
 (IDD +44 734)
 Telex: 858893 FLETEL G

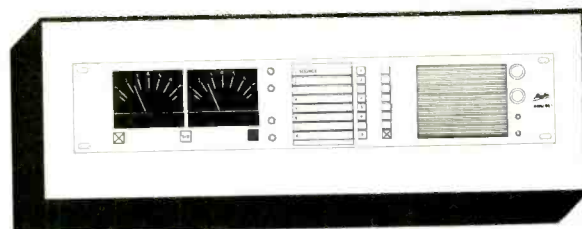

AMU 8S

Audio Monitoring Unit

- Can monitor up to 8 stereo lines
- Integral multi-standard ident generator
- Dual P.P.M.'s and integral speaker
- Stereo speaker and line level outputs
- Compact 2U high rack mounting
- Full remote control facility

Letter: Business of CEDAR

Dear Sir, Following the numerous conversations between Barry Fox, the staff of CEDAR and the National Sound Archive, it is remarkable how little he has managed to understand about CEDAR's history, objectives or current capabilities (*Studio Sound*, May). In addition Mr Fox was supplied with full documentation, including an installation proposal, system specification and price lists for bureau work and system purchases. I discussed these with him over the telephone before he prepared his article and, therefore, cannot understand his drastic errors and omissions. Put bluntly, his grasp of our history and his ignorance about the price and availability of CEDAR are atrocious. In addition, Fox has discussed Neve, the BLNSA, and even the development of optical disk technology but has completely managed to avoid any serious discussion whatsoever regarding the audio performance of CEDAR.

Mr Fox has been invited to Cambridge to view CEDAR on numerous occasions and, having ignored all such invitations, is in no position to comment on our staff, working practices, or premises. Indeed, it is impressive how he has

managed to present our recent move to newer, larger offices as a criticism of the company. For the record, anyone is welcome to visit us and recent guests include EMI (including Keith Hardwick), the BBC, CBS, Conifer, Gotham Audio and Robert Parker.

However, despite Parker's visit, neither he nor Fox are in any position to state whether the CEDAR bureau is profitable or not. They have no information whatsoever on this subject and it was totally unprofessional of Fox to print such a statement. The bureau (which has never demanded royalties) has been invaluable in ensuring that the CEDAR Production System is fully tried and tested and over 100 CDs, plus numerous TV and radio broadcasts, have been processed. These have, without exception, been accepted by our customers.

Fox's further claim that, in January 1990, only one CEDAR CD was available, shows a lamentable lack of research and significant ignorance regarding the penetration of CEDAR into the audio industry. At that time there were, in addition to the PRT *Planets*, 25 CEDAR CDs available from CBS, seven from Reader's Digest

Records, and further releases from Castle, Conifer, Denon, Polygram, Grosvenor and Vintage Productions either in the shops or in the pipeline.

The current realtime CEDAR system represents the culmination of over 5 years research and development by leading authorities in the field of digital signal processing. Performing over 300 million calculations per second of material, CEDAR's DSPs are 1,000 times faster than an 'off the shelf' PC, and Mr Fox has apparently confused the price of the host PC with the selling price of the CEDAR system, which comprises host, DSPs, and software. For the record, the entry-level CEDAR system currently costs £22,000.

The results obtained using a realtime system far surpass those that can be obtained with a batch-processing device. A little thought about the logistics of non-realtime usage makes it obvious how much of an advantage it is to hear the output as you adjust the relevant parameters. In comparative tests at AES/90 in Montreux, a side by side comparison showed that CEDAR was, sonically, far superior to its nearest rival. This has been confirmed by the response to the

scores of A/B demonstration tapes that have been supplied worldwide since 1988 but which Fox has failed to acknowledge.

CEDAR is now progressing smoothly along the course laid down by its parent bodies: the BLNSA and Cable & Wireless. This association, which is advantageous to all parties, was only confirmed after the NSA had had discussions with many other companies and public bodies, and is a consequence of their mutual interests in signal processing. The implication of the 'old-pals act', and the erroneous side-swipe at Dr Roads' association with Mdm Marcos of the Philippines are gutter journalism wholly unsuited to *Studio Sound*.

However, by far the greatest absurdity in Mr Fox's article is the implication that the NSA would consider storing the CEDAR processed copy of a recording and destroying the original. This is ludicrous. I can reassure the public that the British Library is far more aware of its archival obligations than Fox is of his facts.

**Yours faithfully, Gordon Reid,
General Manager, Cambridge
Sound Restoration, 5 Glisson
Road, Cambridge CB1 2HA, UK.**

Barry Fox replies: With the best will in the world, I do not know where to begin defending myself against Gordon Reid's accusations. He was not present at the meetings I had with Christopher Roads, Director of the National Sound Archive, or Kenneth Cooper, Chief Executive of the British Library.

Also 'the greatest absurdity' of which Reid accuses me, namely that I implied the NSA would consider destroying original recordings after storing a CEDARised copy, appears to be a figment of Gordon Reid's anger. I made clear in my text that Dr Roads planned to keep the original recordings 'for as long as they last' after storing CEDARised copies. I also quoted Kenneth Cooper's 'categorical reassurance' that there was no policy commitment to CEDARising before storage.

There is much more I could say but to avoid an unproductive slanging match, I suggest readers simply judge for themselves from the following schedule of events:

On July 15th 1989 I wrote to the

NSA expressing interest in CEDAR. I heard nothing, so I sent reminders on September 4th and 20th. I still heard nothing so on October 19th I wrote to BL asking, "What on earth is happening at the National Sound Archive?" I received a reply from BL but still nothing from the NSA or CEDAR.

On November 9th I wrote to the British Library expressing growing frustration about CEDAR and copied my letter to Dr Christopher Roads.

On November 11th, with article deadlines approaching, I phoned CEDAR in Cambridge and spoke with Gordon Reid (from whom I have previously heard nothing). Reid promised to do a computer print-out of all available information. This arrived; it included the raw text of an article by Reid dated November 14th, and three word-processed letters, to which my name had been added, back-dated to October 18th, 25th and 26th.

In December I finally heard from Dr Roads' secretary and attended a lengthy meeting at the NSA on

January 8th, 1990. Dr Roads promised to send me a demonstration cassette. It didn't arrive, so I wrote a reminder to him on January 18th.

Because I was so worried about some of the things told me by Dr Roads, I asked for the BL comment on them and met the Chief Executive Kenneth Cooper at their HQ on February 8th. I read Cooper passages of text from my draft article and made alterations, excising some passages as a gesture.

Still with no tape, I wrote again to Roads on February 21st, copying the letter to Gordon Reid. In a letter dated March 1st, but delayed by the mail strike, Reid declined to send a tape and suggested that I visit him in Cambridge.

On March 20th, with deadlines now passed I replied to Reid, copying my letter to the British Library's Head Office, saying that my diary was full but "I would be happy to give up a weekend day and drive up to Cambridge on a Saturday or Sunday." I also repeated my request for a demonstration tape adding, "If

you get enquiries from abroad, you presumably don't insist that all enquirers travel to Cambridge?"

I never heard anything from Gordon Reid in reply to my suggestion that I give up a weekend day for a Cambridge demonstration, or received a tape from him. Later I heard from the British Library that Reid had resigned. Now it appears he has asked for, and got, his job back.

After further reminders to the BL Head Office I finally received a tape at the beginning of April, 3 months after it was originally promised by Dr Roads and long after my articles had passed for publication.

Editor's note: We will shortly be publishing a detailed look at the practical and technical aspects of the CEDAR restoration process.

Letters for publication should be sent to the Editor, Studio Sound, Link House, Dingwall Avenue, Croydon, Surrey CR9 2TA, UK.

The drive units at the heart of every new Turbosound enclosure are built by Precision Devices Ltd.

A company specifically established by our parent company, Edge Technology Group, to develop drive units with unsurpassed reliability and audio performance.

DEVELOPING THE CONE AND COIL.

Particular attention has been paid to designing each cone's profile and materials for its intended application.

The voice coils are wound with pure copper for long term strength and reliability, coated with high temperature enamel, onto an epoxy resin-impregnated woven fibreglass former.

The whole assembly is cured at high temperature to give it a completely rigid, integrated structure for greater strength and energy transmission abilities.

AN ADVANCED MAGNET ASSEMBLY.

The magnet assemblies are of the traditional iron and ceramic 'sandwich' type. The difference lies in our attention to detail and the quality of materials.

Top quality low-carbon steel is machined to very fine tolerances to maximise contact between plates. And as tight a magnetic gap as possible in turn gives greater magnetic power and increased cooling for the coil. (In our larger drivers, we also bolt the parts together for extra strength).

Finally, the loudspeakers' frame designs are based on the soundest of

engineering principles, with generous use of die-cast aluminium alloy to ensure their indestructibility on the road. In fact, our frames weigh twice as much as most other manufacturers'.

Guaranteeing that even under massive physical shock, the assembly won't suffer.

ATTENTION TO DETAIL.

All this attention to detail means that every step in the manufacturing chain is designed to enhance our enclosures' performance.

Finally, the components come together in a modular assembly process, with testing at every step, before being fitted into enclosures that have been built with equal precision.

The result is a finished product that produces accurate, natural sound simply through the precise matching of its components. Which means that, more than ever, there is no need for external electronic compensation.

So that's a breakdown of what Precision Devices will mean to you.

And what makes Turbosound enclosures so exceptionally reliable.



TURBOSOUND LIMITED, STAR ROAD, PARTRIDGE GREEN, WEST SUSSEX RH13 5EZ. TEL: (0-403) 711447
TELEX: 878723 TURBO G. FAX: (0-403) 710155. IMC TURBO-UK

HOW DO PRECISION DEVICES MAKE OUR SPEAKERS SO RELIABLE? HERE'S A BREAKDOWN.

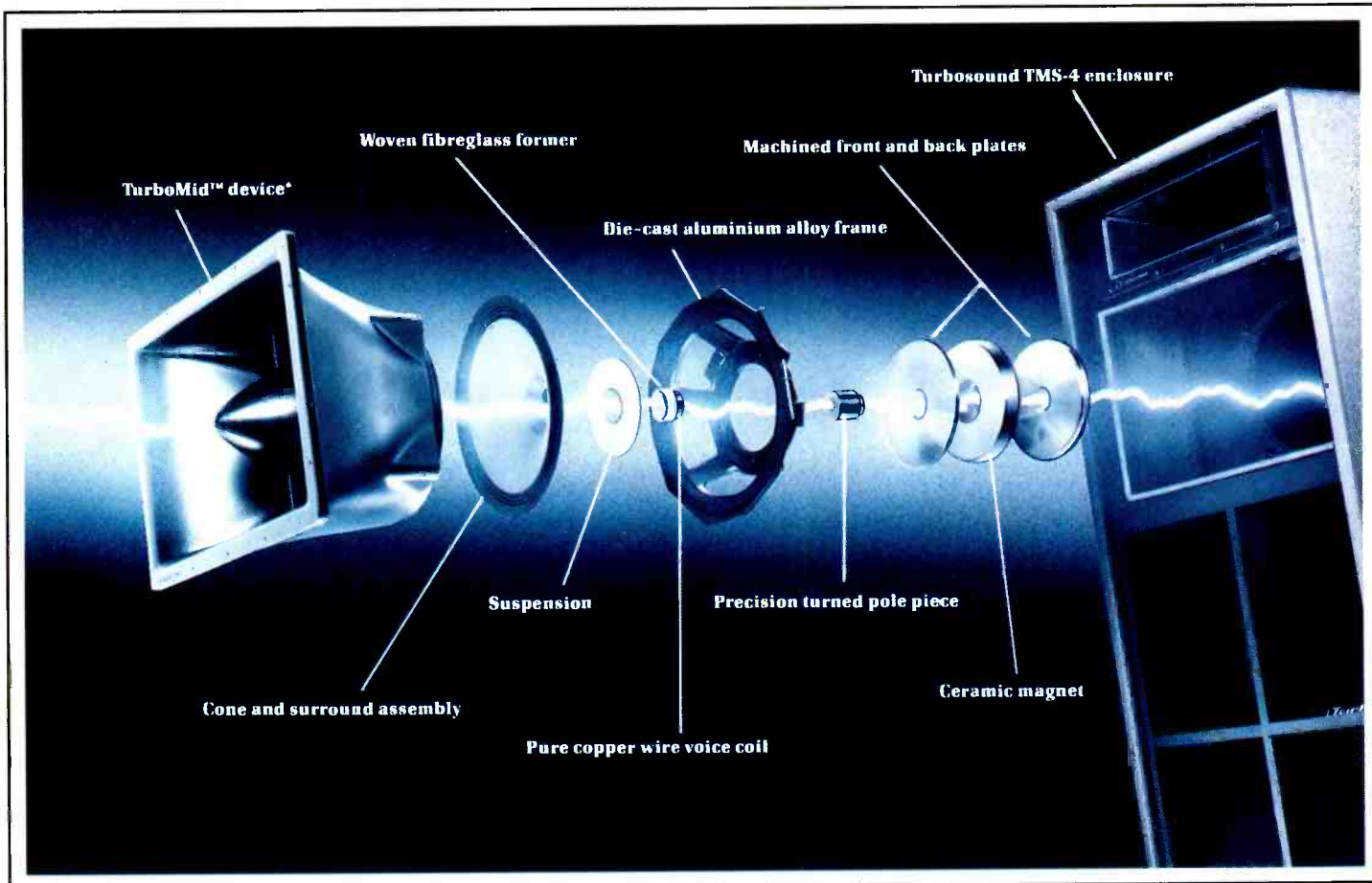

WORLDWIDE AGENTS: AUSTRALIA: A.T.T. AUDIO CONTROLS PTY LTD MELBOURNE (03) 379-1511 AUSTRIA: AUDIOSALES MOEDLING (02236) 26123 BELGIUM: T.E.M. ZELLIK (02) 466-5010 CANADA: DMNIMEDIA CORP MONTREAL (514) 638-8971 DENMARK: PERMEISTRUP PRODUKTIONS KARSLEUND (42) 151300 FRANCE: REGISOF-NE PARIS (01) 4396-5050 GREECE: ALPHA SOUND ATHENS (01) 363-8317 HOLLAND: T.E.M. BREIDA (076) 812872 HONG KONG/CHINA: TOMEE AUDIO CO. HONG KONG (4) 730-0998 INDONESIA: DAVID SUTEDIA & ASSOCIATES JAKARTA (21) 4512617 ISRAEL: BARKAI RAMAT-GAN (03) 735178 ITALY: AUDIO LINK PARMA (052) 598723-4 JAPAN: EDGETECH (JAPAN) LTD TOKYO (03) 295-4741 KOREA: YOUNG NAK SO RI SA LO SEOL (01) 267-9697 NORWAY: NORDEK EQUIPMENT OSLO (02) 231590 PHILIPPINES: STAGE CRAFT INTERNATIONAL INC. MANILA (02) 834-0519 PORTUGAL: CASA PAUL S ARTIGOS ALI SIAIS (11) 010170 (02) 0304456 SINGAPORE/MALAYSIA: SWEET LEE SINGAPORE (03) 236-2307 SPAIN: LEYON BARCELONA (03) 203-4004 SWEDEN: INTERSONIC SIDA KJODI M (08) 714-5853 SWITZERLAND: SINEL SCHENENWERD (64) 413747 TAIWAN: PROSOUND INC TAIPEI (4) 235-1873 THAILAND: BANGKOK GINE GRAPHIC CENTRE BANGKOK (02) 314-3570 K.C.M. BANGKOK (02) 222-4712 TURKEY: NEFAN ISTANBUL (01) 160-4514 UK: FIRST AUDIO LTD. BRIGHTON (0273) 893610 U.S.A.: GROUP ONE INC. NEW YORK (516) 249-3660 WEST GERMANY: ADAM HALL LUSINGEN (6081) 18031

Turbosound Patent Information: Australia: 515, 535 Canada: 1,076,033 Japan: N113424/77 UK: 1,592,246 & 1,598,310 U.S.: 4,215,761 & RE 32,183 West Germany: P2742600/2 Other patents pending

an EdgeTech company
LONDON • NEW YORK • TOKYO



Telekinoradiotechnika 90, Moscow—show report

The nearest equivalent to an AES Convention in the Soviet Union is the Telekinoradiotechnika exhibition. As the name suggests, the main areas of exhibit are television, film and radio, though other fields such as sound reinforcement and consumer electronics are also represented. Unlike an AES or IBC/TTS show, however, there are no technical sessions or lectures.

Held every 4 years, the 1990 show took place in the Moscow Expocentre, which is situated by the Moskva river and far enough away from the main routes to make access a little difficult if you are relying on public transport.

The exhibition covered the main ground floor with some spillover into the first floor, which made some stands not so easy to find.

Most Western exhibitors found the organisation of the event reasonably efficient, though the cost of attending an exhibition in Moscow at present is such that it will be a long time before it can be considered as a possible venue for a European AES.

A wide range of products is encompassed and the show is open to the general public, which means that heads of broadcast organisations are rubbing shoulders with people to whom a television set is perhaps still a source of amazement. One may ask why the general public would bother to visit such a show but an exhibition is always a subject of curiosity and the consumer-oriented companies such as Philips and Panasonic always make sure that part of their stand includes consumer product displays.

Companies such as Sony, Ampex and Siemens all had large stands while other manufacturers tended to be grouped on distributors' stands, eg SSL/Nagra/Albrecht on Cinac Systems, Dolby/Soundcraft Klark-Teknik on Denis Tyler Ltd. Mark IV, with Electro-Voice and Altec, had a dedicated stand and there was a large AKG stand. Other companies were there to test the market and these included New England Digital and Snell & Wilcox.

Some West Europeans such as France and Germany were properly organised and had government-sponsored packages that enabled them to have dedicated exhibition alleys and appropriate promotional material such as plastic bags—almost a hard currency in the Soviet Union.

The lack of government support for

British companies came under severe attack from Snell & Wilcox who felt that export was being actively discouraged instead of promoted.

For the Western pro-audio visitor Soviet exhibitions will appear strange in that stands are chained off from the public, with only 'serious' customers being allowed into the 'inner sanctum' to discuss business. Some stands, such as Sony's, were completely shut off from the outside world with just large windows for people to look through.

It is clear that for a public that has never seen sophisticated goods before, the enthusiasm does need to be restrained, especially when there were 'hits of the show' such as the Klark-Teknik/Midas demo featuring a hard-pressed David Webster on the Tyler stand or the MIDI workstation based around a Korg T1 on the Cinac stand.

The other interesting aspect for the western visitor is the opportunity to see and compare pro-audio products produced in the Comecon countries (the eastern bloc common market). The recent political changes have caused the emergence of independent companies (usually known as co-operatives) who are either producers or, more often than not, engineering consultants. The multitude of technical institutes in the Soviet Union has caused an obsession with technical specifications without too much regard for practicalities and it is amusing to be told that your best-selling product can be improved in ways that will make it technically better but that will be hard to detect in practice.

The bulk of audio equipment is manufactured outside of the Soviet Union with the main centres being Czechoslovakia, Hungary and Yugoslavia.

One Soviet item being heavily promoted was the Mirage E001 graphic equaliser from the co-operative Gamaun. The 31-band

unit features very high technical specifications such as bandwidth 10 Hz to 150 kHz, THD 0.005% and signal/noise ratio 130 dB. The equaliser is claimed to have very low phase shift and amplitude-frequency error coupled with minimum interaction between adjacent bands. An important part of the design is a 'newly-designed multipath slide-switch' for each of the frequency bands.

Also on display was an editing and duplicating system for video called AGAT-2M and controlled by IBM-compatible computers. The system seems mainly intended for broadcast use, as far as I could understand until my Russian ran out.

Tesla of Czechoslovakia manufacture a range of consoles and recorders. Their stand featured a console for installation in an OB van, which probably accounted for the unusual placing of the patchbay. The range of recorders consists of the 4-track ¼ inch EKM 400 with built-in autolocator and the EMS 410/420 broadcast recorders, which are mono

and stereo respectively.

The console range includes three main models: the EMP 124, which has 12 input channels with separate microphone and line inputs, four groups and main outputs, two auxiliary sends (echo and cue), echo return and 3-band EQ; the ESR 1004 and 1806 broadcast consoles with 10 input channels/four groups and 18 input channels/six groups respectively and otherwise identical modules and facilities such as 3-band sweep EQ, four auxiliary sends (two cue, two echo), transformer balanced outputs and extensive monitoring; the ESA 4024 automated recording console with 36 input channels, four return channels (line) with full channel facilities, 24-bus multitrack outputs with microprocessor-controlled central routing, four auxiliary sends, nine VCA groups and bargraph metering.

Elektroimpex from Hungary, a familiar sight at European AES conventions, are an import/export organisation dealing with many product lines. Of interest to the pro-audio world are ML (Mechanikai Laboratorium) tape recorders and BEAG consoles, tape recorders and speaker systems.

The consoles are primarily designed for the broadcast market and do not seem to have evolved much from models that have been shown in recent years.

The main item of interest on the



BEAG broadcast console



Mirage E001 graphic equaliser



View of Moscow Expocentre



Tesla OB console

Elektroimpex stand was the ML STM-800 professional tape recorder, which has features comparable to equipment found in the west. The recorder is available in mono, stereo, 2-track and 2-track with centre timecode versions, and features microprocessor-controlled transport functions and audio electronics. An error detection system is also built-in. Other features include full editing control with jog wheel, rack or console mounting, 10-position internal autolocator—including automatic record drop in/drop out and remote control via EBus. The latter feature allows integration into centrally-controlled studio systems.

Ivo Lola Ribar from Yugoslavia manufacture a wide range of professional audio equipment and systems. The product line includes consoles for recording, broadcast and sound reinforcement, graphic equalisers and processing such as compressors and limiters, modular rackframes with incremental power amplifiers—distribution amplifiers,

line amplifiers, splitters, etc—and loudspeakers.

One new item was the LA6602 active monitor designed for broadcast and small studios. The speaker features a 5 inch bass/mid driver passively crossed over to a 1 inch dome tweeter in a vented enclosure. The amplifier features balanced input, 35 WRMS output, equalisation circuitry, delayed turn-on and overload indicator. The speaker measures 221×335×225 mm and is available with a rackmount kit.

Lola were also putting the accent on their new consoles, which feature a much better standard of finish and more modern design. They also come with smart control knobs, XLR connectors and P&G faders.

Though information was lacking on the larger units, a smaller console such as the modular 1100 series provides good basic facilities for sound reinforcement and broadcast, and features a range of output modules for specialised applications such as theatre sound with matrix

groups and quad panners. Basic format is up to 24 input channels with four groups and stereo or mono master out.

One of the main problems facing Comecon manufacturers is the lack of quality components such as faders, connectors (XLR-style connectors are at a premium), electronic parts, etc, and until this is solved there will not be much movement.

Another point is that professional audio equipment is very expensive and a console such as the Tesla ESA 4024 will easily be in the same price bracket as a Neve, Harrison or SSL. Until the currency situation improves with proper convertible rates, it is difficult to see how things will become competitive. The feeling that with the political changes now taking place in the Comecon countries, Eastern Europe will be the new 'El Dorado' is misplaced and the situation will get worse before it gets better.

Though the business potential is very great, it is still some years away and one possible start will lie in joint

ventures between Comecon companies and outside business.

The most promising aspect for the future will be the gradual changeover of the military manufacturing base (until now a closed shop) to the domestic sector, where the fruits of much research can be used to benefit civilian products such as the pro-audio industry.

Four years is not such a long time and maybe the next (and 5th) Telekinoradiotechnika exhibition will have a few surprises in store for us.

Terry Nelson

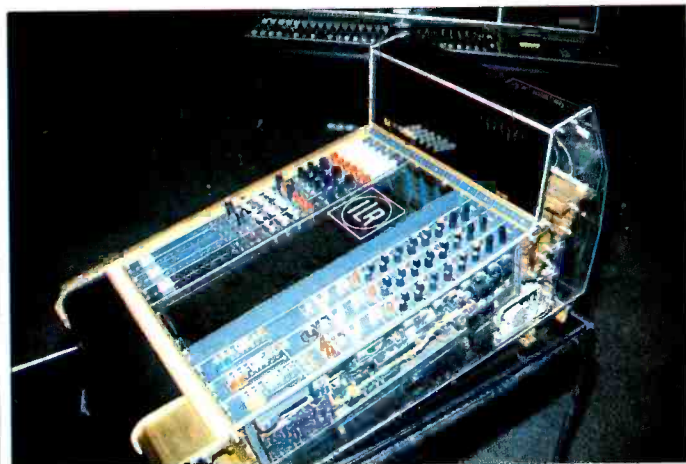

Lola 1100 console



Cinac stand

TCD is the new digital division of Thatched Cottage Audio based in a brand new 5,000 sq.ft. complex adjoining the present Royston site. Having become Europe's largest 8 and 16-track specialist the time had to be right to move into the digital domain, whilst continuing to provide the same quality of friendly efficient service combined with a comprehensive range of equipment kept permanently in stock and on demonstration. You may have not realised that although we are not based in a major city we CAN deliver goods the same day anywhere in the UK. Why not give TCD a try? Regular clientele include Sarm West, PWL, Real World, Eel Pie, Swanyard, Bros, Erasure, Iron Maiden UB40, and the Who — shouldn't you be on this list?

NEVE



The Neve VR with Flying Faders — ring for details



ATARI SOUND TOOLS PACKAGE

Digidesign Sound Tools for Atari. Atari Mega 4 inc monitor and mouse. DAC 200 meg. R/M Hard Drive (+ interface). Total package price **£4185 + VAT**

AIWA DAT MACHINES



Aiwa DAT recorder inc. digital in/out, A/D D/A module, full remote, free tape . . . **£649 + VAT.**

If you require any further information on any of the services which we can provide give us a call on 0223 208110 or on the main TCA number 0223 207979 (11 lines) for full details and brochures. The faxpack, which gives details of installation facilities, the service department, demonstration facilities and the equipment we can promise should answer any questions. If you are converting any kind of audio purchase, why not give us a call — you have nothing to lose! We didn't become the largest pro-audio retailer in EUROPE without being the best!

THE SAME AMAZING SERVICE AND CHOICE BUT NOW DIGITAL

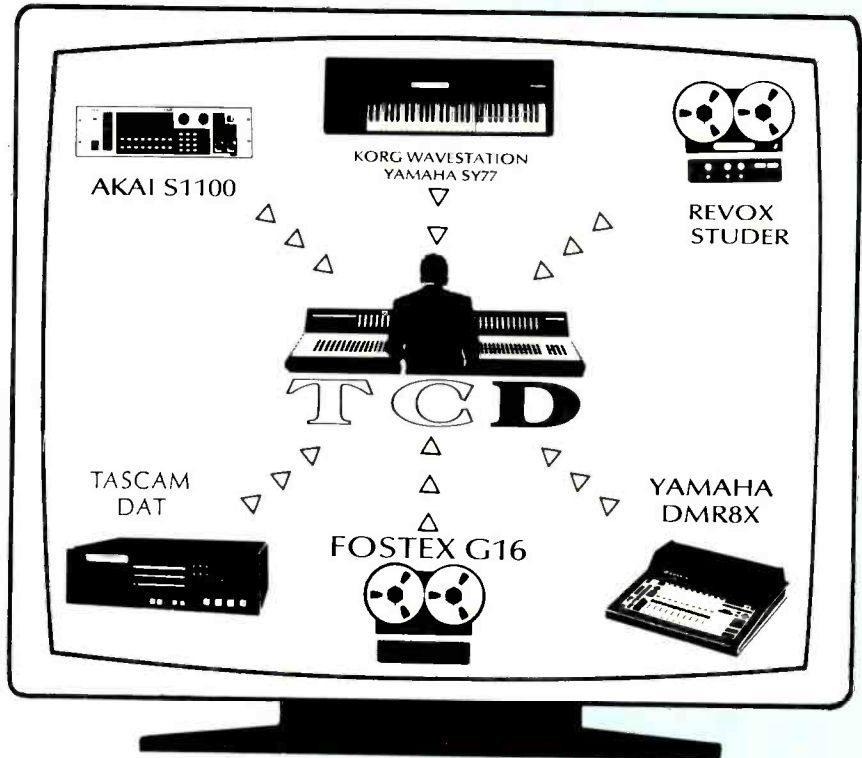

TASCAM MSR 24 plus A&H SABER
At last — a fully professional 24-track system for only

£14,000 + VAT

Combining the best selling A&H SABER in a 24:16:24 format (no repatching required) and the brand new Tascam MSR24 1" 24 track recorder. Complete with a full jack patchbay and all plugs and cables.

Call for full information and demonstration.



SECOND HAND & EX-DEMO UNITS

Acoustic Energy AE2 new	£760
Waldorf Microwave amazing analogue synth	£820
Aphex 612 Expander/Gate	£450
Proteus XR mint	£865
Drawmer 231 Comp/Lim	£350
Fostex E16	£2,499
Revox B77 (new)	£1,075
Otari MX80 24-Track hardly used	£16,500
Korg M1	£975
Roland D50 + PG1000 programmer	£899
Saturn 24-track full remote ex. condition	£15,500
Dberheim DPX1	£599
Neve 8108 48 channel-in-line with Necam 96	£55,000
Sony DTC1000ES	£989
Beyer MC740	£599
Otari MTR90 MKII full autolocate	£17,950
Atari 1040 & monitor & C-Lab Notator	£799
Akai S950 memory exp	£125
Drawmer DS201 gate	£250
Tascam ATR24 2" 24 track (new)	£22,500
Casio DA2 Dat	£525
Yamaha SPX 1000 multiprocessor	£699
Fostex 4030 synchroniser	£899
Akai S1000 2 meg expansion boards (new)	£260
Acoustic Energy AE1 mint	£530

This is a small selection from our current stock — give us a call and we will be happy to send you a full up-to-date list. All prices exclude VAT.

NEW PRODUCT LINES AT TCD

AMS, TC Electronic, Klark Teknik, Quested, KEF, Westlake, Genelec, Dolby, Orban, BSS, Apple, Massenburg, Focusrite . . . just phone for details.

STOP PRESS

TCA Travel . . . in case you didn't know our fully equipped ABTA/ATA Thatched Cottage travel agency has been up and running for some time now, expanding our high standards of service and great value into the travel industry. Whether you are organising a tour, visiting a trade show or simply booking a holiday, give us a call, what have you got to lose? Contact Gill Scott or Glen Bagnell on 0223 314577 or 0860 450499 (mobile)
ABTA No: 89156



North Road, Wendy,
Nr. Royston, Herts

TEL: 0223 208110
FAX: 0223 207952
24 HRS: 0860 445172



TCD

THATCHED COTTAGE DIGITAL

Audio-Technica AT877 mic

Audio-Technica have introduced the AT877 short rifle microphone that finds applications in ENG/EFP, theatre and sound reinforcement. The superdirectional mic measures 280 mm in length and can be phantom or battery powered with automatic switchover. Finish is baked-on theatre black to avoid reflections. The microphone can be supplied in an aluminium carrying

case with 'Zeppelin-style' windshield and full accessories.

Audio-Technica, 1348 Naruse, Machida, Tokyo 194, Japan. Tel: 0427-29-5113. Fax: 0427-28-1710.

UK: Audio-Technica Ltd, Technica House, 11 Lockwood Close, Leeds LS11 5UU. Tel: 0532 771441.

USA: Audio-Technica US Inc, 1221 Commerce Drive, Stow, OH 44224. Tel: (216) 686-2600.

Eventide HS322 sampler board

Eventide's HS322 internal sampler board for the H3000 UltraHarmonizer series provides 16 bit 44.1 kHz sampling for the H3000 with 11.8 secs stereo and 23.7 secs mono. Expanded versions of up to 3 mins will also be available.

The internal sampler board stores two samples in RAM and outputs two mono voices or one stereo. Recording is either manual or audio triggered and the sample can then be edited with the H3000 'knob' or via the numeric keypad. Playback can be initiated manually, by audio level or via MIDI.

Other features include pitch shifting and time compression/expansion for each channel individually and MIDI control of the pitch of either channel.

The board can be retrofitted to existing H3000 UltraHarmonizers and supplied as an option with new units.

Eventide, One Alsan Way, Little Ferry, NJ 07643, USA. Tel: (201) 641-1200. Fax: (201) 641-1640.

UK: HHB Communications, 73-75 Scrubs Lane, London NW10 6QU. Tel: 081-960 2144. Fax: 081-960 1160.

Neutrik G and E connectors and A1 test system

Neutrik have introduced the G series of XLR-style receptacles. Advantages include one-piece design for rear panel mounting with screws or PCB mounting with mechanical anchor, hard gold-plated contact points with square solder pins and excellent price/performance ratio. Also new is the E series PCB receptacle, which is economical on both space and price.

Neutrik have also released the A1 audio test and service system, which contains a sweep signal generator, analyser and digital oscilloscope in a compact table-top chassis. A carrying case is also available. Measurement facilities include level, noise and crosstalk in absolute or relative readings, frequency, THD+N, wow and flutter plus drift.

The A1 features a backlit 256x128 dot graphics LCD, Centronics printer output, balanced 100 k Ω inputs with phantom, 10 W output into 0.1 to 4 Ω (sine or squarewave), BNC outputs and internal monitor loudspeaker.

An optional RS-232 interface with PC software will also be available.



THD+N residual is rated at 0.0025%, making the A1 capable of testing very high performance equipment.

Neutrik, FL-9494 Schaan, Furstentum, Liechtenstein. Tel: 29666. Fax: 25393.

UK: Eardley Electronics Ltd, Eardley House, 182-184 Campden Hill Road, London W8 7AS. Tel: 071-221 0606. Fax: 071-727 9556.

USA: Neutrik Products, 77 Selleck Street, Stamford, CT 06902. Tel: (203) 348-2121.



Tascam DA-30 DAT recorder

The Tascam DA-30 is a professional DAT recorder and incorporates much of the technology of the DA-50. Features include AES/EBU interface and co-axial digital I/O, 32/44.1/48 kHz sampling rates, balanced inputs/outputs with XLRs (+4 dBm) plus -10 dBV phono-type inputs/outputs, independent left and right channel A/D and D/A converters with 64x oversampling, 16 bit delta-sigma A/D conversion and 8x oversampling, 18 bit D/A conversion, full function wired remote

control, parallel port and comprehensive editing and display facilities.

Teac Corp, 4-15-30 Shimorenjaku, 4-chome, Mitaka Shi, Tokyo 181, Japan. Tel: 0422 45-7741.

UK: Teac UK Ltd, 5 Marlin House, The Croxley Centre, Watford, Herts WD1 8YA, UK. Tel: 0923 225235. Fax: 0923 36290.

USA: Teac Corp of America, 7733 Telegraph Road, Montebello, CA 90640. Tel: (213) 726-0303.

GL dynamics processor

GL Design have introduced a 16-channel dynamics processor in a 4U rack. Each channel includes a noise gate, an expander/compressor and a sweep frequency dynamic filter, which can be switched into the compressor/expander section.

Features include switchable long/short release times for the gate section as well as a Gate Hold control, master attack and threshold controls for all functions,

peak/flat/dip switch for the dynamic filter and level trim control. Overload and Gate On status LEDs are also provided together with 5-LED gain reduction metering. A control switch enables several channels in the chassis to be linked together as required or controlled via an external source.

GL Design, 1345 Le Lieu, Switzerland. Tel: 21 841 16 94. Fax: 21 841 18 83.

Master Audio Design AD400/1000 power amplifiers

Master Audio Design AD400 and AD1000 professional power amplifiers are rated at 220 WRMS/channel 4 Ω and 525 WRMS/channel 4 Ω respectively. The AD series amplifiers feature electronically balanced inputs, subsonic filters, an 'intelligent' compressor/limiter and protection circuits for each channel, frequency response of 10 Hz to 40 kHz \pm 1 dB (filter out), LED

metering and status display and 'soft start' circuit.

Harmonic distortion is rated better than 0.05%, S/N better than 100 dB with damping factor of 200:1 kHz/8 Ω for the AD400 and 260:1 kHz/8 Ω for the AD1000.

Master Audio Design, Amate Electroacustica srl, Libertat 62, 08226 Terrassa, Spain. Tel: (93) 786 33 12. Fax: (343) 731 11 41.

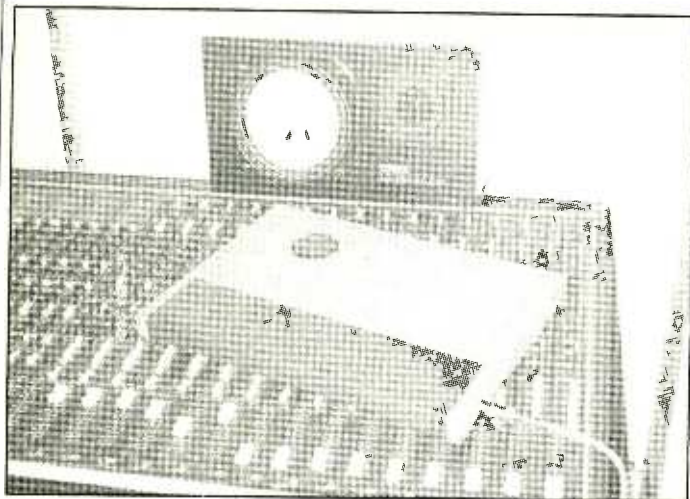

CAS DI.REC.T controller

Coach hard disk recording

Coach Audio Sales have introduced the *DI.REC.T 32* hard disk recording system. It is completely modular and comprises a remote control unit, with typical recorder control functions including Locate, Rehearse and Autopunch; 8-track disk modules with 12.5 mins recording time per track; digital interface modules for all formats including Sony, Mitsubishi, DAT, AES/EBU, etc, and a module rack for up to 32 analogue input and output modules; 2-channel 16 bit delta-sigma A/D converters with 64x oversampling and 18 bit D/A converters with 8x oversampling.

In full configuration, the *DI.REC.T* provides 12.5 mins of 32-track recording although if less tracks are used then the time can be increased, eg 25 mins, 16-track.

The system provides full non-destructive editing with features such as Cut, Copy and Paste, synchronisation to external equipment and realtime backup to streamer or optical disk. Sampling frequencies are 44.1/48 kHz or external word clock.

Coach Audio Sales, Schuren 12, 6670 St Ingbert, West Germany. Tel: 6894 4717. Fax: 6894 383379.

Alphaton DI rack and feedback controller

Alphaton Elektroakustik have launched two new products: the *SM-6000* active DI rack and the *FC100* feedback controller.

The *SM-6000* is a 10-channel rackmount active DI box with isolated transformer outputs. Inputs are via 1/4 inch unbalanced jacks with switchable sensitivities— $-10/+10/+26$ dB. One of three LEDs indicates status. Outputs are on Switchcraft *D3M* and 30 pin DIN multiway connector.

The *FC100* is a small box that is connected between the microphone and the console with power being provided by phantom or an external 12 to 15 V supply. The unit is described as an 'intelligent, in-line, signal processor' that monitors the microphone signal and detects

feedback content arising in the programme material. Setup is quick and easy to do.

In normal mode, the *FC-100* is neutral to the microphone signal and provides unity gain with very low noise and flat frequency response. If feedback should develop, this is sensed by the microprocessor and suppressed. The *FC-100* is specified to provide 12 to 15 dB of feedback cancellation, thus providing greater operating headroom.

Alphaton Elektroakustik, Siemensstrasse 19, D-6233 Kelkheim, West Germany. Tel: 6195 7 40 32. Fax: 6195 84 84. USA: Alphaton, 102 Pebble Beach Drive, Roanoke, Dallas, TX 76262. Tel: (817) 430-0521.

EAA DCM III dynamic control monitor

EAA have released the *DCM III* dynamic control monitor. Measuring only 230x160x170 mm and weighing 5 kg, the *DCM III* is constructed from 15 mm Finnish plywood and houses a 110 mm bass/mid driver in a reflex enclosure, a tweeter for frequencies over 8 kHz, a 50 W power amplifier (130 W peak) and a processor. The processor provides an active filter for the tweeter together with a servo control for the drivers to avoid damage at high volumes.

The *DCM III* is mains powered and

an optional low voltage power supply is also available for use with batteries (7 hours with two *DCM III*). Other features include balanced audio input on *XLR*, front panel level control and metal grille faced with acoustic foam. Frequency range is 80 Hz to 20 kHz ± 3 dB and maximum SPL is 103 dB.

L'Electro Acoustique Appliquee, 4 Place de la Mairie, 91260 Nozay, France. Tel: (1) 64 49 05 42. Fax: (1) 69 01 62 62.

Renkus-Heinz ALS-1 lobing predictor

The Renkus-Heinz *ALS-1* lobing prediction software allows the direct farfield lobing patterns of a stack or cluster of loudspeakers to be displayed, thus allowing changes to be made before the final installation of a system is made. Running on an IBM-compatible computer, the *ALS-1* allows the polar pattern of an array to be optimised by randomising the acoustical path differences. Data input is made easy and includes the number of speakers in the array, type of array (rectangular or circular), polar frequency, type of signal source and coverage angles and the polar co-ordinates of the individual sources relative to the reference position.

Once the polar patterns of the array in question have been shown, the program will calculate the repositioning of sources to reduce lobing, coverage angles of components within the array to reduce interference and SPL values of sources in order to 'steer' the array. The program requires at least 340 k of internal memory and MS-DOS 3.2 or later.

Renkus-Heinz Inc, 17191 Armstrong Avenue, Irvine, CA 92714, USA. Tel: (714) 250-0166. Fax: (714) 250-1035.

UK: Smart Acoustics Ltd, 38-39 Westgate Chambers, Commercial Street, Newport, Gwent NP9 1JP. Tel: 0633 252957.

THX digital spectrum analyser

The THX digital spectrum analyser is principally aimed at tuning up cinema (theatre) sound systems but finds applications in most areas of sound reinforcement. Designed to be used with IBM-compatible computers (Note: read 'laptops' so you can take it with you), the analyser displays the frequency response of a system as well as the background noise level of the venue and the reverberation time (RT60).

The system consists of the analyser chassis with a Plex microphone multiplexer, four measurement microphones, carrying case, interface cables for the computer and an optional printer. Measurements may

be performed in octave or 30 1/3-octave bands and background noise can be displayed compared to NC curves. RT60 is displayed in octave bands.

Other features include specifications exceeding those of SMPTE, ISO and ASHRAE, four weighting standards for the 1/3-octave display plus user-specified functions, multiplexer input to the analyser plus two line inputs, pink noise generator and 60 dB range display. **The THX Group, Lucasfilm Ltd, PO Box 2009, San Rafael, CA 94912, USA. Tel: (415) 662-1900. Fax: (415) 662-2186.**



Studio House Audio

NEW AND 2ND HAND LIST

Mixing Consoles

Soundcraft 2400 new	£10,500
Allen & Heath Sigma 20/24 new	£8,500
Rainbird 2000 28/24 patchbay	£4,000
Trident 80 32/24 patchbay	£16,000
Soundtracs CM4400 28/24 CMS 2 Auto	£8,000
TAC Matchless 32 input	£9,000
TAC Matchless 36 input patchbay	£11,950
Allen & Heath Sigma 32 In-line with auto	£15,000
Soundcraft 38 32/24 patchbay	£3,950
Allen & Heath System B 16/8/2	£850
Soundcraft 800B 40/8/2	£6,950
Soundcraft 800B 24/8/2	£4,950
Soundcraft 800B 16/8/2	£4,100
AMEK 2500 40 input	£29,500
AMEK Angela 36 input with Mastermix	£24,000
Studer 961 2 8st 2mon PPM	£5,000
Soundtracs PC Midi 24/16/2	£3,995
Soundtracs 16/8/16/2	£1,500
MCI 500B JH50 auto	£12,500
Soundtracs CMX 32	£12,000
Soundtracs Trackmix	£5,000
Soundtracs CP6800 32/12/24	£16,000
Soundtracs CM4400 with CMS 2 B input (unused)	£10,500
Chiffren 16 8 16	£1,895
Studiomaster II 32/16/2	£2,750
TAC Matchless 26 patchbay	£7,500
TAC 24 8/2 mmnt	£2,500
Cadac 28/24	£12,000
SECK 12 8 2	£695
SECK 18 8 2	£900

Recorders

Mitsubishi X850 32	£60,000
AMS Audiofile Iversion 81	£35,000
Studer A820 Remiloc w-SR	£29,950
Otari MTR 90 II remiloc	£18,500
Studer A800 IA 24	£12,000
Studer A80 N III 24	£9,950
Studer A80 IV + autolocator	£15,000
Studer A80 Mk II	£8,000
3M M79 2 available	£8,500
Soundcraft SCM 760 III 24 vh	£10,500
Soundcraft SCM 382 16T 2"	£2,850
Studer A80 16 track	£3,500
Tascam ATR80 24 remiloc new	£18,950
Tascam ATR60 8T	£2,500
Tascam 58 8T 1/2" pro version	£1,595
Tascam MS 16 complete	£4,500
Tascam 85 168 complete	£3,500
Tascam 85 16 complete	£2,500
Tascam MSR 24/16/TSR8 new	P.O.A.
Fostex E16 new	£2,950
Fostex E16 with 4050 remiloc	£2,700
Fostex E16 vgc	£2,250
Fostex B16 vgc	£1,750
Fostex G24	P.O.A.
Tascam 38 vgc	from £1,000
Fostex M80 vgc	£795
Fostex A8 good	£695
Otari MX5050 III 8T	£1,750
Tascam 3440 mmnt	£600
Mitsubishi X80	£3,000
Studer 820 2T 1/2" & 3/4" HB	£4,000

Studer A810	£3,000
Studer B67 VU 301PS Console	£1,800
Tascam 52 NB as new	£1,500
Revox B77 II as new	£750
Revox B77 vgc	£600
Revox PR99 II in case	£1,150
Revox A700 record	£600
Sony DTC 1000ES new	£1,130
Sony PCM various	£1,000
Revox B710 as new	£595
Tascam 122 vgc	£250
AMS SDMX	£4,995
AMS RMX16	£2,995
AMS 1580S	£2,995
Lexicon 224 (XL) various progs	P.O.A.
Lexicon PCM 70	£1,300
Lexicon 480L V2 with SME	£6,000
Lexicon 480L V2	£5,000
Klark Teknik DN780	£1,450
TC 2290 32 sec ftr new	£2,000
UREI 1176, 1178 and LA4	P.O.A.
dbx 163, 165, 200, 150, 150X	P.O.A.
Valley Rack + FX	P.O.A.
Yamaha DMP7, Rev7, SPX series	P.O.A.
Dolby 330, 361, Cat22, K9, SR etc	P.O.A.
24 Channels of Bel Noise Reduction	£995
BEL 2400, 8D80s, BC series NR	P.O.A.
Akai S1000, S950, S900, MG macs	P.O.A.
EMT gold foil & remote vgc	£850
Rebis Rack, 2G, 2C, D-ES, sample OBC & Dist	£700
Drawer units secondhand	Cheap
Digitec ODL and FX units new	on demo
JBL 4401	£200
JBL 4435 pair, new	£1,995
JBL 4430 pair, as new	£1,750
JBL 4350 pair, vgc	£1,750
JBL L250 top-sided pyramids	£1,500
JBL 4411 pair	£700
JBL 4333 black ash	£995
ATC SCM 250 pair	£2,500
Tannoy Classic 15" pair	£650
Tannoy LGM as new	£750
UREI B13C pair	£2,250
UREI B11C pair	£1,300
UREI B13B pair	£1,750
UREI B09A pair	£750
Neumann 47, 56, 84, 86, 87, 89, 170 P.O.A.	
AKG 414, 460, 12A, 2BA, 224, 451, 112, 202, 190, 12 etc, etc	P.O.A.
Neumann M49 valve perfect	£2,000
Sennheiser 405, 441, 421, 416	P.O.A.
EV RE20 PL92A, ND757, ND408	P.O.A.
Shure 57, 58, 91, 548, 54, 17	P.O.A.
Beyer 69, 88, 201, DT100 HP's	P.O.A.
Sony ECM 50, P, Tie clip mics	£75
Mic stands galore, booms from	£20
Power amps various	P.O.A.
Dynacord ADDI full kit	£1,995
Navy 201 SM58 Radio Mic NEW	£295
CALREC Soundfield IV as new	£2,500

EXPORT PRICES
(UK Customers please add VAT)
EXPORT A SPECIALITY

**WANTED
FOR CASH
COMPLETE STUDIOS**



0663 64244

STUDIO HOUSE AUDIO
High Lane Village, Nr. Stockport SK6 8AA.
FAX 0663 62328

SERIOUS MONITORING



**Westlake
Audio**



**Rogers
MONITORING**

Listen before you choose

Please send me information on studio monitoring

Name _____

Address _____

Telephone _____



Send to: **Michael Stevens & Partners Limited**
FREEPOST, Bromley BR2 9BR
TEL: 081-460 7299 FAX: 081-460 0499



Publison Infernal Workstation 4000

Publison's *Infernal Workstation 4000* is a 4-track hard disk recorder/editor for post-production, broadcast and recording studios. Main features of the unit are: four independent tracks, each with its own input/output, that act in the same way as a traditional multitrack; editing of each track with a graphics display of the envelopes of all four tracks; VITC synchronisation (with optional decoder board); graphical display of the gain of each track in the form of a line over the envelope graphics; editing functions such as the creation of EDLs, chains and events lists; hard disk options providing 2, 3 or 4 hours of recording time; backup on Video 8 digital cassette and/or optical disk; integrated audio effects for each track such as time compression/expansion, delay, echo and reverberation.

The *Infernal Workstation 4000* consists of the mainframe, computer and pen touchpad.

The *DAB3* storage unit can be supplied fitted with either a Video 8 digital cassette (6 hours total storage) or an erasable optical disk (45 minutes per side). Alternatively, it

can be supplied with both, giving capacity storage coupled with fast access to data. Multiple *DAB3*s can be used for up to 20 hours storage in 2, 3 or 4 hour slices.

The screens can be accessed via the computer keyboard or a touchpad with pen—a 'keyboard' is displayed at the bottom of the video monitor and the 'keys' are turned on with the pen. Initial demonstrations of the unit have proved this facility to be very popular as the touchpad is a better human interface than a standard keyboard.

Specifications include 50 kHz sampling rate 16 bit and interfaces for SCSI bus, LTC, VITC and MIDI-RS232C.

Publison Audio Professional, 18 Ave de la Republique, 93170 Bagnolet, France. Tel: (1) 43 60 84 64. Fax: (1) 43 60 80 31.

UK: SSE Marketing, Unit 2, 10 William Road, London NW1 3EN. Tel: 071-387 1262. Fax: 071-388 0339.

USA: Publison America Inc, 6464 Sunset Boulevard, Suite 980, Hollywood, CA 90028. Tel: (213) 460-6355. Fax: (213) 460-4117.

Lexicon 300 digital effects

Lexicon have announced the *300* digital effects system for music production and film and A/V post-production. High sound quality is claimed and full compatibility with both analogue and digital audio, together with Lexicon's latest developments such as new algorithms and proprietary digital processing circuits. Construction is rugged and fully shielded.

The *300* incorporates a timecode reader for easy remote control of effects and has a 50-entry event list with timecode values and setup number.

Features include seamless change of signal parameters, stereo pitch shifting, delay effects and very

advanced A/D and D/A converters. Interfaces include AES/EBU and EIAJ protocols, professional and consumer digital input and assignable output formats, and *XLR/RCA*/optical I/O connectors.

Lexicon's dynamic MIDI R allows all the *300*'s variable parameters to be accessed via MIDI controllers and recorded on any sequencer. Complete sys-ex communication is also provided.

Lexicon, 100 Beaver Street, Waltham, MA 02154-8425, USA. Tel: (617) 891-6790. Fax: (617) 891-0340.

UK: Stirling Audio Systems Ltd, Kimberley Road, London NW6 7SF. Tel: 071-624 6000. Fax: 071-372 6370.

Fougerolle Melody

The *Fougerolle Melody* is a hard disk-based recording system that can be expanded with further Winchester drives to provide 45 minutes to 9 hours of stereo. The system can also use WORM drive options and optical-magnetic disks.

The *Melody* has particular applications for broadcast, post-production and the creation and storage of sound files. The recording functions of the unit have been made the same as that of a standard tape recorder in order to keep user familiarity and enable the *Melody* to be used quickly.

In broadcast mode, the system can be used as the equivalent of four cartridge machines and the different programme material played back in

sequence automatically or started manually as required.

For post-production, timecode and an external reference for genlock is required. The unit can be used as master or slave and allows full recording, cueing and editing functions.

Melody can be supplied in a variety of configurations, together with options such as a remote control keyboard with tracker ball, DSP card, *Numeris* card and colour graphics monitor. Sampling rates are 32/44.1/48 kHz with 16 linear bits. **Fougerolle Audio, 10 Rue Charles Cross, 95320 Saint-Leu-La-Forêt, France. Tel: (1) 39 95 69 33. Fax: (1) 30 40 93 95.**

Klark-Teknik solid state recorder

The Klark-Teknik *DN735* solid state recorder can record and playback short passages of stereo audio in synchronisation with other devices via externally applied SMPTE timecode. Its primary function is to add an extra two tracks of quality audio to standard VTR machines in order to simplify stereo editing, where the audio is required to crossfade from scene to scene and not be edited with the video frames. Plug-in memory cards will allow a memory increase of up to 175 secs.

The *DN735* can be controlled manually via front panel controls or by remote control. Alternatively, it can be controlled via the serial *RS422* interface.

The menu facility allows various

modes of operation to be set up by the user, thus adapting to the user's preferred method of working. Any international frame rate can be selected and the unit can operate in mono mode, which doubles the storage time.

The unit comes in a 1U 19 inch rackmounting case, claims a 93 dB dynamic range and uses 16 bit oversampling A/D and D/A converters.

Klark-Teknik Research Ltd, Walter Nash Road, Kidderminster, Worcestershire DY11 7HJ, UK. Tel: 0562 741515. Fax: 0562 745371.
USA: Klark-Teknik Electronics Inc, 30B Banfi Plaza North, Farmingdale, NY 11735. Tel: (516) 249-3660. Fax: (516) 420-1863.

AMS AUDIOFILE..

THE PLUS POINT



During the 1980's, one hard disc recorder both established and dominated the market - AMS AudioFile™.

AMS now announce AudioFile PLUS™ as part of a continuing policy of upgrades that take AudioFile into the 90's and beyond.

With a transfer of operating software to the latest technology 32 bit, 4 Megabyte transputer platform, AudioFile PLUS™ offers yet faster operation and the ability to accommodate a range of major new features - further distancing AudioFile from other disc based recorders.

Extended System Architecture also provides for 8 simultaneous inputs/outputs, in analogue and/or several digital formats.

Whether you have yet to make up your mind about hard disc recording or you already own an AudioFile, you'll find it comforting to learn that this system upgrade is once again available for all existing AudioFiles.



Setting the pace for hard disc recording

AMS Industries plc
Billington Road, Burnley,
Lancs, BB11 5ES, UK
Tel: (0282) 57011 Fax: (0282) 39542

AMS London: (01) 722 3925 AMS USA: (707) 762 4840

New York: (212) 586 7376 Chicago: (312) 527 4569
LA: (818) 845 0199 Seattle: (206) 842 7182

**Our advertising agency said
 "You can't say everything about
 the PCM-3348 in one ad."
 ...this time they were right.**

ADVERTISING BRIEF PCM 3348

OBJECTIVES

- ① ESTABLISH 3348 AS ULTIMATE MOST DESIRABLE MULTI-TRACK.
 - ② DEMONSTRATE 3348 AS A CREATIVE TOOL (NOT JUST A RECORDER).
 - ③ POSITION 3348 AS PREFERRED ALTERNATIVE TO 32 TRACK RECORDERS.
 - ④ REINFORCE SONY POSITION AS MARKET LEADER.
- EMPHASISE COMPATIBILITY WITH OTHER DASH DEVICES.*

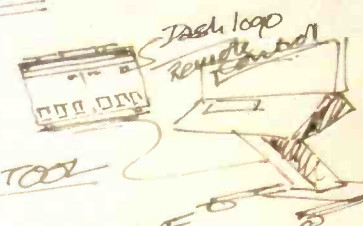

- ①
- ②
- ③
- ④

PCM 3348

- * 48 track digital audio
- * DASH format
- * Most sophisticated on market
- * The only 48 track production model.
- * Market: AUDIO RECORDING STUDIOS (SONY IS THE MAJOR SUPPLIER OF DIGITAL RECORDERS)

KEY FEATURES

- * Outstanding high-speed transport system (mechanical clutch between capstan motor)
- * Digital 'ping pong' (sound memory)
- * Sound memory



For further information contact:
 Athens 2818273 Basingstoke, UK 0256 474011 Brussels 7241711 Cologne 59660 Copenhagen 995100 Dubai 04-373472
 Helsinki 50291 Jeddah 6440837 Lisbon 573046 Madrid 7290988 Milan 02 6128221 Netherlands 02968 81215 Oslo 303530
 Paris 49454000 Rome 06 5920139 Stockholm 7736100 Vienna 61051 Zurich 7333311 Eastern Europe - Vienna 554606
 Middle East - Geneva 336350 Africa - UK 0256 55011 Headquarters - Basingstoke, UK 0256 55011

4 / DASH WORLD

SH climbs

THE 'DASH WORLD' confirmed that...
has had soared past the...

SONY
PCM 3348

FIXATION
M RECORDERS OUTSELL OTHER MAJOR
MATS BY 3 TO 1.
48 HAS MORE FEATURES, FASTER, BETTER SOUND
PERFORMANCE, MORE TRACKS THAN COMPETITION.
UNRIVALLED REPRESENTATION IN PRO AUDIO (& VIDEO)

SONY DEDICATED TO PRO AUDIO
SONY COMMITTED TO DASH (LONG TERM)

ESTHETICS: 3348 IS & LOOKS THE BEST.

RESPOND FOR DEMO

IMPORTANT

tape
digital
cassette
full to SONY)
tions.

348

USER BENEFITS

1. Faster throughput
2. Full compatibility with other 24/48 track machines.
3. Creative tool for innovative engineers.
4. Revenue earning investment.

Digital Audio Products
PCM-3348 Digital Audio Multi-channel Recorder



HAWKER

SIDDELEY

CLAROSTAT

POTENTIOMETERS FOR SOUND SENSE

Clarostats Series 388 Conductive Plastic Modular Potentiometer is renowned for special custom designed audio applications. Engineered for reliability, the series 388 offers not only standard, single, dual, triple and quad arrangements but also more specialised requirements, such as

- Shaft seal, mtg. seal
- Tapped element module
- High voltage stand-offs
- Dual conc. positive ground
- Dual 60° backlash
- Dual w/electrical phased 180°
- 4 sect. conc. panel shaft can operate panel, second & third section if required
- 5 sect. 1/8; 1/4 dia. shaft
- 6 sect. 1/8; 1/4 dia. shaft
- Clutch with detent at L or R position
- Sect. concentric arrangements w/detent.
- 3-turn vernier drive w/push-pull switch
- Dual 3-turn vernier drive or dual conc.
- 5-turn vernier drive
- Valley detent (1-15 positions)
- Dual valley detent
- Valley detent conc.
- Valley detent w/push-pull (BJ) sw
- Multi-position detent (over 15 positions) (31 positions designed)
- Reduced body length styles
- Variable preset valley detent
- Types of terminals available on all styles
- PC terms up to .875 length
- Solder hook terms
- Terminals in forward or rear direction
- V.R. tracking
- Db tracking
- Special output curves for electrical matching to detents
- Linearity
- Dual pots arranged for 360° elect. output



**NEW
MOTORISED
POTENTIOMETER**

HAWKER

SIDDELEY

CLAROSTAT

CLAROSTAT-EUROPE
Elm Road, North Shields,
Tyne & Wear NE29 8SA
England.
Telephone: (091) 296 1451
Telex: 53284 ELMSEN G. Fax:
(091) 258 7040

CLAROSTAT MFG. CO., INC.
1 Washington Street,
P.O. Box 489
Dover N.H. 03820-0489
603-742-1120
Fax: 603-742-0481
Telex: VIA MCI 6713344

The operational advantages of using a hard disk, in place of or in addition to tape, as a medium for audio recording and editing, are well established.

One of the main drawbacks with conventional hard disk systems is the time lost porting the relevant data in and out of the system before and after the session. The use of removable hard disk cartridges provides no general solution simply because current models are limited to a capacity of around 45 Mbytes, giving only a few minutes of stereo recording time.

In comparison, magneto-optical (M-O) disk systems offer considerable advantages in that the disk cartridge is not only removable but can have a total capacity of up to 650 Mbytes (325 Mbytes per side). While these factors have made them increasingly popular as a medium for off-line data storage, relatively slow access times have, until recently, made them unsuitable for use as a primary realtime sound recording medium.

Speed breakthrough

Akai seem to have made something of a breakthrough in this area with the recent launch of their *DD-1000*, using a standard Sony 650 Mbyte M-O drive as the sole recording medium, save for a small amount of buffer RAM. It's a 4-track system in that it allows two pairs of stereo tracks, A and B, to be played back simultaneously although it isn't possible to operate the system as four mono tracks. Also, only one stereo pair can be recorded at a time. The same limitation applies should you record one

or both sets of tracks in mono; you can still only record one track at once and playback two. The two pairs of tracks can be bounced (re-recorded to a single pair of tracks on a different part of the disk) to make way for another part but, just as with tape, once bounced, they cannot be separated.

Although the drive has only one head, access time appears to be almost instant, irrespective of where the data are stored on the disk. Just how Akai have achieved this is understandably a closely guarded secret.

The ADC is 16 bit, the internal processing is 24 bit and the DAC is 16 bit with 4x oversampling. The system provides 30 stereo track mins per side at 44.1 kHz, 25 mins at 48 kHz and approximately 45 mins at 32 kHz. Record times are doubled for mono recordings and both sides of the disk can be recorded on by turning the disk over. Storage time can be increased by slaving one extra drive, on the first software release, and possibly up to six extra drives on subsequent releases. Each drive costs around £2,500. Extra tracks can only be acquired

by chaining two or more complete systems, however, the *DL-1000* remote, to be launched around September, will offer centralised control of up to seven complete *DD-1000*s, each with up to seven drives.

The disk itself is 5/4 inches in diameter and not dissimilar visually from a standard CD, except that it's enclosed in a protective casing to present something like an enlarged 3 1/2 inch floppy. Just like a floppy, the disk can be inserted at the start of the session and simply removed at the finish. This means that the client can leave with the master in hand and, should the need arise, subsequently book into any studio in the world with a *DD-1000* to effect necessary changes quickly. With no uploading or downloading time to worry about, making a few minor alterations to a lengthy programme becomes far more viable. The removability also means that unlimited recording time can be achieved by simply overlapping two disk drives, just as you would two tape recorders. The drives are not designed to be rackmounted, although a tray could easily be designed to rack a pair side by side. Currently,

NO OPTICAL ILLUSION

James Betteridge gives an overview of the new Akai DD-1000 magneto-optical disk recording system



the price of a disk is around £250 but this is likely to drop considerably as demand increases.

The *DD-1000* comes as a 5U rackmounting unit sporting a large 240×64 dot (40 characters by seven lines) backlit LCD screen like that on the *S-1000* sampler, and is completely self-contained, without need of any extra monitors or computer support. Clearly, though, there are various applications for which the *DD-1000*'s onboard LCD is not ideal. Should you have several machines locked together and want to view six or eight tracks simultaneously, or simply wish to list, sort and search through several hundred sound effects, it would be more easily done on a large monitor. In fact a larger screen is bound to make most operations easier and a software package will be available a month or two after the initial launch to work with most of the Apple *Macintosh* range of computers, except perhaps the lower spec ones. The distressing news for Atari owners is that an *ST* version would require a *Mega*, and wouldn't run on the common or garden *1040*. Due to the relatively low numbers of *Megas* in use by studios, Akai are still considering whether or not it's worth writing an *ST* version.

Ins and outs

The system comes as standard with a pair of balanced analogue inputs and two pairs of balanced analogue outputs running at +4 dB, an AES/EBU input and two AES/EBU outputs and a fibre optic input for recording from CDs or DATs with that facility. Sample rate conversion will be included, although the exact parameters have not yet been finalised. Other communication with the outside world is via SMPTE/EBU, SCSI, RS422, MIDI (In, Out and Thru), Word Sync and a Centronics printer ports. The *DD-1000* itself will only read SMPTE/EBU and MTC, whereas the *DL-1000* remote will generate them; it will also read VITC (Vertical Interval Time Code), though not generate it.

The unit is operationally quite similar to Akai's *S-1000* sampler in that it uses a combination of dedicated function buttons and six soft keys. The screen cursor can be moved using a cursor diamond and data is changed using either a wheel, the nudge buttons or the numeric key pad. The wheel also acts as a 'spool rocker'. At the top of the unit are two pairs of bargraph meters showing both input and output levels, depending on what you're doing, and to the right of these are three dual concentric rotary knobs for level adjustments: record, output A and output B.

Operation

On the basis of a few hours demonstration the system appears to be very straightforward to operate and a comprehensive set of help boxes will be available at every stage to ease the learning process.

Calling up the main Record page automatically initiates a new file and allows you to assign to it a 10-character alphanumeric name. Currently, Record is entered manually at the touch of a button, although programmable threshold and MIDI trigger facilities are planned. Record can also be started and stopped using two assignable footswitches on the rear of the unit. The file can be recorded against an external MTC or SMPTE/EBU timecode, or given an internal reference.

Entering the Edit page brings up a waveform display of the recorded data horizontally scaled to

fill the screen, irrespective of how long the recording is. A DETAIL button then allows you to zoom in for editing down to an accuracy of almost one sample. Any number of cut points can be entered from the key pad as timecode readings, alternatively up to 10 can be entered on the fly and subsequently edited for greater accuracy. The end of the first cut section is automatically marked by the start of the second, the end of the second by the start of the third, and so on, making it very quick to block a piece of music or a program into its main parts. All cutting and trimming is entirely non-destructive and reversible.

Edited files can be assembled into larger wholes in two ways. One, called the Song File, is orientated towards musicians and music engineers and allows you to chain together files of any length; any file can be repeated any number of times using a dedicated Repeat function. Having assembled a number of songs, a Track File can be created in which the playing order of the songs is defined, along with fades and the gaps between them, eg for album compilation. The second assembly method is designed for VAPP engineers and works with a standard Edit Decision List (EDL) giving a timecode reading against a file name.

A file, or an edited part of a file, can be pasted in anywhere or repeated any number of times and two files can be overlapped or crossfaded if desired. Time can be counted in mins, secs and frames, sample points or, if you know the tempo, in bars, beats and clocks. As you play through the song a cursor moves down the list, highlighting the cue currently being played.

In order to be able to combine files recorded at different sample rates it is intended to include a resampling mode to re-record all necessary files at the common rate.

For each file in the chain or song you can independently set the fade-up and fade-down curves and times in realtime (up to 60 secs or the length of the file, whichever is the shorter), the final level (from silence to +12 dB of gain) and the balance (stereo file) or pan (mono file). Group fades can also be programmed to fade a number of sequential files in or out as a whole. Apart from duplicating the main unit's front panel the *DL-1000* remote will provide two faders as another means by which dynamic level changes and crossfades can be recorded to the cue list in realtime.

Using what Akai call 'General Purpose' marks, specific points in files may be used as sync points. For instance, in a VAPP situation it would be easy to position a piece of music so that a certain cymbal crash coincided with the shattering of a glass on the picture.

Multitrack accessory

While it may be possible to slave several *DD-1000*s together, Akai are not actually presenting the system as a viable centrepiece for a tapeless multitrack studio. For most applications that need more than two, or perhaps four, stereo pairs, it is anticipated that the system will be synchronised with a multitrack tape recorder, and naturally Akai suggest their *DR-1200* digital multitrack as a strong option. In this way, assembled tracks could be repeatedly laid off in sync to tape and, because all editing is non-destructive (except for bouncing), it would be a simple matter to return to the original data on

disk to re-edit and re-lay it, if required.

Even so, budget allowing, it seems that a second disk drive would be a very worthwhile investment. Apart from doubling your record time and partially insuring against breakdown, it would also allow disks to be copied and selected tracks or files from a number of disks to be compiled on to a single disk, quickly and easily. This would be very useful if you were both storing all your sound effects and stings, etc, on the *DD-1000* as well as using it as a recording/editing medium. With only a single drive, it would be necessary to lay effects off to DAT or to the multitrack, as is common practice with standard effects libraries. This would naturally be substantially slower. The intention is to be able to specify from which drive each track is to be taken for playback for any given file, and for copying between drives there is a direct digital bus.

Cart replacement

A mode called 'Play Sheet' allows you to assign recordings and their edits to keys 1 to 9 on the numeric keypad and play them manually by pressing the relevant key. For broadcast applications this mode can replace nine cartridge machines but, because all keystrokes are remembered and entered against their timecode readings in the EDL, it can also be used to enter cues on the fly. The precise timing of these cues can then be trimmed as usual. Several hundred Play Sheets, each containing nine cues, can be created and stored and then chained together in any order. The zero key can then be used to repeatedly call up the next Sheet in the sequence.

The MIDI facilities in the initial software will include record start and the entering of MIDI messages (a note with its velocity or a controller) in the cue list, on a defined channel. There will also be a means of playing back files and Play Sheets using MIDI note commands, although it isn't intended to be a sampler. With the *DL-1000*, which generates SMPTE and MTC, an *S-1000* could be synchronised via MIDI in order to offer a wider multitrack facility for shorter files and sound effects, etc, leaving the *DD-1000* free for continuous programme.

Timestretch, a non-realtime copy function whereby programme can be shortened in length without altering its pitch, is intended for subsequent software updates. A relatively nominal charge will be made for such major software additions, including possible signal processing facilities, whereas updates intended to improve existing functions will probably be free. All new software will be provided on plug-in chip, not on disc, which raises questions concerning whether the user will be able to fit them, and how that would affect the warranty, etc. A final decision is yet to be reached.

The *DD-1000* has obvious applications in editing of music mixes, VAPP and mastering. Its compactness and self-contained design make it extremely portable to the extent that, in a busy complex where studio space is at a premium, an engineer with a pair of headphones could set up virtually anywhere and get down to work.

For the smaller studio it brings within financial reach the creative power of a hard disk recording system and, of course, without the upload/download problems. In larger facilities that perhaps already have large, multitrack hard disk systems, the *DD-1000* can be used as a flexible pre-production tool, or be slaved-up to offer a couple of extra tracks. □

AKG
ACOUSTICS

ADVANCED MICROPHONE TECHNOLOGY

The C426B Comb. represents the next logical step in the development of a legend amongst professional microphones, the C422, which itself is derived from an earlier microphone that set new recording standards, the C24.

The operating principles of the C426B remain the same - two twin diaphragm condenser capsules which rotate for MS and XY stereo recording, each with individually selectable polar patterns from a remote control unit. But as engineering standards have developed, so has every aspect of the C426B design, which now offers ultra low self noise operation, in-built electronics for the digital age, and a host of physical operating features which make it ideal for busy recording studios.

You might think it presumptuous for us to predict a future legend, but with the support of our customers, the C426B is already on its way.



AKG Acoustics Ltd., Vienna Court, Lammas Road,
Catteshall Road, Godalming, Surrey GU7 1JG.
Telephone: Godalming (048 68) 25702.
Facsimile: (048 68) 28967.
Telex: 859013 AKGMIC G.

Whilst everyone tried to copy the SM58, guess what Shure did?

Went one better.

The SM58 has been a world standard for many years and try as they may, competitors have not yet been able to replicate its performance and reliability.

Now, from the engineering team that brought you the SM58, Shure announce a new improved version – the BETA 58.

Whilst sharing the same low frequency warmth and guts, the Beta's unique supercardioid construction produces an even more open and natural sound. And as you'd expect from Shure, the mike is tough enough to withstand any amount of punishment it's likely to get, both on and off stage.

All this doesn't mean that the SM58 is being discontinued. In fact quite the reverse. It will carry on as a central part of the Shure range – and at a reduced price too.

So, if you are one of the envious competitors trying to replicate the performance of our world standard SM58, there's only one place left to go.

Back to the drawing board.

SHURE

HW International Ltd. 3-5 Eden Grove,
London, N7 8EQ. Tel: 071-607 2717

Peace and quiet, is not something one normally associates with recording studios but on a sunny, spring day sitting on the terrace, listening to bird song and the leisurely working of the adjacent farm Black Barn seems wonderfully tranquil and much farther away from London than just a ½ hr drive.

The studio lies on the fringe of a pretty Surrey village called Ripley (not to be confused with Ripley in Yorkshire) and is approached by crossing one of the largest village greens in England. From the unmetalled road the studio complex is strangely contrasting, with the sombre, weatherboarded studio on one side and the dazzling white of the house on the other. Until recently the house was occupied by the studio's owner, Robin Black, but since he moved to a nearby village, this semi-detached, Edwardian property has been turned into a residential facility, comfortably sleeping six.

Black Barn opened for business just over 3 years ago, having taken the best part of a year to build and equip. The whole structure had to be underpinned before being extensively rebuilt inside and out; great care was taken to retain as many of the barn's original beams as possible, although some were sadly too rotten to salvage. Design-wise, Black relied on his own expertise, not considering it necessary to involve 'heavyweight' studio designers and he contracted a local father and son firm to carry out the building work.

Generally speaking, the design is straightforward: a decent-sized control room connects through glass sliding doors to a 1000 ft² studio, which offers a liveish central area, a deadish side area and a large reasonably live drum booth. The central area takes advantage of the building's full height, being open to the cross-beamed pitched ceiling, while the dead area has a low ceiling packed with absorbent material and curtained walls. The brick walled drum/separation booth, with its tiled roof and three big windows, provides room for the largest of kits with good visibility both around the studio and into the control room.

The rustic feel of the building has been preserved by using old brick and white plaster walls to complement the exposed beams. Concrete floors have been carpeted throughout, although Black is considering laying a wood block floor in the live area. A white Sojin grand piano makes a striking feature in the centre of the room and receives consistent praise for its sound. The studio, like the control room, benefits from natural light and there are uninterrupted views across open countryside.

A large 'air lock' between the two interconnecting sliding doors, provides a useful overdub space and is popular as a vocal booth, although most overdubs are performed in the 400 ft² control room.

The control room continues the fairfaced brick, exposed beam look of the studio but absorbent walls have been cloth covered giving a softer appearance. A large bass trap, which Black modelled on a BBC design, has been built into the rear of the room.

Black: "It was an essential part of the design to have a really good bass trap. I hate working in places where you can feel the bass reflecting back on you—this, however, works a treat."

The front end of the control room surrounding the sliding doors is brick, which has been extended on either side to provide speaker plinths for the Tannoy *FSMs*.

"I looked at all kinds of speakers before choosing these. I'd always loved Tannoys—that's what I was trained on—but they'd lost the kind of poke that people wanted in the control room. Someone said try these and I thought they were wonderful, incredibly powerful without slashing your head off. The results from here have been really good and I'm extremely happy with them."

Sitting on a beam above the right hand Tannoy, is the studio mascot—a green toad sporting a yellow waistcoat. Black Barn's resident engineer Mathew Ollivier, spoke about the creature's chequered history.

"After one session he was found hanging from a beam with a noose around his neck—he left a suicide note saying that he couldn't stand the band's music any more and that this was the only way out. On another occasion he was shot by a German artist and he still bears the scars. However, he seems to have made a remarkable recovery and will hopefully survive for many years to come."

Black Barn was the first studio to install Soundcraft's 3200 console; this large, 64-channel, split console fitted with



Soundcraft 3200 looks through to studio

BLACK BARN

Patrick Stapley visits Black Barn studios in Surrey, UK

MasterMix II, replaces a Soundcraft *TS24* desk equipped with *MasterMix I*. Although perfectly happy with the *TS24*, it had become limited in the number of inputs, especially when running two multitracks and live sequenced sounds. Another consideration was noise, and the impressive figures of the 3200 acted as a strong buying point. Black has considerable admiration for Soundcraft as a company and was perfectly happy to be the first client for the new console.

"I had no qualms taking delivery of the first 3200: Soundcraft had conducted exhaustive tests on the console, ironing out all the teething problems well in advance, and it wasn't until they were 100% happy that I got the desk. So far there haven't been any problems with it."

What are the major advantages over the *TS24*?

"The 3200 is very controllable, there seems to be more of



Outboard equipment rack



Engineer Mathew Ollivier at work

everything—more sends, more mutes, more control in the EQ, which incidentally is wonderful, and noise gates. Being a split console, it's very fast to learn and easy to use—we had an engineer in the other day who hadn't worked on a split console for years and was amazed at just how much easier it was to do things. Also with *MasterMix II*, the automation is much quicker than before and better equipped to deal with a desk of this size."

Soundcraft's logo can also be found on ¼ inch and ½ inch tape machines, the latter being fitted with Dolby SR. The multitrack is a *Saturn*. When the occasion arises, Black Barn hire in additional analogue and digital multitracks and by being close to London, hire equipment arrives reasonably promptly. As far as digital stereo machines are concerned, the studio is equipped with Sony, DAT and *F1*, although Black's personal preference is to mix to ½ inch Dolby SR.

Attached to the control room is a small kitchen and lavatory, this area is hung with gold discs charting Black's 20 years in the business, from Morgan to Maison Rouge to Black Barn. A studio lounge, situated at the end of the building, offers satellite TV, video, darts and a pool table. It has intentionally been separated from the rest of the studio to keep noise and distractions away from the working areas.

Of course the house is always available with its comfortable and relaxed cottage-like atmosphere. The accommodation consists of six bedrooms, one of which—the 'Producer's Suite'—has its own shower room. Catering, which is inclusive in the rate, comprises a cooked breakfast, a light lunch and a full evening meal with complimentary wine. Special diets can be

catered for and barbecues are a regular event in the summer.

Adjacent to the studio is the office; at first glance the building looks like a converted shed but it's not until clambering aboard that one realises it is in fact a caravan.

"We couldn't get planning permission to build an office so instead we made a rather more permanent feature of the caravan, cladding it with the same black weatherboard as the studio and dividing it into two office spaces."

In one of these, is the studio's most recent recruit Diane Wagg. She comes from a management background at Good Earth studios and A&R at EMI; at the moment she is filling in for studio manager Bill Cayley, while he recovers from a recent illness. Wagg is also involved in a management company called MOB, and at the time of writing was in the process of setting up a production company at Black Barn.

"We're looking for bands right now and are in the process of spreading the word. Another area I'm interested in is managing producers and engineers but that won't be until the production company has got off the ground. We are also looking at the possibility of starting our own small record label."

Black is keen to see these new ventures succeed and is presently investing in equipment for the production company.

"Studios with large overheads like ourselves, have to get involved in other areas to survive. It doesn't make financial sense any more to just run a studio by itself, you must have

Equipment list

Console: Soundcraft 3200, 64-channel with Audio Kinetics *MasterMix II*

Tape machines: *Saturn* 24-track, Soundcraft ½ inch stereo with Dolby SR, Soundcraft ¼ inch stereo, Sony DAT 1000ES, Sony 501 F1, Aiwa and Denon cassette machines

Monitors: Tannoy FSM, Yamaha NS10

Outboard: Lexicon 480L, bel BDE 26s sampler/delay, 2×bel BD80 delays, bel flanger, Yamaha REV7, 2×Yamaha SPX90, 2×UREI 1176 LN compressors, 6×Drawmer compressor/limiters, 20×Drawmer noise gates, dbx single-ended noise reduction, dbx de-esser, Orban de-esser, Spanner, Bokse SM9 timecode events controller, Barcus Berry sonic maximiser, Roland TR 707 rhythm composer

Microphones: Neumann Electro-Voice, Sennheiser, AKG, Shure, PZM

other things going on—apart from the financial consideration it also makes it much more interesting for everyone involved."

In the present climate of studio closures, how does Black view the future?

"Actually I feel quite positive, although I've never known a time with so many stories of doom and gloom. I think this year will be very interesting—the strong will survive but I can see a lot of people saying 'this just doesn't make good financial sense' and getting out. While studios continue these suicidal price wars there will be no let up. It needs the strength of all the studios to think sensibly and sort something out and I would certainly like to see the APRS doing more. If record companies and producers want to see studios with the latest equipment in 3 years time, they've got to expect those studios to charge reasonable rates, otherwise this country is going to get left behind. The days of us looking smugly across the water at countries like France, Germany and Spain and thinking we're much better, is history. There are many excellent European studios commanding high rates, which they get and plough back into new technology—you only have to look at the number of studios in Paris with digital gear to realise that."

In these rather uncertain days for UK studios, let's hope Black Barn, like its faithful toad, can survive the bad times and enjoy a long and successful future. □

Black Barn Studios, 3 The Green, Dunsborough Cottages, Ripley, Surrey GU23 6AL, UK. Tel: 0483 222600.



Sojin grand piano in studio

Extreme Measures

-110.0

-115.0

-120.0

-125.0

-130.0

-135.0

-140.0

-145.0

-150.0

0.0

5.00k

10.0k

15.0k

20.0

High-performance Audio Testing With System One + DSP

DESIGNING, MANUFACTURING and MAINTAINING high-performance analog & digital audio equipment places **extreme** demands on your test equipment. Your test set must have **extremely** low residual noise and distortion as well as **extremely** high accuracy... and the variety of systems under test calls for **extremely** flexible test set-up and control.

System One + DSP from **Audio Precision** is the solution. The trace below is a **System One + DSP** FFT spectrum display showing the residual distortion performance of our generator and analyzer. 2nd harmonic distortion of the sine wave is 125dB below the 1kHz fundamental level before nulling. The 3rd, 5th & 7th are all even lower!

This self test is typical of the high-performance, high-accuracy measurement capability of **System One + DSP**.

System One + DSP features include:

- **Dual Channel FFT Analyzer** — Signals up to 80kHz may be acquired and analyzed with 16 bit resolution.
- **Waveform Capture** — Acquire and display signals on the PC screen for analysis in time domain “digital storage oscilloscope” mode.
- **Harmonic Analysis** — Perform harmonic analysis such as measurements of individual distortion components, with automatic tracking to 9th harmonic
- **Processing Power** — Dual high-speed 24 bit internal DSPs and precision 16 bit analog I/O conversion.
- **Low residual THD + N** — Total analog system THD + N (22kHz bw) .001%. DSP analysis permits resolution of distortion as low as 145 dB below fundamental

System One + DSP ... When you're serious about performance.

System One

Audio
precision

P.O. Box 2209, Beaverton, OR 97075
503/627-0832 1-800/231-7350
FAX: 503/641-8906, TELEX: 283957 AUDIO UR



INTERNATIONAL DISTRIBUTORS Australia: IRT Electronics Pty Ltd. (02) 439 3744 Austria, Eastern Europe: ELSINCO elektron GmbH, Wien (222) 812 17 51 Benelux: Trans European Music NV, Belgium (02) 466 50 10 Canada: Eletronix Ltd. (416) 475 8494 Denmark: AudioNord Danmark A/S 85 12 88 11 Finland: Genelec OY 77 133 11 France: ETS Mesureur (1) 45 83 36 41 Germany, West: RTW GmbH 221 70 91 30 Hong Kong: TRP Consumer Electronics, L.c. 887 2008 Italy: Medea S.r.l. 445 36 28 Japan: TOYO Corporation 5 279 0771 Korea: Myoung Corporation 784 9942 Mexico: Vari S.A. 5 250 73 94 New Zealand: Audio & Video Wholesalers, Ltd. 71 73 414 Norway: Lydconsult (09) 19 03 81 Portugal: Acutron ELA 1941 40 87 Singapore & Malaysia: TME Systems PTE Ltd 286 4608 Spain: Telco Electronics, S.A. 1 231 7840 Sweden: Tal & Ton AB 31 30 36 20 Switzerland: Tecrad SA (021) 806 06 36 Taiwan: Litz Technologies Ltd. 703 6280 J.K.: SSE Marketing Ltd. 01 387 1262

INCH AFTER INCH,

SESSION AFTER SESSION,

THRILL AFTER THRILL.

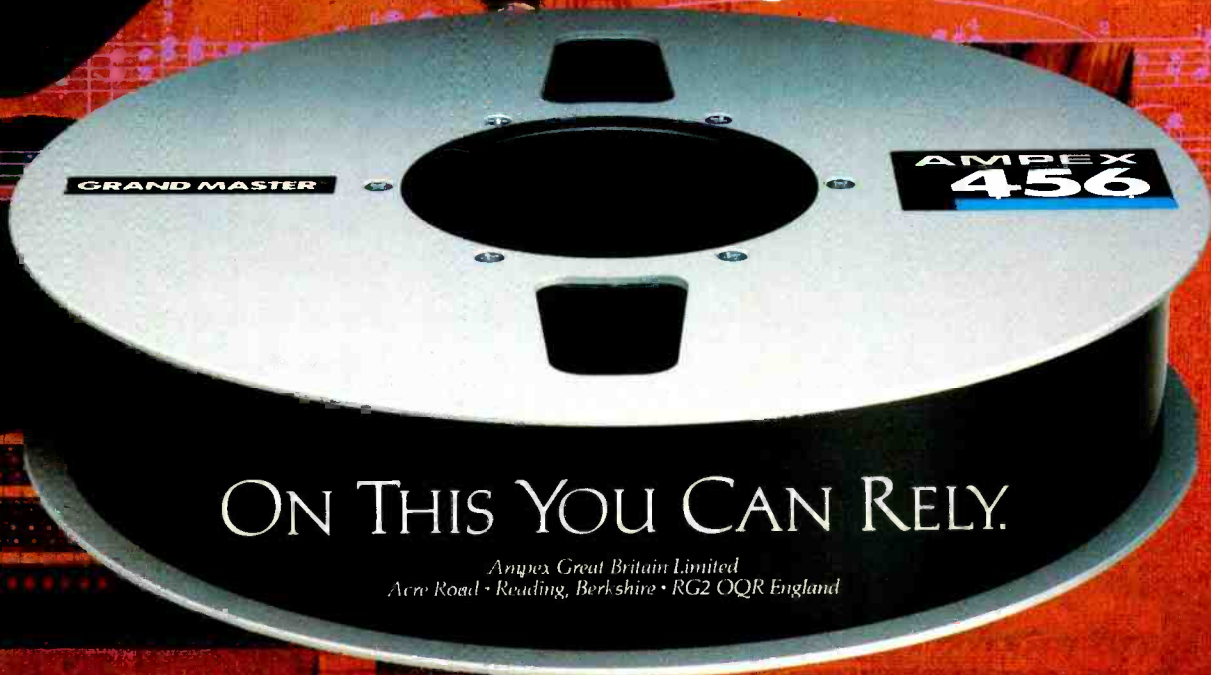

ON THIS YOU CAN RELY.

*Ampex Great Britain Limited
Acce Road • Reading, Berkshire • RG2 0QR England*

Spiritos

EFFECTS

A list and short description of new effects units introduced in the last 18 months subject to information available at the time of writing. We've limited the list to units that enhance audio rather than restore it in any way

ART DR-X and LT: The ART *DR-X* dynamic processor/studio effector claims a 20 kHz bandwidth and a 90 dB S/N ratio. There is a choice of 60 effects—10 can be used simultaneously—and a 200 preset storage capacity. The *DR-X*'s studio sampler is triggered by MIDI, footswitch or manually and offers up to 2 secs sampling time. The ART *Multiverb III Studio Effector* offers the performance of the *DR-X* without the dynamic processing features like the noise gate, the exciter and compressor/limiter.

The ART *LT* is a stripped down *Multiverb III* with the performance of the unit but without its involved programming capacity. It offers 192 of the best ART effects in a one-touch format and the power to process three effects simultaneously.

Applied Research and Technology Inc, 215 Tremont Street, Rochester, New York 14608, USA. Tel: (716) 436-2720.

UK: Harman (UK) Ltd. Tel: 0753 76911.

Alesis Quadraverb: 16-bit digital effects processor features 20 kHz bandwidth, true stereo operation, a wide range of effects (including stereo reverb, delay, chorus, pitch shift) and EQ programs. Up to four effects can be mixed simultaneously. Other features include MIDI IN/OUT sockets together with realtime MIDI control of parameters, LCD readout and 100 memory locations and 90 factory preset programs.

Alesis, 3630 Holdrege Avenue, Los Angeles, CA 90016, USA. Tel: (213) 467 8000.

UK: Sound Technology plc. Tel: 0462 480000.

BASE Spatial Processor: Base is an unusual acronym for an unusual signal processor from US company Gamma Electronic Systems, better known in some circles for the Bedini range of power amplifiers. The Bedini Audio Spatial Environment is a 2U 19 inch rackmount unit that is described as 'allowing you to hear more of the ambient acoustics present during the actual recording'. The processing is analogue and not dependent on software. When creating a stereo mix it is possible to alter the perceived width as well as enhancing a mono signal within the mix to create the desired effect or stereo placement. Demonstration shows the unit can audibly improve the locations of signals with a stereo image. It is also able to bring some audio components forward of the speakers as well as

increase depth. The manufacturers describe the processing techniques as being based upon research into binaural patterns. The BASE is apparently compatible with Dolby, Dolby Surround and dbx processing.

Base, 600 West Broadway, Suite 100, Glendale, CA 91204, USA. Tel: (818) 500-4171.

DOD Digitech Smart Shift: The Digitech *IPS-33B Super Smart Shift* 'intelligent' pitch shifter has the ability to create two- and three-note harmonies from a single input note. The unit generates user defined harmonies in 41 scales from natural minors and chromatics to Dorian and Mixolydian. Other facilities within the unit include stereo pitch detune, chorus and up to 1.5 secs digital delay, both of which can be used simultaneously with generated harmonies. The *IPS-33B* is a 1U rackmount design with 20 kHz bandwidth, MIDI control of all programs and parameters, LED display and a remote control.

DOD Electronics Corp, 5639 South Riley Lane, Salt Lake City, UT 84107, USA. Tel:

(801) 268-8400.

UK: John Hornby Skewes. Tel: 0532 865381.

Eventide Harmonizer: Eventide have released the *SE (Studio Enhanced)* version of the *H3000 Ultra-Harmonizer*. The *H3000SE* features six new algorithms (including Instant Phaser) together with a new Function Generator that adds dynamic parameter modulation capabilities. Also new is an updated basic version known as the *H3000-S* that is a new package including additional programs and features. There is now an *HS322* internal sampler board to fit all models.

Eventide Inc, 1 Alsan Way, Little Ferry, NJ 07643, USA. Tel: (201) 641-1200.

UK: HHB Communications. Tel: 081-960 2144.

Lexicon 300: digital effects system incorporating timecode reader that allows storage of 50 setups with a timecode value in an events list that will change setups against incoming timecode.

Programs include reverb and ambience, mastering functions such as level/balance and EQ, stereo pitch shift and delay effects. Operates at 32, 44.1 and 48 kHz sampling rate with MIDI and most interfaces included.

Lexicon Inc, 100 Beaver Street, Waltham, MA 02154-8425, USA. Tel: (617) 891-6790.

UK: Stirling Audio Systems. Tel: 071-624 6000.

Spatial Sound SP-1 processor: The *SP-1* is designed specially for moving sound from up to four independent audio sources spatially between two to eight speaker locations to which its output may be routed. Reverb processing mode incorporates an external reverb unit to enhance the external unit's spatial effects. Gerzon Processing mode uses a special phase-processing technique for more realistic spatialisation, and so on. The unit lets you create effects such as Doppler, the simulation of distance, the speeding up or slowing down of sound movements through space and the increasing or decreasing in size of sound movement patterns. The *SP-1* may be used in live performances, sound recording and in the creation of cinema surround and theatre effects.

Spatial Sound Inc, PO Box 1111, Mill Valley, CA, USA. Tel: (415) 457-8114. □



BASE First Base signal processor



ART effects units

EQUALISERS

A list and short description of new equalisers introduced in the last 18 months subject to information available at the time of writing. The list divides into two clearly defined markets, the more expensive units that are bought for their inherent sound and the units that sell by virtue of their all-round performance and facilities

Amek Medici: Rupert Neve has designed this unit in conjunction with Amek. The equaliser has two separate control paths, each containing a 4-band parametric equaliser with high- and lowpass filters. Bands from one path may be switched into the other allowing a single 8-band equaliser to be formed. Bands may also be flipped from one path to the other under manual or MIDI control. In addition to the normal EQ functions, new controls like a variable warmth control for low frequencies and a Sheen control for high frequencies have been added.

Amek Systems & Controls, New Islington Mill, Regent Trading Estate, Salford M5 4SX, UK. Tel: 061-834 6747.

USA: Amek/TAC US Operations, North Hollywood, CA. Tel: (818) 508-9788.

API 550b: The 550b features the same circuit design as the 550a but miniaturisation of components has enabled a fourth band to be added for a total of 28 selectable frequencies. The high and low bands can be switched between peaking and shelving and the unit features discrete circuitry throughout. Wiring and power requirements are as the 550a.

API Audio Products, Springfield, VA 22153, USA. Tel: (703) 455-8188.
UK: Stirling Audio Systems. Tel: 071-624 6000.

Focusrite: The ISA 110 mic preamp/equaliser module has been updated since the company's re-emergence in pro-audio last year.

Focusrite, Unit 2, Bourne End Business Centre, Bourne End, Bucks SL8 5AS, UK. Tel: 0628 819456.

Neve Prism: Neve's Prism series of outboard modules has been designed to upgrade any console with the Neve sound. The equaliser module is called the *Formant Spectrum Equaliser (FSE)*.

Neve Electronics International Ltd, Cambridge House, Melbourn, Royston, Herts SG8 6AU, UK. Tel: 0763 260776.
USA: Rupert Neve Inc, Bethel, CT. Tel: (203) 744-6230.

PAST EQ: The PAST equaliser is based on the Neve 80 series technology. The unit is 1U, single-channel and has separate transformer balanced mic and line inputs and transformer balanced output. Dual concentric controls, with an outer switch and an inner pot provide sensitivity and equaliser functions. The equaliser has four overlapping bands each with 18 dB boost/cut on the inner control and switchable frequencies on the outer, plus five high- and low-pass filters.

PAST, 9 Fisher Close, Haverhill, Suffolk CB9 0LZ, UK. Tel: 0440 706752.

SSL Logic FX: A range of standalone processors based on the G series electronics under the name *Logic FX*. The G383 mic amp/equaliser contains two identical mic amp/EQ sections with transformerless balanced inputs and variable input impedance control over the range of 600 Ω

to 8.5 k Ω . The EQ section is 4-band parametric with switchable variable highpass filter.
SSL, Begbroke, Oxford OX5 1RU, UK. Tel: 0865 842300.
USA: New York, Tel: (212) 315-1111. Los Angeles. Tel: (213) 463-4444.

Apex PE133: Apex's first product is the PE 133 paragraphic equaliser—a 30-band graphic combined with a 3-band parametric section and high- and low-pass filters. The graphic section provides ± 12 dB of gain at ISO frequencies. The parametric section has fully adjustable gain, frequency and Q for each band.
Apex NV, Zangerheidestraat 6A, 3751 Munsterbilzen, Belgium. Tel: 011-41 73 32.

ART High Definition Equalisers: These two graphic equalisers are termed 'high definition' by the manufacturers. The two models are a 31-band $\frac{1}{3}$ -octave and a 15-band $\frac{2}{3}$ -octave version, both incorporating 60 mm faders, switchable subsonic and ultrasonic filters, fail safe hardware bypass in case of power loss and clip/signal metering. ART's circuitry is claimed to dramatically reduce adjacent band interaction and increase dynamic range, and constant Q precision filtering and summing networks are used to provide increased accuracy. ART also claim S/N and distortion figures better than many digital specs.

Applied Research and Technology Inc, 215 Tremont Street, Rochester, NY 14608, USA. Tel: (716) 436-2720.
UK: Harman (UK) Ltd. Tel: 0753 76911.

Audio Logic SC 131: A cut-only graphic equaliser with 31 ISO centres. The attenuation ranges are switchable between $-10/-20$ dB and the unit also features variable high- and low-pass filters, ± 12 dB overall gain and balanced/unbalanced input/output on XLRs, $\frac{1}{4}$ inch jacks and barrier strip.

DOD Electronics Corp, 5639 Smith Riley Lane, Salt Lake City, UT 84107, USA. Tel: (801) 268-8400.
UK: John Hornby Skewes. Tel: 0532 865381.

BSS DPR-901: The DPR-901 dynamic is an analogue audio processor that integrates parametric equalisation with dynamic expansion and compression processes. The unit features four parametric bands of frequency selective expansion ($+16$ dB) and compression (-30 dB).
BSS Audio, Unit 5, Merlin Centre, Acrewood Way, St Albans, Herts AL4 0JY, UK. Tel: 0727 45242.
USA: EDC, New York. Tel: (914) 567-1400.

C-Audio graphic EQs: C-Audio's new range has three models. The 2-channel 15-band EQ152, the single-channel 31-band EQ311 and the 2-channel 31-band EQ312. All units are 2U high with level; highpass filter; threshold level control; peak and signal present, all duplicated on each channel.
C-Audio Ltd, Barnwell Road Business Park, Cambridge CB5 8UY, UK. Tel: 0223 211333.
USA: Ocean Marketing, St Petersburg, FL. Tel: (813) 347-4867.

Court Loudspeaker processor: A multifunction signal processor apparently intended for insertion on the power amp input(s) of a monitoring system. Familiar features include a 2-way electronic crossover and a limiter to avoid clipping. An unexpected feature is a fixed curve equaliser, which when switched to 'live' has no effect but in 'recorded' mode boosts high and low frequencies.
Court Acoustic Systems, The Studio, PO Box

TWIN TWIN PPM



Two TWIN movements and two PPM9 boards give simultaneous monitoring of A/B on red and green and M/S on white and yellow pointers. Together these provide complete information about stereo signals, in contrast to the ambiguous readings of phase meters. PPM9 is a two channel PPM driver featuring inherent stability with the law under microprocessor control. Manufactured under licence from the BBC.
ALSO: PPM7, the highest specification analogue drive circuit on the market ★ PPM5, 20-pin DIL hybrid; illuminated TWIN boxes ★ PPM8 IEC/DIN — 50/+6dB scale ★ Peak Deviation Meter ★ Programme and Deviation Chart Recorders; Single and TWIN meter movements ★ PPM10 On-screen TWIN TWIN PPM and Charts.

SURREY ELECTRONICS LTD, The Forge, Lucks Green, Cranleigh, Surrey GU6 7BG
Tel: 0483 275997 ★ Fax 276477



DENON



ver the last few years, the CD has gradually replaced vinyl as the most popular sound source in studios. The CD is small, light and easy to use. Now Denon has made the CD even more convenient than before.

The DN-950FA is a state of the art player that accepts CDs inside a special library case, so once the CD is loaded it never needs to be touched again.

Features of the DN-950FA include:

- Instant cueing – straight to chosen track
- Fast search – allows chosen passage to be selected quickly
- Easy auditioning – backwards and forwards
- Digital Display – remaining or elapsed time
- Adjustable EOM timing – 5 to 35 secs
- Remote operation – switchable remote operation
- Solid construction – built for professional usage

For more information and to arrange for a demonstration, contact Hayden Pro-Audio.

THE QUALITY- AUDIO CART MACHINE

Hayden
Pro-Audio



HAYDEN HOUSE
CHILTERN HILL
CHALFONT ST. PETER
BUCKS SL9 9UG
TEL: (0753) 888447
FAX: (0753) 880109

831, Oakley Green Road, Windsor, Berks.
SL4 4EZ, UK. Tel: 0628 38555.

Harrison Information Technology GQ-series: This graphic EQ features surface mount thick-film hybrid technology. The models are *GQ152* 2x15-band $\frac{2}{3}$ -octave; *GQ301* 1x30-band $\frac{1}{3}$ -octave; and *GQ302* 2x30-band $\frac{1}{3}$ -octave with high- and lowpass filters. All models have 6 dB/12 dB cut/boost range switches.

Harrison Information Technology, Unit 3,
Button End, Harston, Cambridge CB2 5NX,
UK. Tel: 0223 871711.

Klark-Teknik series 300: Graphic equalisers using new 'MELT' filter circuits featuring models *DN300* single-channel $\frac{1}{3}$ -octave graphic providing 12 dB of cut/boost and two shelving filters; *DN301* is a single-channel $\frac{1}{3}$ -octave graphic with cut-only; *DN332* dual-channel $\frac{2}{3}$ -octave graphic; *DN360* dual-channel $\frac{1}{3}$ -octave graphic.

Klark-Teknik Research Ltd, Klark Industrial
Park, Walter Nash Road, Kidderminster,
Worcs DY11 7HJ, UK. Tel: 0562 741515.

USA: Klark-Teknik Electronics Inc, Farmingdale,
NY. Tel: (516) 249-3660.

MicroAudio EQ pods: A computerised equalisation system based on a range of EQ pods: totally tamperproof rackmount equalisers that must be programmed from MicroAudio's *2800* or from their *PC 280* in conjunction with an IBM PC. Use with the *2800* controller allows Auto EQ, which the manufacturers claim makes obsolete the standard method of obtaining an RTA curve and creating a reciprocal EQ curve to correct room anomalies.

MicroAudio Inc, 4438 SW Hewett, Portland,

OR 97221, USA. Tel: (503) 292-8896.
UK: Shuttlesound. Tel: 081-871 0966.

Orban 764B: The *764B* is a stereo equaliser with digital control over all parameters of 4-band parametric EQ with constant Q characteristic and separate high- and lowpass filters. Settings can be stored into 99 memory locations. A *764B/SL* slave version is also available for multiple systems under common control.

Orban Associates Inc, 645 Bryant Street, San
Francisco, CA 94107, USA. Tel: (415) 957-1067.
UK: SSE Marketing. Tel: 071-387 1262.

Peavey Autograph: The *Autograph* is a MIDI programmable 28-band graphic equaliser with a built-in realtime analyser and pink noise source (-10 dB). Special features allow the *Autograph* to be used as a standard graphic with ± 12 or 6 dB resolution, a programmable equaliser where curves can be stored in 128 memory locations or as an analyser with auto-EQ. In addition it can receive MIDI commands to change settings and be controlled by a MIDI librarian or computer.

Peavey Electronics Corp, 711 A Street,
Meriden, MS 39301, USA. Tel: (601) 483-3565.
UK: Peavey Electronics UK. Tel: 0536 205520.

Rane MPE: The *MPE* series of programmable equalisers is available in three versions: *MPE 28* $\frac{1}{3}$ -octave, *MPE 14* $\frac{2}{3}$ -octave, *MPE 47* 4-channel 7-band. All feature 128 memory locations with full MIDI implementation, curve weighting (combining), realtime change and multi-EQ tandem control capability.

Rane Corporation, 10802 47th Avenue West,
Everett, WA 98204-3400, USA. Tel: (206)
355-6000.

UK: Music Lab. Tel: 071-388 5392.

Scientific and Production co-operative of Moscow have produced the *Mirage* $\frac{1}{3}$ -octave 31-band graphic equaliser designed for record restoration and studio and concert hall recordings with claims of high dynamic range, low noise and distortion levels.

The Scientific and Production Co-operative, 9
Petushkova Street, Moscow 123373, USSR.
Tel: 949 00 90.

Summit EQF-100: Summit Audio have extended their range of vacuum tube signal processors with the *EQF-100*. This is a single-channel equaliser with four passive overlapping bands of seven frequencies each plus high and low filter sections of three frequencies each. Highest and lowest bands are peaking or shelving with vacuum tubes used for gain make-up and 990 op amps used for the output stage. Cut and boost is up to 16 dB and bandwidth is variable. Housing is 2U 19 inch rackmounting.

Summit Audio Inc, PO Box 1678, Los Gatos,
CA 95031, USA. Tel: (408) 395-1403.

UK: Autograph Sales. Tel: 071-485 3749.

Taylor Dynamic Equalizer: a 2-channel, 10-band VCA-controlled dynamic equaliser with integral graphic display. Level control of ± 10 dB per band on pots with individual limiting settings on each of the bands. There are individual master L and R meters in addition to 10-channel spectrum analyser.

Hit Design, Ocala, FL 32671, USA. Tel: (904)
622 2779.

USA: Broadcasters General Store, 2480 SE 52nd
Street, Ocala, FL 32671. Tel: (904) 622 9058.

WHICH DUCK PAID LESS THAN



THE ONE WHO BOU

For further information on the new Thompson T24 contact, Th

tc electronic 1128X: satellite version of the 1128 programmable graphic equaliser is for use with an external computer, which provides all the programming and master control functions. In addition to the standard 1128 equaliser features, the satellite/computer combination provides such added facilities as 1/2-octave analysis, visual editing, automatic room equalisation and feedback suppression, SMPTE timecode reading and generation and MIDI functions. The new software for the 2290 effects processor will retrofit to existing units and will be standard on all new equipment.

tc electronic, Grimhoejvej 3, Denmark. Tel: 626 2800.

UK: tc UK. Tel: 0691 658550.

USA: tc electronic USA Inc, North Hollywood, CA. Tel: (818) 503-0404.

TOA Saori: TOA's Saori is a digital processing system designed to sit between the mixing console and power amplifiers to undertake the equivalent operations of two 30-band equalisers, two constant directivity horn compensators, two 4-band notch filters, two 4-way crossovers and eight digital delays—all within a 5U rack space. The construction is modular allowing field replacements and tailoring of systems to meet user needs. It is planned that future upgrades or functions will be added via software ROM or new module cards.

TOA Electronics, Kobe, Japan.

UK: LMC Audio Systems Ltd. Tel: 081-749 9875.

USA: TOA Electronics Inc, South San Francisco, CA 94080. Tel: (415) 588-2538.

White Instruments 4700: The model 4700

1/2-octave, 28-band programmable EQ with RS-232,



Saori integrated sound processor from TOA Electronics

networking and remote options.

White Instruments, PO Box 698, Austin, TX

78767, USA. Tel: (512) 892-0752.

UK: SSE Marketing. Tel: 071-387 1262.

Yamaha DDL3: primarily a digital delay line but with 3-band digital parametric EQ incorporating variable mid-band Q on each of the three outputs.

Level, EQ and delay settings may be stored in 15 memories and are MIDI controllable.

Yamaha Corporation, Hamamatsu, Japan.

UK: Yamaha Kemble, Mount Avenue, Bletchley, Milton Keynes MK1 1JE. Tel: 0908 71771.

USA: Yamaha Corporation of America, Buena Park, CA 90622-6600. Tel: (714) 522 9011. □

£13,000 FOR A 2" 24 TRACK?



UGHT A THOMPSON

Thompson Audio Developments Ltd. PO Box 373 . Biggleswade . Bedfordshire SG18 0AQ . England . Tel: 0757 601655 Fax: 0767 601455



WHO CONTROLS WHO?

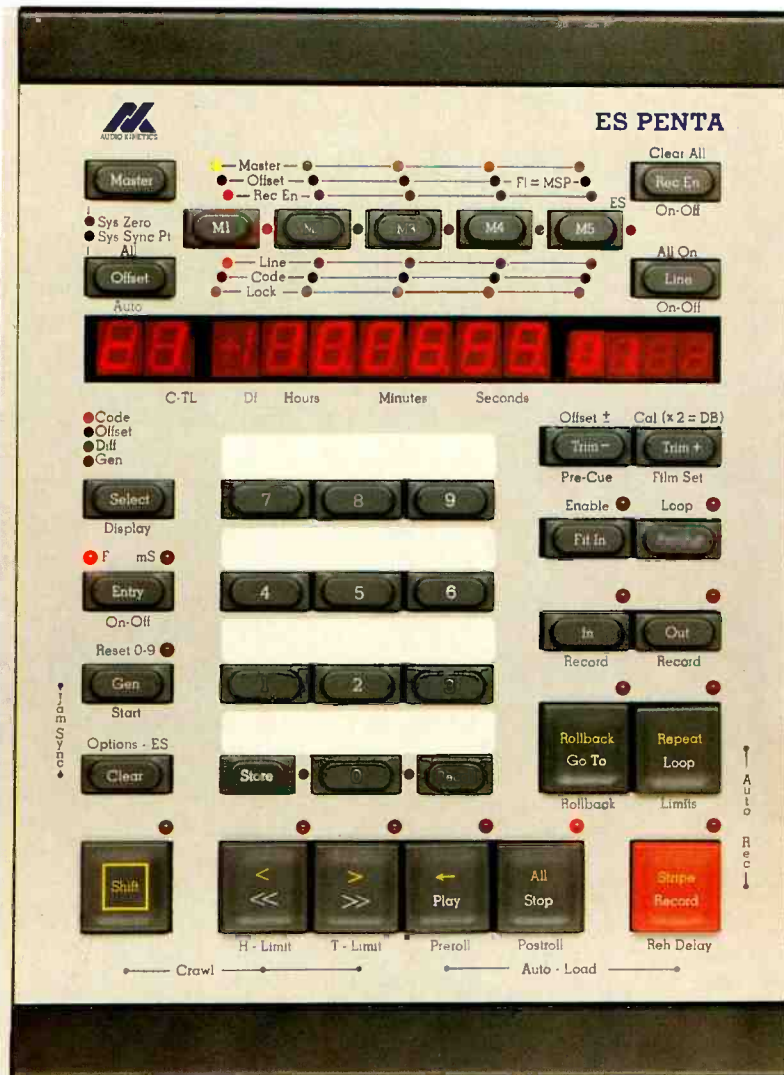

The phrase 'machine controller' often implies working the way the controller does – not how you want. It controls the method of working as well as the machines. But **ES.Lock Penta** is different. As well as providing fully comprehensive five machine control, ES.Lock Penta also provides a few important little extras that help make sure that it's you in control of the controller. Not the other way around.

- Freely re-assignable Master with automatic offset compensation.
- Crash Record Option with automatic capture and optional repeat.
- Record, offset and event accuracy to 1/100th of a frame.
- Remote Master mode allowing console, autolocator or remote machine layback control in parallel with the ES.Lock Penta.

Are you under control, or in control?

Audio Kinetics UK Ltd, Kinetic Centre, Theobald Street, Borehamwood, Herts, England WD6 4PJ.
Tel: 081-953-8118. Fax: 081-953-1118.

ES.Lock Controllers and ES.Lock 1.11 Synchronisers are installed in 21 countries worldwide:
Australia, Magnatech, 2-427-0666. **Austria**, Grothusen, 22-297-2529. **Belgium**, Heynen, 1152-5858. **Canada**, Sonotechnique, 514-739-3368. **Denmark**, Interstage, 31-620026. **Finland**, Studiotec, 0-592055. **France**, Audio Kinetics, UK-81-953-8118. **Germany**, STK, 40-690-1044. **Holland**, Heynen, 8851-96111. **Ireland**, Audio Kinetics, UK-81-953-8118. **Italy**, Audio International, 2-253-90121. **Japan**, General Traders, 3-293-2274. **New Zealand**, Maser - Auckland 9-479-7889. **Norway**, Siv. Ing. Benum, 2-135-460. **Singapore**, Team 108, 748-9333. **Spain**, Telco, 1-231-7840. **Sweden**, Proab, 760-19863. **Switzerland**, Studio World, 56-271233. **Taiwan**, Acesonic, 271-68896. **USA**, 21st Century, 213-463-4718.



Brueel & Kjaer, continue their push into the studio market. Broadcasters and recording studio managers would like to buy more B&K mics but with prices on the high side (up to several times the price of products from any of the other manufacturers) they just cannot afford it. So there is continual pressure on B&K, from customers visiting the company's factory at Naerum, near Copenhagen, Denmark, to reduce the price and sell more. B&K continue to resist, arguing that the only way to reduce the price is to automate and thereby lose control of the product. Remember, the company started out making measuring microphones, which have to be stable under jungle or arctic conditions. Engineers then tried using them in a studio and B&K started selling them for studio use.

Studio Sound editor Keith Spencer-Allen wrote a full run-down on the Naerum factory (July 1987) and, because B&K refuse to automate, the process remains unchanged. It's still all down to manual dexterity.

Some days, the person who clamps the 1.5 micron nickel mic diaphragm between a pair of finely machined metal rings, fails to get useful quantities right. Other days they sail through a batch without any failures.

There is no automatic insertion of components. It takes half an hour to 'stuff' a board by hand, with much of the soldering done manually too. Naerum smells like a real factory, with real cyanide baths in the corner. Although (surprisingly) workers can smoke in some parts of the factory, those who assemble the microphones by hand train for a year and then work in a Class 100 clean room. Total production is still only 15,000 microphones a year, spread over 20 models. Of the total 2,200 staff, 400 work on research and development and 70 are employed to write the company's technical literature on an Atex computer system of the type used by The Times Newspaper Group in London.

B&K make electret mics that work in the opposite way from conventional electrets. Whereas conventional mics rely on a charged, insulating diaphragm B&K has, since 1974, been using a charged back plate and a conductive metal diaphragm. A 20 mm disc of monel (nickel and steel) or silver (for studio mics) is machined flat and polished with diamond dust to 0.5 micron, mirror smoothness. A 15 micron layer of *Teflon* is then sprayed over the polished surface and hit with a beam from an electron gun to give it a 200 V static charge.

The nickel foil diaphragm, just 1.5 µm thick, is suspended just above the charged back plate. When soundwaves move the diaphragm, it generates an electrical signal. Tiny holes are drilled in the back plate, to increase sensitivity.

Each finished microphone is calibrated by hand. This would still be necessary, even with full scale automation of the production process. The component materials, especially the monel metal, vary from batch to batch so the process can never be 100% predictable. The founders, Doctors

Barry Fox

Precision and ethics of Bruel & Kjaer; awards comments

B&K, retain their strict principle, "We won't kill for money." During the Vietnam war, the Pentagon wanted to place a vast order for microphones. These were to be suspended in quartet clusters from a helicopter, to pinpoint the source of any sound from the jungle, by analysing relative phase delays between received wavefronts. The company said no to the order.

They will, however, supply hydrophones, which are almost certainly being used for submarine detection. And most recently B&K, along with the Danish Acoustical Institute, at Lyngby, part of the Danish Academy of Technical Sciences, have been involved in an extraordinary defence project cooked up by the Danish Government.

After the Chernobyl nuclear power station disaster, which leaked radiation over Europe, Danish politicians realised how vulnerable they were to airborne gas attack. So they hatched a plan to provide the whole country with an early warning system. Gas analysers are now being installed all across Denmark to sense even the smallest traces of nerve gas. The sound alarm system was designed by the Acoustical Institute. And believe it or not, the gas sensors are based on B&K microphones.

The sensor has to detect very small concentrations of mustard gas or any of the nerve agents, Tabun, Sarin or Soman. It relies on the fact that toxic gases absorb infra-red light. A pump draws a sample of suspect air into a closed chamber with a window. Light from an infra-red source is shone past a rotating chopper wheel, which pulsates it, and through the window into the chamber. Any gas present absorbs infra-red energy, causing the air temperature to rise very slightly. The chamber is sealed, so the temperature increase causes an equivalent increase in pressure. Because the infra-red light source is pulsating, the pressure increase fluctuates at the chopper frequency. This creates an acoustic wave that is sensed by two microphones in the chamber walls. B&K's mics are probably the only ones in the world with the sensitivity to register the tiny variations in pressure created when only a very small quantity of absorbent gas is present.

In its simplest form, the meter registers the presence of any gas, including water vapour,

which absorbs infra-red light. B&K found that different gases absorb precisely defined frequencies and sell 22 filters, which tune the performance of the meter to a tight range of frequencies and thus gases. B&K will sell them to hospitals for checking on anaesthetic leaks and to local authorities for monitoring seepage of poison gases from land fill waste disposal sites at around £10,000 a time.

Filters tuned to the toxic gas absorption frequencies can detect nerve agents down to a concentration of 15 parts per billion, which will produce minor symptoms in humans after 30 mins exposure. The meter takes 45 secs to make a measurement and will normally be set to take one reading every 10 mins, giving everyone time to run for shelter from a gas attack. By fitting different filters, the meter can be tuned to sense ozone, methane, carbon monoxide or dioxide and nitrous oxide.

The Acoustical Institute is replacing the country's old wartime mechanical sirens with a network of horn loudspeakers. These produce an SPL of over 145 dB at 1 m from the horn. When the meters sense gas they will trigger an oscillator that generates a warble tone, between frequencies of 200 Hz and 650 Hz, and this warble is amplified and fed to the horns.

The nationwide alarm network will not be finished until 1994 but the Danish Civil Defence service has already bought several hundred meters and Copenhagen has sirens. Be warned if you are visiting Denmark. These are tested every Wednesday at noon.

The only weak link in the system is that few people know what to do when the sirens sound. Even employees of the Acoustical Institute and B&K admit they are not sure where to run if the sirens go off at some other time, or if Denmark is attacked with gas at noon on a Wednesday.

Two things stick in the mind from the Dance Music Awards, organised by DMC, the Disco Mix Club, and sponsored by Technics and Stanton—makers of the only gramophone equipment able to withstand the abuse handed out by Disco DJs.

After the usual round of speeches, with bitter snipes at CBS, and collection of the awards by a string of people representing artists who were 'unfortunately unavailable', a very tight group of studio session musicians played a punchy set. Almost immediately the record company audience made for the pay bar outside. Heaven forbid they might hear some music played live.

My favourite award was for the 'best answering machine message'. The winner was a lady from Phonogram who had dubbed an apposite Curiosity Killed The Cat vocal track—*Name and Number*—"We'll leave a message, sorry you couldn't get through..." from a commercial release to answering machine cassette. Nice idea, and a

welcome change from imitation Humphrey Bogart voices. But I thought the record industry was all against the idea of dubbing discs onto tape, especially when the dubber gains from the exercise.

Gas analysers are now being installed all across Denmark to sense even the smallest traces of nerve gas. And believe it or not the gas sensors are based on B&K microphones

The record store (or should it be called a music store today) was like any other. The typical high street—shopping mall locale with a fairly small retail footage.

In the glass front display area, a cardboard cutout of the latest rapster would vie for attention with a Madonna cutout. He took a deep breath, stomped out his cigarette butt and sucked in his not inconsiderable gut.

"Could you help me?"

His query fell on deaf ears as the blue-blond cashier continued her conversation with 'Spike'. 'Spike' was found in most record stores apparently, trying to chat up the airheaded 17-year-old female cashier while shoplifting as much as possible under his capacious and studded leather jacket. The not-so-faint whisp of body odour from under the jacket suggested that 'Spike' could do with a gift of a case of underarm deodorant . . . in fact, at least a dozen cases!

Finally, he caught her not considerable attention. "Do you have *Piano Man* by Billy Joel?"

"No such record. He never made a record called *Piano Man*. We don't have it . . . nobody has it . . . because he never made it."

"How can you be so sure?" the man asked.

"You were probably 2 years old when he made it. Please check the catalogue."

"I don't need to," she said. "If we don't have it, then it either was never made or doesn't really matter."

Awed by this incontestable logic, the man paused and turned to deal with his pimple-faced tormentor. "Why don't you want to help me?" he asked. "After all, I am a customer."

"No you're not," the girl giggled. "You're over 30. You don't count!"

That simulated exchange—based on hundreds of similar actual encounters—serves as a capsule to identify the major ailment eating away at the business of audio as we enter the '90s. The audio business at the top or professional end is charged with the responsibility for recording both new music and making the equipment to record that music. If the professional end of the audio cycle is to be successful, then the end product of the cycle—the sales of recorded music into the home—must be equally successful. Unfortunately, where in years past the record business and the audio business were synonymous, today finds the record business operating as though the rest of the audio industry really did not matter or was just plain abstract to the selling of music on records.

Those charged with selling music are busy re-releasing abandoned or soon to be abandoned LP catalogue onto CD. The volume of new releases has slowed to accommodate that event. The categories of music being emphasised for sale are considerably reduced from the diverse selection emphasised in the late '70s and early '80s. Whether the record companies alone are responsible or the music retailers have the shared responsibility is immaterial. The emphasised music category in the mall high street record stores that account for 80% of all music sold in the relatively interchangeable US/Canada/UK

Martin Polon

Lamenting the plight of those who would buy music. Comment from our US columnist

English-speaking marketplace, is popular music. Further, it seems that the popular music being overwhelmingly retailed is pointed at the 12 to 25 year old age group. Try to find a reasonable selection of classical, jazz, country and western, new age, etc, in these small stores and you find minimalist stocking. Some analysts estimate that the world record industry, which protests loudly that it is losing 25% of all sales due to bootlegging and piracy, is actually losing about 100% of its real sales potential due to the virtual elimination of large categories of customers and musical genres from the shelves of these stores. This means there is real potential to perform at least twice as well financially in terms of record sales, if the industry really wanted to.

Demography: The simple fact is that the citizens, or if you prefer the denizens, of the western world are getting older. There is an immutable piece of history that has shaped our population curve since the middle of this century. That event is World War II. Virtually the entire population of this planet fought the greatest war in the history of our civilisation. Mating and child bearing took a significant back seat. That created a population dip followed by the greatest population bulge yet seen as the pent up energy of mating and reproduction produced the baby bulge and the baby boom and the baby boomers. The boomers were weaned on rock and roll and their demand for music created the growth that has sustained the music industry through the '60s, the '70s and into the '80s. But after this bulge has entered its 30s, we have a significant drop in numbers below the age of 30 since the only parenting group available are the children of the war. These significantly reduced numbers bode ill for anybody selling primarily to the 13 to 25 age group. That, of course, is the target audience of the mall or high street record store and to a large extent of the record industry as a whole.

On the other hand, the over-30s, the excluded element in most record industry marketing schemes (whether intentional or *de facto*), represents ¾ of the spending population and has ¾ of the disposable income. In most record stores, these individuals are effectively disenfranchised. The television networks realise that this shift is happening and are emphasising the fact that their prime viewer is more likely to be 40 than 30. Network research types predict that the prime

viewer age will be 49 by the year 2000.

Stocking patterns: A combination of 'time dating' and a clear focus on rock music reduces the available space for classical music, the bellwether of servicing the over-30s, to as little as two bins in some stores. Four bins was the norm but very few mall stores had more than four bins of classical. Since that averages out to approximately 200 to 300 classical titles from an available pool of 5,000+ titles in the catalogue, it becomes clear that there is not much to entice the older buyer. Contrast that to the same stores stocking no less than 16 bins of rock music and some having as many as 30 bins.

Even obvious crossover artists like Billy Joel are frequently given short shrift in the mall stores. Because of his long term reputation for seven top 10 albums, numerous hit singles, flashy concert performances and strong yuppie attractions, many chains and store managers write him off as just another 'over-30' artist. They stock the obligatory 'Best Of' album and whatever else is easily available. But they ignore a tremendous surge of under-25 popularity that has stemmed from concerts and the latest album *Storm Front* with hit single *We Didn't Start The Fire*. Similarly, the crossover strength of Eric Clapton, Phil Collins, Elton John and Rod Stewart is frequently ignored.

If classical gets short shrift in most stores, the categories of country/western and jazz do even less well. In almost every mall store surveyed, jazz has less significant space devoted to it than classical. Ditto country and western. Other categories averaged half to a whole bin with the exception of children's music, which indicates some fledgling interest by the record industry in the babyboomers' babies—the next population bulge. Many chains use computers and dating codes to keep the stock 'fresh'. Several mall managers told me they were not allowed to keep records that had not sold for 90 days. Some managers felt 60 days was the right time frame to cull or rotate their stock.

There seems to be a mechanism at work that at once becomes self-serving prophecy. If the manager of a given chain of mall record stores decides that classical does not sell, rest assured, it will not! Ditto the appropriate manager at the record label and the manager of the individual store. What happens is this:

- 1 The label does not support the musical area in question. So that chain and those stores will not have the support of the classical promotions staff. Most works will not ship at all and there will be no cardboard cutouts of Yitzak Perlmann and Yo Yo Ma to leaven the influence of Madonna.
- 2 New classical releases are restricted to absolute winners. No diversity is intended or achieved. There may only be one full bin of classical releases in the store.
- 3 Classical sales are low. Older people do not want to go into the store because of 'Spike' and 'Airhead'. Classical buyers who could have been turned into regular customers and who might have bought the occasional pop or jazz record, know how weak the stock is and do not shop there.

TANNOY
MONITOR
SERIES

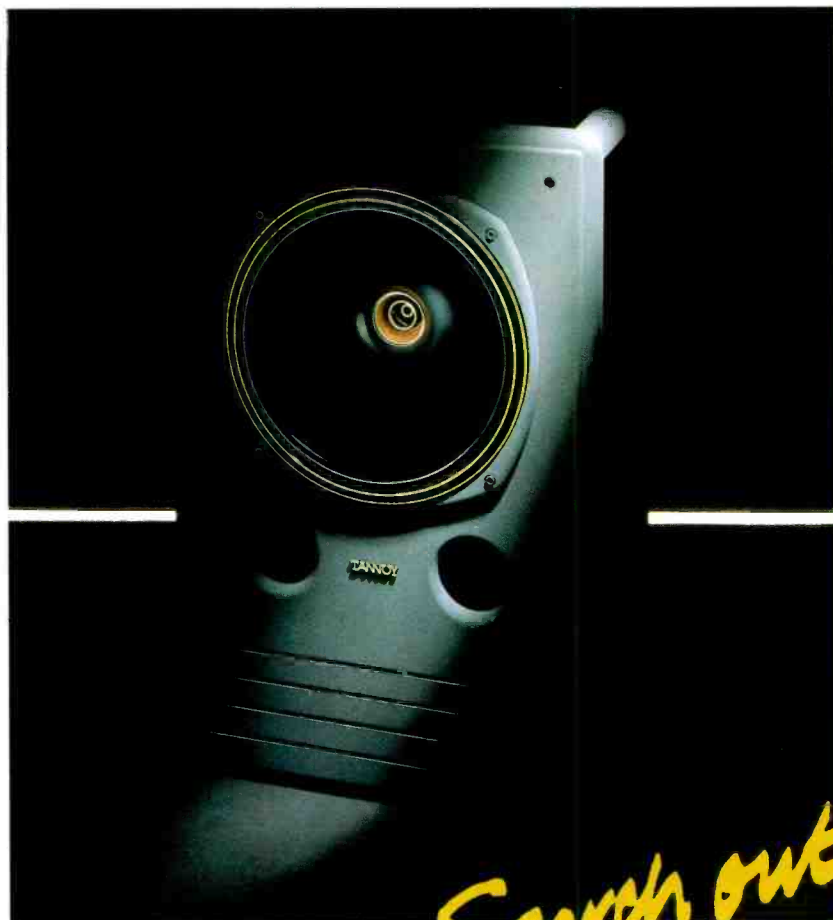

*Search out the
Grey and Gold*



TANNOY LTD., ROSEHALL INDUSTRIAL ESTATE, COATBRIDGE, STRATHCLYDE ML5 4TF, SCOTLAND.
TEL: (0236) 20199. TLX: 778621 TANMFGG. FAX: (0236) 28230.

TGI/TANNOY, 300 GAGE AVENUE, KITCHENER, ONTARIO, CANADA N2M 2C8.

TEL: (519) 745 1158. FAX: (519) 745 2364.

www.americanradiohistory.com

4 The store has a high rate of classical returns. Returns occur because the stock does not justify classical buyers' time and because the chain's computer system returns the store's stock after 60 days.

5 Chain, store and label management, citing the poor sales figures for classical, have self-justified their original perceptions.

Full stocking record stores with thousands of titles have proved successful in major cities in the US and in England. Mega-stores, such as those run by Tower, Virgin, HMV and others, have proven that people will flock to record palaces--starved for a diversity of music. HMV believes strongly enough in this concept to build what has

been billed as the world's largest record store in Cambridge, Massachusetts--a collegiate suburb of Boston. But these and other so-called 'good' record stores only make up about 10% to 15% of the total. A truly frightening figure.

Record store staffing: Small record stores frequently have staffing problems that transcend the basic issues of 'Spike' and 'Airhead'! Unfortunately, staff are generally musically ignorant. They are usually functionally ignorant of the record business. And frequently they are rude, arrogant and potentially offensive to the customers. Even if the help is relatively innocuous, their lack of musical knowledge, even

in areas that could be considered 'their' music, discourages sales. Artists unknown to the sales staff in a record store generally remain artists unsold. It is not enough for the black labelled dividers to name major artists. Customers frequently need hands-on help and that is precisely what is missing from many suburban record stores. One way to sort out those employees who care from those who don't is to ask how many record store employees read *Billboard* and the like on a regular basis? The answer is about 25%, even if the store does receive the record industry 'bible'.

A recent survey of 50 US mall record stores found the following:

- when asking for a recording by Ferde Grofe, 69% of the store staff did not know who Ferde Grofe was
- of the rest, 5% thought he was the drummer for Def Leppard
- of the remainder, 3% thought she was a singer with 'Tin Lizzie'
- 6% gave other wild answers
- only 17% correctly guessed a classical connection
- of those who connected with the classical vein, only about half--or 8% of the 100%--could correctly identify with either the *Grand Canyon Suite* or the syncopated arrangement of Gershwin's *Rhapsody In Blue*--originally for the Paul Whiteman band
- only 4% of the 50 had actually ever heard either piece of music

What is most disturbing about these figures, besides the fact that these young people are supposed to be knowledgeable about what they are selling, is that many did not even know the name of the drummer of Def Leppard. Mr Rick Allen would be offended; I certainly was. Which brings up an interesting question. Why don't record stores employ college level music majors? These students would certainly 'class' up the whole operation and would still relate to the younger buyers. The unfortunate answer is that music students would probably not work for minimum wage.

Death of the LP: What is totally incomprehensible about the forced phasing out of the LP record player is the complete contempt of the record producers for those who constitute 99% saturation of the home market with their LP record players and their collections of 200 or 300 LP discs. These individuals will not all switch over to the compact disc. In fact, a recent study indicated that sales of CD players to over 30 year old buyers was not expected to show substantial increases in the next few years.

One record store owner put it succinctly: "All those who wanted a CD player have them. There will be very few over 30s adding a CD player, at least initially. I am still independent so I can carry a larger stock of things of interest to the 'graying of America'. In my town, an affluent suburb of Boston, those over 60 constitute nearly 20% of the population. By the year 2000, that figure will rise nearer to 30%. I talk to these people. They have hundreds of LP records and what is happening is that they know they cannot

TC 1280/1380

Give us an inch...

... a foot or a meter and the new TC digital audio delays will give you precisely calculated delay times. Of course you can enter delay times as you would on any delay, choosing increments clear down to 5 microseconds. The group delay and Left-Right phase linearity are absolutely outstanding.



The TC 1280 (Stereo) and TC 1380 (3 Tap) delays are based on the technology that made the TC 2290 the most sought after delay unit in the recording industry. We have kept the superb frequency response, low distortion and noise free signal path and added the features most needed in critical applications.



Frequency response: 20-20 KHz +0/-0.5 dB 25 KHz -3dB.
Dynamic range: > 100 dB, THD: < 0,05 % 1 KHz, Analog group delay: 20-20KHz (30 microS, Group delay linearity: 20-20 KHz +/- 5 microS, Stereo synchronization: +/- 1 microS (1280), Max output: +22 dBm.

... If you are a professional in the disc mastering, broadcasting, sound reinforcement or recording fields check out these latest additions to the TC family. Call for the location of your nearest TC dealer.

OF DENMARK

t.c. electronic

INTERNATIONAL HEADOFFICE: T.C. Electronic A/S, Grimhøjvej 3, DK-8220 Brabrand, Denmark. Ph. 45 86 262800. Fax 45 86 262928 • **USA:** T.C. Electronic USA Inc., North Hollywood, 818 503 0404 • **UK:** T.C. Electronic UK Ltd, Oswestry, 691 658 550 • **GERMANY:** T.C. Electronic of Denmark GmbH, Detmold 05231 32972 • **AUSTRIA:** T.C. Electronic of Denmark GmbH, Detmold, 49 523 132972 • **AUSTRALIA:** East Coast Audio, Melbourne, 03 241 2244 • **BELGIUM:** James B. International, I.E. Cap a/j IJsel (HOLLAND), 0031 10 4588166 • **CANADA:** T.C. Electronic USA Inc., North Hollywood, 818 503 0404 • **FINLAND:** Studiotec, Espoo, 90 592055 • **FRANCE:** Phase Acoustic, Marseille, 91 498728 • **GREECE:** Lyrikon, Athens, 3628541 • **HONG KONG:** Jolly Sound Ltd., Kowloon, 3620202-5 • **HOLLAND:** James B. International, I.E. Cap a/j IJsel, 010 4588166 • **ITALY:** CD Videosuono S.P.A., Milano, 02 50841 • **JAPAN:** Otartec corp., Tokyo, 03 332 3211 • **NORWAY:** Musikk og Elektronikk A/S, Tønsberg 033 26798 • **SINGAPORE:** Team 108, Singapore, 748 9333 • **SWEDEN:** Elfa Studio AB, Solna, 08 734 0750 • **SPAIN:** Ear Pro SA, Barcelona, 93 212 7050 • **SWITZERLAND:** Riverside Music, Losone, 093 352794



TAKE — A — CLOSER LOOK AT YOUR JACKFIELDS

Are they engineered to the most precise of tolerances? Do they meet the most exacting specifications? Have they had to pass the most stringent of quality control tests before you ever received them?

In short, are they the very best available?

When you need to purchase different kinds of jackfields, do you have to order from different suppliers? And how long does it take before you receive all the equipment you need?

When you order your jackfields from Plasmec you get the best of both worlds — direct from the manufacturer.

Plasmec are manufacturers of the Mosses and Mitchell range of audio and video jackfields and sockets, widely acknowledged to be the best in the world.

Plasmec can now offer you the very best of jackfields ex-stock with the same or next day delivery.

So, shouldn't you be taking a closer look at your jackfields?

Send for a copy of our full colour catalogue today.

THE BEST JACKFIELDS AVAILABLE TODAY
— AVAILABLE TODAY

Mosses and Mitchell
PLASMEC

Mosses and Mitchell Division · Plasmec Systems Limited
Weydon Lane, Farnham, Surrey GU9 8QL
Tel: 0252 721236 Fax: 0252 712718

SECONDHAND CONSOLES

1	Rank 1000 28 channels 10 years old	£6,995.00
2	Audi II broadcast 15 channel mic full eq 4 years old	£6,400.00
3	11A 1 channel mixer 16 x 2	£3,950.00
4	Mixer 12 4	£750.00
5	Soundtracs MRS Series 24 x 16 with patchbay all cables 16 channel Bel noise reduction	£4,250.00
6	New 80 Series 8066 type stereo custom 40 x 24 24 line input output channels with full EQ/PM in 10 effect sends 60 line channels on remix P and G faders remote patchbay with 1064A EO type	£23,000.00
7	Harrison MRA 36 frame 32 fitted with Mastermix automation approx 5 yrs old	£3,750.00
8	Soundcraft SER 35 32 24 24 P&G faders patchbay fully refurbished	£3,200.00
9	Tweel Audio desk circa 1979	£1,500.00
10	Soundcraft 400 24 10 monitor flightcase	£3,750.00
11	Soundcraft 800 26 6 2 flightcase	£2,800.00
12	Soundcraft 400 26 4 2 flightcase	£2,800.00
13	StudioMaster 20 4 2 PSU + box	£625.00

AMS AudioFile keyboard with full version 8 software 2 hours recording 3 years old	£32,750.00
---	------------

SECONDHAND TAPE MACHINES

Lyric 16 track 2" 7.5 & 15 ips	£3,500.00
Orion MTR12 + mastering machine circa 1982	£2,900.00
Orion MX55 2 track recorder with centre track	£2,650.00
Studer A80 Mk2 HC high speed	£3,995.00
Studer A82 mono	£225.00
Studer A80 Mk3 24 track recorder narrow body	£12,500.00
Studer A80 24 track	£10,000.00
Tascam 34 4 track recorder	£495.00
Studer B67 2 track high speed in trolley	£1,900.00
3 M M 79 24 track with applied micro systems autolocator	£7,000.00
Studer B67 Mk1 30 ips in trolley or maker's box	£2,250.00
Studer C37 + valve machine with new H block	£1,350.00
Studer BB Mk1 3 7.5 - 15 ips	£12,000.00
Studer ABU 24 track Mk2 Mk4 Deck plate Mk3 Heads	£13,250.00
MCI JH24 with Autolocator 3 1982 in good condition	£7,500.00
MCI 16 track 2" 15 + 30 ips vary Speed Mk2 Autolocate	£345.00
Ferraguth Logic 7+	£2,995.00
Ferraguth B16 15 track	£145.00
Ferraguth SP7 mono	£995.00
Ferraguth Studio 8x	£775.00
MCI JH110 v 2 track recorder including replacement head sets Needs attention	2 units each

SECONDHAND REVERBS

FMT 240 Gold Foil reverb	2 units each	£950.00
Ibanez DM 2000		£175.00
Ibanez SDR1000		£225.00
Yamaha Rev 1		£1,995.00

SECONDHAND EFFECTS

UREI LA4	£425.00	
Yamaha SPX90 Mk1	£395.00	
Akar S900	£850.00	
Ashley SC 50 compressors limiters	£130.00	
dbx 152 noise reduction units	£225.00	
Electrospace dual exp comp lim	£375.00	
Lindsay 7670 3rd octave graphics	£350.00	
Neumann high frequency limiters	£525.00	
Krak Teknik DN760	£1,250.00	
Audio & Design comp lim 760 XRS (needs alignment)	Offers	
Orban D-riser 3 in 1	Offers	
Survival projects autotuner	Offers	
MXR 171 Dual 15 band graph EQ	£125.00	
MXR 124 Dual 15 band graph EQ	£135.00	
MXR digital delay (1280 ms)	£190.00	
Munro Electronics 3 way active x over	£145.00	
Ashley SC 77 2 3 way active x over	£190.00	
A&S 5700H compressors + psu	4 units	£250.00

NOISE REDUCTION

Dolby A TTM frame and power supply with 24 carr 22	£2,995.00
Dolby 361s	£425.00
Dolby A XP24 rack in mint condition	£6,500.00
Dolby A SP rack including rack case wired to DC connectors and psu	£6,000.00

Dolby M16 + MB 24 track A type N.R. with boom	£3,950.00
Dolby M16 + Mk 24 track A type N.R. with boom	£3,950.00

MONITORS & AMPLIFIERS

ATC SC M 200 with crossover 9 months	Offers	£3,975.00
Bose Studocraft monitors powered by Marantz PM240 amp		Offers
Eastlake monitors 15" JBL drivers & TAD horns	pair	£1,450.00
Eastlake stage wedges carpeted with 2" & 12" base and plus normal Eastlake top end	pair	£1,250.00
H and H Mosler V800		£375.00
Hill base bins 2" x 12" in each ATCS	each	£250.00
Hill double bins	each	£350.00
JBL 4502	each	£495.00
Munro Associates 5 way system with 8Bs active crossover and separate SU woofers Electrovoice ATC Dynaudio speakers		£6,950.00
Wellard monitors		Offers
Hacker L5501 monitors	pair	£120.00
Aitec monitor FA system (call for details)		£1,500.00
Spendor BC1 monitors	pair	£1,220.00
Yamaha P2200 2 x 275W power amp	4 units @	£395.00
Munro Electronics 2 x 250W power amp	4 units @	£295.00
Munro Electronics 2 x 150W power amp	4 units @	£195.00
HH TPA 500 100W mono power amp		£115.00
Quad 303 2 x 45W power amp	2 units @	£115.00

SPECIAL 16u rack with wheels and lift off lid containing: Munro Electronics 3 way crossover + 1 Munro Electronics 2 x 250W power amps + 4 Connector panel (main signal speaker) + 1 £1,200.00

MICROPHONES/DI BOXES

1 AKG 451E - CK1 condenser cardioid	£130.00	
1 AKG D 126 dynamic cardioid	£95.00	
2 Shure SM 58 dynamic cardioid	£65.00	
2 Shure 945 dynamic cardioid	£50.00	
2 Shure 570F lavalier	£52.00	
1 Shure 515 dynamic cardioid	£22.00	
2 Ross condenser cardioid	£17.00	
2 DI 3 All singing dancing DI box	£65.00	
1 DI 1 passive DI box	£22.00	
AKG C61 valve type psu and cables	£325.00	
Shure SM2 stereo mc & psu	£1,200.00	
Electrovoice R10	4 units	Offers
Electrovoice R11	Offers	£1,200.00
Neumann SM2 valve mics	Offers	£1,350.00
Neumann U47 valve	Offers	£350.00
Neumann KM84	Offers	£295.00
Simpson audio microphone	Offers	£695.00
Sony C48	2 units	£295.00
Neumann U87	5 units	£695.00
Caltec CC50 with CB20C capsule	Offers	£105.00
Beyer M260N	Offers	£65.00
RCA BK88 lavalier mic	Offers	£65.00
Sennheiser MD214 lavalier mic	Offers	£65.00

MISCELLANEOUS

Korg DDD 5 digital drum machine - 3 RAM	£455.00	
Tokai Strat tremolo + case	£600.00	
Seymour Duncan + Dimarzio p.u	£245.00	
Emu II keyboard (V3 software) + library	£1,200.00	
Superphong CT 505 long range cordless	£120.00	
Teac AX 10 echo adaptor	£40.00	
Fairchild rack Mosegate 661 de-esser 673-Dynalizer 675 Ducker	£200.00	
Lindrum	£595.00	
Otari verra auto tape winders	£800.00	
RTW 1206 free-standing peak meter: vertical or horizontal	£295.00	
Roland synth guitar	Offers	£800.00
Sony F1 digital processor	Offers	£495.00
Wollerslat 272 ES desk top high speed stereo mono cassette copier	Offers	£750.00
Sony 701 + C9 B Max (PCMFI)	Offers	£750.00
Sony PCMFI + psu with F1 B Max + psu	Offers	£495.00
Sony PCMFI processor & psu	Offers	£250.00
2 Electrovoice EXD 2 crossovers	Offers	£1,650.00
Publishon DHR 89 harmoniser	Offers	Offers
Par & lift head 1240V		Offers

Ring now for a complete monthly availability list ★ International enquiries welcome.
If there is any item of equipment other than listed secondhand or new that you may require to purchase or sell, please do not hesitate to contact Paul Duddy on the above number. Prices are subject to VAT.

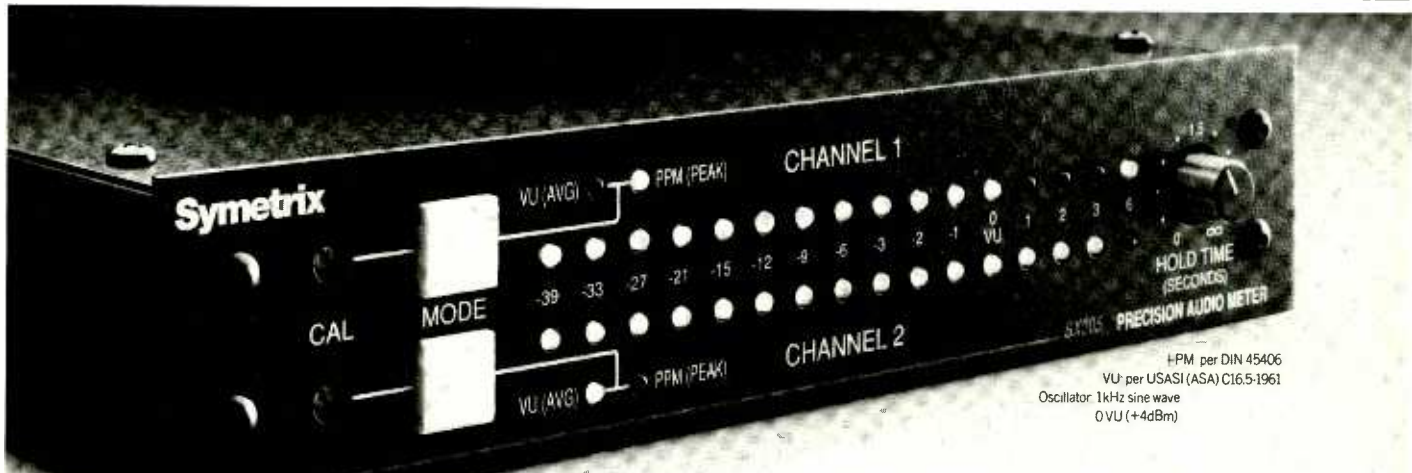

HPM per DIN 45406
VU per USASI (ASA) C16.5-1961
Oscillator 1kHz sine wave
0 VU (+4dBm)

Precision.

The new reference standard. For CD mastering. Analog or digital recording. Concert sound and broadcast production.

Measure voltage and power. Pre-view levels with peak-hold time set to infinity. Measure peak-to-average ratio with concurrent PPM and VU displays.

Use the calibrated 1kHz oscillator to set the meter's line level 'zero' from -20dBv to +12dBv. Select a power 'zero' of 100W or 1,000W.

The microprocessor based SX205 Precision Audio Meter gives you repeatable 1/2dB accuracy. Please call or write for more information and a data sheet.

Symetrix

International Representation:
J.W.M. (M) Ltd.
PO Box 115 - Swindon, Wilts
SN2 1DA - UK
TEL: (0367) 52605
FAX: (0367) 52614

In the UK:
SOUND TECHNOLOGY plc
17 Letchworth Point
Dunhams Lane, Letchworth
Herts, SG6 1ND UK
TEL 0462 480000
FAX 0462 480800
Telex 826967 WILSON

afford to switch to CD, even if everything in their collection exists in the new format. Two hundred CD's at \$15.99 is \$3,200, plus \$200 minimum for a player. That's roughly \$3,500 simply to achieve parity. And if there is a sonic superiority, older people are less likely to appreciate it, all things being considered. But curiously, killing off the LP also cuts away at the bottom end where the 7 inch 45 rpm single will be buried in the same grave as the LP. The single has become the medium of choice for new bands to emerge on. It enabled REM and U2 to make their first waves and it has a strong following in local groups, underground, metal and punk. They are kind of like the baseball cards of music. Young people collect them in hopes of finding a band that goes all the way to the top. It's just another category that made money but which will disappear."

Copying and the record store: Non-record items such as blank cassettes and movies take up much of the available retail space relinquished by the LP, to the tune of 25% of the store's total space. This is a curious happening in view of frequent record industry statements about the need to remove LPs to simplify stocking and to create more floor space. Even more curious is the fact that despite the RIAA's contention that copying is costing the record industry hundreds of billions of dollars worldwide, the record stores sell a complete range of blank cassette tapes to copy with, plus all necessary recording accessories such as head cleaners, demagnetisers, earphones, audio plug adapters, audio patch cables, etc. Sort of like banks selling handguns to bank robbers. In fact, the copying analogy is almost uncanny since the record stores in North America are alleged by some industry sources to sell in excess of 20% of all blank recording media used in the illicit copying process.

Record and tape quality: Many industry observers feel that the commitment to record quality has shifted from the producers to the artists themselves. Many of today's contracts find the artists retaining at least some of the power to control the quality of the release product. One of the reasons that this shift has occurred has been the demise of the powerful independent labels, as they have all disappeared inside major groupings via merger or takeover. A good example is the recent merger of Geffen into the MCA combine; bringing the last large independent with Aerosmith, Cher, Don Henley and Whitesnake under the MCA corporate flag.

The SPARS quality rating system for CD, which awards a letter 'D' to those processes that are done in the digital domain and an 'A' for those transactions that are essentially analogue, has supposedly codified the business of reporting to the buyer of the recording what is the status of his or her purchase. The categories that are indicated by the three letter code involve the original recording, intermediate processing and mastering for CD production. In theory, a 'DDD' signifies a completely digital chain of events. Unfortunately, some labels use it and some don't. Some who use it cover it up with their packaging and some interpret the stages with some largesse.

The rejection rate for CDs after pressing has worked its way higher than when CDs first hit the marketplace. This despite the fact that digital and quality analogue recording, digital post-production, remixing and mastering have never been better and the pressing process has become very reliable indeed.

Oldies, much desired by the older population, have frequently fallen into the hands of thieves and blackguards. 'Best Of' collections frequently suffer from a very relaxed standard of quality. Many are not digitally restored. Others cannot use master tapes gone to electronic seed and resort to bizarre combinations of less than perfect live performances or tracks straight off the LPs. Unless the artist has retained strong control of his or her music, the 'Best Of' album although attractive to crossover sales, frequently remains a disappointment. A particular problem is total indifference of the record company to such collections. Inside notes are non-existent. Frequently timings are not even given. Information on the 'jewel box' or cassette liner is frequently wrong. One up and coming rocker has a live performance album that serves in lieu of a 'Best Of' collection. The liner suggests that the record was recorded at point 'A' in 1980. In fact, a number of the cuts suggest an earlier tour in another city—a point the artist frequently emphasises in the performance.

Information in general on record boxes is notoriously poor. One major label frequently puts identical classical performances out in three different coloured boxes and juggles the second and third selections to produce a variety of nine different units to confuse the public and to be priced wildly variant by the stores. Overall audio quality on CD has disappointed many. Most upsetting to the consumer in survey after survey is the problem of labels re-issuing catalogue onto CD with records of the same or lesser quality than the companion LP.

Pricing: No other factor is as responsible for the public's relative antipathy towards CD. No matter how you slice it, \$15 or £15 per CD runs into consumer resistance. It is the one common thread that is cited again and again in surveys as to why the purchasing public resists the CD.

The bottom line is that the record companies and the record stores, by their retailing policies, set the conditions for the whole audio industry. They influence how much music is going to be sold and what kind, they influence the amount of mainstream recording activity that will occur at the major studios and they influence the overall business velocity of the audio industry as a whole. It can only be fervently hoped that the recent internationalisation and consolidation of the record business will yield marketing programmes that emphasise quality and range of selection as well as quantity and profit. In fact, if the record labels did respond to the major issues detailed herein, the result would improve their bottom line financially by a substantial amount. It would do the same for the rest of the audio industry. Hear, hear! □

VACUUM TUBE SIGNAL PROCESSING AT ITS FINEST

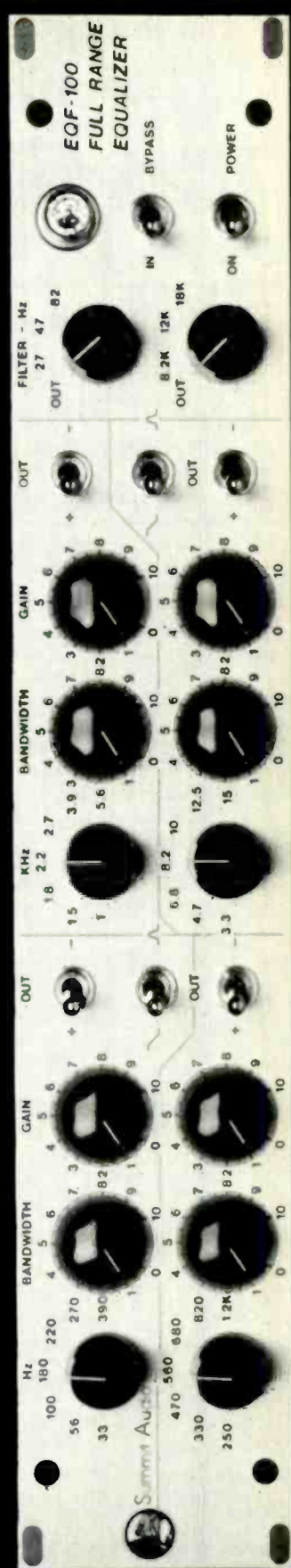

Summit Audio Inc.

P.O. Box 1678, Los Gatos
California 95031 U.S.A.
408-395-2448
FAX: 4083951403

EVALUATING AUDIO OP AMPS PART ONE

Ben Duncan begins a detailed evaluation of op-amps, the primary building blocks of analogue audio equipment, with a look at their history and background

Over the past decade, little black boxes—colloquially called chips or IC's (Integrated Circuits) but more properly IC op-amps—have displaced individual (discrete) transistors in nearly every corner of every category of analogue pro-audio equipment. Their universal application has dramatically cut the cost and time taken to design, develop and manufacture new products, as well as permitting more and more accurate signal processing to go on within a given volume of space. Audio engineers no longer have to spend time designing a linear gain block from scratch. Instead, they can concentrate on system refinements.

Today, one of the industry's standard universal audio gain blocks can cost under 20p (34 US¢) to a large scale manufacturer. It's a small price to pay for such a key component, when the number of

chips in a mixer channel ranges around 25 or more (for all-singing 'n' dancing consoles). Altogether, the use of op-amps has been instrumental in the way that the 'real' price of mixers and processors (with given functions) continues to fall or remain relatively stable at a time when everything else doubles in price every five, or fewer, years.

Some computations

'Op-Amp' is short for 'operational amplifier'. Today's universal audio building blocks have their roots in 'The Bomb' and the original op-amps were the predecessors of digital computers. 'Operations' refers to everyday arithmetic and mathematics like adding, subtracting, multiplying

or logging. Adding is audio's mixing, multiplication is amplification. Division is attenuation or padding-down, and subtraction is like common-mode rejection.

At heart, 'operational amplifier' means nothing more than a direct-coupled amplifier employing enough negative feedback to be linear and stable enough to perform these operations on tiny DC voltages and currents, with sufficient accuracy to form part of an analogue computer. Electronic analogue computing dates from 1943. The first operational amplifiers were developed (and the name coined) by John Ragazzini and colleagues¹, who were working for the USA's National Research Defense Council (NRDC). Built with vacuum tubes, they relied on global negative feedback (invented by Black in 1928) and the long-tailed pair, invented by England's Alan Blumlein in the mid 1930s, for DC balance. They were employed to provide rapid answers to mathematical 'monsters': the tedious simultaneous and integro-differential equations needed to optimise artillery and bomb trajectories, notably for the 'Tube Alloys'* project at Los Alamos. In the 1950s George Philbrick (who was one of the NRDC team) went on to develop commercial 'plug-in' op-amps. Analogue computers must have gone on to help in the design of Teller's 'H' bombs; it wasn't until the second half of the '50s that it became faster and more expedient to program a digital computer to solve some kinds of equations.

From Tinkertoy to eight-legged spiders

For audio, the analogue IC revolution has been a long time coming. In 1950, the US Navy's Bureau of Aeronautics set up a study of automated circuit assembly. The outcome was Project Tinkertoy, where components were 'printed' onto 7/8 inch square ceramic wafers. Several wafers were automatically selected, stacked and linked with machine-soldered riser wires. The miniaturisation was 'blown' by the vacuum tubes which still had to be plugged into the top wafer. In 1957, RCA spent \$18 million of US tax payers' money developing the idea further, using transistors. Their 'Micro-module' system established a compact universal packaging system, where the entire module was treated as a single component for the first time. But within 5 years, it would be obsolete.

Although transistor action had been discovered and patented at Bell Labs in 1947, the new class of rugged silicon transistors hadn't quite arrived in 1960 and discrete transistors made with germanium had yet to be taken seriously by the limited number of pro-audio equipment manufacturers. Transistors were inherently tiny but the miracle of miniaturisation hadn't been pushed to its fullest potential, because the package still needed to be handled by human fingers. Transistor manufacturers were keenly aware that with further development, the same size of package could contain dozens if not hundreds of transistors.

The first integrated circuits (ICs) were made in the USA by Texas Instruments, circa 1961-2, after Jack Kilby (a Texas employee) patented IC processing technology in 1958. Having waited nearly 30 years for a ruling, US patent lawyers are today busy making Japan's manufacturing combines aware of the fact. IC op-amps are a

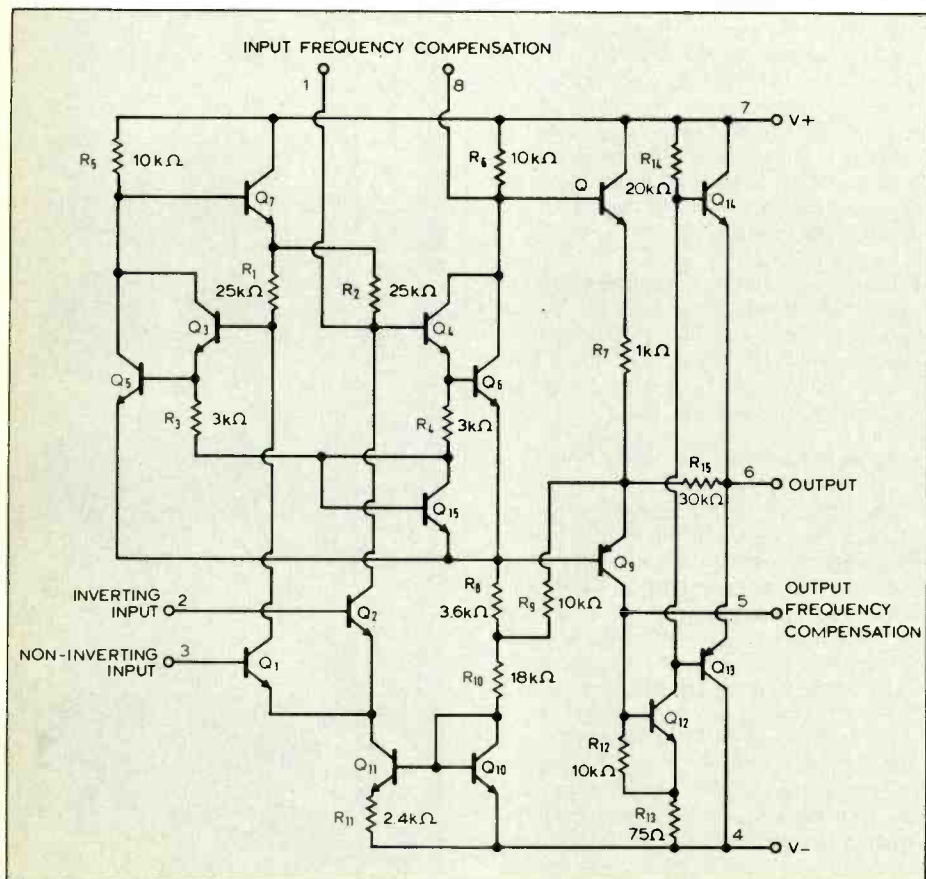

Fig 1: Schematic of the μ A709, the first widely used op-amp

* 'Tube Alloys' was the code-word for the atomic bomb project.

subset distinct from logic, or putting a dedicated analogue circuit function (such as an oscillator or 20 dB RF amplifier) into silicon. They've remained an area of manufacturing and innovation that has (oddly) been left almost exclusively to the USA's semiconductor manufacturing multinationals to exploit. The chips may be partially assembled anywhere in the world (especially where labour costs are low) but the main players are all US-based, although one company (Signetics) has been owned by Europe's Philips for the past 15 years.

The first IC op-amps were made in 1962 by Burr-Brown and George Philbrick Researches Inc, and Fairchild but the first widely accepted op-amp was Fairchild's $\mu A-702$, released in 1963. It had a lot of vices and was only worth using if you were a military or aerospace equipment maker, intent on packing a lot of direct-coupled amplifier stages into a small space, cost regardless. One of the early users might well have been the late Richard Heyser, who was then busy designing NASA's satellite telemetry systems. The 709's designers were Robert J Widlar and Dave Talbert, and the ' μA ' presumably stood for 'micro-amplifier'.

In 1965 Fairchild released the $\mu A-709$. Rather than translate a discrete circuit directly into monolithic form, Widlar instigated a new set of rules: use transistor's and diodes, even matched transistors and diodes, with impunity. He used resistors only where absolutely necessary and avoided capacitors and high value resistors altogether. Where the use of high value resistor seemed inevitable, Widlar put a DC-biased transistor in its place. He exploited the monolithic circuit's natural ability to produce matched transistors and assumed only loose absolute values¹. From then on, the circuitry inside op-amps contained a whole new set of functional blocks that had to be taught to be able to 'read' the circuit (Fig 1). These included transistors shorted to act as zeners or plain diodes (Q10), and transistors clustered in groups to form current sources and mirrors (Q10, 11). In time, strange 'hydra-headed' transistors (unique to monolithic ICs) would be developed with multiple emitter and/or collector terminals.

The $\mu A-709$ was a useful and usable device, the first to run on symmetrical rails (± 15 V) but still no fun for audio. It latched up easily, had an unbiased (class B) output stage (relying solely on NFB to overcome the crossover deadband) and promptly died if its output got shorted¹. Compensation, the business of making sure the beast didn't oscillate silently at VHF across the range of operating conditions, was dangerously open-ended for audio engineers not used to 'things going on' at radio frequencies. It was also something users had to sort out for themselves. Further, semiconductor processing was much dirtier than we're accustomed to now. The input transistors produced not just white and pink noise, but also sporadic bursts of spluttering and popping sounds. In 1965, mankind's understanding of noise mechanisms in semiconductor processing had some way to go. By the time audio had cottoned on to the 709's application as a do-it-all gain block (circa 1968-69 in the UK), it was already obsolescent, despite costing £5, or about £50 (\$85) in today's money!

In 1967, the recently founded National Semiconductor Corporation (NSC) began a second generation of op-amps, with their *LM 101*. In time, it became the basis of a whole family of op-amps. This time, Widlar (who had moved to NSC) aimed to cure all the ills of the 709, as well as reducing the tendencies to oscillation and the limited supply voltage. The 101 was the first op-

amp to run on ± 20 V rails. At full swing, it could exceed +20 dBu, whereas the 709 had rather less headroom. It was the first op-amp to use active loading (a technique that's since been used to advantage in discrete power amplifier circuits) allowing a high open-loop gain to be developed without the need to cascade the signal through so many stages.

In May '68, Fairchild Semiconductor introduced an op-amp called $\mu A 741$. In time it became infamous: even people with only a nodding acquaintance with electronics would recognise its name. The 741's internal circuitry was substantially similar to National's *LM 101*, but had different biasing and improved output protection. It was also the first op-amp to have an on-board compensation capacitor, meaning that designers didn't have to worry about curtailing VHF oscillation (capacitors, even very small ones, had been avoided thus far in monolithic circuits, because they used a lot of real estate and reduced production yields). The 741 was the first op-amp

to be extensively used in audio. It was rugged, easy to use and foolproof. Some years later (after Walt Jung published his work on Slewing Induced Distortion⁴), the industry was made aware that the slew limiting effect of the 741's integral compensation capacitor had a cramping effect on all but the least taxing applications. If you wanted 'good sound' out of a 741, you had to use it at gains of 10 dB ($\times 3$) or less, not stuff big (> 1 V/ $+2$ dBu) signals up it, not use it to boost high frequencies (> 2 kHz) and not try to sum more than two or three signals into it, in mix-amp mode. After some initial over-enthusiasm, it's taken more than a decade to overcome the subsequent bias built up against op-amps in some quarters, after the 741 *débâcle*.

Well read audio designers had already found a way round these problems by employing Fairchild's 748. This IC was a 741 with the on-board compensation removed. In exchange for fiddling with external compensation components (which could be made optimal for the job at hand),



A symphony from Raindirk

"A lot of desks have a sound of their own, the Symphony doesn't, the sound is so natural, no artificial colouring or noise."

— Gary Jones, Coconut Recording (Germany)

"Beautiful, clean-sounding, brilliant e.q., effortless"

— John Hiseman, Producer, Temple Music

"The best-sounding desk I've heard for nearly 10 years"

— Paul Libson, Producer

Experience the flexibility of the Symphony LN with unparalleled clarity and dynamic range — 36 channels open, mixed to stereo, noise output — 94dbvu — dynamic range 110 db, (1 channel 121 db.)



raindirk audio

Unit 2, 10 William Road, London NW1 3EN.
Tel: 071 388 1820/071 387 1262. Fax: 071 388 0339

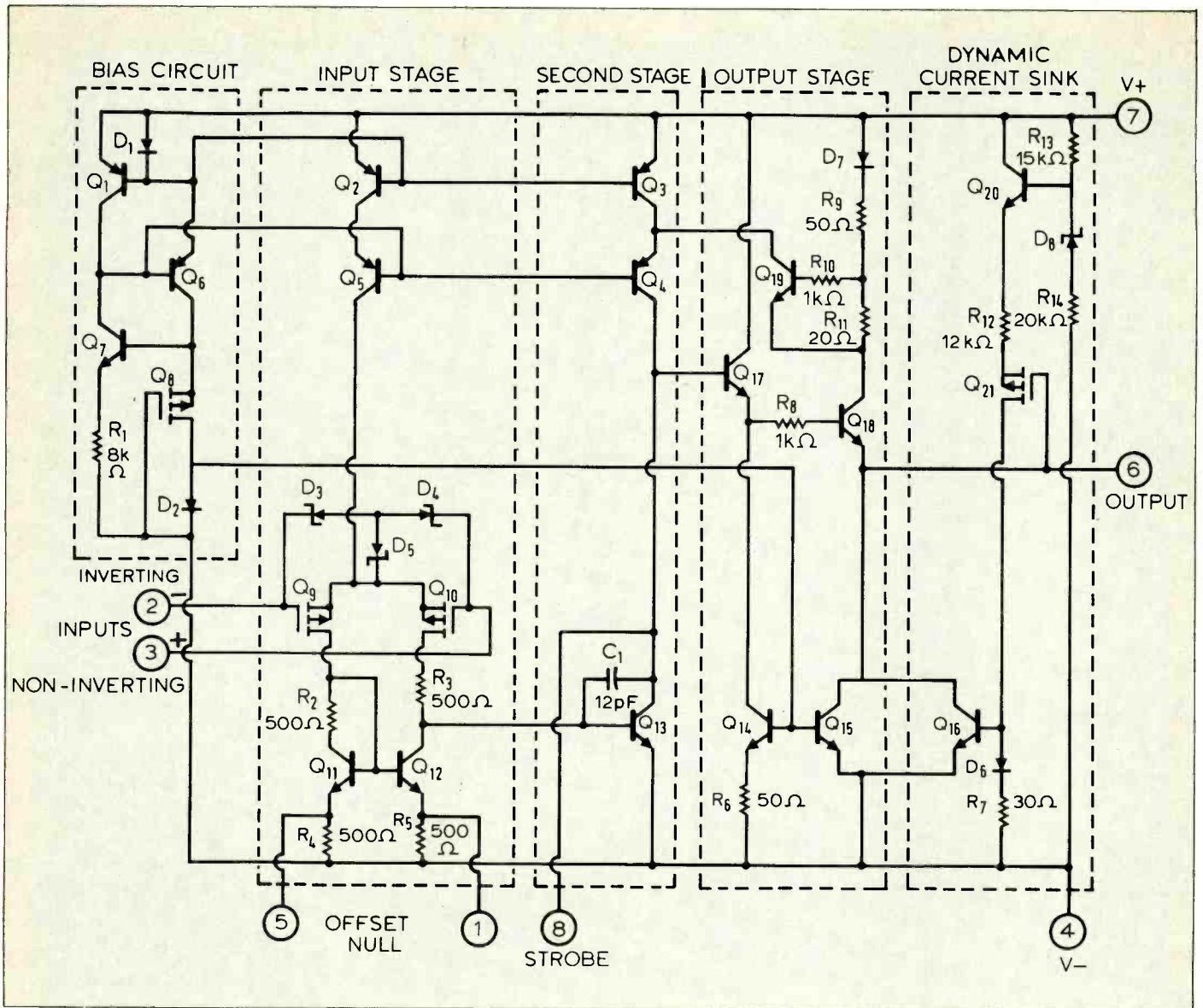

Fig 2: Schematic of the CA3140 op-amp; note MOS-FET input $Q_9, 10$

you could do a lot more useful things with the 748, like build a reasonably good sounding HF equaliser, for example. Or a mix amp to sum 8, 16 or even 24 sources, without engendering nastiness at high frequencies. The 741 went on the beget a whole family of devices (eg $\mu A-747$, $MC1558$ and 348), some with higher speed, or better DC balance. In 1974, Raytheon's $RC4558$ turned the 741's input stage upside down, enabling them to

exploit the lower noise that's intrinsic to PNP transistors. Perhaps the most important development at this stage was the arrival of dual (ie the same $RC4558$) and later, quad op-amps. Raytheon's $RC4136$ was the first quad, followed by Motorola's $MC4741$ and National's $LM348$. A single package could now contain two or four gain stages in the space of one or two. It would prove handy for state-variable and related EQ circuits,

active crossovers and other circuits relying on a multitude of gain-blocks that would have been unthinkable with valves or discrete transistors. Multisourcing had also begun: makers licensed each other's wares so audio manufacturers could (in theory) ensure continuity in the event of shortages by buying identical ICs (with slightly different part numbers) from a range of makers.

CM SERIES. BROADCASTING-FILM-VIDEO

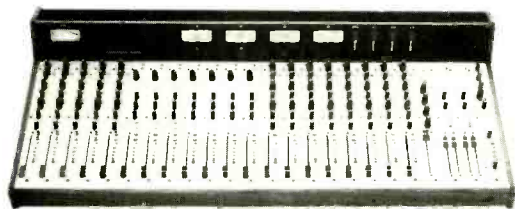

2 and 4 Group Outputs. 3 Standard Frame Sizes

CHILTON

CHILTON AUDIO LTD Chilton Works, 6-8 Wolsey Road, Ashford, Middlesex, TW15 2RB Phone 0784 247124. Fax 0784 240159
Contact Paul Reps

The FET revolution

The first generation of op-amps used ordinary bipolar transistors throughout. To work properly, they needed to draw (or sink) a small current through their input circuitry—or the source. This input bias current developed a voltage across the source resistance. Although the bias current of any op-amp is small by normal standards (typically it's below $1\mu A = 1$ millionth of an ampere), the offset voltage caused by it could get uncomfortably large if the resistance across the input needed to be large to avoid loading a high impedance source. For audio, classic high impedance sources are electric pianos, guitar pickups and, of course, capacitor microphones. If $1\mu A$ has to pass through $1M\Omega$ (a typical load for these devices), then $1V$ is developed across that

Soundcraft 6000



The first of a new generation of Soundcraft consoles which sets a completely new standard of audio quality. The 6000 is a full 16 or 24 bus console, and can be specified from 16 channel frame sizes upwards, with extra slots on patchbay versions for effects return modules. With enough buses and routing options to make adventurous production a pleasure, the uncompromising array of facilities puts you in total command of the mix. The 6000 offers perhaps the highest performance of any comparable console available today. Call us now for viewing/demonstration of the full range.

E-mu Systems

Emax II Keyboard or Rack + Turbo version 16-bit digital sound with spec you won't believe. **Proteus & XR Multibrual modules** — tons of RAM, squillions of pre-sets — in short, the answer to your sound problems. Ring for details.

AKAI DR1200 & DD1000

A-DAM DR 1200 — (Akai Digital Audio Multitrack), 12-channel digital recording onto 8mm video cassette.

DD1000 — Optical Disc Recorder giving up to 50 minutes (25m/disc side) stereo recording at max 48 kHz bandwidth, for digital mastering, editing, AV post-production.

Together they represent the very latest in recording technology. And you can see it here. We offer very favourable new lease purchase terms on recorder/console packages. You may be surprised that the system is technically AND financially more attractive than you thought.

THE LAST WORD IN STUDIO EFFECTS...

BEHRINGER



STUDIO EXCITER TYPE F	£225.00
PROFESSIONAL EXCITER TYPE F with XLR & 21 dBm	£280.00
STUDIO DENOISER: 8 CHANNEL	£450.00
PROFESSIONAL DENOISER: 8 CHANNEL; XLR's; +21 dBm	£570.00
STUDIO DENOISER, 2 CHANNEL	£210.00
PROFESSIONAL DENOISER, 2 CHANNEL; XLR's; +21 dBm	£245.00
STUDIO COMPRESSOR/LIMITER	£315.00
PROFESSIONAL COMPRESSOR/LIMITER; XLR's	£350.00
STUDIO PARAMETRIC EQUALISER	£350.00
SOUND MACHINE EXCITER/PREAMP	£135.00
MULTIBAND DENOISER	£690.00
PROFESSIONAL HEADPHONE AMP	£340.00
MULTIBAND EXPANDER/GATE	£690.00
STUDIO GATE	£315.00
PROFESSIONAL GATE	£350.00
TRANSFORMER BALANCED OUTPUT	£52.00
FULL BROCHURE AVAILABLE, RING FOR DETAILS. ALL PRICES EXCLUDE VAT. P&P	

AMPSOUND

153a Victoria Street, St Albans, Herts. AL1 3TA
Telephone 0727 50075 Facsimile 0727 58977

WE SUPPLY — ACORN, ACOUSTIC ENERGY, AIWA, AKAI, AKG, ALESIS, ALLEN & HEATH, AMPEX, APHIX, ASHLEY, ATARI, BEYER, BEHRINGER, BSS, CABLE & CONNECTORS, CASIO, CROWN, CSR-DAT, DENON, DRAWMER, E.A.R., FOSTEX, HARRIS, INSTALLATIONS, JBL, KORG, MIDI SOFTWARE, MTR, NEUTRIK, OMNIPHONICS, ON-SITE ENGINEERS, OTARI, RACKING, REVON, ROLAND, SENNHEISER, SERVICE, SHURE, SONNITEX, SOUNDCRAFT, SOUNDTRACS, STUDER REVON, STUDIOMASTER, SWITCHCRAFT, SYSTEM PLANNING, TANNON, TASCAM, TC ELECTRONICS, TDK, TECHNICS, THATS, UREI, YAMAHA AND MANY MORE!!! CALL FOR BROCHURES.

"I've waited 14 years for a monitor this accurate. The HD-1 is worth the wait."

Roger Nichols
Engineer/Producer

Grammy Winner for: Ade F. (Columbia: Steve) Jim
Grammy Nominee for: Ribbi Lee (Mercury: Nikki Lee James) Nighthawk (Donal) Fagan



Meyer Sound redefines the near-field monitor with the introduction of our HD-1 High Definition Recording Monitor. The HD-1 was designed to provide the most stable, accurate imaging available today. With an extended low frequency response to 32Hz, the HD-1 needs no external

subwoofer. And the control electronics and power amplifier are built in the cabinet, eliminating the need for additional equipment or rack space. Contact us or your Meyer Sound dealer and listen to the HD-1.

There's no need to wait any longer.



Meyer Sound Laboratories, Inc.
2822 San Pablo Avenue
Berkeley, California 94702
(415) 866-1100
Fax: (415) 866-8356

Autograph
DISTRIBUTORS IN EUROPE OF MEYER SOUND

102 GRAFTON ROAD ● LONDON ● NW9 4BA
TELEPHONE 01-485 3749 ● FAX 01-485 0681

TAC Magnum

QUALITY ASSURED, PRICE UNBEATABLE



You need an edge. The world is competitive and you're creative but hard-pressed. You need a console that allows your creativity to shine through without compromising your finances.

Building consoles to meet that specification is what TAC does to perfection. We deliver an unbeatable combination of performance, features, construction and price.

We know console technology. The MAGNUM is proof positive and is perfect for multitrack, video post and broadcast production. Look at this checklist for comparison:

CONFIGURATION: 24-buss in-line console with dual-input technology, allowing each channel to have two independent signal paths.

EQUALIZER: the powerful 4-band semi-parametric equalizer can be split between channel and monitor paths, giving 72 inputs with eq on mixdown in the 36 input chassis.

AUXILIARIES: 8 Auxiliary sends – four mono and two stereo – can be fed from channel or monitor signal paths. Sends 7 & 8 can also be routed to the 24 busses for extra effects feeds. 8 effects returns, with sends to all 8 Auxiliaries, are provided.

SOLO/PFL SYSTEM: MAGNUM has a Master Status controlled in-place solo switch on both channel and monitor paths. When de-activated, solo switches provide a full Pfl facility. MAGNUM also has two independent Mute groups.

AUTOMATION: channel mutes can be automated via MIDI; C-MIX fader and mute automation system can be fitted.

CHASSIS: welded steel with a pcb-based bussing system and an expandable 288-point TT jackfield.

Some of the many other vital facilities include channel fader reverse, 30-segment LED meters with peak hold, optional stereo line inputs, 8 audio subgroups and comprehensive control room monitor system.

TAC MAGNUM. The only choice.



Total Audio Concepts
Unit 17, Bar Lane Industrial Park, Bar Lane, Basford,
Nottingham NG6.0HU.
Telephone: 0602 783306.
Telex: 37329. Fax: 0602 785112.

In the USA:
10815 Burbank Blvd, North Hollywood,
California 91601.
Telephone: 818/508 9788. Fax: 818/508 8619.



resistance. The problem is potentially much worse as the offset voltage appearing at the input is magnified by the amplification. For a modest gain of 24 dB ($\times 15$), a 1 V offset would result in the op-amp's output 'leaning against' one of the supply rails. Assuming there's a DC blocking capacitor coupling on to the next stage, it's harmless to the op-amp but the sound wouldn't be too healthy—not unless you wanted a fuzz-box.

FETs (Field Effect Transistors) were the initial solution for interfacing high impedance transducers. FETs have slightly lower amplification factors than Bipolar Junction Transistors (BJTs) but the current drawn or sunk from their input (or control) terminal is disproportionately lower still, in the order of a few hundred picoamperes (pA—million millionths of an ampere). For the same 1 M Ω resistance, the offset developed would then be around 1,000 to 10,000 times smaller, ie well under 10 mV (0.01 V) even with a gain of 40 dB ($\times 100$). The first FET op-amps appeared in the late '60s. They were derivatives of regular op-amps, with just the input pair replaced with an FET structure. First generation devices included $\mu A-740$ and *NE536*. By 1974, RCA were building op-amps with MOSFET input and output transistors, beginning with the *CA 3130* series, see Fig 2. Though MOSFET technology was brand new (15 years later, it's still developing), RCA had already gained experience, being one of the originators of CMOS logic ICs. Offset voltages weren't as good as they could have been and early FET op-amps were compromised in other ways too, noticeably by excess low frequency noise.

Op-amps' relationship with audio finally gelled in 1976-77, when Texas Instruments and National Semiconductor released their *TL071* and *LF-351* 'BiFET II' series respectively (Fig 3). After a great deal of frustration op-amps had finally arrived, which would meet quite high audio specifications. For the first time, ion implant and laser trimming were used to make individual ICs more consistent, so there was less need to check

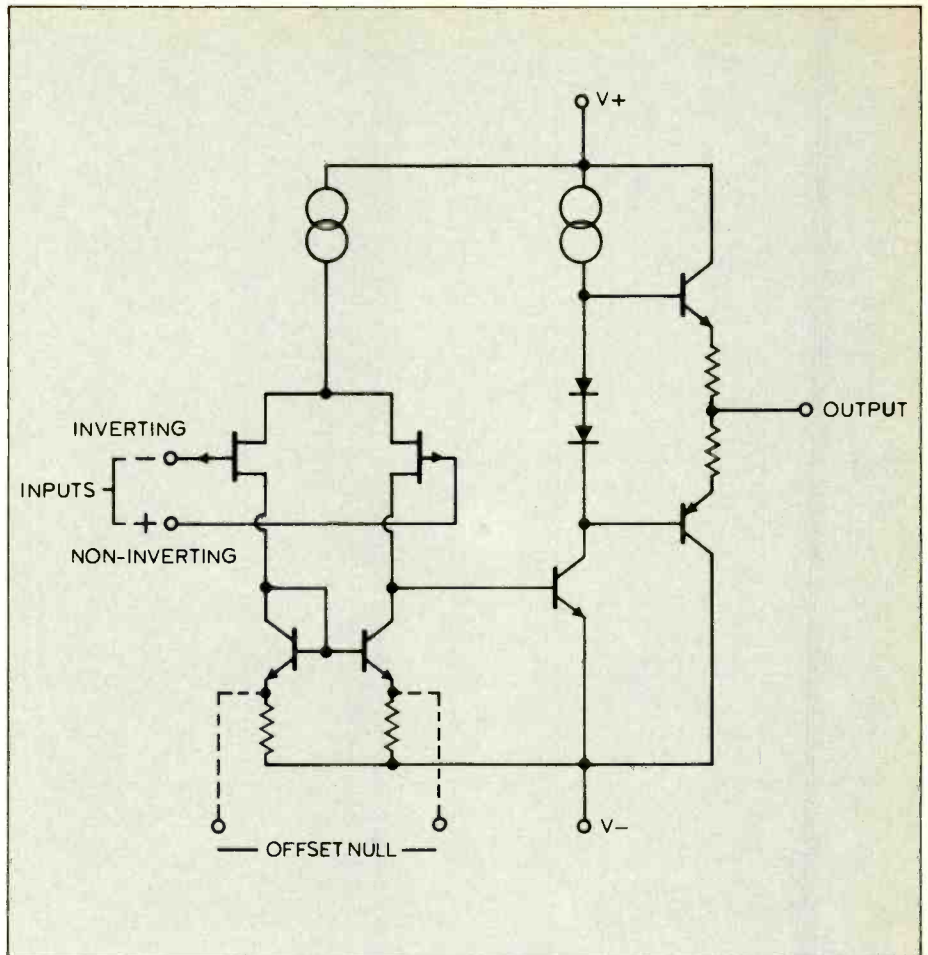

Fig 3: Simplified schematic of general purpose JFET-input op-amps eg TL071, LF 351

fresh batches for rogues. Also, the BiFET op-amp's cost was low and has fallen steadily ever since. They didn't oscillate in unity gain circuits (like buffer stages) and were faster than anything

regularly used before: the new BiFET's slew limit (at 13 V/ μ s) was around 20 times better than the original 741. It was enough to meet Jung's conservative criteria to avoid SID (Slewing

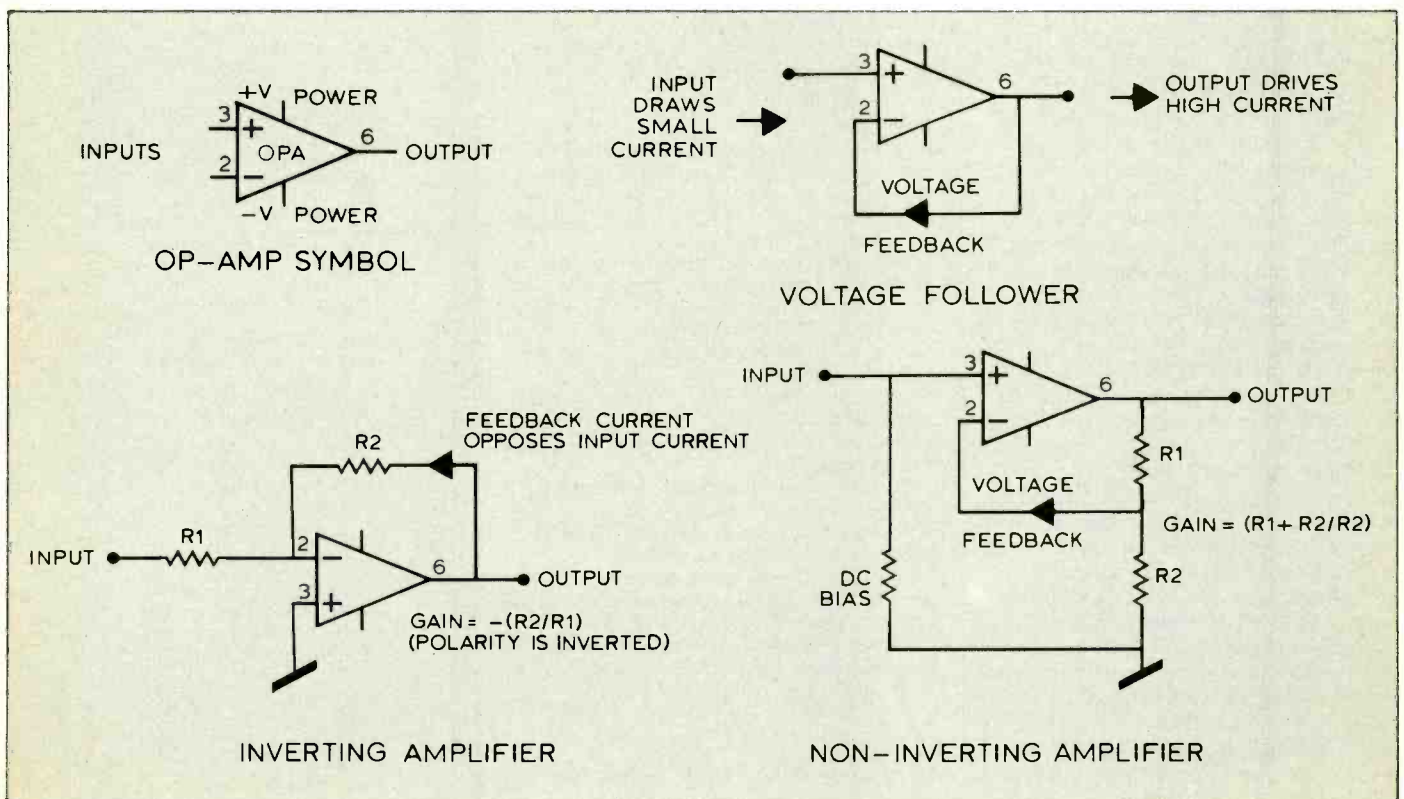

Fig 4: Basic op-amp configurations

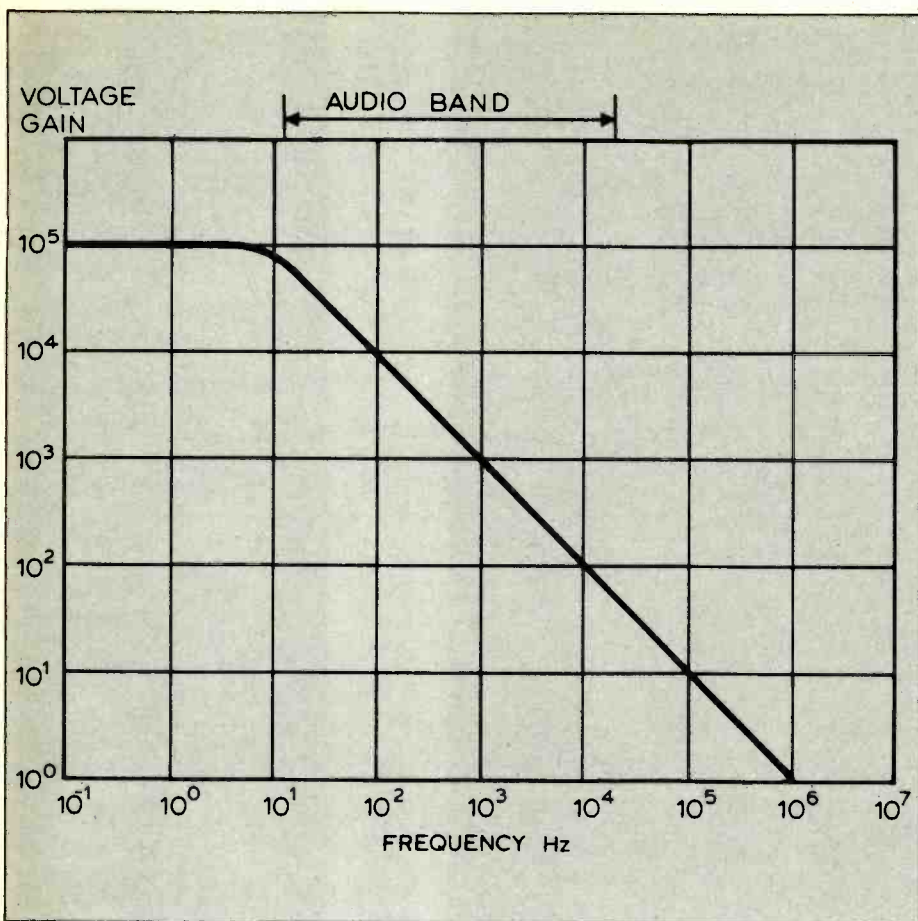

Fig 5: Typical op-amp open-loop gain response

Induced Distortion), so THD wouldn't any longer shoot up when swinging +20 dBu at frequencies immediately above 20 kHz. Although FETs are

Putting the triangle to work

Op-amps (symbolised as triangles in circuit schematics) truly are 'black boxes': there's no need to delve into their internal circuitry to understand how they're applied. For the most part (excepting frequencies $\gg 10$ kHz), their explicit behaviour is predictable and refreshingly independent of their model number; it's just down to simple, in-the-head (or back-of-serviette) calculations based on some of the surrounding component values. Fig 4 shows the main, everyday configurations for audio, with the equations for voltage gain.

The gist of op-amp thinking is to begin with an amplifier stage with very high gain. The gains achieved by modern devices (in what's called their 'open loop' state) are typically between $\times 100,000$ to $\times 20$ million. These are much higher than we'd need for most real applications, especially audio. These high gains are also limited in bandwidth; the gain is generally falling off rapidly below 1 kHz (Fig 5). But as soon as we apply global negative feedback (by connecting a resistive network between the op-amp's output and its negative input terminal), a magical thing happens: the excess gain is traded off for much wider bandwidth, low distortion (and several other desirable qualities), leaving a more moderate gain (say between 0 dB and +60 dB) to be used for everyday signal processing.

intrinsically noisier than bipolar transistors except when interfacing with impedances above 25 k Ω , the new BiFET op-amps seemed (and were) quieter than the first generation of bipolar op-amps. Provided they weren't asked to amplify more than 20 dB (10 \times), they were quiet enough to be used at line levels without embarrassment. Their noise spectra were certainly less obtrusive, tending towards an ethereal 'ssshh'. □

References

- 1 J R Ragazzini, R H Randall & F A Russell, *Analysis of Problems in Dynamics by Electronic Circuits*, Proc IRE, May 1947
 - 2 GWA Dummer, *Electronic Inventions & Discoveries*, 3rd edition, 1983, Pergamon, UK
 - 3 Steve Dove, 'Designing a professional mixing console, Part Three, Op-Amps, Friend or Foe?', *Studio Sound*, Nov 1980
 - 4 Walt Jung, 'Slewing Induced Distortion', *Hi-Fi News & Record Review*, Nov 1977
- ### Further reading
- 1 E A Torrero, 'Integrated Circuits', *Electronic Design*, Nov 23rd, 1972
 - 2 Walt Jung, *IC Op-amp Cookbook* 3rd edition, 1986, Howard Sams
 - 3 'TI Patent Bonanza', *Electronics & Wireless World*, Feb 1990
 - 4 Tony Atherton, 'Pioneers—John von Neumann', *Electronics & Wireless World*, Feb 1990
 - 5 R J Widlar, A unique circuit design for a high performance operational amplifier especially suited to monolithic construction, Proc of NEC, October 1965
 - 6 R J Widlar, Monolithic Op-Amp—The universal linear component, National Semiconductor, Application note AN-4, April 1968

Part 2 brings the history of IC technology up to date as a prelude to a series of op-amp performance measurements that have never been published before.

TASCAM European Distributors

Hi-Fi Stereo Center Kain
Muenchner Bundesstrasse 42,
5013 Salzburg,
AUSTRIA.
Tel: (0662) 37701

Beltronics
Rue de la Celidee Straat 29,
1080 Brussels,
BELGIUM.
Tel: (32) 2 424 0233

So and Hoyem A/S,
Bulowsgarden,
Bulowsvej 3,
1870 Frederiksberg C,
DENMARK.
Tel: (031) 22 44 34

Studiovox Ky,
Atomitie 5C,
SF-00370 Helsinki,
FINLAND.
Tel: (80) 562 3411

Teac France Sa,
17 Rue Alexis de Torqueville,
92182 Antony,
FRANCE.
Tel: (01) 4237 0102

Elina SA,
59/59A Tritis Septemvrious St.,
Athens 103,
GREECE.
Tel: (01) 8220 037

Greenlands Radio Centre,
PO Box 119,
3900 Godthab,
GREENLAND.
Tel: 299 21347

GBC Italiana spa,
Viale Matteotti, 66,
Cinisello Balsamo, Milan,
ITALY.
Tel: (02) 618 1801

Hjodriti — Hot Ice,
PO Box 138,
Hafnarfirdi,
ICELAND.
Tel: (01) 53776

AEG Nederland NV,
Aletta Jacobslaan 7,
1066 BP Amsterdam,
NETHERLANDS.
Tel: (020) 5105 473

Audiotron A/S,
Seidukstgt, 25,
PO Box 2068 Grunerlokka,
0505 Oslo 6,
NORWAY.
Tel: (02) 352 096

Goncalves,
Avenida 5 de Outubro, 53, 1,
Lisboa 1,
PORTUGAL.
Tel: (01) 544029

Audio Professional SA.
New address for contact:
Auprosa,
Francisco Tarrega, 11,
08027 Barcelona,
SPAIN.
Tel: (93) 340 2504

Erato Audio Video AB,
Asogatan 115,
116 24 Stockholm,
SWEDEN.
Tel: (08) 743 0750

Telion AG,
Rutistrasse 26,
CH. 8010 Zurich,
SWITZERLAND.
Tel: (01) 732 1511

Teac Deutschland GmbH
Bahnstrasse 12,
6200 Wiesbaden-Erbenheim,
WEST GERMANY.
Tel: (06121) 71580

TASCAM

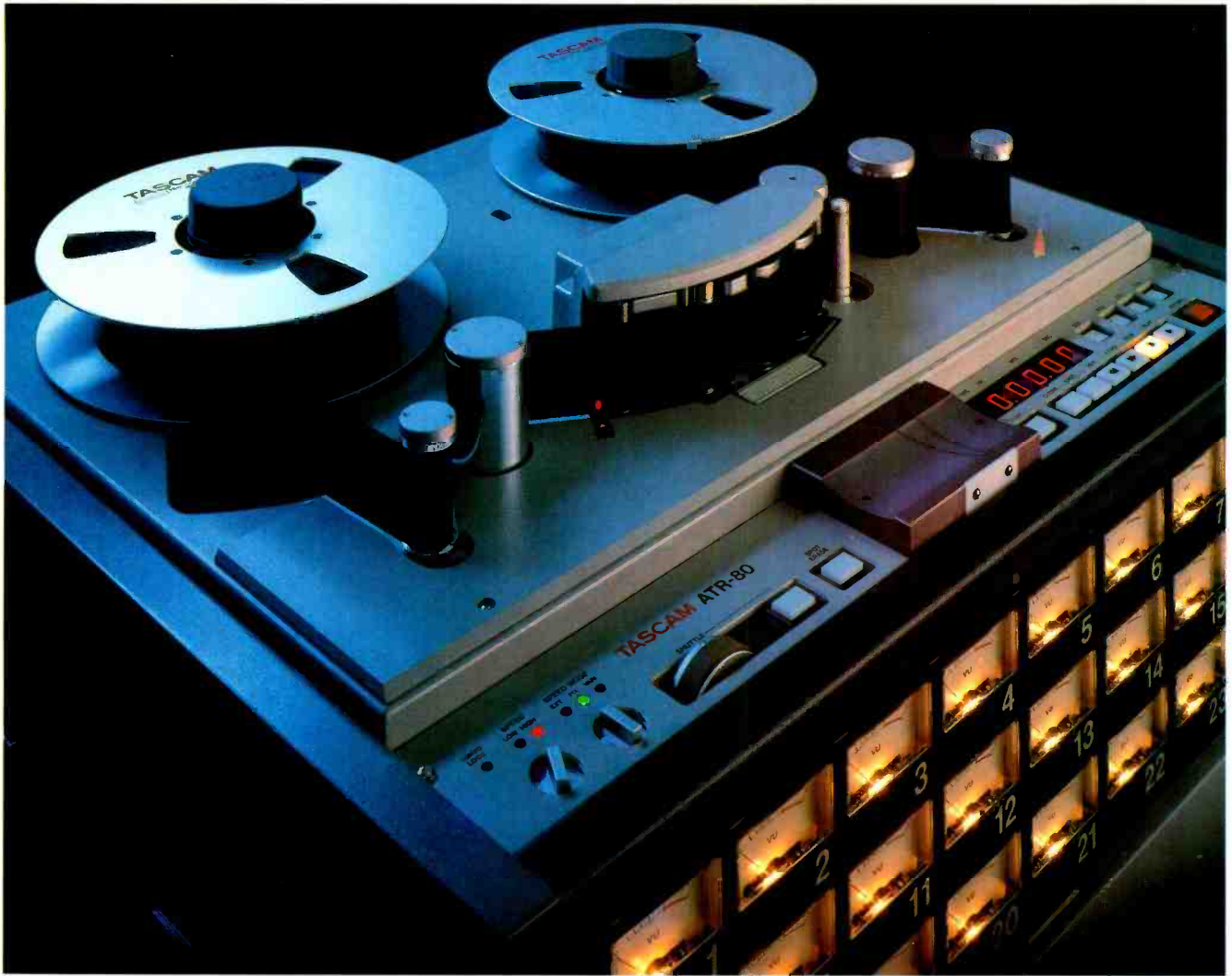

THE VERY LATEST TECHNOLOGY IN 24 TRACK RECORDING IS GOING TO COST YOU LITTLE MORE THAN A FEW MISCONCEPTIONS

You may think you know which 24 track recorder gives you the most advanced technology and design. However, you're probably in for a surprise.

It's the TASCAM ATR-80.

The ATR-80 is an engineer's dream. It has features that make track-laying and mastering faster and easier than it's ever been in a 2-inch 24 track format.

Just look at the speed. Unique samarium-cobalt magnets in the ATR-80 motors produce immense torque at the capstan and allow the reels to shuttle at a lightning 380 ips. Synchronising to video, the lockup time is limited only by your other equipment.

With our 30 years' experience in the design and manufacture of our own unique heads behind it, the ATR-80 achieves superb sonic performance. Full playback response in both the repro and sync heads allows track bouncing operations with no

loss in sound quality. Special circuitry provides for transparent punch-ins and completely gapless and seamless edits.

There's only so much of the ATR-80 that can be described in features. To fully appreciate the excellence of this machine you must lay your hands on the controls.

That's when you will sense the craftsmanship and quality of its design. The transparency and accuracy of its sound. The power, speed and the smoothness of the transport.

Try the TASCAM ATR-80 – all that it will cost you are your misconceptions. You won't miss these one little bit.



TASCAM

Teac UK Ltd., 5 Marlin House, The Croxley Centre, Watford, Herts WD1 8YA Tel: 0923 225235 Fax: 0923 36290

WHY DOES IT SOUND LIKE THAT?

Every equaliser has its own sound, and for some time it has been suspected that this is not simply a matter of their amplitude responses. It has been believed that the ears are insensitive to the phase response of equalisers but now some people are starting to claim that, really, amplitude response is quite unimportant and most of the subjective effect of equalisers is due to their phase response.

Certainly, phase response is relevant, as noted by Phil Newell in his series on monitor loudspeakers'. He notes, correctly, that adjusting the polarity of speaker units to maximise flatness of frequency response can often give a much more coloured result than the other polarity, which can give a sharp dip in the amplitude response but a much smoother phase response. However, this does not prove (and neither did Newell claim) that phase response is much more important than amplitude response, only that both are important and must be carefully related to one another for the best sound.

Let's look at what determines the subjective sound of an equaliser. Unlike others, I do not claim to give definite answers. My aim, rather, is to make some tentative conjectures, report some rules-of-thumb that have often been used with some success and to raise some questions so people can give some intelligent thought to the problem and maybe eventually find some answers.

We will rapidly enter the treacherous areas of hi-fi subjectivism, however, unlike the woolly-minded approach of many in the hi-fi press, I believe that ultimately one needs no magic pseudo-science to explain the mysteries.

The problem with most 'objectivists' who demand measurable reasons for subjective differences, is that they are very narrow-minded about what kind of measurements they will consider. They often demand that measurements can easily be done on conventional audio test setups. We shall see that it is highly unlikely that some of the most audibly important aspects of equaliser response can be measured either in the amplitude or the phase response but that we shall probably have to look elsewhere.

Now this is very near heresy. It is a standard mathematical result in the mathematical theory of linear filters that the behaviour of any such filter is completely determined if one knows its amplitude and phase response. This is no longer true if the filter has nonlinear distortion—and many subjective differences between equalisers are believed to be due to nonlinear distortion effects. However, I claim that even if one has a perfectly linear filter and measures both its amplitude and its phase response, one will still

not, from these measurements alone, be able to predict its sound.

I am a mathematician, and I do believe the theoretical mathematical result that the filter response is completely specified by its amplitude and phase response. The key words in the above are 'if one... measures its amplitude and phase response'. The point is that real-world measurements are never exact, and what we shall see is that incredibly small changes in amplitude and phase response, supposedly quite 'negligible' according to objectivist ideas, can actually have large audible effects. This is not to say that these effects cannot be measured, only that measurements of amplitude and phase responses are not the way to do the measurement.

If I prove to be right in my claims, we shall have to stop thinking of filters purely in terms of their amplitude and phase responses but will have to find other new ways of looking at them.

The evidence

In the late 1950s, H D Harwood at the BBC made a discovery whose importance is still not fully recognised. In investigating the performance of loudspeakers, he discovered that low-level delayed resonances severely coloured the reproduced sound even if these resonances were 40 dB below the main speaker response. At first sight there's nothing very world-shaking about that. But consider what the effect of such a delayed resonance is on the amplitude and phase response; 40 dB down means a signal whose amplitude is only 1% of the main signal. This means that the amplitude response must vary only between 99% and 101% of flat, ie within ± 0.1 dB. The effect on phase response must similarly be within $\frac{1}{1000}$ rad, ie within $\pm 0.6^\circ$. In other words, even in the late 1950s, Harwood showed that variations in phase response of around only 1° and in amplitude response of $\pm \frac{1}{10}$ dB produced audible colouration.

I am not claiming that all possible variations of phase and amplitude responses of this magnitude will produce colourations, only that specific variations produced by delayed resonances.

With the improvements in audio technology since that date, it would probably now be safer to tighten up these figures by a factor 10—in other words to suspect delayed resonances 60 dB down of colouration, even though they would cause amplitude variations of only ± 0.01 dB and phase variations of $\pm 0.06^\circ$.

It should not have been a surprise in the mid 1970s when it was discovered that turntables had a 'sound', since measurements had long revealed

bumps in their amplitude responses associated with delayed resonances in their mechanical system of a magnitude already identified by Harwood as being subjectively important in loudspeakers. However, until that time, most audio engineers had ignored the tiny bumps and kinks in their measurements of record frequency response as being too small to be audible, despite the prior evidence of Harwood's work.

In the mid 1980s, a second piece of evidence—that the ears could easily pick out tiny deviations in amplitude and phase response—emerged, in connection with digital filters. In an early attempt at digital noise suppression, Roger Lagadec, then at Studer, investigated a multiband digital noise gate that split the audio signal into 512 bands, noise-gated the bands separately and then put them back together again. Although this was very effective in reducing noise, it was discovered that there was a disturbing audible colouration, even if the noise-gating action was switched off. It was discovered that this colouration was due to the amplitude response of the filtered bands added together again not being quite flat—there was a ± 0.1 dB ripple in the frequency response. It was found that to remove the upsetting audible colouration required this ripple to be reduced to around ± 0.001 dB. In this case, all the digital filters had linear phase responses—so only the amplitude response could be blamed for the colouration.

So, from a variety of directions, we have been finding that tiny ripples in the amplitude and phase responses can have important subjective audible effects, causing obvious or even gross colourations. And yet, one can also produce large deviations in amplitude or phase response that cause almost no colouration, as we shall see. It becomes evident that simply looking at the magnitude of deviations from flatness of either amplitude or phase responses tells us very little about the subjective result. The ears are responding to something else entirely. But what?

Rules of thumb

Frankly, we don't yet know for sure how the ears determine the degree of colouration of an equaliser. Over the years, however, many indirect clues have been found as to what is happening. If we cannot yet say who committed the murder and how, at least we can list some of the suspects and their possible motives.

One of the oldest suspects, whose guilt is believed in by many audio designers, hi-fi buffs and even professionally respected recording engineers, is known, in the best tradition of spy novels, by a single code letter: Q. The rule of thumb used by many designers is simple: it will sound coloured if the filter has a Q much larger than 0.5. I am indebted to Tom Holmes, formerly of Philips Hi-Fi Labs, many years ago for pointing out that Q smaller than about 0.6 appears to sound uncoloured, and larger than 0.6 appears to sound coloured.

Q is shorthand for 'quality factor'. In recording work, Q is encountered mainly as a number on parametric equalisers—with high Q corresponding to sharp peaks or dips and low Q to broad peaks or dips. However, the concept of Q applies to all filters, even to all-pass filters, which have a flat amplitude response but a nonlinear phase response. It is not intended here to give the mathematical theory of Q—if you are familiar with the theory of filter design you'll already know—however, an understanding of the meaning of Q can be given. Although conventional

For all new & used studio equipment

M.S. AUDIO REGULARLY SUPPLY

STUDER
REVOX
TASCAM
TEAC
FOSTEX
SOUNDTRACS
LEXICON
DRAWMER
AKAI
JBL
UREI
YAMAHA
DENON
ALESIS
CITRONIC
SYMMETRIX
XRI
NEUMANN
BEYER
SENNHEISER
ATARI

SEE US AT
**PRO AUDIO
ASIA '90**
IN
HONG KONG
STAND 415



ALWAYS A GREAT DEAL ON OFFER

.. IF YOU DON'T SEE WHAT YOU WANT
PLEASE RING MIKE OR JENNY..

MULTITRACK MACHINES

MITSUBISHI X850 32 track digital.	EP.O.A.
SONY 3324 remote/auto.	£39,250.00
OTARI 32 track digital.	EP.O.A.
OTARI MTR90 MkII auto. v.g.c.	£17,850.00
OTARI MX80 auto. v.g.c.	£16,750.00
STUDER A820 with SR cards. auto/remote.	£35,000.00
STUDER A80 MkIV auto/remote.	EP.O.A.
STUDER A80 MkII with MkIII h/b. auto/remote. v.g.c.	£14,500.00
STUDER A80 MkII auto/remote. v.g.c.	£12,500.00
SOUNDCRAFT SATURN auto/remote.	£16,950.00
SOUNDCRAFT 762 MkIII 9 memory auto.	£9,000.00
SOUNDCRAFT 762 MkII with MkIII updates. 9 memory auto.	£8,500.00
MCI JH24 Auto 3. v.g.c.	£12,500.00
LYREC 532 16 memory. auto. v.g.c.	£8,500.00
3M-79 XT 24 auto.	£7,500.00
OTARI MTR90 MkI auto.	£9,500.00

MIXING CONSOLES

SSL 4046E with G series modules. G series computer. T/R producers desk. patchbay.	EP.O.A.
SSL 6048E with G series computer. T/R. producers desk. p/b.	EP.O.A.
SSL 4072E with G series computer. T/R. producers desk. p/b.	EP.O.A.
SSL 4048E with E series computer. T/R. producers desk. p/b.	EP.O.A.
SSL 4032E with E series computer. T/R. producers desk. p/b.	EP.O.A.
MCI 556C JH50 auto.	EP.O.A.
MCI 500H series 42 frame 42 ch. patchbay.	EP.O.A.
MITSUBISHI WESTSTAR 44 frame 44 ch. 4 band eq. automated.	£39,950.00
NEVE V3 60 frame 48 ch. Necam 96. automation.	EP.O.A.
NEVE 8068 32 frame 32 ch.	EP.O.A.
NEVE 8078 40 ch. melquist automation.	EP.O.A.
NEVE 8108 32 ch.	£34,750.00
NEVE 8108 48 ch. Necam 96.	£54,500.00
NEVE V2 48 ch with Necam 96.	EP.O.A.
We also have available 4 more smaller NEVES - please phone for details	
TRIDENT TSM 40 frame 40 ch. patchbay. 32 track monitoring. v.g.c.	£21,000.00
TRIDENT TSM 32 frame 32 ch. 24 out. patchbay. v.g.c.	£16,000.00
TRIDENT Series 75 28 ch. patchbay. v.g.c.	£6,250.00
TRIDENT Series 65 32-8-2.	EP.O.A.
TRIDENT Series 65 32 frame, 26-8-16.	£5,950.00
CADAC E Series 32/24 + 8 patchbay. melquist automation.	EP.O.A.
AMEK M2500 48 frame 36 mic/line inputs. 12 stereo inputs. LED metering switchable. righthand patchbay with Mastermix automation.	EP.O.A.
AMEK M2500 36 frame 24 mono ch. 12 stereo ch. patchbay. LED meters. v.g.c.	EP.O.A.
AMEK Angela 36 frame 36 input. patchbay. Mastermix automation.	EP.O.A.
AMEK Angela 36 frame 36 input. patchbay.	EP.O.A.
SOUNDCRAFT TS24 56 frame 48 ch. Mastermix automation. v.g.c.	EP.O.A.
SOUNDCRAFT TS24 32 frame 28 ch. patchbay. v.g.c.	EP.O.A.
HARRISON MR4 36 frame 36 ch. patchbay. Mastermix automation.	EP.O.A.
HARRISON Series 28 40 frame 40 ch.	EP.O.A.
TAC Matchless 26/24. patchbay.	EP.O.A.
TAC Matchless 36 frame 36 ch. patchbay.	EP.O.A.

OUTBOARD EQUIPMENT

LEXICON 480L with Larc.	£4,950.00
LEXICON 224XL remote.	£4,500.00
LEXICON 224 with remote.	£2,250.00
LEXICON 200.	EP.O.A.
LEXICON PCM42.	£495.00
AMS RMX16.	£2,750.00
AMS 15-80s Choice of 2.	EP.O.A.
PUBLISION Infernal Machine IM90 21 seconds. stereo sampling.	EP.O.A.
AUDIO & DESIGN compex limiter.	EP.O.A.
YAMAHA Rev 5.	£650.00
PUBLISION DHM89 harmoniser.	£1,650.00
2xSCAMP Racks - phone for details.	EP.O.A.
AUDIO & DESIGN F769 vocal stresser.	EP.O.A.

2 TRACK MACHINES

OTARI MTR12H 15/30ips. 1/2 inch.	EP.O.A.
OTARI MTR10 15/30ips. 1/4 inch.	£2,750.00
STUDER A820 1/2 inch and 1/4 inch.	EP.O.A.
MITSUBISHI X80 low hours.	£3,450.00

• We also have numerous other mastering machines - please phone for details.
• Please note this is only a small selection of items available. We are also happy to part-exchange your old studio equipment, if you so wish.

VIEWING BY APPOINTMENT ONLY

ALL PRICES SUBJECT TO V.A.T.

ALL PRODUCTS ARE QUICKLY AVAILABLE AND CAN BE DELIVERED WORLDWIDE



IS A SUBSIDIARY OF M.S. MANAGERIAL SERVICES LIMITED

NORTH LODGE, STONEHILL ROAD, OTTERSHAW, SURREY KT16 0AQ
TELEPHONE: 0932 872672 INTERNATIONAL: +44 932 872672 FAX: 44(0) 932 874364

RING NOW
ON
(0932)
872672/874768
FOR MONTHLY
MAILSHOT

theoretical accounts of Q look at the frequency behaviour of an equaliser (ie its amplitude and phase response as a function of frequency) it is actually easier to explain the idea in terms of the time response of a filter.

All filters smear out in time any sharp momentary impulse fed into them and it is a commonplace of filter theory that the behaviour of a linear filter is determined entirely by its impulse response, ie its output waveform when fed with a sharp impulse. All analogue filters (as well as those digital filters that use digital feedback in their realisation—known technically as 'recursive' filters) not only affect the initial shape of the impulse waveform but also affect the way the impulse response eventually dies away to nothing. It is the nature of this decaying part of the impulse that has to do with Q .

A low Q filter invariably has the final part of the decay of its impulse response die away

smoothly without any oscillation or change of signal polarity. If, however, the Q exceeds 0.5, then the final part of the decay oscillates about zero (Fig 1). It appears that the ears are sensitive to such oscillations in the decay part of the impulse response, even at very low levels. Such oscillations are often termed resonances, the frequency of the resonance being the frequency of this final decaying oscillation.

Now Q can be thought of as a measurement of how rapidly the amplitude dies away per cycle of oscillation. The bigger the Q , the smaller the decay (in dB) per cycle, and the more cycles are gone through before a given degree of decay (in dB) occurs.

The effects of this oscillatory decay are audible even if the early part of the impulse response of a high- Q filter is such that it has an absolutely flat amplitude response. It is perfectly possible to design such high- Q 'all-pass' filters (Fig 2 gives a

typical circuit) and generally they sound much more coloured than low- Q all-pass filters, even if the latter are designed to cause many hundreds of degrees of phase shift.

It is significant that, in order to achieve a flat frequency response with a rapid crossover between speaker units, most multiway speakers are actually designed to have an all-pass response and if a high Q all-pass is chosen in order to make crossover rates more rapid, such speakers are likely to sound coloured².

The magic audibility threshold $Q=0.6$, rather than the strict no-resonance figure $Q=0.5$, suggests that the ears will actually tolerate some oscillation in the decay but the amount involved is surprisingly small. For a Q of 0.6, successive cycles of the oscillation are attenuated by about 80 dB compared to the previous cycle. This means that, for a Q of 0.6, alternate polarity swings are about 40 dB below the previous swing of opposite polarity.

The $Q=0.6$ threshold was theoretically suggested on quite different grounds derived from the behaviour of conventional 12 dB/octave lowpass filters. The 'maximally flat' such filter, ie the one with the flattest amplitude response in the pass band, is known as a Butterworth filter and has a Q of 0.71. In much audio work requiring an uncoloured sound, preference has been for use of a lowpass filter with a maximally flat phase response, which is termed a Bessel filter, which has a Q of 0.58. Bessel filters have a slower high frequency roll-off but their 'smoothest possible' phase response has been found to give a subjectively superior sound. The empirical threshold Q of 0.6 for low colouration is very close to the Q of the Bessel filter having maximally flat phase response.

Anecdotal evidence of the importance of Q arises from experiments conducted by Philips in the early '70s with the then-new Dolby A noise reduction system. Dolby A is a multiband system using Butterworth filters to separate the frequency bands. It was noted by many engineers that Dolby A gave some subjective colouration, so Philips' engineers tried replacing the Butterworth filters with Bessel filters. They indeed found that such 'Bessel Dolby A' had a much lower audible colouration than standard 'Butterworth Dolby A'. The only problem was that it was incompatible with the already-standard Butterworth Dolby A system, so it proved to be impractical to introduce the Bessel version into studio use.

Now Dolby A is a reciprocal system, ie one whose decoding nominally exactly undoes its encoding, so that any audible effect of the filters was evident only in the small residual decoding errors due to imperfections in the tape path. Yet, despite the small magnitude of these errors, the difference between the Butterworth ($Q=0.71$) and Bessel ($Q=0.58$) systems was still easily audible.

It is notable that later noise reduction systems introduced by Dolby Labs tended to avoid high Q filters in the critical mid-frequency bands of the audio range.

Work in connection with surround-sound encoding and decoding systems at Philips in the mid 1970s confirming the finding that Q must not exceed 0.6 to avoid audible colouration could be extended from lowpass filters to all-pass filters, ie the effect was not amplitude response.

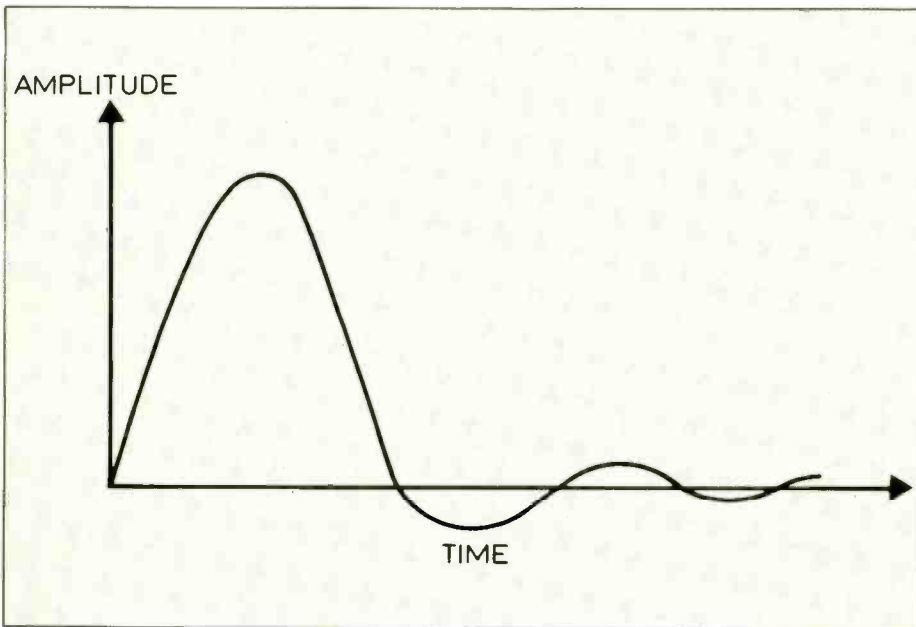

Fig 1: Impulse response of filter with Q greater than 0.5

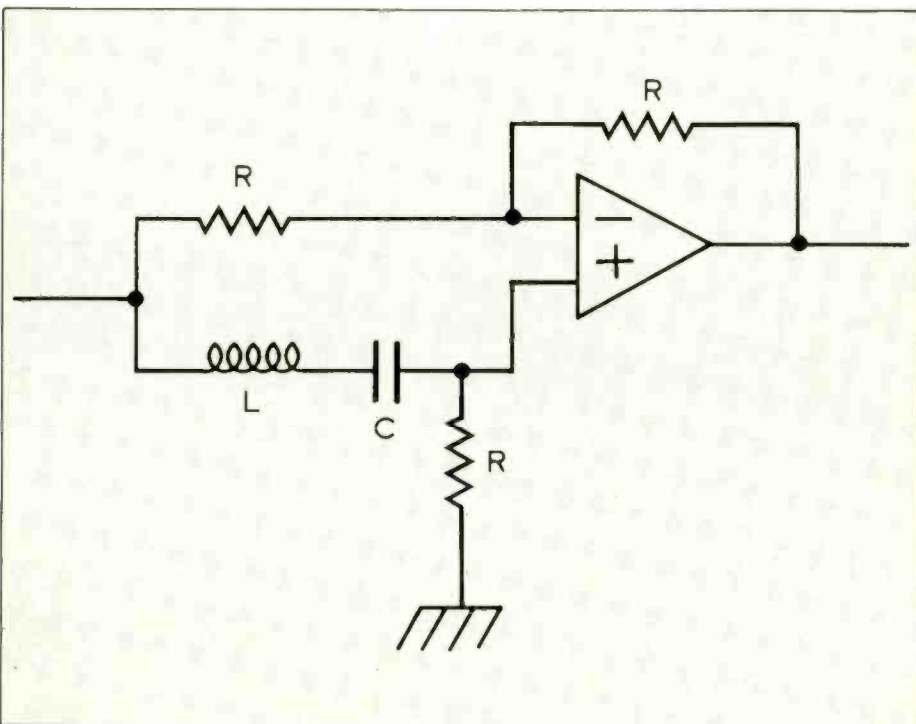

Fig 2: Circuit of high Q all-pass filter with flat amplitude response

Not that easy

OK, so Q is the reason for the 'sound' of equalisers? Low Q is uncoloured, high Q over 0.6 is coloured? If only life were that simple. This

RTW Digital Peakmeters

RTW makes them all: digital and analog PPM's as well.

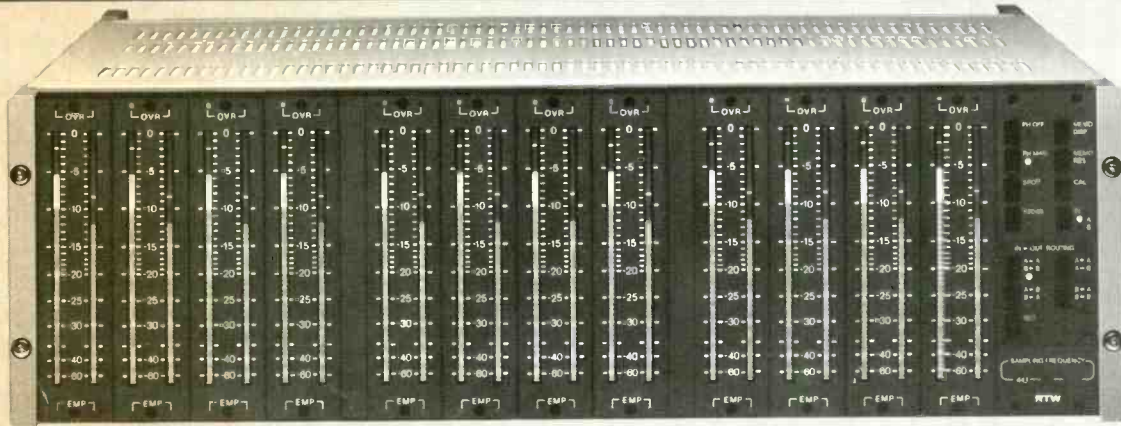

RTW 1190 DMS

24 channel Remote Metering System 1190 DMS for connection to the PCM-3324 (A) SDIF data format (RS-422).

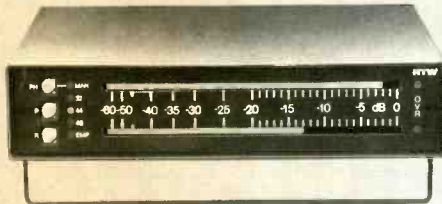

RTW 1152 EBU

2 channel Digital Meter 1152 EBU for connection to the AES/EBU digital format.

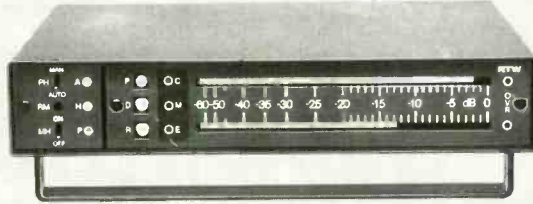

RTW 1150 DA-T

2 channel Remote Meter 1150 DA-T for connection to the PCM-1610/1630 status port.

RTW RADIO-TECHNISCHE WERKSTÄTTEN GMBH · D-5000 Köln 71 · W · Germany
Post Box 7106 54 · Telephone (221) 70913-0 · Tx 8885217 · Fax (221) 70913-32

Australia: SYNTEC INTERNATIONAL, Tel (2) 4064700 · **Austria:** ACOUSTA ELEKTRONIK, Tel (662) 846164 · **Belgium/ Netherlands:** P.A.C., Tel NL: (40) 424455 · **Canada:** J-MAR ELECTRONICS LTD., Tel (416) 4219080 · **Denmark:** S.C. Sound APS, Tel (2) 998877 · **Finland:** AV-POINT ICS AB, Tel (0) 5666733 · **France:** SCV-Audio, Tel (1) 48632211 · **Great Britain:** AUDIO & DESIGN LTD., Tel (0734) 844545 · **Italy:** AUDIO EQUIPMENT SRL, Tel (39) 2000312 · **Japan:** SANIX CORPORATION, Tel (3) 7025315 · **Korea:** DAESAN INTERNATIONAL INC., Tel (2) 7368442 · **Norway:** SIV. ING. BENUM AS, Tel (2) 145460 · **South Africa:** ELTRON LTD., Tel (11) 7870355 · **Spain/Portugal:** SINGLETON PROD., Tel E: (3) 2377060 · **Sweden:** AV MEDIA AB., Tel (755) 65498 · **Switzerland:** AUDIO BAUER AG, Tel (1) 4323230 · **Switzerland:** TECNAD A.S., Tel (21) 8060606 · **USA:** ESL ELECTRONIC SYSTEMS LAB., Tel (305) 7911501

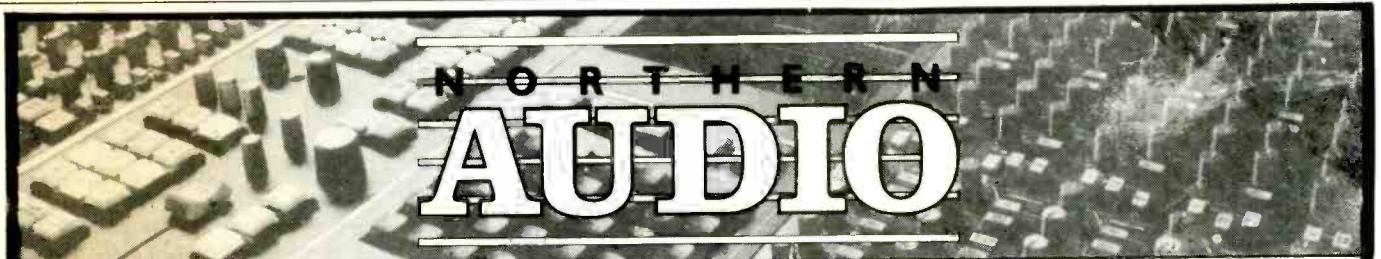

SECONDHAND CONSOLES

- 1 SSL4000E 48-frame 48 mono channels fitted with 'G' Series E/Q throughout. 'G' Series computer. And remote 'G' Series keyboard. V/U metering. L/H patchbay. R/H prod desk. 5 years old in superb order, available 4 weeks. **£115,000.00**
- 2 SSL6040 40 frame 38 mono channels fitted with Total recall VU meters. L/H patchbay. R/H producer desk. 5 years old in fine condition, available June 90. **£65,000.00**
- 3 SSL E Series production desk 40 frame 32 mono channels 'G' Series E/Q. 'G' Series primary computer (no recall). 12 months old. Immaculate. **£69,500.00**
- 4 Neve 'V' Series 48 Frame 48 mono fitted with patchbay. 200 segment bargraph/PPM meters. 8 stereo E/Q sends. 4 stereo reverb, returns with E/Q. full kit of spares. 18 months old in good condition (no automation fitted). **£125,000.00**
- 5 Neve EMI Console 24 I/O mono channels. 24-track monitors in very good order. **Offers**
- 6 Neve 8108 48 input console with Necam automation. 4 rev returns R/H patchbay and penthouse. In fine order. **£39,500.00**
- 7 MCI 636 console with spectre view R/H patch. No automation, lots of new switches etc. **£11,500.00**
- 8 Neve 80 Series 8066 type special custom 40/8/24 24 mic/line input/output channels with full EQ PPM meters. 10 effects sends 60 line channels on remix. P&G faders remote. patchbay with 1064A EQ type. **£34,950.00**
- 9 Platinum Mixing console inline and split console. 44 input channels. 44 controllable monitor faders. 12 master subgroup channels. 2 stereo channels enables 8 stereo returns with noise gates. Dual parametric equalisers. 10 auxiliaries. 24 subgroups. 4 stereo tape returns. external patchbay. 8 months old, good order. **£22,000.00**
- 10 Soundcraft 6000 36 frame. 32/24 with patch. PSU and stand. 12 months old in superb order. Also connected to a Tascam MS16 1" 16-track recorder with AQ 65 autolocator. in pristine condition. Offers for both. **£14,000.00**

WE ARE CONSTANTLY ON THE LOOKOUT FOR USED EQUIPMENT...
NOTICE

We also act for studios as selling agents: let us handle the hassle of getting rid of unwanted items. it does not matter where you are in the world, why not drop us a line listing your equipment or ring us on the numbers below for the best rates. We assure you of our best attention and service plus the utmost confidentiality at all times.

- 11 Soundcraft 8000 PA desk. 40/8/2 PA. 7 months old. **£8,885.00**
- 12 Soundcraft 8000 PA desk 24 input with PSU. 12 months old. **£5,995.00**
- 13 Soundtracs 48 in-line plus extra effects. 48 track mix automation. superb condition. 1 year old. available immediately. **£27,000.00**
- 14 Trident TSM 32/32. 6.7 years old. Good condition. **£19,995.00**
- 15 Trident 80b 30/24/56 with EQ on the monitor returns patchbay PSU complete. 3/4 years old. **£15,500.00**
- 16 Soundcraft TS12 28 input with patch 3 years old. **£9,500.00**

USED TAPE RECORDERS

- 1 Sony 1610 system with 1100A editor. two 5850DA recorders and IF 5850 interfaces. Complete system. **£16,500.00**
- 2 Sony 3324A 24-track with locator and remote. 14 months old. approx. 1,200 hrs. in superb order. **£44,500.00**
- 3 Otari MTR90 Mk2 with auto and remote 3,000 hrs. 3 years. **£17,500.00**
- 4 Studer A80 Mk3 no locators or remotes 5,000 hrs approx. **£19,500.00**
- 5 Studer A80 Mk2 wide body. 5,000 hrs. 6 years. no locators. **£12,500.00**
- 6 Ampex ATR 100 1/2" master recorder. **£3,750.00**
- 7 Ampex MM1200 24-track with autolocator. **£9,500.00**
- 8 Otari MX80 24-track with remote. two years old. **£14,500.00**
- 9 Otari MTR90 Mk1. 6,000 hrs. Audio remote only. **£9,995.00**
- 10 Sony 5002 master recorder. little used. immaculate order. **£3,750.00**
- 11 Otari MTR12 1/4" with centre track timecode. **£5,250.00**
- 12 Studer B67 2-track with butterfly heads in console. **£2,350.00**
- 13 Studer A80 16-track. no remote. little known history. **Offers**
- 14 Studer A80 16-track. no remote. little known history. **£13,500.00**
- 15 Studer A80 Mk4 narrow body 24-track. no remotes. superb. **£2,950.00**
- 16 Otari MTR10 1/4" master two units approx 1983. each. **£2,950.00**
- 17 Ampex ATR800 4-track 2 units. each. **£3,000.00**
- 18 Otari MTR12 1/4" mastering machine circa 1982. each. **£3,000.00**
- 19 Studer A80 RC master machine. Age not known. in fair condition. **£2,750.00**

SECONDHAND KEYBOARDS

- Bechstein 7ft grand piano finished in rosewood. Totally refurbished. built 1909. **£19,500.00**
Yamaha concert 9' grand piano. **£7,500.00**

FOR A COMPLETE STOCK LIST WRITE OR
RING TONY BAYLEY ON
0565-830005

GREYLANDS STUDIOS, MERESIDE ROAD, MERE, KNUTSFORD, CHESHIRE WA16 6QQ. TELEFAX. 0565-830405. TELEX. 666597 NAUDIOG

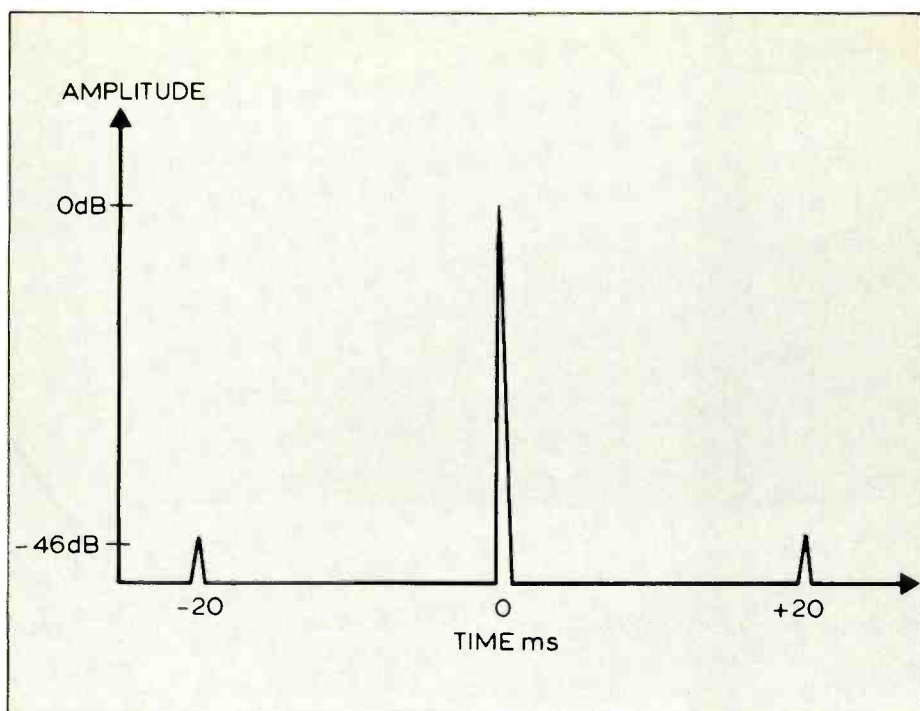

Fig 3: The impulse response of the coloured filter discovered by Roger Lagadec

rule of thumb does seem to work reasonably well over quite a wide range of analogue filter designs but it is far from infallible.

The demonstration that Q is not the crucial factor behind audible colouration comes from the highly coloured digital filter discovered by Lagadec and others at Studer in the mid '80s. The coloured filter had a flat phase response and the amplitude response consisted of 512 ripples of ± 0.1 dB uniformly spaced across the whole audio band (ie at about every 50 Hz). This gives an impulse response as shown in Fig 3, ie the main impulse is surrounded by just two smaller impulses each about 46 dB down, one preceding the main impulse by 20 ms and one following it by the same amount.

Now this filter has no decay whatsoever, ie its Q equals 0. It only has a single discrete pre-response at low level and a single low-level post-response. Yet its colouration is highly audible. Detailed investigations showed that the main cause of the subjective colouration was the pre-response of the filter (ie the part before the main impulse) and that the pre-response had to be held below -80 dB to avoid becoming obviously audible. Minus 80 dB is merely one part in 100 million of the total signal energy and in the past, many 'objectivists' would have howled with derision at the thought that such tiny residues of error could possibly be of any audible importance.

Much of what we now know about audible colouration by filters and equalisers is consistent with the conjecture (informed guess!) that what matters is not amplitude or phase response, but the *low-level* behaviour of the impulse response well away from the main transient. This is certainly not to say that amplitude or phase response, or the high-level behaviour of the impulse response, are unimportant or have no effect but that their main effect is often a relatively benign change of tonal quality, to which the ear can easily adapt, rather than obvious colouration that remains obvious even after time for adaptation is allowed.

The conjecture just made is probably not wholly true, eg a 12 dB/octave treble boost will sound pretty ghastly despite having a good decay behaviour but for moderate and relatively smooth

changes in amplitude and phase response, this hypothesis is at least a reasonable starting point for explaining why some filters sound more coloured than others.

Transient effects

Although we have conjectured that, on the basis of available evidence, low-level effects well away from the main impulse may be largely responsible for colouration, we have not yet specified precisely what kind of low-level effects are important. After all, we have already noted that a smooth non-oscillatory decay is generally relatively harmless.

At this point we enter the realms of conjecture and hypothesis in a big way. The following ideas are suggested as useful to equipment designers and others in getting good results or avoiding bad ones. These ideas are not pure guesswork—they are constrained by a lot of existing psychoacoustic knowledge and knowhow—but neither are they gospel truth. No doubt, with time and experience, these ideas will be refined and exceptions identified.

Everything that is known about the way the ears perceive transients suggests that, all other things being equal, a pre-response (ie before the main impulse) in a filter will have more audible effect than a similar mirror-image post-response after the main impulse. This is not just consistent with Lagadec's findings on his digital filter, but is also consistent with the Haas Effect, whereby transient sounds tend to be preferentially localised by the transient arriving at the ear first, with later transients (up to about 40 ms later, when separate echoes are heard) playing a reduced role. This is also consistent with the physiological effect of forward inhibition or temporal masking, whereby the perception of stimuli tends to suppress or reduce the sensitivity to the perception of stimuli following immediately afterwards.

This is not to say that, in some circumstances, later stimuli cannot also alter the perception of those immediately preceding them. Such backwards inhibition effects are well documented in the experimental psychology literature but

generally, conventional forward inhibition is a stronger effect.

From another point of view, it is not implausible that the ears notice pre-responses much more strongly than post-responses, since pre-responses (ie effects before the cause) are rare in nature. This is not to say that they can't happen. The classic example is sound being picked up from a distant performer by a microphone on a stand on a non-rigid floor. Sound travels much faster through solids than through air, so sounds travelling through the floor and up the microphone stand to the microphone arrive before the main sound arriving through the air.

Generally, only bass frequencies arrive via the floor transmission routes but the characteristic bass pre-response is audible and, once recognised, can be heard as a characteristic colouration.

So one perhaps unexpected moral of our discussion is the need to take precautions to minimise the transmission of sounds to the microphone via the floor (or ceiling or walls, etc). This can be done by suspending microphones in a shock mount or via appropriate cables, by decoupling microphone stands from the floor by suitable compliant damped floor coverings and by using microphone types (notably some omnics) that are relatively insensitive to vibrations transmitted to their bodies.

The particular undesirability of pre-responses is especially relevant to digital filters and equalisers. Although it is not absolutely impossible to design analogue filters that have pre-responses, it is jolly hard. The filters have to be non-minimum-phase, and to have substantial pre-responses must be very complicated. Such complication is much easier to achieve in the digital domain, where memory (and hence pre-delay) is cheap and plentiful.

The classic example of pre-responses in digital filters is something many people (including a previous editor of this magazine) had claimed is always desirable—namely filters having a linear phase response. A filter with a linear phase response suffers from no phase shift at all (other than an overall constant time delay, which we can ignore). This seemed like Nirvana compared with the awful phase shifts suffered by the analogue minimum-phase brickwall filters widely used with non-oversampling A/D and D/A converters.

A little thought, however, shows that linear-phase filters might not always be as desirable as they might seem. Linear-phase filters have an impulse response that is time-symmetric: their pre-response is the mirror-image of their post-response (Fig 4). The reason for this is that they have, by definition, no phase shifts and so behave in exactly the same way whether one looks into the future time direction or the past time direction.

But, being unnatural and of greater audible effect than post-responses, such pre-responses could well have substantial audible side-effects that would be heard as audible colouration—as Lagadec found with his filter.

Note that I am not claiming that extended pre-responses automatically give a coloured sound, only that the risk of such colouration is higher than for similar post-responses. It is ultimately a question of trying out a given filter response empirically and listening for colouration.

To take an extreme example, I would expect that a time-reversed high- Q filter (one whose impulse response is the time-reverse of that of a high- Q filter) to be highly objectionable and a phase-linearised version of a minimum-phase high- Q filter to be only a little less objectionable,

THE SOUND OF SILENCE GT4A NOISE GATE



SIGNAL PROCESSING

- Absolutely quiet operation
- Front panel key switches
 - Rack mounting
- Easy to use • 4 channel

The Omnicraft GT4A is ideal for studio & live work. Available in NEW high-speed version.

Call for literature, review or your nearest dealer.

UK + EUROPE
A.M.G.

USA
C - T AUDIO

CANADA

Call 0428 58775
Fax 0428 58438
Int + 428 58775

Call 1 - 800 C - T Audio
Fax 407 738 0319
Int + 0101 407 738 0622

West Call 416 360 5940
Fax 416 362 2477
East Call 604 222 8190
Fax 604 222 9884

SPA-1

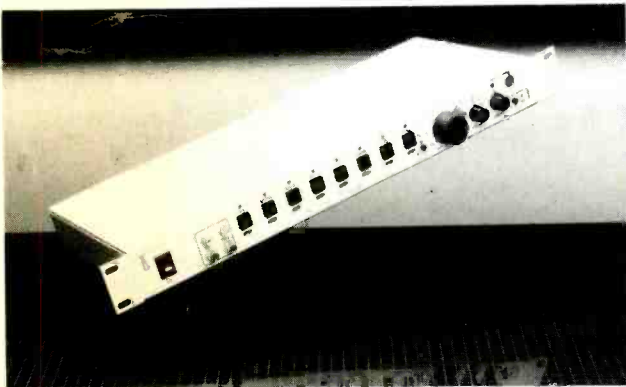

THE PRE-AMPLIFIER WITH A DIFFERENCE . . .

The professional and economical way to interface up to eight unbalanced semi-pro or domestic machines in both record and playback directions, including RIAA/Line channel.

An essential item for all types of Copying Suites, Control Rooms, Quality Control, Editing Facilities and Audio for Video Transcriptions.

TOTALSYSTEMS



41 Windermere Avenue
Basingstoke, Hants RG22 5JH, UK
Phone: 0256 468555

Benelux Agent: Auvio Holland, Tel: 31-71-313642
Fax: 31-71-318904

total audio!



Canford Audio



A claim established over the past ten years and a reputation won by supplying a wide range of high quality audio equipment and accessories fast. Quite a claim, but whatever audio equipment you need, Canford is the name to turn to.



The reputation has been established on our ability to supply the right product at the right price and in the right time scale (next morning if you want). Our catalogue is issued twice a year and runs to over 300 pages. Its up-to-date and totally comprehensive.

So next time you need a connector or two or a kilometre of multipair cable - it's Canford of course.

Phone now for a catalogue.

CANFORD

■ ● *audio* ▶ ▶

CROWTHER ROAD, WASHINGTON
TYNE & WEAR, UNITED KINGDOM NE38 0BW
admin - (091) 417 0057 sales - (091) 415 0205
fax - (091) 416 0392 telex - 558202 CANFRD G

due to such filters having extended 'pre-ringing' in their impulse response. In particular, one would expect digital phase-linear graphic and parametric equalisers to have worse audible colouration than a well-designed analogue or minimum-phase digital equaliser designed more conventionally. Experience of phase-linear digital equaliser products tends to bear out this increased audibility of colouration.

On the other hand, a well-designed pre-response with no sudden sharp changes in level (even at very low levels) or oscillations, and with smooth gradual increase, is expected to be much less objectionable subjectively, as is a pre-response whose ripples and oscillations lie well outside the audible frequency range. I would expect, for example, carefully-designed phase-linear highpass filters for cutting out low frequency rumble noises or for bass speaker equalisation to sound considerably better than current minimum phase highpass filters. The latter's severe phase distortion produces very audible tonal and dynamic colouration even when present in small amounts and of low Q. The key words in the above are 'carefully designed', avoiding a badly shaped pre-response.

In general, it would be expected that digital filters somewhere between the minimum-phase behaviour of analogue filter designs (ie with the minimum phase shift consistent with the actual amplitude response and with no pre-response) and linear phase might sound better than either.

Designing a carefully-tailored pre-response to minimise audible colouration is, as yet, uncharted territory but once they get their teeth into it, I would expect designers of digital equalisers to start coming up with some subjectively interesting products.

I suspect that, as in other areas of audio, there will be no unique 'best' phase response for a given frequency response but, rather, different choices of trade-offs among different subjective virtues and defects. We can look forward to countless future arguments about which of many competing approaches is really best!

Post-responses

So much for the *terra incognita* of digital filters with pre-responses. Conventional analogue filters with only a post-response can still have substantial audible colouration effects, as was recognised by Harwood in the 1950s. How can we find out what kind of post-responses sound 'nice' and what do not? Although Q can be a useful guide, it does not tell us everything we need to know. It is possible to design filters with a high Q that don't sound too bad, and equally possible to design low-Q filters that are pretty awful or even downright unlistenable.

As everywhere else in audio, there is probably no single magic number that guarantees the goodness or badness of a particular filter response. The key to all this probably lies in learning to understand and analyse filters in a large number of ways, ie not placing all one's eggs in one basket.

Traditional frequency responses do tell quite a lot, although they certainly don't tell whether or not an equaliser is guaranteed to sound good. The presence of a broad band of emphasis over a range of frequencies will often give a general indication of the balance of the sound, although not its subjective quality or frequencies of audible colouration. However, areas of raised response, eg peaks, tend to 'stick out' as audible colouration,

although narrowband dips can often be virtually inaudible.

In general, frequency responses give one little information about the audible 'smearing' of transients and phase responses (or the closely related measurement of group delay) may not be that much more helpful. Sudden peaks or dips in the phase response or group delay can be a symptom of audible transient smearing or colouration but on its own, phase or group delay response contains too little information to allow the resulting sound to be reliably predicted.

We have seen that it is also necessary to look at the impulse or time response of filters and that very tiny discontinuities or oscillations in the time response can be audible—especially if they are spaced from the main impulse response by a few milliseconds (before or after). Thus it seems advisable to examine the tails of the impulse response 'under a magnifying glass' if looking for possible symptoms of colouration. It might even be useful to look at the impulse response processed by being fed through a compressor with a very fast time constant, in order to bring up low level artefacts to make them visible.

Neither the response in the frequency nor the time domains alone are adequate. The eye (used to assess measured data) is no good at picking out the frequencies at which trouble is occurring from examination of the impulse response.

Simultaneous time/frequency analysis

For this reason, over the years attempts have been made to analyse sounds and linear system characteristics simultaneously in both frequency and time, plotting the result as a graph over the two variables time and frequency. The most familiar example of this is the speech spectrogram, which plots the level of sounds at each frequency as a function of time.

All such attempts are compromises. After all, a frequency response analyses the response to sinewaves, and a sinewave (by definition) lasts forever. Any attempt to resolve behaviour in time reduces the ability to resolve frequency and *vice-versa*. If one blurs one's resolution in time to a minimum time interval Δt , and one's resolution in frequency to a minimum frequency range Δf , then a famous mathematical result (first used in Quantum Theory) known as the uncertainty principle asserts that one has to have

$$\Delta t \times \Delta f \gg \frac{1}{2}$$

(This is the first and last mathematical formula in this article!), where Δt is the minimum time resolution in ms and Δf is the minimum frequency resolution in kHz. So if one has a time resolution of 5 ms, then the frequency resolution can be no better than 100 Hz—no good for examining details of the bass response.

Actually, as noted by Dennis Gabor (best known for his invention of holography, but who also worked in audio) back in 1946, the ears actually analyse the frequency content of sounds in time faster than suggested by the uncertainty principle by a factor of about 7. The seeming logical contradiction with the fundamental theoretical limit of time/frequency resolution is avoided by the ear's use of *a priori* or previously assumed knowledge of the nature of typical sounds but at the expense of getting the analysis 'wrong' when sounds not of the assumed form occur.

No one has yet succeeded in devising a method of simultaneous time/frequency analysis that beats the uncertainty principle limits on resolution using *a priori* information similar to the ear. Existing methods of analysis do not resolve enough detail in the two domains simultaneously to predict reliably how a filter will sound.

Nevertheless, several of the existing methods of time/frequency analysis do reveal some of the things that cause colouration: for example, both the techniques of *Time Delay Spectrometry* (TDS) invented by Richard Heyser, and earlier techniques of measuring frequency response after cutting off a first part of the impulse response reveal low-level delayed resonances. With these

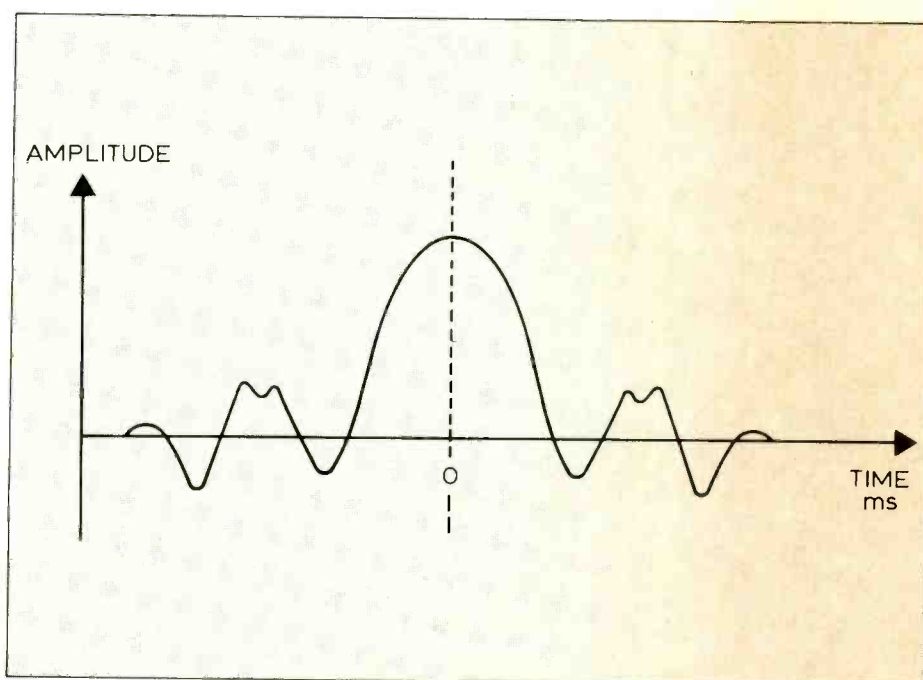

Fig 4: Typical impulse response of a phase-linear filter. Note the mirror-symmetry around time zero

techniques, the initial frequency response may measure flat but the frequency responses associated with later times display a visible decaying resonant peak. However, while these methods have enough resolution to measure the grosser faults of loudspeakers, they still tend to mask the more subtle faults associated with many equalisers and also systems such as turntables.

There is an urgent need to refine existing methods of simultaneous time/frequency analysis to maximise the amount of fine low-level detail that can be seen. In computer-based analysis packages, this means carefully devising the filtering and 'windowing' used to minimise all discontinuity, resonance and aliasing artefacts, and using very high quality graphics to display the results on a very fine time/frequency grid. Otherwise the eye will not be able to resolve the required detail.

Even when this is done, analysis using several different trade-offs of time and frequency resolution will probably be needed, so details that occur predominantly in the time domain and in the frequency domain can both be examined.

Wigner distribution

A mathematically beautiful and elegant method of simultaneous time/frequency analysis was published by Eugene Wigner in 1932 (his application was to Quantum Statistical Mechanics, although its original application was apparently in another unspecified field). Despite its mathematical elegance, this Wigner Distribution has a lot of unwanted 'high frequency clutter' obscuring the wanted detail from the eye—for example, if two frequency components are present, the Wigner distribution also displays a spurious beat-frequency component at the average of the two frequencies. Despite its use in recent audio literature, where the Wigner distribution response of a number of filters and loudspeakers has been published, and despite the fact that in principle it contains all the information needed to understand a filter response, the large amount of clutter present makes it impossible for the eye to make out relevant details.

Nevertheless, the Wigner distribution may well form the basis of future improved methods of time/frequency analysis beating the uncertainty principle limit. This is because it can be shown mathematically (the methods of proof are buried deep in the Quantum Theory literature) that the normal methods of time/frequency analysis can be obtained from the Wigner distribution simply by blurring it with a suitable smoothing filter. (Technical note: this 2-dimensional smoothing filter has a response that is also a Wigner distribution.) Such blurring removes the unwanted clutter, at the expense of also blurring the wanted information. However, by using less drastic blurring than used to obtain conventional time/frequency analysis, much of the clutter can be removed without losing so much detail.

So, by time/frequency analysis using a carefully-smoothed version of the Wigner distribution, in future we may have the tools to see what filters and equalisers are doing in the time and frequency domains with more detail than was previously possible. Designers of the software packages for audio analysers need both to master the relevant mathematical tools and to design the required smoothing filters in the software to avoid the kind of discontinuity or oscillation behaviour we are looking for in the hardware audio filters and equalisers we want to analyse. In other

words, the design of analyser software requires the same kind of skills required to design good audio equalisers.

The future

What an optimistic subheading! Actually, the future understanding of equalisers is still uncertain. What we do now know is that many low-level effects often ignored in the past are very important subjectively and that traditional methods of measurement and analysis are not yet refined enough to reveal their effects. One priority is to refine our methods of measurement and analysis to maximise the visibility of low level effects.

This means as much skill is required in the development of test equipment as has traditionally been applied to audio equipment. Nothing can be taken for granted. In particular, the filtering and 'windowing' on spectral analysis equipment needs to be much better behaved than has been the case until now. Much more attention is also required to the quality of the display of visual information, which should avoid the kind of steps, kinks and coarse grids of current displays, since one is actually looking for such discontinuities in an equaliser response as symptoms of its audible quality.

Meanwhile, the design of equalisers will remain an art, although I hope the questions raised here will help to inform the art and concentrate attention on potentially important factors—particularly in the design of digital equalisers.

One topic not covered is the role of circuit nonlinearities in the sound of analogue equalisers, or of 'rounding error' and requantisation effects in the design of digital equalisers. These are also important but would require several articles to themselves. In the above, I have assumed that the equalisers have been designed carefully enough to minimise such nonlinear effects but, sadly, this is often not the case in commercial products—particularly for digital equalisers.

A gloomy ending

One area of pessimism concerns the viability of using equalisers to compensate for defects in other equipment (microphones, loudspeakers and even multiple stages of bass roll-off in audio electronics). The problem here is that even very tiny residual errors in the frequency and phase responses may turn out to be almost as audible (or in some cases even more so) than the original unequalised errors. Equalisation may improve the tonal accuracy in such cases but it can (and often does) increase the audible colouration.

If this is right, we may be unable, ever, to 'fix it in the mix' properly, and this re-emphasises the importance of using the best and least-coloured sounding audio equipment at every stage of the audio recording chain. The best equaliser is no equaliser! Anything else may add useful creative pizzazz—and it is worth understanding what such creative equalisers are doing—but there are limitations to how far an equaliser can actually 'equalise' an already-coloured signal. □

References

- 1 Philip Newell, 'Monitor Systems Part One: A Look at the Overlooked', *Studio Sound*, pages 46-53, August 1989
- 2 Philip Newell, 'Monitor Systems Part Five: Crossovers', *Studio Sound*, pages 60-67 (December 1989) and pages 48-53 (January 1990)

QUALITY USED EQUIPMENT

from Tony Larking

MULTITRACKS

Ampex MM1200 24 track with remote, VGC.	£9,950
Otari MX80 24 track with remote, approx 100 hrs use. Immaculate.	£16,500
Otari MTR90 Mk2 with remote and autolocate. Nice condition.	£17,950
Studer A80 Mk3 Wide Body 24 track with remote and autolocate.	£12,950
Saturn 24 track, ex-demonstration machine, supplied with 3 months warranty, VGC.	£16,950
Sony 3324 24 track digital. Sony service history with remote and autolocate.	£39,500
Tascam ATR80 24 track with remote and autolocate, VGC.	£17,500
Soundcraft Mk2 24 track with full autolocate, very little used, excellent condition.	£8,450
Otari MTR12 with centre time code track. Unused.	£OFFERS

CONSOLES

Neve 8108 32 channels, 8 VCA sub groups and patch bay, VGC.	£34,950
Neve 8108 48 channels, patchbay and Necam 96 automation.	£55,000
Neve 8078 40 channels and patchbay, VGC.	£P.O.A.
Soundtracs IL48/32 48 channel in line console, private use only, very high quality console, 104 line inputs in remix. IMMACULATE.	£23,950
Soundtracs CP6800 32/24 and patchbay, private use only. 56 line inputs in remix, automated routing and muting fader, automation available as optional extra. Immaculate.	£13,950
Soundtracs CM4400 32/24 and patchbay, VGC.	£8,500
Soundtracs CMX4400 32/24 and patchbay plus CMS2 automated routing and muting.	£9,500
Soundtracs PC MIDI 24 3 months use only, 48 line inputs with Eq, plus extra 8 FX returns, Immaculate.	£4,500
Soundtracs MR 24/8/16 nice condition.	£2,950
Soundtracs MR 32/8/16 nice condition.	£3,950
Soundcraft 6000 28/24 and patchbay, Unused.	£10,950
Soundcraft 6000 32/16 and patchbay, Unused.	£8,950
SSL 6000F 48 channels, G-Series computer, total recall, SSL engineer's report available.	£P.O.A.
Trident Series 80B 32/24/24 and patchbay, one owner from new.	£14,950
Trident Series 80C 32/24/24 and patchbay, VGC.	£14,950
Trident A-Range installed in one of UK top studios from new, then in private studio for past 12 years. Very well maintained, very nice condition. A rare opportunity to purchase one of these highly sought after consoles.	£19,950
Trident TSM 32/24/24 and patchbay, Installed in top studio from new, very well maintained, VGC.	£14,950
Harrison 32 Series 40 channels, 32 monitors, patchbay, 8 aux.	£P.O.A.
Harrison MR4+ Mastermix automation, 36 frame fitted with 32 channels.	£22,000
Ameck 2500 40 channels and patchbay, nice condition.	£27,950
Soundcraft 1600 32 channel frame fitted 24/8/16, patchbay, P&G faders and master PPM meters, little used VGC.	£5,500
Soundcraft 3B large 32 channel console with 24 groups, 24 monitors and patchbay. Nice condition. A lot of mixer for not a lot of money!!	£4,995
Hellios large wrap around console, 26 channels+4 FX returns in good working order, this console has been used to record many hits.	£OFFERS
BEL 24/16/16 budget mixer for 16 or 24 track, 40 line inputs in remix.	£1,495
Soundtracs MRX 24/8/16 fitted with Steinberg Mimix automation, Ex-demonstration.	£8,995

URGENTLY WANTED

Soundcraft 24 Track Machines.
Otari MX80 24 Track Machines.

AJ
Studio
Furniture

TEL 0462 490125

FAX 0462 490126

Prices do not include VAT

THE POSSIBILITIES

The Flex System from Rane: A Powerful New Approach to Modular Signal Processing



F

lexibility, no matter how you spell it, means power. It's the power to meet varied needs. To meet budgets with optimum performance. To efficiently accommodate system growth. Long into the future.

Flexibility is the essence of Rane's new FLEX System. The first universally compatible, cost effective, modular approach to signal processing and routing. With no special requirements. And no dead ends.

Each Flex module is an HR (Half Rack) compatible, UL/CSA/VDE approved, self-contained processing unit. Each capable of being EIA rack-mounted either horizontally or vertically, with inexpensive, readily available hardware. Or simply set on a shelf, stand-alone fashion.

HIGH-POWERED COMPATIBILITY. Using standard 3-pin, 1/4" or barrier strip connectors, FLEX modules are directly compatible with professional audio gear. And since they are remote powered—via Rane's proposed power supply standard—troublesome ground loops, hum and agency approval problems are solved up front by design.

ENDLESS POSSIBLE COMBINATIONS FOR CUSTOM DESIGNS. The FLEX non-exclusive modular concept makes it inherently expandable

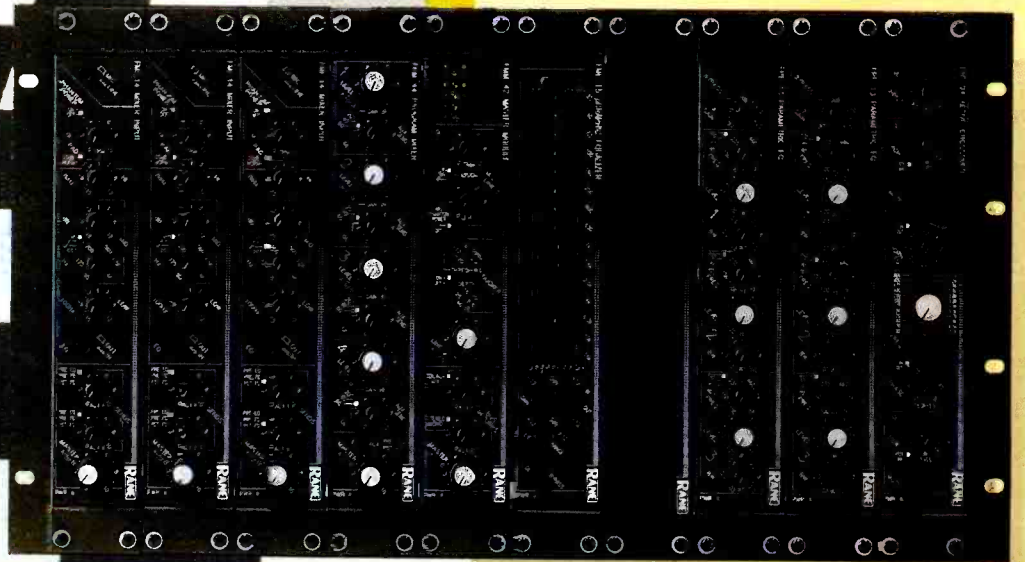

ARE STAGGERING!

and upgradeable. It boasts a large and growing number of functions and components to choose from. Mixers. Preamps. Splitters. Crossovers. Dynamic controllers. Equalizers. Amplifiers. Line drivers. And much more under development.

And thanks to Rane's efficient bus design, system wiring is greatly simplified in even complex mixing and splitting layouts.

COST EFFECTIVE CAPABILITIES. Modular flexibility. Uncompromising performance. All without a premium price. That's the FLEX System manifesto. There is no expensive mainframe to buy; you only pay for the functions you want, when you want them.

Say, for example, you only need a 3 channel mixer with one channel of crossover. The FLEX System delivers. And when your needs expand, just add more modules. No need to obsolete old equipment for a loss.

Whether you use two modules or twenty modules, the FLEX System remains cost effective. And supremely flexible. Year after year.

SUPERLATIVE PERFORMANCE, RANE RELIABILITY. The design and performance of each and every Flex module is, in a word, superlative. Every model carries top-grade studio specifications, utilizing the best components available. The result is unsurpassed performance and reliability.

Our HR compatible modules may be compact, but they're stuffed with more top-notch features than you would have thought possible. For example, the **FMI 14 Mixer Input module** measures only 1.75" x 10.5", yet it boasts a -128dB EIN mic stage, switchable phantom power, true 20dB pad, powerful 3-way EQ section, insert loop, two source-selectable Aux sends and balanced master channel outputs. A single DIN cable, supplied with each module, routes the Master and Aux buses from unit to unit for quick and clean hook-up.

+15/-20dB boost/cut, 2-octave down to 1/30th-octave bandwidth range for notch capability, and a full 10Hz-20kHz frequency sweep range for unprecedented flexibility.

The **FME 15 MicroGraphic Equalizer** brings Interpolating Constant-Q filter performance to the Flex line, pioneered by our full-sized GE 30

current balanced outputs, and you've got a powerful, flexible new crossover standard.

This is but a sampling of the innovative Flex Modules to be released this year. We encourage you to obtain separate, detailed data sheets on the many FLEX System modules. Then compare these with the best standard equipment available. You'll discover that FLEX offers the best of all worlds: compact, cost effective, flexible, uncompromising performance.



The **FMM 42 Master Module** not only provides Aux returns and mixing, but features extra mic and stereo line inputs with ducking capability for paging and other applications.

For even more mixing flexibility, the **FPM 44 Program Mixer** allows 4 separate mic or line inputs to be mixed to 4 output programs, with pre or post fade switch selection for the Aux sends. Both the direct balanced/unbalanced terminal strip and the DIN Flex bus inputs and outputs can be used simultaneously for easy expansion and integration into larger systems.

Carrying on a fine tradition of innovative equalizer technology, Rane sets yet more new standards with the Flex Series. The **FPE 13 Parametric Equalizer** provides 3 separate bands, each capable of

model which has set new industry standards. Minimized filter interaction, smooth combined response and fully balanced three-pin and terminal strip input/output are but a few of the features. Both the FME 15 and the FPE 13 also provide an exclusive Patch I/O jack which allows direct connection to an insert loop jack with a single 1/4" TRS patch cable.

The **FAC 24 Active Crossover** is the next generation to follow in the respected footsteps of our AC 22 and AC 23 designs. In addition to the proven 24dB/octave Linkwitz-Riley performance, the FAC 24 features a true 24-position frequency selector switch to provide plug-in card accuracy and repeatability with the convenience of a knob. Add to this a built-in CD Horn EQ section, electronic phase alignment, summing LF input and three-pin high-



FLEX MODULAR SIGNAL PROCESSORS Series

RANE

10802-47th Ave. W.
Everett, WA 98204
(206) 355-6000

Sound Effects Software

Sound & Music Cataloging Professional Librarian

- Organizes Tapes, DATs, Samples, Floppy Disks, Compact Disks, Broadcast Carts & LPs.
- Contains presorted catalog listings of Compact Disk sound effects & production music libraries.
- Provides easy data entry for your own libraries, checks spelling and allows descriptions of virtually unlimited length.
- Searches library catalogs by sound, style, mood, category, title, synonym or description.
- Enables multiple word searches using AND, OR, ALSO & NOT to specify exceptions, alternatives.
- Sorts & Cross-references by Format, Length, Media, Project, Recordist or Source Roll.
- Allows unlimited number of custom categories.
- Controls Compact Disk playback via Sony CDK-006 60 disk multi-player "jukebox".
- Networks up to 32 stations and 16 jukeboxes.

Sound Effects Spotting Sound Supervisor

- Manages spotting lists referenced to reel, scene, time code or feet/frames.
- Provides search, copy & paste from library to spotting lists.

Dialogue (ADR) Spotting Spotmaker

- Organizes replacement dialogue lines, sorts by character, reel, scene & footage.
- Prints standard cue/line sheets as well as a variety of other forms
- Transfers data to Cueprinter for mixing cue sheets.

Cue Sheet Printing Cueprinter

- Prints standard re-recording cue sheets in feet/frames or timecode on any size paper.
- Conforms footages to picture changes.

LEONARDO SOFTWARE
 10378 Holman Avenue
 Los Angeles, California 90024
 PH: 213.277.5161 • FAX: 213.277.9086



tc 2290

Although this digital delay line has been around for a while regular software updates are being released. Dave Foister runs through the latest version's facilities

Many audio manufacturers produce a new model every year whether it really does anything different or not. The result can be a confusing stream of gadgets, which are obsolete before anybody's got to grips with them. Others establish a solid product and upgrade its software as new possibilities become available. AKG's ADR68K, for example is operationally barely recognisable as the original version although it's still in the same box; another is the tc 2290 DDL from tc electronic of Denmark, which, at the time of writing, is up to software revision 30.08.

Since its introduction about 4 years ago the 2290 has become established as a very popular, widely-used DDL with an impressive endorsement list, although at first glance it's a little hard to see why. We're now used to multi-effects boxes that seem to do everything, but the features offered by this device appear a little tame by comparison. It doesn't do reverb at all, or realtime pitch shifting for instance, nor does it offer the stacked-up multiple effects that have become so common but then tc have not set out to compete in this field; their prime concern is audio quality coupled with maximum manipulation of the facilities provided.

Although the published details are hazy, the 2290 achieves its sound quality by using delta modulation—encoding the difference between successive samples rather than their absolute

values—instead of the more common PCM. This technique involves a sampling frequency of 1 MHz, which means the usual brick wall anti-aliasing filters with all their inherent potential problems, are unnecessary; the frequency response is flat within 0.5 dB up to 23 kHz and only 12 dB down at 30 kHz. Delta modulation also gives better low-level resolution than PCM and the result is a dynamic range in excess of 100 dB (better than the theoretical maximum of 16 bit PCM) and extended HF response with improved phase response. The difference is indeed audibly significant; this is the cleanest, quietest DDL I have heard.

The effects on offer are all the standard ones produced by a straightforward DDL and they are programmed by direct access to the delay line in the old-fashioned way—there are no controls marked 'chorus depth' or 'flange speed'. Delay time is fully adjustable up to the installed memory capacity; the basic unit comes with 1 sec capacity but can be upgraded to a maximum of 32 secs. Delay modulation can be a sine LFO or random, and variable feedback is provided complete with high- and low-pass filters in the feedback path. All this allows flanging, chorus, doubling, echo, and so on, to be set up and some of the 20 factory presets provide examples of these, which can of course be fully edited to form the basis of new effects. A further 80 presets allow user storage of new setups.

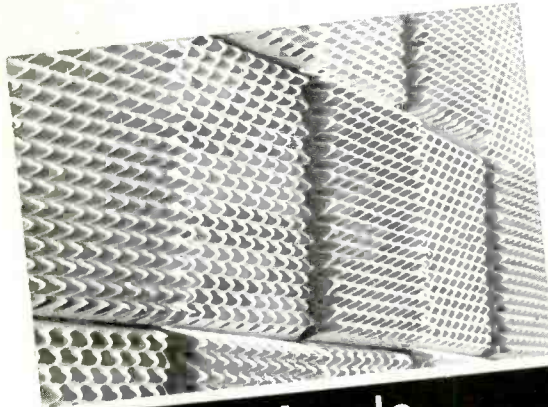

Trade counter opens
8am-5pm Mon-Fri
late night till 8pm Thursdays
Telephone orders processed within
minutes and shipped for same day or
next day delivery
Pay on account or by credit card

**Today's
orders through
your door,
Today
or Tomorrow**

Studiospares warehouse stocks
more than
50 models of microphones
10,000 plugs and sockets
10 miles of audio cable
50 patch bays
5000 chrome cassettes
Thousands of accessories
etc..etc..

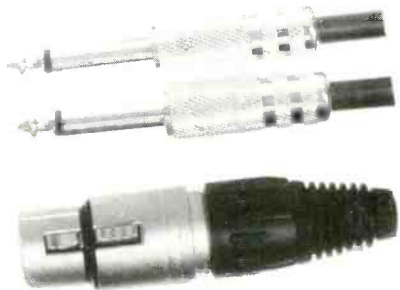

Save time - phone
STUDIO SPARES
first

TRADE COUNTER
Open 8am-5pm Mon-Fri
late night Thurs till 8pm.

TELEPHONE ORDERS 071-485 4908
61-63 Rochester Place, Camden Town,

FAX 071-485 4168
London NW1 9JU

www.americanradiohistory.com

Please send free 64 page catalogue
Please send account application form
Please send credit card application form

NAME _____

ADDRESS _____

SS/07/90



VISA

Now Dolby SR is as easy as one, two, three.



New MT Series

1. Switchable Dolby SR A-type NR

With both new models you can select either Dolby SR or A-type NR for any or all channels. You save time handling tapes from different sources, because you don't have to switch cards.

2. Fast, reliable automatic alignment

Software control enables these new units to align themselves automatically in seconds. There's no need to adjust pots, or manually compensate for variations between reels of tape. You get the same accuracy as before, but in a fraction of the time.

3. Channel grouping

For multitrack and multi-machine use, you can allocate any number of channels to separate groups. The groups align and function independently, and can be assigned different operating modes.

With Dolby SR, analogue is again becoming the preferred recording medium. Dolby SR dramatically expands analogue's dynamic range while preserving its natural sound and cost effectiveness.

Using Dolby SR is now easier than ever, with the new Dolby MT and Model 400 Series. The MT handles up to 24 channels; the Model 400, up to eight. In multitrack, post-production, and mastering applications, their new features save time and boost productivity.



New 400 Series

So now you have a choice. When time and flexibility are of the essence, there's the new Dolby MT or Model 400 Series. For economy, there's the familiar Dolby XP or Model 363 Series.

Either way, Dolby SR is the sound investment for analogue recording.

For further information and a demonstration, contact your Dolby professional products dealer.

Dolby Laboratories Inc. • 100 Potrero Avenue • San Francisco, CA 94103-4813 • Telephone 415-558-0200 • Telex 34409 • Facsimile 415-863-1373
346 Clapham Road • London SW9 9AP • Telephone 01-720-1111 • Telex 919109 • Facsimile 01-720-4118
Dolby and the Double-D symbol are trademarks of Dolby Laboratories Licensing Corporation. ©1989 Dolby Laboratories Inc. S89/8776



In addition there is a panner, giving control over static and modulated pan positions of both the direct and delayed signals, and various dynamic control facilities are provided. These include sine and random amplitude modulation of direct and delayed signals, as well as signal-triggered envelope effects such as ducking an echo effect under the direct signal leaving a louder delay tail when it stops, or gating the effect with the input signal. All these dynamic processes can be combined with the delay effects to produce a surprising variety of results.

Adjustment of these central parameters is easy and intuitive. Although there is only one rotary control, the input level, there are enough separate displays and nudge buttons to avoid confusion. Each set of parameters—delay, panning, feedback, and so on—has its own display and control keys, and these are much more pleasant to use than a lot of current devices. Values are shown on large red LED numeric displays, which can be read from across the room, and the keys are large, clearly-legended and positive in operation. All values can be entered via the accelerating nudge buttons or directly from the main numeric keypad.

One of the more recent upgrades provides a versatile sampling option, with editing, looping, crossfades and so on, together with audio or manual triggering, pitch shifting (including MIDI control), sample storage in presets and sample sequencing. The sampling rate can be halved to give a maximum sampling time of 64 secs and, unlike a PCM system, the difference in audio quality is barely noticeable. Although the device is single-channel, the new software allows two 2290s to be linked as a stereo pair—one as master, one as slave—and the synchronisation between them is claimed to be accurate within 2 µs, which is better than some digital recording systems. Unfortunately, as only one 2290 was available for review this feature could not be tested. Although the unconventional delta modulation principle makes sample dumping difficult using standard protocols, the possibility of bulk dumps for outboard editing, storage, and so on, has not been ruled out for the future.

Many of the parameters involved in controlling these new options, as well as several of the earlier functions, are unfortunately hidden in software and not available directly from front panel keys; this is the price to be paid for this kind of software-upgrade approach to product development, especially when the device has no alphanumeric display that could be used, for instance, to show 'soft key' functions in the manner of, say, the Akai S1000. The system adopted on the *tc 2290* is to use a set of 'special numbers'. There are over 100 of these and typing one of them in calls an internal parameter that can be given a new value from the keypad. Some are switches, such as the one for selecting Double Sampling Time (special number 36 assigned a value of 1 for on, 0 for off) while some have multiple values, such as the pan trigger threshold (special number 11). This is all straightforward enough if you have the manual in front of you with its chart of all the special numbers, their functions and their possible values but it would

be impossible to remember them all. I suspect most of us prefer not to let clients see us poring over equipment manuals (even if we can find them) in the middle of a session, which suggests that apart from some heavily-used ones many of these functions might end up going to waste.

Possibly with the problems of memorising all these numbers in mind, there are two Assign keys on the front panel that can be programmed to perform any sequence of keypresses (including special number entries) up to nine events long. These Assign keys can also access several hidden functions, which to call 'Image Keys'—one, for example, steps up or down through consecutive presets, and another recalls the last preset used.

Stage facilities

Perhaps surprisingly for a unit that has found such wide acceptance in the studio, the *tc 2290* is apparently extremely popular with musicians for stage use, and it has some unusual features with this in mind. The main one is the provision on the back panel of no less than five effects send and return loops for connecting other devices into the *tc 2290*'s signal path (before its own processing); not only that but configuration of these loops can be stored in the presets, so that calling up a 2290 effect also inserts the appropriate other boxes. The Assign keys obviously take on further significance on stage, where they can help with quick changes, and they can be augmented with external footswitches to perform similar command string functions.

Presumably this stage use is the reason why, by default, the delay signal is sent equally to the two outputs but out of phase. No doubt on stage this gives a wide spatial impression but in the studio it is completely unusable and has to be rectified on every preset. On the other side of the coin, this live use of the machine must occasionally save time in the studio when a guitarist's favourite effect can be used without the hisses and hums which can often accompany it.

Conclusion

The *tc 2290* is already too well established to need any recommendation from me; its exemplary sound quality has won it many admirers on both sides of the control room window. The point to make is that it has not stood still but continues to develop. Its original design, particularly in respect of its inflexible front panel layout, means that new features are less easy to use than they might have been but they are there and they work as well as the unit's reputation would suggest. No doubt this is still not the end of the story—I look forward to software version 4.2, the ultimate answer!

tc electronic, Gimhoejvej 3, DK-8220 Brabrand, Denmark. Tel: 86 26 2800.
UK: tc UK, 24 Church Street, Oswestry SY11 2SP. Tel: 0691 658550.
USA: tc electronic USA Inc, 7325 Hinds Avenue, North Hollywood, CA 91605. Tel: (818) 503 0404.



**a.u.d.i.o
SYSTEMS**

**SALES
SERVICE
EXPORT
LEASING
INSTALLATION
HIRE**

**Tel: 021-200 1771
Fax: 021-200 2370**

Here at Palm we make sure that service is our top priority. All equipment both new or used is tested and run before it is sold, tape machines are set up and bias set according to your specification... by the way we automatically give you a free reel of Ampex tape with every new machine we sell. Our service department maybe just what you need, we regularly undertake modifications and build equipment when it is not available. If you simply require a regular service or have an unusual technical problem please don't hesitate to call us we pride ourselves on problem solving and can usually provide the solution you require...

MIXERS

Soundtracs Quartz J2 24 2 now (price increase shortly)	117,900
Soundtracs H48-32 new	133,745
Sonderair 800B 48.2 in flight case	17,400
Sonderair 800B 32 16.2 new	17,900
Sonderair 16 2 Series One in flight case used	1,650
Sonderair Delta 84 2 stereo 4 mono inputs New to clear	11,500
Alesis 1622 new	15,575
Sonderair 800B 16 8.2	11,990
Soundtracs MIDI PC16 & 24 models in stock Call us for details	
Tascam MM1 16 2	4,512
D&R Dayton 24 24 in line, 54 inputs in remix	19,500
D&R 4000 automated, 48 inputs in remix, dls VCA	14,400
D&R Styles fully modular, 16 8 2 Stereo inputs option	13,825
Fades & Mutes automation available on all D&R desks Now!	
Prices exclude VAT	

RECORDERS

3M M79 24 track 2"	16,500
MCI JH1 10B 1/4" hi-profile meters also 1/2" block	12,950
Sony PCM 501	1,400
Sonderair 11 8 track with remote, 15 hours use only	11,750
Tascam MSR24 one only used 20 hours only	16,500
Studio Magnetics 1/2" 16-track 30hrs good condition	12,800
Casio DA11 Portable DAT Recorder New	1,650
Tascam 52 excellent condition	11,200
Tascam MSR16 budget, 16 track New	14,250
Tascam TSH28 budget, 8 track ex-demo (two available)	11,695
Fostex E166 New & Used always available Phone for current deals	
Sony DTC1090 ES DAT Recorder New	11,130
Tascam 122 2 1/4" cassette second user	1,650
Tascam 688 & 684 now available Prices start around	1,860
Teac X3H 1/2" open reel 2 track second user	1,350
Kees C270 2 track recorders, prices from	12,870
Prices exclude VAT	



MONITORS

If you are in the market for serious self powered monitors take a look at the Dutch made Axys Repryl, a speaker system designed for professional use and an ideal compromise between nearfield and high powered monitoring. Repryl 1 is a 3 way active system delivering 113 dB at 1 metre. It incorporates a soft dome tweeter, a 5 inch extended mid range transducer and a 12 inch woofer. Like all the Axys monitors in the Axys range all monitors come complete with qualified aircraft seat track for simple and reasonable installation. For a demonstration and brochures please call us.

ALL PROCESSORS

Roland DEPI3 great condition	1,112
Alesis Quadverb	1,947
JL Conper PPS100 SMPTE/MIDI Controller	1,349
Aphex C Aurat exciter. New boxed limited quantity	1,179
at these prices:	
Alesis Midverb 3	1,310
dls DX 2 channel noise reduction	1,59
Drummer new and used usually in stock call us for full details	
Digitech 128 four effects in one 19" rack unit	1,280
Tascam MTS30 intelligent FSK code read/write	1,499
Yamaha Q2031 31 band stereo EQ	1,373
Dynacore EQ2215 stereo graphic	1,189
Rebus Rack 2 compressors and 5 gates	1,350
XRI XR40 SMPTE read/write, new and used prices from	1,200
Yamaha TX81Z	1,270
Yamaha RX17 drum machine	1,75
Akai XE5 16-bit drum sample player	1,280
D&R 'Qorb' 16 bit digital reverb, 127 programs	1,240
D&R 'Aurax' stereo enhancer	1,155
D&R 'Noise Gate'	1,120
D&R 'Comp/Limiter'	1,120
Roland TR908 excellent condition	1,299
Groove Tube guitar pre amp used	1,490
Essomig Mirage sampler ex-demo	1,600
Casio VZ10m	1,125
Yamaha RX11 used	1,200
QPlay Autolocator for Fostex B&E16	1,150

TAPE AND ACCESSORIES

We place great importance on supporting our customers with a vast arrangement of consumables. We distribute Ampex tape throughout the UK and always have large stocks of all formats including DAT and cassette. Items such as leader tape in all sizes and colours, Editall precision editing blocks, head Dr Mags, Razor Blades, Cable, Empty Reels, Connectors, Patchbays and Trolley Stands are always in stock and can be despatched to you on the same day. A full price list is available by request.

This is just a small example of the equipment we have, obviously our stock changes from day to day, if you are looking for a particular item don't hesitate to contact us and see if we have or can find what you want! We can also sell your unwanted equipment for you - call us for details.

**THE PACIFIC BUILDING
16/17 Caroline Street, Birmingham B3 1TR**

CLASSIFIEDS

Advertisements for this section must be pre-paid. The rate is 70p+VAT per word, minimum £17.00+VAT. Box Nos. £6.00+VAT. VAT (UK only) \$ rate \$2.00 per word, minimum \$50.00, Box No. \$10.00 extra. Semi-display rates on application. Copy and remittance for advertisements in SEPTEMBER issue must reach these offices by 20th JULY addressed to: The Advertisement Manager, Studio Sound, Link House, Dingwall Avenue, Croydon CR9 2TA. Cheques made payable to Link House Publications (Croydon) Ltd. Note: Advertisement copy must be clearly printed in block capitals or typewritten.

Replies to Box Nos. should be addressed to the Advertisement Manager, Studio Sound, Link House, Dingwall Avenue, Croydon CR9 2TA, and the Box No. quoted on the outside of the envelope. The district after Box No. indicates its locality. **SEX DISCRIMINATION ACT 1975:** No job advertisement which indicates or can reasonably be understood as indicating an intention to discriminate on grounds of sex (e.g. by inviting applications only from males or only from females) may be accepted, unless (1) the job is for the purpose of a private householder or (2) it is in a business employing less than six persons or (3) it is otherwise excepted from the requirements of the Sex Discrimination Act. A statement must be made at the time the advertisement is placed saying which of the exceptions in the Act is considered to apply.

The attention of advertisers is drawn to "The Business Advertisements (Disclosure) Order 1977", which requires that, from 1st January 1978, all advertisements by persons who seek to sell goods in the course of business must make that fact clear. From the above date consumers therefore should know whether an advertisement relates to a sale by a trader or a private seller.

SERVICES

CASSETTE DUPLICATING:
GAUSS Loop-Bin / TELEX In-Cassette
 High Quality Blanks / Label Printing
OPEN REEL DUPLICATING
 (ANY SPEED - ALSO TO BROADCAST SPEC.)
SPEECH RECORDING
 (VOICE-OVERS; LANGUAGES; AUDIO-VISUALS)
SPEECH-PLUS RECORDINGS LTD.
 UNIT 32, NO. 19, PAGES WALK, LONDON SE1 4SB. TEL: 071-231 0961

FOR ALL YOUR RECORDING NEEDS

AMPEX · BASF · MAXELL · AGFA · JVC
 AUTHORISED NATIONAL AUDIO/VIDEO TAPE DISTRIBUTOR

Spools, boxes, blades, splicing and leader tape. Blank custom wound cassettes C1-120, labels, library cases and cards, C-zeros, pancake, etc. Broadcast Cartridges.



12 Britannia Road
 Sale, Cheshire M33 2AA
 Tel: 061-905 1127

SOUND AND VIDEO SERVICES

FOR QUALITY, PRICE AND SERVICE

STUDER-REVOX SERVICE

NEW & USED SALES

Factory condition machines
 currently available

Studer A62 Stereo, Trolley	£800.00
Studer B62 Stereo, Trolley	£1,200.00
Studer B62 Neopilot, Resolver	£1,500.00
Studer B67 Mk1, VU, Portable	£1,800.00
Studer B67 Mk1, Trolley	£1,800.00
Studer A80 Mk1, 7.5/15IPS	£2,500.00
Studer A80 RC Mk1, VU	£3,000.00
Studer A810 Mk2, 15/30IPS	£4,500.00
Revox PQ99 Mk3, HS, NEW	£1,850.00
Revox PQ99 Mk2, HS	£1,200.00
Revox B77 Mk2, IEC, NEW	£1,300.00

All Calibrated and Guaranteed

We will refurbish your
 old Studer or Revox
 to factory condition

CALL
0246-275479

RECORDING STUDIO WANTED

Looking to buy large package of studio equipment for one or more studios. All cash offer — also looking for unused pieces — Neve equipment, Valve microphones, outboard gear etc.
 Tel: USA (818) 346 9007, ask for Dave

THE COMPLETE SERVICE.....

D.I.R.E.C.T.

- Record Pressings
- Cassette Duplication
- Compact Discs
- Post Mastering
- P.Q. Encoding
- Print & Reprographics
- Video Duplication
- Competitive Prices
- Free Quotations

*Make it with us
 We make the hits*



MARKET LEADERS

☎ 081-446 3218 LONDON
 ☎ 0480 61880 CAMBRIDGE



THE CASSETTE DUPLICATING SPECIALISTS

Real time & high speed loop bin duplication, printing & packaging. Blanks wound to length
 TEL: 061-973 1884

Leeholme Audio Cassettes

340-344 LEA BRIDGE ROAD, LEYTON, LONDON E10 7LD
 PHONE 081-556 1125 ★ FAX NO. 081-539 8834

THE AUDIO CASSETTE SPECIALISTS

For all your duplicating and blank cassette requirements

- ★ STANDARD AND CHROME TAPE
- ★ CLEAR, BLACK AND COLOURED SHELLS
- ★ ANY LENGTH FROM C3 to C96
- ★ INLAY AND LABEL PRINTING
- ★ RECORDING FACILITIES AVAILABLE

HIGH SPEED HIGH QUALITY LOOP-BIN DUPLICATING BY SRL TAPE SERVICES

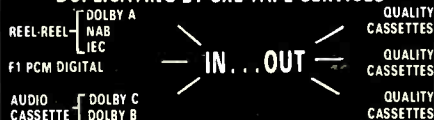

THE BETTER THE MASTER, THE BETTER THE COPY!
 HOW MANY WOULD YOU LIKE? 100-5000
 081-868 5555 081-866 5555 PHONE FOR PRICE CHECK

jbs records

MUSIC-SPEECH-DATA

REAL-TIME/HIGHER-SPEED Quality Cassette Duplication and Blanks from 1-1000. Computer printed Labels. Solo, 1/4" Reel, Sony Betamax or R-DAT recording. Fast Security Delivery service.

FILTERBOND LTD, jbs records div, FREEPOST
 19 SADLERS WAY, HERTFORD, SG14 2BR 0992-500101

TAPELINE

Blank & Duplicated Cassettes

- Real time cassette duplication
- From 1/4" reel, PCM Beta digital, DAT or cassette masters
- Custom Wound Ferric or Chrome Cassettes
- Labels & Inlays • Shrinkwrapping

Telephone (anytime)

061-336 5438

High Quality, Low Cost, Express Service

53-55 CORPORATION ROAD, AUDENSHAW, MANCHESTER M34 5LY

IRONWELL
 CASSETTE - DUPLICATION

If you want cassette copies of the highest quality delivered on time at a price you can afford

Send for Our Brochure

Station House, Station Yard,
 Hinckley, Leicestershire LE10 1UE
 Tel: (0455) 251551

SITUATIONS VACANT

SERVICE ENGINEER

Required for expanding professional audio company. Good knowledge and experience of pro-audio equipment necessary.

Salary negotiable.

Contact: Mike Novak

ELECTROMUSIC

89/97 St John Street, London EC1M 4AB

Tel: 071-253 9410/9079

Fax: 071-608 3539

VOLUNTARY engineers needed to service and extend Royal Marsden Hospital's broadcast standard radio studios in Sutton (Surrey) and London. Call Keith Warner 081-657 3598 (after 7pm).

SERVICES

WANTED: DEAD OF ALIVE! Pultec EQs; Fairchild & Teletronix Limiters; Neumann, Telefunken, AKG, RCA and Schoeps microphones. Tube McIntosh or Marantz amps and preamps. Sontec, ITI and Lang EQs. Neve or API equipment. Boxes of old tubes; Urei, Orban, United Audio, dbx and other outboard gear. Ampex ATR102s or 104s. Parts for MCI JH110/114 recorders. Altec 604s/crossovers/Tannoy speakers, JBL 2231; Altec 288h drivers. Miscellaneous equipment of all types. Please contact: Dan Alexander Audio, 2944 San Pablo Avenue, Berkeley, CA 94702. Tel: (415) 644-2363. Fax: (415) 644-1848.

DISC CUTTING EQUIPMENT and systems bought, sold, installed and manufactured by TAM/ENGLAND, 13a Hamilton Way, London N3 1AN. Telephone: 01-346 0033.

TASCAM/SENN/BEYER, trade counter. Erricks VCD, Brighouse 722121. (X)

THE COMPLETE SERVICE. Disc cutting, pressings, duplicated cassettes and blanks. Bin Masters. Location Recording. Free Brochure. Tam Studio, 13a Hamilton Way, London N3 1AN. Tel: 01-346 0033. (X)

QUALITY CASSETTE MASTERING AND COPYING, any quantity. Video duplication PAL/NTSC/SECAM transfers. 24 hour, seven days a week service. G.W.B.B. Audiovision, 42 Lancaster Gate, London W2 2NA. Tel: 01-723 5190.

"BULLETIN BOARD"

TRIDENT 80B 32-24 and STUDER A80 Mk III 24 TR + FULL REMOTE. Unbelievable package price £24,500!!!

TRIDENT TSM 32-24 very good condition	£13,950
AMEK 2500 36-frame, inc 24 mono + 12 stereo channels, vgc	£17,995
AMEK MOZART	P.O.A.
AMEK Angela 36 input inc Mastermix VCA faders	£17,500
LEXICON PCM-42 Digital delay X2	each £425.00
NEUMANN UB7/UB9s	each from £550.00
TC 2240 stereo Parametric EQ/Preamp	each £450.00
YAMAHA C7 Grand Piano in lovely condition	£4,500
EMT stereo plate inc remote motor	£395.00
Assorted Mic stands	each £17.50
Studio Mic boxes/Headphone Splitter boxes	each £25.00
Mic Leads	each £7.50
REBIS Rack inc: 8 gates, RIAA preamp, 2 autotune, 1 autopanner	£350.00
2 x Dolby 361s	each £325.00

This represents a tiny sample taken from the free monthly magazine BULLETIN BOARD. Do You Subscribe?

Tel: 081-994 4433 Fax: 081-994 9321
Mobile 0831-319111

REALISE YOUR CAREER POTENTIAL

We are the leading specialists in contract and permanent recruitment to the professional audio and broadcast industry with a client base consisting of leading equipment manufacturers and distributors, sound recording studios and post production houses. These are just some of the vacancies we have received instructions to fill.

Senior Field Service Engineer to £20K + Car

International travel. Working on a diverse range of analogue and digital equipment. HNC level electronics and several years maintenance experience in a customer related environment is necessary.

Systems Engineer c£22K

Design and Project engineering of TV, radio and recording studios. Systems experience is essential and knowledge of CAD would be advantageous.

Project Manager c£15K + Car

To work on a variety of projects. Pro-audio systems experience required together with the ability to manage a team of people.

Field Service Engineer £14 - 16K + Car

Educated to HNC level electronics. Working mainly on mixing consoles. Ability to interact well with customers is very important.

Come and show us how we can realise your career potential. Write or telephone Mike Jones, Broadcast Professionals, Unit 9B, Intec 2, Wade Road, Basingstoke, Hampshire RG24 0NE. Tel. (0256) 470704.



Broadcast Professionals

FOR SALE

PARTRIDGE ELECTRONICS

PRESENT REPORTER Model T24

MULTI-USE
SELF OPERATING
TELEPHONE NETWORK.
OUTSIDE BROADCAST UNIT

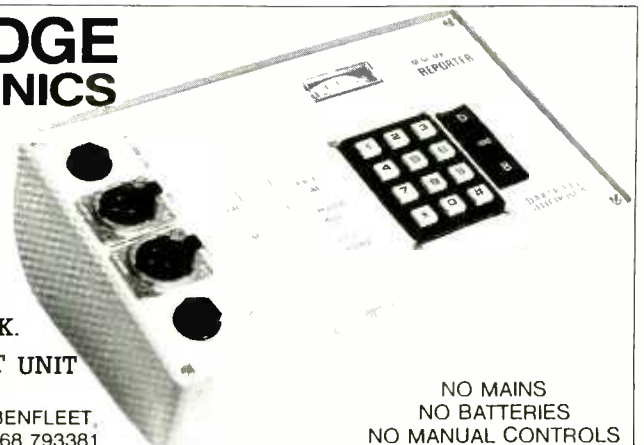

UNIT D, 318 HIGH ROAD, BENFLEET,
ESSEX SS7 5HB PHONE: 0268 793381

NO MAINS
NO BATTERIES
NO MANUAL CONTROLS

MOBILE RECORDING STUDIO for sale. Truck only (25,000 miles, including all internal wiring, mountings, soundproofing) £10,000. With equipment ready to use (16-track and digital) £20,000. Tel: (0929) 423449.

OTARI MTR 90 MK 2 with full remote and autolocate, very low hours, private studio sale. Immaculate. £17,500. Available immediately. Phone 0702 333453.

FOR SALE—OTARI MTR90 Mk II 24-track £18,500. TAC Scorpion 28/16/24 mixing console with patchbay £7,250. ATC 100s self-powered monitors £2,300. Sensible offers considered. Tel: 071-729 6165.

SOUNDTRACS CM4400 38 Frame 32 input. 56 channels on remix. Full patchbay. CMS2 Automation. Large stand easy frame with built-in 19" racks on each end. Absolutely immaculate condition. Mainly private use. Offers Tel: 0636 626582.

! AT LAST ! SPECIALIST FINANCE FOR PRO-AUDIO

- ★ No Deposit
- ★ No Front End V.A.T.
- ★ Low Interest Rates

£100,000 of equipment is yours
for less than £3,000 inc. V.A.T.

Contact:

**Malcolm Toft and Warren Palmer
A.P.T. Financial Services Ltd.**

Tel: 0344 890289

Fax: 0344 882003



AUTOGRAPH SOUND RECORDING
2 Spring Place LONDON NW5 3BA
Tel: 071-485 4515

SALE OF USED PROCESSING EQUIPMENT

DIGITAL DELAYS

Lexicon T92	£ 300.00
Klark Teknik DN 700	£ 450.00
Klark Teknik DN 70	£ 200.00
Urei Model 927	£ 250.00
Deltatad DL1	£ 200.00

REVERBS

Ursa Major 8X32 with remote	£ 1,000.00
Ursa Major Space Station	£ 300.00
MasterRoom XL305	£ 50.00

EQUALISERS

Urei Model 546 parametric	£ 300.00
Klark Teknik DN22	£ 250.00
Klark Teknik DN27A	£ 350.00

MISCELLANEOUS

BSS FDS320 crossover	£ 300.00
Eventide H810 harmoniser	£ 300.00
EXR aural exciter	£ 100.00
Roland RE301 chorus echo	£ 100.00
Roland SRE555 chorus echo	£ 250.00
Boss CE300 super chorus	£ 100.00
ITC SP single cartridge machine	£ 300.00
ITC 3D 3-stack cartridge machine	£ 500.00
Klark Teknik DN36 time processor	£ 100.00

All prices subject to VAT

WE ARE LOOKING FOR MIDAS modules PR002C, PR003, PR009, PR011. R. Timmerman, A. Wolfsstraat 22/4, B2120 Schoten, Belgium.

LOCKWOOD, TANNOY, etc. New and used equipment bought, sold, serviced. Authorised Tannoy specialist. Lockwood Audio, Tel: 0923 210254 Fax: 0923 240558.

SONY MXP42 Stereo portable eng. mixer. Brand new in sealed box with all accessories. Superbly engineered, excellent specification £1,750 + VAT (£4,485 list). 0252-716726.

STUDIO SOUND

AND BROADCAST ENGINEERING

CIRCULATION DETAILS

STUDIO SOUND is available without charge to key personnel actively engaged in sound recording in any part of the world. Copies must be individually requested. Non-qualifying readers will be notified in writing and invited to take out a subscription (see below for details).

NEW READER ENQUIRIES: Link House Publications plc, Link House, Dingwall Avenue, Croydon CR9 2TA. UK. Tel: 01-686 2599

EXISTING READER ENQUIRIES: Circulation Dept, Studio Sound, Link House Magazines Ltd, Central House, 27 Park Street, Croydon CR0 1YD, UK.

Changes of address should be notified in writing to this address and the label containing the old address and reference number should be enclosed to ensure accuracy.

SUBSCRIPTION ENQUIRIES: Subscription Dept, Studio Sound, Link House Magazines Ltd, 120-126 Lavender Avenue, Mitcham, Surrey CR4 3HP, UK.

The cost of an annual subscription to Studio Sound is:

- UK: £24.00
- Overseas surface mail: £30.50/US\$52
- Overseas air mail: £52.50/US\$89

USA airspeeded delivery \$70

The publishers reserve the right to refuse applications considered inappropriate and restrict the number of free copies sent to any one company or organisation.

Studio Sound is available without charge to qualified readers; these are key personnel actively engaged in sound recording in any part of the world. The Publisher reserves the right to refuse applications considered inappropriate and restrict the number of free copies sent to any one company or organisation. Non-qualifying readers can buy Studio Sound at an annual subscription of £24.00. Published by the proprietors Link House Magazines Limited, Link House, Dingwall Avenue, Croydon CR9 2TA and printed by Lawrence-Allen (Colour Printers) Ltd., Gloucester Street, Weston-super-Mare, Avon BS23 1TB.

STUDIO CONTACT FILE

AXIS

24 Track Amek Angela.
C-Mix automation.
1,200 sq.ft. Live Room.
Lexicon 480L. Otari 2-track.

**Phone Tim Strickland on
0742 750283**

for further details



2 STUDIOS

LOADS OF K'BDS inc
FAIRLIGHT 3 Rev. 7
WITH WORM DRIVE

CHAPPELL 9' -
THE BEST RECORDING
PIANO IN LONDON!

HUGE CONTROL ROOM.
CATERING & BEAUTIFUL
LOCATION

PARSIFAL

Lamb House, Church Street, Chiswick W4 2PD
Telephone: 081-994 7711/4445

FOR SALE

BOB TURNER

PRO SOUND & VISION SALES

NEW IN STOCK

All Prices are Exclusive of VAT

ART SGE (20K 20 Bit) Digital Analogue Effects Processor	£425.00
ART EXT Reverb Multi Effects Sampler	£445.00
ART Multiverb II	£325.00
BSS DPR 504 Quad Gate	£585.00
BSS DPR 502 MIDI Stereo Gate	£585.00
BSS DPR 416 4 Ch. Active D.I. Box	£395.00
BSS DPR 402 Stereo Comp/Lim/Exp/Gate/De-esser	£658.00
BSS AR116 D.I. Boxes	£75.00
JBL/Urei 7110 Comp. Limiter	£440.00
JBL Control 10 Studio Monitors	£666.00
Adam Smith Zeta 3 2 Machine Synchronizer	£2,850.00
Valley People Range P.O.A.	
Valley People 2 Ch. De-esser	£495.00
Active-1 Powered Speakers a pair	£260.00
Alesis Data Disc	£375.00
Alesis Quadraverb	£370.00
Fostex E22 1/2" 2-track Master Recorder with Centre Timecode	£2,250.00
Fostex E116 16-track	£3,150.00
Fostex 4050 SMPTE MIDI Autolocator	£600.00
Fostex RM765 Reference Monitors	£245.00
Fostex T40 Headphones	£65.00
Revox RH310 Headphones	£49.00
TC Electronics 2290 8 secs Sampler/Delay	£2,451.00
TC Electronics 112S Programmable, SMPTE, MIDI, Pink Noise, EQ and Spectrum Analyser	£1,795.00
TC Electronics 1280 Stereo Delay	£1,025.00
TC Electronics 1380 Multitap Delay	£1,025.00
TC Electronics 2240 Stereo 4-band Parametric EQ	£576.00
TC Electronics 1140 Mono 4-band Parametric EQ	£343.00
TC Electronics 1144 Bass Guitar Parametric Pre-amp	£343.00
TC Electronics 1210 Spatial Expander	£736.00
Seck 24.2 Desk	£650.00
Seck 18.8.2 Desk	£900.00
Tascam M3500 32 In-line Console including stand	£5,500.00
Tascam MSR24 24-track Recorder with dbx	£8,395.00
Tascam AR80 24-track including remote/autolocate	£26,000.00
Tascam DA-30 DAT Player	£1,277.00
Soundtracs Quartz Console 32 In-line	£17,900.00
Soundtracs Quartz Console 48 In-line	£22,900.00
Sennheiser MKE212 Boundary Mic	£450.00
Sennheiser 441 Mic	£275.00
Sennheiser MD421 Mic	£207.00
Sennheiser MD422 Mic	£240.00
Sennheiser MD429 Mic	£190.00
Sennheiser MD419 Mic	£140.00
Neumann TLM170 Condenser Studio Mic	£1,055.00
Neumann SM69 FET Condenser Studio Mic	£1,827.00
Neumann UM59i Condenser Mic	£2,027.00
Neumann KM884i Condenser Soloist Mic	£367.00
Neumann U89i Condenser Mic	£1,055.00
Neumann U87ai Condenser Mic	£1,055.00
Revox & Studer (depending on model and spec) please ring for price!	
Also in stock: Carver, JBL, Amcron & Denon Amps	
EX-DEMO/SECONDHAND	
Studer B20 + Dolby SR 24-track	£40,000.00
Suder A80 16-track (lv.g.c.)	£6,500.00
Studer B67 in console (mint)	£2,300.00
Studer B62 in console (mint)	£1,100.00

**1 SEAHILL ROAD
SAUGHALL, CHESTER
CHESHIRE CH1 6BJ**

Tel: Chester (0244) 881708

Fax No: 0244 880538

Studer A80 16-track Mk 1	£5,650.00
Studer A80 Mk 3 24-track + auto/remote	£14,000.00
Revox B77 Mk 2 H/S (mint)	£725.00
Revox B77 Mk 2 H/S (domestic use only... as new)	£1,350.00
Fostex E8 8-track	£1,950.00
Fostex B16 + Autolocate	£2,100.00
Fostex B16 + Autolocate	£2,900.00
Fostex Model 80 (8-track)	£695.00
Fostex E2 2-track including stand	£2,450.00
Fostex E22 1/2" 30 ips + centre timecode (as new)	£2,650.00
Otari 1" 8-track	£1,400.00
Soundcraft 1" 8-track + Autolocator	£1,200.00
Soundtracs PC MIDI 24 In-line Desk, Effects Returns, 56 line Returns including full wiring loom and patchbay (3 months old)	£4,950.00
RAM Micro 12.8 2 Desk (mint)	£700.00
Soundcraft 1600 24.16.2 Console	£6,500.00
Trident TSM 32/24/2... recently refurbished... mint	£18,500.00
TC Electronics 2290 64 secs	£3,600.00
TC Electronics 2290 8 secs	£1,500.00
Digitech Smart Shift	£350.00
Digitech DSP256 Reverb	£425.00
Digitech DSP128 Reverb	£140.00
Lexicon 200 Reverb	£1,295.00
Lexicon Super Prime Time	£1,400.00
Lexicon LXP1/LXP5 + MRC Controller including rack	£1,195.00
Pubison 90 Infernal Reverb Processor, 2 x 21 secs sampling	£4,250.00
Yamaha Rev 5	£575.00
dbx 160X	£300.00
Aphex Compellor	£650.00
Aphex Dominator	£750.00
Eventide H3000 Ultra Harmonizer	£1,775.00
Eventide SP2016	£2,950.00
Drawer DS201 Gate	£245.00
Drawer 221 Comp	£250.00
Drawer LXP1 Comp	£195.00
Drawer 1960 Stereo/Valve/Comp	£650.00
Drawer M500 Stereo/Comp/Lim/Exp/De-esser	£600.00
Audio Logic 7.6 Digital Delay Sampler	£345.00
Audio Logic 4 Ch. Gate	£240.00
Sony 501 Digital Processor	£350.00
UREI 1178 Stereo Limiter/Gate in stereo	£850.00
NTP Comp/Lim/Expander/Gate in stereo	£1,195.00
BTX 4500 Synchronizer	£300.00
Korg STD Digital Delay	£295.00
Amcron DC300A Mk 2 Amp	£400.00
Court SN30 Monitors	£1,100.00
Neumann 8M2 Stereo Valve Mic	£1,250.00
Various other microphones in stock, Sennheiser, B&K, Shure, Fostex etc.	
Also... Stand Easy pods for outboard etc.	
We specialise in installations from home studios to Radio Stations.	
Some Clients this year: Vector T.V., Brookside Productions, M.T.V., World Action Sports, Pearl Studios, Eden Studios, Rockfield Studios, Bain Studios, Square One...	
For further information contact: TEL: Chester (0244) 881708 FAX: Chester (0244) 880538 1 Seahill Road, Saughall, Chester, Cheshire CH1 6BJ, UK	

WHAT WE DID FOR AN ENCORE.

Improving on the original H3000 Ultra-Harmonizer—the most successful Harmonizer® in Eventide's history—wasn't easy. But the new H3000SE Studio Enhanced Ultra-Harmonizer already has leading audio professionals shouting "Bravo!"

The first H3000 produced its impressive variety of effects with 11 algorithms. Now the H3000SE adds eight stunning new ones—the classic Instant Phaser®, imaginative ear-openers like Band Delay, Stutter (instant rap!), String Modeller and Patch Factory, plus smooth, natural Reverb II, a linear predictive Vocoder and MultiShift, the world's first six-octave multi-interval pitch shifter. No wonder engineers and producers are raving about the 200 factory presets. Especially since Ultra-Harmonizer audio quality stands out even among other 16 bit digital devices.

Audio explorers are also applauding the new *Function Generator* that lets you program autopanning, arpeggios, sweeping flangers, randomized vocal doublers and much more. And *Soft Functions* that lets you customize your own H3000SE front panel to get the precise sound you need faster and easier. You can even add Eventide's exciting new HS322 Internal Sampling Board—it gives any H3000 up to 23.7 seconds of 16 bit, 44.1 kHz sampling at a breakthrough price. If you already own an H3000, you can add the new SE capabilities with a conversion kit. If you don't, you're trying to do your best work without one of the most powerful audio production tools ever developed. So visit your Eventide dealer and hear how much our encore can do to enhance your performance.

Eventide

One Alsan Way • Little Ferry, NJ 07643
TEL: 201-641-1200 • FAX: 201-641-1640



Denmark
AUDIONORD DANMARK
Mindegade 13
DK-8000 Arhus C
45-86-560377

Spain
LEXON SA
Gresolet 14 bajos
Barcelona 08034
34-3-203-48-04

France
GROUPE 38/TOP AUDIO
14, cour St. Eloi
Paris 75012
33-1-43-40-3800

Sweden
ELFA STUDIO
Banvakisvagen 24
171-48 Solna
46-08-734-0750

Germany
SOUND SERVICE GmbH
FasenenStrasse 45
D-1000 Berlin 15
030-884-30346

Switzerland
STUDIO M&M
Villa Tannheim
CH-5012 Schoenenerd
064-415-722

Italy
PROFESSIONAL
EQUIPMENT SRL
Viale Famagosta, 37
20142 Milan
02-89-10-241a

UK/Republic of Ireland
HHB COMMUNICATIONS, LTD.
7375 Scrubs Lane
London NW106QU
081-960-2144

FOR DEALER INFORMATION
IN COUNTRIES NOT LISTED,
PLEASE CONTACT
EVENTIDE INC.
TEL: 201-641-1200
FAX: 201-641-1640

“I didn't decide to buy the Soundcraft 3200. My clients did.”

Robin Black, Black Barn Studio.



“As soon as we saw the 3200 we knew we wanted one.” This was the reaction of Robin Black and his team at Black Barn Studio when the decision was made to up-grade their equipment.

“It's a decision made with the head and the heart” says Robin, “the feel and sound of a desk is a very personal thing, but if you want to know if it's the right choice for your business you ask the people who really matter – the clients.”

With this conviction and the approval of his regular clients, Robin opted for the 36 input, 32 bus 3200, fitted with Mastermix II automation.

“The beauty of the desk is that it gives you so much more room to play around in, with 64 channels on mix

down and noise gates on every channel. The logic of a split design also means that producers immediately feel comfortable with the console.”

Featuring an advanced EQ design and Soundcraft's patented mic amp and active panpot, the 3200 offers superb performance specifications. “It is exceptionally quiet, which is vital these days when so many producers want to work with digital multitrack.”

Robin adds “buying the 3200 was the best business decision I ever made.”

Soundcraft
3200