

June 1990

\$5.00 £2.00

# STUDIO SOUND

AND BROADCAST ENGINEERING

PREVIEW  
APRS LONDON

A LINK HOUSE MAGAZINE



ISSN 0144-5944



9 770144 594000

# “I didn’t decide to buy the Soundcraft 3200. My clients did.”

Robin Black, Black Barn Studio.



“As soon as we saw the 3200 we knew we wanted one.” This was the reaction of Robin Black and his team at Black Barn Studio when the decision was made to up-grade their equipment.

“It’s a decision made with the head and the heart” says Robin, “the feel and sound of a desk is a very personal thing, but if you want to know if it’s the right choice for your business you ask the people who really matter – the clients.”

With this conviction and the approval of his regular clients, Robin opted for the 36 input, 32 bus 3200, fitted with Mastermix II automation.

“The beauty of the desk is that it gives you so much more room to play around in, with 64 channels on mix

down and noise gates on every channel. The logic of a split design also means that producers immediately feel comfortable with the console.”

Featuring an advanced EQ design and Soundcraft’s patented mic amp and active panpot, the 3200 offers superb performance specifications. “It is exceptionally quiet, which is vital these days when so many producers want to work with digital multitrack.”

Robin adds “buying the 3200 was the best business decision I ever made.”

Soundcraft  
3200

# STUDIO SOUND

AND BROADCAST ENGINEERING



Cones and coils at Tannoy

<b>Editorial:</b>	To maintain studio rates an improved service must be offered but how can you define audio quality? asks Keith Spencer-Allen	<b>5</b>
<b>News:</b>	Events, news, moves and comment from inside and outside the recording industry	<b>13</b>
<b>Products:</b>	Information on new products, developments, upgrades and software updates	<b>21</b>
<b>Letters:</b>	Channel status conversion; generic patterns; F1, DAT and mastering; a warning on credit orders	<b>26</b>
<b>Tannoy—Back to Basics:</b>	Patrick Stapley finds out how and why Tannoy have completely redesigned their studio monitor range	<b>28</b>
<b>Post at Pinewood:</b>	Julian Mitchell visits the studio with the UK's first SSL film post-production console	<b>36</b>
<b>APRS Preview:</b>	A guide to manufacturers, agents and services exhibiting at the June show in London	<b>44</b>
<b>Lansdowne:</b>	A new console and some refurbishment prompted Julian Mitchell's visit to one of London's longest established studios	<b>62</b>
<b>WordFit:</b>	DAR have developed a versatile new system of dialogue replacement. Patrick Stapley reports	<b>68</b>
<b>Medicina:</b>	Caroline Moss visits an Italian facility that operates a mobile recording truck and record companies	<b>73</b>
<b>KFA Box Challenge:</b>	Studio designers KFA believe they can build a studio in less than an hour . . .	<b>76</b>
<b>MidiTap LAN:</b>	Local Area Networking helps with the problems of MIDI data distribution. David Miles Huber reports	<b>81</b>
<b>Optical Disks—An Audio Future:</b>	As technology develops, optical disks become more viable for storage of audio data. Francis Rumsey reports	<b>84</b>
<b>Conversation with John Storyk:</b>	Terry Nelson talks to the US acoustician and architect about his design philosophies	<b>94</b>
<b>Perspective:</b>	US columnist Martin Polon offers some advice to the despondent and newly unemployed	<b>104</b>
<b>Business:</b>	Laser turntable for vinyl; Jazz FM on the air. By Barry Fox	<b>109</b>
<b>Three Channels—The Future of Stereo?:</b>	Michael Gerzon takes a look at 3-channel stereo in the light of recent widescreen TV technology	<b>112</b>

The drive units at the heart of every new Turbosound enclosure are built by Precision Devices Ltd.

A company specifically established by our parent company, Edge Technology Group, to develop drive units with unsurpassed reliability and audio performance.

#### DEVELOPING THE CONE AND COIL.

Particular attention has been paid to designing each cone's profile and materials for its intended application.

The voice coils are wound with pure copper for long term strength and reliability, coated with high temperature enamel, onto an epoxy resin-impregnated woven fibreglass former.

The whole assembly is cured at high temperature to give it a completely rigid, integrated structure for greater strength and energy transmission abilities.

#### AN ADVANCED MAGNET ASSEMBLY.

The magnet assemblies are of the traditional iron and ceramic 'sandwich' type. The difference lies in our attention to detail and the quality of materials.

Top quality low-carbon steel is machined to very fine tolerances to maximise contact between plates. And as tight a magnetic gap as possible in turn gives greater magnetic power and increased cooling for the coil. (In our larger drivers, we also bolt the parts together for extra strength).

Finally, the loudspeakers' frame designs are based on the soundest of

engineering principles, with generous use of die-cast aluminium alloy to ensure their indestructibility on the road. In fact, our frames weigh twice as much as most other manufacturers'.

Guaranteeing that even under massive physical shock, the assembly won't suffer.

#### ATTENTION TO DETAIL.

All this attention to detail means that every step in the manufacturing chain is designed to enhance our enclosures' performance.

Finally, the components come together in a modular assembly process, with testing at every step, before being fitted into enclosures that have been built with equal precision.

The result is a finished product that produces accurate, natural sound simply through the precise matching of its components. Which means that, more than ever, there is no need for external electronic compensation.

So that's a breakdown of what Precision Devices will mean to you.

And what makes Turbosound enclosures so exceptionally reliable.



TURBOSOUND LIMITED, STAR ROAD, PARTRIDGE GREEN, WEST SUSSEX RH13 5EZ. TEL: (0403) 711447. TELEX: 878723 TURBO G. FAX: (0403) 710155. IMC, TURBO-UK.

# HOW DO PRECISION DEVICES MAKE OUR SPEAKERS SO RELIABLE? HERE'S A BREAKDOWN.

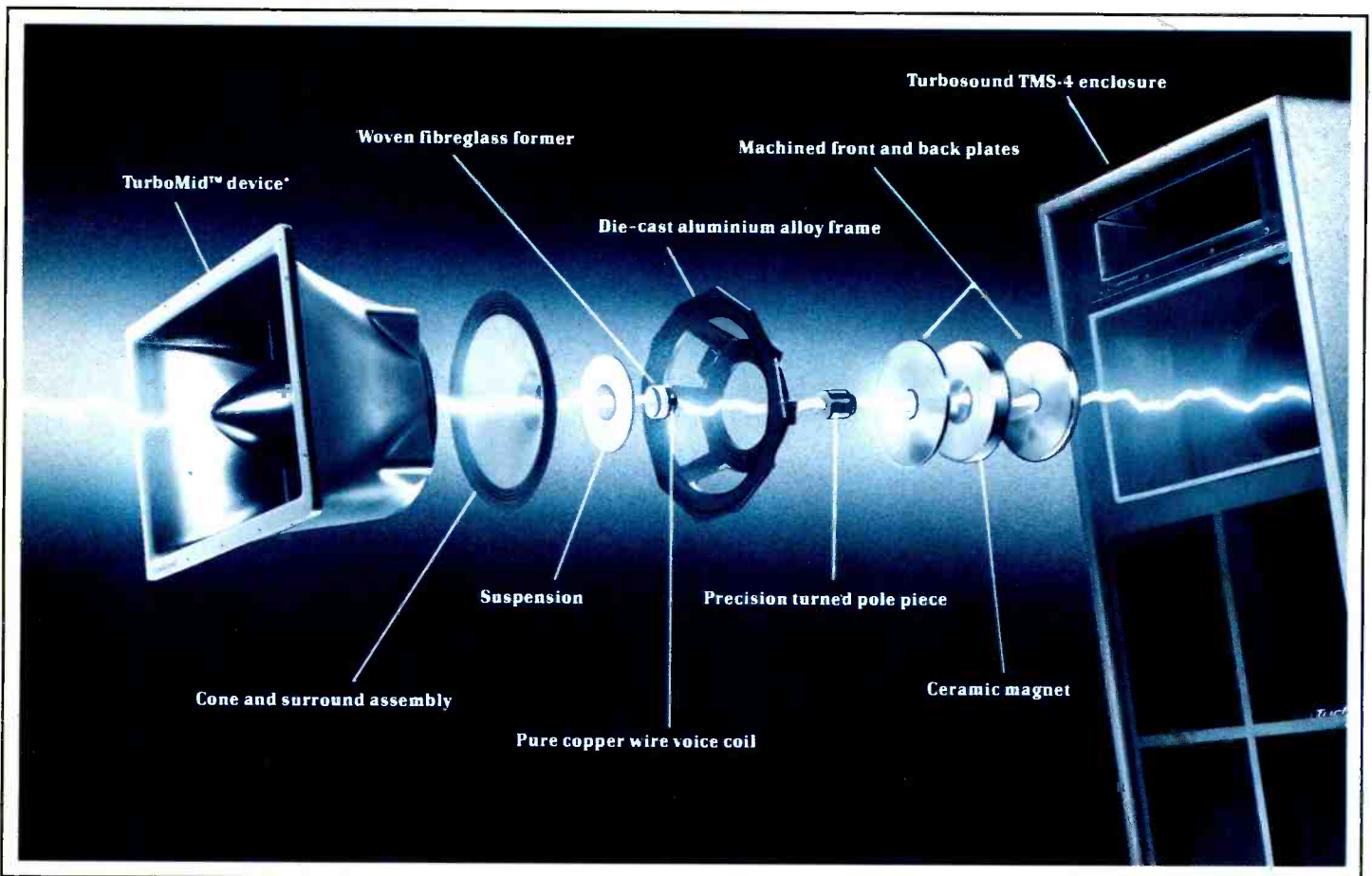

**WORLDWIDE AGENTS:** AUSTRALIA: A.T.T. AUDIO CONTROLS PTY LTD MELBOURNE (03) 379-1511 AUSTRIA: ALPHASALES MÖRNING (02236) 26123 BELGIUM: T.E.M. ZELLIK (02) 466-5010 CANADA: OMNIMEHA CORP. MONTREAL (514) 636-9971 DENMARK: PERMEISTRI PRODUKTIONS KARI SØNDRE (42) 151300 FRANCE: REGISCENE PARIS (01) 4396-5050 GREECE: ALPHA SOUND ATHENS (01) 363-8317 HOLLAND: T.E.M. BREDI (078) 812072 HONG KONG/CHINA: TIM LEE AI SIC CO. HONG KONG (0) 740-1099 INDONESIA: DAVID SUTEDIA & ASSOCIATES JAKARTA (21) 4512617 ISRAEL: BARKAI RAMAT-GAN (03) 735170 ITALY: AUDIO LINK PAKMA (0521) 598723-4 JAPAN: EDGETECH (JAPAN) LTD. TOKYO (03) 295-4731 KOREA: YUNG NAK SU RI SA CO. SEOUL (01) 267-9897 NORWAY: NORDTEK EQUIPMENT OSLO (02) 231590 PHILIPPINES: STAGE CRAFT INTERNATIONAL INC. MANILA (02) 834-0539 PORTUGAL: CASA EMBL ARTIGOS MUSICAIS LTD. OPORTO (02) 0384456 SINGAPORE/MALAYSIA: SWEE LEE SINGAPORE (03) 336-2307 SPAIN: LEXON BARCELONA (03) 203-4804 SWEDEN: INTERSONIC STOCKHOLM (08) 744 5853 SWITZERLAND: SINCE SCHÖNENWERD (04) 413747 TAIWAN: PROSOUND INC. TAICHUNG (4) 235-1873 THAILAND: BANGKOK CINE GRAPHIC CENTRE BANGKOK (02) 314-3570 K.C.M. BANGKOK (02) 222-4712 TURKEY: NEFAN ISTANBUL (01) 160-4514 UK: FIRST AUDIO LTD. BRIGHTON (0273) 693610 U.S.A.: GROUP ONE INC. NEW YORK (516) 249-3660 WEST GERMANY: ADAM HALL USINGEN (6081) 16031

\*Turbosound Patent Information: Australia: 515, 535 Canada: 1,076,033 Japan: N113421/77 UK: 1,592,246 & 1,598,310 U.S.: 4,215,761 & RF 32,183 West Germany: P2742600/2 (Other patents pending).

an **EdgeTech** company  
LONDON • NEW YORK • TOKYO

# STUDIO SOUND

AND BROADCAST ENGINEERING

June 1990  
 Volume 32 Number 6  
 ISSN 0144 5944

**EDITORIAL**

**Editor:** Keith Spencer-Allen  
**Assistant Editor:** Julian Mitchell  
**Co-ordinating Editor:** Ann Lowe  
**Production Assistant:** Dawn Boulwood  
**Secretary:** Elaine Sweeney  
**Consultant:** Sam Wise  
**Columnists:** Barry Fox, Martin Polon (US)  
**Regular Contributors:**

Janet Angus	David Hastilov
James Betteridge	Mike Lethby
Mike Collins	David Mellor
Ben Duncan	Terry Nelson
Dave Foister	Francis Rumsey
Neil Grant	Patrick Stapley
Yasmin Hashmi	

**ADVERTISEMENTS**

**Advertisement Manager:** Steve Grice  
**Display Sales:** Phil Salmon  
**Copy Controller:** Sarah Stanmore  
**Advertisement Production:** Mark Trainer  
**Secretary:** Lianne Davey

**CIRCULATION**

**Circulation and Development Manager:**  
 Colin Enderson  
**Controlled Circulation Manager:**  
 Maria Udy  
**Enquiries:** See classified advertisement

**Director:** Doug Shuard  
**Publisher:** Steve Haysom

**EDITORIAL & ADVERTISING OFFICES**  
 Link House, Dingwall Avenue, Croydon CR9 2TA,  
 UK. Tel: 081-686 2599. Telex: 947709. E-mail:  
 78:DGS1071. ESI: STUDIO SOUND-UK/US.  
 Fax: 081-760 5154/0973.

**AMERICAN OFFICE**  
**Publishing Services Manager:** Fred Vega  
 Studio Sound, 2 Park Avenue, 18th Floor,  
 New York, NY 10016, USA. Tel: (212) 779-1212.  
 Fax: (212) 213-3484.

**JAPAN & FAR EAST AGENT**  
**Contact:** Mikio Tsuchiya, Media Sales Japan Inc,  
 Tamuracho Bldg 3 3 14, Shimbashi, Minato-Ku,  
 Tokyo, Japan. Tel: (03) 504-1925. Telex: J25666.  
 Fax: (03) 595-1709.

© Link House Publications plc 1990 all rights reserved

Printed in England by Lawrence-Allen (Colour Printers) Ltd, Gloucester Street, Weston-super-Mare, Avon BS23 1TB

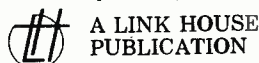

Studio Sound and Broadcast Engineering incorporates Sound International and Beat Instrumental

Studio Sound is published on the third Friday of the month preceding the cover date. The magazine is available on a rigidly controlled requested basis, only to qualified personnel (see classified advertisement for terms)



MEMBER OF THE AUDIT BUREAU OF CIRCULATIONS



Total average net circulation of 19,169 per issue during 1989.  
 UK: 5,272. Overseas: 13,897.  
 (ABC audited)

## Defining quality

It was one of those late night discussions around a bar in some hotel somewhere. The conversation was flowing in a lucid manner, as it is wont to do on such occasions. Into the early hours of the morning the talk got around to audio and there it stayed. When we reached the concept of audio quality it became clear that it was difficult to explain what the professional industry means by audio quality. We may know what we mean among ourselves within the industry but it is very difficult to explain suitably the variable parameters.

For example if we look at the recording of a string quartet, the most 'technically correct' recording would most likely be made with a carefully placed stereo pair of microphones feeding directly into a 2-track recorder. Such a recording would have a minimal signal path, freedom from processing such as EQ, which leads to a low potential noise floor, fewer phase anomalies and other audio problems. At this point we are not considering the musical quality.

Another way to complete the same recording could be with multiples of mics, a multichannel mixer and a multitrack recorder. This could incur many of the problems that the first recording technique avoided and there is a stronger chance that the finished recording may exhibit many technical faults.

If we then take a rock band, without going into the details of the previous example, it is clear that the stereo pair of mics is very unlikely to produce any form of meaningful result. The multi mic/channel/track approach is really the only way to create the most technically correct recording in such a case. It is the only way that levels, acoustics and other variables can be controlled without undue interference with the musicians. Although it may exhibit some of the problems avoided with the minimalist technique, skilful (quality?) engineering will avoid the majority of problems, enhance the musical values and produce a superior recorded end result.

But returning to quality, here we have two different recording methods that use different equipment to produce quality results with different musical forms. So audio quality must also be related to musical type and our expectations of the music. Then there is the problem of consistency or reliability. Are we prepared to accept a trade-off on potential quality for predictable sound quality at all times? We then have to look at the musical dimension and any constraints that the technology might place upon the musicians and the quality of their performance, either in the making of the music or its recording.

Of course all these factors do not stop but they interreact. Remember, it is not just the equipment you use but the way it is used relative to what you are recording. Success and a quality recording is the successful balancing of all the parameters.

Your comment at this stage is probably, "Well so what? As long as I produce recordings that are of sufficient quality then my clients will be happy and in turn so will I."

Fair enough, but how do you then approach the following situation? It was suggested during a recent meeting that the recording studio needs to look at new ways to increase or at least hold quoted studio rates. One idea offered was that the studio should try to offer increased value or at least perceived value in their rates and that theoretically this should make clients happier to pay. Ignoring some of the possible flaws in this approach it would be interesting to look at what extra value the studio might offer. Extra equipment is out as the increased costs would be counter-productive and is unlikely to have the desired effect anyway. There are also the catering services that you could offer such as a choice of 200 types of sandwich or 10 varieties of ground coffee although none of this is going to be seen as beneficial by the record company paying the bills.

It would seem that quality of service is about all there is left and by this we have to be talking mainly about audio quality. So if you have to sell audio quality to perhaps a sceptical client aren't you going to have to be able to explain what it is that you are offering precisely and identify its benefits? Definitely a useful tool if you can handle it.

Keith Spencer-Allen

Cover: Photography by Tony Petch

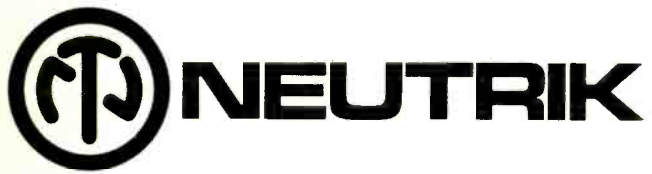

**The Popular  
Connectors  
in  
"MUSIC  
MAKING"**

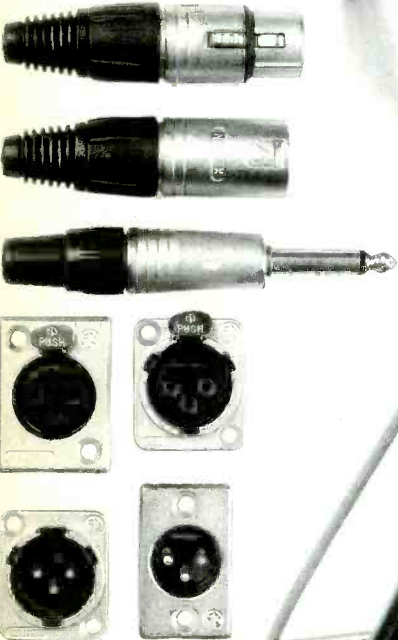

Sound Equipment  
Courtesy of  
AKG Acoustics  
London



Sole Agent U.K.

**Eardley  
Electronics  
Limited**

Eardley House  
182-184 Campden Hill Road  
Kensington, London W8 7AS

Telephone  
071-221 0606/071-727 0711

Telex: 23894

Telefax: 071-727 9556



Original design NC3FC

Current design NC3FX

HEAVY DUTY VERSION  
FOR HOSTILE  
ENVIRONMENTS



NC3MXHD

NC3FXHD

'D' SERIES CONNECTOR  
WITH SOLDER BUCKET  
TERMINATIONS



NC3FDL1

NEW FEMALE PANEL SOCKET  
WITH SHORTEST  
POSSIBLE DEPTH



NC3FP1

NC3FG  
ONE PIECE  
NEW PCB CONNECTOR WITH  
M3 THREADS, PLASTIC BODY  
WITH STEEL PLATE AT REAR  
OF MOUNTING FACE

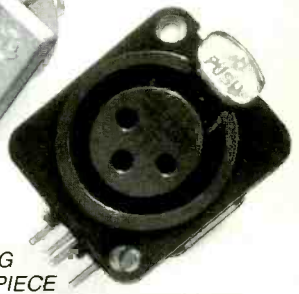

LOCKING JACK SOCKET  
NJ3FP6C

NA2MPNF  
'XLR' MALE TO  
PHONO JACK



NA3MF  
'XLR' MALE TO  
'XLR' FEMALE



NA2FBNC  
'XLR' FEMALE  
TO BNC SOCKET



NC3MRC  
RIGHT ANGLE  
CONNECTOR



NF2C2B  
PROFESSIONAL  
PHONO PLUGS.  
PIN CONTACT  
IN GOLD



NP3TTA  
NEW 4.4mm JACK PLUG WITH  
SOLDER CONTACTS

NP3TTB 4.4mm JACK PLUG WITH  
CRIMP CONTACTS



NP3TB 'B' GAUGE JACK PLUG

A selection of the latest range



Sole Agent UK

**Eardley Electronics Ltd**

Eardley House, 182-184 Campden Hill Road,  
Kensington, London W8 7AS

Telephone: 071-221 0606/071-727 0711  
Telex: 23894 Telefax: 071-727 9556

**The Future is  
within reach**

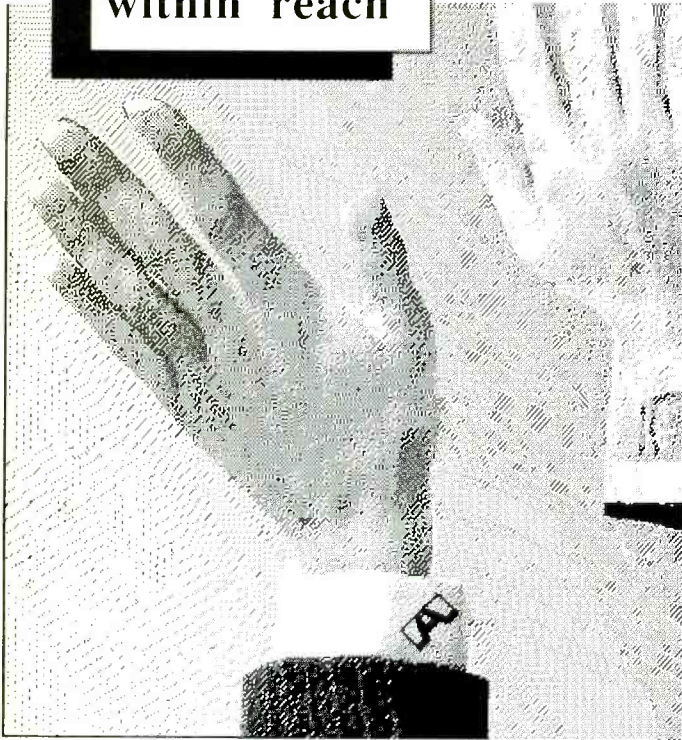

LESTER AUDIO LABORATORIES inc

*... Introducing a revolutionary advance in audio technology that will change your world ... from ANALOG to LIGHTWAVE ...*

The DIGITAL AUDIO SYSTEM DAS 2000™ series from LAL is a fully integrated "smart" audio system. It provides point-to-multipoint fiber optic sound transmission, distribution and routing with automated SOFT PATCH™ programmable memory control for both real time and pre-programmed change-overs.

The DAS 2000 advanced system technology automates previously manual processes, greatly reduces set-up time, improves sound quality and is compatible with both analog and digital equipment. This compact, self-diagnostic, modular system is easily expanded from 16 to 64 channels with a transparent transmission reach of 3 miles over optical fiber.

DAS 2000 has a robust set of features that includes:

- 18 BIT A/D and D/A conversion
- +4dB/+8dB switchable outputs
- Remote gain control Mic-Line level
- SOFT PATCH™ 64X64
- 98 dB dynamic range
- 48V Phantom powering

Call today (214) 637 9311 or FAX (214) 637 9314.

*Discover how DAS 2000 can revolutionize your world.*

**...the Future is Now!**

# HARDWARE HOUSE



**10 YEARS EXPERIENCE  
IN LIVE PERFORMANCE SOUND**

- Equipment Rental and Sales •
- Specialist Radio Mic Applications •
- Sound Design and Engineering •

**Share our experience · Contact us on:**

**01-986 6111**

West Works Chalgrove Road  
London E9 6PB  
Telex 265871 Attn. DGS 2220  
E-Mail Hardware-UK

A member of the Association of  
Professional Entertainment Hire  
Companies

Distributor for  
The Mackney  
Cab speaker  
system



Dealer for AKG, Amcron, Beyer,  
Countryman, Electrovoice, JBL,  
Samson, Sennheiser, Shure, Yamaha

*Media*

14 The Markham Centre, Station Road,  
Theale, Berkshire RG7 4PE,  
United Kingdom.  
Telephone: (0734) 303800  
Fax: (0734) 323121  
(IDD +44 734)  
Telex: 858893 FLETEL G

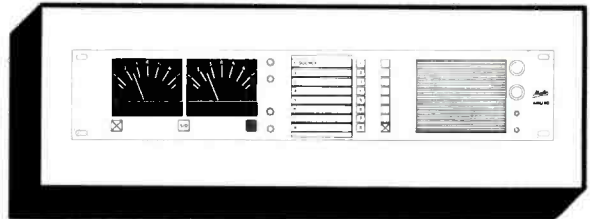

## AMU 8S

*Audio Monitoring Unit*

- Can monitor up to 8 stereo lines
- Integral multi-standard ident generator
- Dual P.P.M.'s and integral speaker
- Stereo speaker and line level outputs
- Compact 2U high rack mounting
- Full remote control facility



---

# AT LAST. A MULTI-PURPOSE DIGITAL AUDIO PROBLEM-SOLVER THAT WON'T BREAK THE BANK.

---

Even in the most sophisticated digitally-equipped studio, transferring audio data within the digital domain can be fraught with problems. And not for the first time, it's taken application-led European design expertise to come up with a highly versatile solution. The FC1 from Audio Digital Technology.

The FC1 brings a new meaning to the phrase multi-purpose. Basic functions include format conversion and transfer between virtually any two channel, multi-track or hard disk digital recording system. But that's just part of the story. The device can not only add or strip emphasis from different incoming digital signals, but it's a natural link between digital recorders and the latest outboard processors.

Teamed with a useful remote unit option, the FC1 even provides digital level mixing and channel cross fading. Furthermore, all this takes place within a true 24 bit architecture, assuring the FC1 a sure place alongside tomorrow's recording technology.

Sheer practicality apart, the pleasant surprise about the FC1 and its remote partner is the cost, a fraction of what you might pay for technology that attempts to cover the same range of applications. If you're serious about digital audio and care about quality, contact ADT now and ask for further details.

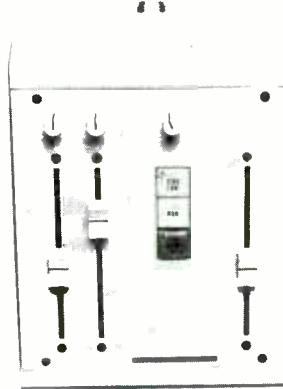

**adt** AUDIO·DIGITAL·TECHNOLOGY

The Coach House, Manor Road, Teddington TW11 8BG, England.  
Telephone: 081 977 4546 Facsimile: 081 943 1545

---

See us on the Prism Sound Stand No 144 at APRS.

---



# DIGITAL RECORDING

There's little doubt that digital technology has brought about a revolution in recording. But with A-DAM, Akai has gone one step further, achieving a technical feat by bringing the cost of digital multi-track recording within the reach of every studio.



Akai's 60 years of experience and long involvement in rotary head technology has resulted in the world's first digital multi-track using compact 8mm cassette tape. Accurate, stable and hard-wearing, this media has proven ideally suited to digital audio with the added advantage of being available in the high street at a fraction of the cost of reel to reel tapes. For the 8mm format, Akai has developed a unique transport system that provides extremely fast rewind and tape search time and maintains an audio quality

**AKAI**  
**DIGITAL**

WHERE INNOVATION TRIUMPHS



# CUT DOWN TO SIZE.

you'd expect from digital machines costing several times more. Combining ease of use with power and flexibility, the DL1200 programmable auto-locator offers a superb range of functions including the ability to slip tracks in time, set crossfade drop-ins, frame accurate drop-ins as well as providing 100 instantly available locate points. The auto-locator can control up to three DR1200 recorders for 36 track digital recording using its own automatic internal synchronisation. Designed to be adaptable, A-DAM will also interface with all popular digital formats. So whether you're planning a new system or simply wish to experience the creative freedom that only this technology can provide, A-DAM will satisfy your highest expectations at a cost that really cuts digital recording down to size.



## A-DAM

AKAI DIGITAL AUDIO MULTI-TRACK FORMAT RECORDING SYSTEM

FOR INFORMATION CONTACT (081) 897 6388

# Dual Domain Audio Testing

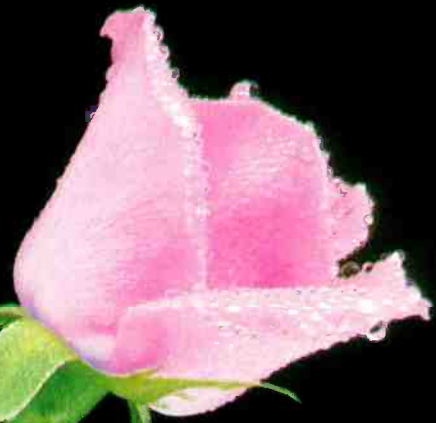

## Analog and Digital

There are two worlds of audio ... analog and digital. These two domains share many basic attributes but when it comes to audio testing, they're distinctly different.

Until now custom hardware was needed to test digital audio devices in their own domain.

Now the System One Dual Domain combines both analog and digital testing capability in one unit.

**ANALOG** audio testing with System One Dual Domain is even more comprehensive than before. Data acquired can be further analyzed using the Digital Signal Processor, which adds harmonic analysis, waveform display and FFT spectrum analysis to the already extensive list of System One's capabilities. New version system software supports color VGA graphics and on-screen cursor function with numeric readouts.

Integrated analog and digital domain audio testing ... only from Audio Precision.

**DIGITAL** audio testing directly in the digital domain is available for the first time. System One Dual Domain provides signal generation, analysis and Input/Output capability and also mirrors familiar analog measurement techniques, now implemented digitally. The multiple-DSP architecture supports both AES/EBU serial and two-channel parallel inputs and outputs at a variety of sampling rates.

## System One

## Audio precision



P.O. Box 2209, Beaverton, OR 97075  
503/627-0832 1-800/231-7350  
FAX: 503/641-8906, TELEX: 283957 AUDIO UR

**INTERNATIONAL DISTRIBUTORS** Austria, Eastern Europe: ELSINCO elektron GmbH 222871751 Benelux: Trans European Music NV, Brussels (02) 4665010 Canada: Glentronix Ltd. (416) 4758494 China, Mainland: Harvest Scientific and Technology Company Ltd. Hong Kong 5-742983 Denmark: nbn Elektronik ApS 86-57 15 11 Finland: Into OY 0 755 7711 France: ETS Mesureur (1) 45 83 66 41 Germany, West: RTW GmbH 221709130 Hong Kong: TRP Consumer Electronics, Ltd 5-887 2008 Italy: Medea S.r.l. 24453828 Japan: TOYO Corporation 32790771 Korea: Myoung Corporation 784 9942 Mexico: VARI S.A. 250 7394 New Zealand: Audio & Video Wholesalers, Ltd. 7173414 Norway: Lydconsult (09) 19 03 81 Portugal: Acutron ELA 251 40 87 Singapore & Malaysia: TME Systems PTE Ltd 286 4608 Spain: Te co Electronics, S.A. 231 7840 Sweden: Tal & Ton AB 31803620 Switzerland: Tecnad SA (021) 806 06 06 Taiwan: Litz Technologies Ltd 703 6280 U.K.: SSE Marketing Ltd 13871262

## Neve win Export Award

Neve Electronics International have won the 1990 Queen's Award for Export Achievement as a direct result of their sales of the V series console with *Instant Recall* and *Flying Faders*. Over the last 3 years Neve have doubled their export turnover with the best results in the USA, Europe and the Far East and a 200% rise in the UK.

In 1989 35 VR series consoles with *Flying Faders* were shipped to the US to facilities like Sigma Sound and Soundworks West. Six VR series consoles went to CBS/Sony studios in Tokyo last year. On the broadcast side Neve's largest single contract last year was for 16 66 series consoles delivered to ORF, Austria's National Broadcast Network.

Laci Nester-Smith, managing director of Neve Electronics International comments, "I'm delighted for all our staff and customers that Neve has won the Queen's Award, particularly in its Jubilee Year. Hard work and a good deal of innovation has brought us back to the top and it's very gratifying to have this achievement recognised by such a prestigious award. The development of the V series has played a major part in revitalising Neve and I'm sure that the introduction of the new VRP console and the 66 series broadcast desk will ensure the company's continued success throughout the 1990s."

## News from the AES

Our next evening meeting will be on Tuesday June 12th, when it is intended to have a lecture on the subject of **Current Developments in Recording Studio Acoustics** but it would be wise to check with the Secretariat nearer the date in case of a last minute change.

This lecture will be held at the IBA, 70 Brompton Road, London SW1 starting at 7.00pm, with coffee at 6.30pm. As with our other monthly meetings members and visitors are most welcome to attend. To help future planning, the dates, speakers and titles of our future monthly meetings are listed below (more details will be available on each nearer the time).

July 10th  
High Quality in Digital Audio  
Bob Stuart

Sept 11th  
BBC Control Room at BH  
George Legg

Oct 9th  
Timecode and its uses  
AES UK Conference

Oct 9th  
AGM & Annual Dinner

Nov 13th  
Digital Audio in Professional Video  
Recorders  
John Watkinson

Dec 11th  
Room & Loudspeaker Correction

using Digital Equalisation  
Peter Craven

A number of new books have appeared that will be of interest to many in the audio business.

● John Watkinson has followed up his highly acclaimed book on **The Art of Digital Audio** with the companion **The Art of Digital Video** (£42.50). He has also written a book entitled **Coding for Digital Recording** (£15.95).

● John Borwick has added to his book on **Loudspeakers and Headphones** with a book looking at the other end of the audio chain **Microphone Technology and Techniques** (£25.00).

● After his book on **Stereo Sound for Television**, Francis Rumsey has now written one on the very topical subject of **Tapeless Recording** (£14.95).

All these and many others are available from the address below or indeed from the AES Stand (129) at the APRS show. Stop by and have a chat!

For further details on any of the above or information on joining the AES, please contact: **Heather Lane, AES British Section, Lent Rise Road, Burnham, Slough SL1 7NY, UK. Tel: 0628 663725. Fax: 0628 667002.**

# THE HIDDEN REASONS FOR SUCCESS



The AMS SoundField is internationally renowned as the cleanest sounding and most accurate stereo imaging microphone in the world.

But it's the SoundField's flexibility that really impresses producers and engineers. Because, either during the session or even after the artists have gone home, the effective position of the mic can be electronically altered by remote control, up-down, in a circle, or zooming in and out like a camera lens.

To experience how a SoundField can surpass your collection of studio microphones, and save you money... call AMS for a demo.



**SoundField**

More than a microphone

AMS Industries plc  
Billington Road, Burnley,  
Lancs, BB11 5ES, UK  
Tel: (0282) 57041 Fax: (0282) 39542

London Office:  
The Courtyard,  
44 Gloucester Ave, NW1 8JD  
Tel: 01 722 3925 Fax: 01 577 3677

## Joe Meek biography

*The Legendary Joe Meek* by John Repsch. Available from Woodford House Publishing Ltd, 110 Chertsey Court, Clifford Avenue, London SW14 7BX, UK. Tel: 081-878 6912. Price £7.50 including post & packing.

"Meanwhile from where they (session musicians) were standing or seated they would hear him (Joe Meek) slamming his machines on and off, sending tapes screaming back and forth. Were they to dare follow the trail of the dozen or so wires back into the control room they could marvel at the most amazing sight of all: Joe at work in his Inner Sanctum, darting about like a mad scientist in the organised chaos of an electronics laboratory. Earnestly seeking to put onto tape what he heard in his head, he would be taking the music apart and reassembling it, adding and extracting here and there, sometimes concocting sounds hitherto undreamt of. Great spinning tape machines,

amplifiers and echo units would be working around him, half a dozen or more at a time, and the incredible speed with which his fingers ran the tapes and changed the plugs had the grace of a virtuoso pianist. Then suddenly the elegance would disappear when one of these weary old machines broke down and he had to start coaxing it back to life, first with some surgery and then with his foot."

Extract reproduced by kind permission of John Repsch.

## Addresses

- **Absolute Sounds** have moved to 58 Durham Road, London SW20 ODE, UK. Tel: 081-947 5047. Fax: 081-879 7962.
- **Keith Monks** have moved to Unit 3, Monkton Park, Farnham Trading Estate, Farnham, Surrey GU9 9PA,

## People

- **E-mu Systems, CA, USA**, have announced the appointment of Charles Askanas to president and chief executive officer.
- **HJB Communications**, London, UK, have announced that Steve Gunn has joined the pro-audio sales team and Chris Heap has joined the service department. Gunn joins from Farrahs and Heap was previously a freelance consultant.
- **John Andrews** has joined Reading-based broadcast systems house **Ian P Kinloch & Co, UK**, as director of

sales and marketing. Andrews comes from 4 years as marketing director for Neve.

- **Expotus Ltd, UK**, have announced the appointment of Martin Claydon as technical sales manager. Claydon comes from Akai pro-audio.
- **Pete Brooks** has returned as hire co-ordinator at **Music Lab**, London, UK, after a 6 month sabbatical.
- **Audio Kinetics**, Herts, UK, have appointed Nick Smith to the position of sales engineer. He will be responsible for sales of both the *ES.Lock* tape machine synchronisation and control products and the Component Automation range of console automation systems.
- **Hilton Sound**, London, UK, have appointed Pete Dolan as controller of European operations and Simon Bohannon has been promoted to general manager. Dolan comes from being director of Wool Hall Studios.
- **Audio Kinetics** have made Roger Patel international sales manager.

## SERIES FOR EXCELLENCE

### 3200 VIDEO

*Two New Video Matrix Amplifiers extend the Video Series*

RGB-YUV and YUV-RGB Matrix Amplifiers now further enhance Avitec's 3200 Series by adding Component Video Converters to this already impressive range of facilities.

— Video Distribution Equalising Amplifiers for Standard, MAC and HDTV systems with options for:

— Most commonly used cable types. Extended Equalisation to 500m+. Video Delays to 1000ns+. Variable Rate Clamping. Signal Detection. — Pulse Distribution Amplifiers and optional Delays up to 4µs. — Video Switching with Local/Remote Control. — Long Video Delays to 2.2µs.

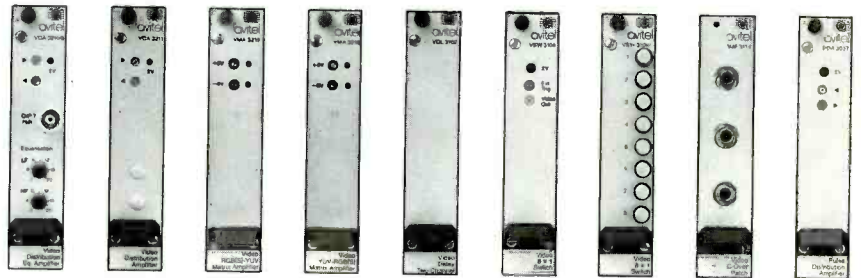

## DISTRIBUTION VIDEO

## In brief

- Salford, UK: **KGM**, distributors of pro-audio equipment, have announced the opening of a new sales office KGM West in Salford, Greater Manchester. The new office hopes to establish a more local service to their existing North-West clients.
- Tokyo, Japan: London-based studio design consultancy **Harris, Grant Associates** have announced the opening of a Far Eastern office in Tokyo. The new office, headed by Sheen Uchida will co-ordinate

projects being carried out by the company in the Far East and Australia.

- Leningrad, USSR: The Russian government is to permit British director Patrick Newman and the Estonian-based film production company Tallinnfilm, to shoot a new fantasy film entitled *Puppet Odyssey*, in Russia. British loudspeaker manufacturer **Celestion** has supplied a pair of *SR1* loudspeaker enclosures and an *SRC1* controller for music

playback on the film set.

- Arundel, UK: **Pro Audio Wiring Services** is a new company providing a service to theatres, leisure centres, radio stations, studios and educational and religious establishments, etc throughout the UK and Northern Europe. They specialise in the design, supply and installation of A/V, paging and communication, PA, sound reinforcement and CCTV systems. Pro Audio Wiring Services, Cornerways, West Cottages, Yapton,

Arundel, West Sussex BN18 0DX, UK. Tel: 0243 552340.

- Long Island, New York, USA: Long Island-based communications company **LNR**, a manufacturer of transmitters and receivers for satellite communications, is using products from SSL subsidiary Audio Processing Technology (APT). APT's data compression system *apt-X 100* demonstrated in LNR's equipment, enables the satellite transmission of digital audio of CD quality.

## Agencies

- Effective from June 1st, 1990, the distribution of **Soundcraft** consoles in Switzerland will move to a newly formed company, Audio Import AG in Basel. Audio Import have also been appointed by **AKG** Vienna for the distribution of their full range of mics and headphones. Audio Import AG, Geispelgasse 13, 4132 Mulfenz

(BL), Basel, Switzerland.

- Protape, retailers and wholesalers of magnetic media and its hardware, are now sole UK distributors of **BNS Professional Loudspeakers**, a Dutch-based company. Protape, Jadwin House, 205/211 Kentish Town Road, London NW5 7EJ. Tel: 081-267 9336.
- The Home Service has announced

that it has been appointed by **AD Systems** to handle the worldwide marketing of the *Optifile 3D* automation system. The Home Service, Unit Two, 10 William Road, London NW1 3EN. Tel: 071-388 1820. Fax: 071-388 0339.

- London pro-audio dealer **Stirling Audio** have been appointed a dealer

for the new Tannoy *Monitor* series.

- **Audio Developments** have announced the appointment of Canford Audio as its UK distributor of portable mixing consoles. Canford Audio, Washington, Tyne & Wear NE38 0BW. Tel: 091-417 0057. Fax: 054-336 1051.

## AVITEL

IN VIDEO & AUDIO

### 3200 AUDIO

Six New Audio Modules complement the Video and Timecode Ranges

Matching the style of Avitel's 3200 Video Series, these Audio Distribution Modules offer a logical extension to an ever-expanding and Integrated system:

- Single and Dual-channel Audio Distribution Amplifiers. — Single and Dual-channel 8 x 1 Audio Switchers, expandable for larger systems and with follow-linking to the Video Switchers. — Line Distribution Amplifier. — Remote Voltage-Controlled D.A. — DART-System Level-Monitoring Unit.

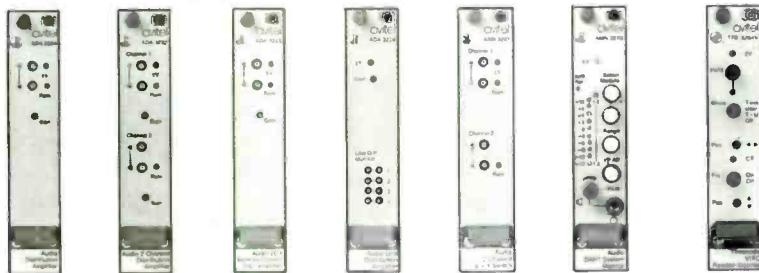

MODULAR TIMECODE  
Products are now also added to the 3200 Series

TRE 3204  
Compact and Economical Timecode Reader-Inserters

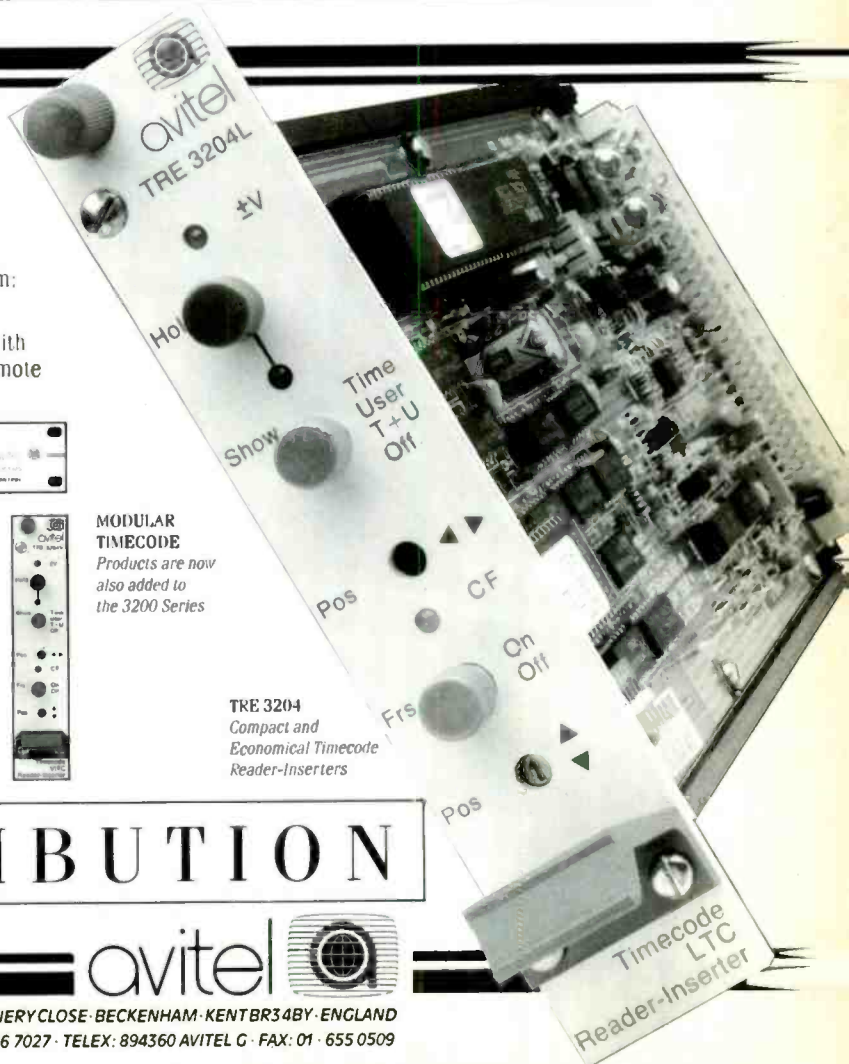

# AUDIO DISTRIBUTION

avitel

UNIT 6 · CROYDON ROAD INDUSTRIAL ESTATE · TANNERY CLOSE · BECKENHAM · KENT BR3 4BY · ENGLAND  
TELEPHONE: 01 656 7027 · (INT) + 44.1.656 7027 · TELEX: 894360 AVITEL G · FAX: 01 655 0509

## Contracts

- London's **Air Studios** have bought a *PCM-3348* digital multitrack and a *PCM-3324A*.
- The Home Service have announced sales of the **Raindirk Symphony** mixers to RTVE the national TV company of Spain based in Madrid; El Camion mobile have two mixers on order the first for a new mobile recording truck, the second is a 48-channel mixer for use in their new Barcelona facility; and Medicina studio in Bologna, Italy have installed a 56-input *Symphony*.
- **Pro Audio Wiring Services** have recently completed their first major contract at the Fairfield Halls and Ashcroft Theatre complex, Croydon, Surrey, UK. Sound reinforcement, show relay and public information systems were designed in conjunction with Fairfield's technical services department and installed over a period of 2 months.
- **Eastlake Audio** have completed construction work on a multitrack music studio in the Libyan capital of Tripoli. It is claimed by Eastlake to be the largest purpose built studio in the Arab-speaking world and on the African continent. The studio floor area of over 400 m<sup>2</sup> allows for large orchestral recording and film scoring. Other current Eastlake projects include a three-studio digital recording complex in a Malaysian City garden location, and Form and Oscar Studios both in Singapore.
- Film soundtrack composer Hans Zimmer has taken delivery of a specially modified **Soundtracs 3200** multitrack recording console for his Los Angeles studio, Media Ventures. Featuring an additional 12 inputs in the patchbay section the 48/32 frame console is the largest 3200 to be built and is accompanied by a standalone patchbay unit.
- **MVC Crow**, Newbury, UK, have despatched the first of two advanced sound-radio outside broadcast vehicles for the Singapore Broadcasting Corporation. The vehicle is a stereo production unit suitable for recording programme material or live events on location and for live transmission via land lines or a UHF stereo link to a base station. Crow have also completed a contract for the supply of audio and video equipment to the Indira Gandhi National Open University, New Delhi, India. The equipment is for the recording of educational programme material on audio and video cassettes.
- Universal Studios, Hollywood have formally reopened their renowned Alfred Hitchcock Theatre with a newly installed **SSL SL5000 M** series console. The desk is designed for three operators and features 80 individual channels with two separate inputs per fader, and six pre-dub returns with four inputs each.
- Pete Townshend's **Eel Pie Studios** in Twickenham, Middlesex, UK, have recently had installed a dedicated **Synclavier** programming suite using two **Soundcraft 200 Delta** consoles. Giving access to a total of 56 inputs, the consoles are configured with 12 dual line modules on the 8-channel frame and a full complement of deluxe inputs in the 32-frame console.
- Italy's national radio station Rai Radio have ordered 15 **Soundcraft 200** radio consoles for use at this summer's World Cup football championships in Rome.
- **Lace City Records**, Nottingham, UK, have bought a **Magnum 24**-bus in-line console from **TAC**. Lace City is a new 24-track studio.
- **Recording Architecture**, London, UK, have recently completed work on an in-house studio facility for publishing company MCA Music. The studio located at MCA headquarters in Hammersmith comprises a small control room and daylit overdub booth, and features an **Amek Mozart** console and **UREI 813C** monitoring.
- **Gauss**, manufacturers of high-speed audio cassette duplicating systems and equipment, have sold music duplicating equipment to four leading companies in Latin America including CBS Argentina.
- Recent **Soundcraft 200 Delta** contracts in Australia include a 24-channel Deluxe with two stereo modules to the Orange Civic Theatre in Central NSW; Troy-Balance Audio in Melbourne have ordered a 24-channel Deluxe for their stock and for demonstration to clients in Melbourne and another 24-channel fitted with two stereo modules to Graeme Lowery at Bellengen Valley Sound.
- **Redwood Marketing**, the Nashville and Los Angeles-based national sales and marketing firm, have completed the first sales of the **Classic** audio mixing console system from **Amek**, Salford, UK. Clients include Turner Broadcasting System of Atlanta, Georgia; The ABC TV network, New York; and the NBC TV network in Burbank, CA.
- **Soundville** recording studios, Lucerne, Switzerland, have ordered a new **Studer** 48-track digital recorder. The machine will be installed in Studio A.
- **TV South** have chosen a **DAR SoundStation II** for audio preparation and post-production. A 16-channel **SoundStation** with **WordFit** software will be going into the Southampton TVS studios.
- **Lansdowne** have invested in the first **Neve VRP** console to be commissioned in the UK. Their complete refurbishment in the control room also consists of acoustic and aesthetic treatment by **Recording Architecture** of Greenwich, UK, and a 48-track digital recorder from **Sony**, the *PCM-3348*.
- **Mersey TV**, who produce the Liverpool-based soap opera *Brookside*, have placed an order for two **Amek** broadcast consoles. Granada TV have ordered a 32-input **Classic** console to be installed on Stage One, home of their major soap series *Coronation Street*. Mainos TV, the Finnish commercial TV company, have ordered a 64/12 **Classic** console.
- **Ridge Farm studios**, Surrey, UK, have installed a 60-channel **Neve VR** console with **Flying Fader** automation and recall on all settings. The studio's investment was a direct response to the rise in popularity of the **VR** series in the US, Europe and Japan in particular.
- **Soundcraft Canada** have announced the receipt of an order from the Cuban government to supply 60 **200 Delta** consoles as well as 11 **SAC 200** radio on-air/production desks. The consoles will be used for Cuba's hosting of the Pan-Am games in August 1991. Completing the order are four series 8000 sound reinforcement consoles, two series 200 **BVE** post-production mixers and two series 200 **Bs**.
- **Prosonus** in Hollywood, CA, have installed **Sonic Solutions No-Noise** in their post-production studios.

From the MA36 to the TRACKMIX 24  
see them all at APRS 90 stand N° 152

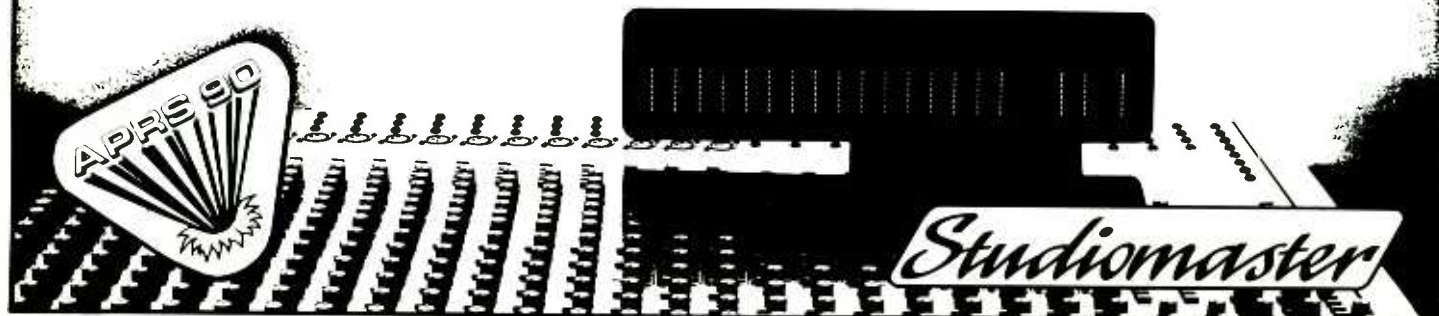



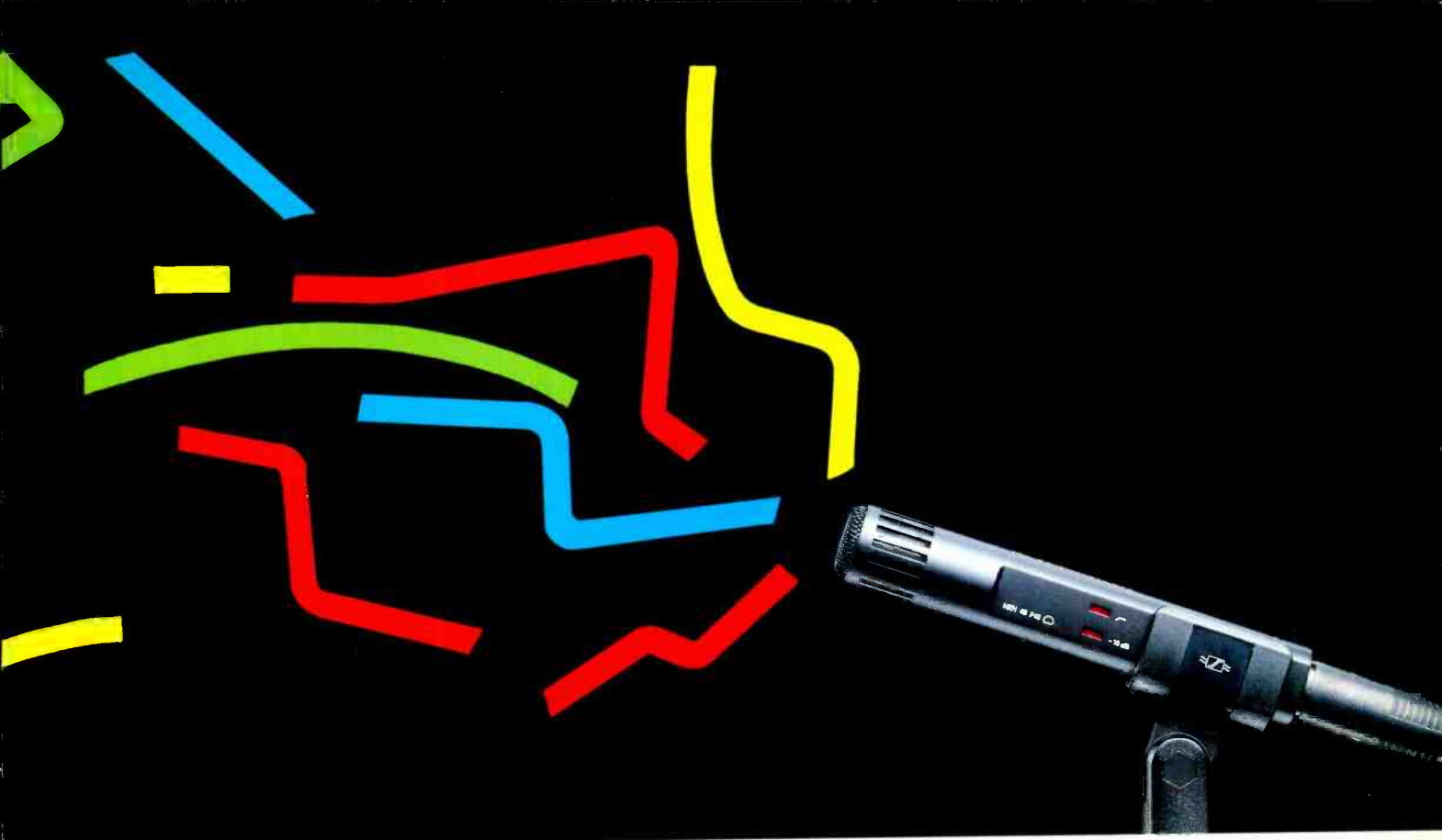

**T**he Sennheiser MKH range of condenser microphones has been designed to capture sound with the detail and clarity demanded by today's advanced digital recording techniques.

The range which comprises omni, bilateral,

cardioid and supercardioid and includes long and short shotguns features state of the art microphone technology. Use of a symmetrical push-pull transducer virtually

eliminates transducer distortion by creating a second identical air-gap acting in the opposite direction to the norm.

All the microphones possess an exceptionally low inherent noise level, high sensitivity, wide frequency response, and all still use the well-proven, Sennheiser-developed RF technology which gives remarkable performance under high humidity and moisture conditions. The MKH range is well suited to and widely used in a broad range of broadcast and music recording applications.

The MKH Range of condenser microphones firmly places Sennheiser at the leading edge of microphone technology.

For literature and technical specifications of the MKH range contact Hayden Pro-Audio.

# SOUND AS AN ART FORM

 **SENNHEISER**

**Hayden  
Pro-Audio**



CHILTERN HILL  
CHALFONT ST. PETER  
BUCKS SL9 9UG  
TEL: (0753) 888447  
FAX: (0753) 880109

## Report from the Frankfurt Musik Messe

Live music made for popular and crowded stands although, in general, there was not a great deal of new products to see. As usual, companies like Akai, Casio and Dynacord had first class demos presented by good musicians that had a thorough knowledge of the products they were demonstrating. But top marks would have to go to a tiny stand displaying African drums being played (very well) by young children. Up to a 100 people gathered around this stand at times, making gangway traffic impossible. Altogether, those selling 'third world' instruments were reported to be the most satisfied with business.

Only a few years ago I remember a young man banging away on some rubber pad arrangement that was called a Simmons. That featured factory pre-Sets and was wired up to a very small guitar amplifier on the corner of someone else's stand. Five years later, the large Simmons stand was the hottest spot at the fair and always featured some new and exciting products. Unfortunately there was nothing like that this year.

It is true that new products were difficult to find, but there were a few. Top of my list would have to be the

little company Lake People, so called because they are based on the shores of Lake Constantine, who have been producing a range of high quality dynamic processors for studio use for the past 5 years. Their newest product is a 20-bit D/A converter and its A/D partner should be in production this summer. They have been able to report major sales to some of the larger German public broadcasters. Also on the broadcast scene, Newmark debuted their dual transport CD player, the *CD 6020*. What sets this player apart from the

rest is its ability for automatic mixing and beat synchronisation. Unfortunately the DJ demonstrating this machine did not seem to have enough time to try it out and was unable to display it to its full advantage.

The one area where there seems to be nothing unusual is keyboards. The new crop designed for the musician look alike, sound alike and have very similar controls. Nearly all seem to have an LED window display and all claim to use some new revolutionary technology.

Perhaps the real reason for the lack of innovation at this and other fairs is the increasingly high cost of R&D and the noticeable lack of long term profit for the original innovator as the original ideas are mercilessly slaughtered by big companies with large marketing budgets who did not have to meet those initial R&D costs.

Not only was the Frankfurt Music Fair bigger and better than ever this year, but it was also better organised.

The German economy is booming like never before and nowhere is this reflected better than at one of this

year's many trade fairs. Although the Music Fair may not be one of the biggest, indeed it is only 1/10 of the size of the Hannover computer fair, 1,077 exhibitors and 62,000 visitors made it Europe's largest music fair and represented a 20% increase over its 1989 figures.

The fair was a day longer than last year and avoided last year's mistakes. Trade visitors and general visitors were kept separate and the piano manufacturers came back to exhibit after last year's effective boycott.

The fair reflected the market place and exhibitors were divided into the two distinct groups of traditional musical instruments and electronics. Although the traditional musical instrument is undergoing a healthy revival, it is the growth of the electronics and pro-audio market that reflected most. This year, three large halls were occupied by keyboards, mixing desks, effects, PA systems and the like. One general hall was equally split between traditional and electronic instruments and the last hall was just there for pianos and pipe organs. Andrew von Gamm

*Familiar faces...*



## Telephone reference

On May 6th, 1990, the 01 dialling code used for London telephone and facsimile numbers was divided into two new codes. The new inner London code is now 071 and the outer London code 081.

Below is a list of new telephone and facsimile numbers of major manufacturers, distributors, suppliers, designers and consultants in the London area.

Company	Tel number	Fax number
Abacus Electronics	081-994 6477	081-994 1766
Acoustic Energy Ltd	081-840 6305	081-579 1761
Akai (UK) Ltd	081-897 6388	081-897 1508
Argent's	071-379 6690	071-240 7696
Audio FX Ltd	071-482 1440	071-485 9302
Audio Kinetics Ltd	081-953 8118	081-953 1118
Audio Rents	081-586 7587	071-483 4143
Autograph Sales Ltd	071-485 3749	071-485 0681
Avcom Systems Ltd	081-740 0051	081-740 8481
Avitel	081-656 7027	081-655 0509
Bauch FWO Ltd	081-953 0091	081-207 5970
Branch & Appleby	081-864 1577	081-422 2949
Britannia Row Ltd	071-226 3377	071-354 1454
B&K Labs UK	081-954 2366	081-954 9504
Casio	081-450 9131	081-452 6323
Cetec International	081-900 0355	081-900 2793
Chromatix	071-229 5131	071-229 4999
SW Davies Ltd	071-485 8559	—
DDA	081-570 7161	081-577 3677
Dolby Laboratories	071-720 1111	071-720 4118
Eardley Electronics Ltd	071-221 0606	071-727 9556
Executive Audio	081-541 0180	081-549 2858
Farrahs	081-549 1787	081-549 6204
Future Film Developments gtc Ltd	071-434 3344 081-991 9152	071-437 9354 081-991 9391
Hardware House	081-986 6111	081-986 8127
Harris Grant Associates	081-900 0255	081-900 2793
HHB Communications	081-960 2144	081-960 1160
Home Service	071-387 1262	071-388 0339
Hilton Sound plc	071-708 0483	071-703 0774
H W International Ltd	071-607 2717	071-609 0295
Hybrid Arts Ltd	081-883 1335	081-365 3729
Kelsey Acoustics Ltd	071-727 1046	071-243 0211
KFA Ltd	081-881 2239	081-888 2133
Korg	081-427 3397	081-861 3595
LMC	081-743 4680	081-749 9875
London Rock Shop	071-267 5381	—
Michael Stevens & Partners	081-460 7299	081-460 0499
Music Lab Sales	071-388 5392	071-388 1953
NED UK	081-741 8811	081-741 8613
PRECO	081-946 8774	081-944 1326
Quested Monitoring Systems Ltd	071-731 7434	071-731 3280
Racal Zonal	071-439 0311	071-437 2126
Raper & Wayman	081-800 8288	081-809 1515
Roland	081-568 4578	081-847 1528
Sandy Brown Associates	071-624 6033	071-625 6688
Sarner Audio Visual	081-743 1288	081-749 7699
Saturn Research Ltd	071-923 1892	071-241 3644
Shuttlesound	081-871 0966	081-870 9300
Soudercraft Electronics Ltd	081-207 5050	081-207 0194
Sound Department Ltd	081-749 2124	081-749 8789
Soundtracs	081-399 3392	081-399 6821
SSE Marketing	071-387 1262	071-388 0339
Stirling Audio Systems Ltd	071-624 6000	071-372 6370
Studio Sound	081-686 2599	081-760 5154
Studiospares	071-485 4908	071-485 4168
Studio TimeLine	081-994 4433	081-994 9321
Syco Systems Ltd	071-625 6070	071-372 7660
tam	081-346 0033	081-346 0530
The Synthesiser Company Ltd	071-258 3454	071-262 8215
Vitavox	081-953 4151	081-953 2272
Wandel & Goltermann Ltd	081-575 3020	081-575 5629



*... and new models  
on stand no. 114*

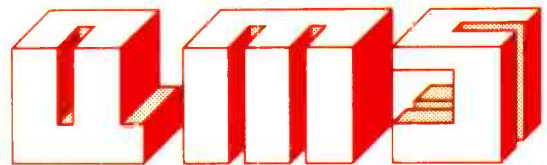

59 Maltings Place, Bagleys Lane  
London SW6 2BX  
Telephone: 071-731 7434  
Fax: 071-731 3280

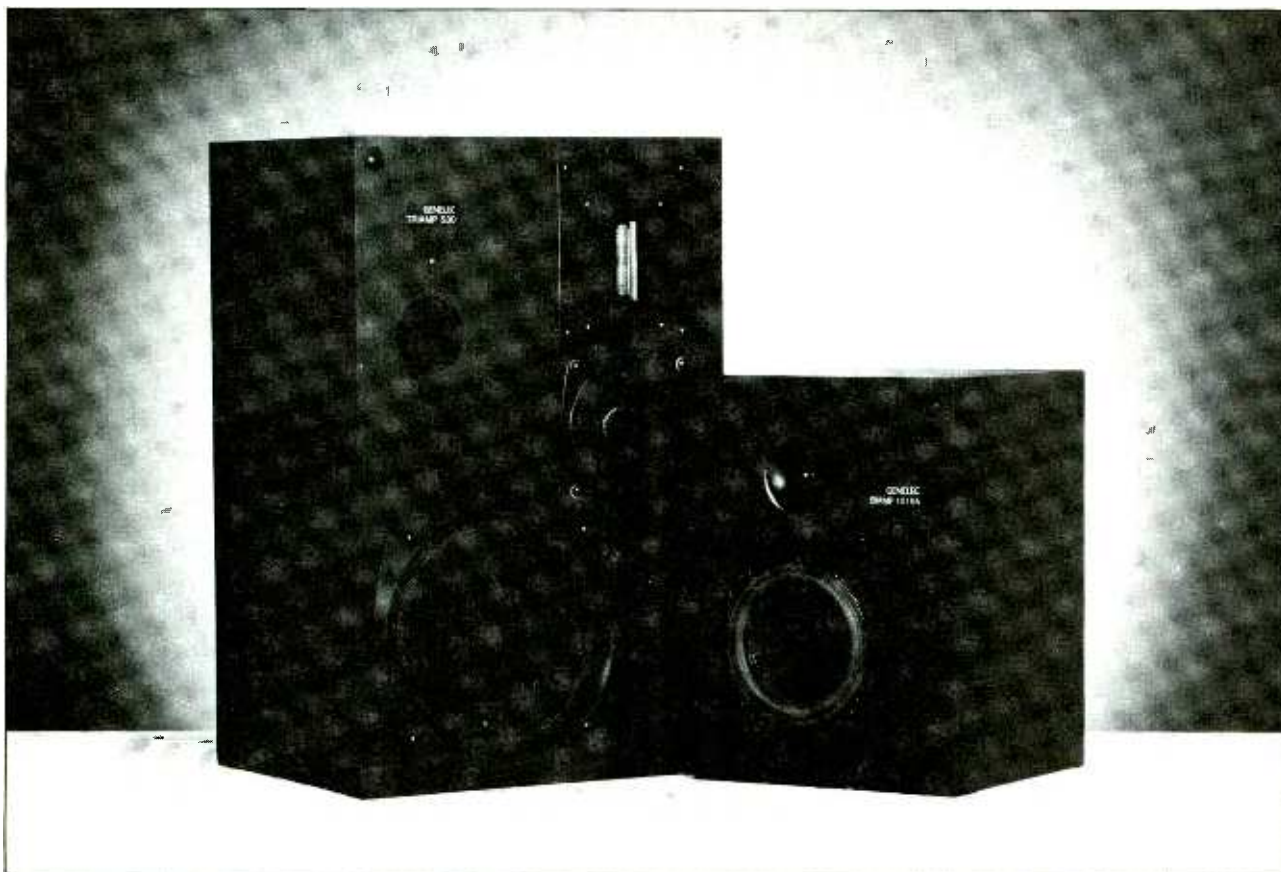

# FREE FROM ARTIFICIAL COLOUR

Genelec Active Monitoring Systems are from Finland, a land blessed with natural beauty. So it's perhaps no coincidence that Genelec products possess an unrivalled purity, with an un-coloured sound that has set recording and broadcasting standards for over a decade.

Seen above are two speakers from the range. The Biamp 1019 A is ideal for OB-vans, video editing rooms and near-field applications.

It's bigger brother the S30 is perfect as a main monitor for small and medium-sized broadcast, drama and music studios – so too is the highly sought-after near-field version.

There is a Genelec to match the whole range of monitoring applications where pure un-coloured sound is desired.

Ring SSE Marketing for more information or a demonstration.

**GENELEC**<sup>®</sup>  
FROM  
SSE MARKETING

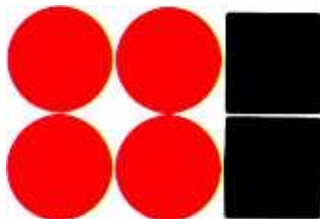

Unit 2 · 10 William Road · London NW1 3EN · Tel 01-387 1262 · Fax 01-388 0339

## ADT digital 'problem solver'

Audio Digital Technology have introduced a device that they are marketing as a digital 'problem solver' although they have also allocated it the model number *FC1*. Developed in conjunction with Prism Systems, the *FC1* is a 2-channel digital audio format converter and signal processor in a 1U design. Working with a 24 bit internal architecture, it recognises AES/EBU, SPDIF and SDIF2 protocols and can provide format conversion and transfer between interface modified PCM 701, DAT, DASH, hard disk

recording systems and digital outboard equipment. Further the *FC1* can strip emphasis from a data-stream, which can be useful when mixing signals with and without emphasis. When equipped with an optional remote control surface, it can also provide digital level mixing and channel crossfading. Delivery commenced in April.

**Audio Digital Technology, The Coach House, Manor Road, Teddington TW11 8BG, UK. Tel: 081-977 4546. Fax: 081-943 1545.**



## Panasonic professional DAT

Panasonic used the NAB Convention to launch two new studio-based DAT machines for the pro market. The *SV-3700* features a front panel shuttle wheel with 0.5 to 15x speed control and a horizontal cassette loading tray. The analogue input uses 'four-stage, one-bit Delta-Sigma' A/D converters with the output being proprietary 18 bit D/As. Other features include programme, absolute and time remaining displays; pushbutton selection of 44.1/48 kHz sampling rates through either analogue or digital inputs; auto fade-in and -out functions for level change; balanced I/Os via XLR-type connectors with -10 dBu or +4 dBm levels; up to 400x fast wind speeds; and an infra-red remote control giving access to most front panel controls.

The *SV-3900* is similar to the *SV-3500* but is equipped with different applications. It has a full

serial control interface enabling remote operation of all transport and programming modes so has few front panel controls. The serial port can be switched to ESbus or P-2 protocols while the other features may be controlled with the *SH-MK360* remote controller. This features a standard keypad for entering PNO and start IDs, all transport controls and a shuttle wheel with 0.5 to 15x range. A single controller can be assigned via the keypad to individually address one of up to 32 *SV-3900* machines connected on the control network.

**UK: Panasonic/Technic, Panasonic House, Willoughby Road, Bracknell, Berks RD12 4FP. Tel: 0344 853176.**

**USA: Panasonic Communications & Systems Co, Matsushita Electric Corp of America, 1 Panasonic Way, Secaucus, NJ 07094. Tel: (201) 348-7000.**



## Fostex D-20 DAT remote

The model *8320* remote control unit for the Fostex *D-20* pro DAT machine is now available. As well as the control of the *D-20* transport functions, the *8320* can write, read and edit Start IDs, Skip IDs, End IDs and can record up to 799 programme numbers. Up to 99 IDs can be programmed to play in sequence. Start IDs and Skip IDs can be automatically recorded and adjusted by frame in the rehearsal mode. The LED display may be switched between timecode or programme time. A locate function with 10 memories can store programme numbers and timecode for autolocation and cue points. The *8320* also allows sub code data such as IDs to be copied as part of a digital

transfer between *D-20*s.

Fostex also have the *4020* events controller now available. This unit can take SMPTE and MIDI commands and handle up to 999 events per output, of which there are eight relay, five pulse and three communications outputs. The unit also reads and generates SMPTE/EBU and MIDI timecode and has a SMPTE to MIDI timecode reader.

**UK: Fostex UK Ltd, Unit 1, Jackson Way, Great Western Industrial Park, Southall UB2 4SA. Tel: 081-893 5111.**

**USA: Fostex Corporation of America, 15431 Blackburn Avenue, Norwalk, CA 90650. Tel: (213) 921-1112.**

## Amek Mozart updates

Amek have announced a number of updates and options for the *Mozart* console. A complete machine control system is being developed in conjunction with Motionworks. This will provide an interface between the Amek/Steinberg *Supertrue* automation system and the *Motionworker* providing control of up to five synchronisers and a MIDI system. The system will be available later in the year. A new version of the Amek/Steinberg *Supertrue* software, CV0.15 will be released in the near future.

A new stereo module is under development with facilities that include both mic and line inputs with MS circuitry on the mic in; routing

for 24 buses and four stereo subgroups; 4-band sweepable EQ that can be split between left and right channels; 16 aux send buses with controls similar to those on the *MZ10* mono input module; and a panpot that can be selected for pan or balance modes and an image pot allowing adjustment from stereo to reverse stereo through mono.

**Amek Systems & Controls Ltd, New Islington Mill, Regent Trading Estate, Oldfield Road, Salford M5 4SX, UK. Tel: 061-834 6747.**

**USA: Amek/TAC US Operations, 10815 Burbank Blvd, North Hollywood, CA 91601. Tel: (818) 508-9788. Fax: (818) 508-8619.**

## Shure stereo VP88 microphone

Shure Bros have introduced their first stereo mic in the form of the VP88. This is a single point stereo condenser operating in MS configuration with a forward facing cardioid and a perpendicular fig-of-8 capsule. The VP has an internal LR matrix or can output an MS signal. Powering can be from phantom power 9-52 VDC, a Shure PS1A power supply or internal batteries giving a

life of up to 70 hours with silver oxide/lithium types. The mic is also equipped with a switchable LF roll-off.

**Shure Brothers Inc, 222 Hartrey Avenue, Evanston, IL 60202-3696, USA. Tel: (312) 866-2200.**

**UK: HW International, 3-5 Eden Grove, London N7 8EQ. Tel: 071-607 2717.**

## Miniature Eela monitors

The *Active-1* is a small stereo monitoring system designed for nearfield applications or as main monitors in OB vehicles. The units are 2-way and identical in size but one contains the PSU and stereo amplifier for the pair. Power can be drawn from the mains supply or 12 VDC from a battery. Quoted specification is 30 WRMS with an input impedance of 10 kΩ and an input level of -10 dBm. Level controls and HF filter are mounted

on the rear of the amp unit. Claimed frequency response is 55 Hz to 20 kHz. Cabinet construction is aluminium with a metal grille. Dimensions are 185×110×115 mm with a weight of 5.5 kg for the pair. **Eela Audio, Hondruglaan 83A, 5628 DB Eindhoven, The Netherlands. Tel: 040-424455.**  
**UK: Dyer Audio Systems, 13 Molesworth, Hoddesdon, Herts EN11 9PT. Tel: 0992 468674. Fax: 0992 467581.**

## SoundTools for the Atari

DigiDesign have announced that the *SoundTools* hard disk based recording and editing system is now available in a version to run on the Atari *Mega ST* series of computers. *SoundTools* was originally developed for the Apple Macintosh computer and DigiDesign claim 1200 units installed at the beginning of the year. Each Atari *SoundTools* system will include a computer card for the *Mega ST2* or *ST4*, an external A/D and D/A converter and the program software. The system will allow the recording of two tracks of audio to any Atari hard disk drive.

There has also been a software upgrade for Q-Sheet A/V to 2.0, a MIDI/SMPTE automation program. The program features a cue list (EDL) based event editor, which

synchronises MIDI events to SMPTE timecode. With version 2.0 and *SoundTools* the user may now add two independent tracks of digital audio to MIDI events such as sequences or sampled sound effects, all synchronised to SMPTE. The program also offers the ability to trigger recording and playback of *SoundTools* from any SMPTE location. Editing features include independent control over volume, stereo panning and pitch shifting for each event.

**DigiDesign Inc, 1360 Willow Road #101, Menlo Park, CA 94025, USA. Tel: (415) 327-8811.**

**UK: Sound Technology plc, 6 Letchworth Business Centre, Avenue One, Letchworth, Herts SG6 2HR. Tel: 0462 480000. Fax: 0462 480800.**



## Portable Dolby SR frame

Bryston have introduced a portable frame for Dolby SR cards. Designed specifically to meet the needs of location film sound recording, the 280-B is a 2-channel frame for Dolby cat 280 cards and with easy interface to a Nagra IV-S and IV-S TC tape machine. It can be powered from the batteries of the Nagra for up to 4 hours or by an external source. To conserve power circuitry the 280-B monitors the status of the Nagra and only delivers power to the SR cards when the tape is actually rolling. The

encode/decode mode of the SR cards follows the Nagra operation. The unit is less than 1 inch thick and weighs 2.8 kg (6 lb 13 oz).

**Bryston Ltd, 56 Westmore Drive, Rexdale, Ontario, Canada M9V 3Y6. Tel: (416) 746-1800. Fax: (416) 746-0308.**

**UK: Roksan Engineering plc, 21 Ddole Road, Llandrindod Wells, Powys LD1 6DF. Tel: 0597 4911.**

**USA: Brystonvermont, RFD 4, Berlin, Montpelier, VT 05602. Tel: (802) 223-6159.**

## DAR SoundStation updates

Digital Audio Research have added new software features for *SoundStation II*. Multi-Channel Drop-In operates in a similar manner to a conventional tape machine but can store multiple drop-in attempts, edit them and restore original audio if

needed. Autolocation enables users to select and return to key points in audio or video programme material and to jump to a predetermined programme point with one keystroke. These software updates will be free to existing and future customers.

## NED PostPro SD Workstation

NED launched the latest in the *PostPro* series at the recent NAB Convention. The SD combines a 24-track hard disk recorder and editor with a *Synclavier* sound design module fully integrated into the overall system. It is possible to use the *Synclavier* RAM for processing of sounds from the hard disk and then place them back without leaving the SD. The system offers eight separate *Synclavier* outputs with the *Direct-to-Disk* recorder being available in 8- or 16-track configurations offering nearly 30 mins per track of continuous recording time at 44.1 kHz.

**New England Digital, 49 North Main Street, White River Junction, VT 05001, USA. Tel: (802) 295-5800.**

**UK: NED Europe, Elsinore House, 77 Fulham Palace Road, London W6 8JA. Tel: 081-741 8811. Fax: 081-741 8613.**

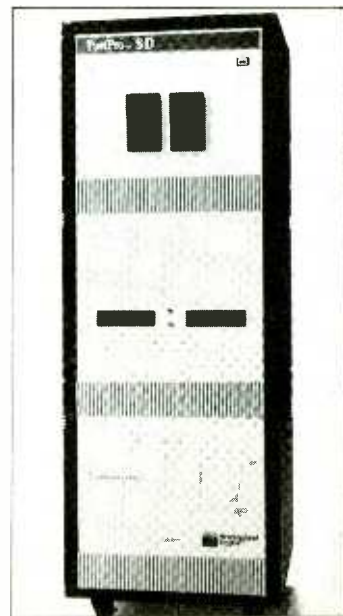

# *Sheer Opulence of Sound*

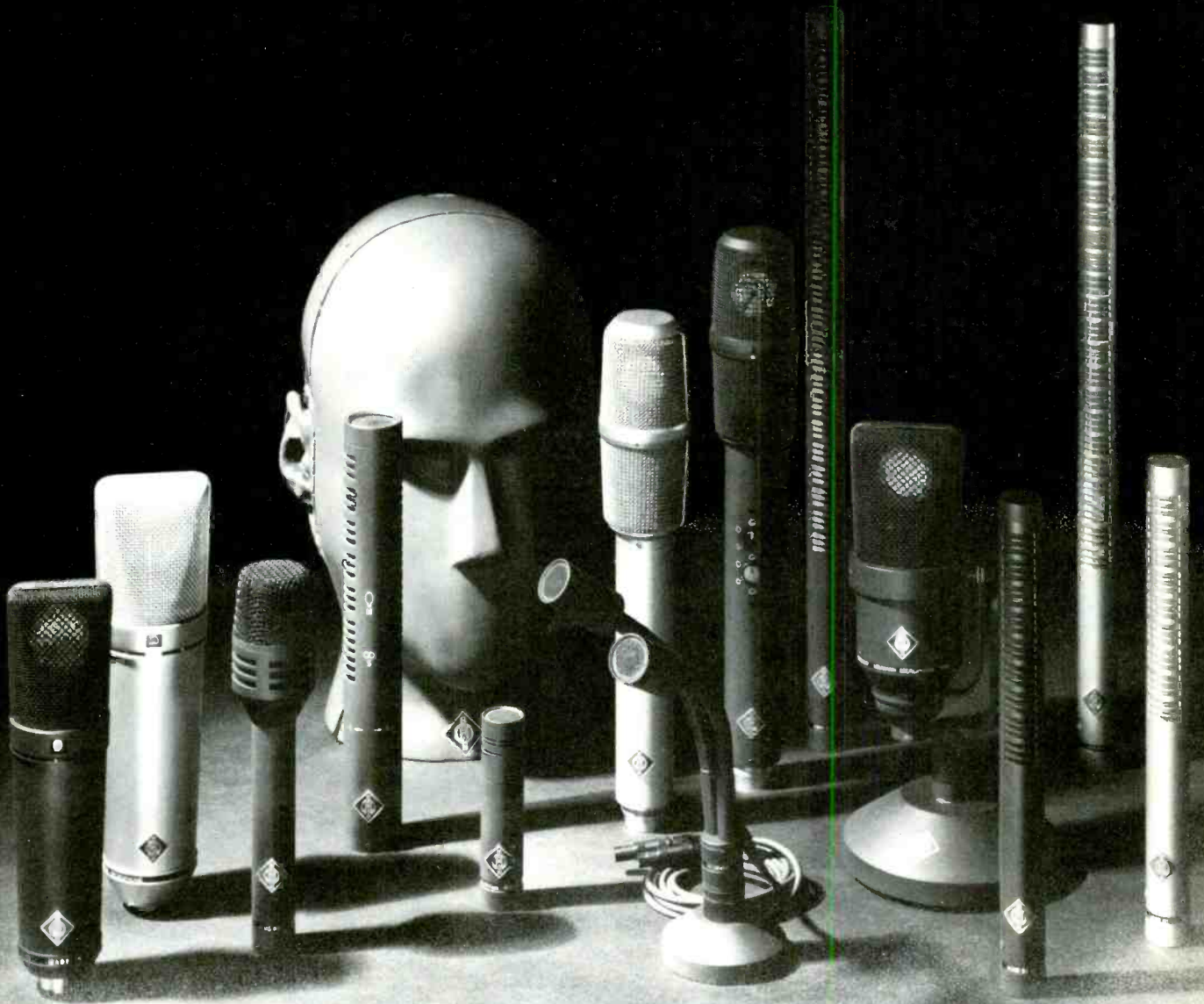

## **The Neumann-Family**

The studio microphones which achieve that elusive perfection.  
There is no comparison. Each one handcrafted by NEUMANN — the world  
leader in microphone technology for over half a century.

Distributors: Argentina: (041) 3129968/3112574 · Austria: (0222) 487741 · Australia: (02) 9751211 · Belgium: (02) 7352193  
Brazil: (011) 5425534 · Canada: (0416) 6652660 · Danmark: (02) 648522 · Finland: (0) 8381 · UK: (01) 9530091 · France: (01)  
45302123 · Italy: (02) 25390121 · Japan: (03) 9506266 · Netherlands: (020) 5105911 · Spain: (01) 5210187 · Sweden: (08) 7340750  
Switzerland: (01) 3913939 · Turkey: (04) 1262919 · USA NY: (0212) 7653410 · USA CA: (0818) 7852241 · Taiwan: (02) 3214454-6



**These AUDIO TRANSFORMERS could be in your hands next week**

**If you use Stevens & Billington's 7-point service plan:**

1. Samples normally supplied in 7 days.
2. Individually designed to your exact needs.
3. Precision quality for high performance.
4. Quick reliable deliveries.
5. 'Mumetal' shielding cans for excellent 'hum' rejection.
6. Flexible call-off arrangement to suit you.
7. Competitive prices.

**'Phone 082571 2568 now - Get your sample next week**



**STEVENS & BILLINGTON LIMITED**

Orchard House,  
Orchard Close,  
Fairwarp, Uckfield,  
East Sussex,  
TN22 3BW.

**Specialists in miniature transformers**

# AUCTION

ANNOUNCING AN IMPORTANT SALE OF THE COMPLETE CONTENTS OF  
**AUDIO ONE STUDIOS**

17, ST. ANNES COURT LONDON W1  
(Formerly Trident Studios)

AT 11.00 A.M.

**TUESDAY 5TH JUNE 1990**

VIEWING ON MONDAY 4TH JUNE 1990  
10.00 A.M. TO 5.00 P.M.

Including equipment and effects from Studios 1&2  
2 post production rooms, programming suite etc.

To receive a list of the items to be sold by auction,  
please contact **JANET BOON** on

**Telephone: 071-722 8833**

**Facsimile: 071-483 1023**

or write to the authorised agents in the sale:

**JACKSON MUSIC LTD.**  
**THE LONDON STUDIO EXCHANGE**  
Unit 4, 6 Erskine Road, London NW3 3AJ

*Catalogues on the door £1*

**T H E  
L O N D O N  
S T U D I O  
E X C H A N G E**

## PRODUCTS

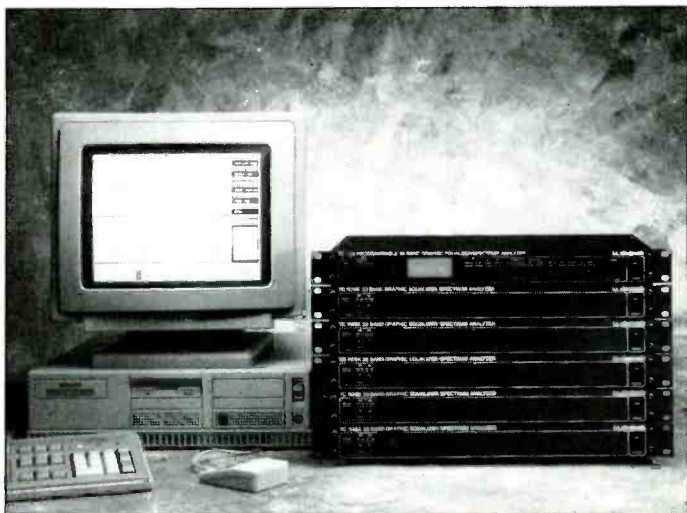

### PC control of TC EQ

TC Electronic have introduced a software package for the PC that allows control of up to 100 of the TC 1128 programmable graphic equalisers. The package includes software and a MIDI board fitting into any IBM PC compatible equipped with an EGA monitor. All EQ settings can be drawn with a mouse and the software will display the actual response curve to each setting. The PC will display RTA on each channel switchable between pre- and post-EQ. The software is also

capable of displaying the phase response curves of each equalised setting.

**TC Electronic A/S, Grimhojvej 3, PO Box 1420, DK-8220 Brabrand, Denmark. Tel: 86 26 28 00.**

**UK: TC Electronic UK Ltd, 24 Church Street, Oswestry, Shrops SY11 2SP. Tel: 0691 658550.**

**USA: TC Electronic USA Inc, 7325 Hinds Avenue, North Hollywood, CA 91605. Tel: (818) 503-0404. Fax: (818) 503-0633.**

### PAS TOC 3

Professional Audio Systems have added the *TOC Studio Monitor 3* to their product range. This is a high output studio monitor with a 15 inch co-axial loudspeaker with a 2 inch throat compression driver for the mid and high frequencies. The LF is handled by two large excursion 15 inch units giving a quoted

response to 25 Hz. The *Studio Monitor 3s* come with an active 3-way crossover network that includes time correction, linear phase filters and active modification.

**Professional Audio Systems, 1224 West 252nd Street, Harbor City, CA 90710, USA. Tel: (213) 534-3570.**

### Pearl TLC 90 mic

The Swedish Pearl microphone company has introduced a robust voice and instrument mic. The *TLC 90* is a cardioid condenser with a transformerless design. Running on 30 to 48 V phantom power, the mic has an LED indicator to indicate power on. Current consumption is 1.5 mA but the manufacturers say that the *TLC 90* is capable of handling at least 135 dB before distortion. The casing is made from

brass and is finished in grey powder paint. The internal assembly is shockmounted in silicone rubber while the front grille and breath filter can be removed for cleaning, or exchanged.

**Pearl MikrofonaLaboratorium AB, Box 98, Vallbogatan 8, 26501 Astorp, Sweden. Tel: 042-588 10.**  
**UK: Elliott Bros (Audio Systems) Ltd, Osney Mead, Oxford OX2 0ER. Tel: 0865 798000. Fax: 0865 792062.**



# AMS AUDIOFILE..

# THE PLUS POINT



During the 1980's, one hard disc recorder both established and dominated the market - AMS AudioFile.<sup>TM</sup>

AMS now announce AudioFile PLUS<sup>TM</sup> as part of a continuing policy of upgrades that take AudioFile into the 90's and beyond.

With a transfer of operating software to the latest technology 32 bit, 4 Megabyte transputer platform, AudioFile PLUS<sup>TM</sup> offers yet faster operation and the ability to accommodate a range of major new features - further distancing AudioFile from other disc based recorders.

Extended System Architecture also provides for 8 simultaneous inputs/outputs, in analogue and/or several digital formats.

Whether you have yet to make up your mind about hard disc recording or you already own an AudioFile, you'll find it comforting to learn that this system upgrade is once again available for all existing AudioFiles.



Setting the pace for hard disc recording

AMS Industries plc  
Billington Road, Burnley,  
Lancs, BB11 5ES, UK  
Tel: (0282) 57011 Fax: (0282) 39542

AMS London: (01) 722 3925 AMS USA: (707) 762 4840

New York: (212) 586 7376 Chicago: (312) 527 4569  
LA: (818) 845 0199 Seattle: (206) 842 7182

# Channel status conversion

Dear Sir, In my article on the AES/EBU interface (*Studio Sound*, December 1989) I suggested that a need existed for a 'black box' to allow modification of channel status bits in the sub-frame. Mike Beville of Audio Design has brought to my attention a box that his company makes which allows conversion of

channel status from consumer to professional format, as well as allowing modification of certain other channel status bits. He has asked that we put the record straight by mentioning as soon as possible that it is available.

**Yours faithfully, Francis Rumsey.**

# F1, DAT and CD mastering—a note from the trenches

Dear Sir, In this age of MIDI and the project/home studio, we (the CD mastering engineers of the world) are encountering more and more music that's been mixed down to any one of several 'semi-pro' digital formats. While I'm quite pleased to see *F1* and DAT recording bring music making of a relatively high fidelity to the masses (music does make the world go round) I'm confronted with an ever-increasing number of irritating foibles, which are creating inconvenient, costly and even irreparable problems when trying to create a finished CD master tape. In hope of lessening the confusion and stress (mine), here are some suggestions to aspiring DIY mixers, etc.

**The tape:** Just because it's zeros and ones doesn't mean that poor tape can't alter the fidelity of your recording. A tape of poor quality can have consequences of varying severity, from an increased incidence of audible digital interpolations (2nd order errors) to digital drop-outs. If you've never heard a digital drop-out try playing back an *F1* recording with the tracking on the VTR set so that it mistracks. Nasty eh? Interpolation errors are far more insidious. These occur when enough information is lost (due to mistracking, bad tape, etc) and the processor cannot successfully recreate the original data. The processor then attempts to 'guess' what the missing data should be, based on samples that precede the lost data. The result is often a slight 'bump' or, in the case of the *F1*, a 'fuzzy click'. What makes these troublesome is their brevity, unless you listen carefully you may not catch them on first listening. These problems occur in all digital formats using rotary

head technology, including DAT. Use name brand tape. Choose high grade (HG) T-120 or L-500 only—not longer— (US types) and in the case of DAT, experiment to find a reliable tape.

**The transport:** There can be considerable variation in performance and alignment from one VCR to the next. While problems caused by these variations are mainly an issue for *F1* format recordings employing ½ inch VCRs (and to some extent ¾ inch U-matics), I wouldn't be surprised to see problems cropping up among DATs, especially the soon-to-be-released inexpensive ones. The best answer is to use a reliable ¾ inch U-matic VTR. For those of you that are using ½ inch video, the rule of thumb should be: avoid newer, poorer-transport Beta and Superbeta (a machine with a PCM switch is desirable), non-standard brand VHS and generally any additional video processing such as HQ. Whichever format you use, employ a well maintained deck.

**The tape (pt 2):** Avoid recording on the first minute and the last minute or two. This tape is not always reliable (this includes DAT).

**The edits:** Ah, the best for last. Please leave the editing to the mastering engineer for two big reasons. Firstly, and most importantly, when recording on any video machine, and ½ inch VCRs in particular, the shape and sync of the video signal take several seconds to stabilise. This means that when you press record, it can take as long as 7 to 10 seconds for the video to become decodable by the digital processor. In DAT-land the delay is much less, from 1 to 3 seconds, but still unpredictable. This means that for your 'edits' to

# Generic patents

Dear Sir, I have previously drawn to your attention attempts by parties in various countries, particularly in Latin America, to pirate rights for generic expressions in the audio/visual industry. Thus, for example, I previously drew to your attention an attempt to register "DAT - DIGITAL AUDIO

TAPE" in Brazil.

It would appear that this type of enterprise is still active as witnessed in a cutting from the Official Bulletin of Intellectual Property of December 15th, 1989, in Venezuela of the mark "DAT - DIGITAL AUDIO TAPE" by a Mr Norman David Cooper Barth. His original application was on August 17th, 1987.

In view of the increased interest in digital audio tape, this attempt by an ingenious individual to acquire the rights over the name, while certainly enterprising, is hardly likely to meet with much approval from the industry.

**Yours faithfully, Iain C Baillie, Ladas & Parry, 52-54 High Holborn, London WC1V 6RR, UK.**

# A warning on credit orders

Dear Sir, I write to warn other readers of an unacceptable practice that has surfaced recently.

Many equipment distributors now accept payment by credit card. On two occasions during the month of December, I ordered goods from two different suppliers. Both companies immediately charged the full amount to my card account even though neither could supply from stock and in one case could not even suggest a delivery date.

Under pressure both companies issued credits.

May I suggest to readers, therefore, that when ordering goods and paying by credit card, it must be stipulated that the debit must only be raised upon despatch.

Meanwhile, I call upon suppliers to cease this dishonest practice immediately.

**Yours faithfully, David G Kitto, Clifton Bank Studios, 29 Jersey Way, Barwell, Leics LE9 8HR, UK.**

*Letters for publication should be sent to the Editor, Studio Sound, Link House, Dingwall Avenue, Croydon, Surrey CR9 2TA, UK.*

# All in one.



**INTRODUCING A WHOLE NEW CONCEPT: THE POSTPRO™ SD.** Presenting the smart alternative to multi-manufacturer component sampling and hard disk recording systems: New England Digital's PostPro SD. For the first time, random access performance is uninhibited by multi-manufacturer incompatibilities. With the PostPro SD, you get all the editing power of Direct-to-Disk™ recording, plus a fully integrated Synclavier® sound module. Switching between music and effects, sound design and editing, recording

and sequencing is truly seamless, truly transparent. The PostPro SD is the first hard disk recorder/editor that lets you go beyond cutting sounds: it allows you to create them. There's also another very important PostPro SD feature: our Total Commitment support package. It means our commitment to you extends beyond technology to offering financing alternatives, training, responsive service and regular software updates.



Synclavier and the New England Digital logo are registered trademarks. Direct-to-Disk and PostPro are trademarks, and Total Commitment and The smart move are service marks of New England Digital Corporation. ©1990 New England Digital UK, Ltd., Elsinore House, 77 Fulham Palace Road, Hammersmith, London W6 8JA. Tel: (44) (0)-81-741-8811

**SEE US AT APRS, STAND 174A.**

# TANNOY. BACK TO BASICS

Tannoy have completely redesigned their studio monitor range. Patrick Stapley finds out how and why

Formed in 1926 Tannoy are one of the long established names of the audio industry. They are, and have been, active in almost all areas of speaker application with their name often being mistakenly used generically for certain types of public address. In many of the more critical areas of audio, Tannoy have relied on their dual concentric speaker designs. In the '60s and '70s within the UK they had by far the largest usage of any monitor system in the studio market. As monitor power handling became more of an issue through the '80s, Tannoy lost some ground in the large monitor stakes but remained in demand in the small to middle sized market.

This month Tannoy launch a new range of monitors that will replace the entire existing range. This is not just a cosmetic change but the result of design changes to the original dual concentric design.

Technical director Alex Garner: "First of all the original range had become very bitty being a collection of nine monitors that had evolved largely from our response to user feedback. For example the *SGM 3000* came about through broadcast studios saying to us that they thought the *SGM 1000* was lovely and loud but they could do with a bit more bottom end, so we put in a



Tannoy monitor series



## Sherrod SL Dayvan

Based on the American Chevrolet G20 or Ford Econoline, the Sherrod Vans are designed to carry up to nine people in the highest standards of comfort and luxury. Ideal company hospitality, hotel courtesy transport, or for large families. Standard equipment includes a powerful 5.7 V8 engine, 4-speed automatic transmission, air conditioning, cruise control, electric windows, luxury fabric trim or leather at extra cost, and a lavish use of teak or walnut hardwood inside. One of our Sherrod representatives will be pleased to arrange a demonstration at your home or office. Prices, surprisingly low for a vehicle of this type, around £24,000 including car tax, VAT and one year's warranty.

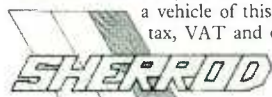

SOLE UK  
CONCESSIONAIRES

### David Boatwright Group

10 Benfield Way, Braintree, Essex CM7 6YS. Tel: 0376 552399

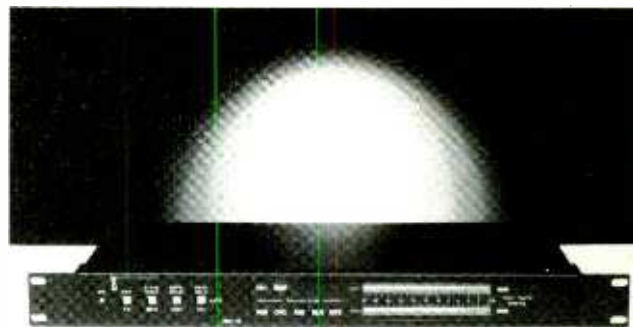

## THE FIRST CHOICE IN DIGITAL AUDIO METERING

**THE DBM-1A**  
REMOTE DIGITAL METER FOR SONY  
PCM-1630 and 1610 SYSTEMS



TOTAL SYSTEMS

41 Windermere Avenue  
Basingstoke, Hants RG22 5JH, UK  
Phone: 0256-468555

# YAMAHA DDL3

DIGITAL DELAY LINE

## THE NEW STANDARD



100dB. 1 IN 3 OUT. PROGRAMMABLE CROSSOVER MODE

**FEATURES AND SPECIFICATIONS**  
1300 Milli Second Delay 20 Micro Second Steps.  
Dynamic range 100dB.  
18-bit Delta Sigma Conversion.  
15 User Memories.  
THD less than 0.03%.  
20 Hz - 20 KHz response.  
**REAR PANEL**  
Balanced + 4dBm Input/Output.  
Front Panel Disable + Memory Protect.  
Remote Control + Memory Select.

### DDL3 Models

● 3-channel Delay + Parametric EQ

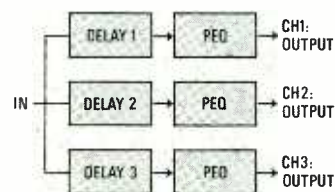

● 3-channel Delay + Crossover

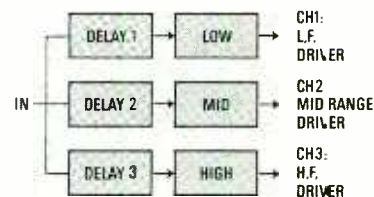

YAMAHA PRO AUDIO SYSTEMS

YAMAHA KEMBLE MUSIC (UK) LTD · PRO AUDIO DIVISION · MOUNT AVENUE · BLETCHLEY · MILTON KEYNES · MK1 1JE · TEL: (09C8) 371771

# Sound Effects Software

## Sound & Music Catalogging Professional Librarian

- Organizes Tapes, DATs, Samples, Floppy Disks, Compact Disks, Broadcast Carts & LPs.
- Contains presorted catalog listings of Compact Disk sound effects & production music libraries.
- Provides easy data entry for your own libraries, checks spelling and allows descriptions of virtually unlimited length.
- Searches library catalogs by sound, style, mood, category, title, synonym or description.
- Enables multiple word searches using AND, OR, ALSO & NOT to specify exceptions, alternatives.
- Sorts & Cross-references by Format, Length, Media, Project, Recordist or Source Roll.
- Allows unlimited number of custom categories.
- Controls Compact Disk playback via Sony CDK-006 60 disk multi-player "jukebox".
- Networks up to 32 stations and 16 jukeboxes.

## Sound Effects Spotting Sound Supervisor

- Manages spotting lists referenced to reel, scene, time code or feet/frames.
- Provides search, copy & paste from library to spotting lists.

## Dialogue (ADR) Spotting Spotmaker

- Organizes replacement dialogue lines, sorts by character, reel, scene & footage.
- Prints standard cue/line sheets as well as a variety of other forms
- Transfers data to Cueprinter for mixing cue sheets.

## Cue Sheet Printing Cueprinter

- Prints standard re-recording cue sheets in feet/frames or timecode on any size paper.
- Conforms footages to picture changes

### LEONARDO SOFTWARE

10378 Holman Avenue  
Los Angeles, California 90024  
PH: 213.277.5161 • FAX: 213.277.9086

heavier cone. The *FSM* was the result of people wanting more of everything—more power, more sensitivity—then they told us that although it sounded great the problem was that their control room had been designed to fit UREIs and they didn't want to rip it apart to fit our monitors, so we built a UREI-shaped cabinet, the *FSM U*.

"The second consideration was that we thought it was time to rethink dual concentric design, not by merely fine tuning our existing designs, but by going right back to basics and starting afresh. We felt this was the only way to make really significant improvements."

Tannoy's research into Differential Material Technology (DMT) has played a very important part in the design of the new monitors, both for drivers and cabinets alike. DMT, as defined by Tannoy, 'is the study of different materials and their relative behaviour in intimate contact, which has allowed a complete understanding of the effect on the sound quality of every "nut and bolt" in the loudspeaker system'. It was first incorporated in the design of the *TP-1* about 2 years ago and later in the *NFM-8*, both speakers must be considered precursors to the new range and the monitors that now replace them have changed little apart from cabinet modifications. DMT has also been used in the series 90 range of hi-fi speakers.

The new range consists of six monitors with easy to remember model numbers: the *System 2 NFM* is a desk top monitor with a 1 inch HF unit and a 6.5 inch bass unit, which replaces the *TP-1*; the *System 8 NFM* is an 8 inch dual concentric nearfield monitor that replaces the *NFM-8*; the *Systems 10, 12 and 15 DMT* are all single dual concentrics replacing the various *SGM* and *LGM* 10 inch, 12 inch and 15 inch models; the *System 215 DMT* replaces the *FSM U*, providing a 15 inch dual concentric and a 15 inch bass unit. All the new monitors share the same technical philosophy and styling but the larger systems incorporate more new features.

## HF units

An important consideration in the overall design of the monitors has been the accuracy and repeatability of components parts, both in terms of their tooling and assembly. Fewer components have been used than in previous speakers and, where possible, a single part has been designed to replace a combination of parts. This is evident in the design of a one part carrier plate, which is a precision casting (8 inch and 10 inch) or moulding (12 inch and 15 inch) that acts as a mechanical datum, centring the HF assembly to an extremely high degree of accuracy.

Mark Dodd, Tannoy's chief acoustic engineer: "The amount of work that's gone into the design in terms of reliability and reproducibility is absolutely enormous. Every possible attempt has been made to ensure the units go together in the same way and that they produce the same results. Without this attention to mechanical detail, we could not have achieved the acoustical results and consistency that we're now seeing."

Another advantage of this kind of design is that it makes servicing much easier and a job like replacing an HF diaphragm can be done with little fuss and great accuracy. In the 8 inch and 10 inch drivers the carrier and waveguide is a single casting made from Mazac, a zinc/aluminium alloy; in the 12 inch and 15 inch the carrier and waveguide components are separate polycarbonate mouldings, which have been solvent welded together. Polycarbonate was

favoured in the larger systems due to resonance problems encountered using metal waveguides.

A major factor that was incorporated in the early design stages and that has had a strong bearing on the way the design was evolved, was the requirement for a low compression ratio. Normally horns have a compression ratio of about 14:1 but this has been reduced in the 8 inch and 10 inch to 7:1, and in the 12 inch and 15 inch to 4:1.

"Although high compression ratios increase sensitivity, which may be very useful for PAs, the loss in quality is not acceptable in the studio, so we've gone for a low compression ratio while building in the extra sensitivity required. Air non-linearities can be quite a problem in horns and the higher the compression ratio the worse they become—so our philosophy has been to help the sound get away from the diaphragm as easily as possible without making it follow a torturous route with lots of discontinuities. To achieve this we've designed a new waveguide while enlarging the gap between the diaphragm and the surface of the waveguide."

A great deal of research has gone into waveguide design, which, without the aid of CAD, would have been an exceptionally long and complex process. The new tulip-shaped, ring-slot waveguide gently shapes the wavefront from the diaphragm, so by the time it has reached the end of the guide, it is perfectly spherical and perpendicular to the fixed surfaces. The flared channels of the guide act as delay paths, producing a phase corrected wavefront that can propagate successfully down the cone to the listener.

One of the more noticeable changes to the new monitors is the use of separate magnets for the HF and LF drivers. This replaces the shared magnet design with a 'piggy back' arrangement; the two ferrite magnets being separated and positioned by the one-piece carrier.

Unlike previous Tannoy dual concentrics, the diaphragm has been reversed so that energy is taken from the convex rather than the concave side. The diaphragms have been made from a light stiff aluminium/magnesium alloy called Duralumin, and are smaller than previous models giving an improved HF response to above 25 kHz. The 8 inch and 10 inch diaphragms are 25.4 mm, the 12 inch and 15 inch are 33.4 mm. The diaphragm surround has purposefully been made narrow to ensure that resonances will be above 25 kHz, and thus avoid interference with operating frequencies. In the case of the 12 inch and 15 inch monitors, the surround material has been formed from precision moulded nitrile rubber to give greater strength as well as providing a good acoustic termination.

The HF coils for the *Systems 2, 8 and 10*, are constructed from round copper wire and a Kapton (polyamide) former, while the *Systems 12 and 15* are made from rectangular copper clad aluminium wire, which has been chemically bonded onto a glass fibre former.

Dodd: "We started off trying a round copper wire for the 12 inch and 15 inch coils but quickly moved to the flat wound copper clad aluminium wire which really did produce a superior result, not just on paper but quite noticeably to the sound."

Polyamide wire insulation has been used for all the HF coils because of its high temperature rating. The coil terminates onto beryllium copper flat strips on the 12 inch and 15 inch speakers; this material being chosen for its fatigue resistance and conductivity properties.

Copper caps have been placed over the pole

**AKG**  
ACOUSTICS

# ADVANCED MICROPHONE TECHNOLOGY

The C426B Comb. represents the next logical step in the development of a legend amongst professional microphones, the C422, which itself is derived from an earlier microphone that set new recording standards, the C24.

The operating principles of the C426B remain the same - two twin diaphragm condenser capsules which rotate for MS and XY stereo recording, each with individually selectable polar patterns from a remote control unit. But as engineering standards have developed, so has every aspect of the C426B design, which now offers ultra low self noise operation, in-built electronics for the digital age, and a host of physical operating features which make it ideal for busy recording studios.

You might think it presumptuous for us to predict a future legend, but with the support of the world's leading recording studios, we believe we can.



AKG Acoustics Ltd., Vienna Court, Lammas Road,  
Cattesall Road, Godalming, Surrey GU7 1JG.  
Telephone: Godalming (048 68) 25702.  
Facsimile: (048 68) 28967.  
Telex: 859013 AKGMIC G.



Tannoy System 215

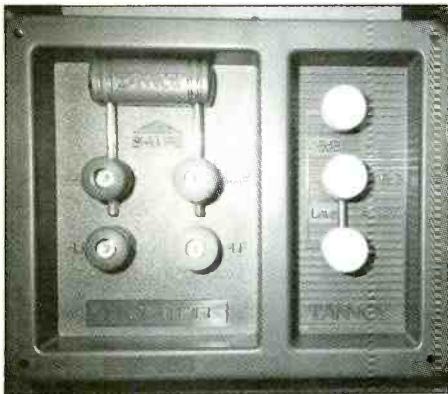

Monitor terminal panel

pieces, in the 12 inch and 15 inch HF units, to reduce flux modulation and coil inductance.

"There are two ways of looking at this arrangement—you can either say that it's like coupling, by transformer action, the coil to a shorted turn, or you can say it acts like a magnetic mirror which produces a field opposing the one produced by the voice coil. Any variation of magnetic field in the gap produced by current through the coil is undesirable. The fields due to current in the voice coil and copper cap sum to zero leaving just the static field due to the magnet so the copper cap minimises the inductance, giving an improved HF response and slower roll off, as well as reducing flux modulation distortion."

Another advantage of the copper cap is its ability to dissipate heat away from the coil and into the magnet, resulting in increased power handling. Additionally, all the HF drivers incorporate a magnetic fluid in the gap to aid

cooling. This 'colloidal suspension of magnetic particles in an inert organic carrier fluid', has five times the thermal conductivity of air, dramatically increasing heat dissipation. Magnetic fluid has the added advantage of ensuring the coil only moves axially. Close attention was paid to ensure that the materials being used in the voice coil assembly would be compatible with magnetic fluid and that no HF over-damping occurred.

Behind the diaphragm in the 12 inch and 15 inch drivers is a felt damping plug and an air cavity, both have been finely tuned to help reduce colouration and also to control rear compliance of moving parts.

## Bass units

The starting point for the design of the bass units came from Tannoy's marketing department, who supplied information on the kind of levels and frequency response clients required. Armed with this information, the R&D team set about the initial stages using a CAD system running proprietary software.

Tannoy's senior design engineer, Paul Mills: "The first stage is to use computer simulation to enable us to get a good idea of how various magnetic systems, coil geometries, compliances, cone weights and all the other parameters are going to behave, so before we go about tooling any prototype parts, we can get a good idea how the bass drivers are going to perform in a particular box. This is extremely valuable as it cuts out a lot of development time."

Three new pressure die-cast chassis have been built—10 inch, 12 inch and 15 inch—which are much more open than previous designs allowing the drive units to breathe well but at the same

time providing high levels of rigidity; the rear of the suspension is also well ventilated helping to cool the motor system and improve power handling. Chassis for the 8 inch and 6.5 inch drivers have a pressed steel construction.

The cone material is polyolefin for all models except the 15 inch, which is paper. A process known as 'Air Dry Felting' has been used in the manufacture of the paper cone, which results in a more controlled mid range performance and is considered preferable to 'Contact Dry' methods. Paper cones have also been treated with an impregnation around the apex, which further improves the mid range performance as well as adding extra strength. Numerous tests were conducted to discover the optimum chemical mix and concentration for this secret solution.

Another important change has been the choice of surround material. Mills: "We've gone to a rubber surround as opposed to the old cambric material. This offers two things, firstly improved linearity of excursion, and secondly much greater robustness. Rubber surrounds have been used before in 10 inch and 12 inch speakers but they have never been popular with 15 inch speakers due to the loss in sensitivity caused by the weight of the material. We took this fact into consideration right from the start and compensated for it in the design of the motor system."

Like the HF unit, which uses a copper cap to deal with eddy current losses, the bass drivers on the 12 inch and 15 inch speakers use a copper ring that slots between the coil and magnet; this lowers the inductance improving mid range performance, as well behaving as a heatsink.

The wire used in all the LF coils is flat wound copper terminating onto cloth-cored beryllium copper braid. Kapton formers are used for the 8 inch and 10 inch drivers; aluminium is used for the 12 inch and 15 inch.

The secondary bass unit in the System 215, is identical to the bass driver in the dual concentric, being a 15 inch dual concentric with the HF unit removed and a dust cover added. Its crossover point is at 250 Hz, and it's separately enclosed and ported.

## Crossover

From the outset of designing the new speakers, Tannoy's philosophy has been to get the drivers right rather than relying on compensatory circuits to tailor their response. This has resulted in very simple crossovers with the minimum number of components and thus the minimum electronic colouration of the sound. All crossovers are hard-wired from point to point and components such as the HF and LF inductors have been sensibly placed to avoid field interference, adding to the discrete nature of the circuitry. From the 10 inch system up, Van den Hul low oxygen copper cable has been used to connect high quality film capacitors and air core inductors, which avoids the saturation problems caused by ferrite cores, therefore eliminating distortion.

The crossovers have been designed to accept bi-wired or single connections from the amplifier and a new terminal panel has been incorporated into the larger monitors. This comprises four gold-plated terminals for the HF and LF connections, which, for conventional wiring, are linked together in pairs by two vertically sliding gold-plated pins. Similarly, control of the HF level is set by a pin moving between three terminals, providing  $\pm 1.5$  dB shelving from 2 kHz to 25 kHz. There is also bass adjustment but this only



# Peak Viewing

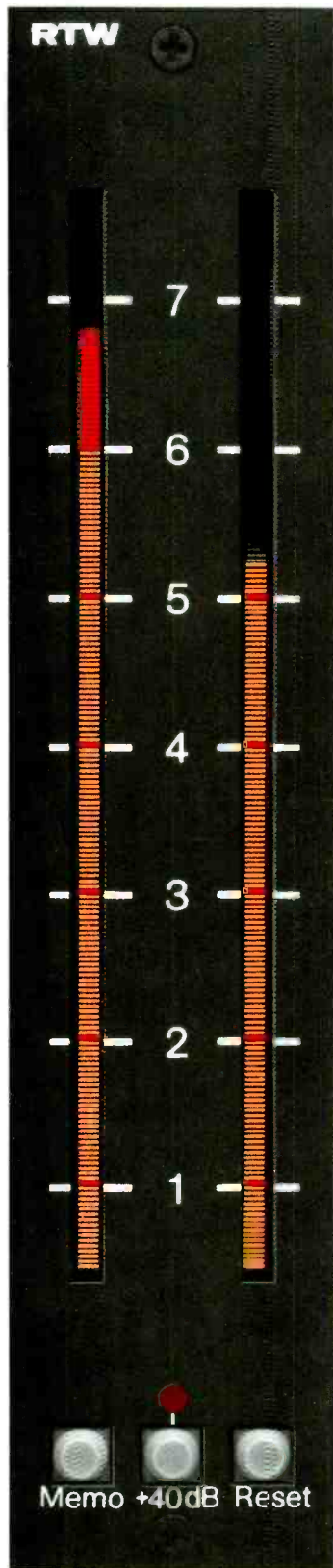

With the recent technological advances in the transmission and distribution of broadcast sound the accurate monitoring of signal level has never been more critical.

## RTW PPM 1130E

Already in service with many U.K. broadcast organisations, the RTW PPM 1130E provides precise indication of even short transient peaks on a clearly readable neon-plasma display, designed to BS Standards\*.

Information on the complete range of RTW Peak Programme and Phase Correlation Meters is available, on request, from Audio Design, Tel: (0734) 844545

Specify the RTW PPM 1130E and improve your peak viewing!

\* B.S. 55428 Part 9.

**AUDIO DESIGN**

Unit 3, Horseshoe Park,  
Pangbourne, RG8 7JW, U.K.  
Tel: (0734) 844545  
Fax: (0734) 842604

## FOR PEAK PERFORMANCE

Mixing complex audio signals from multiple sources is difficult enough, so you need to be sure of the meters.

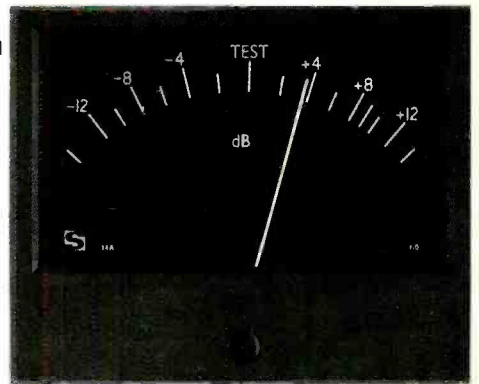

## PPM INDICATORS

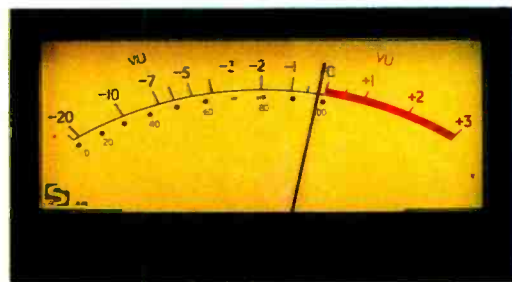

Are they accurate and reliable? Can you read them quickly and clearly?

## VU METERS

Sifam is a world leader in meters and ancillary components for the professional broadcasting and audio industries – backed by more than sixty years experience.

## AUDIO LEVEL INDICATORS

If you need vu meters or PPM indicators to the highest international standards – or something close but less costly – then it's sure to be in the Sifam range, waiting to give you peak performance.

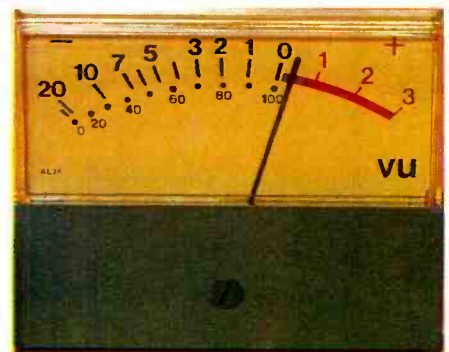

Literature is yours for the asking

## SPECIFY

**SIFAM LIMITED—METERS DIVISION**  
WOODLAND ROAD TORQUAY  
DEVON TQ2 7AY ENGLAND  
Telephone: 0803 613822  
Fax: 0803 613926. Telex: 42864



**APRS EXHIBITION : 6-8 JUNE STAND NUMBER : 016**

appears on the *System 215*, which has its terminal panel fixed to the front rather than the back of the cabinet. This neat method of linkage helps to further simplify the circuitry, and provides a clear visual and tactile indication of settings.

## Cabinet

All the cabinets are manufactured using CNC (Computerised Numerical Controlled) machining, which again ensures precision and repeatability. High density particle board is finished in a grey suede-like textured paint that was first seen on the *NFM-8*. Apart from the *System 2*, the cabinets have railed side panels, bottoms and tops covered in a shiny, speckled grey laminate. Corners and edges have been rounded to minimise sound reflections and diffractions.

Internal cross-bracing has been designed to serve two purposes. Firstly, it braces all sides of the cabinet to inhibit vibrations and, secondly, it supports the back of the drive unit. This support is via a lossy mastic material, which absorbs much unwanted HF energy before it can reach the cabinet. The remaining HF is equally transmitted through the cross-brace where it is absorbed by a layer of lossy glue between the brace and cabinet walls. The glue used to attach the panels is also slightly lossy and plays a part in controlling cabinet resonances (another application of DMT).

The dual concentric cabinets have twin ducted laminar ports for each speaker. The internal wadding material is *TF-1* in all but the *System 2 NFM*, which uses bonded polyester fibre.

Care has been taken to produce a rounded profile at the edge of the speaker, to help blend the wavefronts to the baffle. The old acoustic blanket approach, where an absorptive material was used to avoid diffractive elements has been discarded in favour of a plastic diffraction ring that slots into the perimeter of the chassis. This ring, along with the surround and the edge of the chassis, greatly improves the smoothness of HF radiation. The diffraction ring is painted with two gold rings, being a symbol for dual concentrics.

## Sound

It would be imprudent to make critical judgements on the sound of a speaker system without first being completely familiar with the acoustics of the room and the amplifier. As neither was the case when I heard the *Systems 12* and *15 DMT* in Tannoy's listening room, I am not prepared to comment too boldly. However, a few general observations, I feel, are relevant.

They sound like Tannoys: this is not to say they appear coloured in anyway but they do have a character that Tannoy users will recognise and, I think, will appreciate. There seems to be good continuity across the audio spectrum, which adds to a general impression of accuracy. The imaging is pinpoint and 3D information is well reproduced with convincing depth. After listening to the speakers for some time and at reasonably high levels they were not tiring, and I can imagine they'd be easy to work with over long periods.

Having made loudspeakers since 1933 and dual concentric systems since the early '50s, Tannoy have become a household name, and internationally well respected in hundreds of studios. The *Monitor* series should continue the success story, as well as taking dual concentric design firmly into the '90s. □

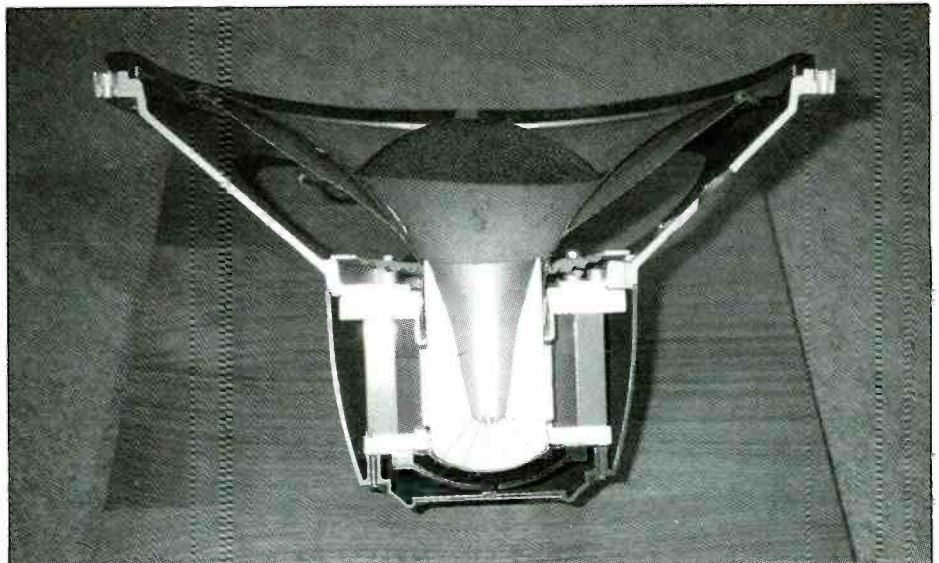

Cross-section of typical old Tannoy design

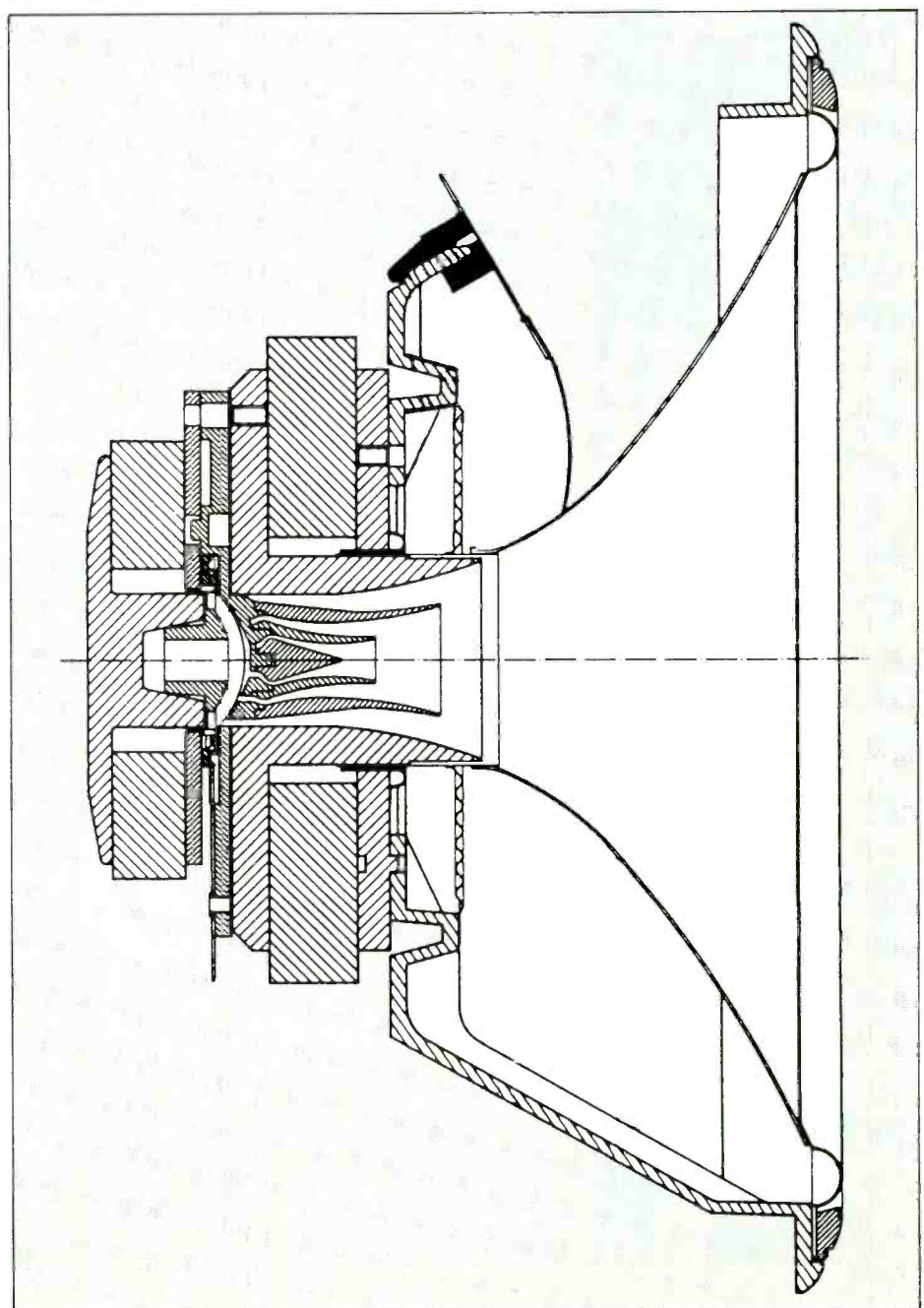

Cross-section of new dual concentric design

# “No one will ever buy a console with a television in it”

Visitor to AES, 1977

It is hard to believe that a modest VDU could attract much attention. Today, even effects processors use visual displays. Why have they become so necessary?

Quite simply, the greater the number of functions in a system, the more flexibility there must be in showing its status. In the recording studio the central piece of creative hardware is the console. To unlock its full potential, Solid State Logic gave engineers digital control of its facilities. The VDU was a side effect of this plan.



In the intervening years our designs were enhanced, incorporating the suggestions of the many leading studios who had adopted our system. Ultimately, the G Series Master Studio System evolved.

G Series offers the fastest execution of complex commands by storing the entire operating program in 2Mbytes of on-board RAM. Its removable Data Cartridges preserve mobility of data, without the capacity limitations of floppy disks. Each cartridge holds 20Mbytes of removable RAM—the equivalent of 80 floppy disks.

Because G Series software represents over ten years of evolution in some of the busiest

recording studios in the world, it incorporates an unparalleled degree of user experience. Advanced facilities like Selective Rollback and Group Set make mixing faster. Rapid comparison can be made between mixes. Large or complex mixes can be handled effortlessly on or off-line.

Throughout, SSL has preserved compatibility with earlier systems, creating a functional standard for the industry. By providing a realistic upgrade path, the investment of studio owners has also been protected. Most importantly, G Series remains at the forefront of audio production technology.

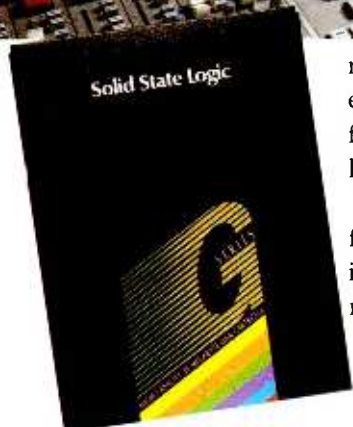

## **Solid State Logic** MASTER STUDIO SYSTEMS

Begbroke, Oxford, England OX5 1RU (0865) 842300

London (01) 706 4948 • Paris (1) 34 60 46 66 • Milan (2) 612 17 20 • New York (212) 315 1111 • Los Angeles (213) 463 4444

• Toronto (416) 363 0101 • Tokyo (03) 320 1101



Dubbing Theatre One with SSL SL S460M

# POST AT PINewood

With the arrival of the UK's first SSL film post-production console at Pinewood Studios Julian Mitchell speaks to head of post-production Graham Hartstone

One of the best compliments you can pay a film dubber after you've seen one of his films is not to say anything about the soundtrack. The argument goes that the dubber's art is making the mix as transparent as possible, as this leaves all the attention on the film's plot. But achieving such transparency does have its side effects, especially when post-production studios try to find justification for the expense of new equipment from the people who hold the purse strings. "How can you expect more money when nobody notices what you're doing anyway?" could be a response, although rather an extreme one.

Graham Hartstone, head of post-production at Pinewood Studios, is familiar with the vagaries of the film industry, "Once the budget's been eaten up by locations, actors and technical wizardry, the production company then sees what they have left for post-production. Everybody else has overspent and gone over time but we can't."

At the moment, however, Hartstone isn't complaining, as Theatre One at Pinewood has just received the first SSL film desk system to be installed in the UK. The *SL 5460 M* has 60 channels with 56 dual line inputs and four mic/line inputs. The console is also fitted with the *G* series computer providing the automation. Up

until now and with the exception of the Theatre Projects desk in Theatre Two, film desks have usually been customised music desks, as was the replaced Neve in Theatre One.

Although a good soundtrack is one you don't and aren't meant to notice, Pinewood has had its fair share of awards and award nominations for films made on site and elsewhere. Oscar and BAFTA award nominees include *Aliens*, *Passage to India*, *Superman—The Movie*, *Pink Floyd The Wall*, *Blade Runner* and *Hope and Glory*. Pinewood's reputation for feature film dubbing is unquestioned but that's only part of what they do there. A feature film will normally take an average of 3 to 6 weeks to dub, sometimes more, so in the time between those long jobs the post-production department takes on television work and some commercials. The appeal to TV companies and advertising agencies is getting the feature film treatment on their products. Obviously a Pinewood soundtrack is something to aspire to.

## Pinewood Past

Pinewood's post-production history goes back as long as the studio itself but through the years and through the decline of the British film

# The World's Most Advanced Stereo Broadcast Consoles



The SL 5000 M Series is an open architecture console system comprising a wide range of standard audio and control cassettes in a variety of mainframe sizes. It can be configured to exactly match your current and future requirements. The use of standard cassettes eliminates the service and maintenance problems often associated with systems of this sophistication.

A unique sectional grid distributes audio and control busses throughout the mainframe, interlocking master and local facilities in virtually any combination you desire. This makes a wide range of applications possible – live radio, continuity, outside broadcast, film and video post production.

The SL 5000 M Series retains the full benefit of computer-assisted operation and centralised assignment, where appropriate. Dynamic fader automation, optional motorised faders, and SSL's Instant Reset™ and Total Recall™ computer systems provide maximum control of these advanced functions.

At last the specialised requirements of broadcast audio production can be served by a new level of operational efficiency and creative flexibility.

*SL 5000 M Series mainframes are available in 3 depths and from 8 to 128 channels wide, allowing consoles of almost any size and capacity.*

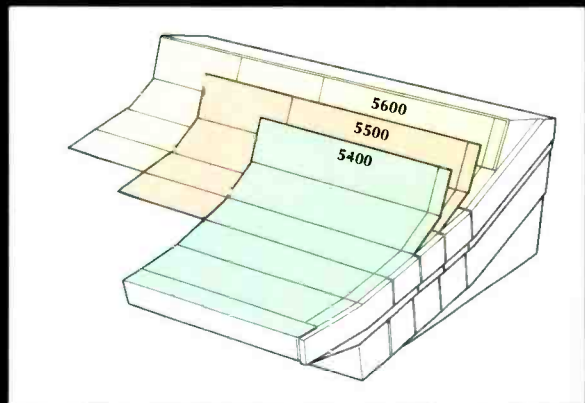

The SL 5000 M Series is used by:

ABC TV, USA  
 Bayerische Rundfunk, FRG  
 BBC Radio, UK  
 BBC TV, UK  
 Radio Bremen, FRG  
 Fox TV, USA  
 ITN, UK  
 NRK, Norway

Nippon Hoso, Japan  
 Paris Omnisport, France  
 RTE, Eire  
 SRG, Switzerland  
 TBS, Japan  
 TVS, UK  
 Videotime, Milan  
 YTV, UK

## **Solid State Logic** SL 5000 M SERIES

Begbroke, Oxford, England OX5 1RU (0865) 842300

London (071) 706 4948 • Paris (1) 34 60 46 66 • Milan (2) 612 17 20 • New York (212) 315 1111 • Los Angeles (213) 463 4444

• Toronto (416) 363 0101 • Tokyo (03) 5474 1144



**Dubbing Theatre Two**

industry things have changed immeasurably. Hartstone: "There used to be a vast amount of films made here and all finished off here, all in-house. There was a full editing staff and full staff in every department, that situation started to wane and turned into more of a freelance business in the late '60s, early '70s. At that time the floor production crews here were dispensed with and we were just left doing post-production only. People had their favourites and wanted to take

them round wherever they went. The facilities are still all here but the majority of the people who staff them are freelance."

In spite of the British film industry's slow demise, Pinewood sustained an enviable reputation for being at, or around about, the forefront of technological changes. After all if the number of films being made on site was dwindling they had to start selling themselves around the world, especially to Hollywood where



**ADR Theatre Five**

budgets would allow for trips to England and use of British technicians.

Looking back Hartstone, a 30-year Pinewood veteran, was rightly proud of Pinewood's achievements. "At the time of the birth of stereo, in the '50s and '60s, we were one of the first to offer magnetic 4- and 6-track. We were first with the 70 mm Dolby divided Surround sound, which was used on *Superman—The Movie* just pipping *Apocalypse Now*. As a result of that we saw the need to record incoming stereo films with separate dialogue and effects in stereo, which was quite an innovation at the time. It meant instead of just one machine that would record dialogue, music and effects, we recorded on three machines, which is the way we chose to do it to get three 4-tracks, or three 6-tracks in some cases if it was a 70 mm release. The main reason we chose the three machines is because the three components could be dealt with separately in case of recutting, it's quite likely you can't put a cut through the effects at the same place as the music, so that proved very useful."

## Pinewood present

Pinewood now is a 'four wall operation', which means film and television productions and television commercials operate with their own crews. The result is that quite a few independent film, TV and associated companies have relocated to the space that had been taken up by permanent staff, David Puttnam has his office here for his own company Enigma. You can see the attraction to independents, the M40 and M25 motorways are a few minutes away and in what other area would you want to be working in the film business in the UK?

Post-production is sited in the main buildings between Heatherden Hall (the main house) and the 007 stage, just to the right of Gotham City—the *Batman* set still awaits the making of the sequel. It consists of three main recording areas Theatres One, Two and Five. Theatres One and Two are the prime dubbing theatres and are of a similar size. Theatre One houses the new SSL 5000 M series film desk replacing a customised Neve music desk earlier this year, Theatre Two has a Theatre Projects desk designed by Sam Wise and installed in 1981, it's the only one of its kind in the world. Each theatre has four multitrack recorders: three main ones, which are used for the main dub, and one which is used if you're all set up with six tracks and you want to make a mono recording. Each theatre has two projectors and up to 17 play-off machines.

When the money for a new desk finally materialised the final choice was based largely on local customer service and modular design. Graham Hartstone: "SSL were already well known to us for their film desks, they allowed us to build up more or less what we wanted with the minimum amount of custom work. Because of their modular system you can have what you want, the size you want and the configuration you want. We also decided on SSL because they're British and local." The 50 miles from Pinewood to Oxford can be judged as being local when you're considering the world market. And the aftersales service was very forthcoming and welcome as the team got used to the new desk.

Theatre Five, a large ADR/effects room, has two Magna-Tech projector systems working on 16 and 35 mm, which, again, is unusual in the industry. "The reason it has two is because when you shoot films on rolls you probably use one roll per reel,

# ScreenSound. A fully integrated audio for video editing suite

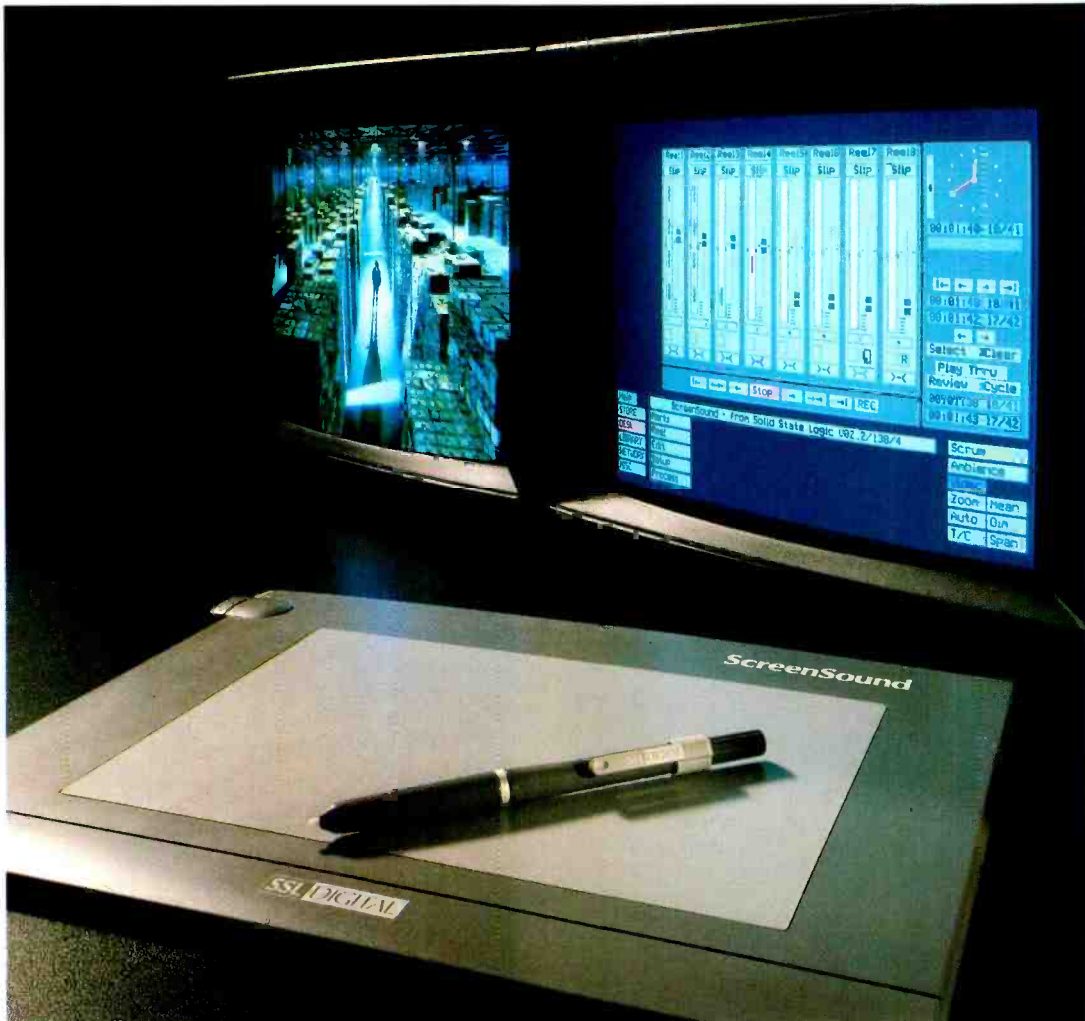

Post production facilities need to take advantage of the efficiency offered by today's technology. Speed and creative flexibility are essential to commercial success. Digital sound quality is no longer a luxury.

ScreenSound is a fully integrated audio for video editing suite. It combines digital audio storage and editing with machine control of multiple VTRs, Laserdisc or film reproducers. It also interfaces with Quantel's digital video editor, Harry.

Simple to learn and fast to use, a cordless pen, tablet and RGB monitor provide control of all ScreenSound functions.

Multiple sound reels enable music,

dialogue and effects to be laid back to picture and synchronised to the exact video frame.

Edit, review, time offset, track slipping, cross fades and many other production techniques are available at the touch of a pen. Gain and stereo pan controls can be automated to timecode.

AES/EBU interfacing keeps digital audio transfers free of analogue distortions and losses, preserving the highest audio integrity through to the final format.

Above all, ScreenSound is a dedicated system - purpose-built to bring the advantages of hard disk sound manipulation to audio post production.

## AUDIO STORE

The hard disk store of sound clips gives title and duration, in addition to powerful search and sort routines.



## SCRUB EDITOR

Provides accurate edit marking and scrub of audio waveform.

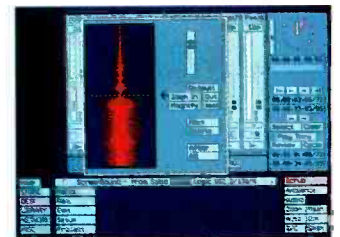

## OPTICAL LIBRARY

An off-line library of sound clips and effects can be compiled on a Write Once Read Many (WORM) optical disc.

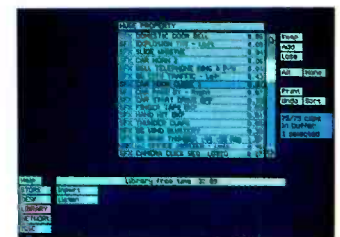

## MACHINE CONTROL

For control of multiple VTRs, laserdisc or film reproducers.

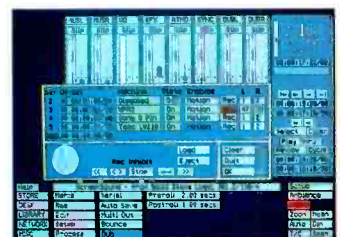

**SSL DIGITAL**  
Solid State Logic

Begbroke, Oxford, England OX5 1RU (0865) 842300

London (01) 706 4948 • Paris (1) 34 60 46 66 • Milan (2) 612 17 20 • New York (212) 315 1111 • Los Angeles (213) 463 4444

• Toronto (416) 363 0101 • Tokyo (03) 5474 1144



**Transfer Suite**

but you might only have one or two lines, in that particular reel, so we're able to work quicker by swapping from one projector to another so the next reel is always ready. You don't have to wind it all the way to 700 ft to shoot a line then wind it all down again on the next reel. That's proved quite a time saver and was a good investment."

Theatre Five is where the Foley work is done and in this world of effects storage on compact disc, hard disk and optical disk its very strange to see thousands of different types of props for effects, it's like an indoor car boot sale. If you still can't find what you're looking for here there's another prop department in the studio.

Downstairs and behind the two main theatres is a transfer suite. Hartstone: "It's a large suite consisting of various bays where we like to consider we can do anything, if we haven't got the equipment we can usually get it in. But the main bulk of the work is on 35 mm or 1/4 inch to 35 mm in the case of rushes. Then for the final stage we have an optical transfer suite where the final print masters are recorded onto a negative, stereo or mono, and sent off to the labs. On top of that we have Theatre Seven, which is quite well known throughout the industry as being a large, luxurious viewing theatre which can screen anything from 16 to 70 mm with 115 luxury seats and a lounge behind for clients."

## Automation

More than anything else feature film dubbing has to encourage creative control. On film desks that means automation that is quick to learn and easy to use. In 1981 Pinewood were first in the UK to commission a desk featuring automation. The Theatre Projects desk was designed with the help of a very detailed brief from the dubbing mixers. Installed in Theatre Two it is the only one of its kind having cost nearly £200,000 9 years ago. The automation covers faders, mutes and panning.

"The desk was custom built because at the time

there really weren't any film consoles they were all customised music consoles, we had a customised Neve console. Sam Wise gave us the opportunity to build what we actually wanted, which has proved very good and has been imitated in some of the designs I see today."

When commissioning the Theatre Projects desk the Pinewood team were careful to look ahead at what might be needed in the future as far as automation was concerned, "We made provision in the software for automating the punching-in but it soon became clear that what was a problem before automation, in other words trying to get your hands everywhere to be able to punch-in and mix at the same time, obviously was eliminated by not having to have your hands on the faders. So you could punch-in anywhere you liked because you always had a level match and your hands were free."

Part of the brief back in 1981 was to incorporate automated panning, something that is still quite rare in automation packages especially for film desks. Hartstone is puzzled at why people don't demand this feature more. "Whatever else happens to a signal it usually travels from left to right the same across the screen because it's fitting the picture. It's a whole area of the dubbing process that you can get out of the way very quickly and being able to build it is probably very much better than doing six things at once."

The SSL desk in Theatre One has the same level of automation as the Theatre Projects desk but has the advantage of the G series computer for instant resets. The choice of the SSL was also made with the inclusion of automated panning in mind. "It has automation of mutes, faders and panning and also the instant reset so all the various setups can be logged into memory and recalled at any time. But it's not *Total Recall*."

Hartstone is happy with the levels of automation he now has, but can it go further? "A lot of people talk about equalisation being automated but the curve of hardware and software goes up dramatically if you add that

amount of controls. The situation is a bit similar to the one of automated punching-in as when you've taken your hands off the faders you've got more creative control for the equaliser. The only other thing I would like automated if it wasn't too difficult would be the auxiliary sends which would be very helpful."

In practice automation allows dubbers to try mix a film one reel at a time, which increases the flow of the dub. "Automation enables us to get a far better overall view of the reel that we're dubbing. There can be a tendency to get awfully bogged down with one little part of a reel, which when you see the reel back you wonder why you wasted so much time on it. We tend to dub in much larger sections, ideally whole reels. If you can get your pre-dubs in such a state that you can get through the whole reel on automation it gives you a far better perspective of the reel but with the accuracy to get in and out and just doctor little bits afterwards. Some directors who aren't used to working that way can get impatient and want to go back straight away to correct things. But you know it wasn't right and you'll put it right on the next pass, it gives you a far better flow right through. You'll spend several runs laying things down on automation 'til you've honed it down to what you think is right. You can have a discussion after every run as to what's still outstanding, then when you've agreed that you're all pretty well there, you put the tape on and go for it. Really what you're doing are minor updates and equalisation. You can then discuss whether you got that right but with the mix stored in the memory it's very easy to go back and dot in and out little parts that you might want to update. If you dub in one whole run you don't get involved with things that aren't worthy of too much time."

## Pinewood future

Having recently witnessed a demonstration of *WordFit* the ADR software from DAR for the *SoundStation II*, Hartstone was suitably impressed with its potential. "I think it's very interesting, it in fact came out a few years ago and we looked at it then, unfortunately the cost was prohibitive. It's greatly improved since the first time I saw it and it was novel to see it used for other things apart from dialogue. The potential for hard disk recording in general is enormous, the problem is in the ideal situation you'll need a lot of these devices and they're very expensive. You'll certainly need one in the theatre because to get out back on to one every time you want to make a change is going to be a pain. I can foresee a situation where you have one of these devices to prepare on and one in the theatre. You can then number crunch overnight or on the spot if things need changing."

Hartstone is confident for the future of cinema and consequently post at Pinewood. He feels that the huge damage the home video market has done to cinema attendance figures is now being patched up and that the threat of home setups incorporating technology like *Surround* sound 4-channel systems is a good thing and not something to worry about.

"What is missing by hiring the video and sitting at home is what I call the 'event factor', you haven't had to make a date with somebody or have got dressed up. I think people miss that and now it's coming back, especially in these multiplex cinemas where you can do other things before going into the cinema." □





**HIRE TO CURE  
YOUR PRODUCTION  
HEADACHES.**

When choosing the right technology becomes a major headache, Hilton Sound's hire service provides the perfect remedy.

With over ten years behind us – and the biggest selection of equipment in Europe – we make it our business to know all there is to know about audio. Our resident experts can prescribe the ideal synchronisation solution. Or help you select the most suitable recording medium, be it analogue, digital tape or hard disk. And when it comes to signal processors and microphones, we offer a wide array of collector's items, alongside the latest and best.

Hiring doesn't just defer a buying decision, it's

frequently more cost-effective. So give Hilton Sound a call if you want objective advice. We're not saying we're the universal panacea for all production and post-production ills, but it makes sense to check out the options before you apply the cure.

**HILTON**  
**SOUND**

HILTON SOUND PLC

10 Steedman Street London SE17 3AF. Tel: 071-708 0483  
Hilton Sound sarl 2 Villa Ghis 92400 Paris. Tel: +331 46 67 02 10

**PIONEERS IN AUDIO ACCESSIBILITY**

**Our advertising agency said  
 "You can't say everything about  
 the PCM-3348 in one ad."  
 ...this time they were right.**

ADVERTISING BRIEF PCM 3348

OBJECTIVES

- ① ESTABLISH 3348 AS ULTIMATE MOST DESIRABLE MULTI-TRACK.
- ② DEMONSTRATE 3348 AS A CREATIVE TOOL (NOT JUST A RECORDER).
- ③ POSITION 3348 AS PREFERRED ALTERNATIVE TO 32 TRACK RECORDERS.
- ④ REINFORCE SONY POSITION AS MARKET LEADER.
- ⑤ EMPHASISE COMPATIBILITY WITH OTHER DASH DEVICES.

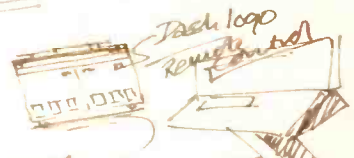

- JUS
- ① DASH
  - ②
  - ③
  - ④

PCM 3348

- \* 48 track digital audio
- \* DASH format
- \* Most sophisticated on market
- \* The only 48 track production model.
- \* Market: AUDIO RECORDING STUDIOS (SONY is the major supplier of Digital recorders)

KEY FEATURES

- \* Outstanding high-speed transport system (mechanical clutch between capstan motor)
- \* Digital 'ping pong' (auto reverse)
- \* Sound memory function

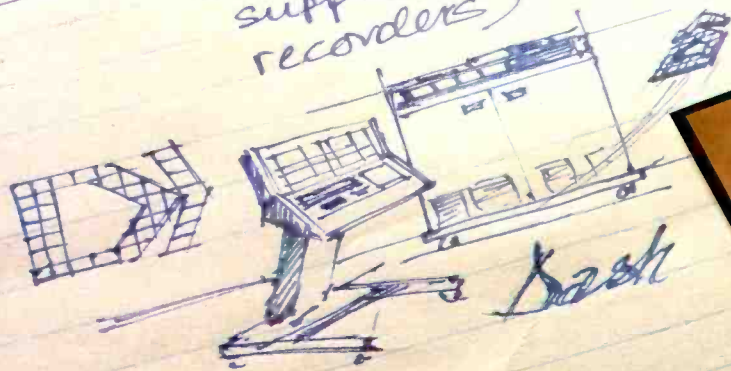

**SONY**

For further information contact:  
 Athens 2818273 Basingstoke, UK 0256 474011 Brussels 7241711 Cologne 59660 Copenhagen 995100 Dubai 04-373472  
 Helsinki 50291 Jeddah 6440837 Lisbon 573046 Madrid 7290988 Milan 02 6128221 Netherlands 02968 81215 Oslo 303530  
 Paris 49454000 Rome 06 5920139 Stockholm 7736100 Vienna 61051 Zurich 7333311 Eastern Europe - Vienna 554606  
 Middle East - Geneva 336350 Africa - UK 0256 55011 Headquarters - Basingstoke, UK 0256 55011

DASH WORLD

# SH climbs

of "DASH WORLD" confirmed that Sony has just scored most of...

SONY  
PCM 3348

RECORDER RECORDERS OUTSELL OTHER MAJOR  
WAYS BY 3 TO 1.  
48 HAS MORE FEATURES, FASTER, BETTER SOUND  
PERFORMANCE, MORE TRACKS THAN COMPETITION.  
UNRIVALLED REPRESENTATION IN PRO AUDIO (& VIDEO)  
SONY DEDICATED TO PRO AUDIO  
SONY COMMITTED TO DASH (LONG TERM)  
AESTHETICS: 3348 IS ~~NOT~~ LOOKS THE BEST.

**RESPOND FOR DEMO**

IMPORTANT

### USER BENEFITS

1. Faster throughput
2. Full compatibility with other 24/48 track machines.
3. Creative tool for innovative engineers.
4. Revenue earning investment.

Digital Audio Products  
PCM-3348 Digital Audio Multi-channel Recorder

tape  
digital  
copster  
to SONY)  
bars.

348

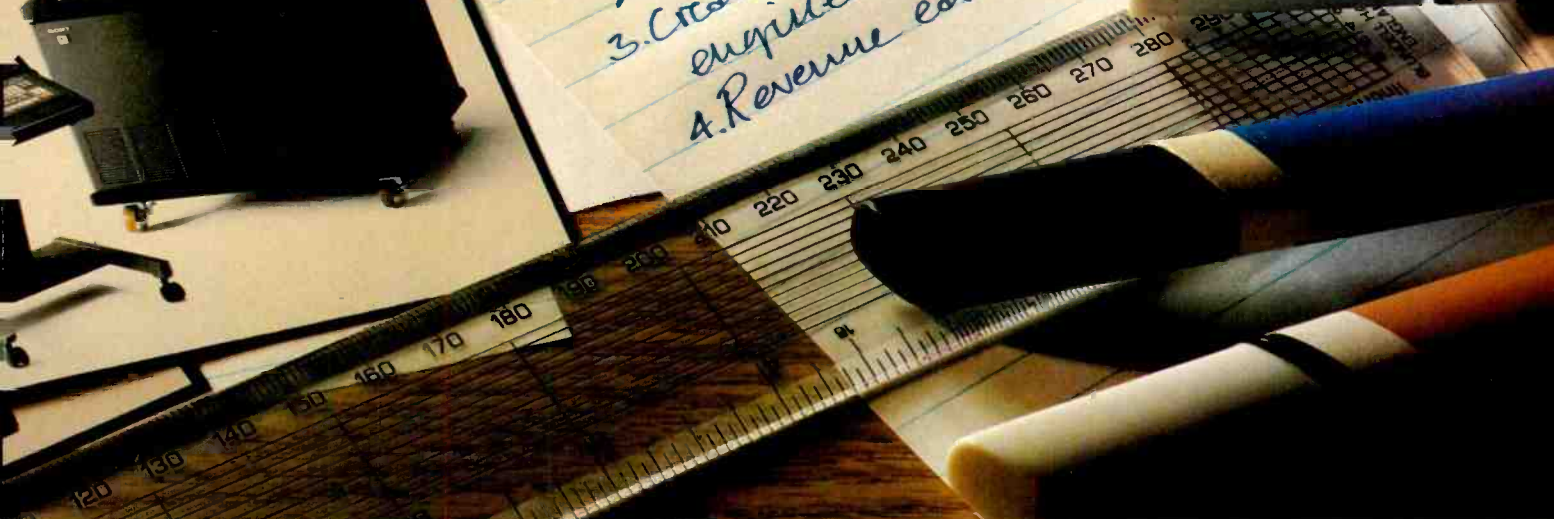

# APRS PREVIEW

This year's annual exhibition of the Association of Professional Recording Studios will be held at Olympia 2, Olympia, London from June 6th to 8th. As usual we have compiled a preview of the exhibits from information available to us at the time of writing. Studio Sound will be exhibiting in conjunction with sister publications One to One and Broadcast Systems International. Both editorial and advertising staff will be in attendance at the stand and around the show

## A

● **Agfa Gevaert:** details of the complete range of Agfa audio and video magnetic tape products. Audio *PEM 468* and *469*, high output, low noise and low print is available for all formats. Agfa also offer VHS; Super VHS, U-Matics, Betacam and Betacam SP video cassettes. ● **Akai:** featuring APRS debut of the *DD1000* optical disk recorder/editor, offering stereo recording of up to 50 mins at 48 kHz. 4-track playback is also included giving the *DD1000* applications in the audio/visual field. Also featured will be the *DL1000* a remote controller for the DD unit. ● **AKG:** One of the AKG stands will be devoted

this year to the launch of the *DSE 7000*. This digital spot editor will be demonstrated each hour during the 3 days of APRS. AKG's second stand will feature headphones, talkback systems, dbx pro-audio products and a new radio microphone system from db Technologies. ● **Alice:** on show will be the new *AIR 2000* on-air desk featuring advanced opto-isolated machine control logic, low noise, off air record bus and modular design. Also details of Alice's turnkey studio installation service. ● **Allen & Heath:** will be showing the latest version of the Saber series console with 24 monitors and 24-track patchbay and the Saber Matrix PA version. Also on show for the first time will be the latest version of *SC Plus* with 4x4 output matrix and the new auxiliary with

talkback, oscillator and playback facilities. Established products include the *Sigma 24*-bus in-line recording console and *Scepter* rackmount 12-channel 20-input version of the *SR plus* sound reinforcement console. ● **Amek:** showing the *Mozart* console featuring the Amek/Steinberg *Supertrue* automation with the Cuelist enabling console switch changes, MIDI events and other events to be triggered from timecode; first European showing of the new *Medici* equaliser designed by Rupert Neve in conjunction with Amek. Features include two separate control paths, each containing a 4-band parametric equaliser with high and low pass filters. Bands from one path may be switched into the other allowing a single 8-band equaliser. Also on show will be the *Classic* console available in frame sizes from 32 to 64 inputs with the option of GML automation system; *BCII* console; *G2520* master production console; *Angela* multitrack console. TAC will be showing the new version of the *Bullet* recording console designed for 16-track work and offered in a 24/8/2 format and the *Magnum* console making its APRS debut. The *Magnum* is a 24-bus in-line recording console.

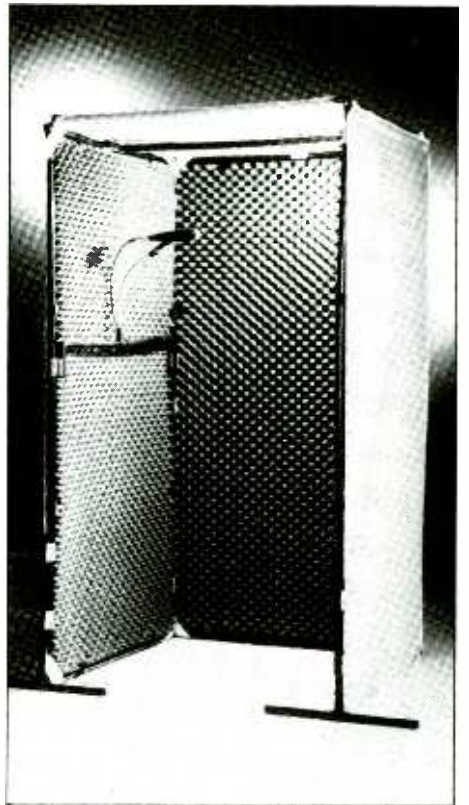

Soundforms modular, portable sound booth



Ampeg 478 low print mastering tape

● **Ampex:** will be showing their range of pro-audio tape products including *456 Grand Master*; *467* digital open reel and digital cassettes; *406/407* audio mastering tape; *478* low print mastering tape; *472* studio audio cassettes; and *467* DAT tape. ● **AMS:** will be showing the *AudioFile Plus* with read/write magneto optical back-up/archive subsystem. Also the *Logic 1* automated digital audio mixing. ● **APRS:** Association of Professional Recording Studios. ● **APT:** showing examples of the data compression technology *APT-X*. ● **Armon:** showing the Alps product range. ● **Audio Design:** will be showing the latest developments of the *Soundmaestro* editing system and all the *Probox* digital interface units. Audio Design have developed a system for locking standard R/DAT

# It's Time To Rack Up Another Hit.



It's hard to follow a great act. Expectations run high. The performance must be flawless. When we decided to carry the legacies of our LA-2A, LA-4 and 1176LN into the next generation, we knew exactly what we were getting into.

Our new 7110 Limiter/Compressor incorporates the characteristics of its predecessors, is the natural addition to a legendary line and has all the potential to become a major hit in its own right. The 7110 combines both peak and average limiting action, producing smooth, predictable RMS style performance like the LA-2A and LA-4 with the precise automatic peak control of the 1176LN.

The 7110, with our exclusive program dependent Smart-Slope™, gives you adjustable compression curves from 1.5:1 through infinity:1. You set

threshold, attack, release time and output level – the 7110 automatically rides the gain with split second response.

To make set-up as simple as possible, we've included an Automatic Preset function. Punch the button on the front panel – the 7110 automatically defaults to program dependent attack and release times, and presets the peak threshold and ratio to consistently used settings. Perhaps the best news of all, the 7110 produces crystal clean sound and is virtually transparent.

Just another limiter/compressor? We don't believe so. After you've heard it for yourself, we think you'll agree. Stop by your local JBL/UREI dealer and give it a listen. And, get ready to rack up another hit.



*The 7110 combines the smooth predictable RMS style performance of the LA-4 with the precise automatic peak control of the 1176LN.*



JBL Professional  
8500 Balboa Boulevard, Northridge, CA 91329  
© 1988 – JBL Incorporated A Harman International Company

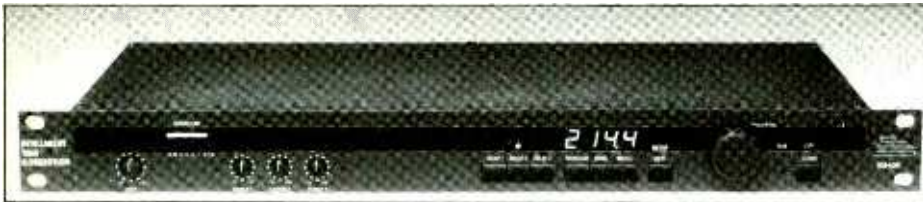

**BSS TCS-803 multitrack time corrector**

recorders to timecode for CD mastering and PQ coding when working in conjunction with hard-disk editing systems. Using the replay unit CD plants could now cut direct from R/DAT coded tapes. An update on the Prodat 1A now provides an optional RS232 computer interface port and the ability to select INT/EXT EBU synch; the new unit will be shown recording CDs with the SPOT-90 CD direct cut Reference Mastering system. ● **Audio Developments:** portable mixers, portable processors and a digitally based editing system. ● **Audio Kinetics:** demonstrating the console Component Automation range and ES Lock machine synchronisation and control products. Products on display include the Reflex and MasterMix II retrofittable automation packages being shown for the first time with moving faders as an option. ● **Audix:** will be concentrating on the new ACC Series Audio Mixers. ● **ASC:** new products include the ASC 'Cart' Remote for the ASC Broadcast CD player which gives the CD player easy cue and recall facilities of a cart machine. New CD Jukebox control software includes DATA-FX for selection and preview of digital sound effects from CD libraries. Discstar, a PC based software for continuous play from CD's placed in categories and linked to realtime. ● **Autograph Sales:** as European distributors of Meyer Sound Autograph sales are showing for the first time in the UK the HD-1 high definition monitors. The HD-1 is a bi-amplified system comprised of proprietary 8 inch woofer and 1 inch dome tweeter in a vented enclosure. Also on exhibition are Summit Audio's vacuum tube signal processors, as well as products from Klark-Teknik, BSS, Lexicon, Micron Radio mics and Saje MEMORY console. ● **Avcom Systems:** showing the complete range of cassette duplication equipment from Telex. ● **Axis:** will be showing Digidesign's Sound Tools hard disk editing system; the Allen & Heath Saber 16- and 24-track console; Tascam's MSR-24 1 inch multitrack; and some new generation DAT machines. Also Soundforms' portable, modular vocal booth will be on display.

## B

● **BASF:** professional audio and video tape, cassettes and calibration tapes. ● **Beyer Dynamic:** new products include the first showing in the UK of the MC742 stereo condenser mic. The MC742 has five different polar patterns which can be changed either manually or via remote control. Beyer will also be showing their M&S combination unit, the MS-1 comprising the M160 and M130 ribbon mics complete with high wind gag and pistol grip for application in film and OB stereo recording. ● **Britannia Row Sales:** will be showing the Westlake BBSM studio monitor and finished ranges; Ramsa mixing consoles; Crest power amps; HowTech phase chaser; Amek consoles; AEG tape machines; Aquarius cartridge machines; Sonosax mini consoles. ● **BRPG:** British Record Producers Guild. ● **Bruel & Kjaer:** exhibiting the new 4012

microphone and the entire range of B&K mics and accessories. ● **BSS Audio:** new products include the DPR-901 dynamic equaliser which integrates parametric equalisation with dynamic expansion and compression; the TCS-803 dual time corrector uses BSS' own D/A converter technology for programmable digital delay; the TCS-804 dual time corrector also provides stereo, dual-tap delay processing with advanced control and remote functions. Established products include DPR-502/4 dual MIDI and quad noise gates and the AR-series of DI units and accessories.

## C

● **Cadac:** demonstrating the 'E' type console with a new automation featuring motorised system faders, which Clive Green & Co have designed. ● **Calrec:** will be exhibiting the new Compact series mixer and VT edit mixer together with a minimixer and an M series desk. The Compact mixer is a new range of broadcast consoles designed for OB trucks and studios. The VT edit desk comprises 10 stereo line channels each with 3-band EQ, HF and LF filters, one stereo auxiliary and full stereo width controls. ● **Canadian Instruments:** representing a wide range of US, Canadian and Far East manufacturers in the UK. ● **Canford Audio:** new products now added to Canford's large list include the MB range of studio mics, the Timecode Calculator, radio mic pouches, the Canford diecast speaker and CD and Betacam tape storage racks. ● **Cedar:** featuring the first public showing in the UK of the CEDAR (Computer Enhanced Digital Audio Restoration) Production System. Also details of recent CEDAR contracts. ● **Cetec International:** examples from the range of duplicating systems and loudspeaker drive units. ● **Chilton:** showing a new family of broadcasting/production consoles. Many frame sizes are available with various facilities as balanced busing, comprehensive EQ and 24-track monitoring. Consoles are finished in a solid teak surround and leather bound front. ● **Citronic:** exhibiting their range of PPX amplifiers, MPX mixers and SPX signal processors. The PPX line of power amplifiers now supports two convection cooled models PPX150 and PPX300 for driving reference monitors. ● **CST:** no information available. ● **Cunnings Recording Associates:** specialist supplier and manufacturer of professional tape recorders.

## D

● **Dyer Audio Systems:** products from Eela Audio. ● **DDA:** featuring two new products on the stand. The DMR12 is a new 24-track recording console aimed at the small 24-track studio, programming suite or private studio. It features 56 modules and patchbay that take up just 2.2 m (85 ins). Also a way of bringing effects returns back into the stereo mix without using the main channel signal path. The console can offer 112

## TASCAM European Distributors

Hi-Fi Stereo Center Kain  
Muenchner Bundesstrasse 42,  
5013 Salzburg,  
AUSTRIA.  
Tel: (0662) 37701

Beltronics  
Rue de la Celidee Straat 29,  
1080 Brussels,  
BELGIUM.  
Tel: (32) 2 424 0233

So and Hoyem A/S,  
Bulowsgarden,  
Bulovsvej 3,  
1870 Frederiksberg C,  
DENMARK.  
Tel: (031) 22 44 34

Studiovox Ky,  
Atomitie 5C,  
SF-00370 Helsinki,  
FINLAND.  
Tel: (80) 562 3411

Teac France Sa,  
17 Rue Alexis de Torqueville,  
92182 Antony,  
FRANCE.  
Tel: (01) 4237 0102

Eliana SA,  
59/59A Tritis Septemvrious St.,  
Athens 103,  
GREECE.  
Tel: (01) 8220 037

Greenlands Radio Centre,  
PO Box 119,  
3900 Godthab,  
GREENLAND.  
Tel: 299 21347

GBC Italiana spa,  
Viale Matteotti, 66,  
Cinisello Balsamo, Milan,  
ITALY.  
Tel: (02) 618 1801

Hjodriti - Hot Ice,  
PO Box 138,  
Hafnarfirdi,  
ICELAND.  
Tel: (01) 53776

AEG Nederland NV,  
Aletta Jacobslaan 7,  
1066 BP Amsterdam,  
NETHERLANDS.  
Tel: (020) 5105 473

Audiotron A/S,  
Seiduksgt. 25,  
PO Box 2068 Grunerlokka,  
0505 Oslo 6,  
NORWAY.  
Tel: (02) 352 096

Goncalves,  
Avenida 5 de Outubro, 53, 1,  
Lisboa 1,  
PORTUGAL.  
Tel: (01) 544029

Audio Professional SA.  
New address for contact:  
Auprosa,  
Francisco Tarrega, 11,  
08027 Barcelona,  
SPAIN.  
Tel: (93) 340 2504

Erato Audio Video AB,  
Asogatan 115,  
116 24 Stockholm,  
SWEDEN.  
Tel: (08) 743 0750

Tellion AG,  
Rutistrasse 26,  
CH. 8010 Zurich,  
SWITZERLAND.  
Tel: (01) 732 1511

Teac Deutschland GmbH  
Bahnstrasse 12,  
6200 Wiesbaden-Erbenheim,  
WEST GERMANY.  
Tel: (06121) 71580

## TASCAM

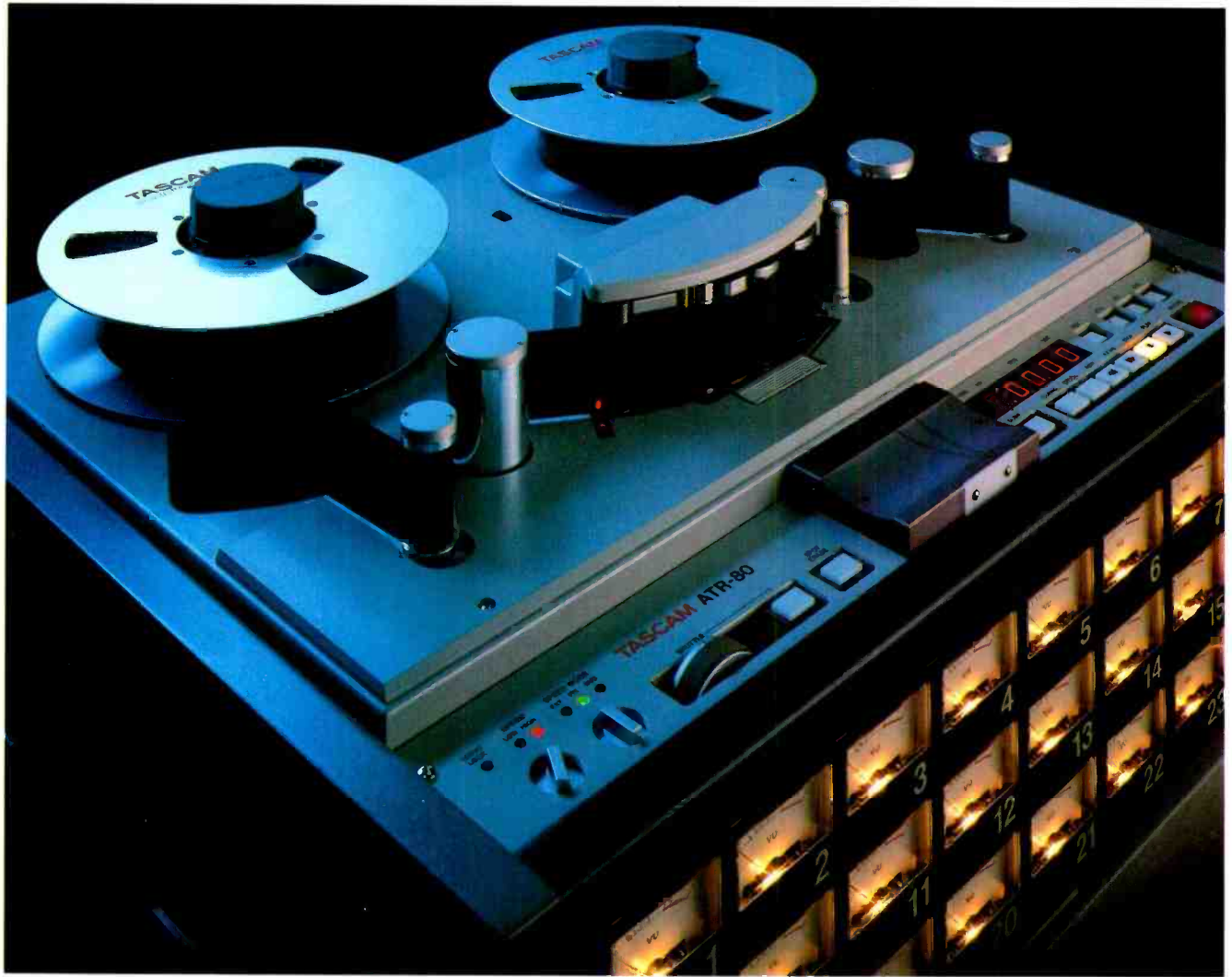

## THE VERY LATEST TECHNOLOGY IN 24 TRACK RECORDING IS GOING TO COST YOU LITTLE MORE THAN A FEW MISCONCEPTIONS

You may think you know which 24 track recorder gives you the most advanced technology and design. However, you're probably in for a surprise.

It's the TASCAM ATR-80.

The ATR-80 is an engineer's dream. It has features that make track-laying and mastering faster and easier than it's ever been in a 2-inch 24 track format.

Just look at the speed. Unique samarium-cobalt magnets in the ATR-80 motors produce immense torque at the capstan and allow the reels to shuttle at a lightning 380 ips. Synchronising to video, the lockup time is limited only by your other equipment.

With our 30 years' experience in the design and manufacture of our own unique heads behind it, the ATR-80 achieves superb sonic performance. Full playback response in both the repro and sync heads allows track bouncing operations with no

loss in sound quality. Special circuitry provides for transparent punch-ins and completely gapless and seamless edits.

There's only so much of the ATR-80 that can be described in features. To fully appreciate the excellence of this machine you must lay your hands on the controls.

That's when you will sense the craftsmanship and quality of its design. The transparency and accuracy of its sound. The power, speed and the smoothness of the transport.

Try the TASCAM ATR-80 – all that it will cost you are your misconceptions.

You won't miss these one little bit.



# TASCAM

Teac UK Ltd., 5 Marlin House, The Croxley Centre, Watford, Herts WD1 8YA Tel: 0923 225235 Fax: 0923 36290

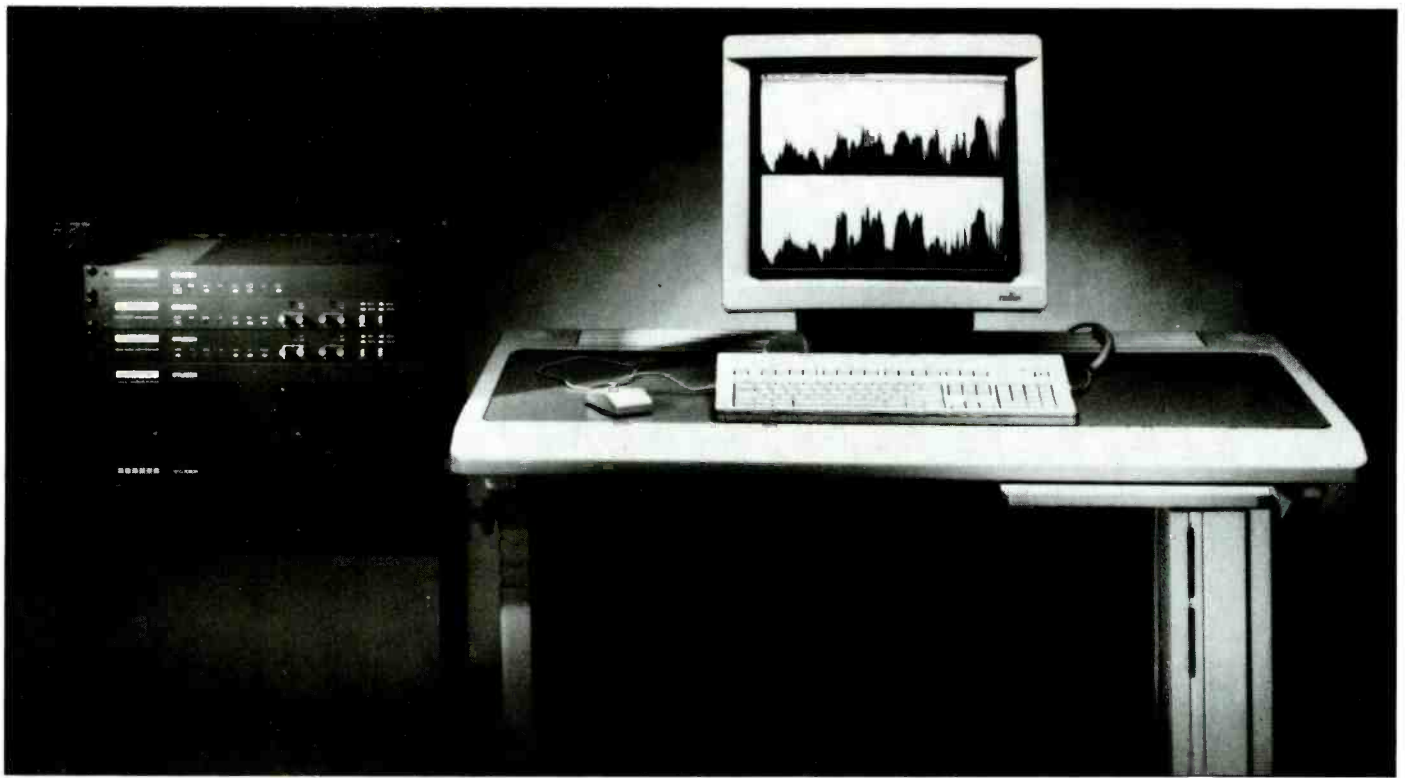

Studer Dyaxis

inputs on mixdown, or 56 dedicated effects sends and returns. The other new product, the *DCM224V*, is a development of the *DCM232* aimed specifically at the post-production facility. Main features include 24-track busing with additionally 4 stereo subgroups, 4/8-track monitoring and mono/stereo matrix sections. The *DCM224V* will be shown in combination with Alpha Audio *BOSS 2* editor systems. Other consoles on show will be the *AMR24*, the *S* and *D* series range, and the *Arena* sound reinforcement consoles in F-O-H and monitor formats.

● **Digigram**: no information available.  
 ● **Digitech**: showing new products *IPS 33B* Smart Shift harmoniser and *DSP 256* multi-FX unit, both of which can be used in conjunction with the *FX17* continuous voltage controller and *PDS 3500* MIDI programmer. Also new are the *820* and *1220* mixers available in standard, line only and rackmounting versions; the *BHM4* Bass Harmony machine; the *MEQ* MIDI programmable graphic equalisers. ● **DAR**: demonstrating the *Soundstation II* and launching two as yet unknown new products at APRS. Two new software enhancements for the *Soundstation II* are

multichannel drop-in which operates in a similar manner to a normal tape recorder and Autolocation System which enables the user to select and return key points in audio and video programme material or to jump to pre-determined programme points in one keystroke. ● **Dolby**: will exhibit their range of analogue and digital audio signal processors. Processors on show will include the new *MT* series and *400* series multichannel units; the new Model *500* digital audio processor and the *SDU4* Dolby surround decoder. ● **Philip Drake**: showing for the first time the *2000* series audio console designed for the broadcast market. Also new the *5000* series stereo audio monitoring and correction equipment providing broadcasters with a means of checking and correcting the integrity of a given signal; the *6000* series microprocessor controlled talkback system in a 4U rackmount and interfacing for up to 16 external sources. ● **Drawmer**: showing two new products, the *DL241* Auto-compressor a new dual gated compressor/limiter incorporating automatic functions like an auto-attack expander/gate with 'auto-ratio' circuitry to prevent chatter on or around threshold; and the

*DS301* dual expander/noise gate which offers auto attack, peak attack, balanced inputs and outputs, and programmable MIDI channels.

## E

● **Eardley Electronics**: showing the full range of Neutrik connectors, test instruments and the Neutrik *A1* audio test and service system.

● **Eastlake Audio**: will be displaying photographs of recently completed recording facility projects in the UK, Europe, Middle East and Far East. Design and construction of future projects will be discussed on the stand by company staff. ● **Elliot Brothers**: will feature a new range of Pearl microphones for MS stereo applications. Also NTP have introduced a new switcher system, *612* series, which is half the size of the previous *512* series. Also details of installation and project management including the recent move of LBC Crown Radio from The City to Hammersmith. ● **EMO Systems**: will be showing an expanded range of stage and studio ancillaries including a new microphone combiner. A machine power supply will be launched at the show which is designed to provide comprehensive information on the power source in both single and three phase applications. The unit will indicate voltage, frequency and current consumption.

## F

● **Focusrite Audio Engineering**: demonstrating the Focusrite Studio Console. ● **Formula Sound**: will be demonstrating their *System 2000* modular mixing console for radio stations and live use. Also on show will be the *AMX6* 6-channel mixer and *PM-80* mixer. Established products include the *Que-8* headphone foldback system. ● **Fostex**: UK debut for the *D-20* edit control system based around the *4030* synchroniser and consisting of two user definable application packages for use on the Apple *Macintosh*; the *8320* remote control offers all the features of the *D-20* front panel and

## STEREO STABILIZER 5

APRS STAND 19



- Rack mounting frequency shifter for howl reduction in public address and sound reinforcement
- Mono version, box types and 5 Hz fixed shift boards Mark 5 also available

**SURREY ELECTRONICS, The Forge, Lucks Green, Cranleigh, Surrey GU6 7BG**  
 Tel. 0483 275997 ★ Fax. 276477



# Now Dolby SR is as easy as one, two, three.



New MT Series

## 1. Switchable Dolby SR A-type NR

With both new models you can select either Dolby SR or A-type NR for any or all channels. You save time handling tapes from different sources, because you don't have to switch cards.

## 2. Fast, reliable automatic alignment

Software control enables these new units to align themselves automatically in seconds. There's no need to adjust pots, or manually compensate for variations between reels of tape. You get the same accuracy as before, but in a fraction of the time.

## 3. Channel grouping

For multitrack and multi-machine use, you can allocate any number of channels to separate groups. The groups align and function independently, and can be assigned different operating modes.

With Dolby SR, analogue is again becoming the preferred recording medium. Dolby SR dramatically expands analogue's dynamic range while preserving its natural sound and cost effectiveness.

Using Dolby SR is now easier than ever, with the new Dolby MT and Model 400 Series. The MT handles up to 24 channels; the Model 400, up to eight. In multitrack, post-production, and mastering applications, their new features save time and boost productivity.



New 400 Series

So now you have a choice. When time and flexibility are of the essence, there's the new Dolby MT or Model 400 Series. For economy, there's the familiar Dolby XP or Model 363 Series.

Either way, Dolby SR is the sound investment for analogue recording. For further information and a demonstration, contact your Dolby professional products dealer.

Dolby Laboratories Inc. • 100 Potrero Avenue • San Francisco, CA 94103-4813 • Telephone 415-558-0200 • Telex 34409 • Facsimile 415-863-1373  
346 Clapham Road • London SW9 9AP • Telephone 01-720-1111 • Telex 919109 • Facsimile 01-720-4118

Dolby and the Double-D symbol are trademarks of Dolby Laboratories Licensing Corporation. ©1989 Dolby Laboratories Inc.

S89/8776



INCH AFTER INCH,

SESSION AFTER SESSION,

THRILL AFTER THRILL.

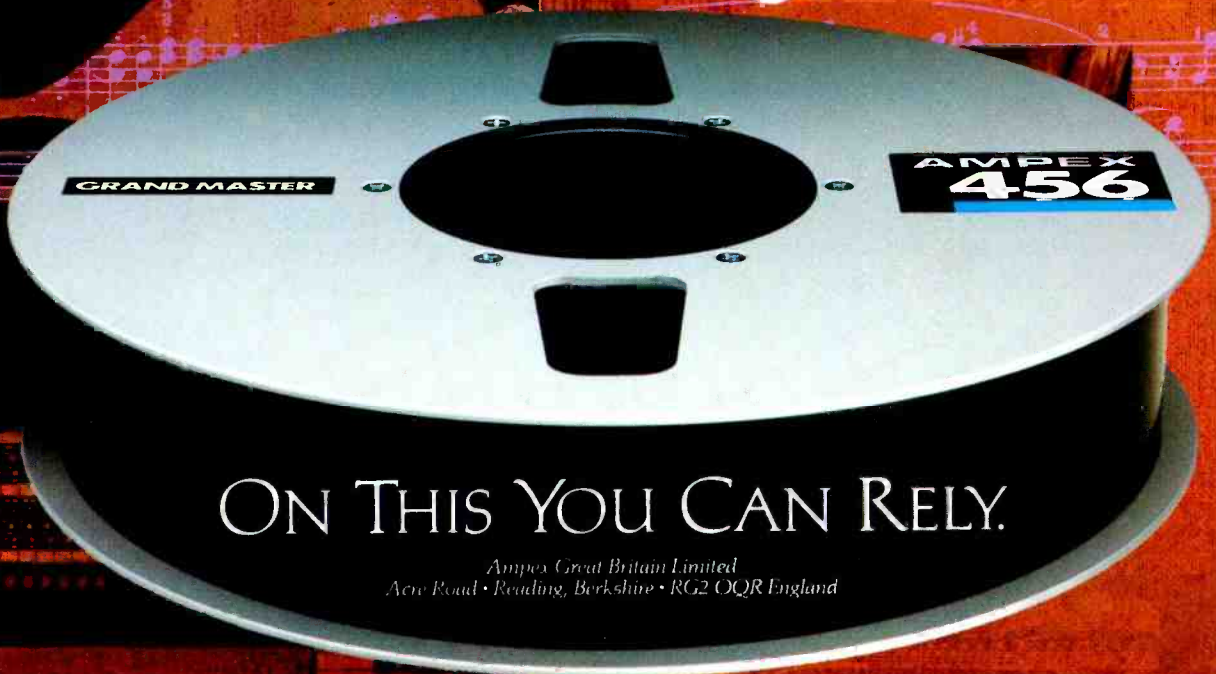

ON THIS YOU CAN RELY.

*Ampex Great Britain Limited  
Acce Road • Reading, Berkshire • RG2 0QR England*

Spiritos

[www.americanradiohistory.com](http://www.americanradiohistory.com)

more. Other functions include the ability to write, read and edit IDs and program numbers; start and skip IDs can be automatically recorded and finely adjusted by frame and SMPTE/EBU timecode can be viewed on a dual function LED display; the *G16* ½ inch 16-track recorder is a successor to the *E16* and has an optional built-in synchroniser allowing the *G16* to chase SMPTE from an external machine and respond to MIDI commands and MIDI timecodes; the *MTC1* interface offers an 80-track machine MIDI implementation and integration with the latest recording software. Also new is the *812* production mixer with MIDI and the *4020* event controller. ● **Future Film Developments:** new products include hearing protectors and headsets; sound pressure level meters; portable broadcast-quality mixer; small monitor loudspeaker and compact VITC timecode reader/inserter. Existing products include patching systems, connectors, cables and winders. **FWO Bauch:** first UK showing for products include the Studer *D820-48* digital multitrack recorder; Studer Editech *Dyaxis* hard disk digital editor with video follow; the Sonic Solutions *Start Lab* recordable *CD Maker* working directly with Sony CD recorder for reference CD manufacture; Lexicon *Opus/e* low cost version of the *Opus*; Neumann *GFM132* Boundary Layer Microphone; ITC *Premium* range of budget cart machines; and gtc's *MSE* multi-control system and Edicom *ADR* system.

## G

● **Goutam Electronics:** are launching two new consoles, the Aries *Astrid* Monitor and Aries



JBL SB1 and SB5 sub bass units

*Artemis* 12-bus each available in 24-, 32- or 40-channel configurations. Each model offers 4-band sweep EQ, 8 aux sends, channel mute and mute bus and balanced outputs.

## H

● **Harman UK:** JBL will be launching a complete new range of JBL amplifiers, Vented Cap Cooled

speakers and Sound Power series cabinets, together with a new crossover component and further additions to the acclaimed Control Series compact loudspeakers. The *JBL 6300* amplifier range consists of four units designed specifically for the European market complying with the EEC regulations laid down by European safety agencies. Intended for the touring market conventional binding posts have been replaced by Neutrik 4-pole *Speakon* connectors and the units

# Drawmer

D F 3 2 0  
universal noise filter

## ONLY CONSPICUOUS BY ITS ABSENCE

As more and more studios turn to the digital mastering medium it is essential that material leaving the analogue multitrack recorder does justice to the wider dynamic range of the digital format.

The Drawmer DF320 is a sophisticated, dual channel, single ended noise reduction system which requires no previous encoding and subsequent decoding of the audio signal.

A dynamic filter, with a unique 'frequency-tracking' Auto mode, combines with a comprehensive auto-attack expander to provide dramatic noise reduction regardless of programme source, in a wide variety of recording/broadcast situations.

Drawmer Distribution, Charlotte St Business Centre, Charlotte St, Wakefield, W. Yorks, WF1 1UH, England.  
Tel: 0924 378669 Telex: 556649 Fax: 0924 290460



**Akai DD1000**

are fitted with an RS422 connector which allows remote control with VCAs. The new JBL vented-gap-cooled speakers have been designed for high powered sound reinforcement, touring and installations. The new JBL 4700A Sound Power Series features the new VGC speakers which improve output capability. ● **Harrison Information Technology:** full range of power amps. ● **Hayden Labs:** showing products from Sennheiser, Nagra and Denon including the Sennheiser *Black Fire 530* mic, *WM-1* portable wireless mixer which permits the signals from up to four wireless mics and one wire bound mic to be mixed prior to transmission to a base station, and a *SER 20* wideband transmitter. From Nagra comes the *Nagra-D* digital recorder and *YMSA 18* noise reduction system. Denon are showing the *DN 970* CD cart player. ● **HHB Communications:** new products from new ranges supplied include the *Stelladat* range of DAT machines; the *Aiwa HDX1* miniature portable

DAT recorder and the Sony *TCD-D10* Pro portable complete with HHB's 48 V phantom power modification. Also new will be Akai's *DD1000* optical disc recorder; the Gentner range of broadcast products, the new *Quad 240* power amplifier and new amps from Amcron. ● **HH Electronic:** complete range of amplification products. ● **Hill Audio:** showing the *Mix* series consoles, a range of 19 inch rackmount mixers, the *Minimix 16/2*, *Multimix 16/2*, *12/4/2* or *16/4/2*, *Omnimix 20/8/8/2*; the *Datum* series modular console range on show for the first time in the UK with 4, 8 and 12 bus versions for recording, sound reinforcement or on stage monitoring in 5 frame sizes; *Concept* series consoles *200* and *400* series; and *LC* and *000* amplifiers featuring two ranges of 8 studio reference power amplifiers with output powers of up to 3 kW. ● **Hilton Sound:** with details of their rental service with bases in London, Paris, and Hilversum, Holland. Equipment list now offers hard disk systems as

well as *DASH* and *PD* tape machines. ● **Home & Studio Recording:** UK home recording magazine. ● **HW International:** new products from Shure microphones include the *VP88* stereo microphone, the first stereo mic to be launched by Shure. Carver are introducing a new range of six amplifiers which completely supersede the existing models. All these amps employ the Carver magnetic field principle which allows for high-power, low-weight units. Other products to be launched will be the range of audio mixers from db Technologies.

## K

● **Kelsey Acoustics:** will be launching two new product ranges at the show from new UK manufacturer Rocktorch. Pro-series products include the *SA-31* 30-band spectrum analyser, the *SA-316* digital delay unit and the *PE4* 4-band parametric equaliser. Also from Rocktorch are the new Kelsey range of studio orientated valve products including the *V-1* valve microphone preamplifier, the *V-2* valve equaliser and the *VD1* valve DI box. Established products include the range of patchbays from *Isotrack* and the new range of XLR patch panels, also the range of Kelsey connectors and cables will be displayed featuring the new Kelsey *D* series stagebox system. ● **Kemps:** audio and video directory. ● **KFA:** will be announcing and demonstrating their new innovations in studio design. They're introducing a variation on modular design for larger studios called *The Production Suite*. The new concept incorporates many aspects of *The Box* philosophy but on a much broader scale. Also on



# Dynamic Processing Has Reached A New Peak.

The name Klark-Teknik has always been synonymous with audio technology at its highest level. Innovative engineering combined with quality components ensure products of outstanding musical purity and durability.

Now, that same commitment has been brought to dynamic processing. With the new Series 500.

The DN500 is the only two-channel compressor/limiter/expander that lets you use its processing functions in any combination — with full function variable knee compression, independent peak limiting and clipping. Plus a variable ratio expander/gate for total dynamic control.

Most importantly, it delivers all the clean, quiet sound quality and reliability you'd expect from Klark-Teknik.

The same high standards are common to all Series 500 products — from the compact DN504 Quad Compressor/Limiter, to the flexible DN510 Dual MIDI Noise Gate and DN514 Quad Auto Gate.

If you're looking for the ultimate in dynamic processing, visit your local Klark-Teknik dealer and find out more about the Series 500. Because at Klark-Teknik, we never set a limit on quality.



Klark-Teknik Research Limited  
Klark Industrial Park, Walter Nash Road,  
Kidderminster, Worcestershire DY11 7HL, England.  
Tel: 05621 741515

Klark-Teknik Electronics Inc.  
308 Bant Plaza North, Farmingdale,  
N.Y. 11735, USA.

Klark-Teknik (Singapore) Pte Limited  
7500A Beach Road, 05-305 The Plaza,  
Singapore 0719

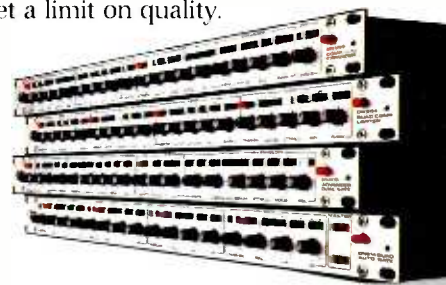

# A ROOM OF MY OWN: MIKE HEDGES

Mike Hedges, a producer with some of the most influential albums of the last decade to his credit (including work with Siouxsie & The Banshees and The Cure) is now firmly committed to working with the Akai Digital Audio Multi-track (A-DAM) in his set-up. At his "home" studio in North West London, Mike has 28 tracks at his disposal, combining an early 70s 16 track analogue machine and a DR1200, of which he has become a firm fan over the last year.

Mike Hedges first saw A-DAM at the AES show, and his interest was stimulated enough to contact Akai to arrange a test of the machine. "Within 24 hours of working with it, I knew that A-DAM would be right for me. It fitted in exactly with what I was looking for—a digital machine with the precision I needed, which is very good value for money. I wouldn't say it's cheap—it's an expensive machine, and it does an expensive job—but relative to other digital machines it's extremely good value."

As well as being a good investment from a financial point of view, the machine had a number of features which made it a very attractive proposition. "Drop-ins and drop-outs are fantastic, especially if we're multi-tracking backing vocals and things like that: we can do that on twelve tracks absolutely cleanly. For instance, you can drop in and out in the middle of words without any difficulty, it's so precise. A lot of people think the Mitsubishi is unbeatable, and it is very good for dropping-in and out, as is the Sony, but this matches them easily—it's perfect. How can you get better than that?"

Things have not been entirely plain sailing, however: Mike had some early problems



*Mike Hedges at "home" with his EMI desk (formerly installed at Abbey Road) and Akai A-DAM system.*

with some of the tape on the market, which highlighted some software deficiencies now resolved by Akai. "In the early days, when I first started using the machine, we did have problems with the first tape we bought: we had drop out problems, and there were a lot of errors being displayed. It wasn't a problem, it just showed that there were errors. Then, the software of the time would cause the machine to stop recording. The new software no longer does that: if there is an error, the machine doesn't drop out of Record, it merely corrects it.

The other thing we did was to change to Maxell tape, and we haven't had a problem since, which has been about seven or eight months, and has been really reliable. In fact, since I've been using the new software, I've used the old tapes for demos. The transport

is excellent—really fast and precise—and the whole system has been extremely reliable. I've had no real problems at all."

Working in a quite unique way which incorporates the use of both digital and analogue multi-tracking for different aspects of the music, Mike is in a position to judge the merits of both formats in a more objective way than probably anybody else in his field. But working with two formats means that synchronicity has to be exact; this is another A-DAM advantage. After getting the required sound on analogue—perhaps its a rhythm section with a 60s feel—Mike can either synchronise the two machines for mixing directly, or, as often happens, he bounces everything off the 16 track, ending up with a sub-master

on the DR1200, in order to do a 12 track mix.

It's not only Mike that is convinced about A-DAM. In the first twelve months since its launch, over 600 systems have been sold world-wide with over 44 sold in the UK alone. As well as Mike, UK users include Dave Stewart, Michael Kamen and Ricky Wilde—whose sister Kim recently completed a new album on A-DAM. Around the world, top artists and producers such as Nile Rodgers, Stevie Wonder, Bob Seger, Madonna and Hans Zimmer are also using the system.

A twelve track A-DAM digital multi-track recording system costs £15,695 and can be expanded to 24 or 36 tracks. For more information on A-DAM contact Akai Digital Division on 081-897 6388.

show will be a further variation on modular acoustic systems in the shape of an expandable voice-over booth called *The Voice Booth*. KFA will also have displays of custom studio furniture produced by their in-house manufacturing facility.

- **KGM Studio specialists:** showing examples of past, present and future studio designs.
- **Klark-Teknik:** exhibiting the recently launched series 500 dynamics including a quad compressor/limiter/expander, a dual compressor/limiter/expander, an advanced dual noise gate and a quad auto gate, each in only 1U of rack space. Also on show series 700 digital delay lines with DN726 stereo broadcast delay.
- **Klotz UK:** demonstrating their range of cables including their Oak-Link system.
- **Korg UK:** MIDI products.
- **KW Electronics:** launching two standard broadcast consoles, the BC1808 aimed at large radio stations. The frames offers space for 18 channels; and the BC1204 aimed at small radio stations and the standard design can accept up to 12-input channels for various functions.

## L

- **Lindos:** will be demonstrating the LA100 Audio Analyser a measurement system comprising the LA101 synthesised oscillator and LA102 measuring kit.
- **LMC:** exhibit features C-Audio amplification and signal processing; the Soundcraft *Venue* 8-bus console and 8000 monitor console; and TOA's *Saori* digital processing system now with IBM compatible software.
- **Lyrec:** full range of Lyrec tape machine products. Featured will be the *Frida* range of 2-track machines in portable and console formats.

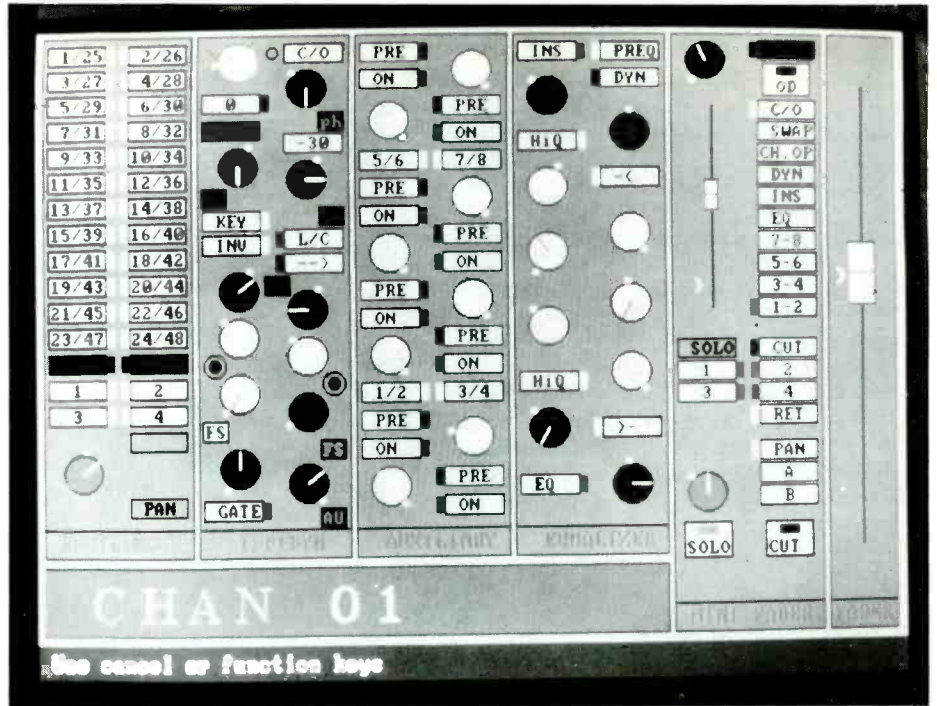

Neve VR audio console graphic display

## M

- **Marquee Audio:** no information available.
- **MBI Broadcast Systems:** showing designs and details of their latest installation of radio studios, control rooms and central apparatus areas. Also showing their range of broadcast mixers and

- **Michael Stevens & Partners:** showing the new products in the Bel music and broadcast range including delays, reverbs and anti-tracking delays. Also first showing in the UK of the Chromatec audio display *TUD-30*. Established products include Rogers speakers, Tannoy monitors and Soundcraft consoles.
- **Mitsubishi:** new products on show include the 20-bit ready *X-86* 2-track digital recorder on show for the first time at APRS. Established products include *X-880* 32-track digital recorder and *X-Ez* digital editor.
- **Mix Publications:** pro-audio magazine from the US.
- **Motionworks:** introducing two new products for the show, the *Midiworker* a MIDI event controller aimed initially at the SSL users. In addition to incorporating 32 event relays, *Midiworker* offers MIDI event firing via the SSL Event Software; *Perfectworker* provides the popular facilities of *Motionworker* in a stripped down form. It offers *Motionworker*'s virtual machine which enables control of console automation systems from an external timecode or MIDI timecode source. For example *Perfectworker* enables a timecode driven automation system to be operated with a MIDI driven music system or hard disk based recorder without the need for a tape machine running to provide the timecode.
- **MS Audio:** newcomers to APRS MS Audio are specialists in secondhand pro-audio equipment. Included are SSL consoles and digital multitracks.
- **MTR:** featuring the *ME 16* 18-channel expandable console and the series *III* 8-track mixers. Established products include DI boxes; Mosfet amps and dual noise gates. Also on display are the full range of Celestion *SR* series speakers, ARX Systems *Quadcomp* 4-channel compressor, *Sixgate* 6-channel noisegate, Rolec 6/2 mixer, Cutec mics and Effekt Electronic mic/instrument pre-amp.
- **Music Lab:** will be announcing new products and services including hire, sales and distribution, design, contracting and installation. Distributed products from the US include Neotek, Rane, Proco interface boxes and Sontec parametric equalisers, dynamic controllers and mic pre-amps.
- **Munro Associates:** with details of their recent studio design contracts and speaker systems.

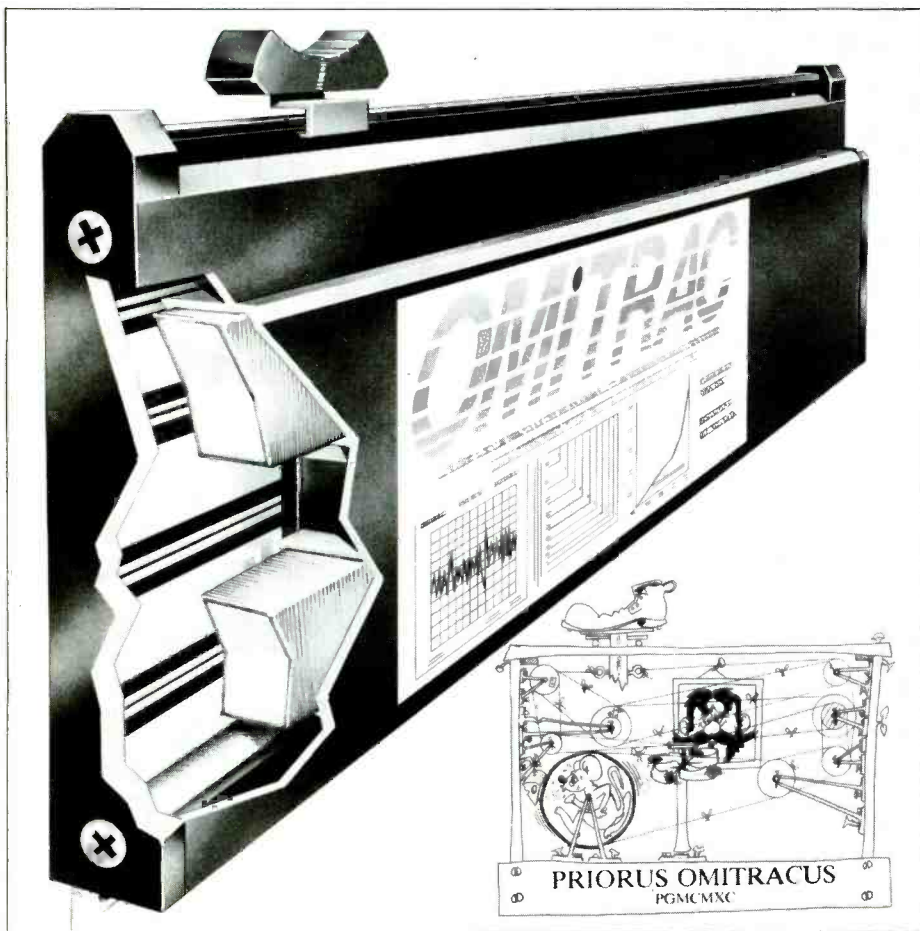

Omnitrac's new motorised fader

# WE BELIEVE THE ES.LOCK 1.11 IS THE BEST SYNCHRONISER IN THE WORLD....



**But then we would, wouldn't we?  
However, it's your opinion that matters,  
so here are some facts.**

The ES.Lock 1.11 incorporates 24-bit servo control and an AK time code reader chip - technology that results in the fastest and tightest lock-up available. The ES.Lock 1.11 also offers integrated chase, control and emulation software - no expensive (yet vital) extras are necessary. An internal machine interface library means that as soon as you plug in a tape machine, the ES.Lock 1.11 knows which one it is. Yet if the machine is non standard, or its transport is not quite up to scratch, you can modify the control parameters. For systems that need remote control, there are Audio Kinetics' five, eight and sixteen machine controllers for use with the ES.Lock 1.11. And for multi-studio facilities, any ES.Lock 1.11 can be assigned between two completely separate machine control networks.

**Now, what do you believe?**

**Audio Kinetics UK Ltd**, Kinetic Centre, Theobald Street, Borehamwood, Herts, England WD6 4PJ.  
Tel: 081-953-8118. Fax: 081-953-1118.

ES.Lock 1.11 and ES.Lock Controllers are installed in 21 countries worldwide: **Australia**, Magnatech, 2-427-0666. **Austria**, Grothusen, 22-297-2529. **Belgium**, Heynen, 1152-5757. **Canada**, Sonotechnique, 514-739-3368. **Denmark**, Interstage, 31-620026. **Finland**, Studiotec, 0-592055. **France**, Audio Kinetics, UK-81-953-8118. **Germany**, STK, 40-690-1044. **Holland**, Heynen, 8851-96111. **Ireland**, Audio Kinetics, UK-81-953-8118. **Italy**, Audio International, 2-253-90121. **Japan**, General Traders, 3-293-2274. **New Zealand**, Maser - Auckland 9-479-7889. **Norway**, Siv. Ing. Benum, 2-135-460. **Singapore**, Team 108, 748-9333. **Spain**, Telco, 1-231-7840. **Sweden**, Proab, 760-19863. **Switzerland**, Studio World, 56-271233. **Taiwan**, Acesonic, 271-68896. **USA**, 21st Century, 213-463-4718.



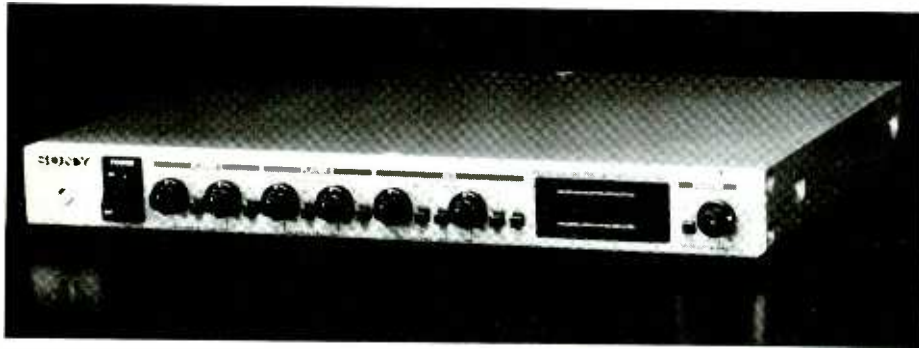

Sony VSP A600 audio mixer

## N

- **Neal:** showing their full range of recording and broadcast studio cassette recorders.
- **NED Europe:** will be giving separate hand-on demos of the *PostPro SD*, an expanded *MidiNet* system, the latest version of the *CMX* editing software, and the *9600* tapeless system will be in a demo theatre.
- **Neve:** UK debut of the Neve *VRP* post-production console, the latest version of the *VR* series. The *VRP* is designed for stereo television, film or multitrack operation and is suited for audio on video post and film re-recording. The *VRP* console features intelligent console routing and Dolby matrix monitoring on switchable 4- and 8-track buses, multitrack operation for up to 48 tracks and integrated storage and resetting of console setting from memory. The *VRP* is also fitted with *Flying Faders* automation. Neve will be showing its *VR* console in the new French mobile unit *Le Voyageur II*, which will be parked outside for the duration of the show. Also on show will be the new *66* series audio consoles.
- **Northwood O'Neil:** no information available.
- **Novation:** no information available.

## O

- **Omnitrac:** showing for the first time is Omnitrac's new motorised fader. Using its proprietary printed circuit board technology

Omnitrac have developed a new method of manufacturing the conductive plastic track used in both its motorised and manual faders. The Omnitrac range of motorised faders use a linear motor concept that utilises a magnetic coupling as opposed to a mechanical drive. The faders retrofit most current production mixing consoles. ● **Otari:** new products on show include the *MTR15* analogue mastering machine available in 1/4 inch 2-track NAB with optional centre track timecode, 1/4 inch DIN and 1/2 inch 2-track version. The machine incorporates full auto-alignment; after last year's acquisition by Otari of Sound Workshop the Series *54* console will be shown. This console will be available from 24-input modules to 46 and features high resolution meters, dual signal paths, 4-band EQ and 10 auxiliary send buses; *Diskmix 3* moving fader automation system will be fitted to the series *54* console featuring new software; also on show will be the series *100* transfer console designed specifically for film and video transfer suites. Established products on show include the *MTR-100A* 24-track recorder and the *DTR-900B* PD format 32-track digital recorder.

## P

- **Palm Audio:** making their debut at APRS Palm will be showing products from D&R Electronica the Dutch console company, including

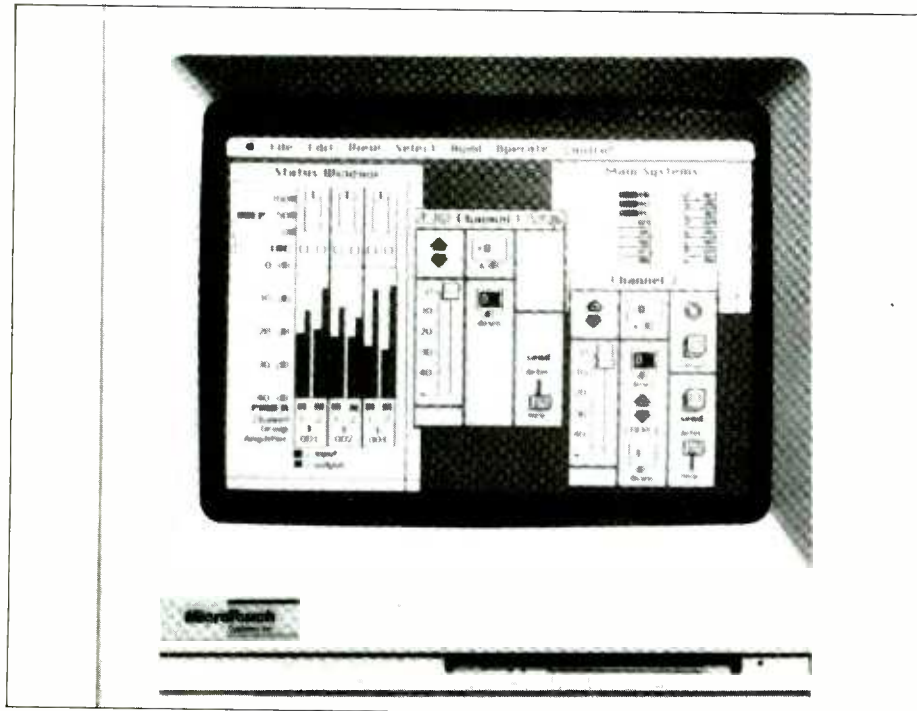

Amcron IQ System

the *Avalon* a 32-bus in-line console featuring 4-band EQ, up to 24 auxiliary sends and a readily available automation system which includes moving faders. New broadcast consoles from D&R include the *Airteq* and the *Aircom*. ● **Penny & Giles:** will be exhibiting their range of studio faders and audio/visual controllers including motorised linear faders and motorised rotary faders. New for the show will be their intelligent fader using optical digital technology. ● **Plasmec Systems:** new products on show include a professional A Gauge jackfield and a new video jackfield. As the exclusive UK distributor for Lone Wolf, Plasmec will be showing the new *MidiTap LAN* unit. Also on show will be the new *Lester DAS 2000* fibre optic transmission, distribution and routing audio system. Established products include digitally controlled attenuators and remote controls from Oxmoor, stereo audio signal test sets and loudness monitors from DorrOUGH, audio switchers from 360 Systems and an audio monitoring system from DK-Audio. ● **Playback:** tape and digital products distributor. ● **Prism Sound:** no information available. ● **PRECO:** on show products from manufacturers that PRECO represent including Apollo Masters, Audiopak, B&B Systems, Composite Video, Leever's Rich and Weircliffe. Products featured include a complete range of audio and video accessory items; Leever's-Rich tape erasers. ● **Pro Sound News:** European pro-audio news magazine.

## Q

- **Quad Electroacoustics:** will be exhibiting a new product the *240* amplifier, a 1U rackmount unit producing 80 W per channel and features Quad's active transformer balanced input, lockable level controls, full heatsinking and Neutrik *NLA* Speakon output connectors. A major option for the unit is a remote control unit and a crossover option is currently in design. Quad will also be showing examples from the *520* and *510* series units both with Neutrik connectors as standard and the *ESL63* Pro quality monitor loudspeaker. ● **Qusted Monitoring:** will be introducing the *H410* passive 3-way system, utilising 4x10 inch bassdrivers with 3 inch and 1 inch softdome and two new amplifiers, the *S200E* and the *DX800E*. Also on show will be an improved version of the sub-bass unit for the *H405* midfield monitor as well as the *HM415* a high powered 4-way active system.

## R

- **Raindirk:** exhibiting an enhanced version of their *Symphony* In-line recording console, featuring optional high resolution bar graphs, completely re-designed facilities module with standard *PFL/AFL* selection. The mixer on show will be fitted with *Optifile 3D*, an automation system with up to 10 groups available. ● **Ranson Audio:** exhibiting the Inovonics processors and stereo generators. ● **REP:** Recording Engineer and Producer magazine from the US. ● **Roland UK:** Effects and samplers. ● **Rolec:** showing the new version of the *PMX-6*, the *PMX 62* mixer. Features include 3-band EQ on each channel and fully balanced in and out ports.

## S

- **Sanken:** full mic range. ● **Saturn Research:**



# In an age of disk and digital, why buy analogue?

We know there are some applications where our 32-channel digital machine, the DTR-900, is the only answer. But if your business is such that you can do anything you want to do in the analogue domain, and at the same time do less damage to your budget, then our brand new analogue 24-channel MTR-100A may be the perfect machine for you.

When you consider that the MTR-100A will literally *change forever* the way engineers interface with audio machines, and



The MTR-100's auto-alignment saves you hours of time by eliminating constant tweaking and re-tweaking between sessions.

that this new way will save you hours spent in non-productive time, the analogue choice begins to make even more sense. You see the MTR-100A features full Auto-Alignment that allows total recalibration of the record and reproduce electronics. This means you can compensate for different tapes in a *fraction* of the time that it previously took, and your studio is not bogged down with constant tweaking and re-tweaking between sessions.

And if you think only digital machines feature high performance transports, think again! The MTR-100A's new transport incorporates reel motors that approach one horsepower – you'll get fast wind speeds of up to 474 inches per second! Of course,

the transport is pinchrollerless to give you the legendary tape handling and ballistics of our MTR-90.

What's more, with its optional EC-103 chase synchroniser, the MTR-100A maintains frame-lock in forward and reverse from 0.2X to 2.5X play speed and will typically park with zero frame error.

Then, there's the sound. New cylindrical-contour heads built by Otari especially for the MTR-100A result in remarkably low crosstalk and outstanding low-frequency performance. Pre-amps are located directly beneath the heads to further improve frequency response, and HX-Pro<sup>®</sup> is built-in for enhanced high frequency headroom. (An optional internal noise reduction package houses Dolby<sup>®</sup> SR/A.) Add all these features to gapless, seamless, punch-in, punch-out, which is also built in,

and your MTR-100A's sonic performance will rival any digital machine in the world.

So there you have it. With these powerful benefits available in analogue, does it make sense to go digital? Certainly, for some applications, a top analogue tape machine like the MTR-100A is the right choice.



Reel motors that approach one horsepower are driven by pulse width modulation amplifiers to tape speeds up to 474 ips.

And because we can see both sides of the question, ask us. We have the information that can help you make the right decision. Call Otari (U.K.) Limited on Slough (0753) 822381, or Fax us on (0753) 823707 or call U.K. Main Dealers, Stirling Audio Systems on 01-624 6000.

**OTARI**



Otari (UK) Limited, 22 Church Street, Slough, Berkshire SL1 1PT.

Trademark Dolby Laboratories Licensing Corporation

showing the 824 multitrack tape recorder with the first showing of Saturn's internal chase synchroniser system. ● **SSE Marketing:** new products to SSE's range include the Ariel Speech Station which is a low cost DSP development board with Sonograph software for use in speech analysis and recognition applications; Momentum FDAS & Ariel Motorola 56000 boards for Spark Station which provides a complete development for the Sun Spark Station; new DSP hardware is now available for the Audio Precision; Digital Audio Labs' desktop recording board which is a development board supplied with record/playback software providing a hard disk based system when used with an IBM AT or compatible; Genelec 1034 new high SPL main monitor system's UK debut; White Instruments model 4700 1/3 octave programmable equaliser; first UK showing of Schoeps KVM 'dummy head' recording system; and the UK debut of the Orban 764B programmable equaliser and the 290RX which is a single ended noise reduction system.

● **Sellmark Electronic Services:** sharing the stand with Audiomatic Systems who will be demonstrating their new 1000 and 2000 series moving fader automation system featuring four SMPTE triggered switches on each channel used for switching in channel EQ/dynamics or any external effects device. Sellmark will be showing the new Omnitrac production version of the linear motorised fader using new conductive plastic track technology. Also new is their CPA 7000



Soundtracs sequel sound reinforcement console

series conductive plastic manual faders. ● **Shep Associates:** showing examples of customised Neve consoles. ● **Shuttlesound:** new products from sound reinforcement suppliers Shuttlesound

include Amcron's *Microtech* reference amplifier featuring alleged ultra quiet operation; Amcron *IQ System* which has been used in several installations including Wembley Stadium; Audio Digital's *PAD 300/18* 18-bit digital delay; *E/V's* series *II N/Dym's* with *Dynadamp* to reduce handling noise and a new unit the *857A*. Also a new concert sound product the *MTS-1* speaker system and *Deltamax* systems and new *Manifold* components. From *Furman* a new product in the area of power conditioning. *Acoustaad* will be demonstrated and a whole new range of *Samson* products will be on the stand. ● **Sifam:** meters and ppm indicators in addition to low cost audio level meters and other panel products. ● **John Hornby Skewes:** displaying products from *DOD*, *Digitech*, *Audio Logic*, *Audio Technica* and *JHS's* own brand products. ● **Smart Acoustics:** will be exhibiting *IVIE's* range of *Real Time Analysers*, new for the show will be the current range of software for the PC based *PC40* analyser; *Goldline* range consists of *Sound Analysers*, sound level meters and test equipment; *Ashly's* range of products includes equalisers, crossovers, noise gates, compressor limiters and also one of the few *Lucas* approved range of amplifiers; *Australian Monitors* range of power amplifiers; and *Renkus-Heinz* range of products. ● **SSL:** will be demonstrating the *ScreenSound* digital audio-for-video, editing, recording and mixing system, which provides full machine control of *VTRs/ATR's* and film reproducers using pen and tablet control surface to access facilities for edit and review, crossfading and time offset; the *SL 5000 M Series* audio production system for stereo broadcast, on-air, continuity and post-production. Features a modular architecture with totally electronic switching. Can be fitted with *SSL Instant Reset*, *Total Recall* or *G series* computer systems; *Logic FX G383* Dual mic amplifier and equaliser; *G384* stereo compressor, both provide *G series* electronics in rackmounting form. Also on show will be the *4040 E Master Studio System*. ● **Sonifex:** exhibiting their range of broadcast cart machines, telephone hybrid equipment and *Sapphire* cartridges. Featuring the *Micro HS series* nab cart machines; the *HY02* telephone balance equipment, and the *Sapphire* cartridges designed to complement the *Sonifex* range of cart machines. ● **Sony Broadcast:** this



Electro-Voice MTS-1 2-way stage speaker system

# 15,000,000 Satisfied Customers

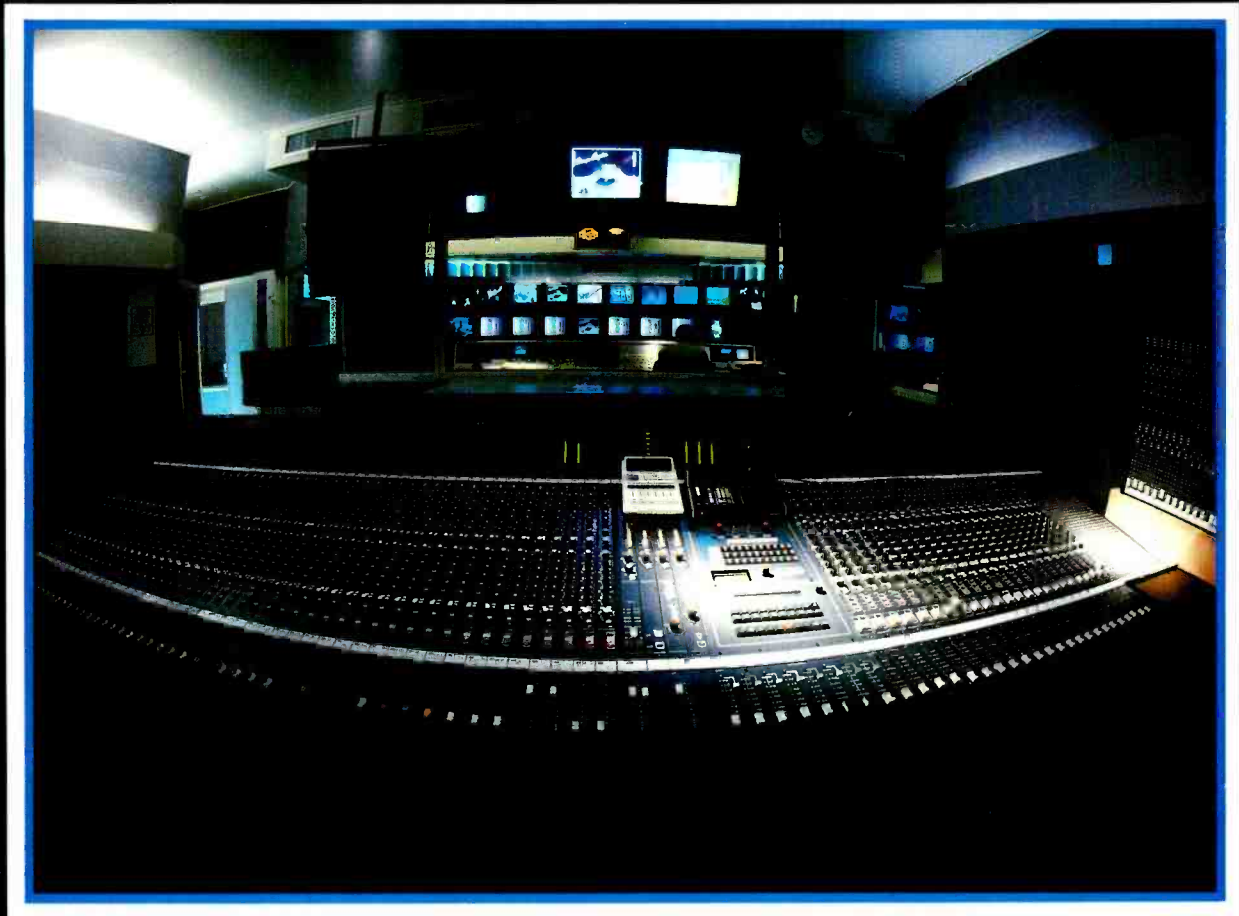

Studio Potel & Chabot

Central Control & Automation



**15 million** people unknowingly rely on the Eric console to enjoy their most popular variety show broadcast live on French television every weekend. For almost eighteen months Eric has been quietly and faultlessly performing the task of producing live stereo transmissions of a variety of artists, bands and orchestras from this famous Paris studio.

Ten similar consoles are located in France, Germany, Japan, USA and England.

Whatever your application, Eric provides sonically excellent analogue technology with commercially proven digital control and impressive performance specifications at a very competitive price.

*You can knowingly rely on Eric.*

## SOUNDTRACS

Soundtracs plc, 91 Ewell Road, Surbiton, Surrey KT6 6AH England

Tel: 081-399 3392, 081-390 8101  
Fax: 081-399 6821 Telex: 8951073 STRACS G

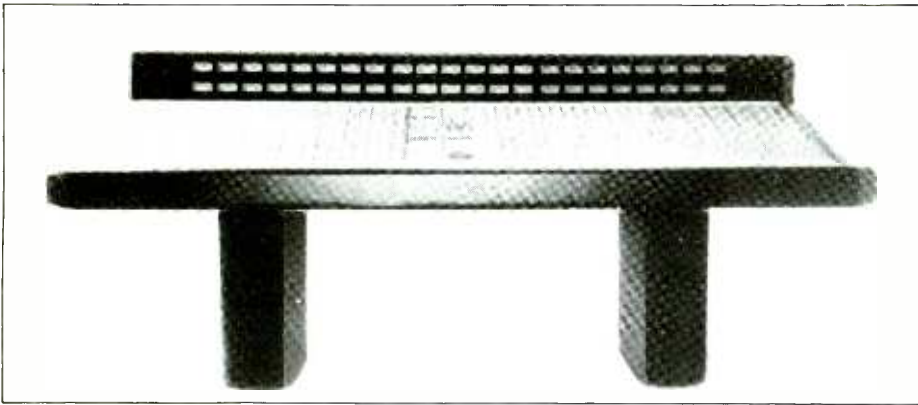

**Trident Vector console**

year Sony's 'Dual market' audio strategy means a balance of new ranges of audio-for-video products with a line-up of music recording hardware. SBC is launching a digital audio mixer designed especially for video-led environments. Shown in production form the VSP-8000 allows single operator control of digital editing suites when supported by the Sony BVE-900. In its expanded form the console offers 32 digital audio inputs and can handle the digital audio output from up to eight D-1 or D-2 VTRs. There are also two new analogue mixers designed for video and broadcast markets, the VSP-A600 and the MXP-290. Sony are also showing a new version of the MXP-3056 in a 36-input version with vacuum fluorescent metering, the MXP-3036. New for APRS are Sony's range of four-head DAT recorders designed for broadcast applications and includes three studios machines and an edit controller. Sony will be showing a CD mastering package combining the DAE-3000 editor with a PCM-1630 processor and a DMR-4000 recorder together with a DMR-2000 U-matic serving as a player. Supporting the system will be a DTA-2000 tape analyser and the SDP-1000 digital audio effector. Established products include the Sony DASH format digital multitracks PCM-3324/48, the APR-24 analogue multitrack, a full range of microphones and the Sony Soundtech range of PA, conferencing, and home recording equipment.

- **Sound & Music:** no information available.
- **Soundcraft:** featuring the worldwide launch of the new 8-bus recording console, *Delta 8*. The *Delta 8* uses a split configuration and offers a total of eight groups with a choice of 20-, 28- or 36-input channels. The *Delta 8* combines features from the 200 *Delta* and *Venue* consoles with applications for broadcast and post-production facilities. Another new product making its APRS debut is the *Venue* live sound console. The *Venue* has been designed for F-O-H mixing and is available in 16-, 24-, 32- or 40-channel frame sizes. Established products include the 200 *Delta* console; the 3200 *Bigfoot* console being shown using the *Uptown* moving fader automation system and the *Magtrax* Dolby *Surround* monitor system to highlight the 3200's post-production and broadcast abilities. Also the series 6000 will be on show.
- **SEP:** UK sound business magazine.
- **Studiomaster Europe:** synchronising and edit systems.
- **Sound On Sound:** UK music technology magazine.
- **Sound Technology:** exhibiting a wide range of professional audio products from Alesis, C-Lab, Digidesign, JL Cooper and Symetrix. Products on show include signal processors, digital multi-effects, drum machines, sequencers, hard disk recording systems, synthesisers and mixing consoles.
- **Soundtracs:** products on show for the first time include the new *Quartz* 24-bus in-line

console, which combines many of the features from the *IL* series and *PC* MIDI series, both also on the stand. The *Quartz* features 4-band parametric EQ, six aux sends and dual line inputs on each channel with MIDI mute automation on inputs and monitors as well as auxiliary masters. Frame sizes are 32-, 40-, and 48-channel. Also new for APRS is the *Sequel* sound reinforcement console which bridges the gap between the *SPA* and the *MX* ranges. The *Sequel* is available in 24-, 32-, 40-, and 48-input versions. Established consoles on display are the *SPA*, *MX*, *MCX*, the *MRX* recording console, a selection from the FM range and FMB on air console.

- **Steinberg:** music software specialists, exhibit includes Cubase 2.0 ST now with score printing and phrase synthesis; Cubase for the *Macintosh*; *Mimix* Desk Automation; Synthworks SY77 for Yamaha's SY77; and *Topaz*, the computer controlled digital instant access recording system.
- **Stirling Audio:** new products from this pro-audio supplier include the *Cyber-Frame* 8-track hard disk film and video sound editing system with automated project management; the new DDA *DMR12* and the Otari *MTR-15* a 2-track recorder with auto alignment. Established products include the *AudioFrame* digital workstation; Otari's tape machines and processor products from Valley International and Lexicon.
- **Studio:** UK studio news magazine.
- **Studio Magnetics:** showing the *AR2400* analogue multitrack recorder; a range of test tapes; the *Seca* range of sound reinforcement products.
- **Studiomaster UK:** new products on show include *Trackmix 24* a new modular console with full 24-track monitoring on a one piece output section, 24- and 32-input base frames and MIDI-MUTE as standard; the *Powerhouse* mixers feature 8- or 12-inputs with built in 2x250 W/channel power amplifiers, on-board 127 programme digital effects processor and 2x7-band routable graphics; *B* Series power amps; *Ufex* range of 1U rackmount effects units, including stereo digital delay. The *Studiomaster Gold* series consist of the *Session Mix Gold 8/2*, *12/2R* and *16/2* expandable to *24/2*; the *Proline Gold*; and *Mixdown Gold* consoles. *Diamond* consoles are also a new range consisting of three models *8/2* rackmount, *12/2* and *16/2*. All models have 3-band EQ, phantom power, 2 aux sends and returns and phono tape in/out connectors.
- **Studiospares:** pro-audio and broadcast suppliers.
- **Studio TimeLine:** will be showing the new *Optifile 3D* console automation system for the first time in the UK. Also the full range of the *Crystal* noise eliminators and *Bulletin Board* the secondhand equipment magazine.
- **Surrey Electronics:** will be showing for the first time the *Television PPM*, *PPM10*, which takes stereo audio inputs and generates a high definition colour video display

emulating co-axial twin movements. The eye can then judge the level displayed at a glance without needing to refer to scale markings. Also on show are stereo variable emphasis limiters; various PPM meters and ambisonics decoder.

- **Syco:** products on show include the *TAC Magnum* mixing console; outboard from BSS and Lexicon; the classic *Midi Moog*, *Obie* rack and *Prophet 5* synthesisers; the Akai *DR1200* 12-track digital recorder; samplers from Roland and Akai; computer and software from Apple, Atari, Opcode and Digidesign.
- **Sypha:** This independent digital audio consultancy will be giving details of system assessment, design, marketing and training in the digital audio field. Also the *Tapeless Directory* will be on sale on the stand as well as a publication reviewing the hard disk recording market and a free list of all tapeless systems on show at APRS.

## T

- **Tam/England:** details of mastering services and duplicating packages.
- **Tannoy:** UK debut of Tannoy's new monitor range which is based on dual concentric design with heavy use of DMT (Differential Material Technology). The Tannoy monitor series ranges from the *System 215 DMT* through to the smallest monitor the *System 2 NFM*.
- **Tape Automation:** tape duplicating equipment including master transport, slaves and loaders.
- **Tape One Studios:** details of digital post-production services including CD ref Tape One's recordable CD service.
- **TEAC:** showing Tascam products including the *DA-800-24 DASH* format digital multitrack, the *MSR-24* 1 inch multitrack, and the *M-3500* mixing console series.
- **Thatched Cottage:** examples of the wide range of products they distribute.
- **The Synthesizer Co:** with exhibits from their music technology based range of products, including *Diki-Devices*; *Zoom 9010* sound processor which offers four discrete digital processors a 4-channel digital mixing facility; the *Russian Dragon* from Jeanius Electronics a device that indicates timing accuracy; *Soundtracs Quartz* 24-bus mixing console, software from Opcode and Digidesign including *DAVE*, *Digital Audio Vision* which allows Digidesign's *SoundTools* to run with Opcode's *Vision* sequencer on the same *Mac* computer.
- **Transco:** details of Transco Laquer mastering. Transco are also distributors of Ampex tape. *BASF* test and calibration tapes on London and South England, *Norsan* cutting styli, *Fuji*, *Afga*, *Sony* audio, *Maxell* and *Thats* tape.
- **Trident:** making its APRS debut is the *Vector* in-line console. There will be continuous demos of the *Vector* all through the show. Trident will also be exhibiting consoles from their other ranges.

## Y/Z

- **Yamaha-Kemble:** UK debut of the *DMR-8* production model digital multitrack mixer. The *DMR-8* is an 8-track 24-bit mixer, an 8-track recorder with locator, synchronisation, timecode/locator and automated mixing system, and including programmable EQ (32-bit) and various built-in effects and signal processing functions all in one unit. The system uses proprietary Yamaha-format tapes. The *DMR-8* exhibit will be an invitation only affair, call Yamaha for details.
- **Zonal:** showing new products *High Dynamic* range studio mastering tape in ¼, ½, 1 and 2 inch; *Loop bin* mastering tape available in ¼, ½ and 1 inch. □

**TANNOY**  
**MONITOR**  
**SERIES**

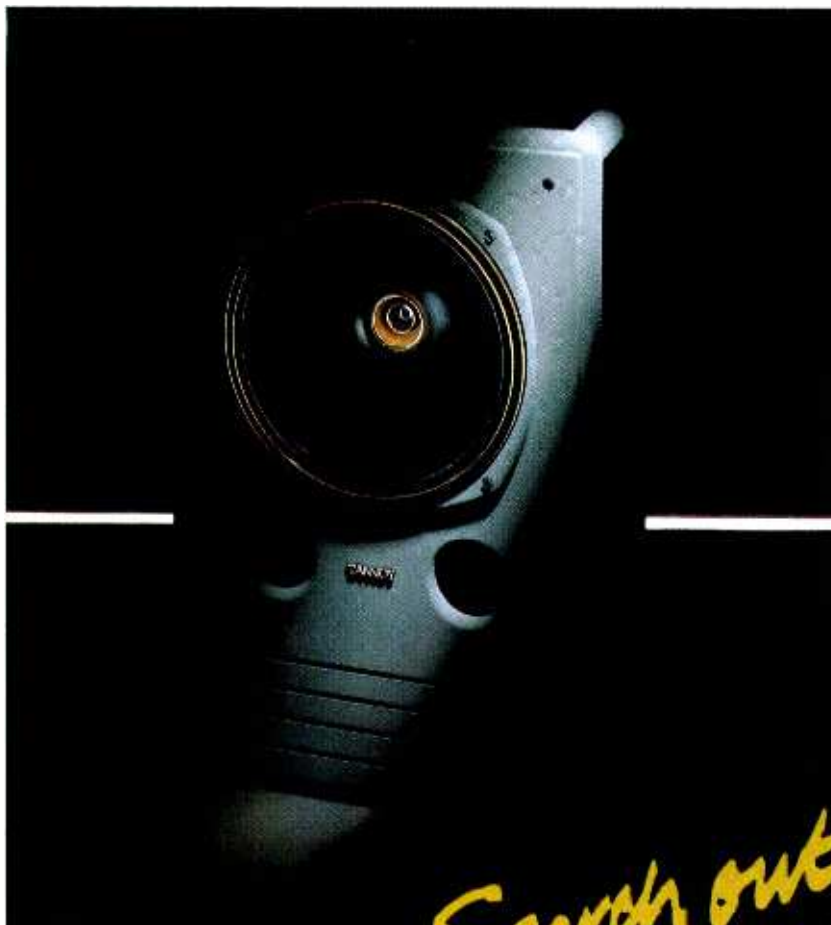

*Search out the  
Gray and Gold*

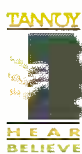

TANNOY LTD., ROSEHALL INDUSTRIAL ESTATE, COATBRIDGE, STRATHCLYDE ML5 4TF, SCOTLAND.  
TEL: (0236) 20199. TLX: 778621 TANMFGG. FAX: (0236) 28230

TGI/TANNOY, 300 GAGE AVENUE, KITCHENER, ONTARIO, CANADA N2M 2C8.  
TEL: (519) 745 1158. FAX: (519) 745 2364.

[www.americanradiohistory.com](http://www.americanradiohistory.com)



Control room

# LANSDOWNNE

Following the installation of a new console and some recent refurbishment, Julian Mitchell visits one of London's longest established studios

**T**here are certain things in life that when mentioned immediately conjure up thoughts of the British craftsmanship and professionalism that was once the envy of the world and still is to a certain extent; Jaguar cars, Harrier jump-jets, the British 'Bobby' and Lansdownne recording studios are a few. Lansdownne has certainly got the pedigree, 32 years as a commercial recording studio and a string of hit records and accolades to its credit, covering all types of recorded music. But it's more than the fact that Lansdownne has been around for a long time, they have a way of

doing things that today some people might call old fashioned but at the same time others might aspire to.

"The experience that people have always got here is invaluable. There are few studios in London that give the experience that a place like this and CTS give because we're still dealing with musicians whether they be rock 'n' roll musicians or straight musicians or jazz musicians or whatever. Effectively we get opportunities to use microphones and there aren't very many people around these days, studios especially, who are using microphones every day. It's recording down a piece of wire a lot of the time with synthesisers." So says Lansdownne co-director Chris Dibble who came to the studio in 1974, effectively straight from school, became an assistant engineer and now is a leading light in the company.

## The pedigree

Lansdownne was founded back in 1958 by record producer Denis Preston spurred on by the enigma that was Joe Meek. The story goes that Meek was feeling creatively impaired at IBC studios where he was a staff engineer and was looking for a freer rein elsewhere. He found the actual building in Holland Park, London, and persuaded Preston, who was also striving for independence, to invest in one of the first truly independent recording studios in the UK. Lansdownne's present owner Adrian Kerridge went with Meek to start the studios.

The building itself, Lansdownne House, had been built in the early part of the century by a South African diamond miner and

# We could have...

# But we didn't.

**W**e've just replaced our popular BGW Professional Series power amplifier models 150 and 250 with the new, twice-as-powerful models 200 and 350.

In designing these new amps, we *could* have followed an industry trend by replacing our fully discrete circuitry with ICs. That *would* have reduced our costs significantly. But we didn't, because the best ICs available still fall short of our standards for sonic quality.

We *could* also have reduced the size and mass of our heat sinks. That would have saved money and still allowed us to meet published specifications with a comfortable margin. But we're not ready to shorten the life of BGW output devices by placing added thermal stress on them. Our standards for long term reliability won't allow it.

We *could* have replaced our expensive precision stepped input attenuators with less expensive detented pots. But we didn't want to give up the precise level control of precision stepped attenuators.

We *could* have used a thermal circuit

breaker rather than the costly magnetic breaker you'll find in every BGW Professional Series amp. But thermal breakers trip-off early in warm summer temperatures. To us, that's unacceptable.

For almost two decades, BGW Professional Series power amplifiers have been designed to meet the exacting performance and reliability criteria of the best facilities in the world. Other manufacturers may be willing to cut corners in order to cut costs. Not BGW. We hold firm in our dedication to building the very best. Not the very cheapest.

To find out exactly what our total quality commitment can mean to you, call us at 213-973-8090 (in the US, 800-468-AMPS toll free) for more information on the new 200 Watt\* BGW 200 and 400 Watt\* BGW 350/350A or the legendary 600 Watt\* BGW 750F and 750G†. Then, for a limited time,

we'll triple our standard warranty at no extra charge when you decide to purchase one.

Thinking of settling for less than BGW?

Well, you *could*...

But you shouldn't.

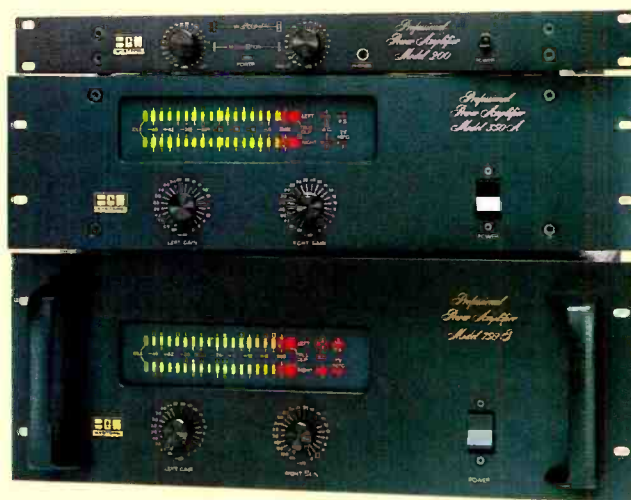

\*Both channels driven into 8 Ohm loads. †Studio version available with low-noise fan.

13130 Yukon Avenue • P.O. Box 5042 • Hawthorne, CA 90251-5042 • Fax 213-676-6713

#### INTERNATIONAL DISTRIBUTORS

Christopher Hawkins • 19 Tornclyffe Court • Kings Avenue  
London SW4 8EW, U.K. • (01) 671-9494

Groupe 38 • 14 Cour Saint Eloi • Paris, France 75012 • (01) 3430-3800  
Ear Pro • C/Juan De La Cierva, 23 Nav. 2 • 08960-Sant Just D'Esvern  
Barcelona, Spain • (03) 473-1143

Kenwood Linear S.P.A. • Via Arbe. 50 • 20125 Milano, Italy • (02) 686-4741  
Invor Electronics S.A. • Fotografielaan 22 • B-2610 Wilrijk, Belgium • (03) 8300367  
Audio Rent Sales • Werbhollenstr. 54 • 4143 Dornach, Switzerland • (51) 702-5515  
Has Audio Team • Hirsimetsantie 13 • Lahti, Finland SF-15200 • (18) 33234  
Seki Electronics • C.P.O. Box 7760 • Seoul, Korea • (02) 756-3331

Audio Consultants Co. • 58 Pak Tai St. 9th Floor • To Kwa Wan, Kowloon  
Hong Kong • 3513628

Trichord Corporation • Bunsei Bldg. #3 1st Floor • 8-8, 5 Chome, Toranomon  
Minato-Ku, Tokyo • Japan 105 • (03) 433-2941

Hawko Trading Co. • 605 Macpherson Rd. #01-15 • Citimac Industrial Complex  
Singapore 13360 • 278-0011

Linfair Engineering & Trading • 7th Floor 7 Jen Aid Rd. Sec. 2  
Taipei, Taiwan R.O.C. • (02) 321-4454

Sea Power Company Ltd. • 8F, No. 23 Sec. 1 • Chung Hsiao W. Road  
Taipei, Taiwan • (02) 314-3113

patron of the arts who was looking for property to encourage the arts and art studios in London. As a result of his philanthropy most of the rooms in the building were suitably tall and well lit. The recording studios, however, were in the basement with the reception on the ground floor. The studios first opened in 1958 having been acoustically designed by Sandy Brown, a jazz clarinetist, of Sandy Brown Associates, really the only acoustic design company around at the time. Lansdowne had an enviable reputation as one of the few independents, further enhanced by the tag 'The house of shattering glass' given to them by IBC studios because of the alleged clarity of their recordings.

The first Lansdowne control room was mono but with cunning foresight a stereo room was built as a mirror image of the mono one above it. The first console was put together by EMI under instruction from Preston, Meek and Kerridge. From those first recordings the studio pioneered its way through 4-, 8-, 16- and 24-track. It was in 1970 that the new control room at the side of the recording area was built from a former office and a Cadac console was installed by Clive Green and Adrian Kerridge. Dibble: "We had one of the first Cadac consoles, which only now has been replaced. The frame was 20 years old, what was inside it certainly wasn't because we modified it numerous times. I

Recording Architecture as Studio Two at CTS had just been designed by them. "That was an acoustic treatment and a visual update rather than the size of this project. We had virtually made our decision to commission them for Lansdowne before we'd had a chance to hear the CTS room but I suppose if there were any problems we could've called a halt on things. We were very confident of what they were doing, however, and we've been proved right, the room sounds great."

Throughout Lansdowne's history the studios were known as the ones that never closed, like the Windmill Theatre in London's Soho, and when it came round to the new refit they were keen to uphold that reputation. So much, as it turned out, that a date was laid down to restart sessions even before the console had arrived. The deadline was March 5th this year and the console arrived in two bits on February 11th. They made it with reputation intact, although with help from sister studio CTS who took the overload when necessary.

Lansdowne isn't the kind of studio to make rash decisions, purchasing or otherwise, so when the time came to choose a console to replace the evergreen Cadac, pragmatism came to the fore. Dibble: "The choosing of the console was a long and drawn out affair. We did not choose that console for the potential it may have had for bringing us work. Two years ago if we ever had been in that frame of mind there would've been only one console we would've gone out and bought. There was no way we were going to have one of those consoles in this room anyway, I've never actually spoken to anybody who has been head over heels in love with the sound of them. They're ergonomically brilliant but audio-wise not really great." (For those of you who haven't guessed yet he's talking about SSL consoles.) "On our old Cadac people used to come in and say how wonderful it sounded, however, it wasn't necessarily the engineers that were dictating that they were sitting behind that desk, because 'you can't make a hit if you're not using an SSL console'. That I don't think is the case anymore, the bubble has burst. You can't knock their success, they've done a lot for the audio industry in this country I would say as well, but I think there are studios around that wish they hadn't bought SSL now. People now want choice, we're going back to that situation."

Whether or not SSL's bubble has burst can only be conjecture, Dibble, however, was full of praise for the Neve and its automation, "As far as all the automation systems I've ever worked on it knocks all of them into a cocked hat. It automates faders and mutes but you can automate EQ ins and outs. Although it comes with the Neve console the automation was designed as a retrofittable system by Martin Sound and we decided to have it on our VRP. There are a lot of layers, you can go in at the simplest layer and just go in and mix, go away and forget about it, but also you get very clever and even then it's not difficult."

The final piece of the upgrade jigsaw was the digital multitrack, by no means Lansdowne's or CTS's first brush with the technology as the ill-fated Neve digital console at CTS can testify. The choice for recorder, however, was a Sony PCM3348, a choice made easier by the knowledge that the machine's cost would be shared between the two studios.

"It took a long time for us to decide, CTS went down the digital path very early, they were a kind of pioneer in that respect and not only in tape machines, that console in fact was put on the back of a truck and replaced by a V3. The greatest amount of work here, however, is still done on analogue, I think one of the reasons for that is SR; it that has revolutionised and given analogue the kiss of life. There are a lot of people who still prefer the sound of analogue. You won't find any studio who hasn't got an analogue tape machine, it has the compatibility factor so you can walk out with a tape from here and go anywhere, the only question is what noise reduction to put on."

## The business end

The recording area at Lansdowne hasn't really changed since it was built. The old control rooms are now empty but available and regularly used for isolation purposes, in fact the old stereo room has been enlarged to assist the drum placement. As far as a sense of history goes the recording room scores highly, the way the place has stayed the same obviously adds to the feeling



Recording area with all three control rooms in view

suppose most of it was only 3 or 4 years old. There are different ages of bits as we constantly modified it to do things we wanted."

## Control room 1990

Lansdowne's history has entered another chapter recently with the refurbishment of the main control room. The upgrade is a major one by anyone's standards and has as its centrepiece a new Neve VP console, the first of its kind in the UK, actually a VRP as it has recall facilities. With such a purchase in mind Lansdowne decided to take the upgrade through the control room and throughout the linking corridors and stairs. A Sony 3348 digital multitrack was also bought with the cost shared by CTS studios, part of the Lansdowne group.

Dibble, "We couldn't have put a new desk in this control room without changing the room, well we could've but it would have been a stupid idea. Recording Architecture designed the room, we liked their philosophy about acoustics, which is minimal if you compare it to Eastlake and Sam Toyoshima, people like that, minimal in the amount and minimal in the cost, which meets our philosophy very well. There was about 6 inches of acoustic treatment in this room, which was taken out giving us much more room."

Lansdowne weren't shooting in the dark with their choice of



**More than one way...**



**Tascam MSR24 + Soundcraft 6000**

1" 24-Track & 24/24½ Desk complete with Remote Control and Looms for fourteen thousand, nine hundred & ninety-five pounds.



**Tascam MSR24 + Allen & Heath Saber**

1" 24-Track & 24/16/24 Desk complete with Remote Control and Looms for thirteen thousand, seven hundred & fifty pounds.



**Tascam MSR24 + Tascam M3500**

1" 24-Track & 24/8/24 Desk complete with Remote Control and Looms for eleven thousand, five hundred pounds.

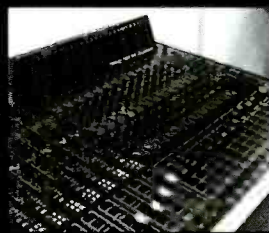

**Tascam MSR24 + StuDiomaster Trackmix**

1" 24-Track & 24/12/24/2 Desk complete with Remote Control and Looms for ten thousand, two hundred & ninety-five pounds.

**...to skin a cat.**

**RAPER & WAYMAN**

Unit 3 ▲ Crusader Estate ▲ 167 Hermitage Road ▲ London N4 1LZ  
Facsimile 081-809 1515 ▲ Telephone 081-800 3288

**All four systems Guaranteed for 2 Years.**

*(Prices exclude VAT.)*



SEE PART OF OUR PRODUCT RANGE  
ON APRS STAND NO. 154

**– The simple and effective choice for monitoring**

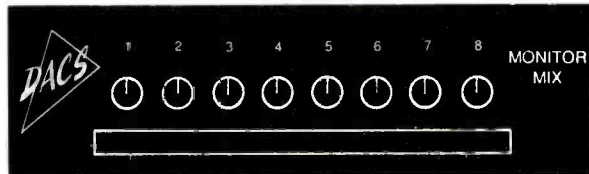

MONITOR MIX – 8 into 2, 2 x 4 into 1, or 8 into 1 audio mixer  
Panel size – 5.25 by 1.75

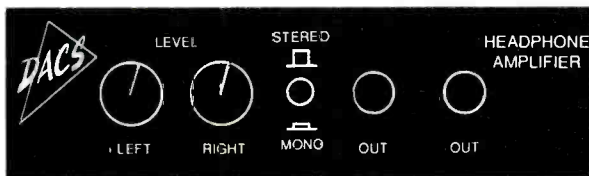

HEADPHONE AMPLIFIER – Stereo or 2 into 1 mixing, clean power to two pairs of stereo headphones  
Panel size – 5.25 by 1.75

Designed for simple, flexible and easily controllable headphone and on stage monitoring. Designed to give musicians the mix they want and engineers the quality they demand.

<b>UK</b>	DACS	for Retail Outlets, Trade Enquiries and Information	Tel: 091 438 5585	Fax 091 438 6967
<b>France</b>	Decides	Tel: (33-160) 192 929	Fax (33-160) 190 644	
<b>Spain</b>	Ventamatic	Tel: (34-3) 230 97 90	Fax (34-3) 321 21 73	
<b>Sweden</b>	Handic	Tel: (46-31) 289 685	Fax (46-31) 681 982	

**OUR SOUND IN ASIA**

**Asia '90**

**SPECIALIST'S WAY TO BREAK INTO THE ASIAN MARKET**

**JULY 11-13 1990**

**HONG KONG CONVENTION & EXHIBITION CENTRE**

For details, please contact:  
**BUSINESS & INDUSTRIAL TRADE FAIRS LTD.**  
28/F., Harbour Centre, 25 Harbour Road, Wanchai, Hong Kong  
Tel: 5756333 Telex: 64882 ASIEX HX  
Cable: BIPCCAB Fax: 8341171, 8345373

**B&I EXHIBITION**  
PAA18.90/SS

"I've waited 14 years for a  
monitor this accurate.  
The HD-1 is worth  
the wait."

**Roger Nichols**  
Engineer/Producer

*Grammy Winner for: Aja,  
F.M., Gaucho, Steely Dan  
Grammy Nominee for Rikki  
Lee Jones-Rikki Lee Jones,  
Nightfly - Donald Fagen*



Meyer Sound redefines the near-field monitor with the introduction of our HD-1 High Definition Recording Monitor. The HD-1 was designed to provide the most stable, accurate imaging available today. With an extended low frequency response to 32Hz, the HD-1 needs no external

subwoofer. And the control electronics and power amplifier are built in the cabinet, eliminating the need for additional equipment or rack space. Contact us or your Meyer Sound dealer and listen to the HD-1.

There's no need to wait any longer.



**Meyer  
Sound**

Meyer Sound Laboratories, Inc.  
2832 San Pablo Avenue  
Berkeley, California 94702  
(415) 486-1166  
FAX (415) 486-8356



**UTOGRAPH**

SALES LTD

DISTRIBUTORS IN EUROPE OF MEYER SOUND

and reading the history books as to who has recorded here and when, sustains the myth.

But all the romanticism in the world can't keep the order books filled. After the '60s heyday and '70s consolidation Lansdowne witnessed the recording slump that turned the market on its head. In 1981 the studio reviewed the situation and made their decision, Dibble explains, "We got involved in music to picture work in 1981, it was a fairly conscious decision of ours to try and broaden our outlook in the industry at that time because we felt that the amount of record work, not just for us but generally in London, was moving sideways. People were starting to open their own studios because of the tax advantages in those days, so we looked into other avenues of music recording. We decided to go into music-to-picture as well, obviously we don't just do that. The work hasn't displaced the solely music recording side but at the time the straight black vinyl work did take quite a dive."

Lansdowne have taken their immutable standards into this world and unsurprisingly have come up against people who on the face of it had all but dropped theirs. "We found the film transfers onto video tape we were getting from the places in the West End were 99.9% absolute crap, the timecode was wrong, there wasn't enough timecode, the film was running at the wrong speed. So we developed our Studio Two into a transfer Telecine suite. If you're doing a motion picture you can generally guarantee if it's 35 mm it'll be travelling at 24 fr/s but if you take it into a telecine suite in the West End they have no concept of what it's going to be used for so they just transfer it at 25, because the standard in this country is 25 fr/s. If you're writing music to that picture it's a waste of time because you take all your timings off the picture you record your music to the picture and when the editor puts them together it doesn't fit.

"So the telecine suite went in about 5 years ago and the bulk of the work is transferring 16 and 35 mm film with timecode to video tape at the right speed for music recording in the studios. About 90% of the videotapes that go through us and CTS are done in our own setup."

Lansdowne's client base in this area is involved mainly with TV programming and film, there are fewer commercials done but when ads do come along they're treated in a slightly different way again as a result of what happens to them once they leave the studio.

Dibble: "When we do commercials we rarely do them *SR*, because they tend to be done then redone and redone in a very short space of time in a period of a few days. We may do a commercial for somebody and they'd ring up and want to remix it and we can't fit them in for a week, so they need to go somewhere else. So Dolby *A* is much more of a standard for that type of work."

Lansdowne do a lot of work for the BBC and independents especially now there are a lot more co-production arrangements happening and film dramas on 35 mm. They dub just the music as the companies or the larger dubbing theatres tend to do the full music/effects/dialogue work. But the studio can mix directly onto magnetic film, as far as the music is concerned so the quality remains.

Mixing for Dolby *Surround* is also catered for and Lansdowne is one of the few studios that Dolby trust to use the encoders and decoders without supervision and a visit as the units are permanently installed in the control room. The studio has two ATC *SCM20s* high up in each rear corner for surround speakers and a centre ATC *SCM100* speaker behind the perforated screen between two ATC *200* main monitors. How did the Lansdowne staff convert to the new medium? Dibble, "We were very enthusiastic, mixing for film is a completely different way of working than mixing for record. It gives us another medium to work with."

Entering the post-production world has been an eye opener for Dibble in as much as how the British and American film dubbings work and the differences between them, "Sound effects and dialogue seem to fill up these films and then they stick music on it, then the dubbing editor gets his hands on it and you can't hear any of the music anyway. There are so many effects, that's the English attitude towards movies. The Americans have a completely different way of doing it, they don't insist on having loud door slams of cars and other doors. In America the music takes you through the sequence. Here you

need to be told what a car sounds like, 'here is a car' or a door slam 'here is a door'."

The move of musicians to open up their own home studios has affected the movie score business in a different way to the music business. When people start up their own studios and have enough equipment to make and record music they may think that all they need to put music to picture is a VHS machine and some kind of synchronisation. This attitude grates on Lansdowne, "A lot of musicians want to get into the film scoring business. A lot of people think doing music for picture is a piece of cake, you have a video machine, a monitor, a synchroniser, a bit of timecode and you're laughing, that's not the case at all. All you need is a basic knowledge really but you can't rely on domestic video machines to get the accuracy, it's knowing how to link all the things together to ensure that whether it's a piece of film or a piece of tape if it's got timecode on it it's going to fit that picture. We never have that problem here, it never happens, but we do have to sort out other people's problems."

## The Lansdowne way

To be an engineer at Lansdowne can be like flying by the seat of your pants, incredibly challenging and requiring not a little skill. One day you could be dubbing the latest drama from Yorkshire TV, the next you could be recording a 70-piece orchestra at CTS straight to stereo. Only motivated people need apply. Of course that would be the case if there were any jobs going which is a rare happening these days as engineers seem to like working there for long periods of their lives. Lansdowne record straight to stereo but make sure they use a multitrack back-up although until now they haven't used one. This practice tends to attract jazz music clients who are looking to offset costs.

Chris Dibble underlines the need for the right training attitude, "It's essential to have the ability to use microphones in a creative sense. You can put a microphone on an instrument anywhere you like but you might not get the right sound. I'm not a believer in the courses that are run by various companies, that's not to say that the APRS course is not a very constructive one but it doesn't take people on at months at a time and ask them for lots of money to give what they regard as experience. I would veer away from employing anybody with those kind of qualifications. The way Lansdowne and CTS have always trained people is to take them straight from college or school, 18 or 19 year olds who have no experience in studios whatever. Then they get their training and experience from the other people here and other engineers, that way they have no nasty habits or inbuilt theories. It's on-the-job training."

The Lansdowne way was introduced into CTS studios in 1987 when they bought the Wembley site. Kerridge and Dibble were looking round for bigger studios for a number of years with large orchestral recordings in mind. They had seen a few places that weren't right, then they heard about CTS. Dibble: "The Lee brothers, of Lee Electric Lighting, wanted to get shed of CTS studios. They hadn't put any money into it for a long time, although it was a fairly busy studio they weren't getting the moral support they required mainly because it was a public company, which it isn't now. Lee decided to sell it and indeed to sell within a given date and if it hadn't been sold within the time they would close it. Adrian and I managed to sign the papers on the Monday it had to be sold by, it was all done very quickly."

As the storm clouds gather round the London music scene in the forms of increased business rates, short term studio rate cutting and the musicians union, a few well established studios have moved out or fallen by the wayside. Air are moving to Hampstead, Audio One, Odyssey, PRT and Good Earth have closed. Lansdowne beaver on with their self-owned site, which seems better than having a landlord at the moment. Chris Dibble cites examples of people going to cheaper studios and spending twice the time, the same amount of money as Lansdowne and getting a bad result. As he says "If you pay peanuts you get monkeys." □

**Lansdowne Recording Studios Ltd, Flat 1, Lansdowne House, Lansdowne Road, London W11 3LP. Tel: 071-727 0041. Fax: 071-792 8904.**

# WORDFIT

## Patrick Stapley visited manufacturers DAR to investigate a practical system of digital processing for ADR

I wonder just how many people are aware when they watch a film, that much of the original dialogue has been re-recorded at a later stage? For whatever reason, whether it be excessive background noise, lack of clarity, a bad performance or even the wrong words—dialogue will generally be post-synced in the studio. The process involves the actor laboriously matching the original speech line by line, while watching a playback of the film. Some actors have a natural aptitude for post-syncing, just like some vocalists are better than others at double tracking but it can be painfully slow, and as a result artistic performance may be compromised for the sake of accurate lip-sync. Even after an actor has given his best, the dialogue editor will often have to tighten things up further, using a razor blade. So refitting dialogue can be both a lengthy and a frustrating business for all concerned... enter *WordFit*.

In a nutshell, *WordFit* electronically restructures new dialogue so that it automatically matches the sync of the original. Two fundamental conditions are essential: first, the original guide track must itself be properly in sync and second, the timing of the replacement dialogue must be within a second or so of the original.

### What it does

*WordFit* is by no means a new system, in fact its origins can be traced back to early '80s research into speech processing at London's Central Polytechnic, in which Jeff Bloom—now one of DAR's directors—was actively involved. A lot of the early testing and development was conducted at Mayflower Studios in London, where the system was used on numerous films including

*Dune* and *Passage to India*. In 1985, *WordFit* became DAR's first commercial product and three large standalone units were sold, two of which are still in use today at Universal in Chicago and Warner's TBS studios in California. With the advent of *SoundStation*, it was decided to abandon manufacture of the standalone system in favour of integration, and it is now offered as an option on *SoundStation II*.

Using a process DAR call, 'non linear time warping', the system time compresses and expands the new dialogue (without altering pitch), correcting the timing to within  $\frac{1}{400}$  sec of the original guide track. Both guide track and replacement track are stored on disk within *SoundStation II*. They are then separately analysed by identical banks of four bandpass filters and the resultant spectral data streams are processed to calculate the time warping path necessary to align spectral features on the replacement track with the corresponding features on the guide. This time warping data, together with speech/silence classifications, is inputted to a waveform editor that works out the optimum points to compress (omit) or to expand (repeat) 10 ms slices of the stored replacement dialogue, taking into account waveform periodicity and pitch synchronisation. These 10 ms segments of speech cannot be repeated more than once, nor can more than one be removed in every two; although during periods of silence these rules do not apply. All this information is stored in an editing instruction file and is used by the waveform assembler to reconstruct a time-aligned output.

Silence is dealt with in a much more flexible manner than speech, and Jeff Bloom illustrates this rather nicely by viewing dialogue as islands of speech floating in a sea of silence; these islands can be pushed and pulled to line up with the



The SoundStation screen following WordFit processing. Note the three display plots: the Guide which is the original location voice sound; the Dub which is the replacement voice; and the Warp which is the WordFit processed Dub track

# MUNRO ACOUSTIC DESIGN

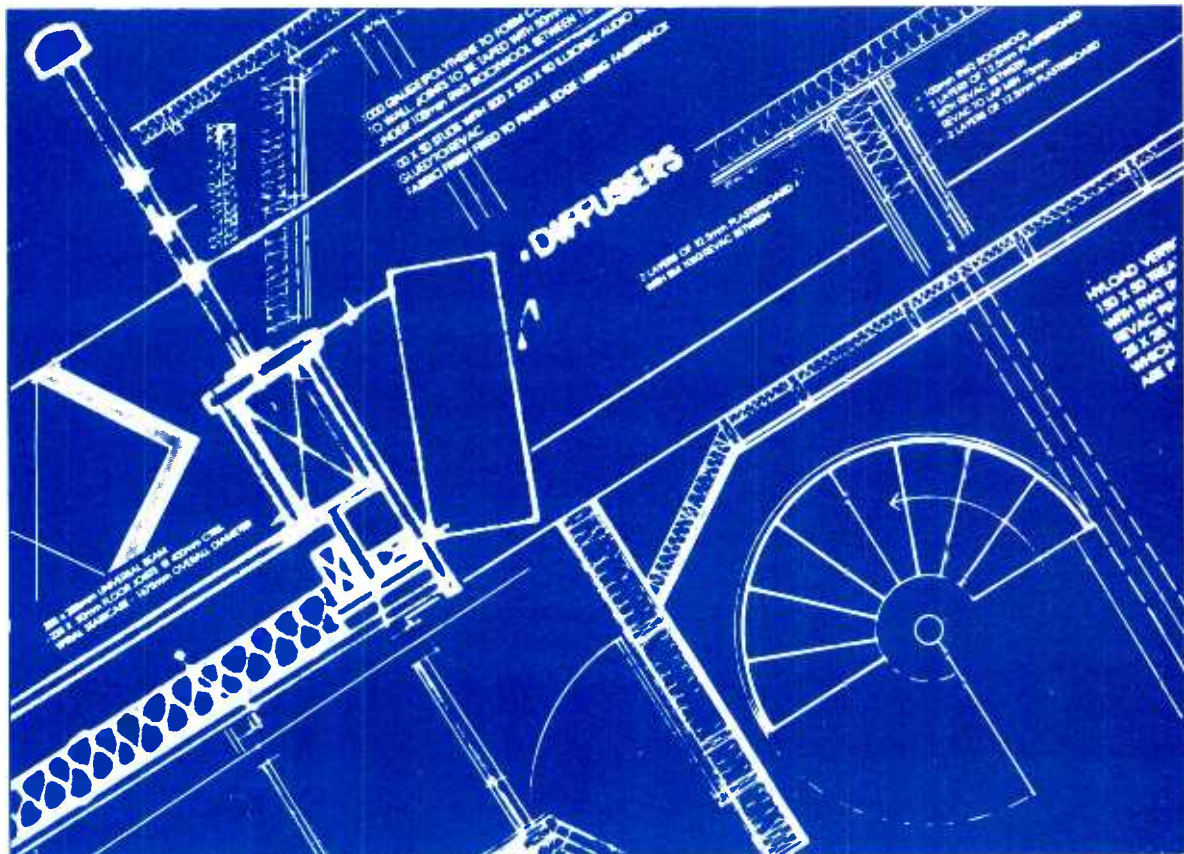

IN TEN YEARS OVER 200  
STUDIOS IN 20 COUNTRIES

With over 30,000 hours of design and project management behind us our experience is valued world wide.

Our clients range from multinational companies, and governments to individual producers and musicians.

We believe in quality and performance, delivered within time and budget.

*Call us*

**MUNRO ASSOCIATES**

The Studio

13-14 Embankment Garden

London

SW3 4LW

Telephone: 071-352 8100

Fax: 071-351 0396

guide, and then, in a less flexible manner, the detail of these islands can be fine tuned.

The quality of the guide is important, and dialogue intelligibility is obviously essential. The spectral analysis is orientated towards speech frequencies, and most background noise, unless it's loud enough to mask the actor's spectrum, will not cause a problem. This also applies to mixed guide tracks where the dialogue, music and effects have all been combined. Extraneous dialogue on the guide is also rejected—the rule being that if it's not present in the replacement dialogue it will generally be ignored.

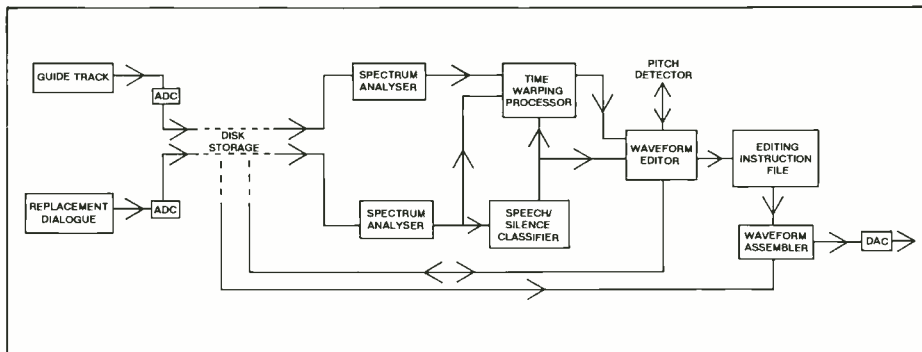

Block diagram of WordFit in SoundStation II

## How it works

WordFit is accessed in SoundStation II from a pop-up menu. First of all the original dialogue is recorded into the system, either as a continuous

section prior to recording the replacement, or in segments recorded simultaneously with the dub voice. The two pieces of dialogue are positioned on separate SoundStation II tracks and the process is

begun by using the touch sensitive screen to select each track and the WordFit key. While the system is working, a display draws three waveforms: the guide, the replacement and the WordFit result—an experienced operator will be able to compare these and quickly judge how successful the processing has been. Finally the WordFitted dialogue is automatically positioned on the next free track (or alternatively it can substitute the replacement dialogue track), ready to be replayed to picture. Any number of takes of the same segment of dialogue can be kept and the system will operate in stereo. Depending on the complexity of the processing, the system works approximately four times slower than realtime but this should become significantly faster in the future.

As it stands, WordFit is extremely simple to use and the minimum amount of operational input is necessary. However, there are times when the processing is not 100% successful, so three alternative Warp presets have been included that reconfigure 40 parameters to provide control over the 'stiffness' of the time warping process. Additionally the WordFitted dialogue can undergo further processing, using some of the regular SoundStation II facilities.

Operationally the new system differs from the old, in that it functions 'off line'. The original WordFit functioned as part of an auto-record cycle whereby the new unprocessed dialogue would be recorded directly to the mag machine, if the performance were considered out of sync, it would then be automatically replaced with the WordFitted version during the first playback—the time taken for film transports to roll back was sufficient for the WordFit processing to be completed.

## Potential uses

WordFit will quite happily sync one actor's voice with another, to the extent where an original female voice could become male, or an adult's replaced with a child's. Even a different language can be catered for, as long as the translation reasonably matches the pace of the original, and in this respect the system offers a powerful tool to the foreign language dubbing studio.

As far as the music studio is concerned, some further interesting possibilities present themselves for exploration. The obvious ones being to correct timing errors during tracking or harmonising, for both singers and instrumentalists. The precision of a sequencer could be used to return errant drummers back to perfect time, or conversely, a too perfect drum machine could adopt the timing of a real drummer. There are all kinds of intriguing musical possibilities but we will have to wait a while to discover the realities. □

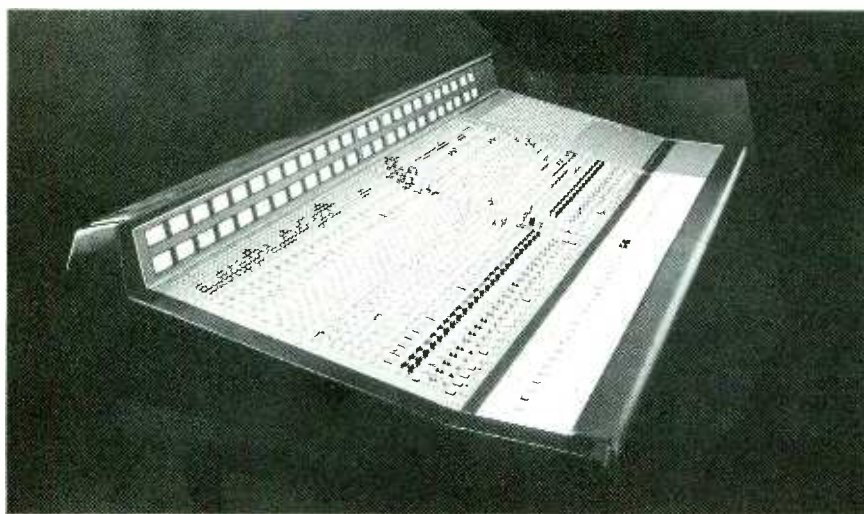

## A symphony from Raindirk

"A lot of desks have a sound of their own, the Symphony doesn't, the sound is so natural, no artificial colouring or noise."  
— Gary Jones, Coconut Recording (Germany)

"Beautiful, clean-sounding, brilliant e.q., effortless"  
— John Hiseman, Producer, Temple Music

"The best-sounding desk I've heard for nearly 10 years"  
— Paul Libson, Producer

Experience the flexibility of the Symphony LN with unparalleled clarity and dynamic range – 36 channels open, mixed to stereo, noise output – 94dbvu – dynamic range 110 db, (1 channel 121 db.)



raindirk audio

Unit 2, 10 William Road, London NW1 3EN.  
Tel: 01 388 1820/01 387 1262. Fax: 01 388 0339

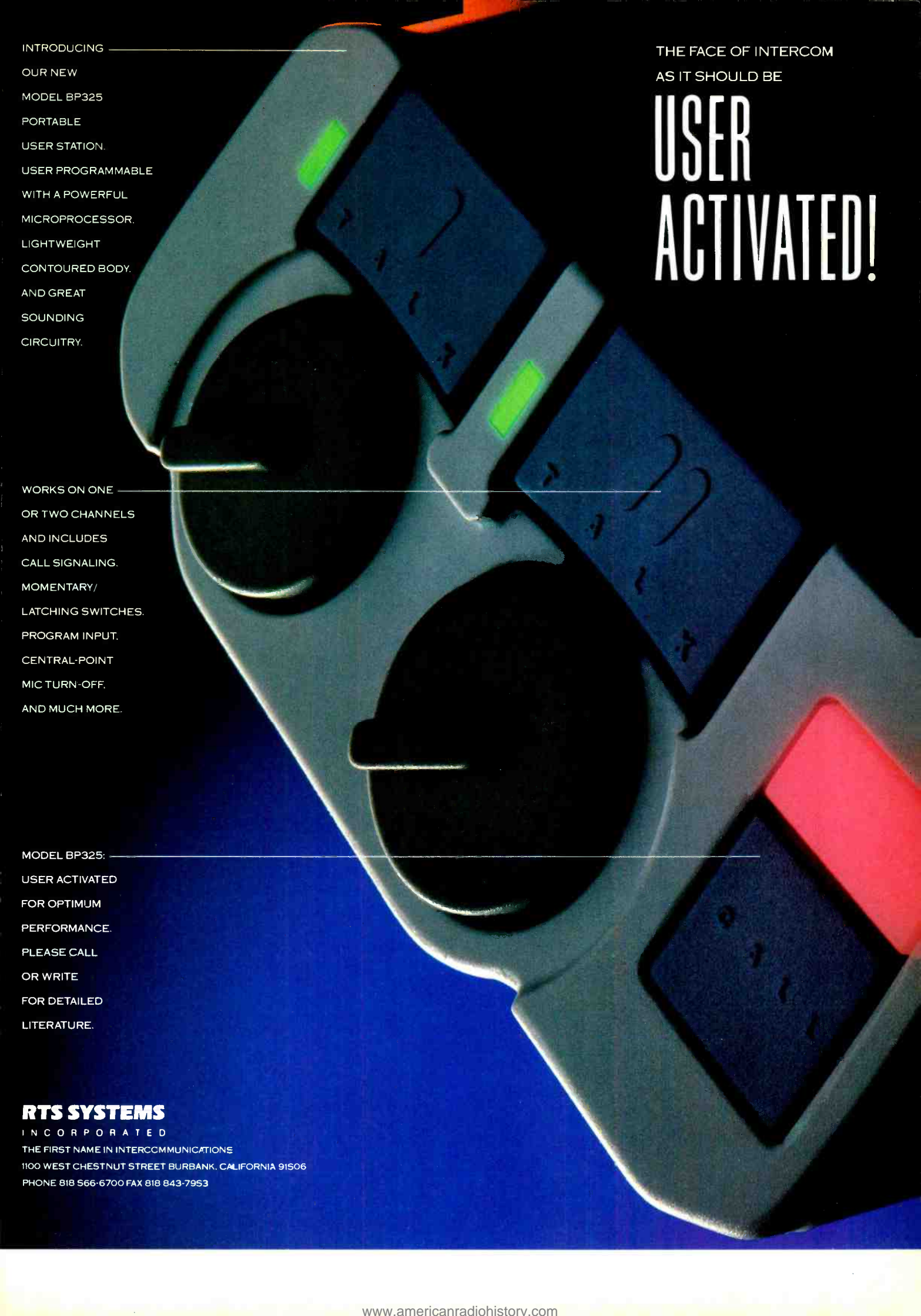

INTRODUCING  
OUR NEW  
MODEL BP325  
PORTABLE  
USER STATION.  
USER PROGRAMMABLE  
WITH A POWERFUL  
MICROPROCESSOR.  
LIGHTWEIGHT  
CONTOURED BODY.  
AND GREAT  
SOUNDING  
CIRCUITRY.

THE FACE OF INTERCOM  
AS IT SHOULD BE

# USER ACTIVATED!

WORKS ON ONE  
OR TWO CHANNELS  
AND INCLUDES  
CALL SIGNALING.  
MOMENTARY/  
LATCHING SWITCHES.  
PROGRAM INPUT.  
CENTRAL-POINT  
MIC TURN-OFF.  
AND MUCH MORE.

MODEL BP325:  
USER ACTIVATED  
FOR OPTIMUM  
PERFORMANCE.  
PLEASE CALL  
OR WRITE  
FOR DETAILED  
LITERATURE.

## **RTS SYSTEMS**

INCORPORATED

THE FIRST NAME IN INTERCOMMUNICATIONS

1100 WEST CHESTNUT STREET BURBANK, CALIFORNIA 91506

PHONE 818 566-6700 FAX 818 843-7953

# NEW DYNAMIC DIMENSION.

## The DC 24 Multi-Function Dynamic Controller.

Other designs give you "either/or." The DC 24 gives you "AND": Two limiters AND two compressors AND two gates AND a built-in crossover, all in one compact unit.

**A NEW SERVO-LOCK LIMITER DESIGN** means more transparent limiting no matter how drastically the program material changes from moment to moment. Our servo-locking circuit is smart enough to continuously maintain just the right ratio necessary to guarantee flawless control.

**SEPARATE COMPRESSION CONTROLS** allow you to dial in the perfect amount of dynamics you want, independently of the limiter. Extremely low-noise, low distortion VCAs guarantee a level of performance that will satisfy the most demanding recording or broadcast requirements.

**THE INDEPENDENT EXPANDER/NOISE GATES** can be adjusted to tighten percussion or turn off background hum and noise, without effecting any of the other dynamic control operations.

**A BUILT-IN 4TH ORDER CROSSOVER** transforms the DC 24 into a bi-amp crossover/processor all-in-one. You can minimize feedback, maximize speaker protection and save considerably on equipment costs. Or use the DC 24 as a band-split mono controller to obtain more consistent broadcast or recording signal strength with less "pumping" and "breathing."

Why put up with the expense and bulk of handling 3 or 4 conventional units? Get greater precision and more versatility with fewer side effects, all packed into a single compact unit. Experience a whole new dimension in dynamic control from Rane.



## RANE

Rane Corporation  
10802-47th Ave. W. Everett, WA 98204  
(206)355-6000





Medicina's main studio with Synclavier

# MEDICINA

Medicina is a two-studio facility with a mobile recording truck and a group of record companies. Caroline Moss visited them at their base near Bologna, Italy



Main studio

A slow but steady change is underway in the Italian recording industry. Studios are beginning to show a greater level of commitment to modern technology, notably digital. In return the studios are finding themselves being taken seriously both by domestic artists who previously went abroad to record, and by an increased amount of international acts who are choosing Italian studios for their latest recording project.

One of the companies typical of this increasing professionalism is the Medicina Sound Corporation group of recording companies located near Bologna, which began 5 years ago with a home studio and now encompasses two recording studios, one with a fully equipped *Synclavier* suite; one of Italy's few commercial mobile units and a group of record companies.

Mirko Bezzi, one of the founder members of the company, must be the only person to have entered the recording industry while designing a nuclear reactor. As a design engineer, he was working on a project in London where he knew several people in the recording industry. So when, in 1984, he visited friends back in Italy who were in the process of updating their 8-track home studio to 24-track as well as replacing most of the recording equipment, he combined his experience in design engineering with knowledge of the studios he'd seen, and took over the studio design for them. Before long he had become involved with setting it up as a commercial venture along with William Barravelli, in whose family home the studio was based.

Bezzi describes his philosophy behind getting the studio up and running: "I analysed what was going on in the studio market, found out what kind of studio was much in demand, what future trends were, etc.

"When it came to hiring people to work in the studio, I thought about finding a house engineer who is really the sound of the studio and part of the reason why people go there. But I didn't want to limit the studio to one sound from a particular person so we decided to have no house engineer, which was a break with tradition. I decided I would provide an assistant—not someone to make the coffee but someone who knew perfectly how the studio equipment worked, and then work with freelance engineers. This wasn't easy in Italy because there were hardly any good ones but nowadays it's become easier; there are a few more."

When Bezzi designed the studio 5 years ago he decided that, given the increasing popularity of MIDI, a large control room



and a small overdub area was the best way of using the basement that housed the studio.

Bezzi: "The studio wasn't very big anyway and there seemed no point in having a medium-sized control room and studio area. There were plenty of recording rooms available in Italy but not many mixing studios, so we chose to go in that direction."

The studio became busy straight away, with its reputation spreading by word of mouth. The studio was the first in the region to provide 48-track recording and a large (64-input) MCI console. Bezzi and Barravelli aimed to provide good recording facilities at reasonable prices so the studio could be used by independent acts and record companies alike, and also provided studio maintenance, which was uncommon at the time and is apparently still a rare entity.

The acquisition of the second studio, Maison Blanche, situated in the countryside near Modena and owned by brothers Umberto and Maurizio Maggi, came about in the spring of 1988. The two studios had formed a good relationship and discovered that they shared the same type of approach towards the running of a studio.

The owners of Medicina purchased the Maison Blanche company, renamed it Medicina Blanche and set up the Medicina group of companies. Medicina Blanche already had established clients and continued to function as before, with an improvement in the equipment in the form of two Otari *MTR 90 II* 24-track tape machines and a Raindirk *Symphony* 52-input console in place of its old MCI. Situated in a large family house in the middle of open fields, the studio is in a tranquil situation for recording long projects and an ideal complement to Medicina, which is near a town and used for short-term work.

Accommodation at Medicina Blanche is provided for up to 10 in the house, and the mother of the two brothers who own the studio and the house—she is affectionately named Mamma by sons and clients alike—supplies the good Italian home cooking. Both control room and studio are spacious and feature large quantities of marble, and the studio has become renowned for its live marble room.

As more and more TV and audio/visual work was undertaken at Medicina, it was decided that significant investment was required. Accordingly, Italy's first *Synclavier* suite was installed at the studio in early 1988 and immediately began attracting work from audio/visual companies.

Bezzi: "We bought the *Synclavier* before we even bought the digital multitrack as that was what I felt I could introduce onto the market—it's a completely new way of working and people were interested to come and see how it works. By buying this machine we can work with both TV and recording projects—we do much stereo sound work for TV, mixing to Dolby *Stereo* and Dolby *Surround*. Medicina is moving more towards sound for picture rather than recording because we have this new *Synclavier* room, and we now have the second studio, Medicina Blanche, for recording projects."

The *Synclavier* installation was followed by the purchase of Mitsubishi digital equipment; unusually Bezzi chose to buy the *X86* mastering machine before buying the two 32-track *X880s* he later purchased. The machines, like the wide range of effects and microphones the studios own, can be transported between the two locations.

Bezzi comments: "I know the choice of the first digital machine to buy was somewhat strange but I needed a digital master, something that was easy to sync to picture. The *X86* was one of the first machines which gave the impression of

giving digital recordings which would last for years with no drop-out."

At Medicina, everything has been wired so that it is controllable by computer. Bezzi: "Even if we don't have top of the range SSL we do have a high degree of automation. We wired the room to be able to use all the computers as standard so we are able to interchange. The link between the studios is digital—no analogue link at all—so we use the AES/EBU interface for transferring 2-channel digital between the two rooms. We now have top level digital technology there—the *Synclavier*, digital multitrack, digital master, digital transfer between formats and digital editing for TV. We were the first company in Italy to begin this TV work and still have the most technology for sound for picture—we do all kinds of synchronisation work and composing music on the picture. Everything we produce is in Dolby *Stereo* for TV and we are producing things that are going to be used in the next 5 years.

"We feel that as a group we're moving in distinct directions. We have formed a 'recording group' and what we're trying to establish is the kind of company which people can look at for reliability and excellent service."

A further acquisition of the Medicina group is the 'Moby' mobile, completed last summer when the company won the contract to provide a PA and recording system for a tour of Italy by one of the country's biggest rock stars, Zucchero 'Sugar' Fornaciari. For this tour the Medicina group decided that it was imperative they built a mobile studio and it was completed just a week before the tour began.

Bezzi: "The PA system was designed especially for the tour by Italian manufacturer, Montarbo. It was a 110 kW system, a brand new design, so the whole thing was a completely fresh approach for what was probably the most important Italian tour of last summer—quite a risky business!"

Medicina and PA company Nuovo Service hired in the complete PA crew and handled the mixing themselves, with Maurizio Maggi engineering the sound in the mobile. All the signals were taken from the stage into the mobile where it was mixed and sent via two channels to the front of house PA. Three channels were sent from the mobile to surround effects, thus everything was redistributed from the mobile out to the PA.

More recently, the group has become active as a record and production company. Bezzi explains: "We started as a way of recording bands that couldn't afford to work in a studio like ours. There are people with new and exciting ideas about music who can't afford to realise them simply because their budget will not allow it.

"We first started with an agreement with an Italian record label in San Remo and started co-producing new groups, giving them the chance to record in a top studio. The people who work for the label have a good approach—they want the bands to be engineered and produced by well known people, for example they have brought UK producers Guy Bidmead, Kit Woolvern and Nick Griffiths over to work on one of the albums.

"After a while you become involved with the bands and want to produce good sounding records—it becomes very exciting. Some of the albums we've produced have been for two heavy metal bands and two Italian rock bands."

Medicina joined up with an existing label, Rose Rosse, which has five sub-labels, each working with different types of music.

"We were lucky to find the right people to work for the label, we have an excellent A&R man and a good administration team so the label has already produced a number of records although we only recently began."

Rosse has caught the attention of the Italian multinational record companies and good relationships are being formed.

To the future, Medicina has designed a new complex to be built in the heart of Bologna in which the administration centre and studio, acoustics of which have been designed by Harris, Grant Associates, will be located. Building has yet to begin although planning permission has finally been obtained.

Bezzi welcomes the opportunity to be nearer to the audio/visual companies located in the city and the possibilities it will afford the company. He says: "Italy is the home of many brilliant musicians—the sad thing is that they often leave to go and work abroad. So on the technical side, we can provide somewhere they can stay in their own country and work at high standards." □

The Medicina Sound Corporation, Via Lamberti, 19, 40059 Medicina, Bologna, Italy. Tel: 51 852534.



# Studio House Audio

## NEW AND 2<sup>ND</sup> HAND LIST

<b>Mixing Consoles</b>		<b>Recorders</b>	
Soundcraft 2400 new	£10,500	Mitsubishi X850 32	£60.00
Allen & Heath Sigma 20/24 new	£8,500	AMS Audiotite (version 8)	£35,000
Randirk 2000 28/24 patchbay	£4,000	Studer A820 Remiloc w/ SR	£29,950
Trident 80 32/24 patchbay	£16,000	Otari MTR 90 II remiloc	£18,500
Soundtracs CM4400 28/24 CMS 2 Auto	£8,000	Studer A800 IA 24	£12,000
TAC Matchless 32 input	£9,000	Studer A80 N III 24	£9,950
TAC Matchless 36 input patchbay	£11,950	Studer A80 IV - autolocator	£15,000
Allen & Heath Sigma 32 in-line with auto	£15,000	Studer A80 Mk II	£8,000
Soundcraft 38 32/24 patchbay	£6,500	3M M79 2 available	£9,500
Allen & Heath System B 16/B 2	£850	Soundcraft SCM 760 III 24 v/h	£10,500
Soundcraft 800B 40/8/2	£6,950	Soundcraft SCM 762 24 remiloc	£8,500
Soundcraft 800B 24/8/2	£4,950	Studer A80 16 track	£3,500
Soundcraft 800B 16/8/2	£4,100	Tascam ATR80 24 remiloc new	£18,950
AMEK 2500 40 input	£29,500	Tascam ATR60 BT	£2,500
Amek Angelia 36 input with mastermix	£24,000	Tascam 58 BT 1/2" pro-version	£1,595
Studer 961 2.8st 2mon PPM	£5,000	Tascam MS 16 complete	£4,500
Soundtracs PC Midi 24 16/2	£3,995	Tascam 85 168 complete	£3,500
MCI 500B JH50 auto	£12,500	Tascam 85 16 complete	£2,500
Soundtracs CM4400 with CMS2 28 input (unused)	£10,500	Tascam MSR 24, 16/ITSR8 new	P.O.A.
Soundtracs CMX 32	£12,000	Fostex E18 new	£2,800
Soundtracs Trackmix	£5,000	Fostex E16 with 4050 remiloc	£2,700
Soundtracs CP6800 32/12/24	£16,000	Fostex E16 vgc	£2,250
Soundcraft TS24 2B patchbay	£12,900	Fostex B16 vgc	£1,750
Studiomaster II 32 16/2	£2,750	Fostex G24	P.O.A.
TAC Matchless 26 patchbay	£7,500	Tascam 38 vgc	from £1,000
TAC 24/8 2 mint	£2,500	Fostex M80 vgc	£795
Cadac 28/24	£12,000	Fostex A8 good	£695
SECK 12 B 2	£695	Tascam 3440 mint	£600
SECK 18 B 2	£900	Mitsubishi X80	£3,000
Soundtracs 16.8/16/2	£1,500	Studer 820 2T 1/4" & 1/2" HB	£4,000
		Studer A810	£3,000
		Studer B67 VU 301PS Console	£1,800
Tascam 52 NB as new	£1,500		
Revox C270 as new	£1,700		
Revox PR99 II as new	£1,150		
Revox B77 II as new	£750		
Revox B77 vgc	£600		
Revox B77 Slide Sync	£600		
Revox A700 recond	£600		
Casio DA1 R DAT mint	£495		
Sony DTC 1000ES new	£1,130		
Sony PCM various	£phone		
Revox B710 as new	£595		
Tascam 122 vgc	£250		
Eventide H3000 B	£1,750		
AMS SDMX	£4,995		
AMS RMX16	£2,995		
AMS 1580S	£2,995		
Lexicon 224 (XL) various progs	P.O.A.		
Lexicon 480L V2 with SME	£6,000		
Lexicon 480L V2	£5,000		
Lexicon PCM 70	£1,300		
Klark Teknik DN780	£1,450		
TC 2290 32 sec fr new	£2,000		
UREI 1176, 1178 and LA4	P.O.A.		
DBX 163, 165, 200, 150, 150X	P.O.A.		
Yamaha TX16W mc library	£700		
Yamaha DMP7, Rev7, SPX series	P.O.A.		
Dolby 330, 361, Cat22, K9, SR etc	P.O.A.		
24 Channels of Bel Noise Reduction	£995		
BEL 2400 8D80s, BC series NR	P.O.A.		
AKAI S1000, S950, S900, MG macs	P.O.A.		
EMT gold foil & remote vgc	£850		
Rebis Rack 2G, 2C, D-ES, sample OBC & Dist	£700		
Drawmer units secondhand	Cheap		
Digitec DDL and FX units new	on demo		
JBL 4401	£200		
JBL 4435 pair, as new	£2,995		
JBL 4430 pair, as new	£1,750		
JBL 4350 pair, vgc	£1,750		
JBL L250 top-sided pyramids	£1,500		
JBL 4411 pair	£700		
JBL 4333 black ash	£995		
ATC SCM 250 pair	£3,000		
Tannoy Classic 15" pair	£650		
UREI 813B pair	£1,750		
UREI 813C pair	£2,250		
UREI 811C pair	£1,300		
UREI 809A pair	£750		
Neumann 47, 56, 84, 86, 87, 89 170 P.O.A.			
AKG 414, 460, 12A, 28A, 224, 451, 112			
202, 190, 12 etc, etc	P.O.A.		
Neumann M49 valve perfect	£1,500		
Sennheiser 405, 441, 421, 416	P.O.A.		
EV RE20 PL92A, ND757, ND40B	P.O.A.		
Shure 57, 58, 91, 548, 54, 17	P.O.A.		
Beyer 69, 88, 201, DT100 HP's	P.O.A.		
Sony ECM 50 P. Tie clip mics	£75		
Mic stands galore, booms from	£20		
Power amps various	P.O.A.		
FM Acoustics 1000W amp	Offers		
Dynacord ADDI full kit	£2,250		
Nady 201 SM58 Radio Mic NEW	£295		
CALREC Soundfield IV as new	£2,500		

EXPORT PRICES  
(UK Customers please add VAT)  
EXPORT A SPECIALITY

**WANTED FOR CASH COMPLETE STUDIOS**

**0663 64244**

**STUDIO HOUSE AUDIO**  
High Lane Village, Nr. Stockport SK6 8AA.  
FAX 0663 62328

# SERIOUS MONITORING



**Westlake Audio**



**Rogers MONITORING**

Listen before you choose

Please send me information on studio monitoring

Name \_\_\_\_\_

Address \_\_\_\_\_

Telephone \_\_\_\_\_



Send to: **Michael Stevens & Partners Limited**  
FREEPOST, Bromley BR2 9BR  
TEL: 01-460 7299 FAX: 01-460 0499

# KFA BOX CHALLENGE

A casual remark made by KFA managing director Mick Fitzgerald over lunch to Studio Sound about how his studio design company, KFA, could possibly build a standard *The Box* studio in less than one hour led to an 'official' Studio Sound challenge to "prove it". Certain conditions would prevail: *The Box* would be built in the KFA factory; no sand soundproofing or air conditioning would be installed and no windows would be fitted. There was, however, still a lot of work to be done to finish *The Box* in time with reputations at stake. Julian Mitchell from Studio Sound was there to adjudicate, keep time and make sure there was no cheating. KFA made it with 7 minutes to spare

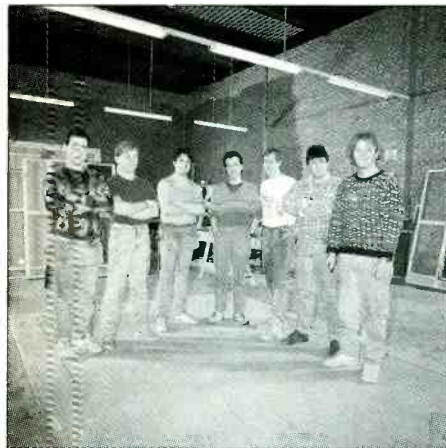

The KFA construction team poses on what will become the studio floor



They're off, on with the first wall panel



Zero plus 6 mins and the third wall panel goes up

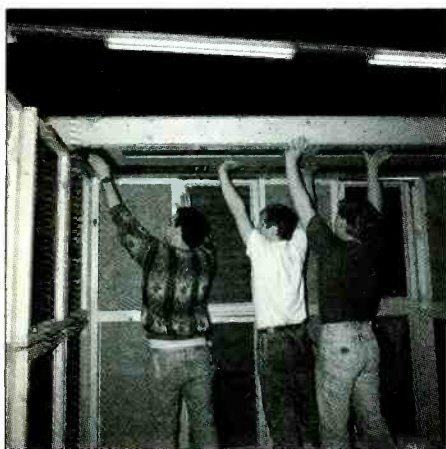

Zero plus 15 mins, roof panels going on

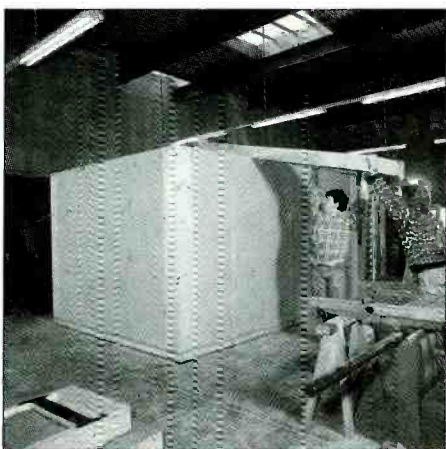

Zero plus 20 mins, roof panels still going on

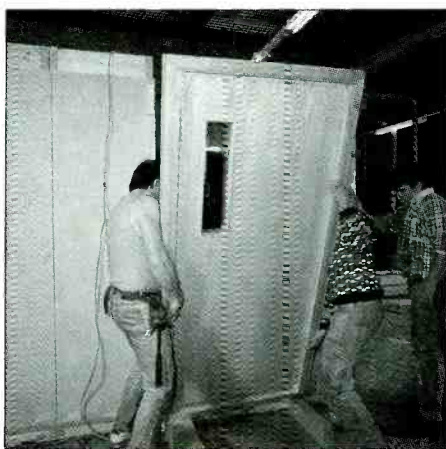

Zero plus 23 mins

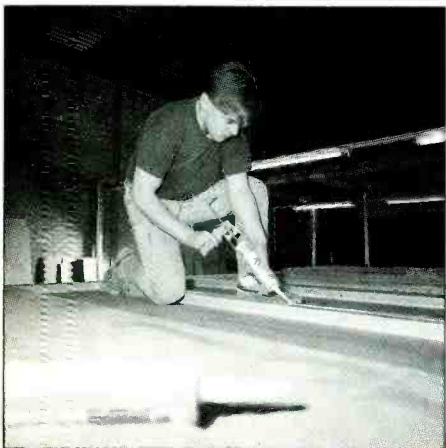

Zero plus 35 mins, all roof and wall panels are sealed inside and out

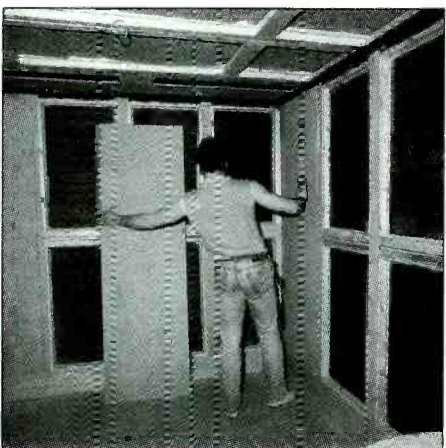

Zero plus 40 mins, wall cloth panels

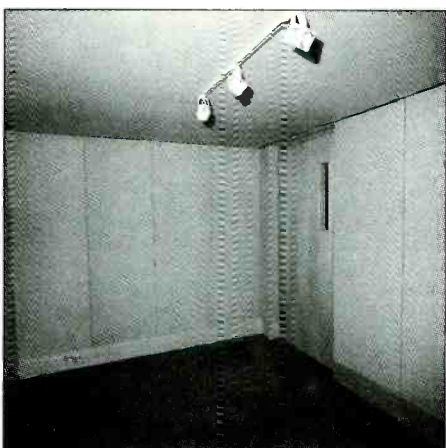

Zero plus 53 mins, the finished studio as passed by quality controller John Banwell

## Advancing The Art.

Trident pioneered sophisticated audio mixing systems over two decades ago. You cut and mixed your best tracks on a Trident and have since longed for our legendary sonics in a mixer designed for your application. The wait is over.

A new standard is emerging from the company that continues to define audio integrity. Vector, the latest in Audio for Video mixing technology. It's heritage is firmly rooted in the finest audio tradition: a tradition unique to Trident.

With four stereo busses, dynamics, stereo inputs, integrated machine control and fader automation options, there really is no other choice. Audition a Vector and hear for yourself. After all, you've been listening to us for years.

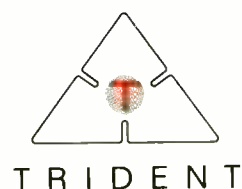



Before you buy *any* mixing console for recording or post-production, we urge you to explore the *Sound Workshop* Series 54 from Otari. You'll discover significant design breakthroughs, reasonable cost, and Otari reliability and product support.

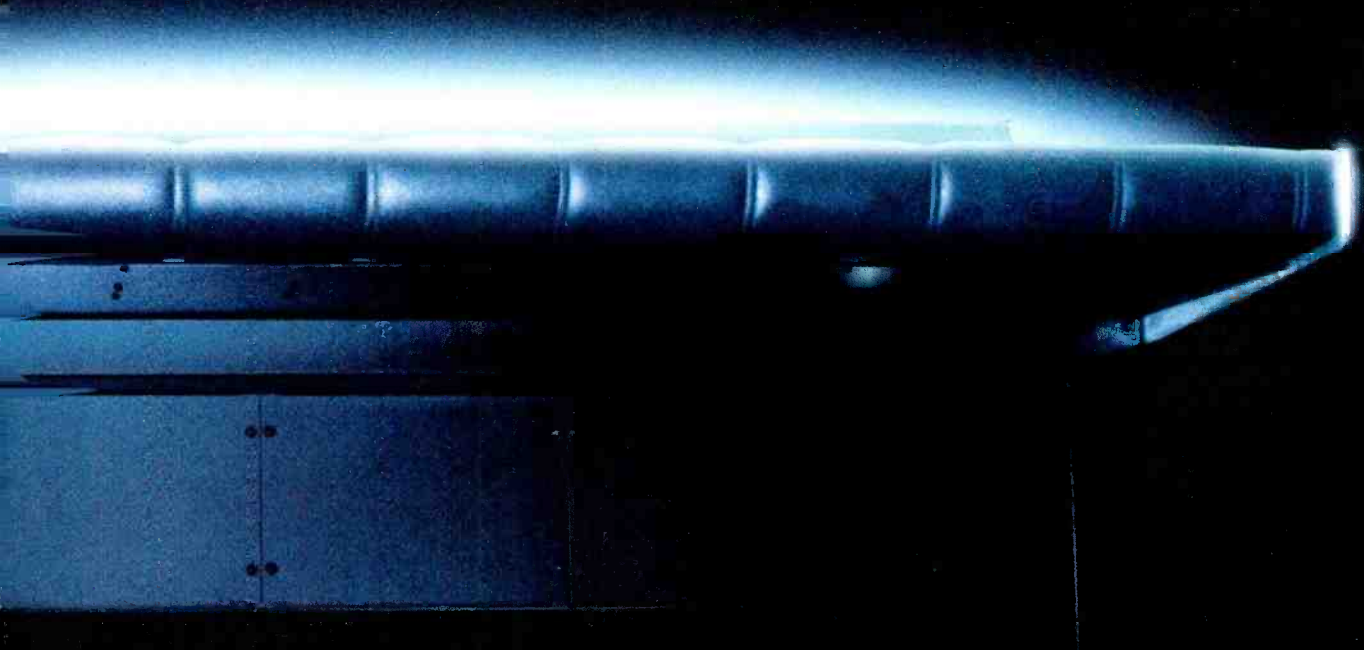

**SONICALLY DEVASTATING.  
FINANCIALLY REWARDING.**

Finally there's a mixing console that sounds great to the engineer, the studio owner, and to the artist! Call Otari for information.

© Otari 1990

**OTARI**

*Mixing Technologies*



# GENELEC

ANYTHING ELSE WOULD BE SECOND BEST

FINLAND: Tehtaantie 17, SF-74100 Iisalmi, tel. 77-13311 fax 77-12267, AUSTRIA: Audio Sales tel. 02236-26123, BELGIUM: Hes Electronics tel. 02-466 81 80, KOREA: Seoul Sound Technology tel. 2-584 4311, FRANCE: Publison Audio Professional tel. 1-43608464, GREECE: Kem Electronics tel. 081-687 8514, HONG KONG: Power Source Development tel. 3-7456189, ITALY: Audio Equipment S.R.L. tel. 039-2000312, JAPAN: Otartec Corporation tel. 03-332 3211, THE NETHERLANDS: Audioscript B.V. tel. 02155-20400, NORWAY: Siv. Ing. Benum A/S tel. 02-145460, SPAIN: Promovisa tel. 081-535 20 17, SWEDEN: Intersonic AB tel. 08-7445850, SWITZERLAND: RTG Akustik AG tel. 061-231912, TURKEY: Ömer Trade & Representation tel. 90(4)-1380296, UK: SSE Marketing tel. 071-387 1262, USA: Quest Marketing tel. 617-964 9466, WEST GERMANY: Audio Export Georg Neumann & Co. GmbH tel. 07131-62470.



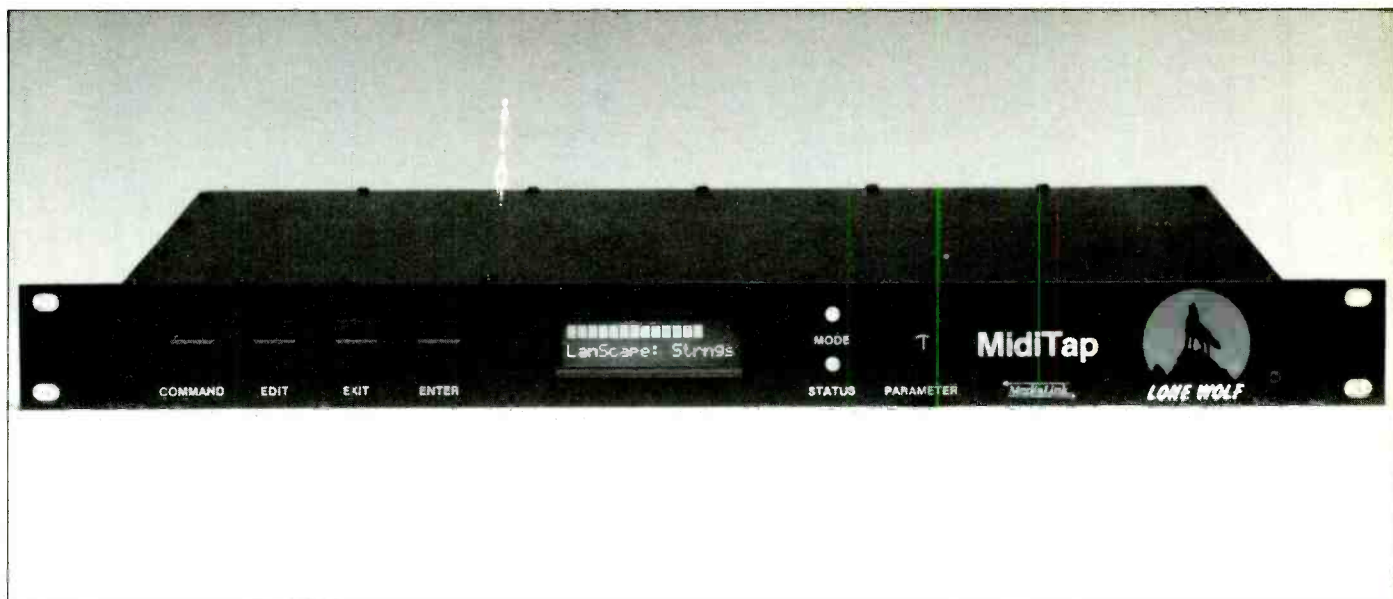

# MIDITAP LAN

David Miles Huber looks at a new MIDI management system that tackles the problems of distribution and system setup

In the land of MIDI production, it's a simple fact of life that when you try to cram large volumes of channels, notes, sys ex, sample dump data and the like through a single, serial data line at 31.25 kbaud, you're bound to run into a traffic jam. When you combine this with the ever expanding instrumentation, effects and mixing hoops that a complex system's setup has to go through, it becomes easier to

understand why many hear the call for a next step in MIDI data distribution.

A large part of these distribution and system configuration problems are currently being addressed by a new generation of MIDI interface, patch and processing systems. These devices are capable of providing extensive routing, merging and filtering over multiple MIDI ports. One such MIDI management system is gaining a great deal

of recognition by tackling the problems of MIDI distribution and system setup in very novel ways, including the use of a LAN (Local Area Network), a computer protocol that has its basis in the world of business. This hardware system is the *MidiTap*, the first in a series of audio production and management devices from the folks at Lone Wolf, Redondo Beach, California.

The *MidiTap* is a single rack device whose front panel includes four software control buttons, a small LCD panel and a velocity-sensitive parameter dial. Its rear panel features four MIDI In and Out ports, an RS232/422 serial port for direct connection to any computer or modem and a set of fibre optic ports. It is the latter that makes this device so unique, as the fibre optic connectors make use of Lone Wolf's proprietary MediaLink protocol. MediaLink is a high speed, bi-directional protocol that facilitates the efficient distribution of large amounts of digital information in either realtime or non-realtime between connected *MidiTaps* or compatible devices. Unlike MIDI, which is limited to a transfer rate of 31.25 kbaud, MediaLink is capable of transmitting digital data, in both directions at speeds of 1, 2, 4, 10 and 100(!) Mbit/s. It is this high data transfer rate that allows multiple *MidiTaps* to be linked together in a virtual LAN network, thus allowing any MIDI device that is connected to any *MidiTap* to be addressed by any other on the network in real performance time.

While using a conventional business LAN system, it's generally no disaster to have to wait a fraction of a second when accessing data while a print or other file is being accessed. However, it would be totally out of the question for a downbeat bass chord to be placed on hold while a lead riff is played out. Thus, when placed into its 'performance mode' MediaLink gives top priority to critical timing information (such as note on/off, velocity, continuous controller data, etc) so that it is transmitted throughout the network without unacceptable delays.

In addition to speed, MediaLink's bandwidth allows a greater number of instruments and devices to be accessed within a multiple *MidiTap* system at one time, without the delays and data bottlenecks that are associated with the 31.25 kbaud rate of MIDI. As an example, using MediaLink's lowest bandwidth, it is possible to transmit up to four discrete MIDI data streams over this optically linked system, with up to 64 MIDI devices (4 ports x 16 channels) available at

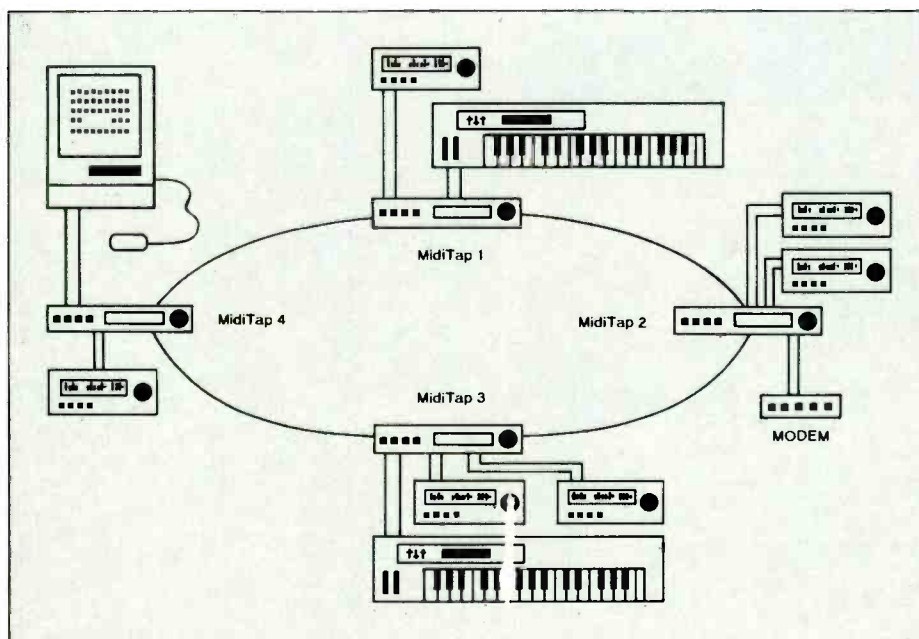

MidiTap LAN network

each *MidiTap*. It should be pointed out, however, that MediaLink is not a replacement or a revision of the MIDI spec. It is simply a system for distributing digital data at high speeds within a network. Once the data reaches a *MidiTap*, it is reconverted and routed to the appropriate MIDI port as true MIDI data.

Now that we've scratched the basics of this unique protocol, just what are the applications of such a realtime network? To begin with, the MIDI spec restricts standard data lines to a length of 15 m (50 ft), while optical cables used within this system can be transmitted over very long distances (we're talking miles folks!) with complete isolation from external interference. This would make it possible for any number of production facilities to gain direct access to setup, controller or actual performance output in realtime, just as though each device were directly connected to all production rooms in question. This is possible because, in effect, they really are

directly connected on the same data transmission/acquisition network. Another application might include the ability for groups of keyboard or other performance controllers to communicate MIDI data to instruments or effects devices that are located hundreds of cable-feet away within the theatre's mixing or equipment room.

In addition to its realtime 'performance' mode, *MidiTap* also may be operated in a 'setup' mode. In this way, all devices operate in a similar fashion to a standard LAN, giving them equal priority on the network. This is used for data that need not be transmitted in realtime, such as MIDI files, system exclusive dumps and other network configurations. Using this communications method, it is also possible to connect directly to another *MidiTap* via a telephone modem. Thus, the remote system will be recognised as an active part of the network for direct up/downloading of system configurations, sound or sample data (an

ideal application for cross-town or long distance musical collaborations).

All these benefits would make *MidiTap* a novel and interesting device on its own, however, one of its strongest selling points is its ability to make use of the LAN network in an intelligent fashion to simplify the process of setting up complex MIDI configurations. In fact, this was the developers' original reason for creating it. They simply got tired of spending long periods of frustrating time repatching complicated setups.

At its most basic level, the *MidiTap* device acts as a patchbay that is capable of routing any MIDI output to any input regardless of which *MidiTap* either device is connected to. On a deeper level, *MidiTap* provides the user with a simplified means for assembling a multitude of devices and program changes into an overall system setup. Lone Wolf makes use of a wide range of device parameters for creating an overall 'snapshot' of a system known as a 'LanScape'. A *MidiTap* LanScape is defined by assigning various 'devices' within the system, each of which may be specified as being either a source device or a destination device. Device names are more than simple instrument identifiers, it is a basic setup definition for setting the MIDI port, channel, filtering and other parameters for one or more instruments or devices. For example, we could create a device and name it M1. M1's parameters could then be specified as follows:

DEVICE NAME:	M1
PORT:	3
MIDI CHANNEL:	15
PRGM. CH. #:	35
NAME:	M1

Such a configuration could be your commonly used setting for an instrument, or a special setup within a complicated configuration. By the same token, a device can be made up of multiple instruments and voices. For example, the device BIG RIFF could be made up of an *EMAX II* and *D-50*.

DEVICE NAME:	BIG RIFF
PORT:	2
MIDI CHANNEL:	5
PRGM. CH. #:	40
NAME:	EMAX II
PORT:	1
MIDI CHANNEL:	7
PRGM. CH. #:	12
NAME:	D-50

Thus, when creating an overall LanScape (which can be made up of any number of devices, voices, etc) it is easy to see what would be the outcome of assigning M1 as the source and BIG RIFF as the destination. However, if BIG RIFF is designated as the source and 'M1' as the destination, *MidiTap* is smart enough to merge the MIDI data streams, allowing either the *EMAX II* or *D-50*'s keyboards to act as controller for the Korg *M1*.

As you can see, this device and communication protocol is both powerful and versatile as far as speed, connectivity and setup ease is concerned. Although it is just now beginning to be placed on the market, several manufacturers are showing a serious interest in this protocol for MIDI, digital audio and time-based applications, it's possible we could see software in the wings that will directly address the *MidiTap* and future Lone Wolf spin-off cubs. □

TC 1280/1380

# Give us an inch...

... a foot or a meter and the new TC digital audio delays will give you precisely calculated delay times. Of course you can enter delay times as you would on any delay, choosing increments clear down to 5 microseconds. The group delay and Left-Right phase linearity are absolutely outstanding.



The TC 1280 (Stereo) and TC 1380 (3 Tap) delays are based on the technology that made the TC 2290 the most sought after delay unit in the recording industry. We have kept the superb frequency response, low distortion and noise free signal path and added the features most needed in critical applications.



Frequency response: 20-20 KHz +0/-0.5 dB 25 KHz -3dB, Dynamic range: > 100 dB, THD: < 0.05 % 1 KHz, Analog group delay: 20-20KHz (30 microS, Group delay linearity: 20-20 KHz +/- 5 microS, Stereo synchronization: +/- 1 microS (1280), Max output: +22 dBm.

... If you are a professional in the disc mastering, broadcasting, sound reinforcement or recording fields check out these latest additions to the TC family. Call for the location of your nearest TC dealer.

OF DENMARK

**t.c. electronic**

INTERNATIONAL HEADOFFICE: TC Electronic A/S, Grmhøjvej 3, DK-8220 Brabrand, Denmark, Ph 45 86 262800, Fax 45 86 262928 · USA: TC Electronic USA Inc., North Hollywood, 818 503 0404 · UK: TC Electronic UK Ltd, Oswestry, 691 658 550 · GERMANY: TC Electronic of Denmark GmbH, Detmold 05231 32972 · AUSTRIA: TC Electronic of Denmark GmbH, Detmold, 49 523 132972 · AUSTRALIA: East Coast Audio, Melbourne, 03 241 2244 · BELGIUM: James B. International, LE Cap aij IJsel (HOLLAND), 0031 10 4588166 · CANADA: TC Electronic USA Inc., North Hollywood, 818 503 0404 · FINLAND: Studiotec, Espoo, 90 592055 · FRANCE: Phase Acoustic, Marseille, 91 498728 · GREECE: Lyrikon, Athens, 3628541 · HONG KONG: Jolly Sound Ltd., Kowloon, 3620202-5 · HOLLAND: James B. International, LE Cap aij IJsel, 010 4588166 · ITALY: CD Videosuono S.P.A., Milano, 02 50841 · JAPAN: Otari-tec corp., Tokyo, 03 332 3211 · NORWAY: Musikk og Elektronikk A/S, Tansberg 033 26798 · SINGAPORE: Team 108, Singapore, 748 9333 · SWEDEN: Elfa Studio AB, Solna, 08 734 0750 · SPAIN: Ear Pro SA, Barcelona, 93 212 7050 · SWITZERLAND: Riverside Music, Losone, 093 352794

# The very best in Video Jackfields — — available ex-stock!

If you need the very best video Jackfields available — and you need them *today* talk to Plasmec Systems!

We've just added a full range of Video Jackfields to our world famous Mosses and Mitchell range, which are capable of meeting the most exacting of professional broadcasting standards!

The new range includes models with 18, 20 and 24 MUSA connectors per row, all manufactured using the finest components available, including MUSAS with solid standard silver plug pins. Models with optional test points are also available.

To complement the range, Plasmec can also offer a full selection of accessories. All models and accessories are available, ex-stock, on a same or next day delivery basis from Plasmec, or from usual stockists.

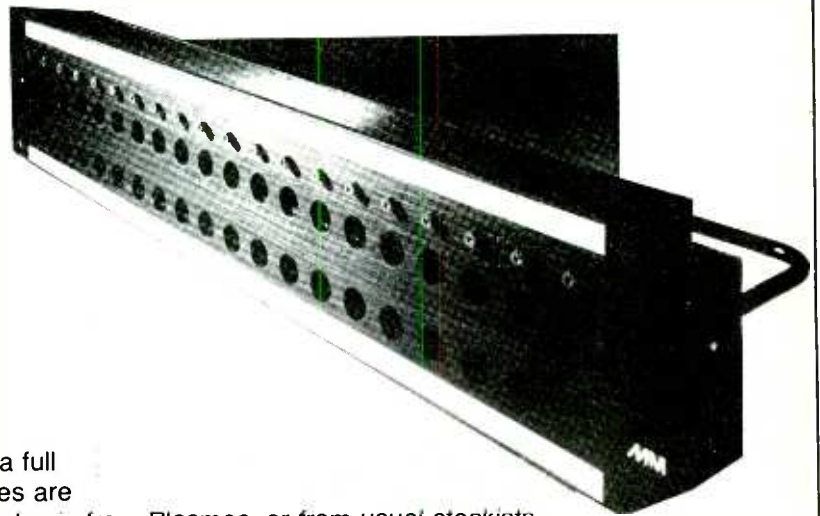

For further information, please contact:-  
Mosses and Mitchell Division,  
Plasmec Systems Ltd  
Weydon Lane, Farnham, Surrey GU9 8QL  
Telephone: (0252) 721236  
Fax: (0252) 712718

**Mosses and Mitchell**  
**PLASMEC**  
Professional Studio and Broadcast Equipment

## YAMAHA AD2X 19 BIT 2 CHANNEL A/D CONVERTER

### THE NEW STANDARD



#### INNOVATIVE UNPARALLELED PRECISION

Yamaha's innovative 'digital floating' technology is applied to these advanced, high-rate, 1-bit delta-sigma converters. Its unprecedented conversion precision delivers 19-bits of Digital Audio. For CD Mastering, 2-track and MTR digital recordings, enhanced DAT performance, Digital Mastering, A to D Mastering transfers, editing and measurement operations, the AD2X substantially improves on the 'quality limiting factor' in all of these processes.

#### FEATURES

Automatic and manual self calibration.  
Internal bit shift for data delay compensation 20-bit output word length.  
Yamaha output formats.  
AES/EBU, CD/DAT and word clock in/out.  
Switchable sampling frequency and emphasis.  
Electronically Balanced Analog input.

#### SPECIFICATION

Conversion:	19-Bits Digital Floating 64 times oversampled A/D
THD:	less than 0.005% (nominal level) less than 0.0018% (max level)
Dynamic Range:	Greater than 110 dB
Hum & Noise:	less than -90dB
Sampling Frequency:	48/44.1 KHz

#### YAMAHA DIGITAL AUDIO SYSTEMS

YAMAHA KEMBLE MUSIC (UK) LTD · PRO AUDIO DIVISION · MOUNT AVENUE · BLETCHLEY · MILTON KEYNES · MK11JE · TEL: (0308) 371771

# OPTICAL DISKS: AN AUDIO FUTURE

Francis Rumsey looks at current optical disk technology and the roles that it is beginning to play in audio

**F**or better or for worse, the future of audio technology is now inextricably linked with developments in computer technology. Sound, once converted into binary data as it is in any digital recording system, may be processed and stored similarly to other data—although there are certain operational constraints on sound systems such as the need for continuous rather than 'burst' transfer of sound to the outputs, in order that we may replay sound files without breaks. MIDI samplers make use of computer storage media for sound data, having a certain amount of internal RAM (Random Access Memory) and perhaps a floppy or hard disk drive attached for more permanent storage. We are also witnessing an explosion in the so-called 'tapeless recording' market, there being a range of products on sale that offer storage of a number of channels of sound in realtime onto hard or Winchester disk drives, together with editing facilities and audio processing. A number of these systems have also added optical disks of varying types with recent trade shows introducing two products based solely around opticals.

The point about optical disk drives is that they combine all the advantages of magnetic floppy and hard disk drives in one unit, and many potential users see them as very important for applications that produce a lot of data, where the floppy disk simply cannot offer adequate storage capacity. They also take removable media, which allows unlimited storage with a single drive, and they have the benefit of speeds approaching those

of hard disks.

Audio demands storage capacities that exceed those of the floppy disk (excepting very short items), since one minute of professional quality digital audio requires around 5 Mbytes of space. The Winchester drive has so far proved to be an ideal repository for such large volumes of data, as it offers fast access and transfer times, but the one major drawback is its fixed nature. The storage surfaces may not be removed from the drive, and when it is full it must be erased to make space for new material. Furthermore, material to be worked on must be uploaded and downloaded, which takes time. It may be seen that we are approaching a future in which original audio will be recorded onto an optical disk, which may then be inserted directly into an editing system for post-production without any uploading time, and may be removed to make way for another job at any point. It is this technology that is the subject of the following article. If we reach this exciting stage in the history of audio, then perhaps we may truly be able to talk about the potential decline of tape recording.

## Overview

Most people's main experience of optical disks will be with the compact disc in domestic systems. They will know that one of the advantages of the CD is the speed that different sections of the disc

may be accessed, that it is durable, small and holds just over an hour of stereo audio. They will also know that it may not be erased or re-recorded. There are many aspects in which the CD and the optical disks used in professional systems are similar. Both have a data capacity of around 600 Mbytes, both use a laser to read the data from the reflective surface and they have about the same diameter.

Optical disks as used in audio systems (and there are a number of commercial examples appearing) are no different from optical drives used in computer systems. There is nothing special about an optical drive to be used for sound storage, except that the drive may be chosen for particular performance characteristics. Most drives interface to the audio system via the same interface as used for hard disk drives, known as SCSI (Small Computer Systems Interface). Any SCSI-equipped drive may be connected to any computer system with an SCSI interface, and here we must consider the audio system simply as another kind of computer. The computer industry is always demanding more speed from its disk drives as microprocessors become faster, and this can only be good for the audio industry where the speed of the drive is probably the most important hurdle to be overcome. Realtime editing is only possible when the average transfer rate of data from the disk is high enough, but more on this later.

There is a number of different families of optical disk drive, which have different operational and technical characteristics. Whether or not disks may be interchanged between them requires some discussion, since the method of formatting and the method of data pickup may differ. Furthermore, each family differs from the other in its suitability for tapeless audio recording. The most obvious difference lies in the erasable or non-erasable nature of the disks. Non-erasable disks are called WORMs (Write-Once-Read-Many), since the disk may only be written once by the user, after which the data is permanent. The compact disc is not even Write-Once (at least from the user's point of view) since it is stamped at the factory and acts as a replay-only medium, although in the last few months we have seen the rise of the CD-R, or recordable CD, which is a CD-compatible disk that may be recorded once but not erased. This will have some applications in tapeless recording but is unlikely to be appropriate for realtime editing, as discussed below. WORM cartridges enclose the optical disk in a plastic case, rather like a large floppy disk, which protects the disk from damage. CDs are single sided, whereas WORMs may be double or single sided.

One major difference between the WORM and the CD format is that WORMs use CAV (Constant Angular Velocity) recording, whereas CDs use CLV (Constant Linear Velocity) recording. Thus the CD drive changes rotational speed depending on the position of the pickup, whereas the WORM rotates at a constant speed. This has a number of effects on performance, notably a longer access time for the CLV system, partly because of the extra servo action required to change the disk speed, and partly because the CD rotates more slowly than the WORM (between 200-500 rpm as opposed to around 1000 rpm), which increases rotational latency (the time taken to access a block of data once the head has moved to the right radius).

The erasable optical disk is similar in appearance to the WORM but uses different technology, which allows data to be erased and the surface re-recorded. Magneto-optical

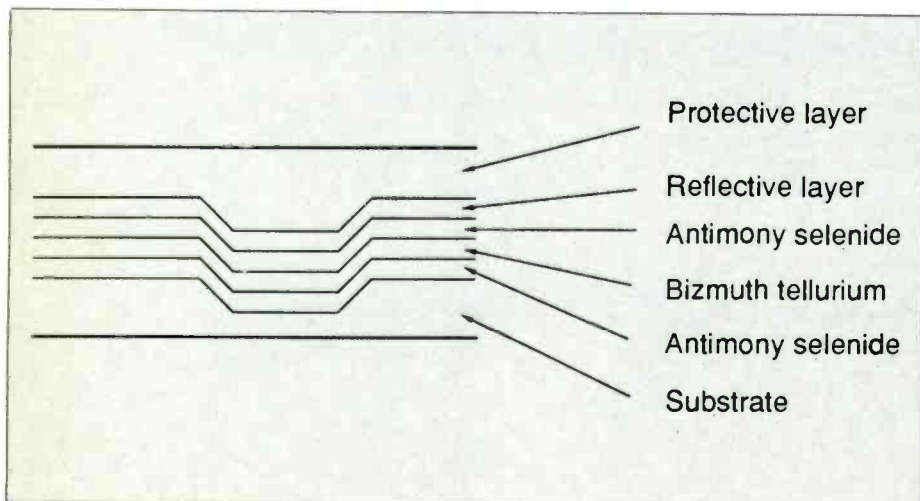

Fig 1: Sony optical WORM disk cross-section

## SERVICE

Here at Palm we make sure that service is our top priority. All equipment both new or used is tested and run before it is sold, tape machines are set up and bias set according to your specification... by the way we automatically give you a free reel of Ampex tape with every new machine we sell. Our service department maybe just what you need, we regularly undertake modifications and build equipment when it is not available. If you simply required a regular service or have an unusual technical problem please don't hesitate to call us, we pride ourselves on problem solving and can usually provide the solution you require.

## MIXERS

Soundtracs Quartz 32:24:2 new (price increase shortly)..... **£17,900**  
 Soundtracs IL48:32 new..... **£33,745**  
 Soundcraft 800B 48:2 in flight case..... **£7,300**  
 Soundcraft 6000 32:16:2 new..... **£7,800**  
 Soundcraft 16:2 Series One in flight case used **£650**  
 Soundcraft Delta 8:4:2 stereo 4 mono inputs  
 new to clear..... **£1,500**  
 Alesis 1622 new..... **£575**  
 Soundcraft 800 B 16:8:2..... **£1,990**  
 Soundtracs Midi PC16 & 24 models in stock call us for full details.  
 Tascam MM1 16:2..... **£642**  
 D&R Dayner 24:24 in line, 54 inputs in remix **£9,500**  
 D&R 4000 automated, 48 inputs in remix,  
 dbx VCA..... **£14,400**  
 D&R Stylex fully modular, 16:8:2, stereo  
 inputs option..... **£3,825**  
 Fades & Mutes automation, available on all D&R desks now!  
 Prices exclude VAT.

Tascam ATR80 2" 24 track ex demo..... **£23,000**  
 3M M79 24 track 2"..... **£6,500**  
 MC1 JHI 10B 1/4" hi profile meters also  
 1/2" block..... **£2,950**  
 Sony PCM 501..... **£400**  
 Soundcraft 1" 8 track with remote 15 hours  
 use only..... **£1,750**  
 Tascam MSR24 1" available now..... **£7,300**  
 Tascam MSR24 one only used 20 hours only **£6,500**  
 Studio Magnetics 1/2" 16 track 30ips  
 good condition..... **£2,600**  
 Casio DA11 portable DAT recorder new..... **£650**  
 Tascam 52 excellent condition..... **£1,200**  
 Tascam MSR16 budget 16 track, new..... **£4,250**  
 Tascam TSR8 budget, 8 track, ex demo  
 (two available)..... **£1,695**  
 Fostex E16's, new & used always  
 available..... **phone for current deals**  
 Sony DTC1000 ES DAT recorder new..... **£1,130**  
 Tascam 122 two track cassette second user... **£550**  
 Tascam 688 & 644 now available, prices  
 start around..... **£860**  
 Teac X3R 1/4" open reel 2 track second user... **£350**  
 Tascam 32 two track second user..... **£600**  
 Revox C270 2 track recorders prices from... **£2,870**  
 Prices exclude VAT.

## KURZWEIL...

We have a limited supply of these top American quality samplers available at very attractive prices. Both rack sampler players and the K1000 keyboard are available. All models have the latest spec and updated software/sounds and includes PXA sound blocks which double the amount of on board sounds. K1000 keyboards are **£1,478** and rocks are at **£1,130+VAT**.

## EMU SYSTEMS

We have just been appointed the Midlands dealer for Emu and have just received our first shipment from the USA. The much talked about Proteus is now here in both standard & XR versions, prices starting from **£780** excluding VAT and feature 32 voice, 16 way multi-timbral E111 sounds. We guarantee if you hear this you'll be sold!!

## PROCESSORS

Digidesign sound designer software with AD/IN  
 for Macintosh..... **£1,995**  
 Rolana DEP 3, great condition..... **£312**  
 Alesis Quadverb..... **£347**  
 JL Cooper PPS100 SMPTE/MIDI controller..... **£149**  
 Aphex C Aural exciter new boxed limited  
 quantity at these prices..... **£179**  
 Alesis Midverb 3..... **£310**  
 Dbx DX2 2 channel noise reduction..... **£59**  
 Drawmer new & used usually in stock, call us for full details.  
 Digitech 128 four effects in one 19" rack unit **£280**  
 Tascam MTS30 intelligent FSK code read/write **£99**  
 Yamaha Q2031 31 band stereo EQ..... **£374**  
 Dynacord EQ2215 stereo graphic..... **£199**  
 Rebis rack 2 compressors and 5 gates..... **£350**  
 XRI XR300 SMPTE read/write new & used  
 prices from..... **£200**  
 XRI XR400 Midi controller..... **£170**  
 Yamaha TX81Z..... **£270**  
 Yamaha RX17 drum machine..... **£75**  
 Akai XEB 16 bit drum sample player..... **£260**  
 D&R Qverb 16 bit digital reverb, 127 programs **£240**  
 D&R 'Aurex' stereo aural exciter..... **£150**  
 D&R 'Noise gate'..... **£120**  
 D&R 'Comp/limiter'..... **£120**  
 Roland TR808 excellent condition..... **£299**  
 Groove tube guitar pre-amp used..... **£600**  
 Ensoniq Mirage sampler ex demo..... **£600**  
 Yamaha RX11 used..... **£200**  
 Q Play autolocator for Fostex B&E16..... **£150**  
 Prices exclude VAT.

## MONITORS

If you are in the market for serious self powered monitors take a look at the Dutch made Axys Repr-1 a speaker system designed for professional use and an ideal compromise between nearfield and high powered monitoring. Repr-1 is a 3-way active system delivering 113dB at 1 metre; it incorporates soft dome tweeter, a 5 inch extended mid range transducer and a 12 inch woofer. Like all the cabinets in the Axys range all monitors come complete with qualified aircraft scab track for simple and resonance-free installation. For a demonstration and brochures please call us.

JBL Control 1..... **£139**  
 JBL Control 5..... **£226**  
 JBL 4406..... **£346**  
 JBL 4408..... **£564**  
 Tannoy system 2 NFM..... **£208**  
 Tannoy system 8 NFM..... **£456**  
 Tannoy system 10 DMT..... **£828**  
 Tannoy system 12 DMT..... **£1,100**  
 Tannoy system 15 DMT..... **£2,278**  
 Axys Repr-1 monitors..... **£3,000**  
 Axys Repr-2..... **Arriving soon!!**  
 Yamaha NST0M studio..... **£230**  
 All prices exclude VAT.

## TAPE & ACCESSORIES...

We place great importance on supporting our customers with a vast arrangement of consumables.  
[www.americanradiohistory.com](http://www.americanradiohistory.com)

We distribute Ampex tape throughout the UK and always have large stocks of all formats including DAT and cassette. Items such as leader tape in all sizes and colours, Editall precision editing blocks, head de-mags, razor blades, cable, empty reels, connectors, patchbays and trolley stands are always in stock and can be despatched to you on the same day... A full price list is available by request.

This is just a small example of the equipment we have, obviously our stock changes from day to day, if you are looking for a particular item don't hesitate to contact us and see if we have or can find what you want!! We can also sell your unwanted equipment for you... call us for details.



a · u · d · i · o  
**SYSTEMS**

**THE LEADING LIGHT FOR  
 TOMORROW'S TECHNOLOGY**

**Tel: 021-200 1771  
 Fax: 021-200 2370**

SALES • SERVICE • EXPORT • INSTALLATION  
 HIRE • LEASING • MAIL ORDER

The Pacific Building  
 16/17 Caroline Street, Birmingham B3 1TR

**SEE US AT THE APRS... STAND 130**

# Saber series



**Saber Recording Version**  
including patchbay and  
Bargraph meters.  
32:16:16 LBGPB.

*For In-line recording  
consoles we offer  
our Sigma series.*

#### 16-track systems

24, 32 and 40-channel versions,  
16-track monitoring and metering.  
MIDI muting as standard. 40 remix  
inputs with EQ and fader in a 24:16:16  
console only 1.25m wide.  
Patchbay option.

#### 24-track systems

28 and 36-channel versions,  
24-track monitoring and metering.  
MIDI muting as standard. 60 remix  
inputs with EQ and fader in a 36:16:24  
console only 1.75m wide.  
Patchbay option.

#### PA/Theatre Systems

24, 32 and 40-channel versions,  
8 x 8 Matrix Output system. MIDI  
muting as standard. Compact, low  
profile console, easily flightcased.

#### All Saber consoles feature :

- Modular construction
- 16 bus routing
- 6 auxiliary sends
- MIDI mute memory system
- Stereo input module option
- Excellent audio performance
- High quality appearance and finish
- High reliability and technical support

**Saber and Sigma—the  
multi-track consoles from...**

**...the total sound spectrum.**

Saber

Scepter

Studio 12

SR Plus

Sigma

SC Plus

System 8

CMC

SRM

**Allen & Heath**

**UK** 69 Ship Street, Brighton, BN1 1AE, England. Tel: (0273) 23346 Fax: (0273) 821767

**USA** 5 Connair Road, Orange, Connecticut 06477, USA Tel: (203) 795 3594 Fax: (203) 795 6814

**ALLEN  
&  
HEATH**

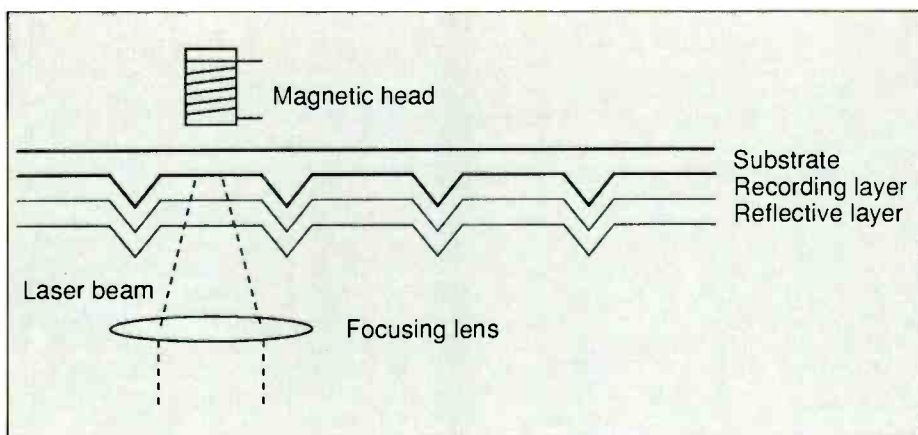

Fig 2: Configuration example of M-O disk, laser and biasing magnet

techniques are used for this purpose (see 'Disk formats: Magneto-optical drive'). The speed of magneto-optical disks is beginning to approach the speed of a slow Winchester drive, which opens up its potential as a direct replacement for the Winchester. One of the major hurdles that had to be overcome in the design of such optical drives was that of making the access time suitably fast, since the optical pickup head is much more massive than the head positioner in the magnetic drive (it weighs around 100 g as opposed to around 10 g). Techniques are being developed to rectify this situation, since it is the primary limiting factor in the advancement of optical storage.

## Disk formats

**The WORM drive:** The WORM writing process involves the one-time modification of the disk's recording surface, such that the reflectivity of the surface is altered. The disk is a sandwich of protective layer, reflective layer, recording layer and polycarbonate substrate (Fig 1). In the Sony WORM disk, the recording layer is itself a sandwich of bismuth-tellurium and antimony-selenide, which is claimed to offer a storage life of over 100 years; an important consideration since WORMs are ideal as an archival medium. In order to write data to the disk, the laser power is increased considerably above the power required to read data, such that the recording layer becomes heated and forms an alloy which has a different reflectivity pattern from the unheated areas. The surface of a WORM disk is 'pre-grooved' and formatted, to provide a guide track for the drive to follow when writing data. On replay, the lower-powered laser light is reflected back from the surface with a varying intensity depending on the existence or lack of recorded areas.

A number of different formats for WORMs exist, and not all disks are compatible between different manufacturers' systems. Panasonic, for example, offers two drives, which differ considerably in performance and capacity. Each requires a differently formatted optical disk. Their *LF-5200* drive uses disks that hold 200 Mbytes per side, using conventional sectors of 512 bytes with fixed angle of arc no matter what the radius, whereas the *LF-5010* drive offers greater storage capacity by operating in a non-standard mode, which increases the number of sectors in outer tracks compared with the number in inner tracks. The disks for this drive have 1024 byte sectors and hold 470 Mbytes per side. The rotation speeds are also different, being 875 rpm in the former and 1200 rpm in the latter. The performance of the

latter drive is much more spectacular than the former offering an instantaneous data transfer rate at the optical head of 5.55 Mbit/s (average) compared with 2.5 Mbit/s. From this it may be seen that the world of WORMs is not a straightforward one.

A WORM disk may be written to until its capacity is filled, the directory of contents being added to as the number of files increases. Since the WORM disk may not be erased, data is very secure, and sound recordings committed to WORM would be free from the danger of accidental erasure. Files tend to be stored sequentially, that is blocks of data are recorded one after the other in numerical sequence, with new files being recorded immediately after the end of the last file on the disk. There is no danger of the disk becoming fragmented since old data is never erased. These factors add up to making the WORM quite suitable for the storage of mono or stereo sound files but perhaps less suitable for multichannel operation. Whether or not realtime editing is possible from a WORM depends on the performance of the drive: an average transfer rate of at least 4 Mbit/s being sensible as a minimum for flexible stereo operation.

**The magneto-optical (M-O) drive:** M-O drives accommodate optical disks that can be erased, and the principle of recording and replay is rather different from that used in the WORM drive, although still making use of the principle of laser pickup from a reflective surface. To write data, the laser is used at a higher power than that used in the reading process, again to heat spots in the recording layer, which is made up of rare earth elements (typically gadolinium and terbium). A biasing magnet is used to create a weak magnetic field in the vicinity of the heated spot on the disk, whose recording layer then takes on this prevailing magnetic polarisation, although under normal conditions the recording layer cannot be magnetised (Fig 2). When the spot cools it retains this magnetisation. Although the data is recorded by a combination of optical heating and magnetisation, it is read by an entirely optical means, which relies upon the fact that laser light reflected from the disk will be polarised depending on the magnetic polarisation of the recording layer. This is known as the Kerr Effect, and the change in optical polarisation angle may be as small as a few degrees, depending on the material concerned. The reflected light passes through a polarisation analyser, resulting in changes in intensity of the light falling on a photodetector. The M-O disk is pre-grooved and sectored like the WORM drive.

The disk may be erased by heating the relevant area as it passes under the laser head, while biasing it with the opposite magnetic field

VACUUM TUBE SIGNAL PROCESSING AT ITS FINEST

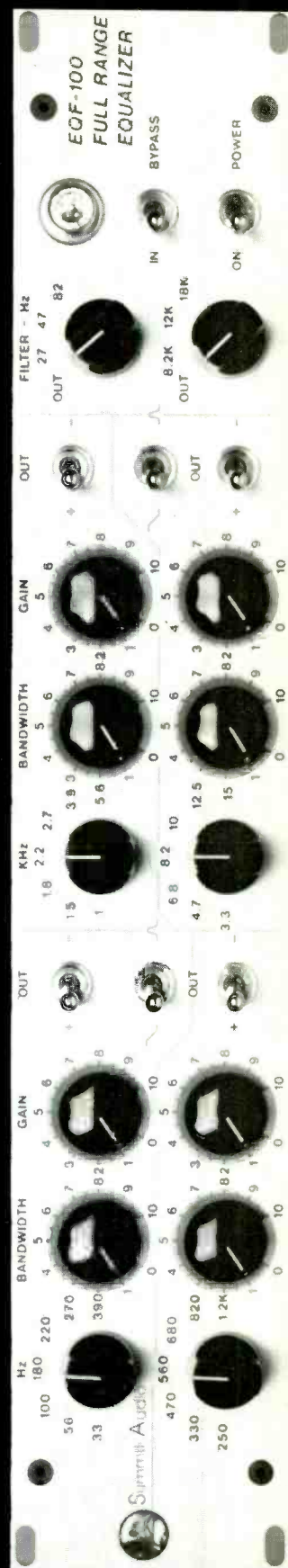

Summit Audio Inc.

P.O. Box 1678, Los Gatos  
California 95031 U.S.A.  
408-395-2448  
FAX: 408-395-1403

direction to that used for recording, after which it may be rewritten by the same process as before. It is this erase cycle, required before rewriting, that makes M-O drives slower to write data than to read it, whereas Winchester drives erase old data simply by overwriting it with new data, and various techniques are being tried to circumvent the problem. In most drives, a permanent magnet is used to provide the biasing field which magnetises the spots on the disk when they are heated, the magnet being physically rotated between erase and write cycles to change the direction of the field (this can be achieved in a few milliseconds). Spots on the surface of the disk are magnetised or not by turning the laser on and off—only heated spots will have their magnetisation changed. Hitachi suggested a solution in late 1987 that appeared to allow rewriting without the primary erase revolution of the disk. It involved the use of an electro-magnet rather than a permanent magnet, on the opposite

side of the disk to the laser. In order to rewrite, the laser heats the relevant areas of the disk and the magnetic field direction is switched electrically between  $\pm 300$  oersteds. It was said that this meant recording could only take place on one side of the disk, and that oxidation of the disk surface would occur more quickly, shortening its life. 'Background erasure' has also been attempted by some designers trying to incorporate M-O drives into audio systems as a means of erasing old files 'in the background' while the drive is not being used for audio transfer, thus freeing up space for new files, which may then be written without requiring the erase pass.

An ISO draft standard exists for M-O drives, to which most of the major manufacturers are sticking. This allows for two different sector sizes (512 bytes and 1024 bytes), giving 297 and 325 Mbytes per side of storage capacity respectively on a 5.25 inch disk (594 M or 650 M in total). M-O drives appear to rotate slightly

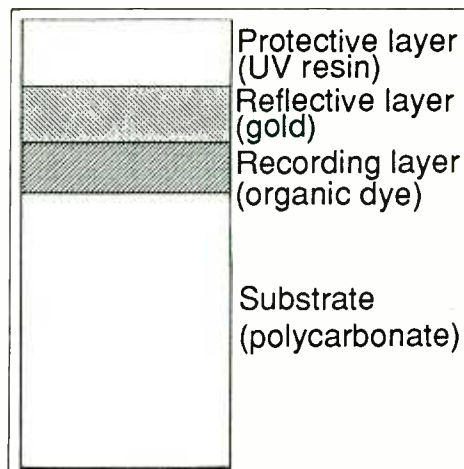

Fig 3: CD-R cross section (Taiyo Yuden, That's CD-R)

faster than WORM drives (Ricoh quote 1800 rpm, Sony quote 2400 rpm and Canon quote 3000 rpm) and again use CAV recording. Standards and interchange are discussed further below. The performance of M-O drives is good, with access time around an average of 95 ms and a usable transfer rate of around 5 Mbit/s. Exactly how this relates to performance in an audio system depends considerably on the file storage strategy used. Some manufacturers have deviated from the ISO specification in order to achieve faster access and greater capacity, using techniques similar to those used in WORM drives, putting more sectors in outer tracks (see 'Improving optical drives: Zoned or modified CAV').

## Phase change drives

To add further to the complexity of the mine-filled subject, there is yet another optical storage method being investigated by companies such as Panasonic. Panasonic claim certain advantages of phase change over M-O technology, not least the elimination of the erase cycle. They also claim that phase change allows upward compatibility from WORM to erasable drives, a simpler drive construction that does not require a biasing magnet, and low cost media.

In phase change recording, data is written by a high power laser, in much the same way as with a WORM, changing spots from a non-crystalline (amorphous) state to a crystalline state. In the crystalline state the reflectivity is increased considerably over that of the amorphous state. Data is again read back by a lower power laser, which detects changes in reflectivity. So the process is very WORM-like but it is claimed that by careful selection of the recording material and laser beam control, the process may be made reversible (and thus data may be overwritten). The only apparent drawback is the number of rewrite cycles allowed, which is an order of 10 lower than that of the M-O disk (between  $10^1$  and  $10^6$ , as opposed to between  $10^6$  to  $10^7$ ).

## CD-R

The CD-R is a write-once compact disc, which conforms with 'Red Book' CD standards, that is it will replay on any standard CD player. As such it has all the characteristics of the standard CD and uses CLV recording. The construction of the CD-R is similar to that of the WORM disk, in that it

### Who says Professional Fader Automation has to cost the earth?

*It is now possible to meet today's complex mixing demands  
with a new generation of console automation system  
that is as easy-to-use as it is cost-effective to buy.*

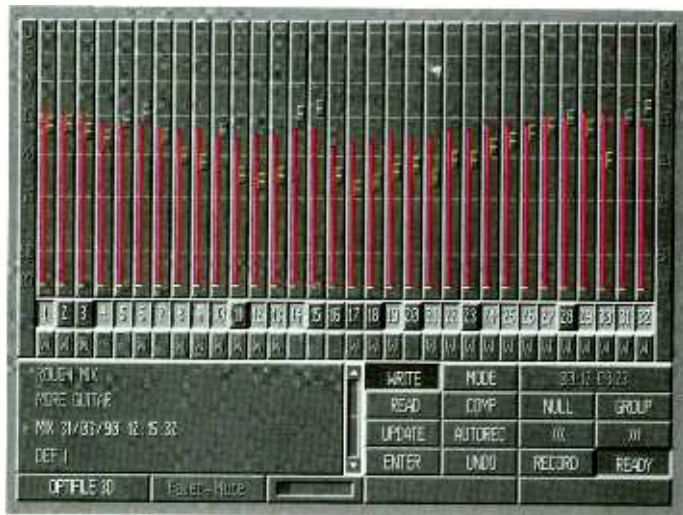

### OPTIFILE

Optifile 3D is a retrofittable automation system that's compatible with any mixing console. It requires no fader change or external PC.

Optifile 3D offers major technological advantages, with maximum flexibility at minimum cost. Call THE HOME SERVICE for your local dealer and you'll wonder what on earth you've been missing.

#### FEATURES

- Muting direct from console
- Minimum keystroke operation
- Simple retrofit to any console
- High resolution converter
- Optional SCSI interface
- MIDI Program changes
- Trim & Merge facility
- Copy track to track
- Full ASCII keyboard
- SMPTE driven



MANUFACTURED BY AD SYSTEMS. INTERNATIONAL REPRESENTATION: THE HOME SERVICE  
Unit 2, 10 William Road, London NW1 3EN. Tel: 071 388 1820. Fax: 071 388 0339





**INKEL**

**MORE MIXER FOR YOUR MONEY**



Mixer Desks by  
**INKEL**  
**PA·Sound**



CANADIAN INSTRUMENTS & ELECTRONICS LTD.  
THE BASS BUILDING, WIDDOWSON CLOSE,  
BLENHEIM INDUSTRIAL ESTATE, BULWELL,  
NOTTINGHAM, NG6 8WB.  
TEL: (0602 ) 770075

**Tired of buying your console  
from a car dealer?  
Give API a call. We'll talk about things like  
"Headroom" and "Tone" . . .**

**. . . Things that most companies save 'till last.**

**Then we'll talk about Discrete circuitry,  
48 busses, GML automation . . .**

**. . . Then we'll talk about LEDs, computers, and knobs . . .**

**. . . Then we'll talk about free TVs, one-touch tuning, and built-in microwave ovens . . . if  
we get desperate . . .**

**API Audio Products, Inc. 703-455-8188  
7951 Twist Lane, Springfield, VA 22153**

**EUROPEAN DISTRIBUTION BY:**

**PAN TECHNICAL SALES & MARKETING**

**THE PROFESSIONAL AUDIO NETWORK**

**8 Leyden Street, London E1 7LE Tel: 071-247 6101 or 071-289 2746 Fax: 071-247 6104**

has a polycarbonate substrate, a recording layer (this time of organic dye), a gold reflective layer and a protective layer (Fig 3).

As a CD it has a storage capacity of around 600 Mbytes, and data is recorded using the 8-14 modulation technique used for ordinary CDs. The CLV recording means that the rotational speed varies as the pickup moves from the centre to the outside and the servo action required for this coupled with the relatively low rotational speed tends to limit access times to around 500 ms. Furthermore, the Table of Contents (TOC) must be written in a one-time operation, based on the PQ encoding of the data stored on the disk, making it difficult to use the CD-R for professional editing purposes in which files might be written to the disk at different times (the 'directory', in other words, may not easily be updated).

The CD-R is intended for purposes that require CD compatibility rather than fast access times and updatability. As such they are not immediately suitable for tapeless recording systems, but can be seen to have considerable value for the storage and archiving of sound material, which does not require realtime editing. Broadcasters see an immediate use in sound effects libraries, since a professional CD player may be cued up and played in manually or under external control with sufficient accuracy for this purpose. Studios and mastering facilities may use them for providing customers and record companies with acetates or test pressings of a new recording.

## Access time and transfer rate comparison

Provided it can be assumed that the storage method is reliable and that the disks will not lose one's data in a few years, the choice of drive will depend primarily on its performance, since it is this that dictates such things as the number of audio channels that may be recorded or replayed simultaneously, how long crossfade edits may be and what gaps there may be between edits. Manufacturers of disk drives play confusing 'specmanship' games in this field, making it extremely difficult to tell whether one is comparing like with like for any given parameter. The following may help to make sense of the figures.

**Access time** is the time taken for the pickup head to move to the relevant track on the disk. This depends on where the head starts from and where it is to end up, so a number of figures could be quoted. Many quote 'average' access time but it is useful also to know the time taken for the head to travel only a short distance, since it may often be doing just this in an optical drive if files are stored contiguously. Track-to-track access time is a useful parameter. Sony quote three access times for its M-O drive: short stroke 22 ms (the time taken to cross 64 tracks, or a relatively short distance); average 95 ms; and full stroke 185 ms (inner radius to outer radius). It is possible that access time may include a proportion for rotational latency (sometimes quoted just as latency), which is the time taken for the disk to rotate until the sector required comes under the head, but this is not always the case. Often latency is quoted separately and this may add considerably to total access time. Sony quote 12.5 ms average latency, while Ricoh quote an

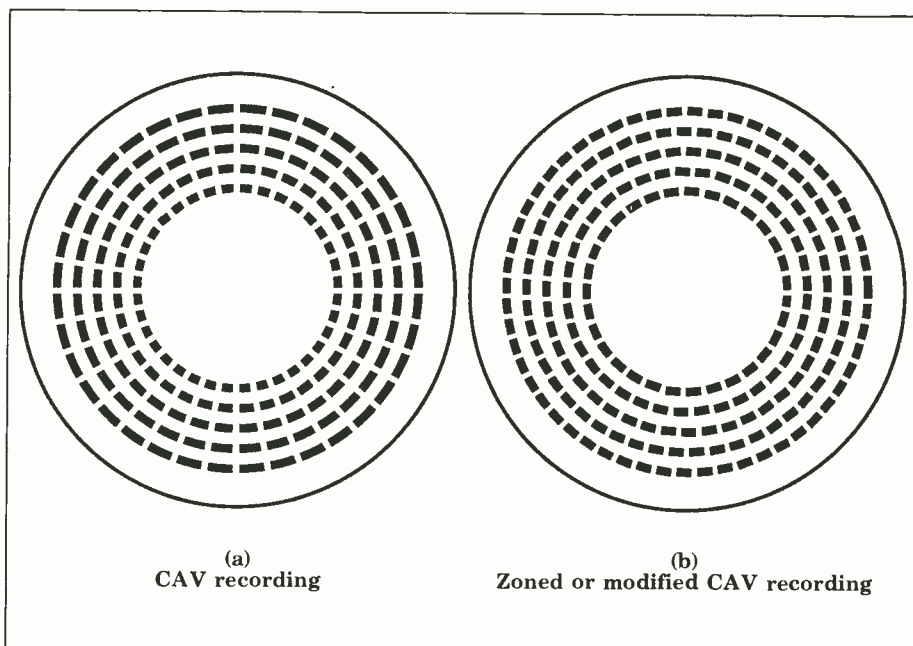

Fig 4: In CAV recording sectors in each track occupy the same angle of arc, while in zoned- or modified-CAV recording a greater number of sectors fill the outer tracks than fill the inner tracks

average access time of 66.7 ms (one-third full stroke plus latency).

Transfer rate is the rate at which data, once located, may be transferred to or from the disk. In most cases, the 'read' transfer rate is given, since the 'write' transfer rate may effectively be lengthened if the track has to be erased before it can be rewritten. There are a number of different points at which transfer rate may be quoted: at the optical pickup, which is the instantaneous transfer rate in any one sector; and (more realistically) the effective or sustained data transfer rate when reading continuously over a number of sectors (which will be lower). Furthermore, since the drive output is often buffered, the controller will also exhibit a maximum burst data rate over the SCSI interface, which shows how fast it can transfer data to the host computer, regardless of how fast it is coming off the disk. To take an example, Panasonic quote three transfer rates for their *LF-5010E* WORM drive: 5.55 Mbit/s at the optical head, 512 kbytes/sec (4 Mbit/s) effective data rate and a burst data rate over SCSI of 1.5 Mbytes/s.

## Improving optical drives

**Access times and transfer rates:** If optical drives are approaching the speeds and capacities of Winchesters, what can be done to make them equal or exceed those speeds and capacities? An American company called Maxtor has claimed significant advances in drive technology, which help to reduce the average access time well below the 100 ms or so of most drives, as well as increasing the transfer rate and increasing the capacity. Canon are also claiming significantly increased rates and shortened access times in the drive, which they are selling to the *NeXT* computer company. As one might expect, the improvements appear to require deviations from the ISO draft standard formatting of the M-O disk, especially in order to increase the capacity.

Maxtor achieves shorter access times using a combination of two methods. Firstly, it separates the optical head into two parts, one fixed and one

movable, such that the heavier part containing the laser is stationary while a lighter mirror may be electrically turned to skew the laser beam across the tracks. Secondly, it uses a method of track location that cuts a further 10 ms off the access time, by cutting the seek down to a single stage process, rather than the dual stage process used in other drives. This leads the company to claim an average 43.5 ms access time. The same drive also sports an instantaneous transfer rate of 13.7 Mbit/s, although it is hard to tell how this is achieved, since the rotation rate is only 2,200 rpm, slower than the Sony drive, which rotates at 2,400 rpm and offers 7.4 Mbit/s. Improvements in the speed of read/write electronics are claimed to help in this area.

Canon achieves an instantaneous transfer rate of 9.1 Mbit/s from its drive, due to the fastest rotational speed of any of the drives at 3,000 rpm. Its access time, though, is only marginally faster than the Sony and Ricoh drives, at 92 ms (½ full stroke), 130 ms (full stroke) and 10 ms average latency. From the preliminary data (the Canon drive is not yet available in the UK) it appears that the drive is slightly different from the ISO standard, offering 256 Mbyte per side capacity, with 1,024 byte sectors, 16 sectors per track (there are 17 sectors per track in the ISO standard for 1,024 byte sectors).

**Zoned or modified CAV:** As already stated, the sector size in the ISO draft standard may be either 512 or 1,024 bytes, giving either 594 or 650 Mbytes total capacity. Sectors should correspond to a fixed angle of arc, and there should be either 31 or 17 sectors per track, depending on the sector size. Companies aiming to increase the capacity of optical disks are doing so by using a method known as 'zoned' or 'modified' CAV recording, in which outer tracks are made to carry more sectors than inner tracks (there is more linear space in the outer tracks, which in normal operation leads to a lower recording density) (Fig 4). In doing so, the disk becomes non-standard but the capacity is increased to nearly 1 Gbyte (1,000 Mbytes). This leads to a dilemma over whether one achieves greater capacity at the expense of standardisation. Maxtor are claiming that their drive will operate in both ISO standard and Zoned-CAV modes. Panasonic's

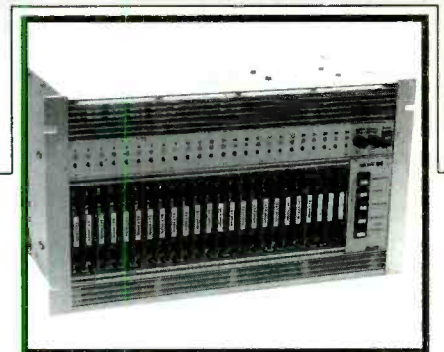
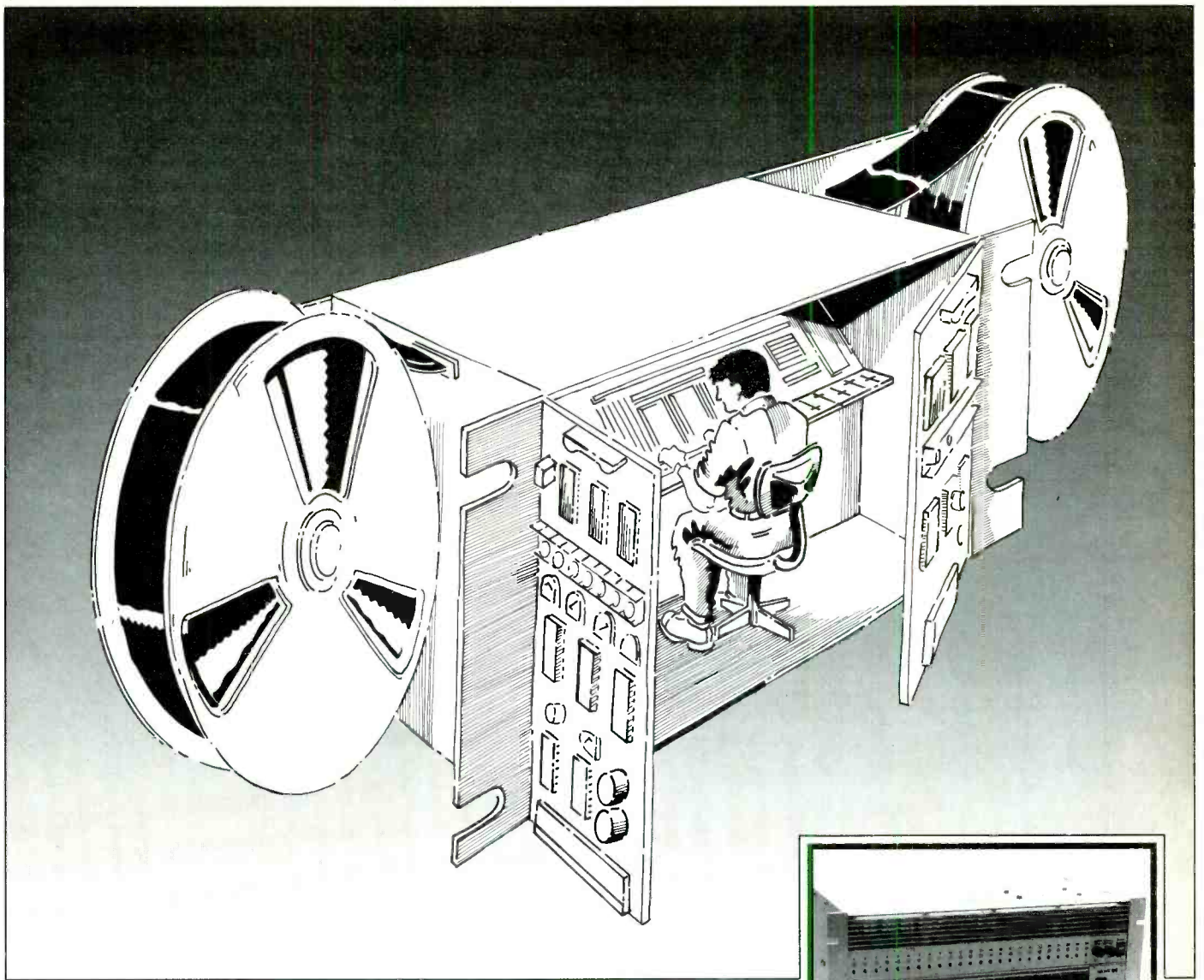

24-channel E413c4 multitrack

## The Best of both Worlds

Whether you are recording your hits on analogue or digital machines, telcom c4 offers you the best from a big noise in noise reduction.

This processing method requires no line-up procedures and provides a dynamic range of up to 118 dB.

It improves analogue recorders to 18-bit comparable performance with natural sound and low tape noise.

Digital recorders such as DASH, PD, R-DAT etc are improved to 20-bit comparable performance for more recording headroom and less quantisation noise.

Here are the latest additions to our DIAMOND EXCHANGE CARDS to fit a wide variety of machines:

telcom c4-300/350 SR  
telcom c4-AC27 for BVH 2000/2500

Contact us and find out whether there is a CARD for your machine. In the UK: phone Tom Belshaw on 012261226

I would like to learn more about telcom!

Address

UK: PRO-BRITRO LTD,  
35 Britannia Row, London N1 8QH  
ROBERT BOSCH GMBH  
Lindener Str. 15, D-3340 Wolfenbüttel  
Phone (05331) 83-364, Telex 95651 ant wf

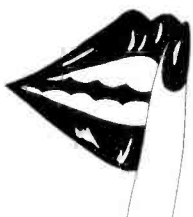

*PSShhh*

**telcom c4**  
**Silence by Design**

**ANT**  
**Bosch Telecom**

LF-5010 WORM drive only operates in modified CAV mode.

## Interchange of optical disks

From the foregoing discussion, it might well be imagined that no single optical disk will ever be readable by any other system. There will certainly be incompatibilities but there are a number of points to be made. The first is that M-O disks conforming to the draft ISO standard should be readable by other drives that conform to the same standard. M-O drives do not all rotate at the same speed but this should not affect interchange, since the data structure on the disks should be the same, although transfer rate will be better on faster drives. Whether or not this interchangeability applies to audio systems using

M-O drives is rather another question because the way in which sound files are stored on the disks will differ between each system. Some systems will store sound files contiguously, while others may scatter-store files to make for better random access performance. Some systems may store stereo sound files as a special entity with a single directory entry, while others may store each audio channel in a separate file. There is no agreement on the number of audio channels that should be served by one drive.

So far, little in the way of progress has been made regarding the standardisation of optical storage for audio systems, since we are in the early days of development and we are seeing the very first products. It is possible that the AES may decide to work towards this end but the variables involved are considerable and the other problem is that the file storage strategy used by each manufacturer is something of a corporate secret, since it is one of the main keys to

successful and flexible operation. It is perhaps unlikely that manufacturers will be altruistic enough to give each other their file strategy details. Perhaps the most that we may hope for is that manufacturers will develop software that allows their systems to read a third party's files, since only if interchange can be made easy will people consider disks as a universal alternative to tape. This situation already exists in desktop computing in other areas, since although a computer may be able to read disks from another drive of the same sort, it may not be able to read and write a particular word processor format, so translator software exists to allow for exchange of text files between word processors.

## Tapeless recording

Most of the products that to date have incorporated either WORM drives or M-O drives have done so by making the optical drive a secondary store for audio data, with the Winchester drive as the main store. The optical drive has thus acted as a library or database of sounds, which may be brought into the main edit or dub by copying them to the hard disk. Now that reasonable speed can be achieved from M-O drives, it is possible that we may begin to see them becoming main storage devices in their own right, with no Winchester in sight. Indeed, Akai have recently shown a digital recorder, the DD-1000, which uses an M-O drive as its main storage, offering two stereo channels of recording and replay (four channels in total but arranged as stereo pairs, presumably to optimise transfer rate).

The performance of the optical drive, as already suggested, limits its potential in audio recording. If it can achieve similar performance there is no reason to consider continuing with the hard disk, unless there is an enormous price difference, since the optical disk has many advantages. Currently, if we dismiss 'vapourware', M-O drives have not reached this stage, although it is only likely to be a short time before they do. The performance of current drives makes them acceptable for stereo recording, or perhaps 4-channel if certain limitations are accepted. In true random access operation, the average transfer rate is adversely affected by the need for the pickup to keep moving between tracks and this is especially true in multichannel operation. Any tapeless system is taxed the most when performing crossfade edits from one file to another, and if the user requires long crossfades performed in realtime between a number of channels simultaneously then he requires a high performance drive.

Optical studio recorders may become more widespread in the next few years. A stereo recorder with no editing facilities could be designed very easily, with the option for connecting the drive to an editing system. Alternatively, the disk from the studio recorder could be edited elsewhere by taking the disk and inserting it into the drive of the editing system. For multichannel applications (this refers to 24-track music recording) it seems unlikely that any form of disk storage will supersede tape recording, at least for the next 10 years or so, since the amount of data produced is too great (4,000 Mbytes required for ½ hr of 24-track). This situation may begin to change as some of the recently developed digital audio compression systems such as apt-X and Dolby's ATC find their way into tapeless recording, since these offer a significant reduction in the data rate while maintaining high audio quality. □

# How To Upgrade Your Studer A-80 (A-800)

Answer: Switch to Saki 24-track Record and Playback heads when replacement time comes.



Ours.

Compare ours vs. theirs. Same crisp, clean audio. Same mechanical and electrical specs down to the last detail. Guaranteed.

Ah, but the difference: The Saki heads are made of long-lasting Permalloy... proven reliable for years of troublefree service. And, just incidentally, priced about 30% less than Studer. Ours vs. theirs—it's no comparison.

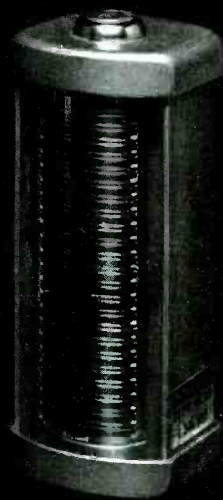

Theirs.

Call us now for immediate, off-the-shelf delivery.

**SAKI**

MADE IN U.S.A.

**SAKI MAGNETICS, INC.**

26600 Agoura Road, Calabasas, California 91302

Phone: (818) 880-4054

Telex 244546

Fax (818) 880-6242

# Soundcraft 6000



The first of a new generation of Soundcraft consoles which sets a completely new standard of audio quality. The 6000 is a full 16 or 24 bus console, and can be specified from 16 channel frame sizes upwards, with extra slots on patchbay versions for effects return modules. With enough buses and routing options to make adventurous production a pleasure, the uncompromising array of facilities puts you in total command of the mix.

The 6000 offers perhaps the highest performance of any comparable console available today. Call us now for viewing/demonstration of the full range of Soundcraft consoles.

THE LAST WORD IN STUDIO EFFECTS...

**BEHRINGER**



STUDIO EXCITER TYPE F	£225.00
PROFESSIONAL EXCITER TYPE F with NLR & 21 dBm	£280.00
STUDIO DENOISER: 8 CHANNEL	£450.00
PROFESSIONAL DENOISER: 8 CHANNEL; NLR's: +21 dBm	£570.00
STUDIO DENOISER: 2 CHANNEL	£210.00
PROFESSIONAL DENOISER: 2 CHANNEL; NLR's: +21 dBm	£245.00
STUDIO COMPRESSOR/LIMITER	£315.00
PROFESSIONAL COMPRESSOR/LIMITER; NLR's	£350.00
STUDIO PARAMETRIC EQUALISER	£350.00
SOUND MACHINE EXCITER/PREAMP	£135.00
MULTIBAND DENOISER	£690.00
PROFESSIONAL HEADPHONE AMP	£340.00
MULTIBAND EXPANDER/GATE	£690.00
STUDIO GATE	£315.00
PROFESSIONAL GATE	£350.00
TRANSFORMER BALANCED OUTPUT	£52.00
FULL BROCHURE AVAILABLE. RING FOR DETAILS. ALL PRICES EXCLUDE VAT, P&P	

## NEW!! PROTEUS/2 from E-mu

AVAILABLE NOW!!! 8Meg of superb 16-bit sounds from the Emulator III library + onboard digital waveforms for limitless sound creations. 32-voice polyphony, 16-channel multitimbrality, 6 polyphonic outputs. Integral effects send/returns and "...one of the clearest and most straightforward user interfaces on any programmable electronic musical instrument." Ring for details now.

**ALSO AVAILABLE:** Proteus/1 16-bit Multi-timbral Digital Sound Module; Proteus XR, Multi-timbral sound module (384 pre-sets); Emax II Digital Sampling Systems: keyboard/rack and Turbo versions of both, Data storage media and manuals, software and accessories. Full E-mu range available.

Ring for brochures/details/prices.

# AMPSOUND

153a Victoria Street, St Albans, Herts. AL1 3TA  
Telephone 0727 50075 Facsimile 0727 58977

WE SUPPLY - ACORN, ACOUSTIC ENERGY, AIWA, AKAI, AKG, ALI SIS, ALLEN & HEATH, AMPEN, APHEN, ASHLEY, ATARI, BEYER, BEHRINGER, BSS, CABLE & CONNECTORS, CASIO, CROWN, CSR-DAT, DENON, DRAWMLR, E.A.R., FOSTEX, HARRIS, INSTALLATIONS, IBI, KORG, MIDI SOFTWARE, MTR, NEUTRIK, OMNIPHONICS, ON-SITE ENGINEERS, OTARI, RACKING, REVON, ROI AND, SENNHEISER, SERVICE, SHURE, SONNIFEX, SOUNDRAFT, SOUNDTRACS, STUDER REVON, STUDIO MASTER, SWITCHCRAFT, SYSTEM PLANNING, TANNAY, TASCAM, TC ELECTRONICS, TDK, TECHNICS, THATS, UREI, YAMAHA AND MANY MORE!!! CALL FOR BROCHURES.

## A New Approach To Noise Reduction...



The recent advances in recording technology; R-DAT and affordable digital multitracks have highlighted the necessity for extremely low-noise mixing consoles.

With its revolutionary high performance mic pre-amps, the Soundcraft 6000 series is designed to meet the most stringent requirements of digital recording.

Developed specifically to meet the needs of modern production techniques, the 6000 series offers up to 68 inputs at remix with EQ and access to auxiliaries.

An optional full-blown automation system and bantam jackfield enables the user to enjoy facilities previously unattainable in middle-market consoles.

As the leading Northern professional audio supplier, we can offer the 6000 series in a package with Otari, Tascam and Akai Digital multitracks or just as an upgrade to your existing facility. If you are in the market for a cost-effective, high performance console and want the best in before and after sales service; Call us - we'd like to talk to you.

# KG M

studio specialists

18/42 Charlotte Street, Wakefield,  
West Yorkshire WF1 1UH, England.  
Tel: 0924 371766 Telex: 556649  
Fax: 0924 290460

**THE NORTHERN ALTERNATIVE**



Studio F at Howard Schwartz Recording in New York

# CONVERSATION WITH JOHN STORYK

Studio designer John Storyk talks to Terry Nelson about his design philosophies

**J**ohn Storyk appears more like a client than a designer. He has the same outward enthusiasm in contrast to the usually calm demeanour of his colleagues. Though pleading tiredness after a gruelling exhibition, Storyk still showed a restless inner

energy and is obviously always pleased to talk about his occupation as studio designer.

Storyk is, from the first, an architect and has a wide range of interests: "I wanted to be an architect since I was 11 years old and I love it. I like building as it deals with people problems,



Whitney Houston Home Studio, New Jersey

stuff like that.

"There are still very few trained architects in the studio design business, which is OK but the client sometimes needs to be aware of where a particular designer he may have chosen is coming from—or if an architect is also involved."

This different approach to acoustics and studio design has led to John Storyk amassing an impressive track record encompassing over 400 projects from many walks of life as well as recording and video studios.

"This year marks 20 years in the business for me and I still find it exciting. There was a moment a while back when I was feeling saturated and I had to back off for a time. Things in the industry seemed to have lost direction and people were wondering which way things were going to go. However, the last 2 years have been very exciting with lots of new things."

One thing Storyk is well known for is that he designed Electric Lady studios for Jimi Hendrix, one of the first independent studios to be built in New York. This was also the first studio that Storyk designed so it seems a good place to start assessing his career.

"Like most people in the studio world, I had my stint as a professional musician playing in R & B bands during the '60s (piano/sax) so I do have that music base—not that I have given it up entirely as I still fool around when I can. Anyway, I graduated from Princeton university in 1968 and I wanted to get some practical experience in an architect's office before going on to advanced studies at Columbia. I was able to get a job at David Todd & Associates and found myself designing the Cerebrum, an experimental nightclub, which turned out to be one of the hot places to go in downtown New York.

"Anyway, one thing leads to another and through the Cerebrum I got to meet Jimi Hendrix who was thinking of doing his own club with a small studio attached to it. Jimi's engineer/producer, Eddie Kramer, was more interested in the studio side of the operation as there were very few independent studios in New York at that time and here was the opportunity to do something really new.

"The final result was that at the moment I was about to present the plans for the club, Eddie had got his point across and the club was now going to be a studio—and I had to design it!

"Well, great, but here I was at 22 years of age having to design a recording studio for the likes of Jimi Hendrix and not really knowing too much about it. It also meant that during the next 3 months I had to learn as much as I could about studios. However, you have to remember that at that time there weren't too many around that I could stick my nose in, see what I had to see and go away and get some ideas together.

"Anyway, that's how Electric Lady got built and I still think that it turned out very well—it was fun."

Did he feel there was a recognisable Storyk style or trademark?

"I hope not! In fact, if I have a style I would say that it is no-style.

"I must admit that I do not like what I call the 'cookie-cutter' approach where you take a basic design and do it everywhere—that's boring.

"What is fun about studio design is that you have a whole crop of problems to deal with that don't usually appear with other building projects. You get special client needs, problems, etc, that have to be dealt with and every one is different. I must admit that I thrive on problems and looking for ways to solve them.

"It's very easy to fall into the trap when

# Back To Reality

Brüel & Kjær

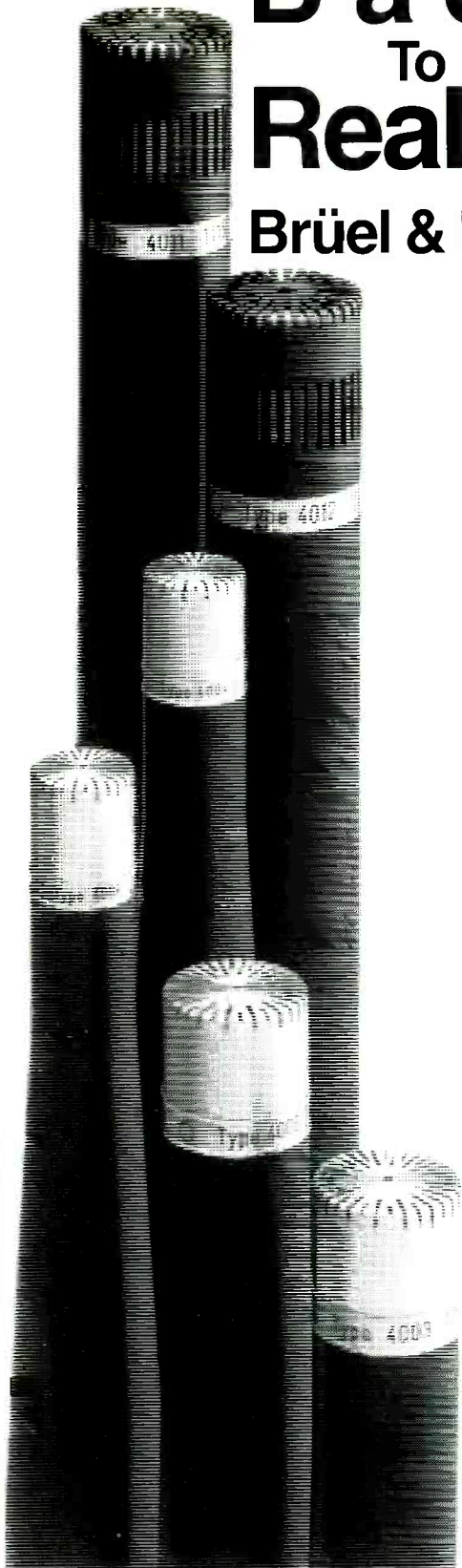

FOR DETAILED  
INFORMATION  
FILL COUPON &  
RETURN TO:

Brüel & Kjær  
Pro Audio (UK)  
Harrow Weald Lodge,  
92 Uxbridge Road,  
Harrow,  
MIDDX HA3 6BZ.  
Tel: 01-954 2366

Brüel & Kjær  
Pro Audio  
18 Nærum  
Hovedgaade,  
2850 Nærum,  
Denmark  
Tel: + 45 42 80 0500

## Series 4000 Microphones

Name \_\_\_\_\_

Address \_\_\_\_\_

\_\_\_\_\_  
\_\_\_\_\_  
\_\_\_\_\_



*total audio!*



*Canford Audio*

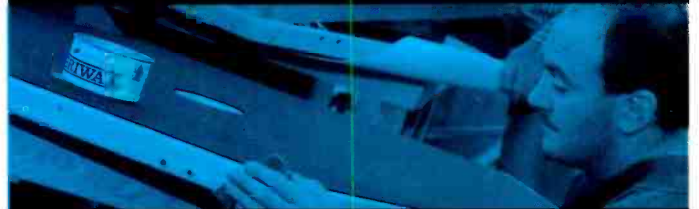

▶▶ A claim established over the past ten years and a reputation won by supplying a wide range of high quality audio equipment and accessories fast. Quite a claim, but whatever audio equipment you need, Canford is the name to turn to.



The reputation has been established on our ability to supply the right product at the right price and in the right time scale (next morning if you want). Our catalogue is issued twice a year and runs to over 300 pages. Its up-to-date and totally comprehensive.

So next time you need a connector or two or a kilometre of multipair cable – it's Canford of course.

Phone now for a catalogue.

# CANFORD

■ ● *audio* ▶▶

CROWTHER ROAD, WASHINGTON  
TYNE & WEAR, UNITED KINGDOM NE38 0BW  
admin – (091) 47 0057 sales – (091) 415 0205  
fax – (091) 415 0392 telex – 538202 CANFRD G

# FREEDOM TO CHOOSE ?



TIMEWARP and WORDFIT are registered trademarks of DAR.

YOU HAVE A CHOICE IN DIGITAL AUDIO EDITORS, UNLESS YOU WANT...

- ② 2 to 16 Channels
- ② Ease of use
- ② Affordable Power and Speed
- ② Rewriteable Optical Disk
- ② WORDFIT
- ② TIMEWARP
- ② Machine Control and Autolocate
- ② Full Expandability
- ② Digital Interfaces
- ② Chase Sync

ONLY AVAILABLE ON SOUNDSTATION II

The unique and essential disk based recorder and editor for video, film and audio post-production.

#### DIGITAL AUDIO RESEARCH LIMITED

2 SILVERGLADE BUSINESS PARK · LEATHERHEAD ROAD · CHESSINGTON · SURREY KT9 2QL · ENGLAND  
 TELEPHONE (0372) 742848 · FAX (0372) 743532  
 6363 SUNSET BOULEVARD · SUITE 862 · LOS ANGELES · CA 90028 USA  
 TELEPHONE 213-466-9151 · FAX 213-466-8793

#### DIGITAL AUDIO RESEARCH





building a studio of thinking that a studio designer is just there to provide a control room that will make all that expensive gear sound great and maybe a studio to match. This is still something that a lot of prospective clients have in mind when we first start talking but it goes much further than that.

"If I have a style, it is to determine the client needs, the problems that may arise because of them and then put it into terms that can be realised within the budget and time available.

"As far as restrictions are concerned, I have had the dubious misfortune of having to do a lot of work in New York, which means that I have got to know their rules and regulations inside out and if you can work with them, I think you can work almost anywhere. You also get to appreciate the cost of every square foot of floor area.

"I also tend to put people first, which to me is far more interesting than the equipment. As far as I am concerned, a \$300 effects gizmo or a \$300,000 console are both the same—they are just tools to be used. However, it is people that are going to use them and work in the space that is housing them and this is the important thing.

"I like to be able to establish a personal relationship with my clients in order to really find out what they need—may not always be what they want!—and then design an environment that will fulfil those requirements.

"The other thing that is vital is planning and thinking through the project as much as possible before starting any final plans—what I call good programming.

"I think one of the things that gave studio acoustics some of their mystique was that they were difficult to measure with any accuracy. With the advent of ETC (Energy Time Curve)

---

## "More happens per square foot in a studio than in almost any other environment"

---

measurements as pioneered by Richard Heyser, we are now able to see the results of what we do and how to go about correcting problems."

Could he elaborate a little on the 'people' aspect of studio design?

"It's really a question of observing what people do in certain environments.

"In the case of a studio control room, a lot of different things are happening in a proportionally small area and often the requirements are different for each of the operating areas. For instance, one place may require a lot of light whereas the place next to it wants hardly any—this all has to be taken into account and catered for.

"OK, we have the control room and the equipment in it, so how is it going to be used? Is an equipment rack blocking access to something or is it going to have a bad effect acoustically?

"This is really all common sense and not too difficult to deal with but then you have to deal with the small, everyday things that make life easy or a problem. How many people are expected to be in the room? What are their reasons for being there? How many times have you seen a beer or cola bottle placed on the console that you know is going to get knocked over when it would be far better to have had a small shelf available. What about ashtrays? If you take all these things into account before you start designing, then everything can be incorporated into the design in

such a way that everything fits together. You don't want somebody coming along halfway through the construction and saying, 'I think we need a small shelf here after all', as that could have a knock-on effect to the whole design: the absorbent panel you put there to allow enough space before coming to the loadbearing column there now has to be moved, which means that ... I think you get the picture.

"Find out what it is going to be used for: music recording, commercials, audio-for-video, pure digital, etc. Are there isolation problems to the outside world? Will there be more than one studio and if so, what will be the isolation requirements between rooms? These first points let you know whether the isolation has to be STC 55, for example, or STC 65. Will the building you are in support the weight or are you going to come up against restrictions that you have to comply with while still getting the required performance? Is the access to the studio sufficient or can it be improved?

"This all gets the basics sorted out before moving on to the layout of the rooms, organising the traffic flow between them and so on.



**Platinum Post's Studio A at Full Sail Center**

"It is very important to view the studio activities from all angles in order not to miss anything out. It is easy to think of a basic studio as a control room, recording room and maybe an office. What about the kitchen facilities, toilets, lobby space, office and lounge facilities for the group that has just booked the studio for 3 months and so on. The service aspect of studios has taken on a far greater importance over the last years and more space needs to be set aside for it now.

"The next important consideration are the floors and these are very much a function of the activities proposed for the studio. For example, if the studio is mainly doing commercials there is no point in putting carpet at the entrance as it will be worn out within 6 months. However, if it is a recording studio for records then you could consider it as people and equipment will not be coming in and out every 3 or 4 hours.

"In general, I put hard floors in the studio and control room and it is only the amount of use that determines whether it is industrial hardwood, oak

parquet or stone tiles. There is also the question of what the client would like to see as well!

"The hard floor has also now defined one of your acoustical parameters and the rest of the design will be a function of it. As far as the studio is concerned, this is where music is created and the musician needs to be able to hear his instrument correctly, which implies a certain liveness to the sound. Or to put it another way, the room has to feel reverberant and be comfortable. For larger rooms, a degree of variable acoustics is also desirable.

"Again, it depends on what kind of work the client envisages doing and providing the right environment for it."

## Control room design

"I don't like to make any two studios the same. My last three studio projects all had similar professional requirements yet they were all way different—that's what excites me.

"As far as the control room is concerned, it has to sound good and this is open to a lot of debate as to what that actually means. I think this means accurate reproduction of the information being presented to the monitors at any of the listening positions within the room. Today's production requirements often go far beyond just the engineer and maybe the producer, sitting behind the console and both wanting to hear the same thing. You may now have keyboards and other things going on in the room and those people will also want to hear what is going on.

"It is also important to hear what is happening in the studio. As one owner said to me, 'I don't want to hear the control room's version of the studio, I want to hear the studio', and he's right.

"What I tend to aim for is a clear first reflexion that is 15 to 20 dB down on the direct signal and with a delay of about 20 ms followed by equally spaced second, third, fourth, etc. reflexions to provide a smooth, diffuse field. In practical terms, this generally means a fairly absorbent front end of the room and highly diffusive rear for the middle and upper frequencies. However, the front of the room should be reflective at low frequencies in order to provide a natural extension to the monitor system. As much as possible, I like to incorporate an expansion ceiling, which gives a horn effect to the low frequencies.

"While the front of the room is reflective to low frequencies, the rest of the surfaces need to have treatment that will ensure sufficient 'venting' to the lows while scattering and dispersing the mids and the highs. In order to have clear stereo imaging the lows should be cleared from the room faster than the upper frequencies."

## Monitors

"This is really a question of preference—choices dependent on the situation. It also depends on whether I have been called in as a consultant to give a point of view or as a designer, where I will have far more control of the situation.

"I do find myself using UREI *Time Aligns* quite a lot and Ed Long has also done some custom monitors with TAD components. I like to mount the speakers at ear level wherever possible as I think it sounds more natural to have the sound coming at you than down to you. However, you have to be careful about any front-to-back splash from the console and treat this accordingly."

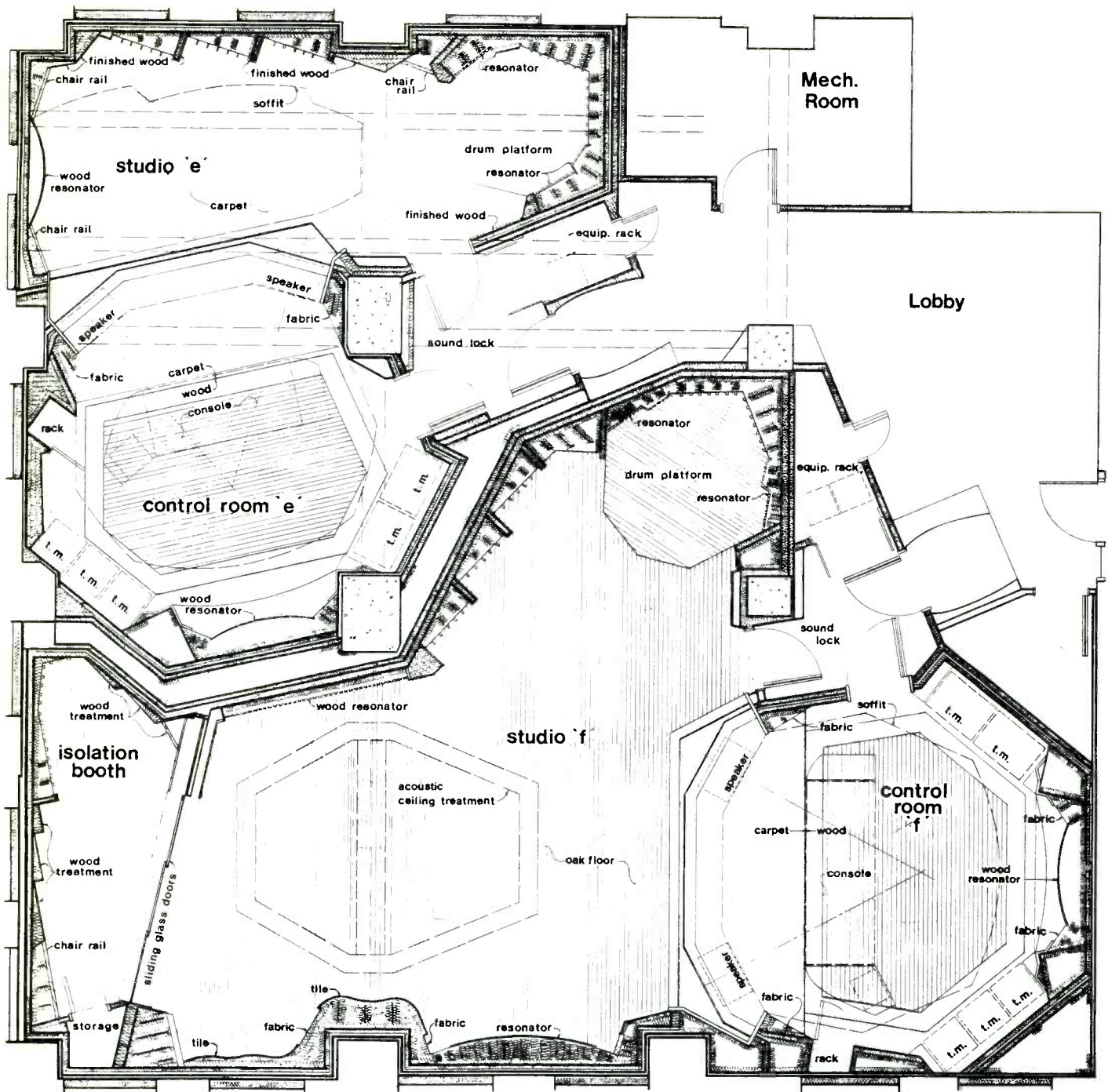

Howard Schwartz Recording, New York

## Rules and conditions

"As we have already discussed, each studio programme is different but this does not necessarily compromise the acoustical priorities—nor should it.

"What I do feel strongly about are things such as the need for two doors into a control room. For a start it's safer and very often removes any feeling of being shut in. Lighting and air conditioning must always be of the top quality: no annoying draughts or noise. Lighting is very important as it enables you to set the appropriate ambience and should be properly designed. With the ever-increasing accent on digital recording, the perimeter room boundary isolation should be to at least NC 25 though I think NC 18 would be

better. This depends on exact studio requirements.

"The one thing that dictates all following conditions in a studio is room size. This may seem pretty obvious but people still have a fixed idea of what they would like their control room, studio, what have you, to be and they say, 'I have x square feet available', when at least 2x is required. It is the given conditions that will decide what the final design will be. However, I do insist on a minimum of 500 square feet being available in order to do a design.

"The same criterion applies to the isolation from the surrounding environments: there is always a most economic method for isolating a studio facility from the neighbours, it just depends where they are and who they are."

In his 20 year career, John Storyk has designed recording studios, video studios, nightclubs, restaurants (including floating ones), private

homes and residential areas. His base as an architect evidently gives him a wider view of things and a more environmental approach together with strict acoustical criteria.

"I like building. In the same way that music is a musician's vocabulary, what I express in my designs is my vocabulary. As music has always been a part of my life, I am fortunate that I can also express it through studio design.

"As we noted earlier, more happens per square foot in a studio than in almost any other environment and it's constantly changing. Studio design means solving problems, meeting challenges, being artistic—and it's exciting. What more could you want?" □

Further reading: *Application of Varying Architectural and Programmatic Requirements to Audio Recording Studio Acoustic Design*, 87th AES Convention, Preprint No 2880

# TAC Magnum

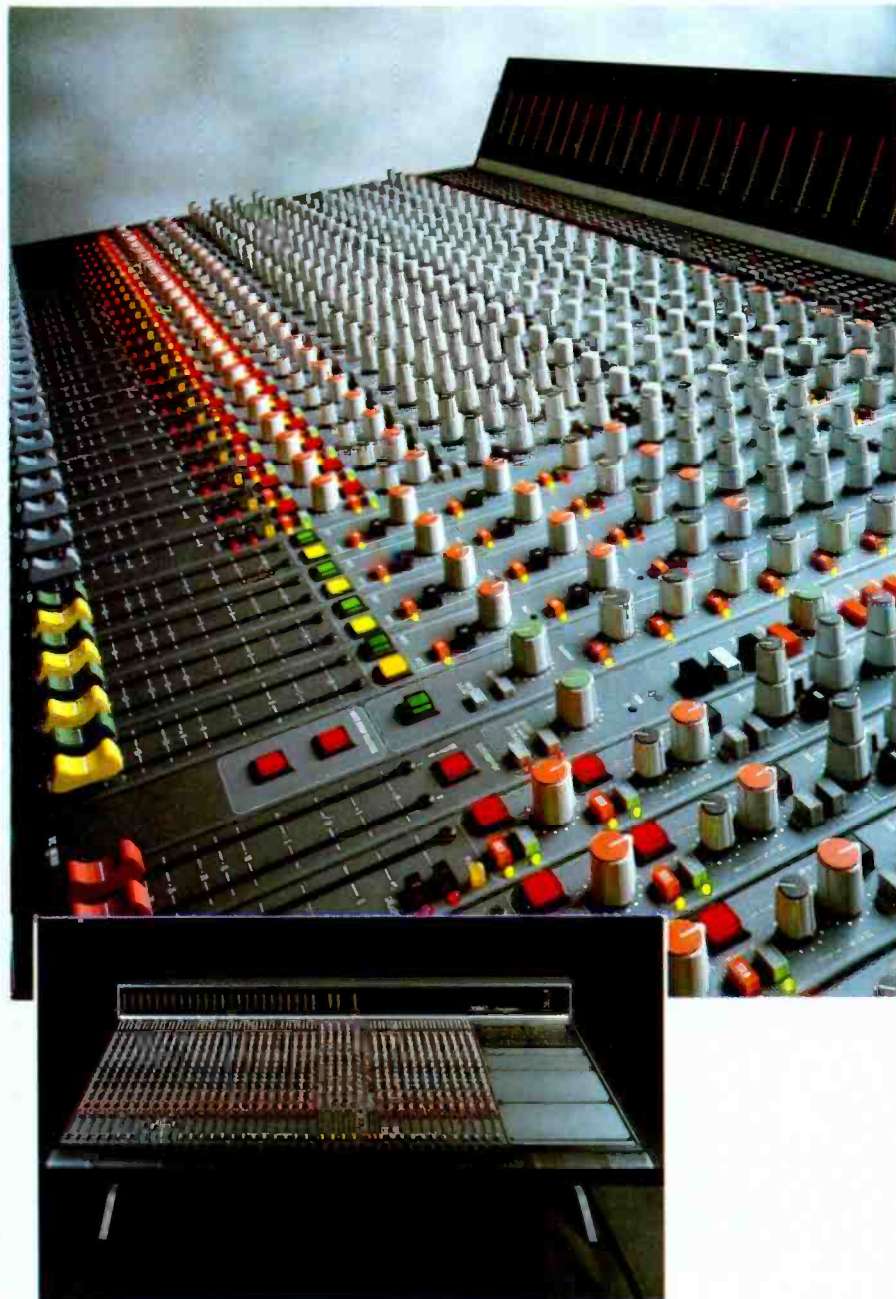

You need an edge. The world is competitive and you're creative but hard-pressed. You need a console that allows your creativity to shine through without compromising your finances.

Building consoles to meet that specification is what TAC does to perfection. We deliver an unbeatable combination of performance, features, construction and price.

We know console technology. The MAGNUM is proof positive and is perfect for multitrack, video post and broadcast production. Look at this checklist for comparison:

**CONFIGURATION:** 24-buss in-line console with dual-input technology, allowing each channel to have two independent signal paths.

**EQUALIZER:** the powerful 4-band semi-parametric equalizer can be split between channel and monitor paths, giving 72 inputs with eq on mixdown in the 36 input chassis.

**AUXILIARIES:** 8 Auxiliary sends – four mono and two stereo – can be fed from channel or monitor signal paths. Sends 7 & 8 can also be routed to the 24 busses for extra effects feeds. 8 effects returns, with sends to all 8 Auxiliaries, are provided.

**SOLO/PFL SYSTEM:** MAGNUM has a Master Status controlled in-place solo switch on both channel and monitor paths. When de-activated, solo switches provide a full Pfl facility. MAGNUM also has two independent Mute groups.

**AUTOMATION:** channel mutes can be automated via MIDI; C-MIX fader and mute automation system can be fitted.

**CHASSIS:** welded steel with a pcb-based bussing system and an expandable 288-point TT jackfield.

Some of the many other vital facilities include channel fader reverse, 30-segment LED meters with peak hold, optional stereo line inputs, 8 audio subgroups and comprehensive control room monitor system.

TAC MAGNUM. The only choice.

QUALITY ASSURED, PRICE UNBEATABLE



Total Audio Concepts  
Unit 17, Bar Lane Industrial Park, Bar Lane, Basford,  
Nottingham NG6.0HU.  
Telephone: 0602 783306.  
Telex: 37329. Fax: 0602 785112.

In the USA:  
10815 Burbank Blvd, North Hollywood,  
California 91601.  
Telephone: 818/508 9788. Fax: 818/508 8619.



# SUCCESS BREEDING SUCCESS

For almost 20 years the simple philosophy that "enhancing the quality of the parts improves the quality of the whole", has led to Citronic becoming one of Europe's foremost professional audio equipment manufacturers.

Our marketing success extends from Western Europe to the Far East and the Americas,



where quality is the key to our customers, who range from the enthusiast to concert touring and broadcast.

Professional people world-wide are recognising the value of entrusting their future to products that not only have a history, but to a company with a commitment to the hi-tech manufacturing of tomorrow.

TM

## CITRONIC

PRO AUDIO

### WHERE QUALITY COUNTS

Citronic Limited  
Bowerhill, Melksham SN12 6JB  
Wiltshire, England  
Telephone (0225) 705600  
Telex 444131  
Fax (0225) 709639

FOR A COMPLETE PRO-AUDIO RENTAL SERVICE  
THERE'S NO REASON TO GO ANYWHERE ELSE

# Dreamhire

(01) 451-5544 (24 HRS)

NEW YORK (212) 691-5544 · NASHVILLE (615) 321-5544

**West German Rental & Studio Facility in the beautiful Black Forest area**

offers for the first time in the UK

Digital Video + Film Post-production Systems for  
Voice Over, Voice Replacement, Synchronisation, Music  
Production, Jingles etc.

our **SYNCLAVIER** and  
**8-TRACK DIRECT-TO-DISK**  
**Digital Audio Systems**

in several different versions (we currently own three  
Synclaviers and two 8-Track Direct-to-Disk Systems)  
available for hire

**with and without operator on short or long  
term basis at extremely reasonable rates**  
(also at your location in UK)

Ask for our 'On the Road' rental rates or our low  
prices for our Studio Rentals. You will be pleasantly  
surprised.

We also rent our Video Post-Production rooms  
equipped with A/B/C Roll Betacam, Ampex ADO,  
Chyron Super-Scribe and much more

**MM-TECHNOLOGY**

Vertriebsgesellschaft audio/visueller Electronik mbH

Bachstr. 2 · 7502 Malsch b. Karlsruhe · West Germany  
Tel: (49) 7246 5005 Telefax: (49) 7246 5009

**HEARD BY MILLIONS  
BUT SELDOM SEEN**

**ducer**

**STUDIO QUALITY CONTACT  
CONDENSER MICROPHONES**

- 42Hz to 22KHz Frequency response
- Superb clarity - true acoustic sound
- Complete isolation
- Easy to use
- More than 5000 systems in use world wide
- Abience-Free Stereo

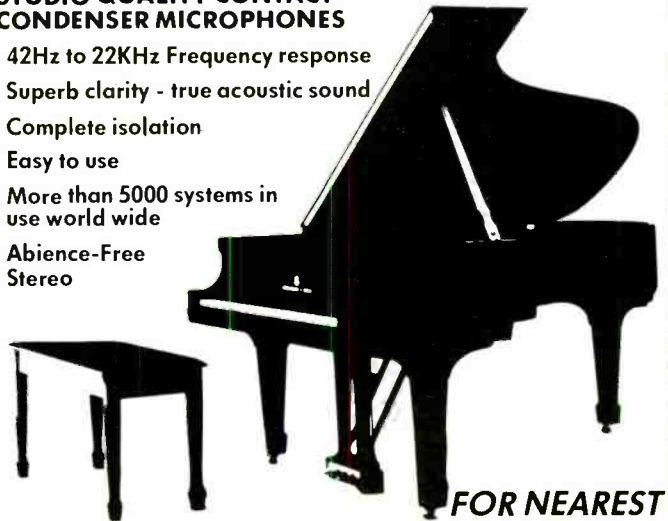

**FOR NEAREST  
DEALER/DISTRIBUTOR CONTACT:-**

**UK + EUROPE  
A.M.G.**

**USA  
C - T AUDIO**

**CANADA**

Call 0428 58775  
Fax 0428 58438  
Int + 428 58775

Call 1 - 800 C - T Audio  
Fax 407 738 0319  
Int + 0101 407 738 0622

West Call 416 360 5940  
Fax 416 362 2477  
East Call 604 222 8190  
Fax 604 222 9884

**6th-8th June 1990  
Olympia 2, London**

**APRS  
90  
THE  
ONE  
SHOW**

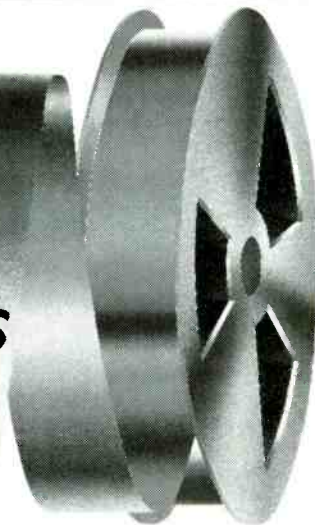

APRS 90... The One Show  
for the pro audio industry.  
APRS 90 is the showcase of  
the world's products and  
systems for recording,  
broadcasting, post-  
production and sound  
reinforcement.

**It makes APRS 90  
The One Show for you.**

Exclusively for professional visitors,  
the annual APRS shows have long  
been the venue for exciting new  
product launches and all the latest in  
pro audio equipment. Year on year,  
the exhibition pushes out to fresh  
frontiers in technology, and new  
markets.

Now, APRS 90 becomes  
The One Show, for what will soon be  
the one market of Europe.

**In London. At Olympia 2.  
6th-8th June 1990.**

**The One Show you must not miss.**



TO REGISTER IN ADVANCE FOR YOUR FREE ADMISSION, PLEASE CONTACT:  
APRS 90 REGISTRATION, 163A, HIGH STREET, RICKMANSWORTH WD3 1AY,  
ENGLAND TELEPHONE: (0923) 772907. FAX: (0923) 773079.



**BC1204 BROADCAST CONSOLE INSTALLED IN RADIO BORDERS**

Our new Broadcast Console type BC1204 has been specifically designed for small Radio Stations. All the necessary facilities required for smooth operation have been incorporated in this design. In spite of the low cost of this console we are using same quality components as on our larger consoles, with a life span of 10-15 years. These are options available to suit most configurations. Contact us for further information.

**KW** ELECTRONICS LIMITED Unit A8, Pinfold Industrial Estate, Rhyll, Clwyd LL18 2YR, U.K. Tel. (0745) 338864 Fax. (0745) 343693

**ACOUSTICAL INTERFACE™ SYSTEM**

**PS9200 DUAL-CHANNEL POWER SUPPLY**



Shown PS9200, 4012 and 7013

**Precision Acoustical Measurements with FFT's, Scopes and Meters.**

**The system includes:**

- Type 1 Measurement Microphone(s), Companion Preamplifier(s) and Cables.
- Available in 1, 1/2 and 1/4 Inch Models.

**ACO Pacific, Inc.,** 2604 Read Avenue  
(415) 595-8588 Belmont, CA 94002

**ACOustics Begins with ACO**

**Rycote**

Beware imitations!

The result of continual original research

**WINDSHIELDS, SHOCKMOUNTS, WIND-JAMMER**

Rycote Microphone Windshields Ltd  
Unit 6, New Mills  
Slad Road, Stroud  
Glos. GL5 1RN England  
Tel: (0453) 759338  
Fax: (0453) 764249

# The AR2400. The **BEST** combination



When it comes to choosing a multitrack recorder, the AR2400 offers the best combination of features, build quality, reliability and value for money in the world.

Consider these facts . . . . .

- ★ Fully professional standard 2" format configuration
- ★ Audio performance comparable to, so called, top range products
- ★ Heavy machined chassis
- ★ Heads and motors from the best European suppliers
- ★ Full in-house manufacture from PCB to precision machined parts
- ★ Excellent reliability backed up by 2 years warranty
- ★ Costing around 50% of an MX80 . . . . . THEN choose.

For more information about this or any other Studio Magnetics products, call or write to:



**STUDIO MAGNETICS**  
UNIT 4  
RADFORDS FIELD INDUSTRIAL ESTATE  
MAESBURY ROAD, OSWESTRY  
SHROPSHIRE SY10 8HA

TEL: 0691-670193  
FAX: 0691-670194

**SEE US AT APRS  
STAND No. A11**

# Hear the Apogee Difference



Over the past few years, Apogee has become famous for enhancing the sound of digital audio recorders and processors. Now Apogee quality is available for virtually any digital audio system, with the introduction of the AD1000 and DA1000 Portable Reference Converters. They're free-standing, can be battery-powered, and use the very latest Apogee digital components. They'll interface with most systems with digital I/O, including DAT machines and EIAJ/F1 format digital audio processors.

Contact us today for full details.

Then hear the Apogee difference for yourself.



*An inexpensive digital I/O modification may be required for EFM processors. Apogee also produces a range of OEM digital products; data sheets and leaflets are available on request.*

**APOGEE ELECTRONICS CORPORATION**  
1517 20th Street Santa Monica  
California 90404 USA  
Tel: (213) 828 1930 Fax: 828 9720

**G**ood morning, Mr Jones. I hope you will not take badly what I am about to say to you! Here at Cacophony Recording, where our slogan is 'We Capture Your Cacophony In Perfect Harmony', our goal is relative perfection. God knows, none of my relatives is perfect—I hope yours are. Anyway, we try always to do our best. I have noticed that you are, well, a bit of a klutz. Now it is not just your problem—the other day with the 48-track digital recorder, I understand that rolling it out of the truck to the fork lift was difficult. I understand we saved money by not having to use the fork lift. And yes, the 48-track was insured. It has more to do with the new DAT recorder you accidentally threw away with its box. Yes, the trash compactor did reduce it so now we have the world's first mini-DAT non-recorder.

"No, I didn't really mind you using paper towels in the second floor bathroom but it would have been better if you had thrown them in the trash can. As it was you stopped up the toilet and caused the tape storage room below to flood. It ruined all our master tapes recorded during the last 6 months.

"Look, I have no problem with your keeping your hamburger warm inside the mixing console. I know there is a lot of heat there. But perhaps you could have taken it easy with the Russian dressing. And could you find some other way to unkink the microphone cables besides throwing one end off the roof with the microphones still connected. Yes, I understand as long as the microphone doesn't touch the ground, the worst that would happen is a little bouncing on the side of the building. Yes, I know accidents happen and we are not in a 'good' neighbourhood and kids probably broke all those windows.

"I am not that angry about the remote recording truck. I know you had to stop to go to the bathroom. No, I surely wouldn't want you to do that to your pants. You were right to stop next to the gas station. But couldn't you have actually pulled in? And couldn't you have put the chocks in under the wheels? I do understand that it didn't seem to be that steep a hill, at the time. No, we didn't have any insurance after the 48-track incident. If our name is mentioned in Lloyd's, they ring a bell. Well, surprisingly the equipment suffered very little damage. No, you can't just replace the top of the truck. You have to buy a whole new truckbody.

"Anyway, mate... the bottom line is, I really don't care if you are my wife's sister's kid. You're fired!!!!"

**H**ow many of you have heard recently those dreaded words: "You're fired"? It's unlikely any of you could be as much of a 'klutz' as 'somebody's wife's sister's kid' but it is less unlikely that you could lose your job at some point in your audio career. Catastrophic job loss is unpleasant but by no means do you experience it all by yourself. Careers counsellors tell us that virtually everyone today can expect to be laid off from their job at least once during their lifetime. Not that this snippet of information makes this inevitability any more pleasant but it does provide perspective. And a positive perspective is the first step in dealing with a job loss.

## Martin Polon

### Someone out there loves you. Advice for the despondent and newly unemployed. Comment from our US columnist

#### Be positive. It is not your fault

When losing a job, the first reaction most people have is to assume that it must have been 'their own fault'. It was 'something I did'. Playing Monday morning quarterback\* after losing a job in the audio industry is not very productive and it can sap the one element most needed to find another job—self confidence. It is really quite immaterial whether you did something wrong. Everyone makes mistakes. We learn from our mistakes and we cannot grow in the job without at least some option of trial and error. It could be helpful to fine tune your own performance to have some idea of what went wrong. But in today's world of exaggerated liability, it is highly unlikely that management is going to identify the 'straw that broke the camel's back'. It is much more likely that a case was built against you on grounds that may or may not have been valid. So write the experience off to kismet and move forwards—don't look back.

#### Clean out your desk and/or locker. Claim your belongings

Take home what is yours and nothing else. This is the point where a lot of bad mistakes are made and careers, if not lives, are ruined. It is very easy to think, "now is the time I get even. I'll take that Sennheiser mic I always wanted. I can 'borrow' this Hewlett-Packard calculator without concern. I have had it for 3 years. Nobody will know. I want to take my Fluke meter home. It's been in my desk for 4 years. They have forgotten they bought it."

All this is poor form. Take nothing with you that is not yours. Take everything that belongs to you but nothing that belongs to them. Even if you know you are a 'short timer' for a month prior to termination, don't use that month to lift half the company's stock. Don't even load up on liquid paper or pens or legal pads. You want to make a clean break. You don't want a member of security staff discovering company property on your person or among your goods. You don't want the property survey unit to find items missing from your assigned inventory. You don't need the black mark of theft on your record and you don't want to have the police involved. Most of all, you don't

\*Monday morning quarterback: One who discusses the game after the event and 'knows' exactly what tactics should have been employed.

want to give the company ammunition to nail it to you again.

Incidentally, if for some reason you have brought on to the company's premises specific items of your audio or test equipment or a calculator or computer, make sure there is a letter on file from the company acknowledging the 'loan' and hopefully covering it with their insurance. That protects you when it's time to leave and the shop supervisor who hates you says "wait a minute, mate, that gadget isn't yours, is it now?"

#### Be careful and prudent in making your exit

Let's go back to our beloved sidekick, your friend and mine—the shop supervisor. What shall you do after he accuses you of trying to steal your own property? (a) Perform on-the-spot dental surgery with a large wrench, expertly changing the shape of his jaw. (b) Obtain 3 lb of the finest grade Czechoslovakian Semtex plastic explosive and rig his car to enter orbit as a trash satellite when he next starts it. (c) Smile, be polite and exit as soon as possible.

The answer is obviously (c). It may well be true that you would feel infinitely better at the time with options (a) and (b) or all the above. But, you will be pleasant and polite for the very same reason that you didn't steal anything. You need 'Them' far more than they need you at this point in time. You need to use this work experience on your CV, or résumé, and you may need a specific recommendation from them. They need you to be pleasant and polite. In almost all cases, management is fearful of a confrontation in case of a job termination. They also fear for their own liability in terms of wrongful dismissal. So the better behaved you are, the more likely you are to get a really positive recommendation. It may gall you but a petty salute to your ego via confrontation buys you nothing now and, really, nothing later.

#### Assemble your financial support package

Under no circumstances sign any kind of document concerning your leaving. Never allow yourself to say I quit. That can cost you whatever severance pay the company will normally provide you. Enquire as to the termination conversion of vacation time, sick leave and especially earned compensatory time off. In many cases, these represent a form of payment to you and have to be paid out at your departure. Check on your pension benefits and depending on your time in your job, whether you have any permanent entitlements to pension benefits. Your health plan may have to be continued by the company for some time, as you were involuntarily separated. Upon termination, you should immediately contact whatever agency of government deals with benefits for the unemployed. Such aid can be quite substantial and will help to tide you over until you can get another job. Pride is not a valid instinct here since you are trying to sustain yourself over whatever time frame is necessary to find the best possible job for yourself.

#### Adopt an austere lifestyle

The proverbial jig is up. No more drinks with the lads down at the local. Forego the weekly Tandoori feast at the neighbourhood Indian



# drake

*The answer to your intercom, audio and video distribution needs.*

*Philip Drake Electronics have an established reputation in the supply of communications and distribution equipment to the broadcast, theatre and audio visual industries.*

*The Drake Broadcast Systems division completes the picture, offering project management, design and installation expertise to meet your system needs.*

We would like to invite you to the launch of our first Stereo Audio Console on Stand Number 004 at APRS, 6-8 June 1990 Olympia 2

For full brochure set, contact...

**Philip Drake Electronics Ltd**  
37 Broadwater Road, Welwyn Garden City,  
Hertfordshire, AL7 3AX, England Telephone: 44 707 333866  
Telex: 25415 DRAKE G, Fax: 371266

## FOR COLLET KNOBS

The most extensive, most adaptable and best looking range of knobs in the industry.

Collet knobs, push-on knobs, slider knobs, pushbuttons.



## PUSH-ON KNOBS



Short, standard or wing knobs. Knobs from 10mm to 38mm diameter in black, grey or red with many accessory and marking options – well over a million standard permutations.

## SLIDER KNOBS

And if you can't find what you need among these, we'll make to your specification (if the quantity is right).



## and PUSHBUTTONS



Printing on knobs? Sifam are unbeatable for high-definition printing of the finest detail.

A detailed and colourful catalogue is yours for the asking.

## SPECIFY

**SIFAM LIMITED – ACCESSORIES DIVISION**  
WOODLAND ROAD TORQUAY  
DEVON TQ2 7AY ENGLAND  
Telephone: 0803 613822  
Fax: 0803 613925. Telex: 42864



**APRS EXHIBITION : 6-8 JUNE STAND NUMBER : 016**

restaurant. You can actually live to a ripe old age without another piece of that exquisitely ripened Camembert cheese from the verdant plains of France. Learn to buy cheaper food and the vegetables that you thought were only put out for the old age pensioners. Eat less meat and more pasta. Your health will improve for it. Perhaps it is time to wait a month or two before buying the latest missive from the Beastie Boys on CD. Ditto the movies. The *Holy Grail* will remain to be saved even if Indiana Jones doesn't do it for you at the cinema this week. Ditto *Batman*, *Ghost Busters*, James Bond and *Star Trek*. Drive as little as possible to keep your car expenses down. Remember that you will need extra money for clothes and résumé reproduction and perhaps for transportation to interviews.

#### Consider a change in geography

It may be time to pull out the old atlas and gazeteer. You are clearly in the right place if audio is your chosen vocation and you live in Los Angeles, New York, Nashville or London. Anywhere else could be more difficult but it depends on what you want to do. If film or television production sound is what you want, then Los Angeles is where you have to be. If audio for commercials intrigues you, consider Chicago. If you like the idea of working with country and folk music artists, consider Nashville. If you are determined to succeed in theatre sound,

then New York City is the place. But there are equally attractive activities going on in San Francisco, Toronto, Miami and scores of other localities involving audio.

But wherever you consider moving to be sure you are not running away from a failed job. Change can be productive if you plan for it. It is important to realise that change means a loss of friends, contacts, housing, etc. It means having to exchange your entire support system for another one. If you do want to move, try a trip to your intended destination and survey the job scene in person. It may be true that the streets of Los Angeles are paved with silver platinum and gold, but do not take anybody's word for that. Find out for yourself. Look before you leap.

#### Produce a résumé appropriate for an audio professional

Through your résumé, prospective employers can find out who you really are and what you can really do for them. A good résumé will emphasise your education, your previous employment opportunities, your work with particular artists, your interests and your future goals. It is a good investment to use a firm that specialises in writing résumés. A résumé professional will help you to emphasise your special gifts, talents, achievements and accomplishments. In that way, you can get your foot in the door for an interview. It may take an interview to 'clinch' a job, but

many audio industry employers admit that it is the résumé that whets their interest.

#### Network among your colleagues and contacts

After a brief waiting period to allow the impact of your transition to settle, get on the phone. Go to meetings. You need to be seen at the local AES meeting, SMPTE gathering, APRS bash, etc. After all, somebody will ask "What happened to good old Charlie?" Better that you are there to answer the question than somebody else. In fact, the more you communicate with your fellow audio practitioners, the sooner a job could come up for you. In networking, you make the fact that you are available known to many. There could well be three or four companies in your area who have admired your work from afar. Once they know you are available, you stand a good chance of being made an offer. You should call on those you did not see at various gatherings. Again, better the story of your departure comes from your lips than via the secondhand grapevine or worse yet from your old company via the 'office gossip'.

#### Make use of newspaper and magazine employment advertising

It's very easy to fall into the trap of ignoring job advertising that you have always viewed as inappropriate in the past, when you still had a job! The comment heard most often about 'in-print' job adverts is that nobody advertises the

# WHICH DUCK PAID LESS THAN



# THE ONE WHO BO

For further information on the new Thompson T24 contact; T

really good jobs. Yet if you check the jobs ads in audio trade publications, you will find that you have a lot of opportunities to choose from. But, you don't have to limit yourself to three or four pro-audio publications. Look in broadcasting magazines, audio/visual magazines, sound reinforcement publications, advertising magazines and music magazines. In this way you might find out about a position for a stereo TV music mixer, an audio position at a museum, a mixing job at a theme or amusement park, a mixing position in an agency commercial studio, and a mixer/maintenance position with a famous composer who has his own elaborate home studio. Similarly, it is not unusual for Sunday newspapers to carry ads for corporate audio positions. There are far more of these jobs than most audio professionals realise and the paper is frequently the key to finding out about these openings.

**Research the job marketplace. Do your homework**

Make getting a new job your current task; as though it were a job, too. This helps to keep you busy during your hiatus. It means going to the library when you are not actually going to interviews. You can use the library to catch up on little used skills that may help you on the next job. You can use the library to search the various newspapers and magazines for job listings. You

can use the library to check on government jobs at local, regional and national level. Make sure you can obtain access to all the important audio trade magazines and professional 'bibles'. If the library does not have them, then arrange to see them at a friendly venue such as a studio or manufacturer or sound rental company. People usually go out of their way to be helpful, if you will only ask. The 'bibles', like *Billboard*, *Broadcasting*, and *Weekly Variety*, are available on the news stand. It may mean finding appropriate expenditure if the library does not have these publications.

**Confidently use all job opportunities**

Do not ignore a potential job. Human nature being what it is, many people fall into the 'they' trap: 'they wouldn't want me', 'they have already filled the job', 'they probably want a woman', 'they probably want a man' and 'they'll probably think I'm not qualified for this job anyway'. All these excuses and many others frequently serve as 'perfectly good reasons' for not applying for a job. In fact, it is most important to remember that you are only as good as you think you are. People will value you as you value yourself. Do not sell yourself short.

**Set realistic goals for yourself and once set—stick to them**

Know in your own mind where you would like to

work, what you expect for a salary, whether you want to supervise or be supervised, etc. Work out all the critical issues before you sit down to an interview. Then, you will find out that you have the advantage. You will know in your own mind what conditions you will be willing to accept and which ones you will not. That also means not taking the first job that comes along, if it is not what you want to do. The rest of your life is the issue at hand and playing a waiting game may provide you with a lot more job satisfaction in the future. It will take some real intestinal fortitude but it will be worth it.

The bottom line in a job search situation is to begin making yourself ready the moment you start a new job. Although that sounds contradictory, it really makes a lot of sense when you consider that the goal is self-improvement. The point is that a well prepared employee is a valuable asset to any business. Consider the issue of computer literacy. If one skill is clearly defined as being vital for a job in audio in the '90s it is skill with a computer. Take some classes while you are looking for work. Buy a new suit. It's an investment that will pay off in the new job as well as in getting the position. Make yourself the most attractive individual that you can. Don't go into an interview at a disadvantage thinking 'if they won't take me the way I am, too bad'. Make sure the rest of the world knows what you know—that you are the best there is! □

**£13,000 FOR A 2" 24 TRACK?**



**IGHT A THOMPSON**

Thompson Audio Developments Ltd. PO Box 373 Biggleswade, Bedfordshire SG18 0AQ, England. Tel: 0757 601655 Fax: 0767 601455



For all new & used studio equipment

## M.S. AUDIO REGULARLY SUPPLY

S T U D E R  
 R E V O X  
 T A S C A M  
 T E A C  
 F O S T E X  
 S O U N D T R A C S  
 L E X I C O N  
 D R A W M E R  
 A K A I  
 J B L  
 U R E I  
 Y A M A H A  
 D E N O N  
 A L E S I S  
 C I T R O N I C  
 S Y M E T R I X  
 X R I  
 N E U M A N N  
 B E Y E R  
 S E N N H E I S E R  
 A T A R I

## M.S. AUDIO AT APRS '90

SEE THE UK'S  
SPECIALIST IN  
SECONDHAND  
PRO AUDIO  
EQUIPMENT

**STAND 149**  
(LEVEL 1)



# ALWAYS A GREAT DEAL ON OFFER

.. IF YOU DON'T SEE WHAT YOU WANT  
PLEASE RING MIKE OR JENNY..

### MULTITRACK MACHINES

MITSUBISHI X850 32 track digital .....	£P.O.A.
SONY 3324 RM3310 remote. Error correction. Excellent condition. Choice of 2.	£P.O.A.
OTARI 32 track digital. 12 months old only .....	£P.O.A.
OTARI MTR 90 MkII with auto/remote. v.g.c. ....	£17,950.00
OTARI MX80 with auto/remote. Good condition. ....	£16,950.00
STUDER A820 with Dolby SR cards and auto. v.g.c. ....	£P.O.A.
STUDER A800 MkIII with auto/remote. ....	£P.O.A.
STUDER A80 MkIII with auto/remote. ....	£14,500.00
STUDER A80 MkII with MkIII updates. auto/remote. good condition. ....	£13,950.00
STUDER A80 MkII with auto/remote. Low hours. v.g.c. ....	£12,750.00
SOUNDCRAFT SATURN with auto/remote. Excellent condition. ....	£17,000.00
SOUNDCRAFT 762 MkIII with auto and DBX. ....	£9,500.00
SOUNDCRAFT 760 MkII with MkIII updates. Remote. excellent condition. ....	£8,500.00
MCI JH 24 with auto 3. Excellent condition. Choice of 2. ....	£12,500.00

### 2 TRACK MACHINES

STUDER A820 ¼ and ½ inch. 12 months old. Excellent condition. ....	£P.O.A.
STUDER A810 ¼ inch. 15/30 ips. ....	£3,750.00
MITSUBISHI X86 excellent condition. ....	£4,000.00
MITSUBISHI X80 low hours. excellent condition. ....	£3,500.00
OTARI MTR 12 ½ inch. v.g.c. ....	£P.O.A.

### MIXING CONSOLES

SSL 4064E G series modules. G series computer. Total recall. Patchbay and producer's desk. 2 years old. Excellently maintained. ....	£P.O.A.
SSL 6048E G series computer. Total recall. Patchbay and producer's desk. V.U. metering. Well maintained. ....	£P.O.A.
SSL 4072E G series computer. Total recall. Patchbay and producers desk. Excellent condition. ....	£P.O.A.
MITSUBISHI WESTAR 44 frame. 44 channel with automation. 4 band eq. 2 years old. Excellent condition. ....	£P.O.A.
NEVE V3 60 frame. 48 channel. Necam 96 automation. v.g.c. ....	£P.O.A.
TRIDENT D1-AN 48 frame. 48 channel. 32 group. 48 Mon. Disc mix. 3 moving fader. Automation. Complete dynamics package upgrade. ....	£P.O.A.
TRIDENT TSM 40 frame. 40 channel. Patchbay. Immaculate condition. ....	£22,000.00
DDA AMR24 36 frame. 36 channel. v.g.c. ....	£25,000.00
SOUNDRACS Inline. 48 frame. 48 channel. Effects returns. Full automation. 9 months old only. Excellent condition. ....	£P.O.A.
HARRISON MR4 32 channel with master mix automation. ....	£22,500.00
TAC MATCHLESS 36 frame. 36 channel. 2 years old. v.g.c. ....	£11,500.00

We have available a further 20 mixing consoles. Prices from £5,000.00. Please phone for details.

### OUTBOARD EQUIPMENT

LEXICON 480L with Larc. ....	£4,995.00
LEXICON 224XL .....	£4,500.00
LEXICON 224 with remote. ....	£1,995.00
LEXICON PCM 70 .....	£1,050.00
LEXICON 200 .....	£1,750.00
AMS RMX16 .....	£2,750.00
AMS 15-80S 6.5/6.5 sec H/De Glitch/DL. ....	£3,500.00
ROLAND SRV2000 Reverb. ....	£395.00
ROLAND SDE2500 Digital delay. ....	£395.00
ROLAND SBX80 Sync box .....	£395.00
YAMAHA REV 7 .....	£450.00
YAMAHA REV 5 .....	£650.00
AKAI S900 .....	£795.00
AKAI S1000 .....	£1,800.00

We have a considerable quantity of outboard equipment available. Please phone for details.

Our extensive stocklist is continually being upgraded. Please telephone for any item you might require or for our monthly mailout lists.

VIEWING BY APPOINTMENT ONLY

ALL PRICES SUBJECT TO V.A.T.

ALL PRODUCTS ARE QUICKLY AVAILABLE AND CAN BE DELIVERED WORLDWIDE



IS A SUBSIDIARY OF M.S. MANAGERIAL SERVICES LIMITED

NORTH LODGE, STONEHILL ROAD, OTTERSHAW, SURREY KT16 0AQ  
TELEPHONE: 0932 872672 INTERNATIONAL: +44 932 872672 FAX: 44(0) 932 874364

**RING NOW**  
ON  
(0932)  
**872672/874768**  
FOR MONTHLY  
MAILSHOT

It looks as if the long-running saga of the Finial laser turntable is finally coming to an end. The idea of tracking grooved discs with a light beam instead of a stylus is as old as the hills. Inventors have been patenting optical turntables since 1929. Philco were advertising a Photo-electric Radio-phonograph for sale in America in 1941. "A rounded jewel floats over the records and reflects the music on a beam of light from a tiny mirror to a photo cell," claimed Philco. "The scraping needle is gone . . . no needles to change. Record wear and surface noise are reduced by 10 to 1."

Twenty years later Decca in Britain commissioned PA Technology to develop a system of cutting master discs with a light beam instead of diamond chisel.

All these schemes foundered. Then, 5 years ago, Californian company Finial claimed to have cracked the problem with a turntable that used laser diodes, similar to those in a CD player, to read stereo from a vinyl LP. Record collectors got very excited; so did recording studios who saw it as a safe way of playing master acetates before electroplating.

In theory it all sounds so simple. Just beam the light from a crossed pair of solid state lasers onto the groove walls and use a position sensor (a light sensitive strip) to read the angular deflections caused by the groove modulations.

In practice it's devilishly difficult to make the system work outside a laboratory, as Finial and their investors found out. In January 1989 the Californian company threw in the towel and admitted that the technology could not be made to work reliably at halfway to reasonable price.

The invention was then bought up by Japanese company CTI who used parts already made (in Japan) to rebuild prototypes made in California. If these sold, said CTI, the company would order fresh parts and make more turntables in Japan. A working LT was demonstrated in Japan at an audio show in October 1989.

With vinyl fast running out of time, cutting rooms are far less interested in the idea now than they were 5 years ago. So Finial has been writing to record libraries and archives in the US, offering the turntable at \$26,000, the price to include on-site calibration of the optics by a technician.

"After 7 long, gruelling years of research and development the one and only Finial laser turntable is finally being sold to the public in very limited quantities," reads the letter from Finial in California. "Vinyl records can now be preserved indefinitely."

The demonstration of a Finial LT in Britain had for years been rather like Elvis Presley's promised tour of Europe. It was always just about to happen. But whereas Elvis never made it to Britain, two Finial turntables finally arrived in the UK early this year. Selected reviewers and potential customers (the National Sound Archive, BBC and Swiss broadcasters) formed an orderly queue.

All those who got their hands on the Finial found good news and bad news. The good news is that the Finial does indeed play vinyl LPs with a light beam, and the sound is good. The bad news

---

## Barry Fox

---

### Laser turntable for vinyl discs, Jazz FM on the air

---

is that, as common sense always foretold, there is no way that Finial's laser beam and electronics can distinguish between high frequency music modulation and specks of dust. Whereas a stylus shovels dirt and dust out of the grooves as it tracks a record, the light beam just reads it as music. The records have to be surgically clean.

Engineers also found that the Finial would not play 10 inch discs, or records with any kind of oddly shaped or pitted groove. Even colour blemishes in the disc confused the laser too.

"A nice idea but . . ." concluded the engineer, reluctantly.

I was promised one of the two turntables in the UK for a BBC broadcast. But the offer was withdrawn. The optics have gone out of alignment, I was told.

Subsequent experience with one of the turntables made me wonder whether Finial had just chickened out. The player is far more susceptible to dirt on discs than anyone previously admitted. Also the player has to be set up with a calibration disc that adjusts the mirrors' heights, etc. In theory the player memorises these settings while under mains power; in practice it may need calibrating again next day.

It is a painfully slow process to play a disc. The player scans the disc, counts the grooves to estimate playing time and counts and displays number of tracks. Sometimes it does not manage this first time round.

The turntable is belt driven, with drawer loading like CD players. One very odd effect is that the optics block (a metal casing containing mirrors, lasers and position sensors) makes an audible tizzy sound in sympathy with the music, like personal stereo headphones. This is caused by compensatory vibration of the mirrors under control of the servo circuits. But, most important of all, dust is a horrendous problem. If the record is not dust-free the sound is completely spoiled by a welter of clicks.

Ordinary cleaning is nowhere near good enough. The disc must be put on a machine (eg the Keith Monks cleaner testers are being loaned with the turntables) that soaks the surface in alcohol and distilled water, then scrubs the surface and sucks the fluid off under vacuum pressure. On the KM machine (costing around £900) both sides must be cleaned separately, a laborious and noisy procedure.

As one archive engineer put it "Playing a disc 100 times with a light beam may not cause any wear, but repeated cleaning will cause more damage than playing it with a stylus."

If the disc is played immediately after surgical cleaning it sounds good but once the disc is put back in its original sleeve, or left in the air, it

attracts dust like a magnet and becomes unplayable again. Finial provide a brush and recommend use of hydrocarbon surface treatment fluids in between wet-vacuum cleans.

Scratches sound like scratches. The automatic suppression circuits, which work by briefly storing the signal in a delay line and taking the 'edge' off scratch clicks is normally left on—although the user can disable it with the penalty of much worse click and scratch noise and very marginally improved HF response.

In short the whole business of playing a record becomes a giant pain in the neck—especially when compared to playing a CD or even playing an LP with a stylus.

Farewell LT.

Nice to see Jazz FM get on air in such a remarkably short time and fulfil its promise to record live music as well as play records. Jazz FM was awarded its franchise in July 1989, started gutting the old Odyssey recording studio near Edgware Road in December and went on air on March 4th, 1990, albeit with building work still going on around the two presentation studios and their Soundcraft desks. The level of automation available at Jazz FM comes as quite a surprise.

Everything is under the control of a Media Touch system with Selector music scheduling computer software. A producer keys a choice of track titles and market research about music popularity into a personal computer and Selector feeds out a running order that matches the preferred mix.

Touch sensitive screens round the station display a menu of the track titles available from a central bank of six Sony DTC 100 DAT recorders and eight Sony CD jukeboxes, each holding 60 discs. Commercials and jingles are stored on a DAMS system, which uses computer Winchester hard disks to record up to 6 hours of digital audio. A presenter can fire off a CD, DAT or DAMS track simply by touching the screen. Media Touch can be used by remote control, with a modem and telephone line providing control contact with a portable touch screen anywhere in Britain. In theory there is no reason why a presenter should not work from home, with a microphone and modem connected by telephone line to the studio. A 5-band Innovonics compressor/limiter in the signal chain processor has been reset to give a broadcast dynamic range of at least 26 dB, far wider than most pop stations.

In addition to the two studios, the station has a very large presentation area, which will be used for in-house concert live recordings. It's not yet ready, so the station has so far been recording concerts in clubs, using the Fleetwood and Zipper mobiles. A DAT deck records the monitor mix straight to stereo, in parallel with the multitrack recordings. In most cases the monitor mix has been used because it has a better live feel. In-house concerts will also be recorded straight to stereo from a Soundcraft desk to DAT. The long-term plan is for Jazz FM to have its own mobile, hopefully setting a trend for further incrementals. □

15 Stockton Drive, Chinley, Stockport, Cheshire SK12 6DG  
Tel: 0663 50948 Fax: 0663 51099

### SECONDHAND CONSOLES

	Price
1. Amek 200, 28 channels, 10 years old	£6,995.00
2. Audix Broadcast 15 channel, mic full eq. 4 years old	£6,400.00
3. DDA 16 channel mixer, 16/4/2	£3,850.00
4. Alice Mixer, 8/2/8	£525.00
5. Soundtracs MR5 Series 24/5/16 with patchbay, all cables, 16 channel, Bel noise reduction	£4,250.00
6. Neve 80 Series, 8066, type special custom, 40/8/24 24 mic/line input/output channels with full EQPPM m. 10 effect sends 60 line channels on remix. P and G faders, remote patchbay with 1064A EQ type	£39,500.00
7. Harrison MR4, 36 frame, 32 fitted with Mastermix automation, approx. 5 yrs. old	£23,000.00
AMS AudioFile keyboard with full version 8 software. 2 hours recording, 3 years old	£32,750.00

### SECONDHAND TAPE MACHINES

Otari MTR12 1/4" mastering machine circa 1982	£2,900.00
Otari MTR90 Mk2 24 track	£19,750.00
Otari MX55 2 track recorder with centre track	£2,650.00
Studer A80 Mk2 RC high speed	£3,995.00
Studer A62 mono 1/4"	£225.00
Studer A80 Mk3 24 track recorders, narrow body	£12,500.00
Studer A80 24 track	£10,000.00
Tascam 34 4 track recorder	£495.00
Studer B67 2 track, high speed in trolley	£1,900.00
3 M M 79 24 track with applied micro systems autolocator	£7,000.00
Studer B67 Mk1 30 ips, in trolley or maker's box	£2,250.00
Studer C37 1/2" valve machine with new H block	P.O.A.
Studer B67 Mk1 3, 7.5 - 15 ips	£1,359.00
Studer A80, 24 track, Mk2, Mk4. Deck plate Mk 3 Heads	£12,000.00

### SECONDHAND REVERBS

EMT 240 Gold Foil reverb	2 units - each	£950.00
Ibanez DM 2000		£175.00
Ibanez SDR1000		£225.00
Yamaha Rev 1		£1,995.00

### SECONDHAND EFFECTS

UREI LA4		£425.00
Yamaha SPX90 Mk1		£395.00
Akai S900		£850.00
Alesis Midverb 11 digital reverb		£325.00
AMS DMX 1580 3, 4/1, 6 sec and deglitch		£3,500.00
Ashley SC/50 compressors/limiters		£130.00
dbx 152 noise reduction units		£225.00
Electrospace dual exp/comp/lim		£375.00
Lexicon 200	2 units - each	£1,800.00
Lindsay 7670, 3rd octave graphics	3 units - each	£350.00
Neumann high frequency limiters		£525.00
Klark Teknik DN780		£1,250.00
Audio & Design comp/lim 760 XRS (needs alignment)		£250.00
Orban De/esser, 3 in 1		Offers
Survival projects autopanner		Offers

Ring now for a complete monthly availability list \* International enquiries welcome.  
If there is any item of equipment other than listed secondhand or new that you may require to purchase or sell, please do not hesitate to contact Paul Duddy on the above number.  
Prices are subject to VAT.

## COME TO AMERICA !!

db ENGINEERING is waiting for you, with incredible values in new & used equipment !!

### Consoles

MCI 636, fitted 28	£17,500
MCI 556, auto, fitted 48	£23,500
Neotek Elite, 40 fitted 28	£30,000
Trident 80B	£15,900
Trident 65,32X8	£6,500
Harrison MR4, 40 w/26in	£21,000
API 2824	POA

### Reverbs & Effects

Lexicon 480L w/LARC	£5,600
Lexicon 224XL	£4,000
Lexicon PCM70, ver. 3.0	£1,250
EMT 250 reverb	£5,900
Teletronix LA-2A	£900
Pultec EQP-1A	£1,150
Pultec Mavec EQ/Pre	£850
UREI 1176LN limiter	£300
All API, Massenburg, Sontec & Jensen/Hardy	call for quotes

### Multitracks

Studer A800 Mkill 4000 hr	POA
Studer A80 Mk IV	£17,700
Otari MTR-90 II, 24 trk	£18,500
MCI/Sony JH-24	£11,500
Otari MX-80, 18 mos	£14,200
Otari MX-70, 16 track	£6,000
Tascam MS-16	£4,100
Fostex E-16 w/4050 loc	£2,650

### 2 & 4 tracks

Studer A80 4tr	£3,600
Otari MX5050B II	£1,200
MCI JH110C, 1/2", 600hr	£2,400
Ampex ATR104, 4tr + 2tr	£2,800

### Mics & Miscellaneous

Telefunken ELAM251	£2,800
Neumann U87	£750
Adams-Smith Zeta Syncro	£1,750
Aphex Compellor ex-demo	£590

### Monitors

UREI 813C	£1,750
UREI 809B	£600
JBL 4430	£1,300
JBL 4312	£300
Yamaha P5002M, 500 w/ch	£900

db, the import/export experts, need Neve, SSL, Neumann, Studer, Trident & all vintage tube mics & processing !!! Top dollar paid for all clean used gear.  
List your for-sale items free in America !!!

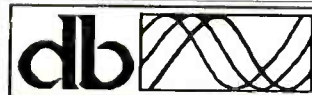

ENGINEERING

Phone 617-782-4838

214 Lincoln Street, Suite 103C, Allston, MA 02134

Call for our special prices on new Aphex, Digidesign, Apple Macintosh, Eventide, Adams-Smith, Klipsch, Ashly & most other major brands !!!

Ask for Mike, Archie or DB !!

Fax 617-782-4935

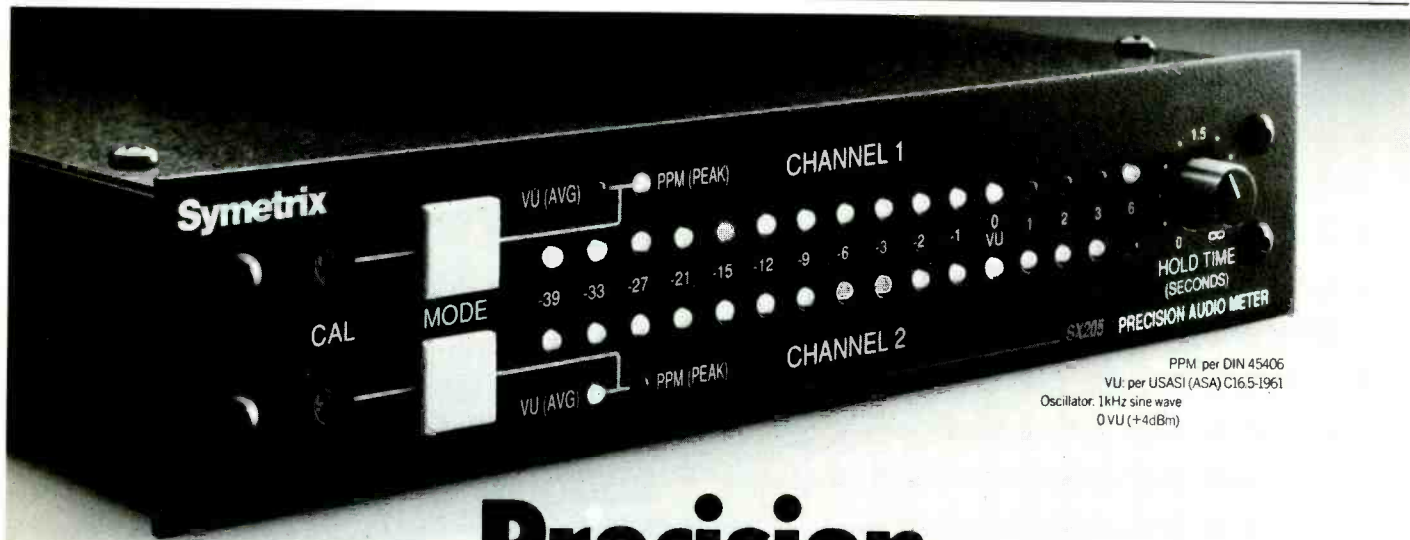

PPM per DIN 45406  
VU per USASI (ASA) C16.5-1961  
Oscillator: 1kHz sine wave  
0 VU (+4dBm)

# Precision.

The new reference standard. For CD mastering. Analog or digital recording. Concert sound and broadcast production.

Measure voltage and power. Pre-view levels with peak-hold time set to infinity. Measure peak-to-average ratio with concurrent PPM and VU displays.

Use the calibrated 1kHz oscillator to set the meter's line level 'zero' from -20dBv to +12dBv. Select a power 'zero' of 100W or 1,000W.

The microprocessor based SX205 Precision Audio Meter gives you repeatable 1/2dB accuracy. Please call or write for more information and a data sheet.

## Symetrix

Signal processing at its best

International Representation:

J.W.M. (M) Ltd.  
PO Box 115 • Swindon, Wilts  
SN2 1DA • UK  
TEL: (0367) 52605  
FAX: (0367) 52614

In the UK:  
SOUND TECHNOLOGY plc  
17 Letchworth Point  
Dunhams Lane, Letchworth  
Herts, SG6 1ND UK  
TEL 0462 480000  
FAX 0462 480800  
Telex 826967 WILSON

**Most studios run an account for convenience,  
- others, because it saves money.**

**APPLICATION FORM TO OPEN AN ACCOUNT WITH STUDIOSPARES**

Government Depts, Government funded bodies and Educational Establishments to complete section A only.

**Section A**

NAME

TRADING ADDRESS

POST CODE  TELEPHONE No

NAME OF CONTACT

**Section B**

IS COMPANY LIMITED YES or NO  COMPANY REGISTRATION NUMBER  No. OF STAFF AT THIS ADDRESS

HOW LONG HAS COMPANY TRADED  IS PROPERTY RESIDENTIAL COMMERCIAL OR BOTH

NAMES OF ALL DIRECTORS  NAMES OF ALL DIRECTORS

ADDRESS TO WHICH STATEMENTS TO BE SENT

POST CODE  TELEPHONE No

IF A LIMITED COMPANY GIVE ADDRESS OF REGISTERED OFFICE. IF NOT A LIMITED COMPANY GIVE HOME ADDRESS

POST CODE

BANKS NAME AND ADDRESS

POST CODE

NAME OF ACCOUNT FROM WHICH PAYMENTS WILL BE MADE

TRADE REFERENCE 1

POST CODE  TEL No

TRADE REFERENCE 2

POST CODE  TEL No

ESTIMATE YOUR LIKELY LEVEL OF PURCHASING FROM STUDIOSPARES IN THE FIRST YEAR £

Please return this application form together with a sheet of your headed notepaper to :-

**Studiospares Ltd.**  
61/63 Rochester Place, London NW1 9JU  
tel 071-485 4908 fax 071-485 4168

**Studiospares didn't reach No 1  
by being out of stock or expensive.**

# THREE CHANNELS THE FUTURE OF STEREO?

Michael Gerzon takes a fresh look at 3-channel stereo in the light of recent high definition TV technology

The development of widescreen and HDTV systems for television has renewed interest in 3-speaker/3-channel stereo, supplementing the traditional left and right speakers with a central one in the middle of the screen. Such 3-channel stereo systems are far from new—they were first investigated at Bell Telephone Labs in the USA in the early '30s, and have been used by the film industry since Walt Disney's *Fantasia* in 1939.

The prime motivation for using an additional channel for a centre speaker is to 'lock' central sounds, such as on-screen dialogue, into a stable physical relationship with the screen. With 2-speaker stereo, the nominally central image is liable to wander around according to the location of the listener/viewer.

Domestic 3-speaker stereo operating from three channels is potentially capable of far more than merely 'locking' central dialogue into place. The extra speaker and channel can be used to improve the quality of other non-central image locations to be markedly better than from 2-speaker stereo. Via such improved phantom imaging at other locations, 3-channel stereo has the potential for a marked improvement even in audio-only applications.

Yet there is a strange paradox here. Despite the fact that 2-speaker stereo (deriving from Alan Blumlein's famous 1931 patent) and 3-channel/3-speaker stereo (deriving from the work of Snow, Fletcher and Steinberg at Bell Telephone Labs in 1933) are about equal in age, no one to my knowledge has seriously tried to design 3-channel stereo to optimise phantom images in the way that Blumlein and others have done with 2-speaker stereo. Snow and others did design 3-channel panpots in 1934 to create phantom 3-speaker images. Such panpots are still widely used in the film industry but their work was on a much more empirical basis than Blumlein's and no systematic psychoacoustic optimisation analogous to Blumlein's work with two channels was done.

Here we outline recent work done by the writer on the optimisation of 3-channel/3-speaker stereo systems to realise the potential for improved phantom images and superior quality from such systems. This work has used much of the psychoacoustic theory of directional sound localisation, originally developed in connection with Ambisonics but optimised here for frontal stage sound. This work has involved not merely understanding and optimising 3-speaker results, but also the development of simple practical technology and system design for the use of this know-how in the sound-mixing studio environment.

In previous work, the theoretical potential for

3-speaker stereo to improve on the phantom-image illusion of 2-channel stereo has not been realised in practical systems. In fact, some 3-channel panpots give inferior images near the central position compared to 2-speaker stereo for a central listener. This is very important when on-screen visual action is to be matched in sound position. This inferior imaging was not too important in large screen film presentation in auditoria, as creating localisation illusions in large auditoria is more hit-and-miss than in the home, due to the longer paths and larger time delays from the loudspeakers to the listener.

It is often forgotten that the Bell work on 3-channel spaced-microphone stereo was specifically aimed at reproduction in auditoria, not in the home. As a result, enthusiasts for Blumlein-type stereo have often unfairly criticised the Bell work as 'not properly understanding stereo' but they forget that Bell were not trying to solve the same problem (reproduction of phantom images in smallish rooms with reasonably centrally-placed listeners) as Blumlein.

While the Bell approach may be appropriate for large auditoria, including widescreen film presentation, it is undoubtedly not the optimum for domestic 3-speaker/3-channel reproduction. Such domestic systems can only realise the potential improvement of phantom image performance by careful design work extending Blumlein and others' work on 2-speaker 2-channel stereo.

## Domestic uses

It now seems likely that 3-channel stereo will be used for the reproduction of frontal stage sounds in connection with domestic widescreen and HDTV systems. Extra channels for this are available in the various D-MAC and other broadcast systems across the world—and 'sub-band' systems can be used to add additional data-compressed channels compatibly to almost any digital sound broadcasting system, conveying the additional information via the least significant bits. The obvious advantage is that central dialogue is locked to the middle of the screen irrespective of listener/viewer position.

At first sight, one requires little more from a 3-channel TV audio system than a conventional 2-speaker stereo from the outer speakers for ambiance and sound effects, plus a central 'dialogue' channel. This is because of the various typical problems encountered in matching sound to picture.

Over the decades, we have learned to accept conventions of visual presentation that involve constantly changing angles and perspectives on a

scene unlike anything encountered in real life. If one attempts to change the stereoism of the sound to match the picture, the ears are much less tolerant of sudden changes of position than the eye and in general, it is better to present a fixed stereo sound image even if the picture is constantly cutting between different viewpoints. (An exception to this rule is that it is sometimes desirable to fade up the level of sounds in the mix when the object producing the sound is subject to a camera close-up.)

The result of this need to keep the sound image fixed is that there is bound to be a mismatch between the sound and the visual positions of objects. Research has suggested that mismatch is audible over 4°, although up to about 11° need not be too objectionable. Thus such mismatches can often be kept to within the 'acceptable' region by piling up all the on-screen sounds at the centre position.

At first sight (and hearing?) all this makes true phantom imaging between the three loudspeakers pretty much irrelevant for TV use. But this is not so for a number of reasons we have so far not considered.

Matching the position of sound and vision is not the only reason for having stereo. In audio-only use, the main advantage of stereo (and probably the reason why it has become the standard domestic audio system) is not the direct ability to localise sounds at particular positions. Rather, if sounds are localised at different positions, it becomes much easier for the ears and brain to separate out the different sounds in a mix. The intelligibility improves, listener fatigue reduces and the subjective distortion is substantially reduced. The better the illusory quality of phantom images, the more these other advantages of the ears' ability to 'listen through' the sounds are obtained.

In conventional 2-speaker stereo, one of the simplest tricks to improve the subjective quality of a mix is instead of piling up several sounds into precisely the same stereo position, giving each sound a slightly different position. The same is true for stereo TV production and there is a strong argument not to pile up all on-screen sounds precisely at the centre of the screen but to distribute them across a narrow stage around the centre. But to do this well requires good quality phantom imaging near the centre of the screen, not just at the centre.

A typical example is the broadcasting of a TV quiz show. It is generally better if each contestant's voice is in a slightly different position from the others, even if this does not match the visual image. This way, if two contestants speak at the same time, it is easier for the viewer/listener to follow what both are saying. A similar consideration applies to interviews, broadcasts of drama, and of musical groups. The ability to form convincing phantom images greatly helps the intelligibility of stereo sound.

A second reason for good phantom imaging is that, especially with HDTV (or even with widescreen conventional-resolution TV with displayed-image enhancement), the need for rapid cutting of camera angles may well diminish in some kinds of programmes. A fixed-angle presentation usually loses a lot of important fine image detail, as compared to what one can see in real life. Close-ups often make up for this loss of resolution. For example, an overall camera shot of an orchestra shows little detail where a close-up may show the strings of the violins.

With HDTV, and its higher (albeit far from perfect) resolution, there is less need for close-ups, and they can use less drastic changes of camera



# D&R Dayner

## Clean and quiet - distortion free !

Dayners signal paths are exceptionally clean and quiet yet the Eq section is powerful enough to put right any difficulties without creating distortion or phase problems.

## FSS - 24 Subgroups without repatching !

The Floating Subgroup System is an internal switching matrix which allows countless routing options, giving you direct connection from all channels to any track of your tape machine, whether you're using 16, 24 or 48 track



**D&R**

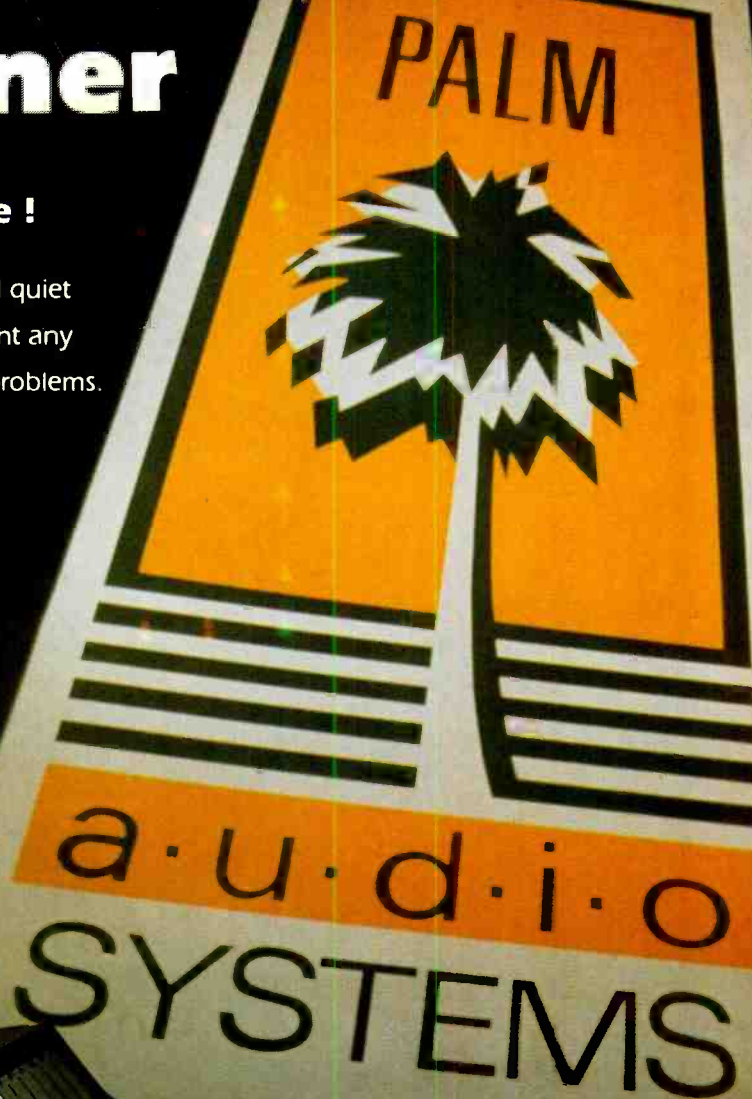

**PALM**  
a·u·d·i·o  
**SYSTEMS**

## Automation !

The fade and mute automation really does set this console apart from the competition, with the ability to 'snapshot' 100 different desk set ups. Add on the "Supergate" option and turn every channel into a completely independent noise gate in it's own right, with the advantage of audio to Midi triggering. All this housed in a precision built console of exceptional strength and quality.

Tel: 021-200 1771 Fax: 021-200 2370

**PALM AUDIO SYSTEMS** The Pacific Building, 16/17 Caroline Street, Birmingham B3 1TR

All D&R products carry a 2 year warranty.

www.americanradiohistory.com

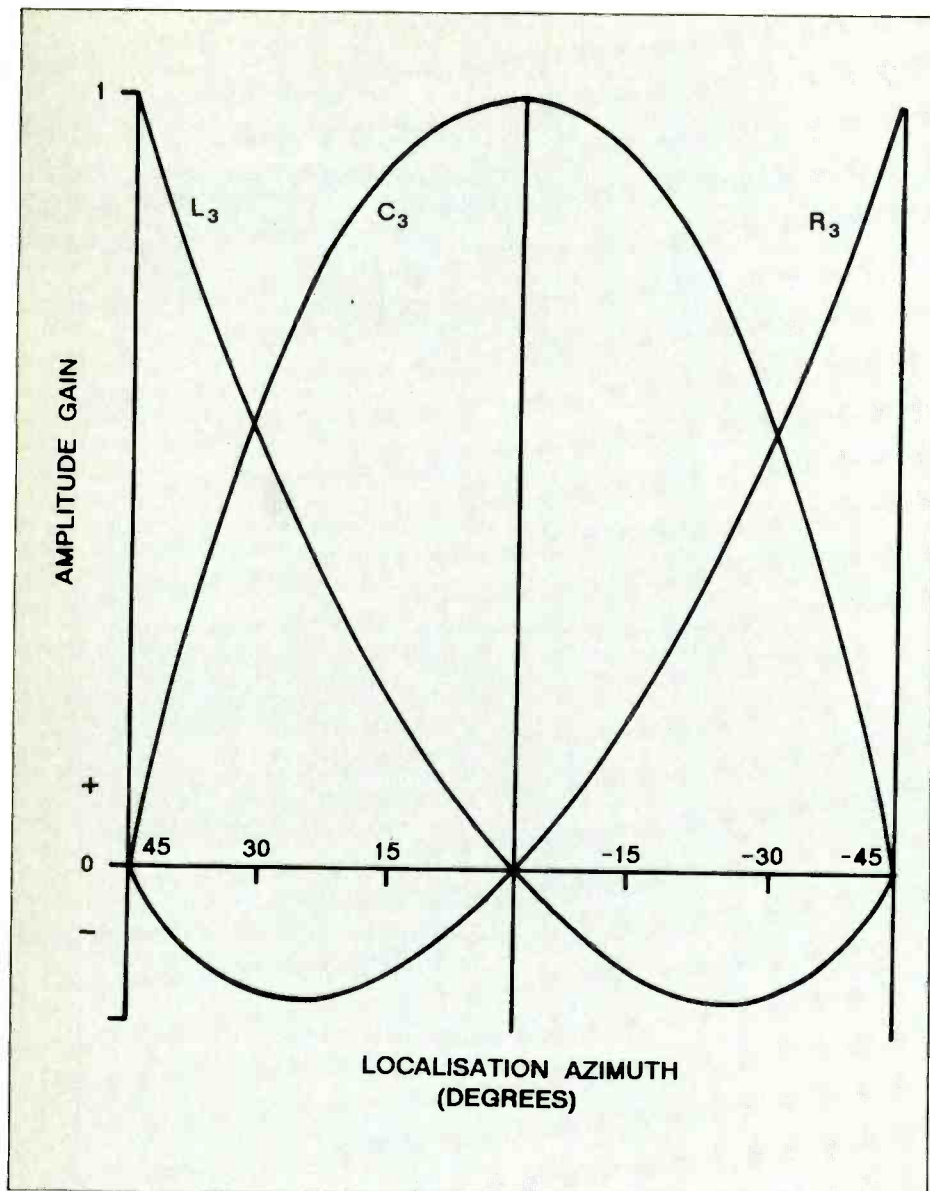

Fig 1: Typical 3-channel panpot law for optimum LF localisation

perspective and angles. While, on artistic or conventional grounds, many programmes will retain current approaches to changing camera angle (and for several years to come, producers will still have to take into account viewers of low-definition TV), there will be an increasing area of programming using relatively stable camera angles. For such programmes, being able to match sound image positions to the picture is a realistic and useful option.

Good phantom imaging causes a higher audio fidelity and quality such as is required for music programmes and also ones requiring a very natural ambience or subtly creative sound effects (including adverts). In many such cases, matching the visual image is either totally unimportant, eg when a creative sound effect is used, or sound fidelity takes artistic precedence over image matching. In all such cases, being able to use the three channels to improve phantom images is important—it is certainly not adequate merely to convey 2-channel stereo via the outer loudspeakers, especially if these are widely spaced apart.

If the technical means for improving phantom imagery via three channels are implemented, one might be in the strange situation where TV audio will be capable of better overall fidelity than conventional audio-only programmes based on two

channels. If this should happen, there would be strong pressure to incorporate the improvements from three channels into audio-only media.

Any technology for improved 3-channel stereo is therefore also potentially important for audio-only media in the future. There are various possible technical means of adding a third channel compatibly to conventional audio media, ie with digital media the third channel can be smuggled in as a data-compressed signal using up the two least significant bits of the two existing stereo channels, with special precautions taken to psychoacoustically mask this altered information for existing listeners. There is room for a third channel in FM radio broadcasting (the quadrature modulation of the 38 kHz subcarrier) and cassette also has the possibility of a third channel within the space currently occupied by two. All these cases can be done in a manner compatible with existing mono and 2-channel stereo uses.

The only media where it could be difficult adding a third channel are the vinyl records, which are unlikely to survive long into the 3-channel era in any case because of CD, and AM stereo broadcasting, which is a low-quality medium in any case.

One of the main uses of 3-channel stereo is much less obvious. It turns out to be an extraordinarily useful production medium for

mastering for mono and 2-channel release. If one mixes down to three channels as an intermediate stage, one has many options for improving the quality of the results obtained in the later final remix to 2-channel stereo. For example, one can derive 2-channel stereo with a wider image width or with better phantom-image psychoacoustics than with conventional 2-channel panpots by going through the intermediate 3-channel stage.

Also, a 3-channel mix can be remixed to other formats (mono, stereo, 3-channel Ambisonic surround-sound, psychoacoustically-improved stereo and even binaural) and allows special AM airplay, video mixes or rebalancing to be done simply without having to go back to the original multitrack. Thus, providing 3-channel technology can be got right, there is a strong reason to start mixing down to a 3-channel mastering format even when current release formats are still 2-channel.

Whatever means are used to convey a third channel, we see that the optimisation of 3-channel stereo is an important issue, affecting the whole future and well-being of both the audio and video industries. It seems wise for audio professionals, studios and the manufacturers of studio equipment to start facing up to the issue of 3-channel stereo at this stage, and not to leave all the important decisions to backroom industry committees who might get things wrong from the end-user point of view if they do not take on board the user's needs. It is also important to ensure that, as soon as is practicable, any programmes produced will be maximally compatible with future 3-channel use, so as to prevent premature technical obsolescence of programmes.

## Psychoacoustics

All the above is contingent on getting good phantom imaging from 3-speaker stereo. Yet it is a fact that, as currently implemented, 3-channel stereo does not give particularly good phantom images even for central listeners. Far from being an improvement, the quality for central listeners of phantom images away from the centre of the stereo stage can actually be worse via three speakers and three channels.

To understand this and try to remedy it, we have to examine the psychoacoustics of image localisation. This is a complex topic but the theoretical methods were presented in relatively simple form in *Wireless World*<sup>1</sup> some time ago. Using these methods of psychoacoustic analysis, plus additional empirical know-how, one can optimise the speaker feeds for three speakers to give as good a localisation quality as possible. One certainly can't get everything right (and surround-sound Ambisonics can get certain things right that a 3-speaker system can't even in the frontal stage sector) but the results can be markedly improved and rendered subjectively much more convincing.

There are two basic theories used in analysing localisation of sounds, although there are other significant methods used by the ears and brain. One theory applies to frequencies below about 700 Hz, and the other between about 700 Hz and 6 kHz. There are two different theories because the ears and brain use different methods of localisation below and above about 700 Hz, which is the frequency at which the wavelength of sound becomes comparable to the size of the head. In practice, the transition between the low and high frequency theories is not sudden but there is a rather fuzzy band of frequencies over which both

TCD is the new digital division of Thatched Cottage Audio based in a brand new 5,000 sq.ft. complex adjoining the present Royston site. Having become Europe's largest 8 and 16-track specialist the time had to be right to move into the digital domain, whilst continuing to provide the same quality of friendly efficient service combined with a comprehensive range of equipment kept permanently in stock and on demonstration. You may have not realised that although we are not based in a major city we CAN deliver goods the same day anywhere in the UK. Why not give TCD a try? Regular clientele include Sarm West, PWL, Real World, Eel Pie, Swanyard, Bros, Erasure, Iron Maiden UB40, and the Who — shouldn't you be on this list?

# THE SAME AMAZING SERVICE AND CHOICE BUT NOW DIGITAL

## NEVE



The Neve VR with Flying Faders  
— ring for details



## ATARI SOUND TOOLS PACKAGE

Digidesign Sound Tools for Atari. Atari Mega 4 inc monitor and mouse. DAC 200 meg. R/M Hard Drive (+ interface).  
Total package price **£4185 + VAT**

## AIWA DAT MACHINES



Aiwa DAT recorder inc. digital in/out, A/D D/A module, full remote, free tape . . . **£649 + VAT.**

If you require any further information on any of the services which we can provide give us a call on 0223 208110 or on the main TCA number 0223 207979 (11 lines) for full details and brochures. The faxpack, which gives details of installation facilities, the service department, demonstration facilities and the equipment we can promise should answer any questions. If you are converting any kind of audio purchase, why not give us a call — you have nothing to lose! We didn't become the largest pro-audio retailer in EUROPE without being the best!

**TASCAM MSR 24 plus A&H SABER**  
At last — a fully professional 24-track system for only  
**£14,000 + VAT**  
Combining the best selling A&H SABER in a 24:16:24 format (no repatching required) and the brand new Tascam MSR24 11" 24 track recorder. Complete with a full jack patchbay and all plugs and cables.  
Call for full information and demonstration.

### SECOND HAND & EX-DEMO UNITS

Acoustic Energy AE2 new.....	£760
Waldorf Microwave amazing analogue synth.....	£820
Aphex 612 Expander/Gate.....	£450
Proteus XR mint.....	£865
Drawmer 231 Comp/Lim.....	£350
Fostex E16.....	£2,499
Revox B77 (new).....	£1,075
Otari MX80 24-Track hardly used.....	£16,500
Korg M1.....	£975
Roland D50 + PG1000 programmer.....	£899
Saturn 24-track full remote ex. condition.....	£15,500
Oberheim DPX1.....	£599
Neve 8108 48 channel-in-line with Necam 96.....	£55,000
Sony DTC1000ES.....	£989
Beyer MC740.....	£599
Otari MTR90 MKII full autolocate.....	£17,950
Atari 1040 & monitor & C-Lab Notator.....	£799
Akai S950 memory exp.....	£125
Drawmer DS201 gate.....	£250
Tascam ATR24 2" 24 track (new).....	£22,500
Casio DA2 Dat.....	£525
Yamaha SPX 1000 multiprocessor.....	£699
Fostex 4030 synchroniser.....	£899
Akai S1000 2 meg expansion boards (new).....	£260
Acoustic Energy AE1 mint.....	£530

This is a small selection from our current stock — give us a call and we will be happy to send you a full up-to-date list. All prices exclude VAT.

### NEW PRODUCT LINES AT TCD

AMS, TC Electronic, Klark Teknik, Quedsted, KEF, Westlake, Genelec, Dolby, Orban, BSS, Apple, Massenburg, Focusrite... just phone for details.

### STOP PRESS

**TCA Travel** In case you didn't know our fully equipped ABTA/ATA Thatched Cottage travel agency has been up and running for some time now, expanding our high standards of service and great value into the travel industry. Whether you are organising a tour, visiting a trade show or simply booking a holiday, give us a call, what have you got to lose? Contact Gill Scott or Glen Bagnell on 0223 314577 or 0860 450499 (mobile).  
ABTA No: 89156

**TCD**  
THATCHED COTTAGE DIGITAL

North Road, Wendy,  
Nr. Royston, Herts

TEL: 0223 208110  
FAX: 0223 207952  
24 HRS: 0860 445172



# TCD

## THATCHED COTTAGE DIGITAL

# It Takes More Than A Little Neodymium To Change The Face Of Driver Technology.



Hailed as the catalyst for a new generation of high performance compression drivers, the rare earth compound neodymium showed up in our R&D lab shortly after it was first formulated. But its extremely high cost and sensitivity to heat had to be overcome before neodymium could live up to its full potential.

The availability of this highly magnetic, extremely lightweight material coincided perfectly with our development of the Coherent Wave™ phasing plug.

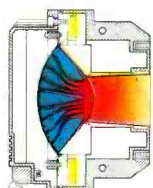

*JBL's 2450J Neodymium Compression Driver with Coherent Wave™ phasing plug provides in-phase combining of sound waves for extended high frequency performance. JBL's patented diamond surround titanium diaphragm with new embossed dome greatly reduces distortion and damage at high SPL.*

This new design, a phasing plug with annular apertures of constant path length, uniformly directs sound through to the throat providing in-phase combining of sound waves for extended high frequency performance. This new technology is combined with our patented diamond surround titanium diaphragm, incorporating a new embossed dome, to reduce the possibility of distortion or damage at high SPL.

## 2450J

The 2450's smaller size translates to tighter spacing of horn arc arrays, more even and precise coverage and greatly reduced requirements for delay. Plus, the 2450 nets out at a mere 4.8 kg (10.5 lb). The benefits of this dramatic weight reduction include lower shipping costs to the site or on the road and significantly less load bearing requirements for both structures and rigging. With built-in mounting points, the 2450 will take much less time to install.

Yes, it took more than a little neodymium to change the face of driver technology. But we're confident you will find the breakthrough results were certainly well worth the wait and the effort.



JBL Professional  
8500 Balboa Boulevard, Northridge, CA 91329  
© 1988 - JBL Incorporated A Harman International Company

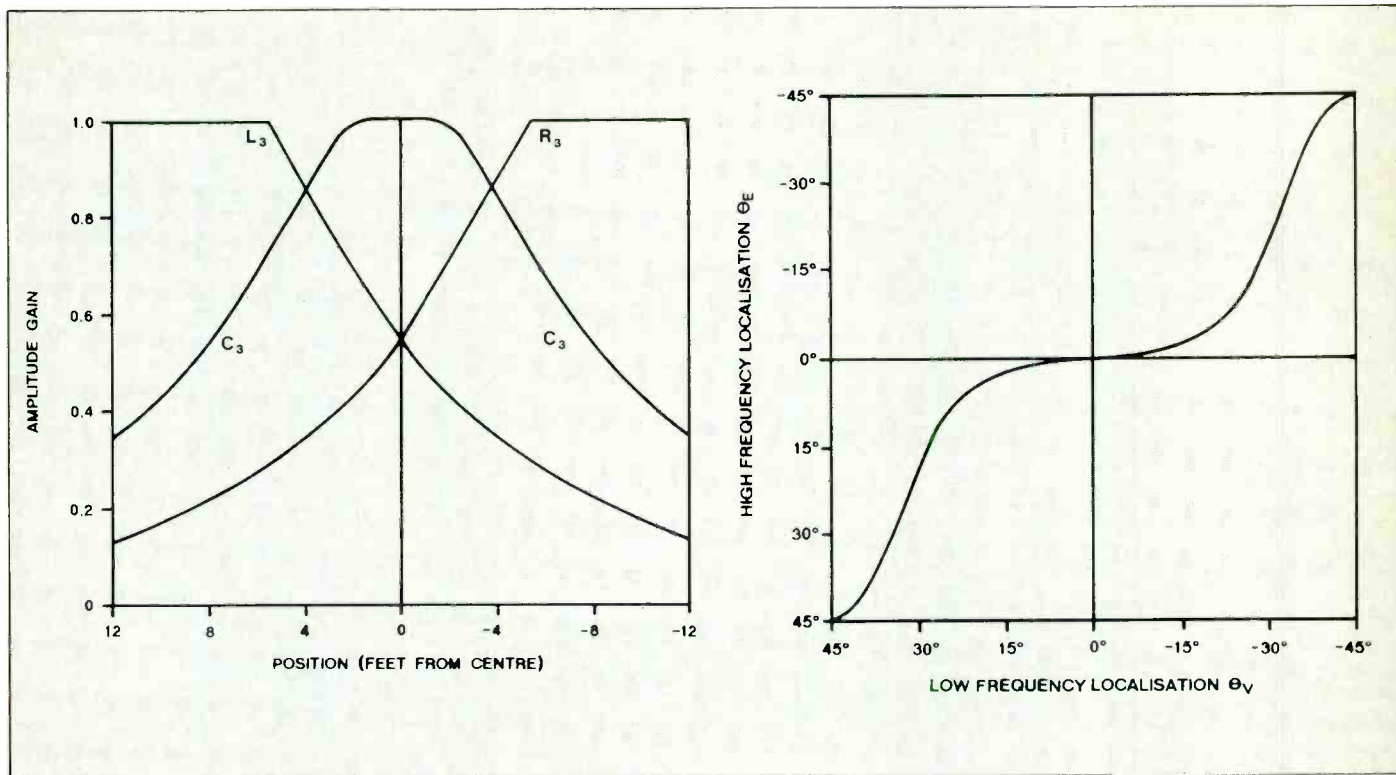

Fig 2: Three-channel panpot law used by Bell Telephone Labs in 1934

Fig 3: Apparent HF localisation angle  $\theta_E$  plotted against LF localisation angle  $\theta_V$  for the panpot law of Fig 1, via a 3-speaker layout subtending  $90^\circ$  at the listener

theories have some application.

Two-speaker stereo is capable of quite good low frequency localisation—the theory of which was understood by Alan Blumlein in 1931. However, this localisation is somewhat unstable when the listener moves or rotates his/her head. As the speaker separation is widened beyond the usual  $60^\circ$  angle subtended at the listener, this poor stability of phantom images markedly worsens, leaving the famous ‘hole in the middle’ and also in images that can be perceived as being elevated as discovered by de Boer at Philips in the 1940s.

This instability of low frequency phantom images cannot be cured even by improved 2-channel stereo panning methods (such as the transaural stereo of Duane Cooper and Jerry Bauck) or by special loudspeaker types (eg those recently designed by Canon) designed to improve image centring. This is precisely the area where 3-channel stereo can give marked improvements, as can Ambisonics.

An improved image stability at low frequencies can be achieved by using a 3-channel panpot law as shown in Fig 1. This shows, for each intended panned image position, the amplitude gain of the sound in the three channels. It will be noted that in this panpot law, the gain becomes negative, ie with a polarity inversion in one extreme speaker when the sound position is panned between the other two. The optimisation of this LF panpot law requires careful theoretical mathematics but its general form shown in Fig 1 is enough for general descriptive purposes. It is possible to design simple analogue panpot circuits and simple digital algorithms to implement such a panpot law well without any great complexity.

By way of contrast, Fig 2 shows the panpot law devised by Snow and others at Bell Telephone Labs in 1934. This obviously very different law has poor LF localisation properties but it was designed for use with reproduction in large auditoria, in which the full requirements of LF localisation cannot be met anyway.

Where the Bell panpot law wins over the law of

Fig 1 is in its high frequency phantom image localisation. Fig 3 shows the computed HF theory localisation of the panpot law of Fig 1 via three speakers. This displays a pronounced and severe ‘detent’ effect at the centre speaker, whereby sounds panned (by the panpot law of Fig 1 optimised for low frequencies) fairly near to the centre are pulled right into the centre speaker at high frequencies. There is also a (much less pronounced) detent effect near the two outer speakers.

Now such detent effects are familiar with all directional sound reproduction systems with a ‘discrete’ panning law (ie one which positions some directions at individual loudspeakers without any crosstalk) and was identified in conventional 2-speaker stereo by Harwood in 1968, and by Kohsaka and others at Nippon Columbia for discrete quadrasonic systems. However, the HF detent effect at the central speaker of the 3-channel panpot law of Fig 1, shown in Fig 3, is very extreme—even sounds supposedly panned significantly far from the centre are pulled right to the middle.

What this means is that the LF panpot law—ideal for LF localisation—is just about the worst possible at high frequencies. The localisation of the Bell panpot law of Fig 2 is shown in Fig 4. While this has much better HF localisation, the localisation stability under listener movement is quite poor—including for central images. Also, the apparent HF localisation is about  $1\frac{1}{2}\times$  as wide at high frequencies as at low frequencies. (There is a somewhat similar discrepancy between LF and HF localisation for conventional 2-speaker stereo.)

The question thus arises of finding an optimised HF panpot law and of devising a reproduction method that conforms to the optimum LF law at low frequencies, and to an optimum HF law at high frequencies.

This question is complicated by several practical operational constraints. A frequency-dependent panpot circuit would be quite complex to implement, and the resulting 3-channel stereo

would not be compatible for mixdown to conventional 2-channel stereo or mono—both of which will remain important for TV and other use. Moreover, ideally, one wishes to use the same mix both for auditorium film and home TV use, since remixing can be extremely expensive.

However, the LF panning law is inappropriate for auditorium reproduction, where the large time delays from the loudspeakers make optimal LF localisation academic. Rather, for auditorium reproduction, one wishes to optimise according to HF localisation laws even at lower audio frequencies. It can be shown that such HF law optimisation gives the best obtainable LF phantom images under auditorium conditions.

This need for two different optimisations of 3-speaker feeds for auditorium and home use means that it is wise to use a single basic frequency-independent 3-channel panpot law, as shown in Fig 1, but that for playback or monitoring, the resulting 3-channel signal should be subjected to an additional 3-input/3-output processing (termed ‘decoding’) to produce the three speaker feeds with optimum psychoacoustics for a given environment. For film release prints, carefully designed crosstalk can optimise phantom image localisation in large auditoria, whereas for home use, such crosstalk will only be implemented at high frequencies in the consumer decoder. The home decoder should be in the home and not at the recording or transmitter end, since one requires that the recorded or transmitted signal be compatible also with mono or 2-speaker stereo reproduction, or even with reproduction via alternative decoders via 4-speaker stereo systems or Ambisonic surround-sound systems.

Should the home user place the highest priority on locking central images to the middle of the screen, the raw left-centre-right signals from the panpot can be fed direct to the three loudspeakers. Those requiring more subtle phantom images will use a simple decoder network to achieve this.

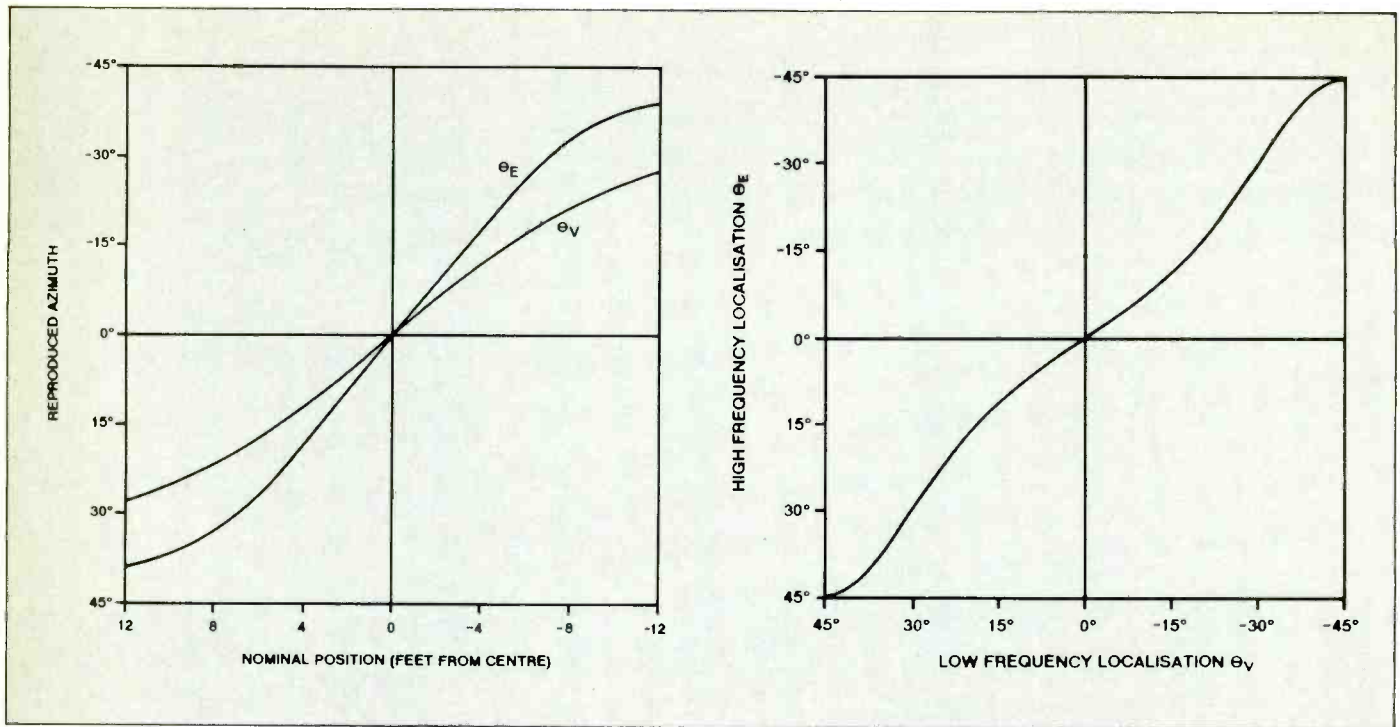

Fig 4: LF ( $\theta_V$ ) and HF ( $\theta_E$ ) localisation azimuths for 90° speaker layout for the 1934 Bell 3-channel panpot law of Fig 2

Fig 5: Apparent HF localisation angle  $\theta_E$  plotted against LF localisation azimuth  $\theta_V$  for one design of improved 3-channel decoding network

Fig 5 shows the HF localisation that can be achieved from the panpot law of Fig 1 via a simple decoding network. Comparing this with Fig 3 shows that the detent effect has been almost completely eliminated and that the low and high frequencies now match in position to within about 4° over a 90°-wide reproduction stage. (Similar matching of low and high frequencies can be obtained for other reproduced stereo stage widths.) The particular decoder involved still gives excellent stability of central images—far better than conventional 2-speaker stereo or the original Bell 3-channel panpot.

2-speaker stereo' conveying image positions beyond the two loudspeakers, 'psychoacoustic 2-speaker stereo' giving an improved phantom image illusion for half-left and half-right positions, Ambisonic 3-channel surround-sound for reproduction via a surround-sound speaker array, binaural reproduction for headphone listening, and transaural reproduction, ie a form of stereo reproduction via two loudspeakers aiming to recreate via loudspeakers binaural signals at the ears after the sound has mixed in the air.

For example, for conventional stereo, the left, centre and right channels are conventionally panned (with constant power gains) or a mixing circuit having the same effect is employed. This results in a conventional 2-channel stereo mix in which intermediate positions are panned conventionally with an almost perfectly constant power gain (within about 0.2 dB).

A mono mix having substantially constant power gain at all positions in the original 3-channel stereo stage can be obtained simply by summing the three channels at equal level.

In Ambisonic surround-sound mixdown, the centre channel is panned to front centre, and the left and right channels to a given angle  $\theta$  (up to say 80°) to the left and right of centre at the same level. This results in an Ambisonic mixdown covering a stage width  $2\theta$  wide, which can extend up to 160° wide while conforming to Ambisonic encoding specifications even for intermediate phantom positions.

A wide 2-channel stereo mix, with stereo images beyond the left and right speakers, can be obtained by mixing down to 2-channel stereo with the left and right channels panned to those beyond-the-speaker positions, and the centre channel panned to centre position, all at equal levels. This results in a 'wide' mix with all phantom positions at almost the same level. This is unlike widened conventional 2-channel stereo, which has excessive sound levels at the edges of the stereo stage.

Further refinements of 2-channel stereo are possible to give improved subjective results. Two examples of this are as follows. It has long been

proposed to 'shuffle' conventional stereo, with wider width at low frequencies than at high frequencies, but such shuffling conventionally introduces an undesirable position-dependent frequency response. If one uses a separate low and high frequency panning matrix from three channels, via a (phase compensated?) crossover network, with the low frequency stereo mix being wide, then the resulting shuffled 2-channel stereo will have a substantially flat frequency response for all image positions. Such optimally shuffled stereo is ideal for widening reproduction from two closely-spaced speakers, such as those to the sides of the screen in an all-in-one TV set or in an all-in-one portable 'ghetto-blasters' unit.

A second psychoacoustic 2-channel mixdown from three channels uses the extra degree of freedom in the 3-channel law to optimise the phantom images halfway between centre and left or right, improving on conventional amplitude panning. Such psychoacoustic 2-channel stereo mixdown can achieve sharper phantom images away from the central panned position without a marked deviation from flatness of frequency response in either mono or stereo. Thus, by initially mixing to three channels and then going through a psychoacoustic mixdown processor, the phantom image results from ordinary 2-speaker stereo can be significantly improved without the complexity of mixdown (or the mono incompatibility) of transaural stereo.

Three-channel stereo material can be converted into a binaural or transaural mix by separately encoding and mixing the left, centre and right channels via binaural or transaural panpots. This gives good imagery of those three positions, although some intermediate positions will not be encoded correctly at higher frequencies. It is possible to modify the mixdown from three channels into binaural or transaural formats to spread these errors more uniformly across the sound stage, and thereby reduce their magnitude. Conversion from 3-channel stereo to binaural or transaural formats, however, can never be perfect but is a much better compromise than is possible from ordinary 2-channel stereo.

## System considerations

The many possible reproduction modes of a 3-channel stereo signal require careful system design to ensure that all modes work well. We have already seen that it is possible to use the LF panpot law of Fig 1 with a decoder to provide improved phantom image localisation quality via three speakers, while giving a more rudimentary effect over three speakers without a decoder.

We have already mentioned the practical importance of having a compatible mix in mono and 2-speaker stereo and that the use of a frequency-independent panpot law, such as that of Fig 1, is vital for this if frequency-dependent mono and 2-channel results are to be avoided. However, 3-channel stereo mixdown proves to be a powerful production tool for a wide range of other important uses than mono, 2-speaker stereo and 3-speaker stereo.

Fig 6 provides an overview of how many of the different uses of the 3-channel material can be derived by subsequent signal processing. The basic idea is that, whatever reproduction mode is chosen, the left, centre and right channels are panned to their respective associated positions by panpots satisfying the appropriate law for that reproduction mode.

Other possible reproduction modes include 'wide

# NORTH AUDIO

## SECONDHAND CONSOLES

1. SSL4000E 48-frame 48 mono channels fitted with 'G' Series E/Q throughout. 'G' Series computer. And remote 'G' Series keyboard. V/U metering. L/H patchbay, R/H prod desk, 5 years old in superb order, available 4 weeks ..... **£115,000.00**
2. SSL6040 40 frame 38 mono channels fitted with Total recall VU meters. L/H patchbay, R/H producer desk, 5 years old in fine condition, available June 90 ..... **£65,000.00**
3. SSL E Series production desk 40 frame 32 mono channels 'G' Series E/Q 'G' Series primary computer (no recall), 12 months old. Immaculate ..... **£69,500.00**
4. Neve 'V' Series 48 Frame 48 mono fitted with patchbay 200 segment bargraph/PPM meters, 8 stereo E/Q sends, 4 stereo reverb, returns with E/Q, full kit of spares. 18 months old in good condition (no automation fitted) ..... **£125,000.00**
5. Neve EMI Console 24 I/O mono channels, 24-track monitors in very good order ..... **Offers**
6. Neve 8108 48 input console with Necam automation, 4 rev returns R/H patchbay and penhouse. In fine order ..... **£39,500.00**
7. MCI 636 console with spectre view. R/H patch. No automation, lots of new switches etc ..... **£11,500.00**
8. Neve 80 Series 8066 type special custom 40/8/24 24 mic/line input/output channels with full EQ PPM meters. 10 effects sends 60 line channels on remix. P&G faders remote, patchbay with 1064A EQ type ..... **£34,950.00**
9. Platinum Mixing console inline and split console, 44 input channels 44 controllable monitor faders, 12 master subgroup channels, 2 stereo channels enables 8 stereo returns with noise gates. Dual parametric equalisers, 10 auxiliaries, 24 subgroups, 4 stereo tape returns, external patchbay 8 months old, good order ..... **£22,000.00**
10. Soundcraft 6000 36 frame, 32/24 with patch, PSU and stand, 12 months old in superb order. Also connected to a Tascam MS16 1" 16-track recorder with AQ 65 autolocator, in pristine condition. Offers for both ..... **£14,000.00**
11. Soundcraft 8000 PA desk, 40/8/2 PA, 7 months old ..... **£8,885.00**
12. Soundcraft 8000 PA desk 24 input with PSU, 12 months old ..... **£5,995.00**
13. Soundtracs 48 in-line plus extra effects 48 track mix automation, superb condition, 1 year old, available immediately ..... **£27,000.00**
14. Trident TSM 32/32, 6-7 years old. Good condition ..... **£19,995.00**
15. Trident 80b 30/24/56 with EQ on the monitor returns patchbay PSU complete, 3/4 years old ..... **£15,500.00**
16. Soundcraft TS12 28 input with patch 3 years old ..... **£9,500.00**

## USED TAPE RECORDERS

1. Sony 1610 system with 1100A editor, two 5850DA recorders and IF 5850 interfaces. Complete system ..... **£16,500.00**
2. Sony 3324A 24-track with locator and remote, 14 months old, approx. 1,200 hrs. in superb order ..... **£44,500.00**
3. Otari MTR90 Mk2 with auto and remote 3,000 hrs, 3 years ..... **£17,500.00**
4. Studer A800 Mk3 no locators or remotes 5,000 hrs approx ..... **£19,500.00**
5. Studer A80 Mk2 wide body, 5,000 hrs. 6 years. no locators ..... **£12,500.00**
6. Ampex ATR 100 1/2" master recorder ..... **£3,750.00**
7. Ampex MM1200 24-track with autolocate ..... **£9,500.00**
8. Otari MX80 24-track with remote, two years old ..... **£14,500.00**
9. Otari MTR90 Mk1, 6,000 hrs. Audio remote only ..... **£9,995.00**

WE ARE CONSTANTLY ON THE LOOKOUT FOR USED EQUIPMENT. . .  
NOTICE

We also act for studios as selling agents, let us handle the hassle of getting rid of unwanted items, it does not matter where you are in the world, why not drop us a line listing your equipment or ring us on the numbers below for the best rates. We assure you of our best attention and service plus the utmost confidentiality at all times.

10. Sony 5002 master recorder, little used, immaculate order ..... **£3,750.00**
11. Otari MTR12 1/2" with centre track timecode ..... **£5,250.00**
12. Studer B67 2-track with butterfly heads in console ..... **£2,350.00**
14. Studer A80 16-track, no remote, little known history ..... **Offers**
15. Studer A80 Mk4 narrow body, 24-track, no remotes, superb ..... **£13,500.00**
16. Otari MTR10 1/4" master two units approx 1983, each ..... **£2,950.00**
17. Ampex ATR800 4-track 2 units ..... each **£3,000.00**
18. Otari MTR12 1/2" mastering machine circa 1982 ..... **£3,000.00**
19. Studer A80 RC master machine. Age not known, in fair condition ..... **£2,750.00**

## SECONDHAND KEYBOARDS

- Bechstein 7ft grand piano finished in rosewood. Totally refurbished, built 1909 ..... **£19,500.00**  
 Yamaha concert 9' grand piano ..... **£7,500.00**  
 Yamaha white G1 grand piano ..... **£3,925.00**

## SECONDHAND REVERBS

- Yamaha Rev 1 ..... **£1,995.00**  
 Yamaha Rev 5 ..... **£650.00**  
 Yamaha S1000 ex-demo ..... **£650.00**  
 Yamaha SPX90 Mk2 ..... **£395.00**  
 Lexicon PCM70 version 3 software ..... **£1,100.00**  
 Lexicon 224XL ..... **£3,950.00**

## SECONDHAND EFFECTS

- Akai S900 ..... **£850.00**  
 Alesis midiverb 11 digital reverb ..... **£325.00**  
 Audio & Design vocal stresser 760XN ..... **£295.00**  
 BBE 402 signal processor ..... **£290.00**  
 Bel BDE 2400 dig del with stereo linking 24 sec. sampling MIDI ..... **£1,650.00**  
 Bel BDE 2400 26 sec. sampler/delay ..... **£1,100.00**  
 BSS DPR502 MIDI noise gate (dual channel 2 units each) ..... **£585.00**  
 Eventide inst flanger F1201 ..... **Offers**  
 Eventide harmoniser H910, no delay ..... **Offers**  
 Lexicon 200 2 units ..... each **£1,300.00**  
 MDB window recorder 16 bit ..... **£595.00**  
 MXR 3rd octave eq ..... **£225.00**  
 Neve compressor limiters model 2254 ..... pair **£950.00**  
 Neve E/Q units 1051 3-band ..... **£795.00**  
 Quantec QRS room simulator 2 units ..... each **£3,500.00**  
 Urei LA4 ..... **£425.00**  
 White model 4000 graphic/crossover 800 Hz ..... **£540.00**  
 White model 4400 graphic/crossover ..... **£540.00**

## NOISE REDUCTION

- Dolby A SP rack 2 units each ..... **£6,000.00**  
 Dolby A XP rack including rack case wired to DC connectors and psu S/R noise generator ..... **£6,500.00**  
 Dolby A TTM frame and power supply with 24 Cat 22 ..... **£3,000.00**  
 Dolby M24H rack complete ..... **£3,500.00**

## MONITORS AND AMPLIFIERS

- Eastlake TM3 monitors 2x15 and tad top with large ham with JBL, 3 spare drivers ..... **£1,300.00**  
 Eastlake monitors with JBL and tabs and Amcrom PSA2 and Amcrom DC3000A. Complete ..... **Offers**  
 Eastlake monitors 15", JBL drivers and TAD horns pair ..... **£1,500.00**  
 Genelec 1025a monitors with amps and crossovers etc ..... **£7,000.00**  
 H&H Mosvet V800 ..... **£375.00**  
 JBL 4435 monitors ..... **£1,500.00**  
 Klein & Hummel self-powered monitors ..... **£875.00**  
 Tannoy 'Little Gold' monitors ..... pair **Offers**  
 Urei 813B monitors, good condition ..... **£1,650.00**

FOR A COMPLETE STOCK LIST WRITE OR  
RING TONY BAYLEY ON  
**0565-830005**

GREYLANDS STUDIOS, MERESIDE ROAD, MERE, KNUTSFORD, CHESHIRE WA16 6QQ. TELEFAX: 0565-830405. TELEX: 666597 NAUDIOG

Finally, the raw 3-channel signals can be reprocessed to give sharper phantom image reproduction via three (or more!) loudspeakers via suitable decoding networks. The optimum decoding network depends on the circumstances. A normal domestic environment requires a different decoding circuit to a large auditorium environment (eg film, SR or A/V applications). A properly-designed psychoacoustic 3-speaker decoder can give quite well-defined phantom image positions without excessive image movement with listener position. It is also possible to design decoders that are to be used with four or more loudspeakers.

Besides handling all these different modes of reproduction, it is worth noting an important subsidiary advantage of 3-channel stereo mixdown. This is in applications where it is necessary to alter the level-balance of the mix. At the expense of some narrowing (or widening) of the stereo image near central image positions, the centre-channel material can be faded up (or down) by increasing (or decreasing) the centre-channel gain before reprocessing into the final reproduction format. This allows listeners/viewers of 3-channel stereo broadcasts or recordings to alter balance to taste and solves the problems of those with non-standard hearing who find it difficult to hear dialogue in the presence of background music or sound effects. Such listeners can fade up the centre-channel feed relative to the outer channels, whether they are actually listening in mono, 2-speaker stereo or 3-speaker stereo modes.

Another use of such level-balance alterations is with sound effects libraries or with library music. If recorded in 3-channel stereo format, the level-balance of the mix can be changed as it is mixed into the final programme in order to meet that particular programme's requirements. Other uses for preparing AM airplay mixes or dance remixes are also evident.

## Operational aspects

Fortunately, there are various simple technologies for implementing optimised 3-channel panpot laws without great complexity. The simplest 3-channel analogue panpot can be realised by a minor modification of existing 2-channel panpot designs, involving two modifications to existing 2-channel stereo mixers: the addition of a few extra components in each mixer channel strip and the addition of another mixing bus (or the reallocation of one of the post-fade mixing buses); the addition of a moderate amount of extra signal processing after the three mixing buses. This will mean that most existing 2-channel stereo mixers can easily be redesigned for 3-channel use and most existing designs should be retrofittable for 3-channel use at low cost.

A 3-channel mixing desk can still be used for conventional mono and 2-channel stereo use by incorporating the conversion circuits for mono and stereo into the mixer—indeed the mono, stereo and 3-channel mixes can be achieved

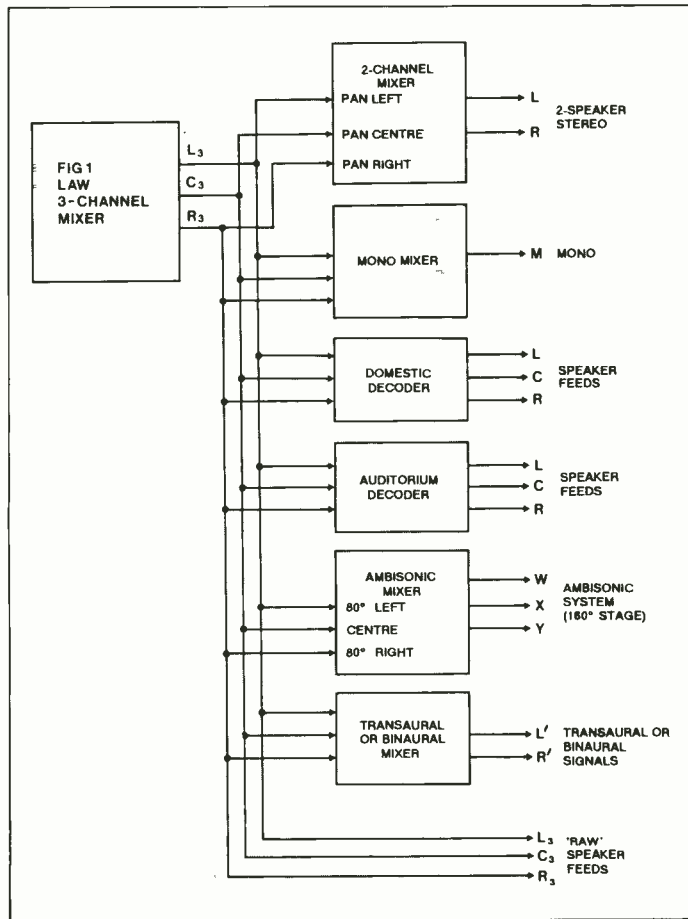

Fig 6: Different uses of basic 3-channel signals satisfying the LF frequency panning law of Fig 1

simultaneously for different release formats. Thus, at relatively little extra cost, studio and PA desks can be provided with the facilities for mono, 2-channel stereo and 3-channel stereo (perhaps also incorporating a 3-speaker decoder for monitoring). Thus, for example, a PA desk normally used for mono or stereo would be '3-channel ready' for those venues where a central speaker cluster is practical, and could give a 3-channel output for recording purposes even when the actual live sound is reproduced in mono or 2-speaker stereo.

Importantly, studio or SR desks of the 3-channel kind described will be operationally identical to present-day 2-channel stereo desks, apart from the user having to select the output mode to be used. Thus operationally, there is no relearning involved in using a 3-channel mixing desk.

Further refinements of the panpot law can be achieved by designing desks around purpose-designed optimised 3-channel panpots. There are very simple designs of such optimised panpots using all three major panpot technologies: digital mixing, VCA technology and using ganged pairs of linear potentiometers. Such optimised 3-channel panpots differ from the 'modified 2-channel panpots' described above in having slightly better psychoacoustics and noise performance—but in most situations, the differences are marginal. The optimised 3-channel panpots are, however, the preferred option when new mixer designs are developed mainly oriented towards the 3-channel market.

As noted earlier, 3-channel mixers will be of advantage even to those users only requiring 2-channel stereo, since the psychoacoustics of the resulting 2-channel stereo can be improved over standard amplitude-panned 2-channel stereo by using a psychoacoustic 3-to-2-channel conversion

network. Also, by mastering in 3-channel format, the master can be re-released in future audio formats, eg 3-speaker stereo, Ambisonic, without remixing from the original multitrack, thereby protecting the investment in mixdown time.

There is still the problem of the lack of a standard 3-channel tape format. The only 'standard' 3-channel tape format is the 1950s ½ inch 3-channel analogue format, which still has much to commend it, especially at a 30 in/s. One of the available 4-channel digital recording formats could also be used, although it should be possible to modify existing digital 2-channel reel-to-reel formats to handle three channels. Users of digital 48-track machines can lay down a 3-channel master mix on three spare channels, and users of videotape formats having three or four audio channels should also have no problems in 3-channel mastering.

This being said, the industry needs to look carefully at mastering media for multichannel stereo.

## Three-channel media

There is also the question of how we get three (or more) channels to the consumer. Digital media

offer an 'easy' way to incorporate additional channels. Essentially, the least significant bits of the existing stereo channels can be 'stolen' and re-allocated to additional data-compressed channels. By appropriate dithering and noise-shaping, most of the subjective loss in the original channels of these stolen bits can be compensated. For example, the loss of the two least significant bits in CD can still give a psychoacoustically weighted S/N ratio for existing 2-channel listeners of around 94 dB—about 3 dB better than currently achieved with the full 16 bits. This subjective improvement is due to the use of optimally noise-shaped subtractive dither, based on work by Peter Craven and myself on optimal dither and noise shaping.

In digital satellite broadcasting, a compatible digital 'sub-band' method of using the least significant audio bits for additional channels has been proposed by Philips. Such systems can be fully compatible with 'existing' listeners, ie those listening to just the basic channels, since the altered least significant bits can be well masked by the basic audio signal by a judicious use of noise-shaping and dither. To minimise loss of quality, this must be done with great care, using proven results. Decoded 3-channel results can be further improved by using a carefully-designed subjectively compatible companding system, and I have devised appropriate algorithms for this.

## Intercompatibility

There is an issue we have not yet really dealt with—the intercompatibility of different multichannel audio formats. For example, supposing that we have a 2-channel stereo



SEE US AT THE APRS  
STAND A03A

# QUALITY USED EQUIPMENT

from Tony Larking

## MULTITRACKS

<b>Ampex MM1200</b> 24 Track with remote, nice condition	£12,500
<b>Fostex E16</b> 16 track, ex demonstration.	£2,850
<b>Otari MX80</b> 24 track, with remote.	£15,000
<b>Otari MX80</b> 24 track, hardly used, Immaculate.	£16,500
<b>Otari MTR90 Mk 1</b> 24 track with full remote & autolocate	£17,950
<b>Studer A80 Mk2</b> 24 track with remote, autolocate & TLS2000. Less than 4,000 recorded hours use, VGC	£11,950
<b>Studer A80 MK3</b> 24 track wide body with full remote & autolocate.	£12,950
<b>Soundcraft Mk2</b> 24 track with 9 memory autolocate plus Mk3 transport update, very little use, Immaculate.	£8,500
<b>Saturn</b> 24 track, ex demonstration machine, supplied with 3 months warranty.	£15,500
<b>Sony 3324</b> 24 track digital, Sony service history, with remote & autolocate.	£39,500
<b>Tascam ATR80</b> 24 track with full remote and autolocate, ex demo	£20,950
<b>Tascam 85-16B</b> 16 track 1"	£2,950

## VARIOUS

<b>Studer A80 VU Mk2</b> 1/2" 30 ips, private use, only 1700 hours VGC	£3,500
<b>Otari MTR90</b> Remote	£1,250
<b>Otari MX80</b> 99 memory, SMPTE autolocate	£1,250
<b>Soundtracs CMS2</b> routing/muting automation for use with CM4400	£500 £P.O.A.
<b>Large Monitoring System</b> 1 pair JBL 4350 Studio Monitors bi-amped with external x-over, plus 2 Harrison Information Technology X800 amplifiers	£2,450
<b>Tannoy Super Red 1000</b> studio monitor speakers, as new.	£1,450
<b>Bel</b> 24 channel noise reduction system, simultaneous encode/decode.	£500
<b>Neumann M260C</b> valve mic with PSU. <b>£OFFERS</b>	
<b>EMT 140 Echo Plates</b> valve or transistor electronics.	£P.O.A.

TELEPHONE 0462 490125

AJ  
Studio  
Furniture

AJ Studio Furniture offer a wide range of quality new and used equipment. Our stock is constantly changing - tell us of your requirements and we will contact you when a particular item becomes available.

Turn your unwanted recording equipment into cash. We are currently looking to purchase particular items of recording equipment for cash. We also handle the sale of equipment on a commission basis.

AJ Studio Furniture high quality Racks. -Phone for a free brochure on our range of high quality studio racks, work stations, tables & studio chairs.

Showroom facilities. To offer a personal service, viewing is by appointment only.

For further details of AJ Studio Furniture contact Tony Larking.

Export Enquiries Welcome

## CONSOLES

<b>Neve 8108</b> 32 channels, & patch bay VGC.	£34,950
<b>Neve 8108</b> 48 channels, in line fitted with Necam 96 VGC	£55,000
<b>Neve 8078</b> 40 channels, one owner from new, VGC	£P.O.A.
<b>Soundtracs IL48/32</b> 48 channel in line console, private use only, very high quality console, 104 line inputs in remix, IMMACULATE	£23,950
<b>Soundtracs CP6800</b> 32/24 with patchbay, ex demonstration.	£15,500
<b>Soundtracs CMX4400</b> 32/24 with patchbay PLUS CMS2 routing/muting automation.	£9,500
<b>Soundtracs CM4400</b> 32/24 with patchbay PLUS CMS2 routing/muting automation.	£8,500
<b>Soundtracs PC MIDI 24</b> 3 months use only, 48 in line inputs with Eq, Immaculate.	£4,500
<b>Soundtracs MR 24/8/16</b> nice condition.	£2,950
<b>Soundtracs MR 32/8/16</b> nice condition.	£3,950
<b>Soundcraft 6000 28/24</b> & patchbay	£P.O.A.
<b>Soundcraft 6000</b> 32/16 & patchbay AS NEW	£8,950
<b>SSL 6000E</b> 48 channels, G-Series computer, total recall, SSL engineers report available	£P.O.A.
<b>Trident TSM 40/24/24</b> & patchbay, very nice condition	£19,950
<b>Trident Series 80B</b> 32/24/24 & patchbay, one owner from new.	£14,950
<b>Trident Series 80C</b> 32/24/24 & patchbay, VGC	£20,950

## 24 TRACK PACKAGES

<b>Saturn 24 track</b> <b>Trident Series 80B</b> 32/24/24	£27,950
<b>Saturn 24 track</b> <b>Soundtracs IL48/32</b>	£36,950
<b>Soundcraft 24 track</b> <b>Soundtracs CM4400</b> 32/24/24	£14,950
<b>Soundcraft 24 track</b> <b>Soundtracs PC MIDI 24</b>	£11,950
<b>Soundcraft 24 track</b> <b>Soundcraft 6000 28/24</b>	£16,950

## WANTED FOR CASH

We have cash available for the following items in Good Condition

**Mixing Consoles by:** DDA, Neve, Soundtracs, SSL, Trident & API.

**Multitrack Recorders by:** Otari, Saturn, Soundcraft, Studer, Sony & Mitsubishi.

Phone for details.

FACSIMILE 0462 490126  
Prices do not include VAT

programme, eg sound effects, library music, commercial music recordings, how can this best be conveyed via a 3-channel stereo medium? Again, suppose we have a 3-channel Ambisonic surround-sound mix. How can this best be reproduced over 3-speaker stereo? With a variety of different signal formats co-existing, all conversion options need to be considered if we are to avoid chaos. The fact is that several audio formats do exist and one will often need to use material from one format in another. This problem is not a new one in that binaural and 2-channel stereo have never really been compatible with one another—both binaural over speakers and stereo over headphones sound wrong. So far, we have merely lived with this problem without solving it but the addition of further formats make it important to think out solutions before the problems get worse.

The problem of reproducing 2-channel stereo over three loudspeakers turns out to have some reasonable solutions—although the results are obviously not as good as full 3-channel stereo. For narrow stage widths, 2-channel material can simply have its left and right channels panned (using 3-channel panpots) to the desired positions but this solution works poorly for wide stage widths, especially when one wishes to fill the whole stereo stage.

We have discovered some remarkably effective linear 2-channel 3-speaker decoding matrices capable of improved image stability for non-central listeners and improved image sharpness for central listeners, as compared to ordinary 2-speaker reproduction, and to prior proposals, eg the Bell Klipsch 'bridged centre channel' method, for 3-speaker reproduction of two channels. Obviously, such 3-speaker decoding of two channels cannot be as good as true 3-channel

decoding but it is quite effective on a wide range of material. We hope to be able to publish both the theory and methods of such 3-speaker decoding of two channels in the near future but it does seem to offer a good second-best option to true 3-channel stereo.

We are rather sceptical about the use of 'logic', 'gain riding' or 'variable matrix' 3-speaker decoders for 2-channel stereo, due to their signal-dependent 'pumping' side-effects, which can cause both dynamic wandering and instability of subsidiary images and increased listening fatigue. This negative comment is not based only on experience of commercially available designs but also on detailed development work on advanced experimental multiband logic decoders based on more sophisticated psychoacoustic design than those on the market. Most commercial logic decoders have paid very little attention to the proper localisation of image directions between the loudspeakers.

A 3-channel receiver needs to know which reception mode is in operation to reproduce each mode optimally over the chosen loudspeaker layout. I suggest that the reception modes involve at least the following options: mono, 2-channel stereo, 3-channel stereo with the panpot law of Fig 1, 3-channel 3-speaker feed-signal mode and 3-channel Ambisonic surround-sound mode. For digital broadcasting, suitable flags in the data stream could indicate the mode being transmitted.

For each of these transmitted modes, a different optimum psychoacoustic matrix is required to feed the three loudspeakers of a 3-speaker stereo receiver. For example, 2-channel stereo requires the use of an optimised 2x3 decoding matrix as described above, a mono signal will be fed to just the centre speaker, a 'figure 1 law' 3-channel

signal will be fed to via a 3-channel decoder, speaker-feed 3-channel signals will be fed straight to the loudspeakers, and Ambisonic signals will be fed to the speakers via another matrix.

These transmitted signals can be designed to minimise the need for mode switching if only a basic 3-channel stereo effect is required but a receiver wishing to get optimum results from each mode will require to know the transmitted mode so decoding can be optimised for that mode.

This complication arises because the optimum decoding for each reception mode is frequency-dependent due to the frequency-dependence of human directional hearing, and the frequency-dependent speaker feeds for optimum reproduction are not compatible with a frequency-independent mono and stereo fold-down for mono and stereo listeners.

Also, the transmission of a mode flag is important because future technological developments may reveal future improved decoders, and set designers should have the option of incorporating these improvements into receivers, which should detect the mode being received. However, system standards should be such that a basic 3-channel stereo receiver without mode switching will receive an acceptable if not psychoacoustically ideal, result.

Besides the modes described above, TV transmitting systems may also wish to include other modes, such as 4-speaker stereo, different varieties of horizontal surround sound, and even full-sphere surround-sound. Any system design for HDTV sound should find a way of making all these modes as intercompatible as possible. Such a system design is feasible but requires very careful thought. Certainly, the one approach to avoid is one that assumes a once-and-for-all rigid

## SERIES AVITEL

FOR EXCELLENCE IN VIDEO & AUDIO

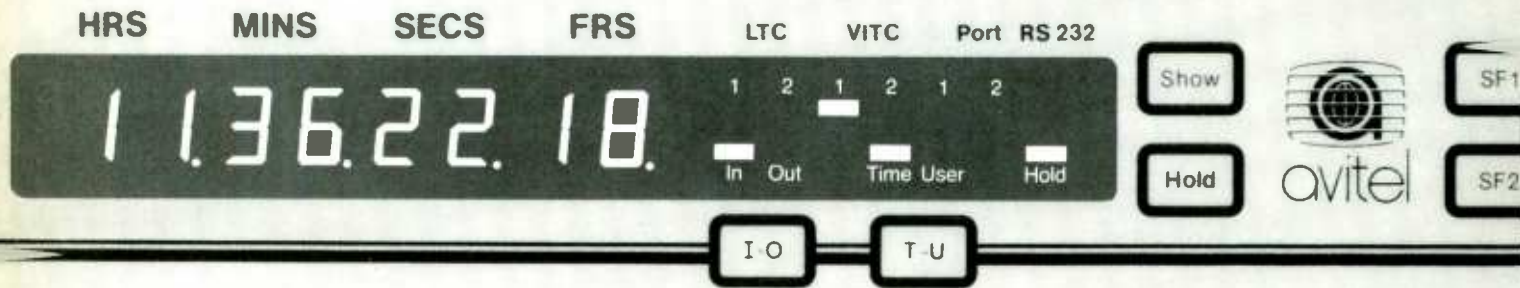

# TIMECODE 'TEN FORTY'

MULTISTANDARD · VITC/LTC · DUAL-READER-GENERATOR · COMPARATOR · TRANSLATOR · INSERTER  
Plus — OFFSETS · MULTI-INTERFACES · MULTIPLE OUTPUTS

The 'Ten Forty' is a new, highly advanced, unique Timecode Reader-Generator-Processor System.

- is elegant in concept, elegant in execution, powerful in resources.
- by exploiting Avitel's extensive Timecode ASIC Technology in combination with multiple processors, the 'Ten Forty' offers a remarkable range of facilities under the control of a sophisticated menu selection system.

Long experience in Timecode, extensive feedback from Users, and significant investment in the latest technologies have combined to produce in the 'Ten Forty' an outstanding, flexible, comprehensive and economical Timecode Processor.

By any standards, it is exceptional to find a Multistandard Reader-Generator with VITC/LTC inputs and outputs, jamming and slaving to either source, translation in either direction and offset capability, in addition to the 'normal' facilities.

The 'Ten Forty' has all of these — TWICE.

This dual channel feature, combined with a comprehensive character generator-inserter, RS232 remote and printer controls, plus uncommitted interfaces and user-definable preset default modes, offer a flexibility of operation quite unique in a single instrument.

And Remote Operation is simple — just detach the Standard Control Panel and extend on a 6-wire Link!

loudspeaker layout since this will limit any future improvements in the art.

## Programme origination

Besides 3-channel panpots, one also needs means of producing 3-channel stereo from non-monophonic sources, including live soundfields. For live soundfields, one possibility is to use spaced mono microphones (as did the experiments at Bell in 1933) panned to positions across the 3-channel stereo stage, eg four microphones might be panned to nominal azimuths at  $\pm 45^\circ$  and  $\pm 15^\circ$  for the panpot law of Fig 1. An ideal 3-channel cannot easily be derived from available coincident microphone arrays but a quite reasonable non-ideal 3-speaker feed signal can be obtained via a suitable  $3 \times 3$  matrix circuit from a soundfield microphone. Where such a very approximate feed is not adequate, a soundfield microphone can be matrixed to give an accurate match to the panpot law of Fig 1 for sounds arriving from a frontal stage but at the expense of an excessive pick-up of sounds from the rear. If it is possible to place a large acoustic absorber behind the soundfield microphone, eg below or above the field of view of an HDTV camera, or disguised behind scenery, then such an accurate matrix might be workable otherwise rear sound pickup is a serious problem.

Two-channel stereo material, such as from sound effects recordings, library music, stereo microphones or commercial music recordings, can be mixed into a 3-channel programme either by restricting it (by means of 3-channel panpots) to a small part of the stereo stage, or by using

suitable  $2 \times 3$  matrix decoders as described earlier. The latter option does tend to give less good image quality than true 3-channel material, and has the problem that it must be made compatible with 3-channel decoding from the 3-channel mixed programme.

An alternative microphone technique can use spaced stereo-pairs of microphones each, panned across a relatively small part of the 3-channel stereo stage. This gives more convincing phantom images than do spaced mono microphones. The use of two or more stereo pairs placed at different locations and mixed into the 3-channel stage might often prove to be a practical means of live stereo pickup for HDTV applications, with 3-channel panpots being used to control the imaging from each pair within the 3-channel stage.

Given the fact that new microphone techniques are still being developed for 2-channel stereo almost 60 years after its initial development, we expect much innovation to occur with 3-channel microphone technique in the future—varying from the development of proper all-in-one 3-channel stereo microphones to quite sophisticated 'matrix' techniques developing the 2-channel MS technique. However, it is not to be expected that the empirical rules-of-thumb for 2-channel stereo mic technique will always work with 3-channel stereo.

The artificial reverberation of 3-channel stereo ideally requires the use of a reverberation unit with three or more appropriately related independent outputs panned across the 3-channel stereo stage. There may be suitable units on the market, eg the Yamaha DSP processor series, and other surround reverb units. Two-channel output reverb units can be used if they are fed into the

three channels by an appropriate  $2 \times 3$  decoding matrix as described earlier but this will in general not give as good results.

## Monitoring and domestic playback

The ideal loudspeaker layout for 3-speaker stereo is of the general form shown in Fig 7, with all three loudspeakers lying on a circle centred at the nominal ideal stereo seat. The equal distance of all speakers from the ideal stereo seat gives maximum phase coherence for phantom imaging, and helps optimise performance away from the stereo seat.

There is no obvious optimum subtended total angle of the loudspeaker layout at the ideally-positioned listener—figures between  $60^\circ$  and  $180^\circ$  have been suggested. Our panpot law of Fig 1 is optimised for good results for any subtended angle up to  $160^\circ$  although image stability degrades as the subtended angle increases, being poor beyond a  $120^\circ$  angle.

For audio applications, there is no need to adopt a rigid standardisation of angle as long as the reproduction method is designed to give good phantom images for the angle used by the listener. For TV applications, however, it is important that sounds from on-screen images should substantially match the position of the visual image. However, for a given loudspeaker layout, it will be possible to incorporate a 3-channel 'width control' adjustment that will allow audible and visible image positions to be matched.

While decoding to three loudspeakers is the

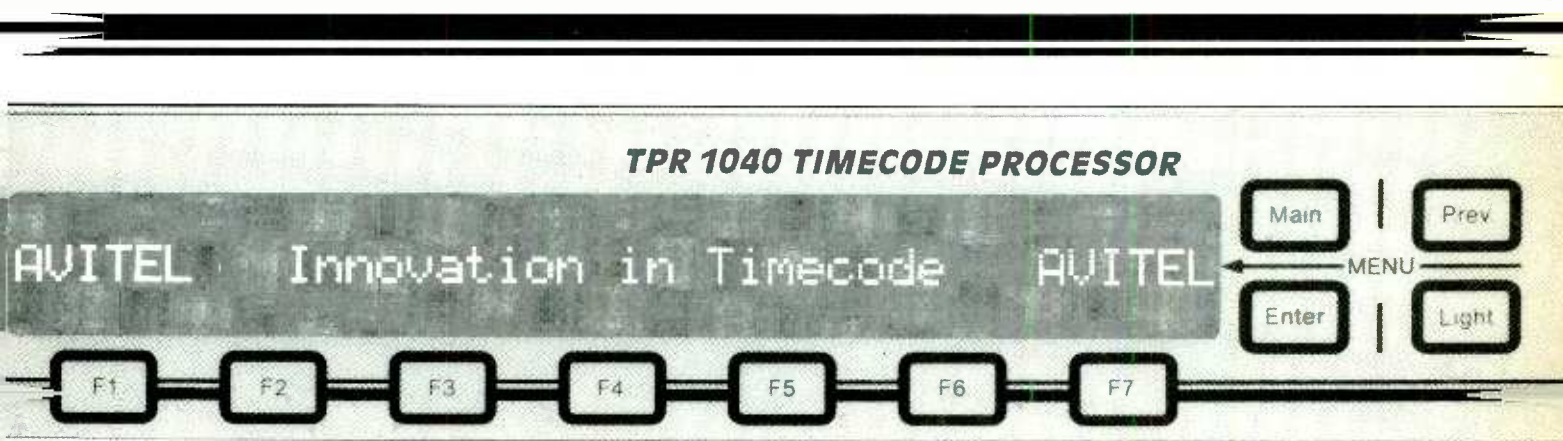

## ... & T R A D.

*Individual Generator and Reader.  
Free-standing and Modular Reader-Inserters.  
Repeater Display.*

Complementing the 'Ten Forty', Avitel's well-established TGE 2040 Generator and TRE 2060 Reader, offer comprehensive facilities for individual applications. For simple video 'burn-in', the Timecode Reader-Inserters in the stand-alone '200' Series and '3200' Modular Series, provide ideal and economical solutions.

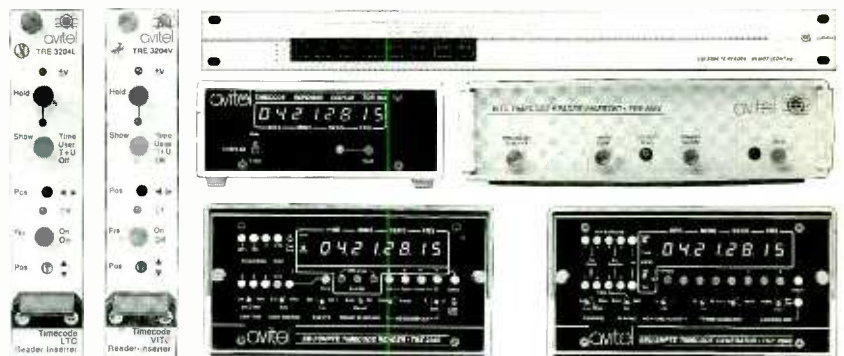

avitel 

UNIT 6 · CROYDON ROAD IND ESTATE · TANNERY CLOSE · BECKENHAM · KENT BR3 4BY · ENGLAND · TEL: 01 656 7027 (INT) + 44.1.656 7027 · TELEX: 894360 AVITEL G · FAX: 01 655 0509

# A Superstar is Born

Introducing a microphone that represents a major breakthrough in performance—the Beta 58. It is the best dynamic microphone **ever** designed for hand-held vocal applications. It incorporates a host of significant advances over **all** currently available live performance microphones:

*Distinctive Shure sound, with smooth presence peak and extended top end. No off-axis coloration.*

*A true supercardioid pickup pattern.*

*Extremely lightweight, yet incredibly rugged.*

*Neodymium magnet gives extra hot output.*

*Absolutely minimal handling noise.*

*Singular immunity to hum.*

It is the microphone to take you to and through the 90's—and beyond.

## **The Shure Beta 58™**

The Sound of the Professionals ---Worldwide®



nominally correct way of reproducing the 3-channel sound, the use of three loudspeakers may not always be practical or desirable. This is because a middle speaker will be either in the middle of the TV screen, or in the middle of a control room window.

Ways round this are either to accept a speaker below or above a picture, with an associated height error, or to use four (or more) loudspeakers. These speakers can involve either a narrow or 'inner' stereo pair and a wide 'outer' one, or can split the central loudspeaker into a 'below-picture' and 'above-picture' pair. In either case, the speakers must be provided with psychoacoustically optimised feeds adapted to the specific layout in use in order to get an optimised image illusion. Naively-chosen speaker feeds will not work well. A number of possible 4-speaker decoders have been devised for use with 3-channel stereo signals.

Although there are several different options for monitoring a 3-channel signal, different monitoring arrangements do sound slightly different, so thought needs to be given either to devising a standardised monitoring arrangement or to understanding the differences between different arrangements, so their effects can be allowed for.

The basic design theory for decoding 3-channel stereo assumes that all speakers are at the same distance from a central listener. If this is not the case, eg if the loudspeakers all lie in a straight line, then the speakers closer to the listener can be fed via a compensating time delay (and also a slight gain reduction) to restore the correct phase coherence of the sounds reaching the stereo seat. Such delay compensation is difficult in analogue systems but is quite easy to implement in systems with digital recording, transmission and signal processing.

In order to design different monitoring and decoding arrangements to meet the widest range of needs, it is important that there be a basic reference method of panning sounds into three channels, such as that of Fig 1. This acts as a reference for evaluating the quality of imaging of different designs. One expects future innovations to discover improved or refined decoders for different speaker layouts but the optimisation of such decoders requires knowing what is to be decoded.

## Surround sound

This article has been primarily about stereo over a frontal stage since the instability of phantom images of 2-speaker stereo is an important defect of existing technology, especially with an associated visual image. However, the extension to the 360° of horizontal surround-sound, to height portrayal, and even to the 4π steradians of full-sphere surround-sound, is also an important issue, which we cannot fully deal with here. The most reliable existing surround-sound technology is that of Ambisonics, which requires the use of three transmission channels for horizontal surround sound and four transmission channels for full-sphere surround-sound<sup>2</sup>.

Such surround-sound is capable of reproducing sounds from every direction while satisfying a variety of psychoacoustic requirements for directional localisation. There is empirical evidence that supplementing such systems with an additional front-centre channel and loudspeaker for large-screen and auditorium applications can be a useful enhancement. Such an enhancement can be done in a way compatible

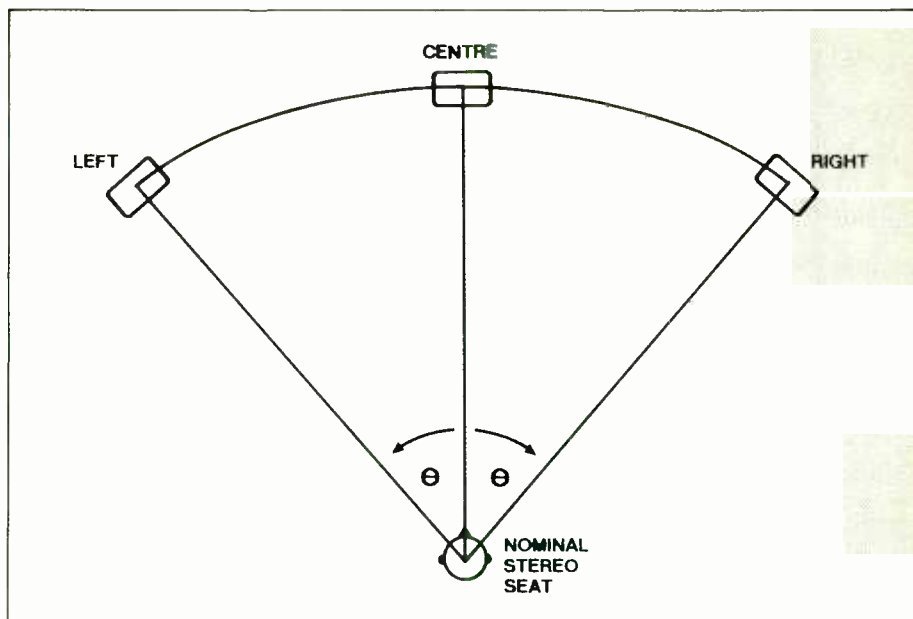

**Fig 7: Three-speaker layout subtending an angle  $2\theta$  at a central listening position. The three loudspeakers should be at the same distance from the nominal stereo seat**

with 3-channel stereo for the frontal sector of directions.

## Conclusions

Three-channel stereo is not simply two sets of stereo pairs (left/centre and centre/right) but properly designed technology using all three speakers and channels together and capable of subjectively enhanced realism as well as the improved stability of central images.

To the writer, one of the big hidden gains of 3-speaker stereo is its lower listening fatigue and artificiality as compared with 2-speaker systems. If properly-designed studio technology is used, the results will not only provide a better match to widescreen TV but offer a superior sound and a more social listening experience for several listeners in a room for audio-only applications.

It is essential that the industry makes the right decisions both about the systems aspects of 3-channel stereo (including mono and 2-channel compatibility) and about the right production technology (notably mixer design and monitoring methods, but also 3-channel mastering formats) to fully realise the potential gains. This would include the potential benefits of using 3-channel mastering as a production format even for 2-channel releases, and the adoption of the same

formats for audio-only and TV applications.

I am preparing a detailed technical report aimed at professional equipment manufacturers and major users that will flesh out the above with much detail, both in general theory and detailed designs and methods, particularly as regards mixers and decoders. However, anyone seriously interested in keeping up with the future of stereo would do well to familiarise themselves with the literature covering work already done over the decades. The history and basic theory of 2- and 3-channel stereo is well covered in a useful compendium of important technical papers<sup>3</sup>. An informed knowledge of the technical foundations of stereophony among audio professionals will help them contribute to the important technical decisions that will determine the future of stereo technology. □

*The author is preparing a detailed technical report on 3-channel stereo, which will be made available to professional audio equipment manufacturers in the audio and video industries.*

### References

- 1 Gerzon M, 'Surround Sound Psychoacoustics', *Wireless World*, December 1974.
- 2 Gerzon M, 'Ambisonics in Multichannel Broadcasting and Video', *JAES*, November 1985.
- 3 *Stereophonic Techniques*, Audio Engineering Society.

## CM SERIES. BROADCASTING-FILM-VIDEO

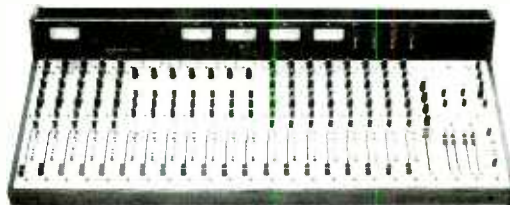

2 and 4 Group Outputs. 3 Standard Frame Sizes

# CHILTON

**CHILTON AUDIO LTD** Chilton Works, 6-8 Wolsey Road, Ashford, Middlesex, TW15 2RB Phone 0784 247124. Fax 0784 240159  
Contact Paul Reps

NOW WITH  
ENHANCED  
AUDIO PERFORMANCE



**ALLEN  
&  
HEATH**

SABER

MAIN AGENTS

**AXIS**  
audio  
SYSTEMS

3 Waterloo Road,  
Stockport, Cheshire SK1 3BD.  
Tel: 061-474 7626  
Fax: 061-474 7619

**Prices from £6699 + VAT**  
Including Stand and Midi Mute  
Processing System  
Finance and Leasing Terms arranged

Please contact AXIS AUDIO SYSTEMS for full colour brochure and/or to arrange demonstration.

With 40 years' experience in the design and manufacture of several hundred thousand transformers we can supply

## AUDIO FREQUENCY TRANSFORMERS OF EVERY TYPE YOU NAME IT! WE MAKE IT!

### OUR RANGE INCLUDES:

Microphone transformers (all types), Microphone Splitter/Combiner transformers, Input and Output transformers. Direct Injection transformers for Guitars, Multi-Secondary output transformers, Bridging transformers, Line transformers, Line transformers to B.T. Isolating Test Specification. Tapped impedance matching transformers, Gramophone Pickup transformers, Audio Mixing Desk transformers (all types), Miniature transformers, Microminiature transformers for PCB mounting, Experimental transformers, Ultra low frequency transformers, Ultra linear and other transformers for Valve Amplifiers up to 500 watts. Inductive Loop transformers. Smoothing Chokes, Filter, Inductors, Amplifiers to 100 volt line transformers (from a few watts up to 1,000 watts), 100 volt line transformers to speakers. Speaker matching transformers (all powers), Column Loudspeakers transformers up to 300 watts or more.

We can design for RECORDING QUALITY, STUDIO QUALITY, HI-FI QUALITY OR P.A. QUALITY. OUR PRICES ARE HIGHLY COMPETITIVE AND WE SUPPLY LARGE OR SMALL QUANTITIES AND EVEN SINGLE TRANSFORMERS.

Many standard types are in stock and normal despatch times are short and sensible.

OUR CLIENTS COVER A LARGE NUMBER OF BROADCASTING AUTHORITIES, MIXING DESK MANUFACTURERS, RECORDING STUDIOS, HI-FI ENTHUSIASTS, BAND GROUPS AND PUBLIC ADDRESS FIRMS. Export is a speciality and we have overseas clients in the COMMONWEALTH, EEC, USA, MIDDLE EAST, etc.

Send for our questionnaire which, when completed, enables us to post quotations by return.

## SOWTER TRANSFORMERS

Manufacturers and Designers

E. A. SOWTER LTD. (Established 1941). Reg. No. England 303990  
The Boat Yard, Cullingham Road, Ipswich IP1 2EG,  
Suffolk. PO Box 36,  
Ipswich IP1 2EL, England.

Phone: 0473 252794 & 0473 219390 - Fax: 0473 236188 - Telex: 987703G

# CLASSIFIEDS

Advertisements for this section must be pre-paid. The rate is 70p+VAT per word, minimum £17.00+VAT. Box Nos. £6.00+VAT. VAT (UK only) \$ rate \$2.00 per word, minimum \$50.00, Box No. \$10.00 extra. Semi-display rates on application. Copy and remittance for advertisements in AUGUST issue must reach these offices by 20th JUNE addressed to: The Advertisement Manager, Studio Sound, Link House, Dingwall Avenue, Croydon CR9 2TA. Cheques made payable to Link House Publications (Croydon) Ltd. Note: Advertisement copy must be clearly printed in block capitals or typewritten.

Replies to Box Nos. should be addressed to the Advertisement Manager, Studio Sound, Link House, Dingwall Avenue, Croydon CR9 2TA, and the Box No. quoted on the outside of the envelope. The district after Box No. indicates its locality. **SEX DISCRIMINATION ACT 1975:** No job advertisement which indicates or can reasonably be understood as indicating an intention to discriminate on grounds of sex (e.g. by inviting applications only from males or only from females) may be accepted, unless (1) the job is for the purpose of a private householder or (2) it is in a business employing less than six persons or (3) it is otherwise excepted from the requirements of the Sex Discrimination Act. A statement must be made at the time the advertisement is placed saying which of the exceptions in the Act is considered to apply.

The attention of advertisers is drawn to "The Business Advertisements (Disclosure) Order 1977", which requires that, from 1st January 1978, all advertisements by persons who seek to sell goods in the course of business must make that fact clear. From the above date consumers therefore should know whether an advertisement relates to a sale by a trader or a private seller.

## SERVICES

### THE COMPLETE SERVICE.....

#### D.I.R.E.C.T.

- Record Pressings
- Cassette Duplication
- Compact Discs
- Post Mastering
- P.Q. Encoding
- Print & Reprographics
- Video Duplication
- Competitive Prices
- Free Quotations

Make it with us  
We make the hits

# SRT

MARKET LEADERS

☎ 01 446 3218 LONDON  
☎ 0480 61880 CAMBRIDGE

## CASSETTE DUPLICATING: GAUSS Loop-Bin / TELEX In-Cassette High Quality Blanks / Label Printing OPEN REEL DUPLICATING (ANY SPEED - ALSO TO BROADCAST SPEC.) SPEECH RECORDING (VOICE-OVERS; LANGUAGES; AUDIO-VISUALS)

### SPEECH-PLUS RECORDINGS LTD.

UNIT 32, NO. 19, PAGES WALK, LONDON SE1 4SB. TEL: 01-231 0961



### TAPELINE

- Blank & Duplicated Cassettes
- Real time cassette duplication
- From 1/4" reel, PCM Beta digital, DAT or cassette masters
- Custom Wound Ferric or Chrome Cassettes
- Labels & Inlays + Shrinkwrapping

Telephone (anytime)  
061-336 5438

High Quality, Low Cost, Express Service  
53-55 CORPORATION ROAD, AUDENSHAW, MANCHESTER M34 5LY

### Leeholme Audio Cassettes

340-344 LEA BRIDGE ROAD, LEYTON, LONDON E10 7LD  
PHONE 01-556 1125 + FAX NO. 01-539 8834

#### THE AUDIO CASSETTE SPECIALISTS

For all your duplicating and blank cassette requirements

- ★ STANDARD AND CHROME TAPE
- ★ CLEAR, BLACK AND COLOURED SHELLS
- ★ ANY LENGTH FROM C3 to C96
- ★ INLAY AND LABEL PRINTING
- ★ RECORDING FACILITIES AVAILABLE

### HIGH SPEED HIGH QUALITY LOOP-BIN DUPLICATING BY SRL TAPE SERVICES

REEL-REEL  
F1 PCM DIGITAL

DOLBY A  
NAB  
IEC

QUALITY CASSETTES

AUDIO CASSETTE

DOLBY C  
DOLBY B

QUALITY CASSETTES

IN...OUT

THE BETTER THE MASTER, THE BETTER THE COPY!  
HOW MANY WOULD YOU LIKE? 100-5000  
01-868 5555 01-866 5555 PHONE FOR PRICE CHECK



### THE CASSETTE DUPLICATING SPECIALISTS

Real time & high speed loop bin duplication, printing & packaging. Blanks wound to length

TEL: 061-973 1884

### jbs records

#### MUSIC-SPEECH-DATA

REAL-TIME/HIGHER-SPEED Quality Cassette  
Duplication and Blanks from 1-1000. Computer printed Labels. Solo, 1/4" reel, Sony Betamax or R-DAT recording. Fast Security Delivery service.

FILTERBOND LTD, jbs records div, FREEPOST  
19 SADLERS WAY, HERTFORD, SG14 2BR 0992-500101

### SOMETHING EVERY STUDIO MUST HAVE!

Tape Deck Console with up to 11 units rack mounting facility.

Fits all popular tape decks and NO RACK MOUNTING KITS ARE NECESSARY. REVOX-TASCAM-FOSTEX (including the 7" Fostex Deck) with Free rack mounting screw kit

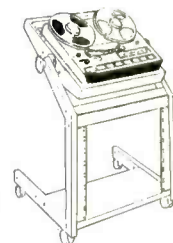

£109.00 PLUS VAT

This product is designed and manufactured by us

**TASCAM** We are a major TASCAM dealer for 4, 8, 16 & 24 track

**STUDIER REVOX**  
SALES • HIRE • SERVICE

**AMPEX** All formats up to 2" from stock at competitive prices

MAIL ORDER ANYWHERE - ACCESS-VISA

**TSP Professional Audio**  
7 HOVE PARK VILLAS  
HOVE, EAST SUSSEX  
BN3 6HP  
TEL: (0273) 822485

LOCKWOOD, TANNOY, etc., new and used equipment always available and wanted. Lockwood Audio Sales 01-866 0671. (X)

### CASSETTE DUPLICATORS

The specialists in the supply and servicing of cassette duplication equipment

SONY TELEX GRAFF TASCAM WOLLENSAK

AIWA Cassette Decks

Bulk Custom Wound Cassettes

AKG BEYER JBL FOSTEX SECK

SCS AUDIO VISUAL LTD BODEN STREET  
CHARD SOMERSET

SCS

TELEPHONE 0460 67237

SCS

If you want cassette copies of the highest quality delivered on time at a price you can afford

Send for Our Brochure

Station House, Station Yard,  
Hinckley, Leicestershire LE10 1UE  
Tel: (0455) 251551

## SERVICES

### FOR ALL YOUR RECORDING NEEDS

AMPEX · BASF · MAXELL · AGFA · JVC  
AUTHORISED NATIONAL AUDIO/VIDEO TAPE DISTRIBUTOR

Spools, boxes, blades, splicing and leader tape. Blank custom wound cassettes C1 120, labels, library cases and cards, C zeros, pancake, etc. Broadcast Cartridges.



12 Britannia Road  
Sale, Cheshire M33 2AA  
Tel: 061-905 1127

FOR QUALITY, PRICE AND SERVICE

### UHER SERVICING

FOR RELIABLE SERVICING OF UHER 4000/4200/4400 BY  
QUALIFIED ENGINEER WITH ALMOST EIGHT YEARS UHER  
SERVICING EXPERIENCE.

CONTACT:

TONIC AUDIO



ACORN WORKSHOPS, HAROLD WILSON IND. EST.  
VAN ROAD, CAERPHILLY, MID-GLAM. CF8 3ED  
TEL: 0222 863906 FAX: 0222 864756



JBL DDA

YAMAHA ESS FOSTEX

Soundcraft QUANTUM ADAMSON-SMITH

RANE Drawtek SENNHEISER

Tel: 0932 566777 · 01-439 8421  
041-357 4306 · Fax: 0932 568989

### STUDIO CONTACT FILE

# AXIS

24 Track Amek Angela.  
C-Mix automation.  
1,200 sq.ft. Live Room.  
Lexicon 480L. Otari 2-track.

Phone **Tim Strickland** on  
**0742 750283**

for further details



2 STUDIOS

LOADS OF K'BDS inc  
FAIRLIGHT 3 Rev. 7  
WITH WORM DRIVE

CHAPPELL 9' -  
THE BEST RECORDING  
PIANO IN LONDON!

HUGE CONTROL ROOM.  
CATERING & BEAUTIFUL  
LOCATION

**PARSIFAL**

Lamb House, Church Street, Chiswick W4 2PD  
Telephone: 01-994 7711/4445

### RECORDING STUDIO WANTED

Looking to buy large package of studio equipment  
for one or more studios. All cash offer —  
also looking for unused pieces — Neve equipment,  
Valve microphones, outboard gear etc.  
Tel: USA (818) 346 9007, ask for Dave

## EAST MIDLANDS AUDIO SERVICES

NEW, USED AND REFURBISHED  
PROFESSIONAL AUDIO EQUIPMENT

2/4, Whitecotes Lane, Chesterfield,  
Derbyshire S40 3HL

Tel: 0246 275479 ★ Fax: 0246 550421

STUDER A62 Stereo, Trolley.....£800.00  
STUDER B62 Stereo, Trolley.....£1,200.00  
STUDER B62 Neopilot, Resolver.....£1,500.00  
STUDER B67 Mk 1, VU, Portable.....£1,800.00  
STUDER B67 Mk 1, Trolley.....£1,400.00  
STUDER A80 Mk 1, 7.5/15IPS.....£2,500.00  
STUDER A80 RC Mk 1, VU.....£3,000.00  
STUDER A810 Mk 2 15/30IPS.....£4,500.00  
STUDER A80 Mk 1 16 track.....£4,300.00  
REVOX PR99 Mk 3 HS NEW.....£1,850.00  
REVOX PR99 Mk 2 HS.....£1,200.00  
REVOX B77 Mk 2 LEC NEW.....£1,300.00

## FOR SALE

## RECORDING STUDIO PREMISES FOR SALE

Superb ex-bank premises.

Very secure with many original fittings  
(marble/parquet floors, mahogany panels  
and doors plus strongroom).

Private composers studio at present.  
Ground floor double-door access.

Good parking, public transport and taxis,  
wine bars and restaurants.

3 ft thick walls mean no noise problems.

FREEHOLD INCLUDES:

3 Bed, 1 recep. mews maisonette with  
separate entrance (tenanted). 5 mins  
Chelsea Bridge, 15 mins West End

**£195,000 FREEHOLD**

Ring **Tim Fraser**

**081-948 4400**

## PRO AUDIO WIRING SERVICES LTD

Cornerways  
West Cottages  
Yapton  
Arundel  
West Sussex  
BN18 0DX UK

Design, supply and installation of sound reinforcement, CCTV,  
paging/communications and A/V systems in the UK and  
Northern Europe

Contact **Bob Stokoe** on **0243 552340** (24 hour answering)

## NEVE DIGITAL SOUND DESK

Applications include CD mastering and signal processing  
within the digital domain.

Technical specifications:

44.1 kHz sampling

Inputs: 4 channels digital Sony 701/Betamax or AES/EBU 2 channels  
line level analogue with A/D converters

Outputs: Sony 701/Betamax plus 2 line level analogue

All switchable between stereo, mono L + R, L to both, R to both.

Equalisation: Bass, treble, shelving plus 2 mid lift and cut. +12 dB,  
-24 dB bass roll off 25 Hz-280 Hz, treble roll off 5 kHz-16 kHz 12/24 dB  
oct.

Dynamics: Limiter, Compressor, Expander, Noise gate delay  
0.02-2 msec's

Notch filter selectable in 1 Hz steps 25-200 Hz, 5 Hz steps 200 Hz-1 kHz,  
50 Hz steps 2-15 kHz

7 step L.U. generator 40 Hz-15 kHz plus SLATE

Offers in five figures are invited.

Further details available from **Crispin Jewitt** on **071-589 6603**.



# MIDAS

## TECHNICAL SALES PERSON

KLARK-TEKNIK are leading designers and manufacturers of professional audio equipment used throughout the world.

We now require a Technical Sales Person for MIDAS XL Live Performance Consoles.

The successful applicant will organise the internal support and scheduling of MIDAS products as well as international travel for direct sales and support of MIDAS worldwide distribution network. Applicants will have appropriate experience in Live Sound and Installation work and a thorough Technical understanding of Professional Audio Systems.

The position provides a salary commensurate with a challenging, responsible position and an attractive package including a company car.

Applicants should apply in writing enclosing full CV to:



Peter Tongue  
International Sales Manager  
KLARK-TEKNIK RESEARCH LTD  
Klark Industrial Park  
Walter Nash Road  
Kidderminster  
Worcs  
DY11 7HJ

# Projects Engineering Manager

Customised Products £23-£25K + Car

Part of the most dynamic group of companies in the broadcast industry, my client is involved in the design and manufacture of advanced technology equipment for the pro-audio, broadcast, film and video post production markets.

Undisputed world leaders in their field, they now seek an experienced manager to assume responsibility for the projects engineering team. A key role in ensuring that products are delivered to specification and timescale, this will involve extensive interaction with sales, manufacturing and engineering departments internally, and with customers located throughout the world.

Ideally educated to degree level, you will be a competent team leader and will possess well developed communications, planning and organisational skills. Your experience will have been gained in a projects, systems or technical services environment, and an interest in audio is particularly relevant.

This is a significant career opportunity and the position carries a comprehensive benefits package which includes company car, pension and life assurance scheme. Relocation assistance will be provided where appropriate.

Interested?

Please telephone or write to Mike Jones,  
Broadcast Professionals, Unit 9b, Intec 2,  
Wade Road, Basingstoke, Hants. RG24 0NE.  
Tel. (0256) 470704.



**Broadcast Professionals**

The Broadcast Division of Professional & Technical Appointments

# BOB TURNER

## PRO SOUND & VISION SALES

1 SEAHILL ROAD  
SAUGHALL, CHESTER  
CHESHIRE CH1 6BJ  
Tel: Chester (0244) 881708  
Fax No: 0244 880538

### NEW IN STOCK

All Prices are Exclusive of VAT	
ART SGE (20K 20 Bit) Digital Analogue Effects Processor .....	£425.00
ART EXT Reverb Multi Effects Sampler .....	£445.00
ART Multiverb 11 .....	£325.00
BSS DPR 504 Quad Gate .....	£585.00
BSS DPR 502 Midi Stereo Gate .....	£585.00
BSS DPR 416 4 CH Active D.I. Box .....	£395.00
BSS DPR 402 Stereo Comp/Lim/Exp/Gate/De-Esser .....	£658.00
JBL/Urei 7110 Comp. Limiter .....	£420.00
JBL Control 10 Studio Monitors .....	£666.00
Adam Smith Zeta 3 2 Machine Synchronizer .....	£2850.00
Valley People Range .....	P.O.A.
Fostex E22 1/2" 2 TRK Master Recorder with Centre Time Code .....	£2250.00
Fostex E16 16 TRK .....	£3150.00
Fostex 4050 SMP2 Midi Autoclaver .....	£600.00
TC Electronics 2290 8 secs Sampler/Delay .....	£2451.00
TC Electronics 1128 Programmable, SMPT, MIDI, Pink Noise, EQ and Spectrum Analyzer .....	£1795.00
TC Electronics 1280 Stereo Delay .....	£1025.00
TC Electronics 1380 Multitap Delay .....	£1025.00
TC Electronics 2240 Stereo 4 Band Parametric EQ .....	£576.00
TC Electronics 1140 Mono 4 Band Parametric EQ .....	£343.00
TC Electronics 1144 Bass Guitar Parametric Pre-amp .....	£343.00
TC Electronics 1210 Spatial Expander .....	£736.00
Seck 24.2 Desk .....	£650.00
Seck 18.8.2 Desk .....	£900.00
Tascam M3500 32 Incline Console including stand .....	£5500.00
Tascam MSR24 24 TRK Recorder with DBX .....	£8395.00
Revox & Studer (depending on model & spec) please ring for price!	
Also in stock ... Carver, JBL, Amcron & Denon Amps	

### EX-DEMO/SECOND HAND

Studer 820 + Dolby SR 24 TRK .....	£40,000.00
Studer A80 8 TRK (V.G.C.) .....	£1750.00
Studer B67 in console (mint) .....	£2300.00
Studer B62 in console (mint) .....	£1100.00
Studer A80 16 TRK MK1 .....	£5650.00
Revox B77 MK11 H/S (mint) .....	£725.00
Revox B77 MK11 H/S (domestic use only ... as new) .....	£900.00
Fostex E8 8 TRK .....	£195.00
Fostex B16 + Autolocate .....	£2100.00

Fostex E16 + Autolocate .....	£2900.00
Fostex Model 80 (8 TRK) .....	£695.00
Diari 1" 8 TRK + Autolocator .....	£1200.00
Soundtracs PC MIDI 24 Inline Desk, Effects Returns, 56 Line Returns (3 months old) .....	£4650.00
Ram Micro 12.8.2 Desk (mint) .....	£700.00
Soundcraft 1600 24.16.2 Console .....	£5500.00
TC Electronics 2290 64 secs .....	£3600.00
Digitech Smart Shift .....	£550.00
Digitech DSP 256 Reverb .....	£425.00
Digitech DSP 128 Reverb .....	£140.00
Lexicon 200 .....	£1295.00
Yamaha Rev 5 .....	£575.00
DBX 160X .....	£300.00
Aphex Compellor .....	£650.00
Aphex Dominator .....	£750.00
Eventide H3000 Ultra Harmonizer .....	£1775.00
Eventide SP2016 .....	£2950.00
Drawmer DS201 Gate .....	£245.00
Drawmer 221 Comp .....	£250.00
Drawmer LXPI Comp .....	£195.00
Drawmer 1960 Stereo Valve/Comp .....	£650.00
Drawmer M500 Stereo/Comp/Lim/Exp/De-Esser .....	£600.00
Urei 1178 Stereo Limiter .....	£950.00
BTX 4500 Synchronizer .....	£500.00
Kor STD Digital Delay .....	£295.00
Amcron DC300A MK 11 Amp .....	£400.00
Westlake HBSM12 Monitors in Stands (mint) .....	£2495.00
Court SN30 Monitors .....	£1100.00
Nueman SM2 Stereo Valve mic .....	£1250.00

Various other microphones in stock, Sennheiser, B & K, Shure, Fostex etc ...  
Also ... Stand Easy pods for outboard etc.

We specialise in installation from home studios to Radio Stations

Some Clients this year ...

Vector T.V., Brookside Productions, M.T.V., World Action Sports, Pearl Studios, Eden Studios, Rockfield Studios, Sain Studios, Square One ...

For further information contact:

TEL. Chester (0244) 891708

FAX. Chester (0244) 880538

1 Seahill Rd., Saughall, Chester, Cheshire, CH1 6BJ, U.K.

**FOR SALE**

**OTARI MTR 90**

Mk1, 16-track, pre-wired for 24-track, with remote. Good condition, studio use only. Heads re-lapped once.  
 Also MTR 10 1/4" 2-track with centre-track time-code and conversion kit for 1/2" 4-track, operation in console with 4 VU meter-bridge.  
 £11,450 the pair, will split.  
**Phone 071-379 3435, extension 245.**

**WANTED! NEVE EQUIPMENT**

OF ALL TYPES. WE BUY AND SELL VALVE MICROPHONES, OUTBOARD GEAR AND CONSOLES.  
**Dan Alexander Audio**  
 2944 San Pablo, Berkeley, CA 94702, USA  
 Tel: (415) 644-2363  
 Fax: (415) 644-1848

**QUALITY CASSETTE MASTERING AND COPYING**, any quantity. Video duplication PAL/NTSC/SECAM transfers. 24 hour, seven days a week service. G.W.B.B. Audiovision, 42 Lancaster Gate, London W2 2NA. Tel: 01-723 5190.

**THE COMPLETE SERVICE.** Disc cutting, pressings, duplicated cassettes and blanks. Bin Masters. Location Recording. Free Brochure. Tam Studio, 13a Hamilton Way, London N3 1AN. Tel: 01-346 0033. (X)

**DISC CUTTING EQUIPMENT** and systems bought, sold, installed and manufactured by TAM/ENGLAND, 13a Hamilton Way, London N3 1AN. Telephone: 01-346 0033.

**TASCAM/SENN/BEYER**, trade counter. Erricks VCD, Brighouse 722121. (X)

**STUDER B67** 1/4" master in console, Vu bridge, cutter, perfect condition (almost unused). Reasonable offers considered. Tel: 0273 774420 (ask for George).

**APEX** on body cassette printer CA15. £5,750 o.n.o. + VAT. Tel: 0734 302600.

**THE MUSIC SUITE** — High quality, realtime cassette duplication from DAT, PCM F1, reel-to-reel or cassette masters. Also hard-disk digital editing. Tel: (0239) 711032.

**ITC DELTA NAB CARTRIDGE** stereo recorder/reproducer set £995 + VAT. Also ITC Premium Line mono model RP with 4 model SP reproducers £1,800 + VAT for the 5 machines. All units in superb condition having been carefully used for production only. Tel: 081-888 1909.



**CIRCULATION DETAILS**

STUDIO SOUND is available without charge to key personnel actively engaged in sound recording in any part of the world. Copies must be individually requested. Non-qualifying readers will be notified in writing and invited to take out a subscription (see below for details)

**NEW READER ENQUIRIES:** Link House Publications plc, Link House, Dingwall Avenue, Croydon CR9 2TA, UK. Tel: 081-686 2599

**EXISTING READER ENQUIRIES:**  
 Circulation Dept. Studio Sound, Link House Magazines Ltd, Central House, 27 Park Street, Croydon CR0 1YD, UK.  
 \*Changes of address should be notified in writing to this address and the label containing the old address and reference number should be enclosed to ensure accuracy.

**SUBSCRIPTION ENQUIRIES:** Subscription Dept. Studio Sound, Link House Magazines Ltd, 120-126 Lavender Avenue, Mitcham, Surrey CR4 3HP, UK.

The cost of an annual subscription to Studio Sound is UK: £24.00  
 Overseas surface mail: £30.50 US\$52  
 Overseas air mail: £32.50 US\$58.99  
 USA airspeeded delivery \$70

The publishers reserve the right to refuse applications considered inappropriate and restrict the number of free copies sent to any one company or organisation.

**SITUATIONS VACANT**

International Japanese musical instrument manufacturer seeks software writer to develop large scale project. The successful applicant will have had experience in audio or music products and will be proficient in 8086 Assembler language with experience of embedded microprocessors. Experience with 'C' will also be an advantage. The job will initially involve working from home, preferably within easy distance from London. An excellent salary is offered for this challenging position.

Apply PO Box

**ADVERTISERS INDEX**

ACO Pacific Inc.....	102	Lester Audio.....	8
AD Systems.....	88	Media Products Ltd.....	8
ADT.....	9	MM Technology.....	101
Akai.....	10, 11, 53	MS Audio.....	108
AKG.....	31	Munro Associates.....	69
Allen & Heath Ltd.....	86	New England Digital.....	27
Amek Ltd.....	99	Northern Audio.....	119
Ampex (UK).....	50	Otari.....	57, 78, 79
AMP Sound.....	93	Palm Audio Systems.....	85
AMS Industries plc.....	13, 25	PD Audio.....	110
ANT Bosch.....	91	Plasmec Systems.....	83
Apogee.....	103	Pro Audio Asia.....	65
APRS.....	101	Quested Monitoring Systems.....	18, 19
Audio Kinetics.....	55	Rane Corporation.....	72
Audio Marketing Group.....	101	Raper & Wayman.....	65
Audio One.....	24	RTS Telex.....	71
Audio Precision.....	12	RTW.....	33
Autograph Sales Ltd.....	66	Rycote Microphone.....	102
Avitel.....	14, 15, 122, 123	Saki Magnetics.....	92
Axia Audio Systems.....	126	Saturn Research.....	IBC
BGW Systems Inc.....	63	Shure Bros.....	124
Bowright.....	29	Sifam.....	33, 105
Bruel & Kjaer.....	95	Solid State Logic.....	35, 37, 39
Canadian Instruments.....	89	Sony Broadcast.....	42, 43
Canford Audio.....	95	Soundcraft Electronics.....	IFC
Chilton Audio.....	125	Soundtracs plc.....	59
Citronic Ltd.....	100	Sowter Ltd.....	126
Curtis & Welles.....	102	SSE Marketing.....	20
DACS.....	65	Michael Stevens.....	75
DB Engineering.....	110	Stevens & Billington.....	24
Digital Audio Research Ltd.....	96	Studio House Audio.....	75
Dolby Laboratories Inc.....	49	Studio Magnetics.....	103
Philip Drake Electronics.....	105	Studiomaster.....	16
Draowner Distribution.....	51	Studio Spares.....	111
Dreamhire.....	100	Summit Audio.....	87
D&R Electronics.....	113	Surrey Electronics.....	48
Eardley Electronics.....	6, 7	Symetrix.....	110
FWO Bauch Ltd.....	23, OBC	Tannoy.....	61
Genelec.....	80	TC Electronic.....	82
Hardware House.....	8	Teac UK Ltd.....	46, 47
Hayden Pro Audio.....	17	Thatched Cottage Audio.....	115
Hilton Sound.....	41	Thompson.....	106, 107
Home Service Ltd.....	70	Total Systems.....	29
JBL.....	45, 116	Trident Audio.....	77
KGM Studio Specialists.....	93	Turbosound.....	4
Klark Teknik Research.....	52	Yamaha.....	29, 83
Larking Studio Furniture.....	121		
Lionardo Software.....	30		

Studio Sound is available without charge to qualified readers: these are key personnel actively engaged in sound recording in any part of the world. The Publisher reserves the right to refuse applications considered inappropriate and restrict the number of free copies sent to any one company or organisation. Non-qualifying readers can buy Studio Sound at an annual subscription of £24.00. Published by the proprietors Link House Magazines Limited, Link House, Dingwall Avenue, Croydon CR9 2TA and printed by Lawrence-Allen (Colour Printers) Ltd., Gloucester Street, Weston-super-Mare, Avon BS23 1TB.



# SATURN FACT FILE

## 2.

### AUTO ALIGN

*The Saturn 824  
Auto-Alignment system  
calibrates Bias, Record Gain,  
Record HF, LF, and Phase  
Compensation.*

*Fully automatically.*

*For 24 Tracks.*

*In less than 10 minutes.*



**SATURN**  
RESEARCH

Saturn Research Ltd. Unit 3A, 6-24 Southgate Road, London N1 3JJ. Tel: 071 923 1892 Fax: 071 241 3644

# SPOILT FOR CHOICE

Choosing between Studer's A820 and A827 multitrack machines is not easy.

True, the A820 is the flagship model and the A827 has been produced as a cost-effective solution, but fundamentally they are very similar. Both have the ultra fast proven tape transport with 14" reel capacity giving the highest spooling speeds (up to 15m/s or 590ips) for 24, 16 and 8 track tapes. Both feature the same microprocessor controlled DC capstan motor for standard 7 1/2/15/30ips, with reverse play and varispeed functions, and both incorporate the same comprehensive interfaces for the tape deck and audio peripherals.

## The Features

### A820 - The Flagship Model

- Integration of Dolby A/SR noise reduction system
- Full automatic alignment of audio parameters including noise reduction
- Bar graph metering PPM/VU with a resolution in alignment mode of 1db per segment

### A827 - The Cost-Effective Model

- Optional integration of TLS4000 Synchroniser with local control panel
- Permanent sync output per channel for triggering noise gates etc.
- Microprocessor controlled audio alignment (MDAC)

Whatever decision is made, it will not have been easy. Such is the luxury of being 'Spoilt for Choice'.

## STUDER REVOX

STUDER INTERNATIONAL AG Regensdorf Telephone (411) 8402960  
STUDER REVOX AMERICA INC Nashville Telephone (615) 254-5651  
STUDER FRANCE S.A.R.L. Paris Telephone (1)4533 5858  
STUDER REVOX CANADA LTD Toronto Telephone (416) 423-2831

**BAUCH**  
*Solutions*

F. W. O. Bauch Limited  
49 Theobald Street, Boreham Wood, Herts WD6 4RZ  
Tel: 081-953 0091 Fax: 081-207 5970