

June 1987

£1.50

# STUDIO SOUND

AND BROADCAST ENGINEERING

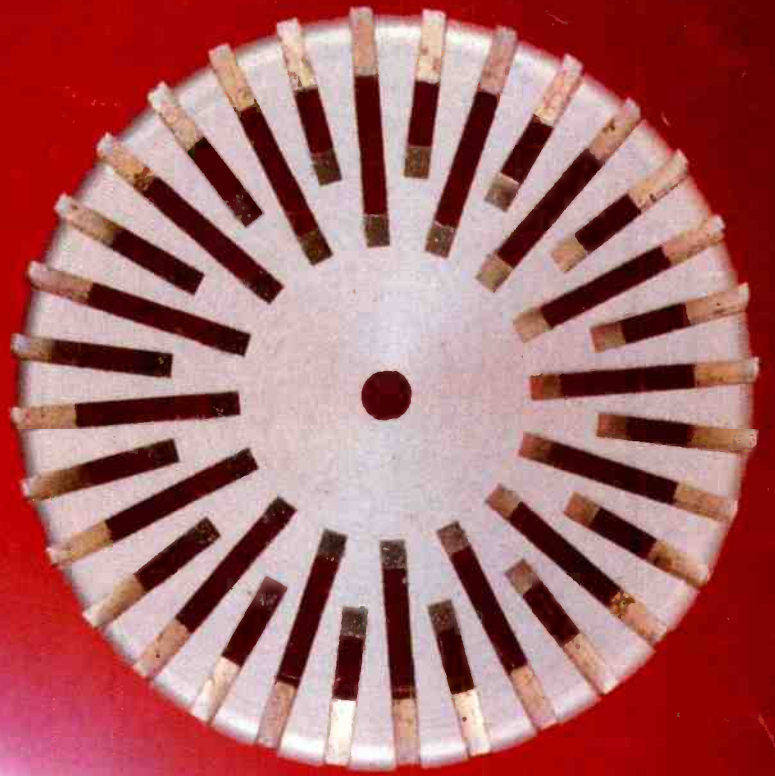

## MICROPHONES





This machine is a major advance in analogue multitrack recorders.

It took five designers three years to develop it. A multitrack to match or beat Studer and Otari machines. But with many powerful, exclusive new innovations.

Tape handling is probably the most important function of any machine

The Saturn's unique 'COLT' (Calculated Open Loop Tension) transport handles tape like no other multitrack using computer-linked motion sensors and bi-directional heavy-duty spool motors.



## DESIGNED TO COMPETE WITH THE BEST IN THE WORLD.

Conventional closed loop systems rely on the critical alignments of mechanical tension arms. COLT replaces them with more accurate and reliable electronic calculations. The result is virtually constant tape tension through all modes from end to end of the tape.

The tape is always brought to play speed before the pinch roller is engaged, and the pinch roller/capstan system ensures "extraordinarily low wow and flutter," (Sound Engineer and Producer November 1986) with rapid acceleration and high wind speeds. In short, precision tape handling that's as smooth as it is fast.

It also reflects the no-compromise long-term reliability we've built in at all stages.

The audio electronics have a response that's virtually flat to 27kHz, and a superb S/N ratio. Allied to Dolby SR, this new analogue purity means performance to beat 16-bit digital.

Even from the mix position, Saturn looks way ahead. The revolutionary Total Remote console stores all auto-alignment parameters, a major benefit in any busy studio.

It also provides digital control over every function, allowing cueing and editing with great accuracy.

Among its facilities are three fully programmable function keys, four monitor status memories and a sophisticated record/rehearse system. And much more.

It's time to take a look at a major new name in professional multitrack

The Soundcraft Saturn.

- 5 Editorial:** Keith Spencer-Allen on the possible demise of microphone technique
- 12 General news:** People... Address changes... Stolen equipment... Literature received... Software update... Addendum... Erratum... The Syn-Aud-Con approach... In brief... Agencies... Contracts... Obituary
- 16 Product news:** Neotek Elan and MIDI Direct... Studio Technologies mic preamplifier... Aries Performance console... Wireworks CX cable... Canford Audio jack cleaner... In brief... AKG C522 ENG microphone... Beyer MCE10 mic... Q-max 600... Samson TD series wireless mic... DDA updates... Digitrans hw 870... Stirling/ITA overbridge... BSS MSR-604 mic splitter... CEM DPE equaliser
- 22 Music news:** Hybrid Arts... Korg DS-8... RSF SD140 drum machine... Bacchus software... Oberheim DPX-1
- 28 Good Earth:** Janet Angus charts the ups and downs of Tony Visconti's London studio
- 32 Microphones:** A short guide to mics introduced since January 1986
- 36 Electrostatic pressure transducers:** Jorg Wuttke on the theory and application of Schoeps boundary layer mics
- 42 The Studio:** Following on from *The Trial* and *The Castle*, Jack Field's vignette raises some thought-provoking questions
- 50 Royal opera on tour:** Insider David Mellor deals the sound in the Far East

# CONTENTS

- 56 MS technique:** The two sides of stereo recording theory explained by Mike Skeet
- 58 Letters:** Put levy on recorded media... Digital recording in Scandinavia... Originals are best... Add more tracks
- 60 Perspective:** US correspondent Martin Polon goes underground in search for the truth about R-DAT
- 64 Business:** Barry Fox looks at a possible alternative to R-DAT, DAT on sale in Japan, and explains the dangers of factoids
- 70 Review:** The Jecklin disc dummy recording head is examined by Dave Foister
- 72 Review:** Hugh Ford evaluates from Sennheiser, Beyer and Milab
- 82 Review:** Neil Grant on Westlake's BBSM-12 direct radiating monitors



See page 32

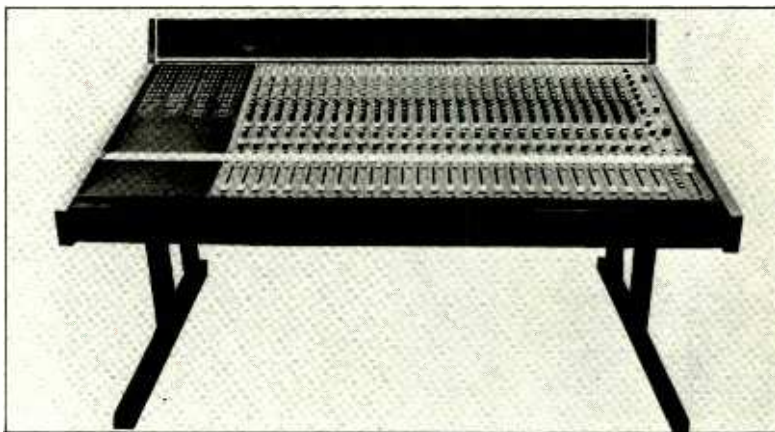

See page 16

## EDITORIAL

**Editor:**  
Keith Spencer-Allen  
**Deputy Editor:**  
Carl Anthony Snape  
**Staff Writer:**  
Jonathan Kaye  
**Production Editor:**  
Ann Horan  
**Production Assistant:**  
Carrie Love  
**US Commentator:**  
Martin Polon  
**Secretary:**  
Cecilia Farrelly

**Cover:** Beyer MPC-60 directional boundary mic and Bruel & Kjaer phase grid from 4000 series mic. Photography by Roger Phillips

## ADVERTISEMENTS

**Sales Manager:**  
Mark Walsh  
**Display Sales:**  
Damian Dowling  
**Secretary:**  
Jane Everist  
**Production Manager:**  
Jacky Pearce

**Japan and Far East Agent:**  
Media Sales Japan Inc, Tamuracho  
Bldg 3 3 14, Shimbashi Minato-Ku  
Tokyo, Japan  
**USA Agent:** Joe Statuto, Rt 1, Box  
40A, Montague, TX 76251, USA.  
Tel: (817) 894-6923.

**Commercial Manager:**  
Phil Guy  
**Director:**  
Douglas G Shuard



Editorial and advertising offices:  
LINK HOUSE, DINGWALL  
AVENUE, CROYDON CR9 2TA,  
GREAT BRITAIN  
Phone: 01-686 2599  
International: +44 1 686 2599  
Telex: 947709  
E-mail: 78:DGS1071  
IMC: STUDIOSOUND-UK/US  
Fax: 01-760 0973  
© Link House Publications  
PLC 1987. All rights reserved.



A LINK HOUSE  
PUBLICATION

Publisher and consultant to  
APRS for Studio Sound's  
Producer's Guide to APRS  
Members 1984/85

June 1987                      Number 6  
Volume 29                      ISSN 0144-5944



# THE ADVANTAGES OF A STUDIO CONDENSER WITHOUT A SOUND OF ITS OWN



For all of its virtues, the typical studio condenser imparts a definite character to any recording. These impositions are often considered inevitable technical imperfections: accepted, ignored or tolerated by audio engineers.

Characteristic anomalies of condenser performance such as exaggerated high end response or distortion have even been rationalized as compensation for the high frequency losses inherent in typical analog formats. Nowadays, however, they are increasingly viewed as unnecessary intrusions in critical analog and digital recording situations.

**A Condenser For The Digital Era: The Difference is Nothing.** The increased dynamic range of digital recording is perfectly complemented by the self-effacing nature of the MC 740. The microphone is virtually inaudible. No coloration, no self-noise — no sonic footprint, not even a fingerprint. All

five of its pickup patterns are equally uniform, identically transparent. We feel your prior experience with large diaphragm condensers will confirm this as a unique achievement.

**An Atypical Approach To Condenser Sound.** Beyer has never relied on conventional technical solutions. A manifestation of this kind of thinking, the MC 740 eliminates the icy, strident quality typical of most condensers to reproduce voices and instruments with warmth and intimacy. It's no coincidence that these are characteristics often ascribed to our ribbon microphones.

The MC 740's freedom from exaggerated sibilance or graininess and its greatly reduced distortion are immediately apparent to critical listeners. European and American engineers have already commented on the startling accuracy of the 740, and the way it reveals the subtle differences between instru-

ments and ambient environments.

**Accuracy And Versatility Without Compromise.** Uniform (<2 dB: from actual machine specs, not just published specs) frequency response curves for all five polar patterns may seem a remarkable breakthrough. To Beyer, this is simply a design criterion for the microphone. Similarly, there is no contradiction in the fact that the 740 is exceptionally sensitive, yet also withstands extreme SPLs (up to 144 dB with the 10 dB attenuator in circuit).

**Hear What You Could Be Missing.** The MC 740's unconventional design offers a clear alternative. The best way to evaluate the difference the MC 740 can make is to work with it in your studio. To arrange a hands-on audition of this remarkable new audio instrument, contact your Beyer dealer or write to us: Beyer Dynamic (GB) Ltd., Unit 14, Cliffe Industrial Estate, Lewes, East Sussex BN8 6JL.

## ACCURACY IN AUDIO

**Canada:** ELNOVA 4190 rue Sere, St. Laurent, Quebec H4T 1A6  
Tel. (514) 3 41 69 33 Telex: 5824086  
**Australia:** Rank Electronics Pty. Ltd., 16 Suakin Street, P.O. Box 42  
Pymble N.S.W. 2073 Tel: (2) 4 49 56 66 Telex: 71289

**Great Britain:** beyerdynamic Ltd., Unit 14, Cliffe Industrial Estate  
Lewes, Sussex BN8 6JL Tel: 0273-479411

**Germany:** Eugen Beyer Elektrotechnische Fabrik GmbH & Co., Theresienstrasse 8,  
Postfach 13 20, D-7100 Heilbronn Tel: (07131) 617-0 Telex: 728771

**beyerdynamic**



**T**here is a fairly common view being expressed these days that with an increasing amount of available processing equipment expected to be mastered by the sound engineer (certainly in popular music), a solid knowledge of microphone technique has been displaced as a fundamental component of the profession. Not only is the ability to successfully manipulate the 'knobs' seen as a more desirable asset for the engineer but also samplers, MIDI systems, console automation systems and synthesiser programming which comprise this new aspect of the engineer's job have actually reduced the need for microphones themselves. I think that in many cases this is quite true. I have engineer colleagues that have to refer back to the booking book to find the last time they had more than three musicians in, playing together, using microphones. Now this is certainly not a universal condition but it is fairly well spread in the major recording capitals. Many of those who have seen this change in attitude to microphones have expressed most concern over the future of the accumulated knowledge of the use of mics themselves. If you are not using a specific ability then you tend to lose it—and this is what some people fear. Unfortunately such technique has to be practised—just reading a book is not enough as the multiple modifications to placement and mic choice that are made in a given instance are based upon judgement at the time and just cannot be quantified in print.

To some, the question is fairly simple: is the passing of mic technique to a lower status within the engineer's arsenal of techniques and knowledge to be regretted or not? I have a personal interest in microphones and techniques and so from my point of view it is. But if we look at the development of sound recording then perhaps it is what might have been predicted.

Many years ago when equipment was primitive and the engineer was truly an 'engineer', building equipment and nursing other items through sessions because they were just not reliable, the role of the engineer was quite different; he had his work cut out just handling the equipment. At the same time recording techniques evolved that made the best of the available equipment. For example, the art of disc cutting developed to a very high degree, and quickly, when it was the only effective recording medium. The transition to magnetic tape meant that although a knowledge of disc cutting was of benefit for the recording engineer it was no longer a fundamental part of his job. If CD and cassettes continue to replace the vinyl disc as they are at present then a knowledge of vinyl cutting will become even more redundant. If, then, we look at microphones as just a way of capturing sound and not as a cog around which all other aspects of recording revolve, then their replacement with other techniques is quite predictable because the results of using microphones are not so predictable—that is there are so many variables in mic use that the 100% guarantee of success does not exist. In some eyes this means that, like unreliable equipment, the unpredictable areas and problems must be removed to make the recording process a far more logical process. Unfortunately such an attitude also shows in the music it records.

# EDITORIAL

I would at this point like to say that although the above is definitely happening it is not as widespread as some would have us believe. Microphones are still very popular but now they are not the only way to capture sound. In fact there are far more things happening in the area of mics right now than at almost any time I can remember. I have found tremendous interest in stereo mic techniques, particularly in MS; omnidirectional microphones are experiencing a resurgence of interest for uses as diverse as live sound to multitrack despite all the long held belief that directional types were the only way. We have several new types of mic using boundary type approaches, stereo handhelds and subminiature types. The time has never been better for choice and the freedom to experiment.

All I can really say in summary is that we are going/have been through a change of attitude to mics and their place, and as long as we see it in this way, the recording process will just be stronger.

Keith Spencer-Allen

**STUDIO  
SOUND**

AND BROADCAST ENGINEERING

STUDIO SOUND is published on the second Friday of the preceding month. The magazine is available on a rigidly controlled requested

basis only to qualified personnel (see back page for terms) or for an annual cost of **£18.00 UK, £24.50** overseas surface mail or **£46.50** overseas airmail to non-qualifying readers or where more than two copies are required in a studio or small organisation.

**Circulation enquiries.**

**New readers:** Link House Publications plc, Link House, Dingwall Avenue, Croydon CR9 2TA, UK. Tel: 01-686 2599.

**Free subscriptions:** Controlled

Circulation Dept, Studio Sound, Link House Magazines Ltd, Central House, 27 Park Street, Croydon CR0 1YD, UK. Tel: 01-760 0054.

**Paid subscriptions:** Subscription Dept, Studio Sound, Link House Magazines Ltd, 120-126 Lavender Avenue, Mitcham, Surrey CR4 3HP, UK.

**US mailing agents:** Postmaster please send address corrections to Studio Sound, c/o Expeditors of the Printed Word Ltd, 515 Madison

Avenue, New York, NY 10022. Total average net circulation of **14,686** per issue during 1985 UK: **6,094**. Overseas: **8,592**. (ABC audited).

Studio Sound and Broadcast Engineering incorporates Sound International and Beat Instrumental. Printed in England.



MEMBER OF THE A.B.C.

# TRAD

FOR SALE	£	FOR SALE	£
AMEK 2000 24 INPUT 16 MONITOR	£1500.00	DOLBY A360 NOISE REDUCTION UNITS	EACH £375.00
AMEK ANGELA 39-24 AUTO READY	£23000.00	DOLBY A361 NOISE REDUCTION UNITS	EACH £410.00
NEVE 8068 32+4-24	£48000.00	DOLBY M16H NOISE REDUCTION UNITS	EACH £4000.00
NEVE 8048 4 BAND EQ 32-16-24 NECAM 2 AUTO	£50000.00	DOLBY M24H NOISE REDUCTION UNITS	EACH £6500.00
TRIDENT TSM 40-24	£50000.00	QUAD 606 AMPS NEW	£352.00
TRIDENT A SERIES 28-24-48 76 ON REMIX	£20000.00	EAR 660 ALL VALVE COMP/LIM	£750.00
RESPONSE 10-4	£250.00	EAR 822 VALVE EQ	£550.00
ALICE 18-8-8 PRODUCTION DESK 4 AUD:DES:COMP LIM	£1300.00	EAR 823 VALVE EQ	£550.00
INKEL 8-2 NEW	£280.00	EVENTIDE 949 HARMONISER	£1200.00
NEVE 10-4 A SERIES	£3000.00	ELECTROSPACE DIG: DELAY, NEW	£1000.00
3M M79 24 TRACK A/LOCATE	£10500.00	EMT 140 VALVE ECHO PLATE REMOTE	£1500.00
LYREC 532 24 TRACK 32 MEM A/LOCATE	£12500.00	EMT GOLDFOIL 240	£1,750
STUDER MK1 16 TRACK A80	£6500.00	STEINWAY 6'2" GRAND PIANO	£3500.00
LYREC TR55 1/2" STEREO AS NEW	£4000.00	BLUTHNER 6'2" GRAND PIANO RECOND. RELACQUER	£4500.00
PHILIPS PRO 51 STEREO FERRITE HEADS 4 OFF	EACH £450.00	TRAD EDITING BLOCKS 2"	£56.00
ITC TRIPLE STACK CART M/C X2+1 RECORD MODULE	£3000.00	TRAD EDITING BLOCKS 1"	£40.00
REVOX A77 LOW SPEED STEREO SERVICED	£250.00	TRAD EDITING BLOCKS 1/2"	£28.00
NEUMANN U87 AND U89 MINT	P.O.A.	TRAD EDITING BLOCKS 1/4"	£12.00

ALL TYPES OF WEBBER TEST TAPES IN STOCK

## TRAD

## ELECTRONICS SALES LTD

149b. St. Albans Road, Watford, Herts, WD2 5BB, England  
Tel: Watford (0923) 47988/9 Telex: 262741



**Buy one,  
get four  
free.**

**Symetrix**

They say you get what you pay for. Indeed, the 528 Voice Processor proves the point. Five high performance signal processors in a single rack space, for about what you'd expect to pay for each. Mic Preamp, De-esser, Compressor/Limiter, Downward Expander, Parametric EQ/Notch Filter. Even 48v phantom powering and a balanced line input. No compromises, nothing left out.

The 528 Voice Processor is the ideal mic input system for sophisticated recording and high level sound reinforcement systems. Control annoying sibilance, optimize spectral balance. Set overall signal levels. Reduce noise. And, eliminate resonances and ring frequencies with the 528's extremely selective EQ and filtering.

Get what you pay for, and then some. Get the 528 Voice Processor. Call or write for a detailed spec sheet.

Signal processing at its best

In the UK:  
SOUND TECHNOLOGY, LTD.  
6 Letchworth Business Centre  
Avenue One, Letchworth  
Herts SG6 2HR  
Telephone: 0462 675675

Exclusive International Representation:  
E & E INSTRUMENTS INTERNATIONAL, INC.  
PO Box 1313  
Laguna Beach, CA 92653, USA  
Telephone (714) 494-0231  
Telex 182291 EASTMAN LGNH



# GIVE ME FIVE



No jive, Clive. It's Rane's PE 15. And it's the first and only parametric equalizer and notch filter with five filters, all in one box.

That's a lot, Scott. Five separate, completely independent bands. So you have significantly greater control capabilities than the traditional four band designs.

But that's not all, Paul. Each band has a full,

**RIGHT  
AS  
RANE**

four-octave frequency sweep range, and an individual LED-indicated bypass switch on each band.

Don't settle for less, Jess. The PE 15 is easily the most flexible, powerful, compact, high-performance and cost effective parametric equalizer you can get.

So what do you say, Jay? Rane Corporation, 6510 216th SW. Mountlake Terrace, WA 98043. 206/774-7309.

**RANE**  
CORPORATION

*UK Distributor:*

Music Lab Sales, 72-74 Eversholt Street, London NW1 1BY. Tel: 01-388 5392 Telex 28159

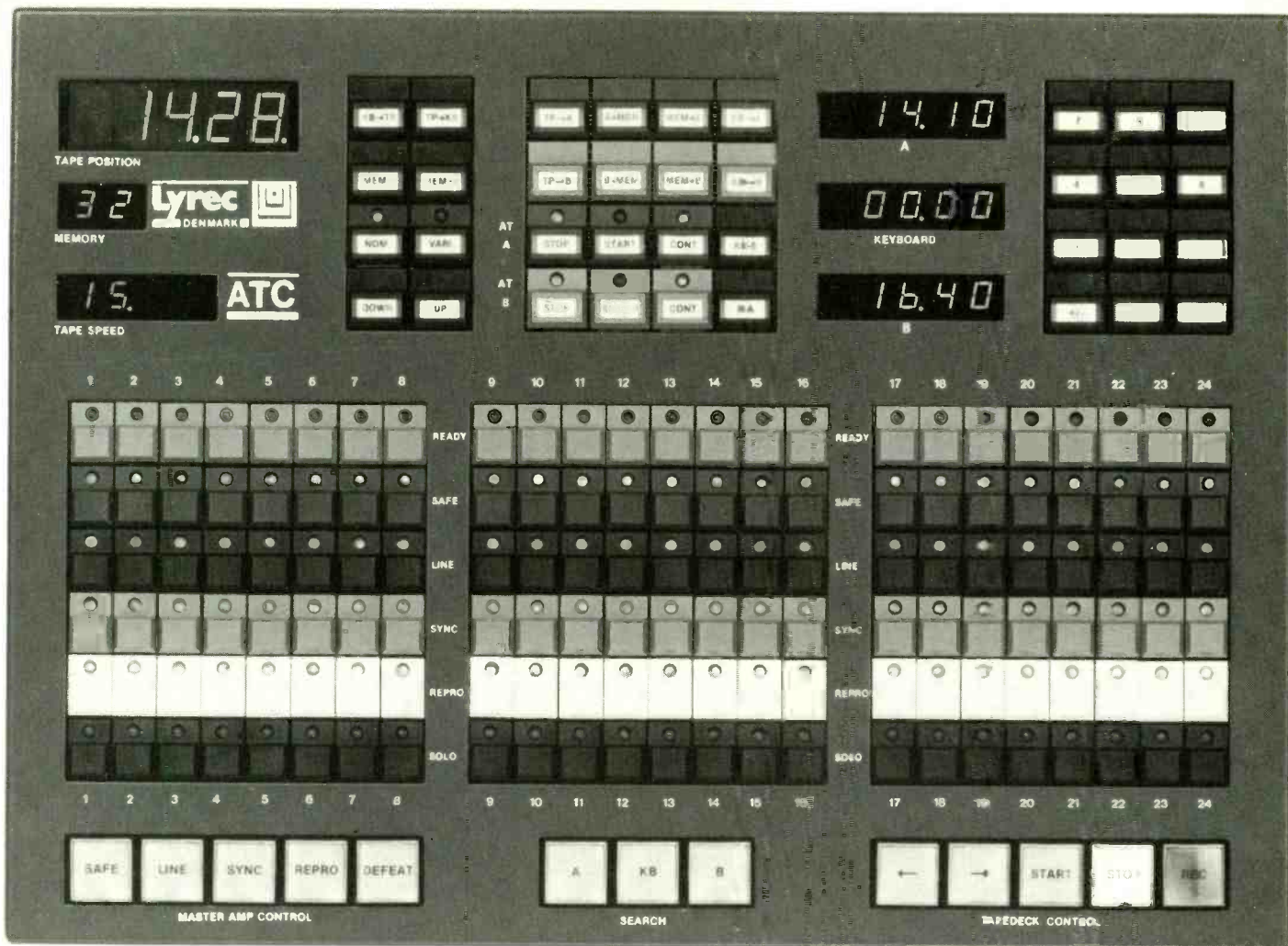

## best in the business

The Lyrec ATC is the heart of the TR533's easy and flexible operation and, in spite of its' small size, offers the engineer more than 250 remote control functions, some of which, like the solo function, are unique to Lyrec. A balance engineer sometimes works under stressed conditions that do not allow for long sequences of commands, and therefore it was designed around the one button – one function philosophy; an important feature being the direct search to three tape positions.

It is impossible to outline all the virtues of the TR533 in a small ad; **PLEASE send for our booklet.**

You'll be amazed at what the competition **cannot** offer!



**Lyrec**  
OF DENMARK



Lyrec (U.K.) Ltd.  
13 Hampden Hill  
Beaconsfield, Bucks. HP9 1BP  
Telephone: (04946) 4425  
Telex: 838725 LYREC G

Lyrec Manufacturing A/S Hollandsvej 12, DK-2800 Lyngby, Denmark. Phone: +45 2 876322 Telex: 37563 LYREC



# Who keeps on choosing Neutrik XLR type connectors in the UK?

## Who are the large network of independent nationwide Neutrik Distributors in the UK?

We are pleased to say no regular name dropping is necessary.

Just to say we thank you for your continued custom and trust in Neutrik Connectors.

Ultimately it is our users who have given Neutrik connectors this **Professional Image**.

We have a lot to live up to!



also available

### TP401 Audio Measuring System

(Made by Neutrik AG on the Isle of Wight)

### Neutrik Audiograph Audio/ Acoustic Analysis System

Sole Agent UK

### Eardley Electronics Ltd.

Eardley House, 182-184 Campden Hill Road

Kensington, London W8 7AS

Telephone: 01-221 0606/01-727 0711

Telex: 23894 Telefax: 01-727 9556

## GETTING TO THE HEART . . .

APRS STAND NO. SB35

C-ducer mikes capture the sound of acoustic instruments by direct contact. Superbly.

No fuss, no mike-stands and no effect from neighbouring sounds. 12-string, banjo or tom-tom, piano, sax or big gong are all fair game for this remarkable mike.

Available in two lengths, the C-ducer is less than 1 mm thick, flexible enough to follow curved surfaces and has a frequency response surpassing that of the human ear. All of which make it perfect for no-hassle quality stagework and recording.

Less than the cost of an average conventional microphone, C-ducer can transform your live and recorded sound in an instant. Check it out on your instrument at a dealer near you and you'll become a lover.

Audio Marketing Group, Unit 19 Holder Road, Aldershot, Hants.  
Tel (0252) 319171

Madness Grateful Dead  
Dire Straits UB40 Linn  
Wham Spandau Ballet  
Jose Feliciano Toto Willie  
Kris Kristofferson Pink Fl  
Jan Armatrading Stevie  
Chick Corea Chas and Dave  
Fairport Convention Neil Sedaka  
Van Morrison Frank Sinatra ( )



C-ducer

...for Lovers of Real Sounds

C-T Audio Marketing, Inc. South Tech Industrial Plaza 3050 SW 14 Place, Suite 3  
Boynton Beach, FL 33435 USA Tel: (305) 738-0622

# THE LANGUAGE OF OTARI SPOKEN AS ONLY WE KNOW HOW

**When we speak Otari, we mean business. Because for a busy studio it would be hard to find a better multitrack proposition.**

**Especially when you add the expertise of the UK's top Otari specialists – backed by Service Director Rod Thear and his team, with over 15 years' Otari experience between them.**

**The MX-80 multitrack brings Otari's high performance, precision handling and reliability within reach.**

**Sound quality is remarkable; with the Dolby rack it's outstanding. Outmoded or secondhand machines are no longer the only options.**

**The MTR-90 needs no introduction; its tape handling is flawless and with our new, custom Dolby SR' overbridge its status as the world's most successful multitrack is assured.**

**Finally, the new MTR-20 – the ultimate analogue mastering recorder. Its sophisticated electronics, engineering quality and operational flexibility set standards others will aspire to.**

**Whichever one suits your needs, you'll find our back-up as solid and reliable as Otari machines themselves.**

**And that's great news in any language. Call Garry Robson or Mick Boggis for details.**

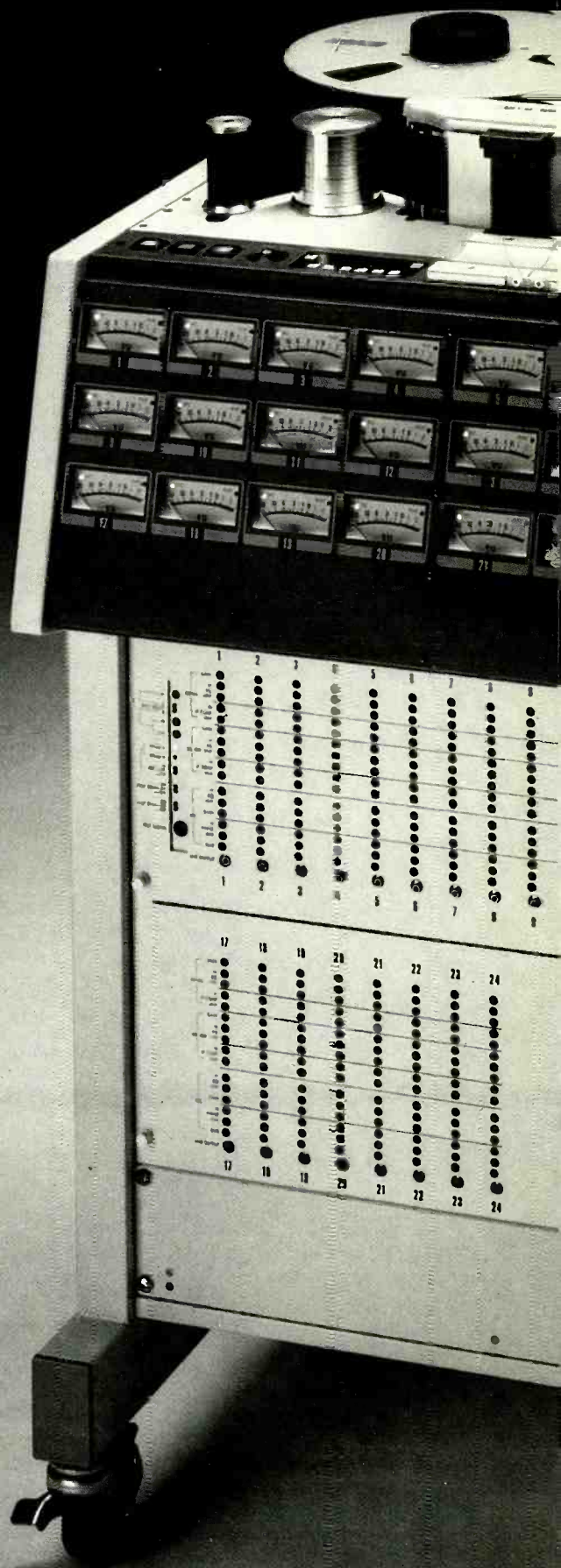



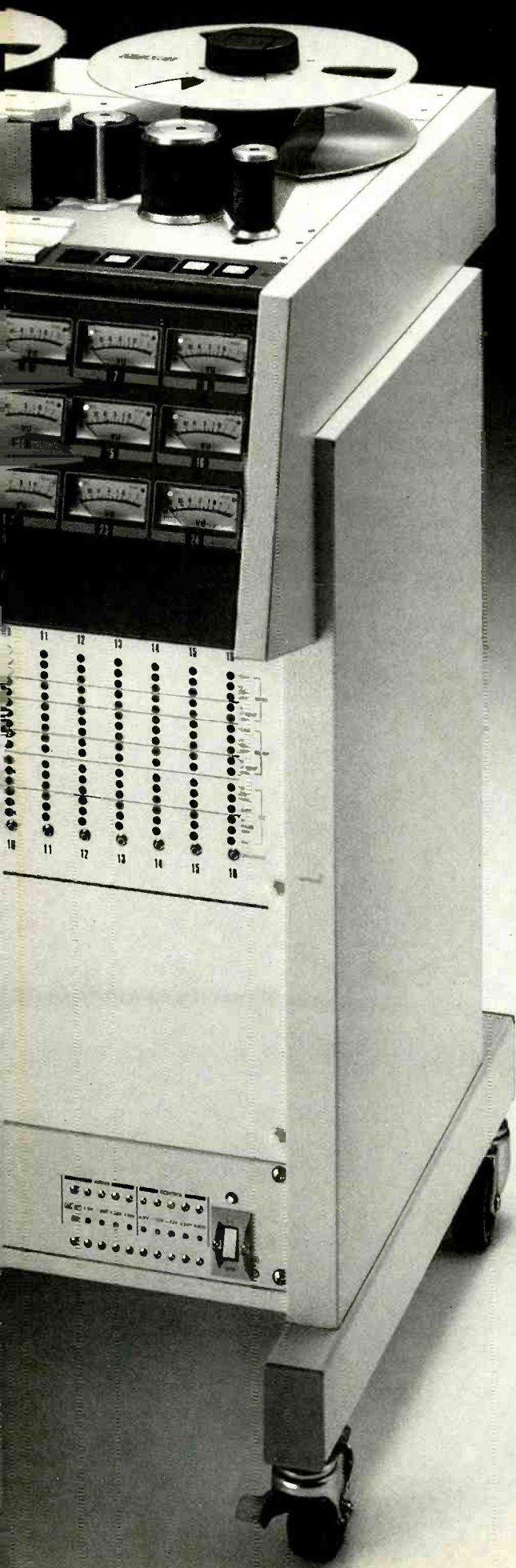

◀ **MX-80** New multitrack in 2" 16/24/32 track versions. Features closed-loop constant tension transport with 30/15/7.5 ips speeds, each with gapless punch in/out. Integral facilities include Dolby HX-Pro\*, synchroniser interface, switchable EQ curves and 4-cue autolocator. Full remote provided; Dolby SR\* overbridge, timecode-based autolocator and chase synchroniser optional.



▲ **MTR-90** Top quality multitrack in 1" 8 track and 2" 16 or 24 track versions. Pinchrollerless PLL capstan transport under electronic control with fast lock-up, digitally timed gapless punch in/out's and 14" max reel size. Facilities include spot erase, bidirectional cue, elapsed-time indicators and easy-access tilting deckplate. Interfaces provided for transformerless audio I/O (or transformer option), RS232C I/O and SMPTE. Optional: Dolby SR\* overbridge.



▲ **MTR-20** New stereo mastering recorder with quartz-PLL capstan and closed-loop Optimum Tape Guidance System with electronic control. Full auto-align plus 2 memory set-ups per speed/EQ, 4-point autolocator, optional broadcast I/O including fader start, gapless punch in/out, reverse play/erase, library wind mode and tape time/timecode display. Options: full autolocator, 1 or 2-button punch in/out, variable wind speed and many more.

**OTARI**<sup>®</sup>

AT

**Stirling** **ITA**

1 Canfield Place, London NW6 3BT. Telephone 01-625 4515  
Fax. 01-372 6370. Tlx. 946240 CWEASY G Ref No. 19014280

\*Dolby SR and HX-Pro are trademarks of Dolby Laboratories Ltd.,

# NEWS

## People

- George Kuchmas has been appointed general manager of manufacturing for Sony Professional Products in Fort Lauderdale, Florida. He moves up from manager of material and production control.
- Pro-Bel Ltd of Reading, manufacturers of broadcast switching systems, have appointed Roger Henderson as director responsible for software systems.
- T Bryce McCrerrick, director of engineering of the BBC since 1978, is to be succeeded on June 1st, 1987, by Mr C. W. Denny, who has been assistant director of engineering since 1985.
- Apogee Electronics Corporation of Santa Monica in California have appointed Grace Gehman as marketing director. Gehman comes from DLG record production company where she was president.
- Tannoy have announced the appointment of Ed Form as director of engineering. He will be responsible for all loudspeaker development and

- production engineering.
- Kevin Draper has been appointed senior technician with Star Hire of Cambridgeshire, suppliers of Turbosound/Soundcraft PA systems. Draper comes from Quad Electroacoustics where he was production supervisor.
- Viewplan plc, UK audio/visual hire company, have appointed David Slaymaker as managing director. He will be supported by Marjorie Blake, who was appointed deputy managing director/finance director.
- Jerry E. Smith has been named vice president, Sony Professional Audio Division, with responsibility for sales and marketing to recording studios and film and video production facilities.
- Pro-Bel Ltd of Reading have appointed Peter Rawlings to the newly created post of proposals and contracts manager, where he will liaise with customers, the sales department and project engineering groups.

## Address changes

- Musicable, UK manufacturers of pro-audio jacks, leads and cables, have moved to larger premises. The full address is: Unit 5, Middlegreen Trading Estate, Middlegreen Road, Langley, Berks SL3 6QX. Tel: 0753 691387.
- Sound Technology plc have announced new UK telephone and fax numbers. Tel: 0462 480000. Fax: 0462 480800.
- S W Davies (UK) have moved to: 5/7 Buck Street, London NW1 8NJ. Tel: 01-485 8559.
- Arup Acoustics of London have moved to: 10a Stephen Mews, London W1P 1PP. Tel: 01-636 2853/01-580 5849/01-636 1531.

## Stolen equipment

Hardware House in London reports stolen equipment in three separate incidents. A Nady diversity radio mic in a CP briefcase was left at the Hammersmith Odeon on January 14th. Two Hackney cab speakers with Electro-Voice components was stolen from the back of a car on

January 21st in North London. And another hirer never returned with a Nady diversity radio mic—it was hired on February 10th with false security papers under the name of M. (Michael) Bell. Phone 01-986 6111 with any details.

## Obituary

It is with much regret that we announce the death of Richard C Heyser, president-elect of the AES, and an influential figure in the audio engineering industry. In all, he was awarded nine patents in audio and communication techniques, including time-delay spectrometry.

Heyser was born in Chicago in 1931. From 1956 until he died, he was associated with the Jet Propulsion Laboratory of the California Institute of Technology in Pasadena, working on communication and instrumentation design for all major space programmes, including conceptual design for America's first

satellite, *Explorer I*. Throughout that time, Heyser maintained a personal lab where he conducted research on audio and acoustic measurement techniques. Many of his findings were submitted to the *AES Journal* and to *Audio* magazine, of which he was senior editor. Other work included association with Synergetic Audio Concepts, where Live End, Dead End theories were put into practice, and sitting on the Publications Policy Committee of the AES.

Heyser was a fellow of the Acoustical Society of America, member of the IEEE and a fellow of the AES, receiving its Silver Medal Ward.

## Literature received

- The Institution of Electrical Engineers have published their 1987 Publications Catalogue, which details the books, conference publications and journals currently available from the IEE, as well as the new titles due for publication during 1987. Copies of the catalogue are available from: Owen Byatt, Books Administrator, IEE, PO Box 8, Southgate House, Stevenage, Herts SG1 1HQ, UK. Tel: 0438 313465.
- Recently published is the 1987 edition of *The White Book—The International Production Directory*.

This is the fourth annual compilation of names and addresses of companies and individuals involved in the production of recorded music, live performance, television, film, video, conference and exhibitions. The 720-page directory contains over 25,000 entries in 179 categories and covers the UK and 31 other countries.

Further information and copies can be obtained from: Dick Tee or Doug Stewart, Unit 18, Central Trading Estate, Staines, Middlesex TW18 4XE, UK. Tel: 0784 64441.

## Software update

- A new Mix Page has been incorporated into the Fairlight *CMI series III* software. It has a more accessible layout and graphically displayed wave forms. Source and destination wave forms can be mixed by inserting, crossfading and adding the selected sections. Proportional Mode displays these wave forms in relative sizes, rather than stretching them to fill the screen.
- E-mu Systems Inc have made available a hardware update for the *Emulator II, II+ and II+HD*. Attack Modification affects the transient generator's initial lag time to

improve the attack transient response, providing claimed decreases in attack times of up to 4 ms (depending on the sound). The modification is available from E-mu service centres.

- Sound Technology plc have introduced a software update for the Bokse *SM-9* SMPTE/MIDI timecode events generator, which will provide several new performance features. Users should contact: Sound Technology plc, 6 Letchworth Business Centre, Avenue One, Letchworth SG6 2HR, UK.

## Addendum

In our article on exotic cables in the April issue, we omitted the address of Music Interface Technology. MIT,

3037 Grass Valley Highway, Suite 8212, Auburn, California 95603, USA. Tel: (916) 888-0395.

## Erratum

In our March News section, we inadvertently wrote that the Used Equipment Price Guide included 'medical and audio processing

equipment'. It should have read 'musical and audio processing equipment'.



# HARDWARE HOUSE



With eight years experience of using radio systems for live performance we are ideally placed to tell you the advantages and disadvantages of going cordless.

We can also offer an extensive range of professional sound equipment including the recently developed 'Hackney Cab' speaker system.

To find out more about equipment rental and sales and our specialist technical and engineering services please phone us at any time on:

**01-986 6111**

**Hardware House (Sound) Limited**  
West Works, Chalgrove Road  
Morning Lane, London E9 6PB

UK distributors for MADY radio systems and Countryman microphones. Dealers for Amcron, AMEK/TAC (live performance), Court, EAA, Electrovoice, JBL, Yamaha

## SOWTER AUDIO FREQUENCY TRANSFORMERS

You name it! We make it!

For the past 45 years we have concentrated on the design and manufacture of high grade audio transformers during which period our total sold exceeds half a million. We continually take full advantage of all the improvements in magnetic and insulating materials and in measuring techniques utilising the most up to date instrumentation.

We have a very large number of original designs made for clients all over the world but naturally there are certain types of Sowter Transformers which are in constant demand. These have taken into account the tendency towards small size without sacrifice of performance, particularly for PCB mounting, and a few of these are listed below. They can be supplied with or without mumetal shielding cans. Performance requirements can be modified on request (utilising our readily available questionnaire) and generally without alteration in price.

We specialise in **LOW COST AND QUICK DELIVERY** which means a few days only or ex-stock.

### TYPICAL PERFORMANCES

Sowter Type No	3575	4652	3678	6499	6471	6469
Description	Miniature bridging transformer	Line output	Multi primary microphone transformer	Line output high level low distortion toroidal core	Splitter combiner transformer	Midget mic transformer for BT private systems
Impedances	10kΩ/10kΩ can be fed from 50-600Ω	600 or 1500 inputs or outputs	Phys 60, 200 or 600Ω Sy 5kΩ down to 1kΩ	600Ω/600Ω	200Ω/2Bal. Primary TW0 200Ω Secondaries	Py 600Ω Sy 60kΩ
Frequency range	20Hz-20kHz	20Hz-20kHz	30Hz-20kHz	20-20kHz	20Hz-20kHz	300Hz-3kHz
Performance	-0.1dB over above range	-0.25dB over above range	-0.5dB over above range	±0.3dB 40Hz 15kHz ±0.5dB 20Hz 20kHz	-0.5dB over above range	-0.5dB over above range
Maximum Level	7.75V r.m.s. on secondary	7.75V r.m.s. on 600Ω	on 5kΩ/3.4V r.m.s. at 30Hz	26dBm at 30Hz	2.3V r.m.s. at 30Hz	0.6V <sub>p-p</sub> on Py
Maximum Distortion	With 10V r.m.s. at 40Hz only 0.12%	Using 600Ω and low impedance source it is 0.1%	Less than 0.1% at 1kHz	0.1% at 30Hz at 26dBm	negligible -0.1% at 1kHz	negligible
Shielding	Electrostatic screens and mumetal can	Mumetal can if desired at extra cost	Mumetal can	Toroidal can	Mumetal can rigid fixing bolts	PCB mounting
Dimensions	33mm diam - 22mm high	36mm high - 43mm - 33mm	33mm diam - 22mm high	50mm diam - 36mm high	33mm diam - 37mm high	11mm high - 19mm - 17mm
Prices each at works	1.5 - £10.83 50 - £9.77 100 - £9.27	1.5 - £9.67 50 - £8.89 100 - £8.69	1.5 - £9.67 50 - £8.67 100 - £8.41	1.5 - £17.12 50 - £15.69 100 - £15.35	1.5 - £14.59 50 - £13.37 100 - £13.08	1.5 - £3.89 50 - £3.55 100 - £3.29

**E. A. SOWTER LTD.** (Established 1941) Reg. No. England 303990  
The Boat Yard, Cullingham Road, Ipswich IP1 2EG, Suffolk, PO Box 36, Ipswich IP1 2EL, England. Phone: 0473 52794 & 0473 219390 - Telex: 987703G SOWTER

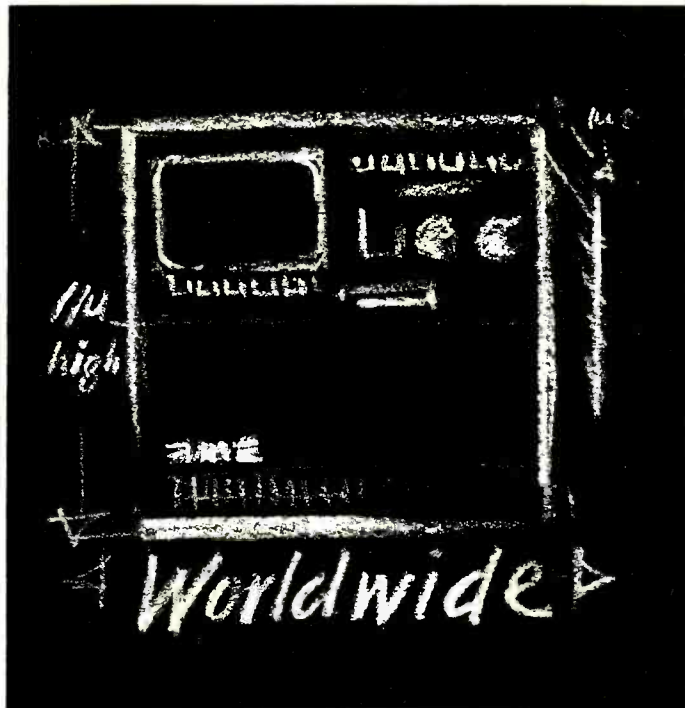

In the world of hard disc based recording, one particular system is rapidly achieving byword status.

The AMS AudioFile.

The Japanese have discovered a yen for its reliability.

Frankly, the French have fast developed a penchant for its fidelity.

And you can bet your bottom dollar, the number of Stateside studios with this most valuable production tool is growing and growing.

All told, the AMS AudioFile is in use in more locations, in more countries than any other system. A hard fact that's hard to ignore.

You won't have to travel the world to test a system. The AMS AudioFile is available for demonstration in Australia, Belgium, Canada, Finland, France, Germany, Holland, Italy, Japan, Sweden, Switzerland and the USA.

For more details on a hard disc demo contact AMS today.



**Advanced Music Systems,**  
AMS Industries plc, Burnley, Lancs.  
BB11 5ES. Tel: (0282) 57011.  
Telex: 63108 AMS-G. Fax: (0282) 39542.  
Harris Sound Inc. (Los Angeles)  
Tel: (800) 2331580.

The Queen's Award for Export Achievement to Edendeck Ltd. 1984/85 and AMS Industries plc 1986.

In July 1985 Edendeck Ltd. became AMS Industries plc.



## In brief

# NEWS

## The Syn-Aud-Con approach

A Recording Studio Designer's Workshop is planned for June 12 to 14th, at the Master Sound Astoria Recording facility in New York. Sponsored by Synergetic Audio Concepts (Syn-Aud-Con), the workshop is aimed at sharing design, construction, and proof of performance technology of recording control room and studio design. The format will have a heavy emphasis on measurements, and qualified

designers who attend will have an opportunity to describe their latest projects. Hosts for the evening will be Don and Carolyn Davis, and staff will include designer Charles Bilello and Dr Peter D'Antonio of RPG Diffusers.

More information is available from: Synergetic Audio Concepts, PO Box 1239, Bedford, IN 47421, USA. Tel: (812) 275-3853.

- The 1987 Prix Ars Electronica computer art contest is open for competition for the first time, with prizes awarded for outstanding creative achievement in animation, graphics and music. Music must be digitally produced, taped, and be between eight and 20 minutes in length. The Prix Ars Electronica is donated by Siemens AG, and more information can be had from: ORF-Landesstudio Oberosterreich, Franckstrasse 2a, A-4010 Linz, Austria. Tel: 0732-53481/267. Fax: 0732-53481/250.

- The Institute of Broadcast Sound, on the occasion of their 10th anniversary, awarded Dr Ray Dolby a Fellowship of the Institute, after delivering his London lecture on 13 March on Spectral Recording.

- West London Electric are nearing completion of their extensive rebuilding of their warehouse and offices. As suppliers of pro-audio equipment, as well as sound reinforcement, PA, closed circuit TV and intercom equipment, the company expects to increase their capabilities dramatically. West London Electric Ltd, 9-11 High Street, Acton, London W3 6NQ, UK. Tel: 01-992 2155.

- British loudspeaker manufacturers Tannoy have been awarded their

second Japanese Golden Sound Award. They are the only manufacturers ever to have won this award more than once.

- Syco Systems, in association with the Gateway School of Recording and Music Technology, have announced a series of formal examination courses for Fairlight CMI programmers. Each course will cover both theoretical and practical aspects of CMI operation and programming, and will run over a four-day period, culminating in a comprehensive examination.

- Hollywood is the home of the newly formed Shelex Company, which specialises in assisting small and inexperienced manufacturing concerns in establishing representation and distribution networks. For more information contact Shelley A. Herman, PO Box 3752, Hollywood, California 90078, USA. Tel: (213) 849-4136.

- Straight Wire Audio and Audio & Design Recording have announced the establishment of a joint venture for the distribution and manufacture of Audio & Design products in the US. A&D USA, formerly located in Seattle, have been acquired by SWA and will be moving into the latter's new manufacturing premises in Arlington, Virginia.

# DON'T GET ALL

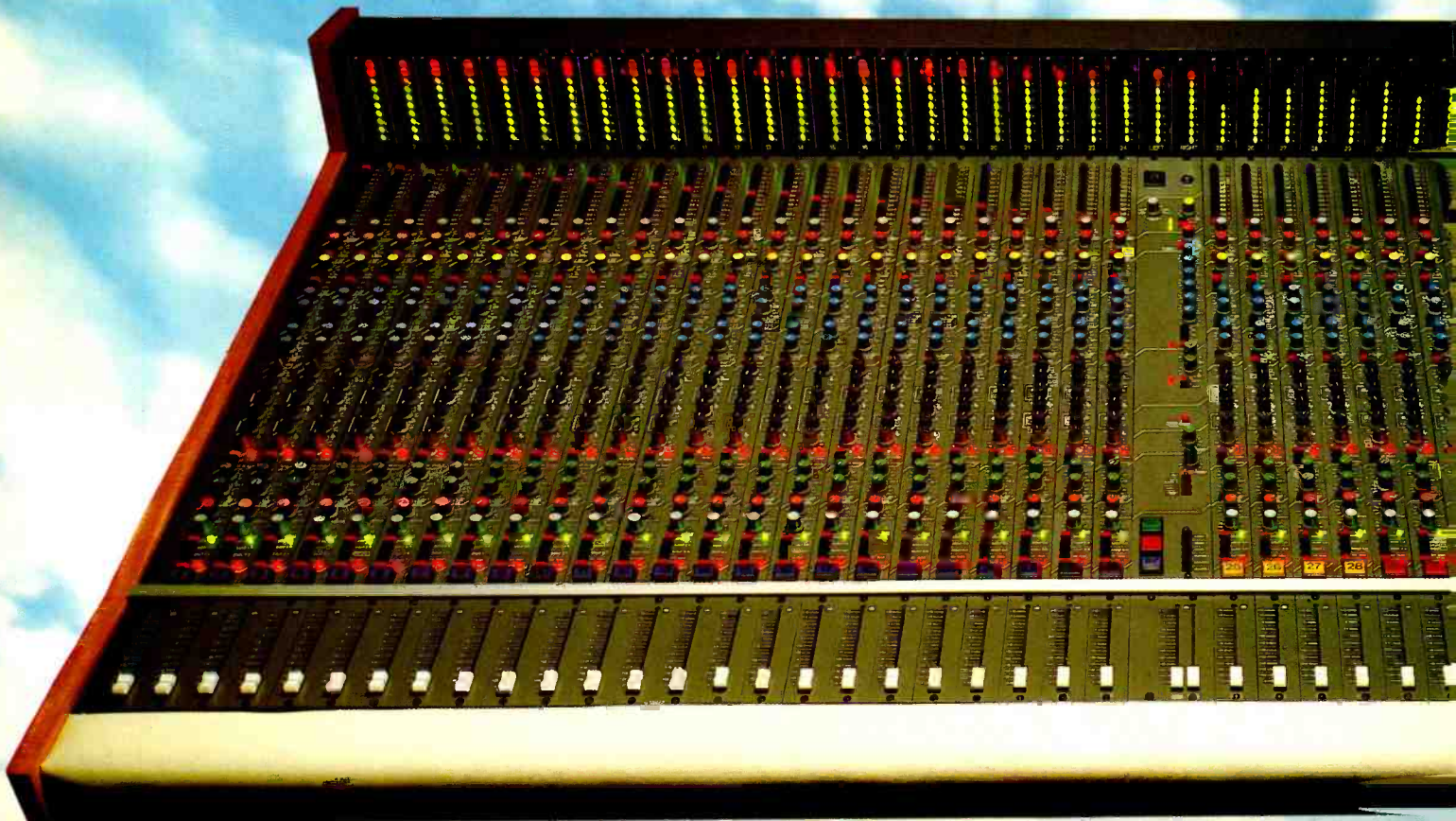



# Agencies

- Teac and Harman (Audio) UK Ltd have agreed that the sales and marketing of the new Tascam *ATR-80 2* in multitrack recorder will be handled by the Tascam Pro-Audio Group at Teac's UK offices.
- Sound Technology plc of Hertfordshire have been appointed UK distributors for DOD and Audio Logic pro-audio products.
- IMG/GMI of Quebec (a subsidiary of Soundcraft Electronics) have been appointed sole Canadian distributors for TDM Design and Circuit Design Technology products.
- Qusted Monitoring Systems have announced the appointment of

Apogee Electronics as distributors of their line of studio monitoring speakers throughout the US.

- IMG of Quebec, a subsidiary of Soundcraft Canada, have been appointed exclusive Canadian distributor and importer of all products manufactured by ADA of Oakland.
- Audio FX have been appointed UK distributors for the Voyetra Technologies range of IBM PC-compatible software.
- Clydebank-based P F Magnetics have recently been appointed Scottish master distributor by Agfa Magnetic Tape Ltd and Ampex GB Ltd.

# Contracts

- Apogee Electronics have announced the purchase of two sets of three Qusted *Q412* monitors by Enterprise Studios in Burbank, California.
- Power Station Recording Studios in New York City have recently purchased two Otari 32-track *DTR-900* digital tape recorders.
- Contracts amounting to over £1 million have been awarded to Audix Ltd of Essex, by Voice of Kenya for this summer's African Games. The completed facilities will include a

radio centre with production studios, edit areas, central control room and complete commentator control systems. Audix is also supplying a number of mixers for the television studios and OB vehicles.

- Solid State Logic are supplying HTV West's TV centre in Bristol with two *SL 5000 M* series consoles.
- New York's Sterling Sound have taken delivery of Neve's *DTC 1* digital console for CD mastering.
- Soundtracs have announced a series of orders for their *CP6800*

consoles. A total of six are scheduled for delivery, each in 32/12/24/2+2 format and with Soundtracs automation. This brings the number of *CP6800s* sold since production began in October 1986 to 24.

- Terminal 24 studios in London have replaced their Amek *Angela* with the new *G2520* multitrack production console. It is equipped with 40 inputs and full *MasterMix* automation.
- A Martin Audio speaker system is to feature in the reopening, after a £2 million refurbishment, of the Hammersmith Palais in London, which will be renamed La Palais. The 8 kW Martin rig was chosen by installation company Avitec.
- Spectrum Studios of Portland, Oregon, have installed an MCI *JH-500* automated mixing console. Spectrum have also recently added a Lexicon *224XL* digital reverb to their inventory.
- Audio Palombi, Britannia Row's Westlake Audio dealer in Italy, purchased two new Westlake *BBSM 15* studio monitors during the London AES.
- Unique Recording Studios in New York City have recently installed the following: two Lexicon *480L* digital reverbs, a Lexicon *224X*, and two Studer *A-80RC 1/2* in 2-tracks. New mixers and multiple cassette decks were installed in the updating of the programming and edit rooms.
- Canford Audio of Washington, Tyne & Wear, have been chosen to design and install a complete sound and communications system in the major refurbishment of Newcastle's Theatre Royal, with a completion date set for this coming September.
- Abbey Road Studios have purchased a Sony *PCM-3324 DASH* format 24-track, their first digital multitrack recorder.
- Stirling/ITA have announced recent sales. Ex-10CC member Lol Creme has purchased a Trident *65 28/16* console. Ronnie Bond has selected a Soundcraft *2400 28/24* plus a Soundcraft *760 24-track* tape machine for his new studio. Rod Thompson purchased an Otari *MX80*, TAC *Matchless* and an Audio Kinetics *Pacer*, and a TAC *Scorpion 26/12/2* went to Billy Livesey. The Cocteau Twins have purchased an Amek *Angela* with full Audio Kinetics *MasterMix* automation.
- The Theatre Royal de Monnaie in Brussels, as part of its restoration programme, has installed an Amek *M2500*. The equipment was supplied by audio consultant engineers ASC of Brussels.
- Regent Sound in New York City have bought a Sony *MXP-3036* recording console and an *ADS-3000* SMPTE-based hard disk automation system.
- Livingstone Studios of north London are to install an SSL *SL 4000 E* series console, the third such console purchased in the last two years.

# MIXED UP...!

## SECA 24 BUSS RECORDING CONSOLE

### Features:

- ★ 8 Auxiliary Busses Pre-post switched
- ★ Fully integrated 19" rack patchbay
- ★ Logic switched routing with Reset
- ★ 4 Band Semi-Parametric Eq
- ★ Low Pass/High Pass Filters
- ★ Fast LED in/out metering
- ★ Group-mute facility
- ★ 4 Monitor groups
- ★ Integral floor stand
- ★ Penny and Giles faders

Sound Professionals

Acres (UK) Ltd

Featherbed Lane, Shrewsbury, Shropshire SY1 4NJ, England  
Telephone: Shrewsbury (0743)66671/236672 Telex: 35188 ACES G

# NEWS

## Neotek Elan and MIDI Direct

Neotek have introduced the *Elan* recording console which, with a second input on each module, can provide 72 inputs and 30 auxiliary buses in a 6 ft frame. Among the special features, according to the manufacturer, are exceptionally flexible signal flow architecture, bandwidth and isolation to handle multiple synthesiser tracks and noise and distortion superior to digital recorders.

The console is available in two frame formats holding 28 or 36 modules. Input modules feature mic and line level inputs, 4-band sweep EQ, six Aux sends, assignment to 24 multitrack buses and high resolution bargraph metering. Fader module options provide logic mute groups with in-place solo.

Standard consoles are fitted with Elco multipin I/O connectors, leg set and comprehensive patchbay using metal frame Bantam jacks.

Automation available includes factory installed Audio Kinetics, Digital Creations, GML or the new Neotek *MIDI Direct* system.

*MIDI Direct* is a comprehensive

automated mute system that provides read, write and update of the mute functions (including mute group masters) on the Neotek *Elite*, *Elan* and *Esprit* consoles.

The system, which is entirely microprocessor controlled, communicates with MIDI sequencers and editors through a set of MIDI In and MIDI Out jacks. The console can be any one of 16 MIDI 'instruments' on the MIDI bus. Song position pointers are added to allow instant access to any point in the sequence of commands and two editing modes make changing automated mutes a simple matter of pressing the console's mute switches when the change is required. Up to 64 mute switches can be automated.

The system is only available for Neotek consoles and was designed in co-operation with Jim Cooper of JL Cooper Labs.

**Neotek Corporation, 1154 West Belmont Avenue, Chicago, IL 60657, USA. Tel: (312) 929-6699.**  
**UK: Syco, Conduit Place, London W2. Tel: 01-724 2451.**

## Studio Technologies mic preamplifier

A self-powered dual microphone preamplifier has recently been introduced by Studio Technologies. The *Mic-PreEminence* has been designed, according to Studio Technologies, to have unrivalled technical and sonic performance due to the mic preamp's low noise, low distortion and high speed design. It has been specifically developed to

work with digital recording systems and provides an in/out transformerless, balanced interface with phantom powering, phase, signal indicator and trim controls.

**Studio Technologies Inc, 5520 West Touhy Avenue, Skokie, IL 60077, USA. Tel: (312) 676-9177.**  
**UK: Turnkey, Brent View Road, London NW9 7EL. Tel: 01-202 4366.**

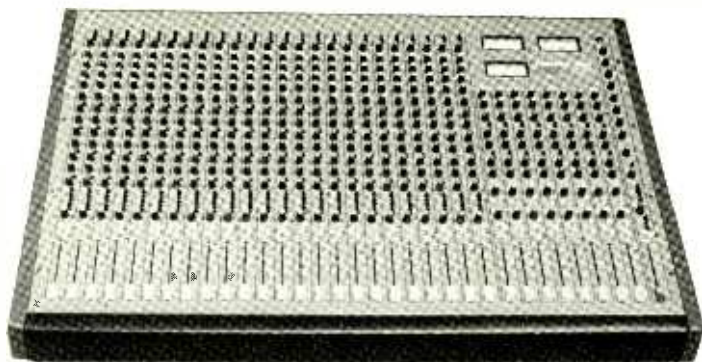

## Aries performance console

Designed specifically for sound reinforcement applications the *Aries* performance series is expandable from 24 input channels to 40 using 8-channel modules. Channel facilities include balanced mic inputs, phantom powering, pad, phase reverse and line input select, 3-band EQ with swept MF, high pass filter and EQ bypass. Also available are eight auxiliary sends (switchable pre-/post-fader), PFL, mute and mute bus.

Comprehensive subgroup facilities are included. Features include pan,

mute, stereo mute, mute bus and PFL. All eight FX returns have 2-band EQ with bypass and 4 aux which are switchable pre-/post-fade and assignable to any of the eight aux buses.

Other standard features include 100 mm faders, oscillator, talkback, headphone output and facilities to connect an external 8-way meter bridge.

**Goutam Electronic Products Ltd, Unit 3B, 6-24 Southgate Road, London N1. Tel: 01-249 5306.**

## Wireworks CX cable

Wireworks have introduced a new microphone cable—the *CX* series—to replace the former *CP* range. The new cable is PVC covered with conductive plastic shielding and according to Wireworks has greater flexibility, lower capacitance and is available in a choice of 11 different colours.

As with all Wireworks cables the

*CX* series are complete assemblies terminated with Neutrik *XLR*-type connectors. They are available in six stocked lengths (5, 10, 25, 50, 75 and 100 ft). Special lengths and terminations are available on request.

**Wireworks Corporation, 380 Hillside Avenue, Hillside, NJ 07205, USA. Tel: (201) 686-7400.**

## Canford Audio jack cleaner

Canford Audio has introduced two new products to simplify and speed up the chore of cleaning jackfields. The Canford jackfield burnisher is machined from tool steel, treated to create a fire burnishing surface and then chrome plated to produce a durable finish. Cleaning is accomplished simply by inserting the tool, twisting slightly then removing.

The Canford jackfield solvent injector is designed for cleaning switch contacts. The tool is inserted

into the jack which automatically opens the contacts. A special channel enables the plastic tube of a solvent aerosol to reach them. When the tool is removed the movement of the switch contacts completes the cleaning process.

**Canford Audio, Crowther Road, Washington, Tyne & Wear NE38 0BW, UK. Tel: 091-417 0057.**

**USA: Connectronics Corporation, 652 Glenbrook Road, Stamford, CT 06906. Tel: (203) 324-2889.**





# NEUMANN CONDENSER MICROPHONES



It is essential that microphones used for digital recording be capable of covering a dynamic range of at least 96dB, since this is the range between the quantizing noise of a 16-bit system and its clipping level. Neumann condenser microphones have always provided 110 dB – some as high as 129 dB (r.e. IEC179) – but this is only one of their many advantages. There is no doubt that your digital recordings will continue to have their best chance at success if they are made using Neumann microphones. We'll be glad to send you our catalog 120.

**AUDIO EXPORT GEORG NEUMANN & CO GMBH**  
Badstraße 14 · Postfach 1180 · D-7100 Heilbronn · Tel. (0 71 31) 8 22 75  
Telex 7-28 558 audex d · Cables Audioexport

**GOTHAM**  
AUDIO CORPORATION

1790 Broadway, NY. (212) 765 3410  
Sales Office: West Coast (818) 785 2211  
Canada (416) 665 2542

**F.W.O. Bauch Limited**

49 Theobald Street, Boreham Wood, Hertfordshire WD6 4RZ  
Telephone 01-953 0091, Telex 27502



# NEWS

## In brief

● Court Acoustics have improved their range of graphic equalisers with the following additions: electronic balanced input circuitry; optional transformer inputs/outputs; auto bypass relay on power down; overload indicator; and improved power supply regulation. Court Acoustic Sales Ltd, 29 Beethoven Street, London W10 4LG, UK. Tel: 01-960 8178.

● RCF have released two lab series compression drivers. The N681 is a 1 in driver with a 100 hr sine wave power handling of 35 W (100 W programme), with a titanium diaphragm, aluminium voice coil on a polyamide former with a response

of 500 Hz to 20 kHz and a sensitivity of 108 dB. The N980 is a 2 in driver handling 100 W (250 W programme), with a carbon fibre diaphragm, copper voice coil on a polyamide former, a frequency response of 400 Hz to 10 kHz and sensitivity of 111 dB. RCF Spa, 42029 S Maurizio (Reggio Emilia), Via G Notari 1/A, Italy.

● Altec Lansing have launched their A12-8A loudspeaker system, which is claimed to produce high level acoustic outputs and is aimed primarily at cinemas, theatres and auditoria.

## AKG C522 ENG microphone

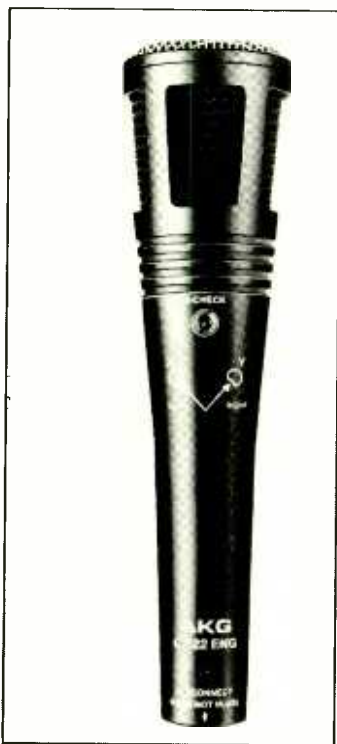

The AKG C522 ENG is a twin cardioid condenser mic with built in rechargeable batteries intended primarily for broadcast use. The mic is designed for simple hand-held stereo XY recording and is contained within a robust metal housing. A prominent battery check LED is fitted and an integrated on/off switch is activated by inserting or removing the cable connector.

The microphone is supplied in a special case containing stand adaptor, elastic shock mount, foam windscreens, balanced XLR terminated stereo cable and an unbalanced lead terminated with a miniature stereo jack.

AKG Akustische U Kino-Geräte Gesellschaft GmbH, Brunhildengrass 1, A-1150 Wien, Austria. Tel: 222 95 65 17-0.

UK: AKG Acoustics Ltd, Vienna Court, Catteshall Wharf, Catteshall Lane, Godalming, Surrey GU7 1JG. Tel: 04868 25702.

USA: AKG Acoustics Inc, 77 Selleck Street, Stamford, CT 06902. Tel: (203) 348 2121.

## Beyer MCE10 mic

Beyer Dynamic have introduced their first uni-directional tie clip mic. The MCE10 has a diameter of 9 mm and a total length of 21 mm and is claimed to be one of the smallest clip-on electret mics of broadcast quality.

Technical specifications include frequency response, 40 Hz to 20 kHz; nominal impedance 700  $\Omega$  and signal to noise 61 dB. The MCE10 utilises a black chromium-plated brass case and comes with a detachable metal windshield which is claimed to reduce wind noise by as much as 20 dB.

Eugen Beyer Elektrotechnische Fabrik GmbH & Co, Theresienstrasse 8, D-7100 Heilbronn, West Germany. Tel: 071 31 617-0.

UK: Beyer Dynamic, Unit 14, Cliffe Industrial Estate, Lewes, Sussex BN8

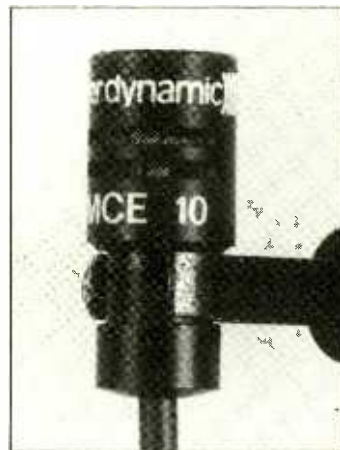

6JL. Tel: 0273 479411.

USA: Beyer Dynamic Inc, 5-05 Burns Avenue, Hicksville, NY 11801. Tel: (516) 935-8000.

## Q-max 600

McKenzie Acoustics have introduced a 3 U high rack mountable stereo power amplifier. The Q-Max 600 MOSFET is rated at 200 W/channel into 8  $\Omega$ , 325 W into 4  $\Omega$ , and 650 W into 8  $\Omega$  bridged mono, and is claimed to have less than 0.005% harmonic distortion. Frequency response (ref 1 kHz) is -0.3 dB down at 20 Hz and -0.1 dB at 20 kHz.

Main features include LED bargraph level display, protection LED indicator and input circuitry designed to eliminate hum loops without removing the mains earth connection.

McKenzie Acoustics Ltd, Albion Drive, Thurnscoe, South Yorkshire S63 0BA. Tel: 0709 898606.



## Samson TD series wireless mic

Samson have introduced a new wireless microphone system featuring dbx noise reduction. The Concert TD (True Diversity) wireless system is designed to minimise companding problems such as poor transient response, 'pumping' and serious noise. The system is claimed to offer a 40 dB reduction in FM transmission medium noise and provide a 115 dB dynamic range.

The TD system consists of a 1U high rack mounted, crystal controlled

CR-2 receiver with up to 10 channels available for simultaneous use. The handheld transmitter includes a variety of optional mic capsules, including the Electro-Voice N/D 757. A belt pack transmitter (CT-2) is also available and this can be used with the GC-1 musical instrument cable and a wide selection of popular electret condenser lavalier mics. Samson Products Corporation, 124 Fulton Avenue, Hempstead, NY 11550, USA. Tel: (516) 489-2203.



# ***THE DIGITAL LEADER***

## ***The most advanced 2-Track Digital Audio Recorder***

Waiting for new digital technology can be a frustrating business. At Mitsubishi we know that one piece of hardware is worth a thousand promises. Our experience in delivering over 200 digital audio machines over the past three years, added to our recent advances in high density recording and LSI technology has resulted in the new, second generation Mitsubishi X-86, the first system compatible digital mastering machine. Just being the first isn't enough though, so we've given the X86 a performance capability so advanced that it'll be in a class of one for many years.

## ***Performance, Features and Choice***

With frequency response flat from 20kHz to 20kHz, dynamic range of more than 90dB, distortion of 0.05%, and crosstalk better than 70dB, the X-86 will virtually outperform any other machine on the market. Unique features include 14" reel capacity, tach or SMPTE counter, built-in autolocator, two analog cue tracks, time code track and auxiliary digital track, very low power consumption, razor splice editing, external sync input and easy servicing.

You can choose between three versions of the X-86, each specifically tailored to the requirements of music recording, film or broadcast use, and it is even available with a 96kHz sampling rate showing a frequency response beyond 30kHz.

## ***The only Digital Family***

Mitsubishi offers a complete range of digital audio recorders and support equipment; the X-86 2-track (in three versions) X-400 16-track, X-850 32-track and XE-2 Electronic Editor.

Call or write for more information, and join our family.



Unit 13, Alban Park  
Hatfield Road  
St Albans, Hertfordshire  
Telephone 0727 40584

***X-86***  
***TODAY'S TECHNOLOGY  
TODAY***

# NEWS

## DDA updates

DDA have recently restyled their *D* series consoles thereby allowing more flexibility for standard metering options. The new design also allows the production of larger frame sizes (32, 48 and 56 module—the latter giving 44/8/2 using PA type outputs). The restyled consoles also incorporate a unique module fastening system which provides much easier access. The new consoles are electronically compatible with existing consoles and there should be no problems mixing old and new modules.

A new Auxillary Returns has also been developed with each module containing four independent return sections. All standard frame configurations are quoted with space to accommodate two of these

modules.

The *AMR24* is now also available in two expanded frame configurations with the 24 output version available with up to 44 inputs. DDA have also developed a version with 32 Group/Monitor modules. This offers a maximum 36/32 with connectors, patchbay and monitoring for two 32-track machines. Both versions are supplied in a 122 in frame with full patchbay and metering.

**Dearden Davies Associates Ltd,**  
Unit 1, Inwood Business Park,  
Whitton Road, Hounslow,  
Middlesex TW3 2EB, UK. Tel:  
01-570 7161.

**USA:** Klark-Teknik Electronics Inc,  
30B Banfi Plaza North, Farmingdale,  
NY 11735, USA. Tel: (516) 249-3660.



## Digitrans hw 870

Dutch recording facility, Wisseloord Studios, have developed the *hw 870* bi-directional digital audio converter. The *hw 870* enables completely digital two-way conversion between the Sony *PCM-3324* multitrack recorder and the Mitsubishi *X-850*, AEG *MX-850* or Otari *D-900* PD multitrack machines. This removes the need to use the D/A A/D converters.

The 19 in rack unit contains three main sections: power supply, master

module and six channel modules (four channels per module). A master switch selects between DASH or PD format with LEDs indicating 44.1 or 48 kHz sampling. A front panel trim pot is provided for sync error.

Emphasis can be switched in or out on the channel modules and LEDs indicate the presence of data on each channel.

**Henk Korff, Wisseloord Studios,**  
Hilversum, Holland. Tel: 35-17256.

## Stirling/ITA overbridge

Stirling/ITA have developed a new overbridge for mounting Dolby units on the Otari *MTR90*. The unit is available in either a flat-pack or ready assembled version complete with wiring loom. Fitting is straightforward with the necessary

mounting hardware included.

The overbridge is compatible with all Dolby systems including SR and the *XP24*.

**Stirling/ITA, 1 Canfield Place,**  
Swiss Cottage, London NW6 3BT,  
UK. Tel: 01-625 4515.



## BSS MSR-604 mic splitter

Brooke Siren Systems have recently released details of the *MSR-604* microphone signal distribution system. The 1 U high case contains four fully independent channels. Signal degradation is claimed to have been virtually eliminated and overall performance improved with the provision of proper current driving stages for long multicore runs.

Each channel has two rear mounted, electronically balanced outputs to drive front-of-house and stage monitor mixer feeds and two, front mounted transformer balanced outputs to drive radio, TV or mobile recording facilities. All channels have an electronically balanced input,

independent phantom power switch and gain/headroom control. The unit also has a local/remote gain selection (+4 dB/+14 dB) facility, the latter being accessed via the FOH console's phantom power switch.

A 1 U high, separate power supply (*MSR-602*) provides the necessary DC power and is capable of driving up to 10 *MSR-604s* (40 channels) via power in/out sockets at the rear of the *MSR-604*.

**BSS Ltd, 202-208 New North Road,**  
London N1 7BL, UK. Tel: 01-226 0099.

**USA:** Klark Technik Electronics Inc,  
30B Banfi Plaza North, Farmingdale,  
NY 11735. Tel: (516) 249 3660.

## CEM DPE equaliser

The *DPE* is a parametric digital equaliser with 99 program memories and MIDI interface. In common with all the variable parameters input gain is controlled via two up/down push button controls. Four-band equalisation is provided (20 to 600 Hz; 60 Hz to 2 kHz; 200 Hz to 8 kHz and 600 Hz to 20 kHz). Q, centre-band gain and centre frequency are all selectable. A Band Selection panel uses LEDs to indicate clipping bypass mode and to indicate on the main display which frequency band is being adjusted or displayed.

As with the input, the output has

adjustable levels (0-99) and a 10-segment bargraph indicating levels.

The unit features a BNC video output enabling the display of all 99 programs (in pages of 20 programs) and the user to display any selected EQ curve. With the optional *DPE/S* board the single-channel configuration can be converted to dual channel use. The *DPE* uses a 1 U high 19 in rack mount case. **CEM Electronica SRL, Strada Statale Ticinese N5, 28040 Varallo Pombia (Novara), Italy.**





The fact that we don't want to mention digital recording in this advert is no reflection on its undoubted merits, or the merits of Brüel & Kjær Series 4000 Professional Microphones.

The thing is, we've seen enough adverts claiming that the ultimate microphone for digital recording has arrived; too many in fact. To paraphrase Shakespeare, "methinks they do protest too much". And he was acknowledged as a genius without mentioning digital recording once....

All we'd like to say is: don't listen to us, listen to our microphones. They speak for themselves.

#### SERIES 4000 PROFESSIONAL MICROPHONES

**Brüel & Kjær** 

**Brüel & Kjær (UK) Ltd**

Harrow Weald Lodge · 92 Uxbridge Road · Harrow · Middlesex · HA3 6BZ · Telephone: 01 9542366

Australia (02) 736-1755 · Austria 02235/563\*0 · Belgium 02/241-8982 · Brazil 11-2468149 · Canada (514) 695-8225 · Finland (90) 8017044  
France (1) 64572010 · Federal Republic of Germany (04106) 4055 · Great Britain (01) 954-2366 · Holland 03 402-39994 · Italy (02) 5244141  
Japan 03-435-4813 · Republic of Korea 02-793-6886 · Norway 02-84 6360 · Spain (91) 268 10 00 · Sweden (08) 711 27 30  
Switzerland (01) 8606705 · Taiwan (02) 7139303 · USA (617) 481-7000 · Local representatives and service organisations world-wide

86-348

# MUSIC NEWS

## Korg DS-8

The DS-8 is a compact multi-timbral FM synthesiser. It features a 5-octave velocity and pressure sensitive keyboard and a large LCD display for editing sounds, defining keyboard splits and multisplits, and controlling MIDI parameters.

The rear panel has connections for MIDI In, Out and Thru, Left/Mono and Right Audio Out, Control Pedal and Assignable Footswitch, Program Up footswitch and stereo headphones. The front panel features an A/B balance slider that mixes the outputs of two independent sets of FM tone generators, and there are also controls for overall Timbre, overall EG (envelope) rate, Velocity On/Off,

After Touch On/Off, Portamento On/Off and Multi Effects On/Off/Select buttons. The latter unit offers Long Delay, Short Delay, Doubling, Flanger, Chorus and Manual options.

Editing is carried out using a single data entry slider and four keyboard modes—single, layer, double and multi—can be selected. There are 100 onboard memories with another 100 accessible using a RAM card. A joystick performance control is provided.

All editing functions are labelled on the top panel and MIDI functions include Pitchbend, After Touch and System Exclusive filter.

## Hybrid Arts

Software for the Atari ST micros from the Hybrid Arts range is now available in the UK. *EZ-Track* is a straightforward 20-track polyphonic MIDI composer intended as an introduction to MIDI sequencing.

*MIDITrack* is a more advanced composer with a massive note capacity and two synchronisation options—MIDI and clock pulse, or MIDI and SMPTE.

*DX-Android* is an 'intelligent' editor for the Yamaha DX synthesisers. It acts as a patch

librarian, storing thousands of sounds on a single disk, but can also create new musically useful sounds using artificial intelligence routines.

*CZ-Android* has many of the same facilities and is intended for the Casio CZ range of synthesisers.

Hybrid Arts, PO Box 480845, Los Angeles, CA 90048, USA. Tel: (818) 508-7443.

UK: Syndromic Music, 24-26 Avenue Mews, London N10 3NP. Tel: 01-831 9489.

## DS-8 assessment

The DS-8 has a warmer sound than Yamaha's FM synthesisers, thanks in part to its built-in digital delay line. It is capable of string sounds reminiscent of both FM and analogue synthesisers, very clear percussive sounds, and some very warm effects. It is compact and inexpensive and its multitimbral facilities make it ideal for MIDI composition provided that the lack of individual outputs is not seen as a great disadvantage.

Korg have also launched the SQ-8, a miniature battery-powered 8-track MIDI sequencer which is ideal for use with the DS-8 or with other MIDI equipment.

UK: Korg UK, 32-34 Gordon House Road, London NW5 1NE. Tel: 01-267 5151.

USA: Korg USA, 89 Frost Street, Westbury, NY 11590. Tel: (516) 333-9100.



## Looks like it's

Getting the producer, the manager, the roadie and the tape op. to help is one solution - but their hands aren't the same as your hands, and the final mix won't be your mix.

Necam gives you as many extra pairs of hands as you need, whenever you need them - and they're all yours!



No juggling with fader bars and cursors on VDUs or trying to null LED indicators in time to switch to 'write'. No noise and distortion from VCAs. Just real faders moving in real time, reproducing your previous best mix precisely as you did it and instantly - instinctively - updating it however and whenever you choose.



# RSF SD140 drum machine

The SD140 is a digital drum machine featuring MIDI and user sampling. It has 14 sounds on board and any of these can be replaced by a user sample of similar length. The Bass Drum and Toms have programmable filters while the Hi-Hat has programmable decay.

Functions are arranged in four 'pages' to cover Compose, Inputs & Outputs, MIDI and Sampling facilities. Each sound has a separate output and there are two main displays, a 2-digit LED and an LCD window. The membrane switches for programming are reminiscent of those on the Yamaha DX7; patterns are programmed in real-time, with

variable auto-correction, by tapping the front panel sound pads. The SD140 synchronises to MIDI, tape or drum machine clocks (24/48/96 ppqn).

The sampling process is very straightforward but samples cannot be trimmed, individually re-tuned or otherwise edited. User samples are retained in memory while power is off and can be saved via MIDI to a computer or other System Exclusive data recorder. A software editing package for samples will be available for the Atari ST computer.

UK: Capelle Music, 333A London Road, Hadleigh, Essex. Tel: 0702 559383.

# Bacchus software

Bacchus are the first company to introduce a software editing package for Yamaha's TX81Z rack mounting multitimbral FM synthesiser. The Bacchus *Graphic Editing System* runs on the IBM PC and compatibles and shows all four operators simultaneously together with the sinewave and non-sinewave forms available on the synth.

Also displayed are the algorithm selected, effects (delay, pan and

chorus) and MIDI implementation (Note Limits, Detune, Note Shift and so on). An icon system under mouse control is used in the package and the company also has available a *Voice Manager* modular editor/librarian for the Yamaha DX and TX synths.

Bacchus Software Systems, 2210 Wilshire Blvd. # 330, Santa Monica, CA 90403, USA. Tel: (213) 820-9145.

# Oberheim Electronics DPX1

Oberheim's DPX-1 is the first 'digital sample player', a 19 in rack mounting unit which cannot sample itself but which can play back sound disks from other samplers.

Since the filters and amplifiers of the Prophet 2000, Ensoniq *Mirage* and Emulator II only exist in software, the DPX-1 can imitate their playback functions with 8-note polyphony and full MIDI control.

The DPX-1 has two front panel disk

drives or 3½ in (Prophet, *Mirage*) and 5¼ in (Emulator II) disks, and the next likely software update will cover the Akai S9000 sampler.

Oberheim Electronics Inc, 2250 S Barrington Avenue, Los Angeles, CA 90064, USA. Tel: (213) 473-6574.

UK: Sound Technology, 6 Letchworth Business Park, Avenue 1, Letchworth, Herts SG6 2BB. Tel: 0462 675675. □



## time for a Necam.

You can group together as many faders as you like and have as many different groups as you need.

You can set up muting groups, take up to 999 snapshots of fader and mute settings, use up to 128 event switches, merge different mixes into each other or into snapshot set-ups.

Necam gives you all this, plus precise machine control and replay accuracy to ¼ SMPTE frame.

There's nothing like having Necam at your fingertips, so call John Andrews and book the Neve demo studio for your first experience.

We know you'll like the look of what you see.



CAPTURING SOUND AT ITS PUREST

# *What does it take to pro-audio centre*

*It takes more than a warehouse  
full of the best audio equipment.*

*We've got that of course.*

*Names like Amcron – we have every*

*Our directors started out building  
sound systems for rising stars, and  
the staff all have very similar  
backgrounds.*

*We've found that customers  
from way back are still  
regulars – like Phil Collins,  
who we knew when he  
was just a drummer.*



**WELCOME**

*model. Yamaha – we're the biggest  
pro-audio stockist in the UK. Sony –  
we launched low-cost digital in this  
country.*

*It also takes experience: at HHB  
you won't find slick salesmen, just a  
team that knows its business inside  
out.*

*You'll also find everyone at HHB  
has a one-track mind. (Or 24 track  
if you want to see our range of Amek  
TAC consoles and Sony recorders!)*



*It takes space for facilities:  
while you're exploring our  
demo room, you can be sure  
that our service and hire*







# Be the best equipped in the country?

*departments are hard at it to preserve our reputation for the best back-up in the business.*

*Our enlarged digital editing suite now includes AMS Audiofile, as well*



*as Sony CD mastering.*

*It takes comfort: we realised that the hair shirt was out of fashion*



*and so in our new premises you'll find a high level of comfort that extends throughout the building.*

*And of course to make your visit more palatable we're always happy to offer you suitable refreshments.*

*We feel that, with our unmatched technical expertise, approachability and reputation – and our new premises – we've earned the right to call ourselves the first pro-audio – centre in the country.*



# The art of shaping sound.

SONEX is a high-performance acoustical foam that upgrades your studio inexpensively. Ideal for a temporary isolation booth, it can also eliminate slap echo and harsh resonances in the main room or silence noisy tape equipment in the control booth. Write for our color brochure today.

SONEX is manufactured by Illbruck and distributed exclusively to the pro sound market by Alpha Audio.

**Alpha Audio**  
2049 West Broad Street  
Richmond, Virginia 23220 USA (804) 358-3852  
Telex 469037 (ALPHAAUD CI)

Acoustic Products for the Audio Industry



# Gateway

SCHOOL OF RECORDING  
MUSIC TECHNOLOGY  
AND  
MEDIA STUDIES

## EUROPE'S LEADING MUSIC

### INDUSTRY SCHOOL

Courses for 1987:-

- Primary and Advanced Multitrack Recording
- Sampling and Midi Workshops
- Composing and Producing Radio and T.V. Commercials
- The Synthesizer Week, FM/DX Programming Weekends
- Synchronisation, using codes (SMPTE/EBU) Music to Picture

For complete Brochure and Prospectus Call:-  
Gateway School of Recording  
and Music Technology

1A Salcott Road, London SW11 6DQ. 01-350 0340

We give a Certificate of Recognition for each completed Course.

Gateway Courses should not be confused with  
ANY others offered...

# Noise Gates Should be Seen & Not Heard

A noisegate should close a signal path when the intended signal is absent. When open, the noisegate should pass the signal with nothing added, subtracted or changed.

With its unique application of optical switches (rather than the noisier VCA's used conventionally) the Omni Craft offers very low noise & high performance - at an affordable price.

Just £199.00 buys you four noise gates in a mains-powered, rack-mounting package, with facilities to "key" the gates from external triggers as well as adjustable Range, Threshold and Release Time.

Also available are plug-ins for most popular rack systems.

Studio performance for the budget-conscious!

Call us for literature & information.

## Omni Craft - - - the quiet one!

APRS Stand  
No. SB35



Audio Marketing Group, Unit 19, Holder Rd., Aldershot, Hants, GU12 4RH, UK.  
Tel: (0252) 319171



# **SHURE**<sup>®</sup>

## SM58



# **It's the real thing.**

Distributed by HW International, 3-5 Eden Grove, London N7 8EQ. Telephone: 01-607 2717

# GOOD EARTH

## *Janet Angus visits this refurbished London studio*

In 1985 Good Earth found they had a problem. The studio was block booked for nine months by the Moody Blues. That in itself didn't appear to be a problem—quite the reverse really since the studio's income was guaranteed for that period. The only trouble with bookings of this nature, as every studio owner will know, is that when you resurface at the end of it, your regular customers are nowhere to be seen. Having been turned away they have been forced to look elsewhere and, in many cases, are gone never to return again.

This is what happened at Good Earth. Producer/owner Tony Visconti had happily worked away over the years on various album projects with an administrative staff looking after that side of things, and the studio had more or less run itself. Now he had to find a way of letting the world know that the studio was back on the market and would welcome the odd client.

This is where Stephen Bentinck-Budd came in, bringing with him a type of professional marketing strategy which most studios never even glimpse, let alone experience. He also brought with him Omer-li Choen whose determination and singlemindedness matches that of Budd's, and the results have been encouraging to say the least.

Budd: "I was appointed as marketing manager, managing budgets and producers, as well as Tony and the engineers. We have been trying to get back on an even keel after the nine month lockout and we are now (September) just about full."

Omer-li's first task was to research the market and establish exactly where the client base lay.

"I built up a database. You know, so many studios market

haphazardly. The first step is to find out exactly who is there; who makes the bookings? I collated a list of addresses and telephone numbers of as many producers as possible. Then we invited producers and record companies to come and see what we are about. We must have seen about 100 people. And we also held a launch party—just exposing the studio to as many people as we possibly could."

The market research showed what many studio managers suspect but can never quite prove—that the equipment is not necessarily the most important factor in making a producer choose a specific facility. As far as the producer is concerned, amazingly enough, one of the first and foremost criteria turned out to be parking. That's easily dealt with—Good Earth now provide parking for the producer. So what else?

"We discovered that things like the atmosphere and efficiency—intangible things for the most part—were people's reasons for choosing a studio. The staff have got a lot to do with it.

"Because studios in London are all pretty much the same it is these intangible reasons that swing the balance; the only thing left is the human element.

"At first it didn't seem necessary to have a house engineer but we found that people do want someone around who knows the equipment well. Our engineer Sid Wells came from MCA studios and in fact he has started being in real demand; people do tend to use him.

"It is the service element that counts. Staff have to be, not exactly servile, but polite, friendly. It is the difference between going to a restaurant where the waiter is quite polite but just serves you, and a restaurant where the waiter wants to give you the best service possible. So we provide extras, like food.

"The one most important element of marketing is the job you do whilst the client is here and that's the indefinable bit."

Stephen spends a very large proportion of his time on the telephone, keeping potential clients constantly aware of the studio.

"On average I call between 15 and 20 people a day, about 250 a month, just finding out record company plans and keeping in touch, keeping people aware of the studio. We started this marketing campaign in January and in February people started coming in. The studio now is working 29 days a month. We are getting a lot of new bands down here and also we have boosted the number of producers; they, after all, are the main clients.

"When price cutting started we worked out what the unit scale had to be through cost analysis and we found that we could charge a reasonable price. We are not the cheapest but we are certainly not the most expensive either. Aiming to work 29 days a month, apart from the financial advantages, keeps the staff morale high when the facility is a constant hive of activity."

This in itself presents a more acceptable face to visiting potential clients. One day a month is given over to 16 hours maintenance.

Marketing is an area that most studios really don't know that much about, and even those that have an idea, don't have the time to sit down and work it out properly. With increasing competition and the 'price cutting war' currently in progress in





Bend me shape me  
as long as you



anyway you want me  
love me it's all right.

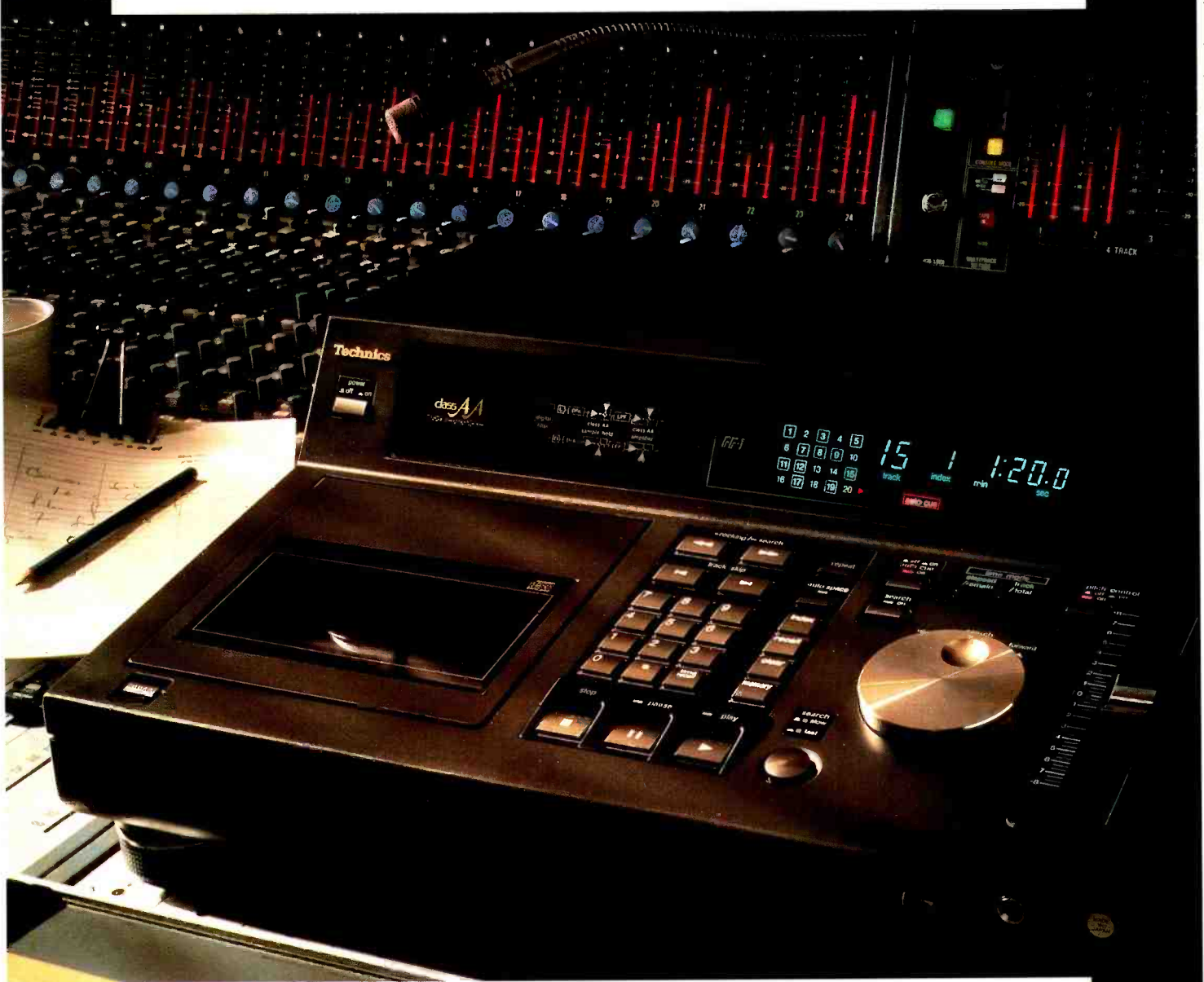

## Technics SLP 1200 Professional CD Player.

The Technics SLP 1200 is one of the most versatile players you can buy.

A rocker switch allows forward or backward jumps in 0.15 sec. increments for scratch effects.

And thanks to its fast/slow search dial and  $\pm 8\%$  pitch control, disco mixing is also possible. The former feature lets you cue to 0.04 secs accuracy, while the latter allows you to play over a semitone sharp or flat.

For broadcast use, no other CD player has such advanced programme facilities with direct entry and memory of cue points to 0.1 secs, auto-cue, which finds the start of the music, repeat function and remote control to name but a few.

As for sound quality, its damped chassis, independent power supplies, separate D/A converters for each channel and Class AA operation are some of the things that put it in a class of its own.

TECHNICS, 300-318 BATH ROAD, SLOUGH, BERKS. SL1 6JB. TEL: SLOUGH 34522



many places, marketing is becoming more and more important.

Omer-li: "Marketing doesn't necessarily mean spending lots of money on a series of ads—it might be better spent on personal appointments; the more you do, the more effect you have."

Stephen suggested that the APRS might have a function here; as a central body to the industry, maybe it could play an educational/advisory role? "The APRS could be a more effectual body to unite studios to look at pricing etc. If the APRS were more involved (we have very little contact with them), maybe lobbying record companies, etc, explaining the studios' point of view. It could be the leading light in telling studios how to run a business. It could organise workshops on business development to give them ideas."

Good Earth came into being some 10 years ago, then a private facility. Over the years it has developed a lot of character as the rooms evolved. The recording facilities currently include a spacious control room, looking on to the main recording area with its variable acoustics; adjoining this is a separate isolation room, and a third recording area is provided by the 'live drum room' cum pool room.

The control room underwent acoustic refinement in early 1983 when Andy Munro was brought in:

"By then the hessian and wooden plank era had been phased out by Tony Visconti who had implemented various changes. The Eastlake small monitors (which I much prefer to the big system because there is less of a gap between the bass drivers and the mid range horn) were freestanding on Dexian frames and there was no LF damping to speak of—typical of many rooms built in the 60s and early 70s when acoustic treatment consisted of sticking a load of Rockwool on a wall, 'Oh it's too dead' and putting some wood on instead. Consequently the room didn't have the correct balance between LF and HF. Most people used too much HF absorption and not enough LF. In reality LF absorbers are not as effective as HF absorbers and so you have to use proportionately more of them.

"So we flush mounted the speakers to increase the in-phase component of the LF radiation and then created a tuned LF absorbing front wall which we brought round on to the side walls (with all the acoustic panelling) which were consequently splayed."

The other major acoustic alteration carried out was the installation of a large angled bass absorber at the rear of the room (1) to tighten the overall bass and (2) to add diffusion at mid and high frequencies.

The monitors were EQ'd with White graphics, "Set to optimise the loudspeaker response, not to introduce so-called room equalisation, which is a fruitless exercise.

"When I first measured the room there was no balance between the left and right—stereo summing was very poor, which I consider to be the absolute criteria—more so than having absolutely flat frequency response.

"The thing I remember most about Good Earth, however, is that the enterprise was designed so that the whole job could be finished in three days and three nights. The only problem we had was a horrendous earth hum. The carpenters finally finished sweeping up at 9am and David Bowie arrived for a television session at 10am!"

The recording rooms themselves were left to continue their

natural development.

"As far as I'm aware the studios are the result of having the sound tailored over the years by process of experiment and it was generally agreed that no work would be done on them by me. We thought about making the live room more isolated but decided in the end it was best to leave it alone. If it works, don't touch it."

The live room really is the pool (as in snooker, not swimming) room and a false metal 'rolling ceiling' slides into position, blotting out a skylight and providing a certain amount of isolation and liveness to the sound of the room. There is an increasing trend towards sounds of character rather than tightly controlled sounds as a result of the predictable nature of the sound given out by the various electronic keyboards, etc, which abound in the studio today. The whole approach towards acoustic environments is changing as people seek something new and different.

This has worked in Good Earth's favour as far as the live room is concerned—the rather unpredictable nature of the acoustic has led to it making a name for itself, and a good many clients have been known to come back simply for that.

A relatively dead 14×10½ ft isolation booth adjoins the main recording area with communication windows through. The L-shaped main room is 582 ft<sup>2</sup> and has a variable acoustic which is principally live (parquet floored) at the back, and deader (carpeted) at the control room end. Drums are often also recorded in here, with the walls' acoustics variable by the utilisation of different treatments including wood, curtains or aluminium sheets. This room is home of the 6 ft Steinway grand piano which is visited by the piano tuner twice a week.

Further recording area is provided by the large corridor which runs alongside the studio and which has been known to be used for vocals on many an occasion, especially when a band wants to record everything live which they still do even these days, sometimes!

The control room floor is arranged in three tiers—a variation on the breaking up standing waves theme whereby the ceiling is usually varied—in this case it is flat. Across the room widthways sits the SSL *SL 4048E* 48-channel console with the nearfield Yamaha *NS10M* and Auratone monitors.

Tape recorders are two Otari *MTR-90* 24-tracks with btx *Shadow* synchroniser; Otari *MTR12* ½ in, and Studer *A80* ½ in and ¼ in machines. There is also a Sony *F1* and two Studer *A710* cassette decks.

Outboard effects are arranged on the right hand side of the console. A recently acquired Publison *Infernal Machine 90* heads the list which includes Lexicon *224XL*, AMS *15.80S*, Quantec *Room Simulator*, EMT *140* plate and *240 Gold Foil*, DeltaLab *DL2* and *DL1* digital delays, Eventide *Instant Flanger*, MXR *Autoflangers* and *Autophasers*, two Drawmer dual noise gates, two UREI *1176* compressor/limiters, Audio+Design *Vocal Stressor* and stereo limiter, two Allison *Gain Brains*, two Kepex noise gates, *Scamp* rack, Orban 3-channel de-esser, Trident and Audio+Design equalisers and Bokse *SU-8* Universal Synchroniser.

The microphone complement is suitably varied, latest addition being Sanken *CU41s* which Tony Visconti is reputed to have fallen in love with.

Tenders are out (or in, whatever tenders do) for phase two of the Good Earth resurrection; a second studio-cum-programming suite-cum-video post-production/jingles/soundtracks room. The equipment complement planned is to include Soundtracs *CM4400* mixing console with Soundcraft *Saturn* 24-track machine and a U-matic. It is to have its own separate vocal booth in addition to being tie-lined to the live room. This studio will be totally separate from the rest of the facility with its own kitchen and relaxation area.

A recent project at Good Earth was the music for *Biggles* the movie. Stephen: "We want to establish Good Earth firmly in the A/V market. We are ideally placed for it and it won't cost too much money to move into it." With advertising and film agencies pouring out of the surrounding Soho streets, it would be hard to contradict him.

Meanwhile, Tony Visconti continues to produce records and provide overall direction, his latest decision being to hold off on the digital front for the time being.

Good Earth Studios, 59 Dean Street, London W1V 5HH, UK. Tel: 01-439 1272.



# QUALITY CONTROLLER.

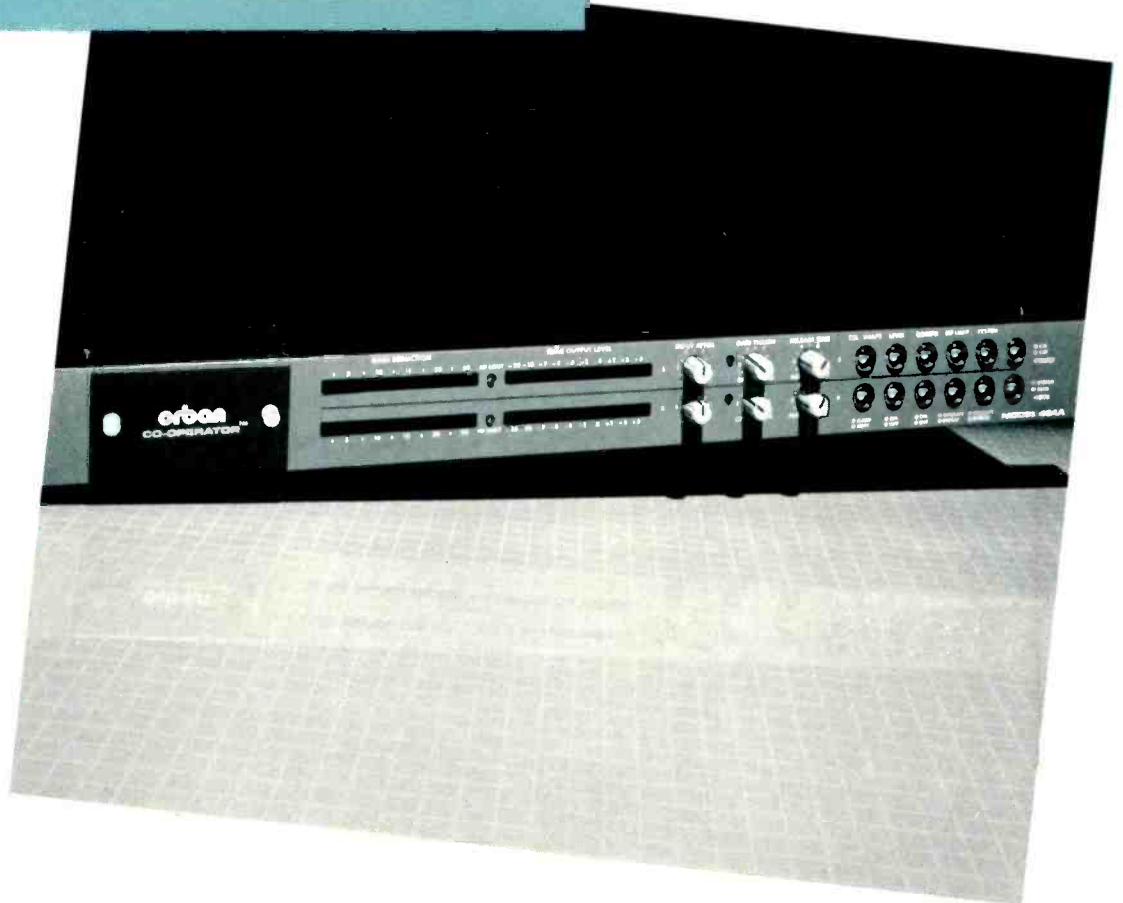

## THE NEW ORBAN CO-OPERATOR™ AGC SYSTEM

Introducing the *Co-Operator*: an integrated, easy-to-use Gated Stereo Leveler/Compressor/HF Limiter/Peak Clipper in a powerful and economical dual-channel package. The *Co-Operator* automatically rides gain, controls excessive high frequency levels, and limits peaks while protecting audio and video tape recorders, broadcast cart machines, mic channels, STL microwave links, and SCA's.

Its simplified controls ensure top results—even from non-technical operators. Yet there is sufficient versatility so that you are never locked into a single "sound".

The *Co-Operator* rides gain subtly and intelligently—the way *you* would—to preserve the dynamic "feel" of the program material while effectively controlling levels. Or, if gain-riding is not desired, use it as a transparent, no-compromise safety limiter. Either way, it's always alert to safeguard audio quality. It contains a:

- Smooth leveler for transparent gain riding—without long-term distortion-producing overshoots
- Fast compressor and/or peak clipper can be activated to protect against short-term transients. Adjustable release time and release shape let you optimize processing for music or voice
- "Silence Gate" and compressor/leveler crosscoupling team up to prevent pumping and noise breathing
- HF Limiter with six switchable pre-emphasis curves from 25 to 150 us allow you to match the medium being protected and guard against sibilance overload

Ask your Dealer about Orban's new Model 464A *Co-Operator*—your subtle, automatic quality controller.

### Orban Associates Inc.

645 Bryant St., San Francisco, CA 94107 (415) 957-1067 Telex: 17-1480



SCENIC SOUNDS EQUIPMENT LIMITED  
Unit 2, 12 William Road, London NW1 3EN.  
Tel: 01-387 1262 Telex: 27939 SCENIC G

# MICROPHONES

*We present a listing of microphones and relevant components, that have been introduced since January 1986.*

## AKG

**D112:** dynamic bass mic, incorporating 'bass tube' and resonance cavity for better transient response.

**C414B-ULS:** designed specifically for digital recording, it has four switchable polar patterns, 1 in gold-sputtered foil diaphragm with Teflon coated lead out wires, 12 dB/octave bass cutout filter and -10 or -20 dB attenuation.

**C410:** stage or studio condenser for vocals, mounted on ultra-lightweight boom; phantom powered voltages between 9 and 52.

**C522 ENG:** twin cardioid condenser for broadcast use.

**D321:** dynamic hypercardioid for vocals.

**AKG Akustische u Kino-Geräte GmbH, Brunhildengasse 1, Wien, A-1150, Austria. Tel: (222) 956517.**

**UK:** AKG Acoustics Ltd, Vienna Court, Catteshall Wharf, Catteshall Lane, Godalming GU7 1JG. Tel: 04868 25702.

**USA:** AKG Acoustics Inc, 77 Selleck Street,

Stamford, CT 06902. Tel: (203) 348-2121.

## Audio-Technica

**AT803a:** omnidirectional miniature condenser, phantom or battery powered.

**AT805S:** omnidirectional miniature condenser as above, 2 in long and 5/8 in diameter; for vocals and acoustic instruments.

**AT831a:** unidirectional (cardioid) mini condenser; battery or remote powered; for vocals and instruments.

**AT871:** Recently launched boundary mic.

**Audio-Technica Corporation, 2206 Naruse, Machida, Tokyo 194, Japan. Tel: (0427) 295111.**

**UK:** Audilec Distribution Ltd, 6 Hornsby Square, Southfields Industrial Park, Landon West, Essex SS15 6SD. Tel: 0268 419198/9.

**USA:** Audio-Technica US Inc, 1221 Commerce Drive, Stow, OH 44224. Tel: (216) 686-2600.

## Beyer Dynamic

**MCE6:** electret capacitor mic for wide range of instruments; advance on **MCE5**.

**MCE80:** back electret hypercardioid with 12-48 V phantom or battery powering.

**M 380:** dynamic directional fig-of-eight for instruments, especially bass drums.

**M700:** dynamic supercardioid condenser vocal mic; built-in footfall filter.

**MPC 40:** electret condenser boundary mic for piano.

**MC 734 N:** cardioid condenser for solo vocals: switchable 3-stage filter to change low frequency response; for studio applications.

**MC 734 PA:** stage version of above; 6 dB higher audio level.

**MC 736 N:** directional condenser cardioid lob shotgun; phantom power between 12-48 V; designed for field pickups.

**MC 737 N:** same basic design as above with large signal to noise ratio, very high sensitivity.

**MC 740:** studio condenser with six switchable polar patterns (5-pin XLR version allows remote



*C-ducer tape mic for percussion*



*Audio-Technica AT871 boundary mic*

switching); 3-pin XLR is standard.

**Beyer Dynamic Elektrotechnische Fabrik, Theresienstrasse 8, Postfach 1320, Heilbronn, D-7100, West Germany. Tel: (71) 316170.**

**UK:** Beyer Dynamic (GB) Ltd, Unit 14, Cliffe Industrial Estate, Lewes, BN8 6JL. Tel: 0273 479411.

**USA:** Beyer Dynamic (USA) Inc, 5-05 Burns Avenue, Hicksville, NY 11801. Tel: (516) 935-8000.

## Bruel & Kjaer

**Stereo microphone sets:** pairs of mics, within 1 dB amplitude response and 10° phase. Set 3529 is powered by B&K 2812 supply and 3530 by 48 V phantom powering. Kit includes case, clips, graduated mounting boom and two types of protection grid.

**Bruel & Kjaer A/S, Naerum, DK-2850, Denmark. Tel: (2) 800500.**

**UK:** Bruel & Kjaer (UK) Ltd, Harrow Weald Lodge, 92 Uxbridge Road, Harrow HA3 6BZ. Tel: 01-954 2366.

**USA:** Bruel & Kjaer Instruments Inc, 185 Forest Street, Marlborough, MA 01752. Tel: (617) 481-7000.

## C-Ducer

**APT (Acoustic Percussion Trigger):** includes control unit to trigger drum machines from acoustic drums.

**UK:** Audio Marketing Group, Unit 19, Holder Road, Aldershot, Hants GU12 4RH. Tel: 0252 319171.

**USA:** C-T Audio Marketing Inc, South Tech Industrial Plaza, 3050 SW 14 Place, Suite 3, Boynton Beach, FL 33435. Tel: (305) 738-0622.

## Crown/Amcron

**GLM 100:** miniature omnidirectional electret condenser.

**GLM 200:** same as above but hypercardioid; both designed for stage or studio, clipping to instruments, performers and structures. All-purpose clip, tie bar, belt clip and windscreen included.

**Crown International Inc, 1718 West Mishawaka Road, Elkhart, IN 46517. Tel: (219) 294-8000.**

**UK:** HHB Hire & Sales, 73-75 Scrubbs Lane, London NW1 6QU. Tel: 01-961 3295.

## Electro-Voice

**PL10:** dynamic cardioid with extended frequency response for low frequency drums, guitars and bass cabinets; integral nesting system, steel housing, internal shock mount/blast filter.

**PLA:** mini omnidirectional condenser for acoustic instruments; battery or phantom powered and designed to run in dual mode.

**N/D series:** range of cardioid dynamic mics.

**Electro-Voice Inc, 600 Cecil Street, Buchanan, MI 49107, USA. Tel: (616) 695-6831.**

**UK:** Shuttlesound Ltd, Unit 15, Osiers Estate, Osiers Road, London SW18 1EJ. Tel: 01-871 0966.

## Milab

**LC-28:** transformerless line level condenser; preamp and line driver amp incorporated, separately switchable 20 dB pad and high pass



Combining quality philosophies with new manufacturing methods brings greater choice. In the past, affordable consoles were limited to a narrow range of options. T.A.C. have changed all that. We bring the philosophy of choice together with a competitive pricing policy and an outstanding manufacturing quality. We offer many advantages of a custom console builder with our product range. There are now at least 52 versions of the TAC scorpion, including the new XPB jackfield version. And if a split monitor console is not to your liking, the TAC Matchless series offers an In-Line console with specifications proven in over 200 installations worldwide.

# TAC

## SOUND ENGINEERING

# SCORPION

- Steel Chassis
- 8, 12 or 16 Buss
- 4 or 8 Aux Sends
- Split Monitor Console
- 8, 16 or 24 Track Monitoring
- Comprehensive TT Patchbay
- Printed Circuit Motherboard
- 4 Band Semi Parametric Equaliser
- Wide Variety of Configurations and Options



# MATCHLESS



- 24 Buss
- 8 Aux Sends
- 2 Mute Groups
- 8 Effects Returns
- 8 Audio Subgroups
- 24 Track In-Line Monitor
- 26 + 36 Input Frame Sizes
- 19" Switchcraft TT Jackfield
- 4 Band Semi-Parametric Equaliser
- Dual Signal Paths on Each Input Module

# TAC

## TOTAL AUDIO CONCEPTS

Sales and Factory  
**TOTAL AUDIO CONCEPTS**  
 Unit 17, Bar Lane Industrial Park,  
 Bar Lane, Bastford,  
 Nottingham NG6 0HU  
 Tel: 0602 783306  
 Telex: 37329 AMEKNI G

In the USA:  
**AMEK CONSOLES INC.**  
 10815 Burbank Blvd,  
 North Hollywood, CA 91601  
 Tel: 818 508 9788  
 Telex: 662526 AMEK USA





# Ever get the feeling you have to buy more video/audio patching than you really need?

The trouble with ordinary patching systems is that they're not really cost effective for small edit requirements because they give you more jacks than you need.

But now ADC's exclusive Video/Audio Modular Patchbay – VAMP – lets you custom design your own bay. Our VAMP saves you money, because you can buy the exact number of video or audio circuits you need; and add circuits as your needs increase.

It saves time too – just ring ADC or an ADC broadcast distributor for fast order turnaround and delivery.

And it saves space by allowing you to combine audio and video patching in one bay.

VAMP audio modules feature ADC's exclusive OCP punchdown ID contact for fast, durable terminations, with no soldering or wire stripping. Video modules feature ADC's SJ2000 self-normalling jacks, or a pair of CJ2011 single coax jacks. Each VAMP chassis holds up to 20 modules, which you can mix or match audio/video to suit your needs.

For flexible audio and video patching with no wasted space or unnecessary costs, revamp your system with ADC's VAMP.



## Breeze through circuit labelling with SAILS

Our exclusive Self-Adhesive Identification Labelling System – SAILS – makes circuit labelling easy and efficient. Each VAMP chassis comes with a sheet of form feed computer-printable adhesive-backed labels. The unique polyester label material won't smear or yellow, it's easy to write or type on, and removes cleanly without tearing. Over half-inch width gives you plenty of room for circuit designation.

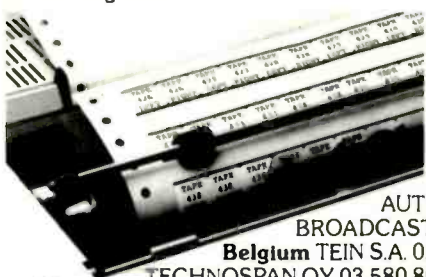

ADC Europe Ltd., 126/128 Crockhamwell Road, Woodley, Berkshire, RG5 3JY. Tel: 0734 441955. Telex: 849103 ADCEUR G. Fax: 0734 441001

**AUTHORIZED ADC BROADCAST DISTRIBUTORS:**  
**Belgium** TEIN S.A. 02 215-7785; **Finland** TECHNOSPAN OY 03 580-803; **France** AUDIO PLUS SA 014 585-1599; **Israel** SOTEK 04 254-401; **Italy** SIRCES SRL 02 564962; **Norway** ERCOTRON A/S 02 933-565; **Spain** LEXON SA 03 203-4804; **Sweden** ERCOTRON AB 08 756-7355.





# MICROPHONES

filter, direct input to tape machines and consoles.  
**Milab International AB, PO Box 510,  
Spinngatan 3, S-260 50 Billesholm, Sweden.  
Tel: 42 730 70.**

**UK:** Court Acoustics Sales Ltd, 29 Beethoven Street, London W10 4LG. Tel: 01-960 8178.

**USA:** EXP, 11288 Ventura Blvd, Suite 304, Studio City, CA 91604. Tel: (818) 843-1830.

## Neumann

**U 87 Ai:** all-purpose condenser mic, continuing U 87 tradition; omni, cardioid and fig-of-eight polar patterns, DC converter replaces internal batteries, improved transmission of 8 to 10 dB, improved S/N ratio of 3 to 6 dB.

**RSM 190i:** stereo condenser mic; mid-hypercardioid, side-fig-of-eight polar patterns, compatible with mono, mid-side or left-right configuration, remote controllable stereo image, high overload capability and sensitivity, transformerless balanced output.

**KU 81 i:** dummy head with two pressure mics where 'ears' should be. Polar pattern similar to human outer ears; loudspeaker monitoring capability; auditory canal of only 4 mm.

**Georg Neumann GmbH, Charlottenstrasse 3, Berlin 61, D-1000, West Germany. Tel: (30) 251 4091.**

**UK:** FWO Bauch Ltd, 49 Theobald Road, Boreham Wood, Herts WD6 4RZ. Tel: 01-953 0091.

**USA:** Gotham Audio Corporation, Eighth Floor, 1790 Broadway, New York, NY 10019. Tel: (212) 765-3410.

## Ramsa

**WM series:** pro miniature electret condenser mics for wide range of applications; **WM-S1** and **WM-S5** need 48 V phantom powering, **WM-S2** and **WM-S10 12** to 48 V phantom power or standard batteries.

**UK:** Panasonic UK Ltd, 300 Bath Road, Slough, Berkshire SL1 6JB. Tel: 0753 34522.

**USA:** Panasonic Professional Audio Division, Matsushita Electric Corporation of America, 1 Panasonic Way, Secaucus, NJ 07094. Tel: (201) 348-7000.

## Shure

**16L-LC:** low impedance, unidirectional, battery powered electret for stage vocals and instrument miking.

**SM48:** low-impedance unidirectional (cardioid) dynamic vocal mic for all-round use.

**SM94:** unidirectional (cardioid) for instrument miking and recording.

**SM96:** same as above but for vocals.

**Shure Brothers Inc, 222 Hartrey Avenue, Evanston, IL 60202. Tel: (312) 866-2200.**

**UK:** H W International Ltd, 3-5 Eden Grove, London N7 8EQ. Tel: 01-607 2717.

## Sennheiser

**MKH range:** RF circuitry condenser mics with transformerless inputs. **MKH 20** is omnidirectional, **MKH 30** is fig-of-eight, **MKH 40** is cardioid; all designed specifically for digital

recording.

**Sennheiser Electronic AG, Wedemark, D-3002, West Germany. Tel: (5130) 5830.**

**UK:** Hayden Laboratories Ltd, Hayden House, Chiltern Hill, Chalfont St Peter, Gerrards Cross, Bucks SL9 9UG. Tel: 0753 888447.

**USA:** Sennheiser Electronic Corporation, 48 West 38th Street, New York, NY 10018. Tel: (212) 994-9440.

## Sanken

**CMS-2:** MS stereo push-pull condenser with flat response, titanium diaphragm and weighing only 180 g (0.4 lb).

**CMS-7:** MS stereo condenser, lightweight and portable, hand-held for indoor/outdoor TV and radio broadcasting; in cardioid and hypercardioid formats.

**UK:** Stirling ITA, 1 Canfield Place, London NW6 3BT. Tel: 01-625 4515.

**USA:** Martin Audio, 423 West 55th Street, New York, NY 10019. Tel: (212) 541-5900.

## Sony

**ECM-44:** general application omnidirectional with 8.5 mm capsule for unobtrusive miking; powered by internal AA batteries.

**UK:** Sony Broadcast (UK) Ltd, Belgrave House, Basing View, Basingstoke, Hants RG21 2LA. Tel: 0256 55011.

**USA:** Sony Corporation of America, Professional Audio Division, Sony Drive, Park Ridge, NJ 07656. Tel: (212) 418-9470.

## TOA

**K4:** condenser mic with interchangeable cardioid capsules—**KMM** music, **KMV** male voice, **KFV** female voice.

**KY:** condenser cardioid compact pencil type with interchangeable capsules **YMM**, **YMV** and **YFV** for music, male and female voice.

**K1/2/3:** range of cardioid electrets for general purpose, musical instrument and vocal use respectively.

**J1/2/3:** range of large capsule dynamic cardioids with similar uses to **K** series.

**UK:** TOA Electronics Ltd, Hutton Industrial Estate, Tallon Road, Brentwood, Essex CM13 1TG. Tel: 0277 233882.

**USA:** TOA Electronics Inc, 480 Carlton Court, South San Francisco, CA 94080. Tel: (415) 588-2538.

## Yamaha

**MZ Series:** pro unidirectional dynamic mics for vocals and instruments. **MZ101**, **MZ102Be**, **MZ103Be** for vocals; **MZ104** is general purpose; **MZ105Be** for percussion instruments. 'Be' denotes Yamaha's beryllium diaphragm, others have 2-layer polyester film.

**Yamaha Nippon Gakki Co Ltd, Hamamatsu, Japan.**

**UK:** Yamaha-Kemble Music (UK) Ltd, Mount Avenue, Bletchley, Milton Keynes MK1 1JE. Tel: 0908 71771.

**USA:** Yamaha International Corp, PO Box 6600, Beuna Park, CA 90620. Tel: (714) 522-9105. □

When your  
ambitions  
are greater  
than your  
budget



You need microphones that are sensitive but you also need microphones that can handle peaks without distortion.

You want microphones that are right for vocals, while microphones for instrument recording are essential.

And with all of them you need to be able to capture the right sound without resorting to lots of equalisation.

You could end up with an expensive collection of different microphones.

Or you could equally well choose just one — the LC-25 from Milab.

See Milab microphones at the APRS, Stand SB4-6.

# Milab

Court Acoustics Sales Ltd,  
29 Beethoven Street, London W10 4LG  
Telephone 01-960 8178

# ELECTROSTATIC PRESSURE TRANSDUCERS

*Dipl-Ing Jörg Wuttke of Schoeps discusses some conventional and new viewpoints*

FIG. 1  
DIFFERENT DEPTH PERSPECTIVES AS A FUNCTION OF THE MICROPHONE PLACEMENT

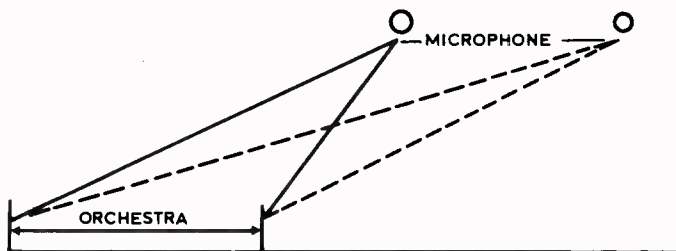

FIG. 2  
POLAR DIAGRAM FOR MK2 AND MK3

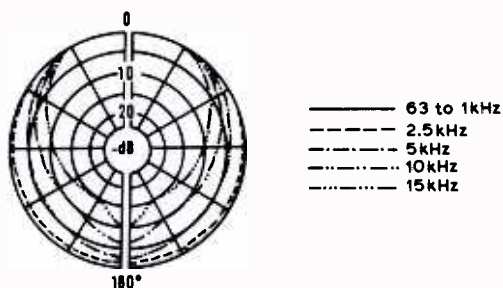
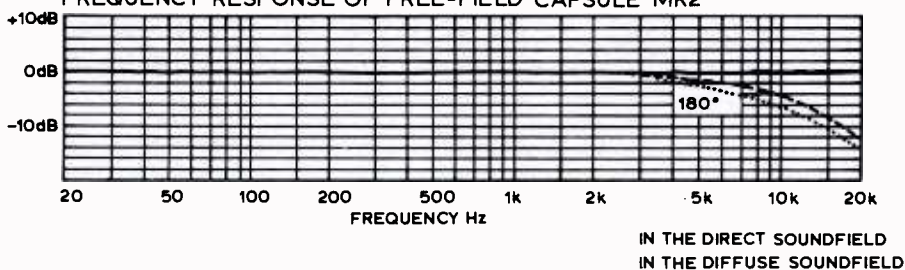

FIG. 3  
FREQUENCY RESPONSE OF FREE-FIELD CAPSULE MK2



When we consider various recording techniques, the advantages and disadvantages of omnidirectional microphones should be compared with those of the more commonly employed directional microphones. In theory, exactly the same balance of direct and reverberant sound energy could be obtained through the use of an omnidirectional microphone instead of a cardioid, simply by placing the omni closer to the sound source by a 'distance factor' equal to  $1/\sqrt{3}$ . But this simple correspondence does not usually hold up in practice. 'Distance factors' always assume a point source of sound and perfectly spherical wave fronts which arrive at the microphone precisely on its axis. Perhaps these conditions can be partially met when miking a single instrument but when we record any larger group of instruments or an entire orchestra, the situation becomes much more complicated. We no longer have anything that resembles a point source of sound, so there is no basis for calculating fixed distances or angles of sound incidence. Furthermore, the spatial perspective of an omnidirectional microphone is geometrically quite different from that 'seen' by a more distant cardioid (Fig 1). The ratio of the distances to the nearest and farthest instruments is different.

I am not offering any value judgments here on either of these two microphone techniques. There are factors that weigh for and against each microphone type and each recording method; those who are adept at both methods can obtain excellent results with whichever one they choose to employ. But I do want to make it clear that directional microphones cannot be replaced by omnidirectional microphones as easily as is sometimes supposed.

One very important reason for the growing interest in omnidirectional condenser microphones is their ideal low frequency response. The output voltage of a capacitive transducer is proportional to its membrane excursion; so in principle, it can have unlimited low frequency response. Pressure gradient transducers, on the other hand, have an inherent roll-off beneath about 100 Hz whenever the microphone is more than a few meters away from the sound source and there is no proximity effect. Should there seem to be some conflict between this and the frequency response curves in microphone sales literature, this is due mainly to the circumstances of making measurements in anechoic chambers, where pressure gradient microphones show more low frequency output than would be available in actual use. So given the increasing possibilities for preserving and reproducing even the lowest audio frequencies, especially as a result of digital recording media, omnidirectional condenser microphones have indeed been gaining in importance. Spaced microphones can more readily lead to recordings that have low stereo correlation but the new media are less restrictive in this respect as well.

If we consider the situation at high frequencies, however, we will see the particular problems of the classic pressure transducer. An omnidirectional pickup pattern cannot be maintained at frequencies where the microphone is physically large in relation to the corresponding sound wavelengths. Instead, there will tend to be a more or less sharply defined directionality at high frequencies. As a result, any high frequency



energy which arrives at oblique angles, or from a reverberant soundfield, will not be picked up as strongly as it would be on axis (Fig 2).

Two basic types of pressure transducer have emerged from the practical requirements of acoustical measurement. One is designed for very close and direct placement in the near field of a sound source, or in an acoustically 'dead' environment. The other is suitable for the extreme opposite situation, that is, in a reverberant environment and at a distance where the reflected sound energy is heavily predominant. Fig 3 shows the frequency response curve for the 'free-field' type (Mk2). The response is quite linear on-axis but at oblique angles and in the diffuse field there is a high frequency roll-off. On the other hand, the response of the 'diffuse-field' capsule (Fig 4) is flat in the diffuse soundfield, while showing a high frequency elevation in response to sound arriving on-axis.

Over the years, quite a few recordings of large ensembles or even entire orchestras have been made with only two or three omnidirectional microphones. Some well-known instances of this would include the Jecklin plate, the classic Mercury 'Living Presence' recordings, and many recordings from Telarc. The microphone placement in such recordings is typically at distances from the sound source for which neither a free-field type of transducer nor a diffuse-field type is ideally suited. But the response characteristic that would be the most appropriate for this distance is not easy to define, depending as it usually does on individual properties of the recording environment, on the material that is to be recorded, and on physiological as well as subjective criteria. Schoeps have therefore tried to arrive at a suitable characteristic by means other than pure calculation and measurement.

We asked certain customers to take a pressure microphone having very flat frequency response, and to use precision equalisers to set the frequency response which gave them the sound they liked best. Such a procedure, by the way, would not have been sensible to follow with directional microphones, since many sonic differences among them are known to result from variations in their directional response, something for which an equaliser can never compensate. But the relationship of polar response to frequency is essentially the same in all pressure transducers of similar size and shape, and that is what we are dealing with in this instance. As a matter of fact, even the phase distortion caused by ordinary equalisation is about the same as that which would occur in the transducers acoustically, if their response were to be modified in corresponding fashion.

The results of these listening tests were surprisingly unanimous. The first thing learned from them was that the onset of the high frequency rise in a typical diffuse-field pressure transducer happens too soon—that is, at frequencies which are lower than desirable. Furthermore, their response drops off again above 10 kHz, whereas it should actually continue to rise. The preferred frequency response, for a cylindrically-shaped microphone of 20 mm diameter, would begin to rise at 5 kHz. On a logarithmic frequency scale, it would continue to rise steadily to 20 kHz, where it would reach a value of about +6 dB (Fig 5).

It is not so easy to achieve this particular characteristic in practice. After all, the unwanted

hump in the frequency response of a classic diffuse-field microphone (Fig 4) is not caused by the system resonance alone. Even if the transducer is 'tuned' to a very high frequency, such that its mechanical impedance is like that of a spring throughout the entire audio frequency range, a microphone of average dimensions will still show a rise followed by a drop-off at high frequencies. The reason for this is the influence which the capsule has on the soundfield. Any objects which are not small in comparison with the wavelengths of sound disturb the very soundfield that they are in, by creating diffraction and reflection effects. This then leads to

variations in sound pressure as a function of frequency and the direction of sound incidence. For example, if sound waves with planar wavefronts strike a solid, cube-shaped object head-on, the sound pressure at the centre of the cube's front surface will have a frequency characteristic such as that shown in Fig 6. (Ref. Müller, Blank, Davis—Bell Telephone 1937.)

The conditions depicted have been simplified and stylised in order to make visible the influence of the size of a reflective object. The curve is also shown, not as a function of frequency as such, but in terms of the ratio between the length L of one edge of the cube and the wavelength of the tone.

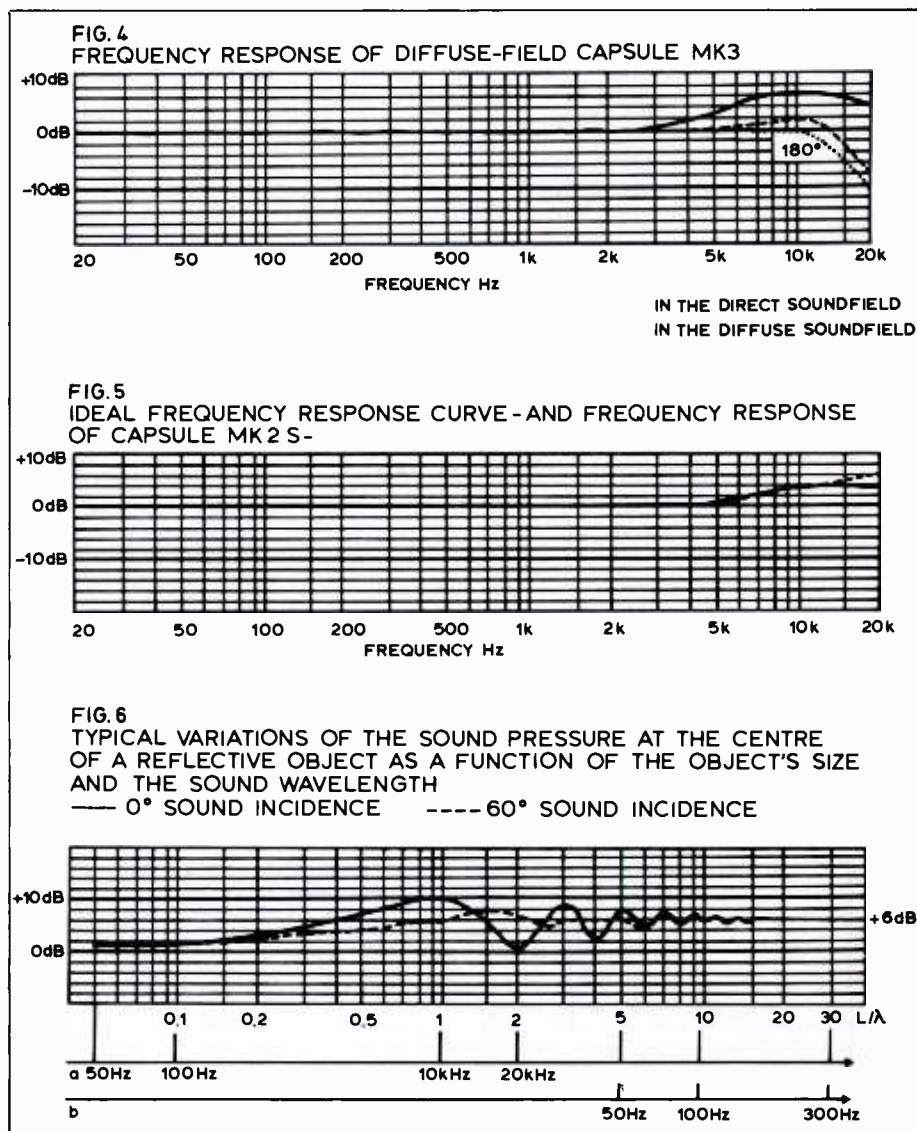

# ELECTROSTATIC PRESSURE TRANSDUCERS

FIG. 7  
MECHANICAL SYSTEM AND ELECTRICAL ANALOGUE OF AN ELECTROSTATIC PRESSURE TRANSDUCER

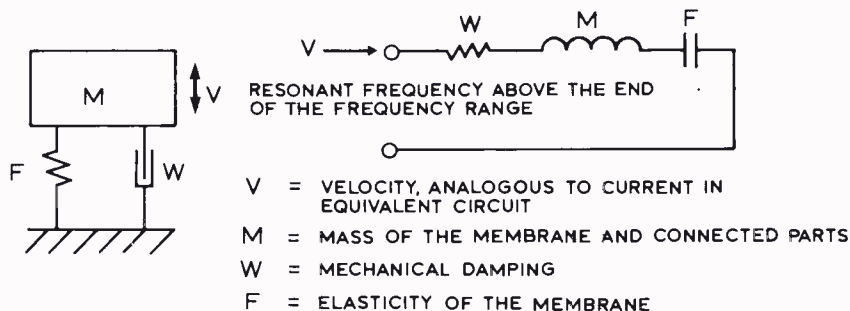
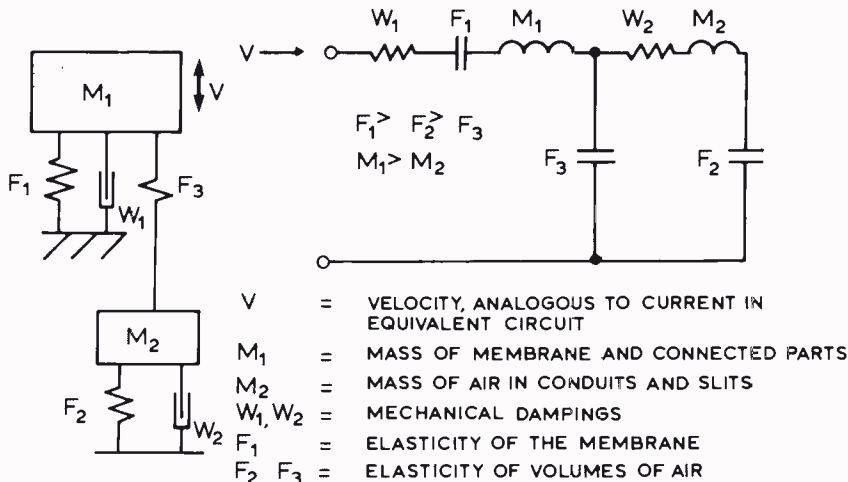

FIG. 8  
SIMPLIFIED MECHANICAL SYSTEM AND ELECTRICAL ANALOGUE OF MK 2 S



With other shapes, such as cylinders, there will be a similar response characteristic but it will always depend greatly on the angle of sound incidence. The greatest increase in pressure will always occur when the sound waves strike the reflecting surface head-on. This corresponds to the greater sensitivity of a microphone to sound arriving on its axis.

Calculating the relationship of  $L$  to  $\lambda$  for a microphone of average size, we arrive at the upper frequency scale (a) of Fig 6. The frequency scale beneath it (b) becomes valid if the microphone diaphragm is placed in the centre of an extremely large plane surface, as with the boundary layer microphone which will be mentioned later.

In order to give a microphone capsule the frequency response of Fig 5 rather than that of Fig 6(a), the moving system must be constructed in an appropriate manner. Fig 7 shows the simplified mechanical diagram of a condenser pressure transducer along with its electrical analogue. An increase in electrical current in this analogy would correspond to a higher sensitivity at any given frequency.

It certainly would be feasible to place the resonance of the series circuit just above the frequency where the pressure characteristic rises, but the high impedance at frequencies just below that would result in a lower output level and thus a reduced signal-to-noise ratio. The frequency response below this resonance would also suffer.

Fig 8 shows the greatly simplified equivalent circuit for a newly developed capsule type, the Mk 2 S. The introduction of the circuit branch with  $W_2$ ,  $M_2$ , and  $F_2$  shunting  $F_1$  (which is resonant at a higher frequency) results in high sensitivity and a signal-to-noise ratio worthy of digital recording technology. Moreover, the impedance characteristic is suitable, when realised with the appropriate dimensions, for extending the frequency response in the manner we have been aiming for. Only above 16 kHz does the rise in frequency response gently begin to turn back (Fig 5). A special bit of detail work which is employed to extend the frequency response, but which cannot be seen in the equivalent circuit diagram, involves making use of the particular distribution of sound pressure on different regions of the membrane.

The accumulation of reactances in the moving system (Fig 8) might lead to the assumption that the phase response will be adversely influenced. In fact, however, it is possible to achieve a degree of linearity equal to that of the pure arc-tangent construction of Fig 7, by the suitable dimensioning of the minimum-phase network shown.

Phase response in audio is rarely discussed, and probably for that reason there exist some false ideas about it. So hopefully it will be all right to mention here that the ideal phase characteristic actually is one which increases as a linear function of frequency.

To illustrate this, let us imagine a hypothetical sound pathway which, of itself, causes absolutely no alteration to any aspect of the sound. At certain frequencies, the length of this pathway would represent one half of the corresponding wavelength, or  $180^\circ$  of phase shift. At twice these same frequencies it would then be equal to a full wavelength, or a  $360^\circ$  phase shift, for exactly the same path length. So the absolute value of the phase angle is not a real consideration. What





## IT DOESN'T MAKE A BAD STUDIO GOOD. IT MAKES A GOOD STUDIO BRILLIANT.

Otari's new DTR 900 digital multitrack recorder isn't the first digital recorder on the market.

But it's undoubtedly one of the most advanced.

For a start, it includes Otari's legendary pinch-rollerless transport.

It combines outstanding sonic performance with utter practicality for the operator.

And best of all, it's ready to work with complete reliability, 365 days a year, from the first day it's installed in your studio.

If that sounds like a machine your studio could use, we'd be delighted to send you a fuller description of it, in our literature.

Alternatively, we'll be happy to arrange a complete demonstration.

But first, we'd like to warn you that the DTR 900 sells for a fairly serious sum of money. And no recording machine – even one as advanced as ours – will make an average studio better than it is.

But all we can say is that if your people have the skills, the DTR 900 will make them shine as never before.

### THE OTARI DTR 900. DIGITAL FOR PROFESSIONALS.

Otari Electric (UK) Limited  
22 Church Street, Slough, SL1 1PI, Berkshire.  
Telephone: (0753) 822381. Telefax: (0753) 823707  
Telex: 849453 OTARI G

Otari Corporation.  
2 Davis Drive,  
Belmont, California 94002  
Telephone: (415) 592-8311  
Telefax: (415) 591-3377  
Telex: 910-376-4890 OTARICORP BLMT

Otari Electric Co Ltd,  
4-29-18 Minami-Ogikubo,  
Suginami-ku  
Tokyo 167  
Telephone: (03) 333-9631  
Telefax: (03) 331-5802  
Telex: J26604 OTRDENKI

Otari Singapore Pte Ltd,  
625 Aljunied Road,  
07-05 Aljunied Ind,  
Complex Singapore 1438  
Telephone: 743-7711  
Telefax: (743) 6430  
Telex: RS36935 OTARI

Otari Electric Deutschland GmbH,  
Rudolf Diesel Strasse 12,  
D-4005 Meerbusch 2  
West Germany  
Telephone: 010 49/2159/50 -861, -862 or -863  
Telefax: 010 49 2159 1778  
Telex: 8531638 OTEL D

# ELECTROSTATIC PRESSURE TRANSDUCERS

## The Definitive Gate



Fixed or tracking four stage envelope lets you create envelopes as well as modifying them.

High resolution filters for frequency conscious gating or programme equalisation.

Trigger mask up to four seconds can be used to remove offbeats or change accent levels.

Envelope delay up to two seconds gives slapback and repeat effects.

**Developed for the new breed of studios where perfection is the only standard. The Rebis RA701 gives the warmth of analogue with digital precision.**

Velocity sensitive MIDI output drives synths and drum machines without the need for special pads or interfaces.

Merge input allows units to be chained to give a single MIDI output.

Stereo and duck facilities, 90dB attenuation range, 5 volt trigger in/out and external key input.



For full information/demonstration contact:

**Rebis Audio Ltd.** Kinver Street, Stourbridge West Midlands DY8 5AB. ENGLAND. Telephone: (0384) 71865. Telex: 335494. Fax: (0384) 397105

**Australia:** John Barry Group, Artarmon N.S.W. 02 439 6955. **Austria:** Bauer Sound, Himberg 02235-89298. **Belgium:** S.E.D., Bruxelles 522 70 64. **Canada:** Heintl Electronics Inc., Ontario 727-1951. **Denmark:** Kinovox A/S, Lyngø 02 18 76 17. **Finland:** Studiotec, Espoo 592055. **France:** High Fidelity Services, Paris 285 0040. **Germany:** Thum & Mahr Audio, Langenfeld 2173-7806-0. **Hong Kong & China:** Audio Consultants Co. Ltd., Kowloon 3-7125251. **Italy:** Startek, Bologna 32 10 63. **Jamaica:** Audiofon Systems Ltd., Kingston 926-2569. **Japan:** Hibino Electro Sound Inc., Tokyo 442-4101. **Netherlands:** Special Audio Products B.V., Amsterdam 140035. **New Zealand:** Maser Broadcast Systems Ltd., Glenfield 444-3583. **Saudi Arabia:** Fadil Halwany & Sons, Dammam 8570848. **Singapore, Malaysia & Indonesia:** Bell & Order, Singapore 7438081. **South Africa:** Tru-Fi Electronics, Johannesburg 786 7177. **Spain:** Singleton Productions, Barcelona 237 70 60. **Sweden:** Tal & Ton, Gothenburg 803620. **Switzerland:** E.M.M. Studio, Basel. 061 54 20 45. **U.S.A.:** Rebis U.S. Atlanta, Georgia 404 633 6626.

must be kept constant is the 'group delay', the rate of change of the phase angle as a function of frequency.

The *Mk 2 S* does have some directivity at high frequencies. Experience shows that this characteristic is helpful for the localisation of sound sources in spaced omni recordings; there still is a demand, however, for a microphone having the same high frequency response in both the free-field and the diffuse-field. The usual way to obtain this is to build smaller microphones but that solution has inherent limitations. For a variety of reasons, smaller membranes have lower sensitivity, which in turn leads to a decreased signal-to-noise ratio. Thus it is no coincidence that practically every cylindrical microphone which you could use without hesitation in a studio today will be at least 16 mm in diameter. A preponderance of such microphones will be found to be approximately 20 mm in diameter.

There is, however, another possible path toward obtaining a more nearly frequency-independent polar response from a pressure transducer. We know that the deviations from omnidirectional response are a function of the diameter of the diaphragm and the size and shape of the microphone housing. If the diaphragm is small in comparison with the sound wavelengths, and there are no diffractions and reflections around the microphone housing, then the directional pattern will always be like that of a 'point source'. Instead of making the microphone smaller to accomplish these objectives, we could try making the body of the microphone very much larger than the sound waves. The response irregularities due to diffraction and reflection, as shown in Fig 6, would then be shifted down to very low frequencies. If the microphone body is large enough, they can be shifted down to infrasonic frequencies where they would have no further audible effect. Within the audio range, the pressure increase, assuming the perfect reflection of sound energy, would amount to 6 dB. Since the degree of pressure increase (Fig 6) at high ratios of  $L$  to  $\lambda$  is less dependent on the angle of sound incidence, the polar diagram also becomes more frequency-independent.

It can easily be figured out that a microphone of this kind would have to be several meters in size. Very thin transducers have therefore been developed which, when set against a large surface, become for practical purposes a part of that surface. These are most easily used by placing them on the floor of a room. While an adequate degree of sound reflection at low frequencies is usually available from walls or floors, a reflector must be provided for the middle and high frequencies. For this reason the microphone capsule is integrated into a rigid plate. Microphones of this type, known as 'boundary layer' microphones, should not be mounted on stands, or else the bumpy response shown in Fig 6 would fall in the middle of the audio frequency range. When the microphone is properly mounted on a large, reflective surface, its directional pattern will be hemispherical and quite independent of frequency. Unlike the classic pressure microphone, there is no need to aim a boundary layer microphone at the sound source. Even at the highest frequencies, the pickup pattern will not tend to become much more sharply directional. □

Presented at the 79th AES Convention in October 1985.



# To us, it's sheet music.

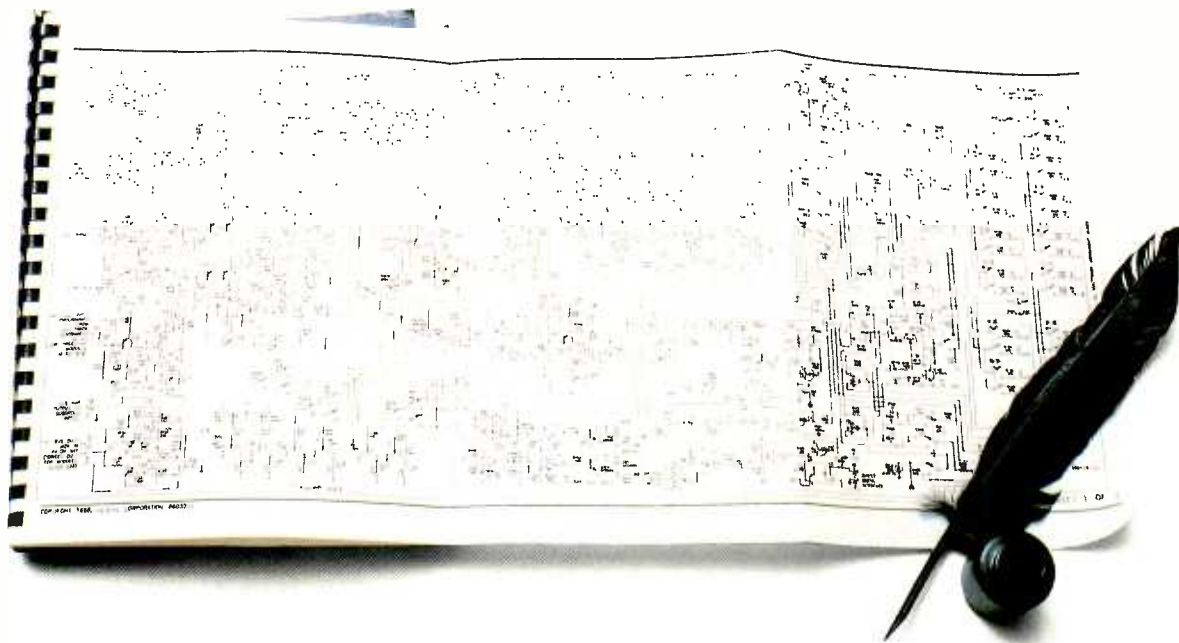

It goes without saying that great performance begins with great design. And that mixing console designs are judged by the most critical performance standard: Great sound.

Still, you may not care that Neotek designed transformerless consoles years ahead of everyone else. Or that we introduced state variable equalizers. Or that circuits that others would say are revolutionary are pretty much old hat with us. Our new hybrid amps, for example.

But you do care about sonic quality. That's how your own work is judged. It's how you judge ours.

Neotek's reputation for performance is built on outstanding circuit design. It's the reason no other console sound compares.

Our sound is the reason Abbey Road bought their first American made console. The reason you find Neotek credits on the finest classical CDs. Why top mic and synthesizer manufacturers demonstrate on Neotek consoles.

You can put our designs to work in your studio. Whether you need to capture a perfect vocal, get every nuance of a drum kit, or input a hot sample that makes your synth sound its best,

your Neotek sound will be remarkably brilliant, clear, and musical.

That's why we work so hard to put our console designs at the leading edge of technology. It puts your sound ahead of all the muddy and fuzzy alternatives.

Great composers write each note carefully on the page. Every passage leads to their vision of the whole. So it is with Neotek's artists of circuit design.

We suspect that Brahms, Beethoven, and Mozart never wrote a schematic.

But if they had. . .

## NEOTEK

1154 west belmont avenue  
chicago, illinois 60657  
(312) 929-6699

# THE STUDIO

## Fiction: Jack Field after Franz Kafka

It looked like snow: it felt like snow. M decided it might snow but it had not by the time he reached the studio gate. As usual the guard took his papers and returned them without examination. The control room was cold, as usual, but M's classification did not allow a heater. He checked that nobody was in the studio then took a piece of copper wire from an inside pocket. Furtively, he removed the monitor amp cover and strapped the wire across the output transistors. His frozen fingers fumbled the oscillator knob to 1 kHz and the output to max. One of M's rare smiles crossed his face as he crouched over the glowing output stage: "An engineer still has a few tricks," he thought, and he thought less happily about the day's session: patriotic songs, as usual, sung by a choir, as mostly. Well, it made the setting up easy but here too was danger: sometimes they changed the arrangements a little so that he would be fading up the lead singer's mic at the wrong time, and the look on the producer's face would tell M that in some remote bureau a mark would be made against his name.

With an inner sigh he unplugged the tone, removed the wire and began the setup. As usual two mic plugs were broken but there were no replacements because the factory had declared them unbreakable in normal use. Once M had seen a fabulous plug, steel cased, three sturdy pins, it was mysteriously marked simply 'X'. He had walked on it, jumped on it, danced on it for 10 minutes before giving it back to the amused visitor.

The Limiter. Yes, the most difficult problem. The shouts of ecstasy at the end of every song (and sometimes in the middle) had made M persevere with his requisition for a stereo limiter or two monos. They had given him one mono: if it was not used, questions would be asked to which the technical answer would be unacceptable. M was still pondering this when his tape op walked in, showing his usual mock regret at having missed the setting up.

"Your dedication to your work is a credit to the studio."

M forced a deprecating smile. The tape op's father was something in a ministry; it was not wise for M to try to assert

his theoretical authority.

Mercifully, the morning session went uneventfully, the producer showing no more than vague displeasure at every aspect of the balance.

Lunch for M was a release, a holiday journey to the dirty cafe across the road; it didn't matter that he often didn't get served until it was too late to eat the tasteless food. Today the soup was good and paying for the rest of the meal he didn't have time to see, he crossed the street and presented his papers to the guard. The guard opened them, looked at them with laboured concentration, glancing frequently at M as if he had never seen him before. M kept silent, hoping he'd gone to sleep over his food.

"You are to see the inspector."

"But I have a session this afternoon," M protested.

"That is in other hands and is no longer your concern."

So it happened; it was almost a relief. But if M could guess what the charge was, he might yet have a chance. The inspector kept him waiting two hours, then made an elaborate pantomime of not noticing M's presence when he was finally ushered in.

"Ah, the *chief* balance engineer of the studio; *please* sit down." Pause.

"We have been just a little worried," (It was always 'we'.) "about some of the requisitions we've been receiving over your signature."

M kept silent.

"You seem to be using a rather large quantity of power transistors," (So that was it.) "and the electronics factory are worried in case their quality is falling."

M had to commit himself. "It is true, inspector, that we have had a number of output transistor failures. My tentative suggestion is that the high levels at which we are monitoring may be the cause."

"Who dictates these levels?"

"The producers, inspector."

"So you think our producers are failing in their responsibilities?"

"Of course not, inspector." It had been a forlorn hope, anyway.

"You have considerable experience of our recordings," said the inspector. "We need someone to assist trainee producers in the selection of new patriotic song writers and performers. Technically it is within your ability, piano and vocal in mono at 3 3/4 in/s. You should be able to ensure a high standard of quality in this most important part of our organisation."

It was snowing when M shuffled into the street. He didn't go back to his apartment: they would already be moving his things out. Instead he caught a train to a small town about half an hour away. He had heard of the organisation called Remix but had been afraid of asking questions. Now it was his only hope. He found the small radio repair shop, pushed open the door.

"Yes?" said the proprietor dully.

"I have a tape recorder that needs a new life," said M.

"What model?"

"A studio model."

"I can't help you."

"Perhaps I'll try Remix."

The proprietor's hand went surreptitiously under the counter and M noticed a soft click from the door lock. Two men appeared from the back of the shop; they had guns.

"We don't like spies. Come with us."

"I'm not a spy. I am. . . I was chief balance engineer of the studio."

"Easily said." They took him to a basement room.

"Listen."

One of his own patriotic song recordings: his face tightened while they watched closely. They stopped the tape.

"Here's a bulk eraser: wipe it!"

He took the tape and placed it almost lovingly on the turntable; the familiar buzz shook the roll as he rotated it and a slow smile of deep pleasure spread across his face. Suddenly the two were embracing him and shaking his hand.

"We've been waiting for you so long, but we must be so careful."

M was crying with emotion but the other two became solemn.

"Hold up your right hand," they said, holding up theirs with the first two fingers in a reverse V, then they commanded M to repeat the axiom of Remix:

"We shall overshoot!" □





# SONY®



## An unbeatable track record

### The number of tracks is one of life's dilemmas.

There are not enough for some, too many for others. So working on the theory that 24 tracks were enough for many projects but 48 were often necessary, we designed the PCM-3324. We followed that with the RM-3310 Remote Control and Synchronizer... 24 or 48 tracks as you like, when you like. Not only that, we made sure that the DASH format provided for up to 48 tracks on a single machine, guaranteeing upward compatibility.

Producers were not slow to realise the creative advantages of this way of working. Studio Managers saw a safer return on their investment, so thanks to them we had a success on our hands. Now we have added the IF-3310 and VSU-3310 to further improve system flexibility.

If you want to know how to solve the track dilemma, find out more about the Sony system, then contact our customers who'll tell you just how good it is. Who are they?... If you don't know perhaps you shouldn't be reading this advertisement.

*To get people into your studio you need to make it inspiring and enjoyable to work in.*

*Enter the Fairlight Series III. The perfect catalyst.*

*Only with a Series III will you create an environment that is both creative and productive for the band and their producer.*

#### START WITH A RASPBERRY

*No matter what is sampled, it will surprise you.*

*With 14 megabytes of waveform RAM (Random Access Memory) you can sample over two and a half minutes of sound at 44.1kHz. (With stereo also a standard feature.)*

*The sound is stored in 16 bit linear format (exactly the same as compact disc) with a sample rate of up to 96kHz, so the sound quality is startling. Existing sounds can be moulded into as many variations as you want. Use them on their own or combine them with others. Either way, the permutations are endless.*

*And the sampling facility itself is so easy to use, building up your own collection of custom made sounds to add to the Series III library is simple.*

#### AN ORCHESTRA OF ONE

*You don't have to be Brahms and Liszt to be staggered by the Series III's vast library of sound samples.*

*The Series III's major sections of the orchestra, such as strings, woodwinds, brass and percussion really wouldn't seem out of place at The Proms.*

*Together with an array of specialised sounds, aural textures and sound effects, the Series III's library is unmatched.*

*But don't be fooled into thinking it's just a cold computer. It's full of sensitive human musical feelings.*

*It has the unique ability to respond with the same range of expressions you might expect from an acoustic instrument. Attack, decay, dynamics, vibrato are just a few that can be set individually for every single key on the keyboard.*

#### COMPLETE CREATIVE CONTROL

*Full control of composition, arrangement and performance within one software suite has never been*



*available before until CAPS. Designed by musicians, CAPS (Composer, Arranger, Performer Sequencer), is an ingenious tool giving you the freedom to build up songs from any other of the machines facilities.*

*Along with the Page R sequencer, a complete composition can be quickly built up by inserting, copying, merging, reversing, rotating and deleting notes and patterns (measures) in real or step time.*





FILLS PEOPLE WITH IDEAS AND A STUDIO WITH PEOPLE.

*Another unique method of music input is the MCL (Music Composition Language) where 'unplayable' poly-rhythms and poly-tonalities can simply be typed in.*

*The Series III also forms the heart of any audio and video post production, with four MIDI ports to control external equipment and a powerful SMPTE 'Eventsync' cue page.*

*Altogether, the most powerful creative and pro-*

*ductive tool in the music industry today.*

*Could you handle a busy studio? Call SYCO today for a demonstration and to be included on the exclusive list of Fairlight Series III equipped studios.*

*fairlight* SERIES III

THE COMPANY BEHIND YOUR SUCCESS

Syco, Conduit Pl London W2 Tel 01-724 2451 Tlx 22278 Fax 01-262 6081

ITALY: CEM ELETTRONICA (0321) 95151; JAPAN: MATSUSHITA ELECTRIC TRADING CO (06) 282 5600; NEW ZEALAND: TEKRAM AGENCIES LTD (3) 792 111; NORWAY: LYDROMMET A/S (02) 114085; SCANDINAVIA: SLT STUDIE OG LYDTEKNIK (01) 713344 (DENMARK); SINGAPORE: JT MUSIC 473 4586; SPAIN: VENTAMATIC (93) 230 9790; SWITZERLAND: EXIM STUDIO AG (061) 54 2045; USA: FAIRLIGHT INSTRUMENTS INC LOS ANGELES (213) 470 6280; NEW YORK (212) 219 2656

# CLARITY BEYOND BELIEF

Sennheiser studio microphones have long stood for quality, being widely used by studios throughout the world. With the increase in digital recording the need for a microphone with extremely low inherent noise and capable of accepting high sound pressure levels with low distortion is required. The MKH 40 with its cardioid response has been designed to meet these requirements.



## MKH 40 P 48

“The clarity of this mic is astonishing...”

Simon Croft *Sound*, February 1986



# SENNHEISER

Hayden Laboratories Ltd, FREEPOST, Hayden House, Chiltern Hill,  
Chalfont St Peter, Bucks SL9 9BS. Tel. (0753) 888447



Sennheiser manufactures an extensive range of audio products. Please tick the appropriate box if you would like information on the following.

Dynamic mics  Electret condenser mics  Tie clip mics   
Studio condenser mics  Radio mics  Infra-red sound  
transmission  Headsets  Headphones

Please send me further information on the Sennheiser range of Dynamic microphones.

NAME .....

ADDRESS .....

.....

.....



# SAJE DEALS THE WINNING HAND!

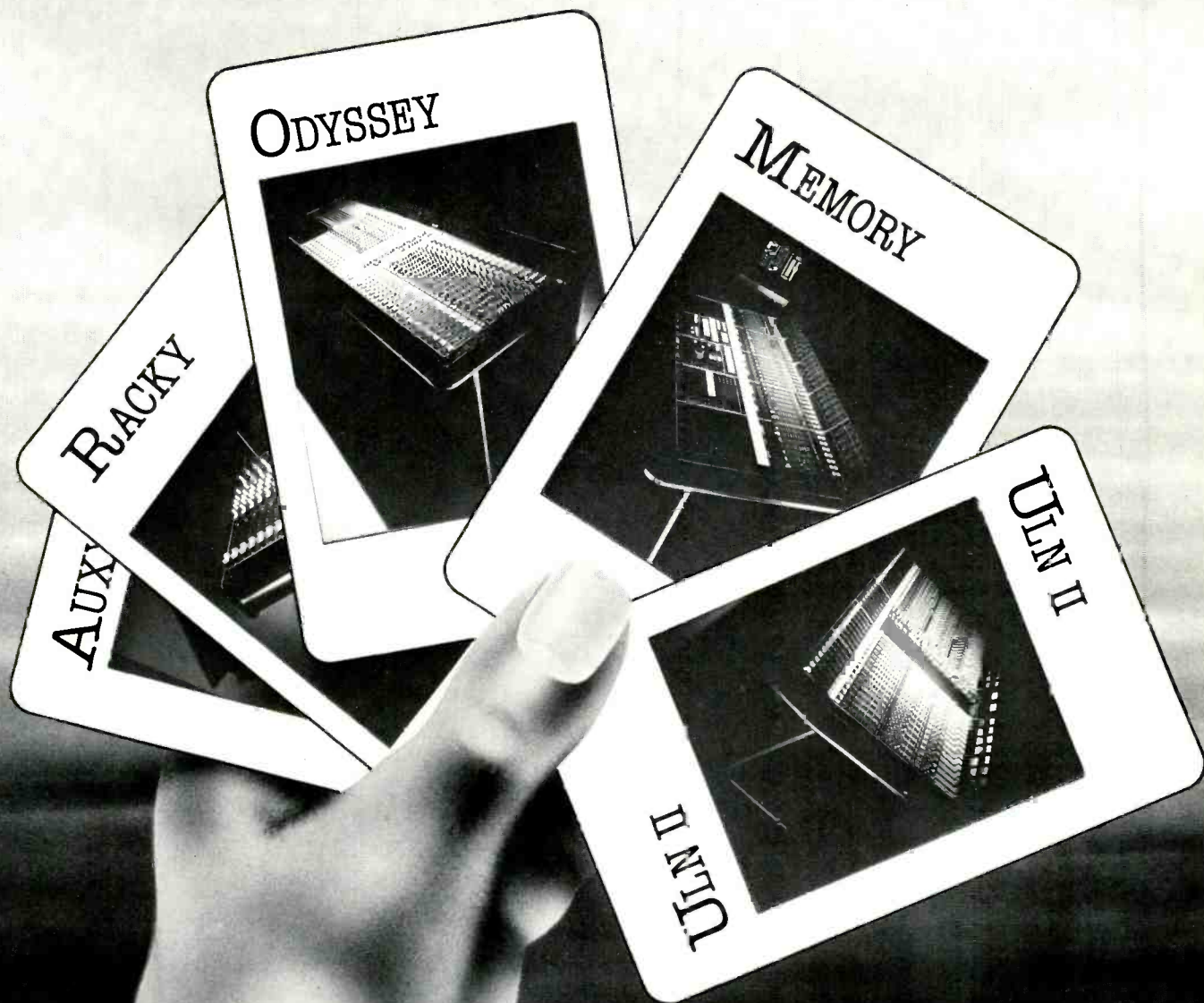

**SAJE** AUDIO CONSOLES

*"Leaders of the Pack"*

3 Rue Verte 95100 Argenteuil France. Telephone: (1) 39.61.15.62 Telex: 699672F SAJE.

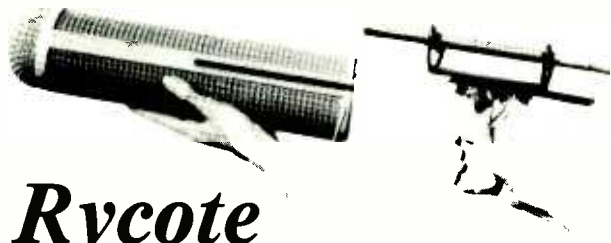

## Rycote windshields

new  
a twist locking end cap  
a fantastic unique  
wind JAMMER  
a large windshield  
for stereo

Rycote Microphone Windshields, New Mills, Slad Road  
Stroud, Gloucestershire GL5 1RN, England  
Tel: 04536 79338

# TWELFTH

## Sound Broadcasting Equipment Show



THURSDAY 24 SEPTEMBER, 1987

EXHIBITORS' DATA  
AVAILABLE ~ CALL

0734 583086

# Sound sense

The famous 4104 STC developed ribbon microphone, now distributed by Seasim Controls Ltd. This robust broadcast quality microphone is ideally suited for outside broadcasting where there is a high level of background noise, it has an excellent record for reliability and is used widely by broadcast networks.

Other microphones in the range include the superb 4038 studio ribbon microphones with a BBC specification making it an outstanding choice for the orchestral hall as well as the broadcast and recording studio. The 4021 pressure operated moving coil microphone for measurement standardisation & high quality studio work & the new 4160 which is a very reasonably priced Cardioid Dynamic Microphone



### Seasim Controls Limited

The Paddocks, Frith Lane,  
Mill Hill, London NW7 1PS  
Tel: 01-346 9271. Telex 21189 24 hour export service worldwide.

Write for brochure for  
information on the complete range  
of microphones.



# WE DIDN'T REACH No.1 BY BEING OUT OF STOCK OR EXPENSIVE!

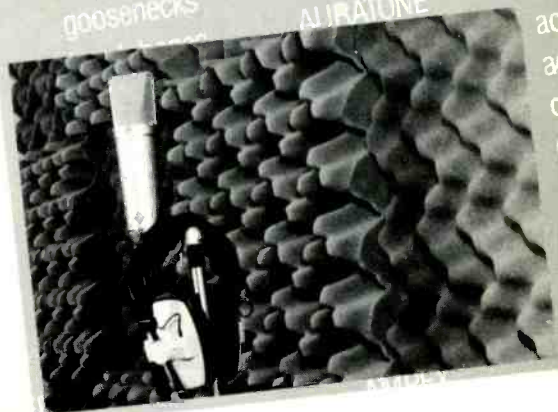

TRADE COUNTER OPENS  
8.30am - 5pm Mon-Friday.

Today's  
orders through  
your door, Today  
or Tomorrow

The UK's largest supplier of  
MICS + TAPES + CABLES  
PLUGS + EFFECTS UNITS  
CASSETTES + RECORDERS  
ACOUSTICAL TREATMENT  
MIXERS + ACCESSORIES  
Wholesale prices all items

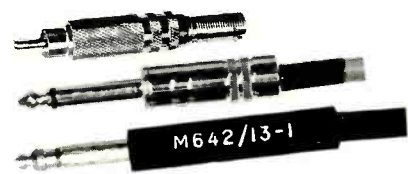

Save time - phone  
**STUDIO SPARES**

TRADE COUNTER  
Open 8.30am - 5pm (Mon - Fri)

TELEPHONE ORDERS: 01-482 1692

16 Stucley Place, Hawley Crescent, Camden Town, London NW1 8NS

*first*

ADMIN: 01-485 4908

Please send free 56 page catalogue

Please send account application form

NAME \_\_\_\_\_

ADDRESS \_\_\_\_\_



# ROYAL OPERA ON TOUR

*David Mellor, sound engineer on the Royal Opera's tour of the Far East, discusses the use of modern PA and monitoring equipment on classic works at home and on tour*

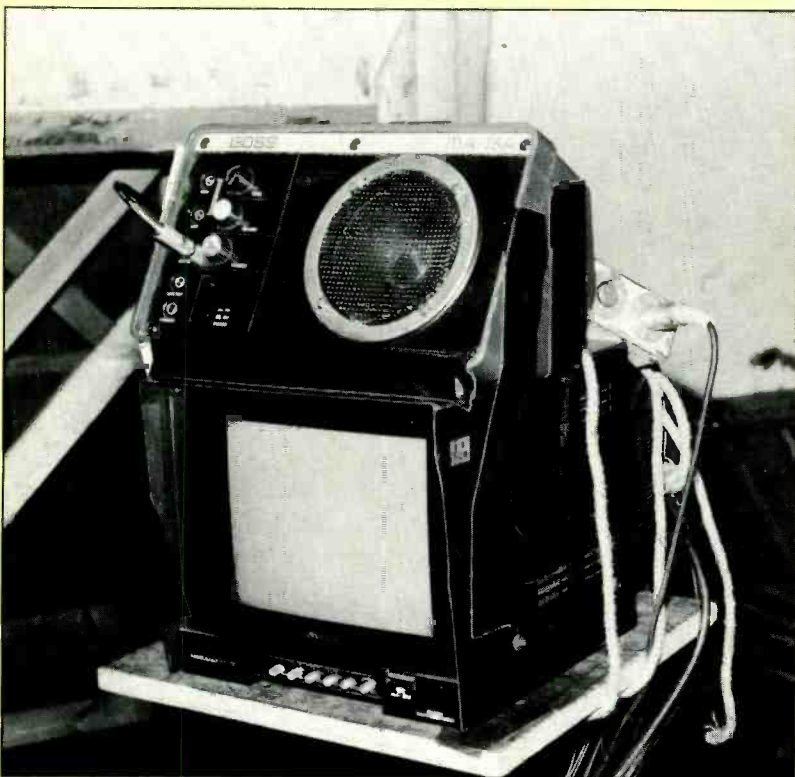

*On tour A/V monitoring foldback from the orchestra pit*

The use of sound and video systems at the Royal Opera House in Covent Garden has grown over the last 20 years under the guidance of such people as Phillip Clifford, Philip Leaver, and the current senior sound engineer, Eric Pressley. While it would be easy to dismiss the present extensive setup merely as a result of the technical staff wanting to improve their facilities, the need for this technology is soundly based on modern production styles and working methods. People at the sharp end of opera—usually the conductor and producer—can achieve things now which were impossible when most of the popular operas were originally performed, thanks to the available technology and the expertise that has been developed to harness it.

Touring, however, is a situation where performers and musicians are prepared to 'rough it' to an extent, although I have found on three trips abroad with the company that there is little room for short cuts. But before going on to describe the specific requirements of the Far East tour, I should explain in general terms the problems that necessarily arise in opera performances.

First of all, though, I should say that at the Royal Opera House, the principal singers are amplified very infrequently, and then only for a production effect (or to counter a difficulty caused by the production). Apart from Stockhausen's 'Donnerstag', which was a special case, amplification would only be used over a few bars of music. So to reiterate the point, there is no 'cheating' at the Royal Opera House—it's definitely not on.

## *Foldback*

I'm sure most people would not believe me if I said that when you stand on stage you cannot hear a 100-piece orchestra in the pit. Nevertheless, this is the case—especially if you are singing with a voice almost loud enough to be heard in the street outside.

Of course, the audience don't want to see giant wedge monitors at the front of the stage, so something more discreet is required. There's no need for the performers to hear the sound of their own voice but they do need to hear the orchestra clearly. When the band is blasting away *fortissimo*, then there is no problem. The difficulties arise when there is a quiet section, or when the producer has taken the action upstage where there is no clear line of sight between the artist and the pit. At 'home', a couple of small column speakers—affectionately known as 'stripeys'—are permanently fixed behind the proscenium arch with more added at the sides of the stage to cover dead areas. I shall explain more about the technique used in positioning these speakers in the descriptions of specific productions.

Given that there must have always been some problem in hearing the orchestra, it becomes apparent that a little foldback (and it is usually less than 100 W worth) can give a producer the freedom to take his performers anywhere on stage while maintaining their ability to hear sound from the pit. We take it for granted now but lack of foldback must have restricted performance standards in the 'good old days'.

The performers on stage are not the only people who need foldback. The stage manager also likes to know what is going on, and we must not forget the poor bloke in the prompt box who can work much more effectively if he can hear the orchestra clearly rather than having to go by the muffled leakage into his enclosure. These people, among others, also like to watch TV.

## *Video*

The one person in an opera performance that everyone needs to be able to see is the conductor. The old-fashioned way of doing this is simply by looking at him, which has the advantages of simplicity and reliability! But consider the possibilities of having a video camera and a few monitors available. By having monitors mounted inside the proscenium arch, and available anywhere in the wings, performers no longer need point their heads at the conductor—or perform amazing contortions—to be able to keep the beat and receive cues. This means that they



can look at each other on stage, or anywhere the producer wants them to.

Some conductors insist that a screen image does not carry quite the same authority as the real thing, and they may have a point. But I am quite convinced that performances can be so much more natural using monitors that it is well worth going to some trouble to find optimum positions for them.

In addition to the conductor camera, a camera is situated in the front-of-house area trained on the stage. This is normally used by the stage manager, but can be made available to anyone else who needs a stage picture.

## Offstage

Among all this new technology at the Royal Opera House are three very useful trolleys. The trolleys each carry a small video monitor, a speaker, headphone outlet and illuminated music stand. The idea is that the chorus-master or members of the music staff—*repetiteurs*—can have access to the conductor at any point backstage. Most operas will have a chorus or an instrumental section performed from the backstage areas and the trolley helps the *repetiteurs* to relay the conductor's beat. In the old days, the function of the trolley was performed by a sharp pair of ears and a hole in the cloth!

In many cases the offstage chorus or band will need to be amplified. This is not because musicians are more expensive than they used to be and that less are used! Once again, it comes down to production methods. Sets are built up much more than they used to be, and chances are that they will obstruct sound much more than their nineteenth century flown cloth counterparts. Hence the need for artificial aids. I am not talking about kW PAs, just subtle reinforcement. High-end domestic speakers such as the Proac range have been found to be suitable because they will deliver sufficient power for the job and yet be small enough to hide in the set. Secreting the speaker 'inside' the performance greatly aids the illusion of natural sound.

## Rehearsal

The differences between a concert sound check for a band and an operatic rehearsal are not small. In the first case, the sound engineer is the performer's link with the audience and in most cases the sound man's importance will be fully recognised. In the operatic theatre however, the sound engineer is the servant of disparate groups of people with usually conflicting requirements. Take as an example a Mozart piece with harpsichord *continuo*. The harpsichord will need its own microphone for foldback as it will often be the only instrument playing. The conflict is that the singers will want to hear plenty of it, yet the conductor will soon notice if the sound from the foldback is leaking into the auditorium. This situation has many parallels, and hopefully the experienced sound engineer will form his own idea of what is in the best interests of the performance as a whole and leave battles of egos to those in a position to have them.

During the rehearsal, if it is a new production or a performance in an unfamiliar theatre, the sound engineer will be satisfying performers' requirements for foldback speakers, video monitors and communication systems, as well as organising his equipment for amplification and sound effects. All the time he will be keeping uppermost in his mind that if one person in the audience becomes aware during the performance of the sound man's existence, then he will have failed.

## On the road

Including technical preparation and rehearsal time, the Far East tour lasted six weeks and covered five theatres in two countries. I would like to concentrate on two operas: Puccini's *Turandot* performed at the NHK theatre Tokyo, and *Samson et Dalila* by Saint-Saens given at the Bunka Kaikan in the same city.

As with any tour, thorough planning was necessary and there had been extensive liaison between the technical management at the Royal Opera House and the Japan Performing Arts

Foundation. It was decided that the best way of organising the sound system was to arrange for some equipment to be provided in Japan and the rest to be shipped over (there is obviously little point in taking a video monitor to Japan, for instance).

The equipment taken was roughly as follows: eight Turner A300 amplifiers (bridged mono); two Turner A500 amplifiers (bridged mono); four Proac *Studio 3* speakers; Audio Developments *AD 007* mixer; Audio Developments *Picomixer*; two Sonifex cartridge players; Lexicon 224 reverb; microphones, spares kits, test equipment etc, and an emergency video system (not used!).

Equipment supplied in Japan: eight Turbosound *TMS 4* speakers and amp racks (TOA *300D*) and crossovers (BSS); ten video monitors of various sizes; eight Boss miniature powered speakers; four Bose *801* speakers; Yamaha foldback mixer and two TOA *300D*s in racks.

The conductor and front of house cameras were supplied by the theatres concerned.

## Open Road

It would have been impossible to have arrived in Japan with a



Takahiro Ono sounds out the Turbosound TMS 4s

# ROYAL OPERA ON TOUR

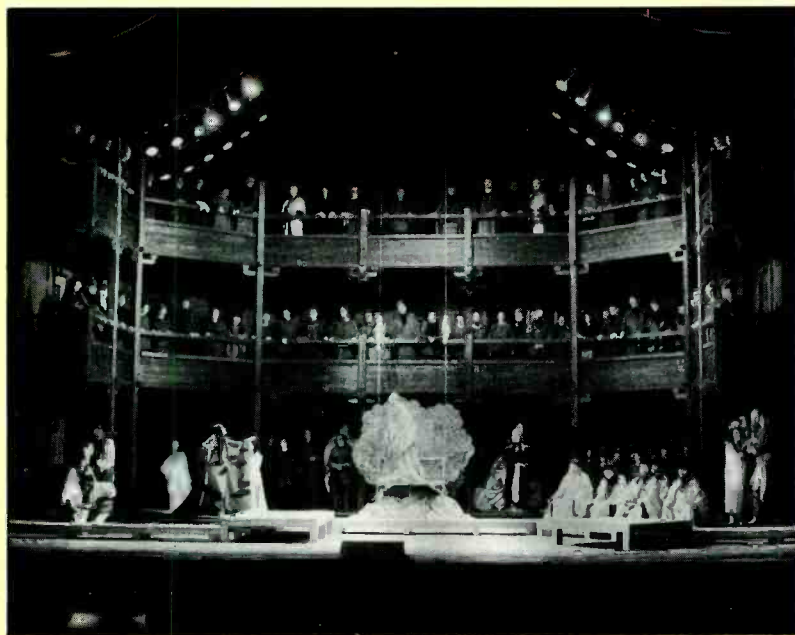
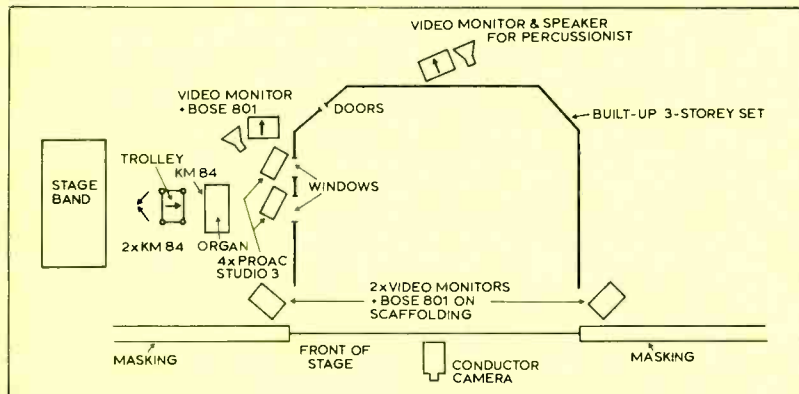

Photo: Zoe Dominic

Stage set of *Turandot*



Layout for *Turandot* Act I

load of gear and rented equipment and expected to have performed a useful function—considering that one's presence should be unnoticed by the audience. Fortunately we had available the services of a PA company, Open Road.

In addition to normal PA work, Open Road have worked on many projects with Japan Performing Arts including the Paris Opera, Vienna State Opera, La Scala and the Metropolitan Opera of New York—a solid background. Although each company has its own quirks I gather that our video requirements in particular were modest in comparison with some.

The main man in Open Road as far as I was concerned was Takahiro Ono, who did a brilliant job throughout the tour, and was ably assisted by Tsuneo Miho and Kyoji Hotta. I cannot praise their work too highly.

## Turandot

*Turandot* was Puccini's last opera, first performed in Milan in 1926. Set in ancient China, it tells a story which would probably not get past the censors if given as a straight TV drama in English. Although I am sure that few people can honestly say that they enjoy the plot, the music is terrific, and can get very loud indeed without artificial aids. In addition to the orchestra, there is a stage band of around 10 or so players and an organ. As the NHK (Japan's national broadcasting organisation) theatre does not boast a pipe organ, an electronic substitute—by Yamaha—was called in. Both the band and the organ had to be amplified.

Although amplifying a band may seem an easy task there are a few small problems which may cause some difficulty. The main one is that the speakers have to be hidden in the set to produce a natural sound—anyone who thinks that he can do this with speakers at the front of the stage and a little clever trickery will soon learn to think again. The diagram shows the speakers to be placed behind open windows in the set on the same side as the band. It used to be more difficult, since there were half-open shutters over the windows when the production was first given in Los Angeles in 1984 (but somehow they did not find their way back to London).

The size of the windows dictates the size of the speakers (four Proac Studio 3s) and their proximity to the band dictates the maximum level before feedback. In practice it has always been possible to achieve enough output to satisfy the conductor, in this case Jacques Delacote. I used a conventional stereo pair of Neumann KM84s. After a period of negotiation with Malcolm, the pit manager, we managed to get the band into a tight enough grouping for this to work. A thorough search for a direct output on the organ proved fruitless, so I put a KM84 on its internal speaker which worked well enough. The little six-channel Picomixer went between the mics and the amps and performed admirably. That was my little bit in the production and I was happy—other people were not.

'We can't see the TVs!' is the typical war cry of the chorus when they are after the blood of a sound engineer.

*Turandot* is a built-up set with two upper storeys where the chorus stand. In Act One, a five metre moon flies in, isolating the conductor from about 50% of the performers on stage. Back home at the Royal Opera House, two video monitors at a height of three metres inside the proscenium arch are sufficient to get round the problem, but at the NHK, two more at stage level were employed. It was found effective to carry this system through to the rest of the shows.

Other monitors were used for a percussion player hitting a gong behind the set, an assistant stage manager cueing entrances and for the conductor of the stage band. The organist could see a monitor already installed in the house for the benefit of the fly operators. Video monitors and speakers do tend to move during a show and my assistant, Steven Zissler, accomplished this task with his usual efficiency. *Turandot* is one of those lovely shows that, as far as sound goes, practically runs itself. One problem that did arise was that there was no way of fading the proscenium video monitors.

Back at Covent Garden we have a Cox fade-to-black unit with which the stage manager can turn down the brightness of the monitors when necessary, during a total blackout for instance. This was the only disappointment we had when we arrived in



# UNIVERSAL

# 普 遍 通 用

# Universale

# Uniuersell

# UNIVERSEL 万 能

Why is it always such a struggle to link audio and video tape transports through most synchronizers? Because each machine speaks a different control language. Translating reel and capstan commands for one type of transport is complicated enough. Factor in a multitude of machine-specific commands and transport design philosophies, and you have a real nightmare.

### Rethinking the synchronizer

That was our first step in unraveling the machine communication and control problems that complicate your work. What makes LYNX the only truly universal synchronizer and machine control interface is an innovative design that uses distributed processing and a unique approach to software architecture. TimeLine's U.S. technology is so advanced, LYNX actually overcomes the "impossible" language barrier between audio machines and video editors.

### Hands-on, not hands-and-knees

The transport synchronizer/resolver interfaces with your tape machine in one step through the front panel menu.

No DIP switches, no rotary switches. No opening the unit to change ROMs. No complicated alignment procedures. Simply hook up the cable and push two buttons.

Even the LYNX can't repair tapes or transports. But when peripheral problems do occur, LYNX has diagnostic messages and status indicators to help you track them down and get back to work fast. LYNX even reads, generates, resolves and translates timecode and pilot.

### Take control

Next time you catch yourself daydreaming about how easy life would be if your tape machines could finally talk to each other, try a LYNX. See how TimeLine's universal machine control interfacing, intuitive front panel operation and outstanding reliability (our first production unit is still in constant use) can make all your audio and video transports work together — and make them all work for you.

# TIMELINE



ELECTORI CO., LTD.

AEG Nederland N.V.  
Prof. Audio Dept.  
Aletta Jacobsiaan 7  
1066 BP AMSTERDAM  
THE NETHERLANDS

**AEG**  
Phone Number: 020-5105486  
Fax (3): 020-5105240



GRISBY MUSIC PROFESSIONAL s.r.l.  
Via delle Industrie, 4  
60022 CASTELFIDARDO (Ancona) - Italy  
Phone (0711) 781714-5-6 Fax (0711) 7819048

**Stirling** ITA

1 Canfield Place, London NW6 3BH, Tel. 01-625 4515.  
Fax: 01-372 6370, Telex 946240 CWFASYG, Ref. No. 19011280.

GEXCO TECHNOLOGY INTERNATIONAL INC.

317 St. Paul's Ave., Jersey City, NJ 07306/USA, Tel. (201) 656-7166, Telex 285261 GEXCEL, Fax. (201) 654-2386

# ROYAL OPERA ON TOUR

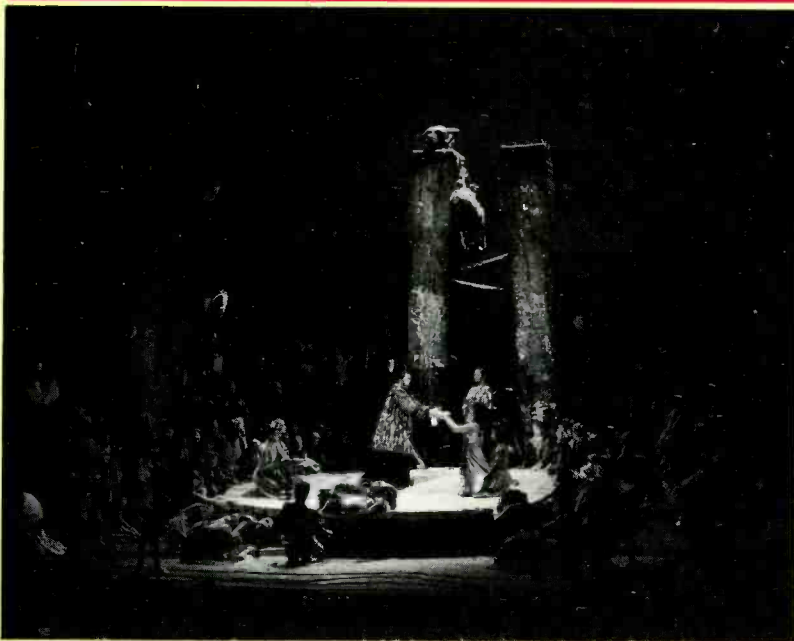
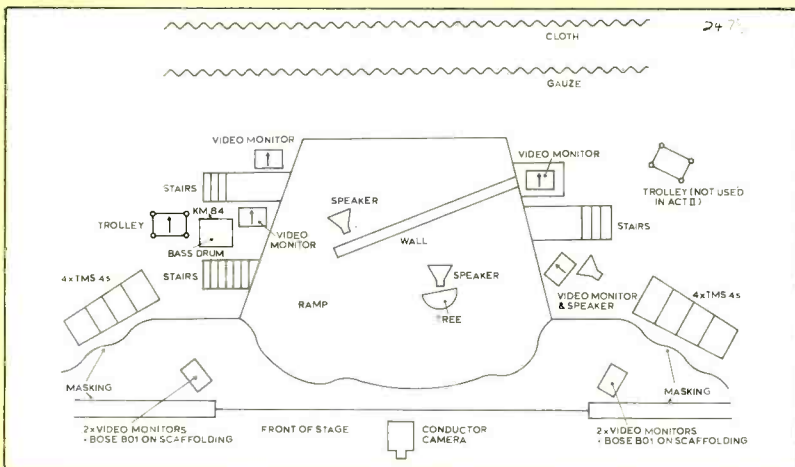

Photo Clive Barda

*Samson et Dalila Act III*



*Layout for Samson et Dalila Act II*

Tokyo, that something we had asked for had not been provided. Obviously we could not have taken our own as Japan is NTSC, so the fact that wires had been crossed somewhere along the line might have been a problem.

Mr Ono came to the rescue, in conjunction with the theatre staff, who arranged for the four proscenium monitors to be on two AC circuits independent of the rest of the theatre equipment so that they could all be switched off simultaneously at the stage manager's cue. It took a radio link to get the message across the stage but at least it worked—and worked every time. This system also had to be employed in the other theatres.

We were lucky that switching off the power to the monitors worked because some sets flash brightly when they are switched off. Obviously, this is unacceptable. If this had been the case we would have probably been in the situation of hiring in extra equipment, and perhaps an extra operator. The fault was mine for not making myself sufficiently clear at the preparation stage.

## *Samson et Dalila*

Although Saint-Saens wrote 13 operas, this is the only piece of his that is regularly performed. First shown at Weimar in 1877, it is strong on melody and has an exciting orgy scene in the final act.

I think I can speak for most of the technical staff of the Royal Opera when I say that we were not keen on travelling between two theatres continually—which we had to do because it is necessary for the sake of the singers to alternate shows. For most departments it was made very bearable by the efficiency of the Japanese staff.

The Bunka Kaikan is a smallish theatre situated in Ueno park in Tokyo. One of the biggest problems generally was the lack of backstage space. Royal Opera House people know all about that of course but in this theatre it was not lack of floor space but height! Only the stage area itself was built to full height and it was impossible to store built-up scenery out of the way. This is the stage crew's problem but it has a knock-on effect to other departments, including mine. The worst thing to happen was a cut mains cable that took the entire sound system out for around ten minutes during a show. It doesn't take ten minutes to change a fuse of course—it's just that on a dark and crowded stage it takes a while to disconnect all the mains powered items and find the damage before you can switch power on again.

*Samson et Dalila* is a big show for video and we used ten monitors on stage. The theatre had a distribution system but we still had to use some loop-throughs. I don't like to do this because you are in the situation of chains and their weakest links, but one has to rough it a little on tour.

Of all the operas I have done, I think *Samson et Dalila* is my favourite because I get to destroy the Temple of Dagon! (I once helped to guillotine 18 nuns but that was just a small matter.)

Turbosound TMS 4s were the order of the day here. I had not used them before although I had treated myself to a demonstration before I left England. This was another case of wires getting crossed. I had asked for four, and I got eight! Sometimes you know when to keep your mouth shut.

We used some old Sensurround bins from the film *Earthquake* at the Royal Opera House at one stage but the Turbosounds definitely had the edge here. I thought it was a very good effect but it occurred to me later that the Japanese audience might have found it rather tame. They have real earthquakes in Tokyo.

## *Sayonara*

I thought Tokyo was a great place and I was very reluctant to come home. It was a very satisfying tour altogether, playing *Samson et Dalila* and *Turandot*, plus *Carmen* and *Cosi fan Tutte* in Seoul (South Korea), Osaka and Yokohama as well as Tokyo.

Contrary to some opinion, Japanese audiences are very responsive and enthusiastic—and critical too. I made some good friends there, Takahira Ono from the Open Road company and interpreter Kwijoong Kim. Thanks to them both for making this article possible. □



# MRX SERIES MIXERS

# SOUNDTRACS

A British company dedicated to the design and manufacture of one of the broadest ranges of mixing consoles in the World. We offer ten individual models in over fifty versions to suit your specific requirements.

The choice is yours.

Applications:	16 Track Recording;
	Broadcasting Production;
	Video Post Production.
Options:	Stereo Inputs;
	Patchbay.



Soundtracs plc. 91 Ewell Road, Surbiton, Surrey.  
KT6 6AH, England Telephone: 01-399 3392  
Telex 8951073/STRACS/G Fax: 01-399 6821  
U.K.: Studio Equipment Distribution (0582) 452495

# MS TECHNIQUE

*Mike Skeet makes some basic suggestions on the mid and side method*

Most recording engineers have heard of the Mid & Side (MS) stereo pair microphone system, some have tried it and all have probably found it difficult to set up and have been quickly put off. I was put off by two areas of difficulty: first of all getting the physical arrangement of the two basic mics into a manageable form, then the electronic patching which must be arranged in the mixer. This is at best usually cumbersome to operate.

MS requires a sideways facing figure-of-eight microphone and either a mid omni or a forward

facing cardioid. The mid mic is fed to both stereo channel outputs. The figure-of-eight is fed in-phase to the left and phase-inverted to the right. The result is, with a mid omni, a stereo pair of cardioids at 180°. With a mid cardioid the result is like a hypercardioid pair at 120° or so.

The latter is what I wanted, for I find that a stereo pair is most useful when there is a degree of rejection from behind the mic to allow control of the acoustic. But I find a crossed pair of cardioids very bunched up in the centre stage (there are ways to mitigate against this). The other extreme is the crossed figure-of-eight pair

which gives all the rear of mic acoustic that's going and, in attempts to change the balance, going closer to the performers often increases apparent width too much. But some of the 'out of phase' rear ambience seems to give a crossed pair recording more life, so the chance to operate hypercardioid at 120° proved an ideal compromise in practice.

There is also a particular inherent advantage in working with a crossed pair produced by M&S means. One mic faces forward, so there isn't the usual centre stage HF deficiency which can happen with crossed directional mics due to their polar patterns.

To remove all my earlier difficulties I have devised a mounting for the MS pair that has proved as easy to handle as a normal stereo mic and I have produced an electronic matrix unit that plugs into a mixer's insert sockets and converts the two channels concerned into a normal stereo pair as far as everything post the insert point is concerned.

## Physical

Fig 1 shows the physical arrangement that can easily be copied. In my case a ubiquitous Coles (née STC and BBC) 4038 ribbon is the side microphone. The mid is a JVC M501 electret cardioid. The latter is noisier than I would like but is a rather good microphone. Apart from its silver finish it appears to be identical to a black Nakamichi I have seen and exchanged capsules between the models.

Care is needed when deriving a mounting system that one does not acoustically impede either microphone. The ribbon model is cradled and screwed down to the curved part of a 19x6.5 mm aluminium strip which holds the pair together, supports the adjustable boom attachment and the output XLR(M) for the ribbon. Existing tapped holes in the ribbon's magnet are used.

The 4038 has a toroidal transformer which normally lurks in the suspension 'handle'. I had toyed with the idea of mounting this inside the mic itself but was concerned about the acoustic effect so it quite satisfactorily ended up on the outside of the body as shown. A small non-ferrous nut and bolt holds the transformer's thin metal case to the mic case.

Some delicate soldering is needed to re-connect the twisted wire input from the ribbon and the new output screened pair for the short trip to the XLR(M) socket. Care is needed when the meshes are off the ribbon and magnet assembly. The slightest air movement stretches the ribbon. In

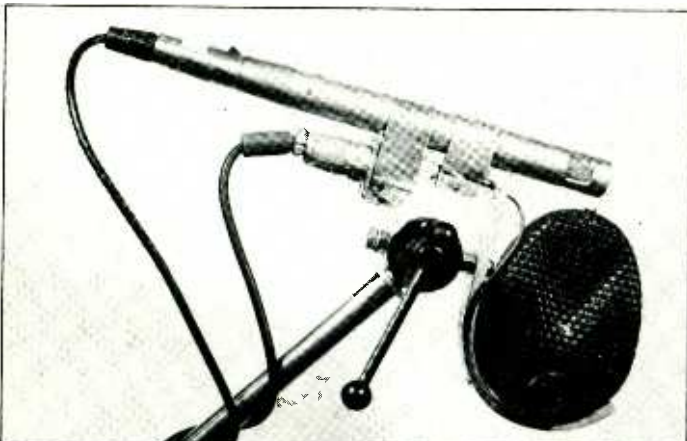

Fig 1: Physical microphone arrangement. Note ribbon transformer and boom end adjustment

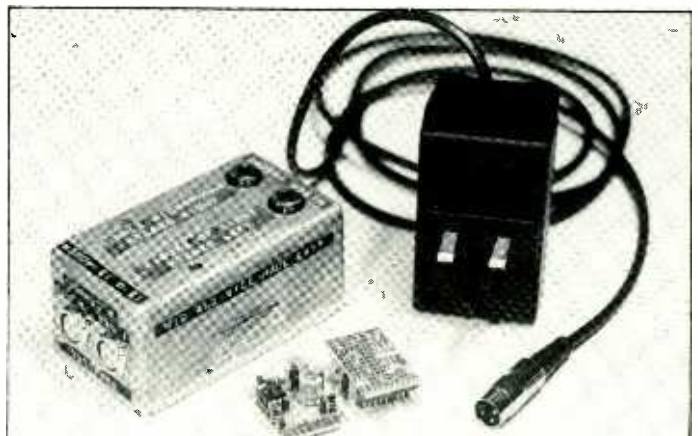

Fig 4: Die cast box, plug-in electronics and Time Machine regulated PSU



normal use the very fine mesh under the overall grille reduces air movement considerably.

The adjustable boom attachment comes from an old microphone stand. If any reader can identify its parentage I'd be grateful as I want to produce more MS pairs in addition to the two currently in use.

## Electronics

Fig 2 shows the arrangement for matrixing (mixing) the MS mic outputs into a stereo pair. The mic preamps are the normal ones in a mixer. The matrixing unit merely extracts the MS signals post mic preamps and returns the signal as a stereo pair. Individual mic sensitivity differences are dealt with by the appropriate input gain control (see later).

The M signal is fed equally to left and right outputs. Note the phase indications on the polar diagram symbols. Thus the S mic left is in the same phase orientation as the M mic. The S signal is mixed via a Virtual Earth Mixer (VEM) straight into the left output while the right feed is phase inverted before being mixed into the right. It suited me to use a standard plug-in module (ITZA 2-channel VEM module) for the active units allowing the whole lot to go into a No 2 sized RS diecast box. There is an overall phase inversion through the unit but this is not really of any concern due to the randomness of absolute phase in our industry! Phase inversion at the input channels would take care of it for the squeamish.

For completeness the full circuit of the ITZA VEM module is shown in Fig 3. The 47 pF capacitors are for radio frequency interference suppression. The 47R output resistor prevents possible instability due to output lead capacitance. One and a half modules are effectively employed and require  $\pm 15$  V powering. A Time Machine 15-0-15V regulated PSU is recommended for this stage (see Fig 4).

Should the electronic DIY side be an impediment, a complete MS matrix unit and PSU is made by Central Recording Services.

## Setting up

Varying the mix between the MS mic feeds, the output goes from mono to 'hole in the middle'

wide stereo. The 'correct' setting is not really all that critical. To give some idea of relative sensitivities and enable the channel gains to be set, have someone speak  $45^\circ$  off centre axis and compare the levels from both mics, listening on one of the output channels, panned centre. It would be best from the headroom point of view to reduce the gain of the highest output channel.

Some might find it a good idea to alter the value of the appropriate mixing resistors in the matrix to permanently set up for the particular pair of mics. Although the Coles 4038 ribbon has a higher output than I expected, a low noise mic preamp is desirable. In my case the electret proved to be noisier than the combination of Coles and the mixer preamp. □

## Addresses

4038 ribbons: Coles Electro-Acoustics Ltd, Pindar Road, Hoddesdon, Herts EN11 0BZ, UK. Tel: 0992 466685.

15-0-15V PSU: Time Machine, Abbotsford, Deer Park Avenue, Teignmouth, Devon TQ14 9LJ, UK. Tel: 0626 72353.

ITZA modules: Whitetower Records, 44 Challacombe, Furzton, Milton Keynes MK4 1DP, UK. Tel: 0908 502836.

CRS MS matrix unit: Central Recording Services, 17 Roy Close, Narborough, Leicester LE9 5DN, UK. Tel: 0533 866883.

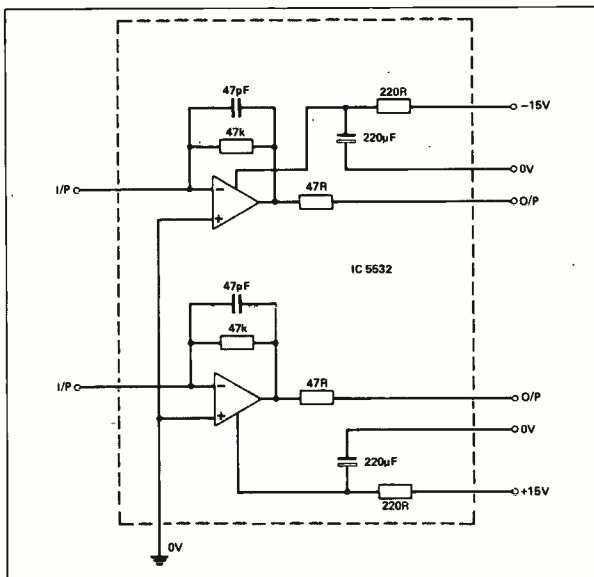

Fig 2: Basic MS matrix circuit

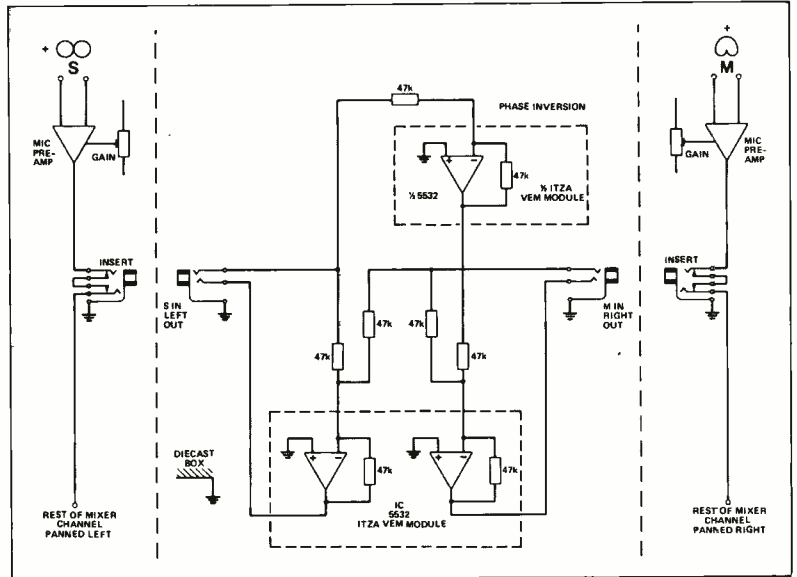

Fig 3: Full circuit of ITZA plug-in module

# LETTERS

## Put levy on recorded media

Dear Sir, The BPI and others within the industry continue to argue that it is reasonable for a levy to be made upon blank cassettes so that they, the copyright owners, receive retribution for the illegal domestic copying of records. Their argument does not appear to have impressed the Government sufficiently, so far, the proposed levy of 10% remaining 'on the shelf'.

My concern is that the idea will be dusted down and presented in a later Parliamentary session, eventually introduced to affect many innocent users of cassettes. Such disparate groups as the blind, songwriters and professional users such as myself. In my case cassettes are used for demos to clients and some audio visual soundtrack masters, licence fees for music being paid to MCPS. We are assured, rather blandly, that there will be an equitable means of reclaiming the levy: yet another organisation to collect and distribute income and pay rebates where due. Another burden in the chain of business administration, adding to VAT and the like.

Am I missing something, or is there complete sense in the notion that the tape levy is a ludicrous concept? Why can't copyright owners increase the price of recorded media and grant the right to copy such works for non-commercial purposes? The pre-existing organisations that gather royalties would simply deal with larger figures. No inconvenience would occur. Royalty gathering efficiency would be maintained.

The BPI claim that 10% of the price of a cassette is not enough anyway. On a C90 it approximates to 15p for around 2 LP running

times. Can 7½p added to the price of an LP, or 12p if that isn't sufficient, be a sales killer when vinyl is variously around £5 or £6 and CD around £11?

Yours sincerely, Martin L Goldman, Ad Air, 16 Red Hill Lane, Great Shelford, Cambridge CB2 5JR, UK.

## Digital recording in Scandinavia

Dear Sir, In 'Recording in Scandinavia' (*Studio Sound*, January) under the paragraph Norway you are writing: "The Oslo based studios, facing the reality of the CD factory, are currently discussing whether they would be able to get together and co-operate on the joint purchase of digital recording equipment which they could then all use."

To my knowledge there are no plans like that to be put into work at the present. But as the distributor of Mitsubishi Pro Audio in Norway, we delivered a Mitsubishi X-850 32-track, X-80 and X-86 2-track digital machines to Rainbow Studios in Oslo, August 1986. Rainbow Studios are run by the internationally known and respected recording engineer Jan Erik Kongshaug. Mr Kongshaug is the engineer of most of the recordings released on the famous ECM label. All ECM recordings are now done 32-track digital on Mitsubishi equipment at Rainbow Studios here in Oslo.

We have also delivered another Mitsubishi X-850 32-track digital recorder for use in Norsk Lydstudio in the city of Trondheim, Norway, in January 1987.

More Norwegian studios are seriously looking into the possibility of installing digital multitrack tape recorders in the foreseeable future.

Thank you for an informative and splendid publication.

Yours faithfully, Nils B Kvam, Marketing Director, Audiotron A/S, Seilduksgt, 25, Postboks 2068 Grünerløkka, 0505 Oslo 5, Norway.

## Originals are best...

Dear Sir, Your editorial 'Changing the Past' (*Studio Sound*, February) made me dig about in my old boxes of tapes and I listened to a recording I had made 20 years ago. I felt no desire to enhance, expand, 'stereofy' or remix anything I found there.

Back 'then' we painted our musical pictures with very different shades to the ones we use today: the very fact that we were technically limited became a source of creation in itself and if we go back to enhance the past, we destroy it.

In 1985 I tried an experiment; I asked a local club DJ to play old Motown hits now and then, sometimes in their original form and sometimes in their revised versions with added bass-beat, etc. The original versions were noticeably better 'floor-pulls' than the enhanced versions. If any producers are interested, we documented our findings and will gladly send them the results.

Your faithfully, Andrew von Gamm, Manager, Eifel Audio, 5558 Dierscheid.

## ... add more tracks

Dear Sir, After reading your editorial (*Studio Sound*, February) I nearly shuddered at the thought of Sgt Pepper being remixed, even by a 'caring' engineer.

There is another very attractive way to fill out the playing time of CD releases from this era and, perhaps unwittingly, you chose an excellent example in the case of the famous Beatles album.

This and many other albums of the mid and late '60s were released in mono and stereo and many mono albums feature not only different mixes (ie not just a left-right summation) but sometimes even entirely different takes!

*Sergeant Pepper's Lonely Heart's Club Band*, *The Beatles*, *The Piper at the Gates of Dawn* and *Sell Out* are just a few examples. In fact *Sell Out* is famous among collectors for the number of mono/stereo differences.

Adding different mono tracks to the end of a stereo CD would increase playing time whilst neatly avoiding any legal problems arising from more radical changes of format.

As for any form of signal enhancement of older material for CD release, I say leave the tapes alone but please use original masters not yet re-equalised for disc cutting. The Buddy Holly CD is a superb example of the quality attainable. At the other end of the scale, some cheap Elton John compilations on CD are unspeakable.

Yours faithfully, B Möllenkramer, Ereprijsstraat 35, 3765 AD Soest, The Netherlands.

### STEREO STABILIZER 5

APRS  
STAND 302



- Rack mounting frequency shifter for howl reduction in public address and sound reinforcement
- Mono version, box types and 5 Hz fixed shift boards also available

SURREY ELECTRONICS, The Forge, Lucks Green, Cranleigh, Surrey GU6 7BG.  
Tel. 0483 275997



# Post production is a race against time.

# And now there's a faster way to finish.



You can't afford to use equipment that slows you down. Because the competition is waiting to pass you by.

In a unique response to this situation, Tascam's engineers have created the first racing machine for audio post production.

## Introducing the 24 Track Tascam ATR-80 Recorder/Reproducer.

The ATR-80 is built for speed. The kind of speed that makes post production a lot more productive.

For example, it shuttles at 380 IPS. Which means you'll never have to wait for the audiotape to catch up with the videotape.

It cuts editing time too, because unlike other audio recorders, the ATR-80 allows edit previews. In other words, it eliminates retakes and ruined tracks.

It also accelerates the overdubbing process. Tascam's unique heads are so uniformly responsive, you can make final EQing decisions right in the Sync Mode. Without ever having to rewind and check the sound from the Repro head.

The ATR-80 even accepts 14 inch reels—a complete, uninterrupted one hour show's worth of tape.

The fact is, no other post production recorder keeps you competitive in so many ways.

So take a look at an ATR-80 and put it through its paces.

It'll be first past the post.



# TASCAM

A 32-Track version of the ATR-80 will be available soon. © 1986 TEAC Corporation, Tokyo.

For further information please telephone Chris Braclik on 0494 26211

# MARTIN POLON'S PERSPECTIVE

**A**uthor's note: R-DAT has done what no audio innovation has accomplished since the post-World War II introduction of the LP record; polarised the world audio industry into warring camps. The hardware and software potential for R-DAT is so great as to cause the professional marketplace and the consumer hardware arena to be placed diametrically opposite the major software producers—the record companies. Numerous opinions have been expressed, many in anger, about the viability of this new digital format and the threat it poses to the software industry via illicit copying. The audio industry needs to gain some perspective so that internal confusion and bickering does not influence the consumer marketplace worldwide. Dear Reader: pray consider the column below in the spirit with which it is offered.

Here at *Studio Sound* we have turned the full resources of Link House, that bastion of intelligence gathering in beautiful downtown Croydon, to the task of bringing you—our loyal readers—the full and detailed story behind new developments in the audio industry. With virtually unlimited travel and editorial support from the *Studio Sound* editors and publishers, I have been able to ferret out the real truth about R-DAT. That truth is so shocking that I can scarcely set the words down on to the page. But here it is: the Iran-contra scandal involves not only Iran, Israel, Saudi Arabia, Bahrain, Switzerland, and an ever increasing cast of thousands but also could involve the shipment of the first Rotary-Digital Audio Tape recorders (R-DAT) to the Contras to neutralise the impact of compact disc pressing facilities suspected of being placed in Sandanista hands by forces firmly behind the 'vinyl' curtain.

I first sensed the existence of this story when I was standing at the lobby bar in the Los Angeles Hilton Hotel during the Fall AES convention. Many of us spend much of our time at the lobby bar to gather input. My reporter's sixth sense began to tingle after my third drink. Wild Turkey straight up with a ginger ale chaser during the late afternoon 'happy hour'. Several things caught my attention immediately. The three men standing at the other end of the bar were wearing 'sand and spinach' tan and green camouflage uniforms. Two of them had .223 caliber (5.56 mm) Russian-made AK-74 rifles slung over their shoulders similar to the US M-16 rifle first used in Vietnam. This in itself was not that unusual since after all, we were in Los Angeles and it was at an AES convention. I thought that they possibly could be sales engineers from a Bulgarian console maker. However, the third man was striking. He was tall with a dark, thick, lush

beard. He had symbols of rank upon his shoulder epaulettes. Another clue was his AES registration badge. It said, "Hello, I'm Jose. Teniente, Revolutionary-Digital Audio Team (R-DAT)." But what really tipped me off was that here we were in Los Angeles at a 'happy hour' at an AES convention and these three men were not happy. That is a misdemeanor in the City of the Angels. That clinched it. I was on to something big.

I tightened the belt on my Gucci reporter's smoking jacket and sidled over to their part of the bar. After being frisked by Mutt and Jeff with the rifles I began to converse with Jose of the beard. His English was perfect, of the Queen's variety, in fact. He explained that he had attended Cambridge and hoped to be an acclaimed acoustician. But, he had been called back to serve his patriotic duty and now he ran the mysterious digital audio team from 'somewhere' in Central America. He seemed very disturbed. I asked him why. He indicated that he had found out from Albanian contacts at the show that his sworn enemies the Sandanistas were soon to have a capability for pressing Compact Discs. I was shocked. I had heard that the Soviets were supplying armed Mil-8 helicopter gunships and might add MIG-25 jet fighters to the kitty, but CDs? Did the Soviets have no sense of decency? I was stunned. He grumbled and pulled something out of his pocket. It was an R-DAT cassette. I knew what it was even though he flashed it for only a second. "This will show them", he muttered. He took my card.

Our conversation ended far too abruptly when two bulky men apparently without necks dressed in black polyester raincoats approached the bar. The three revolutionary audio specialists slipped inconspicuously into the stream of humanity in the Hilton lobby. The black raincoats puzzled me since the weather in LA was in the low 70s. Jose shrieked as he left that they were with the Kay Geh Beh. The two walked over to me. I tried to appear nonplussed and stated that I hoped to find their latest album in some of the hipper record stores on Melrose Avenue. But, in my heart of hearts I had always known that these bulky men in raincoats had been at AES shows before. They were ostensibly, the sales engineers for Bulgarian 2-channel single-track mixing consoles. I paid for my drinks and left.

That was it. I left LA with my secret and I was determined to get the rest of the story. If there was an escalation of CD pressing in Central America, there just had to be covert activity going on to neutralise it. And R-DAT would be the tool. But days turned into weeks and weeks into months and nothing surfaced. I could find nothing to link R-DAT and CD in CA. Then, one day the phone rang. I answered. The voice said, "This is deep notch." I was on the trail again. After being led on a chase about the Northeastern seaboard of

the United States, I ended up one night in a concert for glass harmonica in Bayonne, New Jersey sponsored by the Society of Chemical Waste Users interested in Music (SCUM). The concert was over an hour late in starting, as someone had placed water softener in the water supply for the glass harmonica. A man sitting behind me with a military bearing identified himself as 'deep notch'. We talked while the water supply was corrected. Since there were only three other people in the auditorium, we were undisturbed. The interview was on.

**SS:** Who are you?

**Man:** Colonel Stanley South. But don't play it up.

**SS:** I don't understand.

**South:** Think about it, college kid. Who is the other guy. The other colonel.

**SS:** Oh, I see. Stan and Ollie. Laurel and Hardy (he winces).

**South:** Yes. Look at the fine mess he's got us into this time.

**SS:** Why are you talking to me. Breaking the code of digital silence, as it were?

**South:** I'm in trouble in 'La Maison Blanc'. You know, the home on the hill.

**SS:** Why?

**South:** They caught me listening to classical music. I had been given a complete set of Gene Autry and Roy Rogers-Dale Evans records, when I went to work. But, you can't imagine what it's like sitting at your desk plotting air drops of R-DAT recorders in Central America while listening to 'Happy Trails' again and again.

**SS:** Now, tell me why you would use the R-DAT against the CD.

**South:** The record companies tell us that R-DAT will destroy the CD pressing plants around the world. "A recording studio in every home," is the quote they use, isn't it?

The Ayatollah thinks R-DAT steals souls—the record companies think it steals profits—in a Republican term, isn't that the same thing?

**SS:** You really don't believe all of the claims made against R-DAT?

**South:** I don't know what to believe. There are supply shortages of CDs in the US and elsewhere, but the record companies have applied significant time and energy to use customs controls and copyright pressure to keep foreign CD releases out of the market even if they are their own. I read that some estimates show 8 billion copies of acceptable quality being made illicitly of pre-recorded music every year in the Civilised World. If that estimate is to be viewed as reality, then virtually every man, woman and child would be making at least two copies. On the other hand, I see copier combos coming out of Japan with a CD player acting as a master, coupled to dual copiers. Add a pair of high speed dubbers and you have a copying company in your garage or spare bedroom.

**SS:** So you feel that neither the software producers or the hardware makers are playing fair?

**South:** That's not exactly what I said. The record companies feel strongly about home copying and with some justification with the dual copiers being made for the current cassette system. That is why they have pushed the 'copy protection chip'. Let's face it. The Japanese are not going to win the Nobel prize for peace and love in consumer electronics manufacturing. It's all business to them... their business. Rebecca-san of Sunnybrook Farms does not live just outside Osaka. A dozen major electronic manufacturing facilities live just outside Osaka.

**SS:** Does the 'chip' and its companion notch filtering of all pre-recorded software to be issued upon its adoption really provide inaudible





TRUTH...

OR  
CONSEQUENCES.

If you haven't heard JBL's new generation of Studio Monitors, you haven't heard the "truth" about your sound.

**TRUTH:** A lot of monitors "color" their sound. They don't deliver truly flat response. Their technology is full of compromises. Their components are from a variety of sources, and not designed to precisely integrate with each other.

**CONSEQUENCES:** Bad mixes. Re-mixes. Having to "trash" an entire session. Or worst of all, no mixes because clients simply don't come back.

**TRUTH:** JBL eliminates these consequences by achieving a new "truth" in sound: JBL's remarkable new 4400 Series. The design, size, and materials have been specifically tailored to each monitor's function. For example, the 2-way 4406 6" Monitor is ideally designed for console or close-in listening. While the 2-way 8" 4408 is ideal for broadcast applications. The 3-way 10" 4410 Monitor captures maximum spatial detail at greater listening distances. And the 3-way 12" 4412 Monitor is mounted with a tight-cluster arrangement for close-in monitoring.

**CONSEQUENCES:** "Universal" monitors, those not specifically designed for a precise application or environment, invariably compromise technology, with inferior sound the result.

**TRUTH:** JBL's 4400 Series Studio Monitors achieve a new "truth" in sound with

an extended high frequency response that remains effortlessly smooth through the critical 3,000 to 20,000 Hz range. And even extends beyond audibility to 27 kHz, reducing phase shift within the audible band for a more open and natural sound. The 4400 Series' incomparable high end clarity is the result of JBL's use of pure titanium for its unique ribbed-dome tweeter and diamond surround, capable of withstanding forces surpassing a phenomenal 1000 G's.

**CONSEQUENCES:** When pushed hard, most tweeters simply fail. Transient detail blurs, and the material itself deforms and breaks down. Other materials can't take the stress, and crack under pressure.

**TRUTH:** The Frequency Dividing Network in each 4400 Series monitor allows optimum transitions between drivers in both amplitude and phase. The precisely calibrated reference controls let you adjust for personal preferences, room variations, and specific equalization.

**CONSEQUENCES:** When the interaction between drivers is not carefully orchestrated, the results can be edgy, indistinctive, or simply "false" sound.

**TRUTH:** All 4400 Studio Monitors feature JBL's exclusive Symmetrical Field Geometry magnetic structure, which dramatically reduces second harmonic

distortion, and is key in producing the 4400's deep, powerful, clean bass.

**CONSEQUENCES:** Conventional magnetic structures utilize non-symmetrical magnetic fields, which add significantly to distortion due to a nonlinear pull on the voice coil.

**TRUTH:** 4400 Series monitors also feature special low diffraction grill frame designs, which reduce time delay distortion. Extra-large voice coils and ultrarigid cast frames result in both mechanical and thermal stability under heavy professional use.

**CONSEQUENCES:** For reasons of economics, monitors will often use stamped rather than cast frames, resulting in both mechanical distortion and power compression.

**TRUTH:** The JBL 4400 Studio Monitor Series captures the full dynamic range, extended high frequency, and precise character of your sound as no other monitors in the business. Experience the 4400 Series Studio Monitors at your JBL dealer's today.

**CONSEQUENCES:** You'll never know the "truth" until you do.



JBL Professional  
8500 Balboa Boulevard  
Northridge, CA 91329

## MARTIN POLON'S

# PERSPECTIVE

protection?

**South:** A matter of syntax. Do TOW anti-tank missiles constitute defensive weapons when they are supplied to Iran? What is inaudible and to who? That is the ultimate question. No sane person objects to the record companies achieving fair and even-handed protection for their business commodity. And although the R-DAT camp thinks that a chip in the system can be easily defeated, the real issue is a form of audio censorship. It's sort of a First Amendment right for listeners. Shall someone shove for the sake of discussion, a notch filter identified digitally as a sixth-order Chebyshev type II or in the analogue world as a sixth-order Chebyshev with three biquad stages into your music. Into everyone's music. All mastering through this thing with the centre frequency at about 3830 Hz and -3 dB points slightly above 3710 and 3960 Hz ( $\pm 125$  Hz). If the system is to work properly, it appears that the notch needs to be rather deep for detection although it is adjustable from -12 dB to -80 dB. Accept this as an example of what might be, because other options are always possible. The 'chip' in the recorder detects the notch through rectification, integration and comparison. No notch—the machine records. Presence of notch—it leaves 20 s gaps in the recording. Sort of a digital version of stuttering.

These frequencies were chosen specifically for their relative non-interference with the reproduction of recorded music. I have been told that many studio and music professionals have heard the notch and find it acceptable. But, the bottom line is freedom of choice. I don't think we want this radical solution without exhausting all other options and conducting a significant level of testing if we want it at all.

**SS:** Didn't the signatories to the current R-DAT concordat on hardware standards try to design the system to meet some of the complaints of the record companies?

**South:** Yes they did. And Iran is also a signatory to the Geneva Convention. Bottom line, however, is that they did try to prevent this whole mess from popping up. The original plan was to restrict the length of recording time to prevent direct copying of the entire contents of a CD. Similarly, the lack of digital inputs and outputs and of a 44.1 kHz sampling rate would all discourage CD copying. But the record companies have felt all along that these accommodations were not enough. And there is some possibility that renegade equipment makers, perhaps outside of Japan, might 'jump' some or all of these restrictions to gain an advantage in the consumer marketplace.

**SS:** Where are the R-DAT equipment makers now on all of this?

**South:** Both sides did sit down in Vancouver, Canada at the end of 1986 to try and work this all out. But the software makers were adamant

about the protection circuitry and the talks failed. The members of the Electronic Industries Association of Japan (EIAJ) have apparently agreed not to accept the compromise of placing any kind of copy protection chip in the R-DAT system. Their point was that the 'chip' could be defeated too easily to justify the adoption of the protection scheme. And their contention that the bulk of the public does not gratuitously make copies could be correct. Then we would be penalising the music listener by filtering his or her music while the real pirates would defeat the copy protection circuitry through relatively straightforward electronic techniques. What Japan giveth, a backroom electronics lab technician taketh away.

**SS:** Where does that leave the 'protection chip' proposal scheduled to appear before the US Congress and potentially on the agenda for the European Economic Community (EEC) tariffs agency?

**South:** Well, it is just possible that the chip in question is a 'bargaining chip' rather than a realistic proposal. If that is so, then record companies may wish to accept Congressional and EEC 'help' via surcharges on blank R-DAT media. And the real fear here may be something else. So far, the record industry has not had to endure the rental mania that has swept the motion picture industry. CDs have apparently seen the public's perception of the fragile nature of LPs rub off in terms of little interest in record rentals. It is not clear that R-DAT software or copies of CDs would enjoy the same disdain. In fact, some fear that R-DAT tapes could spark the same kind of rental boom now seen for current movies... hot records going out for \$1 to \$2 per day. Add the threat of simple and efficient high speed contact printing for commercially produced R-DAT software and the digital tape system poses several legitimate enterprises that would threaten the expansion of CD. The motion picture lobby is interested in linking into this also to use the 'chip' to disable VCR copying and to try and gain cash value out of the multiple rental scene.

**SS:** Will we see R-DAT products in Japan, the United States and/or the EEC this year?

**South:** The answer is yes and no. We should. The list of over 60 original R-DAT system signatories has grown to over 80 companies having strong interest in selling R-DAT machines and systems in some format or another. There were 15 companies showing R-DAT discretely at the Fall 1986 Japan Audio Show. The system was shown in plexiglass 'cages' at the Los Angeles AES show. By all that is logical to the Japanese mind, the system should be made available in Japan early this year. This should be followed up later at the end of Spring in Great Britain and Europe with US availability shortly after that.

**SS:** So that would be that. R-DAT would be a reality in the market.

**South:** No, not exactly. The fear of some kind of legislative restriction will keep R-DAT makers sweating in the short term. There is a possibility that the record companies will take a them-vs-us position before Congress pointing out that the evil of trade deficits hinges upon some kind of action against foreign imports and foreign technology. And what better place to start than R-DAT. It's the ideal trade action for the American system. Congress looks good, the American record industry is sated and the consumer will never know what he or she is missing since they have never had the product in their hands. There is nothing the Japanese can or will do except to accept the consequences gracefully. Practice 'Dakyo'. Accept compromise. The only fly in that particular ointment is that the record companies are now owned in considerable part outside the United States themselves. So I do not think anyone will be showing R-DAT at the Consumer Electronic Shows in the US this year with any intent to actually deliver the product to dealers until this 'protection' issue is settled once and for all. No one wants to be holding illegal hardware that can't be sold in the most important retail audio hardware market in the world. And the same formula could be used to swing similar EEC sanctions once the US Congress had set an example or even at the same time.

**SS:** What about the professional marketplace?

**South:** That's a horse of a different colour. The likelihood of true digital in/out R-DATs appearing seems high during 1987. Priced in the \$5,000-plus price range initially, pro-R-DAT units would fit into three marketing niches out of the starting gate. It would be an obvious format to bring radio and television broadcasters worldwide into digital audio recording and playback. Even if the promised edit capacity is late in coming for R-DAT, much of what is done in station operation can be done without editing. Air checks, archival recording, live concerts saved for later rebroadcasts, etc. Secondly, the recording studio would welcome a 2-track digital machine using a cassette, if only to replace the analogue cassette for convenience copies. Give the artist a digital tape to pop into his auto-DAT or walk-DAT and you can be sure that the home studio revolution will find R-DAT machines replacing cassette decks in the all-in-one console/recorder category. Lastly, the R-DAT should become the medium of choice for CD transfer. It would replace the U-matic/digital electronics combination with technology 15 years more advanced especially in terms of the tape transport. Professional units will have a high enough price tag to avoid the issue of protection.

**SS:** So what is the bottom line for all of this?

**South:** It's technology. You can never stop it. Even if the record companies and the motion picture industry succeeds in crippling R-DAT they will not win another confrontation with technology. The next level of recording advance for audio and video will most likely occur in the realm of optical disc and/or some form of semiconductor memory cards or blocks. These developments will be part of the relentless advance of computer technology. Consider then the option of the \$4.3 billion record industry going before the US Congress and trying to inhibit or surcharge the development of computer recording media needed for growth within the \$200 billion US computer industry. Consider also that \$55 billion IBM is part of that industry and IBM has never been tamed by the US Government in court. The record industry is going to end up looking sillier than the White House does today, with everyone knowing nothing about everything. □



# Dolby spectral recording

*The ideal format for highest quality multi-track recording.*

**Quality...**Signal integrity and clean transients over an extremely wide usable dynamic range are characteristic of recordings made with Dolby SR.

**Practicality...**Dolby SR can be used with any professional analogue recorder, retaining the efficiency and flexibility of established studio techniques. This makes Dolby SR the ideal format for highest quality multi-track recording.

Dolby SR gives the freedom to record anywhere. It works well with the many thousands of professional recorders all over the world, or the new generation of very high quality analogue recorders. It is already being used for some of the finest recording projects.

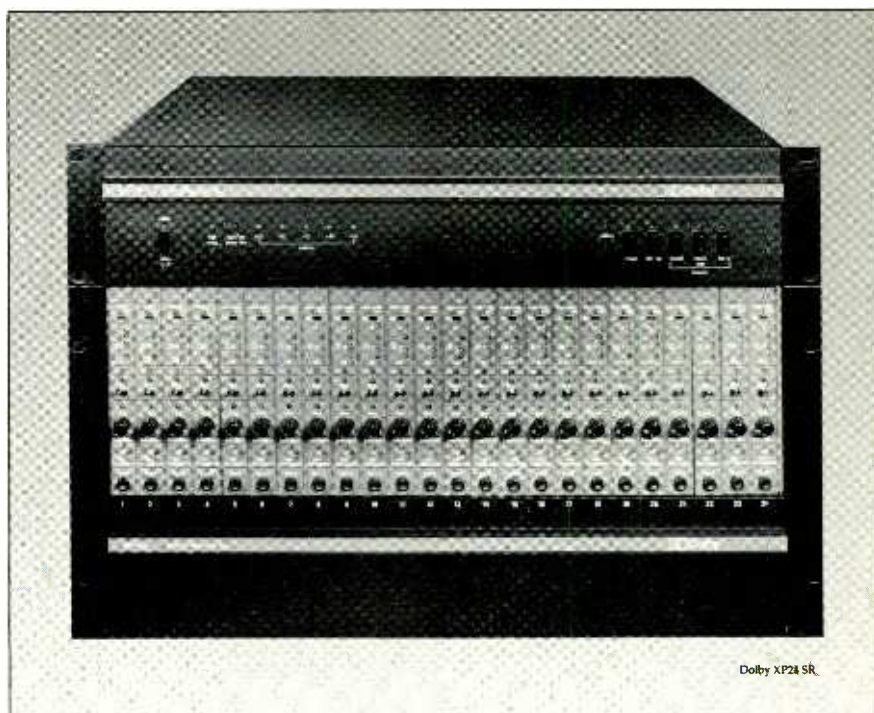

**The multi-track solution...**The Dolby XP24 SR multi-track unit is now available. It can hold up to 24 Dolby SR modules, Cat. No. 431, each containing the complete SR circuit for one channel.

Drop-in/Drop-out switching is silent and there is ample dynamic range available in the low-distortion input and output circuits. There is an accurate LED meter and an UNCAL setting for rapid realignment on overdub sessions. The separate power supply with a low-noise fan keeps the unit cool even under difficult operating conditions.

In short, everything you need to maintain the unsurpassed quality of Dolby SR recording.

The Cat. No. 431 modules are also available separately to retrofit existing SP and XP Series Dolby A-type NR units. For the earlier Dolby M Series units, as well as Model 360 and 361 single-channel units and Model 365 two-channel units, the Cat. No. 280 Dolby SR module is already being delivered in substantial quantities.

## The new master recording process

**Dolby SR**

Dolby Laboratories Inc., 346 Clapham Road, London SW9 9AP, Telephone 01-720-1111, Telex 919109  
100 Potrero Avenue, San Francisco, CA 94103-4813, Telephone 415-558-0200, Telex 34409

"Dolby" and the double-D symbol are trademarks of Dolby Laboratories Licensing Corporation. L87/05

# BARRY FOX'S BUSINESS

**A** new spoiler? And one that does not need circuitry built into the recorder like Copycode?

Surely this can't be the case.

Tom Keen of Milton Keynes reckons he has finally done it. The record industry is in two minds. It sounds like what they always wanted. But they have only recently given up on spoilers and backed the CBS idea of Copycoding recordings and lobbying for laws which will compel recorder manufacturers to put matching switch-off circuitry in recorders. Dare they confuse the issue by looking at the new system, called *Viper C*?

Keen says the IFPI wishes he had offered it earlier. The BPI won't invest any money. Philips is studying it. CBS failed to turn up for a demonstration.

Keen admits that he knows little about the record industry. He first thought about spoilers when he thought about selling records by post and wanted to stop people taping them, returning discs as 'faulty' and asking for their money back.

Keen's first try was the old HF chestnut. An ultrasonic signal to interfere with the recorder bias or sampling oscillator. Last year, with the help of Cranfield Institute of Technology, he found out the problems. You can't cut the HF signal on to disc in real time and the home taper easily filters it off. Keen found all this out by giving a demonstration to the BPI which was every bit as unsuccessful as the demonstration of Gerry Bron's abortive spoiler in 1980.

Keen says he then spent 'thousands of hours' developing a Mark II version which is *Viper C*. In addition to the HF tone, there is an audible tone which is 'released' once any attempt is made at filtering off the HF tone. Like a viper it gets you either way.

Keen has built a prototype which, he says, works with discs. To make it work with tape he will need an injection of funds. And, I fear, black magic. He won't give full technical details, but what he does say points a pretty clear route.

Identical tones in anti-phase will cancel out when mixed. (That's why the old quadraphonic systems lost some signals in mono.) An HF tone will not cancel an MF tone. But if there are two different HF tones they will beat together to produce a phantom MF tone. If this is in anti-phase to another mid band tone of the same frequency, both will be hidden. Then, if the HF spoiler tones are filtered off, their beat tone disappears. So the hidden tone emerges from the

mid band and spoils reproduction.

If this is how the system works, it is a clever idea. But surely impractical. CD has a top range of 20 kHz, and an HF spoiler at 19 kHz will not be popular with loudspeaker designers, animals or golden-eared humans. Whatever the tone frequency, there will only be complete cancellation when every tone is retrieved with exact accuracy of pitch and level. How many audio systems can achieve such perfection? Any non-linearity will release part of the hidden tone.

Tom Keen admits that his hidden tone is "not totally inaudible," and some hi-fi enthusiasts, "who want to be clever," will say they can hear it. But, he says, it will be no worse than the unwanted noise you get from a cassette radio or even compact disc, because "not even studio recordings are clean... only people with ears like bats will hear anything wrong with a recording treated with *Viper C*... and whether they hear anything wrong on a double blind test remains to be seen."

**D**AT finally went on sale in Japan on March 2, at prices as high as expected — £800 and more. Also as expected the Japanese did not build in CBS Copycode circuitry, so that their recorders will obligingly refuse to record anything with a Copycode notch sucked out of the audio spectrum. They did, however, make the token gesture of setting a 48 kHz or 32 kHz sampling rate for recording/replay and 44.1 kHz for replay only. This prevents direct digital dubbing, although few people seriously believe that the quality loss from straight wire analogue dubbing will be noticeable.

JVC played super smart. The company waited until the other firms had announced price and features, then came up with a feature which no one else was offering, at a price only £50 above the £800 norm.

JVC is offering half speed recording, so that a two hour cassette runs for four hours. This halves the high cost of tape, £8.50 for a nominal 2 hour cassette—and should make the record industry really miserable. The half speed mode, say JVC, is ideal for off-air recording. Expect soon to see a DAT recorder with built-in radio tuner and timer, to perform like a video recorder.

The DAT standard makes provision for half speed recording but as it halves mechanical tolerances manufacturers have fought shy. JVC say they can achieve half speed tolerances because the technology is similar to that used for half speed VHS video recording, which JVC pioneered

five years ago.

In normal modes DAT codes in 16 bit linear words, the tape runs at 0.815 cm/s and the track width is 13.6 microns. The heads must track with an accuracy of  $\pm 3$  microns. Pre-recorded DAT tapes will have a wider track, 20.4 microns, and run faster at 1.2 cm/s. This is designed to cope with mass duplication errors, which may be a special problem with sandwich transfer techniques. The penalty of wide track mode is reduced playing time; a two hour cassette runs for 80 minutes.

All the DAT recorders now being launched will cope with wide track pre-recorded tapes — when the record industry finally recognises DAT as unstoppable and issues some. Coping with the LP mode is much more difficult.

The tape speed is halved to 0.4 cm/s, sampling frequency dropped to 32 kHz and the coding standard reduced to 12 bit non-linear. The same heads are used so the track pitch remains the same. As a result the tracks overlap, and the margin for reading error halves. A flywheel and ceramic tape guide posts smooth tape transport, and the whole mechanism is suspended to isolate it from vibration.

Only the best tape will work at half speed. If the surface is too smooth it sticks; if it is uneven it jitters. The trick is to have tape which has very fine, and regular, deformations of the surface. 'Runnability' will be the new buzzword for DAT tape.

**T**here is a new 'fact' about hearing loss in the folklore. It goes like this: 'A health report from

China brings the sobering news that 77 musicians from the Municipal Orchestra at Changchun had their hearing tested, and 74 were found to be partially deaf. This was due to the musicians being too close to large cymbals and gongs.'

Sounds interesting. So I asked the *London Standard*, the evening newspaper which reported the report, for a source reference. The *Standard* put me on to a freelance journalist who told me that a friend of his had picked up the story in Australia where it had been reported after someone had picked it up out of a Chinese daily newspaper, called *Health*.

I checked with the Embassy of the People's Republic of China in London (that's the one just round the corner from the BBC, which used to be famous for bristling with odd aerials).

The Embassy Press Attaché, a Mr Kuang Weilin, helpfully tried for more than two months to find the original report for me. He couldn't. The best he could do was suggest that I write direct to China's Ministry of Health in Beijing. This I confess I haven't done. Enough is enough.

This 'fact' about orchestra deafness is starting to sound suspiciously like a 'factoid'. That's something that everyone believes because they have always been told it is true. I once heard of someone who was sued for libel because he 'knew', like every schoolboy 'knows', that the Church owns lots of property in Soho which is used for brothels. When it came to the crunch, he couldn't find a shred of evidence to prove what he thought he had known.

Moral: Beware unsourced information. It may well be fiction or at best heavily garbled by the time you hear it.

"Send reinforcements, we are going to advance," said one soldier to another. By the time the message had got to the end of the trench it was, "Send three and four pence, we are going to a dance".



# AKG

ACOUSTICS

THE C414 B-ULS  
UNMARRED SOUND + TECHNOLOGY FOR YEARS TO COME



ADV 355/1/E



Digital recording techniques call for  
high quality microphones and audio  
processors.

**We supply the microphones.**

Get more information from your dealer or directly from

AKG AKUSTISCHE U. KINO-GERÄTE GESELLSCHAFT M.B. • Brunhildengasse 1, A-1150 Vienna/AUSTRIA Tel. (222) 95 65 17-0, Tx: 131839 akgac a, Fax: (222) 92 34 58  
AKG ACOUSTICS LTD., Catteshall Wharf, Catteshall Lane, Godalming, Surrey GU7 1JG/GB Tel: (4868) 25 702, Tx: 859013 akgmic g, Fax: (4868) 28 967

[www.americanradiohistory.com](http://www.americanradiohistory.com)



## DBM-1A

### REMOTE DIGITAL METERING UNIT

Connects to status port on Sony  
PCM-1630/1610 Systems

New features include peak hold segments  
and high brightness display



TOTALSYSTEMS

Weller Eggar House,  
High Street, Hartley Wintney, Hants RG27 8NY  
Tel: 0251 26 4757

## Your Guarantee

NO GUESSES

NO GIMMICKRY

The circulation of this publication  
is independently audited to the  
professional standards  
administered by the Audit  
Bureau of Circulations

ABC

*The Hallmark of Audited Circulation*



KEITH MONKS

## THE NEW FISHPOLE HANDBOOM RANGE



Model	Minimum Length		Maximum Length		Number of Sections	Weight
FP363	25"	.65m	61"	1.55m	3	1 ¼ lbs, 0.5kg
FP364	38"	.97m	126"	3.20m	4	2 ½ lbs, 1.1kg
FP365	47"	1.19m	114"	2.89m	3	2lbs, 0.9kg
FP366	30"	.77m	75"	1.91m	3	1 ½ lbs, 0.6kg
FP367	53"	1.35m	189"	4.85m	4	3 ½ lbs, 1.5kg

\*Specifications changed from time to time

- LIGHTWEIGHT
- FULLY ADJUSTABLE
- ROBUST CONSTRUCTION
- FINISHED IN MATT BLACK

JUST ONE OF THE NEW  PRODUCTS SET FOR RELEASE AT APRS 87



KEITH MONKS LTD, PROGRESS HOUSE, ALBERT ROAD, ALDERSHOT, HAMPSHIRE GU11 1SZ, UK.  
TEL: 0252-334121/2/3/4 (Overseas: area code 252) Telex: 858606 KMAL G





## PERFECT TRANSPARENCY!

The Sanken CU-41 is a unidirectional double-condenser microphone that is quickly becoming the world standard among recording professionals. Ideal for a wide variety of broadcasting and recording applications, it delivers a completely natural, uncolored sound over the entire frequency range—free from distortion. Because of its uniform phase response, a pair of CU-41's produce a perfect stereo image. The CU-41's uncompromising performance makes it ideal for digital audio recording, and allows the truest analogue masters possible.



## TRUE STEREO IN A PORTABLE MICROPHONE!

The Sanken CMS-7 is the first portable MS stereo condenser microphone in the world that accurately captures a natural stereo perspective in any environment. Designed primarily for indoor and outdoor TV and radio broadcasting and motion picture making, the lightweight CMS-7 mounts on a boom and enables a single person to easily handle all outdoor stereo recording. Its special battery power supply/switchable matrix box, which clips to a belt and incorporates a stereo aperture control (which can be set for mono applications), lowcut selector, and an optional output jack for stereo headphone monitoring allows direct connection to a field recorder.



Japan's most original microphone maker.

### SANKEN DEALERS WORLDWIDE

AUSTRALIA:  
BELGIUM:  
CANADA:  
DENAMARK:  
ENGLAND:  
FINLAND:  
FRANCE:  
HOLLAND:  
HONG KONG:

Syntec Int'l,  
ASE Pvba,  
Gould Marketing,  
SLT,  
Stirling Audio,  
MS-Audiotron,  
3M France,  
Stage Theater,  
A.C.E.

Tel: (02)406-4700  
Tel: (015)411152  
Tel: (514)342-4441  
Tel: (01)713344  
Tel: (01)625-4515  
Tel: (90)5664644  
Tel: 3/0316423  
Tel: 03494-54121  
Tel: 3-7452343

ITALY:  
NORWAY:  
S. AFRICA:  
SWEDEN:  
SWITZELAND:  
U.S. L.A.:  
U.S. NASHVILLE:  
U.S. NEW YORK:  
W. GERMANY:

Grisby Music Pro.,  
Siv. Ing. Benum,  
Eltron,  
Tal & Ton,  
Tecnad SA,  
Audio Intervisual,  
Studio Supply,  
Martin Audio,  
Coach Audio Sales,

Tel: (072)781714  
Tel: (02)145460  
Tel: (011)7870355  
Tel: (031)803620  
Tel: (021)353501  
Tel: (213)469-4773  
Tel: (615)366-1890  
Tel: (212)541-5900  
Tel: 06851/70141

Sanken sole export agent Pan Communications, Inc.

Azabu Heights 607, 1-5-10, Roppongi, Minato-ku, Tokyo 106, Japan

Telephone: 03-505-5463 Telefax: 03-505-5464 Telex: 2423934 KNMPCM J Cable: PANCOMMJPN

# A MARRIAGE OF CONVENIENCE BRINGING TOGETHER THE BEST AN. DIGITAL PRODUCTION TOOLS AVAILABLE

**NEW**



## Editron 500A

Control of up to 15 audio, video or film transports.

Multiple mixed frame-standards can run simultaneously.

999 Events.

Programmable VCA control.

A, B loop for machine sharing in multiple locations.

Unique software driven architecture allows easy machine changes – no dedicated hardware.

Simple change of floppy disc and keyboard turns system into Video Editor.

Video edit-list stripping option.

Full colour graphics give critical information at a glance.

10 user soft keys for customised operations.

Session set-ups stored on disc for easy retrieval/editing.

20 comparators for external devices, repeat fireable.



## Lexicon PCM 70

Lexicon Digital effects set world standards for sonic quality.

The PCM 70 offers the essence of Lexicon sound as well as being the only digital reverberator to have Dynamic MIDI™ for control of all reverb and effects parameters.



# OGUE AND

# BLE



## dbx 150X

The dbx 150X features two separately powered, simultaneous encode/decode channels of dbx Type I noise reduction giving up to 40 dB improvement in signal to noise ratio using analogue tape.

The 150X can be mounted singly or in pairs in 1U of rack space – full rack mount kit included as standard.

The 150X outperforms its best selling predecessor, is more flexible and breaks a new price/performance barrier.

We know it sounds too good to be true but assure you it's for real.

To prove to yourself that digital signal to noise ratios are attainable for well less than two hundred pounds, call Scenic or a stocking dealer soon.



Despite being deceptively simple in appearance and very affordable, the PCM 70 has a specification which puts it in the top rank of professional digital signal processors.

Call us for the name of your nearest stocking dealer.

# D

FOR 15 YEARS SCENIC SOUNDS HAS SOUGHT OUT AND DISTRIBUTED PRODUCTS WHICH OFFER THE BEST TECHNOLOGY OR BEST VALUE OF THEIR KIND.

WE ENJOY DEALING WITH OUR CLIENTS DIRECT, ADVISING AND LEARNING FROM THEM, BUILDING UP LONG TERM RELATIONSHIPS.

WE ALSO RECOGNISE THAT YOU MAY PREFER A LOCAL SOURCE OF SUPPLY, SO WE HAVE CREATED A NETWORK OF DEALERS TO ENSURE THAT MOST OF OUR PRODUCTS ARE EASILY ACCESSIBLE WHEREVER YOU ARE BASED.

DO CONTACT US FOR DETAILS OF OUR RANGE AND OUR DEALERS.

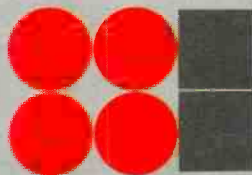

SCENIC SOUNDS EQUIPMENT LIMITED  
Unit 2, 12 William Road, London NW1 3EN  
Tel: 01-387 1262, 01-734 2812  
Telex: 27939 SCENIC G

# REVIEW

## Dave Foister tries out the Jecklin OSS disc for recording stereo with omni discs

Of all the various attempts down the years at surrounding the listener with sound, binaural recording must surely be the most practical and accessible method. To achieve its effect it doesn't need fancy decoders, it doesn't need four matched loudspeakers (or the consequent restrictions on listening positions) and it doesn't need prolonged self-destructive format battles between manufacturers. All it needs is a pair of decent headphones. Unfortunately it generally sounds lousy on loudspeakers, but more of that later.

The idea of recording exactly what the ears would hear in a given situation, so that subsequent replay over headphones recreates the original 3-dimensional soundfield around the listener, is by now as old as the hills, and has been approached by many different people in almost as many different ways. The simplest method must be the ORTF back-to-back (but slightly angled) pair of cardioids, with the capsules at 'standard' ear spacing, and the most sophisticated, Neumann's rather unnerving dummy head, complete with flexible ears and (rather stern) facial features. There can't be many engineers who haven't tried some kind of binaural experiments—I can recall wiring a pair of open-backed headphones to serve as microphones, while a fellow student stuck a pair of omni 451s inside a hollowed out polystyrene wig stand—and there can't be many who haven't been impressed by some form of binaural recording; hands up those who remember looking involuntarily over their shoulders at a startling paging call during the BBC Radio drama, *Oil Rig*.

The success rate of the various systems is highly variable. I have experimented with an ORTF-style set-up, recording opera in the round and various contemporary works, and the effect on the listener seems to have depended quite critically on the width of their own heads. Those unfortunate enough to have heads similar to mine have found the results spectacular—not surprising since I set it up for my own ears—but any significant variation from this has caused the image to collapse back into the head or to become very confused. The Neumann system appears to have a far higher success rate but the Neumann head is far from cheap.

Perhaps the best compromise is the system used by the BBC, among others: a pair of ear-spaced omnis with an approximately headsized baffle disc

providing acoustic isolation between them. This was the method used for the BBC's *Revenge*, possibly the most famous binaural experiment of all. The BBC set-up was pretty much 'home-made' and anyone who wanted to try it for themselves had, until recently, either to follow suit and make their own 'head' or pay the price for the pukka Neumann job. Now a set-up similar to the BBC system is available ready-made, and at a very reasonable price.

The Jecklin OSS disc consists of a plastic disc, 350 mm in diameter, with a layer of acoustic foam on each side to reduce the effects of reflection. Bulldog-type microphone clamps are attached in such a way as to place the microphone capsules at the centre of the disc, and the whole assembly is mounted via lockable swivel points on a sturdy bracket fitted with a standard bush for attaching to stands, slings and so on. It is designed to be used with omnidirectional microphones—Jecklin recommend KM83s, B&K 4001s, or Sennheiser dynamic omnis—spaced 165 mm apart, which is

roughly the distance between the average pair of ears. The whole rig should be placed in the ideal listening position in the room. Jecklin suggest, although this is by no means a new idea, that any spot microphones deemed necessary to 'lift' weak instruments should be delayed to coincide with the arrival of that sound at the head itself. They also suggest that such spot mic signals should have reverberation added, although this would seem to me to defeat the object of the exercise.

I tried the disc in various applications, with varying degrees of success. The initial reaction was that it sounded slightly dull and lacking in sparkle, possibly due to the absorptive effect of the foam, but a slight treble lift soon restored the sound. In a concert situation the results varied from impressive (for a conventional stage set-up) to spectacular (in the case of an electro-acoustic concert with multichannel sound). The conventional concerts acquired an extra depth and realism, as one would hope. The instruments on stage were clearly in front of the head, although not quite as far as in real life, with a very natural left-right spread, making it easy to accurately locate individual instruments, and the central image was strong and stable. When the audience applauded, the effect was quite startling, the applause completely surrounding the listener with a strong feeling most of it was to the rear.

The electro-acoustic concert was particularly well-suited to binaural methods since the sound surrounded the audience in the hall, and indeed via the disc it was possible to identify each speaker position, front and rear. This recording conveyed the effect of the concert in a way no other 2-channel system could have done, and it would be worth having this facility if only for these occasional 'in-the-round' events.

In all these cases one had a strong sense of the room one was listening to. With virtually all the reproduced sound 'out of head' the subtle ambient information containing the clues about the size and shape of the room was all there. It was fun, too, to be able to eavesdrop on people during quiet moments in rehearsal—with a binaural system it



Disc with Neumann KM83s  
(Mics courtesy of FWO Bauch Ltd)

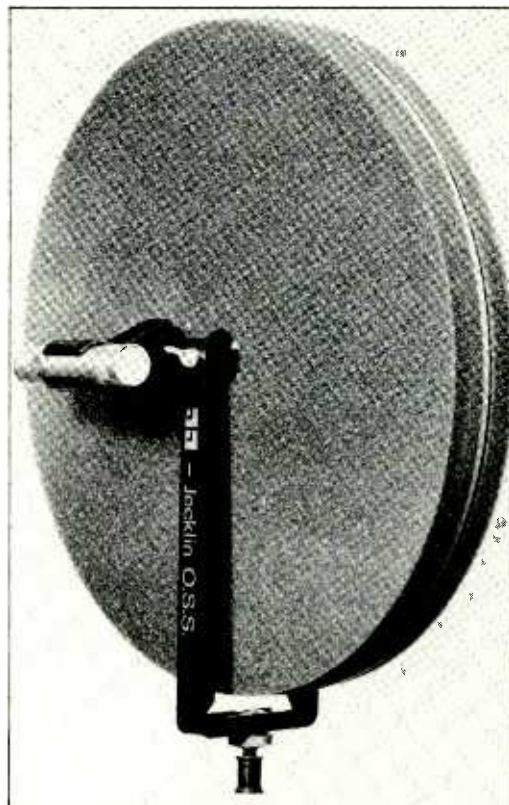



is particularly easy to use the cocktail party effect to home in on conversations.

In the studio the results were less satisfactory. I tried the disc as a drum overhead pair, on a grand piano, and various other things, and found it a little disappointing, although this is possibly because my studio is a relatively dead room. I imagine the effect on a drum kit in a good live room could be quite exciting. There was also the problem that most of the work I was doing was multitrack pop stuff, mostly conventionally miked and designed to be heard on speakers, and the head just didn't fit the overall sound. One thing I tried, however, worked extremely well and suggests other avenues of exploration: I overdubbed a pair of congas in stereo using the disc. This worked well on speakers, since there was no centre information to get lost, and on headphones the congas jumped sideways out of the head, expanding the restricted straight-line-through-the-head effect of an otherwise conventional mix. It would be interesting to try a similar trick with backing vocals, string sections, even stereo electronic instruments with the disc between a pair of speakers.

The problem to watch, of course, as with all the concert recordings I did with the disc, is the poor loudspeaker compatibility. With all binaural recordings, the sound tends to clump in the speakers, leaving a particularly bad hole in the middle, and any illusion of realistic imaging is lost. This, of course, is the reason binaural methods are still little used, despite their advantages, and the problem has been the subject of much research for years. Jecklin's literature claims, however, that with the disc it is possible to overcome these problems using 'compensation signals'. If this is true then it's a major breakthrough. However, Jecklin give no clues as to how this system is supposed to work, and don't even begin to suggest how it should be done. If they have cracked it, I think we should be told.

Unfortunately, this is typical of Jecklin's rather confused publicity concerning the disc. It appears to be aimed at the layman, although it suggests using professional microphones costing several hundred pounds. Nowhere does it come out and say that it is a binaural set-up—the word 'binaural' appears only once in Jurg Jecklin's AES paper, in an ambiguous context—but everyone in the business who's seen my review sample has immediately said, 'Oh, I see you're using a dummy head.' Indeed, Jecklin seem to be suggesting that this is a new idea of some kind. Some of the theoretical background given is very old work, including some standard text-book graphs showing the relationship between level differences, arrival-time differences and stereo placement, some of it is so vague as to impart no information whatever, and some is just plain wrong. Jecklin have here a good product at a good price. It enables anyone with a decent pair of omni microphones to sample the delights of proper binaural recording without either building their own head or parting with a lot of money. It doesn't need vague claims of being something new in order to sell—in fact unscientific waffle and unsubstantiated promises of loudspeakers compatibility are more likely to put hardened pro engineers off. If it were simply marketed as a practical, affordable dummy head it should be a good seller, since it fits that description very well and as such does an excellent job. □

**Precide SA, CH-6834 Morbio Inf, Via Vela, Switzerland.**

**UK: Presence Audio, Eastland House, Plummers Plain, Horsham, West Sussex RH13 6NY. Tel: 044485 333.**

# SCHOEPS

Colette series with interchangeable capsules for a variety of applications.



## Get the Iron Out!

Since more than 10 years,  
Schoeps has got the transformer out of the microphone.

— Contact —

- AUS** Klarion Enterprises Pty. Ltd. P. O. Box 379, South Melbourne, Victoria, 3205, Tel.: (03) 6135 41
- A** Studer Revox Wien Ges. m. b. H., Ludwiggasse 4, 1180 Wien, Tel.: (02 22) 47 33 09
- B** Heynen B.V., Bedrijfsstraat 2, 3500 Hasselt, Tel.: 011-21 00 06
- BR** Centelec Equipamentos e Sistemas Eletrônicos Ltda., 20561 Rio de Janeiro/R. J., Tel.: (021) 268-79 48
- CDN** Elnova Ltd., 4190 Rue Seré, St.-Laurent, Québec H4T 1A6, Tel.: (514) 341-6933
- SF** Lounamaa Electronics Oy, Uimarinpolku 27 A, 00330 Helsinki 33, Tel.: 90-488 566
- F** ELNO S. A., 18-20, rue du Val Notre-Dame, 95100 Argenteuil, Tel.: (1) 39.82.29.73
- HK** Audio Consultants Co., Ltd., 58 Pak Tai Street, Tokawan, Kowloon, Hong Kong B. C. C., Tel.: 3-712 52 51
- I** TDS - Tecniche del Suono S. r. l., Piazza Crivellone, 5, 20148 Milano, Tel.: 46.96.105
- IL** Kollinor Ltd., 18 Ha'arba'a Street, Tel-Aviv, Tel.: 03-26 32 98
- J** Imai & Company Ltd., 1-6 Tomihisacho, Shinjuku Tokyo, Tel. (03) 357-0401
- NL** Heynen B.V., P. O. Box 10, 6590 AA Gennep, Tel.: 08851-96111
- N** Siv. Ing. Benum A/S, Boks 145 Vinderen, Oslo 3, Tel.: (02) 14 54 60
- P** G. E. R. Av. Estados Unidos da América, 51-5°, Dto. 1700 Lisboa, Tel.: 88 40 21
- E** Singleton Productions, Via Augusta, 59 Desp. 804 - Edif. Mercurio, Barcelona-6, Tel.: 237 70 60
- S** NATAB Akustik AB, P. O. Box 6016, 55006 Jönköping, Tel.: 036-14 24 80
- CH** PAJAC - Jaques Zeller, Morges 12. 1111 Echichens, Tel.: 021-72 24 21
- GB** Scenic Sounds Equipment Marketing Ltd., 10 William Road, London NW1, Tel.: 01-387 1262
- USA** Posthorn Recordings, 142 West - 26th Street, 10th Floor, New York City, N.Y. 10001, Tel.: (212) 242-3737

**Schalltechnik Dr.-Ing. Schoeps GmbH,**  
Postbox 410970 D-7500 Karlsruhe, Telex 7826902, Tel. (0721) 42016/42011

# REVIEW

## Hugh Ford's technical evaluation of five microphones: the Sennheiser MKH 20, 30 and 40, Beyer's MC740N(C) and the VIP-50 from Milab

### Manufacturers and agents

**Eugen Beyer Elektrotechnische Fabrik GmbH & Co, Theresienstrasse 8, Postfach 1320, D-7100 Heilbronn, West Germany.**

**UK: Beyer Dynamic (GB) Ltd, Unit 14, Cliffe Industrial Estate, Lewes, Sussex BN8 6JL.**

**USA: Beyer Dynamic Inc, 5-05 Burns Avenue, Hicksville, NY 11801.**

**Milab International AB, Box 510, Spinnngatan 3, S-250 50, Brillesholm, Sweden.**

**UK: Court Acoustics Sales Ltd, 29 Beethoven**

**Street, London W10 4LG.**

**USA: EXP, 11288 Ventura Boulevard, Suite 304, Studio City, CA 91604.**

**Sennheiser Electronic KG, D-3002 Wedemark, West Germany.**

**UK: Hayden Laboratories Ltd, Chiltern Hill, Chalfont St Peter, Gerrards Cross, Bucks SL9 9UG.**

**USA: Sennheiser Electronic Corp, 48 West 38th Street, New York, NY 10018.**

Measurements were taken in the laboratory and in an anechoic chamber. A Bruel & Kjaer 4165 ½ in high output microphone calibrated for sensitivity with a Bruel & Kjaer 4420 pistonphone was used as a reference for the sensitivity and frequency response measurements.

The frequency response of the samples was assessed with the sample and reference microphones placed in line with the tweeter 1 m from a Bowers & Wilkins 1400 loudspeaker in the anechoic chamber. The reference microphone was used to drive the compressor in the sweep oscillator in order to obtain a constant 94 dB sound pressure level (equivalent to 1 Pa or 20 dB above 1 µbar).

In order to plot the true response a pen speed of 100 dB/s with a plotting speed of 16.7 s/decade was used. This is faster than many manufacturers' plots which hide parts of uneven responses.

The polar responses were plotted under similar conditions: the sound pressure was set to make the front outputs coincide on the plots as is normal practice. The polar responses were plotted at 125 Hz, 1 kHz, 10 kHz and 16 kHz whilst using a ½-octave filter to eliminate the effects of turntable noise.

Because loading can affect frequency response if long cables are used the approximate output impedance of the microphones was determined by measuring the output whilst applying ½-octave noise with the microphones feeding the standard phantom powering network and then loaded with 300 Ω. The voltage drop when loaded was used to determine the approximate output impedance at 125 Hz, 1 kHz and 10 kHz.

While interference pickup in the microphone cables is normally considered to be controlled by the balanced inputs stages of the microphone

### Manufacturer's specifications

Make	Beyer	Milab	Sennheiser	Sennheiser	Sennheiser
Model	M740N(C)	VIP50	MKH 20	MKH 30	MKH 40
Type	Condenser	Condenser	RF condenser	RF condenser	RF condenser
Pattern	Variable	Variable	Omnidirectional	Fig-of-eight	Cardioid
Sensitivity	10 mV/Pa	14 mV/Pa	25 mV/Pa	*	25 mV/Pa
Attenuator	10 dB	10/20 dB	10 dB	10 dB	10 dB
Filter(s)	80/160 Hz	200/400 Hz	HF boost	High pass	40/120 Hz
Maximum SPL	144 dB	143 dB	142 dB	*	142 dB
A-weighted noise	17 dB	18 dB	10 dB	*	12 dB
Freq response	40 Hz-20 kHz	40 Hz-20 kHz	20 Hz-20 kHz	*	40 Hz-20 kHz
Impedance	No limits	No limits	Curve	*	Curve
Minimum Load	150 Ω	180 Ω	160 Ω	*	150 Ω
Powering	1000 Ω	1000 Ω	1000 Ω	*	1000 Ω
Powering current	48 V	48 V	48 V	48 V	48 V
Connector	1.4 mA	3.5 mA	2.0 mA	*	2.0 mA
Weight	XLR-3	XLR-3	XLR-3	XLR-3	XLR-3
Finish	390 g	400 g	100 g	*	100 g
	Not specified	Not specified	Not specified	*	Not specified

\* Specification not yet available

### Measured results

Make	Beyer	Milab	Sennheiser	Sennheiser	Sennheiser
Model	M740N(C)	VIP-50	MKH 20	MKH 30	MKH 40
Sensitivity	9.5 mV/Pa	14 mV/Pa	24 mV/Pa	27 mV/Pa	23 mV/Pa
Self noise					
A-weighted RMS	15.5 dB SPL	17 dB SPL	12 dB SPL	10.5 dB SPL	10 dB SPL
CCIR peak	25.5 dB SPL	32.5 dB SPL	22 dB SPL	20 dB SPL	18 dB SPL
CCIR RMS	21.5 dB SPL	29.5 dB SPL	17.5 dB SPL	15 dB SPL	15.5 dB SPL
Impedance					
100 Hz	160 Ω	400 Ω	150 Ω	150 Ω	150 Ω
1 kHz	160 Ω	250 Ω	150 Ω	150 Ω	150 Ω
10 kHz	200 Ω	250 Ω	150 Ω	150 Ω	150 Ω
Current at 48 V	1.5 mA	4.4 mA	2.0 mA	2.0 mA	2.0 mA
Output for 10 Oe field					
Equivalent SPL	52 dB	<40 dB	<54 dB	60 dB	64 dB
Wind noise	Poor	Poor	Good	Poor	Poor
Handling noise	Very good	Poor	Excellent	Good	Very good
Pop sensitivity	Medium	Medium	Medium	Poor	Very poor
Weight	360 g	390 g	98 g	105 g	98 g

Note: Wind noise and pop sensitivity quoted without windshield



amplifier, this is not the case if interference is picked up in the phantom powering of condenser microphones. This source of unwanted signals was evaluated by inserting 1 VRMS of audio frequency in series with the phantom power supply and selectively measuring the resulting output from the microphone as shown in the plots which relate frequency to the equivalent sound pressure level.

The final measurement was to determine the sensitivity to external magnetic fields such as those from power cables. Each microphone was 'searched' by a coil with a calculated 1 Oe 50 Hz magnetic field at its centre and the resulting 50 Hz output related to the equivalent sound pressure level that would cause the same output level.

The tabulated results for handling and wind noise and also pop sensitivity are purely subjective results without the use of windshields. In some cases windshields made dramatic improvements in the sensitivity to wind noise and pop sensitivity.

## Sennheiser MKH 20 P48

The three types of Sennheiser microphones reviewed here are part of a new range, all of which have exceptionally low noise and high output, the latter requiring some caution in use but essential if the low noise capabilities are to be used.

Each microphone is supplied in a good quality case containing a windshield and stand adaptor together with an individual frequency response plot.

Difficulty was experienced in measuring the noise performance as it is far from easy to achieve noise levels below the measured noise around 10 dBA SPL which is far quieter than most studios and marginal in the anechoic chamber used for the measurements.

All three microphones use the established Sennheiser radio frequency condenser principle

SENNHEISER MKH 20 P48 FREQUENCY RESPONSE

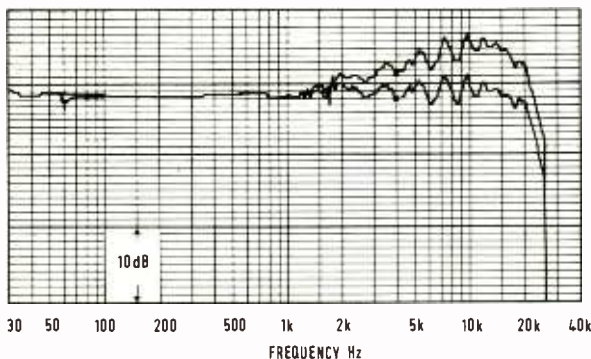

SENNHEISER MKH 20 P48 MAGNETIC FIELD SENSITIVITY

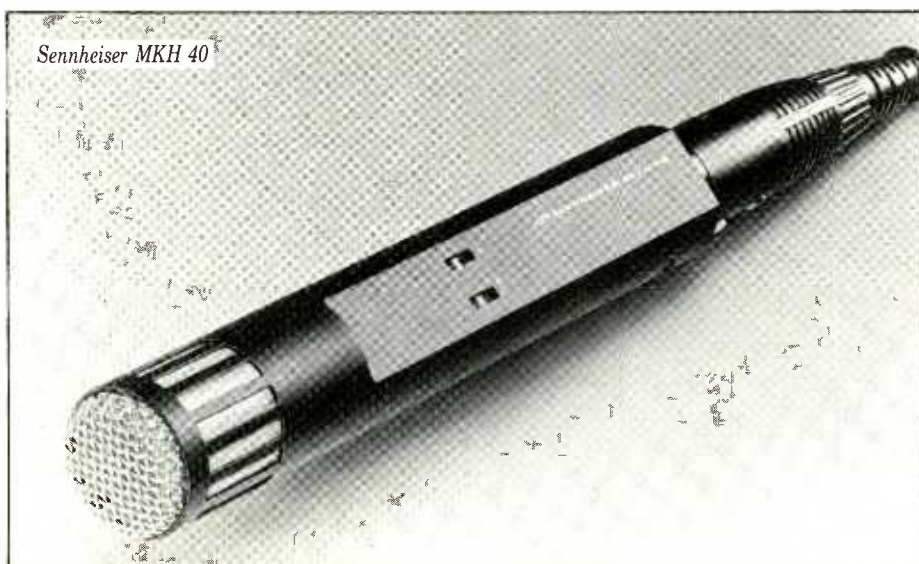
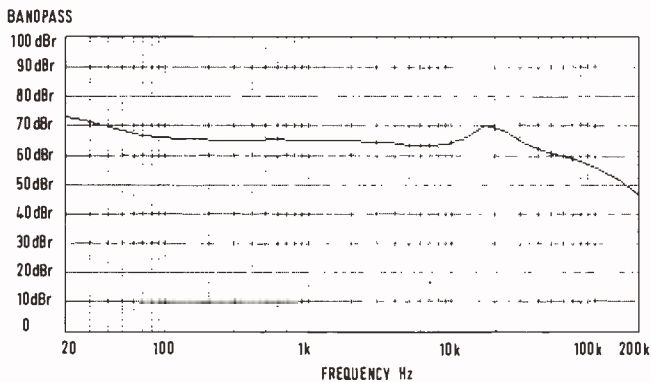

**AT LAST — A SMPTE  
READER/GENERATOR/MIDI  
CONVERTER FOR UNDER  
£300. FEATURES INCLUDE  
SONG POINTERS & MIDI  
MERGE. UNBELIEVABLE?  
GIVE US A RING & FIND  
OUT ABOUT THE NOMAD  
SMC10 — ONLY  
£299 + VAT**

### SOME OF OUR SECONDHAND & EX-DEMONSTRATION STOCK

Eventide 949 Harmonizer excellent condition .....	£750
Fostex model 80 8-track, 3 months old .....	£1,250
RSD Series II 16,16,2 — mint .....	£2,600
Roland S10 sampler .....	£690
BEL BDE 3200, 32 sec, 99 window super-sampler, as new, silly price .....	£999
3M M79 + Full autolocate — excellent .....	£10,250
TAC Matchless 26:24:8:2 + patchbay + stand, 9 months old .....	£8,500
Yamaha SPX90 .....	£435
BEL BD80 (8 sec) .....	£465
Sony PCM 501 (new) .....	£485
BOKSE US8 Universal synchroniser .....	£245
Q.Play programmable remote for E16, B16 + M80 .....	£99
Selection of ex-demo Yamaha power amps .....	Phone
Fostex E16 w/remote — 3 months old .....	£3,600
Tascam 38 — As new (full guarantee) .....	£1,475
Slapback scintillator (exciter) .....	£150
Yamaha 31 band graphic eq. (2 only) .....	£160 each
Symetrix quad expander gates .....	£325
Ashly stereo gate .....	£199
Drawmer DS221 compressor/limiter .....	£275
AHB Keymix computer mix down system .....	£1,200
(fits any desk — routing & muting — 16T)	
Midi-CV converter—play your old synths & samplers...	£60

Plus loads more — give us a ring!

All prices exclude VAT

Special offer 8-track starter package (M80, MTR 1282  
plugs, cables, patchbay) .....

£1,650 + VAT

Just some of the new products we stock  
Akai S900, S700, X7000 and the brand new 24-track  
Yamaha — RX5, DX7II, TX81Z, SPX90II  
plus

RSD series II desks, TAC Matchless and Scorpion, Fostex  
E16, Tascam, Tannoy and loads more.

From Fostex to Neumann, TAC to Yamaha, we are main  
dealers for all the latest high quality products, most of it  
on permanent demonstration in our 3 24-track studios.

If you have any audio requirements, give us a ring

For those of you who are seriously considering starting a  
commercial 8, 16 or 24 studio venture, I've come up with  
three packages. Each contains EVERYTHING you will need  
for your first paying session, from the multitrack machine  
right through to DI boxes and cables. The price of the 8  
track system is £4300 + VAT. The 16 track is £8450 + VAT  
and the 24 track is £15,000 + VAT.

At Thatched Cottage I proved it *could* be done. In the last  
2 years I have helped many new studios open *and* start  
making money — my experience could help you. Give me  
a ring and have a chat — what have you got to lose?

Special offer computer package. Atari 520 Steinberg Pro-24  
and Nomad SMPTE/Midi reader generator ...£875 + VAT

• EXPORT • FULL CREDIT FACILITIES AVAILABLE • MAIL ORDER •



**Thatched  
Cottage Audio**

Telephone Dave on  
**Bedford (0234) 771259/771166**  
**Thatched Cottage Audio,**  
**Cross End, Thurleigh, Beds.**

# REVIEW

such that no DC voltage is present in the capsules thus virtually eliminating problems associated with high humidity or condensation. A further feature is the use of electronically balanced

outputs eliminating any transformers in the signal path.

The three microphones are similar in construction with the body being formed from a lightweight steel tube flattened on two sides to the rear where a 3-pin XLR plug is recessed. Two slide switches are recessed in one side of which is a 10 dB attenuator and the other modifying the frequency response.

The entire microphone is finished in matte black with subtle silver coloured markings with access for servicing being by removing two Phillips head screws which are rather rough to feel on the side of the microphone bodies.

The MKH 20 is the omnidirectional version with a flat grille at the 'working end'. The frequency response plot shows a flat response with the internal slide switch providing random incidence correction to the extent of +5 dB boost above 5 kHz.

While the polar response is not that of a perfect omnidirectional microphone the high frequency response falls off smoothly to the rear without

any peculiarities and in complete agreement with the manufacturer's data.

The microphone was unusually tolerant of handling noise and quite good on wind noise and popping without the windshield provided. Using the windshield gave a very good overall performance in these respects.

The microphone was quite insensitive to external magnetic fields and to interference in the phantom power supplies.

## Sennheiser MKH 30 P48

The fig-of-eight version is similar in many respects but is slightly longer than the MKH 20 and includes grilles in the sides below the end grille.

Overall the on axis frequency response is very flat with the internal switch inserting a 3 dB/octave bass cut below 300 Hz. Reference to the polar response shows this to be almost perfect but with slight deviations at 16 kHz.

SENNHEISER MKH 30 P48 FREQUENCY RESPONSE

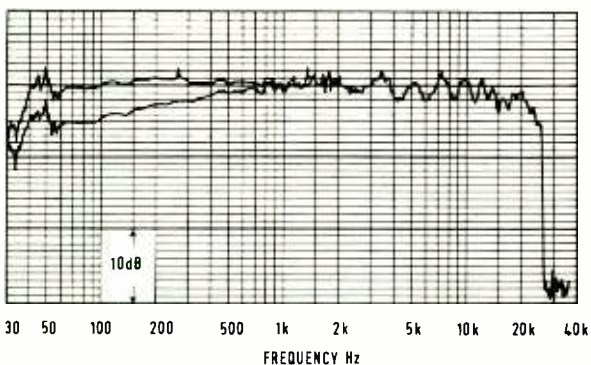

SENNHEISER MKH 30 P48 MAGNETIC FIELD SENSITIVITY

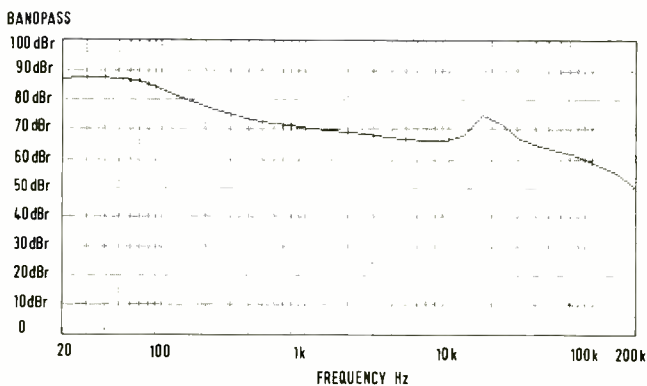

### SENNHEISER MKH SERIES POLAR RESPONSE

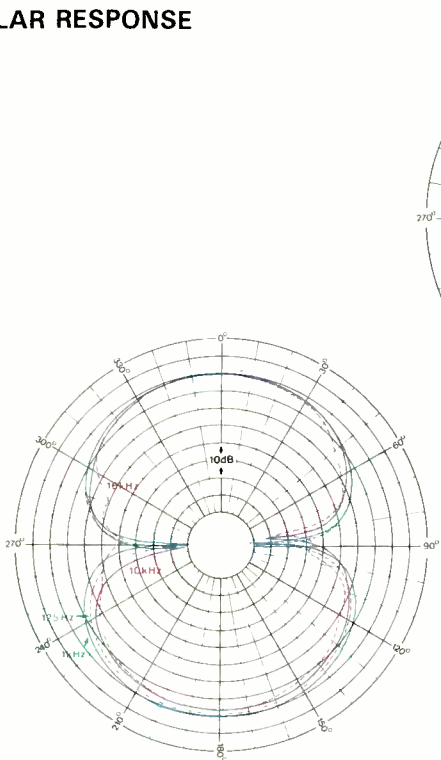

MKH 30 P48

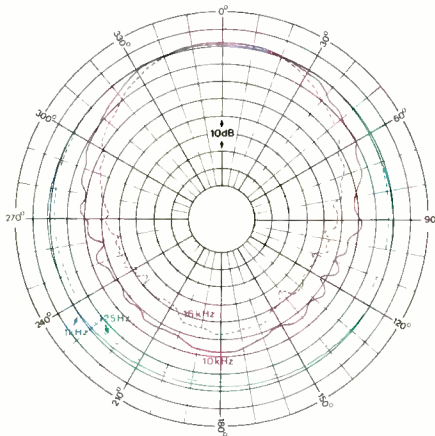

MKH 20 P48

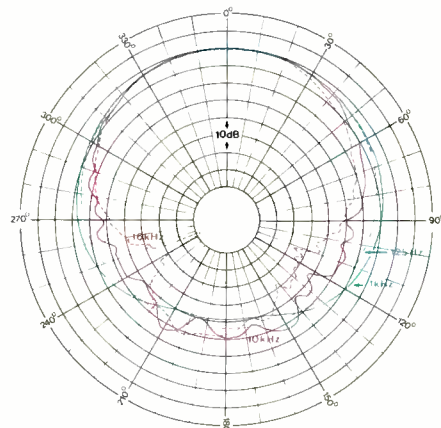

MKH 40 P48





**The M20 from AEG sets new standards for professional tape recorders in the studio.**

This professional machine is right at the cutting edge in terms of technology, ease of operation, reliability and ergonomics.

The M20 is the latest development from the inventor of the magnetic tape recorder in a successful line stretching back 50 years.

It has every impressive feature the professional could ever desire. The latest microprocessor technology. Sync amplifier for monitoring with the recording head during electronic editing. Electronic and storable automatic bias adjustment for different types of tape, with all sorts of equalization (such as NAB and IEC), and that at all 4 speeds. Incorporation in computer-controlled systems via standard interface. Timecode option. Built-in or portable for studio and mobil operation. Optimal operating in horizontal or vertical position. Continuous vertical and horizontal adjustment of Variostand allows perfect ergonomics for any operator. Suitable for 19" plug-in systems. The M20 represents the ultimate combination of state of the art electronics and high-precision mechanics. For higher demands and new applications, e.g. in conjunction with computer-controlled editing systems or stereo television. It's tomorrow's answer to today's sound studio.

Please forward further information about the new Magnetophone M20 from AEG.

Name \_\_\_\_\_

Company \_\_\_\_\_

Street \_\_\_\_\_

Post Code/City \_\_\_\_\_

AEG Aktiengesellschaft  
 Professional Tape Recorder Branch  
 Bücklestrasse 1-5  
 D-7750 Konstanz  
 West Germany  
 Phone: (07531) 862370  
 Telex: 733233

K2 WAK 3619 E

Please see us at the 15th International Television Symposium and Technical Exhibition – Montreux, 12. 6. – 16. 6. 1987 Montreux Convention Center 2nd Floor, Stand 402

**AEG**

# REVIEW

This version was much more sensitive to wind noise and popping but use of the windshield provided removed this criticism providing good rejection of wind noise and very good immunity to popping.

Magnetic fields did not represent a problem but this version was more sensitive to low frequency interference in the phantom supplies, high frequency interference being a more common problem associated with studio lighting dimmers.

## Sennheiser MKH 40 P48

Finally we come to the cardioid version in this range of microphones, again with a flat frequency response rolled off 12 dB/octave at 40 Hz or at 6 dB/octave below 120 Hz when the internal switch is operated.

Again the measured polar response was very close to the manufacturer's data with a well controlled pattern below 10 kHz but some

peculiarities at 16 kHz at  $\pm 120^\circ$  from the front.

The performance in relation to magnetic fields and to the phantom supply was similar to that of the MKH 30. Again, having side ports, this microphone was sensitive to wind noise if used without the windshield. Sensitivity to popping without the windshield was very poor and even with the windshield this may be a problem in some applications.

## Beyer MC740N(C)

The MC740N is a multipattern studio microphone available in two versions, one equipped with a 5-pin XLR connector allowing the polar pattern to be remotely switched. As standard the microphone

is supplied in a padded plastic box also containing an elastic suspension. Mains or battery power supplies are available as an option.

The 37 mm diameter tubular body has the XLR-3 plug in the bottom and three thumbwheel switches around the periphery at the top below the matte black grille which matches the body, all parts being well finished.

Of the three switches one is a 10 dB attenuator, another selects a flat response, an 80 Hz or 160 Hz high pass filter and the third switch the polar pattern. This may be omnidirectional, wide angle cardioid, cardioid, hypercardioid or fig-of-eight with the three switches showing their current setting through apertures in the body.

The noise performance of this microphone was good at 15.5 dBA and better than the manufacturer's claims. However, the frequency response (which was independent of the polar pattern) leaves much to be desired in the 5 to 10 kHz region with the low frequency response being controlled by the high pass filters.

Reference to the polar diagrams shows that with the exception of the fig-of-eight pattern the high frequency response falls off quite severely at more than  $30^\circ$  off axis. Furthermore the balance off-axis is not very smooth and sensitive to the angle off axis although the fig-of-eight performance is good.

The rejection of noise in the phantom supply was generally good but very frequency sensitive. As a studio microphone the handling noise was good and wind noise is unlikely to be a problem.

## Milab VIP-50

A studio microphone of different design the body is a rectangular section with the grille at the top being tapered to almost a point and providing good mechanical protection. In the base is the 3-pin XLR plug and a threaded hole for the stand adaptor. As standard the microphone is supplied in a substantial moulded plastic carrying case complete with a rather clumsy shock mount and

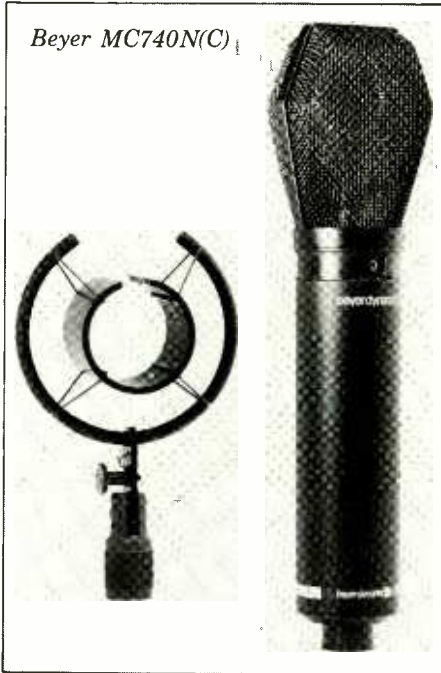

SENNHEISER MKH 40 P48 FREQUENCY RESPONSE

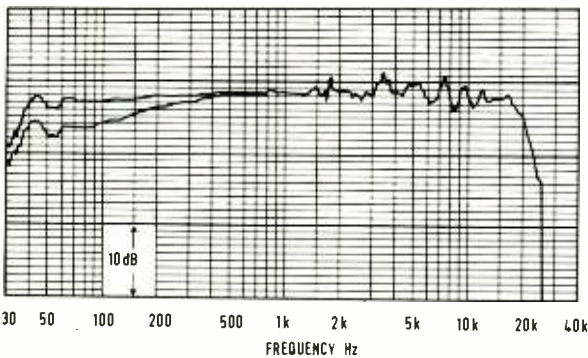

BEYER MC740N(C) FREQUENCY RESPONSE

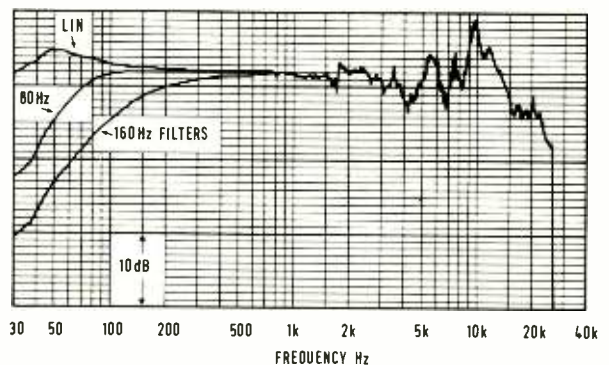

SENNHEISER MKH 40 P48 MAGNETIC FIELD SENSITIVITY

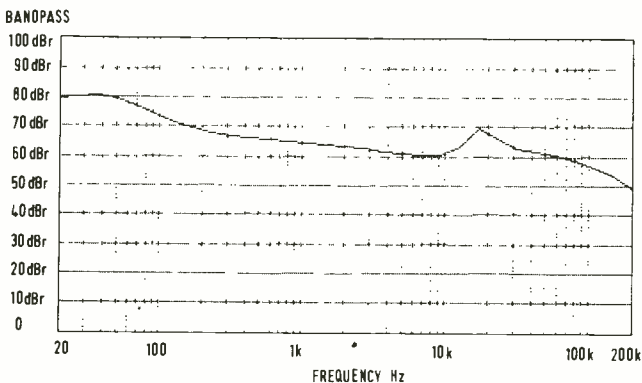

BEYER MC740N(C) MAGNETIC FIELD SENSITIVITY

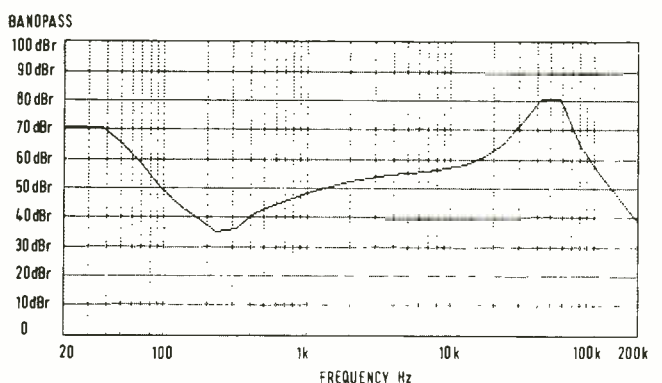



# THE ULTIMATE DIGITAL PROCESSING EQUIPMENT

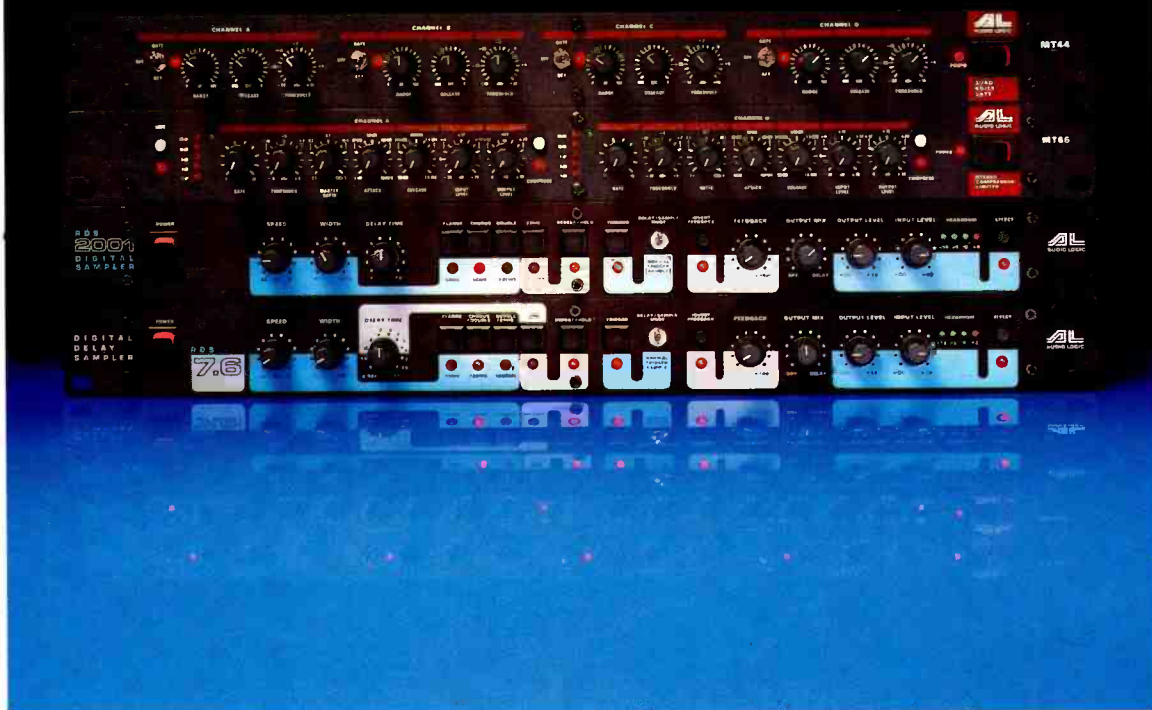

AUDIO LOGIC and DOD  
The best in digital delays, graphics equalisers  
and sound processing

## YET MORE

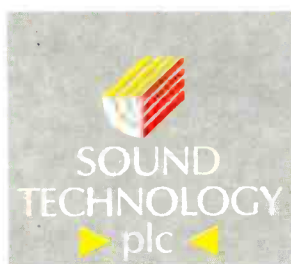

6 Letchworth Business Centre, Avenue One, Letchworth, Herts SG6 2HR  
Telephone: 0462 480000 Fax: 0462 480800 Telex: 826967

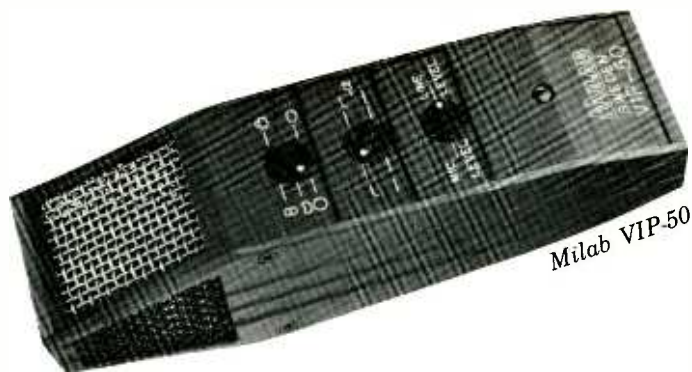

Milab VIP-50

# REVIEW

windshield. A modified type of shock mount is now available.

At the front of the microphone are three miniature rotary switches which are easy to operate. The bottom switch offers 0 dB, 10 dB or 20 dB attenuation with the middle switch having a flat position or inserting 200 Hz or 500 Hz high pass filters. The third switch with six positions selects the polar diagram between

MILAB VIP-50 FREQUENCY RESPONSE

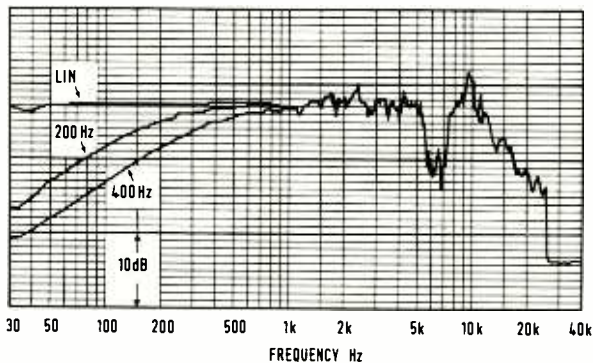

BEYER MC740N(C) POLAR RESPONSE

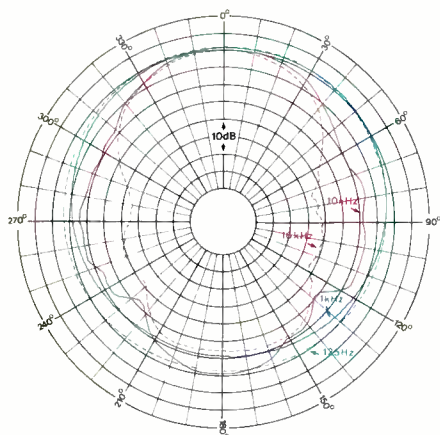

OMNI

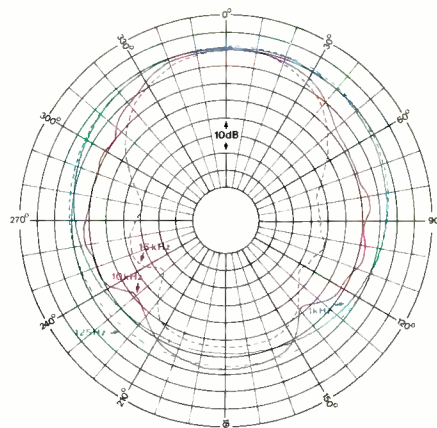

WIDE CARDIOID

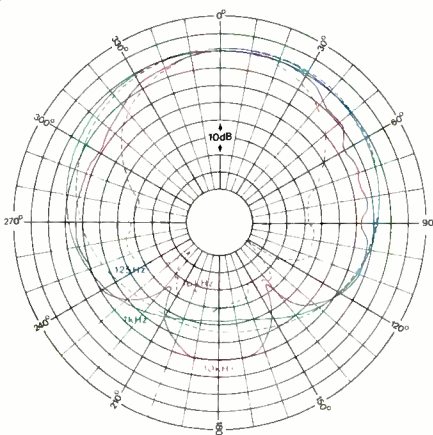

CARDIOID

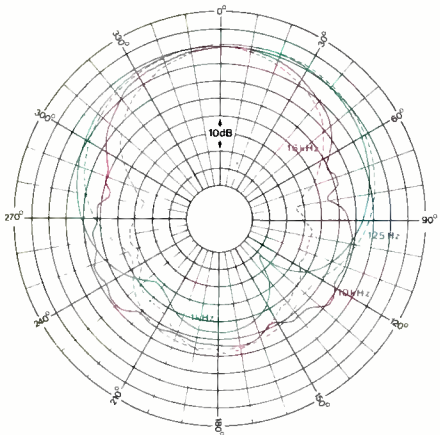

HYPERCARDIOID

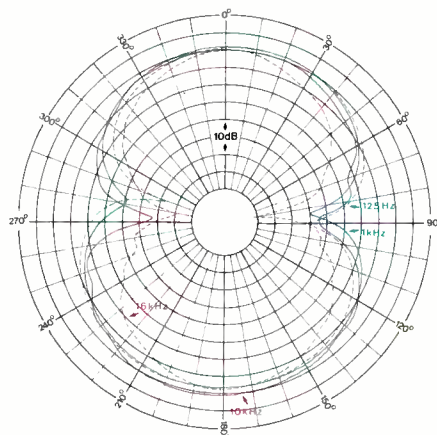
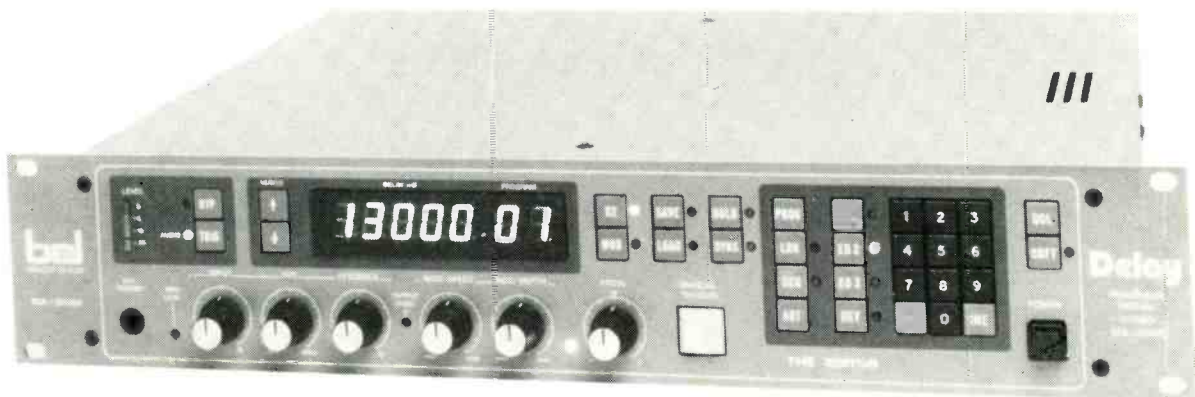

FIG-OF-EIGHT



# BEL BDE-2600S STEREO DDL-SAMPLING EDITOR

13 SECONDS STEREO SAMPLING @ 18kHz OR 26 SECONDS MONO SAMPLING @ 18kHz



The stereo features of the BDE-2600S make it an ideal studio instrument for lifting brass and vocal parts and spinning them back into the track.

MIDI compatibility and pitch shift combine to make a very versatile creative tool.

99 memories, sequencer,

Optional disk drive available to store your samples and sequences.



**BEL INNOVATIVE DIGITAL TECHNOLOGY**

29 GUILDFORD STREET, LUTON, BEDS LU1 2NQ  
TEL: (0582) 452495

# Source or sampling?

"There is no better sampling" \*)



The TC 2290 is the first sampler/delay in the world to give you 100% accurate sampling up to 32 seconds. Make an A/B comparison with any analog or digital master tape or compact disc, and you will notice there is no difference.

The new TC 2290 digital delay is based on a totally new converter principle. With a linear frequency response up to 20KHz +0/ -0,5

dB an additional roll-off up to 33KHz and a unique 100 dB dynamic range, the TC 2290 is very warm, transparent, crystal-clear, musical... with absolutely no noise. It has 18 bit resolution - better sound quality than a compact disc, and many new innovative effects.

Ask your dealer for a demonstration of the new world standard of delay + programmable sampling. Just a few features are: delay with

ducking, chorus and delay simultaneously, automatic panning 100 presets and MIDI feature making it possible to control the TC 2290 from a computer.

**Big studios will like the extras, small studios will love the price**

\*) "There is no better sampling" is a quote from Bob Schwall - Right Track Studio in N.Y.C.

OF DENMARK

# t.c. electronic

U.K.: STATE OF THE ART DISTRIBUTION  
HIGH LANE VILLAGE, NR. STOCKPORT SK6 8AA  
PHONE: 0663 62442

WEST GERMANY: 08157/7677, DENMARK: 06262800, GREAT BRITAIN: 010456262800, SWEDEN: (031) 134950, NORWAY: (033) 26798, HOLLAND, BELGIUM, LUXEMBURG: 003110-4588166, AUSTRIA: 00498157/7677  
ITALY: (02) 5084.1, FRANCE: (91) 498728, SPAIN: 91-4426426, USA: (201) 384-4221, CANADA: (416) 727-1951, JAPAN: (03) 329-8051, AUSTRALIA: (03) 6992388, FINLAND: 90-814133, GREECE: 01-3628541, SWITZERLAND: 073/226616

# REVIEW

omnidirectional, wide cardioid, cardioid, hypercardioid or fig-of-eight with the sixth position being completely unidentified.

Whilst in practice this also selects the omnidirectional pattern it confuses operation of

the switch as one assumes that moving the switch one click will select the next indicated position.

Reference to the frequency response plot (which was similar for all patterns) shows the characteristics of the high pass filters which operate at 6 dB/octave and seem to be rather severe in action. At the high frequency end the response falls 10 dB between 10 kHz and 20 kHz (confirming the manufacturer's data) but with a severe 'suck out' around 6.5 kHz.

Whilst the polar response in the omnidirectional

and wide cardioid modes is rather unbalanced the performance in the cardioid, hypercardioid and fig-of-eight modes is very good. The measured results show noise is higher than the other microphones reviewed here, however, 17 dBA is a reasonable standard and the performance of some of the other microphones is quite exceptional.

Whilst the microphone was insensitive to external magnetic fields it was sensitive to 'muck' in the phantom supply and also drawing 4.4 mA care is needed in selecting power supplies. □

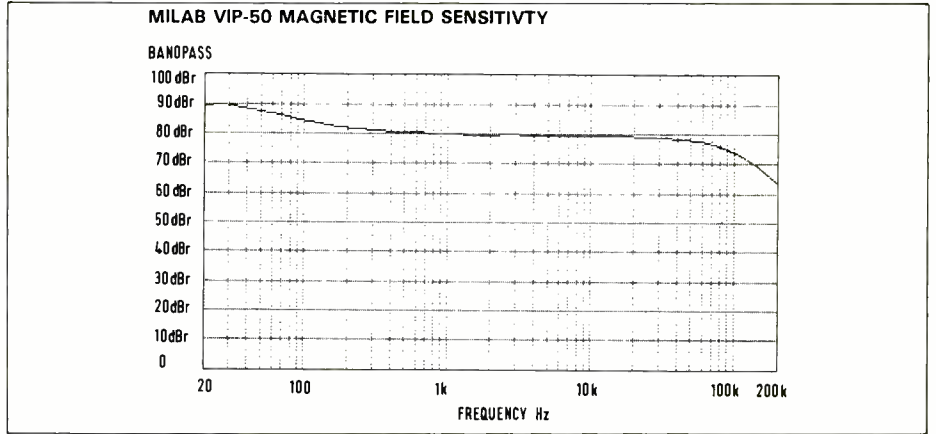

## MILAB VIP-50 POLAR RESPONSE

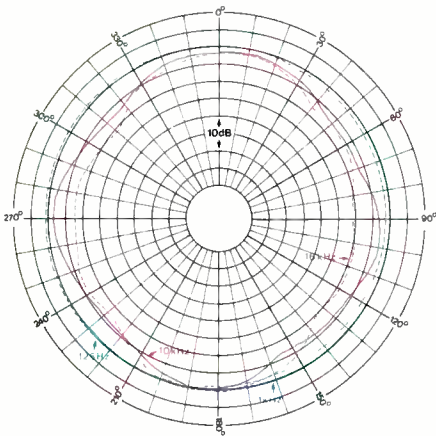

OMNI

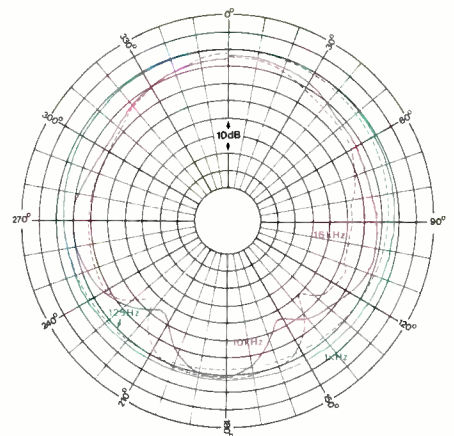

WIDE CARDIOID

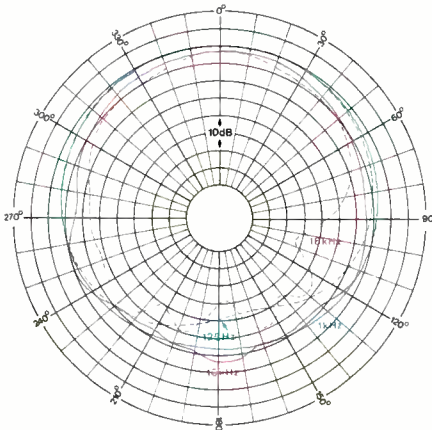

CARDIOID

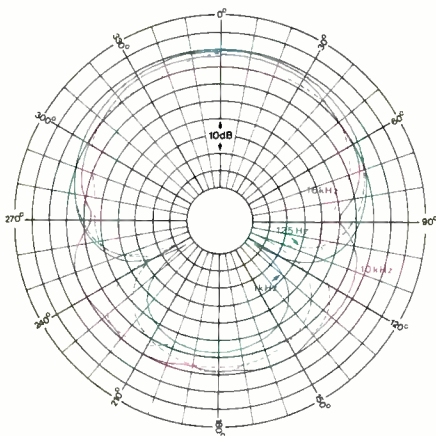

HYPERCARDIOID

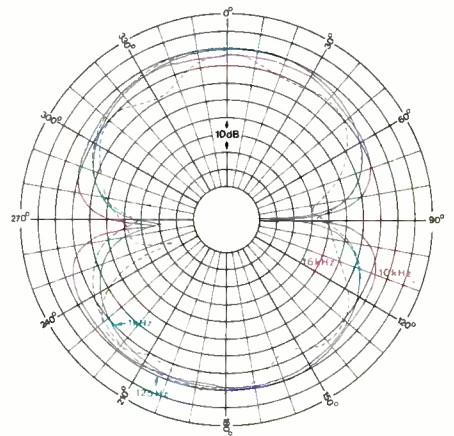

FIG-OF-EIGHT



# AUDIO JACKFIELDS & JACK SOCKETS

Mosses & Mitchell are the largest manufacturer of Audio Jacks and Jackfields in the UK. We are approved suppliers to the BBC, British Telecom, Pye Telecommunications and many other major telecommunication companies throughout the world. We manufacture a complete range of Audio Jacks & Jackfields and offer a design and manufacturing service geared to meet your specific requirements. For further information and technical data on our products contact:

## MOSSSES & MITCHELL

Plasmec Systems Limited  
Weydon Lane, Farnham, Surrey GU9 8QL  
Telephone: Farnham (0252) 721236  
Telex: 858820 Plasmc G

## Problems getting sound & vision together?



**B**igger problems if they do arrive together! Seriously though, effortless control of video and audio tape is vital in the studio. We have applied our expert knowledge of tape transports to develop a unique range of products: the CM50 autolocator now with optional SMPTE reader, the CM250 synchroniser available in 'chase' and 'control' versions and the CM255 superlocator and theatre control system. *Call us now and we'll send you our comprehensive brochure ... in a flash!*

Applied



Microsystems

Bagshot Road, Chobham, Woking,  
Surrey GU24 8BZ. ☎ (09905) 6267.

# Drawmer

*Ingenuity*

A  
FAMILIAR  
FACE...



DRAWMER DISTRIBUTION LTD.

CHARLOTTE STREET BUSINESS CENTRE  
CHARLOTTE STREET  
WAKEFIELD - WEST YORKSHIRE  
WF1 1UH ENGLAND  
Telephone: 0924 - 378669 Telex: 556649



THE DS 201 OFTEN EMULATED STILL UNSURPASSED

# REVIEW

## A technical evaluation of the Westlake BBSM-12 direct radiating monitor by Neil Grant

Currently the largest in a range of direct radiating monitor cabinets, the Westlake BBSM-12 uses drive units that are entirely of European origin, which is unusual for an American manufactured speaker.

The appearance of smaller, standalone monitors reflects the interest still being shown for independent monitor systems, and a lessening of the traditional reliance on main monitor systems.

The increased use of nearfield monitors is interesting. This has been principally due to the lack of consistent reference standards within control rooms due to the poor quality and linearity of previous generations of main monitors, and partly due to the erratic nature of control rooms as monitor environments.

By working within the nearfield of a known pair of speakers, engineers have minimised the effects of the surrounding room, and maintained at least some consistent reference to reality.

The BBSM-12 monitors have been designed as freefield speakers, and though right on the logical size limit, can be classed as nearfield devices.

### Crating

Each cabinet is delivered in its own cardboard carton, suspended internally by two foam inserts. It was obvious that the review pair had travelled the Atlantic and, though neither cabinet had sustained any damage, the packing was felt to be a little lightweight for the contents. Severe mishandling could lead to damage.

No manual was shipped with the system and the only accompanying literature was a copy of Westlake's own sales leaflets with which I would have thought most potential owners were familiar

with prior to the purchase of the system.

Manufacturers should supply detailed information regarding the mounting, set-up, and alignment of their systems, along with any relevant maintenance information that will assist the purchaser through the life of the system.

### Cabinets and drivers

The BBSM-12 is a 3-way system, passively crossed over at 500 Hz and 4 kHz. Two Audax 310 mm drivers cover the bass section, one Audax 165 mm driver the mid band, and the familiar Audax H34 34 mm tweeter the high frequency section. The cone drivers use lightweight moulded synthetic chassis assemblies, and the tweeter has a neat separate grille assembly to protect the fabric of the dome itself from prying fingers.

All the drive units had a quantity of semi-setting dampening compound liberally spread on the rear of the magnet assemblies. The effect would be to add mass, and lower mechanical resonances inherent in the units themselves, all of relatively lightweight construction.

Electrical connections are to the rear of the cabinet, terminating in a nicely recessed barrier strip. Dual sets of terminals are provided, though one set is not connected. This could be to facilitate future bi-amping of the system, or the termination of a double cable. There should be no problem in terminating quality multi-strand speaker cable, suitably fitted with a large crimped connector.

Cabinet construction is substantial, both bass drivers are loaded into a common chamber with two reflex ports. The mid range driver is loaded into a separate sealed chamber. All drivers are

front mounting, and can easily be removed and replaced.

So, too, can the T nuts into which the fixing bolts are screwed. Careless attempts to find the nut can very easily displace this into the depths of the cabinet, which then requires the removal of the balance of the drivers in order to find, and replace, the offending metal-work.

The mid range driver is displaced forward, bringing the acoustic centre of the device closer to the vertical position of the tweeter. The edges of the mid section are nicely chamfered, the whole forming a pleasing detail.

Internally, the cabinet is braced with a series of short, relatively lightweight, soft wood battens. Each batten is liberally covered with the same semi-setting compound as the drivers, providing the same function, and reducing the tendency of the braces to resonate at high SPLs.

The crossover assembly is hard-wired and made off directly to the rear and side walls of the cabinet. The wiring is substantial and the components of good quality. All hook-up wiring to the drivers themselves is of a similar standard.

The cabinet finish is a textured utility black, which will withstand reasonable abuse. All four drivers are recessed into the baffle, and the edges of the cabinet are neatly chamfered. Internal damping to the bass section enclosure is a small

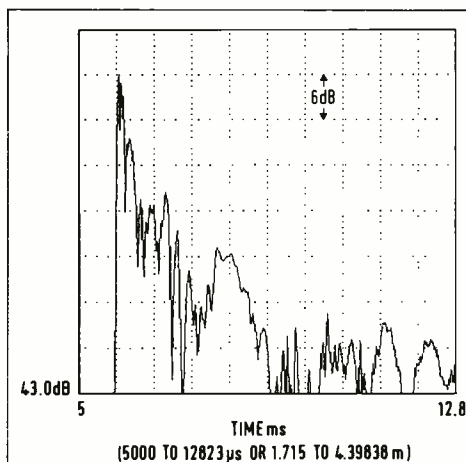

FIG 1 ETC AND BROADBAND AMPLITUDE  
0 dB is located at 0.00002 Pascal  
Scale: 7.3366E - 01 m/in or 2.8884E - 01 m/cm  
2138  $\mu$ s/in or 842  $\mu$ s/cm  
Line spacing: 19.6072  $\mu$ s or 6.72526E - 3 m  
Line width: 26.6658  $\mu$ s or 9.14636E - 3 m  
Window file name: A:HAMMING.W8T

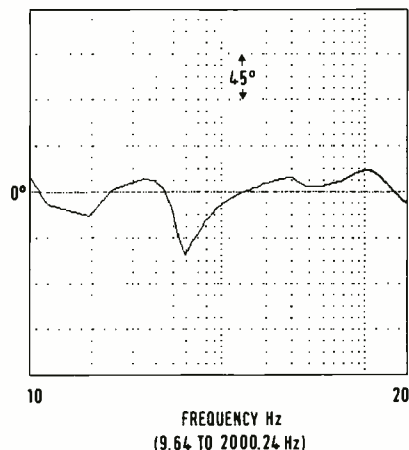

FIG 3 BROADBAND MODULUS OF IMPEDANCE (PFC)  
Log frequency axis: 2.7 decades  
Resolution: 3.4267E + 01 m and 1.0010E + 01 Hz  
Sweep rate and bandwidth: 100.19 Hz/s and 1.0010E + 01 Hz

### Manufacturer's description

**System type:** 3-way, medium power, phase coherent monitor with internal high level crossover.

**Configuration:** Two active 12 in woofers ported, 6½ in mid range in sealed non-resonant enclosure, 1¼ in dome.

**Power rating:** 180 W below 500 Hz, 50 W above 500 Hz.

**Sensitivity:** 89 dB SPL/V/m ( $\pm 0.5$  dB).

**Impedance:** Nominal 4  $\Omega$ , 2  $\Omega$  minimum.

**Frequency response:**  $\pm 3$  dB 60 Hz to 15 kHz on axis, suspended.

**Crossover:** Frequencies—500 Hz, 4 kHz. Type—

RLC, 24 dB/octave minimum. Phase compensated within 30° (measured acoustically to include driver delay).

**Cabinet finish:** Oiled walnut with brown grilles (BBSM-12F). Black utility, optional black grilles (BBSM-12).

**Weight:** 123 lb (55.9 kg).

**Dimensions:** (whd)

34×19×23 in/86.36×48.26×58.42 cm.

**Westlake Audio, 7265 Santa Monica**

**Boulevard, Los Angeles, CA 90046, USA.**

**UK: Britannia Row Ltd, 35 Britannia Row, London N1 8QH.**



amount of medium density glass fibre around the edges of the cabinet. The sealed mid range enclosure is wadded out similarly.

## Time domain performance

Fig 1 is an ETC, showing the behaviour of the system to a passing transient. The initial arrivals from the mid range and tweeter are close, though the bass section lags both other units. Decay from the tweeter and mid range are good, though the bass section shows some signs of being a little under-damped, taking some time to settle.

A certain amount of diffraction is visible from around the edges of the cabinet but generally performance is reasonable.

## Modulus of impedance

Fig 2 confirms that the BBSM-12 is a nominal 4 Ω system. The lowest point on the impedance curve is at 109 Hz just above the quoted minimum of 2 Ω.

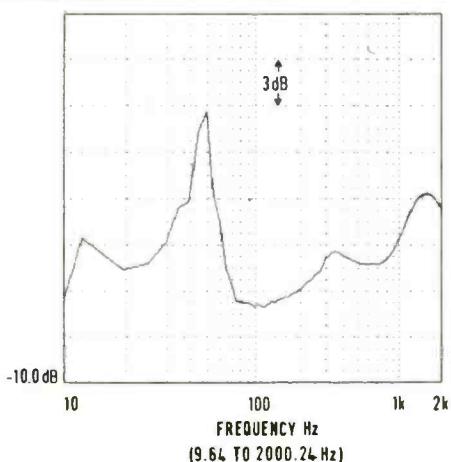

FIG 2 MODULUS OF IMPEDANCE  
0 dB is located at 4 Ω  
Log frequency axis: 2.7 decades  
Resolution: 4.8526E +02 m and 1.4175E +01 Hz  
Sweep rate and bandwidth: 10.02 Hz/s and 1.4175E +01 Hz

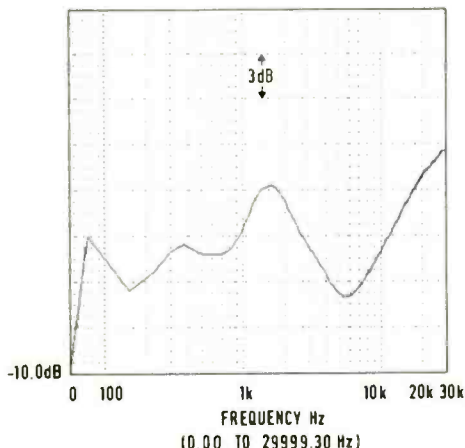

FIG 4 BROADBAND MODULUS OF IMPEDANCE (EFC)  
0 dB is located at 4 Ω  
Log frequency axis: 2.7 decades  
Resolution: 1.0836E +01 m and 3.1653E +01 Hz  
Sweep rate and bandwidth: 1001.91 Hz/s and 3.1653E +01 Hz

# THESE INNOVATIVE CONDENSERS COMBINE SOUND PURITY WITH RUGGED DEPENDABILITY



## WE MADE OUR FIRST ONE 53 YEARS AGO

Our model D40 was quite an innovation in 1933 — but it's light-years behind our current line of electret condensers. They're as rugged and resistant to humidity and sun as our legendary dynamics — and their performance does not deteriorate with age. They handle high SPL superbly!

They will not deteriorate with age!

FROM THIS SMALL:



Our remarkable SM98 was an instant success because it delivers big microphone performance even though it's less than 32mm long. Our SM83 lavalier is even smaller — yet it features a tailored response that overcomes chest resonances.

TO THIS BIG:



This is the first "forgiving" shotgun. Its smooth off-axis response minimizes off-axis coloration shift, and its extraordinarily light weight keeps it steady on the boom or in the hand.

SPECIALIZED FUNCTIONS:

Our SM82 line level microphone has a balanced line level output which drives telephone lines or other line level inputs directly — without remote amplifiers, and using unshielded cable.



Truly inconspicuous "boundary effect" surface microphone. Unintimidating appearance. Half-cardioid polar pattern is excellent for isolating performers without barriers.

## SHURE CONDENSER MICROPHONES



Shure Brothers Inc.  
222 Hartrey Ave., Evanston, IL 60602-3696 U.S.A.  
Telex 4330191 / Fax (312) 866-2279

# REVIEW

This curve illustrates the electrical behaviour of the system between 10 Hz and 2 kHz.

The modulus of impedance at higher frequencies is shown in Fig 3 and there is a second impedance minimum close to the second crossover point at 5.3 kHz. Again, the impedance is 2.2  $\Omega$ .

## Electrical phase

The speaker is highly reactive at the lower frequencies and Fig 4 shows a worst case capacitive reactance of  $-53^\circ$  at 59 Hz. This is, therefore, a very difficult load for many amplifiers. It is important that any amplifier used is capable of driving low impedances and is capable of delivering large amounts of current at low frequencies without any interruption from the amplifier protection circuitry.

Capacitive loads at higher frequencies contribute to harsh sounding systems due to slew rate limiting but at the higher impedance minimum the capacitive reactance is a relatively reasonable  $-15.5^\circ$ , which should cause little difficulty.

It would be advisable, considering the impedance of the system, to use a first class multi-strand hook up cable, to avoid degrading the system performance with a marginal cable.

## Frequency domain; amplitude response

The system broad band amplitude response is shown in Fig 5. The response is generally smooth, though lumpy in the lower bass and mid range.

Upper mid range, and higher frequencies are smooth, the extreme high frequencies especially so, rolling off smoothly past 25 kHz.

The performance of the individual drivers is shown in Fig 6.

The system is balanced slightly bass heavy, and the combined response of the two 310 mm bass drivers contributes most of the lower mid irregularities. The other mid band losses are due to cabinet diffraction effects.

Acoustically, the mid and bass drivers crossover at 500 Hz, and mid and high frequency drivers at 3.5 kHz. With the exception of the tweeter section high pass filter, all crossover slopes approximate fourth order filters.

Westlake have claimed the speaker is 'phase compensated within  $30^\circ$ , measured acoustically to include driver delay'. I take this to mean that if the propagation delay inherent in the measurement is removed, and then the phase shift between the electrical input and the

observed output of the device is measured, the observed response is within  $\pm 15^\circ$ .

Before even starting the measurement, it is difficult to see how this can be achieved; the system has three sections, each separated by fourth order filters, all of which possess  $360^\circ$  of phase shift, like it or not.

In addition, the bass section possesses substantially more than  $30^\circ$  of phase shift due to the fundamental high pass filter action of the system. Again, this is merely physics, and very little can be done to improve the situation apart from lowering the high pass corner frequency.

The only way it is possible to get close to the claimed figure is to isolate all four drivers from the passive crossover network and then measure each device independently, only within the individual pass band. This is generally arbitrary, and would be a process normally used only for identifying the acoustic centre of individual drive units within a multiple unit system.

Since the manufacturer clearly indicates that the measurement was for a complete system, I have provided a curve of the phase shift for the entire system.

Fig 7 is a Nyquist display of magnitude against phase angle; the two rotations are quite visible and there is something in excess of  $700^\circ$  of total phase shift within the system.

The silly thing is that this is a creditable performance, and the display shows the satisfactory behaviour of a competent system. So it is really only an inadequate and optimistic specification that is at fault.

The low frequency response of the system in 4  $\pi$  space is shown in Fig 8. The system is 3 dB down at 50 Hz, exceeding the manufacturer's specification, but the amplitude response is somewhat irregular, confirming the original suspicions with regard to the low frequency system damping. This also confirms that the speaker is designed to be free standing, away from room boundaries, and should not be wall mounted, or placed up against a room boundary, without modification.

The subsequent rise in bass performance would be inaccurate, and should be avoided.

## System decay and polarity response

Fig 9 better illustrates the time domain performance of the system. These quasi 3-dimensional curves show the frequency dependent decay of the system. Note the time taken for the bass components of the cabinet to

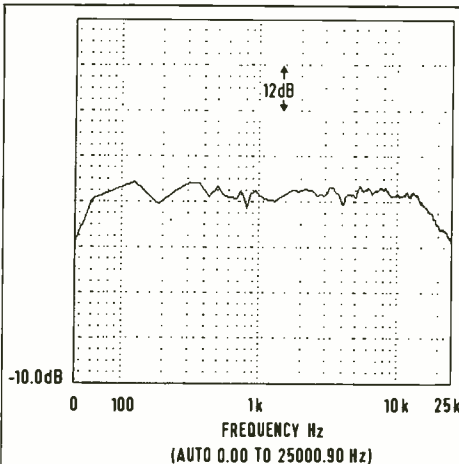

FIG 5 ETC AND BROADBAND AMPLITUDE (EFC)  
0 dB is located at 0.00002 Pascal  
Log frequency axis: 2.7 decades  
Time of test: 5830  $\mu$ s, 1.9997E +00 m  
Resolution: 7.6111E +00 m and 4.5066E +01 Hz  
Sweep rate and bandwidth: 2030.90 Hz/s and 4.5066E +01 Hz

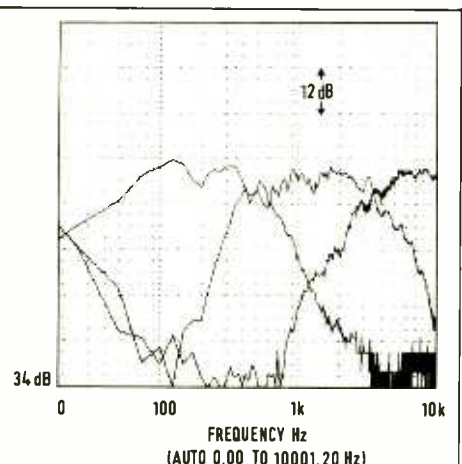

FIG 6 AMPLITUDE OVERLAYS (EFC)  
0 dB is located at 0.00002 Pascal  
Log frequency axis: 2.7 decades  
Time of test: 5820  $\mu$ s, 1.9963E +00 m  
Resolution: 7.6111E +00 m and 4.5066E +01 Hz  
Sweep rate and bandwidth: 2030.90 Hz/s and 4.5066E +01 Hz

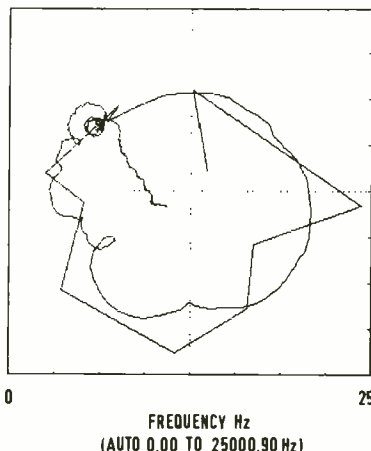

FIG 7 ETC AND BROADBAND AMPLITUDE (NPP)  
Time of test: 5820  $\mu$ s, 1.9963E +00 m  
Resolution: 7.6111E +00 m and 4.5066E +01 Hz  
(12 dB of automatic screen gain)  
Sweep rate and bandwidth: 2030.90 Hz/s and 4.5066E -01 Hz

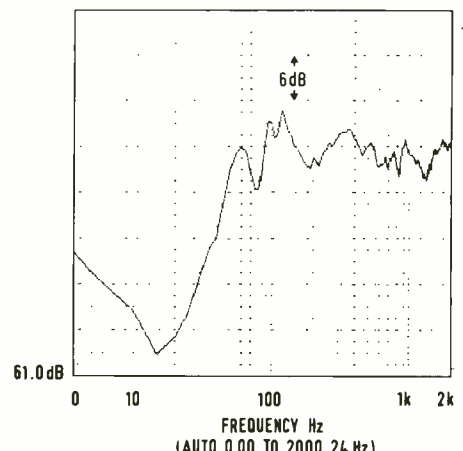

FIG 8 BASS RESPONSE (EFC)  
0 dB is located at 0.00002 Pascal  
Log frequency axis: 2.7 decades  
Time of test: 5830  $\mu$ s, 1.9997E +00 m  
Resolution: 2.4198E +01 m and 1.4175E +01 Hz  
Sweep rate and bandwidth: 200.92 Hz/s and 1.4175E +01 Hz



# SONY®

## Whether you shout it or whisper it, the quality is always the same

We'd like to 'whisper' a few facts that could well change your outlook on microphones.

You may not realise that Sony have been in the professional audio business since 1950.

We released our first condenser microphone, the C-37A, in 1953

It quickly became a classic in Japan and the USA.

We were responsible for the world's first transistorised condenser microphone in 1965.

Called the C-38, it has now sold over 23,000 units.

More recently, some new members of the Sony microphone family were introduced to carry on this tradition; the C-535P and C-536P. They join the already highly proclaimed C-48 at the top of our range.

So, if you thought we only made funny little microphones which clipped onto newsreaders' ties, then you've most certainly been getting the wrong message . . . . Sorry, we should have shouted louder.

Just send the coupon for the latest microphone catalogue, or call your nearest Sony dealer.

The right choice of microphone has never been more important than in this digital age. And you can expect the very best from the leader in digital audio.

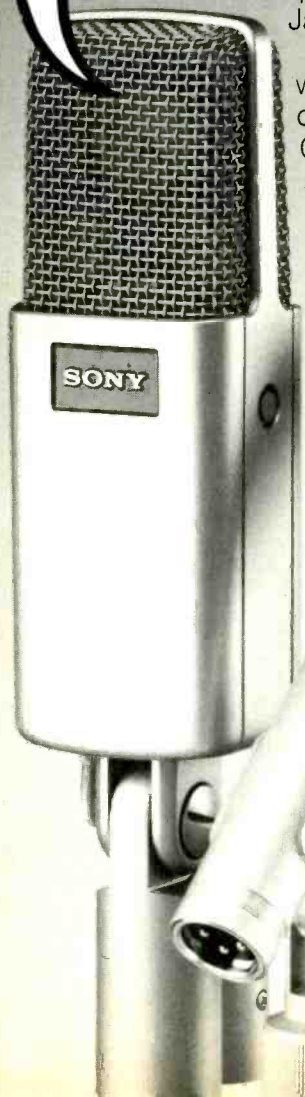

SONY

SONY

HHB Hire & Sales  
73/75 Scrubs Lane  
London, NW10 6QU  
Tel: 01 960 2144  
Tlx 923393

Future Film Developments  
114 Wardour Street  
London, W1A 3DG  
Tel: 01 437 1892  
Tlx 21624 Alofld.G.

ASC  
4A King Street  
Mortimer  
Reading, RG7 3RS  
Tel: 0734 333100

Marketing Services, Sony Broadcast Ltd.  
Belgrave House, Basing View, Basingstoke  
Hampshire RG21 2LA. Telephone (0256) 55011

Please send me my copy of  
Sony Professional Microphones to:

Name \_\_\_\_\_

Position \_\_\_\_\_

Company \_\_\_\_\_

Address \_\_\_\_\_  
\_\_\_\_\_

Tel. \_\_\_\_\_



SS/6/87

**SONY®**  
THE LEADER IN DIGITAL AUDIO.

# REVIEW

## Manufacturer's comment

Many thanks for this review. There are, however, several points we would like to comment on. First of all, while we use all European-originated drive units for the *BBSM-12*, this is not the case throughout the *BBSM* series. In the *BBSM-12*, these particular drivers produced the best possible combination for what we wanted.

Secondly, our quoted statement in the query on phase alignment concerns the degree of synchronicity within which the woofers work in relation to the mid range, and the mid range to the tweeter at crossover points. Testing is at the crossover point and performance is observed one octave above and below that. We do not specify total propagation decay time.

Finally, the point is well taken on the subject of information not supplied with the monitors. We are indeed working on it!

decay, by comparison to the rest of the system.

There is also an obvious resonance at 300 Hz that takes considerably longer to decay than the balance of the system, along with a rather ragged settling of the mid range driver.

Note also that as the bass section settles, the frequency of resonance also lowers. This is characteristic of moving coil transducers.

This is generally an indifferent performance for this class of speaker and could be improved.

The polar response of the system is illustrated in Fig 10 with two curves: a conventional 3D, with the centre curve being on axis with the measurement microphone and the outer two curves being in line with the edges of the cabinet baffle, at 90° to the centre curve; and the same display converted to iso-contours, the FTC.

With the exception of the waist band effect at 200 Hz the dispersion of this system is excellent, with full and even broad band coverage up to 12 kHz. As would be anticipated, directivity increases markedly above this point.

It should be borne in mind when installing the *BBSM-12* system, and other speakers having extremely broad, even coverage angles, that the boundary effects of the room walls and ceiling

will now play a much larger part in influencing the perceived response at the console. It is important to make every effort to exclude reflections from the listening area, either by splaying and angling surfaces or, where this is not possible, by placing absorbent material on the boundary surface. Failure to do so may degrade the response of a monitor such as the *BBSM-12* through comb filtering, substantially more than a preceding generation of much more directional devices might have been affected.

## Distortion

Distortion, shown in Fig 11, at low levels is quite excellent for a studio monitor, though as levels are increased towards 100 W, second harmonic distortion rises dramatically. This would tend to indicate that the coil excursion has reached the non-linear portions of the magnetic field. Third harmonic distortion is still well controlled and very low, indicating good suspension control over the drivers.

## Summary

I appreciate the irony inherent in an American manufacturer purchasing quality European components, developing a speaker system, and selling the assembly successfully back into Europe, but Westlake have done a very good job.

The *BBSM-12* is as large a cabinet as could be easily accommodated free standing in most rooms, and much too big for many, but sits very happily as a compromise between the increasingly expensive and sophisticated main monitoring systems, and the nearfield monitors on the console meter bridge.

Generally, the system performance is good and the standards of construction of the cabinet, cabling, passive crossover and drive units, are satisfactory.

The lack of a manual is disappointing, as is the general information available to the purchaser. The system is not inexpensive and much greater effort should be put into accommodating prospective purchasers.

In all other respects, the *BBSM-12* sets a standard for others in an increasingly interesting niche in the speaker marketplace. □

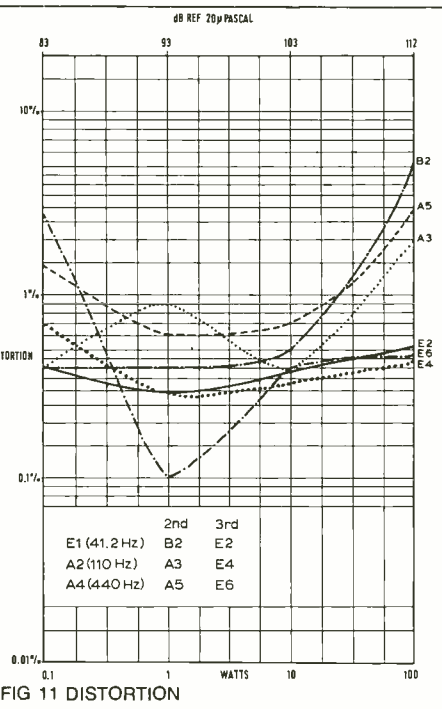
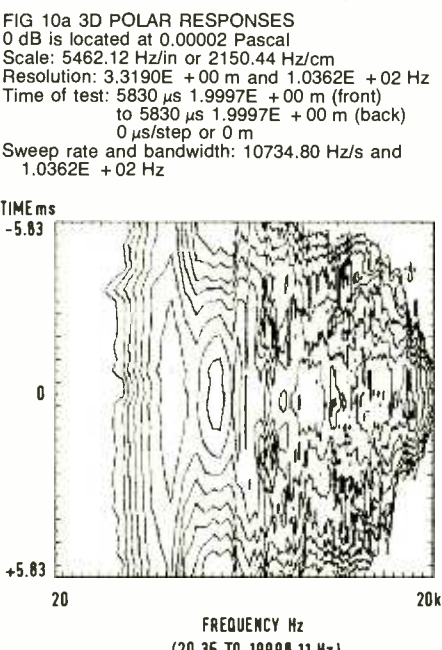
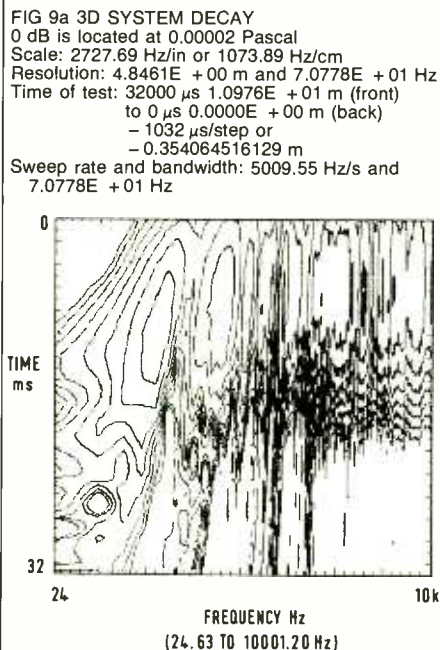
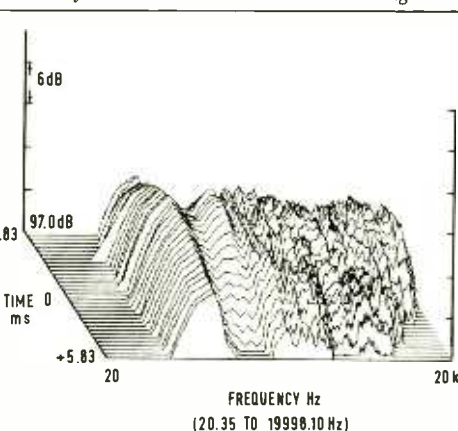
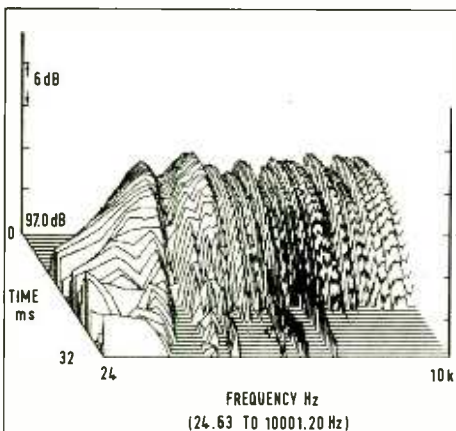



# A Moment of Silence

It was a historical moment when we delivered this console to its user, a moment of silence.

The One hundredth 8000 Console!

The third generation of a continuing success. Due to its "audiodynamic" styling, the 8000 is a jewel for the studio, we have given it a lot of thought and attention, as to its transparent audio paths. While the unlimited possibilities from the In-line system will let you be more creative. Whether this is for 24 track recording or for video post production. The 8000 series III is one of the few studio systems that your accountant will be overcome by. Maybe after its agreeable price, you still have a budget. For the disc based fader automation "Score". The 8000 series III with the "Score" is a technically and financially unbeatable team. Call or write to D&R Electronica B.V. Rijnkade 15B, 1382 GS Weesp The Netherlands. Tel. 02940-18014, tlx 18503 dr nl or call one of our distributors.



## 8000 Series III Beyond Comparison.



**Audio & Recording** 2019 Sydney AUSTRALIA, 36-38 Daphne St. Bolany tel: 61-26669935 **Stage Sound** A-1140 Wien AUSTRIA, Pfadenhauergasse 1 tel: 43-222921656 **A.S.E. pvba** 2800 Mechelen BELGIUM, Kon. Astridlaan 216 tel: 32-15421152 **J Mar** M4H 1E9 Ontario CANADA, 6 Banjan Drive, Toronto tel: 1-4164219080 **Power Play Music aps.** DK 2200 Copenhagen DENMARK, Norrebrogade 125a tel: 45-1244048 **Studio Spares** NW 6NS London ENGLAND, 16 Stuckley Pl., Camden Town tel: 44-14854908 **Sahkolliikkeiden oy** 01301 Vantaa 30 FINLAND, P.O. Box 88, Sahkometsla tel: 358-908381 **Mettler Audio** 75009 Paris FRANCE, 1-3-5 Blvd de Clichy tel: 33-148782911 **Sound Service** 1000 Berlin 15 GERMANY, Fasanenstrasse 45 tel: 49-308834262 **Professional Equipment** 20142 Milano ITALY, V.le Farnagsta 37 tel: 39-2817839 **Jon Vedum Elektronikk** N-1381 Heggedal NORWAY, Aarnolveien 2 tel: 47-2798990 **Bose sa** 28027 Madrid SPAIN, Arisoteles 3 tel: 34-4050611 **Montezuma Recording** 10265 Stockholm SWEDEN, Kocksgatan 17 tel: 46-8436291 **Isler ag** 8048 Zurich SWITZERLAND, Badenerstrasse 808-810 tel: 41-14321444 **W.J.R. Distributors Inc.** GA 30318 Atlanta U.S.A., 1379 Chattahoochee Ave. tel: 1-4043516367.



# EXHIBITION

## 20TH INTERNATIONAL EXHIBITION OF PROFESSIONAL RECORDING EQUIPMENT : 24-26 JUNE : OLYMPIA 2, LONDON

- |  |   |  |
|--|---|--|
| Allotrope Limited                          | Eardley Electronics                           | Publison                               |
| J. I. Arbiter Limited                      | E.M.O. Systems Limited                        | Professional Audio Limited             |
| Audio Kinetics Limited                     | Elliott Brothers                              | Presence Audio                         |
| Abac Rustin                                | Film Tech Electronics                         | Quested Monitoring Systems Limited     |
| Audio Systems Components Ltd               | Paul Farrah Sound Limited                     | Quad Re-An Products Limited            |
| Applied Microsystems                       | Formula Sound Limited                         | Rebis Audio Limited                    |
| Audio & Design Recording                   | Future Film Developments                      | Radford Laboratory Instruments Limited |
| AKG Acoustics Ltd                          | Focusrite Limited                             | Roland UK Limited                      |
| AKG Akustische u Kino Gerate               | Goutam Electronics Products Limited           | Rauch Precision Engineering Limited    |
| Audilec Distribution Ltd                   | G2 Systems                                    | Recording Studio Design Limited        |
| Audio Marketing Group                      | Harman Audio UK Limited                       | Studio Week Spotlight Publications     |
| Audio Developments Limited                 | Harrison Information Technology               | Soundcraft Electronics Limited         |
| Audio Video Marketing Limited              | H.W. International                            | Solid State Logic                      |
| Amek/Tac                                   | HHB Hire & Sales                              | Shuttlesound Limited                   |
| Avcom Systems Limited                      | HH Electronics Limited                        | Stirling/I.T.A.                        |
| Allen & Heath Brenell Limited              | Home & Studio Recording Ltd                   | Sound Technology Limited               |
| Aces UK Limited                            | Hayden Laboratories                           | Studiospares                           |
| Aries (UK) Ltd                             | Hill Audio Limited                            | Soundtracs Plc                         |
| Ampex Great Britain Limited                | HVS Developments                              | Surrey Electronics Limited             |
| Alice (Stancoil Limited)                   | International Musician                        | Sound Engineer and Producer            |
| Audio Digital Technology Ltd               | Jackson Music Limited                         | Studio Sound                           |
| Akai UK Limited                            | Klark-Teknik                                  | Sifam Limited                          |
| Autograph Sales Limited                    | Klark Acoustics                               | SOS Publications Ltd                   |
| AMS/Calrec                                 | KW Electronics Limited                        | State of the Arts                      |
| Agfa Gevaert                               | Kelsey Acoustics Limited                      | Syco Systems Limited                   |
| Bell & Howell Limited                      | King Instrument Corporation                   | Sony Broadcast Limited                 |
| Britannia Row                              | Kemps Publishing Group                        | Shape Technology Limited               |
| F.W.O. Bauch Limited                       | Lindos Electronics                            | Shep Associates                        |
| Bruel & Kjaer UK Limited                   | Lyrec UK Limited                              | Studio Equipment Distribution          |
| BASF United Kingdom Limited                | Music Lab                                     | Sonifex Limited                        |
| Beyer Dynamic GB Limited                   | Midas Audio Systems Limited                   | Michael Stevens & Partners             |
| Cougar Audio Technology Limited            | Mitsubishi Pro Audio                          | Scenic Sounds Equipment                |
| Componex Limited                           | Keith Monks Limited                           | Tape One Studios                       |
| Court Acoustic Sales Limited               | 3M UK Plc                                     | TAM/England                            |
| Cunnings Recording Associates              | MTR Limited                                   | Toa Electronics Limited                |
| Canford Audio Limited                      | Mosses & Mitchell                             | Tannoy Limited                         |
| Canadian Instruments & Electronics Limited | Marquee Electronics Limited                   | Theatre Sound & Lighting               |
| Cameron Video Systems Ltd                  | Minim Electronics Limited                     | Trident Audio Developments Limited     |
| Cadac Electronics Limited                  | Martin Audio Limited                          | Tape Automation                        |
| Cetec International                        | Nemesis Electronics Limited                   | Turnkey                                |
| Connectronics Limited                      | Neve  | Trad Limited                           |
| Crest Audio                                | Nomad   | TEAC Corporation UK Office             |
| Digital Creations                          | Otari Electric (UK) Limited                   | Tascam                                 |
| Drawmer Distribution Ltd                   | NEAL (Lee James Electronics Ltd)              | Wellard Research Limited               |
| Dolby Laboratories Inc.                    | The Professional Recording Equipment Co. Ltd. | Yamaha Kemble Music (UK) Limited       |
| DDA  | Playback Limited                              | Zonal Limited                          |
| Eastlake Audio (UK) Ltd                    | Penny & Giles Limited                         |  |
| Edge Technology Group                      | Pro Sound News                                |  |

**Tickets: APRS, 163a HIGH STREET, RICKMANSWORTH, HERTS WD3 1AY, ENGLAND**



# Media Products

Our new range of BPO audio jackfields are of the highest quality and economically priced, from £150.

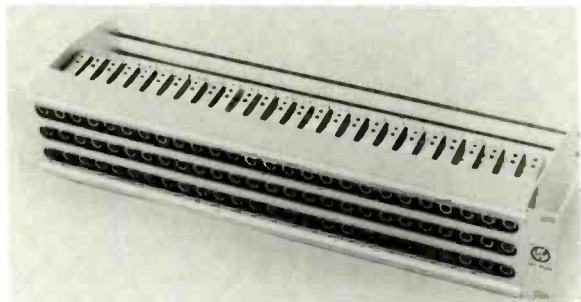

Featuring Mosses & Mitchell 5-point palladium contact gauge B jacks, the jackfield occupies just 2U, of rack space. Standard versions are 2 or 3 row in 20, 24 and 26 ways. Please contact us today for information on our range of audio and video systems equipment.

*'It's in the name'*

Media Products Limited  
Unit 4,  
Chiltern Enterprise Centre,  
Station Road, Theale,  
Reading, Berks., RG7 4AA  
United Kingdom.

Phone (0734) 303800  
Telex 858893 FLETET G  
Fax (0734) 509262 (G2/3)

## ACOUSTICAL INTERFACE™ SYSTEM

### PS9200 DUAL CHANNEL POWER SUPPLY



Shown PS9200, 4012 and 7013

**Precision Acoustical Measurements  
with FFT's, Scopes and Meters.**

**The system includes:**

- Type 1 Measurement Microphone(s), Companion Preamplifier(s) and Cables.
- Available in 1, ½ and ¼ Inch Models.

**ACO Pacific, Inc.,**  
(415) 595-8588

2604 Read Avenue  
Belmont, CA 94002

**ACOustics Begins with ACO**

## NORTHERN AUDIO

### PROFESSIONAL STUDIO EQUIPMENT SECONDHAND PRODUCTS

#### USED CONSOLES

Neve 8108 with Automation Necam 96 console, 4 years old, available immediately  
S.S.L. 4000E 40 frame 32 fitted, V/US and recall, 3 years old  
Harrison 32/32 56 frame 56 fitted with Alison 65K programmer and Fadex, 7 years old in good condition  
Neve V range with Necam 2 48 frame with 36 fitted, 16 months old in good condition  
MCI 628 JH 50 Auto light meters, 4/5 years old  
Amek 2500 36 fitted with Alison auto Amek V.C.A. faders  
MCI 636 AFVU 36 fitted full parametric EQ9 returns phase meters, available 4-6 weeks JH50 automation, nice condition  
Amek 2500 40 frame, 40 fitted with Alison 65K programmer  
MCI 636 A VU, 36 fitted with JH50 automation, 5/6 years old  
Trident A series 28-24-2, 13 years old in good condition  
Trident 75 series 24/16/24 with patch and stand, 1 year old  
Trident TSM 32/24/24 available immediately

#### USED MACHINES

3M 32/4/2 digital machine complete with editor  
Studer A80 wide body 24 track recorder Mk2 3 headblock  
Studer A80 narrow body 24 track recorder Mk2  
Trident TSR 24 track recorder, 3 years old  
Otari MTR 90 Mk1 autolocate, 4 years old in good condition  
3 x Studer A80 master machines  
Ampex ATR 102 1/4 master machine with spares (little used)  
Studer A810 Master recorders 3 in stock, 6 months old  
Lexicon 224X with 4.4 and remote  
1 Lexicon 224XL 6 months old, in good condition  
Klark Teknik 780 DIG reverb with latest updates

Neumann U87I mic (two in stock)	each	£600
Neumann U67I		£550
Neumann U471 FET mics 4 in stock	each	£695
AMS 1580 S with 13 in A 6.2 in B, 2 locks/harmonisers		£4,000
AMS 1580S with 6.2 and 1.6 seconds, hardly used		£4,500
AMS RMX Dig reverb, 12 month's old, spotless		£3,250
Eventide 949 harmonizers, the pair		£2,400
JBL 4430 monitors, 1 year old		£1,900
Nemesis 4 band full parametric EQ (two channels)		£595
Fairlight with latest MIDI and SMPTE upgrades		POA
Emulator 11 with 2.4 updates, 2 years old		£4,250
Drawmer DS1960 valve compressor		£495
Ursa Major space station		£595
Klark Teknik DN70		£450
EMT 240 Gold foil reverbs (two in stock)	each	£1,250
EMT 140 TS stereo plate in good condition		£1,350

We stock new Revox tape machines, Drawmer effects, Soundcraft, Bokse effects, Lexicon, Publison, Quad, Yamaha, Tannoy, Studer, AMS effects, AKG, Sennheiser, Beyer, Shure, Neumann, Nemesis, Bel Audio Products, Soundtracs mixers, TC Electronics, Neve.

#### NOTICE

We also act for studios as selling agents, let us handle the hassle of getting rid of unwanted items, it does not matter where you are in the world, why not drop us a line listing your equipment or ring us on the numbers below for the best rates. We assure you of our best attention and service plus the utmost confidentiality at all times.

**WE ARE CONSTANTLY ON THE LOOKOUT FOR USED EQUIPMENT. PLEASE GIVE US A RING.  
RING TONY BAYLEY ON 061-483 9563/4299 *anytime* or WRITE TO US AT:  
4 CHEVIOT ROAD, HAZEL GROVE, STOCKPORT, CHESHIRE SK7 5BH  
TELEX 666597 NAUDIOG**

Tel: 061-483 9563/4299

# Working with midi and timecodes?



*The Steinberg Research SMP-24 provides all the answers. Here's how to control your system utilising the three working modes of the SMP-24 . . .*

## **When used interactively with the Pro-24 program:**

*SMPT E start offset and cue points together with tempo data can be saved as a Pro-24 song file. Tempo and time signature changes from the Pro-24 mastertrack govern midi sync. and clock out rates of the SMP-24. Each Pro-24 track is assignable to any of 64 separate midi channels via the SMP-24s' four midi outputs. The SMP-24 also has two mergeable midi inputs – overdubs can be made whilst syncing to tape for example. For on-stage use, the SMP-24 accepts Pro-24 song files into its' on-board sequencer negating the need to use your computer at all.*

## **When used as a stand-alone SMPTE synchroniser:**

*63 sync. programs are available each of which stores start offsets and cue points. Four timecode standards can be selected including E.B.U. The SMP-24 will also read and write MTC (the midi timecode standard). One bit resolution means accuracy down to a sub. frame. Locking time is less than 3 seconds and there is no problem using varispeed codes. An external clock may be used as a tempo reference; this could be: an audio trigger, tempo-tap from front panel or footswitch, any trigger from 1-254 PPQN, or a midi clock. Naturally, the SMP-24 converts timecode to Midi sync. and other clocks up to 254 clicks per. beat. All data can be saved to tape.*

## **When used as a midi processor and controller:**

*64 midi configuration programs each of which can route either midi input to up to four midi outputs and assign midi channels for all inputs and outputs. Each output may be transposed by pitch and/or velocity and a high and low split point can be set. In addition, there are 64 master midi programs which combine up to four of the configuration programs outlined above, and can hold 20 patch change programs. Furthermore, all programs have fully comprehensive filtering of midi data.*

## **And just to make life easy . . .**

*The SMP-24 can respond to external midi patch changes to access master midi programs, this makes system re-configuration an instant event simply by changing a program on a synth! The SMP-24 can be programmed so that any front panel function can be toggled by footswitch, the polarity of which can be reversed. There is a built-in metronome. Midi transmission rate can be doubled. Display mode can be switched from letters to numbers to suit your preference.*

*All in all, the SMP-24 has been designed to make life easy. And at £799. (ex. VAT) it's easy on the pocket too!*

Steinberg Research The Spendlove Centre, Charlbury, Oxford OX7 3PQ  
Telephone: (0608) 811325 Telex: 837883 SPEND G FAX: (0608) 811323 Computer: (0608) 810005



# SAM THERAPY

has moved to a spacious new Andy Munroe designed studio — 10 minutes from the West End

— Studio 1 24/48 Video —

— Studio 2 16/24 Programming —

— Daylight and Parking —

— Fairlight Series III —

— DDAMR24 —

— Otari MTR90 —

— Extensive Outboard + Mics —

— Keyboards Guitars Percussion —

— 01-960 1336 —

WE KNOW MORE  
ABOUT THE  
PIANO MIDI-MOD  
BECAUSE  
WE KNOW MORE  
ABOUT  
THE PIANO.

*Designed by Forte Music, the MIDI-MOD retains all the subtleties of a grand piano, without any loss of piano quality.*

*Call Cristofori and talk to the craftsmen.*

*Cristofori*

Cristofori Ltd, 20 Conduit Place, London W2  
Telephone 01-402 4304 Telex 22278 Fax 01-262 6081

## JAPANESE TAPE ★ 5-SCREW SHELL CUSTOM WOUND AUDIO CASSETTES

Competitive rates ★ Rapid service ★ Full guarantee

LENGTH	STUDIO FERRIC			MASTER FERRIC			MASTER CHROME			PROFESSIONAL SERIES—FULLY PACKAGED			
	50-249	249-999	1000+	50-249	249-999	1000+	50-249	249-999	1000+	10-99	100-249	250-999	
C1-C5	20p	19p	18p	30p	28p	26p	32p	31p	30p	C7	34p	32p	30p
C6-C9	22p	20p	19p	31p	30p	29p	34p	33p	32p	C10	35p	33p	31p
C10-C19	26p	24p	22p	33p	31p	30p	36p	35p	34p	C15	36p	34p	32p
C20-C29	28p	27p	25p	35p	34p	33p	42p	41p	40p	C20	38p	37p	36p
C30-C39	31p	29p	27p	38p	35p	34p	46p	45p	44p	C30	44p	40p	38p
C40-C49	33p	31p	29p	42p	40p	39p	52p	51p	50p	C45	46p	42p	40p
C50-C59	36p	35p	34p	50p	48p	46p	60p	59p	58p	C60	52p	46p	44p
C60-C69	38p	37p	35p	54p	53p	52p	66p	65p	64p	C90	60p	56p	52p
C70-C89	46p	42p	41p	72p	70p	68p	84p	82p	80p	C120	76p	72p	70p
C90-C95	48p	43p	42p	74p	72p	70p	90p	88p	86p				
Library Cases	6½p	6p	5p	6½p	6p	5p	6½p	6p	5p				

Above prices include Inlay Cards, Side Labels, Library Case.  
The product is supplied overwrapped

All prices exclude VAT. Orders of £80 (ex VAT) Carriage Paid. Small orders add £4 P&P



**LONDON SALES:** Battersea Wharf,  
Queenstown Road, London SW8 4NP  
Tel: 01-627 3760

**NATIONAL SALES:** PO Box 19,  
Stratford-on-Avon, Warwickshire CV37 6SA  
Tel: (0789) 68579

PANCAKES AVAILABLE FOR LOADERS AND DUPLICATORS (TRY TURNING JAPANESE!)

# STUDIO SOUND'S

## PRO-AUDIO DIRECTORY 1986/7

From the publishers of the world's leading professional recording magazine **Studio Sound**, comes the latest edition of their sister publication, **The Pro-Audio Directory**.

This unique and vital reference source has been completely updated and revised to provide in one volume information on every aspect of the professional recording industry; From Acoustic Materials to Tape Recorders; From Mixing Consoles through to Synthesisers.

In addition to its forty extensive hardware sections are chapters covering Dealers in the UK, USA and Worldwide. Pin-pointing which equipment can be brought where – anywhere in the world.

The ultimate section is the extensive address listing featuring the full details of over 3,000 companies mentioned in the directory, including key contact names. Also there is a cross reference listing of Worldwide Distributors detailing international availability of any given product. This information is not available in any other publication.

The Pro-Audio Directory has all the information you need, and to make sure it is straight forward to use, this edition sees a complete redesign with an even greater emphasis on clarity.

To ensure you stay in touch with the expanding, rapidly changing world of professional recording order your copy of the specialised **Pro-Audio Directory** now.

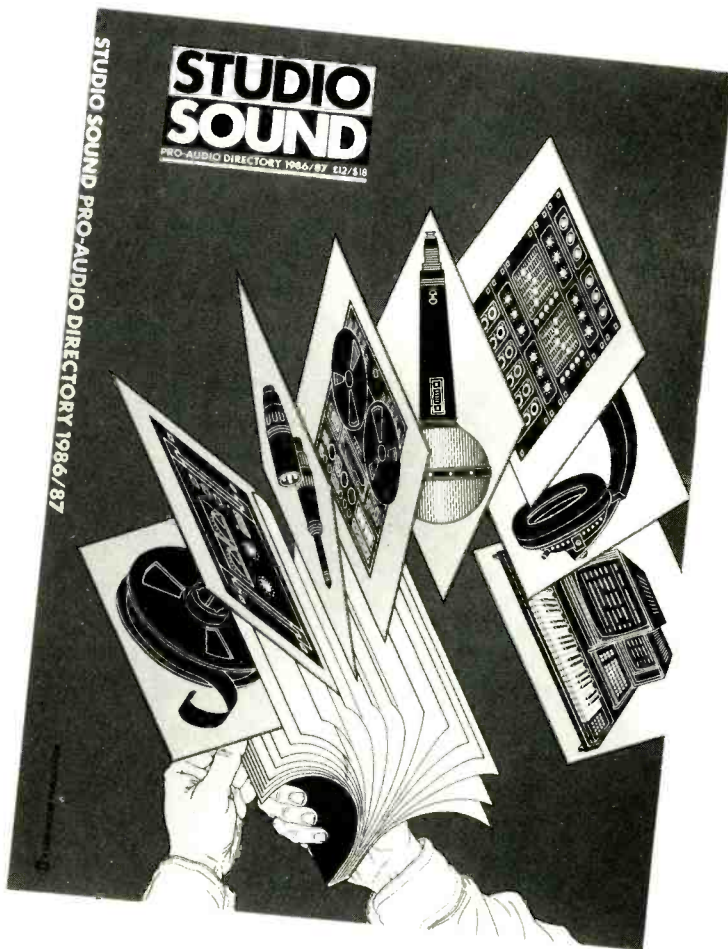

Professional Publications Group, Link House Magazines Ltd, Dingwall Avenue, Croydon CR9 2TA, United Kingdom.

Please send me ..... copies of  
**Pro Audio Directory 1986/7.**

£13 (UK) £14.00 Europe \$25 USA Airmail  
£16.50 World Airmail. *Includes Postage and Packing.*

I enclose a cheque/postal order/International money order  
payable to **Link House Magazines** for the amount \_\_\_\_\_

Or debit my credit card



Credit card No.

Credit card holders can order by simply ringing 01-686 2599  
ext 550, quoting credit card No.

Signed \_\_\_\_\_

Name \_\_\_\_\_

Address \_\_\_\_\_

(please print)

Please return the completed order form enclosing full  
remittance (including delivery) or giving your credit  
card number to **Professional Publications Group,  
Link House Magazines Ltd, Dingwall Avenue,  
Croydon, CR9 2TA, United Kingdom.**

Please allow 28 days delivery in Britain, extra overseas depending on  
country and delivery method.



# CLASSIFIEDS

Advertisements for this section must be pre-paid. The rate is 60p+VAT per word, minimum £15.00+VAT. Box Nos. £5.00+VAT. VAT (UK only) \$ rate \$2.00 per word, minimum \$50.00, Box No. \$10.00 extra. Semi-display rates on application. Copy and remittance for advertisements in AUGUST issue must reach these offices by 18th JUNE addressed to: The Advertisement Manager, Studio Sound, Link House, Dingwall Avenue, Croydon CR9 2TA. Cheques made payable to Link House Publications (Croydon) Ltd. Note: Advertisement copy must be clearly printed in block capitals or typewritten.

Replies to Box Nos. should be addressed to the Advertisement Manager, Studio Sound, Link House, Dingwall Avenue, Croydon CR9 2TA, and the Box No. quoted on the outside of the envelope. The district after Box No. indicates its locality. **SEX DISCRIMINATION ACT 1975:** No job advertisement which indicates or can reasonably be understood as indicating an intention to discriminate on grounds of sex (e.g. by inviting applications only from males or only from females) may be accepted, unless (1) the job is for the purpose of a private householder or (2) it is in a business employing less than six persons or (3) it is otherwise excepted from the requirements of the Sex Discrimination Act. A statement must be made at the time the advertisement is placed saying which of the exceptions in the Act is considered to apply.

The attention of advertisers is drawn to "The Business Advertisements (Disclosure) Order 1977", which requires that, from 1st January 1978, all advertisements by persons who seek to sell goods in the course of business must make that fact clear. From the above date consumers therefore should know whether an advertisement relates to a sale by a trader or a private seller.

## SERVICES

# MRC

A ZONAL COMPANY

The Magnetic Recording Company, a subsidiary of Zonal, Britain's leading manufacturers of professional magnetic sound recording products, offer you cassette duplication of music, speech and data using Gauss loop bin, as well as the best equipment for winding, printing onbody labels and inlay cards.

You will get the service and quality that is expected of a company that has been in the magnetic products business for over 30 years.

### MAGNETIC RECORDING COMPANY

Holmethorpe Avenue,  
Redhill, Surrey, RH1 2NX.  
Tel: 0737-67171  
Telex: 946520  
Fax: 0737-67610

**THE COMPLETE SERVICE.** Disc cutting, pressings, duplicated cassettes and blanks. Bin Masters. Location Recording. Free Brochure. Tam Studio, 13a Hamilton Way, London N3 1AN. Tel: 01-346 0033. (X)

**QUALITY HIGH-SPEED** cassette copying also video cassette copying and processing. Any quantity. While you wait. 24-hour, 7-days-a-week service. Central London W2. GWBB Audiovision. Tel: 01-723 5190, two lines. (X)

**TECHNICAL TRANSPORT LIMITED.** No longer need you have to risk your valuable and delicate equipment to man with van. Experienced technicians with latest vehicles will meet your transport requirements and give technical assistance. Phone 01-698 0099.

**REAL-TIME** cassette copying, high quality, very economical, using cassette, 1/4" or digital masters. Master preparation and editing service. Digital mobile recording. Steve Pontin Audio Services 01-398 7933.

**MUSIC SUITE** low cost, real time cassette duplication, labels and inlays. Master from 1/4 inch, PCM, cassette. If you're looking for quality phone 0239 711032.

100 C-60 cassettes beautifully copied in stereo from £59.50 (plus VAT)

We can copy from 100 to 5,000 high quality cassettes on our high speed loop-bin system, load them precisely into top-class shells. Price includes library case and all production work from your 1/4 in edited master. Any length C-5 to C-90. Ring for price check.

**STUDIO REPUBLIC**



47 High Street, Pinner 01-868 5555 01-866 5555

### CASSETTE DUPLICATION

Quality Cassette Duplication, High-Speed and Real Time, Overwrapping, Exact Length Blank Cassettes, Labels and Inlays

Tel: Leicester (0533) 602064

**ACCURATE SOUND LIMITED**  
QUENIBOROUGH (Ind. Est.) MELTON ROAD  
QUENIBOROUGH, LEICESTER LE7 8FP

*Check It Out...*

**DIRECT FROM OUR MODERN U.K. PRESSING PLANT**

- CUTTING · PRESSING
- TEST PRESSING
- LABELS · SLEEVES
- CASSETTES
- ARTWORK
- COMPETITIVE PRICES

**MARKET LEADERS**

# SRT

01-446 3218

**CASSETTE DUPLICATING:**  
GAUSS Loop-Bin / TELEX In-Cassette  
High Quality Blanks / Label Printing  
**OPEN REEL DUPLICATING**  
(ANY SPEED - ALSO TO BROADCAST SPEC.)  
**SPEECH RECORDING**  
(VOICE-OVERS; LANGUAGES; AUDIO-VISUALS)  
**SPEECH-PLUS RECORDINGS LTD.**

UNIT 32, NO. 19, PAGES WALK, LONDON SE1 4SB. TEL: 01-231 0961

SELECTA

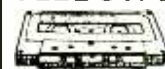

SOUND

AUDIO CASSETTES  
04024 53424

## CLASSIFIEDS

## SERVICES

### FOR ALL YOUR RECORDING NEEDS

AMPEX AUDIO AND VIDEO TAPE MAIN DISTRIBUTORS  
Spools, boxes, blades, splicing and leader tape. Blank precision wound cassettes C1-120, labels, library cases and cards. C-zeros, pancake, etc. Broadcast Cartridges.



12 Britannia Road  
Sale, Cheshire M33 2AA  
Tel: 061-905 1127

FOR QUALITY, PRICE AND SERVICE

## CASSETTE DUPLICATORS

Specialists in the supply and service of cassette duplicators, bulk custom wound cassettes, and accessories

**GRAFF SONY TELEX WOLLENSAK**

Main Dealers UK and Export

**SOUND CASSETTE SERVICES LIMITED**  
BODEN STREET, CHARD, SOMERSET

0460 67237

**NATIONWIDE**

### REAL TIME AUDIO CASSETTE DUPLICATION

on the latest equipment

- Quality superior to high speed copying. • No mastering charges • Any quantity at very competitive prices • Fast delivery. All work guaranteed. **BLANK CASSETTES (C1-C100).**
- Highest quality screwed or welded housings • Ferric or Chrome tape
- **LIBRARY CASES • LABELS • INLAY CARDS •** Phone or write for immediate quotation.



**AUDIOCOPY (Dept SS3), Unit 3**  
Buslingthorpe Green, Meanwood Road,  
Leeds LS7 2HG. Tel: (0532) 625650

## STUDER REVOX

WE ARE THE TAPE MACHINE SPECIALISTS. WE PROVIDE PROMPT EFFICIENT SERVICE AND REPAIRS FOR THE WORLD FAMOUS RANGE OF STUDER REVOX MACHINES. WE ALSO HANDLE TEAC/TASCAM+NAGRA RECORDERS IN OUR WELL EQUIPPED WORKSHOPS WITHIN EASY REACH OF LONDON.

★ WHEN YOU RELY ON YOUR EQUIPMENT, YOU CAN RELY ON US!

**3M SPARES OFFICIAL UK SERVICE CO.**  
Service Calls Save Time!

153A VICTORIA STREET, ST. ALBANS  
Telephone: 58977 (0727)

**THE SOUND & VISION WORKSHOP LIMITED**

jbs records

### MUSIC-SPEECH COMPUTER

REAL-TIME or HIGHER-SPEED Quality Cassette Duplication and Blanks from 1 to 1000+. Computer printed Cassette Labels. Speech and 1/4" reel-to-reel recording/editing. Fast Security Delivery service.

FILTERBOND LTD. jbs records div. FREEPOST  
19 SADLERS WAY, HERTFORD SG14 2BR. 0992-500101

### REAL TIME CASSETTE COPYING

All work carried out on Nakamichi machines to the highest standard. Normal or chrome tape available.

We also supply blank cassettes wound to length. AGFA and BASF chrome tape available

**GATEWAY CASSETTE SERVICES**  
1 GAUDEN ROAD, LONDON SW4 6LR  
TEL: 01-627 4758

## Revox & Uher Sales & Service

16mm sound 35mm slide projectors, open reel and cassette recorders, amplifiers, etc., serviced and repaired. Bell & Howell, Elf, Ferrograph, Revox, Tandberg, Uher approved service agents. Maintenance contracts available. Visit our Amateur Radio Showroom at:-  
58 High Street, Newport Pagnell. Tel: 0908 610625.

## Photo Acoustics Ltd

## Alf sound

### CUSTOM WOUND BLANK CASSETTES AT AMAZING PRICES!

C1 - C120  
REAL TIME CASSETTE DUPLICATION  
CASSETTE LABELS AND INLAY CARDS

**061-969 7618**

Alf sound, St. Martins Studios  
Greenbank Road, Ashton-on-Mersey,  
Sale, Cheshire M33 5PN.

CALL FOR DETAILS AND FREE PRICE LIST

### REAL TIME CASSETTE DUPLICATION

USING AIWA AD F770 CASSETTE DECKS  
FROM 1/4" AND PCM F1 MASTERS

- Custom wound blank cassettes
- Shape MK10 and ICM-CO's
- Inlay card and label printing

TEL 0222 554195  
BACKYARD RECORDING  
STUDIO LTD



Let Saki expertise relap your tape heads in London

Factory-approved laboratory and training guarantees finish to original performance specification

**ALL MAKES RELAPPED**

Tapetek, 44A Brighton Road, London N16 8EG  
Tel: 01-254 5203 or 0836 215900 (mobile)

Replacement Saki heads from:

Tape Marketing, 13 Elm Road  
Faringdon, Oxon SN7 7EJ 0367 20262



THE CASSETTE DUPLICATING SPECIALISTS  
Real time & high speed loop bin duplication, printing & packaging. Blanks wound to length  
TEL: 061-973 1884

## STUDIO FOR SALE

**FREEHOLD HOUSE** with private 24-track studio for sale. Suit producer/songwriter/artist £300,000, including equipment London area. Box No. 449.

**LOCKWOOD, TANNOY, etc.**, new and used equipment always available and wanted. Lockwood Audio Sales 01-866 0671. (X)

## AUDIO TRANSFORMERS

- **STEVENS & BILLINGTON LTD.** •  
have been manufacturing high quality **AUDIO TRANSFORMERS** since 1963. To discuss your requirements please ring our engineer on **0342 22339** •

## FOR SALE—PRIVATE

**AMEK 2500 CONSOLE** 36/24/36 inline. Allison Automation, Barograph Metering, perfect order £30,000. Also Delta Lab Effectron 1024 £195. Delta Lab DL4 with 2 second extra memory module £495, Rebis rack and supply £60. 5 parametrics £30 each, Alesis XTC reverb £295. Hammond L100 valve organ with Lesley £395. Tel: 01-671 3731.

**STAGE ACCOMPANY DRIVERS AND COMPACT DRIVERS.** SA 8520 and SA 8525. Now available in U.K. Delivery from stock. Call for details. M.P.A.V. 01-403 0020.

**CADEY 16-TK Recorder**, remote control, test tape, 2-inch tapes, £2,500. M&A Mixer module, subgroups, inputs, circuits, Klone drum kit £95, Copicat Echo £40. Peter 01-399 3990.

**SPEEDY REVOX SERVICE**

Plus **TEAC/TASCAM, FOSTEX, UHER**, most Mixers, Amplifiers, Effects. Priority Bookings taken. Collection/Delivery arranged. A personal service by experienced engineers.

34 Danbury Street, London N1 8JU  
Telephone 01-359 9342/3030

**RAPER & WAYMAN**

**CLONE**  
01-237-9748

Real time high quality cassette copying from digital Sony 701, 1/4" or cassette format (Agfa, TDK, BASF), labels and inlays fully typed. Analogue editing facilities.

**488-490 OLD KENT ROAD, LONDON SE1 5AG**

## CLASSIFIEDS



## FOR SALE—PRIVATE

NEVE 80 SERIES CONSOLE 28/8/24, immaculately maintained (52 remix channels) £22,000.

NEVE 24/8/24 (10 cue. Sends 68 remix channels), £10,000. (Both desks package £30,000). Tel: 01-521 2040.

NEVE Com/Lims 2254. Pair £950. Tel: 01-521 2040.

AUDIO DEVELOPMENTS AD062 multimeter, 10-2-1, individual phantom/T switching, auxiliaries, communications, 105mm PEG's, additions provided for. Battery/external D.C. excellent condition private use. £4,400 including flightcase. Tel: Chester 43219.

AKG Bx15 reverb £180. Used GPO Jackfields. WANTED small mixer 8-16 channels. Alice, Chiltern etc. Steve 01-398 7933.

SOUNDCRAFT SH 16:8:16, Ampex AG440 Stereo mastering machine, Ashley parametric equaliser, Delta Lab D.D.L., harmoniser, Amcron DC300A, G.P.O. Patchbays drum machine, lots more Tony 0424 424788.

ACES TR16 2" £2,750 and scully 1" 8-track sync master model £1,500. Fender Rhodes 88 piano £300. DBX 150 type 2 £120 no VAT. Arch Studios Glasgow. 041-959 6251.

KURTZWEL 250 EXPANDER (no keyboard) £5,750 ono; Yamaha KX88 keyboard £850 ono; Yamaha Rev 7 £850 ono. Call 0926 312190.

SOUNDCRAFT 2" MACHINE low hours £8,750+VAT. Ring 0377 (47191) (47311).

3MM M79 24-TRACK recorder with XT 24 autolocate. Superb condition, regularly maintained, all heads and bearings recently replaced. £8,950+VAT. Tel: 0633 49603.

## FOR SALE—TRADE

## STUDIO DESIGNERS AND CONSULTANTS

### INSTALLATIONS

Audio, Video & Electrical Contractors  
Complete project management  
Prefabrication off-site

Elliott Bros

0865  
249259

STUDIO DESIGNERS  
CONSULTANTS  
CONSTRUCTIONS  
09323 54517  
CEEZEE ASSOCIATES

SOUND  
ADVICE

A complete service for anyone needing  
studio design and practical acoustic advice  
0732 459185

## AUDIO LEADS

Cable Technology  
PRO AUDIO CABLES & SYSTEMS

IMPORTERS OF KLOTZ PROFESSIONAL  
AUDIO CABLE, CABLE SYSTEMS AND  
CONNECTORS FOR THE MOST  
DEMANDING USE IN RECORDING,  
BROADCAST, AUDIO VISUAL AND P.A.

72-74 EVERS HOLT STREET, LONDON NW1 1BY  
TEL: 01-387 5783 TELEX: 28159 MUSLAB G

## FOR SALE—TRADE

WESTLAKE HR-1 Monitor speakers and Westlake HR-1X 4-way crossover.  
FM Acoustics FM801/LI Amplifier.  
FM Acoustics FM600A/LI Amplifier.  
FM Acoustics FM300A/LI Amplifier.  
Westlake BBSM6-F Mini Monitors. White 4400 1/3 Octave monitor equalisers, for details phone (0342) 893046.

STELLAVOX AMI 48 Portable Mixer, unused. Complete with DC/DC and mains P.S.U.'s plus Nagra 4S interconnects in custom-built samcine case. Cost £3,500 offered for £2,500. Tel: 01-722 1572.

stepp DIGITAL GUITAR SYNTH—absolutely amazing! Cost new over £4,000 available now! Will accept reasonable offer. Ring Paul 985 3869, 985 2409.

TEAC 244/34/38 discounts and HP and leasing. Erricks VCD, Brighthouse 722121 (Bob) (X)

USED recording equipment: buy, sell, trade. Phone (USA) 415-474-1625 or 213-660-5719.

DISC CUTTING EQUIPMENT and systems bought, sold, installed and manufactured (under licence from ORTOFON). TAM/ENGLAND, 13a Hamilton Way, London N3 1AN. Telephone 01-346 0033. (X)

TASCAM/SENN/BEYER, trade counter. Erricks VCD, Brighthouse 722121. (X)

## CHROMATIX

HAVE THE FOLLOWING SECOND HAND ITEMS FOR SALE:

1. FAIRLIGHT II complete with slave keyboard
2. LINN 9000 drum and MIDI sequencer
3. PPG Wave 2.2 with MIDI
4. EMU Emulator I with large library
5. JBL 4320 Monitors (pr)
6. LINN LM-1 drum machine (the classic sound much sought after)
7. POWERTRAN MCS-1 digital delay/sampler (as new)
8. ROLAND Space Echo RE-301 the original space echo sound.
9. YAMAHA TX-216 — low-noise DX-7 modules
10. LEXICON PCM-60 — top quality reverb
11. REVOX B-77 with varispeed — just serviced
12. ROLAND DDR-30 drum set with pads

All items are on sale at extremely attractive prices. If you are interested in any of the above please call

01-229 2041

# EQUIPMENT FOR SALE

## ALL EQUIPMENT IN PERFECT CONDITION

B&K 2010/1902 Superhet Analyser

B&K 2305 Level Recorder with four pots

B&K 4440 Gating System

B&K 2971 Phasemeter

B&K 2206 Precision Sound Level Meter with Cap

B&K 2426 Autorange Milivoltmeter

Enquire for full list of B&K!

HP86, 3.25 Disc Drive, Biodata Microlink III

HP7475 A6 Pen Plotter, other accessories

Tektroniks Computer 31, 152 and 2xDM501 Multimeters

HP3580A Spectrum Analyser

Sound Technology 1700A

Distortion Measurement System

Philips 6652 Programmable High Res. Timer/Counter

Patron 1065 Auto Cal D.M.M.

Sennheiser Universal UPM 550 AC/dB Meter

Kemo VBF/14 Band Pass/Stop Filter

Technon I.M.D. Analyser

Wayne Kerr B221 Universal Bridge

Ampex ATR100, Stereo with Spare Pads

Nagra IVS Stereo Portable Recorder

PLEASE CALL ANGUS MCKENZIE FOR FULL LIST  
TELEPHONE 01-349 0511 STRICTLY 9.30a.m.-5.00p.m.

## CLASSIFIEDS

**FOR HIRE**

35 BRITANNIA ROW LONDON N1 8QH

**BRITANNIA ROW** 01 226 3377

**Multitrack, 2-Track & Studio Effects**

**PROPERTY FOR SALE**

W. CORNWALL. Converted school, mod. house, sep. annexe flat. All in walled det. location. Village 1/4m. Town 2m. Present use Local Record Co. & accom. Main studio (8Tr) approx. 48' x 18' x 15'. Lge control rm. Established label & catalogue. In-house cass. prod. Plenty of room for expansion, up-date or sep. enterprise. Reason: owners coming retirement. Offered complete with Company, or as property only. Ring (0736) 731246.

**FOUNTAIN**

—Television—

**SOUND ENGINEER**

Fountain Television is a busy Studio and post-production facility, needing a Sound Engineer preferably with experience in both production and 24-track/Q-lock work.

cv to Debbie Arnold  
Fountain Television, PO Box 625, New Malden, Surrey

**SITUATIONS VACANT**

**SOUND ENGINEER** required for new residential 48-track studio. Experience not prerequisite. Telephone 0377 (47191) (47311).

**WORKING IN THE USA?**



"THE BEST THAT MONEY CAN RENT"  
Complete selection of pro audio equipment for hire. Outboard Equip ★ Digital Recorders ★ Walkie Talkies  
1619 Broadway, New York, New York 10019  
Phone (212) 582-7360/IMC(367)/MCI Mail 260-0455

**FIELD SERVICE ENGINEER**

£12 to £15K + car. Maintenance experience on pro-audio equipment essential. Digital experience desirable.

**PRO-AUDIO SALES £14-£18K + car**

Sales experience with a manufacturer preferred. Some overseas travel.

Contact Mike Jones  
Professional and Technical  
Appointments  
(0256) 470704



Sarm Studios require a senior maintenance engineer with experience of Studer and SSL. Sony digital experience would be an advantage.

Good salary and perks A.A.E.

**RING**  
**ROB SPAIN**  
**ON**  
**01-229 1229**

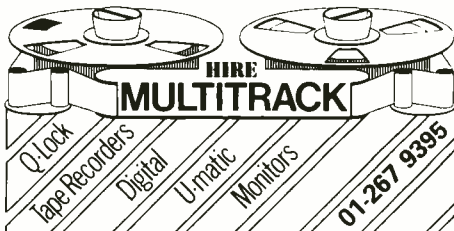

**STUDIO SOUND**

AND BROADCAST ENGINEERING

**CLASSIFIED ADVERTISEMENTS ORDER FORM**

Please use this coupon for all your sales and wants.  
Rates: 60p + VAT per word. Min £15.00 + VAT.  
Box Nos. £5.00 + VAT extra. VAT (UK only) \$rate \$2.00 per word, minimum \$50.00, Box No. \$10.00 extra

PLEASE PRINT IN BLOCK CAPITALS

To: **STUDIO SOUND**, please publish the above advertisement for . . . . . insertions under the heading . . . . . Cheque/P.O. to be made payable to **LINK HOUSE PUBLICATIONS LTD, LINK HOUSE, DINGWALL AVENUE, CROYDON CR9 2TA.** Is a Box No. required Yes/No. If no, please include remittance to cover name and address and/or tel. no.

Name . . . . . Address . . . . .



# PROFESSIONAL VIDEO

INTERNATIONAL YEARBOOK 1987/88

TENTH EDITION PUBLISHED BY

**BROADCAST-SYSTEMS-ENGINEERING**

## 10 YEARS SERVING THE PROFESSIONAL BROADCAST INDUSTRY

### A must for your bookshelf!

For 1987 the Professional Video International Year Book is published in the popular A4 magazine format. With its successful editorial coverage of equipment and services covering the international broadcast industry with 1,000's of listings by manufacturers, brand-names and in many cases their UK and Overseas distributors, plus a summarised text of product lines.

All this invaluable information is classified under sections, ranging from aerials antennae and masts to video cassette storage and cases, therefore ensuring that looking for the equipment you need can be found in our comprehensive easy to use publication.

Published in association with Broadcast Systems Engineering the international magazine for the broadcast industry.

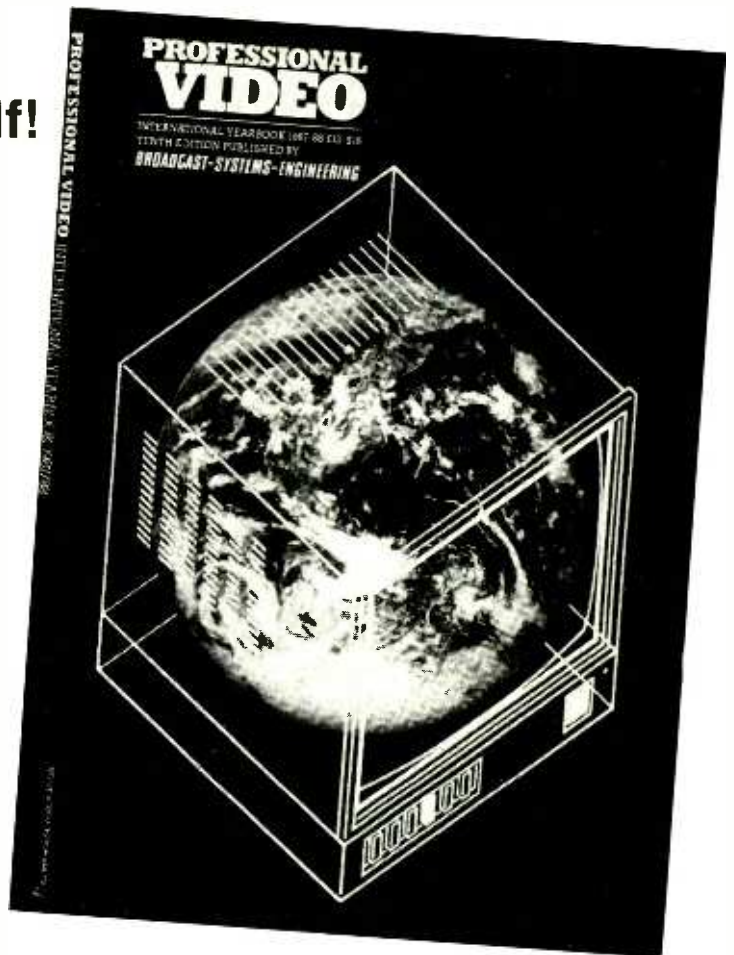

Professional Publications Group, Link House Magazines Ltd, Dingwall Avenue, Croydon CR9 2TA, United Kingdom.

Please send me ..... copies of  
**Pro Video International Year Book 87/88.**

£14.00 (UK) £16.00 Europe \$27 USA Airmail  
£19.00 World Airmail. *Includes Postage and Packing.*

I enclose a cheque/postal order/International money order payable to **Link House Magazines** for the amount \_\_\_\_\_

Or debit my credit card



Credit card No.

☐ Credit card holders can order by simply ringing 01-686 2599 ext 550, quoting credit card No.

Signed \_\_\_\_\_

Name \_\_\_\_\_

Address \_\_\_\_\_

(please print)

Please return the completed order form enclosing full remittance (including delivery) or giving your credit card number to **Professional Publications Group, Link House Magazines Ltd, Dingwall Avenue, Croydon, CR9 2TA, United Kingdom.**

Please allow 28 days delivery in Britain, extra overseas depending on country and delivery method

# AUDIO SERVICES

Professional Audio & Audio for Video Equipment

Phone and ask for our latest list - more bargains are coming in daily!

## NEW HIGH-TECHNOLOGY EQUIPMENT

- From JELLINGHAUS of W. Germany come two very new and innovative ideas. The first is a cost effective fader automation system called the C-Mix system, which is retrofittable into virtually any mixer from 16 to 64 inputs utilizing the capabilities of the now well established ATARI 1040 ST. The C-Mix can bring real time automation to many smaller studios. Example price for 32 Faders £2,600 + Computer. Write or phone for details. The second product is an absolute winner - A manual programmer for the Yamaha DX-71. Loads of knobs and switches to fiddle enabling easy editing of sounds. Storage of which is carried out in the normal way, connection to the keyboard is simply via any suitable midi lead. Price £395
- Sony PCM 601 The New Digital Audio Processor. Available from stock. £750
- T.C. Electronic of Denmark. Professional parametric equalisers and spatial expander. The parametrics are of the highest standard electronically and construction-wise, the spatial expander has to be heard to be believed. Please phone for a demonstration.
- Steinberg Research SMP-24. In essence a similar function unit to the Bokse SM-9, this unit comes into its own when used in conjunction with the PRO-24 Sequencer. All song timing information may be stored on the Atari computer along with the corresponding sequence and then subsequently stored onto disc. Also a 'Midi Merge' facility is provided to enable the sequencer to receive both note input etc AND midi clock information. Price £799
- Rebis Midi Gate - A very useful production tool. Acts like a Drawmer DS-201 but with a few extra tricks like trigger mask, trigger delay key filler may be used on audio plus a midi output which sends note on and key velocity dependent on audio amplitude information. Price £495
- Yamaha DMP-7 Digital Effects and Mixer Coming Soon - Watch This Space!
- Amazing Alesis Microverb in stock now. 16 bit linear processing only 5 1/2" wide. Stick three together like jumbo Stickle bricks, and they rackmount. Price each £216. Special three deal + rack kit £599
- 24-track sequencer package, comprising: ATARI 1040 ST, monochrome monitor, mouse, word processing & language software plus STEINBERG RESEARCH Pro 24 software. All ready-to-run. Demonstration arranged by appointment. New Low Price £825

## SECOND HAND, EX-DEMO & NEW EQUIPMENT

### TAPE RECORDERS

- STUDER A-80 2 inch 16TK with Dolby M16 Phone London office for details  
 STUDER B62 Stereo, Lovely Condition £795  
 OTARI MX-5050 4HD 4TK - little use £1,200  
 TEAC 80-8 c/w dBx, vari-Speed & Remote, Brand New! £1,650  
 TEAC 3440 - As New £625  
 TEAC 3340S - With New Heads £495  
 TASCAM MS-16 + dBx + Autolocate + Console Stand - Showroom Model £9,250  
 TASCAM ATR-60 1/2" Eight Track Professional + Console + Overbridge £4,950  
 TASCAM 58 DB - New, One Only £2,950  
 TASCAM 32 - New, Ex-Demo £875  
 TASCAM 38 - New, shop Soiled £1,450  
 TASCAM 122 - Mint, Boxed As New £395  
 FOSTEX E2 1/4" Stereo + Centre Track £2,400  
 FOSTEX Model 80 - New £1,295  
 FOSTEX E-16 - From Stock P.O.A.  
 REVOX B77 II £1,095  
 REVOX PR-99 II £1,695  
 UHER 4200 c/w Case & Mics - Mint Condition £595

### MIXING CONSOLES

- AHB Sigma 20/24 Automation Ready - On Demonstration £12,960  
 AHB System 8 MK II 1616 - Brand New, 2 left £1,450  
 AHB System 8 MK II 168 - Shop Soiled £1,195  
 AHB system 8MK I 1616 (Fully Recon'd) £1,050  
 AHB System 8 MK III 24.16 with JELLINGHAUS Automation £4,895  
 AHB CMC 24 MK I (24.16) - New £1,950  
 AHB CMC 16 MK I (16.8) - New Absolute Bargain £1,040  
 AHB CMC 24 MK II - New £3,100  
 AHB Studio 12 For Broadcast or Disco Applications £1,895  
 SOUNDTRACKS MR Series (24.8.16) £5,100  
 SOUNDTRACKS PC Midi Series 16 Input version £4,045  
 RSD Studiomaster Series II 16/16 + 8 Chan Add-On (24.16.2) - Showroom Model £2,800  
 RSD Studiomaster (16.8.2) - New, Ex-Demo £1,150  
 PLATINUM Level IV 32/8/32 Modular - New £5,500  
 BEL (24.16.2) Modular - 2 Yrs Old £1,850  
 TASCAM M312 (12.4.8) - New, Ex-Demo £1,395  
 TAC Matchless - New, To Order P.O.A.  
 TAC Scorpion Prices From £2,950  
 SECK (12.8.2) - New, To Clear £685  
 SECK (18.8.2) - New, To Clear £895  
 FOSTEX 450 16 Chan - New, To Clear £952  
 RAM RM10 - New, To Clear £434  
 RAM RM16 - New, To Clear £587  
 TASCAM 388 - Ex-Showroom, To Clear £1,950

### OUTBOARD GEAR ETC

- AMS RMX-16 - Latest Software, 9 Months Old £3,000  
 AMS DMX-1580S 6.4 Secs + 1.6 Sec Dual Pitch Change DE G £4,250  
 LEXIXCON 224 XL With Larc £6,000  
 T.C. ELECTRONICS 2290 with 32 Secs Sampling - New £2,535  
 YAMAHA SPX-90 II - New £545  
 YAMAHA DMP-7 Digital Reverb/Mixer Motorized Faders, Midi etc. - New £2,600  
 ROLAND DF-15 - New £216  
 ALESIS XTc - One Only, Ex-Demo £545  
 ALESIS Microverb - New To Clear £299  
 3 x ALESIS Microverb inc Rackmount Kit - New £599  
 ALESIS Midverb II - New £373  
 DELTALAB ADM-1020 (15K Bandwidth) - 2 Only £169  
 AKG BX-20E - Perfect Bargain £295  
 DIGITECH RDS 3600 (36) Secs - New £320  
 REBIS RA701 Midi Gate - New £495  
 AUDIO + DESIGN Gemini Dual Comp/Lim - New Special Offer £250  
 AUDIO + DESIGN Panscan Auto Panner - New £375  
 AUDIO + DESIGN Compex Stereo - S/H £750  
 AUDIO + DESIGN F700RS - As New £500  
 AUDIO + DESIGN Transdynamic + 3 x Express Limiters £1,500  
 DRAWMER DS-201 Noise Gate (Quantity Discounts) £295  
 DRAWMER DL-221 Comp/Lim (Quantity Discounts) £345  
 DRAWMER LX-20 Comp/Exp (Quantity Discounts) £225  
 YAMAHA GC2020B Balanced £245  
 T.C. ELECTRONIC 1210 Spatial Expander £735  
 T.C. ELECTRONIC 2240 HS 4 band 2 Chan Parametric £575  
 T.C. ELECTRONIC 1140 HS 4 Band Mono Parametric £345  
 T.C. ELECTRONIC 1220 2 Ban Stereo Parametric £265  
 HARRISON GP215 2 x 15 Graphic £362  
 HARRISON GP130 Mono 31 Band £473  
 HARRISON GP230 2 x 30 £583  
 FENDER STRAT Red, Maple Neck, Trem. Custom Electronics £395  
 FENDER RHODES Stage 73, Good condition £250  
 GIBSON LES PAUL DE-Luxe Black, c/w Hard Case £395  
 EMULATOR 1 - Mint Condition £995  
 QUAD 405 S/H £175  
 JBL 4350 Monitors Mint with JBL X-Overs £1,500  
 MICROPHONES New & Used From: NEUMANN, AKG, SENNHEISER, BEYER, SHURE  
 MONITORS From JBL (Full Range In Stock) TANNY, YAMAHA, UREI  
 AMPLIFICATION By HARRISON, UREI, YAMAHA, QUAD & RAUCH  
 16 Track Studio For Sale Complete (B16, System 8, Tascam Etc) Lock Stock & Barrel in Chester Area  
 Around £12,000 Offers

Loads more equipment in stock - we have gear coming in all the time.

Please note: the prices above do not include VAT

**STUDIO HOUSE** All major credit cards accepted. **LONDON**  
 High Lane Village 4 Wellington Road,  
 Stockport SK6 8AA St. John's Wood,  
 Tel: 06632 4244. Telex: 665721 London NW8 Tel: 01-586 3167

Normal opening hours are 9.30 am to 6.00 pm Monday to Friday; 10.00 am to 2.00 Saturdays.  
 If you intend to call at either of our premises we recommend you make an appointment first.

## INDEX TO ADVERTISERS

APRS	88
AMS Industries PLC	13
Aces UK	14, 15
ACO Pacific Inc	89
ADC Europe	34
AEG Aktiengesellschaft	75
AKG	65
Alpha Audio	26
Amek Ltd	33
Ampex (UK)	IBC
Applied Microsystems Ltd	81
Audio Service Co	98
Beyer Dynamics	4
Bruel & Kjaer A/S	21
C Tape Developments	9, 26
Court Acoustic Sales Ltd	35
D & R Electronics	87
DOD Electronics	77
Dolby Laboratories Inc	63
Don Larking Audio	79
Dr Schoeps Gmbh	71
Drawmer Marketing	81
Eardley Electronics	9
FWO Bauch Ltd	IBC
Gateway	26
H W International (Shure)	27
Hardware House	13
Hayden Laboratories Ltd	46
HHB Hire & Sales	24, 25
J.B.L.	61
Keith Monks	66
Lyrec UK Ltd	8
Media Products Ltd	89
Mitsubishi Pro Audio Group	19
Neotek	41
Neve Electronics Labs Ltd	22, 23
Northern Audio	89
Neumann	17
Orban	31
Otari	39
Pangbourne Musical Dist.	91
Plasmec Systems Ltd	81
Point Promotions	48
Rane Corporation	7
Rebis Audio	40
Rycote Microphone Windshields	48
Saje	47
Sam Therapy	91
Sanken	67
Scenic Sounds Equipment	31, 68, 69
Seasim Controls Ltd	48
Shure Bros	83
Sony Broadcast Ltd	43, 85
Soundcraft Electronics	IFC
Sound Technology plc	77
Soundtracs plc	55
Sowler Ltd, E.A.	13
Steinberg Research	90
Stirling I.T.A.	10, 11
Studio Spares	49
Surrey Electronics	58
Sycos Systems	44, 45, 91
Symetrix	6
T C Electronic	79
Teac UK	59
Technics/Panasonic	29
Thatched Cottage Audio	73
Timeline	53
Total Systems	66
Trad Sales & Services	6





# REFINING THE FINEST

*Advanced recording equipment demands advanced recording tape. Which is why for ten years Ampex has continued challenging machine capabilities. Through a decade of technological improvements, Grand Master® 456 remains an audio tape of unequalled sophistication and consistency. Which is why more top albums are recorded on Ampex tape than any other tape in the world. For Grand Master 456, the beat goes on.*

Ampex International, Magnetic Tape Division, Acre Road, Reading RG2 0QR, England, (44) 734-875200

**AMPEX**

Ampex Corporation • One of The Signal Companies

## AND THE BEAT GOES ON



# The workstation



**Studer A812** – the efficient new workstation for the hectic broadcasting environment. It is remarkably rugged, fast, and user-friendly. All controls can be programmed from a menu of over 40 functions. This saves time, soothes nerves, and provides flexibility for future applications.

To keep up with your often frantic pace, the A812 function menu offers four “true” dump edit modes, three rollback/locate start sequences, four fader start modes, four record/play speeds, winding speeds from 1 to 12 m/sec, library wind, and three vari-speed display formats, plus shuttle control, microprocessor control of all transport and audio functions, phase compensated audio electronics, and ...

As if that weren't enough, the A812 has a spacious and practical editing section.



## STUDER INTERNATIONAL AG

Althardstrasse 10, CH-8105 Regensdorf

### Sales Offices:

**Australia**, North Sydney 4064700 **Austria**, Vienna 473309 / 473465 **Belgium**, Hasselt (011) 229664 **Canada**, Toronto (416) 423-2831 **Denmark**, Gentofte 451652340 **Finland**, Helsinki 80/742133 **France**, Paris (1) 45 33 58 58 **Germany**, Löffingen 07654-8030 **Great Britain**, London/Herts. 01-9530091 **Hong Kong** 5-441-310 / 5-412 050 **Italy**, Milano (02) 25390121 **Japan**, Tokyo 03-320-1101 **Netherlands**, Gennep 08851-96300 **Norway**, Oslo (02) 356110 **Singapore** 2507222/3 **Spain**, Madrid 2317840 **Sweden**, Solna 08/7340750 **USA**, Nashville (615) 254-5651

**Worldwide:** Studer International AG, Regensdorf, Switzerland, +41 1 840 29 60.