

November 1991

Recording ■ Engineering ■ Production

\$4.00

# REP

TM

The Pro Audio Applications Magazine

A11200-----PMEBA1931 XXXXX FEG  
F1042091000000 29 06 1  
DUG POMEROY OWNER  
POMEROY AUDIO  
193 BAL TIC ST  
BROCKLYN NY 11201

## AUDIO ARCHITECTURE: Modern Studio Design

AN INTERTEC PUBLICATION

# GUARANTEED EXCELLENCE.



With the first high quality, high powered, solid state amplifier manufactured by Crown in 1967, we began setting industry standards. Today, with a complete line of amplifiers, Crown is one of the most recognized names in sound amplification in the world.

Our success can be attributed to many people and to many

things. But encompassing all of them is our commitment to excellence... guaranteed excellence. It's found in the engineering details that go into every Crown amplifier from Power Base to our acclaimed Macro series. It's found in stringent manufacturing, precision assembly and a level of support unmatched in the industry.

Proof of Crown's guaranteed excellence is our unprecedented 3+3 No-Fault Extended Warranty... up to six years of transferable protection for all Crown amplifiers.

To experience Crown's tradition in our full line of high quality amplifiers, call us at 1-800-535-6289.

GUARANTEED EXCELLENCE



Made in America

Exported as Amcron

Circle (1) on Rapid Facts Card

P.O. Box 1000 • Elkhart, Indiana 46515-1000



## British studio performance at a revolutionary American price!

MEGAS Studio is the first 24 buss recording console to combine world class *British sound* with a wealth of smart, practical features for today's recording situations—*priced from \$17,100\**

Featuring a highly flexible split console design, the Studio can be specified in 16 or 24 discrete buss formats and is available in 24 to

40 input configurations with or without patchbay.

An ideal choice for today's input-intensive recording, the Studio has an on board MIDI computer which can be interfaced with a sequencer to provide automated MIDI muting. It also comes with an exceptionally smooth, transparent 4-band EQ for optimized sonic performance.

The MEGAS Studio can accommodate a combination of mono or stereo input modules and comes with full metering as a standard feature.

MEGAS Studio. Superior sound and performance at a price that'll revolutionize the way you think about British consoles.

# MEGAS STUDIO

Circle (3) on Rapid Facts Card

**SOUNDTRACS** INC.

Soundtracs distributed exclusively in the United States by: Samson Technologies Corp., P.O. Box 9068, Hicksville, NY 11802-9068 TEL: (516) 932-3810 FAX: (516) 932-3815

\*Suggested retail price for the Model 24/24 Megas Studio console. Other prices will vary somewhat based on specific configuration and features.

© 1991 SAMSON

# Contents

Volume 22, No. 11

November 1991



14

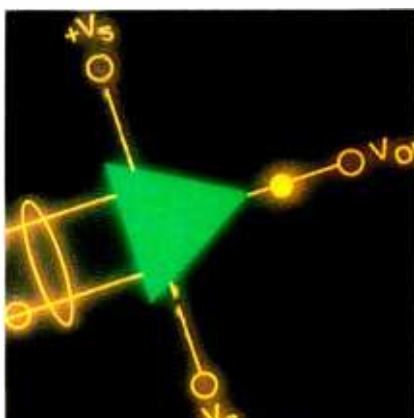

32



44

## Audio Production

- The R•E•P Interview: Keith Cohen** 26  
Producer/engineer Keith Cohen on remixing pop and dance platinum.  
*By: Brad Leigh Benjamin*
- Balancing the World** 32  
Adding Analog Device's 2141 and 2142 chip set to unbalanced audio equipment. *By: John La Grou*
- Power Station** 36  
Covering audio for video and film. *By: Mary C. Gruszka*
- Designing the MTSU Media Complex** 38  
Providing state-of-the-art production facilities for the innovative recording industry program at Middle Tennessee State University.  
*By: Richard Zweibel*
- GTN: A Full-Scale Production Facility** 44  
Designing from the ground up: digital workstation networks, analog tape capabilities and isolation-intensive acoustic design. *By: Gary Pillon*
- Hands On: Meyer Sound Laboratories HD-1** *By: Mike Joseph* 56

## Sound Reinforcement

- Live & Direct** 48  
Touring sound technology in permanent installations.  
*By: David Scheirman*
- Upscale Festival Sound Reinforcement** 49  
A case study in landing, and keeping, long-term contracts with high class regional jazz, folk and classical festivals. *By: Bruce Borgerson*
- Roadwork** *By: Mark Herman* 54
- All Access** *By: Mark Herman* 55

## Departments

- From the Top ..... 5
- Letters ..... 6
- Random Access ..... 8
- Fresh Tracks ..... 14
- Sound Business ..... 22
- Digital Domain ..... 24
- First Look ..... 63
- Cutting Edge ..... 64
- Classified ..... 66
- Advertisers Index ..... 72
- Rapid Facts Card ..... 73
- Subscriber Card ..... 75

**On the Cover:** The radical Studio One, The Strongroom, London, featuring a Neve 48-channel V3 Series console with flying faders.

R•E•P: Recording•Engineering•Production (ISSN 0034-1673) is published monthly by Intertec Publishing Corporation, 9221 Quivira, Overland Park, KS 66215. Subscriptions rates are \$26 to qualified readers, \$30 to non-qualified readers per year in the United States, \$50 for qualified and \$60 for non-qualified per year outside the United States. Optional airmail for non-qualified reader, outside the United States is also available for an additional \$55 per year. Foreign subscriptions are payable in U.S. funds only by bank check or money order. Adjustments necessitated by sub-cription termination at single copy rate. POSTMASTER: Send address changes to R•E•P: Recording•Engineering•Production P.O. Box 12960, Overland Park, KS 66282. Second-class postage paid at Shawnee Mission, KS 66202 and additional mailing offices.

Photocopy rights: Permission to photocopy for internal or personal use is granted by Intertec Publishing Corporation for libraries and others registered with Copyright Clearance Center (CCC), provided the base fee of \$2.00 per copy of article is paid directly to CCC, 21 Congress St., Salem, MA 01970. Special requests should be addressed to Cameron Bishop, group vice president, Intertec Publishing Corporation.

ISSN 0034-1673 \$4.00 + \$0.00

©1991 by Intertec Publishing. All rights reserved.

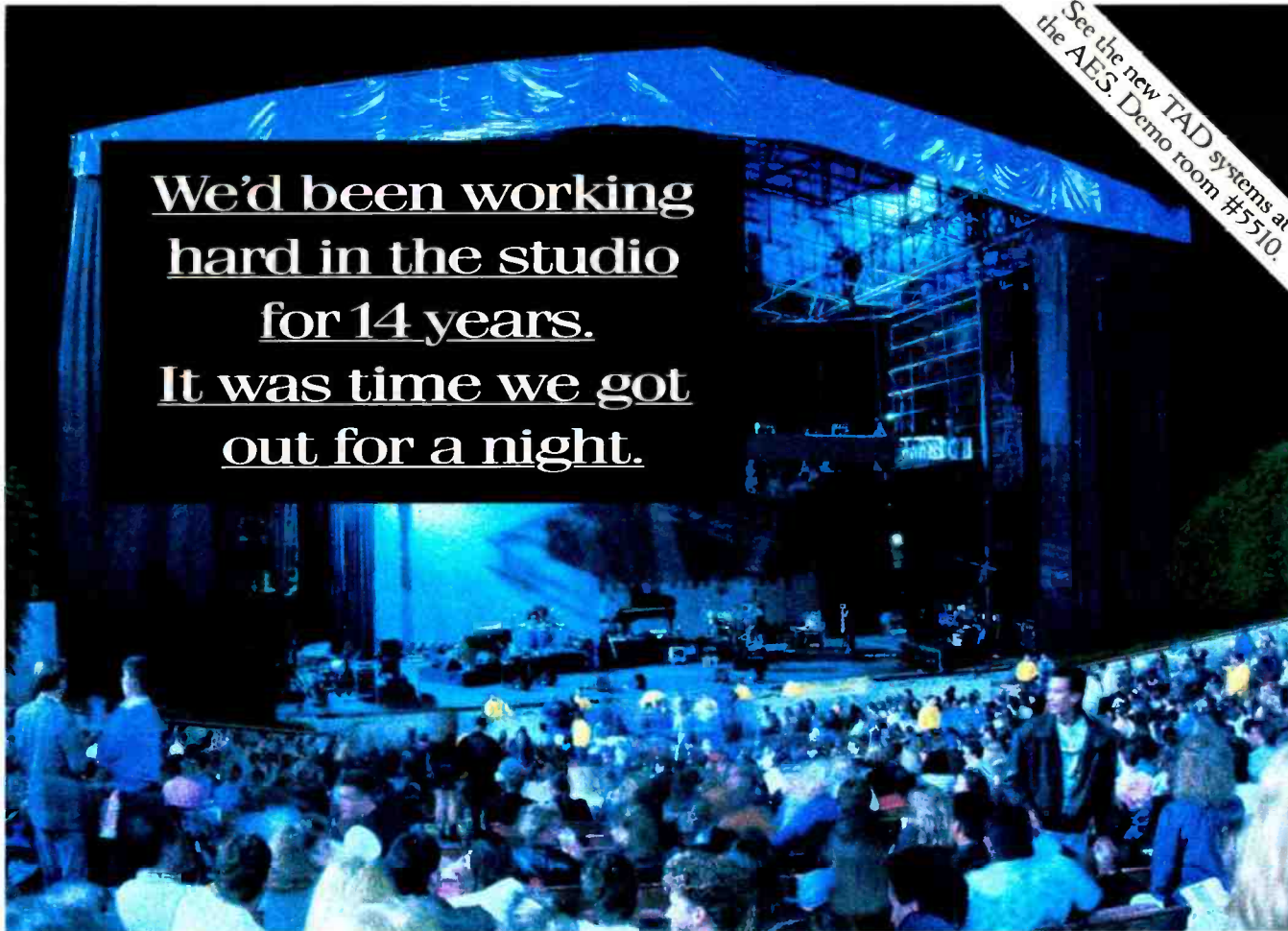

We'd been working  
hard in the studio  
for 14 years.  
It was time we got  
out for a night.

Spending years on end cooped up in small, dark rooms with a bunch of engineers takes certain special qualities. Durability, for one. We've always been known for that. Of course, clear, uncolored sound quality doesn't hurt, either. Or hand-assembled components, with gap precision to plus or minus one-millionth of an inch.

These features got TAD speakers into studios like Record Plant, NOMIS and Masterfonics. And the same features are now getting us out of them.

See, we had this funny idea that if TAD could make music sound terrific in a small room, we could make music sound terrific in a huge arena. And every outing we've had with Maryland Sound has proved us right.

Not that we won't still work our woofers off in studios from L.A. to London all day. But, at night, we'd like to get out and jam more often.

**TAD** Technical  
Audio Devices®

Pioneer Professional Products Division

# NEW MQ™ SERIES. MASTER QUALITY DIC//DAT™ FOR THE ULTIMATE QUALITY MASTER.



DIC//DAT introduces its new MQ Series DAT tape. Master Quality media crafted with second-generation technical improvements based on extensive R&D and feedback from audio pros in the field. The one DIC//DAT perfected for professional use.

- ▶ **NEW MQ "Formulation Finish"** reduces friction and provides more efficient tape-to-head contact for superb performance even in the face of high search and rewind speeds.
- ▶ **NEW MQ proprietary DIC MicroFinity metal particle technology** creates a consistently high quality magnetic medium for uncompromising professional DAT recording.
- ▶ **NEW MQ exclusive DIC//DAT tape lengths** include an extra two minutes for tone recording, test signals and pre-roll identification—as well as the industry's only 15–30 minute DAT cassettes for small programs, demos and test tapes.
- ▶ **NEW MQ dust-busting cassette design** virtually eliminates recording errors and tape jamming due to environmental contamination.
- ▶ **NEW MQ unique window calibrations** for easier reading and more accurate time judgment.
- ▶ **NEW MQ extra-strong DIC//DAT cassette shell** made in the U.S., with new window ribs for increased stability, 100% anti-static plastic, and the industry's only fiber-filled slider for structural integrity, stands up to the most rigorous studio use.

# DIC//DAT™

# 122 MQ™ SERIES

TAKING MUSIC TO THE *Nth* DEGREE.  
222 Bridge Plaza South, Fort Lee, NJ 07024 • 1/800-DAT-I-DIC (in NJ, 201/224-9344)

Circle (5) on Rapid Facts Card

**DIC**  
DIC Digital

© DIC DIGITAL SUPPLY CORPORATION, 1991

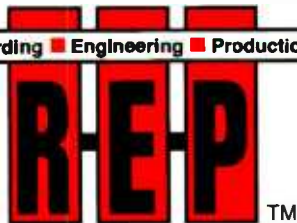

## EDITOR

*Mike Joseph*

## SENIOR ASSOCIATE EDITOR

*Sue Edwards*

## GRAPHIC DESIGNER

*Liz Vetrnick*

## EDITORIAL ASSISTANT

*Joe Ramsey*

## DIRECTORY EDITOR

*Pat Blanton*

## GROUP MANAGING EDITOR

*Tom Cook*

## CONSULTING EDITORS

*John Monforte, Technical Consultant*  
*David Scheirman, Live Performance*  
*Laurel Cash-Jones, Editorial Consultant*  
*Sarah Coleman, Washington Correspondent*  
*Dan Levitin, Music Production Editor*  
*Rick Schwartz, Contributing Editor*  
*Mark Herman, Contributing Editor*  
*Dan Torchia, Contributing Editor*

## GROUP VICE PRESIDENT

*Cameron Bishop*

## PUBLISHER

*Dennis Milan*

## MARKETING DIRECTOR

*Darren Sextro*

## GROUP SPECIAL PROJECTS DIRECTOR

*Czatdana (Dana) Inan*

## PROMOTIONS MANAGER

*Evelyn Hornaday*

## MARKETING COORDINATOR

*Sally Nickoley*

## ADVERTISING BUSINESS MANAGER

*Dee Unger*

## ADVERTISING PRODUCTION SUPERVISOR

*Mary Birnbaum*

## ADVERTISING COORDINATOR

*Pat Eisenman*

## CLASSIFIED ADVERTISING COORDINATOR

*Mia Fountain*

## PRESIDENT

*R.J. Hancock*

## CORPORATE CIRCULATION DIRECTOR

*Sandra Stewart*

## CIRCULATION DIRECTOR

*Doug Wilding*

## CIRCULATION COORDINATOR

*Susan Link*

## CUSTOMER SERVICE

*913-541-6628*

R•E•P is an applications-based publication targeted at professional individuals and companies active in the commercial business of studio and field recording, audio for video, live sound production and related fields. Editorial content includes descriptions and demonstrations of audio production techniques, new products, equipment application, maintenance and audio environment design.

## Member, Business Publications

Audit of Circulation

Sustaining member, Audio

Engineering Society

Sustaining member of Acoustical Society of America

Member, International Communications Industries Association

Associate member of Society of Professional Audio Recording Services

©1991 by Intertec Publishing. All rights reserved.

# From the Top

## How Much Detail Is Too Much?

**N**one of us wants to be caught turning out product that sounds "dirty," or "distorted," or "muddy." And if it sounded great when we mixed it? Then there must be something going on that we didn't catch, or didn't understand, or didn't hear. Was it the monitoring?

Today's monitoring environments need to do more than "cheat" the acoustics through the trick of optimizing direct-to-reflected path lengths (what we do when we stick monitors in our face, far away from the nearest large boundary surface); they have to be designed from the ground up as efficient, effective chambers that allow detailed listening, yet handle standard physics problems in aesthetic ways.

Which brings up a very interesting subject: How much aural detail is too much? Once upon a time, when monitor speakers generally had serious arrival-time offsets and less-than-linear responses, a speaker that sounded decent made most music sound good. One that had a bad sound made the music sound bad, unless the mix was twisted so much as to sound good in those speakers, which, of course, created an end product the inverse of the speaker's response — sounding terrible out in the "real world". Case-in-point: Why did so many of the rock mixes from the late '60s have amazing bass and biting treble? They were mixed on Altec 604s mounted in Altec enclosures, reknown for their midrange and not much else.

But what happens when you have monitor speakers and a mixing environment so accurate that time/distance offset between two microphones in the studio is readily audible? Obviously, you have to work more diligently to "get it right" up front. Does the end product sound better? Are you now spending all your time chasing phase anomalies, as opposed to balancing timbres? At what point have you surpassed something even the best home speaker system might reveal?

Here's an analogy: At 30,000 feet elevation, out of the window of a plane, the ocean's surface looks as smooth as glass. At 500 feet, the waves show up large and ominous. At 10 feet, right in the middle of it, the detail of shooting spray and churning whitecaps obliterates even the blueness caught from afar. What is the proper distance to photograph the ocean, if the purpose is to impart the feeling and emotion of the thing? With a microscope, a drop from a wave wouldn't even be recognizable as ocean matter any more, just a jumble of swimming micro-creatures and swirling fluids. Get the point?

As strongly as any of us would argue that a monitoring environment which pre-offers an uncolored, uniform sound at any listening lo-

cation is a standard to work toward, so too might we all argue that too much technical attentiveness takes a certain element of artistic interpretation out of the act of creating and capturing music.

Let me share an interesting anecdote having to do with acoustics and speakers. At the AES show last month, I was handed a Roland RSS demonstration CD, my first "carry-it-away-for-later-listening" example of modern-day, stereo-encoded spatial environment material that really, truly, amazingly shows off the technology (and boy, does it work!). At shows, Roland demonstrates the process, which relies on subtle phase and signal time manipulation, on Meyer HD-1s, taking advantage of their wide polar pattern and uniform phase response. Playing the disc at different manufacturers' booths and listening on various monitors, it was quite amazing to note that the spatial effect varied from non-existent to intense. Had I stumbled across the universal aural tester for speaker phase linearity?

At Right Track Studios on 48th Street in Manhattan, the recently installed Genelec 1035A big boys proved a very interesting test. In the near field of the soffit-mounted speakers, the RSS effect was good. Further back in the room, say a yard behind the board's mix position, and at the client's couch along the back wall, the effect was non-existent. Back at the board, switching to the new, baby Genelec 1031A near-fields on the meter bridge, the RSS imaging was incredible! I asked Ilpo Martikainen from Genelec, "Why the discrepancy?"

Thanks to the MLSSA analysis program Ilpo had running on a portable Toshiba 5200 laptop, he pulled up curves he had previously run in the Right Track control room. There on the screen glowed the answer in translucent magenta: The main speaker's signal arrival time was relatively undiluted by contributing reflections at the mixing position, but there were some. Simple math (milliseconds-to-feet) indicated console top, floor and ceiling reflections affecting the main signal, adding time-delayed clutter. The phase-sensitive RSS material was being played with, in essence, by acoustic phase anomalies.

As I listened to the 1031A near-fields on the meter bridge, the imaging was great — acoustically direct and without reflections. Back to the mains and listening in the back of the control room, Melissa showed numerous serious reflective contributions: a coffee table top, floor, ceiling, walls, console, back wall, you name it. The fidelity was good, but signal-cluttering multiple arrival times sent the phase linearity out the window. The RSS-processed material fell apart completely. Even stereo imaging suffered. But, that's normal for a back wall couch. And the CR at Right Track is a well-designed, good sounding room. Imagine the opposite! Food for thought, indeed.

I'd love to hear your responses on this timely subject. ■

**Mike Joseph**  
Editor

## Discrete Op-Amps

From: John Hardy, *The Hardy Company, Evanston, IL.*

Regarding the "Digital Domain" column in the June 1991 issue, there were several points regarding discrete op-amps raised by Jim Williams (as reported by Rick Schwartz) that were either extremely biased against discrete op-amps, lost in translation or editing, or grossly oversimplified for the sake of the brain-dead.

The article refers to the 990 discrete op-amp and other discretely as "nothing more than good integrated chip designs made with separate components." It does kindly state that, "The main advantage of going discrete is the designer can select each transistor for its part in the circuit to optimize performance," but it misses several other important advantages to discrete op-amps:

1. The schematic of the 990 shows a pair of emitter inductors (L1 and L2) in parallel with the emitter resistors (R1 and R2) of the input pair of transistors (Q1 and Q2). Ideally, the emitter circuit of Q1 and Q2 should be the lowest possible impedance for the lowest noise. Yet a higher impedance is required for stability at ultra high frequencies. With L1 and L2 you can have the lowest-noise throughout the audio bandwidth, and maximum high frequency stability. No trade-offs in performance. This particular design feature earned Deane Jensen U.S. patent #4,287,479. Here is the point: These inductors are made of ferrite beads measuring .230"D x .390"L. Try fitting two of them on a chip of silicon measuring .062" x .062", which is the approximate size of the chip used in most monolithic op-amps such as the 5534!

2. The input pair of transistors in the 990 is the National Semiconductor LM-394 super-matched transistor pair. It is a monolithic IC containing 100 transistors. 50 transistors per section are randomly connected in parallel to achieve extremely low noise and averaging of variations in parameters. The silicon chip that is used in the LM-394 is as large as a 5534 chip!

3. The output transistors (power transistors) Q8 and Q9 are also built with chips that are as big as, or bigger than, most monolithic op-amps. Combined with the fact that the large 990 package (1.125" x 1.125" x .600") has about 14 times the surface area of an 8-pin dip package, the 990 can obviously dissipate much more heat, and therefore, provide much higher power levels than a monolithic op-amp. The 990 can drive a 75Ω load to a +24dBv output level when operating from bi-polar 24V power supplies. The 5534 is typically limited to 600Ω loads, and bi-polar 18V power supplies.

The ability of the 990 to drive extremely low impedances is important in applications where its output is being sent to many different pieces of equipment simultaneously, such as multiple power amps in a sound system, multiple tape recorders in tape-dupe applications, etc. The feedback components around the 990 can also be much lower in impedance resulting in the

potential for lower noise. What good is a low noise monolithic op-amp if you are forced to use resistors and capacitors around it with higher than desirable impedances to keep from overloading the op-amp, with the result that those resistors and capacitors become the dominant noise source?

4. Resistors, capacitors and diodes can also be individually selected for optimum performance. In the case of the 990 discrete op-amp that the Hardy Company manufactures, metal-film resistors with a 1% tolerance and a 100ppm temperature coefficient are used extensively. Ultra-stable capacitors with a 30ppm tempco and a temperature rating of 125° centigrade (257°F) are used. Monolithic integrated circuits are getting better all the time, but the manufacturers cannot consistently fabricate resistors and capacitors with anywhere near this high degree of accuracy, stability or high temperature capability. The extreme differences in requirements between input transistors and output transistors are also difficult to deal with due to process limitations. There are still severe limits to how much you can do on one piece of silicon measuring .062" x .062".

The only advantage that the article concedes to discrete op-amps is increased headroom. Even then, it tries to trivialize discretely by further stating that it, "...doesn't necessarily translate into lower noise performance," and "Integrated circuits are now able to go beyond discrete capabilities." It sure sounds like an attempt to bury the concept of discrete op-amps in favor of monolithics.

Mr. Williams wonders why people even use Bi-Fet op-amps anymore. Op-amps with Field-Effect Transistors (FETs) at their inputs typically have much lower input bias currents and much higher input impedances than bi-polar op-amps. This can be important in some applications, so a bi-polar op-amp should not be substituted without careful analysis of the surrounding circuitry. In fact, the article later states, "For example, you can replace the FETs in AKG mics with lower-noise Hitachi or Toshiba types." Note that the AKG mics use the FETs in a *discrete* amplifier circuit. The article dismisses discrete op-amps and FETs on one hand, but endorses them on the other. The fact is, there are times when discrete op-amps and/or FETs are the only way to go!

Another minor point. The article states that: "A servo amp rolls off everything below one cycle, so it won't damage your studio monitors." Actually, a servo amp rolls off everything at whatever frequency is chosen by the designer of the circuit. It might be one cycle (isn't that "Hertz"?), or it might be one one-hundredth of a cycle, or even 100 cycles, as the designer sees fit. The servo also keeps dc voltages from reaching controls and switches where clicks and pops could occur during operation.

I completely agree with the overall concept of the article that there is *much* room for improvement in equipment. However, I do not appreciate such disregard for the abilities of discrete op-amps. By the way, forget all the specs

for a moment: many people feel that some discrete op-amps simply sound better than monolithic op-amps! Isn't that usually the point?

## Where's the Zero? Reaction

From: Chris Wicht, *New York.*

The authors of this article [R•E•P June] couldn't have chosen a worse comparison to justify the need for a standard. Anyone who has traveled out of the U.S. knows that the obsolete and unpractical British measurement units are *not* universal standards, whereas the metric system is.

Contrary to what Mr. Bushnell and Schwartz are trying to have the readers believe ("one foot as a linear measurement is a standard," "...are universally adopted," etc.), these units have to be converted to the metric system in order to be used for important calculations — ask NASA — which certainly proves that when it comes to "convenience and universal understanding" scientists and people who rely on technical knowledge and accuracy have to use meters, grams and liters (Woaw, units that you can actually divide and multiply by 10, 100, 1,000 and so on!).

I have always turned to R•E•P for technical excellence and accuracy and am very disappointed by this faux pas. Congratulations for an otherwise excellent article.

## Digital Considerations

From: Robin Whittle, *Real World Interfaces, Melbourne, Australia.*

This is my response to the letter in the April issue ["DAT Questions"].

Recording engineers have had several decades to learn about the idiosyncrasies of analog tape — bias levels, bias intermodulation, erasure level, print-through, tape saturation, record and playback EQ, head alignment, head-tape contact anomalies, wow and flutter, etc. Now, with digital audio, they can forget about all of these and start worrying about a new set.

The technical information on A/D and D/A converters that circulates in the audio trade press is generally not very informative, so it is not surprising that engineers are unaware of the finer points. The glossy brochures and gushing press releases try to convince them that they are hearing real 16-bit digital audio, but the reality is that the last one, two or three bits are usually noise or distortion. Phase response problems are hard to measure and are likely to be the cause of much of the criticism that has been directed at digital audio. ■

Send letters to R•E•P, Box 12901, Overland Park, KS 66282; or fax 913-541-6697. Letters must be signed and may be edited for length and clarity.



# THE MOST IMPORTANT DIGITAL EQUIPMENT ISN'T WHAT YOU THINK IT IS.



It's the tape.

And it's why Sony is so totally in-sync with every aspect of digital recording.

Because we pioneered virtually every major digital tape format: 1630. FI. DASH. DAT.

And since we also developed the digital hardware they perform on, we didn't merely learn each tape's parameters through trial and error.

Moreover, each Sony tape is designed to capture the ultimate in digital sound. Which is precisely why we're as committed to digital audio tape as we are to digital recording itself.

So if you're committed to the quality of what people hear, just think Sony. The Leader In Digital Audio!™

**SONY**  
PROFESSIONAL TAPE

## CALL NOW!

As reported in the *Wall Street Journal* (and you wonder why the business world thinks people inside the recording industry are nuts), Boston recording engineer and Headroom Studios owner Bill T. Mullin is producing albums created from messages left on his answering machine. His initial offering, titled "Call Now! 1-800-OUT-BAND," has satirical and political themes assembled out of elements from over 50 messages, which, according to Miller, "Don't make sense out of context, and then again, don't make sense in context." The album is allegedly a tale about "an insane genius whose obsessions with food, TV, sleep, sex, drugs, rock 'n' roll, fame and fortune turn out to be a strange path to enlightenment."

The album's musical backing tracks are created by a collaboration of Boston-area guest musicians. The phone machine-captured voice talent ranges from spoken Spanish played backward to a man who acts out the part of a record company executive in commenting on the music: "It's got a kinky beat. It glues me!"

Although Miller welcomes what he calls "totally wacked-out and original" phone contributions for upcoming albums, he indicates that, "I've really got about all the burps I could possibly use." Art for art's sake, or tomorrow's commercial hit? ■

*Whenever I listen to music at a concert hall, I always think, 'How can I reproduce the wonderful musical sound and its great emotion, as I hear it in the concert hall, with an audio system in my home without spoiling the quality?'*

— Japan's Dr. Yoshiro Mochida commenting on his home audio system.



Quote and photo courtesy of R•E•P's friends at Denon.

## PEOPLE

BEC Technologies has appointed **Michael C. Creamer** to vice president of sales and marketing; **Bob Proctor** to vice president; **Al de Marcken** vice president in charge of operations and manufacturing. **Greg Horn**, of BEC's Entertainment Support Group, will be executing field product training and demonstrations to production and touring sound companies ... **Bill Yount** joins MTX as director of OEM and commercial sales ... Sigma Sound Studios promoted **Dave Hecht** to chief tech, appointed **Al Shapiro** to maintenance director, and named **Tony Maserati** operational consultant ... **Vance Walden**, an audio-for-video mixing engineer formerly with Editel, and **Torbin Bullock**, an assistant audio engineer, join the staff of Music Annex Audio Post Production ... NFL Films Video hires **Dave Robidoux**, a 1991 graduate of Berklee College of Music, as an assistant audio engineer ... Doug Swan Associates joined the team of Panasonic/Ramsa representatives. **Swan** will cover eastern and central Florida; **John Chase** will represent western Florida; and **Dana Sadowski** is the office manager ... **Tom Mackno** has been promoted to vice president of engineering for The Calzone Case Company ... **Perry Lancaster**, former senior technician at Studer Dyaxis joins dBm as service director ... **Oldrich Mikoska**, president of Studer France S.A.R.L., will assume the presidency of the newly formed Studer Digitec S.A.; **Jean Schwob** was named vice president; **Philippe Delacroix** was named general director ... TOA Electronics announced appointments to its newly created engineered sound management team: **Chuck McGregor**, product applications consultant; **John Murray**, marketing development manager; **Walter Best**, **Robert Slaughter** and **Bill Ford**, regional managers ... **David P. Aucoin** was promoted to vice president of customer services of Avid Technology ... **Cal Vandegrift** was named director of export sales for Symetrix ... **Steve Cheung** now heads the international marketing operation for Audio Processing Technology, an SSL subsidiary ... **John DeBrocke** was appointed to the position of midwest regional sales manager of HM Electronics ... **Shane Keister**, noted composer, arranger, producer and keyboardist, signed on with Atlantic records as a staff producer. ■



## NAT Award winners chosen:

The magic moment arrived, and we chose! In a random drawing held during the AES convention, R•E•P editorial staff member Sue Edwards reached into the pile of more than 500 August R•E•P National Audio Test drawing entry forms and pulled out the following winners:

**First Prize:** (1 Eventide H-3000-KS Ultra Harmonizer) Robert E. Long, Little Rock, AR.

**Second Prize:** (1 pair Genelec 1031A Monitor Loudspeakers) Larry A. Roll, Palo Alto, CA.

**Third Prize:** (1 Shure FP42 Mixer) Collyer Spreen, Plano, TX.

**Fourth Prizes:** (4 Electro-Voice N/D 857 Microphones) Phil De Carlo, W. Keansburg, NJ; J.S. Steel, Naperville, IL; Carmine Fergo, Medford, NY; and Kerry Dexter, Tallahassee, FL.

Congratulations! Enjoy the goodies, and thanks for your entries. Special thanks to Eventide, Genelec, Shure and Electro-Voice for supplying the prizes. ■

# Trend Watch

**The cost of doing business:** Manufacturers at last month's New York AES convention unveiled numerous lower-cost digital recording systems, both disk- and tape-based. Roland's DM-80, with remote and fader/pot control surface, was a definite show-stopper. Also shown was the Alesis ADAT 8-track professional digital audio recorder. The under-\$4,000 deck uses a standard \$10 S-VHS video cassette, while allowing digital and analog I/Os to and from the recorder; full overdubbing and track bouncing; the capability to tie 16 decks together in better than single-sample-accuracy synchronization for 128 total tracks; and an optional intelligent remote controller featuring full sync lock to external devices, multiple point location searching, record-rehearse/auto punch-in capabilities, and a number of other features formerly common to only large format machines. If the delivered package works as smoothly as the pre-production units demonstrated, the price of true digital multi-track production and signal storage just hit a new low.

**Environment:** American Helix, Pennsylvania-based CD manufacturers and CD project managers have announced the introduction of an environmentally-correct CD package they are calling C-Case, made from recycled cardboard and utilizing soybean ink. The package contains no plastic.

**What's old is new again:** From our friends at *The Eardrum*, the house organ of the Chicago NARAS Chapter: Mike Kenopka spills the beans on "The Famous Jet-Age Backwards Wah-Wah Effect" used by folks like Pink Floyd. First, take your standard off-the-shelf Foxy Lady guitar pedal, reverse the leads (ie: plug it in wrong), and doodle with the volume and tone pots on the guitar. A little real signal might sneak through, but according to Kenopka, the pedal should be "wildly oscillating." Work your foot, the instrument's pots, and hit the pickup switch a couple of times, and you too can go completely retro! Remember, it's never too late to rediscover an old analog effect. (Note: we haven't tried this ourselves, as we respect the integrity of our monitor tweeters). ■

## Noise at Work

In response to the United Kingdom's Noise at Work Regulations, which came into force last year, England's APRS (Association of Professional Recording Services Limited) has produced an information survival pack for studios and other users of professional audio equipment. Included in the packet is a Health and Safety Executive Statement of the Regulations; wall posters with the theme "Keep Sound Levels Down;" "Reminder" stickers for use on headphones; and sample hearing protectors.

The hope by the organization is that studio owners and personnel will police themselves, thereby avoiding any potential interference from government agencies. No such situation exists in the United States, yet. ■

# Random Access

## STUDIO UPDATE

Name/Location	Details
<b>NORTHEAST</b>	
Promix/New York	Purchased DISTRAMIX mixer from Meridian Communications for the "White Oak Dances Project" tour, featuring Mikhail Baryshnikov.
Hip Pocket/New York	Opened Studio D, featuring an MCI 416 console; a Sony APR-24 analog tape recorder; DAI recorder; Neve Prism rack; Focusrite and API modules; Lexicon PCM70; Yamaha SPX901I; H300; Rev7; a 32-voice Synclavier, a Fairlight IIx; an original Mini-Moog (circa 1971); a vintage 4-voice Oberheim, OB-8, and Matrix 12; Yamaha DX5 and Rev7.
Sear Sound/New York	Acquired a mint condition AKG C-24 mic; a pair of AKG C-12A mics; and a Pultec MEQ-5 EQ; and added a Lexicon Model 92 dual digital delay unit.
Macrose Music/Manhattan	Hired studio designer/architect John Storky of the Walters-Storky Design Group to design and supervise construction on its expansion.
Rock Garden Rehearsal Studios/Kenilworth, NJ	Expanded to include a 700-square-foot showcase rehearsal room, designed and installed by Echo Audio and features Echo Audio Ease III tri-amped speaker enclosures powered by all Crest amplification.
NFL Music Dept./Mt. Laurel, NJ	Added a MIDI system that is supported by an Akai S-1100 sampler and three sound modules: an Emulator Proteus, Yamaha TG77 and Korg M1.
Interface Video Systems/Washington, D.C.	Agreed to purchase the assets of Powerhouse Studios and plans to reopen it as DC Post.
<b>SOUTHEAST</b>	
Ultrasonic/New Orleans	Installed a Studer 827 24-track recorder and 24 channels of Dolby SR. Other additions include Tannoy monitors with custom-designed crossovers, a Lexicon 300 digital reverb and two DBX 160 XT compressor/limiters.
<b>SOUTHERN CALIFORNIA</b>	
Take One Recording Studios/Burbank	Installed a Trident Series 80C console with 48 inputs and an Otari MTR-90 III tape machine. Effects and outboard gear include Neve modules and a Lexicon 480-L.
<b>NORTHERN CALIFORNIA</b>	
Robert Berke Sound/San Francisco	Purchased a second Cyberframe digital workstation with 8-track, 8-hour capacity.
<b>CANADA</b>	
Cinar Studio Centre/Montreal	Celebrates its third anniversary by adding a Solid State Logic SL 4000 G to the SL 6000 already in use.
Video Post & Transfer/Kitchener, Ontario	Installed four sets of Tannoy System 215 DMT Studio Monitors in its video/audio post production complex in Dallas.

## NEWS NOTES

**Studer Revox AG** completed the acquisition of a majority interest in Digitec and changed the name to Studer Digitec S.A.

**NVision** has formed the Audio Products Division to meet the needs of the expanding digital audio market.

**Digital House Ltd.** has expanded its Manhattan offices located at 101 West 57th Street, New York, NY 10019; 212-333-5950; fax 212-262-5631.

**Audio Processing Technology** has consolidated all its operations in Belfast, Northern Ireland.

**SPARS** will host a weekend business conference titled "The Business of Operating a Recording Studio: Realities and Opportunities in the '90s" in Los Angeles, January 25-26, 1992.

**Yamaha** has established the Pro Digital Product Department as a separate department for marketing, sales and end-user support.

**Korg USA** has formed the Professional Audio Division, dedicated to servicing studios, production facilities and audio-for-video post houses.

**DeWolfe Music Library** has issued a music copyright primer titled, "A Guide to Clearing Music for Broadcast and Audio/Visual Programs," written by Andrew Jacobs. For a free copy, write to the DeWolfe Music Library, 25 West 45th Street, New York, NY 10036; 212-382-0220; fax 212-382-0278.

**Saki Magnetics** has expanded their professional relapping and maintenance service to include heads of any size, material, format or from any manufacturer. Full relap services are priced as low as \$40 for 1/4-inch heads. Contact Saki Magnetics at 26600 Agoura Road, Calabasas, CA 91302; 818-880-4054; fax 818-880-6242.

## ADDRESS CHANGES

**J.L. Cooper Electronics** has moved to a larger headquarters in Los Angeles. They can be reached at 12500 Beatrice St., Los Angeles, CA 90066; 213-306-4131; fax 213-822-2252.

**Digital Designs Intl.** has moved all its operations to 100 N. Quapah, Suite K, Oklahoma City, OK 73107; 405-946-4500; fax 405-946-4544.

**RPS Communications** has relocated to 3 Bittersweet Court, Centerport, NY 11721-1765; 516-734-3300; fax 516-734-8168. The move allows the company to expand from public relations, marketing consulting and strategic planning to include advertising, direct mail and graphic design. ■

# We built our woofer and tweeter a better home.



## DMT AND TRANSDUCER HOUSINGS —

All Cabinets used in the new Tannoy Monitor Series represent considerably more thought and design than the average 'chipboard cabinet of the correct volume'.

Cabinets are constructed from a high density space-frame with rounded corners and edges, supporting MDF/high pressure twin laminated walls.

Rounded corners and edges greatly inhibit sound reflections and diffractions from cabinet boundaries. These can be major sources of irregularities in the reproduced sound, particularly in terms of the perceived placement of instruments within the sound stage. For the high frequency unit to make an effective job of launching all the detail that it can generate into the listening space, it must be held rigidly in the cabinet throughout its operational frequencies.

This is the key to the Tannoy cabinets. If a 'rigid' cabinet



is used, the redundant energy from the rear of the bass unit and frame cause endless resonance problems within the cabinet. Differential Material Technology provides the answers by using a variety of different adhesives between the rear of the drive unit and brace, the cabinet walls and the brace and within the layers of the MDF laminate.

The lossy couplings effectively transmit and absorb energy in a frequency selective way. Put more simply, at low frequencies the drive unit sees the cabinet as a rigid structure and at higher frequencies as a resonance absorbing/damping structure.

DMT provides an ideal cabinet solution for the complete frequency range, eliminating unwanted loudspeaker biases.

The overall result is a true representation of the mix, unequaled referencing capability, guaranteeing what you hear is what you get — every time.

Tannoy / TGI North America Inc. • c/o Bill Calma • 300 Gage Ave., Unit 1, Kitchener, Ontario, Canada N2M 2C8 • (519) 745-1158 • Fax (519) 745-2364

## Not your average woofer and tweeter.

Circle (7) on Rapid Facts Card

# All you'll ever need in a tape.



FROM THE COMPANY that brings you Ampex Grand Master<sup>®</sup> 456—the tape more gold albums are recorded on than all other tapes combined—comes some gold of its own. Ampex 499 Grand Master<sup>®</sup> Gold, our newest high-performance analog mastering tape.

ENGINEERED TO EXCEED all expectations, Ampex 499 delivers low print through and the lowest noise, lowest distortion, and highest output of any analog mastering tape. Not to mention superior mechanical characteristics designed to ensure problem-free tape handling on today's high-performance transports.

# And then some.



WITH THE UNSURPASSED levels of consistency that you've come to expect from Ampex mastering tapes. And all backed by the most highly acclaimed customer service and technical support in the industry.

SO IF WHAT you need is performance, and then some, go with Ampex. Grand Master 456 and 499 Grand Master Gold.

**AMPEX**  
A MASTER OF ENGINEERING

## Peter Holsapple and Chris Stamey: "Mavericks"



Label: RNA/Rhino  
 Produced by: Chris Stamey and Peter Holsapple  
 Engineered by: James MacMillan, John Siket, Bill Scheniman, Jon Rosenberg  
 Mixed by: George Cowan  
 Recorded at: Water Music (Joboken, NJ); Bearsville (Bearsville, NY)  
 Mastered by: Greg Calbi at Sterling Sound  
 SPARS Code: ADD

**Comments:** This album has been growing on us steadily since its release earlier this year, until we reached the point where we just had to review it. Tons of musical ideas manifest themselves in nice melodic touches found all over this record — in guitar hooks, vocal harmonies and cello lines. The album is casual but not careless, loose but not at all sloppy.

**Of special interest:** The production/engineering is straight ahead and low-key, never overshadowing the performances, allowing the vocals to carry the overall sound. The compression is subtle, the reverbs sound like SPX-90s or Rev-7s used to their max. The acoustic guitars are recorded particularly well; panning keeps the multilayered acoustic guitar parts and vocals distinct. The lyrics are introspective and literate without coming on too strong. ■

## The Isaac Stern Collection: "The Trio Recordings, Volume II, The Complete Beethoven Trios"

Label: Sony Classical  
 Produced by: Andrew Kazdin  
 Engineered by: Fred Plaut, Milton Cherin, John Guerriere  
 Recorded at: 30th Street Studio (New York); Winterthur (Switzerland)  
 Compilation Remixes Produced by: Andrew Kazdin  
 Compilation Remixes Engineered by: Ray Moore  
 SPARS Code: ADD

**Comments:** A 4-CD compilation of superb performances from 1965-1970, featuring Stern-Violin, Eugene Istomin-Piano and Leonard Rose-Cello. The recording is excellent. One remarkable achievement of the engineering is that the instruments retain their tonality and spatial focus throughout the recording, even as dynamics change and the players themselves move. The ambiances sound natural.



**Of special interest:** As simple a concept as panning makes this recording work very well. The violin and cello are panned at 9:00 and 3:00 respectively, with their ambiances filling in toward the center. The piano covers the area between 12:00 and 2:00, again with the ambience toward the center and the instrument more outward. It is this panning which keeps the instruments somewhat close together in the soundscape and yet distinct, and affords the listener a vantage point not obtainable anywhere in the real world, but only through the wonder of recording. ■

## Little Feat: "Shake Me Up"



Label: Morgan Creek  
 Produced by: Bill Payne and George Massenburg  
 Mixed by: George Massenburg  
 Assistant engineer: Nathaniel Kunkel  
 Recorded at: Conway Studios (Hollywood); Castle Oaks Studios (Calabasas, CA)  
 Mastered by: Doug Sax and Alan Yoshida at the Mastering Lab  
 SPARS Code: DDD

**Comments:** Well, here they are again, with Dr. Wizard at the board, the boys from the funky side. As per usual, the music kicks booty, with an ever-wider ranging style and form encompassing beat-regions from Louisiana to Detroit, Yew Nork to the smoggy basin. The production clarity is both enlightening and mildly frustrating — is it possible for something to be too clean, even the fuzzy guitars? Or maybe too clear? One walks away with the sense that this is the brightest recording heard all year, yet without a trace of harshness, edginess or sharpness. We imagine that this is a true example of an all-digital recording done right.

**Of special interest:** Great low end. Count the creative use of samples. Also, check out the many textures and flavors of guitar sounds, vocal treatments and the general processing of drums (reverb/slap). Overall tight dynamic control is something we've come to expect from Massenburg. The mixes hang right in there, everything clear, in subtle layers, each element in its place. We like it a lot. ■



# You've Heard The Applause For The PRM™ 308S...



The PRM™ 308S is being applauded by top professionals — like *Don Was, Kenny Loggins, Joe Hardy, and Walter Afanasieff* — for their uniform frequency response, minimum coloration of signal, a selectable switch for reference and EQ playback, and most of all just for "THE SOUND!"

## PRM 308S Features

- Mirror-image (left & right) pairs
- Switch-selectable response modes (equalized and reference)
- Acoustic foam blanket reduces baffle reflections
- Impedance 4 ohms

Plus, there's more where that came from... Peavey. Namely the PRM 205A, 208S, 310S, and 312A phased reference monitors, all with many of the same great characteristics as the 308S to meet your particular needs and budget.

# ...Hear Here!

## PRM™ 205A / PRM™ 208S



- High-accuracy two-way system
- Small size fits atop most consoles
- Impedance 4 ohms



- High-accuracy two-way system
- Switch-selectable response modes (equalized & reference)
- Impedance 8 ohms
- Acoustic foam blanket reduces baffle reflections

## PRM™ 310A / PRM™ 312A



- Mirror-image (left & right) pairs
- High-accuracy three-way system
- Switch-selectable response modes (equalized & reference)
- Acoustic foam blanket reduces baffle reflections
- Impedance 8 ohms



- Mirror-image (left & right) pairs
- High-accuracy three-way system
- Independent variable control of mid and high frequency levels
- Impedance 8 ohms
- Acoustic foam blanket reduces baffle reflections

**PEAVEY**  
AUDIO MEDIA RESEARCH

Circle (9) on Rapid Facts Card

## Guy Clark: "Old No. 1"



Original Label: RCA  
Reissue Label: Sugar Hill  
Produced by: Neil Wilburn  
Engineered by: Al Pachucki, Tom Pick, Ray Butts  
Mixed by: Neil Wilburn, Phil Smee  
Recorded at: RCA Studios and Chips Moman's American Studios (Nashville)  
Catalog Numbers: CH-CD-1030 ("Old No. 1"); SH-CD-1031 ("Texas Cookin'")  
SPARS Code: AAD

## Guy Clark: "Texas Cookin' "



**Comments:** That Sugar Hill has reissued Guy Clark's first two RCA albums on CD is something of a major event, worthy of attention in these pages. For those who don't know, Clark is the Texas singer-songwriter considered by many to be the best songwriter around. A "songwriter's

*Continued on page 20*

Dan Levitin is R•E•P's Music Production Editor and a producer based in Stanford, CA.

# FOCUS:

## GUY CLARK, Producer/Artist

**R•E•P:** You're sort of a "songwriter's songwriter." Some of the best songwriters record your tunes, and say that you are one of their favorite writers. R•E•P's readers would be interested in knowing about recordings from the songwriter's perspective. How do you feel about the studio?

**GC:** The studio is a tool; it's there to be used. Over the years I've learned to treat it a little differently. At first it was, "Wow, I'm going into the studio — this'll be really fun." At this point, it's more of a tool, because, first of all, it's very expensive to do that, especially if you're paying for it yourself. And to me, the very end of my product is performing live, not necessarily recording.

**R•E•P:** A lot of people sound stiff in the studio compared to their live show; you sound pretty natural and loose.

**GC:** Are you talking about on one particular record, or just in general?

**R•E•P:** I think on all five of them. In the progression of them, it gets smoother as you go, and "Old Friends" is my favorite. It sounds like you're sitting in someone's living room...

**GC:** Well that's kind of the way I approached it. "Old Friends" was done on an Otari 8-track. It was the first time I produced my own record — with a friend of mine, Miles Wilkinson who's an engineer — and we just kind of had to make it up as we went along, you know, how to do it for the money we had. And since I was financing it, we had no money to speak of. We decided on the songs and he and I would go into the studio ourselves and just do all 10 songs in a row, like a set, not stopping. We did that for a week or two until one day we got all 10 of them in a row, like a performance, and then we went back and overdubbed everything.

**R•E•P:** Neil Young records that way, too. How long did it take you?

**GC:** In terms of actual time, not that long, but it was spread out over a couple of weeks. We recorded it in the basement of the publishing company, SBK.

**R•E•P:** I can't believe you did that 8-track. It sounds terrific — it's actually one of my favorite engineered recordings.

**GC:** Well, Miles is a real master, plus we had some really good microphones. We mixed it to digital ...

**R•E•P:** What do you do to make it sound and feel like being in the studio is a natural thing?

**GC:** I don't know, it's an unnatural thing to begin with, for me. And I just kind of accept it as that. This is not a natural thing.

**R•E•P:** Do you sing and play guitar at the same time? Does that help?

**GC:** Sometimes.

**R•E•P:** When you're overdubbing vocals do you have a guitar in your hand?

**GC:** Usually.

**R•E•P:** Your songs are really stories. The characters all feel real, like you're writing about real people and real events.

**GC:** Well they are. I mean, that's one of the things that I try to do, is to write about stuff that I know about. Some of that stuff you just can't make up, you know, it had to happen.

*Continued on page 20*

# Have your cake...

You can have it both ways with System One.

Most audio test sets fall into one of two categories...

There are the specialty testers, like tape recorder test sets, video/audio monitors or pricey short interval test systems. Then there are conventional general purpose audio testers, which can do basic testing but lack the capability to fill today's specialized testing needs.

Investing large amounts in specialty systems that don't also meet your day-to-day audio testing needs is both expensive and frustrating.

SYSTEM ONE solves the problem by providing both high performance general purpose audio testing and innovative specialty testing functions. Basic SYSTEM ONE configurations are priced competitively, yet can grow with your needs to include these advanced functions:

**FASTest** – Test any audio channel in 2 seconds or less

**MLS** – Quasi-anechoic measurements of loudspeakers

**FM** – Automated Stereo Proofs

**TV BTSC** – Automated Stereo Proofs

**DUAL DOMAIN TESTING** – Direct digital domain testing of digital audio and interfaces.

**TAPE TESTING** – Complete magnetic tape recorder and media testing.

**SPECTRUM ANALYSIS** – Audio FFT analysis

**EBU 0.33** – Short interval testing

Circle (10) on Rapid Facts Card

## and eat it too.

With System One, you can have it both ways!

### Audio precision

P.O. Box 2209, Beaverton, OR 97075  
503/627-0832 1-800/231-7350  
FAX: 503/541-8906, TELEX: 283957 AUDIO UR



INTERNATIONAL DISTRIBUTORS Australia: IFT (02) 439 3744 Austria: Eastern Europe: ELSINCO elektron GmbH 222 812 17 51 Belgium: Trans European Music 02466 50 10  
Canada: GERR Electro Acoustics Ltd. (416) 868 0528 China, Hong Kong: ACE (HK) (852) 424-0387 Denmark: AudioNord Danmark ApS 86 57 15 11 Finland: Genelec Oy 77 13311 France:  
ETS Mesureur (1) 45 83 66 41 Germany: RTW GmbH 221 70 91 30 Holland: Trans European Music - 03408 70717 Israel: Dan-El Technologies Ltd 3-544 1466 Italy: Medes Srl 2 4840 1780  
Japan: TOYO Corporation 3 (5688) 6800 Korea: Myoung Corporation 2 784 9942 New Zealand: Audio & Video Wholesalers, Ltd. 71 73 414 Norway: Lydcornelit '09) 19 03 81  
Portugal: Acutron ELA 1 941 40 37 Singapore & Malaysia: TME Systems PTE Ltd 298 2608 Spain: Telco Electronics, S.A. E31 7101 Sweden: Tai & Ton AB 31 80 36 20 Switzerland:  
Dr. W.A. Gunther AG, 01 910 41 41 Taiwan: Litz Technologies Ltd 2 758 3179 U.K.: SSE Marketing Ltd 71 387 1262



**S**



**M**



**L**



**XL**

This is the one. The one with the new speaker. The one with digital processing. The first one of its kind. It's the YST S1520S speaker system. And it's not what you're used to.

First things first, let's talk YST.

It stands for Yamaha Active Servo Technology. It lets us make some unorthodox cabinet tunings in the S1520S speakers. In other speakers these tunings would leave you with under-damped low-frequency output. But YST recovers woofer damping electronically. What you get is tight low-frequency output.

little at all. By locking in selected parameters you can prevent the system from being pushed too far. It can set delays up to 1.3 seconds in increments of 20  $\mu$ sec. While digital EQ

lets you do all kinds of fine-tuning. Right from the box, the C20's ROM contains programs all set to make the S1520S sound great. And there's plenty of memory left over to store your own modifications.

The system also includes the Y20. It's the heart and soul of YST. The Y20 monitors Back EMF. While it

impregnated cone. The system is available with an interchangeable medium format horn in 60 or 105 degree versions. And best of all, the S1520S is just the first in a line of high-end Yamaha speakers that will have YST.

Now how do you rig a system like this? Yamaha has answered all the questions of rigging with the CRG1520 Component Rigging Grid. It's designed to make rigging simple and secure. It's a modular



## One YST S1520S System fits all.

And range that extends lower than other speakers this size (all the way down to 50 Hz).

To all this we've added state-of-the-art digital processing. It's the C20 Digital System Controller. And it makes the system easily programmable. You can adjust EQ, cross-over, time/phase alignments and a



lot more. So you can customize the sound to whatever situation you get into. Whether it's a picnic for the company big-wig or a convention for thousands of them.

The C20 can give users total programming access or limit it to very

electronically synthesizes parameters for the woofer. The result is more precise woofer control with less distortion and less acoustic interaction between the drivers.

The Y20 also gives you the ability to use any professional power amplifier you want. And because it's designed to fit right into the amp rack, there's no need for added sense wires to the speakers. And calibrating it is a simple set-it-and-forget-it procedure.

Now back to that YST speaker. It's got a 15" high power, high sensitivity woofer with a carbon fiber



grid system. So it lets you attach cabinets to each other. The grid hardware locks into

Aeroquip stud fittings built into the top and bottom of the cabinet. So arrays of any size and shape can be easily constructed.

There is no other system like the YST S1520S. It's the one that's digital. It's the one with YST. It's the one system that fits all. It's the one that's available from selected Yamaha dealers and contractors.

# YAMAHA<sup>®</sup>

Continued from page 16

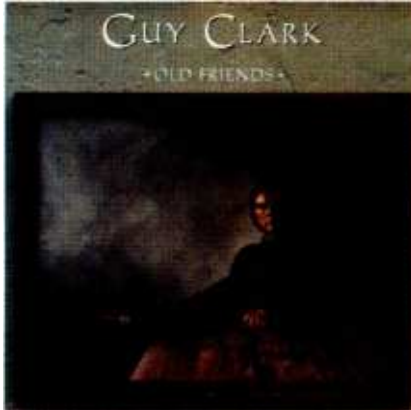

## Guy Clark: "Old Friends"

songwriter," some of the best in the business have called him their favorite. Rosanne Cash, Rodney Crowell, Townes Van Zandt and Jerry Jeff Walker have all sung his praises, paying tribute to him in interviews and performing and recording his material. George Strait, Ricky Skaggs, Willie Nelson, Waylon Jennings, The Everly Brothers and Asleep At The Wheel have also recorded his songs. Lyle Lovett, Steve Earle and Michelle Shocked have similarly applauded him. Clark's songs are all real slices of life, told through the eyes and heart of a craftsman as skillful as Larry McMurtry, Ken Kesey and Ambrose Bierce. Bringing songwriting to the level of good fiction — where it is impossible to tell the difference between the truth and the recollection, the story and the storyteller, Clark delivers his songs with a casual, often playful honesty, which is uniquely compelling.

Three of his five albums are now available on Sugar Hill, including 1988's "Old Friends." The production and arrangements on all are excellent, the engineering dignified and musical. It is often easy for us as producers and engineers to become so entrenched in technical aspects that it is, at the heart of things, the song around which all our work revolves. ■

## FOCUS:

Continued from page 16

**R•E•P:** That's the spark in the song. So many songs on the radio sound like they were written by some guy who has learned how to write songs, but doesn't have anything to say, he just sits down and cranks 'em out.

**GC:** Yep, I hear a lot of that too. I figure 5% or 10% is really good, original material, and the rest of it is copying that. Consequently you wind up with a lot of songs that are really all the same song.

**R•E•P:** Who are some of your favorite songwriters?

**GC:** My favorite is Townes van Zandt. As far as I'm concerned, in terms of raising songwriting to an art level, he's the best there is. I love Rodney [Crowell]'s writing, Rosanne [Cash]'s, John Prine's — they all write well. Lyle Lovett ...

**R•E•P:** Those are all people who, when you've listened to a few of their songs, you feel like you know a little about them. You don't get that always with the people who are just "cranking out the hits."

**GC:** I know what you mean. There's a difference. And usually you find the difference is that the songwriters who are sitting in Nashville, New York or wherever, aren't going out and playing them for the folks. There's nothing wrong with that, it's just that I find the majority of the songs I like are written by people who go play them for the folks, as opposed to people who just sit in one place and write songs. You can tell the difference. To me, the playing of them is an extension of the writing, that's the last step in the process.

**R•E•P:** I like your song about driving the bulldozer ["Heavy Metal"] on "Old Friends." Have you actually driven a D10?

**GC:** No. No, that was more of a metaphor. I've seen one, I've been up close to one, but I've never driven one. It was about man's fascination with big, powerful machines, with steam engines and those kind of things, it's kind of a universal metaphor, I think.

**R•E•P:** Does the metaphor involve technology in general?

**GC:** Not technology, just the bigness of it all. The power.

**R•E•P:** There's a running theme in a lot of your songs about working with your hands.

**GC:** That's something I've always enjoyed doing and I still do. It's very rewarding, especially working with wood. I used to build guitars.

**R•E•P:** Have you thought of recording live, so you could get that feeling on tape?

**GC:** It's an interesting idea, but I've never heard a live tape of myself that was really good enough to make a record of, because it's always pretty loose, and I'm not a great guitar player. I might do it with a couple of players, but it's something I just haven't gotten around to yet. There's a difference between playing live and making records because there's the visual thing going on, and interplay with the audience. But if you take that performance and just isolate it on a piece of tape, and play it back, there are a lot of flaws in it that don't really hold up, at least to me. I think I could do a live album of older material, songs I've been doing for years. But not an album of new material — I don't know them well enough. ■

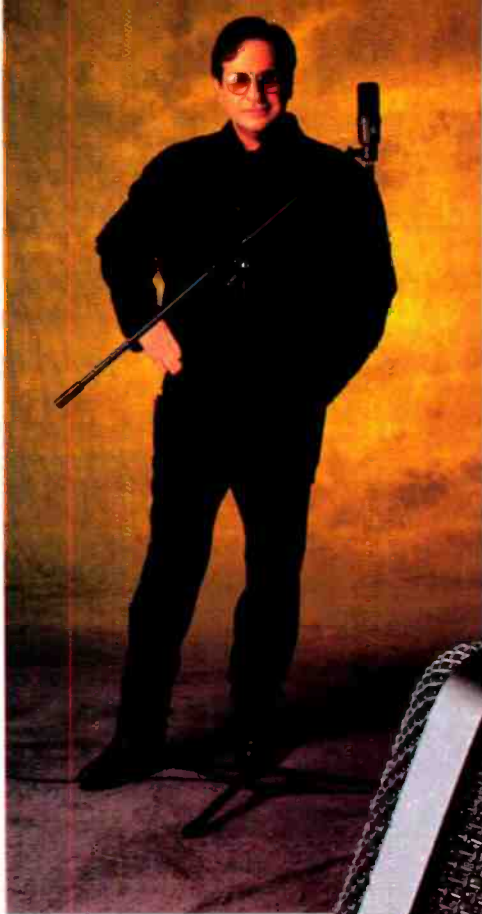

We asked Phil Ramone  
to field test our new  
AT4033 studio  
condenser microphone.

He wouldn't  
give it  
back!

Phil Ramone photos by Michael Bloom

AT4033  
Studio Condenser  
Microphone

Phil Ramone knows exactly what he wants from a studio microphone. And when he tested a sample of our new AT4033 cardioid condenser microphone, he knew it was right for him and ideal for the artists he records.

He liked being able to concentrate on getting the right music from the musicians, rather than first spending time experimenting with EQ to get the right sound.

What Phil Ramone heard was the result of new condenser technology inside the AT4033. The diaphragm is only 2 microns thick, with a vapor-deposited gold conductive coating just 50 angstroms thick. This sophisticated, very low-mass diaphragm is aged in a five-step process that insures unchanging performance for years.

The high head-room and wide dynamic range, plus low noise floor, make the AT4033 ideal for the most demanding digital recordings. And the maximum input SPL is an awesome 140 dB, so important when recording high-output instruments and very close-up vocals. In addition, transformerless design contributes to overall sonic transparency. The AT4033 also includes a switchable 10 dB pad and lo-cut filter, plus a built-in pop filter and internal shock mounting.

We're not certain we'll ever get the sample AT4033 back from Phil Ramone, but no matter. We're busy making your AT4033 right now. For more details on this impressive new microphone, ask your A-T sound specialist to schedule a test of the AT4033 today.

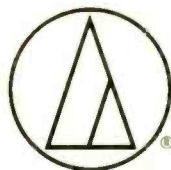

**audio-technica®**

Available in Canada and the U.S.A. from Audio-Technica U.S., Inc.  
1221 Commerce Drive, Stow, Ohio 44224  
(216) 686-2600 • FAX (216) 686-0719

Circle (12) on Rapid Facts Card

## Un-Conventional

By Rick Schwartz

Just when you thought it was safe to miss the AES convention, out of nowhere comes one of the best shows in years. Everyone I spoke with seemed surprised by the quality of new products at the show. It's unusual to see companies spending so much on R&D in such a volatile economic climate. Although the number of exhibitors was down from two years ago, there are some that believe our industry needs to be thinned out. The marketplace will simply not support 75 digital workstations for long.

### WORKSTATION WARS

Fortunately, most serious players are already in the game. It looks as if Alesis, Digidesign and Roland will be slugging it out for market share in the project studio arena. I was surprised to see how far Alesis had come with its stand-alone 8-channel recorder. The ADAT (not to be confused with Hybrid Arts ADAP) records 40 minutes of digital audio on a standard S-VHS videocassette. Alesis demonstrated two units performing seamless punch-ins and digitally bouncing tracks. Impressive? Very.

But don't get your checkbook out yet. Alesis still has some work to do on its BRC remote control (needed for SMPTE lockup). Although the ADAT doesn't have virtual random-access track capabilities or powerful DSP functions found in other workstations, it could really hurt the makers of 8- and 16-track semi-pro tape recorders. 8-tracks for under \$4,000, with up to 16 machines lockable, is very impressive indeed.

### THE TRICKLE-DOWN EFFECT

It's encouraging to see high end workstation technology trickling down into lower cost systems. Sonic Solutions, known for its powerful CD mastering software, introduced a new low-cost digital workstation for the Macintosh with real-time playback of up to 12 channels from a single hard disk (This I have to see for myself!). The system includes software, a Mac Nu-Bus card, optical digital I/O and delta-sigma converters for only \$6,000. The system can be expanded to include dynamic automation, machine control and even NoNOISE options.

Although Akai seems to have found a niche for the DD1000 in broadcasting, the company recently added features that should make the unit more popular in the post-production environment. Akai showed new machine control capabilities that require only a new EPROM and a serial cable to control most popular VTRs. Also, Gefen Systems has modified its popular

M&E organizer to work with the optical-based recorder. Using the Gefen database, which runs on the Macintosh, the organizer will automatically record and name a whole list of sound effects or music cues from a CD jukebox without any operator assistance. This is a real timesaver.

### TALK OF THE SHOW

Aside from the Alesis ADAT and the Euphonix CSII console, a very flexible system that keeps all of the audio in a rack and features a digital software driven console as a remote control, there were other items of notable interest, including Sony's new large-diaphragm tube microphone with the cooling fins out the back; the East German perestroika microphone from Gotham Audio, which uses the same mic capsule as the original U47; and the Fostex PD2 portable time code recorder, which is sure to give Nagra a run for the money.

The PD2 has a built-in time code generator with jam sync capability that records both Fostex and IEC-standard time code. It also has impressive error monitoring capabilities, featuring an annunciator triggered by either analog or digital overloads. After recording, the unit will fast-wind to an error location to check sound quality. At \$10,950, it's not cheap, but it's priced competitively with a top-of-the-line Nagra.

### THE PRICE OF PROGRESS

Analog Devices and Neve each showed 20-bit converters. Performance is impressive, but you can buy a nice car for the cost of a stereo pair. At least now the audiophiles will have a chance to put their money where their mouths are. If you're on a budget, Analog Devices and Ensoniq have teamed up to create a reasonably priced 18-bit converter with a dynamic range of 103dB.

Although I was impressed by the high-end digital consoles from AMS and TOA, I'm waiting to see whether the rumors of digital modules for the Euphonix CSII are true. The Euphonix is clearly a prime candidate for consoles of the future, with its compact, all-digital control surface, user-definable signal path and possibly the first true total reset system. Speaking of automation, DDA demonstrated a new console called the Profile, which the company claims is the least expensive digitally controlled console with a moving fader and snapshot automation system.

Desktop CD publishing is really starting to take off, thanks to recent price cuts by Sonic Solutions, Studer Revox and Yamaha. Although Studer currently has the most affordable unit, the D740 is not scheduled to ship until this January.

### POST PRODUCTS

TimeLine introduced the low-cost Micro Lynx synchronizers, intended for smaller studios that require two or three machine lockups. Project studios will find the Micro Lynx attractive because it converts SMPTE to MIDI and has a word clock option for digital workstations. The

basic system will lock two transports, and features a built-in time code generator with jam sync capability and a wideband reader. The system includes a keypad with special function keys, and a jog wheel for only \$2,495.

Film mixers have always depended on the Dolby Cat. 43 to clean up their dialogue tracks. Dolby introduced a new background noise suppressor that uses SR technology to provide up to 18dB of steady-state noise suppression.

Brainstorm introduced an exciting new product that will find a home in many post houses. The SR15 time code distri-player is a must for any serious time code user. It includes a 1x5 time code distribution amp, which reshapes code and has individual front-panel level controls to compensate for long cable runs. The SR15 also includes a 4-digit counter, which reads the incoming time codes frame rate or pilot tone frequency and also shows potential problems, such as jitter or wow and flutter, and LED indicators for drop frame, color frame and video code.

It also generates 50/60Hz sine or square wave pilot tones for resolving purposes, based on time code, video or ac mains. If the microprocessor detects a bad sync word, dropped bit, discontinuous address, repeated frame or a drop out, the 'good code' LED will blink off. Look for a full product review soon.

### A DIGITAL SWISS ARMY KNIFE

Lexicon showed a universal digital interface that solves compatibility problems caused by poor or impartial implementation of digital standards. In addition to conversion between most professional and consumer formats, the LFI10 provides front-panel indication of all error types with internal counters, which will record and print errors using a computer. It also allows the user to view and modify information, including format, emphasis, copy prohibit, sample rate and emphasis flags.

Lexicon also showed an acoustic enhancement system called LARES, which could possibly be the biggest breakthrough in live sound in many years. The system uses two mics and a 480L to lengthen reverberation time without increasing level. It also can dramatically increase gain before feedback.

### DIGITAL SYNTHS

Some synthesizers are notorious for their poor noise performance. Yamaha has joined Emulator with the addition of digital outputs on its new synthesizer. The SY99 has a digital output for direct connection to digital recorders, allowing an extremely quiet and punchy signal to be recorded. Now if someone could make a digital microphone that sounds like a U47.

Although the new Kurzweil K2000 has a digital input, it's missing a digital output. Not only does it feature sounds from the Kurzweil 250 and 1000 series, but it also reads Akai S900 and 1000 disks. The unit comes standard with 8Mbytes of ROM and four SIMM slots which can house up to 64Mbytes of RAM (using expensive 16Mbyte chips). And it sounds great. ■

Rick Schwartz is a contributing editor to R+E+P and Director of post-production at Music Animals, Los Angeles.



# Meyer Sound Reinforcement Series

**MSL-10A** "I've been using the MSL-10A for the biggest venues on our current tour. In terms of power, dynamics and clarity, nothing else even comes close."

*Chris Carlton  
Audio Engineer  
Julio Iglesias*

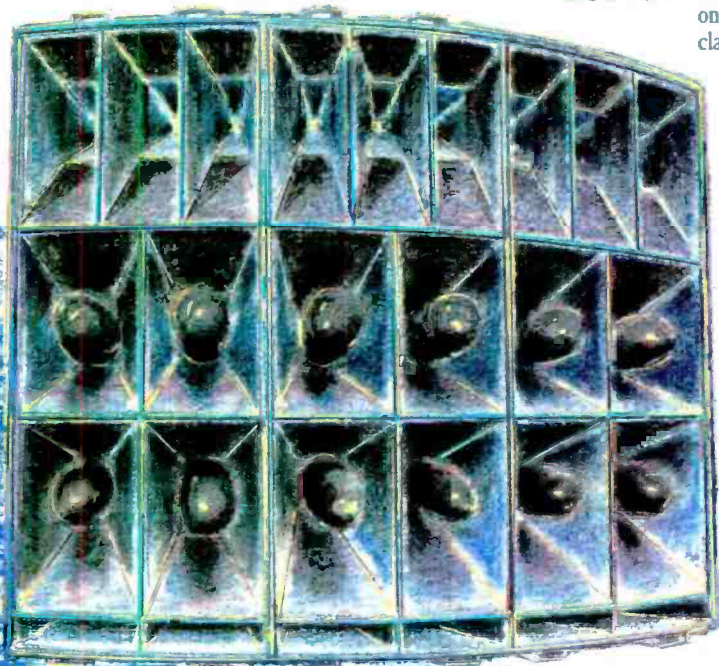

## UPM-1

"I needed a speaker that was small and unobtrusive, yet produced the full musical range. I found what I was looking for in the UPM-1."

*Paul Schulz  
Owner-Caffe SOMA*



## UPA-1B

"For nine years Meyer has been our standard. Because we use MicroMonitors and have no onstage volume, we rely totally on the PA for our live sound. The quality of the UPA-1, especially supported with SIM® Equalization, far exceeds that of all its competitors."

*Tuck & Patti  
Windham Hill Jazz  
recording artists*



## MSL-3

"We required a system that could reproduce the subtleties of a Broadway musical, yet reserve enough power for rock and roll. Our MSL-3/650-R2 system does exactly that!"

*Terry Smith  
Technical Director  
Opryland USA*

**SIM®** "Grand opera demands the ultimate in sonic realism. SIM® Equalization is my most important tool for satisfying the needs of conductors, artists and opera lovers."

*Roger Gans, Sound Designer, San Francisco Opera*



Meyer Sound Laboratories, Inc.  
2832 San Pablo Avenue  
Berkeley, CA 94702  
(415) 486-1166  
FAX (415) 486-8356

©1991 Meyer Sound

Circle (14) on Rapid Facts Card

MEYER SOUND

## THE REP INTERVIEW:

# KEITH COHEN

By Brad Leigh Benjamin

**S**o this guy calls me on the phone for *GQ* and I say, 'GQ?! What are you guys calling me for? Have you seen the way I dress?!' Comfortably attired in a red baseball cap, urban techno-beachwear and unlaced high-tops, Keith Cohen hardly fits the image of a poofy *GQ* boy. Streetwise, self-assured, and a little rough around the edges, he looks more like a rapper who surfs, or maybe a surfer who raps.

Mentioned in the same breath as Shep Pettibone and Jellybean Benitez, Keith Cohen is one of the best of a new breed of studio specialists known as remixers — hired guns who can turn average album cuts into radio chartbusters and megadance hits. Having co-produced the singles "Straight Up" and "Cold Hearted" for Paula Abdul, Cohen continues to turn up the heat on a career sizzling with hit singles mixed for The Bangles, Miami Sound Machine, Glenn Medeiros/Bobby Brown, the Calloways, Louie Louie, LeVert, After Seven, Robert Palmer and Elton John. Cohen also churns out singles and dance mixes for some of the hottest producers in the industry including Don Was, Terry Lewis and Jimmy Jam. *LA/Babyface*, the Calloways, and the reclusive one, Prince.

Weaned on rock 'n' roll in his native Florida, Cohen's music and engineering studies at the University of Miami and Full Sail Center For The Recording Arts eventually brought him to Los Angeles where he has carved out a formidable niche as a remixer in the R&B/Dance genre.

Cohen's home base has been Larrabee Studios in Los Angeles, where he works in Studio A on an 80-input SSL G Series console with To-

Brad Leigh Benjamin is a free-lance writer based on the West coast.



tal Recall, dual Studer A800 Mark III 24-tracks and a Studer 827 48-track tape machine. Cohen likes the sound of analog, especially for low end. He mixes to 1/2-inch tape. Forget the digital editor/workstations too. Cohen cuts and splices the 1/2-inch master to get all the stutter and reverse effects he desires.

**R•E•P:** So much of your notoriety in the industry is attributed to your success with R&B remixes. How did you develop your feel and instincts for the music?

**KC:** 90% of all the jobs I did at Yamaha were R&B, and I started getting really into it. The other good thing about Yamaha was the room was fairly inexpensive to book, and they had an SSL and a lot of gear. A lot of DJs were doing remixes there. One time an engineer called in sick, and they couldn't get anybody. I kind of filled in for him. That got me started mixing for a couple of these DJs, and the product

**"People put all kinds of stuff on tape that they really don't need."**

was coming out pretty good, so I kept working with them as my way out of assisting and into mixing. One of the first big mixes I did was "Walk Like an Egyptian," which was song of the year on *Billboard*. The record company had done an original mix which was released but didn't chart real well, so they had Steve Beltran and me cut a new 7-inch remix with producer David Kahne, and they released that 7-inch as a new single. That ended up being the single that really broke the tune and got all the airplay.

**R•E•P:** When a record company or a producer asks you to remix the album version of a song, what materials do they provide you with?

**KC:** Usually for a remix, they'll send us the

masters, and we make our own overdub reel with all new parts. We listen to the song and think about what it needs to get over on the radio or on a dance floor, and we try to add that element. We end up tracking new drums most of the time, and new bass, some new keyboards, maybe a sampled vocal line processed with different phrasing or a new melody line. We listen to the tape and think about what the song needs to really make it kick.

**R•E•P:** How many of the original tracks from the multitrack do you use?

**KC:** It depends. A lot of times the only thing I'll use from the original master is the vocal. On *Forever Your Girl*, I mixed several of the tunes on the album itself. I also remixed all the songs that were chosen as singles. When it was time to do *Shut Up And Dance*, I didn't want to give them extended versions of the same mixes, so I just used Paula's vocal and tracked new drums, new bass, new keyboard parts, and changed the songs from funk tunes to club tunes ... house tunes.

**R•E•P:** Do you actually play or program all of the new parts yourself on the remix?

**KC:** I play guitar and keys, and I like to program drums too, but on my mixes, I just hire somebody who does nothing but play all of the time, you know, studio players — someone who can program keys and work with my ideas for drum patterns. I use three or four different people in L.A. On Paula's mixes, I use this guy named Doug Grigsby. I also use Brad Buxer who plays with Stevie Wonder a lot. I work with David Frank from the System. I use one guy per mix depending on who's available and who'd be right for the tune.

**R•E•P:** Where do you start?

**KC:** First I come up with good drum samples and sounds that will work for the tune. Then

*Continued on page 30*

# While some transformer makers have been standing still...

## We've Been Setting *NEW* Standards

- Computer-controlled Swiss winding machines for previously unattainable uniformity
- Proprietary, custom core alloys for lowest distortion
- Improved wire bonding techniques for long-term reliability in the field
- All materials are 100% inspected to our stringent specifications prior to assembly
- Higher quality, consistency and performance without a higher price
- Efficiencies and improved yields in manufacturing allow more competitive prices in high quantities.

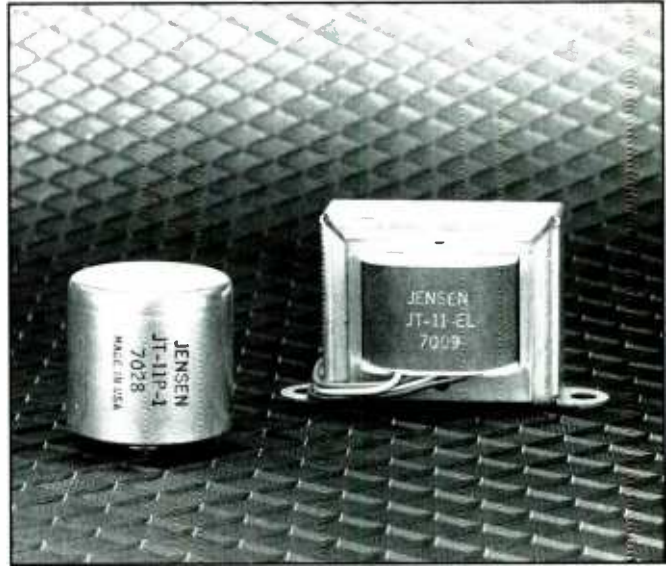

Over the years, superb specifications, outstanding performance, and unsurpassed reliability have earned Jensen a solid reputation as the world's preeminent manufacturer of audio transformers. We recently made major changes in the manufacturing process, with significant improvements in both absolute performance and transformer-to-transformer consistency.

We control every facet of design and construction, from core alloy selection to computerized electronic modeling. Because Jensen transformers are designed to function as an integral part of "real-world" circuits, not as an afterthought, all parameters are optimized. The result is a clearly audible improvement in performance.

Discerning engineers specify our field proven transformers, by the hundreds of thousands, for the most demanding environments – professional recording studios, fixed and mobile broadcast facilities, and touring sound systems. It's no accident that returns and failures are rare; we place strong emphasis on quality control. Transformer performance is verified in our modern, highly automated test lab using Audio Precision and Hewlett-Packard equipment.

We take this extra care because we are dedicated to excellence. We have an experienced technical staff who offer you free transformer applications consultation with the help of our powerful COMTRAN software. This AC circuit analysis and optimization program is one of the engineering tools we use to model and design our high performance transformers. COMTRAN is available for HP computers and 386™ PCs.

Call or write for information or to receive our free newsletters. The next time you need a transformer, remember... insist on the best – insist on a Jensen.

### Choose From a Wide Variety of Transformer Types and Packages

- Microphone Input
- Microphone Splitting
- Line Input
- Direct box
- Line Output
- Electret Mic Output
- Interface of +4 dB to -10 dB circuits
- Repeat Coil
- Special Types

10735 Burbank Boulevard  
North Hollywood, CA 91601  
FAX (818) 763-4574  
Phone (213) 876-0059

*Visitors by appointment only. Closed Fridays.*

**jensen**  
TRANSFORMERS, INC.

UK Distribution by: SSE Marketing Ltd. • Unit 2, 10 William Rd., London NW1 3EN • Telex: 27939 SCENIC G • Phone: (071) 387-1262 FAX (071) 388-0339  
Australia Distribution by: Syntec International Pty. Ltd. • 60 Gibbes Street • Chatswood, N.S.W. 2067 • Telex: SYNTEC AA 70570 • Phone (02) 406-4700 FAX (02) 406-6136  
Far East Distribution by: Towa International Corp. • 2nd Azuma Bldg. • 1-14 Sakuma-cho, Kanda • Chiyoda-k.J., Tokyo 101 • Phone (03) 253-3537 FAX (03) 257-0824  
New Zealand Distribution by: Barton Sound Systems, Ltd. • 18 Norwich Street • Auckland 1 • Phone/FAX (09) 732-416

*COMTRAN is a registered trademark of Jensen Transformers, Inc. 386 is a trademark of Intel Corporation.*

Circle (15) on Rapid Facts Card

OTARI

PRODISK 464

THERE ARE A LOT OF DISK RECORDERS OUT THERE.  
BUT ONLY ONE WITH THIS NAME ON IT.

Right now, it seems like everyone is building digital audio workstations. The difference is, we'll still be building them three years from now.

around the world have come to trust for product support and customer service.

Speaking of the future, you can

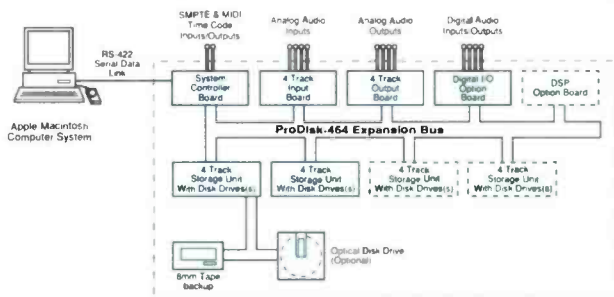

*There's nothing worse than to find yourself locked-in to outdated technology. Otari's ProDisk 464 lets you expand from 4 to 64 tracks, and easily upgrade to new hardware, software, and storage media as it becomes available.*

Sure, Otari's new ProDisk™464 is the only digital audio workstation to give you up to 64 tracks. True, it's one of the few to use standard SCSI devices so you won't be locked-in as technology advances.

be sure that ProDisk's open architecture allows for hardware, software, and storage media enhancements as they come along, and that it's plug-compatible with your current equipment. And if you're familiar with Otari's product philosophy, you know you're going to get the best cost-performance value on the market.

But as much as we'd like to tell you about its great features, given what the future is going to bring in this rapidly changing technology, the most important thing about the ProDisk is the Otari name up front—a name that professionals

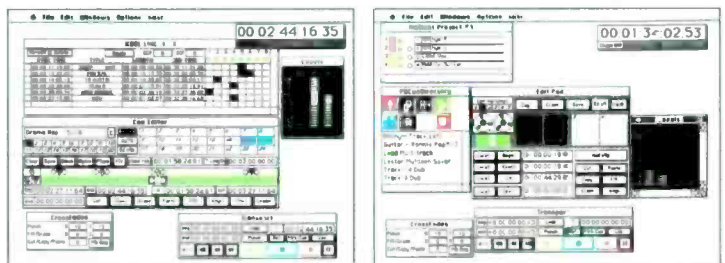

*Otari's ProDisk 464 can switch hats fast! If the project is audio post—sembling EDIs, recalling cues, sound effects, and dialog from libraries—choose the Cue List mode. But if you're doing music recording, the Multitrack mode makes tracking, overdubbing, and mastering quick and easy. This way you're got the best of both worlds no matter what the job!*

Most of all, you can be sure you've purchased "The Technology You Can Trust." Call Otari at (415) 341-5900 for complete information.

**OTARI**

# balancing

## THE WORLD

By John La Grou

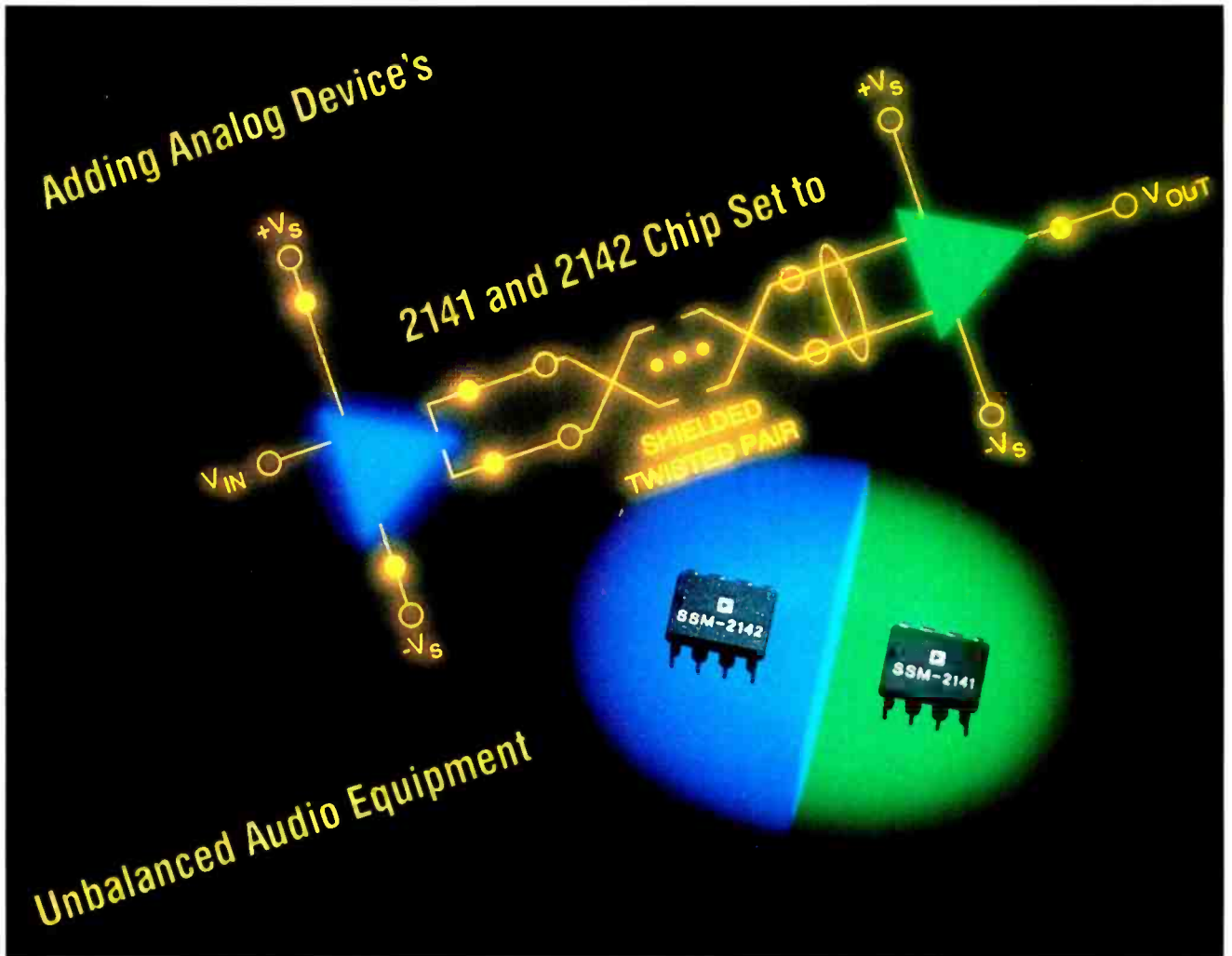

Sooner or later (usually sooner), every recording engineer experiences the frustration of interfacing unbalanced lines into balanced equipment. Traditionally, this has meant using multiple high quality transformers and/or direct boxes, a costly and often prohibitive solution for small studios. Some of us simply tie pin 3 to ground and forget it.

Recently, a leading manufacturer of integrated circuits introduced two devices that specifically address this audio interface problem. The Analog Devices SSM-2141 and SSM-2142 are described as a "fully integrated solution for equivalent transformer balancing without the problems of distortion, EMI fields, and high

cost." These ICs have proven to be very easy to use. More importantly, they sound good. Analog Devices (formerly PMI-SSM) designed the 2141 and 2142 as self-contained building blocks. All that remains to create a complete balancing system are common components, such as a power supply, a suitable enclosure, and a few ordinary audio parts. This article will focus on the design and construction of transformerless, active interfaces using the 2141/42 chip set.

#### HOW THEY WORK

The 2141/42 ICs are standard 8-pin plastic, monolithic integrated circuits designed to operate under industrial conditions. Both ICs implement fast differential amps with high open-loop gain. On-board, thermal tracking thin-film resistors are laser-trimmed to better than .005% tolerance, which is how the ICs develop their

excellent common mode performance. Both ICs are internally protected against output shorts. The 2141, a balanced receiver, is set to unity gain (0dB) using four internal 25k $\Omega$  resistors in a traditional balanced diff-amp configuration. The 2142, a balanced driver, provides a fixed gain of two (6dB) using a three-amplifier, cross-coupled topology which mimics a true balanced transformer.

Note: Analog Devices is preparing a 2143; essentially a 2141 with a user-selectable gain of -6dB, 0dB, or +6dB. Because the 2141 exhibits a typical CMRR of 100dB, it is quite sensitive to source imbalances. As such, always use high quality studio interconnect cable (Mogami 2549, etc.) and assure that source resistances into the 2141 inputs are closely matched. Similarly, the 2142 balanced outputs are internally optimized and require no loading resistors or other passive output circuitry. Adding compo-

John La Grou is a principal of Millennia Media, an audio/video design, production and consulting team in Sacramento, CA.

nents to the 2142 outputs could cause common mode imbalances.

### CONSTRUCTION

A fully functional single-channel interface schematic is shown in Figure 1. In situations where  $-10/+4$  gain structuring is required, an op-amp can precede the 2142. However, many balanced recording devices have sufficient gain structure, making additional interface gain generally unnecessary. When hand-building a non-critical audio device, I generally use perforated, glass-epoxy board into which circuit components are neatly inserted. Soldering directly to IC leads will work, but it can be tedious. Wire wrap-type IC sockets provide heavy leads which offer solid solder points. After all components have been placed and soldered, the finished board can be securely mounted to any chassis. If ground and power planes are not available, heavy gauge bus wire is recommended: 12- or 14-gauge is not too large. Some may call this overkill. However, all too often I've seen the effects of poor grounding on distortion and stability in audio circuits (read: stray currents, parasitic oscillations, etc.). When you're able to use beefy power and ground lines, do it. Additionally, well placed heavy bus

leg of a decoupling capacitor as close as possible to an IC power supply input pin and the other leg to a nearby ground bus point. Do this on each power pin. Analog Devices suggests using .1uF decoupling, but experience has shown that 1uF (or larger) tantalum capacitors paralleled with .01uF monolithic is often more effective.

If your interface box will be used in a strong RF environment (radio stations, etc.), it's good practice to encircle each input and output lead with a ferrite bead close to the IC body. A few nanofarads of capacitance to ground will complete the RF filter. Also, make sure that the box seals tightly. Integrated circuits, alas, are not passive devices. Though these ICs perform like transformers, they are sensitive to electrostatics (ESD) and source overloading. Linear ICs are not as delicate as CMOS, but it's still important to protect them from static fields. Further, if your interface will be used with uncertain source potentials (touring systems, poor grounds, etc.), diode input protection is recommended.

As with any quality audio device, keep all internal wiring short and clean. Construct strong solder joints, check your work, measure voltage points, power down, then install one IC at a time and retest. Patience is your best insurance. In other words, double-check everything ... twice! A generic parts list accompanies the schematic. For those desiring better-than-average sonics, use better-quality parts. Mogami 2799 console cable is ideal for internal audio wiring. If you ac-couple, use low impedance, low leakage electrolytics. Neutrik hard gold over nickel XLR's and Switchcraft phone jacks have proven themselves time and again. Gold plated, multi-wiper IC sockets increase reliable performance.

### VARIATIONS

For portable applications, in-series batteries can substitute as a bipolar power supply. Rechargeable, field replaceable Ni-Cad battery packs are a good choice for remote production and can be readily designed into a custom-built box. Power requirements into low impedances could be high so carry extra Ni-Cad packs. The simplicity of the 2141/42 chip set encourages the builder to consider multiple channels, such as a 4- or 8-line interface box. I have recently completed a 16-input version that interfaces a balanced 16-track ATR into unbalanced mixer line inputs. All 16 channels are mounted into

As with any quality audio device, keep all internal wiring short and clean.

wire can add mechanical support. Treat your buses somewhat like mains wiring in a good studio. That is, connect analog grounds ultimately to one single point, often called a star ground. The power transformer center tap is a logical choice, though a centralized chassis ground lug is more common in production. Use care to avoid ground loops. Depending on the application, a well filtered and regulated bipolar dc power supply in the range of 12V to 18V is required. Higher voltages provide additional headroom, but don't exceed  $\pm 18V$ . When wiring power to any audio IC, it's important to decouple very close to the IC body. Attach one

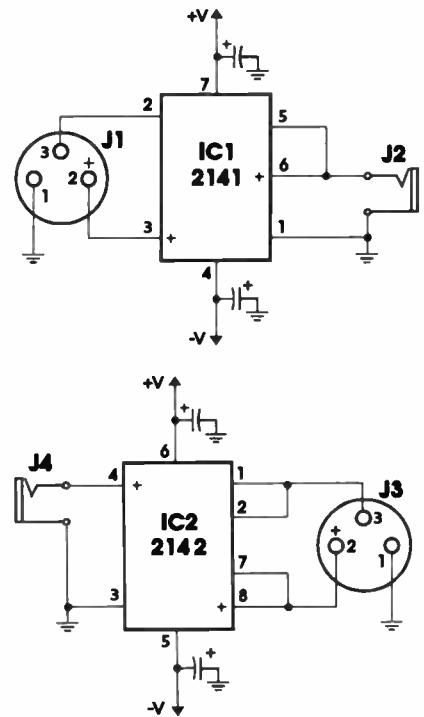

### PARTS LIST

- J1: 3-pin Female XLR or other audio connector
- J3: 3-pin Male XLR or other audio connector
- J2, J4: 2-pin Phone Jack or other audio connector
- IC1: Analog Devices SSM-2141-P
- IC2: Analog Devices SSM-2142-P

See text for capacitor values

Per AES Proposal AES14-199X, Balanced XLR connector pin 2 shall be positive polarity.

SSM-2141 & 2142 ICs are distributed by Newark, Allied, and others. About \$3.00 each.

Figure 2. Single channel schematics of balanced send and receive sections, as built and tested by the author.

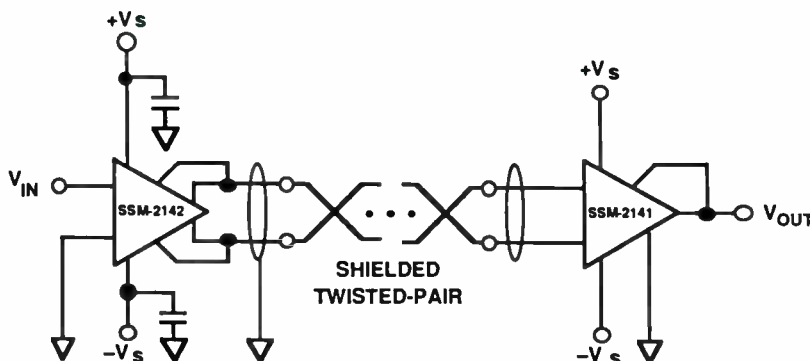

Figure 1. Functional schematic of Analog Device's chips in a balancing circuit.

a chassis measuring 2" x 4" x 7". The package is physically attached to the rear of the mixer. This interface allows the ATR to remain balanced through 30 feet of umbilical and a normaled patch-bay, becoming unbalanced just before the mixer inputs. Many recording devices, including mixers, have adjustable input attenuation, making  $+4/-10$ dB matching a simple process. When attenuation is not available at an unbalanced destination, a log-taper potentiometer or simple resistor divider can immediately follow the 2141.

Audio manufacturers might take note: adding IC sockets to a product is relatively inexpensive. For instance, a mixer could be designed with sockets to accept 2141/42 chips, but optionally sold as a lower priced unbalanced unit. As the user's needs evolve, the mixer could be balanced by simply plugging in chips. Think of it: converting a 24-input mixer into a fully line-balanced machine, includ-

ing aux sends and receives, for around \$100 and an hour's worth of labor — with no soldering, no trimming. The dearth of additional parts required with the 2141/42 ICs make them ideal for in-box modification to unbalanced devices, as well. Using these chips, I've achieved great-sounding mods directly inside of "semi-pro" audio gear, including unbalanced mixers, effects boxes, and MIDI rigs. Audio recorders, musical instruments, power amps and quality hi-fi gear are good candidates also. When modifying existing products, always assure that the stock power supply is hefty enough to handle the extra ICs. And, remember, the first hole you drill will probably void your warranty. If the idea of punching holes in your audio gear makes you queasy, stick with external interfaces.

### PERFORMANCE

The sound of the 2141/42 chip set is remarkably transparent. The 2142 driver, with a 15V/uS slew rate, 500kHz power bandwidth, and 50Ω output impedance rivals the best audio op-amps. The 2141 receiver, with .01% THD, 100dB CMR, and 500kHz power bandwidth bests high grade audio transformers — at less than 10% of the cost. With an 18V bipolar supply, the ICs will typically swing about 10.5 VRMS, slightly less into heavier loads. Unless you're interfacing to George Massenburg devices (18 VRMS!), this should be sufficient headroom for most professional applications. A lab test was performed on a hand-built, de-

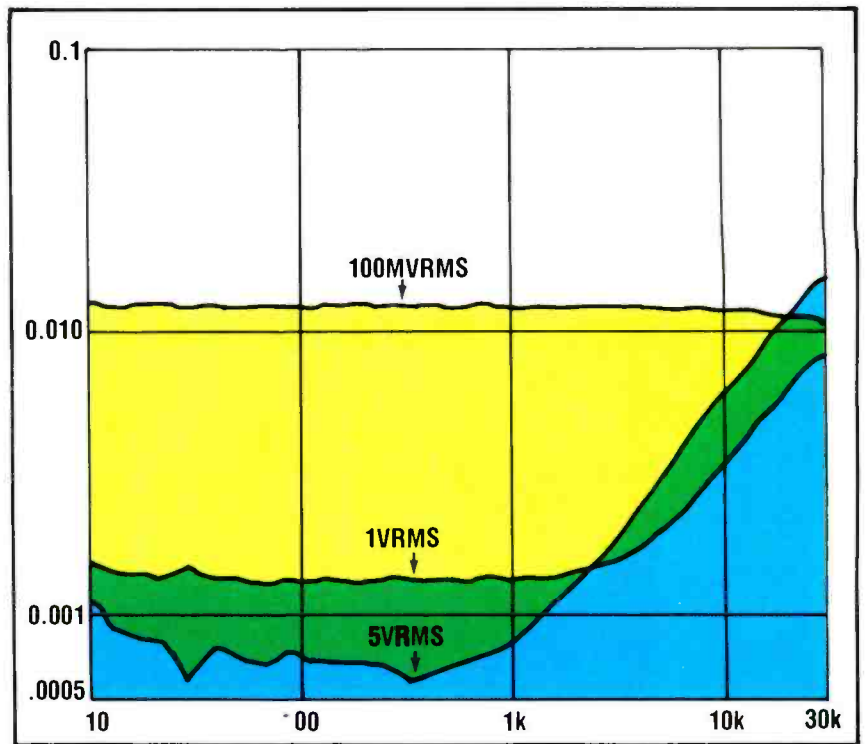
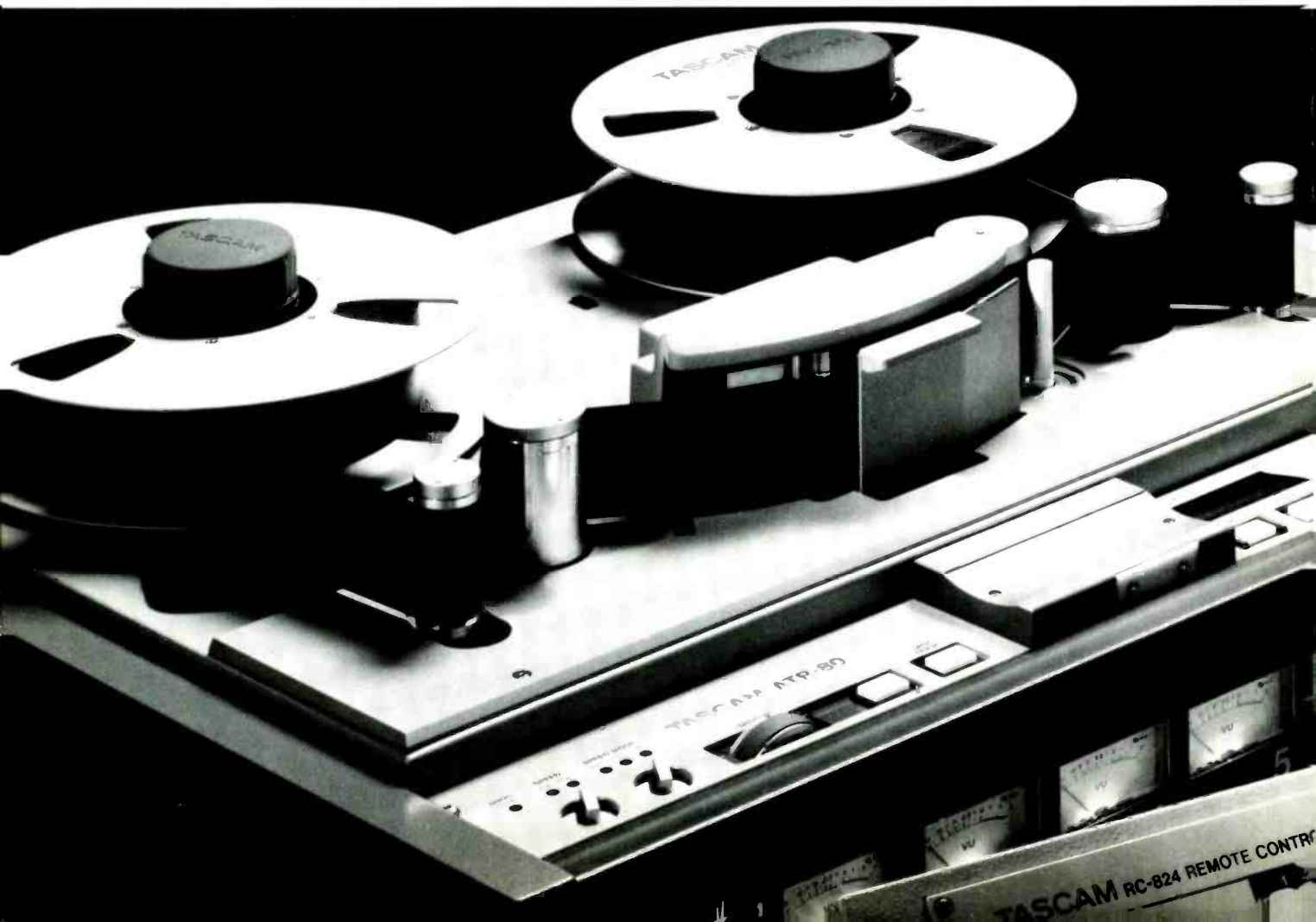

Figure 3. Analog Devices SSM-2141 THD+N (%) vs. frequency (Hz).





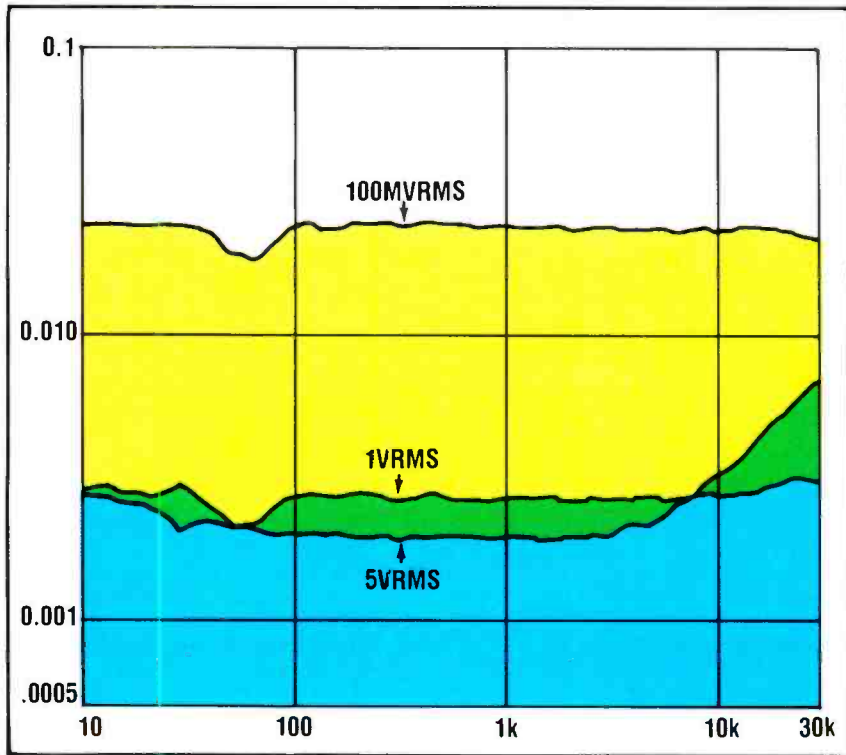

Figure 4. Analog Devices SSM-2142 THD-N (%) vs. frequency (Hz)  $R_L=2k\Omega$ .  $V_s=\pm 18V$ .

coupled, 4-channel interface box, each channel configured identically to the schematics of Figure 2. The power supply is  $\pm 18V$ . The test results are shown below and in figures 3 and 4.

	2141	2142
THD+N, 20Hz-20kHz, nominal	.004%	.004%
(see graphs)		
Slew Rate, 5VRMS, 600 $\Omega$ load	11.0V/ $\mu$ S	14.3V/ $\mu$ S
CMRR, 60Hz	97.4dB	
Bandwidth (-3dB), 1VRMS, 600 $\Omega$ load	2.2MHz	2.8MHz
Bandwidth (-3dB), 5VRMS, 600 $\Omega$ load	560kHz	630kHz

#### SUMMARY

The luxury of fully balanced audio has for the most part been the domain of large, professional studios. Now that good-sounding, high-performance balancing is affordable and easy, anyone with a little time and inclination can upgrade. The benefits are immediately noticeable. Those nagging little hums that don't quite get under the noise floor now will, when coupled with proper studio grounding techniques in a balanced system. There are many ways to electrically balance and unbalance audio. Designs using op-amps and discretes have been used for years. However, this designer has found no solution as facile as the 2141/42 chip set. And until we're all using light-waves, it looks like this may be the most cost effective transformer alternative yet. ■

## ONLY A MACHINE THIS SUPERIOR COULD MAKE \$35,000 SOUND LIKE A BARGAIN.

If you think \$35,000\* for the ATR-80 sounds like a lot of money, try to find a machine as good for under \$50,000.

Found one yet? Didn't think so. Because, at that price, the ATR-80 is simply the best 2" 24-track around.

Best in editing characteristics: special circuitry provides transparent punch-ins for gapless edits.

Best in lock-up capabilities, too: lightning fast and limited only by the performance of your other equipment.

So get into your Tascam dealer today and check out the ATR-80. Sit down and admire the craftsmanship firsthand. Feel the power, the speed, the smooth response. Experience the incomparable sonic quality. With the ATR-80, you'll see how much \$35,000 will buy.

# TASCAM®

© 1989 TEAC America Inc., 7733 Telegraph Road, Montebello, CA 90640, 213/726-0303  
\*Manufacturers suggested retail price.

Circle (18) on Rapid Facts Card

# POWER STATION STUDIO D/A-V 1

By Mary C. Gruszka

Cashing in on their "expertise in sound," New York's Power Station is entering what they feel will be the future for most music recording studios — audio for video and film. About a year ago, Power Station opened their new \$2 million Studio D/A-V 1, the fourth studio at their midtown Manhattan location. Studio D/A-V1 was designed from the beginning to meet the audio demands of video and film producers. Its 80-input SSL 4000 G-Series console with Total Recall can handle 24- through 96-track digital and analog recording, overdubs and mix-to-picture. Up to five audio tape recorders can be used at any one time. A Studer A800 analog 24-track, Studer A80 1/4-inch and 1/2-inch 2-tracks, a Sony 3348 digital 48-track and Otari DTR900 digital 32-tracks are all available. The room also has Dolby and Shure HTS surround systems and is capable of generating a discrete surround mix as well.

A General Electric Talaria large screen video projector and four Mitsubishi 35-inch color monitors allow the easy viewing of the pictures. Generally, video playback is from a 3/4-inch U-Matic VCR and layback is to a Sony BVH-2800 1-inch VTR with digital audio tracks. The machines are locked together through an Adams Smith synchronizer, and are controlled through MotionWorks and Adams Smith A/V 2600 machine control systems.

New England Digital's Post Pro and Synclavier 9600 are available for music scoring and sound effects tasks. A variety of effects units, processors, CD players, DAT and cassette machines are housed in racks either directly behind the audio mixer (in the base of the producer's console) or mounted in one of the walls.

Mary C. Gruszka is the owner of MCG Audio Consulting, a New York-area company specializing in TEF analysis, systems design and acoustical consulting.

Heading up the audio post room is Bill Ivie, director of audio post-production, who was brought in for his expertise in this area. "We've done voice-overs for 'This Week in Baseball' and 'Powerstick Hockey,'" he says. "For 'This Week in Baseball' we lay in the voice-overs and 30 to 40 pieces of music and effects." Other clients include Miller Genuine Draft, Miller Lite, American Express, IBM, Chevrolet, Nestle's and Campbell's plus films such as Lethal Weapon 2 and My Blue Heaven.

"A recording studio is the best place to do sound for pictures," says Tony Bongiovi, owner and founder of Power Station. "This was a natural evolution for Power Station," says Barry Bongiovi, manager/studio manager. "It was a timely situation in building the room. In a few years you will see more of these types of rooms." MTV and music videos have been a huge influence on the need for high-quality audio for video, according to Tony. "With the advent of HDTV, and the expansion of cable programming showing first-run films in surround, the demand for sound quality is high," says Barry. "We see the future in video."

"This is a new area for Power Station," says Bob Pargament, director of sales. "We employ our expertise in the music industry to create CD-quality, high definition sound for commercials, corporate videos and films."

**"A recording studio is  
the best place to do  
sound for pictures."**

**—Tony Bongiovi**

How did Power Station, in the recording business for 14 years, get involved with audio for video? "We started with the idea a few years ago," says Barry. "We got involved with the post production of 'She's Back' about four to five years ago, and got interested in doing the complete audio post-production for a film, like developing the sound effects, dialogue replacement, etc. We built a little suite to accommodate this and hired people. We learned quite a bit from that experience. We temporarily turned one of the studio/control rooms into a mixing room and brought in 1-inch video masters and a synchronizer."

That early session proved that doing audio for video in a recording studio environment was possible, plus it offered other possibilities, including some advantages over a dedicated audio for video facility. "Studio D was designed from its inception to be a hybrid room to handle both music mixes, recordings and audio post-production for video and film," Barry says. "We cater to people who want to do post-production for their records. We can do the scoring here (in one of our other rooms) and take it to Studio D/A-V 1 and do the music mix and add dialogue and effects."

"We started building about two years ago, in June 1989," Barry says. "We had a busy schedule that year. To accommodate our clients, we brought in our construction crew from 2:00 a.m. to 10:00 a.m. when sessions were not running. There was no way we could do construction with sessions happening at the same time. We did this for several months. All of our construction people were willing." Construction took about a year. "The first sessions were Chevy Blazer commercials done in stereo surround," Barry says.

## THE LAYOUT

The D/A-V 1 control room is larger than most control rooms used for recording, but its approximate 23' x 20' x 12' dimensions are typical for audio for video rooms. According to Barry, "The size of the control room is about 25% bigger in every dimension [than our other rooms]. We wanted our clients to be comfortable in the environment. It was tough to design the room so that both the music people and the post-production people would feel comfortable. It's a balancing act, and we feel that it worked out well." The control room was designed to accommodate 15 people and has a long producer's desk on a tier above and behind the audio console. The large audio console itself can accommodate three mixers for music, dialogue and effects. The Post Pro and the Synclavier controls are within easy reach. Between the front wall and the back of the console, there is space for more equipment, such as synthesizers and samplers.

Despite its larger size, the D/A-V 1 control room was designed to have acoustics similar to the other three control rooms at Power Station. "We use the same acoustical treatment, the same look and the same wood design," says Barry. "All our clients find it an easy switch to this room from the others." The floor is wood, and ceiling tiles cover the sloped ceiling. The wall treatment is wood and fiberglass insulation material wrapped in a brown burlap-like fabric. "We used slatted and diaphragmatic absorbers," Tony says. "The goal was to distribute the acoustics as linearly as possible." The large monitor system mounted in the front wall is new for Power Station. "We feel we jumped ahead of the other rooms with the monitor system," Barry says. "The size of the room dictated that we get bigger monitors."

The monitors installed were custom-designed by George Augspurger of Perception, Inc. Augspurger normally offers his custom monitor design as part of his total studio design service. In the case of Power Station, "I did the monitor design for someone else's room," Augspurger says. "We came up with the basic requirements for the monitor system. After the installation, we did a series of experiments to integrate the monitors in the room in the best way possible."

The monitor system consists of a 2-way monitor along with a subwoofer, one set for each channel. The 2-way monitor uses a proprietary horn of Augspurger's design and a TAD 4001 driver. The woofer is a TAD 1603. Both are built into a custom enclosure. The woofer is not mounted on a flat baffle, Augspurger notes.

This offers some advantages. "The whole cabinet is about four times as stiff [as conventional designs]. It also simplifies the time alignment as the woofer is back about three inches so it lines up with the high frequency driver. And third, it minimizes the woofer from becoming a point source. Most big 15-inch woofers become pretty direct at around 1,000Hz. [With this design], audio energy is spread out over the console an octave above crossover."

The high frequency section was modified after listening tests showed the sound was too diffuse. The mod was to remove the vanes from the horns. "I already had detailed TEF data on the horn throughout development. So I had the data on what the horn would do if we took out the vanes to let the horn become more directional. Power Station looked at the curves and decided to take out the vanes," Augspurger says. "We have the high frequencies very direct," Tony says. This allows the mixer to hear the left and right channels distinctly. The subwoofers also use the TAD 1603 and are mounted directly below the full-range monitors.

### ROOMS THAT MATTER

Adjacent to the control room is a 15' x 20' multipurpose isolation booth that has been used for voice-overs, guitar overdubs, horns and vocals. Behind the control room is its associated machine room, which houses the videotape machines, a film dubber and a rack of electronics which includes the synchronizers and machine control equipment. Careful attention was paid to sound isolation between the various rooms and the other studios at Power Station.

The isolation room, for example, is separated from the control room by a double door. The control room entrance door is lined with a sheet of lead for the extra mass. Access to the equipment mounted in racks in one of the control room's walls is through a door opening out to the hallway. This thick, well-sealed access door provides the needed isolation.

"You don't need exotic materials," Tony says. "With careful planning, you get the isolation you need." Craftsmanship also counts. All of the woodworking, consoles, doors, etc. were built in Power Station's own woodworking shop in the basement. "We've had the same carpenter in-house for the last 15 years," Tony says.

Because Power Station is a recording studio complex, all of its equipment, tape machines, mics and experienced mixers are available for the Studio D/A-V 1 audio for video sessions. "This is a recording studio with an audio for video facility in it," Tony says. The SSL SL4080-VU-TR G-Series console "gives us the capability to do 24- to 96-track recording and mix-downs," Barry says. "We've even done a 120-track transfer with three machines." Because Power Station has SSL consoles with G-Series computers in Studios B and C, "we can move the recall from one room to another," Barry says. "We do the entire mix in an automated fashion and lay it back to 1-inch. "With Studio D/A-V 1, we were able to further accommodate

our long time jingle client, Steve McCabe, creative producer at ad agency Backer, Spielvogel, Bates, Inc., on the Miller spots. He was able to have total control of his project. He did the entire score, then did the music mix in D/A-V 1, layed in the sound effects and voice, did his final mix and layback, and came out with the complete product. He doesn't have to rely on outside firms. He's now done about 8 or 9 spots start to finish [at Power Station]," says Barry. "We can do everything an audio post room can do and more," Tony says. "We make sure that the same [outboard] equipment is in each room," says Barry. "In addition, the studio has access to every piece of equipment we have."

Power Station's inventory of equipment is extensive. A whole section of their basement houses a wide assortment of analog and digital tape machines, guitar amps and complete drum kits. Their mic collection contains vintage RCAs, tube Neumann U47s, along with the usual contingent of AKG, Sennheiser, Neumann and Shure mics, to name only a few. Outboard gear includes Pultec EQs, Neve and Focusrite mic preamps/EQs, Neve, UREI, and dbx compressors, Drawmer tube compressors, Lexicon digital effects processor, Eventide Ultra Harmonizer plus phasers, flangers, de-essers, reverbs and delays. "You just can't get this equipment in a video house," Tony says.

Power Station found that although music recording/mixing, audio post-production and sweetening for video and film share some of the same techniques, there are differences. In post-production, you have a short turnaround. "We have more time to make a record than

to do post-production," Barry says.

With the audio for video client base that Power Station has amassed, they may indeed be on to something. "We have been doing sound for 15 years," Barry says. "We work with the best clients. We help set the standards in the music industry. With the knowledge and staff that we have, I can't think of a better situation for audio post-production for video." ■

For information on the Power Station, contact Bob Pargament at 441 W. 53rd Street, New York, N.Y. 10019; 212-246-2900; fax 212-556-0326.



Photos from top to bottom:

1. The D/A-V 1 Control Room features an SSL SL4080-VU-TR G-Series console and remote screen/control surface for the NED Post Pro and Synclavier.
2. The 80-input SSL G-Series with Total Recall allows automation swapping with two of the three other music rooms in the building.
3. Studio D/A-V 1 Machine Room.
4. D/A-V 1's iso booth provides a live environment for voice-overs and instrument overdubs.
5. A section of the renowned Power Station mic locker. Most mics were being used.

# DESIGNING THE MTSU MEDIA COMPLEX

By Richard Zweibel

Providing state-of-the-art production facilities for the innovative recording industry program at Middle Tennessee State University.

**A** new \$15 million educational facility opened this fall at Middle Tennessee State University in Murfreesboro. The College of Mass Communications, headed by Dean Dr. Edward Kimbrell, offers classes in several disciplines, including radio, television, journalism and the recording industry. The new facility is a unique, state-of-the-art teaching environment designed from the beginning to address the specific requirements of these disciplines. The audio production spaces are operated by the Recording Industry Management department under the direction of department chairman Richard Barnett. The RIM department offers a four-year curriculum in the recording industry, teaching students the business of the music industry, as well as technical issues.

The 90,000 square-foot building includes two studio complexes, eight edit suites, a television studio with associated video and audio control rooms, two post production rooms, a digital graphics lab, a MIDI lab, an electronic newsroom, a 30-foot mobile teleproduction vehicle,

Richard Zweibel is an audio system designer and associate at The Joiner-Rose Group, Inc., Dallas.

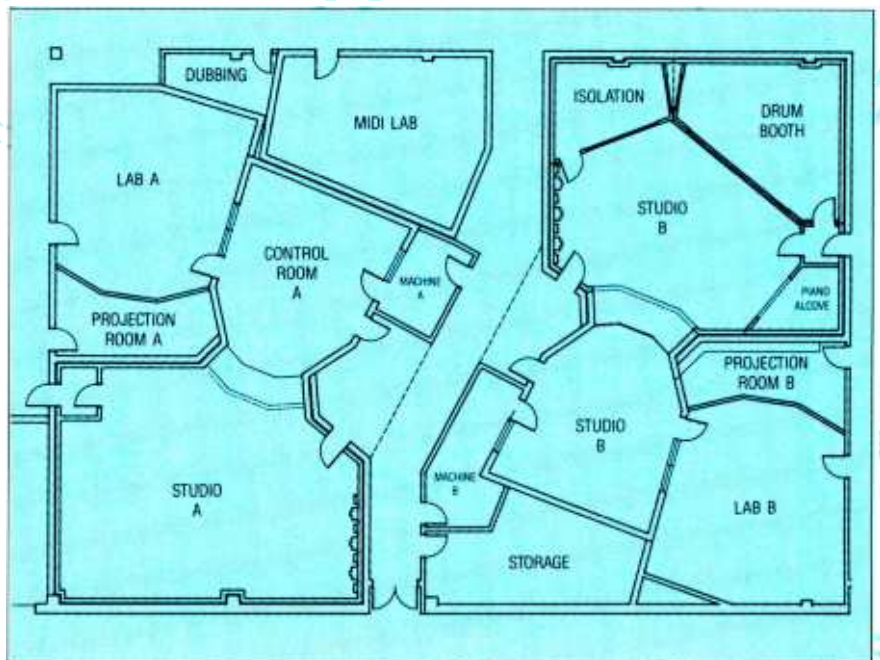



# The future of entertainment was changed 43,000 feet over Greenland.

Garry Greth, chief engineer of radio station KLON, was on a flight from L.A. to Frankfurt. He didn't know it at the time, but he was about to make history.

Somewhere over Greenland, he was going through the SV-3900 Pro-DAT manual, when he first realized what he could do with this new technology from Panasonic. The SV-3900 was the system he had chosen to link KLON and the Eurojazz network for the first American produced continuous jazz programming ever heard on the Continent. Only then did it dawn on him how endless the possibilities were. And that they were to take him far beyond the applications he was used to.

What Garry did was create an automated network of SV-3900s which broadcast 22 hours of jazz every day for Eurojazz. Custom programming, recorded at KLON, was sent to Germany daily for automated transmission. Commercials, features and music were programmed on the SV-3900s to start and stop at precise times day and night, with no operator intervention. There was no room for error.

The SV-3900 provides *bidirectional serial remote control* via industry standard protocols. To Garry, this meant an unparalleled opportunity to excel in a game where you can make up your own rules, simply because there are none.

That's why the SV-3900 represents such an unprecedented array of endless applications for broadcast, recording, and installed sound. Like automated replay for radio. Or programmable, random access playback of satellite network broadcasts.

In mastering sessions, you can control up to 32 Pro-DATs with the MK-390 remote controller. Or hundreds with a

computer. And you have automated random access high-speed search of up to two hours of stereo material stored on multiple Pro-DATs.

Commercial DAT duplication, not to mention automated replay in installed sound systems are handled with the greatest of ease.

So, if you'll ever need more than one DAT machine, the SV-3900 is your only choice.

And with the *Software Developer's ToolKit* available for Macintosh and DOS-based systems, you can customize your SV-3900 to your needs, whether it's making history somewhere over Greenland or somewhere closer to home.

For more information on the SV-3900, contact Panasonic, 6550 Katella Ave., Cypress, California 90632. Or call (714) 373-7278.



**Panasonic**  
Professional Audio Systems



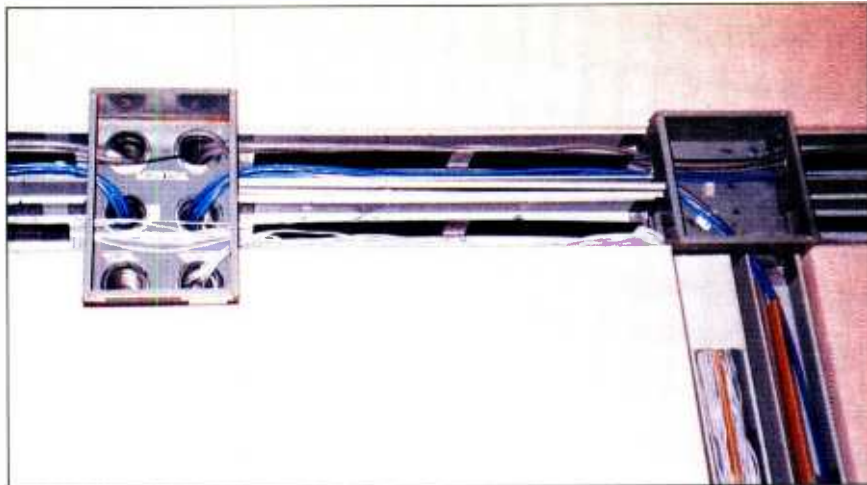

*Detail of Studio A cable run.*

a central machine room, classrooms, seminar rooms and maintenance areas. This article will focus only on the systems aspects of the audio production spaces.

In 1986, The Joiner-Rose Group was assigned the task of designing the technical and acoustical aspects of the facility. It was realized that a project of such a large scope required design expertise in several disciplines, and the following design team was assembled: Acoustics — mechanical, sound and vibration isolation — Russ Berger, Richard Schrag and Randy Kratzer (now operating as the Russ Berger Design Group) and Tom Rose; Audio Systems Design — Richard Zwiebel; Video Systems Design — Gary McAuliffe; MIDI Systems Design — Vance Breshears and Richard Zwiebel; Project Manual Preparation — Gary White, C.C.S.; and Audiovisual Systems Design — Dave Burnor.

### THE LAB CONCEPT

"One of the great challenges in teaching audio production is to enable more than three or four students to both see the action and hear the results. People gathered around a console cannot hear what the mixer hears; probably most of them cannot see exactly what he's doing, and as a group they change the acoustics within the control room," says Berger. Clearly, a solution more conducive to teaching was required. To fulfill this, Berger developed a design featuring a lab located directly adjacent to each control room, where students can see multiple aspects of the control room operation, and simultaneously listen to an accurate audio monitoring system.

Each of the two labs is designed to be an acoustically accurate listening room, using monitors identical to those located in the associated control rooms. The instructor teaches from the front of the lab, while a lab assistant or guest producer will handle operations in the control room. Full communication capabilities via microphones and overhead speakers exist between the instructor, lab assistant and students, providing a completely interactive teaching environment. The labs have three rows of tiered seating, allowing 25 students a clear path of sight to the video screens and instructor, with each seat offering a listening environment which rivals that in the mix position.

In addition to controlling lab playback volume, the instructor has complete pan and tilt

control over three video cameras; one located above the mixing console, one in the front wall of the control room and one roving camera mounted on a tripod.

Three rear projection video screens are located in the front wall of each lab. The center screen will typically display console automation data, or a WaveFrame workstation's video output. The left screen will typically display the actual console surface as seen from the overhead camera, and the right screen will display either outboard gear, tape machines, activity in the studio or video program material. This arrangement allows the students to accurately hear and see control room and studio activity while seated in a classroom environment.

To accommodate situations such as a visit by a guest producer, where many students may want to participate at once, both labs can be tied together. Up to 50 students seated in the two labs can see and hear activity in the control room, as well as have complete communication with control room personnel.

### STUDIO COMPLEX A

This complex was designed to accommodate the needs of audio for video and film, as well as traditional music recording, and includes a studio, control room, lab and machine room. Studio A is a large (38' x 50') room equipped with a lighting grid. The studio is tied to the mobile teleproduction facility to allow the production of music videos to take place. Masonry low-frequency diffusing series are coupled with a balance of absorptive and reflective surface finishes, which accommodate a wide range of recording sessions. Interconnect panels are located around the perimeter of the room to allow connection of mic, line, headphones, speakers and MIDI tie lines to the control room.

Control Room A features an SSL G 4056 mixing console with LCRS panning, Boxer IV monitors, Meyer HD-1 nearfield monitors, Dolby SEU-4 surround encoder, Lexicon 480L digital reverb, Sony 7010 DAT recorders, a MIDI station, and numerous other outboard units. A Sony 3324A digital 24-track and Otari MX-80 analog 24-track recorder are located in the adjoining machine room.

The monitor wall in the control room includes sound-rated laminated glass to allow vision into the Studio. While the loudspeakers are

supported from pedestals, their enclosures are suspended from an independent system of beams and columns, and both the pedestals and enclosures are isolated from the room's floating floor, walls and ceiling. A masonry low-frequency diffusing series was constructed along the entire rear wall of the control rooms. It serves as a framework for the high-frequency acoustical diffusers by RPG Diffuser Systems and as an HVAC return air chase.

Studio Complex A is presently the only educational studio in the country equipped and authorized to teach Dolby Surround encoding procedures. Control Room A and Lab A are also equipped with complete Dolby Surround playback systems.

### STUDIO COMPLEX B

Studio B is primarily designed for music production. It consists of the main studio space, a large drum room, an iso booth, a piano alcove, the control room, the lab and a machine room. The same type of interconnect panels and low-frequency diffusers found in Studio A are located in Studio B.

Control Room B is physically and acoustically identical to Control Room A. It features an Otari series 54 mixing console, a MIDI station, a variety of outboard units and has monitoring identical to that found in Control Room A. Tape machines include a Sony 3324A digital 24-track recorder, a Studer A-827 analog 24-track recorder, a Sony 3402 digital 2-track recorder, a Sony 7010 DAT recorder and an Otari MX 55 analog 2-track recorder. Additionally, a WaveFrame Audioframe digital workstation is located in machine room B.

### THE WAVEFRAME SYSTEM

A digital workstation system is an integral part of the new facility. The Audioframe system by WaveFrame Corporation includes 16 analog inputs and outputs, an 8-track hard disk recorder, a 16-voice digital sampler with 16MB of RAM memory, 64 channels of digital mixing with external control surfaces, a universal digital interface, and 96 digital inputs and outputs. The system offers approximately eight hours of hard disk storage and two hours of removable media storage. A control surface has been included to allow the mix to be performed using a more familiar "physical" interface if a student prefers this to using a mouse.

A building-wide token ring network, as well as other tie lines, allows the WaveFrame system to be operated from locations throughout the facility, including the three control rooms, both labs, the MIDI lab and post Production Room 1. To eliminate the distraction caused by fan noise from the computer and drives, a mode of operation was developed which allows the computer to remain in Machine room A, with the rest of the system easily transported from space to space on a roll-around cart.

The workstation system is designed to incorporate the two Sony digital 24-track recorders to allow a totally digital 48-track recording and mixing system. Operating in this mode, students are able to produce a complete project entirely in the digital domain from post-mic preamp A to D, through 48-track digital recording and mixdown, to the final 2-track digitally recorded tape. This includes tracking, sampling, multitrack recording, mixing, editing, equalization, reverb, effects and 2-track recording. By incorporating the hard disk recorder, 56-

track digital production is possible as well.

One interesting mode of operation allows an instructor or student to operate the system from the front of either lab. The video display from the WaveFrame would appear on the large center rear-projection screen allowing the entire class to clearly see the display. Audio monitoring takes place on the Boxer monitors and potentially the surround speakers as well. This mode allows digital workstation production, including such functions as 48-track digital mix-down, to be taught before a class of 25 students in the comfort and convenience of a classroom environment, with the benefits of an acoustically accurate room.

Operating in this fashion frees the control rooms to be used simultaneously for other projects. If the system is already set up in another room, the students can still monitor as described above without having to physically move any equipment.

#### THE MIDI LAB

As a progressive school program, it was considered mandatory that a thorough knowledge of MIDI applications be an integral part of the education received at MTSU. To accommodate this requirement, a fully equipped MIDI lab was integrated into the design. The lab contains eight identical student stations and an instructor's station. All stations are Macintosh-based and include a Roland D-70, an Akai S-1000, an E-mu 9010 Proteus I, a Lexicon LXP-1 and LXP-5, a Tascam MM-1, 424, and 112 and a Mark

of the Unicorn MIDI Time Piece. Software includes Opcode Galaxy Plus Librarian, Digidesign Turbosynth and Mark of the Unicorn Performer.

The instructor can audibly monitor any student's progress either on headphones or on monitor speakers, and have two-way communications with the students on an individual or group basis via their headphones and microphones. The instructor can also monitor their

**"People gathered around a console cannot hear what the mixer hears; probably most of them cannot see exactly what he's doing."**

computer screens by using Macintosh LAN software. The instructor's video monitor signal can be projected onto a large screen at the front of the room to allow all students to clearly see what the instructor is doing from their seats.

Video program from the Central Machine Room may also be presented on the screen.

Additional audio production areas include the TV Audio Control Room, used in conjunction with the TV Studio and the TV Video Control Room; the Dubbing Room, used for copying, transferring, or editing tapes (DAT editing capabilities are provided by a Sony 7000 DAT editing system); and the Mobile Teleproduction Truck, which can be used for multitrack remote recording.

Any facility of this size needs a high-quality maintenance facility, and MTSU has included this in their program. Directed by David Thibodeau, this program, using the latest technology, teaches the students the subject of maintenance in addition to providing maintenance services for all audio equipment in the facility.

The entire facility was designed to operate as one integrated system. A network of overhead cable trays, conduits and raceways allows interconnects between any two points in the facility. The main cable raceways, which connect rooms, are run overhead in the hallways and are primarily 4-feet wide. Smaller overhead cable trays branch off of the main tray to each technical space. In the technical spaces, cable ladders allow the cables to either go below a raised computer floor and into floor troughs and conduits, or to go directly to the wall-mounted cable raceways. The system of cable trays and raceways provides an easy method to change cables to accommodate future needs.

# M-1

## MICROPHONE PREAMPLIFIER

SUPERIOR SOUND QUALITY. RE-DISCOVER YOUR MICROPHONES!

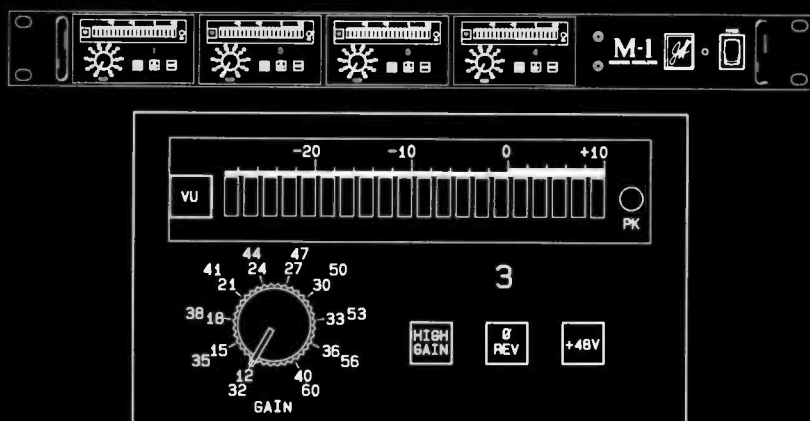

(ACTUAL SIZE)

- THE BEST JENSEN INPUT TRANSFORMER: THE JE-16-B.
- THE BEST OP-AMP: THE 990 DISCRETE OP-AMP.
- DC-SERVO ELIMINATES ALL COUPLING CAPACITORS.
- THE BEST JENSEN OUTPUT TRANSFORMER OPTION: THE JE-11-EM.
- ILLUMINATED SWITCH BUTTONS.
- TOROIDAL POWER TRANSFORMER.
- UNIVERSAL POWER SUPPLY.
- XLR CONNECTORS. GOLD OPTIONAL.
- TWO METER OPTIONS. VU-1 SHOWN.
- CUSTOM KNOB & PUSH BUTTONS.

**THE JOHN HARDY COMPANY**

P.O. Box AA631  
Evanston, IL 60204

(708) 864-8060

Telex: 910-3E0-4670  
(JOHN HARDY CO)

# Moving?

Take us with you.

Just peel off your subscription mailing label and attach it to the address change card inside this issue. Please allow 6-8 weeks to process your address change.



A network of multichannel audio and video tie lines interconnects all of the technical spaces. Numerous patchbays in each of these spaces are dedicated to this purpose, allowing the capabilities of any system in the building or mobile teleproduction truck to be used in conjunction with any other systems as the need arises. J.L. Cooper Electronics developed new products to allow MIDI data to run the long distances required in this facility.

The house synchronization system is an integral part of the design of the facility. All audio and video equipment capable of synchronization are tied together via a TimeLine Lynx system and time code patchbays located in the machine rooms. This allows any of these units to operate synchronously with complete flexibility of configuration.

A facility of this magnitude presents special challenges for the technical power and grounding systems. All electronic equipment is powered from a separate system fed by isolation transformers and power conditioning equipment. Each machine room has a ground rod driven into the earth directly below the electrical panel. This panel has an isolated ground bar tied to the ground rod via a short length of 500 MCM cable. All equipment grounds and isolated outlet grounds are tied directly to this isolated ground bar. 4/0 insulated ground wires tie each of the machine rooms and the Central Machine Room together to reduce the potential for noise or hum induction to occur when using equipment in mul-

iple areas of the facility via the building tie lines. Other ground wires were provided to meet electrical code requirements.

#### INSTALLATION OF THE SYSTEMS

Since so many different areas of specialization were required to create the facility based upon the design produced at The Joiner-Rose Group, the technical systems were divided into several different contracts. The Audio contract was awarded to Spectrum Sound, Nashville; equipment was supplied by Studio Supply, Nashville; and installation and testing was provided by Interface Audio, Atlanta. By using the resources of these three companies, it was possible to install the systems in a short period of time while maintaining the high level of quality required by the project. The MIDI contract was awarded to Victor's House of Music, Ridgewood, NJ.

As project manager, one of my duties has been to coordinate the efforts of the several different contractors involved in the whole project. In many cases, a cable may start in the patchbay of one contractor and terminate in the patchbay or panel of another contractor. Additionally, it was necessary to coordinate panel finishes, connector pin-outs, color codes, multiple panels provided by different companies within a single box, cable numbering, etc. All of the contractors worked together to provide a smooth coordinated effort. The cable numbering scheme, based on the Interface Audio system, allows a technician to determine

which contractor installed the cable, what signal type is carried within it, the number of conductors and the origination point. All cable information from all contractors is stored in a computer database.

Quality acoustics and all of the technical systems incorporated into the design, while very important, do not make an excellent educational program on their own. The most important ingredient is the quality of the faculty and the curriculum offered. This is where the program at MTSU shines the brightest. Chris Haseleu, studio manager of the Recording Industry Management Department, and the rest of the Recording Industry Management faculty, all have a serious desire to see the students succeed in their chosen areas. 75% of the students who have previously graduated from the four year program find employment in the music industry.

The new Mass Communications Building at MTSU was designed to accommodate future needs by providing for easy expansion of systems while building upon a solid foundation of acoustically accurate rooms. The combination of a technically advanced facility, a complete well-rounded curriculum in the music industry, and a first rate, dedicated faculty provides the platform to educate the next generation of music industry professionals. These graduates will be well trained to meet the needs of the music industry of the future. ■

# "SHORT CUT TO PURITY"

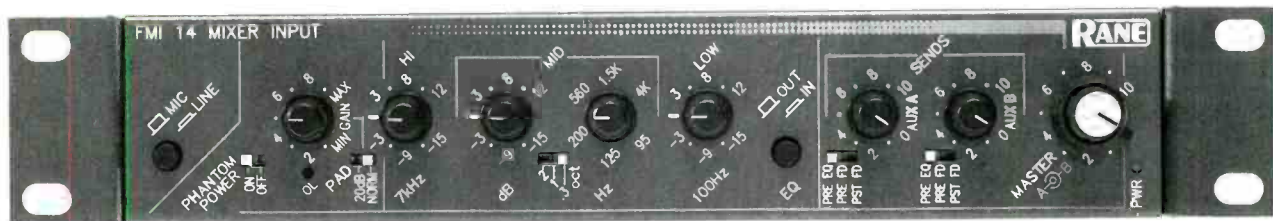

The Flex Series FMI 14 Microphone Preamp is simply the shortest path to the cleanest, purest recordings—digital or analog. This compact module offers the kind of serious features found on big consoles, but without the extra circuitry, switching and long routing lines.

Features like an ultra-low noise/low distortion mic preamp stage, 48V phantom, our patented Accelerated Slope™ EQ, fully assignable aux sends, external power supply and the new HR format.

More leading recording engineers are taking advantage of the minimum coloration and maximum performance flexibility found only with the FMI 14. From the Flex Series...pure and simple.

RANE CORPORATION 10802-47th Ave. W., Mukilteo, WA 98275. (206) 355-6000

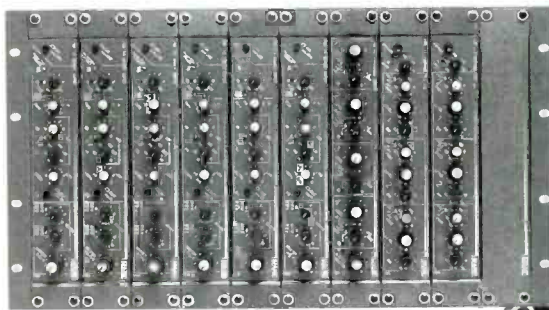



# A FULL-SCALE PRODUCTION FACILITY

By Gary Pillon

**Designing from the ground up: digital workstation networks, analog tape capabilities and isolation-intensive acoustic design.**

**W**hen General Television Network (GTN) began construction on a multi-million dollar audio post-production facility last January, their timing may have seemed a bit off. Even though there was the threat of blizzard conditions, an uncertain economy, and another type of storm whipping up in the Middle East, GTN had made a commitment to the Phase Two expansion of their Oak Park, Michigan headquarters.

"Fortunately, we couldn't have had a more mild winter in Michigan," says Doug Cheek, GTN vice president and director of operations. "Although we were aware that the economy was slipping, we felt strong enough to go through with it." This decision was based solely on instinct. In 1989, when GTN committed \$1 million to their Phase One Upgrade Program, they purchased a Lexicon Opus Digital Audio Workstation and were the first to offer

Dolby SR noise reduction in Detroit. GTN felt that by keeping on the "bleeding edge" of technology, they would continue to be in demand, and could keep their facility steadily booked. Teaming the equipment with award-winning Opus Lexicon specialist Paul Stelly, they instantly became a winning combination. Bookings increased 600%. This prompted GTN's CEO Joan Binkow and her senior management team to initiate the second phase of their plans with a \$3.5 million audio post center.

GTN hired veteran Detroit Sound Design mixer Jay Scott to help the design team, which included studio designer Russ Berger, systems integrator 21st Century Limited, architect Hobbs & Black, A.J. Etkin Construction and interior designer Alexis Lahti. Binkow told the team to make up their "wish list" and get underway. Early design meetings were guided by client need. "We wanted this to be a place where clients could be creative, productive and comfortable," says Binkow. "Ordinary was not in our vocabulary."

With a 6,700 square-foot physical plant, there were numerous design issues to consider. Room sizes, functions, acoustical treatments, air handling and client amenities were of special concern. "GTN was always clear that they did not want to compromise the performance of the finished product," says Russ Berger, of Russ Berger Design Group, Inc., Dallas. "And, although this expansion represented a significant financial commitment to quality audio production, GTN's target budget did not allow for any surprises once construction began." Berger's final layout includes two unique mixing suites, an offline transfer room, separate client rooms (with private monitoring) attached to each mix area, a dedicated service bar, restrooms and a central audio tech room that emulates their video tech room design.

Although the two audio control rooms have different equipment complements, they are physically and acoustically identical, so the audio product will sound the same in both rooms. Berger's design makes it easy for GTN's clients

Gary Pillon is a 21-year veteran of audio production at GTN.

to make a transition between the suites. The rear wall of each control room features low-frequency and RPG acoustical diffusers mounted in a masonry wall. This assembly doubles as a return air chase for the HVAC systems.

"For the monitor wall, we employed a design which completely isolates the loudspeaker support pedestals from their enclosures, the surrounding walls and the ceiling. The enclosures were constructed to allow GTN to change out speakers in a matter of hours, rather than weeks, but still realizes the benefits of having them built into the wall as if it were custom fit to a specific box. We feel strongly that a facility should be able to respond to new products and equipment upgrades without undergoing major renovations to the entire room," says Berger.

#### FLOATING BY DESIGN

Other design and construction highlights include extensive use of glass panels throughout the center: huge air conditioning plants that allow air to "fall" quietly into the rooms during sessions; and complete sound isolation designs, including "room-within-a-room" and floating floor techniques. With two independent high-powered audio suites in such close quarters, extremely high sound isolation performance is necessary. Berger recognized two other problems that made sound isolation imperative: GTN's existing soundstage is immediately adjacent to the new building, and furthermore, GTN's neighbors routinely test earthmoving equipment on a test site adjacent to the GTN property. Structure-born and ground-born vibrations were real concerns for Russ Berger and his team.

"We solved these problems by designing each of the control rooms and booths with independent 8-inch floating concrete slabs. Masonry walls are supported from the isolated slabs, so that there are double CMU walls between adjacent audio spaces," says Berger. Floating triple layer gypsum board ceilings complete the

room-within-a-room enclosure. The structure of the audio post center is completely separate from the existing building, with isolation joints in the exterior walls and an independent roofing system.

GTN's goal of starting operations in July meant that the project also had a tight construction schedule. "For us, knowing that we faced schedule and budget limitations made it essential that our contract documents were as complete and accurate as possible," says Berger. "Airtight plans make for better bids, and fewer coordination problems in the field." The tight schedule also meant that the general contrac-

tor, A.J. Etkin construction, had to do an outstanding job of sequencing different trades, scheduling materials delivery and estimating individual construction tasks. "And, of course, it meant that we all had to maintain excellent ongoing communications all the way through the construction process," says Berger.

#### ROLLING IN THE GEAR

With the building construction well in hand, the GTN audio team was ready to fit each of the rooms with their goodies. "Each room, although similar, was tailored to match a specific segment of the growing marketplace," says



In a world of "or equals," Oxmoor Corporation introduces the DEQ-I and DEQ-II—high-resolution, programmable equalizers that simply have no equal.

**Exceptional security.** Set them and walk away, because Oxmoor's sophisticated system is more than just an easily removed front panel.

**Comprehensive control.** Both the DEQ-I and DEQ-II feature 29 constant-Q, minimum-phase, 1/3 octave combining filters, plus sweepable second-order low- and high-pass filters. Adjustment of third-octave filters and output gain is in precise 1/2 db steps over a

## TWO EQUALIZERS. NO EQUALS.

(±) 12 dB range. Store up to eight equalization curves and other settings in non-volatile memory presets for rapid recall. The DEQ-II's large LCD display and versatile front-panel controls make programming simple, while the DEQ-I's numerical read-out assists in programming through internal controls. Rear ports allow programming either model by a PC, a Macintosh, a PA-422 compatible controller system, or another DEQ-II.

**Unequaled value.** An unbeatable combination of security, flexibility, and performance—all at an affordable price.



# OXMOOR®

Oxmoor Corporation, 2111 Parkway Office Circle, Birmingham, AL 35244  
(205) 985-7040 Fax: (205) 985-9966



The iso booth of API provides clear sightlines from both the engineer's and production/director's chairs.

Circle (23) on Rapid Facts Card

Cheek. According to Cheek, API is aimed at the national/spot program market. Mixers Stelly, Scott and new staff member Bob Meloche command a custom-LED 40-input version of Solid State Logic's latest 6000 series console. Each input has its own dynamics section to complement the highly regarded SSL Equalization Modules. Dedicated compression and EQ can also be added to the program outputs.

The ability to fine-tune every parameter of the incoming signals, work out an updatable automated mix and store the results exists by using the SSL Total Recall System that GTN had installed. The monitoring section features a custom surround module that can take a mix from mono to stereo, then to full Shure HTS Stereo-sound in three clicks. There's enough busing and group assignment to allow full stereo music and effects mixes while keeping stereo dialogue tracks isolated for possible second language revisions. The Shure left/center/right surround, using high-amped KRK speakers allow full-bandwidth signals to be fed to the surround channel. "Your imagination is no longer limited to the space between the stereo mix. With three million home decoders now in use, the finished product has a greater residual value as those numbers increase."

GTN installed the top analog and digital ma-

With two independent high-powered audio suites in such close quarters, extremely high sound isolation performance is necessary.

chinery available. They picked up 16 channels of ScreenSound, SSL's hard-disk digital audio system. To make it work throughout the plant, they ordered the world's first SoundNet, which allows data and channels to be accessed from multiple locations. Fed by optical and tape storage media, the ScreenSound can quickly reload projects done there or elsewhere for final mixing on the 6000 system.

Otari recorders provide an analog option to the ScreenSound. They installed MTR 12 and MTR15 1/4-inch time code and 1/2-inch 4-track machines as feeders and storage devices. They also purchased an MTR100-A 24-track 2-inch recorder and loaded it with patchable dbx outboard units and Dolby SR Noise Reduction. They have two Motionworkers, which allow any of the tape decks to be "called" into a mixing suite without leaving the centrally located room.

Facility networking was a major consideration to the design. GTN added several Macintosh IIx computer systems to the complex, linked together by Ethernet. Sound effects can be created or loaded from CD-ROM into Digidesign's Sample Cell, then sequenced by Opcode's Studio Vision MIDI program and triggered by time code or played by a MIDI keyboard. Outboard processing also got a complete upgrade. New reverb units from Eventide, Yamaha and Lexicon create the space and ambience effects



*GTN's ground-up production facility ties audio and video together in a comfortable, aesthetic environment.*

for the master stereo or surround tracks. An Aphex Aural Exciter and Orban De-Esser can also be used to enhance or clean up tracks. A standard phone patch is part of the room, while an optional satellite downlink allows clients to record full bandwidth audio from major studios worldwide. Studio mics including the Beyer 740 and Neumann O-89, can be augmented with Neumann RSM 1911 or Crown SASS-P stereo location units and PZM Stereo Shotguns.

#### ROOM NUMBER TWO

AP2 features their Lexicon Opus Digital Audio workstation and KRK monitoring, possibly the first of its kind in a video facility. The Lexicon's new configuration of Sabre hard drives and multiple I/O's makes it one of the best-equipped Opus units in the country. The recently released fully assignable digital equalization and the imminent addition of Lexicon automation make it a truly flexible one-piece digital production system. Access to ScreenSound, the Mac programs or any of the analog machines by using the various networks works well with the Opus's capabilities to lay work back into any of the video formats available, including

digital transfer to D2. A generously sized voice-over room and client areas enhance AP2's functional capacity. R-DAT machines and processing gear in the room allows CD pre-mastering in-house.

Common to both rooms, the facility offers time coded Nagra machines, allowing work with field tracks for film transfer elements; Dolby C noise reduction of Betacam SP tapes; Dolby SR on 1-inch elements; digital recording on the D2 format; and 500 music and sfx CD's organized on the Gefen M&E computer program. The latter can be loaded into their Mac system and spotted against a workprint, then networked into one of the other rooms for the final mix. An off-line room will be available for music and sound effect searches. Effects can also be created on the Mac. Gary Pillon, GTN's Emmy Award-winning audio engineer noted that effects "Can be created at offline rates and then called up during the on-line"

GTN's ultimate goal was to integrate sound and vision into one venture. Clients are able to work to picture from any of GTN's many video sources, and a Write Once/Read Many videodisc recorder has been included to help



speed things up when working in the random access domain. The AP1 and AP2 rooms contain Mitsubishi 35-inch direct view monitors, and voice rooms and client areas have their own Sony video feeds. Since the two rooms share a single machine room, many of the equipment needs are centralized, allowing separate access for the technical personnel from

the client spaces. "If there is an equipment failure or other technical crisis it can be handled unobtrusively without tripping over a producer," says Russ Berger.

Doug Cheek says, "We think of this new audio post center as an investment in the community. We delivered, on time and on budget, a very sophisticated tool for our clients to use." ■



*Construction continued in spite of a "typical Michigan winter."*

## Hey Glenn, what do you do with your 56K?

*Glenn Meadows is the president of Masterfonics Inc. in Nashville, Tennessee. His mastering credits, 350 of which have achieved Gold/Platinum status, include: Alabama, Hank Williams Jr., Dan Fogelberg, and Reba McEntire. Recent 56K projects include: Steely Dan Gold Extended/MCA, Reba McEntire/MCA, and Sawyer Brown Curb/Capitol. He has been mastering since 1973.*

"The 56K has made my life much easier. In an effort to find a digital mastering system suitable to my needs, I evaluated several other systems on different platforms. The 56K proved significantly easier to use and faster to learn, as well as very quick to do the type of edits I normally did with analog tape.



The playlist in SoundStage is the most intuitive I have seen. I use it daily for quickly changing the song order on compact discs, as well as reassembling songs for different required mixes. What used to be done in a day with tape can now be done in minutes with the 56K.

I've seen the competition... used it..., and in my opinion, there is no better 2 track mastering solution on the market today."



**A Professional System.  
A Reasonable Pricetag.  
Still \$1995.00.**

turtle  
beach  
systems

PO Box 5074, York, PA 17405 717 843 6916 Fax 717 854 8319

Circle (24) on Rapid Facts Card

# Live & Direct

## Touring Sound Technology In Permanent Installations

By David Scheirman

The "one-box" revolution is now more than 15 years old. In the mid-1970s, touring sound companies first began to field modular, "all in one" speaker enclosures, intent on designing a full-range box that could be used in multiples, combined into hanging clusters, and easily trucked around the country. This approach to speaker system design has helped to define the way that portable concert systems are built and used by nearly every company that hopes to be competitive in that market. Without a modular speaker system inventory, every show means that a "custom" system must be assembled from a variety of speaker parts and configured for a different use in each situation. That translates into design time, labor costs, logistical challenges and hanging headaches.

Although simple "box jobs" may look attractive because of cost savings on labor time, they are not always the panacea that is dreamed up on the drawing board. There is certainly still a place, especially in large-scale reinforcement systems that employ long-throw horn devices for buildings with complex architectural characteristics, for engineered systems featuring designed arrays with "naked" horn devices. These devices are then configured to offer optimum coverage and intelligibility in a building space that many boxed, premanufactured systems could never achieve.

Manufactured products from a variety of sources compete for the modular box system market. To name some of the most visible, and some of the new entries to this market, one would have to list Adamson, Apogee, Community, Eastern Acoustic Works, Electro-Voice, JBL, Klipsch, Martin, Meyer Sound Laboratories, Nexo, Renkus-Heinz, Stage Accompany and Turbosound. There are others. The product lines and design types available from these companies vary considerably.

John Meyer's early efforts in this direction originally helped to focus and define a market for high-performance, compact enclosures, one which has been addressed by many firms since. Meyer Sound, as just one example, has offered an arrayable, modular, full-range loudspeaker enclosure with a dedicated system controller (electronic crossover with carefully-matched signal processing) and integral rigging fittings for a decade.

David Scheirman is R•E•P's live sound consulting editor and president of Concert Sound Consultants, Julian, CA.

JBL Professional's Concert Series enclosures, available since 1986, comprise a full product line for "build-your-own-array" system designers that includes long-throw, high-frequency modules, full-range mini enclosures, and a full scope of products including road-worthy enclosures and the hanging gear to suspend them. Yamaha's Pro Audio Division, on the other hand, has formally introduced its small-format YST arrayable box system with attendant hanging gear this fall at the Conference of the Audio Engineering Society.

So what makes a "modular speaker enclosure," you may ask? Wasn't even the venerable Altec A-7 cabinet a "modular boxed system"? By today's standards, no it wasn't. Just because a manufacturer offers a predesigned cabinet housing a couple of speaker components doesn't make it a "modular, arrayable professional speaker system." Although an A-7 did combine speaker components in one box, that box didn't combine well into an array, it didn't have a dedicated system controller for optimizing performance, and it was not equipped to hang without custom design time and internal modifications.

"One needs to be very methodical in checking out the various systems that the manufacturers are selling," said Dave Robb of Jaffe Acoustics, a senior sound system designer and consultant who has experience in portable touring and permanent installation camps. "Anybody can cut a wedge-shaped wooden box, throw some drivers in it, and call it an arrayable modular speaker system. But that doesn't make it true. There are specific performance criteria that a product must meet before we will specify it for use in a job."

So what does the well-dressed modular speaker enclosure look like in today's high-performance, competitive marketplace? It is probably a wedge-shaped box able to be combined into multiple box groupings that are compact and that enable the creation of curved arrays. Its horizontal coverage pattern may nearly match its trapezoidal shape, so that those arrays actual perform well. It will have internal rigging fittings, perhaps as a readily available option. It will feature a rugged input and patching panel, a durable front grill for component protection, and will have its own custom-matched electronics package or "system controller" so that the end-user only has to add power amplifiers and cabling to the system to be up and running. And, to judge from current product specifications, it will probably be rather expensive ... one cabinet with a single 12-inch speaker and one horn-mounted compression driver may have a retail price of nearly \$2,500.

"For a while, 'designer speaker systems' were a novelty," said Ken Berger, president of Eastern Acoustic Works. "Instead of giving a focus on style, or following trends, what we have worked on for years now is an integrated product line that gives the consultant, system designer or installer a 'toolkit' of compatible modular speaker enclosures that can all complement each other in both the portable and

installed system markets."

EAW's marketing and engineering term, "Virtual Array Series," attempts to get across the high value that the company places on the performance attributes of modular enclosures when they are combined to make large systems.

JBL Professional's first new product introduction in its Array Series line, an extremely compact enclosure based on a new custom-built 14-inch woofer frame and a 2-inch compression driver, is intended to take advantage of the high current interest in these high-performance, space-saving boxes. The product will be marketed in conjunction with the companies recently available ES-52000 digital system controller, a new-generation electronic crossover with built-in bandpass limiting, system EQ, signal delay, and other circuitry developments intended to wring the highest possible performance from small enclosures.

"In today's market, a system must rig easily and hang well, sound great right out of the box with no hassles, and have some sort of component protection circuitry so that the customer doesn't damage the components," said Bill Gelow, product engineer for JBL's new Array Series devices. "There are a lot of options to choose from now, and someone in the market for this type of system must carefully examine their needs."

The variety of products available to system designers and sound contractors can make assembling a complex, high-performance speaker system quick and easy, or it can lead to information overload. "We've had some big installation jobs lately where we literally could not have completed things in time without prebuilt modular speaker systems from reliable manufacturers," said Will Parry, head of Maryland Sound's permanent installation division, which has used this technology recently for major systems in theme parks, stadiums and arenas. "The time available for contract fulfillment and installation completion can be shorter than you might imagine in today's business climate."

MSI designs and builds its own touring sound systems and is often involved in system design-and-build jobs. Another touring company active in the installation business now is Clair Bros. Audio of Lititz, PA, which originally helped start the entire one-box phenomenon with its S-4 loudspeaker enclosure 15 years ago. Now, Clair has developed the R-4 enclosure, an arrayable full-range speaker system specifically intended for permanent installations.

It's clear that modular loudspeaker enclosures with their dedicated electronics control packages are a powerful tool for the design and installation of permanent systems and that they are evolving quickly as different manufacturers apply research and development time to optimizing their performance ... juggling size, shape and box volume with frequency response characteristics in an effort to offer the highest output and best fidelity in the smallest package. ■

# UPSCALE FESTIVAL SOUND REINFORCEMENT

**A case study in landing, and keeping, long-term contracts with high class regional jazz, folk and classical festivals.**

**By Bruce Borgerson**



**N**ice work, if you can get it. The surroundings are pleasant, often at well-groomed venues located in historic small towns or posh mountain resorts. You stay in one place for several days, up to a couple weeks. Actual rates paid are relatively attractive, and a good working relationship can bring predictable return business for many years to come. Welcome to the land of "upscale" summer music festivals.

The diversity of acts can be refreshing: one weekend might bring Wynton Marsalis and Ladysmith Elack Mambazo, the next Emmylou Harris or the New World Symphony under the baton of Michael Tilson Thomas. This "nice work" is found at the festivals that appeal to the more affluent, 25-and-older crowd. Backed by corporate, community and foundation underwriting, such festivals offer a source of stable income for mid-sized sound companies suffering from a general downturn in touring by developing pop/rock artists. But, since the better festivals are more concerned with quality

and reliability than price, you can't depend on landing contracts (thank God!) simply by slashing your rates. A different approach is called for, as exemplified by one highly successful regional company based in Eugene, OR.

#### **CASE STUDY: GEORGE RELLES**

Those four critically acclaimed acts mentioned above represent a cross-section of festival work on the 1991 summer calendar of George Relles Sound Reinforcement. Relles has been cultivating this segment of the market for all of his 17 years in business, to the point where he estimates that ongoing summer festival contracts now represent over 60% of his gross income. Relles' approach to concert sound was heavily influenced by his own experiences as a musician: a long-time banjo player, he toured regularly with Mason "Classical Gas" Williams. Relles was often dismayed by the quality of sound he heard, whether at bluegrass festivals or outdoor orchestral "pops" concerts, particularly when reinforcement was contracted to companies primarily experienced in rock music. Consequently, when he decided to start his own SR company, he opted for an approach that contrasted sharply with most oth-

er budding SR companies of the time. For example, instead of starting out with the accepted "rock-standard" Altec A-7 cabinets and Shure SM57/58 mics, his initial investment was in Klipsch LaScala speakers and a half-dozen AKG 451 mics.

Over the years, as Relles gradually expanded his capabilities, he maintained an emphasis on quality equipment suitable for a wide-range of acoustic or low-level amplified music. The original Allen & Heath console was upgraded to a Hill Audio B series 24-input, then a Hill Concept Series 32-input, and finally in 1990 a mint-condition, used Gamble HC-40 for house mixes and a new Ramsa WR-S840 for monitors. After the LaScalas came a JBL-loaded Harbinger system, and most recently a Meyer Sound array suitable for most mid-sized venues. Throughout this time he continued to build his mic inventory, with a particular emphasis on condenser models from Neumann and AKG.

Throughout most of the summer, Relles keeps two systems on the road, criss-crossing the Northwest from Northern California to Montana. A half-dozen "upscale" festivals anchor his schedule, with in-between dates booked with community celebrations of one sort or another. A computer printout of national touring acts who have used Relles' services demonstrates how he has established himself in a secure niche. Broken down into musical categories, his roster lists 31 bluegrass acts, 34 folk and 81 jazz. What's more, the 45 rock acts listed tend toward the likes of Linda Ronstadt, Los Lobos, Bonnie Raitt and David Lindley.

At this point in his career, Relles has the luxury of being selective. He does not work any county fairs, the unappetizing summer staple of many mid-size regional companies. He will not accept "fuzzy" contracts, such as the one

Bruce Borgerson is a free-lance writer and principal of Tech/Write Communications, a pro audio PR and consulting firm in Ashland, OR.

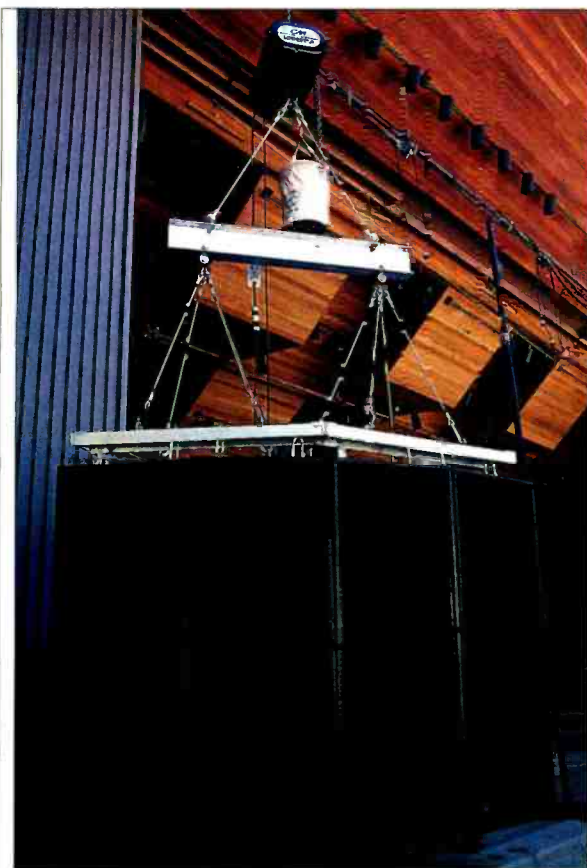

Expecting to fly: Relles' Meyer MSL-3 cabinets ready to hoist under their new custom rigging.

proffered by an Oregon county parks and recreation department, which required commitment to a certain number of performances without specifying exact dates or specific artists. Though this uncompromising attitude has cost him a few jobs, he feels it has helped maintain his overall reputation as a leading, high-quality company in the Northwest. The following comments on "how to succeed at festivals" were culled from conversations during one typical

weekend at the Britt Festivals in Jacksonville, OR.

#### EQUIPMENT SELECTION

With particular emphasis on quality instrument mics and condenser models, Relles says, "Get plenty of good mics." One of Relles' favorites is the Shure SM81 for acoustic guitar. "It may not be the most expensive or flattest mic around, but in a festival situation where I need a ton of gain before feedback, I get wonderful things out of it. In combination with the Gamble console, I am amazed how loud I can get a guitar before feedback."

Concerning console selection, acceptability to top touring acts has to be a consideration. "That played a part in choosing the Gamble," Relles says. "The reputation of the board is very good, even though some engineers are not that familiar with it. Sometimes I get specific requests for the Yamaha PM-3000, because that is what many touring engineers will use on 80% of their shows. Since they know where to set all their input gains and where to make their patches, it is easier for them to work on. But the built-in patchbay on the Gamble does help, and everybody likes the sound of the parametric EQ."

An abundance of console inputs is also an essential criterion. "You want to have a console where, if you have a sound check and an opening act, you don't have to disturb your settings. So you should have a minimum of 32, but preferably 40 or more. Having a second console may not help, because at some festivals (Britt for example) there is no room for a sec-

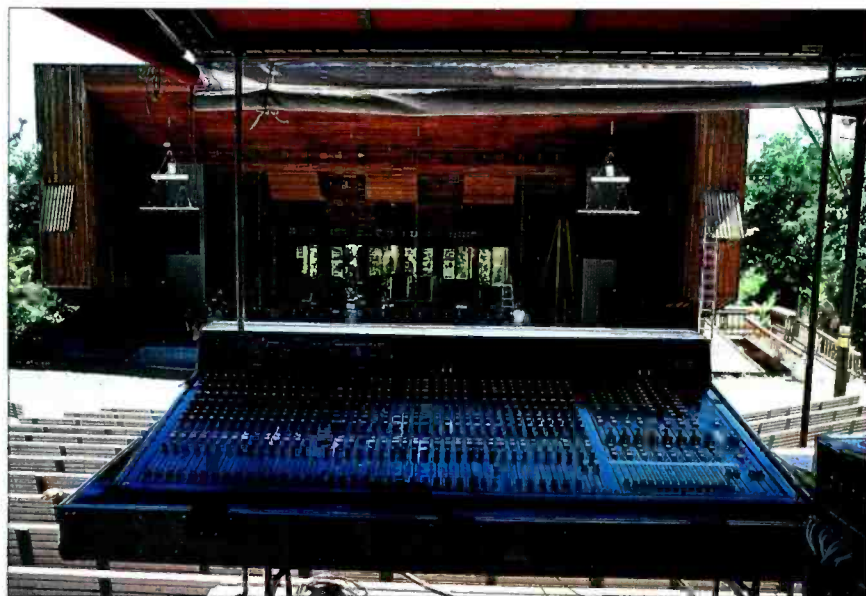

A view from the platform: the Britt Festival's stage area from the FOH position, behind the Gamble HC40.

#### SR FOR WYNTON MARSALIS: A PURIST/MINIMALIST APPROACH

For his appearance at the Britt Festivals, 8-time Grammy winner Wynton Marsalis required only 13 inputs; all mics with no DIs for his 7-piece jazz group. He let Relles' monitor mixer, Mike Nemeth, take the night off, as stage monitoring was not required. And, except for parametric EQ on the Gamble HC40 input strips, no signal processing of any kind was used. After the performance, Marsalis' house mix engineer, David Robinson, provided some insights into this "purist/minimalist" approach.

**General philosophy:** "Wynton feels, personally, that the fewer microphones on the stage the better. He tries to keep as close to naturalism as possible. I spend a lot of time sitting right inside the band during rehearsals, listening up close. That helps me understand the sound of each instrument, and how it fits in the sound of the band as a whole. What you hear in the 20th or 30th row should be the same as what you hear sitting right on the bandstand. I try to recreate that warm, heavy, jazz sound. Jazz is not a thin music. It has definite weight to its character, a certain woodiness and darkness throughout the group, including the bass, piano, and drums, which all have a wooden sound. Brass should have a weight to it as well."

**Mic selection:** "I don't necessarily look for top-of-the line or esoteric mics, but I do prefer a good selection of quality mics, like Neumann, AKG, Beyer and Schoeps. We use the EV RE20 for Wynton because it is a rugged, good-sounding mic. We are considering getting our own Neumann U87 for Wynton and taking it on the road with us, though we aren't sure how a studio mic will work out in live situations on the road."

**No kick drum mic:** "Well-placed overhead mics should pull the kit into a good balance. Also, in many venues, the bass drum has a tendency to bleed into the bass mics because of low-end resonance on stage, so there is no need to emphasize it further."

**No reverb:** "The wood stage shell and the amphitheater at the Britt had such a natural vibrancy and acoustic ambience that there was no need to add to it."

**No compression:** "You really do have to watch the horn mics. Sometimes Wynton will play right on the mic, and when he hits loud notes the peaks can be a problem. I work with him, and try to get him to stay six to 10 inches away. There are a few passages where he may clip, but I would rather live with that in a concert situation than alter his dynamics with compression."

**No monitors:** "That's Wynton's aesthetic, and as an engineer I am grateful for it. He feels that, when a band plays without monitors, they concentrate less on what is in front of them and more on what is around them. They have to pay very close attention to subtle changes in the rhythm section, to shifts in tempo. This allows them to be better musicians, especially in the context of jazz, which relies on each individual bringing talents to bear in the context

*Continued on page 53*



# HEAVY DEALS

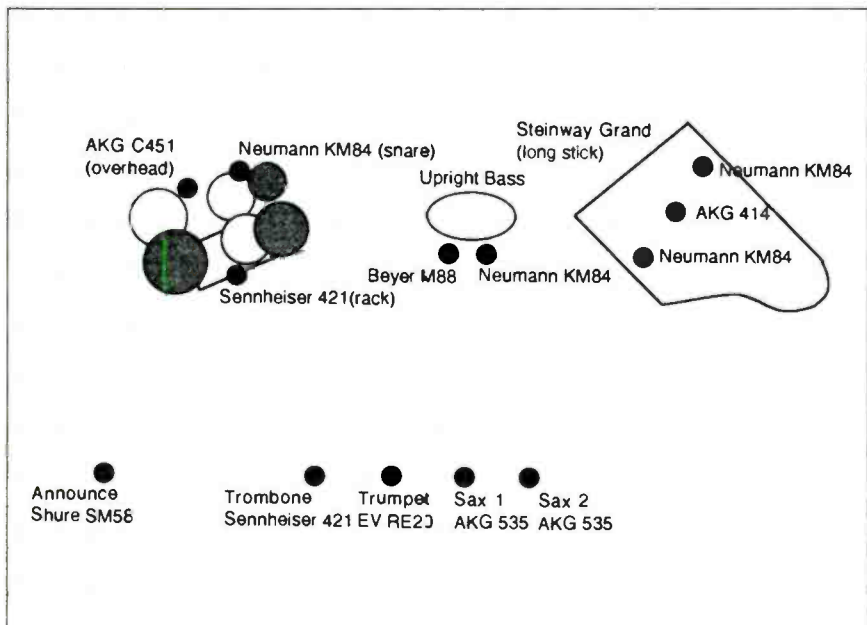

Wynton Marsalis stage plan from the Britt Festival, July 26, 1991.

and main mixer, though you might fit in a small 8- or 12-input submixer."

How about VCA grouping? "Some people don't like VCAs, but I find VCA groups helpful when mixing classical. When you are grouping different sections, like the high strings for example, and you need to pull a section down, you don't change your reverb ratio. I generally prefer my Hill console for classical for that reason, and to me it does give a clean, natural sound."

When it comes to reverb, Relles' racks show a certain fondness for Lexicon. "I started with a Lexicon 200, because at the time I bought it back in 1983, it was the only high-quality digital reverb I could afford — around \$5,000 as I remember. Since then I have added the PCM70 and the LXP series with the MRC controller. A lot of touring mixers will have programs already worked out on Yamaha units, so I will probably be getting one of those soon."

Relles also advises investment in one high-quality parametric, particularly if your console is limited in that department. His personal favorite is the Meyer Sound CP-10.

## TRADE TRICKS FOR ACOUSTIC MUSIC

After long years of working with acoustic musicians, Relles has learned how to deal with mics, monitor levels and level-hungry performers.

"Monitor levels can be a real problem with acoustic groups. If they are demanding rock 'n' roll levels, and they have miked instruments, you have a big problem with vocals from the monitors hitting the guitar, and introducing a comb-filter or phase-shifted effect to the mix. Then you have to run the vocal mic that much hotter, or otherwise the singer sounds like he's in a bathroom singing through a cheap club system. You can discover that problem by muting the guitar mic, which cleans it up instantly. "Sometimes a real problem is performers who do not understand the dynamics of the sound system out in the house. In some festivals, groups will come on one after another,

with no sound check. They step up to the mic and do their 'test 1, 2, 3' routine. I used to think it was tacky to let the audience hear that, but I've learned a lesson since. If they don't hear themselves booming out into the house on that mic check, they will bitch and moan the whole show about not being loud enough. So now, when they do their 'test, test,' I have the system cranked up all the way. They grin ear to ear, start out playing happy, and then I pull it down to a reasonable level."

## MIXING THE CLASSICS

Since many classical festivals — even those with top-name conductors — do not hire their own mixing engineers, it's important to be familiar with miking and mixing classical music. Relles has some tips: "I basically have two approaches. For a 'pure' classical performance with an audience under 3,000, I will usually use six Neumann KM-84s set in three coincident pairs left, center and right. Sometimes I will mic the basses separately, along with any weak instruments. I usually put a pair of AKG 460s stage left and stage right to augment high and low strings as needed. For symphonic pops concerts, particularly in large parks where I use delay towers, I will mic each stand separately using the KM84s, AKG 460s and 451s. This is a different kind of show, where you want more of a rock 'em, sock 'em effect."

Relles prefers to do all of his mixes in stereo, though he advises caution when the audience is widely dispersed. "At Sandpoint, where the audience wraps around 180°, you can have a real problem, so I usually have a mono mix speaker off to the side, and sometimes I will cross over the signal to the far cabinet in the array."

A must for classical festivals is a high-quality digital reverb. "I use my Lexicon 200 for a hall sound, with a 2.2- to 2.4-second RT60, and the high-end rolled off at about 4kHz."

Many festivals are located in residential neighborhoods, and will therefore impose strict loudness limits and ending times. The Britt Festival

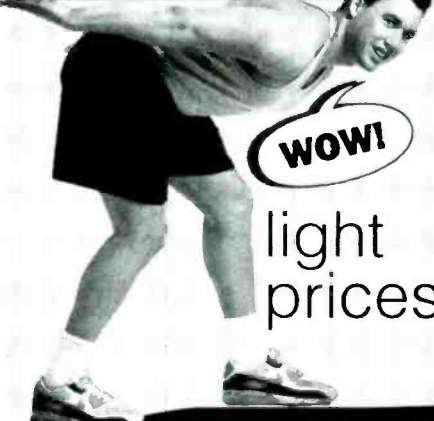
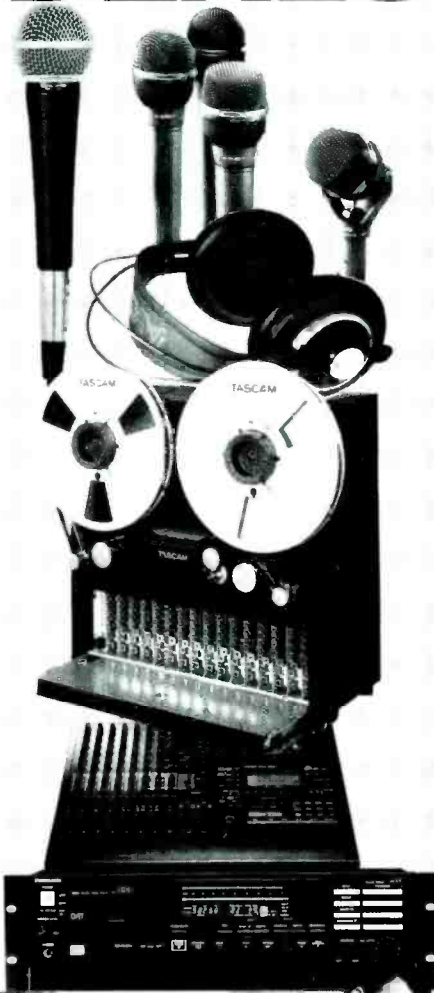

Over 300 top quality product lines priced so low we promised not to print them!

**1-800-356-5844**

AUDIO • VIDEO • LIGHTS



Consultation: 608/271-1100  
5618 Odana Rd., Madison, WI 53719

Circle (29) on Rapid Facts Card



Ladysmith Black Mambazo's house mixer, Fred Schuchman at the Gamble, with system owner George Relles holding up the rack.

plished with no foul-ups. This is where ample console inputs can be a real life-saver.

#### SOMETHING COMPLETELY DIFFERENT ...

Working festivals can be a study in contrasts. Relles' work last July 26 and 27 at the Britt Festivals serves as a good example. The Friday bill was Wynton Marsalis, with solo pianist Marcus Roberts opening (See sidebar): all instrumental, no vocals, no monitors, 13 inputs total for both acts.

The next night brought Ladysmith Black Mambazo as headliners, with the Balafon Marimba Ensemble opening the show, with an 8-member group playing multiple instruments. It was a fortunate combination: Balafon used up most of the SM-81s and KM-84s and a couple of dozen inputs, with the matched set of AKG 535s and remaining inputs held in reserve for the South African acapella group. "Those two were easy," Relles says. "What you really have to prepare for is a marimba band followed by a big Salsa group!"

David Robinson mixed Wynton Marsalis using little more than a straight wire with gain. Ladysmith mixer, Fred Schuchman applied compression to all three sub-groups (basses, tenors and lead vocal), a touch of graphic EQ and two different reverb units for ambient brilliance and overall hall sound. Despite their different approaches, both mixers expressed a high degree of satisfaction with the mic selection, Gamble console and Meyer Sound house arrays. ■

tivals are particularly strict, with a restriction of 90dB-A at the FOH position, averaged over 15 minutes, with readings taken every 30 seconds. "This can be problematic," says Relles, "since a few years ago B.B. King and band were up to 97dB with the house mains shut off!" Most festivals tend to be more lenient, allowing aver-

ages of around 97dB-A. In any case, system fullness, balance and clarity are essential to deliver maximum "perceptual loudness" when desired.

Strict ending times (10:30 p.m. at Britt) mean you absolutely must be prepared to start on time. Intermission set-ups must be accom-

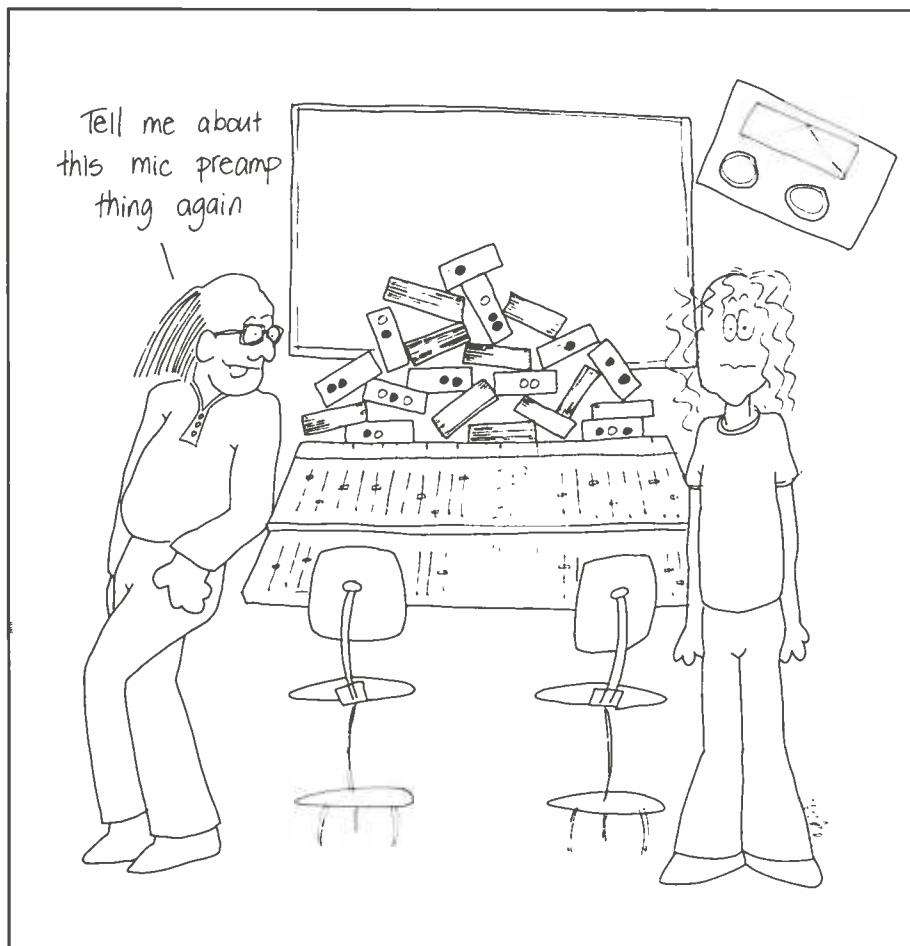

# REPRINTS

**Interested in ordering article reprints out of this or another issue?\***  
**Reprints can be excellent learning tools for your technical staff and great marketing tools for your sales staff.**  
**Call or write Intertec Publishing Corp., P. O. Box 12901, Overland Park, KS 66212; (913) 888-4664.**

\*Minimum order 500 copies.

Continued from page 50

of a group, so that the group itself can then become a distinct individual. I think it [no monitors] does make for better musicianship, and from a sound standpoint this is wonderful, because the less extraneous the sound is on stage, the better."

**Gamble HC40 console:** "I like it very much. It's very clean, and there are no problems with the EQ being too harsh or too soft. When you run subs on it, you don't have to worry about degradation. What goes to the mains is what you had at the input."

**Britt Festivals Performance:** "It was excellent. I had no problems at all. They had a wonderful system there, extremely clear and well balanced. I also like the acoustic properties of the stage, which is all wood with good natural resonance."

#### RELLES SOUND EQUIPMENT LIST

Equipment provided by George Relles Sound Reinforcement for the Britt Festivals concerts on July 26 (Wynton Marsalis); July 27 (Ladysmith Black Mambazo); and July 28 (Dizzy Gillespie).

**House speakers:** (8) Meyer Sound MSL-3, (4) 650-R2 subwoofer.

**House console:** (8) Gamble HC-40, 40x16 with eight line returns.

**House effects rack — reverb and delay:** Lexicon 200, LXP-1, LXP-5, MRC, PCM-70; Audio Digital ADD-2; Delta Lab ADM 512.

**Dynamics processing:** (1) A+D Scamp Rack with Dual Gate, (2) Expander, (4) Compressor; (2) Drawmer M500; (4) Valley International Rack with Gain Brain II, (4) Comander, (1) DSP.

**Equalization:** (1) Meyer Sound CP-10 parametric; (2) Scamp parametric and (3) sweep; (2) Valley Maxi Q; (2) Klark-Teknik DN410 dual parametric and DN360 graphic; Sundholm 2103 graphic.

**Processing:** BBE 822 Sonic Maximizer, BBE 220R exciter.

**Monitor console:** Ramsa WR-S840 40x18.

**Monitor effects:** (3) Valley Maxi-Q; (4) Gain Brain II; BSS DPR 504 4-channel gate; (2) Lexicon LXP-1; (2) dbx 1531X and 1531P (7) graphic equalizer.

**Monitor speakers:** (4) Meyer Sound UM-1 and (4) UPA-1A; (2) EAW 222.

**Power amps:** (12) Hill DX1500, (8) Hill LC1200.

**Mics:** Neumann KM84, KM100; AKG C451, C414, C535, C460; Beyers M260, M88; Shure SM81, SM 57, SM 58; Sennheiser 421; EV RE 20, N/D408A; Countryman EM101 and others. ■

# STUDIO QUALITY

Direct-To-Disk Audio Editing  
on PC/ATs with  
**MICRO SOUND™**

- 2 or 4-track analog 16-bit A/D and 18-bit D/A 64x/8x oversampling converters
- Direct-digital transfers to/from DAT or CD
- Windows 3.0 based graphic waveform editor
- Record from 8KHz to 48KHz rates
- Rearrange segments in any order using crossfading or butt-splicing for linear arrangements playing in real-time
- Disk-Layering™ will mix overlapped segments with unique fade/gain settings, from up to 20 files to play 4, 6, 8...32-track simultaneous mixes
- Zoom from sample level to track-hours to make edits (undoable anytime)
- Hear edits using Play mark, Scrub, Audition and more
- SMPTE/MIDI Chase-Lock to incoming timecode, locking and playing within 1 second
- Overdubbing optional
- Ready-to-use MicroSound™ WorkStations also available

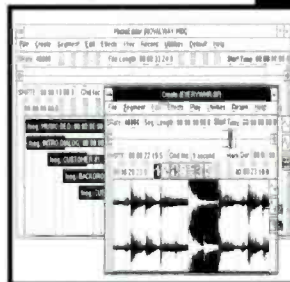

**MTU**  
Micro Technology Unlimited

156 Wind Chime Court  
Raleigh, NC 27619  
Phone: (919) 870-0344  
Fax: (919) 870-7163

You CAN  
have a  
Digital  
Audio  
Studio  
NOW!

To  
find  
out  
how —  
CALL  
WRITE  
or FAX  
today - for  
a free  
brochure  
that  
explains  
how to  
meet your  
audio  
needs.

Circle (25) on Rapid Facts Card

## Sam Ash

PROFESSIONAL

### INNOVATIVE SOLUTIONS FOR PROFESSIONALS

- DESIGN • SALES
- SERVICE • PARTS
- INNOVATIVE
- FINANCING PLANS
- RUSH DELIVERY



AKAI A.D.A.M. 12-TRACK  
DIGITAL AUDIO RECORDER

#### NEW YORK'S LARGEST PRO AUDIO INVENTORY

• PROCESSORS BY EVENTIDE, LEXICON, DBX, SYMETRIX, VALLEY PEOPLE, T.C. ELECTRONICS & AUDIO LOGIC • D.A.T. FEATURING SONY, TASCAM, CASIO AND OTHER LEADING PROFESSIONAL BRANDS • SAMPLERS FEATURING THE AKAIS-1000 & S1000HD, THE ROLAND S-770, S-550, & S-330, THE EMU EMAX II, F111 & PROTUS • INTRODUCING D.A.R. DIGITAL WORKSTATION—POSTPRODUCTION POWER TOOL.

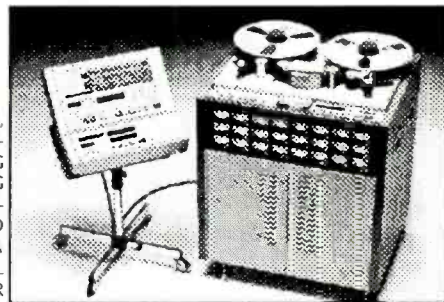

TASCAM ATR-80 JAPAN'S FINEST 2" 24-TRACK

723 SEVENTH AVENUE (THIRD FLOOR)  
NEW YORK CITY • 10036 • (212) 719-2640

Circle (28) on Rapid Facts Card

# Roadwork

By Mark Herman

In retrospect, last winter was dead, spring was late and the summer was mediocre at best. This fall has seen many acts drawing poorly at the gates, with many productions scaling down expectations and trimming costs wherever possible. It's no picnic out there for many sound companies, pro equipment retailers and manufacturers. Once again weekly tour prices are being radically slashed, and the winter concert season looks like it could be very slow for some time. This is probably not the year you'll see sound company research and development, or large capital investing. Things could get very interesting if promoters and acts continue to postpone concert dates and tours until the economy rights itself. Brace yourself for a long, slow winter season.

**Clair Tour Update ...** In the midst of the summer and fall slowdown, Clair Bros. (Lititz, PA) has maintained a healthy client roster. Most of Clair's equipment has been working with the following tours through the past four months ... Sting began his summer doing stadiums in Europe, traveled across North America and is scheduled to return to Europe ... Paul Simon's North American tour went through the summer and early fall with a system featuring 144 S4 Series II boxes. **David Morgan** (R•E•P 'Spotlight', Sept. 1991) did a great job mixing FOH with a Gamble EX56 console; **"Dr." Dave Staub** handled stage mixing. One of the tour's highlights was the free concert in New York's Central Park in mid-August, a show which drew an estimated 700,000 people ... The highly unpredictable Prince began rehearsals in July and is just now scheduled to go out in mid-November ... Ex-Eagle Don Henley enjoyed a successful summer and fall tour that finished in October; **Trip Kahlaf** mixed using a 48-box S4 rig ... Steve Miller and Stevie Nicks finished their respective tours in August. Both systems featured high-end ATI Paragon consoles out front ... 38 Special started in September ... The Yes reunion tour that finished in August played a mixture of sheds and coliseums ... Clair's Japanese division has been keeping five systems busy primarily with Japanese acts ... Amy Grant's latest tour started in July and is continuing through Christmas with a 48-box rig ... Lynyrd Skynyrd's tour started in July and is slated to continue through late November ... Pop group Roxette is currently carrying 48 boxes across Europe and will continue into 1992 ... Debbie Gibson used a 16-box system July and August ... Australian star Kylie Minogue recently played Europe ... C&C Music Factory toured with Clair Oct. 7 through Nov. 15 ... Bob Dylan was out for a fall run with 24 boxes ... Hard-working Kenny Rogers is still touring with his typical three weeks on and one to two weeks off routine ... Clair's CTS house drive system has become standard on most of their systems. The t.c. electronic 6032 remote control EQ sys-



*Delicate Productions' Martin F2 concert speaker system.*

tem — pioneered by Clair — is being used on many of the Clair Bros. touring rigs.

**Blast From The Past ...** How many watts of amplifier power were used at 1967 Woodstock for the main PA system? **Bill Hanley**, one of the main engineers at Woodstock, states that 12,000W of McIntosh amps powered the entire main PA supplied by **Terry Hanley Audio Systems**. Isn't that amazing? Now some heavy metal drummers use nearly that much for their drum fills alone.

**Speaker shootout ...** Ace Music Center (Miami and Orlando, FL) coordinated a large scale speaker shootout September 18th and 19th at Walt Disney World for Disney Audio personnel. Loudspeaker manufacturers Meyer, Adamson, JBL, Yamaha, EAW, MacPherson, Ramsa, EV, Community, Tannoy, Bond, Intersonics, Apogee, Renkus Heinz, Klipsch and Fane demonstrated equipment in eight speaker categories. Each manufacturer provided power amplification of their choice. This was the first time this many speaker manufacturers (16 total) have ever gone head-to-head on the same stage.

**Audio Analysts Moves ...** For years Audio Analysts has been one of the leading sound companies in the concert touring field. In early September, they moved their main U.S. operations from Plattsburgh, NY to Colorado Springs. AA will still keep a warehouse in Plattsburgh and their offices in Montreal and Los Angeles. AA has been touring with the highly successful New Kids On The Block. The New Kids are the most profitable act in the world with over \$110 million earned this past year alone.

Canadian loudspeaker manufacturer **Adamson Acoustic Design** recently exported FOH systems to sound companies Armonia Nova (Bologna, Italy), Inversiones Intertek (Caracas, Venezuela) and Lyd Systemer (Oslo, Norway). U.S. companies buying Adamson's innovative Acoustic Waveguide boxes included Continental Sound (Chicago), Gulf Coast Sound (Houston) and Golden State Sound (Santa Rosa, CA).

Those interested in lighting production as well as audio may want to know that this year's **Lighting Dimensions International** show is in Reno, NV, November 22-24. The LDI 1991 show attracts numerous exhibitors, industrial producers, system designers, concert designers, TV and film studio execs, lighting companies, club owners and others from around the world.

**Quiz ...** 1. What is the primary input op-amp in a Yamaha PM3000 mixing console? 2. What model high-frequency driver is most frequently used in the popular EAW KF850 concert cabinet? Answers ... 1. Texas Instruments NE5532P. 2. The TAD 4001 and the new TAD 4002.

**Schubert Systems Group** (North Hollywood) has been providing Bonnie Raitt's tour with 40 boxes of SSG Steradian mains and 16 subs. Consoles for Raitt have been a Gamble EX56 FOH and a Gamble SC40x16 on stage. A Gamble HC24 and a Yamaha 2408 were supplied for the support act. Other SSG work included the Doobie Bros. tour, three weeks around Halloween with Oingo Boingo and Luis Miguel's October tour.

**RAT Sound** (Sun Valley, CA) is making a move up to national touring with the controversial, but highly seasoned Red Hot Chili Peppers. They have put together their largest system ever to play the 5,000- to 12,000-seat venues in the large cities on their itinerary. Sound, lights and band gear are tightly packed into one semi ... Several months ago, Rat Sound had equipment stolen out of one of their trucks. Some of the items lost were amp racks with Crest 7001, 4801 and 2501As, a 200-foot, 52-pair Mass-to-Mass snake, two TAD-loaded subwoofers, four wedges and several TDM 24CX4 crossovers.

**Odds and Ends ...** **Third Ear Sound** (Richmond, CA) was the first U.S. sound company to take possession of the new Soundcraft Europa. The new 40-channel FOH console was delivered in late September ... **Frontline Sound and Lighting** (Milpitas, CA) bought a 36-channel, 4-matrix Soundcraft Venue house console. The Venue was immediately put to work on a 32-week theatrical show ... **Mid West Audio Group** renovated the sound system at the Louisville Arts Center (Louisville, KY). The upgrade included t.c. electronic TC1128 programmable EQs, TC1380 multitrack delays and TC1280 stereo delays ... **Delicate Productions** (Camarillo, CA) is providing sound for the current Natalie Cole tour. The red hot Cole is using 24 Martin F2 and four F1 cabinets, a Yamaha PM3000 out front and a Midas XL3 on stage. Delicate bought their new Midas XL3 in mid-September. ■

Mark Herman is president of Hi-Tech Audio Systems, a sound reinforcement equipment rental company based in South San Francisco.

**STATEMENT OF OWNERSHIP**

**Statement of Ownership, Management and Circulation (Act of August 12, 1970; Section 3685, Title 39, United States Code).**

1. Title of publication: R•E•P: Recording, Engineering, Production.

1A. 341-673.

2. Date of filing: Sept. 17, 1991.

3. Frequency of issue: Monthly.

3A. Number of issues published annually: 12.

3B. Annual subscription price: \$26 & free to qualified.

4. Location of known office of publication (street, city, county, state, zip code): P.O. Box 12901, Overland Park, Johnson County, Kansas 66212.

5. Location of the headquarters or general business offices of the publishers (not printers): 9221 Quivira Road, Overland Park, Johnson County, Kansas 66215.

6. Names and addresses of publisher, editor, and managing editor. Publisher: Dennis Milan, 9221 Quivira Road, Overland Park, Kansas 66215. Editor: Mike Joseph, 9221 Quivira Road, Overland Park, Kansas 66215. Managing Editor: Tom Cook, 9221 Quivira Road, Overland Park, Kansas 66215.

7. Owner (If owned by a corporation, its name and address must be stated and also immediately thereunder the names and addresses of stockholders owning or holding 1 percent or more of total amount of stock. If not owned by a corporation, the names and addresses of the individual owners must be given. If owned by a partnership or other unincorporated firm, its name and address, as well as that of each individual must be given. If the publication is published by a nonprofit organization, its name and address must be stated.) Intertec Publishing Corp. is a wholly owned subsidiary of Intertec Group, Inc., 717 5th Ave., 22nd Floor, New York, NY 10022.

8. Known bondholders, mortgagees, and other security holders owning or holding 1 percent or more of total amount of bonds, mortgages or other securities (if there are none, so state): None.

9. Paragraphs 7 and 8 include, in cases where the stockholder or security holder appears upon the books of the company as trustee or in any other fiduciary relation, the name of the person or corporation for whom such trustee is acting, also the statements in the two paragraphs show the affiant's full knowledge and belief as to the circumstances and conditions under which stockholders and security holders who do not appear upon the books of the company as trustees, hold stock and securities in a capacity other than that of a bona fide owner. Names and addresses of individuals who are stockholders of a corporation which itself is a stockholder or holder of bonds, mortgages or other securities of paragraphs 7 and 8 when the interests of such individuals are equivalent to 1 percent or more of the total amount of the stock or securities of the publishing corporation.

10. This item must be completed for all publications except those that do not carry advertising other than the publisher's own and are named in sections 132.231, 132.232 and 132.233, postal manual (Sections 4355a, 4354b, and 4356 of Title 39, United States Code).

	Average No. Copies Each Issue During Preceding 12 Months	Single Issue Nearest To Filing Date
--	--	-------------------------------------

A. Total No. Copies Printed (Net Press Run) .....	23,977	26,200
B. Paid and/or Requested Circulation		
1. Sales through dealers and carriers, street vendors and counter sales .....	—	—
2. Mail subscriptions .....	20,167	20,126
C. Total Paid and/or Requested Circulation .....	20,167	20,126
D. Free Distribution (including samples) by mail, carrier delivery or other means .....	1,808	1,935
E. Total Distribution (Sum of C and D) .....	21,975	22,061
F. Office use, left over, unaccounted, spoiled after printing .....	2,002	4,139
G. Total (Sum of E and F should equal net press run shown in A) .....	23,977	26,200

I certify that the statements made by me above are correct. (Signature of editor, publisher, business manager, or owner.)

Douglas A. Wilding,  
Circulation Director

# All Access

By Mark Herman and Louis Adamo

SHOWCO, DALLAS

Headline Act:  
**George Michael**

Dates: Oct.-Nov. 1991  
Region: North America

**PERSONNEL**

**House Mixer:** Benji Lefevre (independent)

**Monitor Mixer:** Chris Wade-Evans (independent)

**Head System Engineer:** David "Cowboy" Conyers

**Technicians:** Mike Allison, Eddie Harbin, Jim Putnam

**CONSOLES**

**House:** Harrison HM-5 with Extender plus DMP 7

**Monitor:** Harrison SM-5 with Extender plus DMP 7

**AMPLIFIERS**

**Main FOH:** Crown Macro-Tech 1200, PSA-2

**Lows/Subs:** Crown Macro-Tech 1200, PSA-2

**Monitors:** Crown Macro-Tech 1200, PSA-2

**FOH MAIN CABINETS**

**Model:** (16 Column + Nearfield Fill) Showco Prism Arena Array

**Flying System:** Showco Prism Suspension System

**Delay Speakers:** Showco Prism Flown Delay System (Stadiums/Domes)

**LOW END CABINET/SUBWOOFER**

**Model:** Showco Prism Arena Subwoofer Array

**ONSTAGE MONITOR WEDGES**

**Model:** (32) Showco BFM Series-600

**Crossover:** Showco 1017 2/3 way Constant Voltage Biamped Crossover System

**Model:** (6) Showco BFM Series-450

**Crossover:** Showco 1017 2/3 way Constant Voltage Biamped Crossover System

**Model:** (6) Showco B-1

**Crossover:** Showco Model 1018 Monitor Subwoofer Crossover System

**ONSTAGE SIDEFILLS**

**Manufacturer/Model:** (8) Showco Prism Stereo Flown Sidefill Array

**Crossover:** Showco Prism Model 1015 Sidefill Monitor Crossover System

**HOUSE SIGNAL PROCESSING**

**Equalizers:** Showco I.R.P. TEQ

**Crossover:** Showco Prism Digital Control System

**Reverb:** (2) AMS RMX-16, Yamaha Rev7, Yamaha SPX-9011

**Delay:** AMS DMX15-80S

**Other Effects:** Roland SRE-555

**Gates:** Drawmer DS201, dbx 904

**Compressor/Limiters:** dbx 160X, UREI 1176LN

**DAT Machine:** Panasonic SV3700

**Cassette Machine:** Tascam 122 MKII

**CD Player:** Tascam CD501

**Headphones:** Fostex T20

**Intercom System:** Clearcom

**Analyzer:** Klark-Teknik DN60, Crown BDP-2

**ONSTAGE SIGNAL PROCESSING**

**Equalizers:** Showco I.R.P. TEQ

**Effects:** (2) Yamaha Rev5, (2) Yamaha SPX-9011

**Gates:** Drawmer DS201, dbx 904

**Compressor/Limiters:** Klark-Teknik DN504 Quad Limiter

**Headphones:** Fostex T20

**Analyzer:** Klark-Teknik DN60

**MICROPHONES:**

**Vocals:** Showco custom-modified Sony WRR Series Wireless Systems

**Background Vocals:** Shure SM58

**Kick:** Sennheiser 421

**Rack Toms:** Sennheiser 421

**Floor Toms:** Sennheiser 421

**Overheads:** AKG 414

**Snare Top:** B&K 4011

**Snare Bottom:** AKG 414

**Hi-Hat:** AKG 460

**Guitars:** Shure SM57

**Keyboards:** Showco Custom Matching Transformers

**Bass:** Countryman DI

**Percussion:** AKG 414, Shure SM57, AKG 460

**Saxophone:** Sennheiser 421

**Choir:** Neumann U87

**MISCELLANEOUS**

**House Snake:** 58 + 12 pairs

**Multi-pair connectors:** I.T.T. Cannon Seismic

**Stageboxes:** Showco custom

**Splitter:** 3-way splitter

Mark Herman is a contributing editor to R•E•P. He and Louis Adamo are co-owners of Hi-Tech Audio, a sound reinforcement equipment rental company based in South San Francisco.

**HANDS ON:**

# MEYER SOUND LABORATORIES HD-1

By Mike Joseph



It is virtually impossible to go to an audio convention or seminar, whether it be AES, NAB or a SPARS workstation gathering, and *not* see the Meyer Sound HD-1 High Definition Audio Monitor doing duty as *the* demo-stand monitor. And slowly but surely, the monitor is making its presence equally known in studios and production facilities. An ever greater number of albums are touting the fact that the mix-downs, if not the entire projects, were completed on the HD-1s. Clearly, this diminutive, rather expensive self-powered loudspeaker is positioning itself as the reference device of choice. If ever there was a buzz over a monitor (pun excluded), this Meyer product has it.

## SPECS AND DESCRIPTION

Manufacturer: Meyer Sound  
Laboratories, Inc.  
Contact: Mark Johnson  
2832 San Pablo Avenue  
Berkeley, CA 94702  
PH-415-486-1166  
FAX-415-486-8356  
Model: HD-1  
Price: \$4,500 per pair  
Design: 2-way, self powered with  
internal protection  
circuitry.  
Components: (1) 8-inch woofer, (1)  
1-inch dome tweeter  
Output Level: 125dB SPL peak  
(claimed), 1/3-octave  
average, 40Hz to 20kHz.  
Size: 16" H x 12" W x 14" D (add  
2" D for amp chassis).  
Weight: 51 pounds

Mike Joseph is editor of R•E•P.

## THOUGHTS ON MONITORS

By Dan Levitin

Engineer Roger Nichols (Steely Dan, John Denver, Rosanne Cash), who now endorses Meyer HD-1s, has been using audiophile speakers for years. One of the speakers he ended up working with was Miller & Kreisel's 3-speaker system, two satellites with a 400W powered subwoofer.

"Walter [Becker] went out to M&K in Culver City and picked up a set from Ken Kreisel, which I tried using in the studio. I liked them, but there is always the problem of where to put the subwoofer in the control room," Nichols says.

I recently A-B'd the M&Ks with the Meyer HD-1s for a week in a variety of different settings. The HD-1s have a much broader angle of stereo imaging along the x-axis (from side to side). Along the y-axis (up and down) the HD-1s are also very good, though not as good as along the x-axis. Along the z-axis (back to front) the HD-1s begin to lose their sound as you get too far back. Nichols suggests the listener form an equilateral triangle, with his ears the same distance from the speakers as the speaker's separation, but no farther than a meter and a half away.

The HD-1s are incredibly accurate but not very musical. I would rather mix to HD-1s, but would prefer in almost all cases, listening back on M&Ks. In listening to a variety of music, classical, jazz, rock and metal, the M&Ks uniformly sounded much better; the material sounded more musical. The HD-1s presented the music with a stark accuracy that was in many cases disappointing, and in others annoying. I was unable to find one classical recording that sounded good on the HD-1s, nor any small jazz combo recordings. Over the HD-1s, the orchestra sounded like a disparate group of instruments, strangely smeared in some instances, strangely distant from one another in other instances.

John D'Arcy, a design engineer for M&K in the early 1980s, spoke about the speaker's design. "The tweeter on the baffle of the HD-1s drives me up the wall. It has the same sort of effect as cupping your hands behind your ears. The only reason I know, is that we did a lot of work trying to design a bookshelf speaker. Whenever we put the tweeter in the same physical box as the woofers, we ended up with this big baffle problem, which you can hear on the Meyers.

"With a dome tweeter, you have sound radiating in two pi steradians, which means that sound is coming off the tweeter and running parallel to the surface of the speaker. Eventually that sound strikes the baffle so that you create frequency and phase anomalies by reflection, and you end up with additive and subtractive effects. If Meyer went to a trapezoidal design, that would solve a lot of the problems." The M&Ks are shaped to combat this problem.

Engineer Jeffrey Norman worked on the Grateful Dead's album "Without A Net" using HD-1s. "Both the producer and I can be at the board, and I can be on one side working and still be talking about the center. But one's distance away from them is crucial, particularly in mixing; you really have to be in that equilateral triangle.

"The HD-1s have an unusual ability to show you where things are placed — they're great detail speakers. In fact, they would show detail so clearly that we were afraid of putting down the reverb we heard. Hearing the mixes elsewhere, we realized they were too dry, so my feeling was that they were really reproducing exactly what was going on. But they're really not my favorite speakers for listening. They're not particularly fun to listen to."

Norman is also a fan of M&Ks. "The M&Ks are some of the greatest sounding speakers I've ever heard. I liked them right away. I thought they were very clear and made it easy to 'see' things."

My own subjective impressions parallel those of Mr. D'Arcy and Mr. Norman. While the HD-1s have many advantages in the studio which some other speakers have not provided, they are hardly a panacea for all monitoring problems. Although they seem to be among the most technically accurate nearfield speakers available, prospective buyers should not necessarily expect them to be great listening speakers.

This brings up the larger question of transducer philosophy. While there are microphones which have a perfectly flat frequency response, why is it engineers keep returning to old tube 47s and M49s for vocals? These mics may not be as technically accurate, but they have a quality that we describe as "musical" or "warm." Speakers, being the transducers which undo the process a microphone has created, may be subject to the same listener perceptions. ■

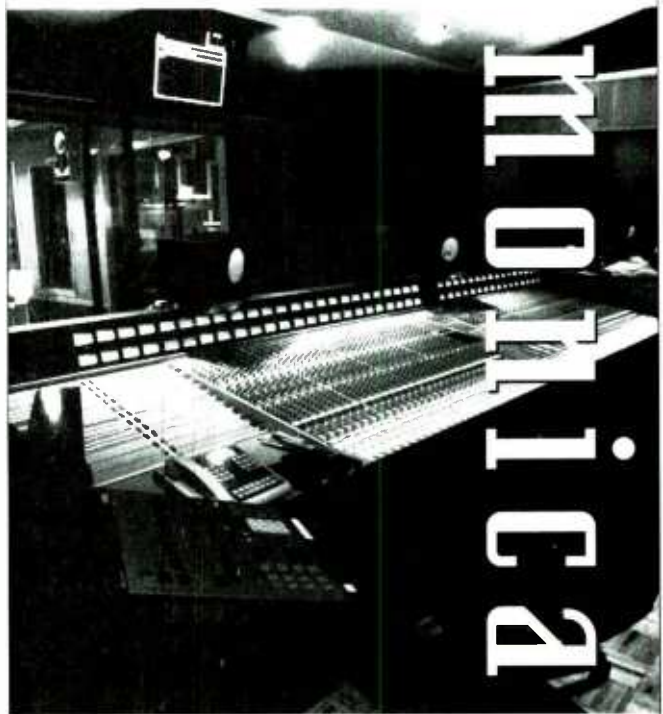

## 20 BLOCKS FROM THE BEACH

55-G 64 input  
(With E EQ-fully automated)

Neve Classic/8108-32 input

32 TR Digital  
48 TR Analog

2 TR Computer Hard Disk Editing

Call: Marianne Mari. Phone: (310) 450-3193.  
Fax: (310) 452-9053. Santa Monica Sound,  
2114 Pico Boulevard, Santa Monica, CA 90405.

Santa Monica Sound

Circle (30) on Rapid Facts Card

Curiously, though, in evaluating its industry reception, an interesting phenomenon occurs: the more people one talks to, specifically people who have lived with and used the speaker extensively for projects, the more strong opinions one finds. The surprise is that the opinions are not all raves.

Specific comments have ranged from the purely subjective ("I absolutely love them") to the more objectively enlightened ("We took our last mix from the album, which we've now heard on over two dozen speakers in as many rooms, and played it back on the Meyers. It sounded radically different. It scared us"). Curious indeed. Are they merely better than anything anyone has used before, or do they actually process the sound in some strange and unfathomable way?

What is known is that, by any definition or means of measurement, the 2-year-old HD-1s are truly high-quality devices. The overall attention to detail, linearity in the spectral and time response, and mechanical component design all rate exceptionally high.

But wait! Listen to the speakers for any length of time, and, if you are tuned in to subtleties, your ears will tell you that something's going on here. Program material that you've come to take as exemplary samples of superior production can wither on the HD-1s. Personal example: Out of five songs which I regularly use as definitive program test material, all but one sounded poor on the Meyers. The one, Thomas Dolby's "Pulp Culture," sounds amazing!

My test selections often sound better or worse as a group at various studios over different systems, but never before have I experienced the specific phenomenon just described. Others I speak with concur. Certain material sounds great; other seemingly good material (or worse) sounds, well, worse. It's almost as if these speakers were microscopes, expanding minuscule flaws, whether phase or amplitude in nature, to obvious proportions. But how, you might ask, can they do that? They're only speakers, right?

Maybe not. Clearly, the folks in Berkeley have something going, but they aren't necessarily talking. The patent, it is said, is still pending. We do know this: The 2-way designs use a slightly doctored, yet still conventional pair of devices: an 8-inch cone low-frequency driver with a 2-inch voice coil and massive magnet structure, and a doped silk dome direct radiating tweeter with a 1-inch voice coil, all in a traditional vented cabinet. Inside, though, resides extensive analog electronic technology. To quote the manual, the crossover consists of "optimized pole-zero filter combinations to complement transducer response and to achieve acoustical transparency and flat phase."

Claims are made that the performance emulates that of a true point-source, as if it were physically possible for a 2-way to accomplish that. The numerous phase-altering filters reside internally with an amplifier section for each device — Meyer claiming 150W "burst" for the woof and 75W "burst" for the tweet. What you have, then, is not your typical 2-way amped-up loudspeaker.

In the process of reviewing this device, we went to extraordinary lengths to be sure we were measuring things right: We now hold more than 100 curves and graphs taken from

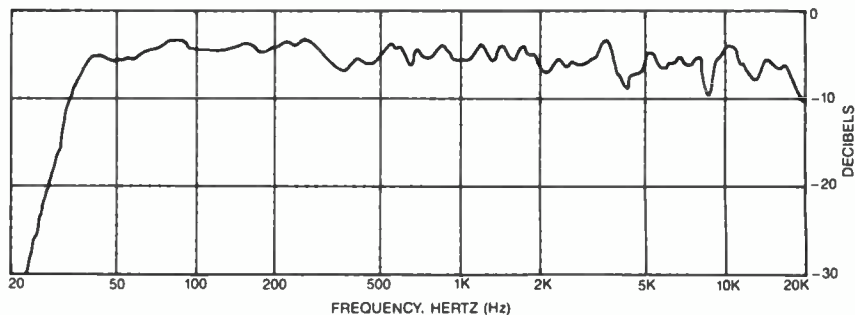

Figure 1. Meyer HD-1 composite frequency response: one meter anechoic on tweeter axis and near-field below 100Hz. 0dB = 90dB SPL.

measurements made at two separate anechoic acoustic measurement facilities, and corroborated against independent measurements made by the National Public Radio technical staff at the huge National Bureau of Standards anechoic chamber outside Washington, DC. We consulted with the Meyer staff on many occasions. As our extensive measurements will show, the speakers clearly involve a technology as complex as we have ever seen stuffed into a 2-way package. Ready for an interesting journey?

#### PHYSICALLY SPEAKING

At a weight of 51 pounds each, the HD-1s are heavy little boys. Their depth of 16.5-inches (including the out-jutting electronics in the rear), 12-inch width and 16-inch height make them all but too large for most meter bridges. Innovative users have built perches on top of Ultimate Support Stands, or flown a shelf from meter bridge to stand, in order to position the speakers as close as possible to the hot seat. As will be shown later, the closer they are to you, the better.

The input section accepts either +4dBu or -10dBV switchable levels on an XLR connector. Impedance loading is stated as 10kΩ, electronically balanced. The power supply is universal, with a selector to set up 100-, 120-, 220- or 240Vac, 50Hz or 60Hz.

Construction appears to be 3/4-inch medium or high density particle board with a mahogany veneer on both sides. The quality of the fabrication is quite good, with all components

recessed, including the plastic tuning port tubes. Internal damping material has an adhesive backing and is carefully positioned around the inside of the cabinet. The electronics package is well-designed, shielded and incorporated in the cabinet. Attention to detail is everywhere.

The speaker components consist of the aforementioned woofer and dome, the former having two magnet structures on the back of the apparently stamped (not cast) basket. Each magnet is about 50 ounces, with the second oriented in opposite polarity to cancel stray magnetic fields. This almost eight pounds of weight is a lot to hang off the end of a speaker frame without additional support. Watch out for large jolts.

The woofer cone is made of treated paper and is hung from a foam surround. The tweeter's appearance is unique because of its bright green "specially impregnated silk dome." Light weight and stiffness seem to be the goal here.

Electronically, the many active phase alignment filters and two amplifier sections reside on a piggy-back chassis inset on the rear of the speaker cabinet. MOSFET output stages operate in a Class A mode at lower outputs and bias up to Class AB at higher levels. The specific circuitry that enables this is unknown. Two single-pole passive crossover filters are mounted separately inside of the enclosure. Componentry for these are of the highest quality.

On the front panel, a 2-way bidirectional LED, green under normal power-on operation, shows

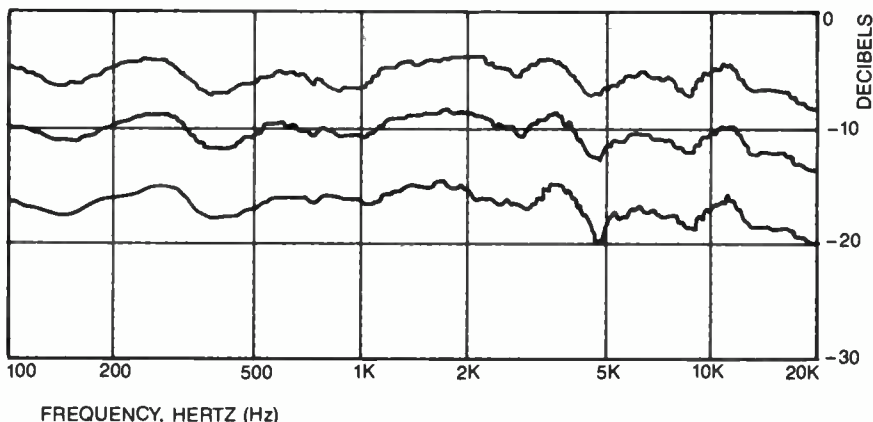

Figure 2. Frequency response on tweeter axis with varying distance. Top trace = 0.5 meters; middle = 1 meter; bottom = 2 meters.



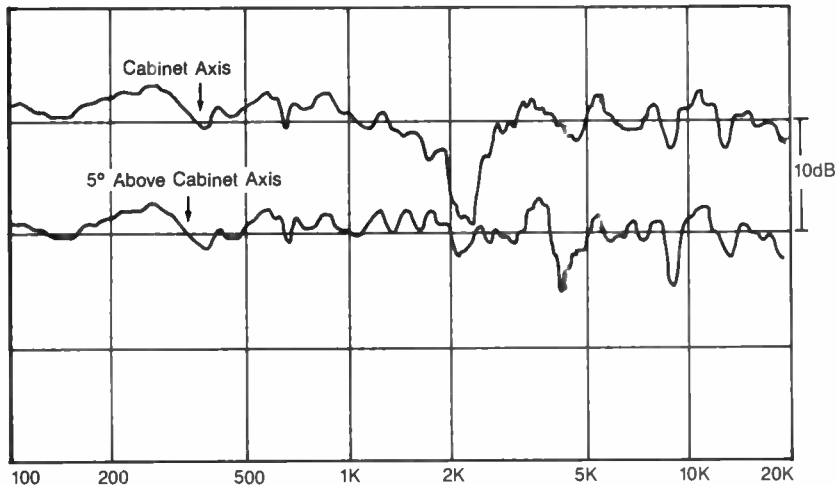

Figure 3. One-meter frequency response at two measurement locations. Top = cabinet axis; bottom = 5° above cabinet axis. Traces displaced for clarity.

red when the internal limiting protection circuitry is active. Under what might be considered normal loud operation, it is not difficult to tickle the red LED. The effect of the limiters in operation shall be discussed later. The electronics allow no user adjustments.

A nice feature of the Meyer HD-1 is the removable wooden transport cover, useful in shipping and in the normal act of moving the speakers from room to room. The well-exposed

tweeters on the front baffle almost demand this level of protection.

#### MEASUREMENTS

Lacking the space to publish a virtual book on all we found out about the speakers, we will endeavor to hit the high points, performance-wise. It needs to be said that the HD-1s are not like most competitive devices. Clearly, they suffer physics, as do all electromechanical devices,

with real-world limits on excursion, wavelength-related pattern narrowing, cone breakup and efficiency. In speaker design, by optimizing certain parameters, others, by definition, are always compromised.

Meyer's design parameters target linear phase response in a specific plane, for monitoring at a specific distance. This is readily evident in *all* of the measurements. Even though they are designed to emulate a point-source (Meyer's claim) at a given locus, they still act like a 2-way at the crossover, which we'll discuss at length. By clever use of electronic processing and component selection (using an oversized magnet to boost midbass woofer efficiency, and then applying active EQ to bring-up the bass, for example), the other performance parameters are, if not optimized, certainly delivered.

Their designers claim a very narrow window of variation in the frequency response ( $\pm 1$ dB). We were able to come somewhat close ( $\pm 2.5$ dB) in one position only (0.5 meters, using a wire-suspended B&K 4133), but our measurement was verifiable repeatedly at different facilities, using various measurement systems (UREI sweep,  $1/3$ -octave warble tone, TEF, MLSSA).

Figure 1 indicates the 1-meter tweeter on-axis response, representing a more user-realistic listening distance than 0.5 meters, and includes low frequency composite information supplied by nearfield measurement techniques. The low frequency response is superb, tracking linear-

## DISC MAKERS

Get The Most Out  
Of Your Studio Recording

### Complete Cassette & CD Manufacturing

Complete packages for:

- Cassette
- Duplication, Record
- Pressing, Compact Disc
- Replication, In-house
- ort department for design,
- typesetting, film work
- and printing, In-house
- mastering department
- for a great sounding product

Club Series:  
**300 C-45**  
HX Pro Cassettes  
with B&W Inserts  
**\$550**  
Includes design and typesetting

**SAVE MONEY!  
DEAL DIRECTLY  
WITH THE  
MANUFACTURER**



Call TODAY for this free, full color catalog:  
**1-800-468-9353**  
Call us toll free and we'll tell you how to get started

1328 N. 4th Street  
Philadelphia, PA 19122  
215-232-4140 FAX: 215-236-7763

Circle (27) on Rapid Facts Card

# ARCOUSTICS, Inc.

## ARCHITECTURE + ACOUSTICS

TWEETER PLANE  
12'



ELEVATION REFLECTIONS



720 Greenwich Street, Suite 2C, New York, New York 10014  
212-727-9645 • Fax 212-206-7320

Circle (28) on Rapid Facts Card

ly to 40Hz, with the -6dB point at 33Hz.

Both loudspeakers of the pair supplied were tested (the better of the two is shown), with a variation of only 1.5dB around 150Hz as the only real deviance between units. Differences in this range are usually the result of cone surround variations in manufacturing and are difficult to control, even though, through the use of a novel post-manufacturing filter tuning step, the HD-1s can literally be "pulled-in" to spec at the factory by using the numerous electronic filters on-board the internal crossover/amplifier. Meyer Sound has gone to extensive lengths to design a QC test chamber and software-driven FFT measuring package to simplify and improve the performance tolerances in this process. (Refer to AES paper #3173 — "Design of a Small Anechoic Chamber," presented at the 91st AES Convention in New York).

In discussions with the Meyer staff and the various independent lab technicians who carried out the measurements, it became clear that these speakers are indeed quite highly critical in their working distance and measurement angle relative to the tweeter axis. To a greater extent than some other speakers of this size and design, differences of several inches a meter away would change the frequency response by a large amount.

As Meyer's staff made considerable light of the crucial importance of measuring distance and angle, we have included 0.5-, 1- and 2-meter, 1/3-octave measurements to show the nature of this issue (See Figure 2). Given the dimensions of the cabinet and the symmetrical location of the tweeter, the variable 4.5kHz dip and 8kHz-to-9kHz harmonic are most likely cabinet-edge diffraction effects, readily measurable at distances more than one meter, but present even close up. These frequencies are approximate harmonics of the crossover, which is "acoustically" centered at 2.2kHz.

Attempts to measure the speaker on the usual baffle-axis, which is to say below the tweeter axis and between the two components, created a major dip above the crossover point. Measuring here also showed the tweeter to be acoustically out-of-phase in the crossover region (See Figure 3). The higher trace indicates a measurement taken on cabinet baffle axis at one meter. The lower trace shows the response when captured 5° above cabinet axis, or slightly above tweeter axis at one meter. These measurements reveal a definite "sweet spot" above axis in the vertical plane, where phase alignment resolves. It is important to know that this sweet spot, which shall be explained even more clearly as we view the polars, is only evident in the crossover region, the area of greatest phase interaction between devices.

The frequency response on all graphs other than Figure 1 is shown down to 100Hz only, even though our primary facility's chamber was accurate to below 50Hz. Meyer claims its speakers are designed for half-space, or board-top use, therefore true anechoic low frequency measurements at distance are not fully representative. We acknowledge that, which is why Figure 1 only includes the near-field low end measurement.

### ELECTRONICS AND PATTERNS

By viewing the output of the electronic sections before the speaker components, it is possible to see the effect the active filter sections

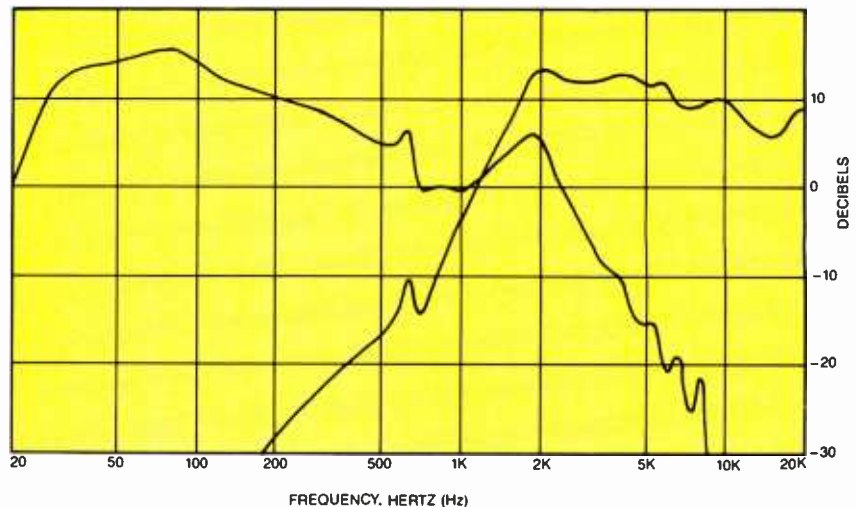

Figure 4. Voltage transfer characteristics. Electronic crossover output feeds to speaker components, before passive 1-pole filter sections.

have on frequency response (See Figure 4). It's safe to say that there's a lot going on here in both phase and related amplitude terms — no one small frequency range can be called the crossover point. Both devices are effectively covering the same octave of frequencies, although at different levels and phase alignments, from below 1kHz to above 2kHz. This is also the range, not coincidentally, that shows the greatest amount of "tilt-up" in acoustic directivity. Note that Figure 4 excludes the effects of the passive, single-pole, low-pass and high-pass filters before the speakers, which add a slightly steeper curve (and some level of additional protection) to the component feeds.

Of interest is the active boost to the woofer at 1.8kHz, extending the response of the 8-inch into tweeter territory and contributing to pattern control. At 4kHz, the signal to the passive filter before the woofer is only 25dB below the 70Hz peak. The shallowness of the filter slope is probably more an issue of controlling phase effects than actually relying on woofer output there, because the device's normal acoustic output would be minimal in this range. The low frequency curve shows the excursion-limiting high-pass infrasonic filter beginning at 30Hz and down 10dB by 20Hz.

The horizontal polar plots (See Figure 5) are taken on tweeter axis, and cover 1/3-octave ranges around 200Hz, 1.5kHz, 5kHz and 12kHz. With the exception of the latter, the HD-1 has a fairly consistent 120° to 180° horizontal pattern. Some variations occur in the mid-band, as the woofer narrows down with frequency (120°), and around and slightly above the crossover, where it goes to the moon. Above 5kHz, the tweeter beams considerably, narrowing its projection angle progressively with frequency, until its pattern is below 60° total. This is standard wavelength-less-than-piston-diameter stuff. Meyer literature claims the single-number coverage angle for the HD-1 is 60° at the -6dB point. We question that, in light of the above. 140° average would be closer to reality, with the extremes ranging from 180° to 40°.

By viewing the horizontal element of the -6dB coverage angle vs. frequency graph (See Figure 6), one can see the speaker's true polar directivity. Note the woofer's collapsing pattern

as its output frequency (wavelength) approaches its cone diameter. At and above crossover (remember the voltage transfer functions in Figure 4), the pattern goes very wide as the two components combine output. We also see cabinet effects here. Above 5kHz, the tweeter starts beaming, narrowing to less than 60° total at 20kHz.

The vertical polar component is equally interesting, showing a swing toward the narrow side in the 1kHz range (100°, predominantly woofer, but already into the crossover region), and a serious bounce in the high crossover area, again where the two devices are acoustically combining, creating an extremely wide vertical pattern, again with some cabinet effects.

### VERTICAL SKEW

When you view Figure 7, a composite of four vertical polar plots centered on the crossover region, things become clearer. Imagine the speaker lying on its back, pointing straight up, with the tweeter to the left of the vertical 0° line. That is the physical layout this chart depicts. Below the crossover region, with test signal in the woofer only, the response is

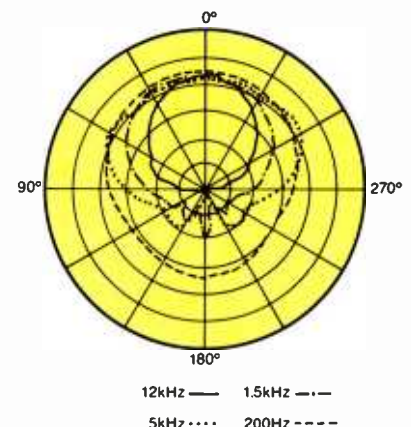

Figure 5. Meyer HD-1 horizontal polar plots.

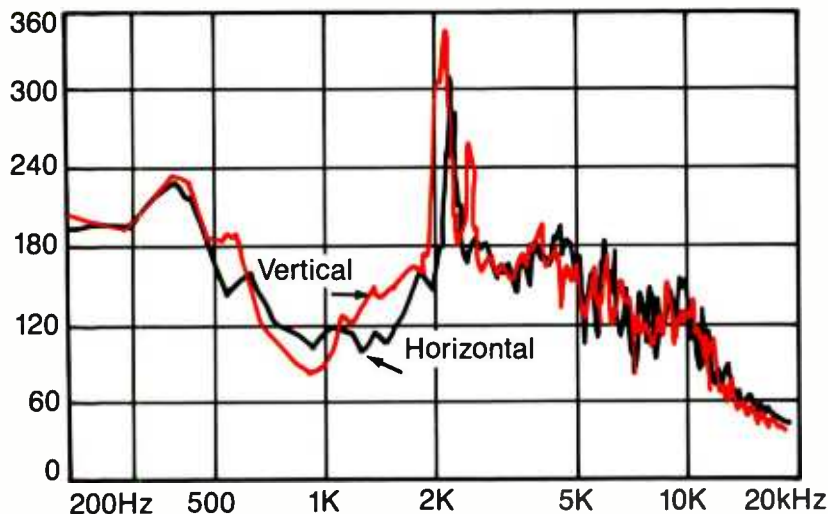

Figure 6. Coverage angles at -6dB down points.

smooth, the radiation pattern determined primarily by the device's size, mounting position on the baffle and the cabinet. In the crossover region proper, with the acoustic interaction of both devices as their slightly time-offset outputs combine acoustically at some specific phase angle, the pattern tilts up. The result is noticeable up into the next octave.

In and of itself, this is not a bad thing. For a vertically placed near-field monitor, keeping the signal aimed at you and off the console top, where it will splash back up and cause cancellations with the original signal, is a good thing. However, the height of the HD-1 might mean that the user is slightly below the tweeter, one meter or more away, below the *sweet spot* where both devices are positively combining, and specifically, in the null of the pattern, where the components are out of phase. Remember that on-baffle axis is where the midrange frequency response dip occurs.

Additionally, note the large lobe that exists below the null, at 30° to 50° below vertical axis, throughout the crossover region. This specifically is not a good thing, because it will cause a fair percentage of energy to displace downward, toward the console top.

It is not clear why the designers chose to tilt the response that far vertically, creating the null dead-cabinet-center, on cabinet axis, around 2kHz (refer back to Figure 3), and causing a large downward lobe to exist in exactly the frequency region where it isn't wanted — mid-band. Given the time alignment flexibility available in the filter sections, crossover-region pattern steering in the vertical plane seems quite a matter of choice, not compromise, pending design priorities. Can this be a compromise for overall phase linearity?

The phase vs. frequency graph (See Figure 8) is extremely telling. Whereas most 2-way speakers would indicate a time displacement in several hundreds of degrees, the HD-1 has a total phase swing below 16kHz of less than 180°. That's great! The rapid fall around 1.5kHz (crossover) is troublesome, though.

It is clear that the HD-1 designers have put the majority of effort into total linear phase alignment, which is another way of saying optimizing coherent wavefront propagation —

getting the entire signal out of the components at one point in time, in one plane in space. Because the components are mounted on the same flat baffle, with their acoustic centers displaced (the woofer behind the tweeter), phase/delay filters are used in effect to retard the various signal components, simultaneously flattening frequency response and aligning the total harmonic wavefront. Remember, however, alignment only happens at one point in space in a 2-way, so at various positions off axis (or on cabinet axis, in this case), alignment is out. It is laudable, though, that the total phase lag across the bandwidth is tweaked as tightly as it is.

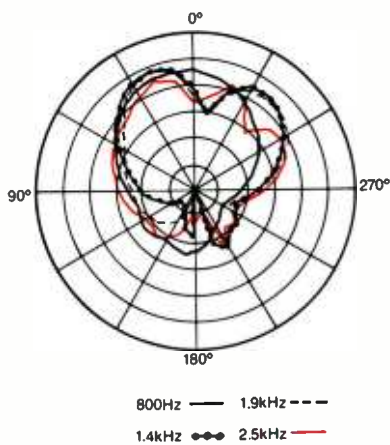

Figure 7. Vertical polar plots centered on crossover region.

#### FURTHER RESEARCH

Generally, the 3-D waterfall views are so clean that there's not much interesting to see: We didn't need to include them here! The attack or signal onset 3-D view of the HD-1's arriving wavefront, as too the decay 3-D, are extremely uniform. The decay-side waterfall shows generally rapid damping, with few ran-

dom oscillations continuing to hold over after the signal is withdrawn. The slight holdovers that do exist are smooth in nature, not steeply sloped or ragged, which would contribute to harsh or edgy results in a given frequency band. Nice work.

The ETC graph (See Figure 9) shows a depiction of the speaker's energy output over time, corroborating the waterfalls. This particular energy time curve shows multiple immediate rapid radiations, most probably the cabinet edges, which might contribute to the frequency response irregularities noted in Figure 2. Although sharp, these are rapid in onset and well down in level. These reflections are too short and arrive too soon to suggest anything other than a speaker-born source.

Finally, as we discussed last month, it is always interesting to study the effects that protection circuits, whether limiters or thermal switches, have on powered speakers. Indeed, the circuitry in the HD-1 has a major effect when triggered, as shown in Figure 10. We were somewhat amazed when we first saw the results. Before you react similarly, the traces need some explanation.

The signals applied were continuous sine wave sweeps at levels increasing in 3dB increments. The measurements were made at three meters, so absolute frequency response was not of concern. Primarily we were looking for variations from one trace to another, correlated to sound pressure level at one meter. Following the familiar rule of thumb, we added approximately 9dB to go from three meters to one meter equivalent level in anechoic space (you would add 3dB to 4dB more in a reflective environment), resulting in the bottom trace representing approximately 90dB SPL at one meter.

As can be readily seen, under these conditions, the frequency spectrum becomes highly non-linear somewhere in the mid-90dB range. The trace corresponding to 100dB SPL is well-compressed, selectively by frequency, over the tweeter's range and in the lower reaches of the woofer's output. Only the mid-band (400Hz to 1.5kHz) remains dynamically linear.

Looking back at Figure 4, imagine a compressor sitting across a signal with this spectral response. What you get is Figure 10. When the actively emphasized line-level speaker processing signal passes a preset threshold, it limits

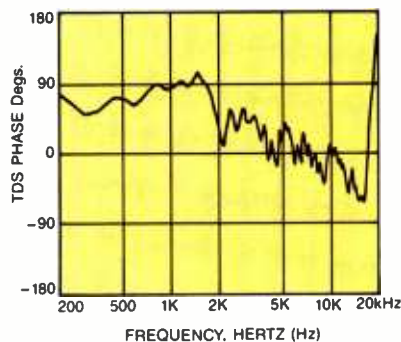

Figure 8. Acoustic phase vs. frequency. Measurement made at three meters with B&K 4133 microphone.

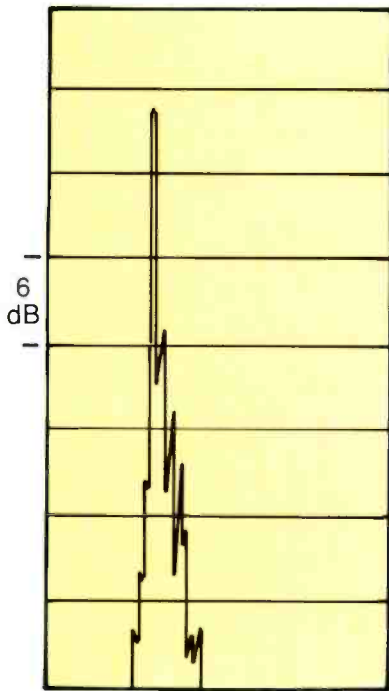

Figure 9. ETC (Energy Time Curve). 6dB/vertical division 1,000 $\mu$ sec/horizontal.

the dynamics. What gets hit first are the areas with the highest emphasis — 30Hz to 150Hz and 2kHz to 10kHz. Pretty basic. The limiters for each section appear to be following the active equalization.

It is important to emphasize, despite the radical appearance of the traces in Figure 10, that swept sine waves are not music or voice, with their ever-changing dynamic content and transients with variable crest factors. The traces shown are merely an *indication* of how the limiters might respond with steady-state waveforms, those containing more average than peak content. The attack and release responses

of the limiting circuitry are not exercised in the Figure 10 graph. One assumes that normal program material, with its higher peak-to-average values, allows greater SPL outputs to be achieved before protection. This shows what happens, though, when limiting is engaged. Be forewarned: Avoid red LED's.

#### WRAPPING IT UP

All in all, the Meyer HD-1s feature a considerable amount of engineering prowess. A lot is going on at all times in the system, and it is safe to say that the signal is well-processed by the time the air is stimulated. That noted, they are an excellent-sounding system with the right program material. Material sounding good in the HD-1s does indeed sound good out in the world, with caveats.

**But wait! Listen to the speakers for any length of time and your ears will tell you that something's going on here.**

A potential solution to the aspect of crossover region pattern tilt-up is rather straight forward: Lay the speaker on its side, facing straight forward, tweeters on the inside. The 10° to 30° acoustic toe-in would put the sweet spot right in your face in a normal mix position. Across the spectrum, the response would be balanced and smooth. Directly in front of either speaker, you would be more off-pattern from the distant unit, but still on the side of the sweet spot, and sitting in the null of the high crossover

region of the closer unit. The downward firing lobe is now harmlessly aimed to the side. The net effect might be to balance out levels, stabilizing the center image.

As far as the protection circuit's dynamic compression goes, this speaker is not designed to play loudly. Enough mixers have commented to us on the sense of "motion" they hear inside their mixes at moderate to loud levels (above 90dB SPL, while occasionally flashing the red LEDs), to indicate that limiting is noticeable. Refer to Figure 10 once again if you have any doubt that the frequency response changes with limiting protection.

Considering the few caveats indicated — overall directivity, midband polar pattern/phase alignment on cabinet axis, and preferred operating levels possibly in conflict with the frequency selective limiting — the Meyer HD-1 presents a time-coherent, well-balanced sound, applicable to those who desire analytical monitoring of high quality audio. The low end is exemplary, with only a touch of tuned-enclosure boxiness.

We are aware of conjecture in certain circles that their internal electronic manipulation of phase alignment interacts with certain phase-anomaly intensive program material, such as multi-microphone classical recordings, large open-miked drum kits, etc. We have spoken to several engineers who indicate the HD-1s seem to have less "air" than other equally flat-measuring speakers. We can't say. Technically, the flatter the response, the fewer single frequencies are pulled up and exaggerated, be they in a hiss band or a hum band.

It is clear, however, that the Meyer HD-1s are the most microscope-like speakers you might ever hear. As stated in *From the Top* this month, one wonders whether it is imperative to hold such an exacting magnifying glass up to every sound, making it obviously and clearly good or bad. But, how much is too much? Our mind isn't made up on the subject yet. It sure suggests a number of further questions on audio monitoring in general, though. ■

Circle (100) on Rapid Facts Card

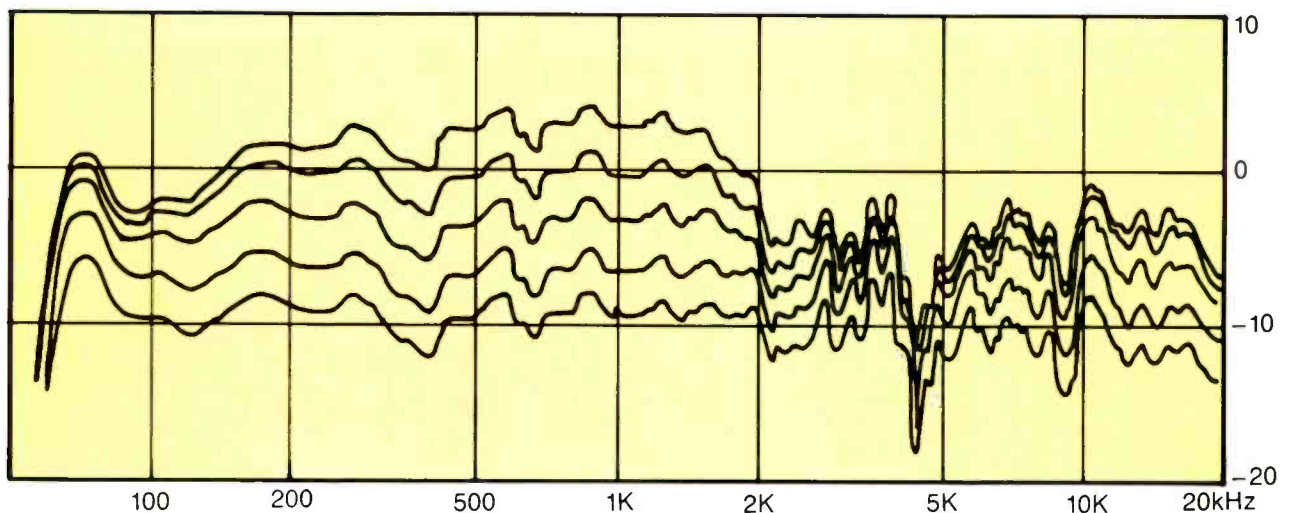

Figure 10. Dynamic limiting by protection circuitry with varying input levels (3dB/step). Swept sine-tone source. 0 = 100dB SPL (approx.) at one meter.

## AW GEE, NEW FROM APOGEE

By Laurel Cash-Jones and Fred Jones

### TALKING ABOUT PORTABILITY ...

HHB Communications of London, which is known for its unique adaptations of various products, has developed with Aiwa the HHB 1 PRO portable DAT. It comes in a custom-built metal flight case with internal cutouts for all items necessary for recording, and is designed as a complete package for the remote engineer or broadcaster. It includes an HHB 1 PRO portable DAT recorder with all accessories and carrying case, a Sony ECM 979 stereo condenser microphone with windscreen and a comprehensive selection of cables.

The complete system weighs in at only 7.6kg (16.7 pounds) fully loaded. Power for the HHB 1 PRO is supplied via a multi-voltage mains transformer and rechargeable batteries. If you get really stuck, this DAT machine also has the distinction of being the only one in the world that will also run on regular dry cell batteries. Input connection is by balanced XLR connectors, and the unit supports AES/EBU and S/PDIF digital interfaces, so you can connect the HHB 1 PRO to almost anything you come in contact with on the road.

Circle (101) on Rapid Facts Card

It's a new analog-to-digital converter, the AD-500 to be exact. What's more, it's a portable stereo unit to be used in the studio or on the road. The AD-500 features a discrete front end that will accept up to +27dBm input levels with low distortion and 100dB common mode rejection. Sample rates of 32kHz, 44.056kHz, 44.1kHz and 48kHz are provided via an internal 10 ppm crystal that can be locked to PAL, NTSC, or 60Hz monochrome video or sync. The AD-500 will also lock to external sources, such as AES/EBU, S/PDIF, Optical, or word clock sync.



One of this unit's unique features is that it can lock to an external sync source while generating a perfect ratio output, such as locking to 44.056kHz and putting out 44.1kHz, making it mighty handy when dealing with all of the different formats that one confronts in the cruel world of digital audio. The AD-500 has a suggested list price of \$1,695.

Circle (103) on Rapid Facts Card

## MORE SOFT THINGS FROM OPCODE

Opcode Systems has released an update to its Studio Vision Integrated MIDI and digital audio sequencing software. This new version will give Vision OMS compatibility for access to more than 200 MIDI channels. This will give it the ability to talk to various other products, such as Mark of the Unicorn's MIDI Time Piece 128-channel MIDI mode, Lone Wolf's MIDI Tap, and the soon to be released Opcode 240-channel Studio 5 interface/processor/patcher/synchronizer.

OMS compatibility will also give it the ability to allow Studio Vision and Digidesign's SampleCell to run together on all Macintosh II computers by directly accessing SampleCell through an OMS driver. Punch-in on-the-fly let's you start a sequence in play and go in and out of record without stopping. You can also paste MIDI files on the clipboard from Studio Vision to Track Chart, and from CUE to Studio Vision.

This new version is System 7.0 compatible and is 32-bit clean so that you can use more than 8Mbytes of RAM on your Mac. All in all, this upgrade definitely moves Studio Vision into the future.

Circle (104) on Rapid Facts Card

## BUT ENOUGH ABOUT HARDWARE

Let's talk software! From Steinberg Digital Audio comes three new products. First is the Time Bandit, which is an off-line Time, Pitch, and Harmonisation (their spelling) program that allows you to process any audio files stored in the Sound Designer 1, 2 or Audio IFF format. Time Bandit employs a unique system that analyzes parts of the digital audio data and selects the appropriate algorithm to process it. Harmonizing of any musical interval is performed by the virtual keyboard on the screen.

The next item is the Topaz MT digital audio recorder, which is now available as a multitrack. It also has a fast and user-friendly interface, and is now fully integrated into Steinberg's MIDI recording program, Cubase.

If you guessed that the last product described here would be a new version of Cubase, you must be a mind reader. Actually, it IS a new version of Cubase. It now allows you to add digital audio tracks (up to 16) using Digidesign's PRO tools hardware. Audio tracks are now treated and edited exactly the same way the MIDI tracks are handled in Cubase. ■

## REACH A NEW SUMMIT

With an all-new hybrid design, Summit Audio introduces the DCL-200 dual-channel compressor/limiter. These clever folks know that some of us engineer types prefer the sound of a tube, but still want the reliability of solid-state electronics. To accomplish this somewhat difficult feat, the DCL-200 uses 12AX7A gain stages in conjunction with Summit's own discrete 990 op-amps at the output stages.

To ensure that the quality of this little beauty is superb, each DCL-200 is hand assembled and tested at Summit Audio's own factory in Superior, WI. I wonder if they are high on a mountaintop too?

Among this unit's many features are a continuously variable "soft-knee" transition characteristic (like some football players we know) from 1:1 to greater than 7:1. Of course,

as you would expect on such an upscale device, the threshold level, attack and release time, and output level are all front-panel adjustable. The DCL-200 may be operated in either a stereo link mode or dual mono mode.

Dual meters are switchable for gain reduction or output level, and LEDs are provided for overload protection, regardless of the meter selection. A side chain insertion point is offered to allow for external source triggering or frequency-dependent operation.

Speaking of frequency response, the DCL-200 Boasts a bandwidth of 5Hz to 70kHz. Distortion is claimed to be less than 0.05% at +4dBm, noise at unity gain is -80dBm, and input clipping level is +25dBm. Inputs and outputs are transformerless with XLR connectors, while the side chain connections are via 1/4-inch TRS jack.

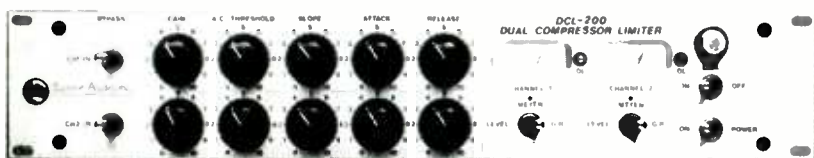

Circle (102) on Rapid Facts Card

Laurel Cash-Jones is R•E•P's editorial consultant and a Los Angeles-based free-lance writer. Fred Jones is an audio industry observer and a Los Angeles-based free-lance writer.

## J.L.COOPER CONTROL STATION

The CS-10 Control Station has been designed to provide an easy-to-use hardware interface for Digidesign's Pro Tools, a multichannel disk-based digital audio recording and editing system. The CS-10 features conventional controls, large buttons for record, play, stop, fast forward



and rewind, a footswitch input for hands-free operation, an optically encoded jog/shuttle wheel for precise positioning and effortless "scrub" editing. Also included are eight 100mm faders, six rotary potentiometers that can be programmed for effects sends, pan left and right, boost/cut, frequency and bandwidth.

Circle (106) on Rapid Facts Card

## DEMETER DIRECT BOX

The Stereo Tube Direct Box (STDB-2) is a 2-channel rack-mount version of the Tube Direct-Box. The unit also has a volume control. A 4-channel model is also available.



Circle (107) on Rapid Facts Card

## TELEX EGM MICS

Telex EGM Series includes the EGM-40P/EGM-41P permanent mount, and the EGM-40Q/EGM-41Q quick mount goosenecks. These unidirectional electret condenser mics feature a silent mic on/off switch, and are available in 12- or 19-inch styles.

Circle (108) on Rapid Facts Card

## MEYER MID-BASS

The DS-2 Mid-Bass loudspeaker consists of two 15-inch MS-15 cone drivers mounted in a folded horn enclosure. The horn features a hyperbolic flare and a balanced compression chamber that presents a symmetrical load to the drivers for high power handling and low distortion. The unit is designed with vertical steel reinforced rods for safety and arrayability and meet flying specifications for Meyer Sound's MSL-3s.

Circle (109) on Rapid Facts Card

## LYNX KEYBOARD CONTROL

The keyboard control unit is designed for multemachine synchronization and editing. The unit controls up to six tape or film transports and two programmable GPI closures. Any machine may be operated individually or any selection of machines may be operated as a synchronized group, and any may be the master. For more intensive applications, the unit's capabilities may be expanded with the Lynx System Supervisor. Features include lighted keyswitches, an alphanumeric display and easy-to-learn, self-prompting software.

Circle (110) on Rapid Facts Card

## MTX PRE-AMP

Hand-built in the United States the Pro-Control Two stereo pre-amp from MTX Soundcraftsmen features digital C-MOS electronic switching for distortion-free and noise-free operation. The unit handles audio signals from a compact disc



player, tuner, magnetic phono/turntable, VCR, laser disc player and conventional audio or DAT tape deck. Tone control has turnover frequencies of 100Hz and 10,000Hz, and the volume control is sealed and tapered for 300° control.

Circle (111) on Rapid Facts Card

## EMC HEADS

Electro-Magnetic Components is offering replacement heads for the Otari MTR-10/12/20 series of tape recorders. Improvements have been made in overall frequency response. Heads feature EMC's patented 2-piece design that allows the worn crown to be replaced for less than the cost of a new head.

Circle (112) on Rapid Facts Card

## KRK MONITOR

The KRT-9000 near-field console-top monitor can generate spls above 108dB and efficiency of 91.5dB. With a 2-way time-aligned crossover, the monitor combines aerospace technology and materials with cutting edge design and construction. The units are 16 1/2" x 13 3/4" x 14" and weigh 35 pounds.

Circle (113) on Rapid Facts Card

## PRODUCERS SOUND EFFECTS

The Sound Designer Series is the latest addition to the company's sound effects library and is a compilation of hi-tech 21st Century sounds. The Producers Sound Effects Library is a natural-sounding collection and is guaranteed by the company to be more usable than any other library.

Circle (114) on Rapid Facts Card

## BIAMP MIC/LINE MIXER

The Advantage 60li mixer is a single rack-space, 6-input mic/line mixer. Each input uses a differentially balanced, discrete transistor pre-amp. Inputs accept signals for mics, standard



line level devices, and devices that require 600Ω transformer input. Each signal has a balanced input on barrier strip, a trim control, a peak indicator and a level control. Channels five and six include 30dB pad switches for mic or line inputs.

Circle (115) on Rapid Facts Card

## AD SYSTEMS OPTVIEW

Optview is designed to eliminate guesswork in film and video dubbing by giving advanced warning on-screen seven seconds before cue points. The stand-alone dedicated computer identifies each of 24 soundtracks during recording and allots memory. 24 tracks can be displayed in different colored bar graphs for easy identification.

Circle (116) on Rapid Facts Card

## MACKIE MIXER

The MixerMixer combiner allows three smaller mixers to be used as one large one with no loss of inputs, aux sends or headphone monitoring.



All combining is at unity gain, so no level or headroom is lost, and no additional noise is introduced. The unit can be used on tabletops or mounted to the inside surface of a rack. A remote fader that controls the overall output level is optional.

Circle (117) on Rapid Facts Card

## APHEX MODULARS

The 9000 series modular processing system is a compact rack that serves as the base for up to 11 modules. Four processors have been reduced in size to fit the rack: the Aural Exciter, Compellor, Expressor and Expander/Gate. A parametric EQ, the model 9901, will soon be ready. The 8126 modular distribution amp and 8000 series modular system rack are designed for applications that require signal splitting and routing to several destinations. The 8126 fea-

tures a servo-balanced, RF suppressed input that is switchable via an A/B selector and can be operated remotely. Also included is a fuse and diode on each leg of the outputs that protects from damage from power supply.

Circle (118) on Rapid Facts Card

### GOLD LINE DSP-30

The DSP-30 1/3-octave Audio Spectrum Analyzer is a portable, real-time, multi-function test instrument with a full 85dB window. Options include a printer interface, ports for



RS232, an oscilloscope, or a color monitor, plus an EPROM nonvolatile memory with 30 memory storage. RT60 will be available in the near future.

Circle (119) on Rapid Facts Card

### VALLEY DYNAMITE 2

The Dynamite 2 multifunction audio signal processor offers the ability to simultaneously compress, gate or expand, and peak limit the audio signal. Each processing mode can be used independently. Special circuitry is designed to allow the unit to differentiate between simple and complex waveforms. An on-board anticipatory release computer delivers short release times without dynamic distortion and modulation. Each of the two channels offers continuously variable front panel controls for expander/gate/ducker threshold and range; a shared control for compressor/expander release time; compressor threshold; limiter threshold and output gain. The compressor offers setting of 3:1, 6:1, or 20:1. A hardware bypass switch is provided on each channel.



Circle (120) on Rapid Facts Card

### DEMETER PREAMP



The Tube Microphone preamp (VTMP-2) is designed to give the quality of tube amplification in a package that is convenient to operate and easy to interface with consoles and tape recorders.

Circle (121) on Rapid Facts Card

### BOND LOUDSPEAKER

BOND ElectroAcoustics, a division of Equity Sound Investments has introduced an actively cooled loudspeaker system. The BOND system contains a 12-inch and a 2.84-inch compression driver in a co-axial arrangement. Available in either a compact trapezoid cabinet or a low-profile monitor, a single cabinet can achieve long-term output of 128dB. "Power Cooling", a licensed technology from Inter-sonics, is a fan-actuated, forced air cooling system that virtually eliminates power compression in the BOND loudspeakers.

Circle (122) on Rapid Facts Card

### KURZWEIL K2000

The K2000 synthesizer features a sound generation process based on Variable Architecture Synthesis Technology (VAST). The K2000 has 24-voice polyphony with up to four oscillators



per voice; 16-bit linear format; 8Mbytes of on-board ROM, including 200 sound programs and 168 keymaps; 31 sound-shaping algorithms, each with up to three configurable digital signal processors per voice; and six polyphonic audio outputs, configured as a stereo master pair plus four separate master outputs.

Circle (123) on Rapid Facts Card

### LYNX INTERFACE

The SSL data interface for G Series studio computer has an optional special plug compatible to connect the Lynx system supervisor to operate from the SSL G Series console. The unit uses standard SSL G Series software, Sync panel and cables.

Circle (124) on Rapid Facts Card

### AIWA HHB1 PRO KIT

The HHB1 Pro Kit, developed by HHB Communication in conjunction with Aiwa, is a compact package of equipment and leads for outdoor broadcasting. Included are an HHB1 PRO professional portable DAT recorder with carrying case and accessories; a Sony EXM 979 stereo electret condenser mic with foam windshield and various cables and interface leads; a metal flight case; a multivoltage mains transformer and rechargeable batteries. An XLR input and AES/EBU and S/PDIF digital interfaces allow it to be used with a variety of equipment.

Circle (125) on Rapid Facts Card

### TOA ix-9000

The ix-9000 mixing system uses 18-bit linear pulse-code modulation with 64x oversampling. The unit digitizes analog audio inputs, then processes all signals digitally before re-converting them to analog at the outputs. The unit can be configured for various applications. The modules fit into two digital racks. All modules

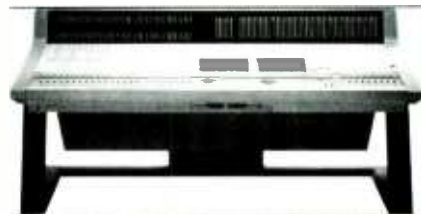

come with mixing bus assign switches. Mixing buses allow a 64-input/48-output architecture with full matrixing. The system interfaces to inputs and other equipment through a digital patching system with 256 inputs and 256 outputs.

Circle (126) on Rapid Facts Card

### APOGEE CONVERTER/FILTER

The AD-500 analog to digital converter is a portable, stereo unit for 16-bit audio applications, including DAT recorders, CD mastering, disc-based workstations and video production. The unit's front end accepts up to +27dBu input levels with low distortion and 100dB common mode rejection. Sample rates of 32, 44/056, 44.1 and 48kHz are provided by an internal 10ppm crystal locked to PAL, NTSC, or 60Hz monochrome video or sync. The device will also lock to external AES/EBU, S/PDIF, Optical or WordClock sync sources.

Circle (127) on Rapid Facts Card

### AMPEX 499

Ampex's new 499 Grand Master Gold premium analog mastering tape is available in 1/4-inch, 1/2-inch, 1-inch and 2-inch widths. A non-porous, high-energy, ferric oxide formulation allows for operating levels of +9.0dB and beyond.

Circle (128) on Rapid Facts Card ■

# Classified

## LEASING/FINANCING

### EQUIPMENT FINANCING "LOANS BY PHONE"

- NO FINANCIALS REQUIRED FOR TRANSACTIONS UNDER \$50,000
- NEW OR USED EQUIPMENT
- \$2,000 TO \$200,000
- NO DOWN PAYMENT
- SALE-LEASEBACK EQUIPMENT FOR WORKING CAPITAL

TO APPLY OR REQUEST  
ADDITIONAL INFORMATION  
CONTACT MARK WILSON

**(800) 275-0185**

**FAX: (214) 235-5452**



### Options to Lease.

Akai A°DAM 12-track digital recorder plus a Soundcraft Delta 8 24-channel deluxe input- \$789/mo.

Fostex G16S plus Fostex 820 20x8 board - \$242/mo.

Lexicon 300-\$115/mo.

Fostex G24S with Dolby S noise reduction plus Soundcraft Delta 8 24-channel deluxe input-\$559/mo.

Above prices are based a 60-month lease. Other lease packages available between \$5,000 and \$75,000.

Subject to credit approval, minimum 2 years in business.



4262 Grand Ave., Gurnee, IL 60031  
708°336°OPUS

### LFCI Equipment Leasing

- Up to \$75,000 with credit application only
- Provides:
  - Off-balance sheet financing
  - Tax benefits
- New & used equipment
- Generate capital by selling & leasing back equipment
- Nationwide
- Dealers welcome
- Over 10 yrs in the A/V industry

Apply by phone

**(800) 626-LFCI**

## HELP WANTED

### AUDIO ENGINEER

Christian Television Ministry has an opening for a 2nd shift **AUDIO SWEETENING ENGINEER**. Applicant must have automated mixing experience and a minimum of 2 years audio for video post-experience. S.S.L., MTR-90 II. Adams Smith.

For application call: (214) 620-1586, ext. 6267 or mail resume to: Robert Tilton Ministries, Attn: Personnel, P. O. Box 819099, Dallas, TX 75381-9099

Invest Your Advertising  
Dollars in  
R•E•P's Classifieds!

## EQUIPMENT WANTED

Mercenary Audio  
wants what they want  
but we want it more!

**HAVE CASH / BUYING NOW**

Tel: 617-784-7610 Fax: 617-784-9244

### EQUIPMENT WANTED

BUY OR TRADE  
YOUR USED MULTITRACK RECORDERS  
AND CONSOLES

**EAR PROFESSIONAL AUDIO/VIDEO**

(602) 267-0600

### Wanted: Dead or alive

Pultec, ITI, Lang, Sontec EQs, Telefunken, Neumann, AKG or RCA mics. UREI, dbx, UA, Teletronix, Fairchild limiters and other gear. Boxes or tubes; API or Neve consoles and old guitars.

**Dan Alexander**

5935 Market St. Oakland, CA 94608  
415-644-2363 Fax 415-644-1848

### WANTED

NEVE-SSL-API-TELEFUNKEN-SONY  
NEUMANN-OTARI-MCI-PULTEC-URIE-AMS  
OR ANY USED CONSOLE, TAPE MACHINE,  
VINTAGE MIC OR PROCESSOR YOU WANT  
TO SELL—CALL ANYTHING AUDIO

617-426-2875

## FOR SALE

### MILAM AUDIO

**"THE SOURCE"**

SINCE 1967

CONSOLES  
MULTI-TRACKS  
MONITORS

D.A.T. • AMPS  
EFFECTS • MICS  
USED EQUIPMENT

1470 Valle Vista Blvd.  
Pekin, IL 61554  
(309) 346-3161  
800-334-8187  
FAX 309-346-6431

### PULTECS FOR SALE

Two EQH-2's \$3,000, or best offer for the pair. Contact: Jonathan Curtis, WRPI.

518-276-6248.

**CHESHIRE**  
SOUND STUDIOS

### FOR SALE

**WORLD FAMOUS CHESHIRE SOUND STUDIOS**  
ATLANTA, GA

2 SSL ROOMS, 48 TRK - 32 TRK DIGITAL  
Owner retiring. Serious inquiries only.  
404-321-3886

### TUBE MICS

Only the finest in tube mics bought and sold.

Call Bill Bradley

**(216) 723-6494**

**FAX (216) 723-6595**

### 19" x 1 3/4" ADC TT PATCHBAYS

Balanced/normalled, 144 points like new.  
Cost \$395.00 — Sell \$114.95 each.  
4 or more \$104.95.

References available.

Call J. Patrick Green (916) 922-5060

**Greensweep Productions**

**USE R•E•P CLASSIFIEDS**



**FOR SALE, con't.**

## STUDIOWORKS

Recording & Broadcast Equipment

### FACTORY DIRECT PRICES ON 3M & AMPEX TAPE

ADAMS-SMITH	LEXICON
ALLEN & HEATH	NEUMANN
FOSTEX	OTARI
HAFLER	SENNHEISER
JBL/UREI	SOUNDTRACS

J. L. COOPER

Over 70 Professional Lines!

## SONY

Professional Audio

(800)438-5921

(704)375-1053

Sony used & demo sale

Sony 3036 loaded 32/non-auto. \$52K w/warranty.  
Sony 3036 loaded 36 w/auto & hard drive \$80K w/warranty.

## WHAT COULD YOU HAVE IN COMMON WITH:

HIT FACTORY-NY, HIT FACTORY-LONDON, POWER STATION, RECORD PLANT-L.A., LARRABEE SCUND, ELECTRIC LADY, RIVER SOUND (Donald Fagen/Gary Katz), BATTERY STUDIOS, TOKYUFUN, THE TOY SPECIALISTS, RACK ATTACK, LAfx, DREAMHIRE, STUDIO FX (SYDNEY), GLENN FREY, STEVIE B, JON BON JOVI, AND MANY OTHER OF THE WORLD'S FINEST STUDIOS, RENTAL COMPANIES, AND ARTISTS?



### ONE STOP SHOPPING...

*FAIRCHILD Teletronix, Pultec, Telefunken Elam 250s, AKG C24s, Neumann U47s, M-49s.*

WE ALWAYS HAVE TUBE NEUMANNs and AKGs, TUBE COMPRESSORS & EQUALIZERS....PULTECS, LANGs, FAIRCHILD, API, NEVE, LA-2As ETC. WE BUY, SELL AND TRADE—LIST YOUR FOR SALE EQUIPMENT FREE!! WE HAVE LISTINGS ON CONSOLES AND 24 TRACKS. NEVE, SSL, AMEK, TRIDENT, API, OTARI, STUDER AND MCI....*"this is not a problem."*

### THE CONNECTION, THE SOURCE, THE PROFESSIONALS

TEL: 617-784-7610

FAX: 617-784-9244

CUSTOM LENGTHS RECORDED OR BLANK  
ALSO TELEPHONE ON-HOLD SYSTEMS



MADE  
IN  
U.S.A.

OUR  
15th  
YEAR

MANUFACTURER DIRECT

MANN ENDLESS CASSETTE INDUSTRIES

P. O. BOX 422093, SAN FRANCISCO, CA 94142-2093  
(415) 221-2000 FAX (415) 387-2425

JVC DS-DT 900 DAT Recorder Demo  
Sale: \$3,700. ORDER TODAY!

Also: List your used 2-24 TRK gear with  
us for free!

We buy, sell and trade Pro Audio Gear.

Call Barry at BCS

818-845-7000

**Synclavier.** 56 voice. 24 sampling.  
32 FM. 9 Meg RAM. 260 Meg Disk.  
Mac II. Release "0" software. **Neve**  
**8048.** 32 inputs. 24 monitors. 1081  
EQ/Pre amps. 3 2254k comp/limiters.  
**Studer A-80** VU MK IV 1/2" 1202  
hrs.

201-656-7023

### DYAXIS-STUDER EDITECH DIGITAL AUDIO WORKSTATION

Digital Processor, 1 hr (640 mb) hard  
drives., DSP card for EQ and time scal-  
ing, all hard and soft updates. \$15,900.

Call: 313-994-4992

## VTMP-2 TUBE MICROPHONE PRE-AMP



ALL TUBE DESIGN. TWO CHANNELS OF JENSEN 13K6C MIC TRANSFORMER INPUTS AND INSTRUMENT LEVEL  
INPUTS, PHANTOM POWER, VARIABLE GAIN, LOW THD (.06%), LOW NOISE (124 EIN), REASONABLY PRICED  
USED BY: WALTER BECKER, HUGH PADGHAM (STING), RY COODER, ALLAN HOLDSWORTH,

ANTON SANKO (SUZANNE VEGA), MICHAEL HEDGES & OTHERS

FOR INFORMATION ON THIS PRODUCT OR THE TUBE DIRECT BOX CONTACT:

**DEMETER AMPLIFICATION • INNOVATIVE AUDIO**

(213) 470-6426 FAX (213) 470-8817

1907 PARNELL AVENUE, LOS ANGELES, CA 90028

## WE'VE GOT THE GOODS!!

We offer a line of unique products described by  
many as the most eclectic in the industry. Many  
are our own design and manufacture. When you  
need something special, call us.

The Mic Pole  
Cable Keepers  
AKG Boom Parts  
Tall Mic Stand  
RFI Trap  
Boom Weight

The Mic Clamp  
Super Cable Keepers  
Atlas Stand Parts  
Really Tall Mic Stand  
Line to Mic Adapter  
*and so much more!!*

Call or write for a free catalog!

**BLACK**  
AUDIO DEVICES

Box 106  
Ventura, CA 93002  
(805)653-5557

Circle (37) on Rapid Facts Card

# Classified

FOR SALE

## D.A.T. In Stock!

### BASF

- Digital Audio Tape In Stock
- Analog Tape, Audio Accessories
- Phone In Order, Ship Same Day
- Great Quality — Great Price

Call us at

**(313) 662-0669**

for prices on tapes & duplicating

### World Class Tapes

Audio Tape Distributors & Duplicators

670 Airport Blvd., Suite 1

P.O. Box 7611

Ann Arbor, Michigan 48107

(313) 662-0669

(1-800-365-0669 outside Michigan)

Circle (38) on Rapid Facts Card

### American Pro Audio

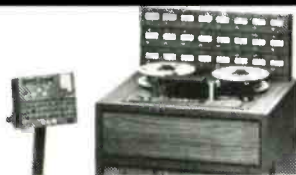

- Sony/MCI • Trident •
- Tannoy • Eventide •
- Yamaha • Tubetech •
- Fostex • Soundtracs •
- Beyer • Roland • Akai •
- Ramsa • Panasonic •

#### Mini Lease Program

New or used, trade-ins 24-60 months with buyout option \$5K-25K **no** financials required min. 2 yrs in business.

**1-800-333-2172**

**USE R-E-P  
CLASSIFIEDS**

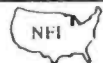

### SUPERCOUSTIC ACOUSTIC FOAM

GUARANTEED LOWEST PRICES IN THE COUNTRY.  
WE'LL BEAT ANY DEAL.

48" x 48"

IMMEDIATE  
SHIPPING

2"-\$15.50

3"-\$23.50

4"-\$27.50



Medium Blue or Custom Charcoal Colors.  
**Stop Sound Now!** With the Highest Density Polyurethane Foam available anywhere. Excellent sound proofing for all applications. Custom colors and sizes, also available.

**Warning** - Don't buy low density bed size mattress foam that has no sound absorbing properties or specs. Buy from the only company that specializes in foam and Guarantees satisfaction! Call now for FREE Catalog, Specs. & Samples

#### NATIONAL FOAM, INC.



1-800-247-4497

IN CA (213) 650-8906



6311 De Soto Ave., Suite A  
Woodland Hills, CA 91367

Check  
C.O.D.

Circle (39) on Rapid Facts Card

### CAD PF-8 FOR SALE \$ 500.00US ea.

Brand new fully loaded units still under warranty loaded with your choice of 1002 compressor or 1004 noise-gate cards.

Call: (514) 595-3966

### NEW, USED, DEMO EQUIPMENT

LARGEST SELECTION OF CONSOLES, RECORDERS AND OUTBOARD EQUIPMENT  
OTARI, TRIDENT, AMEK, ALESIS, TASCAM, FOSTEX, AKAI, DIGIDESIGN  
PRO TOOLS, SOUND TOOLS, MACINTOSH, IIC/IFX, TUBE GEAR, NEUMANN MICS, TRIDENT 24, 24TK RECORDERS, DAT RECORDERS, TASCAM M3500/3700, EVENTIDE H3000, LEXICON 300, TC ELECTRONIC 2290, DRAWMER GATES

CALL FOR EQUIPMENT FAX LISTING

EQUIPMENT LEASING AND SYSTEMS  
SPECIALISTS-NEW AND USED COMPONENTS  
EAR PROFESSIONAL AUDIO (602) 267-0600

### THE BEST VALUES IN USED EQUIPMENT

Yamaha DMP7 and Sony MXP 3000 mixers  
Ramsa WR8420 21 mono, 7 stereo, 4 tape  
Adam Smith 2600 series, large selection Call  
Akai S1000 Digital Sampler  
Otari MTR9024 24 track JBL 4430 speakers  
Fostex 8 & 2 trk ATRs, Sync. TC & mixers  
Equalizers, compressors, amps & more!

The Best Values in quality, used audio equipment are in our FREE catalog! Call Fax or Write today!

### MICOR VIDEO EQUIPMENT

5545 N. Clark Street, Chicago, Illinois 60640-1222  
312-334-4300 Telex 910-240-9449 Fax 312-334-4385

## THE RE-USEABLE WRAPPER

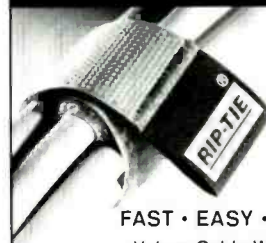

FAST • EASY • TIDY  
Velcro Cable Wraps

### RIP-TIE

800-348-7600

Seam Tech

P.O. Box 7394 San Francisco CA 94107 • FAX 415-777-9868

Circle (40) on Rapid Facts Card

**Power supplies**  
for almost any tube microphone.  
If you want your mic to sound the very best, get it a new power supply. From \$275.

Call Bill Bradley

(216) 723-6494

Fax (216) 723-6595

### The Studio POP Filter

A Great Improvement on a Good Idea!



Open up the sound of your vocals and voice overs without annoying "POPS" ruining your best take!

• Standard mic stand adaptor with threaded brass insert

Only  
**\$2400**

• One piece plastic rims, 4" 5" & 6" diameter-in cream or black

With optional  
Clamp and  
Gooseneck  
\$4495

ONE YEAR GUARANTEE plus shipping

AUDIO VISUAL ASSISTANCE

565 Sherwood Road,  
Shoreview, MN 55126  
Phone: 612-481-9715



Circle (41) on Rapid Facts Card

### AVOID OBSCOLESCENCE CHOOSE AUDIO UPGRADES

Replace the IC's, transistors, and caps in your console; tape machine and outboard gear and achieve better than new specs!

### AUDIO UPGRADES

Box 7551 Mission Hills, CA 91346  
(818) 780-1222 FAX (818) 892-7785

**FOR SALE** con't.

**SALE! PLUS FREE ADHESIVE!**

**MARKERFOAM™ ACOUSTIC FOAM GIANT 54" x 54"**



**Immediate Shipping**

2" Reg \$29.95 Now \$19.99 • 3" Reg \$39.95 Now \$29.99! **KILL NOISE QUICK!**

High performance, full-size sheets of super high density Markerfoam. EZ mount. Blue or gray. Super-effective sound absorption for studios. Markerfoam offers best value, looks professional & is proven in studios worldwide. Request Foam-Buyers Guide Catalog, specs & free samples today. VISA, MC, AMEX, COD, PO's. QUANTITY DISCOUNTS

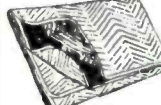

**MARKERTEK JUMBO SOUND ABSORB BLANKETS**

Heavy-duty 72"x60" padded blankets absorb sound wherever they're hung or draped. Fabulous for stage, studio & field use. Top professional quality at a super saver price! Weight: 6 lbs. Black, \$19.99.

**MARKERTEK BLADE TILES™**

HIGH PERFORMANCE LOW, LOW COST!

\$2.99 per tile. 16x16x2" America's best acoustic tile value, only from MarkerteK! Charcoal. Also available 16x16x3" as shown, \$3.99 each.

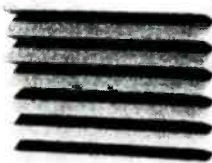

**MARKERSTIK™** Foam adhesive. FREE with any Foam purchase in this ad! Limited offer. A \$5.95 per tube value.



**SONEX**  
All the colors and sizes plus great prices!

Get our **FREE 150-page catalog** of over 5,000 exclusive and hard-to-find supplies for audio & video.

**800-522-2025** America's most unique catalog for audio & video!

**MARKERTEK™ VIDEO SUPPLY**  
145 Ulster Ave., Saugerties, New York 12477 U.S.A.

Circle (49) on Rapid Facts Card

**WHY GO ANYWHERE ELSE FOR ANYTHING AUDIO WHEN WE HAVE IT ALL ?**

ADAMS-SMITH AKAI AKAI-DIGITAL AKG API ART ASHLY BBE BSS CASIO-DAT CREST DBX DDA DEMETER DIC DRAWMER EVENTIDE FOSTEX GML HAFLER HILL KLARK-TEKNIK LEXICON MACKIE DESIGNS MIDIMAN MILAB MONSTER CABLE NUMARK PS-SYSTEMS RANE SAMSON-WIRELESS SENNHEISER SONTEC SONY SOUNDTRACS STUDIOMASTER SUMMIT AUDIO SYMETRIX TANNOY T.C. ELECTRONICS TECHNICS TUBE-TECH WHITE

**anything audio**

**professional audio and video systems**

USED SPECIALS - 23 TUBE MICS IN STOCK NOW-Neumann U64, U67, U47, M49; Telefunken 251, AKG C12 & C60-Call for details. • SSL 4040E, \$70K • Neotek Series II, \$40K • Neve 8038 \$75K • MCI JH636 w/Auto \$25K • API 32x24 Call • TAC Scorpion 36X12X24 \$14K • Tac Scorpion 30X8X16 \$8K • (5) Neumann U87's \$1.4K • AMS Audiofile \$55K • AMS 1580s \$6K • ProDisk 464 12 chnl/6 hr Call • (2) Studer A800 MKIII \$40-44K • Studer A80 MkIV \$27K • Mits X850 \$85K • Otari MTR90-II \$28K • Otari MTR12 2-Trk 1/4" \$6.5K MCI JH24520K • Dolby SR, \$17K • Fostex E16 \$4K • Tascam MS-16 \$5200 • Panasonic 3700 \$1K • (5) 8-tracks in stock now btw \$1-4K • (2) Adams-Smith 2600 \$5K • (3) Zeta III \$2K • (2) Urei LA4A \$1K • Tube-Tech MP-1A, \$1350 (new) • Rev 7 \$550 • Spectra Sonics 610 Comp \$500 • Lexicon PrimeTime II \$450 • Lexicon 200 \$1800 • Beyer M500 \$225 • Hafler P505 \$500 • DBX 166 \$335 • DBX 160's \$450 • Tannoy LGM12 \$1K • Eventide 969, \$1K • Summit Audio EQP-200A, \$1540 (new) • Alpha Audio DR 2, \$7995 • AKG 414, \$350 • Tube-Tech PE-1C, \$1273 (new) • CALL FOR COMPLETE USED LISTING • 1000'S OF ITEMS AVAILABLE • LIST YOUR USED EQUIPMENT

**SPECIAL ON AKG HEADPHONES & MIC STANDS**

**800-788-2875**

**FAX 617-426-2763**

63 MELCHER STREET BOSTON, MA 02210 617-426-2875

Circle (42) on Rapid Facts Card

**QUALITY**  
New & Used Equipment

**INNOVATIVE**  
Studio Design & Installation

**RELIABLE**  
Service & Maintenance

**IN STOCK NOW**  
SOUNDTRACS MEGAS STUDIO 32 X 24 X 24

**POST AES SPECIALS**

**BUY, SELL & TRADE**  
Vintage & Used Equipment

**Loudspeaker Enclosure Design for the Macintosh**

Displays • Frequencies • Resonance • Accurate sine Waves • Phase • Impedance • Group Delay Calculators • Enclosure Dimensions (Rectangular & Trapezoidal) • Vent Dimensions



Features: Large Driver Library • Easy Parameter Entry • Model Based or Vent Enclosures • Units Conversion • Multiple Drivers • Vents • Basic Enclosure Design • \$249.00

619-480-8961

Classified Advertising is available by the column inch (Classified Display): \$40 per inch, per insertion, with frequency discounts available. 1" minimum, billed at 1/4" increments thereafter. 10" maximum per ad. Blind ads (replies sent to R-E-P for forwarding) \$25 additional. Reader Service number \$25 additional. Ads 4" and larger will receive a free reader service number and your company's name listed in the Advertiser's Index. Spot color (determined by magazine) \$150 additional. No agency discounts are allowed for classified advertising. Contact Renée Hambleton, 913-541-6745, for information on frequency and pre-payment discounts, or send your order and materials to:

Renée Hambleton  
R-E-P  
9221 Quivira Rd.  
Overland Park, KS 66215  
Fax your ad to : 913-541-6697



**ENGINEERING**  
214 Lincoln St.  
Suite 103C  
Boston, MA 02134

**The oldest East Coast broker !!**

**(617) 782-4838**  
fax **(617) 782-4935**

**Otari & Tascam factory service.**

New specials on Hafler & Ashly amps, Sontec EQs, Eventide, TC Electronic, Aphex, Tannoy monitors, AKG & Adams-Smith. dbx noise reduction in stock.

**WE NEED YOUR CLEAN USED GEAR !!!**

**List Your For-Sale Items Free !!**

**SSL 4040, \$75K; 4056E/G, \$220K; Neve 8026, \$25K; 8068, \$65K; 8108, 28in, \$50K; DDA DMR-12, 56 in, \$35K; Trident 80C, \$45K; Trident 24, \$17K; Amek Angela, \$35K; MCI 542C, 42 in Auto, \$27K. CALL for prices on API, TAC, Harrison, Soundtracs & Soundcraft. 2 4 Tracks; Otari MTR90 II, \$27K; MX80, \$21K; Studer A800MkII, \$38K; MCI JH24, \$18.5K. Otari MX70 16tr, \$10K. Processing; AMS 1580, \$2.8K; RMX16, \$4.5K; Eventide H3000S, \$1.7K; H3000B, \$2.2K; Pultec Mavec, \$1K; Mics; Neumann U67 tube, \$2.2K; AKG C12A (tube), \$1.4K.**

**WANTED: UREI 1176, 1178, LA-3A; dbx 160; Lexicon 224XL, 480L, PCM70, PCM42; All Neumann & AKG.**

Circle (43) on Rapid Facts Card

**PAQUITO & SONS**  
Since 1952  
PROFESSIONAL AUDIO & ELECTRONICS ACCESSORIES FOR THE DISCRIMINATING AUDIO PROFESSIONAL  
CALL OR WRITE FOR YOUR FREE CATALOG  
PO. BOX 540596 DEPT. R  
MERRITT ISLAND, FLORIDA 32954  
407-453-8120

**SOUNDCRAFT TS 24**  
inline console.  
40 frame fitted w/32 inputs, 24 buss, Mastermix Automation, P & G faders, 584 pt. patchbay, peak/v.u. bargraphs \$33K.  
CONTACT:  
Steve Feindell (902) 423-0233.

# Classified

## FOR SALE

**SINGERS!**  
REMOVE VOCALS  
FROM RECORDS AND CDs!



**SING WITH THE WORLD'S BEST BANDS!**  
An Unlimited supply of Backgrounds from standard stereo records! Record with your voice or perform live with the backgrounds. Used in Professional Performance yet connects easily to a home component stereo. This unique product is manufactured and sold Exclusively by LT Sound - Not sold through dealers. Call or write for a Free Brochure and Demo Record.  
**LT Sound**, Dept. RP-3, 7980 LT Parkway  
Lithonia, GA 30058 (404) 482-4724  
Manufactured and Sold Exclusively by LT Sound  
**24 HOUR PHONE DEMO LINE: (404) 482-2485**

### Now You Can Afford THE WORLD'S FINEST AUDIO TRANSFORMERS

REICHENBACH ENGINEERING is now marketing their Legendary audio transformers through **BAUER COMMUNICATIONS INC.** Reichenbach pioneered the technology giving you flat group delay, and the besel response, with no overshoot or ringing. Our low distortion core material eliminates that muddy bottom end.

	1	25	100
RE-115K-E .....	\$49.01	40.46	31.26
RE-11P-1 .....	\$46.66	38.69	29.75
RE-MB-C .....	\$39.58	32.82	25.24
RE-MB-D .....	\$69.23	57.41	44.15

ACCEPT NO SUBSTITUTES  
INSIST ON A  
**REICHENBACH!**

 **BAUER COMMUNICATIONS, INC.**

Phone (800) 627-7277 Fax (818) 894-0715

(formerly marketed as Jensen transformers)

**TEKCOM CORP.**

SOUND REINFORCEMENT,  
MULTI-TRACK RECORDING  
AND DIGITAL AUDIO  
SPECIALISTS  
COMPETITIVE PRICES  
EXPERT TECHNICAL  
SUPPORT & SERVICE  
DESIGN AND INSTALLATION

TekCom sells virtually every product on the market with mid-Atlantic exclusives on the full line of Otari tape recorders, Trident and DDA consoles, Disk Mix & J.L. Cooper automation systems, and ProDisk direct to disk recording/editing system.

**(215) 426-6700**

1020 N. Delaware Ave.  
Philadelphia PA

## VINTAGE EQUIPMENT

**WANTED**  
Tube U47s, C12s, Elam 251s  
TRIDENT 80Bs, 80 SERIES NEVES  
Anything of exceptional audio quality  
Cash or Trade  
"this is not a problem."  
**MERCENARY AUDIO**  
Tel: 617-784-7610 Fax: 617-784-9244

## INSTRUCTION

**BOOKS, VIDEOS, TAPES**  
Recording • Live Sound • Music Business  
Composition • MIDI • and more!  
Over 550 titles.  
**FREE CATALOG (800) 233-9604**  
6400 Hollis St. #12, Emeryville, CA 94608  
**MIX BOOKSHELF**

## MISCELLANEOUS

**AUDIO AFFECTS**  
STUDIO EQUIP. FOR HIRE  
Technician on staff 7 a.m. - 1 a.m.  
Open 7 days a week  
Digital Tape Machines,  
Synclavier Systems,  
Effects Processors, Reverbs  
(213) 871-1104 (818) 980-4006  
Ask For Mark

## ANNOUNCEMENT

great body gets new head!  
**OPUS**  
under new ownership.

ALL OF OUR TECHNICAL & SUPPORT STAFF & SALES ENGINEERS REMAIN UNCHANGED. GIVE US A CALL AT (708) 336-OPUS FOR OUR NEW PROMOTIONAL PRICES OR WRITE US FOR A BROCHURE DETAILING OUR NEW PRODUCT & SERVICE LINES AT 4262 GRAND AVE., GURNEE, IL 60031.

YOUR PROFESSIONAL AUDIO VIDEO SOURCE. 

Circle (47) on Rapid Facts Card

## SERVICES

**AUDIOPHILE QUALITY...**  
**EUROPADISK, LTD.**  
US' MOST COMPLETE FACILITY!

- Cassette Duplication
- Compact Disc Production
- DMM Vinyl Pressing • Custom Graphics • Mastering Studios

COMPLETE PACKAGES with state-of-the-art Neve Digital Mastering for CD, Studer & Lyrec HX-Pro Cassette Duplication, DMM Mastering for Vinyl and a complete in-house art department - design, layout, typesetting, color separation. Get THE BEST at no extra cost!

For a Complete Brochure, call or write:  
**EUROPADISK, LTD.**  
75 Varick Street, New York, NY 10013  
☎ (212) 226-4401 FAX (212) 966-0456



**USE R-E-P CLASSIFIEDS**

## SERVICES

**JBL** LOUDSPEAKERS—EXCLUSIVE  
Warranty/Non Warranty Repair.  
Factory Authorized Center  
Professional-High Fidelity  
Four Day Turnaround For Stocked Kits.  
All Work Done By Factory Trained  
Technicians.

**PS ★ AR**  
PRICE STEVENSON ACOUSTIC RESEARCH  
1591 Broad Run Rd., Downingtown, PA 19335 (215) 383-1083

**RCA MICROPHONES**—Repair  
service on all models. Complete  
sound and cosmetic restoration.  
We also repair other ribbon types.  
ENAK Microphone Repair, 420  
Carew Avenue, Pitman, NJ 08071.  
(609) 589-6186.

**BUILDING A STUDIO??**

**STUDIO & ACOUSTICAL DESIGN**  
**COMPLETE STUDIO PLANS**  
**WIRING SYSTEM DESIGN**  
**STUDIO INSTALLS & PRE-WIRING**  
**OTARI & TASCAM SERVICE**

Have your new room or facility designed  
& built by audio professionals with over  
20 years experience as mixers, produc-  
ers, musicians & studio owners.

**db ENGINEERING**  
**Boston, MA (617) 782-0648**

**MAGNETIC RECORDING**  
**HEADS**—RELAP/REPLACE-  
MENT for Audio, Video, Time  
Code, Duplication. 29 years of  
head design experience. IEM,  
350 N. Eric Dr., Palatine, IL  
60067; tel (708)358-4622.

## DUPLICATION SERVICES

**DISC MAKERS**

- **Cassette Duplication**
- **Record Pressing**
- **CD Replication**
- **Video Duplication**

Complete Packages

**CALL FOR OUR FREE FULL COLOR CATALOG**  
**1-800-468-9353 (In PA: 215-232-4140)**

**DISC MAKERS**  
1326 North 4th Street  
Philadelphia, PA 19019

**AUDIO & VIDEO CASSETTE DUPLICATION**

- Every Tape Checked for Quality Control!
- Real Time & High Speed • Complete Packaging •
- 3/4", VHS, Hi-Fi, S-VHS, DAT •

**1-800-365-TAPE (8273)**

**EASTCO PRO** • Free Catalog •  
AUDIO/VIDEO CORPORATION • BUFFALO, N.Y.

**COMPLETE CD AND CASSETTE**  
**PRODUCTION**

**DIGITAL HOUSE**  
212-333-5950

**MASTERING REPLICATION**  
**PRINTING TOTAL PACKAGING**  
**POSTERS GRAPHIC DESIGN STUDIO**  
**PERSONALIZED EXPERT SERVICE**

101 WEST 57TH ST. NEW YORK, N.Y. 10019  
**"FOR THOSE WHO HEAR THE**  
**DIFFERENCE"**

**ALIGNED AUDIO INC.**  
**SUPER QUALITY**

- ▶ Audiophile Record Pressing
- ▶ CD Replication
- ▶ Real Time and High Speed
- ▶ Cassette Duplication
- ▶ Direct On-Shell Imprint in Colors

**COMPLETE PACKAGES**  
Call Today for your Free Catalogue

☎ **1-800-869-6561**  
OR **1-718-788-6969**  
FAX **1-718-499-0421**

Circle (45) on Rapid Facts Card

*Full Color  
Cassette Inserts  
Only \$109*

**1-800-95J-KARD**  
Free Catalog Anderson Graphics

**ESP**

**CD'S AND TAPES**  
**COMPLETE**  
**PACKAGES**

- CD REPLICATION
- HIGH SPEED CASSETTES
- AUDIOPHILE REAL TIME CASSETTES ON TDK-SA
- COMPLETE PRINTING AND PACKAGING

**EASTERN STANDARD PRODUCTIONS, INC**  
26 BAXTER STREET  
BUFFALO, N.Y. 14207  
TEL 716-876-1454  
FAX 716-877-6395  
1-800-527-9225

**1000 CD'S**  
**\$2300.00**

**COMPLETE PACKAGE**

**1-800-527-9225**  
**FOR A FREE BROCHURE**

## RENTAL EQUIPMENT

**A TOTAL EFFECT**

Eventide H-3000 SE	Includes remote patchbay.
T.C. 2290 (32 sec.)	
T.C. 2290 (32 sec.)	
T.C. 1210 spatial ex.	24 hr. service
Publison Infernal 90	
AMS S-DMX	7 days a week
AMS RMX-16	
Eventide SP 2016	
Lexicon 480L	
480L Larc & Manuals	

All for **\$300 a day**  
or **\$1200 a week!**  
(That's \$171.43 a day!)

Call for advance bookings today  
**(818)345-4404**  
Encino, CA

Circle (46) on Rapid Facts Card

**SOUND REINFORCEMENT**  
**MIXING CONSOLE RENTALS**

New!	Midas XL-3	- ATI Paragon
New!	Soundcraft Europa	- Gambel EX56
	Yamaha PM3000	- Gamble HC40
	Ramsa WR-S852	- Gamble SC32
	Ramsa WR-S840	- TAC Scorpion
New!	Soundtracs Sequel	- ATL 32x12
New!	Soundtracs Megass	- Yamaha 2408
	Soundcraft 800B	- TOA RX-7

PSU's • Reverbs • Delays • Multi-FX • Gates  
RDAT • Comp/Limiters • EQ's • SDL-5 subs  
Console Accessories: Covers-Lights-Cables

- FREE travel and shop setup time
- World's largest live console inventory
- 9 yrs of console rental specialization
- Worldwide service & backup
- Spare PSU and cables included
- Inventory in SF - NY - Orlando - LA
- Tours - Weekly - Daily - Long Term
- EXTREMELY COMPETITIVE PRICES!

**Hi-Tech Audio**  
(415) 742-9166

**Invest Your Advertising Dollars in R•E•P's Classifieds!**

# Advertisers Index Sales Offices

	Page Number	Rapid Facts Number	Advertiser Hotline
Aligned Audio	71	45	718-788-6969
Ampex Recording Media	12-13	8	415-367-3809
Anything Audio	69	42	617-426-2875
Arcoustics, Inc.	59	28	212-727-9645
Sam Ash Professional	53	26	212-719-2640
Audio Precision	17	10	800-231-7350
Audio-Technica U.S., Inc.	21	12	216-686-2600
Audio Visual Assistance	68	41	612-481-9715
Crown International	IFC	1	219-294-8000
dB Engineering	69	44	617-782-4838
DIC Digital Supply	4	5	201-224-9344
Disc Makers	59	27	216-232-4140
Full Compass Systems	51	29	800-356-5844
Hardy Co.	42	20	708-864-8060
Innovative Audio Systems	67	37	213-470-6426
JBL Professional	BAC		818-893-8411
Jensen Transformers Inc.	27	15	213-876-0059
KABA Research & Development	31	17	800-231-TAPE
Markertek Video Supply	69	49	914-246-3036
Mercenary Audio	67	unlisted	617-784-7610
Meyer Sound Labs	25	14	415-486-1166
M.T.U.	53	25	919-870-0344
National Foam Inc.	68	39	213-650-8906
Opus Recording & Equipment	70	47	312-336-6787
Otari Corp.	28-29	16	415-341-5900
Oxmoor	45	23	205-985-7040
Ramsa/Panasonic	39	19	714-373-7478
Peavey Electronics Corp.	15	9	601-483-5365
Rane Corporation	43	22	206-355-6000
Santa Monica Sound	57	30	310-450-3193
Seam Tech	68	40	415-543-0170
Shure Brothers, Inc.	IBC	2	800-25-SHURE
Sony Professional Audio	23		800-635-SONY
Sony Professional Tape	7		201-930-7081
Soundtracs Div. Samson Tech	1	3	516-932-3810
Tannoy North America Inc.	11	7	519-745-1158
Tascam	34-35	18	213-726-0303
Technical Audio Devices	3	4	213-816-0415
A Total Effect	71	46	818-345-4404
Turtle Beach Softworks	47	24	717-843-6916
World Class Tapes	68	38	313-662-0669
Yamaha International Corp.	18-19	11	714-522-9011

## CLASSIFIEDS

*Renee Hambleton*  
913-888-4664  
9221 Quivira Road  
Shawnee Mission, KS 66215  
Telefax: 913-541-6697

## SANTA MONICA, CA

*Herbert A. Schiff*  
213-393-9285  
*Jason Perlman*  
213-458-9987  
*Kelly Daugherty*  
213-451-8695  
501 Santa Monica Blvd.  
Santa Monica, CA 90401  
Telefax: 213-393-2381

## CHICAGO, IL

*David Rutenberg*  
312-435-2360  
55 East Jackson Blvd.  
Chicago, IL 60604  
Telefax: 312-922-1408

## NEW YORK, NY

*Stan Kashine*  
212-332-0634  
38th Floor  
888 Seventh Ave.  
New York, NY 10106  
Telefax: 212-332-0663

## OXFORD, ENGLAND

*Richard Woolley*  
Unit 3, Farm Business Centre  
Clifton Road  
Deddington, Oxford  
OX15 4TP England  
Telefax: +44(0) 869-38040  
Telephone: +44(0) 869-38794  
Telex: 837469 BES G

## FREWVILLE, SOUTH AUSTRALIA

*John Williamson*  
*Hastwell, Williamson, Rep.*  
*Pty. Ltd.*  
109 Conyngham Street  
Frewville 5063  
South Australia  
Phone: 799-522  
Telefax: 08 79 9735  
Telex: AA87113 HANDM

## TOKYO, JAPAN

*Mashy Yoshikawa*  
Orient Echo, Inc.  
1101 Grand Maison  
Shimomiyabi-Cho, 2-18  
Shinjuku-ku, Tokyo 162, Japan  
Telephone: 03-235-5961  
Telex: J-33376 MYORIENT

*"I've been sold on Beta's superiority since I first tried them. I use them on vocals, drums, amps, and brass because their sensitivity and resistance to feedback make them the perfect fit for the groups I work with. And the Beta 58 Wireless is the first system I've found that gives my artists the freedom of a radio mic without sacrificing sound quality."*

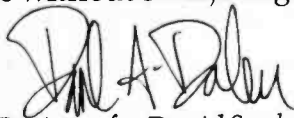

*Paul Dalen, Sound Engineer for David Sanborn and Lisa Stansfield.*



## Shure Beta Microphones. Buy Them On Word Of Mouth Alone.

Before you select a microphone, listen to the leading pros who use the Shure Beta Series on stage. They'll tell you about the benefits of Shure Beta's advanced transducer design, extraordinary gain-before-feedback, and true supercardioid polar pattern, as well as its outstanding sensitivity and low handling noise. But most important, they'll tell you that nothing beats a Beta for live performance. And that's not just talk. Try Shure Beta today and get the final word for yourself. Or call us for more information at 1-800-25-SHURE. The Sound Of The Professionals®...Worldwide. **SHURE**

Circle (2) on Rapid Facts Card

# The 4200 Series. Designed For The Control Room, Not The Living Room.

Today's recording studio has evolved into a multi-function facility which simultaneously addresses the specialized needs of music recording, film and video post, and radio production. In this environment, where the most critical listening often occurs in the final mix, close proximity monitors are often more important than the mains. The problem: most console top monitors, unfortunately, were designed for the living room not the control room. Until now.

With the 4200 Series we're taking our stand from where you sit: right where you work at the console. Designed, engineered and tested from this position, the 4200 Series is the first console mount monitor created specifically for the professional recording environment.

Both models give you pin-point imaging by delivering high and low frequency information to your ears at precisely the same instant. By virtue of their symmetrical design the 4200 Series monitors are mirror imaged.

And so nothing gets in the way of your music, the 4200 Series introduces our uniquely sculpted Multi-Radial™ baffles incorporating newly designed pure titanium tweeters and low frequency transducers. The combination of these technologies successfully corrects time arrival anomalies and eliminates baffle diffraction distortion.

4200 Series: console top monitors designed in the studio, for the studio, with sonic performance rivaling much more expensive monitors. 4200 Series: the shape, and sound, of things to come. Available at your local authorized JBL Professional dealer.



JBL Professional  
8500 Balboa Boulevard, Northridge, CA 91329

■ A Harman International Company