

\$1.50

OCTOBER 1976
VOLUME 7 - NUMBER 5

Recording engineer producer

INCLUDING: CONCERT SOUND REINFORCEMENT

1001 2POME ROYDO
DOUG POMEROY
BIG APPLE STUDIO
44 2 GREENE ST
NEW YORK

RELATING RECORDING SCIENCE • TO RECORDING ART • TO RECORDING EQUIPMENT



helios electronics ltd

England.

A Company of Human Beings

Helios Electronics Ltd. was founded in April 1969 by Richard Swettenham to provide not merely another studio hardware manufacturing company, but rather a service conducted by enthusiastic individuals to meet as precisely as possible the technical requirements arising out of the experience of leading recording engineers. The enthusiasm with which our efforts were received in the first year confirmed the rightness of our intention, and the basis of our main activity remains in the field where each project is given serious study in the light of the client's needs. The amount of engineering effort this entails is considerable, but is justified by the new experience gained from each such project.

By gearing our activity to this policy, we are often able to put forward prices much closer to competitive standard products than might be imagined. In discussion with Helios engineers, a client will often find himself being gently persuaded that he does **not** need certain expensive features.

To Helios, custom design is not merely the arrangement of standard modules in different patterns. New modules are constantly being created to meet individual requirements and preferences. Physical layouts aim towards ergonomic ideals, related always to the user's actual control room environment. The Helios design team combines electronic design capability with the inestimable advantage of very many years of practical studio operational experience. Theory is always the servant of realism and common sense. Nothing is done to look impressive in specifications, but always to provide real advantage to the user.

Standard recording consoles:

For the studio requiring less complicated facilities, on a limited budget, but with no compromise on sound quality the semi-standard PS range was introduced in versions from 10 input 4 group 8 track up to 26 input 8 group 24 track. Many of these units have been expanded after delivery to accept more inputs and tracks.

Memory assisted mixdown:

We offer voltage controlled amplifiers in channels, operated by standard faders, with grouping and master DC busses, plus our own programmable cut switching matrix; all this capable of interfacing with any memory system handling analog levels; direct digital communication is currently being studied.

Mobile Sound Vehicles have for long been a Helios specialisation; the first of Europe's multitrack recording vans, completely designed and installed by Helios for The Rolling Stones in 1970, is, after conversion to 24 track in 1975, still a leader in the field, and many others have followed.

Film re-recording:

Study of the requirements, particularly for high speed documentary and news production, has led to designs including sweep frequency equalisers, instant equaliser switching, signal presence and advance cue indicators. There are dual-purpose consoles combining the needs of music scoring and dubbing.

Broadcasting:

The SB range with two or four output groups is intended for smaller television mobiles and sound broadcast studios. It features choice of equalisers on input channels and instant access to all active elements from the front of the unit.

Free Grouping units following Nordic practice are available, as are self operated disc jockey units with automatic voice-over facility.



helios

Helios Model 1167 Console with: 28 inputs, complete with 3 band equalization, linear echo sends to 4 channels, 2 independent cue systems, P & G faders and variable gain for both microphone and line inputs; 16 buss selectable with pushbuttons, panning between odd and even busses, 24 track monitoring from 24 v.u. meters. Available in both stereo and quad, 28 or more inputs, with delivery of stock units in 3 months.

CONSOLE USER LIST.

Apple Records	London	Strawberry Studios	Manchester
ARC	Lagos, Nigeria	Talent Studios	Oslo, Norway
Arctic	Trondheim, Norway	Topic Records	London
Barbarossa	Munich, W. Germany	TPA Studios	London
Basing Street Studios	London	Island Records Mobile	London
Berwick Street Studios	London	La Maison Rouge	London
Funky Features	San Francisco, USA	Lane's Mobile Studio (LMS)	London
Hansa Tonstudio	Berlin, W. Germany	Rolling Stones Mobile	London
Harry J. Records	Kingston, Jamaica	The Manor Mobile	Oxford
Island Records	London	Release Records	Dublin
Magritte Studios	London		
Mainos Television	Helsinki, Finland	John Burn	Steve Miller
The Manor	Oxford	Eno	Leon Russell
Musicland	Munich, W. Germany	John Entwistle	Steve Winwood
Olympic Sound Studios	London	Alvin Lee	Ron Wood
Rampart Studios	London	Paul McCartney	

Distributed exclusively in the
United States of America by . . .

**EVERYTHING
AUDIO**

For more information circle No. 101

Accept our invitation to contact us and discuss your studio needs.

7037 Laurel Canyon Blvd., North Hollywood, California 91605 / 982-6200

Our "Stripped

It may seem funny to call a professional tape recorder "stripped down," but we think when you take a look at all the features you get as standard equipment on the new BOUSE APD 1600 you may change your mind about the others. And features are just one of the advantages you get with BOUSE. Example: While most engineers would agree that the closed loop tape path has been the ultimate refinement in the evolution of the modern studio recorder, we've gone further. We've improved that method even more by using *dual* capstans with a crystal controlled phase locked capstan servo and eliminated the pinch rollers,

fixed tape guides, and tape lifters. Check the tape wrap! Now take a look at the tape transport, it's machined from a 2" thick solid aluminum plate, and bolted to a one piece welded steel tubular frame which forms the console. That's ruggedness! After all, we are an aerospace precision machine company. And the electronics? We're using the latest in IC technology for both performance and ease of service. We'll match our specs against anybody's. Want to know more? Drop us a line and we will be happy to send you complete specifications on both our 16 and 24 track recorders. We think they're the best you can buy.

Compare the features:

16 track	APD 1600	3M 79	MCI JH-114	AMPEX MM 1200
Dual capstans	Yes	No	No	No
Closed loop tape path	Yes	Yes	No	No
Auto-Replay	Yes	Option	Option	Yes
Digital Counter	Yes	Option	Option	Yes
16 track wired for 24	Yes	No	No	Yes
Complete remote control	Yes	Option	Option	Option

Compare the price:

BOUSE APD 1600 with AUTO-REPLAY, digital counter, and complete remote control: \$18,750.

3M Model 79-16 with SELECT-TAKE, digital counter, and complete remote control: \$24,745.

MCI JH-114-16 with AUTO-LOCATOR, digital counter, and complete remote control: \$21,000.

AMPEX MM-1200 with SEARCH-TO-CUE, digital counter, and complete remote control: \$23,650.



*Manufacturers published features and prices at time of publication.

For more information circle No. 102

Down" Model

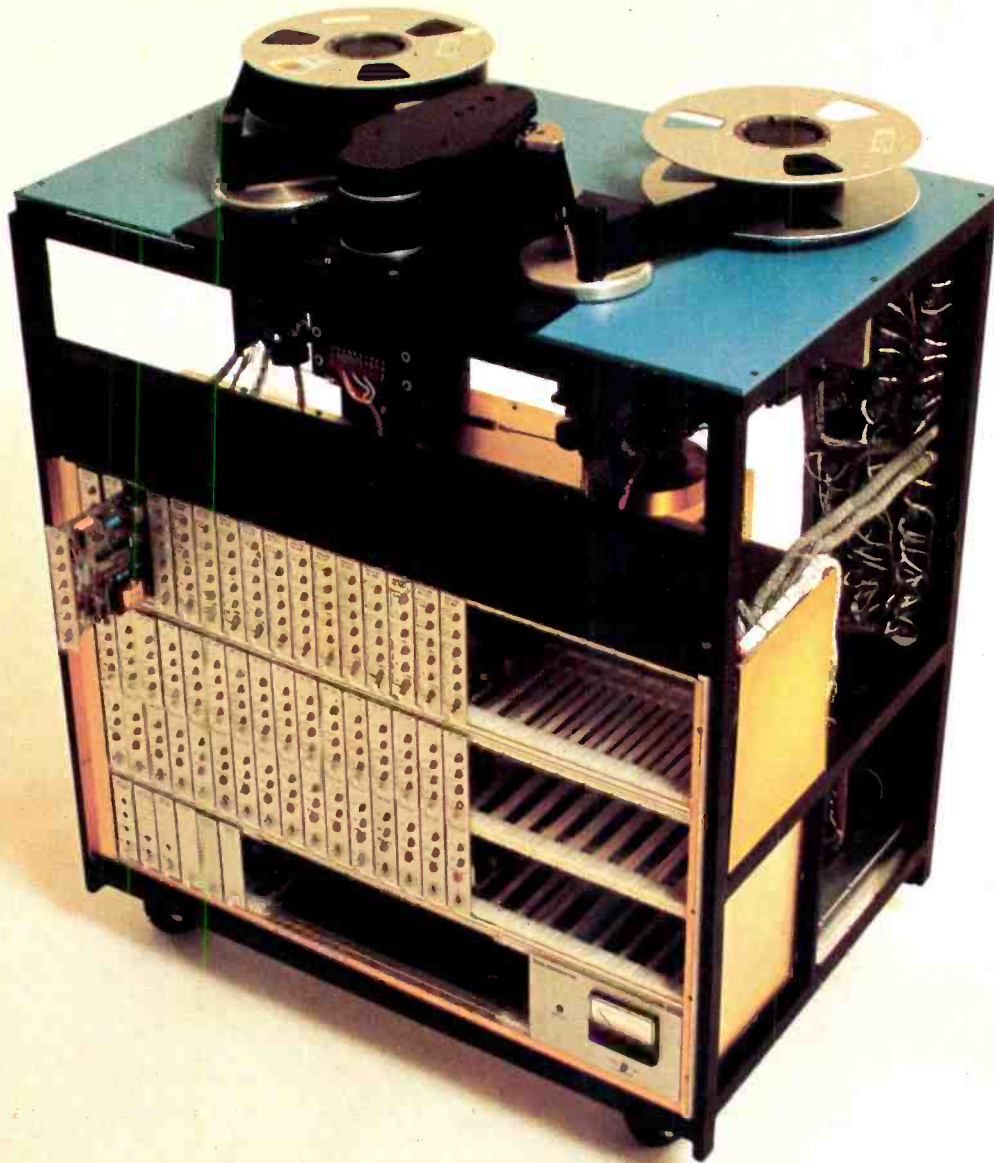

Bouse Manufacturing Company/Newport Beach, California
D.STRIBUTED EXCLUSIVELY BY

AUDIO CONCEPTS, INC./DAVE KELSEY SOUND
7138 Santa Monica Boulevard • Hollywood, California 90046 • (213) 851-7172

R-e/p 5

RECORDING engineer/producer

- the magazine to exclusively serve the recording studio market . . . all those whose work involves the recording of commercially marketable sound.
- the magazine produced to relate . . . RECORDING ART to RECORDING SCIENCE . . . to RECORDING EQUIPMENT.



Editor/Publisher . . . MARTIN GALLAY
Associate Editor . . . GARY KLEINMAN
Consulting Editor PETER BUTT
Business Manager V. L. GAFFNEY
Circulation Manager. LARRY DOUGLAS
Assistant Editor MARGE ANDERSON



'RECORDING engineer/producer' is published bi-monthly (six times a year) by RECORDING & BROADCASTING PUBLICATIONS, 1850 No. Whitley Avenue, Suite 220, Hollywood, CA 90028, and is sent to qualified recipients in the United States. Subscriptions for other than qualified individuals or companies may be purchased at \$7.50 per year (6 issues). All foreign subscriptions Surface Mail - \$8.50, Air Mail - \$15.00.



RECORDING engineer/producer is not responsible for any claim made by any person based upon the publication by RECORDING engineer/producer of material submitted for publication.



Material appearing in R-e/p may not be reproduced without written permission of the publisher.



Controlled Circulation postage paid at Los Angeles, California.

Address all correspondence to:
RECORDING engineer/producer
P.O. Box 2449
Hollywood, CA 90028
(213) 467-1111

. . . the emerging importance of the concert sound
STAGE MONITOR ENGINEER:
"A Little More Snare In My Monitor, Please!"
by David Hadler . . . page 16

Neil Diamond's invisible, underneath
Vocal Stage Monitor
by Chris Forman . . . page 20

an operational profile of
engineer/producer
ALAN PARSONS
by Howard Cummings . . . page 29

$\frac{RIAA + NAB}{2} = De'ja Vu$
Half Speed Cutting Returns
by Stan Riker and Peter Butt . . . page 43

The JBL way:
INSIDE THE STUDIO MONITOR
by Garry Margolis . . . page 51



THE COVER

. . . an unusual posterization portrait
of a standard photo of a HARRISON
SYSTEMS console . . . by Nashville
graphic designer HERB PAINTER.

AUDIO from the
MAGNETIC RECORDER'S
Point of View
by David R. McClurg . . . page 61

8 - Letters & Late News
83 - New Products
97 - Classified

THIS ISSUE OF R-e/p SPONSORED BY THE FOLLOWING ADVERTISERS

A&R Record Mfg. 99	Frap 54	Recording Supply 99
Allison Research 63	Garner Industries 96,97	SAE 14
Ampex Corp. 42	Haeco 76	Scully, L.J. 45
Ashley Audio 49	Harrison Systems Cvr 3	Scully Recrdg Inst 11
Audio Concepts 45	Inovonics 94	Shure Brothers Cvr-4, 67
Audio Consultants 85	Interface Electronics 97	Sierra Audio 60
Audio Des. & Mfg 89	Intl. Tapetronics 97	Soundcraftsmen 82
Audio Industries 39	JB_ 64	Sound Workshop 84,88
Audiotechniques 96,97	Kustom Electronics 73	Spectra Sonics 7,78
Auditronics 31	Lang, Rus 12	Stanton Magnetics 80
Auratone Products 66	Lexicon 33	Studer of America 79
Bouse Mfg. 4-5	MCI 15	Sugarloaf View 35-36
Bruer 95	Magnetic Recovery 40	3-M, Mincom 25
Capitol Magnetics 75	Magnetic Reference 56	360 Systems 58
College Recording Arts 90	MicMix Audio 83	Taber 86
Countryman Assoc 88	N'ville Studio Systems 13	Tapco 41
Crown International 46	Neve 50	Telex 23
dbx 21	Orban/Parasound 57,59	Thompson CSF 71
Eastlake Audio 60	Pacific Recorders 87	Unisync 86
Electro-Voice 28	Panasonic/Technics 17	UREI 8,90
EI-Tech 69	Peavey Electronics 55	Westlake 52-53
Everything Audio Cvr 2-3	Quantum Audio 48	White Instruments 81
Express Sound 27		Yamaha International 19

Another incomparable SPECTRA SONICS Model 1024-24 Audio
Control Console, configured to 12 inputs, for Preston Smith's
GREAT AMERICAN MUSIC MACHINE, Denver, Colorado.



Quality: SPECTRA SONICS audio control consoles show the care and attention to detail that are the mark of the skilled American craftsman. The internal wiring, module construction, console housing, and the control display reflect the precision and distinctive craftsmanship that is characteristic of SPECTRA SONICS.

Capability: SPECTRA SONICS audio control consoles provide an immediate initial capability that may be increased to 32 inputs and 32 outputs, at minimum cost. The flexibility of the system will provide line/microphone selection, attenuation, equalization and, through assignment controls, various other combinations for the most sophisticated signal processing now required in today's studio.

Reliability: SPECTRA SONICS audio control consoles have an established reputation of superior reliability. Through creative design, the circuitry is developed to function well below operating

limits to enhance an extended life for the components. Through empirical data on SPECTRA SONICS audio amplifiers, a reliability rate of 99.9% has been derived. These amplifiers are used in SPECTRA SONICS audio control consoles and materially contribute to system reliability.

Performance: SPECTRA SONICS audio control consoles are guaranteed to outperform any other console in the world in noise, frequency response, distortion, and peak overload. All consoles are provided with documented data acquired in tests of the complete system. Guaranteed performance specifications are: Frequency Response, $\pm 1\text{dB}$ 20Hz-20kHz; Signal/Noise Ratio (microphone input), not less than 82.5dB below +4dBm, output for a -50 input (50 ohms source); Signal/Noise Ratio (line input), not less than 87dB below +4dBm output for +4dBm input; Harmonic Distortion, less than .01% at +18dBm (1kHz); Intermodulation Distortion, less than .02% at +4dBm; Crosstalk, not less than 60dB at 20kHz (typically 80dB).

770 Wall Avenue
Ogden, Utah 84404
(801) 392-7531

6430 Sunset Blvd., Suite 1117
Hollywood, California 90028
(213) 461-4321

SPECTRA SONICS

LEADER IN ADVANCED TECHNOLOGY



LA-4 Son of LA-3A

The LA-4 Compressor/Limiter is another great UREI performer. It offers advanced IC design, added features, and a lower price. The LA-4's new electroluminescent light source, the heart of its patented Electro-Optical attenuator, is an L.E.D. which will not change or deteriorate with age. Compression ratios are adjustable from a soft, smooth 2:1 compression through super tight sounding 20:1 limiting. The natural sounding RMS gain control action makes it ideal for professional recording and re-recording. Half rack size. Priced under \$350.00.

Available from your UREI dealer.

UREI
QUALITY
OF COURSE



11922 Valerio Street No. Hollywood, California 91605 (213) 764-1500

Exclusive export agent: Gotham Export Corporation, New York

For more information circle No. 104

LETTERS and LATE NEWS

from: JIM CUNNINGHAM
Director, Technical Facilities
United Recording Corp.
Hollywood, California

*re: Digital Delay by Ken Schaffer in
the August 1976 of R-e/p.*

I noticed a couple of errors in this article which, I believe, are worth taking the time to set straight. The first is Ken's contention that the only way to get delay was to use miles of wire. One way was documented in the April 1961 issue of the Audio Engineering Society Journal. This article outlined the use of 300 Low Pass Filter sections (all pass to audio) to obtain 10 milliseconds of delay. I remember in the 60's asking a certain company who made delay lines for a quote on a 100 millisecond line. Some months later the answer came back: \$100,000 in quantities of 100! Another, far more economical way to get non-digital delay is and was the COOPER TIME CUBE; a strictly acoustic device.

The other error concerns delay panning. This canard has been around the industry for a long time, and should be laid to rest. As Madsen points out in the October 1970 issue of the AES Journal, a delay of only 0.7 milliseconds (700 milliseconds) will shift an image from center to one side of a pair of stereo speakers. With increased delay, no further movement takes place, only an impression of enhanced intensity. Obviously, this effect is of little use to anyone listening on loudspeakers because listener movement of more than a foot off center destroys the intended effect. Larger amounts of delay (10-20 milliseconds) can be used for left-right assignment, but the effect is not comparable to volume panning as Ken suggests.

Incidentally, the Madsen paper referred to has an interesting delay line application overlooked by Ken: that is the extraction of ambience information. Briefly, if a recording containing some reverberation is reproduced on one stereo speaker, and a delayed version of it (20 milliseconds) fed to the other speaker, the direct sound stays in the undelayed speaker, but the reverberation spreads between the two speakers. This is because reverberation is statistically incoherent and thus cannot be *steered* by the delay the way the coherent direct sound can.

Schaffer replies:

"I agree with Jim. If there's anything worse than a canard, it's an old canard, and if delay-panning means you can't get up and dance - - - the point he mentions certainly makes it sound that way - - - I'll stay with volume panning. But I'm sure there are people who've actually done some work with placement-by-delay, and I, for one, would be interested in hearing about it. So much for theory.

Regarding pre-digital methods of delay, I used to think there were few pictures sillier than that of double-tracking through hundreds of miles of wire . . . until I conjure the image of the 300 low pass filters. So until I can afford a delay line of my own I'm gonna keep on winding that coil . . . simplest is best!"

From: Howard Cummings
Los Angeles, CA

In his article "Why You Can't Wait For Digital Delay" (R-e/p, August 1976), Ken Schaffer refers to ADT in text and pictures as Automatic Double Tracking. This is a misnomer. The correct term is actually *Artificial* Double Tracking, a technique developed by Ken Townsend of EMI-London through the use of a crystal oscillator on the U.K. BTR 2 tape machine.

Also his reference to the Beatles likely employing ADT on the album Rubber Soul ('65) should be clarified. The Beatles used this effect in material as early as 1963-1964. The actual experts on this matter would be engineer Martin Smith, tape-op Ken Scott, and Producer George Martin.

The Return Of Professionalism To 8-Track Recording.



Scully's 284B-8 doesn't compromise on quality. It's the only master recorder/reproducer of its type that handles 14" reels at speeds up to 30 ips. And when you consider its other features, you'll know that the 284B-8 is a sound investment.

- Handles 1" tape on 10½" as well as 14" reels
- Standard DC capstan servo with pitch control
- Innovative low-noise electronics
- Motion direction sensing
- Dynamically operating disc brakes

- Variable speed accessory with L.E.D. speed read-out

Sales, service and replacement parts are available from over 200 distributors worldwide. Get the facts, contact Scully Recording Instruments, Audio/ Electronics Division of Dictaphone Corporation, 475 Ellis Street, Mountain View, CA 94043 (415) 968-8389 TLX 34-5524

▶ Scully
Recording Instruments

Scully and Dictaphone are trademarks of Dictaphone Corporation, Ives, New York

For more information circle No. 105

FROM: Bob Both
Twain Recording
West Milford, N.J.

Thanks for the article "the Small Studio . . . a roundtable . . ." in your August 1976 issue.

I myself am the owner of one such studio, although it, perhaps, leans more toward the 16 track studio than the small 4 track. My studio "Twain Recording" is an 8 track state of the art operation, a step ahead of most small studios, and a step behind the 16 track studio. All of my equipment (Scully, DBX, Neumann, E-V, etc.) is state of the art.

I am currently thinking about going 16 track, but I am a bit hesitant. Most of our business is from people who are not quite ready for 16 track or just don't need it.

I have seen the studio world from both sides of the fence, both big and small. My engineering engineer has been quite varied, having done some remote, T.V., concert, 16 track, 24 track in addition to smaller work, too. I have

engineered in many big studios (A&R; Sound Ideas; Record Plant, N.Y.; Wally Heider's, S.F.; Criteria, Miami,) and worked with many artists both big and unknown. My credits include gold records on James Brown LP's and singles. I point these things out because it has helped give me a very good perspective of the recording industry. The small studio is definitely needed, and it is hard to compare them to the larger studios. Even though there are many similar factors, they are in two different worlds, each with its own advantages and disadvantages. The smaller studio often has more of the *living room* quality which the clients like because there is, seemingly, less pressure. However, the smaller studio does not automatically mean lesser quality; the needs of a given project should be considered in selecting the right studio. Obviously, in many cases it is the budget that decides.

There are many small studios putting out excellent product, and just about as many others that are so poor they shouldn't even be called studios. There are so many

factors which determine a good final recording that even with all the latest equipment it is possible to fail in the process. [*ed: perhaps this comment shouldn't be restricted to small studios.*]

Too many small studios have unexperienced personnel, which in my opinion, is worse than being under-equipped.

AUDIO ENGINEERING SOCIETY 55th Convention Program

October 29 - November 1, 1976
Waldorf Astoria Hotel
New York City

FRIDAY, OCTOBER 29 -

9:30 AM

Session A: **AUDIO IN MEDICINE**
Session B: **SIGNAL PROCESSING
& TRANSMISSION
SYSTEMS - 1**

2:30 PM

Session C: **ARCHITECTURAL
ACOUSTICS**
Session D: **SIGNAL PROCESSING
& TRANSMISSION
SYSTEMS - 2**

7:00 PM

Session E: **ELECTRONIC MUSIC**
Session F: **SIGNAL PROCESSING
& TRANSMISSION
SYSTEMS - 3**

EXHIBITS OPEN 1:00 PM - 9:00 PM

SATURDAY, OCTOBER 30 -

9:00 AM

Session G: **PSYCHACOUSTICS**
Seminar: **AUDIO EQUIPMENT
INTERFACE - 1**

2:00 PM

Session H: **MEASUREMENT &
INSTRUMENTATION**
Seminar: **AUDIO EQUIPMENT
INTERFACE - 2**

EXHIBITS OPEN 11:00 AM - 8:00 PM

SUNDAY, OCTOBER 31 -

9:00 AM

Session J: **SOUND REINFORCEMENT**
Session K: **DISC RECORDING
& REPRODUCTION**

2:00 PM

Seminar: **SOUND REINFORCEMENT**
Session L: **DIGITAL TECHNIQUES**

7:00 PM

**SOCIAL HOUR
AWARDS BANQUET**

EXHIBITS OPEN 12:00 NOON - 5:00 PM

MONDAY, NOVEMBER 1 -

9:00 AM

Session M: **TRANSUCERS - 1**
Session N: **MAGNETIC RECORDING
& REPRODUCTION - 1**

2:00 PM

Session O: **TRANSUCERS - 2**
Session P: **MAGNETIC RECORDING
& REPRODUCTION - 2**

EXHIBITS OPEN 10:00 AM - 5:00 PM

Holds any model



Ampex, MCI, Scully, Tascam, Otari and any other 19" x 15 1/4" tape transport fits our RL 500 console. Constructed with the same care as the Scully consoles which we have manufactured for the past 12 years, the RL 500 incorporates the newest design features, including front panel removal for deck access in both horizontal and vertical positions and a rear shelf for your power supplies. Add these advantages to Rus Lang's reputation for quality, and the RL 500 becomes the best value on the market. Ask for details and pricing.

custom consoles and portable carrying cases for electronic equipment

Rus Lang Corporation

247 Ash Street, Bridgeport, CT 06605 Tel: 203 384 1266

DEALER INQUIRIES INVITED

FROM: R. Gary Schatzlein
President
Talun Midwest Recording
Center

As always, I read the August issue of R-e/p with interest. Your article on "smaller studios" in the Tampa-St. Petersburg area was intriguing and appropriate, since it marked a shift in emphasis away from heavy coverage in the trades of the "major recording centers" on the coasts and in Nashville.

I couldn't help thinking as I read the article, however, that major studios, equivalent in acoustic design, equipment, and calibre of product and clientele to the best anywhere, in cities other than the major recording centers tend to go unnoticed.

The example which obviously comes most rapidly to my mind is our multistudio complex in Indianapolis, which is competitive in both performance and appearance with the finest studios anywhere. Our 24-track Studio A has a number of unique acoustic features which would be of interest to your readers, and we keep it busy with every-

thing from LP's for United Artists to original-score TV music for some of the nation's leading advertisers . . .

ED: Agreed, gentlemen.

There are an enormous number of facets to the subject —

An additional word of thanks to the many, many, many, R-e/p readers who took the time to write commenting on their view.

Promise: more coming, from all areas.

PURPLE JOINS NASHVILLE'S AUDIO CONSULTANTS

In an announcement by Audio Consultants' president, Claude Hill, Jr., Dave Purple has been named as Sales Manager of the Nashville-based studio design, equipment and installation firm.

A "Grammy" award winning engineer (Isaac Hayes, Stax), Purple has spent the last two years as Professional Products Manager of dbx.

"His experience in all phases of recording and studio operation including extensive work in disc mastering will greatly complement the capabilities of our other engineer-

ing people," said Hill in making the announcement.

NEVE REPORTS MAJOR ORDERS FOR NECAM AUTOMATION

Rupert Neve & Company Limited announce that three of London's leading recording studios have placed orders for NECAM, the company's computer-assisted sound mixing system.

The three studios are Air Studios in Oxford Street, the Music Centre in Wembley and E.M.I. at Abbey Road. The three systems, which will be linked to existing Neve consoles, are expected to be installed by November.

According to David Harries, Studio Manager of Air, "the decision to add NECAM is a logical step in our continual aim to provide the best recording facilities available.

Ken Townsend, Manager of the studios of E.M.I. Abbey Road notes, "NECAM is an outstanding advance in technology, and its

continued on page 100 . . .



THIS IS YOUR TEST TRACK

The "Test Track" was built with one purpose in mind—to demonstrate to you every piece of gear in its proper environment. After all, we're in this business to sell professional audio gear—not lemons.

Come test drive your own equipment.

Nashville Studio Systems
16 Music Circle South • Nashville, TN • (615) 256-1650

Dealers for • TEAC/TASCAM • OTARI • BGW • JBL • EL-TECH CCNLS

For more information circle No. 107

www.americanradiohistory.com



Powerful alternative.

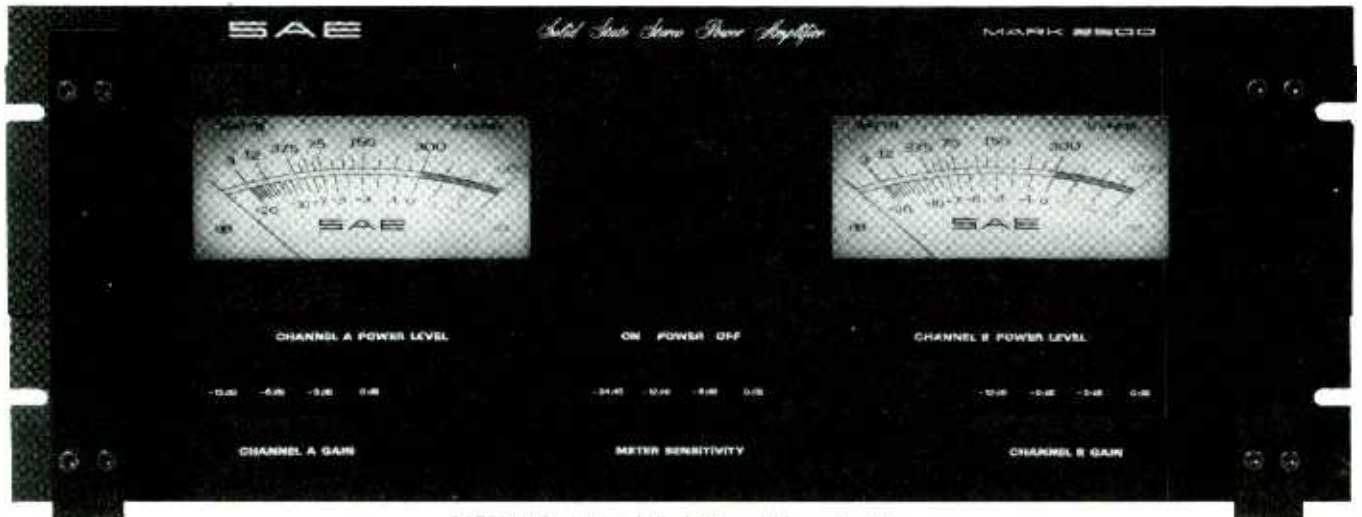

SAE 2500 Professional Dual-Channel Power Amplifier

When you compare power amplifiers, you have to look at the hard facts. The SAE 2500 Professional Dual-Channel Power Amplifier has them—top power, specifications, reliability and features that make it the most "powerful alternative."

Power. 450 Watts RMS per channel, both channels driven into 4 Ohms from 20Hz to 20kHz at no more than 0.1% total harmonic distortion. Or, 300 Watts RMS per channel, both channels driven into 8 Ohms from 20Hz to 20kHz at no more than 0.05% total harmonic distortion.*Plus, a new, smaller wide-channel power transformer coupled to 4 computer-grade capacitors for a power supply that varies no more than 10% from no load to full load. (For extra protection, there are relay and thermal cut-out devices.)

Other Specifications:

IM Distortion from 250mW to rated power at 4 or 8 Ohms with any 2 mixed frequencies between 20Hz and 20kHz at 4/1 voltage ratio.....0.05 Max.
 Frequency Response at rated power.....±0.25dB, 20Hz to 20kHz
 Noise.....Greater than -100dB below rated power
 Transient Response of any Square Wave.....2.5µsec. rise and fall time
 Slew Rate.....40V/µsec.
 Dimensions..... Front panel: 19"Wx7"H, Chassis: 15¾"D (excluding handles, controls and connections)

*These specifications comply with FTC requirements for power amplifiers.

2500 INTERMODULATION DISTORTION @ 8 OHMS, FULL POWER 49V RMS BOTH CHANNELS DRIVEN

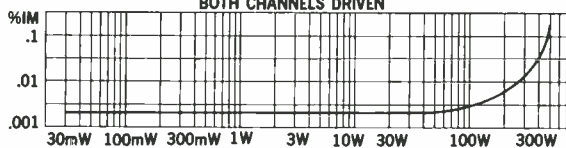

2500 TOTAL HARMONIC DISTORTION @ 8 OHMS, FULL POWER 49V RMS BOTH CHANNELS DRIVEN

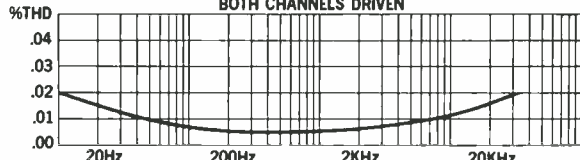

Reliability. The SAE 2500 gives you high current capability with Parallel-Series-Output Circuitry (PSO)—without loss of wide power bandwidth, low leakage current or super-high slew rate. Sixteen triple-diffused output transistors have an electrical and thermal SOA 50% higher than maximum design requirements for reliable high demand capability. This configuration can handle anything from continuous full signals to highly reactive surge loads—all day long without failure or overheating. Dual relay disconnect circuits and plug-in board design further assure reliable performance.

Features. Feedback level controls assure a constant input impedance of 50k Ohms and reduce the noise figure to more than 100dB below rated output in all positions. Loudspeaker protection relay-activated circuit automatically disconnects speakers in case of ±DC outputs. Plus, direct power reading VU meters and forced air cooling.

The SAE 2500 Professional Power Amplifier weighs only 58 lbs. making it practical for portable sound reinforcement, public address, communications and recording applications.

The professional alternative.



Scientific Audio Electronics, Inc.
 P.O. Box 60271
 Terminal Annex
 Los Angeles, California 90060

Please send me the reasons (including available literature) why the SAE 2500 Professional Dual-Channel Power Amplifier is the "Powerful Alternative."

Name _____

Address _____

City _____ State _____ Zip _____

For more information circle No. 108



**Beethoven
would have flipped
over the MCI JH-500!**

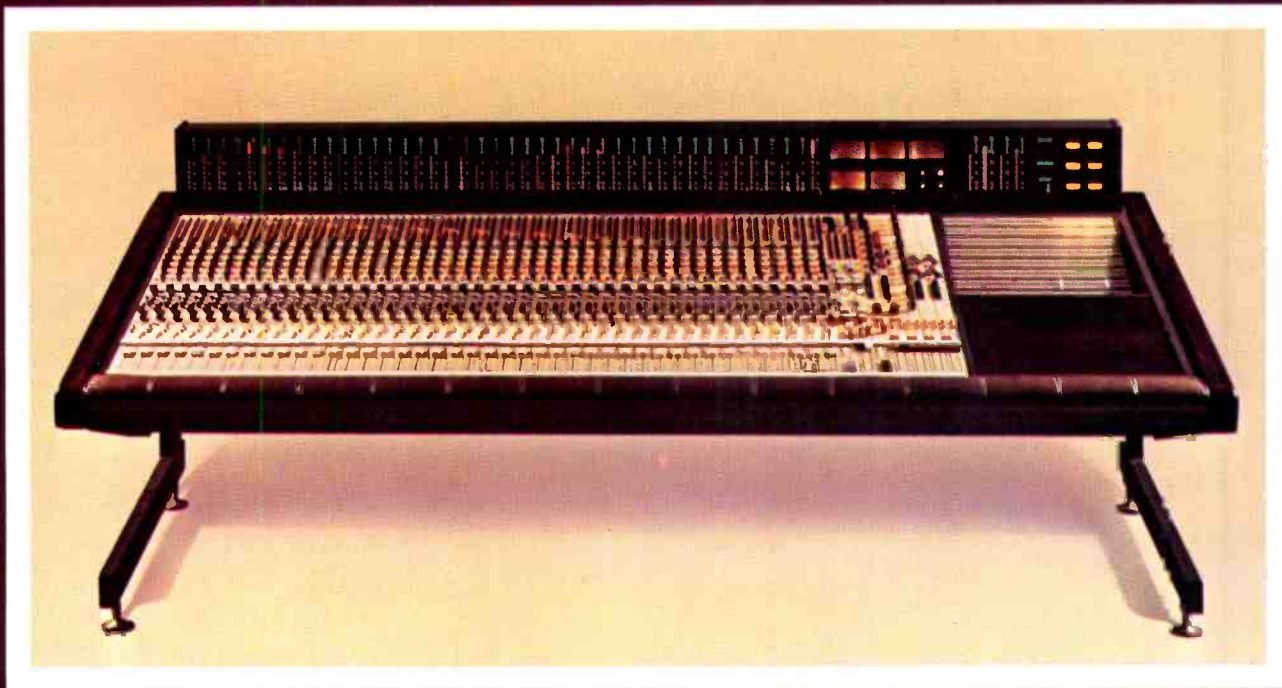

Sorry, Ludwig.

We created the JH-500 too late for you. But not too late for these leading studios in the world:

Atlantic Records (2) Criteria Record Studio Marquee Studios
The Mill Studio, Ltd. Sound 80 Sunshine Sound Hugo & Luigi Studio Katy
Autumn Sound Benson Publishing TK Productions
One Step Up Studios CBS London Master Sound

The JH-500 Series, first shown just a year ago,
is now being used by all these studios, and soon to be used by many more.
We were too late for Beethoven, but it's not too late for you!

The JH-500 Series of automation ready consoles are now also available with the 100 segment MCI "PLASMA DISPLAY", the most versatile level metering device in use today, for "VU" (as per ASA standards) or "PEAK" Display, with a selectable "PEAK ACCUMULATE" function.



4007 N.E. 6th Avenue / Ft. Lauderdale, Florida 33308 / (305) 566-2E53 / TLX 51-4362 MCI-FTL

Visit us at booths 43-50 at the 55th AES Convention, Oct. 29-Nov. 1 at the Waldorf Astoria Hotel, New York City.
For more information circle No. 109

Technics introduces components designed for professional use only.

The SE-9600P. Regulated stereo power amplifier with a lot more than just power. Like 100% constant-current and voltage power-supply regulation. Which means complete freedom from transient IM distortion. It also means high-level transients introduced in one channel won't affect the other. There's also only 0.08% IM distortion. A frequency response of 5 Hz to 150kHz (+0dB -3dB).

A S/N ratio of 110 dB. A 4-step damping factor control. And 110 watts per channel, minimum RMS, into 8 ohms from 20 Hz to 20 kHz with no more than 0.08% total harmonic distortion.

The SU-9600P. The stereo preamplifier that performs as well as it looks. Starting with an unheard of magnetic phono overload tolerance of more than 1 1/3 volts (1350mV RMS at 3mV sensitivity). An equally impressive phono-2 S/N ratio of 76 dB (referred to 3mV input). Virtually non-existent total harmonic distortion (0.02%). As well as bass and treble negative-feedback tone controls calibrated in 2.5 dB steps. With turnover pushbuttons at 125 Hz and 500 Hz as well as at 2kHz and 8kHz.

The SH-9090P. The Universal Frequency Equalizer that has no equal. You get 12 dB of boost or attenuation for 12 bands (10 Hz to 32 kHz). Plus the center frequency of each band can be continuously shifted by as much as ±1 octave. In addition, the bandwidth (Q) for each of the 12 bands is continuously variable from 0.7 to 7. The result: You have more control over response shaping than with any other single instrument. (Configuration: one in, one out.)

The SP-10MKII. In every respect, it's everything you want in a professional turntable. So much torque it only takes 0.25 of a second to reach the exact playing speed at 33 1/3 RPM. Our lowest wow and flutter (0.025% WRMS) and rumble (-70 dB DIN B). A quartz-locked frequency generator DC servo motor. And, of course, the reliability of Technics direct drive. The system that radio stations use. And discos abuse. Supplied without tone arm.



Panasonic Company
Technics Dept. 717
One Panasonic Way
Secaucus, N.J. 07094

Attention: Sid Silver,
Technical Service Specialist.

- Send me technical information on the Technics Professional Series.
 Have a Technics audio specialist call for an appointment.

NAME _____ TITLE _____
Please Print
COMPANY _____
ADDRESS _____
CITY _____ STATE _____ ZIP _____
AREA CODE _____ PHONE NUMBER _____

Technics
by Panasonic
Professional Series



THE EMERGING IMPORTANCE OF THE CONCERT SOUND STAGE-MONITORING-ENGINEER

"More Snare in My Monitor, Please!"

by DAVID HADLER

By this time, we have all read and heard a great deal about Rock Sound Reinforcement . . . the industry that has grown up trying to satisfy this decibel hungry animal. Primarily, because of the sophistication of the performers, as well as the concert performance productions these days, one individual facet of the overall technology is developing at an even faster rate: the sound system that the band must listen to . . . *their own monitor systems!*

There is little question, that Rock P.A., generally has grown a good deal louder during the past few years. Back in the period 1971 - 1973 it was common to measure on-stage levels of 110 to 115 dB SPL, with only the occasional band producing 3 to 4 dB louder. However during the past two years on-stage levels typically measuring in excess of 120 dB are found to be commonplace among major touring acts.

Without any consideration of the artistic merits or demerits of levels in this region, or a discussion of the physical danger to the human auditory apparatus, these SPL magnitudes present a very real challenge for the *MONITOR ENGINEER* to overcome in providing the number and variety of clean signals of infinitely different mix and EQ necessary for the show.

The first and most obvious question in such a situation is, just what does the individual musician need to hear in order to perform? Viewing the stage as an acoustical environment, it is not difficult to see that the question must be prefaced by another, that is, which musician standing where, on what stage, must hear *what* in his monitors?

At this point, it is probably valid to emphasize that Concert Sound is an inherently transient business, which says, right away, that there will be few, if any permanent *fixes!* Those working in the business are confronted with compound problems of constantly changing acoustical environments. The environment changes drastically each night on a different stage so the parameters of the system such as EQ, speaker placement, level mix, etc., must also change. Then, too, on any given stage during any single performance there are any number

Dave Hadler . . .
STAGE MONITORING . . .

of dynamic acoustical environments to control.

Some situations, as will be seen call for smooth, wide area coverage for those performers who move around on the stage during the performance. Other performers require monitors with tighter polar patterns. Some monitor situations may require strong low-end punch, such as for drums. Still others may carry only mouth harp or trumpet, requiring brighter mid and high frequency, with very little response below 250 Hz.

The sound pressure levels referred to earlier represent both near-field (the acoustical environment very near a loudspeaker or sound source, unaffected by reflections from walls, ceilings, etc.) and reverberant sound (reflected sound from walls, ceilings, floors, etc.) The near field sound on stage comes mostly from the musicians' instruments, while the reverberant sound is that of the total reinforcement system coming back out of all the recesses of, say, in an extreme case, a hockey arena. It is perhaps not difficult to visualize that the lead singer who stands in the near field in front

THE AUTHOR

DAVID HADLER has been audio engineer for: *The Doobie Brothers, J. Geils Band, Traffic, Jefferson Airplane, Derek & The Dominos, Mad Dogs & Englishmen (Joe Cocker), Hot Tuna, Roberta Flack, among others.*

Currently, Mr. Hadler is head of a company located in Boulder, Colorado, specializing in custom electronic hardware and consulting services for the professional tour musician.

In addition, Mr. Hadler has participated in engineering and installation of sound systems for the Atlantic City Pop Festivals, New Orleans Pop Festival, Miami Rock Festival, Latin Casino Supper Theater, Electric Factory Club. He has done one day installations in over 72 theaters and arenas and stadiums in the United States, Canada, England, Japan and Australia.

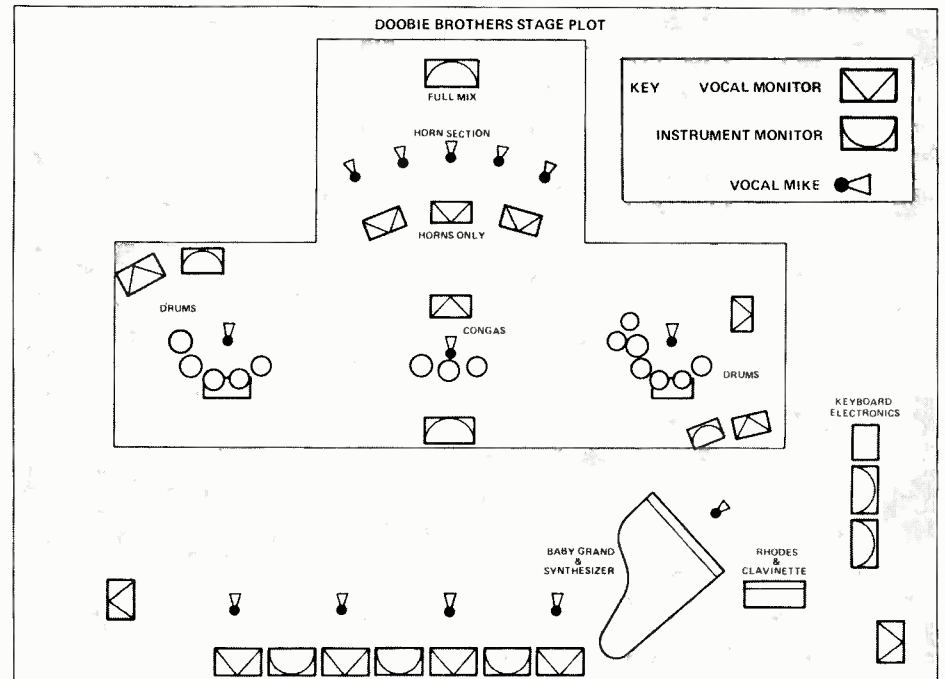
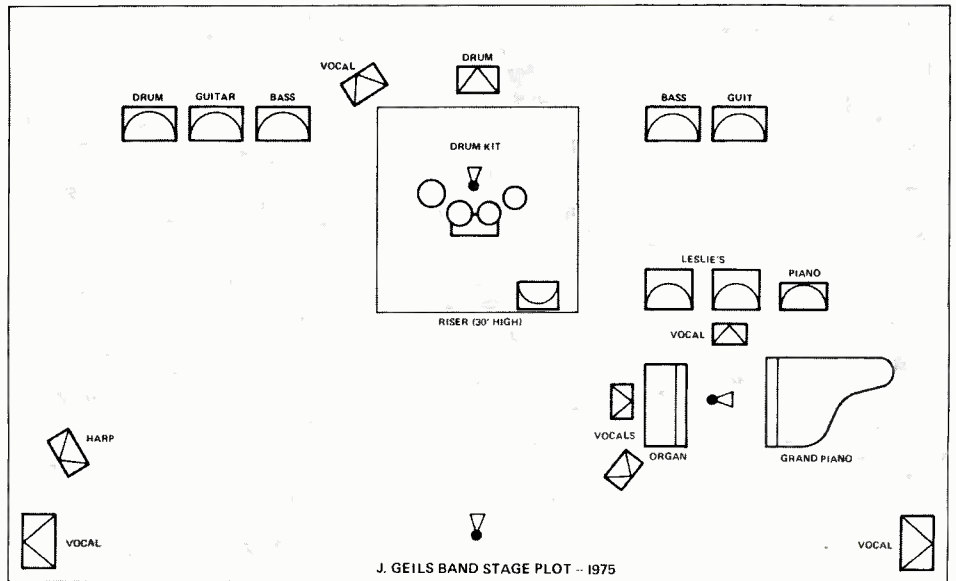

of the guitar amps at down-stage, center has a far different acoustical environment than the keyboard man at stage left, who is surrounded by the amplifiers of his own keyboards (acoustic piano, synthesizer, clavinet, Fender-Rhodes, etc.) It is well known that in addition to hearing his own performance each member of the band keys his part to other instruments or vocal sounds. Each musician's requirement, thus, is to hear himself, as well as certain parts of others in the band.

Figure 1 is the typical set-up of the J. Geils Band during tours in 1975. It represents a fairly open stage with good separation among six performers. (By definition, good

separation is the situation where each microphone only hears what it alone is supposed to hear, such as the microphone over the snare drum hears only the snare, etc. Not unlike separation in the studio, but somewhat more difficult to control.) The number one problem during this tour was to deliver a strong signal of just the lead singer's vocal across the full width of the stage, with minimal hot spots (an area of measurably higher SPL than in surrounding or adjacent area.) This requirement allowed the performer to move back and forth across the stage without setting up a feedback field. Each of the other performers had his own monitor, as well, into which a separate signal was fed,

Think of them as your musical instruments.



The audience can't see you. But they can sure hear you.

They don't know it, but they're depending on just one person to get the music to them. And that guy is you.

It's not something an amateur can do. It's an art. And that's why Yamaha has designed 3 superb mixing consoles with the qualities and range of controls that the professional sound reinforcement artist needs.

For instance, our exclusive 4x4 matrix with level controls gives you more exacting mastery over your sound than the conventional method of driving speaker amps directly from the bus outputs.

Features like that are years away except on the most expensive mixers. On the Yamahas, it's standard equipment. And so are transformer

isolated inputs and outputs, dual echo send busses, an input level attenuator that takes +4 dB line level to -60 dB mike level in 11 steps, and 5-frequency equalization.

Whether you choose the PM-1000-15, the PM-1000-24 or the PM-1000-32, Yamaha gives you the flexibility you need to turn your job into an art. And because they're designed from the ground up to perform on the road, more and more professional sound men around the United States and the world are depending on Yamaha, night after night, gig after gig.

If you've never thought of your mixing console as a musical instrument, we'd like to invite you to stop by your Yamaha dealer. Once you've checked out the operation manual and tested for yourself what the PM Series can do, we think you'll come away a believer.



YAMAHA

Box 6600, Buena Park, CA 90620
For more information circle No. 111

with the mix determined by the individual performers. The mixes were often varied during the show, as required.

In all, six different mixes were fed to the vocal monitors. For example, the drummer required his bass drum, snare, tom-tom, and vocal in his monitor. Also, at various times a mix of the keyboard vocal and lead vocal had to appear in order for him to sing a true harmony.

The lead vocal monitor system developed for this tour consisted of two large columns on each side of the stage, firing across the stage at each other. Each column contains six SRO 12" speakers on two circuits with an array of tweeters at the top to boost the high end. Each column is 7 feet high and weighs over 300 pounds, requiring perhaps 700 Watts input. The system provided fairly smooth coverage across the down stage area. (Older stages, for some reason or other, tended to gently slope from the back to the front, hence the term 'down-stage' when referring to the front of the stage closest to the audience.)

In explaining the choice of speakers which went into this segment of the monitor system it had been noted that the lead singer was wont to unexpectedly approach the monitors during the heat of the performance. It was, thus, decided to avoid using any horns in this system because of their tendency to go into feedback if approached suddenly. So, in this case full frequency response was sacrificed in order to deliver smooth coverage and high level. Perhaps a lens configuration would have improved the top-end due to their inherently smooth wide coverage.

In addition to the side monitor columns, there are two floor monitors situated upstage in front of the organ, so that when the lead vocal is not down-stage within the fairly broad monitor pattern, there is another location on stage where he can stand and still hear himself. As was mentioned previously, it is extremely important to stress pattern control so that signal spill and leakage is not rampant across a portion of the stage that doesn't require it. The floor monitors in this case were fiberglass cabinets built by Community Light & Sound

... at least one permanent fix:
NEIL DIAMOND'S "UNDERNEATH" VOCAL MONITOR
by Chris Foreman

Anyone who has been fortunate enough to see a Neil Diamond show in the last year or so, and diverted enough of their attention from his spectacular performance to look at the stage, probably noticed that a lot of the clutter normally associated with a pop concert was missing.

The primary credit for this uncluttered appearance goes to the stage itself. It was specifically designed for Neil's own distinctive style, his continuous, intimate contact with his audience by STANAL SOUND of Kearney, Nebraska. Stanal has the exclusive responsibility for Neil's concert sound reinforcement. The objective was to develop a personal monitor system for Diamond for this special stage to give him the coverage he needed for his wide ranging performance, with minimum feedback potential over the entire front of the stage area, *yet the monitor speakers had to remain as invisible as possible.*

The solution to this particular monitoring challenge was a unique combination of two side fill, floor monitors, with a front fill monitor located *underneath* the stage. The side fill monitors are Stanal SS-1's, a biamplified version of the Altec 1218A (originally developed by Stanal). They are Formica covered to blend with the solid oak stage. The front fill monitor covers the area in the immediate vicinity of Neil's vocal mike stand, projecting its sound upward through a grilled opening in the stage floor.

The development of this front fill monitor progressed along two, converging paths. The monitor speaker itself was conceived and built by Steve Woolley of Stanal Sound, as a possible higher power version of the Altec 1221A slope monitor. The Stanal monitor uses an Altec 31A horn, with a special model throat, and an Altec 291-16A driver. Mounted below the horn are two model 50-03-03333-10 Altec woofers, the same woofer used in the 1221A (a version of the 417-8H-II guitar speaker that has been optimized for vocal use).

The cabinet is the same general design as the 1221A, but larger (about 5 cubic feet interior volume) to accept the larger horn and extra woofer, and to extend the bass response. Two circular ports (one on each side of the woofers), were chosen to make the system "sound good".

Steve Woolley makes the interesting comment that a vocal monitor for front fill doesn't really need to have exceptionally good bass response since most of the vocal range is above 100 Hz, and because the main (house) speaker stacks on the sides of the stage cover the stage itself with adequate low bass sound. Thus the primary criteria for this monitor was the production of loud, undistorted sound in the vocal frequency range. From that standpoint, the monitor is an unqualified success! Standing in front of the monitor, testing a vocal mike will "make your pants legs flutter" as Stan Miller, owner and president of Stanal Sound, would say. One suggestion for a model number was the "SKM-1000", for "Stanal Kill Monitor", an apt description.

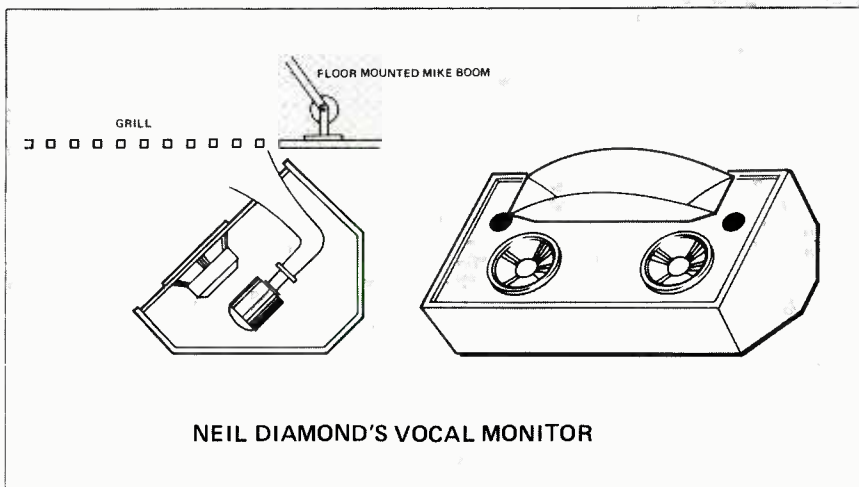

**this dbx 216 comes with
pre-assembled cables and connectors
and a free spare plug-in module**

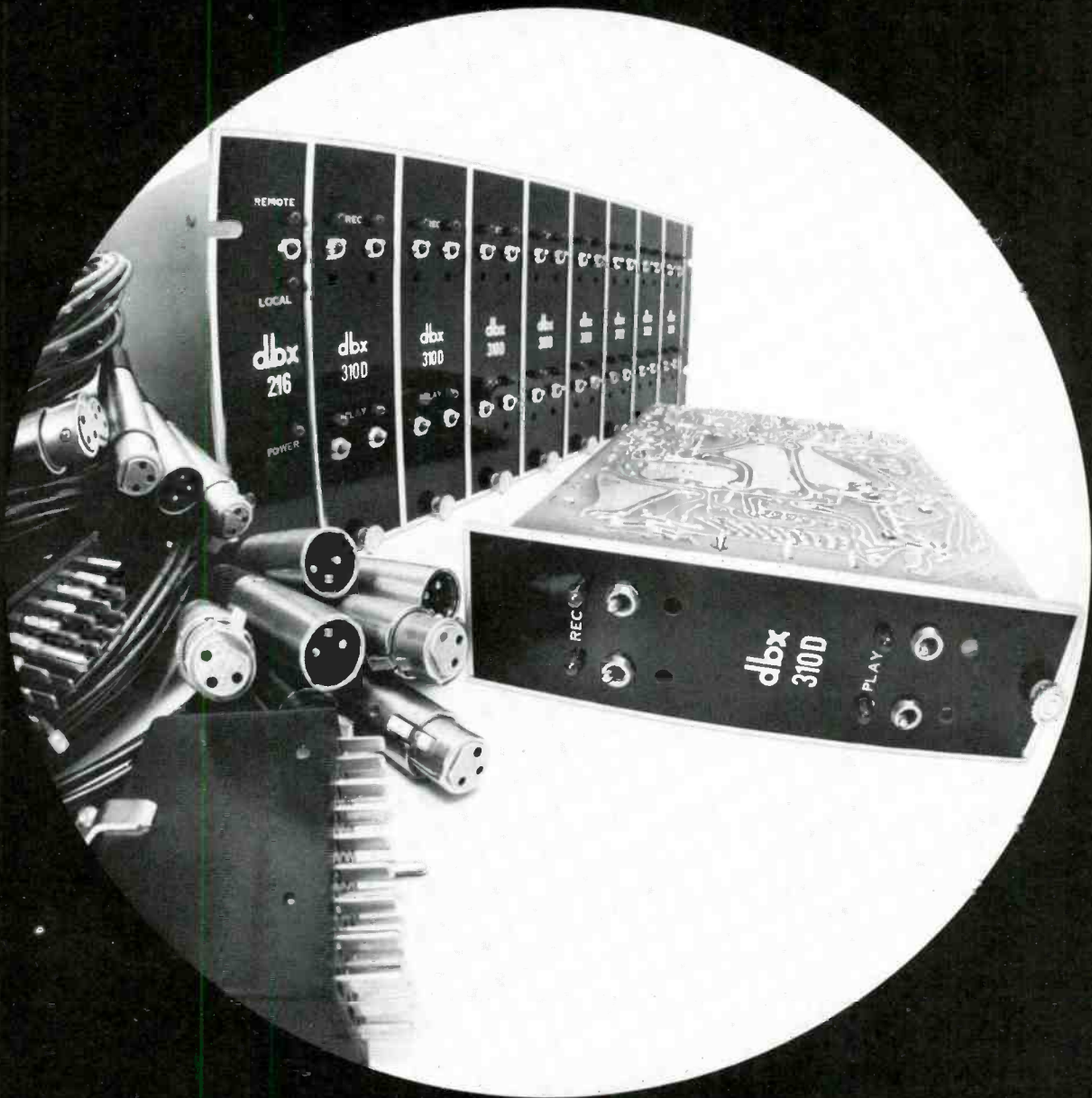

**something to think about
if you've ever wired in a Dolby M16**

dbx noise
elimination

dbx, Incorporated
296 Newton Street
Waltham, MA 02154

For more information circle No. 112

R-e/p 21

Stage Monitor Engineering

Co., with a JBL 2130 and a horn and driver by R.F.C.*

Another problem that becomes apparent when addressing stage-monitoring specifically, is the practical impossibility of doing 6 accurate mixes, or however many are required, for the on-stage system while sitting out in the audience at the house mixer location. The obvious solution is to have the monitor mixer located just off stage in the closest possible proximity to the performers, which receives the same microphone signals through splitter transformers.

For the particular applications we are discussing here, a custom mixer was designed which allowed 16 inputs to go out in 8 different mixes. This was simply done, as shown, with a knob matrix, since sliders would have required far too much space. The signals were then sent through appropriate narrow band filters, equalizers, etc., and on to the monitor amplifiers. However, any detailed discussion of the electronics involved is purposely omitted in this article in favor of a specific focus on the operational problems involved in stage monitor engineering . . . as well as some of the broad solutions.

Another note, at this point, is in order to stress the critical importance of fabrication and packaging. This already complex system must be assembled and disassembled, packaged and trucked 300 to 600 miles night after night, day after day. The Concert Sound Reinforcement System packaging requirement ought in some ways to exceed military specs for comparable mobile electronic gear. The Rock P.A. industry no longer tolerates the system failures which characterized the industry in the early 1970's. With 18,000+ people in attendance zero defects must be the rule.

The three photographs included illustrate a number of the details of the Doobie Brothers stage monitor system. Although the monitoring for this band was approached in much the same way as was the J.

*A little known but fairly good Italian speaker imported into the U.S. a number of years ago.



Neil Diamond's invisible, underneath vocal stage monitor (continued)

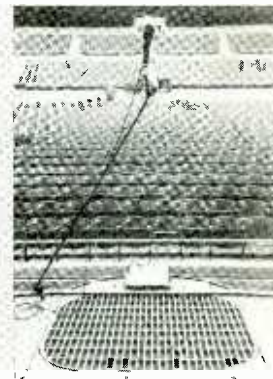

The appearance of the monitor is functional. The 32A horn certainly wouldn't win any beauty contest, but was designed for smooth coverage. The cabinet is black, painted plywood with a simple grill over the woofers. Since it is always hidden beneath the stage, however, the monitor's appearance is secondary to its function.

Since the entire stage is carried on tour, the location of the monitor is always the same. It is placed on a stand below the floor grill, but does not touch the stage to avoid acoustic coupling. The monitor is biamplified (800 Hz crossover) using a rack with a D150A Crown amplifier which powers the high frequency driver, and a DC300A Crown amplifier for the woofers. Only half of each amplifier is used for the front fill monitor, the other halves drive the two side fill monitors. Both the front fill and the side fill monitors receive totally separate mixes from the monitor mixing console (a Yamaha PM-1000 supplemented by a Yamaha PM-700, and various other electronics).

The *invisible* monitor described here represents a specific solution to a specific monitoring problem, and since few performers carry an entire stage on tour, this solution is not a universally applicable one. It does, however, illustrate several important principals of monitoring design. It is a "slope" cabinet (triangular shape to aim the sound up at the performer), and is versatile enough to be used on top of the stage as well as below it. It was designed for optimum response in the vocal range, with little emphasis on super low or super high frequency response (to gain those frequencies would have required a larger cabinet and extra super tweeters). It was biamplified for greater efficiency, and lower distortion; and it was built to withstand the abuses of the road.

Significantly, the monitor passed its final exams with flying colors; the artist likes it.

Geils band, the system is considerably more sophisticated due to the larger number of musicians as well as the more complex mixes required. This system is, perhaps, an excellent example of a large group state-of-the-art monitor system.

As shown in the stage plot (Figure 2) for the Doobie Brothers, there are 5 musicians downstage, 3 musicians center-stage. Comparing the Doobies to the J. Geils band, at least one situation was easier to handle; there was not a lead singer moving across the full width of the stage. Simply, there wasn't room. However, the other side of the problem was that there were thirteen musicians, each requiring unique mixes . . . some requiring two or three mixes.

Again comparing the two bands: Peter Wolf, lead singer for the J.

Geils band required a monitor mix consisting of his vocal with just a touch of the back-up vocals present in the monitor. The Doobie Brothers with 3 lead vocalists, all of whom played instruments, required separate mixes for each. Michael MacDonald, for example, required his vocal, kick and snare from the stage right drummer, as well as back-up vocals and rhythm guitar in his monitor . . . all at varying levels depending on the stage environment.

To those readers familiar with recording studio monitor mix systems it is, perhaps, evident that we are already surpassing the more elaborate studio systems. Most studio situations are typically involved with, maybe, one to six tracks of a 16 or 24 track tape . . .

Old-New Reel Time Recorder

Telex/Magnecord series 1400 broadcast quality recorder/reproducer. An old name that spells reliability. A new design for today's state of the art.

- The Old. Telex/Magnecord products are still made in the USA so parts and service are always available. The series 1400 is still built on a solid die cast aluminum main frame for reliable operation around the clock. It's still available in full, half and

quarter track configurations, has fail safe differential brakes and accepts 8 1/4 inch reels. It also still comes with three motors—but then, that's touching on the new.

- The New. A brushless d.c. servo drive with a crystal oscillator control reference so accurate it virtually eliminates program timing errors. New, three speeds: 3 3/4 - 7 1/2 - 15 ips. New catenary head block for straight tape loading, the convenience of one hand cueing and the bi-level illumination of push button controls. New DTL logic controls eliminate EMI and provide fast, spill

proof tape handling gentle enough for half mil tape. And new electronics, clean to 60 dB S/N at all speeds.

- If you're looking for a real time, reel recorder with old name reliability but designed for today's demands, you'll find it in the Telex/Magnecord series 1400. For complete information please write:



PRODUCTS OF SOUND RESEARCH

TELEX[®]
COMMUNICATIONS, INC.

9600 ALDRICH AVE. SO. • MINNEAPOLIS, MINN 55420 U.S.A.

Europe: 22, rue de la Legion-d'Honneur, 93200 St. Denis, France

Canada: Telak Electronics, Ltd., Scarborough, Ontario

For more information circle No. 113

R-e/p 23

at any given time. Developing a mix in the studio situation requires fewer cue sends than developing a mix for 13 tracks of *simultaneous over-dubs* . . . which is the essence of monitoring for a live performance. In addition, it is obvious that the concert monitor engineer doesn't have a *re-take* situation to work with. From the time the band sets foot on stage there is no re-take. With feedback always an ever present danger in near field live microphone environments the margin for error is indeed quite small.

As was stated earlier, a band the size of the Doobie Brothers required a monitor mix console with capability for in excess of any commercially available. A custom mixer was designed with 30 inputs and 16 outputs. As may be seen in figure 5 this represents massive knob density. Color coding is necessary to preserve some sanity for the monitor mix engineer. One drawback of the high knob density is the pos-

sibility of losing position during a tight mix if a change should have to be made. It is possible to handle one or two active mixes at one time, but any more, experience has shown, become confusing to even the best monitor mixers. It must be remembered that each musician can really only hear his own monitors, and depends on this information delivered to him for his performance. Should any changes be required during the show that performer needs the attention of the monitor mix engineer *immediately!*

The monitor mix engineer is generally watching the show from stage left or right, and must be completely familiar with not only the requirements of each performer, but he must know the music well enough to anticipate changing the mix as the show evolves. It is quite important that he listen to each mix in the order of urgency so that the performer with most acute *pain* is serviced first. The expression *pain* is used because this is the

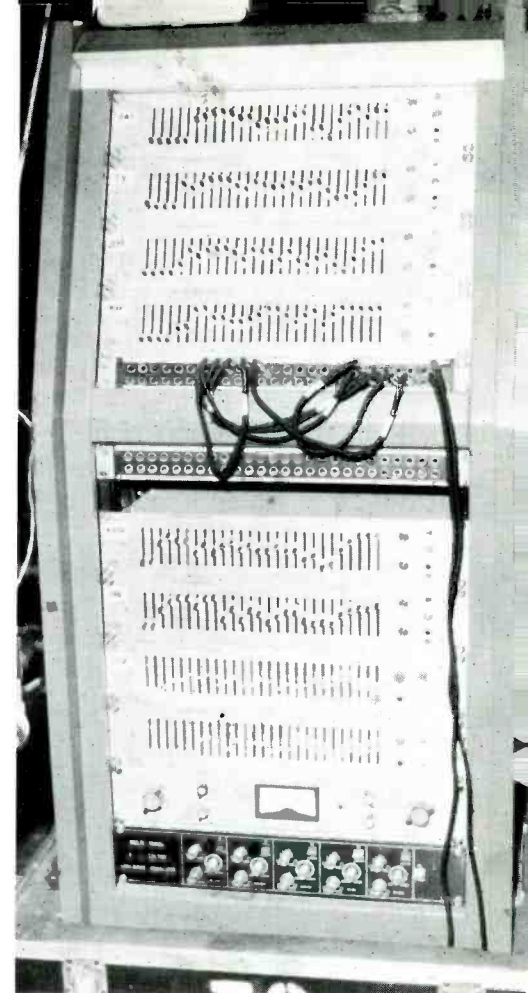

typical reaction of a great number of performers reacting to an incorrect monitor situation. It blows their performing gig if they cannot hear their monitors correctly. Hand signals are not an uncommon method of communication between the artist and the engineer. Occasionally, however, the *pain* is so intense as to evoke screams of indignation. Perhaps the worst performer symptom, however, is a deep sulk, and the engineer is then unaware of the problem throughout the performance, maybe well into the next day before he finds out something is amiss. The really good monitor engineer is sensitive to intuitive communications, and knows right off what is needed. With this in mind the problems of two or more mixes changing at the same time should be evident. A future article will no doubt deal with alternatives to these problems such as performer-controlled monitor systems and multiple engineer

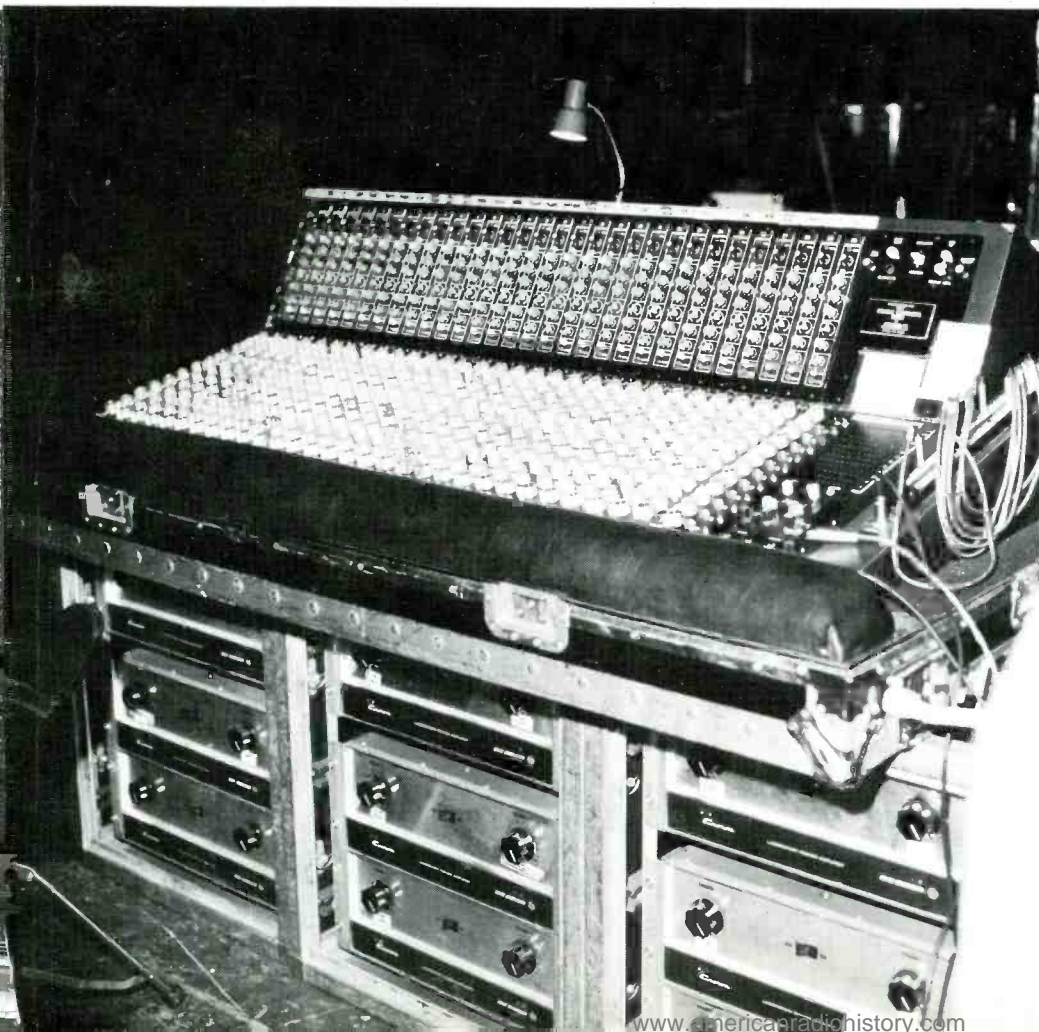

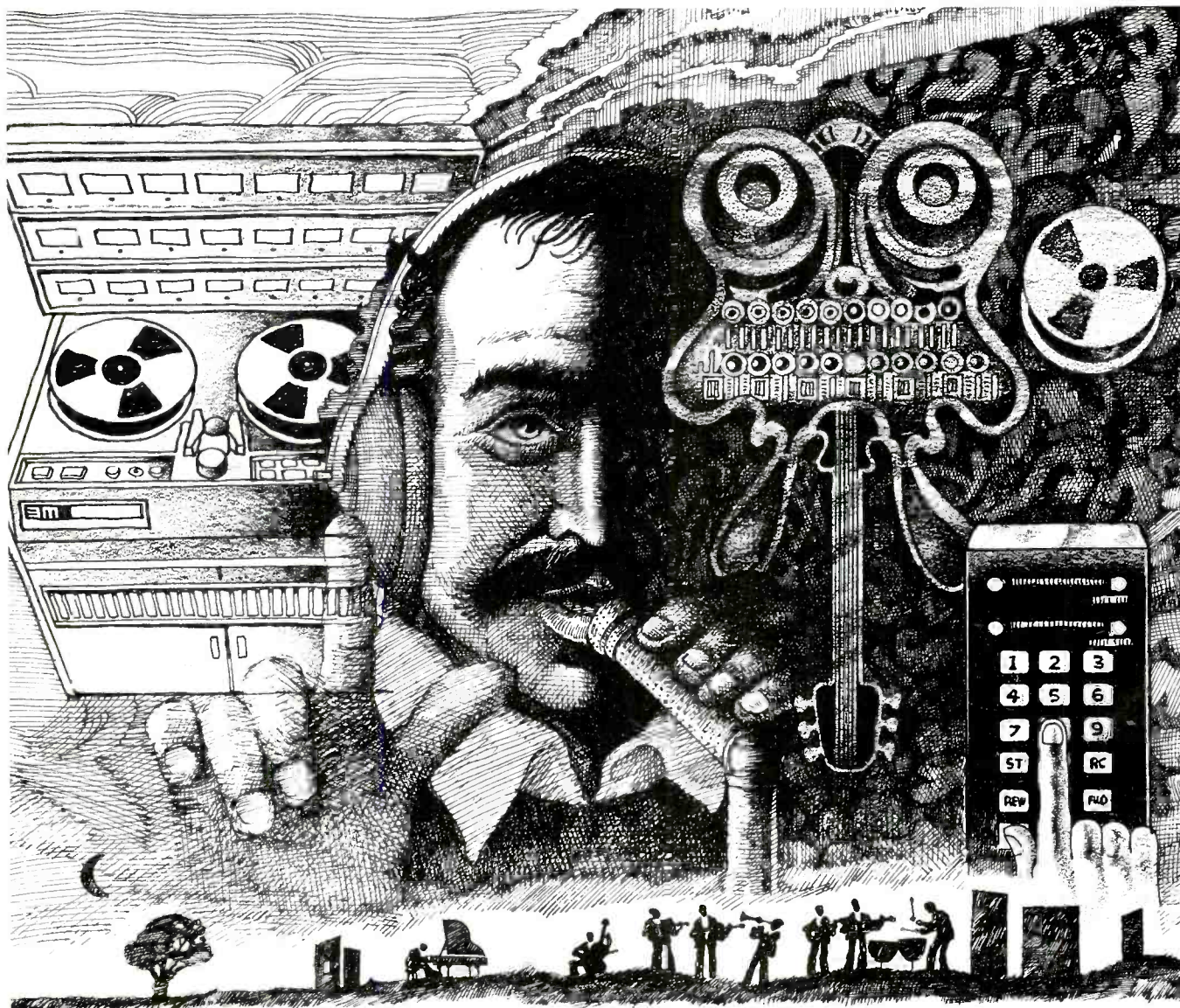

Let our Series 79 bring out the best in you.

Buying a recording system is a lot like getting married. It's a long-time partnership. That's why 3M has designed a total recording system that even the most finicky and demanding engineer can love. With these features that free your mind from equipment worries to let you concentrate on performance:

A "brainy," new way to locate cues. An exclusive Series 79 feature. Our new Selectake II Cue Locator combines a powerful, mini-computer to program and locate cues digitally. Cue overshoot and long crawl times are completely eliminated. Saves time, saves tape. It can even save sessions.

The steadiest capstan drive in the business. Our exclusive 3M IsoLoop® differential capstan drive gives you smooth tape flow, easy

threading and editing, and precise tape handling. More than that, it achieves incredibly low wow and flutter and excellent tape-to-head contact by reducing unsupported tape length to just 3½."

Transport changes at your fingertip. Mode to mode transport changes are made via logic circuits for direction change and braking at the touch of a button. No more jams, tape spills, or machine damage.

Roll along at your own speed. Speeds of 7½, 15 and 30 ips are switch selectable with automatic equalization for each speed. Variable speed control (6 to 36 ips) is standard on multi-track and optional on the 2- and 4-track models.

These recorders grow as your needs grow. Buy a recorder to fit

your current needs in 2-, 4-, 8-, 16- and 24-track configurations. Optional heads and guides let you convert your recorder to up to 24-tracks later on.

3M quality means Money, Money, Money in the long run. You've got to consider your recording gear's resale value when you trade in or trade up.

Recording people know that 3M gear is built to last a long time. That proven reputation helps it keep its value.

So, if your current recorder isn't doing you justice, get together with the Series 79. And bring out the real you.

Mincom Division 3M
COMPANY
3M CENTER • ST. PAUL, MINNESOTA 55101

For more information circle No. 114

www.americanradiohistory.com

R-e/p 25

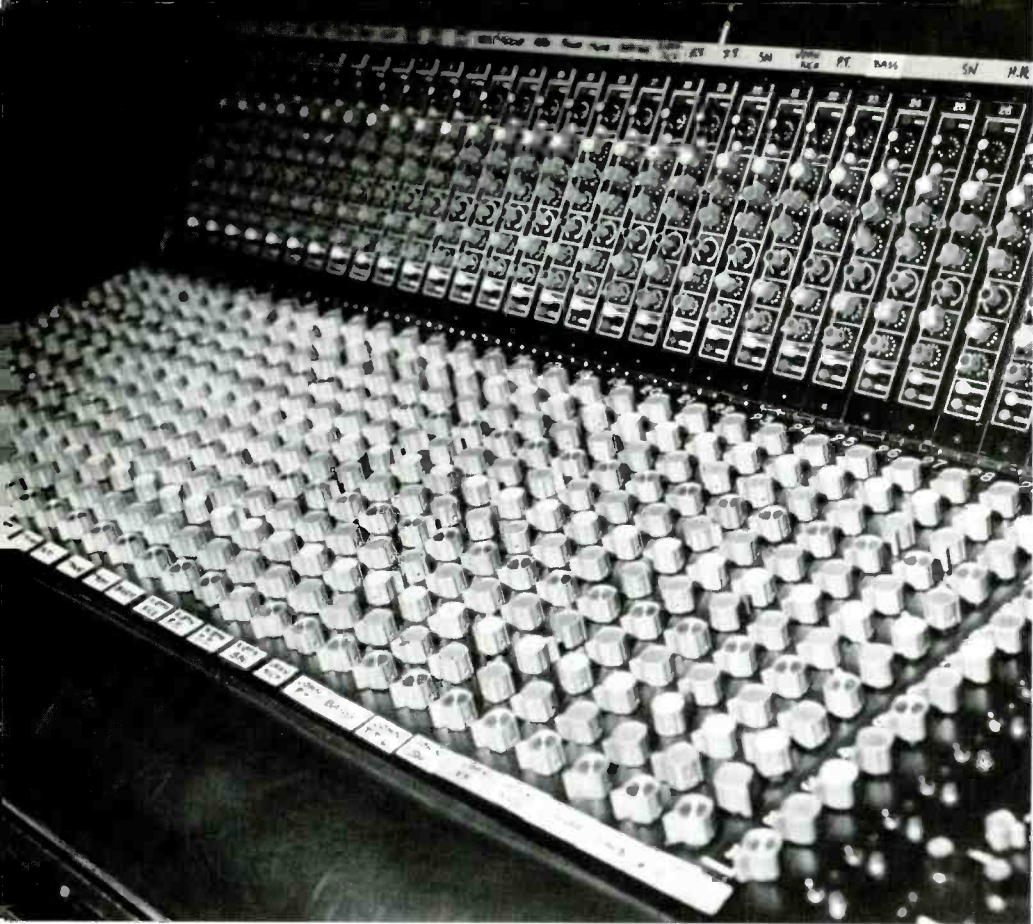

systems.

With 13 musicians hearing as many as 16 different monitors another problem becomes obvious: that is, *separation* (where each microphone only hears what it alone is supposed to hear.) There are 16 monitors blasting away on stage which may be heard through, as many as, 50 different microphones. For example, when the snare drum is soloed it may hear the monitor nearest the snare if that monitor is not pointed or focused properly, so that it is not heard in the snare microphone. If the monitor is heard, another problem occurs for the house mixer, for the same reasons. As the house engineer raises the snare mike level this same microphone is hearing not only its intended near-field input, but also the reverberant field of other monitor and instrument fields. The situation that results is that as the snare input level comes up, so might the guitar, the lead vocal and the keyboards. As the number of monitors on stage increases, the separation decreases, and so one problem is solved only to be replaced by another.

In addition to the 16 monitors shown in Figure 1, there are 5 other systems on stage that allow certain

performers to turn other instrumental signals up and down, at will, to account for widely varying acoustics in each stage location. It is expected that the business will see an even greater trend to more elaborate musician controlled monitor systems. So, these monitors, too, are heard and amplified by microphones and other vocal mix and monitor systems, only tending to regenerate the sound levels. This proliferation of monitors create a truly difficult reverberant field to overcome.

The most obvious solution is less level and fewer monitors. This, if it is possible, takes us back in time and there is little likelihood that the performers would be satisfied. Getting rock performers to turn down is indeed difficult to achieve for any protracted period of time. It does seem best to approach super high levels and a profusion of on stage monitors as a fixed problem. This is undoubtedly as it should be because of the musical judgements involved, which should not be within the province of the engineer. Only when the acoustic situation defies all the solutions that technology can yield, only then might the engineer seek to suggest some modification of the

artistic judgement. From first hand experience this will be the utmost exercise in tact and diplomacy.

In all, stage monitor systems face the same parameters as P.A. systems (loudness separation, EQ, distortion, pattern control) in addition to unique problems of their own. The engineer role in this situation in most ways is similar to that of any mix engineer. First is to determine what the performers require, to do their job on-stage. Second, to put together the mechanical requirements into a coherent electronics system that is serviceable, flexible and as near fool proof as possible. Flexibility is important, because the requirements always will change or mature. Besides the system will also have to serve other bands, such as opening acts.

Lastly, the monitor mix engineer is something like an air traffic controller helping the musicians to their destination, but must be ready at any point to change the pattern to fit the traffic.

I hope to follow this article with several others, being more precise about several aspects of the main subject such as electronics, speaker enclosures, and microphone techniques, and packaging.

If You Don't Have A Fortune To Spend On Your Studio, We Can Help You.

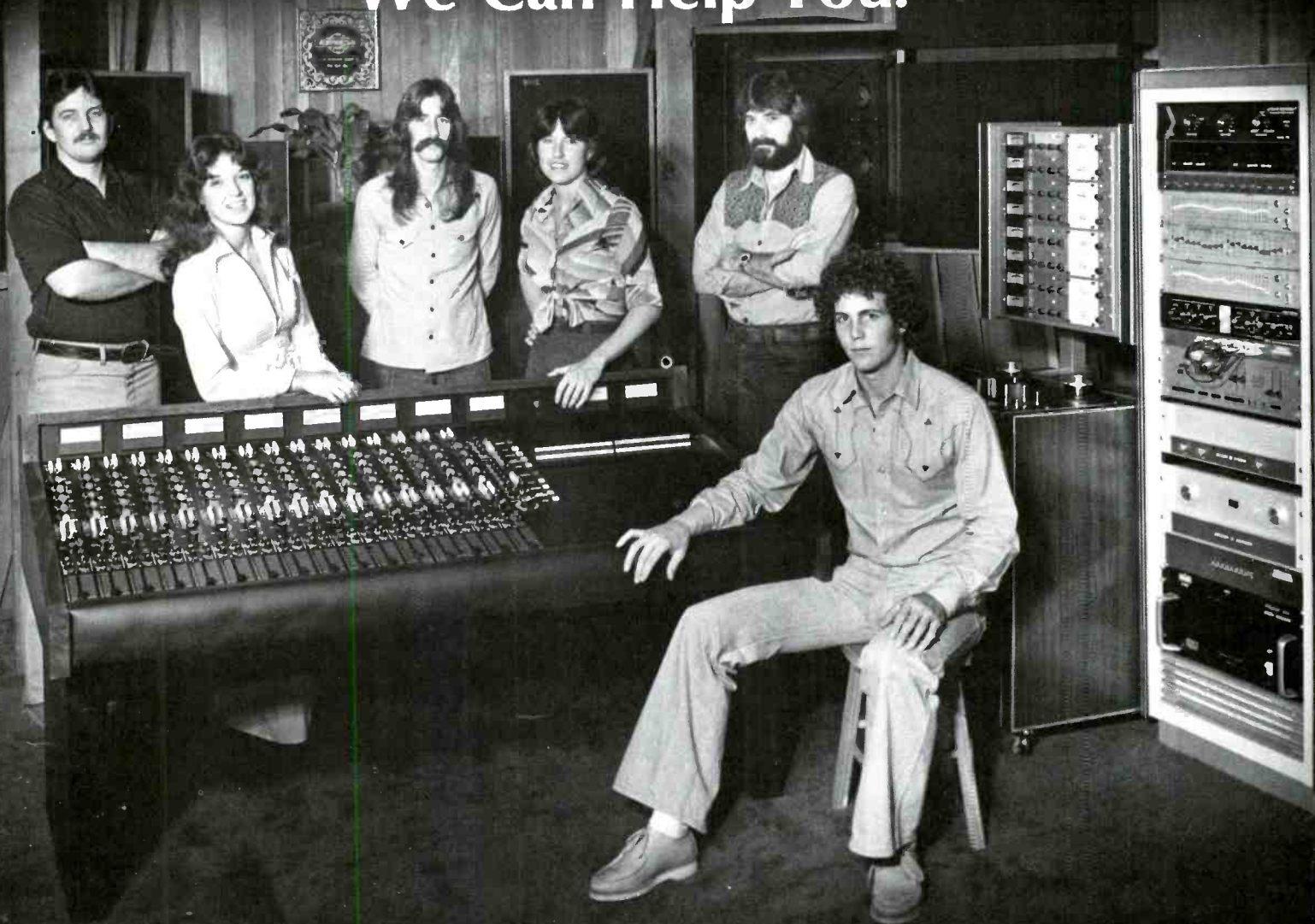

For two years, THE EXPRESS SOUND CO. has specialized in turnkey studio systems for people just like you. Working intimately with our clients, we have confronted and solved the complex problems relating dollars to performance. More than ever before, your success and profit will be born of hard work and talent. Mega-budgets are no longer the requisite ingredient in the studio formula.

We're waiting to hear from you...with a quarter million dollar inventory, a complete technical services department and a committed and conscientious crew of professional people just like you.

Even if you have a fortune to spend, we can still help you.

1833 NEWPORT BLVD.
COSTA MESA, CA. 92627
714/645-8501



For more information circle No. 115

R-elp 27



Two Electro-Voice engineers have a quiet discussion about the merits of dynamics vs. condensers.

The discussion is easy to settle because there are such obvious differences. Take our RE20 dynamic and our new CS15 electret condenser:

RE20 Continuously Variable-D Dynamic:

It's designed to be virtually free of proximity effect and p-popping. And it's designed for as near perfect response 180° off-axis as the state of the art allows. Also, we planned it to take SPL's you wouldn't believe.

Can It Deliver?

In the anechoic chamber, the RE20 exhibits the widest, most uniform response curve of *any* available cardioid dynamic. The RE20's cardioid polar patterns are almost identical on axis and 180° off. It has excellent transient response.

And The Durability?

This microphone's grandfather could drive nails into pine boards and continue to perform unabashedly. The RE20 adds the ability to handle very high inputs. That's durability. We back this claim with the strongest dynamic microphone guarantee in the business.

CS15 Single-D Cardioid Condenser:

It's designed to be light, to reject off-axis sound, and to provide controlled bass boost. In the recording, broadcast and sound reinforcement jobs where a swinging singer has two mike positions, close and closer, or the bell of a trumpet is surrounding the mike, it's designed to deliver wide, smooth response. And we've developed an electret that can endure SPL's that would have blown the charge off earlier electrets.

Can It Deliver?

In the anechoic chamber, the CS15 exhibits the wide, uniform on-axis response characteristics of the most expensive condenser microphones. Its off-axis response is excellent also. The microphone can be powered remotely with from 8 to 48 volts.

And The Durability?

The CS15 condenser is every bit as rugged as our most rugged dynamic.

We back this claim with the strongest condenser microphone guarantee in the business.

Specifications

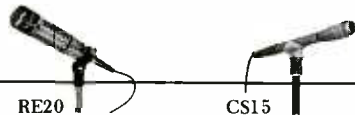

Specifications	RE20	CS15
Model Number	RE20	CS15
Element	Dynamic	Electret Condenser
Polar Pattern	Cardioid	Cardioid
Response	45-18,000 Hz	40-18,000 Hz
Output Level (0 dB=1 mw/10 dyn/cm ²)	-57 dB	-45 dB
Max. SPL (1% THD or less at 1 kHz)	greater than 150 dB	141 dB
Impedance	50, 150, 250 ohms balanced	150 ohms balanced
Case Material	Machined Steel	Machined Steel
Sugg'd Resale Net Price (Slightly Higher in Western States)	\$315.00	\$225.00

Electro-Voice®
a gulton company

Dept. 961RP, 674 Cecil Street
Buchanan, Michigan 49107

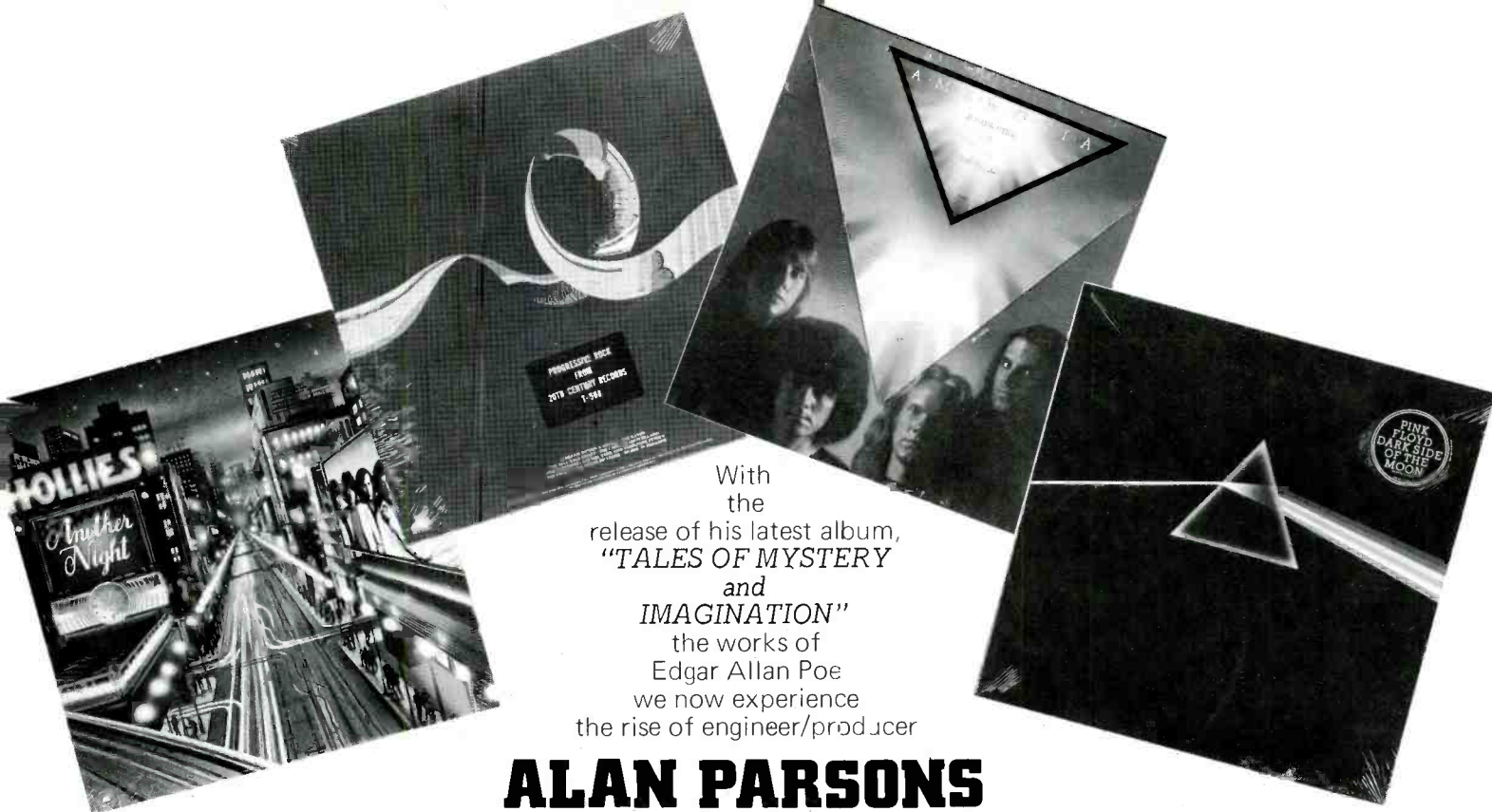

With the release of his latest album, "TALES OF MYSTERY and IMAGINATION" the works of Edgar Allan Poe we now experience the rise of engineer/producer

ALAN PARSONS

through THE FALL OF THE HOUSE OF USHER
by Howard Cummings

Howard Cummings: How did you get involved in this business?

Alan Parsons: Well, I started playing piano when I was 6 or 7 and started playing flute when I was 13. Then I gave up for awhile and kind of lost interest in playing music and had more interest in listening to it. When I was about 13, I started playing guitar and got interested in The Beatles and started saying "How the hell did they do that?" I left school and got a job for a big research lab at EMI, Middlesex, and found my main interest didn't lie in television camera research. After a short time I went to the high-speed duplication department and one of the first things I heard was The Beatles REVOLVER LP on probably the first good Hi-Fi system I'd ever set eyes upon . . . and I thought . . . "Hey, what's going on?". Within a year-and-a-half of that I started work at EMI-Abbey Road. (October '67)

Howard Cummings: What were some of your main musical influences back in the 50's and 60's?

Alan Parsons: Mmmmm, I was never an

Elvis fan. A little Eddie Cochran – I was probably a Cliff Richard fan more than anything, also the Shadows. He was probably one of the first persons to get a sort-of clean studio sound with engineers such as Malcolm Addey, one of the greats who's since moved to the States.

Howard Cummings: Do you remember the first series of sessions you worked on?

Alan Parsons: Some of them were the Hollies SORRY SUZANNE sessions around when Graham Nash left. Also the HOLLIES SING DYLAN LP which I assisted on with Peter Bown. Peter is an Abbey Road engineer who helped me considerably in the early part of my career. I assisted on The Hollies HE AIN'T HEAVY, HE'S MY BROTHER . . . Here's something I bet you didn't know. Who played piano on HE AIN't . . .

HC: Elton John. He also played on CAN'T TELL THE BOTTOM FROM THE TOP.

AP: Oh, you did know. I was also involved in some of the Beatles' LET IT BE sessions in the Apple basement. That was kind of unusual because first of all, I was on staff at EMI working at Apple, and second of all, the Apple studio at that time (Jan. '69) was virtually only two rooms separated by a pane of glass. There was also the EMI console moved into Apple for their use and I think there were two of them because it was an 8-track session.

HC: How about their ABBEY ROAD

sessions?

AP: Yes, I was a "second" on some of it. I remember my part was fairly involved with chalk marks on the tape bringing in cues etc. That was their first 8-track board 8-track tape session. Some of their "white" album had been 8-track tape with 4-track board. One interesting technique we tried (with Geoff Emerick) was the pre-echo thing on MAXWELL'S SILVER HAMMER. By using the three tape recorders we got a backwards echo intro so it would sound "J-JOA-JOA-JOA-JOAN was quizical . . .". But we decided it sounded too cheap.

HC: How were the George Martin vibes while he was working with Geoff Emerick and Phil MacDonald? (engineers).

AP: I think it was George that was holding the whole thing together at that time because the break-up of the Beatles was coming – it was imminent.

HC: Could you see it?

AP: Literally only one or two of the Beatles would be there for over-dubs on their own songs. The basic tracks were done fairly quickly and the album was done in about 8 weeks.

HC: Did you work on the Hollies BUTTERFLY album?

AP: No, that was probably the last thing Graham worked on before leaving. I was still at the duplication facility at the time. I always thought that was one of their best albums – so far ahead of its time then.

The Author

HOWARD CUMMINGS, based out of Los Angeles, deals in recording for music, film, and audio visual presentations.

He is a member of AES, and has been a past contributor to R-e/p.



“... the use of one microphone against another? I consider that a very minor difference compared to what you get from EQ!”

HC: When that album hit the States, it was in such altered form with a re-mix, missing songs, missing sound effects. With my being a great Hollies fan, it was very disappointing. The stereo hardly sounded good.

AP: Really? In those days, even SGT. PEPPER was really a mono record and the stereo version was not as good because everything was geared to mono much more in those days.

HC: After their Dylan album came “HOLLIES SING HOLLIES” and their CONFESSIONS album. How did you feel working on that material?

AP: I thought they were going for another BUTTERFLY and writing all their own material. I thought the song CONFESSIONS OF A MIND was the best one. It was the first time they had tried to link up two different tunes together, and it worked!

HC: How do the Hollies and Ron Richards work?

AP: The usual thing is for one of them to just sing it with a guitar to the others and sort of roughly work out some harmonies and Ron will say “Oh it needs another chorus here” or the structure gets changed around and then they go into the studio and usually within an hour-and-a-half they have a backing track. Then they spend a half-hour working out the harmonies, then take a break, then come back and do it. They generally did a track a day, and we’d mix a song within an hour and an album in less than a week. You know, Ron Richards and all the people from that school used to try as much as possible to leave the mixing to the engineer, and then comment on it. They were the real producers as opposed to the engineer-oriented producers.

HC: It seems to be somewhat of a different school in the States.

AP: I don’t think I could work for an American really. I tried it with Richard Perry once.

HC: Bobby Elliott (Hollies drummer) says The Hollies lean towards being fast in the studio as far as recording. Were there any instances where they spent a great deal of time working on something?

AP: No, not really. They generally spent more time when Mikael Rickfors (Allan Clarke replacement, ’71-’73) was with them, working out the vocals. But if they walk in the studio and walk out not

having done anything, it would be very unusual and they’d be very upset. They work well together and have an ear for each others parts.

HC: How did you go about recording the Hollies harmonies . . . three separate mikes or Tony and Terry . . .

AP: Three separate FET 47’s recorded on one track, then double-tracked, then triple-tracked.

HC: Two or three over-dubs in sync with themselves?

AP: Right. Since Allan’s voice was stronger than Tony’s and Terry’s, I used to give him his own mike and face him towards the control room. Terry would be on Allan’s right facing the wall with his own mike and Tony would be on Allan’s left facing the other wall with his own mike.

HC: Now I don’t know what you did and what Peter Bown did, but how about Bobby Elliott’s drums, because for me, especially on the ROMANY album, the drums are very good on things like DEL-AWARE TAGGETT, TOUCH, and the stereo congas on WORDS DON’T COME EASY.

AP: I remember doing the stereo congas on WORDS . . . I remember . . .(chuckles) I remember someone saying there was too much echo on them but I ended up leaving it on. I’m quite an echo freak actually. But what I generally do is use a D20 on bass drum, 84 on snare, 86 on high-hat, and for the last 3 or 4 years I’ve favored a ribbon mike on the overhead for a bit of “air”. It provides for more of a blend in stereo drums. Speaking of air, when we recorded THE AIR THAT I BREATHE, I used a ribbon mike for the toms over-dub which sounds somewhat like tympani.

HC: Did they ever come in and say “We want something different”?

AP: I don’t know if they would ever come in and say they wanted something different. Bobby would sometimes say “Let’s try and get a bit more crack out of the snare.” Sometimes they would stroll over during the mix and push their respective fader up.

HC: How about other great songs by them like THE BABY and LAY INTO THE MUSIC?

AP: No, I wasn’t involved because I was getting involved with my production career at the time. But ask anyone they’ve worked with and they’ll say they’re the tops. They’ll even say “Thank You” when they leave, unlike some other groups.

HC: Let’s talk about your work with McCartney.

AP: The first thing I did with McCartney was a bit of mixing on the WILD LIFE album. (’71) I was fairly new to engineering at that time and did a mix on a song called I AM YOUR SINGER while no one was there, partly for my own amusement and partly because they wanted some ref copies anyway. They ended up using mine which made me very pleased. I also did some singing on TOMORROW. Remember in the middle-eight where it goes ba-ba-ba-ba-ba-ba-ba. (chuckle) Then soon after that was some of RED ROSE SPEEDWAY with other engineers.

HC’ How does McCartney work in the studio?

AP: There is no special approach, just go in and see what happens. He kind of uses the studio to rehearse and he is not at all good at describing the effect he wants to get.

HC: For example he doesn’t say “Give me +4 at 10k”.

AP: Right. He’ll say, “Make it sound better”. (laughter) So I look for the “better” knob. (laughter all around) Chris Blair (EMI cutting engineer) has literally got that in one of the cutting rooms at Abbey Road – knobs labeled “funky”, “heavy” . . .

HC: (laughter) “Disco” . . .

AP: (laughter) “Laid Back”.

HC: Any comments on HI HI HI or C-MOON?

AP: Oh, HI HI HI took for-ever. We spent weeks and weeks and weeks, must have mixed it about 8 times.

HC: How did you feel about the final mix?

AP: I wasn’t too happy with it. I tell you, what upset me most about HI HI HI was I thought the way they used to do it “live” was better. It used to have a different rhythm to it. I remember we spent a long time mixing it on small speakers trying to make it sound good for radio. I think we were going over the top on EQ as a result of that, and we’d play it on little speakers and they’d say “We can’t hear the bass and the bass drum”. So you’d turn it up so you could hear the bass and the bass drum and then you play it on the big speakers and it would blow your head off! (laughs)

HC: So Paul wanted something that would be compatible in one mix for small and large speakers.

AP: (laughter) Yes. We also went around Europe in the Rolling Stones truck taping concerts and it was better then. Also, out of all that stuff came one song – THE MESS – out of five days. He’s very good at spending money for things like that and then doing nothing with it.

NUMBER ONE



SON AND GRANDSONS



SON 52 inputs
26 mixing positions



GRANDSON 35 inputs
18 mixing positions



GRANDSON II 48 inputs
24 mixing positions

For years, the Audiotronics family of consoles has produced sound leaders. From New York to Bangkok.

Our Son and Grandsons deliver faultless performances night after night. In front of the most hardened authorities.

Yet our success is no mystery. In both recording and the broadcast industry, Audiotronics has become a standard for craftsmanship and technology. A reputation won on the firing line.

Think about it. And don't make a sound without calling us first. Leasing/Financing Plans Available.

 **audiotronics, inc.**
P.O. Box 12637 • Memphis, Tenn. 38104 • 901/276-6338

HC: What about mikes for RED ROSE SPEEDWAY?

AP: I think I was using an 87 on snare because the 84 was new to us at that time . . . probably C38A on tom-toms . . . even C38 on the bass drum which I favored at that time.

HC: How about Paul's bass . . . was it direct?

AP: Nearly always, yeah.

HC: Rickenbacker?

AP: Yes. He had an Epiphone guitar also. He had the Hofner bass stolen and it was a big tragedy because it was one of the original Beatle-basses, stolen from a van or something.

HC: How about Henry McCullough and Denny Laine's guitars?

AP: They were probably 87's. I think choice of mikes for electric guitars is a sort of very unimportant thing because it's an artificial sound being produced in the first place.

HC: Did you have anything to do with the McCartney special on TV? (1973)

AP: No. The only things for TV that studio engineers generally do is for the one-off singles that must be re-recorded for TV broadcast. The Union demands it be newly recorded for that purpose in three hours, which is a bring-down for some of the groups. I remember when I did a PILOT thing, they sent a Union man around and a BBC man around and the guy was literally writing down every track as we were over-dubbing it making sure that all the needles were moving at the right places and all that. It was unbelievable!

HC: Did you work on any material with Pink Floyd prior to DARK SIDE OF THE MOON?

AP: I mixed the ATOM HEART MOTHER LP, of which my favorite track was Rick's — SUMMER OF '68 I think. ATOM HEART was a hairy mix — probably the hairiest mix I had ever done up to that point. We had a lot of ADT's, a lot of echoes, a lot of tapes running, a lot of extra sound effects going on in the mix. I remember we had a problem with the drums coming through the fold-back speaker when we over-dubbed the choir . . . there was a bit too much leakage but we changed some things and it came out OK in the mixing stage.

HC: Who was supervising the mix at that time?

AP: It was usually the guy that had written the song.

HC: Did you work on the MORE sound-track or OBSCURED BY CLOUDS?

AP: No. I think they were done at AIR-

London, Morgan, or in France. In comparison to DARK SIDE, they were done fairly quickly.

HC: How prepared were the Floyd when they went into the studio for DARK SIDE?

AP: Well they were prepared for what they thought they wanted to do when they first came in. (Laughs) Because they had been on the road performing the piece in one form three or four months previous to the studio, we could work on the backing tracks rather quickly, but then everything would change and they'd say "Let's try this, let's try that" — that's when the time started piling up.

HC: What part did Chris Thomas play in the mix?

AP: Chris came in the last week as a fresh "ear", 'cause we'd all got so close to it. I didn't think it was strictly necessary to bring him in — I would have been happier doing it myself as I had when the Floyd used to go home early from the studio to watch the football matches. One thing that upset me was that Chris wanted to limit drums on some tracks, which I hate! It could have had a better drum sound. So I'm not saying DARK SIDE OF THE MOON was bad, but it could have been better from my viewpoint.

HC: What about the heart-beat on the intro of SPEAK TO ME?

AP: That was bass drum Kepexed with a lot of EQ around 100Hz.

HC: Did the guys go out and record their own sound effects with a Nagra or what?

AP: The sound effects came from the EMI library at times, and the rest were actually created in the studio by tearing up strips of paper or pouring money out of dust pans for MONEY. The loop for that track was actually harder than we thought it was going to be because even if the tape was off 1/4", the rhythm would sound off and we ended up cutting it by length rather than by sound. The sounds came off a 4-track tape for the quad mix. On the segues I had to be careful of Dolby alignment. Editing from a copy back into a Dolby master, you can have all sorts of problems because the Dolby alignment can differ. For that reason, I generally don't mix Dolby. Hiss never stopped any record selling. Like when The Beatles did SGT. PEPPER four-to-four, they preserved signal-to-noise by using elevated levels and 1" tape for the 4-track.

HC: How do you mean the Dolby alignment differs?

AP: The Dolby manual actually stipulates between L.A. (U.S.) studios and London studios. The three ways of doing it are: to record at Ampex Zero-level which is also

“. . . I find a lot of people over here frown upon the board reading +12 with EQ. Anything you can do with EQ . . . if it works . . . go ahead!



the standard Dolby level; or you can keep the Dolby level at Ampex level and use an elevated tape level so that the Dolby level remains at Zero and your signal level remains 4 dB above that; and the other way is to use elevated Dolby level and elevated tape level such that your elevated Zero is your Dolby Zero. So it's important when you take tapes from studio to studio that you check the Dolby tones to see what's going on.

I have had trouble with this Al Stewart LP, bringing Dolby tapes over here (U.S.) and finding that Dolby alignment is different. Even if you line up theoretically to the same level you aligned to in England, it still doesn't come out quite the same.

HC: Let's talk about the difference you did find between U.K. Dolby alignment and U.S. Dolby alignment.

AP: The Abbey Road philosophy is to use Ampex level to line up the Dolbys with, and then to use an elevated +4 referenced to Ampex level, which is standard CCIR to actually record the material at. Then the Dolby level stays at Zero.

The philosophy over here is either to record at Zero with the Dolby at Zero, or to use an elevated Dolby level which means that the peak modulation on the tape is at Dolby level. That's really the reason for putting a Dolby tone on the tape so you know which way it's going to go, but all too often it gets forgotten about.

HC: Back to the Floyd . . . how about Roger Waters vocal mikes in the studio?

AP: Probably 87's or 47's.

HC: What about Richard's synthesizers?

AP: They all play synthesizers. David is pretty much the wizard at programming them. He programmed the travel section in ON THE RUN. On ANY COLOR YOU LIKE, he was being fed a long tape loop that he was playing to . . . so he was playing DA DA DA and it would come back da-da-da, da-da-da. We did it in stereo and I patched it in such a way that I used two echo-sends, the second of which is fed from the first return and the first echo-send is fed from the second return and you get a bouncing back and forth. Another thing you can do is to feed each echo-send to its own channel

but feed a small amount of the first channel into the second channel and have the second channel set slightly above the first one, then on each repeat it will move from left to right. Another thing I've also done is when I've run out of tracks or wanted to save some tracks for something else, is just take off onto 1/4" tape the track that you don't want. In that case, you would have to either mix the material at the same time or note the machine numbers so you could use the machine at a future session and hope it stays in sync with your multi-track. But, after DARK SIDE, we did some work on what could have potentially been the Floyd's greatest LP featuring non-musical instruments — things like bottles and the plucking of a rubber band into a mike for the bass.

HC: Could you elaborate on this "rubber band" LP because I would guess there were great things in the works since the Floyd were usually experimental.

AP: I figure it was a great shame that they didn't go on with it because it had the makings of becoming a tremendous album. At the time we were doing it, four-five months after DARK SIDE, it was literally all experimentation. While we were recording the rubber band for example, we were encountering some problems in that when you record it, you're dealing with a fixed-pitch. We discovered, (chuckles) almost by accident, the best way of getting the rubber band right was to sort of prop it up on match sticks on a table. Then we found if you put your finger in-between it would change pitch of course . . . and then you found you got an even better sound by sticking match sticks in the middle, which was the re-discovery of the fret. (chuckle) The mike was literally about 1/8" away from the rubberband. The rubberband was about a foot long to get a low note. Eventually we ended up with a riff that had been played with this rubberband, made a tape-loop of that, and dubbed on a sweeping-up brush banged on a floor as a high-hat . . . amazing high-hat sound, really quite authentic.

HC: Were you picking up the bristles or the wood sound on the floor?

AP: It was probably about a foot away so it was a bit of both.

HC: Parquet floor?

AP: Yeah.

HC: Were you using an 87 on the rubber band?

AP: No it was an 84 — Oh that was another thing!! We decided to record the album on one mike! It would obviously be over-dubbed and over-dubbed but I kept the mike in a place where I knew where it was, just praying that it wouldn't break down so at the end of it we could say we used one mike. (chuckles)

Now relax, playfully invite your muse, and transform these tracks, adding body, stereo perspective, flanging, and a host of other time-base effects. Since Lexicon introduced digital delay over six years ago, most studios have come to depend on it at least for doubling and slap. Now, the stereo 102-S with the new VCO module* produces many other effects, including more natural double tracking, flanging, vibrato, time delay panning, extreme pitch modulation, and signal transformation for special effects. Of course, you can also use the two channels for completely independent processing.

The Lexicon Delta-T has earned an enviable reputation for its 90 dB dynamic range, impeccable audio quality, high reliability, and functional modularity. All this is retained in the new 102-S, while two channel operation, finer delay steps (3 ms), and the VCO have been added. And the 102-S is economical. Its totally modular construction allows you to start with a bare bones mono system and expand later as needs and budget grow. We'll help you define the configuration you need to get started. Call or write Lexicon for further information.

Write on your letterhead for AN-3, *Studio Applications of Time Delay*. A 30-minute demo tape is also available for \$1 in cassette, or \$5 on 7 1/2 ips/2 track tape.

*The new VCO module also fits any 102-B or C mainframe to enhance its time-base signal processing capability.

For more information circle No. 118

lexicon

60 Turner Street
Waltham, Massachusetts 02154
(617) 891-6790

R-e/p 33

HC: So you used an 84 for all instruments.

AP: Yes, mainly because the capsule is very near the end. An 87 . . . the capsule is a good 1/2" away from the face of it and to record the rubberband you'd have to be absolutely on top of it cause it's so quiet.

HC: What about EQ on the board?

AP: Ummm . . . a fair amount of bottom-end . . . around the 150 sort-of mark . . . probably +12 . . . and probably filtering off a bit of top to get rid of the plucking sound. The snare drum was done with aerosol spray, shhh-shhh-shhh, but you couldn't get it short enough by pressing it so I had to record a long spray and then cut it to 1/2" lengths of tape between white leader into a loop to get sh . . . sh . . . sh . . . it was a really good snare drum sound.

HC: So you had all these things on 1/4" loops?

AP: We made the bass-loop, then I dubbed on the brush, then each individual beat of the snare had to be dubbed in after that and then another loop was made on the 24-track. So it went click-track on 24-track, then the brush, then a couple beats of the snare individually keyed-in, then a bass drum which was just footsteps on the floor using a lot of EQ.

HC: Plimsoles? (English tennis shoes)

AP: Probably was . . . yes it was. Then a loop was made of the 24-track so you had a continuous thing. The whole thing took about two days.

HC: How much material was compiled?

AP: Very little. A lot of it was also compiling tapes of wine glasses vari-speeded at different pitches so you could make up different chords by combining different tracks on the 24-track.

HC: Did you use liquid in the wine glasses?

AP: No. It was matter of scraping your finger on the edge and then vari-speeding it from a loop. In order to make the edit not jump in a loop, you have to make a very long cut . . . the splice would have to be about 2 1/2 inches.

HC: A longer diagonal instead of 45°.

AP: Right.

HC: So we have aerosol spray, plimsoles, broom, rubber band, wine glass . . .

AP: Blowing into bottles.

HC: And that would simulate what sound?

AP: . . . It's sort of like an organ if you have lots of them and use VSO. We also had electric razor and egg slicer. (Using

the wires for plucking)

HC: Was anything ever built into a song?

AP: They kind of tried but there were never any vocals to it. Oh, another thing was footsteps . . . we over-dubbed footsteps to simulate footsteps. Rick was holding the mike by his feet while he walked around the studio. Each group member tried it and it turned out that Rick had the most suitable shoes. (Laughter) But it really is a shame that album didn't surface. It could have been really something.

HC: Well how many minutes of net time did you end up with in the time you spent?

AP: Well that's the thing (laughter) we ended up with virtually zero . . . and it's a shame because there was a lot of time spent on it, but to do that, some of it became very tedious. We probably spent in excess of a week doing it and the majority of that was spent VSOing.

Later the Floyd wanted me to set up their studio and continue to go on the road — I had done three American tours with them and it was they that brought me to America.

HC: With the Azimuth Co-Ordinator?

AP: (Laughter) The Azimuth Co-Ordinator was a very early object which became superceded when people started building quad pan-pots. But it was literally the first quad pan-pot I had seen.

HC: How did you deal with the Pink Floyd P.A. mixes while you were on tour . . . did you use a Teac 4-track 1/4" for sound effects and cues and things?

AP: Yes . . . we literally just went into the studio for a day or two and put everything on the Teac we thought was necessary for the P.A. It seems odd to me that they were able to play to that (effects) at all because all the sound effects — the way the mixer was hooked up — went straight into the quad P.A. and they didn't reach the stage P.A. at all.

HC: Did they haul around their own mixing board?

AP: Yes. It was built by Allen & Heath.

HC: What was the configuration?

AP: I think it was 24-in . . . a four-way stereo out plus the quad buss'. So when you selected the quad outputs, it didn't reach the P.A. If it was in a hall with two levels, then you would have two levels of quad speakers.

HC: So that might have contributed to the longer reverberation problems that may have existed for cues.

AP: Yeah. Another thing was the fact that the poor people that had to sit near the speakers had to endure that loudness.

HC: I noticed that somewhat when I saw their movie, also the fact that the EQ was somewhat shrill for a film.

AP: With the Floyd, the way the P.A. was set up, was we were careful to avoid that — that excessiveness in the 3-4k range — which is the sort of "hurting" range. We wanted to make sure that when we had an "S" sound coming through the mike, that it didn't sound k-k-k, that it really did sound s-s-s. In fact, sometimes to get around that, I would often take mid-frequencies out and add at top-end around 8-10k and subtract around 3k with the equalizer on the board.

HC: How similar were your P.A. mikes compared with the studio situations?

AP: All dynamics in P.A. — mainly for their proximity effect . . . I think dynamics have a much better lack of distant pick-up than condensers. You have to EQ them a lot more, they don't "pop" and they're more reliable.

HC: What about brands of dynamics?

AP: About 3/4 of them were Shure, and the vocal mikes were Sennheisers.

HC: How about quantity of mikes for P.A. tours?

AP: There never seemed to be enough. (Laughter) One seemed to find that one mike a night would go "out" and in the general panic of the road it would always get put back with the ones that were working (laughter all round) so you would not discover which one it was until the next night when you'd find there was another one "out". (laughter all round)

HC: So you see Roger up on stage going (mouths vocal without singing)

AP: (laughter) I was always paranoid about vocal mikes not working so I would literally check them seconds before the Floyd would come on stage cause that was the one thing you couldn't bluff.

HC: I have a tape of the Floyd doing DARK SIDE OF THE MOON "live", and the intro seems to be somewhat different than the LP. Did you have anything to do with it?

AP: I'm fairly sure I didn't have anything to do with it. The only time I recorded anything on the road with them, it was only about half the concert.

But touring with Pink Floyd was a grueling experience; traveling, up early every morning, staying at the same Holiday Inn in every city (laughs), and probably not getting more than 4 or 5 hours sleep — but like I said, the show itself was the thing that made it all worthwhile . . .

Continued on page 37 . . .





organization located in New York City, is equipped to handle
ave—under one roof—the facilities, know-how and man-
-n design and planning through construction and installation

vironments, from blueprint right through to your first session —
are functional, comfortable, dramatic, mood-setting. Each
fully executed—allowing the recording artist, engineer
ial.

faithful reproduction of the sounds created by musicians and
gineers we understand your needs. We begin with an inde-
-ents. Our construction designs are based on the most
maximum recording fidelity. Our interior finishes and furniture

g board where complete construction documents are
designs the most sophisticated and durable building equip-

he architectural plan. We design and construct editing,
oths, and multi-purpose studios of all types.

and climatization design. A large emphasis is placed on
-f this documentation is part of our comprehensive architec-

alization, using 1/3 octave real time frequency response
ustom-built, calibrated octave reverb meters. Finally, we
nal audio equipment. As design consultants, not committed
our clients on the most desirable sources and methods

our total recording environment.

O.D.O. Recording, New York City
Quad 5 Studios, Merrick, Long Island
Record Plant—B, Los Angeles
Willis A. Ramsey Studio, Austin, Texas
Leon Russell's Studio, Tulsa, Oklahoma
Howard M. Schwartz Recording, New York City
Shelter Church Studio, Tulsa, Oklahoma
Sigma Sound, New York City
Sound Mixers, New York City
Startrack Sound Studio, Philadelphia
Trackmaster Audio, Buffalo, New York

BEAUTY BORN of SOUND

Sugarloaf View, Inc., an architectural and acoustical design firm, provides all your recording room construction and audio needs. We have the power to perform every technical and aesthetic function, from the design of recording studios.

Sugarloaf View, Inc., creates total, personalized recording environments for all your recording room needs. Our recording environments and design is architecturally unique, individually planned, purposeful and designed to express the total range of their artistic potential.

Architects

The primary purpose of every studio is optimum control and flexibility for vocalists. Because we are both architects and acoustical engineers, we provide an independent viewpoint that is adapted to your specific requirements. Our up-to-date building and acoustical methods to achieve maximum control and selection complement your studio's space requirements.

Planners

We begin with a concept, then transfer this idea to the drafting stage. Plans are prepared. At the construction stage, we incorporate into our design the equipment and audio hardware.

Acousticians

We integrate your particular audio and acoustic needs into total control and cutting rooms, instrument and vocal isolation booths.

Engineers

We supply your electrical (high voltage) signal (low voltage) control, lighting and its integration with an architectural scheme. All contained in our architectural/acoustical design package.

Consultants

Our specialists supply room monitor system analysis and equipment recommendations. For room reverberation measurement, we use current data to supply the most current data on state of the art and professional equipment. To any single line of audio equipment, we are able to advise on the best choice for equipment purchase, installation and interface.

We invite your inquiry about our many services. Let us create your studio.

Projects

Ray Armstrong Recording, Champaign, Ill.
A&R Recording, New York City
Arrest Recording, Washington D.C.
Atlantic Recording, New York City
Aura Recording, New York City
Bearsville Theatre Complex, Bearsville, New York
Bearsville Recording Studio, Bearsville, New York
Blue Rock Recording Studio, New York City
Broadway Recording, New York City
Century III, Boston, Mass.
Electric Lady Studios, New York City

Fredonia College, Fredonia, New York
Generation Studios, New York City
Hljóorifi, Hafnarfjörður, Iceland
Hugo and Luigi Records Corporation, Englewood Cliffs, N.J.
The Hit Factory, New York City
Isley Brothers Studio, Mt. Kisco, New York
KBK/Earth City Sound Studio, St. Louis, Missouri
Master Disc, New York City
Margalooff, Cecil Synthesizer, Los Angeles
Bob Marley Studio, Kingston, Jamaica
Ochoa Recording Studios, San Juan, Puerto Rico

SUGARLOAF VIEW

ARCHITECTURAL & ACOUSTICAL
DESIGN & CONSTRUCTION

SUGARLOAF VIEW, INC.
75 EAST 55TH STREET
NEW YORK, NEW YORK 10022
(212) 759-7588

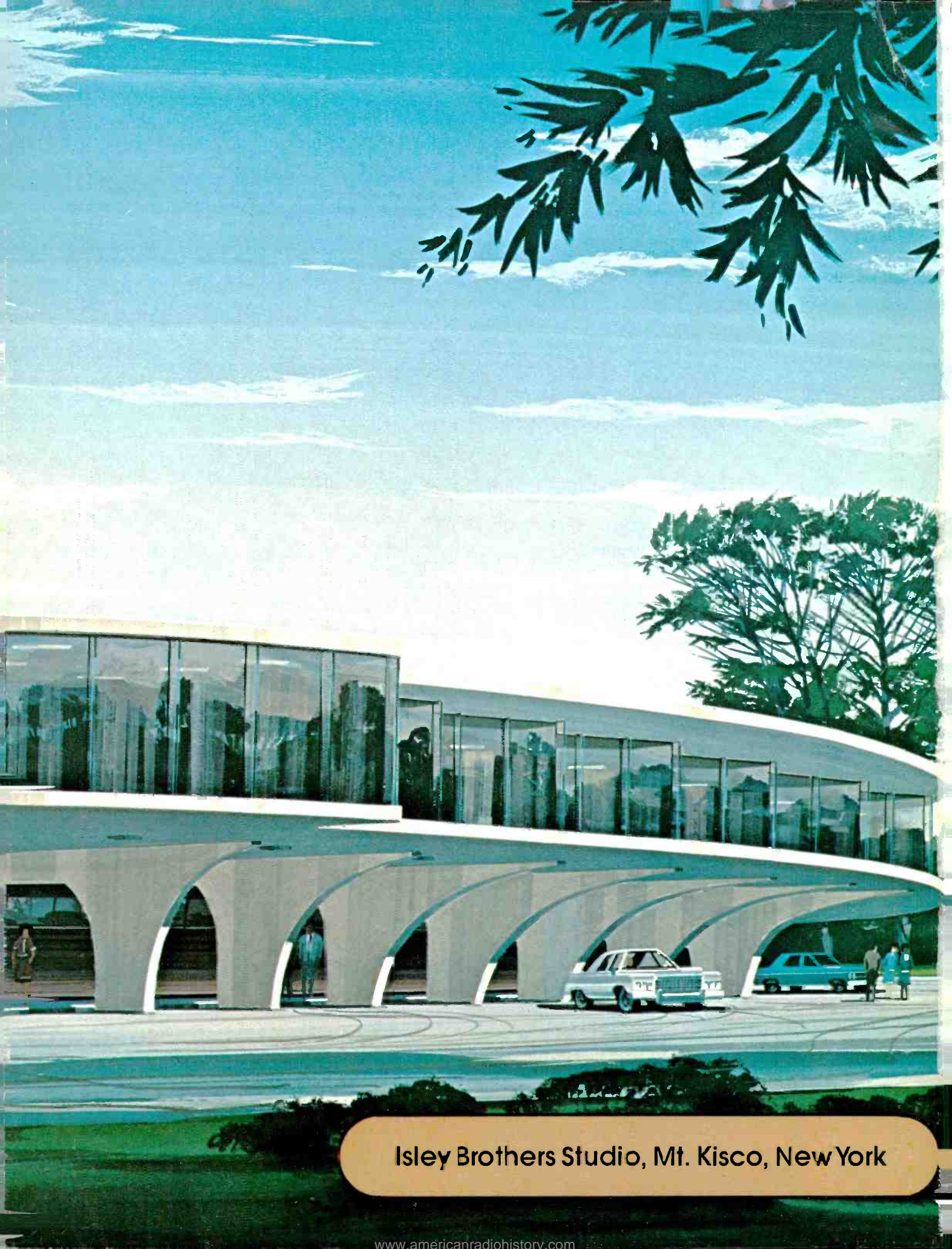

Isley Brothers Studio, Mt. Kisco, New York

you felt the audience was applauding you as well as the group. I tried doing P.A. for Cockney Rebel after the Floyd and it just isn't the same thing. There's no one I'd rather have done P.A. for than the Floyd because you're so much a part of the production.

Afterwards there was talk of my recording a future LP, (WISH YOU WERE HERE) but Brian Humphries did it at Abbey Road as a free-lance, which is somewhat unheard of for EMI . . . other than the fact that Geoff (Em-erick) had done some work with Mc Cartney. You must have special concessions from the top of the company.

HC: Was there a bit of a fuss when he came in to do WISH?

AP: Yes. I figure it was among the other engineers. The more "junior" engineers always thought that if the senior engineers didn't want to do it, they should have a crack at it.

HC: How did you get involved with the group Ambrosia?

AP: A friend of theirs, Gordon Parry, the chief classical engineer at Decca, phoned me up from L.A. one night while I was working at Abbey Road and said "DARK SIDE OF THE MOON is the best album I've ever heard. Will you come and work with these friends of mine - Ambrosia?" So I was going to be in L.A. anyway for the Grammys. We met, I heard some of the tapes, and was very impressed. They asked me to stay a couple of weeks and mix the album, and it turned out, 6 months later I returned (laughter) because it took them that long to finish the recording.

HC: Was it hard dealing with someone else's lay-down on Ambrosia I?

AP: Yes. It was difficult and fun. You have to learn the material starting anew. I remember there was some fairly raucous EQ . . . some +20's.

HC: Literally?

AP: Yes.

HC: In what instances?

AP: Drum things. I find a lot of people over here frown upon the board reading +12 with EQ, but I'm much a believer in that. Anything you can do with EQ, if it works, go ahead.

HC: So if it came to a choice of mikes or placement or EQ to achieve something, which would you choose?

AP: EQ. Another American philosophy is the use of one mike against another. I consider that a very minor difference compared to what you can get with EQ.

HC: So you're more into picking some microphone instead of a specific microphone.

AP: Right. Obviously there's a difference between a dynamic and condenser, but within that category I don't worry about brand. I do consider polar-diagrams, but otherwise I prefer to handle it from the board.

HC: Why did you go to London for the strings on Ambrosia II? (SOMEWHERE I'VE NEVER TRAVELED)

AP: Partly because I'm used to the way the board works over there, partly because of the size of this studio (Mama Jo's), and partly because of the musician's union. There's tremendous union problems and expense over here. I also wanted to work with conductor Andrew Powell.

HC: What else did you deal in on this new LP?

AP: Ambrosia is very much into different instruments, and Burleigh (drummer) used a metal plate dipped into a bucket of water. You hit it and then dip it into a bucket of water and get a descending scale. (Song - THE BRUNT) We also had an African drum which you change the tone of by putting your fist inside the end.

HC: Was it something that might have been tapered?

AP: Yeah. We recorded that (Darboka) with two mikes - an 87 to get the attack

of the hit and an 84 inside to get the sound of the bottom. (Song - THE BRUNT)

HC: Why don't we talk about the "warehouse" recording.

AP: Well the warehouse was an attempt to capture the "liveness" of a gig because it was a sort of rock n' roll "live" song. (CAN'T LET A WOMAN) We just recorded in a warehouse and set the group up as if it were a "live" gig. We used a studio mike set-up along with some distant mikes to pick up some room sound which is really the root of the whole thing.

HC: On to your project . . . TALES OF MYSTERY AND IMAGINATION - THE WORKS OF EDGAR ALLAN POE. How did the ProJect come about?

AP: Eric Woolfson, now my manager, brought up the idea to me about two years ago, but the time wasn't right to work on it then. When we decided to start, we observed that the public was very interested in terror entertainment - things like "Towering Inferno", "Jaws", "Earthquake", etc., so we proceeded on that basis. After getting backing from Russ Regan at 20th Century, we decided to maintain some sort of secrecy on the ProJect to prevent pirating, so we gave the songs "working" titles for the sake of recording. THE FALL OF THE HOUSE OF USHER became FROM USHER WITH LOVE, THE CASK OF AMON-TILLADO became BRISTOL CREME,

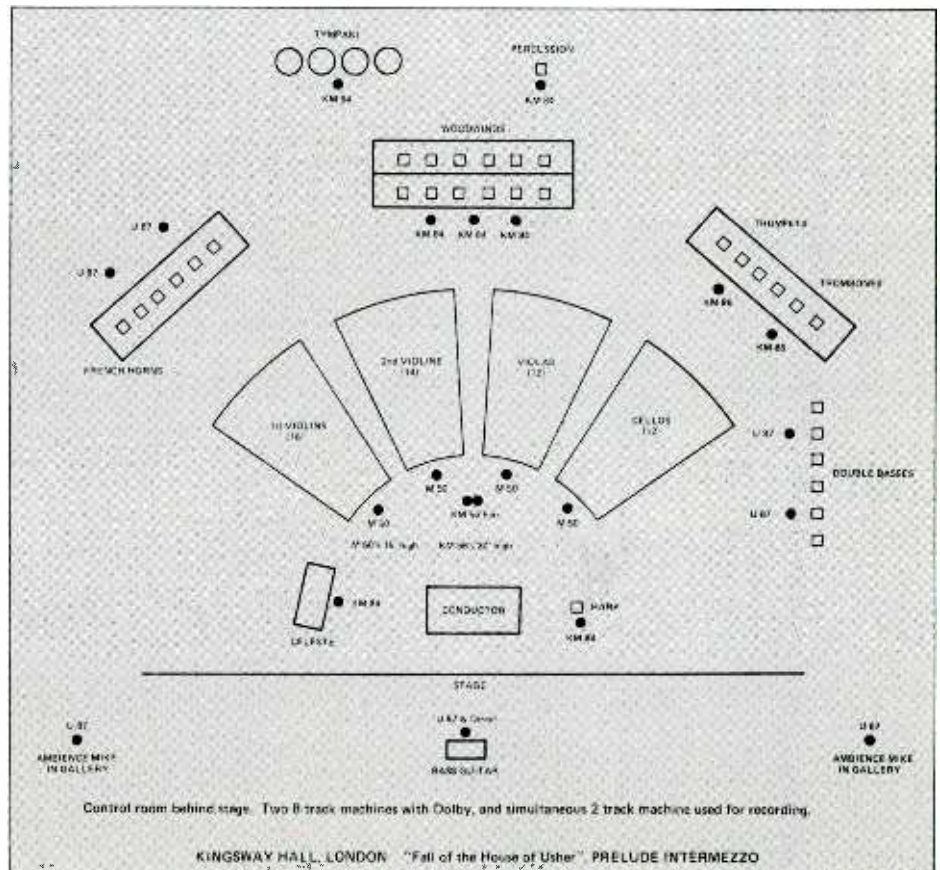

and TELL-TALE HEART became I'M NOT COMING OUT.

HC: Please describe the "intro" of the ProjEct.

AP: The intro of DREAM WITHIN A DREAM was 8-tracks of acoustic guitar being strummed with the thumb on the "open" string.

HC: So it was open-chording?

AP: Yes. The string-y wash at the beginning is 8-tracks of acoustic guitars and the piano doing arpeggios across the keyboard, and 4-tracks of recorders. The second section still has the bass thing happening but it was extracted from THE RAVEN and made into a loop. So the bass-line is American and everything

else is English because Ambrosia played on THE RAVEN.

HC: What's the background on the Harmony Vocoder in THE RAVEN?

AP: I wish I knew how the thing worked more-so than I do, but EMI didn't want to divulge it. Basically what happens is if you mouth the words into a mike, it converts that voice into digital information, takes out the pitch information, but keeps the actual consonant and vowel sounds of the voice, combines it digitally with musical information that's being fed from another source such as guitar or oscillator, then out it comes as a combination of the two but not a direct sum, and it comes out in such a way that you can play it on a keyboard; the pitch

information is resolved through a keyboard.

HC: How did you go about recruiting Arthur Brown and Terry Sylvester for vocals?

AP: Well Arthur Brown I had remembered from his "FIRE" track in 1968. He was just kind of an aesthetic choice.

HC: So you had him in your head for 7 years.

AP: Yeah. He came in and did the song in two takes — ripped it up! The funny thing is when he walked in, I wondered, "Is this the real Arthur Brown?" He was very quiet, mild-mannered — (speaks softly) — "Hello, how are you? Oh we have some tapes here, very nice, da-da-da-da. I think I've got it, testing 1-2-3, WHOARRGH!!!!" (laughter all round) We were all knocked over backwards!! With Terry — I've always considered him to be under-rated as a songwriter and singer and I felt his voice would be good for the tracks he did. One thing we kept in mind was not to make this album a superstar Rod Stewart-Roger Daltrey situation. But it's nice to see someone inquiring about some of the human aspects in an interview.

Anyway on this Arthur Brown song, TELL-TALE HEART, the bass track was not played as you hear it. It was done with tape-echo and was actually played do-da-do-da-do-da-do and with the tape it goes do-do-do-do-do-do. (quicker) I think it was VSO'd 7 1/2 ips. Another thing we did on this track — going back to splicing — was on Smokey's (Alan's wife) voice — in the aaaahhhh section of the verse, was to have her sing the note onto 1/4", then gradually ease the tape away from the erase head so that it would slowly stop wiping.

HC: What about the horns in AMONT-ILLADO?

AP: The bit in AMONTILLADO has stereo horns — three horns on one side going ba-ba ba-ba and those on the other going aaa-aaa (answering) and has the effect of it moving across. And while the strings are playing on their own — we had all manner of instruments playing on that originally but we decided it sounded much better with just strings for the final mix.

HC: What sort of mikes on the French horns?

AP: 87's. For trumpets and trombones — I like the (STC) 4038's. It's very much an Abbey Road thing to use ribbons on those.

HC: How about the monitors for these sessions?

AP: Over the years I have got used to the Abbey Road sound of JBL speakers just mounted on tables. It's a fairly "raw"

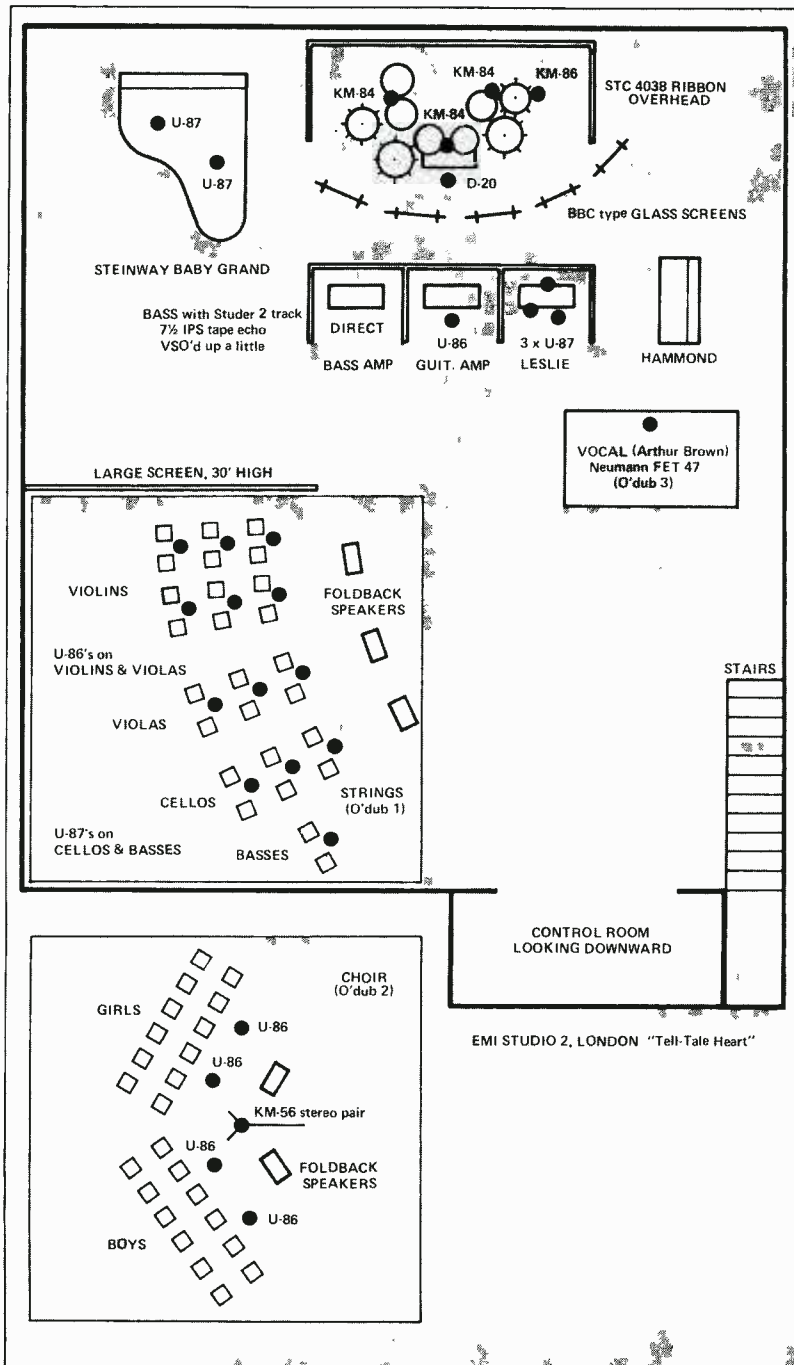

**“Audio Industries
gives us superb service
on our new MCI
JH500 Series console...”***



**“...It’s a great combination, the best console around
with a fine sales and service team.”**

Everyone wants a “Deal.” Why not? You’re a Pro ... and don’t the Pros deserve a deal? Trouble is, a lot of guys selling equipment will “Deal” themselves out of business if they’re not careful. And, AFTER you’ve plunked down the cash and gotten “The Deal,” where are you when you need some spare parts really fast or service call to fix something? Sure, you may have a studio technician ... and it’s his job to keep things cooking. Don’t forget though, he needs some friends too... Like the Dealer who STOCKS the spares and the dealer’s people who have the factory training.

At Audio Industries, we know how to take care of people. Especially when they need us the most, like in the middle of a session.

For two decades we’ve helped this
For more information circle No. 120

industry grow RIGHT: From the early days of multi-track recording we have been supplying L.A.’s best studios with everything from recording tape to complete studio packages. WE are the West Coast’s Pro Audio Dealer for a good reason.

We’re the one-stop supplier who doesn’t stop after we’ve sold you the equipment.

audio industries corporation

The People and The Products.

We have 'em both.

* One Step Up Recording. Los Angeles
Owners: Allan Goodman & Norman Ratner



**audio
industries
corporation**

1419 North LaBrea Ave.
Hollywood, Calif. 90028

(213) 851-4111/Telex: 67-7363



R-e/p 39

sound you get. They don't sound great — it's far from great — the bottom-end leaves something to be desired. But you work on it a bit harder and when it does sound good, it'll sound good anywhere.

HC: Well how did you go about mixing the PrOject because it has such good bass response, transient response, and dynamic range for a pop recording?

AP: I had the speakers (JBL 4321's) literally sitting up on the edge of the desk looking straight at me.

HC: So you had the mix hitting you in the face from 4 feet away. Do you like to monitor at high levels?

AP: I like to do both actually. I start off fairly high and when it get's into the intricate parts or vocal balance, I go low.

HC: How did you go about recording the thunderstorm effects on THE HOUSE OF USHER?

AP: Yeah. That was a genuine electrical storm in Hampstead, London, one of the worst they had had in years with houses flooded and EMI echo chambers under water! The storm was actually recorded with a "dummy head".

HC: A "dummy head"? Could you explain the Dummy Head principle? (Kunstkopf)

AP: It's a recording head with micro-

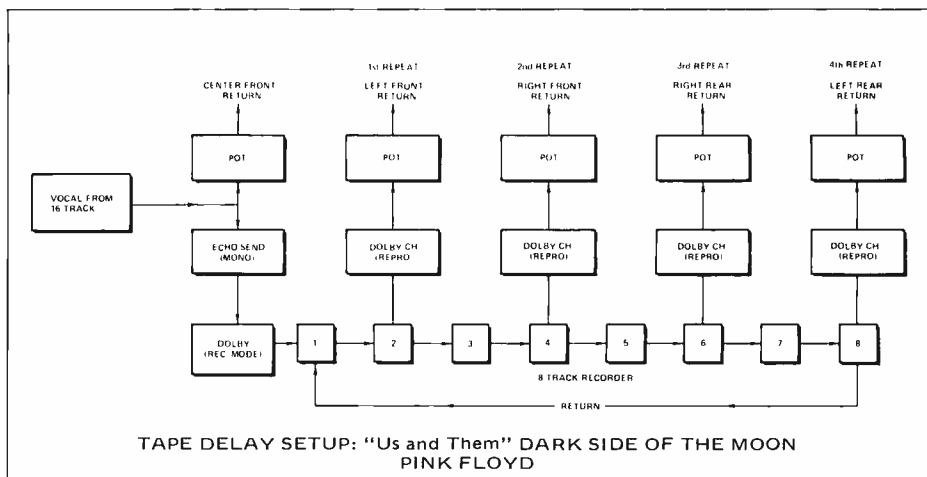

phones at the ears . . . actually a model of a human head with electronics so you can get the true perspective of what the human ear actually hears in stereo, and when you play it back on headphones you get this ridiculous feeling of direction. You put it in the environment in which you wish to record, and monitor its "eardrums" at the console. It came from a German company called Delta Acoustics. That's what made me lose interest in Quad — using this "head".

HC: Back to the storm — did you run it through some limiters or EQ it because when I heard it, it knocked my socks off!

I was just imagining the cutting engineer going through a fit.

AP: No, straight ahead without limiters, possibly a little EQ. I thought there might be some problems with the lacquers, but Doug (Doug Sax, The Mastering Lab, Hollywood) said "no" — after he cut some refs!

HC: The closing in USHER kind of reminded me of The Beatles A DAY IN THE LIFE. Did you consciously do that?

AP: Yes, the build-up. But we attempted to make it even more horrifying. We used about 85 musicians at once.

HC: What sort of miking did you use for THE HOUSE OF USHER?

AP: The prelude is multi-mike combined with a stereo pair. All the bits in-between are purely a crossed-pair of KM56's. I used a lot of 49's on the strings, recorded at Kingsway Hall, London. Gordon Parry was a big help in setting it up. Keith Johnson also helped out on some things. He's sort of technical wizard . . . designed his own 3-track machine . . . all his own deck, all his own electronics, metal heads . . . amazing!

HC: The mandolins sound nice in USHER.

AP: In order to get a better blend of double-picking, I put a tape-echo on them and played it back onto itself so it comes out as a smooth plucking since there are only two of them. So it was tripled and quadrupled.

HC: Have you ever tried any computerized mixing?

AP: I tried the API-Allison set-up at The Manor (U.K.) on The Hollies FROM BOULDER TO BIRMINGHAM as an experiment and it wasn't behaving perfectly. I could see it's usefulness for certain things but not for that because it was a straight-forward mix. On the Ambrosia album it would have been a God-send.

HC: What problems were you encountering?

RELAP OR RECONTOUR?

DO THEY MEAN THE SAME THING?

Each head is designed by its manufacturer with specific radius and ramp angles for maximum head performance. RELAPPING means simply polishing out the wear step. This increases the radius and brings the outer core edges closer to the tape, both of which can cause problems. RECONTOURING involves the processes of duplicating exactly the manufacturer's designed contour, insuring maximum head performance and reliability.

Chances are that you can get by with relapping CAN YOU AFFORD TO TAKE THE CHANCE?

MRT HAS RECONTOURED THOUSANDS OF HEADS, FROM EVERY MAJOR MANUFACTURER. MRT'S FACILITY IS ALWAYS OPEN TO OUR CUSTOMER. WE INVITE YOU TO VISIT OUR FULLY EQUIPPED FACILITY AND TO SEE FIRST-HAND THE DIFFERENCE BETWEEN LAPPING AND CONTOURING, OR HOW EDGE SLOTS ARE PUT IN, OR WHAT A HEAD GAP LOOKS LIKE UNDER 600X MAGNIFICATION.

MRT RECONTOURS ALL HEAD TYPES AND ASSEMBLIES THRU 24 TRK.

MAGNETIC RECOVERY TECHNOLOGISTS, Inc.

10145 Sepulveda Boulevard • Mission Hills, California 91345

(213) 892-5611

EXPERT SERVICE

DEPENDABLE QUALITY

24 HOUR DELIVERY

AP: You'd suddenly find a track would disappear for no reason at all and presumably there was a drop-out on the encoding track.

HC: So something was recorded on the multi-track and it just didn't show up on the fader.

AP: Right. Presumably the drop-out was telling the fader to drop that fader at that time and then bring it back later, so I ended up mixing BOULDER at Abbey Road.

HC: How did you find The Manor . . . the Helios board and such?

AP: I found the board alright. I found the monitoring very odd there — the Westlake system. I just can not get used to the bottom-end in Westlake rooms.

HC: Too deficient?

AP: Yeah. A different kind of deficient from the JBL sound at Abbey Road. When I did this rough computer mix of BOULDER TO BIRMINGHAM, I mixed the bass at what I felt was a comfortable level and then I played it on JBL's and it practically drowned everything.

HC: Are you in the habit of following all the steps through the recording chain?

AP: With something as short as the Hollies sessions, it usually went through on its own, but with something as long as Pink Floyd, you had to. One learned to have faith in the people upstairs in cutting rooms to do a good job whether you were there or not. The system in England is vastly different than the U.S. in that Producers do not always turn up at cutting sessions, especially for singles. And we usually don't cut refs over there either.

HC: How about Quad processing?

AP: I've totally lost interest in it. About the only thing I got involved with was DARK SIDE which I thought turned out pretty well in Quad. (SQ)

HC: As a producer, what sort of interest do you take in the promotion of your artists?

AP: I show concern and interest but I don't actually do any promotion. With the Poe album, we laid down specific terms as to how the thing would be treated, as well as the running order of the songs.

HC: Is there anyone you admire as far as producers or engineers?

AP: Ummm . . . I admire Mickie Most as a Producer in the pure sense of the word because he's one of the few Producers as Producers left, and if it isn't happening in the studio, he goes home — which I love to see. I certainly respect George Martin. I think Roy Baker has got some good sounds in his time. I think Ken Scott gets some good sounds, but I think my #1 has to be Geoff Emerick really.

He consistently gets great sounds.

HC: Comments on your Grammy nominations?

AP: I wish I'd won. (laughter) It would have been a nice thing to have. I was there on both occasions — heart beating madly. There's a lot of things said about the Grammys — record company power etc., but it seems strange to me that Janis Ian should win a Grammy. It seems strange to stick it in for an engineering award. I'm sure it's a beautifully recorded album, but I think the Grammy should be based on inventive recording techniques as opposed to pure Hi-Fi. Things

like weird types of echo and stuff like that should be considered.

HC: I'll wind it up by asking what makes you tick?

AP: I wouldn't be in this business if it weren't for the fact that I enjoy it. Every album has its ups and downs but there's a tremendous satisfaction no matter how much hard work and bull has occurred. There's always a great amount of satisfaction in hearing a finished album and being pleased with it.

HC: And a great sense of relief also.

AP: Yeah!! (Laughter)

The Live Reverb Chamber From TAPCO

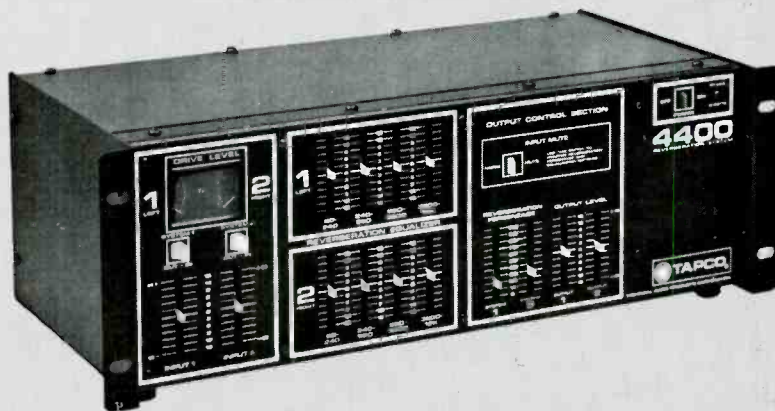

We designed features into our two-channel Tapco 4400 Reverberation System that, quite literally, give you the electro-mechanical equivalent of a live reverb chamber. Innovations that make our 4400 a more usable reverb at a more reasonable price include: **Bi-Level Peak Sampling** circuits and **Dual Differential Constant Current** drive circuitry that minimize the "spring slap" associated with other reverbs, and smooth out any reverb irregularities. **AutoPad®** gain controls match the 4400 to any audio equipment. **Reverb Drive Meters** let you constantly monitor your signal level for optimization of performance. The four-band **Reverberation Equalizer**, with specially selected center frequencies, allows you

to synthesize a reverb that is indistinguishable from the reverb quality you get in nearly any size room. **Input Mute** permits you to conveniently evaluate the reverb decay by itself. These features are unique — and they'll work for you!

The reverb quality of any brand has to be heard to be completely assessed. So lend an ear. Hear and compare the 4400 at your Tapco dealer.

The Tapco 4400 Reverberation System goes for only \$389.00 suggested pro net. Nothing has been eliminated except the price!



For more information write or call Larry Farypa, TAPCO, 405 Howell Way, Edmonds, WA 98020 / 1-206-775-4111

For more information circle No. 122

Soul trio in Studio A. Beethoven's 5th in B. Rock concert in the park.

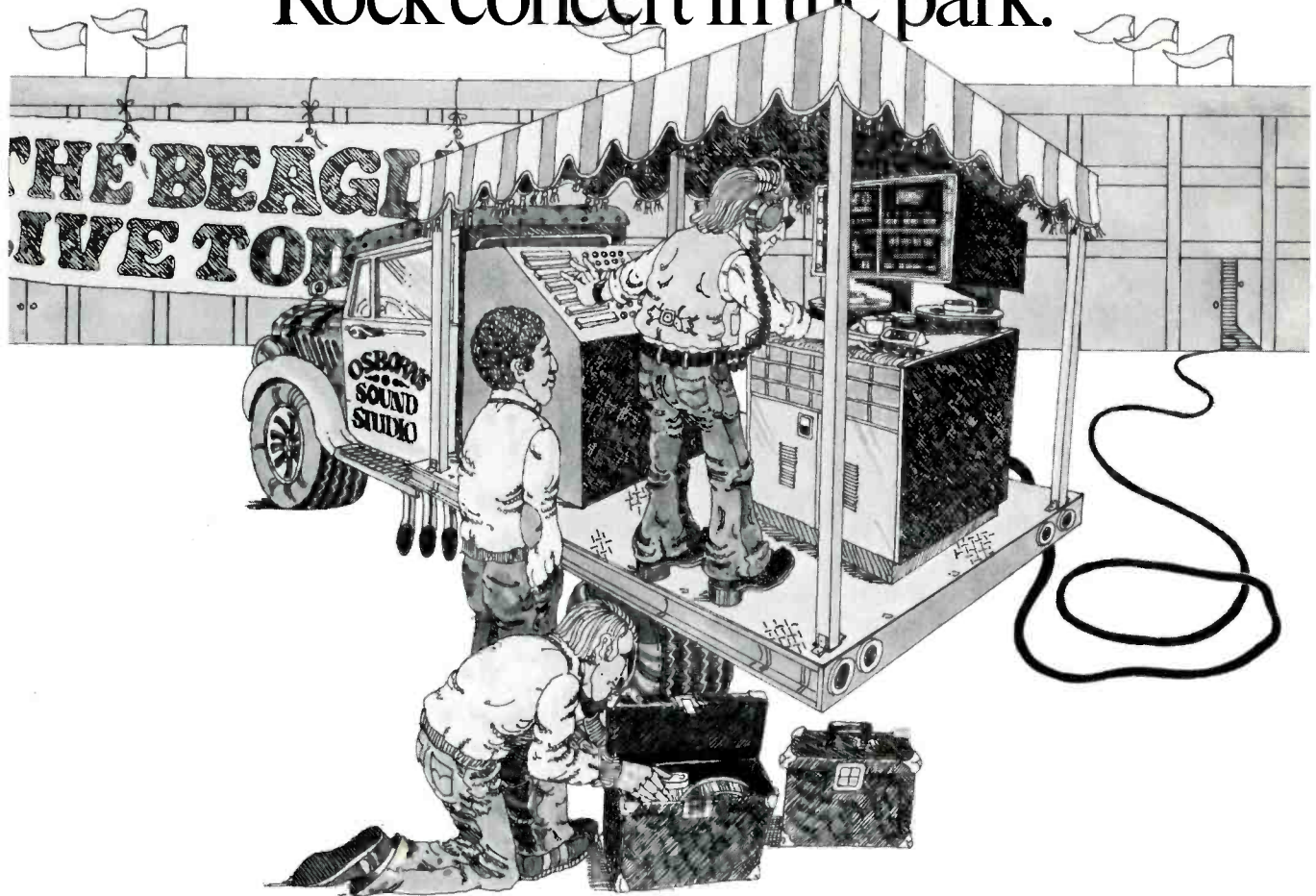

MM-1200 gets around.

The best multi-channel audio recorder in the world is also the most versatile. It handles 16-inch reels of two-inch tape for 16 or 24 channel work, and does a beautiful job with an 8-track head and one-inch tape. It'll give you the flexibility to record a vocal quartet one day, and a full orchestral ensemble the next.

You'll probably buy

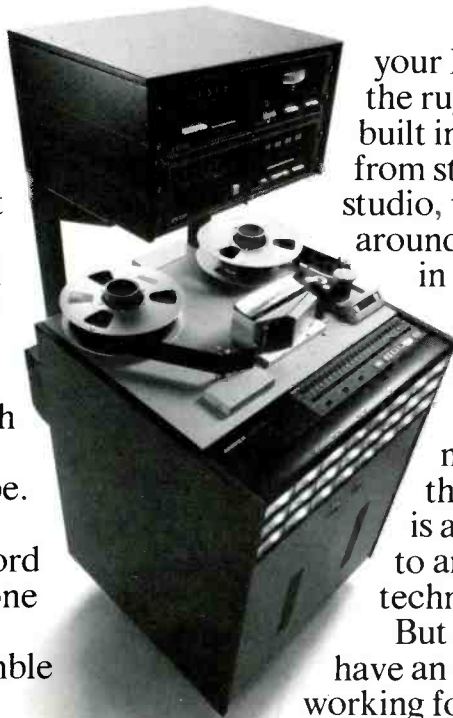

your MM-1200 for the ruggedness built into it. Roll it from studio to studio, truck it around town, shift it in the booth, it'll stay aligned. And when it comes to maintenance, the MM-1200 is an open book to any service technician.

But after you have an MM-1200 working for you, it'll be a real breadwinner.

Engineers love to work MM-1200 sessions because the machine is easy to control and set up, producers love the way each channel is crisp and isolated, and accountants love the way our multichannel machine keeps returning profits on the original investment.

MM-1200 is the multi-channel audio recorder from Ampex, for studios that can't take chances.

AMPEX

Complete technical and performance specifications are available in a free brochure. Write us at 401 Broadway, Redwood City, California 94063, or call (415) 367-2011.

$\frac{\text{RIAA+NAB}}{2} = \text{Deja Vu}$

HALF SPEED CUTTING-

by

Peter Butt
Westlake Audio

Stan Ricker
JVC Cutting Center

New discoveries are always exciting. The opportunity to display new, different, unprecedented results to an apathetic world has an attraction for some of us that is almost perverse. There has been noted in the family of man, a propensity for the belief that one's own experience encompasses the sum total of human observation. Equally seductive is the appeal of sharing of events and/or knowledge that one has deemed unique or especially valuable in one's own sphere of perception. We need not look further than the evangelical proselytism for illustration. Contemporary Sauls are still seeing The Light on their respective roads to Damascus.

Disc mastering has been with us for quite a few years, now. Over those years, the technology has advanced continuously toward the state in which we now view it. Surveying the cyclical trends that seem to be common to historical developments in general, each improvement in the disc recording process has raised expectations of the newly obtained results to the point where still further refinements seem to be out of the question. Until the next one comes along, that is.

Over the past several years, improvements in the disc recording process have tended to fall into the classification of "fine tuning" or "honing" of the process. Variables that are recognized to limit the quality level of the final recorded product are either eliminated or minimized as much as possible. Master lacquers have been cut with modifications to the variable pitch control system, hand selection and trimming of noise reduction devices used to reproduce the master tapes, multi-band signal limiting, with and without the advance ball, inclusion of the cutting head in the feedback system, and DC coupling of the signal channel.

All of these techniques, and others that do not

come readily to mind have been tried and retained or rejected in the evolutionary course of events. Each of these singular techniques, taken by themselves individually, have been responsible for significant improvements in the advance of the art. It is doubtful, however, that any specific development has been solely responsible for the level of disc quality to which we have become accustomed. It is safe to say that each innovation, be it stylus heating or helium cooling, was heralded as the precursor of the Millennium to follow the Armageddon of the present.

Attempts to affect the disc mastering process in a more fundamental way have been encountered with less frequency. Perhaps the most famous and fruitful of this class of approach have been the direct-to-disc music productions of the last several years. The joint efforts of Lincoln Mayorga and Doug Sax, released on the Sheffield record label, are particularly fine examples of the potential of the disc medium.¹ The hypothesis to be demonstrated was that the magnetic recording process inherently degrades the audio signal in an unavoidable way. The elimination of the magnetic tape from the signal path by recording the live performance directly on the disc was, and still is, a major departure from the prevailing established procedures.

The reader will recall that this approach was innovative only within the context of recent recording history. Prior to the development of magnetic recording, direct disc mastering was the only way to achieve any kind of result whatever. At that time, the introduction of intermediate magnetic recordings would have been at least as worthy of comment. Although the Sax-Mayorga collaborations are interesting and have provided many, the authors included, with superbly executed recordings worthy of thought, comment and demonstration, their

method has not revolutionized the industry.

The disc recording art has progressed to a stage where further improvements can be had at increasingly high cost with what seems diminishing contribution to the end product. The majority of attempts at improvement in the recording process are generally the optimization of factors not previously optimized. The Sax-Majorga experiments were different in that they sought to change the methodology in a fundamental way. It is possible that some of the superiority in sound quality could be attributed to the care and skill of the plater and disc presser. The degree of signal degradation due to the amplitude and phase distortion inherent in the magnetic recording and reproduction processes has still not been firmly established. It seems reasonable to assert that improvements in any widely applied and highly refined process must originate with departures from traditional approaches to the problem itself.

From the past: Enter half speed cutting

In the early 1970's, the Japanese Victor Company introduced the CD-4 discrete quadraphonic disc system. Because of the nature of the CD-4 process, recording and reproduction bandwidths to 45 kHz are a necessity. As of this writing, no disc recording equipments having that necessary bandwidth capability exists. Too, the development of such a system remains an unlikely near term event. However, the wide-band recording problem was resolved, most fundamentally, by the resurrection of the reduced-speed mastering techniques that were in wide use in the mid to late 1950's when stereo was young, and wide-band cutting systems were more a matter of theory than of practice.

In the years since the introduction of the CD-4 quadraphonic system, its popularity has waxed (no pun intended) and then waned. Of late, the demands for CD-4 masters has taken a definite decline. Although developed specifically for CD-4 mastering, the JVC mastering system, however, has been found to be capable of cutting stereo grooves that are worthy of comment and are the subject of this article.

The physics involved—

Casual reflection of the comparison between operation of a disc mastering system at real-time bandwidths and at half-speed conditions will lead to several performance expectations. One of these is that the signal bandwidth seen by the entire system will be shifted downward in frequency by an octave. In terms of absolute band-pass frequency, the system will be operating at almost exactly half the frequency range necessary for real-time cutting. Because stylus velocity is directly proportional to modulation frequency for a given signal amplitude, maximum velocities should be half those implied for real-time cutting. The amount of power required to drive a cutting head is directly proportional to the cutting velocity for a given signal level. Our experience with mechanics has shown that the energy required to impart motion is proportional to the square of the velocity achieved.

In other words, to cause a given mass to move at twice a given velocity, four times the energy must be applied. If the mass being considered is the cutting stylus and its suspension mechanism, we would expect that the power required for a given groove excursion (velocity) at half speed (frequency) would be one-quarter that necessary for real-time recording.

In fact, this is observed to be true. The indicated cutting head drive currents can be seen to be about 6 dB below the levels noted at real-time. This amounts to only a quarter of the power. The advantages in terms of power dissipation are that the cutting head coil temperature rise is only one-fourth that seen at real-time. Thermal overload problems that may require limiting at real-time have a 6 dB greater margin at half-speed. In application, the Neuman BSB-74 acceleration limiter is normally bypassed in the JVC system as it has not been observed to have any function in half-speed mastering.

Another consideration, as far as the comparative physics of the half-speed cutting situation is concerned, is the amount of feedback available for control of the cutting stylus motion. Figure 1 shows a plot of the feedback curve measured on the half-speed cutting system. The head is a Neuman SX 74, serial number 536, and the driver amplifiers are SAL 74 serial number 044. The head resonance peak in the region of about 930 Hertz is readily apparent. The decline in feedback available above the resonance peak is cause for particular interest. The feedback declines from about 30 dB at about 1 kHz to less than 0.6 dB at 15 kHz. It can be seen that motional control of the cutting stylus is reduced to almost negligible levels at high driving frequencies.

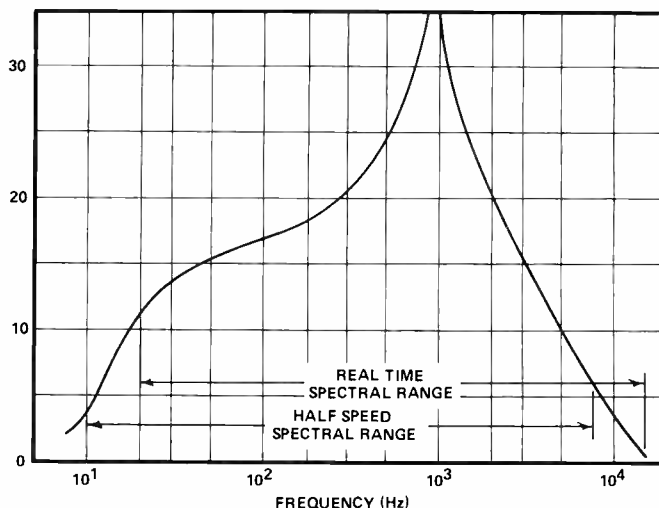

Figure 1. Feedback versus drive frequency curve measured for Neuman SX74 cutting head No. 536 driven by SAL74 amplifier system No. 044.

Also shown in Figure 1 are the signal bandwidth ranges for real-time and half-speed signal spectra. The feedback available at 7.5 kHz is about 6 dB compared with 0.6 dB at 15 kHz. There is less feedback at 10 Hz than at 20 Hz, however it does not drop below 3.6 dB anywhere in the half-speed bandwidth range.

Subjective analysis—

An audition of discs cut at half speed seem to

ASK THE MAN WHO BUILDS THEM

If you want to find out what's new in lathes, ask Larry Scully. He has designed "THE LATHE", a mastering unit which is years ahead of anything else on the market. RCA discovered this fact when they were able to increase the average level by 2.5 db with the new Scully system. Another advantage is service and parts-support . . . it's around the corner, not across the sea. For all the details, talk with Larry or any of the boys at Scully. Their reputation for quality manufacturing dates back to 1920, but their thinking is 1980.



a cut above the rest

"THE LATHE" BY L. J. SCULLY

L. J. Scully Manufacturing Corp., 138 Hurd Avenue, Bridgeport, CT 06604 Telephone 203 368 2332

LARRY AND "THE LATHE" WILL BE IN ROOM 5J DURING THE AES SHOW

R-e/p 45

Are you sure what the crossover point for your next installation should be?

If not...
you might think
about including a
Crown VFX-2
in your tool kit.



This unique, dual-channel unit has continuously variable filters. With it you can "fine-tune" the crossover point in any sound reinforcement system.

As a temporary test rig, the VFX-2 installs quickly. You can diagnose crossover problems in existing systems, no matter how old or new, and prescribe a solution.

For permanent installation, you'll find that the VFX-2 costs less than many fixed filters, and provides other advantages. For one, a 15dB gain that eliminates the need for input transformers. An 18dB per octave rolloff that's sharp by any standard. Crossover points can easily be changed to suit different performances. The VFX-2 also works as a bandpass filter, or for tri-amping a mono system.

Hum and noise 113dB below rated output (IHF), IM distortion less than 0.01%, 19 inch rack mount.

Try a VFX-2 on your next installation. Be sure.

When listening becomes an art,



Crown

Box 1000, Elkhart IN 46514

show greater transparency and definition of high frequency information as compared to identical program material cut at real-time at equal signal levels. Additionally there is a distinct improvement in stereo image stability in the half-speed discs also. Recordings of violin exhibit the scraping sounds of bow against string that are shrouded in a disc mastered at real-time. Percussion remains clear and distinct during orchestral crescendoes. Brass passages retain the "bite" of the attacks typical of that family of instruments. The subjective effect is that of improved clarity and transparency of program material. Distinct instrumental voices retain their identity and individuality in the presence of other sounds. Subtle effects are apparent in half-speed recordings where they are obscured in real-time discs.

Groove echo seems to be less apparent than one is accustomed to expect. Is it possible that the lower tangential and radial groove velocities of the cutting stylus through the lacquer cause less stress, and less "spring-back" than at lower speeds? This appears to be an entirely possible speculation. Experiment in this area may yield some interesting objective results.

In summation, the half-speed approach seems a method to be preferred for recordings where greatest accuracy is a consideration.

Other factors: The cutting stylus-

All of the preceding considered, there are still other factors that contribute to a remarkable improvement over simple half-speed application of the Newman SX-74 cutting system. One is the use of the special stylus designed for the requirements of CD-4 cutting.² In addition to being about 1 mm shorter (not a silly millimeter as we shall see) than the standard stereo cutting stylus, the CD-4 stylus features a smaller relief angle and a larger burnishing relief angle to improve groove cutting performance at the short wavelengths used for the CD-4 system modulated carrier.

The contributions of the CD-4 stylus tip geometry to stereo cutting are probably negligible if they exist at all. However, the shorter stylus length would reasonably seem to have an advantage in any circumstance. Consider that the stylus is acting much like a cantilevered beam having its load concentrated very nearly at its tip by the mechanical resistance offered by the lacquer. If we consider the stylus suspension to be quite rigidly fixed due to the action of system feedback acting upon the stylus suspension mechanism through the cutter head drive coils, we might presume to apply a classic handbook formula to an estimation of the relative deflection of the two stylus designs. The maximum deflection of a loaded cantilevered beam at its end is proportional to the cube of its length.³ Taking the cube of the ratio of the two stylus lengths: 2.4 mm divided by 1.37 mm, we arrive at a figure of about 5.4 for the ratio of the tip deflections for styli of otherwise similar characteristics.

This matter is of some importance to the subject at hand because there is a marked reduction of

channel separation in real-time stereo cutting systems at frequencies above 10 kHz. This phenomenon is attributable to mechanical deflection of the stylus and its carrier assembly. The measured improvement in stereo channel cross-talk at drive frequencies in the 10 kHz to 15 kHz region runs from

about 3 to 10 dB for the CD-4 stylus.⁴ Because of cutting at half speed, frequencies above about 8 kHz (16 kHz/2) are unusual and not very significant while the real-time cutter is required to cope with signals in this range routinely. It can be seen, therefore, that half-speed cutting achieves a cleaner high frequency stereo image than is possible at real-time.

Signal Processing—

Another factor working toward a better end-product cut at half-speed is the use of noise reduction. The JVC Cutting Center uses both 'dbx' curve 1 and Dolby curve "A" noise reduction systems adapted for operation at half normal reproduction speeds. Although half-speed units may be obtained from both Dolby Labs and 'dbx', no proliferation of such devices has been reported.

The tape reproducer amplifiers are special half-speed units also, designed and built by JVC. NAB and IEC reproduce equalizations are selectable for both the preview and program reproducing amplifiers.

The mastering console used for program signal processing is also a custom JVC design. (Shown in the photograph of Figure 3). The single-line block diagram for the CD-4 cutting system is shown in Figure 4. Limiting equalization, and level control are handled in the console. All limiter and equalization devices are half-speed specials that act pretty much like their real-time counterparts, but at an octave below real-time frequencies. At present, there is no provision for the addition of echo during transfer.

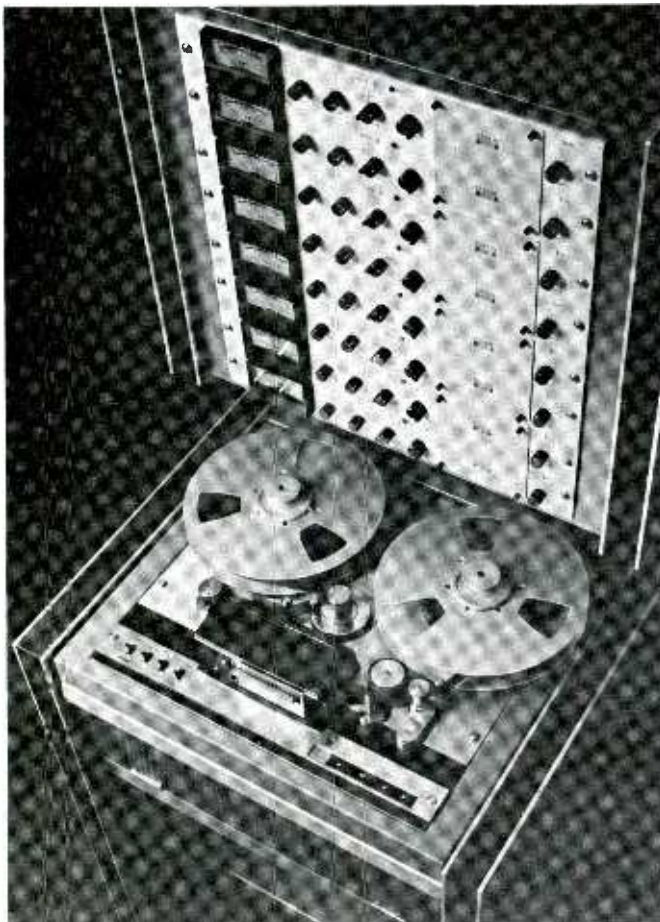
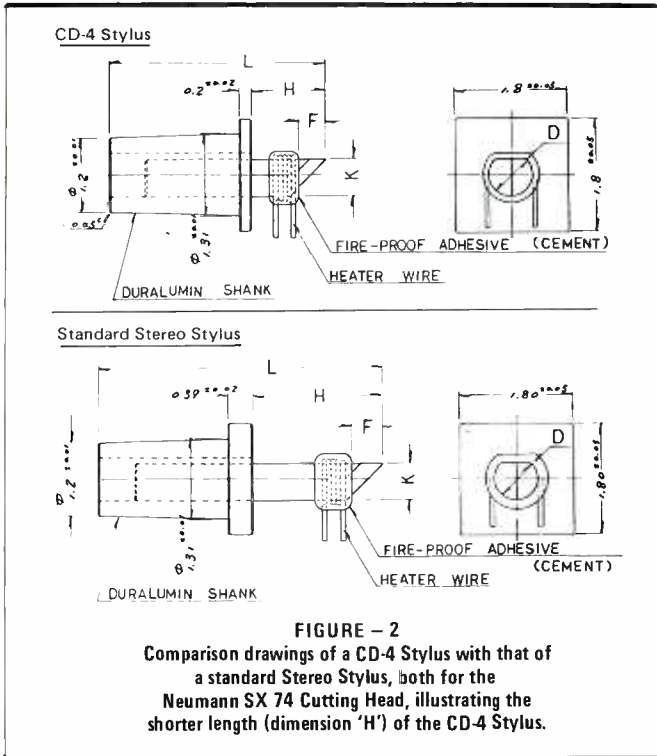

The Sensible Alternative MX-7308

- Sensibly priced at \$8150 including console
- Compatible one-inch eight track format
- Motion sense logic to prevent tape damage
- Reel tension servo to improve start time
- Professional 600 ohm +4 or +8dBm outputs with XLR connectors
- Optional remote synchronous-reproduce on all channels
- 15/30 ips now available from stock (7 1/2/15 ips on special order).

OTARI

The only company with both one-inch and one-half inch eight track recorders

Otari Corporation
981 Industrial Road, San Carlos, Calif. 94070
(415) 593-1648 TWX: 910-376-4890
In Canada: Noresco Mfg., Toronto (416) 249-7316
MANUFACTURED BY OTARI ELECTRIC CO. TOKYO, JAPAN

For more information circle No. 126

R-e/p 47

4 PROFESSIONAL MIXING CONSOLES 1

For the Price of 1



- A RECORDING CONSOLE
- A SOUND CONSOLE FOR THE ROAD
- A MIXDOWN CONSOLE
- A SOUND CONSOLE FOR THE CLUB

The QM-8A is the first fully professional, value-engineered mixer designed for demanding music people. This second generation system is the product of over four years of field experience and evaluation. Its electronic and mechanical components are chosen to obtain uncompromising performance with maximum dollar value. Whether you're interested in laying down clean tracks in your next session, or in feeding pure, undistorted audio to any size sound reinforcement system, the QM-8A has a lot to offer. Look at the features, the specifications and the price...we think you'll agree.

STANDARD FEATURES INCLUDE:

- 8 Balanced, low-Z mike inputs
- 8 Unbalanced, high-Z line inputs
- 4 Monitor outputs
- 4 Mixing buss outputs
- Expander input jack
- Complete 8x4 monitor system
- Complete talkback system
- Headphone cue system

The QM-8A is made to bring out the artist in every technician, as well as the technical excellence every artist deserves. High in reliability, versatile in function, this console is one of a kind...four times the system you'll find anywhere.

For full technical specifications and the name of your nearest dealer, write or phone (213) 841-0970.



Quantum Audio Labs 1905 Riverside Dr. Glendale, Ca. 91201
 Quantum Audio Labs is an independent manufacturer and is not affiliated with any retail stores, although companies bearing a similar name may appear on Q.A.L.'s authorized dealer list.

For more information circle No. 127



The echo, if it were to be added at this point, would play back on the finished product at twice the real-time frequency. Not a beneficial effect for the majority of creative efforts. There are those, however, who may find double-speed echo a novel contribution to their products' sales appeal.

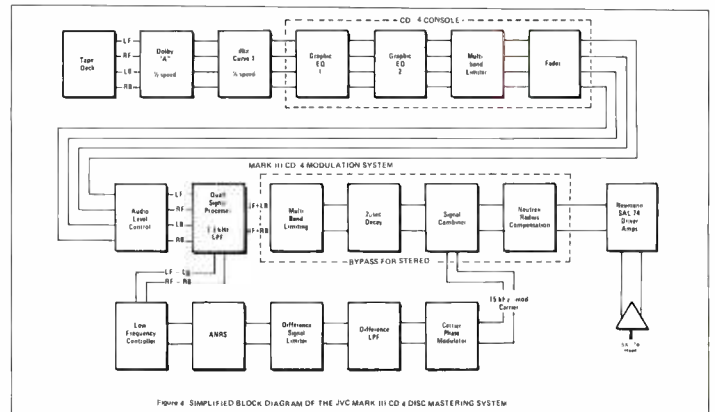

The limiting of the signal is done at two different points. The first is a three-band limiter after the graphic equalizers. The second is a six-band limiter that is necessary for control of the baseband signal level for CD-4 applications. This second limiter is not normally used for stereo cutting. The section of the signal diagram to the right of the dividing line is bypassed and the 15 kHz CD-4 carrier is disabled for stereo applications. There is a 7.5 kHz, lowpass filter having a 27 dB/octave slope in the audio path at the console output. Its presence does not seem to adversely affect the quality of discs cut on the system. If desired, it also can be by-passed.

Cutting—

In practice, test cuts of the program material are made at the diameters they will have at the final cutting. Changes in level, limiting, if any, and equalization are made based on judgements made of real-time playback of the test cuts. This is a fairly time consuming process because test cuts must be made and auditioned to verify that a satisfactory result has been achieved. All cutting takes place at half speed and therefore takes twice as long as normal. Reference playbacks are a necessity because the impressions of program quality during the half speed cutting are in no way representative of the real-time playback.

This may appear to be a disadvantage. It may not be as much of a handicap to the generation of truly precise recordings. In fact, it is necessary to test-cut programs at real-time, as well as at half-speed, to assure that there are no faults in the process. The half-speed approach requires that this step be taken as an absolute necessity rather than as a luxury to be afforded if time permits. There is no way to tell what the disc sounds like without the test cut audition. Demands for high through-put can diminish the importance of the test cutting in a real-time situation. At half-speed it is simply impossible to assume that everything's ok and skip this operation for convenience. Considering the time and many thousands of dollars represented by the average album master tape, producers are justified in demanding that every care be afforded their product. The extra cost is probably small in comparison to the investment already outstanding.

The interested reader may find it valuable to examine an example of half-speed disc mastering for himself. By an odd coincidence, Ken Scott discusses the production of an album later mastered at half-speed in the August, 1976 issue of RE/P, pages 38-40. The record is Stanley Clarke's album, "School Days". (Nemperor Records NE 439).⁵

So then, half-speed disc mastering has been accidentally re-discovered. By a curious and unplanned turn of events it has been blessed with the benefit of perhaps millions of dollars in development costs

and the finest equipment that technology can produce at this time. All of these factors act together to yield a rather interesting result.

History is reputed to repeat itself. In this case, the replay seems to hold benefit for the recording industry and the music-buying consumer alike. As for us hardened audiophiles, it's just nice to hear that things are getting better than they used to be.

REFERENCES

1. Teton, Andrew P., "Sheffield Records: A New Look at an Old Technique — Direct-To-Disc Recording" *Recording Engineer/Producer*, Jan/Feb 1974, Vol. 5, No. 1, p. 37
2. Inoue, T., Owaki, I., Totsuka, K., Nakamura, S., Eargle, J., "Improvement in Cutting Styli for CD-4 Discs" *JAES* Vol 23, Oct., 1975, pp 641-643.
3. Oberg, E., Jones, F., Horton, H., "Machinery's Handbook" 20th Ed., 1975, p 417, Industrial Press, Inc., N.Y.
4. Ibid. Ref. 2
5. Cummings, H. "The Diverse World of Engineer/Producer Ken Scott" *Recording Engineer/Producer*, Aug., 1976, Vol. 7, No. 4, pp 38-40.

PARAMETRIC PRICE-PERFORMANCE *breakthrough*

\$599

SUGGESTED LIST PRICE

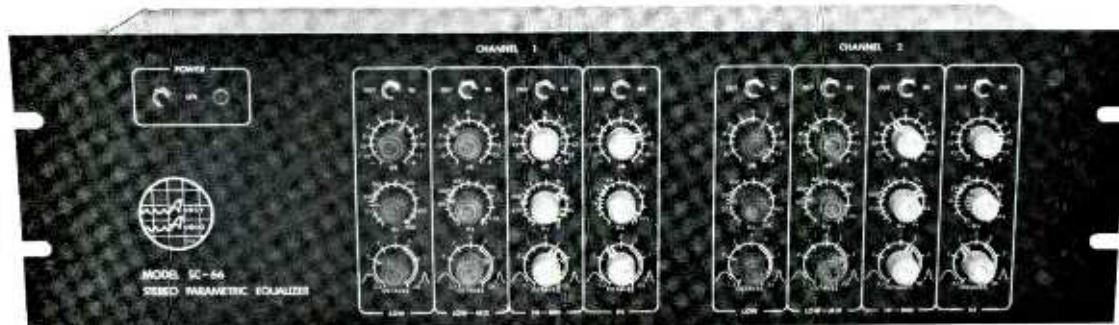

- true narrow-band (.05 oct.) through broad-band (3.3 oct.) equalization
- 50:1 frequency range, each band
- ± 15 dB eq. range, precise center "flat" position
- separate IN-OUT switch for each band
- ultra clean & quiet (-87 dBV noise, $< .05\%$ THD)
- internal power supply

At Ashly, we're definitely into Parametric Eq. We've used it extensively in our big SE series consoles for years. The SC-66 represents the culmination of these years of design, listening, and field testing. You can now have infinite control of all equalization characteristics at your fingertips with accuracy and resolution previously considered impossible. Check out an SC-66 at your pro-audio dealer.

Dealer inquiries invited



ASHLY AUDIO INC.

1099 JAY ST.
ROCHESTER, N.Y. 14611
(716) 328-9560

Neve models 8058/8068. The **NEW** 24 track consoles.

At \$57,700*, it's the best console deal around!

Designed for the small, medium or large control rooms, the new Compact Range of consoles gives you Neve quality of performance and unequalled service, at very attractive prices. And we included all the custom features that make Neve consoles number one around the world.

Why should you buy Neve?

Beside the superior engineering, you want to deal with a stable, progressive and reliable company, one that will remain in business for many years to come. Remember all those console brands of a few years back? Most of them, if not all, are gone. And their customers often scrambling for support, parts and service. Neve's been around since the early sixties, and we're still here, financially stronger than ever before.

Need financing assistance?

As an additional service to you, Neve will be happy to assist you in preparing applications to leasing or lending institutions. We do not offer any direct financing, but often succeed in establishing a dialog between prospect and lender. Write for our Financing Assistance brochure, outlining your plans and your company's background.

The best selection of stock, standard and custom consoles!

Neve offers the best selection of sound mixing consoles for any application, of any manufacturer. From 10 in/2 out to 40 in/32 tracks in standard designs. And we can give you the most advanced automation system through our NECAM, as well as VCA subgrouping and programable muting. Tell us your requirements, and we can make it for you.

Our financial terms are safer.

Neve asks for a one third part payment at the time you order your console. Balance is due at time of delivery. This puts the pressure on us to deliver on time, and we do. Other console suppliers may demand as much as 80% of the contract price by the time your console goes to test, virtually removing any delivery incentive. We don't leave you hanging. That's why Neve is the business man's choice for a console.

The Compact Range is very successful.

Since introducing these 24 track consoles in the spring of this year, we have received many orders, in North America and around the world. Deliveries have started with Nashville and Dublin. Others are scheduled for Toronto, Montreal, New York and Los Angeles.

***Attractive pricing.**

The 8058 console is priced at \$57,700 fitted with 24 inputs. The 8068 console costs \$69,900 fitted with 32 channel strips, whereof 4 may be used as mic inputs or reverberation returns.

Various optional equipment is available.

Extensive equalization is included. Above prices are quoted FOB Bethel, Connecticut or Toronto, Ontario, exclusive of federal, state or local sales or use taxes. Subject to change without notice.



**Call Tony Langley (203) 744-6230
In Canada, call Clary MacDonald (416) 677-6611**

Rupert Neve Incorporated, Berkshire Industrial Park, Bethel Connecticut 06801
Tel: (203) 744-6230, Telex: 969638
Rupert Neve Incorporated, Suite 609, 6255 Sunset Blvd., Hollywood, California 90028
Tel: (213) 465-4822
Rupert Neve of Canada, Ltd., 2717 Rena Road, Markham Ontario L4T 3K1, Canada
Tel: (416) 677-6611
Rupert Neve & Company Ltd., Cambridge House, Melbourn, Royston, Hertfordshire, SG8 6AU England. Tel: (0763) 60776
Rupert Neve GmbH, 6100 Darmstadt Bismarckstrasse 114 West Germany. Tel: (06151) 81764

 **Neve**

The JBL Way

INSIDE THE STUDIO MONITOR

by
GARRY MARGOLIS

Of all the machinery found in today's recording studios, the most mysterious device is the studio monitor. All artistic judgements about recordings are made subjectively through monitor speakers. Therefore, it is important that monitors inject as little personality of their own as possible. Accuracy of reproduction is paramount.

Unfortunately, more witchcraft has been promulgated about loudspeakers than any other recording tool, although microphones run a close second. Even though many people are aware of objective standards for electronic and magnetic products and are equipped to measure such parameters in their own environments, audio transducers remain a black art, evaluated subjectively and used without understanding.

There are, in fact, objective criteria for studio monitors. There are no magic boxes. This article will discuss some of the factors entering into the design and use of a studio monitor.

MONITOR DESIGN CRITERIA

When a studio monitor is designed, several parameters must be considered, all of which interact and affect the final system. Required bandwidth must be balanced against required efficiency, distortion, size and cost. Basic physical properties of generating and propagating sound in air limit the design. One cannot get maximum possible bandwidth and efficiency in a minimum size box at a

minimum price. Tradeoffs are inevitable.

It is presently impossible to make a single piston which radiates all audible frequencies equally efficiently with equal dispersion and still maintains usable sound pressure level (SPL) and minimum distortion. Current technology therefore requires the use of two or more transducers for the system, and the audio spectrum must be divided between them. In most designs suitable for studio applications, the transducer which handles the lowest part of the audio spectrum is the least efficient. It must work harder than a high frequency unit to produce equivalent SPL. Thus, the studio system design effort usually begins with the woofer.

Figure 1 shows the options available in selecting the bandwidth and efficiency of a woofer. When extended low frequency response is chosen, efficiency must be sacrificed, given the same size piston. The woofer in a studio monitor is not required to have extremely high

efficiency. Since the distance between the loudspeaker and the listener is small, it is possible to develop reasonable levels without inordinate amounts of power.

There is, however, a point of diminishing returns. The fundamental frequency of the lowest note on the bass guitar is 41.2 Hz, and 32 Hz is the lowest "C" on the piano. Choosing a woofer which provides flat response below 30 Hz needlessly sacrifices efficiency, since almost no musical sound exists below that frequency. Even flat response to 30 Hz may sacrifice too much maximum loudness for some applications. In such cases, two woofers may be needed to retain this bandwidth with high SPL, as in the JBL 4350 Studio Monitor.

If flat response to 30 Hz is required, but high SPL is not necessary, the woofer piston size may be reduced along with enclosure size. The relative low frequency response of the 12" woofer used in the JBL 4315 Studio Monitor for example,

... continued on page 54

The Author
GARRY MARGOLIS is an applications engineer for JBL, responsible for professional product information. His background includes mixing and production for records, film, broadcast and live theatrical sound. He has led university-level courses in audio theory, music recording and motion picture re-recording. He is a member of AES, SMPTE and Local 47 of the American Federation of Musicians.

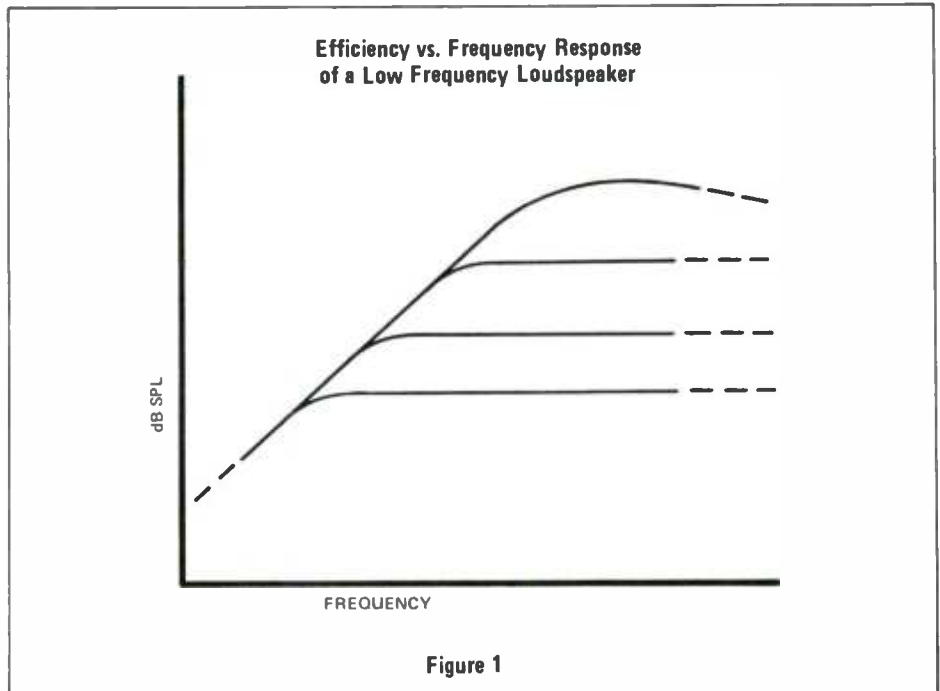
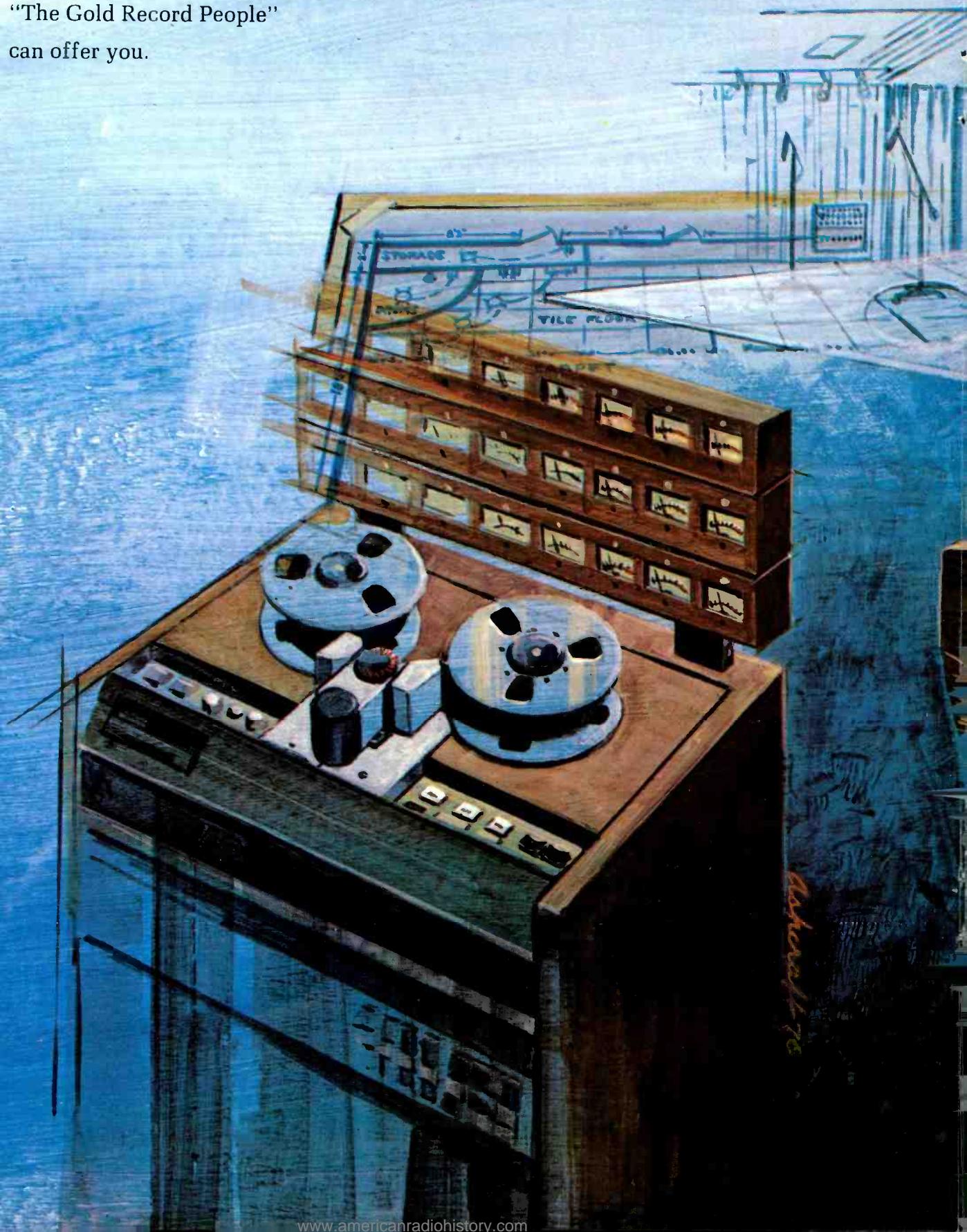

Figure 1

Looking for a Recording Studio?

Whether you are looking for studio time, equipment or design, you owe it to yourself to find out what "The Gold Record People" can offer you.





© 1999 Westlake Audio

For more information circle No. 130

from acoustic design
to down beat...

**Westlake
Audio**

6311 Wilshire Blvd.
Los Angeles, California 90048
(213) 655-0303

R-e/p 53

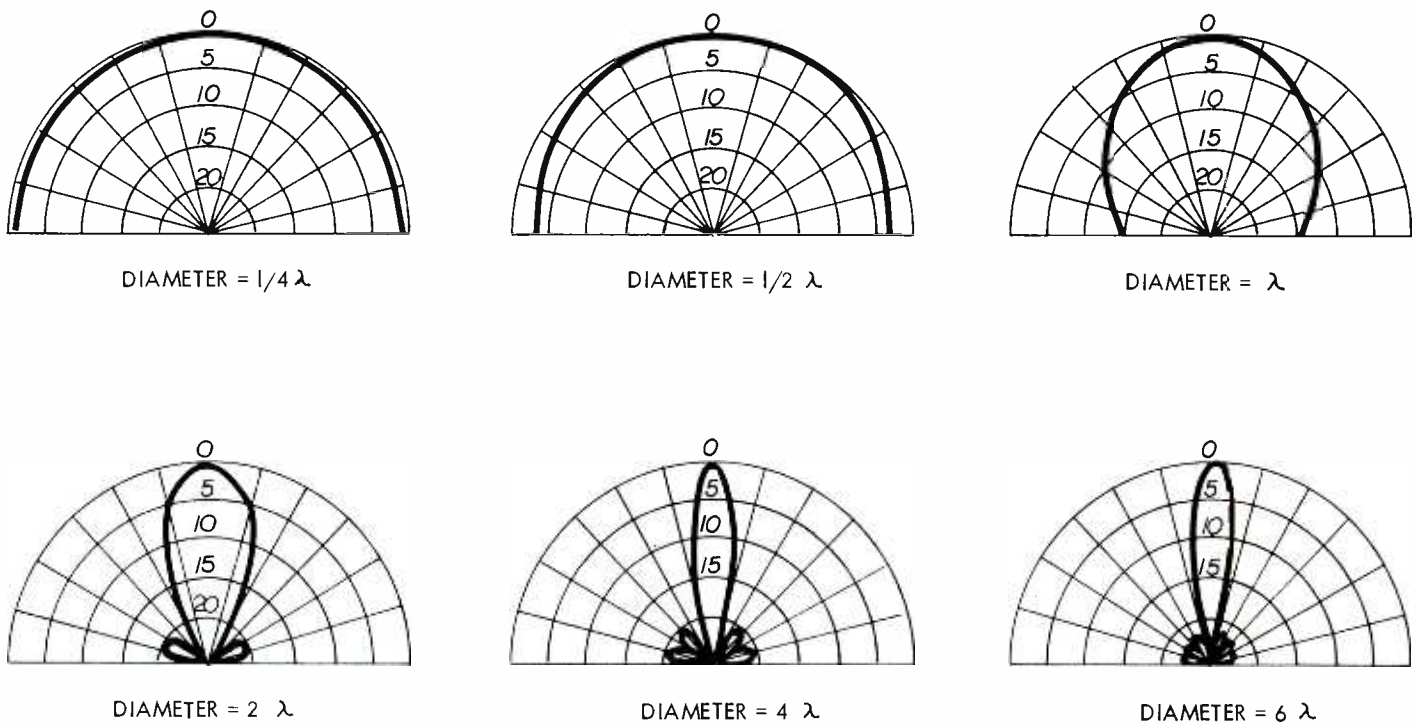

Figure 2: Dispersion of a Single Direct Radiating Piston With Respect to the Wavelength of the Radiated Sound

Inside the Studio Monitor . . .

continued from page 51

is the same as the low-end response from the 15" woofer used in all of the current JBL full-size monitors. The efficiency of the 12" speaker is lower and the maximum output level is consequently lower, but the bandwidth is the same.

A moderate-efficiency 15" woofer suitable for studio monitoring will have smooth on-axis response up to approximately 1 kHz. A transducer must then be selected to take over the response above that point. This transducer will probably be more efficient, so it will require less power to match the loudness of the woofer. Less power handling capacity, therefore, is needed. Of course, smooth-

est possible response, maximum bandwidth and lowest distortion are sought.

However, finding a single transducer to operate from approximately 1 kHz up to 20 kHz with reasonable characteristics is also nearly impossible. If smooth, flat response to 20 kHz is not required, a two-way system may be adequate, but flat response to 20 kHz almost always requires a third transducer.

One additional factor enters into our decisions. The dispersion of a direct-radiating piston is a function of both the wavelength generated and the size of the piston. If the wavelength is smaller than twice the diameter of the piston, dispersion will narrow and side lobes will develop, as shown in Figure 2. Also, if two pistons are mounted next to each other and are radiating the same signals, such as in a number of double-woofer monitors available from several manufacturers, dispersion in the plane corresponding to the long dimension of the array will narrow and lobe at a much lower frequency than in the opposite plane. To avoid these problems as well as improving intermodulation characteristics and phase response, another transducer can be added to cover the region between 300 and 1000 Hz.

We now have a number of options. We can have a two-way system which does not cover the full audible range. We can have a three-way system which does cover this range, or we can have a four-way system which covers the full range with greater accuracy than the three-way system.

Now we come to the most difficult part of the design. The acoustical outputs of the transducers must be combined in such a way that the transitions between them are as smooth as possible. Unfortunately, loudspeakers are not perfect devices, and they are not exactly linear in their responses. For example, loudspeaker impedance varies non-linearly with frequency, which makes crossover network design quite a challenge. Also, an otherwise usable transducer may have sloping response over a part of its desired operating range, which may be compensated in the network design.

Further, the physical spacing of the transducers on the enclosure baffle panel will affect their interactive responses in the transition regions. If a compression driver mounted on a horn or horn/lens combination is used, the length of the horn will also affect response through the region of transition. The horizontal dis-

THE MOST ACCURATE PROFESSIONAL PICKUP IN THE WORLD!



FOR GUITAR, PIANO, BASS . . . ANY ACOUSTIC INSTRUMENT.

FOR INFORMATION WRITE OR CALL:

FRAP
FLAT RESPONSE AUDIO PICKUP
(A DIVISION OF STROBOMONIX, INC.)
Box 40097, San Francisco 94140 • (415) 824-2223

For more information circle No. 197
R-e/p 54

THE PEAVEY 600 MIXERS

Combining, for the first time:
performance, reliability, & value
in a small board!

Performance.

- 6 channels
- Hi & Low EQ each channel
- Variable input attenuation 0 to 40dB each channel
- 6 Low Z, 6 Hi Z inputs
- Effects & Monitor Send each channel
- Stereo Pan (600S)
- Master EQ
- Master Main & Monitor
- 20 Hz to 20 kHz response
- Less than 0.1% THD
- Pre Monitor, Post Effects
- -123 dBv equivalent input noise
- 5 volts RMS out
- Effects return (Pan capability with 600S)

Reliability.

Needless to say, reliability is the most important feature of any sound reinforcement component. Thousands of hours of research and field testing has resulted in Peavey circuit designs and innovations that create equipment that is world famous for trouble free operation. That same "roadability" and reliability know-how is built into the 300 and 600S Mixers.

Value.

We invite you to compare the 600 Mixers feature for feature, dollar for dollar, with anything on the market. The value will speak for itself.

Peavey Electronics Corp. / 711 A Street # Meridian, Mississippi 39301



For more information circle No. 131

R-e/p 55

placement between the voice coils of the cone device and the compression driver should be even multiples of one-half the wavelength of the transition frequency to maintain proper acoustical phasing.

In order to obtain imperceptible transitions, JBL engineers design a crossover network which will work with ideal transducers. Connecting this network to the proposed system, the acoustical response is measured and the network is modified until the smoothest possible results with the actual transducers used in the system are obtained. This design method automatically takes into account the characteristics of the individual transducers and their interaction in that particular configuration. In the JBL 4343 (and the earlier 4341), as an example, a classical second-order Butterworth design (12 dB/octave, 3 dB down at the transition frequency) resulted in a 3 dB bump in acoustical response in the lowest transition area due to mutual coupling between the woofer and midrange cones. Modification of the network, so that the electrical response was down 6 dB at crossover, eliminated this acoustical anomaly. This same special crossover characteristic is required when the 4343 is bi-amplified.

It often happens that the proposed group of components and enclosure design need modification for smoothest possible response, at which point the engineers go back to the drawing boards and try again. Several systems may be designed in this manner until acceptable results are obtained.

If no transducer is available with characteristics suitable for the required

application, a totally new transducer will be designed and built specifically for this purpose. The midrange drivers in all three of JBL's four-way monitors are examples of this. The midrange unit in the 4350 also happens to be a good compact reinforcement woofer for some applications, so it is available separately under the model number 2202A. The midrange drivers in the 4315 and 4343, however, are not suited for any other application.

After the designers are satisfied with the objective and subjective performance of the system, given the limitations on size and cost initially set, the JBL "Golden Ear" panel auditions the proposed system against existing units - both previous JBL designs and competitive systems. The members of this panel are drawn from various departments at JBL and have widely varying musical tastes. Many have extensive experience in the recording industry. Outside producers and mixers may also be invited to comment. If this panel is not satisfied with the proposed system, it goes back for further refinement. Only if the consensus recommends acceptance is the system released for production.

It can be seen that the development of a top-quality studio monitor is a difficult, exacting task. For this reason, JBL generally does not recommend construction of custom monitors unless the builder has considerable experience in designing systems which have the required reproduction accuracy and he has access to highly sophisticated acoustic laboratory equipment to evaluate the work in progress.

But what happens to all of this careful design when the finished system is installed in a real room? This aspect of monitor application is where most problems are found.

JBL publishes detailed specifications on all of its studio monitors, including frequency response and distortion figures. These specifications are measured in acoustically neutral "hemispherical free-field" conditions. Since JBL monitors are used in a large variety of rooms with many different acoustical characteristics, measuring in one size and type of room would yield results which would not be applicable for most other rooms.

As shown in Figure 3, the system is mounted in a 30' x 40' (10 x 12 m) test platform on the roof at JBL. The baffle is flush with the platform and the system radiates upward. A microphone is suspended directly above the system at a distance of from 6 to 30 feet (2 to 10 m) and measurements are taken for the curves and numbers published in JBL literature. It is reasonable to conclude that any significant deviations from these results when measurements are made with the system installed in a control room may be traced to room acoustics and the method of mounting the system in that room.

A number of consultants and studio designers have built different control room configurations which attempt to solve the myriad acoustical problems confronting the mixer and producer. JBL does not endorse any specific room design concept, since many have a number of advantages and none has clear superiority. Some of the characteristics of the



Magnetic Reference Laboratory

Whether you're using low noise or high output tape, with or without Dolby, from 1/4" to 2", 3 3/4 to 30 ips, you'll choose MRL . . . because only MRL guarantees every test tape they manufacture.

Their dependability and accuracy have made MRL the world wide choice of most major recorder manufacturers . . . and, after all, they would know what test tape is best for their recorders, they're the people who design and build them.

For full information, contact:
Magnetic Reference Laboratory, Inc.
229 Polaris Ave., Suite 4
Mountain View, CA 94043
(415) 965-8187

Exclusive Export Agent: Gotham Export Corp., New York, N.Y.

interface between the room and the loudspeaker system, however, should be examined.

If the reverberation characteristics of the control room are not uniform in frequency response and/or there are acoustical standing waves present, the response of any system in that room will be affected. Monitor equalization is of limited value in smoothing out rough response. Third-octave equalization in the direct field of a loudspeaker system can be very difficult to accomplish successfully, since a microphone cannot discriminate between the direct and reverberant fields in a room in the same manner that the ear does. This can result in differences between perceived and measured response if the reverberation characteristics of the room are not uniform. It takes an extremely skilled person who has sufficient experience to make final equalization adjustments by ear in order to minimize this factor. Also, if more than approximately 3 dB of equalization is used, some subtle, yet difficult to describe effects can be audible, which may be related to phase shift and ringing. Finally, no amount of electrical equalization can eliminate standing wave effects, since these vary according to the precise position of the

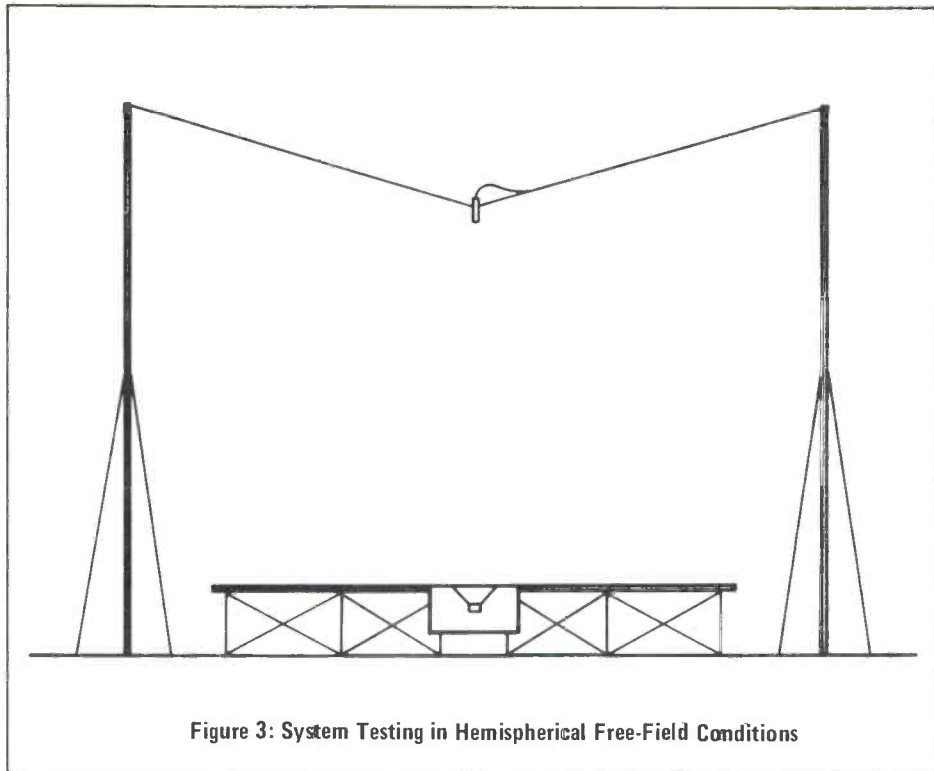

Figure 3: System Testing in Hemispherical Free-Field Conditions

listener in the room.

If the woofer is at the intersection of two room boundaries — at the corner intersection between two walls, at the junction of the floor and wall,

or at the wall/ceiling joint — low frequency radiation will be restricted to less than a hemisphere. Consequently, bass response will be accentuated. Still greater accentuation will be obtained

The Colorless Limiter.

What's a seemingly sane company like Orban/Parasound doing introducing yet another limiter? Well... for starters, because our new 418A Stereo Compressor/Limiter/HF Limiter is a direct descendant of our fabulously successful OPTIMOD-FM broadcast limiter—the one that's already been adopted by major groups and networks because of its unprecedentedly clean, natural, high-definition sound.

Then there are the 418A's unique features: its colorless, accurate sound is complemented by a remarkable operational simplicity because an internal analog computation circuit makes continuous, automatic adjustments of release time depending on program characteristics. This frees the operator from the task of manually determining (usually compromise) attack and release times, and makes the 418A fast and hassle-free to use. Although the 418A's release time is always "automatic," the basic speed of operation is continuously variable so that density may be augmented as desired—without worry that pumping or "holes" will appear.

In addition, the 418A incorporates a high frequency limiter with four user-selectable threshold time constants. As such, it's a natural for conditioning a signal to fit onto any consumer medium—like cassette—without high frequency overload distortion. Use it to mix through whenever time pressure is high—like demo sessions, or radio commercials. Use it in the broadcast production room to produce clean tape cartridges free from high frequency overload.

The 418A is also the first FET limiter that tracks accurately in stereo... without adjustments... forever!

The colorless limiter comes in any color (as long as it's blue) and is available from your Orban/Parasound distributor for \$950. Write us for his name, and the complete 418A story.

orban/parasound

680 Beach Street
San Francisco, CA 94109 (415) 673-4544



with the woofer at the intersection of three room boundaries (two walls and the floor or ceiling). This effect may be diminished with acoustical treatment, but "bass trapping" requires a great deal of space to accomplish well.

MONITOR/CONTROL ROOM INTERFACE

Mounting a monitor away from the room walls will result in rough and diminished low frequency response, since low frequencies will have a double path - - one directly from the woofer and another around the enclosure - - as shown in Figure 4. The larger the enclosure, the lower the frequency at which this effect occurs. If the room configuration permits, flush mounting the monitors so that the baffles are even with the surrounding wall surface will yield the most uni-

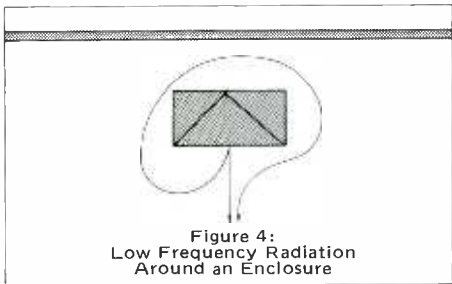

form response.

If the monitor is installed too close to the listening position, the wavefronts from the individual transducers will not have a chance to combine properly, and the individual transducers will be audible as separate units. The minimum working distance from the JBL 4311 or 4315 is about 3 to 4 feet (1 m); single-woofer full-size JBL monitors should be at least 6 feet (2 m) from the listener; and the 4350 should be at least 8 feet (2.5 m) away.

Another problem which occurs is insufficient level in the room. As mentioned earlier, there are tradeoffs between bandwidth and efficiency (given equal size) as well as size and efficiency (given equal bandwidth). In order to achieve wide bandwidth, efficiency must be sacrificed. Many older monitors are quite efficient and do not need high amplifier power levels to achieve high SPL's. However, these older monitors do not have the extended bandwidth of the new JBL systems. If a current JBL monitor is installed in place of an older system, the original amplifier may not be adequate to the task and may be driven into clipping.

We now discover a totally new problem. Many popular amplifiers will work

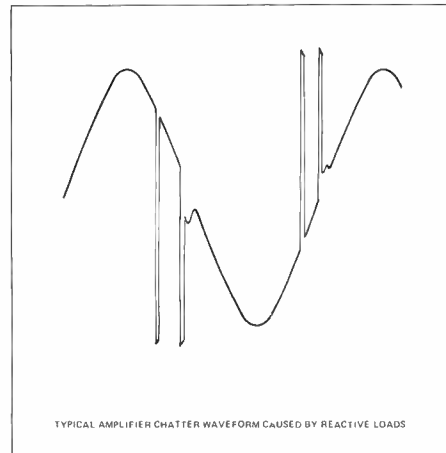

quite well until they reach the clipping point, after which their output protection circuits will "chatter" or produce large high frequency spikes. A typical chatter waveform taken from a popular studio amplifier is shown in Figure 5. Such spikes can destroy a high frequency driver. Cracking sounds on sharp low frequency impulses are an audible symptom of amplifier chatter. This phenomenon is much more likely to occur with reactive loads (such as those provided by large voice coils and massive magnetic assemblies) than with resistive loads, so it may not show up on a test bench. If chattering is a problem, in-

RADEKAW!

2020 frequency shifter

Tuneable percussion just arrived. Our Model 20/20 Frequency Shifter raises or lowers its input frequencies by any amount, up to 5,000 Hz.

There's a world of new instrumental sounds, all possible by processing the original track with a Frequency Shifter. Generate non-harmonic partials by compressing and expanding original spectra. Hear subtle tuning changes, or radical shifts in timbre, at the turn of a knob.

Get clean phasing, tremolo, and pseudo-stereo too, all in one special effects package. It's voltage controlled, and synthesizer compatible.

Accepts just about any input level, and has separate outputs for 600Ω studio lines, and low-level musical instrument amplifiers.

It's one of a kind, the price is right (\$495) and it's available now from 360 Systems. Write for all the facts!

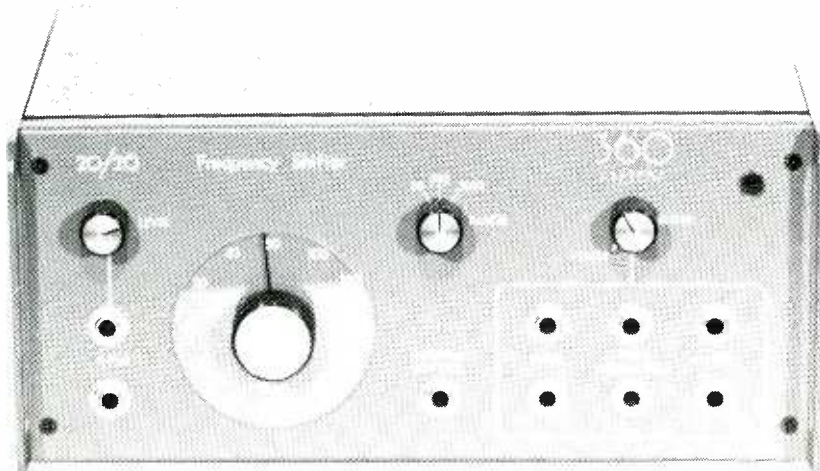

360
SYSTEMS

2825 HYANS STREET • LOS ANGELES,
CALIFORNIA 90026 • (213) 384-8447

—electronics for live performance—

creasing the available amplifier power or changing to an amplifier which does not exhibit chatter are recommended.

Even if an amplifier does not chatter, it will produce square waves when it clips, which, by definition, are collections of odd-order harmonics. These harmonics have far more high frequency energy than normal program material and can burn out high frequency drivers.

Although most amplifiers used in studios are free from this problem, assuming that they are properly installed, there are some units, particularly inexpensive or "home-brew" designs, which may become unstable with reactive loading. The resulting high frequency oscillations can destroy high frequency transducer voice coils. Although studio monitors generally do not use electrostatic transducers, which obviously have large capacitive reactance, one hidden source of capacitance is the wire connecting the amplifier and the loudspeaker.

Assuming that a quality amplifier is used and that clipping is avoided, it is important to choose a monitor based on the expected maximum SPL to be achieved in the room. As mentioned before, one cannot get as much level out of a small system as from a large system, assuming equivalent bandwidth. For ex-

ample, measured at 8 feet (2.4 m) in free-field conditions at rated power, a single JBL 4311 or 4315 will produce 99.5 dB SPL, while each of the current single-woofer full-size monitors will produce 104.5 dB and the 4350 will produce 111 dB SPL! Attempting to squeeze more level out of a monitor than it is capable of delivering will invariably result in component failure.

Unfortunately, it is extremely difficult for the user to make valid evaluations of new monitors, for several reasons. Most people, for example, will listen to tapes which they have previously mixed on other systems. The hidden problem with this approach is that if the original monitor was not smooth and flat in response, the recording will probably have an overall equalization which is the inverse of the original monitor's response. Further, room acoustics and system placement can markedly affect the sound of a monitor, as discussed earlier.

One evaluation method is to listen for detail. An accurate monitor, for example, will tend to reproduce acoustic guitar chords so that each individual string will be clearly audible. Subsidiary voices in large masses of sound should be well defined. High frequency response should

be smooth across included angles of 60° horizontal and 30° vertical, so that the acoustical balance does not change with the location of the listener.

Stereo localization is another simple factor to evaluate. A monaural signal panned to the center should be sharply defined, without smearing or broadening. Incidentally, this last test is recommended for final critical balancing of monitors, since a 1-dB imbalance between the drivers of two systems may be heard by a discerning listener - - if the acoustics are good.

There are many "magical" and "revolutionary" new speakers appearing in the marketplace every month. In order to achieve some of the claims made for these systems, however, the laws of physics would have to be repealed. As yet, JBL has not learned how to violate these laws. Current JBL monitors are as accurate as our present understanding of physics allows, given restraints on size and cost. JBL is constantly engaged in research into the mechanics of sound reproduction, and expects that in a few years, studio monitors will be available which will be as far ahead of current units as these present ones are superior to the previous generation of loudspeaker systems.

The Live-Performance Equalizer

The list of acts using the Orban/Parasound 621 Parametric Equalizer on the road reads like a "who's who in the Hot 100." And no wonder—like the proverbial one-man band, the O/P Parametric replaces a whole ensemble of audio processing devices—and never misses a beat. Not only will the 621 perform broadband equalization with a minimum of ringing (unlike third-octave equalizers), but its "Constant-Q" design also lets it create narrowband, tunable notches for feedback suppression.

Each of the four bands tunes continuously over 4.3 octaves with no change in curve shape. The "Q" of each band is continuously variable over a ratio of better than 10:1. Overload/noise ratio is a high 107 dB (typical); midband THD is below 0.01% at +18 dBm, assuring wide dynamic range and recording studio quality. A peak-stretching overload light and front-panel gain control permit instant correction of overload. And the 12 dB of available gain can be very handy when you're caught short.

Above all, we know that there are no second takes

in live shows. That's why we insist on an exceptionally rigorous quality control program. For example, each opamp used in the 621 is pre-tested before installation, and all 621's are carefully burned-in at high temperature before shipment. And it's nice to know that if trouble should ever develop, Orban/Parasound is well-known for fast, fairly-priced service. We've been in business for eight years; we are committed to customer satisfaction because we plan to be around many years more. Our equalizers reflect this commitment to quality, value, and service. They await your examination at your Orban/Parasound distributor. Write us for his name, and further information.

orban/parasound

680 Beach Street
San Francisco, Ca. 94109
(415) 673-4544

Write for free article: "How to Choose Equalizers for Professional Recording Applications."



now
you can
have



the best of both worlds!

[OR CAN OUR SUCCESS MAKE MONEY FOR YOU?]

SIERRA AUDIO, the company that, for the past four years, has been quietly guiding KENDUN RECORDERS into a pre-eminant position in the studio business is "going public." Do you need answers to profit hindering problems? For example: Do string players disrupt your traffic office while on a break? Do you have to play a 24 track master through because the legend doesn't tell you what you need to know? Do you have isolation problems between instruments or between control room and studio? Do you need advice on financing or equipment interaction and logic? Is your monitor system serving up doubts instead of mixes? Do you need a brighter, tight drum sound and more isolation at the same time? Is expansion in your future?

Then, we suggest you engage a qualified consultant — one that deals with these problems everyday. Just as you would hire an accountant for tax advice, a professional consultant to short-circuit problems is a sound idea.

And, we think you should consider us!

SIERRA AUDIO represents and builds the most successful studio design in the world . . . Tom Hidley's EASTLAKE AUDIO. We are also dealers for the finest lines of studio equipment; proven performance in our own experience: Amber, Ampex, Dolby, Inovonics, Roger Mayer, MicMix, Neumann, Orban, Shure, UREI, White Instruments to name but a few.

And, to satisfy the perfectionist's desire for the utmost in consoles, Sierra is the exclusive Western U.S. dealer as well as the exclusive foreign exporter of the outstanding SPHERE line of Audio Consoles.

To inquire about an evaluation of your operation, whether a turn-key installation, or the streamlining of present facilities, place a call to Kent Duncan for experienced responsive consultation:

(213) 843-8115

SIERRA* AUDIO ●

621 S. GLENWOOD PLACE, BURBANK, CALIFORNIA 91506

We won't promise the World, but we will deliver what we promise!

EASTLAKE REPRESENTATIVE UNITED STATES • AUSTRALIA • CANADA • CENTRAL & SOUTH AMERICA

AUDIO from the MAGNETIC RECORDER'S point of view!

by
DAVID R. McCLURG
© 1976

WHAT'S A DECIBEL

Before we go even one step further, let's take a moment to be sure we all understand what a decibel is. We realize the decibel is confusing to some people. But if you really want to be comfortable with audio or tape recorder specifications, you can't escape the decibel since several specifications are directly expressed in decibels and others use decibels to indicate their tolerance range.

The Decibel Defined: First, let's define the term:

A decibel (the dB for short) is a comparison between two levels of electrical or acoustical power (or electrical voltage and current). A positive decibel figure means a gain or increase in level. A negative decibel figure means a loss or decrease in level.

And here is the most important fact of all. The decibel is a relative unit, not an absolute unit like a Watt, Volt, Ampere (or even a nanoWeber or microHenry). Instead it expresses a comparison or ratio between two levels of these other measuring units, in a convenient form. (At least someone thought it was convenient.)

Unhappily, it's when we get into the form of the ratio, that many of us begin to fidget uncomfortably. Suddenly, we're deeply immersed in the mire of logarithms and to some it's like swimming in a sea of mud. However, you can actually chart your way through the whole swamp quite easily - - without logarithms - - if you can keep the following four principles in mind.

Then, when you want to compare decibel ratios, you simply refer to a table for the multiplication factors that each decibel represents, and you can forget all about calculating logarithms. A partial table of multipliers is shown in Figure 2-1.

It might also help if you knew that the main reason the decibel and its hated logarithms are used at all is that the ratios of power (or voltage and current) are so great in audio that counting the zeros would take far too much time and actually be more confusing. Some kind of shorthand is handy to have around, so that's where the log comes in.

In addition, the human ear - - which is after all the beginning and end of the whole process of recording - - operates logarithmically itself. It can hear a tremendous range of sounds (something like 10^{12} or 1,000,000,000,000 to 1 from the softest to the loudest sounds). So if you're into natural things like wheat germ and granola, you'll like the decibel. It and its logarithms are as natural as hearing itself.

Basic Decibel Principles:

1. In sound recording, most elements multiply an input by a factor to produce an output. The decibel uses addition as a substitute for multiplication in order to conveniently deal with the very large changes in magnitude between the input and output (or any other) levels. It cuts out all the zero counting.
2. Each and every decibel (or fraction of a decibel) represents a successive multiplication. These can be expressed in a table of values so you and your \$9.95

calculator can become an instant expert. All you do is get the multiplication factor from the table and multiply it by the level that's being increased or decreased. For example a 3 dB power ratio translates into double or two times. So 6 dB equals two times two, or four times as much. Similarly, 10 dB means a multiplication factor of ten times, so 20 dB is 10 dB +10 dB or 10 times 10 which still equals 100 times despite the new math our kids learn in school.

3. The table of multiplication factors is different for power than it is for voltage and current. This is because power is the square of voltage or current, so it gets big by squares (1, 4, 16) instead of arithmetically (1, 2, 4). We'll discuss which table to use later.

4. We said that each and every 3 dB change doubles or halves the power. However, and this is really important, the difference in apparent level as perceived by the ear is much more complex than this. In point of fact, with most people, a two-times increase (3 dB) in power level is not twice as loud at all. Instead, it's only the first change in level that they can even hear! Usually, 1 dB and 2 dB changes can only be heard by a well trained ear.

To sound twice as loud, it takes a ten-times (10 dB) increase in power for most people's ears. Keep this in mind when

Power Ratios In dB. (10 log P _{out} /P _{in})	Multiplier	Voltage Ratios in dB. (20 log V _{out} /V _{in})
For each 10 dB, add a zero.		For each 20 dB, add a zero.
3	2X (double)	6
10	10X (10 ¹)	20
20	100X (10 ²)	40
30	1,000X (10 ³)	60
60	1,000,000X (10 ⁶)	120

Figure: 2-1. Partial List of Decibel Values

Portions of this article were originally published in the January 1976 issue of "BROADCASTER" magazine (Toronto, Canada) entitled "Professional Vs: Consumer Audio Recorders" by David R. McClurg and Robert Cook.

you compare specifications. For instance, with amplifiers, it means that an amplifier with a power output of 50 watts when compared to one with 25 watts (a ratio of two-to-one or 3 dB) would only just begin to sound louder. You'd have to go to a 250 watt amplifier (10 times or 10 dB) to get a doubling of the apparent loudness. So forget about trading your 25 watt amplifier for a 35 or 40 watt special. You probably won't hear any difference in level at all.

Power and Voltage Ratios:

Now let's clear up the confusion (if any) between power levels (10 log) as opposed to voltage and current levels (20 log) as far as tape recorder specs are concerned. We'll start with an example. Does a 60 dB unweighted signal-to-noise ratio represent a difference of 1,000 (10³) to 1 which is a voltage ratio, or 1,000,000 (10⁶) to 1 which is a power ratio?

Would you be able to forgive us if we said it doesn't matter? That's right, it doesn't matter just so long as the ratios you're comparing are voltage to voltage or power to power. Just don't try to compare voltage to power or power to voltage or you'll get into deep trouble.

Here's when you should use one or the other. When you're considering levels, such as input and output signal voltages within a tape recorder, an amplifier stage, a limiter, or at a point in the system before the final power amplifier, voltage comparisons are more common. But when you are considering the overall effect of a change in level in terms of what you hear at the end of the chain in the playback monitoring speaker, then power is more meaningful. For this reason, we will stick to power comparisons in the context of this book.

Here's an example. Consider signal-to-noise ratio in terms of its final effect, the loudness level heard by the human ear. One recorder quotes a signal-to-noise ratio of 66 dB, another says it has 63 dB, a level difference of 3 dB. In terms of output power as perceived by the ear when listening to a loudspeaker, this is a just perceptible change to most people. But if you find a 10 dB difference (ten times) between two recorders, the higher level will sound twice as loud and is much more significant (assuming of course the measurements were taken the same way).

Decibel Tolerance Ranges:

Tolerances, too, as expressed in deci-

POWER (10 log) (Overall recording system from microphone to playback monitoring speaker.)		VOLTAGE (20 log) (Internal recorder, amplifier stage, limiter, etc.)
dB	PERCENTAGE RANGE	dB
±0.25	.94 to 106%	±0.5
±0.5	.89 to 112%	±1.0
±1.0	.79 to 126%	±2.0
±1.5	.71 to 141%	±3.0
±2.0	.63 to 159%	±4.0
±3.0	.50 to 200%	±6.0

Figure 2-2. Decibel Tolerances in Percentages

bels are sometimes confusing. Figure 2-2 describes the percentage range represented by the decibel tolerance.

For example, a frequency of 50 to 18,000 Hz ±2 dB means that in terms of output power, the response curve of that machine if plotted on a graph will not have any wiggles in the otherwise reasonably flat tracing that go beyond the lines representing 2 dB above and 2 dB below the 0 line. To put it another way, the recorder will have the same power output for each frequency within this bandwidth, within a tolerance of ±2 dB. Incidentally, the spread of ±2 dB must be measured from the 0 line, not from the highest or lowest point. If measured from the highest or lowest point, it might more accurately be +1 to -3 or some other non-symmetrical value.

But, what does ±2 dB mean? It means within an output power range of 37% less than the stated output power to 59% more. In other words, anywhere from 63% to 159% of the output. (The reason it's more on the plus side than on the minus is that the two numbers are multiplicative reciprocals of each other. If you multiply 0.631 by 1.585 you'll get 100 or very close to it. Similarly, if 1.0 is divided by 0.631 the result will be 1.585.)

The ±2 dB specification for professional recorders (of -37% to +59%) can be compared to the ±3 dB tolerance more often used in consumer recorder specifications. This represents in terms of power output a range of from 50% less to 100% more or 50% to 200%.

THE NATURE OF SOUND

Sound has been characterized by acoustic scientists as having four measurable physical variables that are perceived objectively. These are amplitude or intensity, frequency, wave form, or envelope, and duration. It might seem on first impression that these would correspond almost exactly to our subjective interpretations of sound which we call loudness, pitch, timbre, and time (see Figure 3-1). Unfortunately, these subjective interpretations are subject to many other variables so that a direct comparison is not always valid.

Amplitude or Loudness:

First, let's look at the amplitude or loudness levels that the human ear can perceive. The dynamic range heard by the ear begins at the threshold of hearing at zero decibels and increases upward more than 120 decibels to the threshold of pain. This is the loudness level where sound is no longer perceived and pain takes over. In terms of power ratios, this represents an astonishing range of more than 120 decibels . . . or some one trillion (10¹²) times.

The reason the ear can hear this range is that it is equipped with its own compressor/limiter mechanism so that it can boost sounds too weak to be heard, and diminish sounds so loud they might damage the ear. The weakest discernible sound power has been described (by physicist Alexander Wood) as correspond-

<u>OBJECTIVE</u>	<u>SUBJECTIVE</u>
Amplitude or Intensity	Loudness
Frequency	Pitch
Waveform or Envelope	Timbre or Color
Duration	Time

Figure 3-1. OBJECTIVE vs. SUBJECTIVE INTERPRETATION OF SOUND

After a flurry of bold claims and brash statements from several manufacturers, regarding their purported automation systems, the Turtle has a question: Where are they?

One ad, for instance, shows photographs of a fully automated console and suggests that it is run by the advertiser's own automation programmer. **WRONG!** The console in question is powered by the Turtle's first generation system.

Another, claims to have been first to create automated mixdown, a claim of dubious importance in the first place. Actually, a company called Olive deserves credit for being first. The Turtle, of course, has the honor of the "first successful system".

But what about the Turtle's second generation system? Several months ago, the Turtle astounded the business world by actually turning down orders for its successful first generation system. It did this because it had proven to itself that a far superior system was in its laboratories. Being a Turtle, it took its time in packaging this new system, while orders for same filled its desks. (Of course, it didn't worry about someone else grabbing the orders... there was no one else.)

Finally, on July 4, the world had its first chance to view the Turtle's new triumph. Some 200 Turtle controlled lights and 10 channels of Turtle powered audio were trained on the historic Old State Capitol in Springfield, Illinois. It was a tribute to Abraham Lincoln, the United States and the Turtle. Every night since, some 500 people have watched and listened as the Turtle flawlessly faded the faders, dimmed the dimmers and switched the switches.

A second triumph came on August 12, when Quadrafonic Studio in Nashville, Tennessee, turned on 32 of the world's first centrally controlled programmable equalizers. (Of Turtle origin, of course.)

On both occasions, the Turtle's staff was there, making notes and corrections, so the subsequent production equipment might offer the best possible performance.

To those in the industry who have patiently awaited the Turtle powered systems, which they ordered, we apologize for the time we have taken in packaging (you know how turtles are).

In consolation, though, we do offer evidence that our second generation system does, indeed, do what we claimed it would. Our Fabulous Fader does fade fabulously, our Great Equalizer equalizes greatly and our 65K programmer does program 65,000 bits rapidly and reliably.

allison research, inc.

2817 Erica Place · P.O. Box 40288
Nashville, Tennessee 37204
Dial (615) "ALLISON" or (615) 385-1760

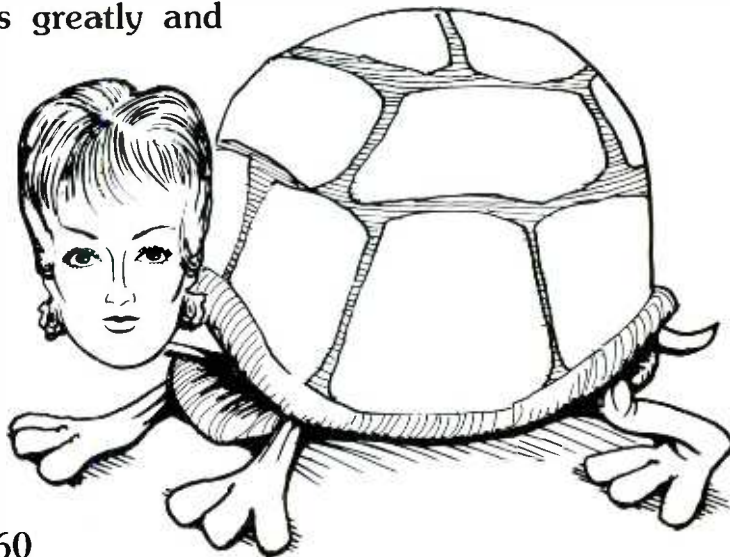

Audio from the Magnetic Recorder's Point of View

ing to the power of a 50 watt light bulb seen from a distance of 3,000 miles! (Think of a person in San Francisco being able to see a small desk lamp shining in New York.)

Figure 3-2 shows the relative sound pressure levels of common sounds. Within this auditory landscape a few landmarks along the way are of interest. For example, a professional sound studio will be something on the order of 30 to 40 dB, which is also the level of very soft music. The average residence is 45 to 50 dB. Normal conversation at about three feet is 55 to 60 dB. Loud classical music averages from 80 to 90 dB and reaches occasional peaks of 110 dB. Loud rock music goes up as high as 115 dB or more. And, if you ride the subway in New York, you are often experiencing 100 dB levels, some 40+ dB or 100 times greater pressure than the conversation you're trying to carry on with the inmate in the next seat.

Dynamic Range and Transients:

What does this mean to the recording

engineer and his professional audio recorder? Remembering that the very softest music is about 35 dB and the very loudest music is about 115 decibels, this represents a total dynamic range of about 80 dB. The best professional recorders, using full track recording techniques, offer about 72 dB of weighted signal-to-noise ratio from the floor of residual noise to the point of objectional distortion (usually defined as 3% harmonic distortion).

Although the recorder falls short of meeting this 80 dB requirement, the fact is it probably comes close enough for most uses for the following reasons. In the first place, not too many recordings require this total 80 dB range, and those that do can be compressed before recording and expanded afterward. Also, 80 dB isn't necessary because the average listening environment is quite noisy (50 to 60 dB) so the requirement for program loudness is to get over the noise, but below a level that will have the neighbors beating on the walls. Furthermore, when a very loud sound level occurs, it usually

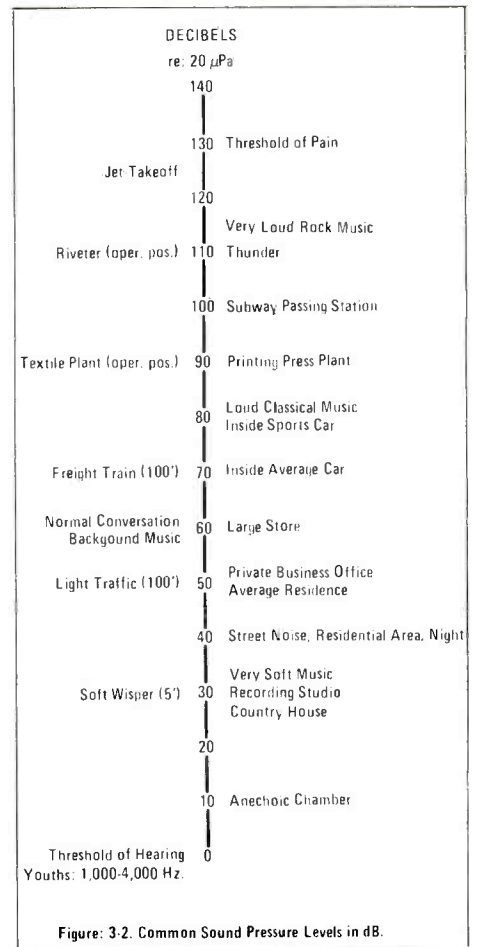

Figure: 3.2. Common Sound Pressure Levels in dB.

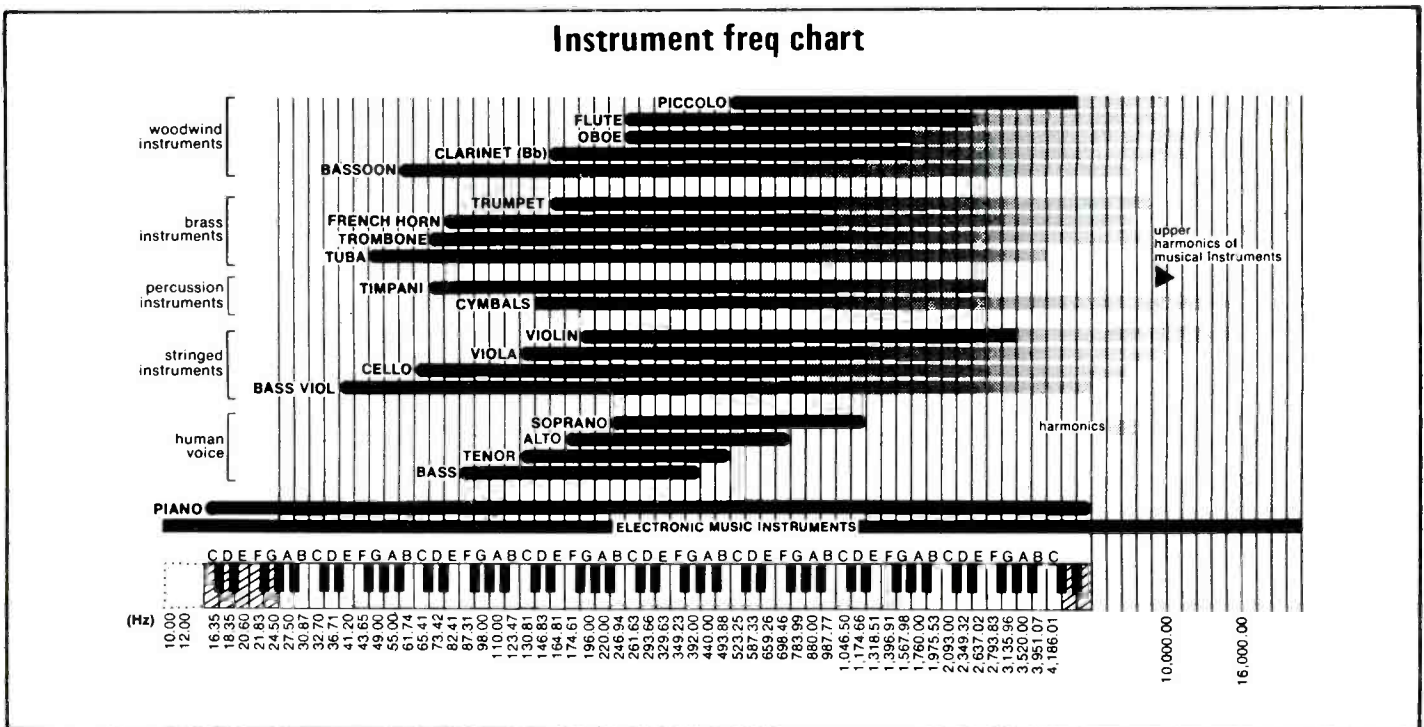

Figure: 3-3. FUNDAMENTAL FREQUENCIES and OVERTONES of INSTRUMENTS and VOICES



Five monitors. One sound. Five JBL studio monitors.

You could record with any one, play back on any other, and take your pick among the rest for mixing or mastering.

The only differences are acoustic output, size and cost.

No matter what size your studio is, you can cross reference with any other studio using JBL's.

But reading isn't knowing for sure. Come listen to one. Or two. Or five.

JBL Studio Monitors from \$303 to \$1596.

James B. Lansing Sound, Inc., 8500 Balboa Blvd., Northridge, Calif. 91329.
For more information circle No. 138

www.americanradiohistory.com

JBL

Quincy Jones... demands quality



Photographed at RECORD PLANT, Los Angeles, CA
 "...I mix with AURATONE® 5C Super-Sound-Cubes™ the little powerhouse speakers. They tell me exactly what will be in the grooves. You hear it all with AURATONE®!"

Join "Q" and other seasoned music world pros, top record company executives,



engineers, producers, and artists who lay it on the line with AURATONE®.

Durability, flat full-range response, amazing power handling, and portability have made AURATONE® 5C's the Record Industry's favorite



"mixdown monitors,"...for comparison and final mixes, auditioning, remotes, and reference standard speakers.

See your Dealer or order Factory Direct (30-day return privilege, one year guarantee). \$49.95 per pair. Shipping and handling add: U.S.: \$3.00 pair, Foreign: \$7.50 pair. Calif. res. add sales tax.

Mail to: AURATONE PRODUCTS
 P.O. Box 580-C6 Del Mar, Ca. 92014

Ship ___ pair 5 C's. Amount Enclosed \$ _____

Name (Please print) _____ Job Title _____ Date _____

Shipping Address _____

City _____ State _____ Zip _____

Please send additional information.

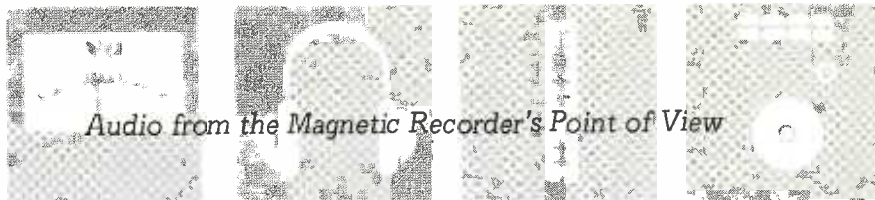

Audio from the Magnetic Recorder's Point of View

is a peak or transient of very short duration. These peaks push the recorder into an overload or saturation condition. However, recorder saturation is far more gentle than the harsh, grating distortion associated with amplifier overload.

Frequency:

Besides intensity and duration, another basic characteristic of sound is frequency. Looking at Figure 3-3, we see that the fundamental sounds of the human voice and most musical instruments fall within the range of about 100 to 3,500 Hz. Overtones extend up to about 16,000 Hz and make up the envelope or waveform of each instrument (their timbre or color in subjective terms).

It is starting transients and overtones that enable us to tell the sound of one instrument or voice from another. This is why it is so important for the recorder to capture these frequencies (and the harmonics they generate within the complex sound waveform), in order to provide a true representation of the original sound.

Young people are capable of hearing sounds from about 20 Hz to 20,000 Hz, but the upper range above 5,000 Hz falls off considerably as people get older, particularly with men. For all practical purposes a recorder frequency response from 50 to 16,000 Hz ±2 dB (for the total system, including redubs) would probably be quite acceptable, although many recorders extend to 18,000 Hz or more and have some useful response a bit higher.

THE RECORDING PROCESS

Magnetic recording is based on the fact that certain materials can be magnetized when brought near a magnetic field and will remain magnetized after the field is removed. Electric current passed through a coil of wire wound around an iron core (an electromagnet) is a common means of creating a magnetic field. A recording head is just such an electromagnet, resembling, in fact, a kind of ring or horseshoe magnet, with a gap between the poles.

Making a Recording:

To make a recording an electric signal from a transducer, such as a microphone, causes magnetomotive force proportional to the signal to flow in the core of the head. This creates a magnetic field that bridges across the head gap. Figure 4-1 shows typical record and playback heads.

To make a recording, magnetic tape is pulled across the record head at a precisely constant speed. This tape consists of a thin plastic base on which an even thinner coating of tiny ferric oxide or chromium dioxide particles are uniformly deposited. Within the coating are bonded millions of particles, tens of layers thick.

Each oxide particle represents a discrete magnetic domain with a north-south dipole. As the tape leaves the record head gap, the magnetic field at the trailing edge of the gap causes the magnetic domains on the tape to become oriented in varying

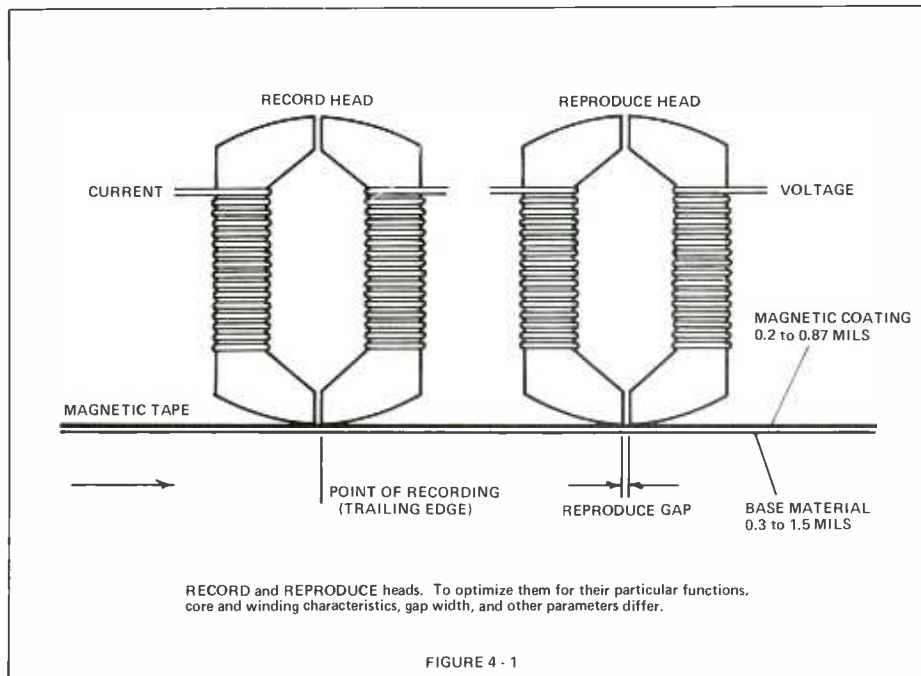
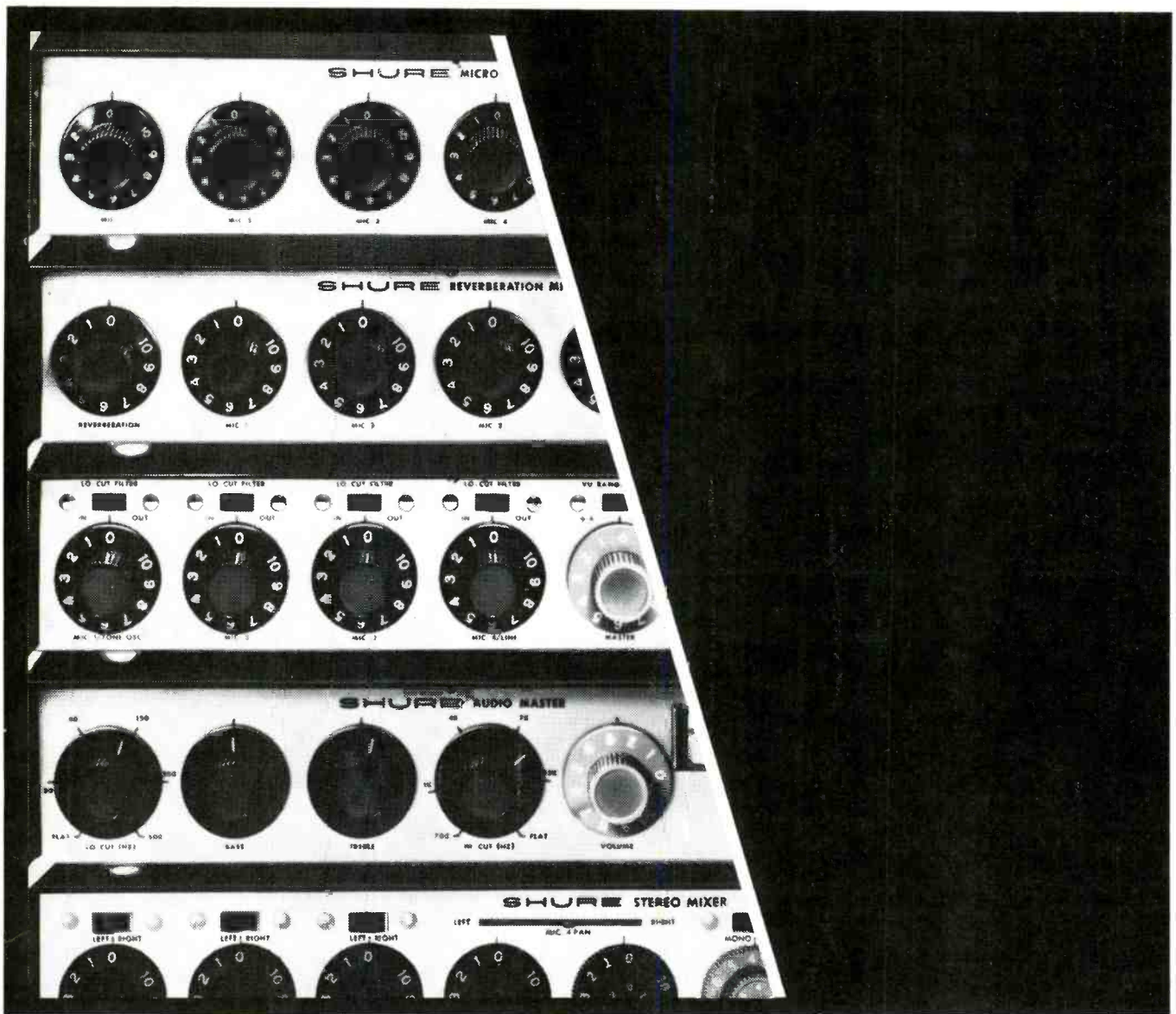

FIGURE 4 - 1

For more information circle No. 198



Panel full of miracles.



Shure mixers, audio level controllers, and feedback controllers are all designed to deliver more audio control, more features, and more performance dollar for dollar than any other components with similar audio features. Their compact size and modular "stackable" design mean they can be easily combined in various configurations in even the smallest spaces. And they're versatile—their input-output flexibility equips them for an extremely wide range of audio applications, giving you control you never thought possible without bulky, expensive installations. You can easily put together a system that's exactly right for your precise needs without putting extra dollars into built-in features you really don't need. For the details on our entire line of miracle workers, write:

Shure Brothers Inc.
222 Hartrey Ave., Evanston, IL 60204
In Canada: A. C. Simmonds & Sons Limited



Manufacturers of high fidelity components, microphones, sound systems and related circuitry.

For more information circle No. 139

R-e/p 67

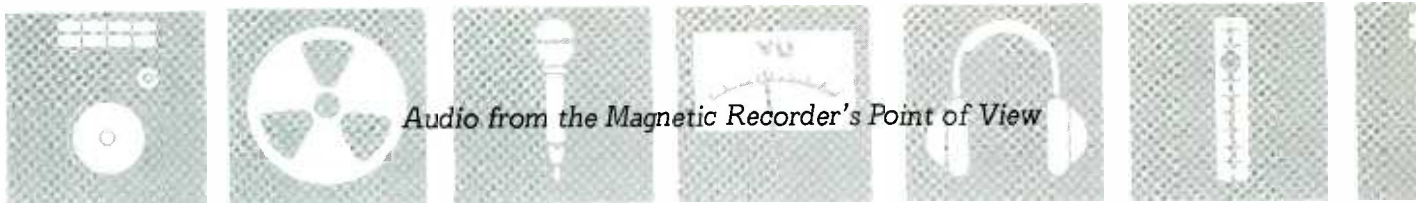

Audio from the Magnetic Recorder's Point of View

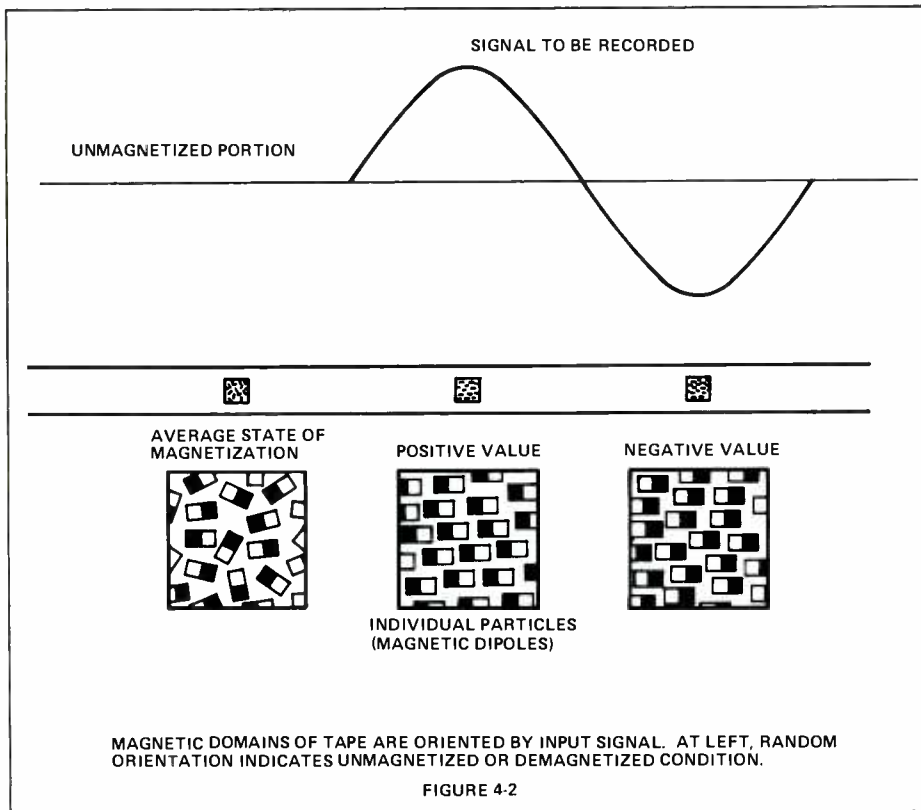

degrees and patterns of magnetism according to the field created in the head by the input signal. Note that the particles themselves do not become physically reoriented. Only the direction of magnetization is changed. Note also, that in an unmagnetized or demagnetized tape the domains are still present, but since they are randomly oriented, the net effect is an average magnetic flux of zero at any point on the surface of the tape. Recording forms the domains into patterns that produce a varying magnetic field at the tape surface. (see Figure 4-2).

Playback:

After passing the gap in the head, the oxide particles retain their magnetism. On playback, the process is reversed. The remanent magnetization of the oxide particles creates a magnetic field which can be reinduced in a reproduce head. This head then transforms the varying flux amplitude back into an electrical signal voltage.

In effect, the record head is an electrical to magnetic transducer. The reproduce head is a magnetic to electrical transducer.

Biasing to Correct Distortion:

Recording a signal directly on the tape causes severe distortion at the zero cross-

over point of the signal, due to the nonlinear nature of the magnetizing process. Figure 4-3 shows this distortion. The solution to this inescapable problem is to add a very pure high frequency symmetrical wave to the audio signal to move the recording into the linear portions of the magnetization curve. Since the frequency of the bias signal is chosen to be more than five times higher (usually over 100 kHz) than the highest frequency in the re-

order bandwidth, it does not interact with the audio signal or generate harmonics. In fact, it is not necessarily recorded at all because it is outside the recorder bandwidth.

It is important to realize that the bias frequency is added linearly not in an amplitude modulation process, so no sidebands or sum/difference frequencies are created. The bias signal must be as perfectly symmetrical a waveform as possible to minimize distortion products, though it does not necessarily have to be a sine wave.

Just exactly how bias works is still a subject of some debate among recording theorists. However, it does seem to act directly on the oxide particles and since tapes differ in size and formulation of their particles and coating thickness, each type of tape requires its own particular bias setting. Professional recorders make this relatively easy to do by putting the bias adjust control on the front panel so each tape can be optimally matched to the recorder.

Record/Reproduce Limitations:

Frequency response limitations in a recorder/reproducer system seem to be more of a problem in the high frequency area (short wavelength) rather than in the low frequency area (long wavelength). In fact, record low frequency response is essentially flat up to about 800 Hz. The characteristic bumps we usually see in an overall system response curve are caused mostly by the shape and size of the reproduce head and shields. However, these geometric considerations can be minimized by good head design and any remain-

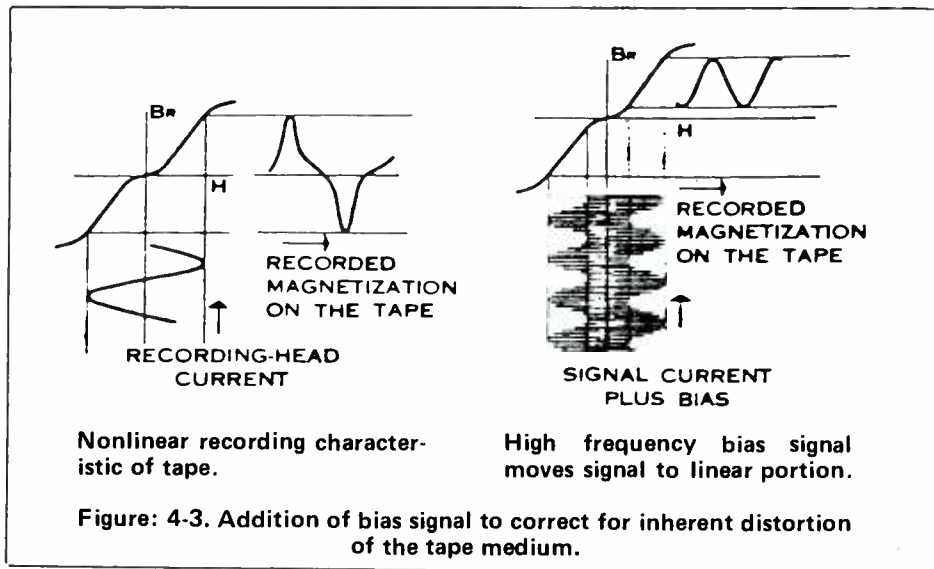

SWEET SIXTEEN



When you stepped up from four tracks to eight, you knew sixteen wasn't far off. And if you've been looking for someone to put it all together for you, consider it done.

The el-tech 1616-25 recording console gives you all of this:

- 16 Input Channels
 - 16 Monitor/Cue Channels
 - 2 Cue Busses
 - 2 Echo Busses
 - 8 Mixing Busses and 8 Direct Outputs
 - 96 Point Patch Bay
 - 5 Band — 15 Frequency EQ
- ... and luscious good looks.

At \$9775.00, what could be sweeter?

AVAILABLE EXCLUSIVELY THROUGH:

THE EXPRESS SOUND CO.
1833 NEWPORT BLVD.
COSTA MESA, CA. 92627
(714) 645-8501

NASHVILLE STUDIO SYSTEMS
16 MUSIC CIRCLE SOUTH
NASHVILLE, TENN. 37203
(615) 256-1650

For more information circle No. 140

el-tech

112 17TH STREET
KNOXVILLE, TENN. 37916
(615) 546-5509

R-e/p 69

MAP

HAS A COMPLETE
LINE / CAPABILITY
TO SOLVE YOUR
MODULAR CONSOLE
AND COMPONENT NEEDS

- MIC, TAPE & PHONO PREAMPS
- LINE, MIXING & BOOSTER AMPS
- 15 WATT POWER AMP
- AUDIO DISTRIBUTION AMP



*VCA'S



- PARAMETRIC EQUALIZER
- GRAPHIC & SHELVEING EQUALIZERS
- COMPRESSOR-LIMITERS
- * CONDUCTIVE PLASTIC STUDIO FADERS
- PRECISION OSCILLATOR

- CONSOLE CONTROL MODULES FOR MULTI-TRACK RECORDING
- BROADCAST CONSOLE INPUT MODULES

Standard
Console
Frames
Available

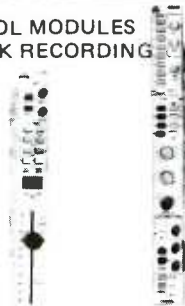

* NEW

PLUS . . . A complete line of

- AUDIO OP-AMPS • TRANSFORMERS
- POWER SUPPLIES • ACCESSORIES
- AND 80 WATT MONITOR AMPLIFIERS

MAP

A single source to solve all your Modular component needs



or to meet your most exacting console requirements. (Most components available from stock)

FOR COMPLETE CATALOG CALL OR WRITE RICK BELMONT . . . TODAY

Manufacturers of • Consoles
• Console/System Components



MODULAR
AUDIO PRODUCTS

A UNIT OF MODULAR DEVICES, INC.
1385 Laxeland Ave., Airport International Plaza
Bohemia, New York 11716 516-567-9625

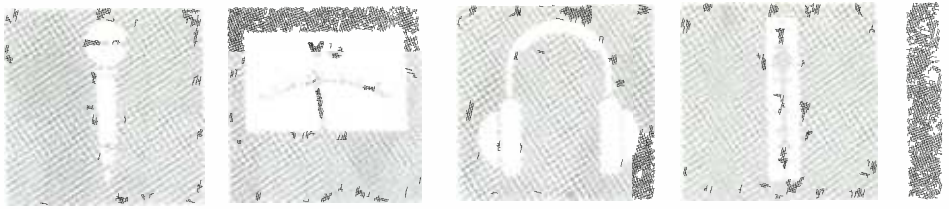

ing effects compensated for in record equalization (either cut or boost as required by the particular head/recorder configuration).

On the high frequency side, the limitations are more fundamental and even today are not fully understood by recording physicists. According to the latest theories (see Bibliography) first-order high frequency limitations are due to a combination of properties of tape coating thickness and bias fields (for the practical effects of bias, see Figure 4-7).

Basically, the recording process works this way: for a given bias field the signal is recorded at a certain depth in the coating. Near the surface, the magnetization is lowest. At the rear of the coating (near the base of the tape), it is highest. The principle is that when the magnitude of the bias equals the magnitude of the coercivity at a given point, recording takes place. If the bias field is increased (overbias), the magnetization is pushed past the coating thickness (into the base, so to speak) and the output decreases. If the bias field is reduced, the output will again decrease, because the magnetization values are lowest. This effect is virtually independent of the wavelength of the input signal.

However, the reproduce function is very much wavelength dependent because of spacing losses. The spacing loss formula is:

Spacing loss = $55 \text{ d}/\lambda$, where d is the distance from the head to the depth where the signal is recorded, and λ is the recorded wavelength.

Based on this principle, Figure 4-4 shows flux frequency response of a record/reproduce system. It indicates that above 800 Hz, recorded flux drops off at a 6 dB, and then a 12 dB rate as shown.

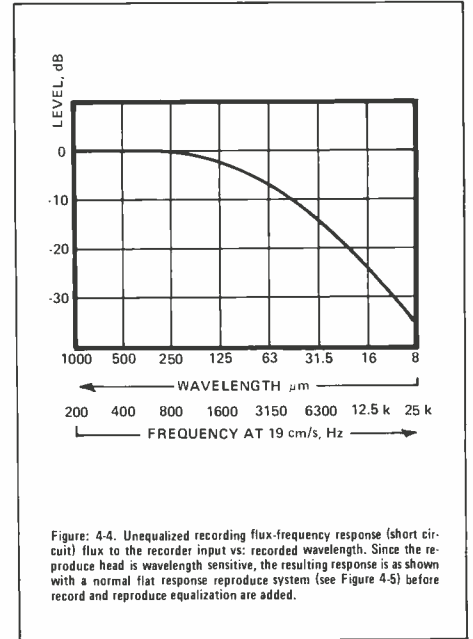
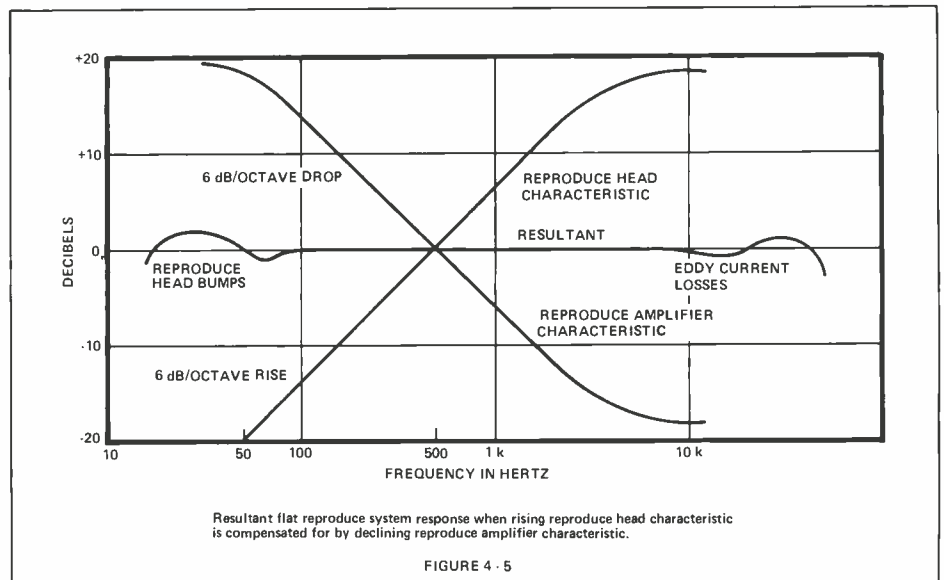

Figure: 4-4. Unequalized recording flux-frequency response (short circuit) flux to the recorder input vs. recorded wavelength. Since the reproduce head is wavelength sensitive, the resulting response is as shown with a normal flat response reproduce system (see Figure 4-5) before record and reproduce equalization are added.

In this analysis, we are presupposing the normal conditions where the combination of reproduce head and reproduce amplifier provide the essentially flat reproduce system characteristic shown in Figure 4-5, when reproducing a constant magnetization from the tape. This graph indicates that while the reproduce head takes the derivative of the flux on the tape (so that its output rises at about a 6 dB per octave rate), the reproduce ampli-



Resultant flat reproduce system response when rising reproduce head characteristic is compensated for by declining reproduce amplifier characteristic.

FIGURE 4 - 5

Introducing...

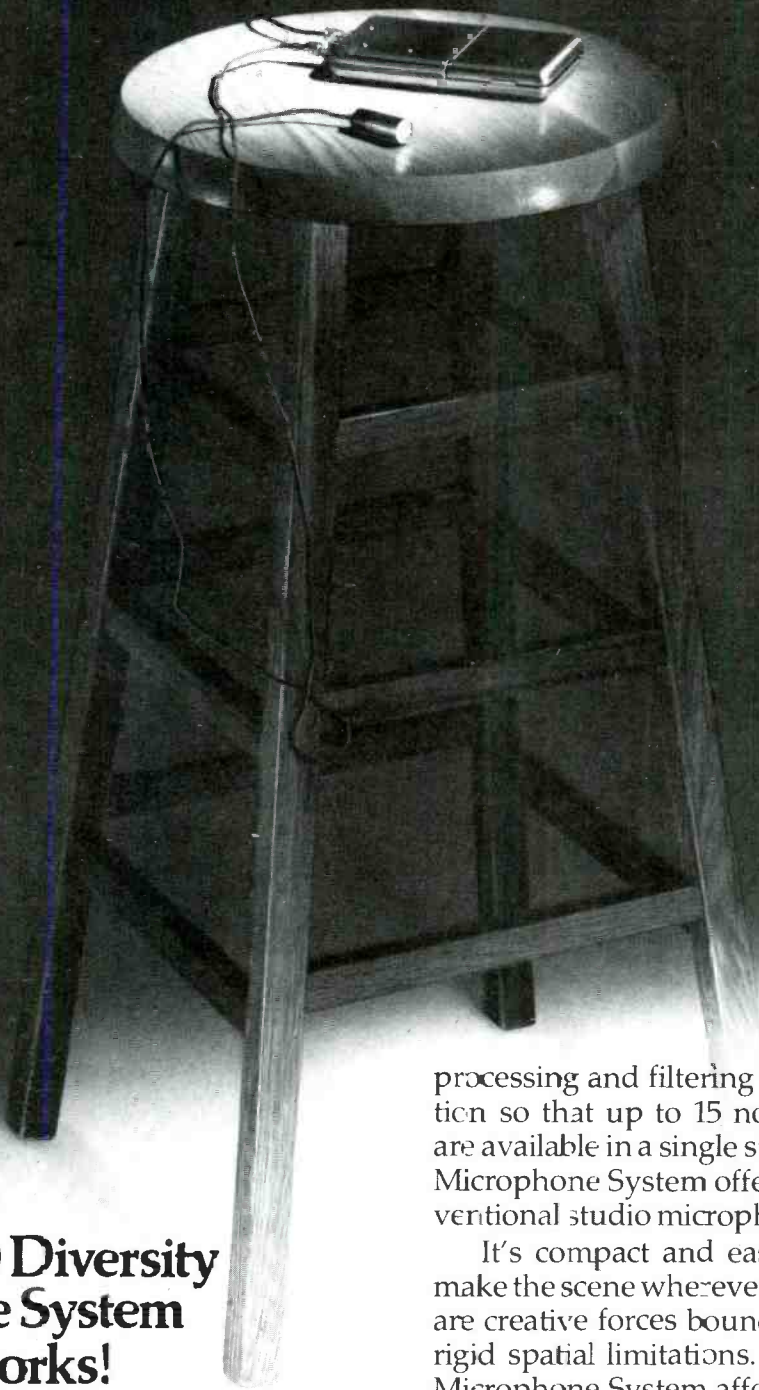

the only 950 Diversity Microphone System that really works!

At last, a wireless microphone that doesn't sound like a wireless microphone. Here's a diversity microphone system that has minimized distortion, maximized range and reception.

Automatic diversity switching using two antennas and high dynamic range front-ends, insure dropout-free performance, even in difficult locations.

It operates at 950 MHz and employs a combination of precision control, signal

processing and filtering to reduce intermodulation so that up to 15 non-interfering channels are available in a single studio. The 950 Diversity Microphone System offers the reliability of conventional studio microphones.

It's compact and easily concealed. Able to make the scene wherever the action is. No longer are creative forces bound by cables, booms nor rigid spatial limitations. And the 950 Diversity Microphone System affords the flexibility of interchangeable microphones.

It will revolutionize studio programming and remote operations for news, sports, and special events.

950 Diversity Microphone System. The broadcast-quality wireless microphone that goes anywhere, captures anything. Already successfully on the job, it really works!



THOMSON-CSF LABORATORIES, INC.

37 Brownhouse Road, Stamford, Connecticut 06902
(203) 327-7700/TWX (710) 474-3346

For more information circle No. 141

R-e/p 71



fier takes the integral of the output voltage (at a descending 6 dB per octave rate). The practical result in a typical recorder is a flat reproduce system response. Therefore, the reproduce head responds more or less directly to the descending recorded flux curve, so that overall unequalized record reproduce response is pretty much as in Figure 4-4. Here is where equalization comes in to play.

Equalization:

To produce a flat response from the system flux frequency curve of Figure 4-4, equalization is added during record and reproduce. Typical curves for 15 and 7½ ips are shown in Figure 4-6, along with the resulting frequency response curves for these speeds when the equalization is applied to a curve such as that of Figure 4-4. The table included in Figure 4-6 summarizes the transition frequencies and equivalent time constants for some of the more common equalization curves.

Minor Effect of Reproduce Gap Loss:

You will note that it is the combination of coating thickness and bias field that primarily limits high frequency response. Earlier theory cited the reproduce gap effect as the primary factor, and while still a consideration, it can be essentially negated by good head design and careful manufacture. The narrowness of the reproduce gap does indeed limit high frequency response because a short wavelength signal will produce little useful output if it is smaller than the gap. But manufacturing narrow gap heads is not as much of a problem as it once was, and at audio frequencies, losses due to gap effect are often less than 1 dB (10%) at 15,000 Hz in a good professional recorder or a high quality cassette deck.

It might be noted in passing that changing coating thicknesses is similar in effect to changing bias. In fact, if a different tape is used, one of the major reasons it must be rebiased is because the coating thickness is often different.

Need to Match Bias:

Matching the recorder bias to the specific tape being used has always been important, but is especially true today with the new high coercivity formulations that go beyond the low-noise, high-output tapes we've had for some time. The new tapes require something on the order of 20 to 35% more bias current than general purpose tapes, so be sure the recorder can

provide this increased bias if you want to try the new tapes on an older machine. A signal-to-noise increase of 3 dB or more can be achieved.

Each type of tape not only has a different chemical formulation, but to reduce tape-caused noise, uses the smallest possible oxide particle that it can. (Theoretical limit to size is the smallest particle that still retains its magnetic dipole char-

acteristics.) Surface smoothness (a function of the binder and polishing process) are also a consideration. However as was mentioned earlier coating thickness is the most important factor. With all these variables, it is vital that the bias be adjusted to match recorder to tape.

In overall recorder performance, correct bias is even more important than correct equalization since its effects on freq-

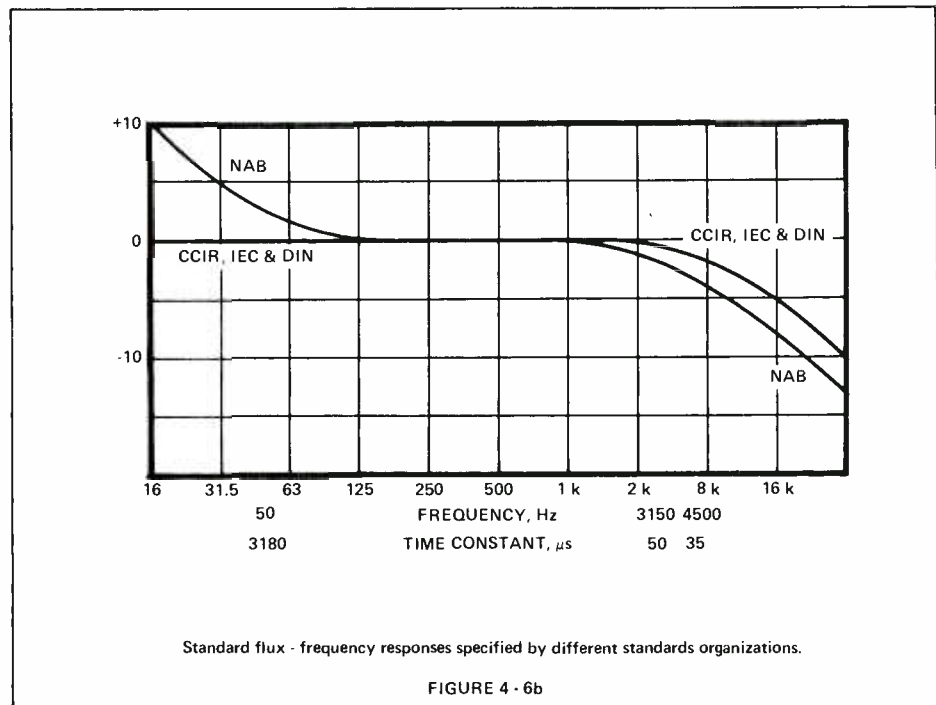
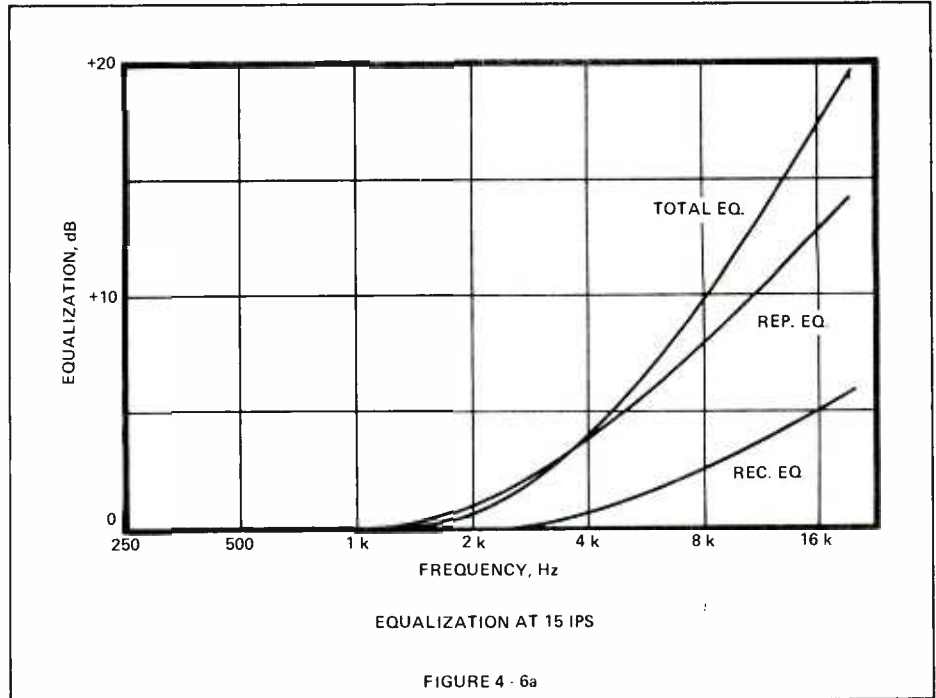

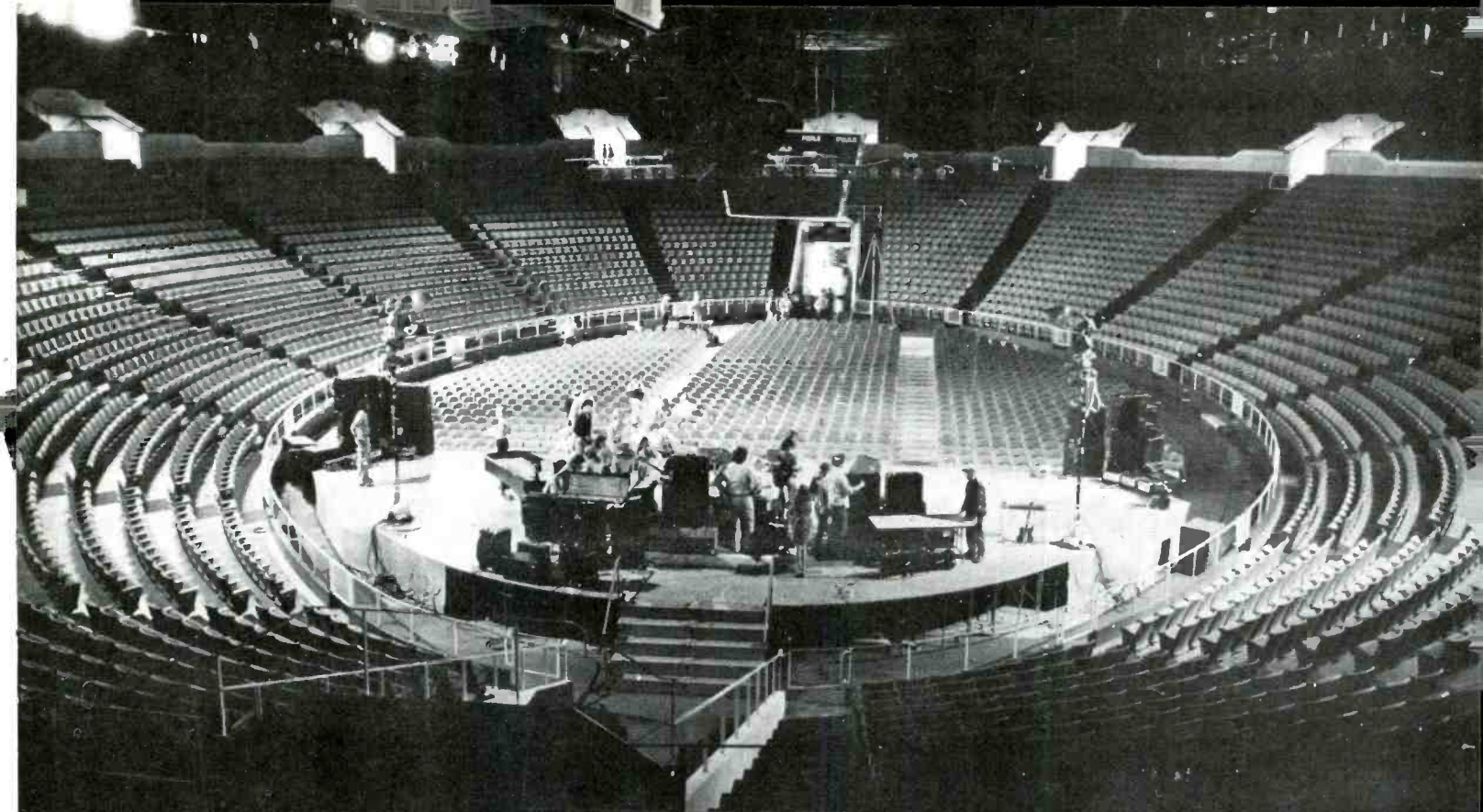

Montreux Casino The Midnight Special Oral Roberts University

Sound Systems by Kustom

Mabee Center at ORU, NBC's Studio 4 in
Burbank, the Montreux Jazz Festival.

Kustom.

Handmade electronic assemblies
coupled with premium Electro-Voice horn
drivers and speakers.

Professional consultation throughout all
phases of planning and construction—coupled with
the kind of service it takes to keep the largest hall alive
with clean, controlled Kustom sound.

When sound is everything . . . *Kustom*[®]

Chanute, Kansas 66720

For more information circle No. 142

www.americanradiohistory.com

R-e/p 73

Audio from the Magnetic Recorder's Point of View

TAPE WIDTH	TAPE SPEED		TIME CONSTANTS (μ s)	TRANSITION FREQUENCIES (Hz)
	ips	cm/s		
NAB: U.S.A: Broadcasting & Recording				
1/4 inch 6.3 mm	3.75	9.5	3180 & 90	50 & 1800
	7.5	19	3180 & 50	50 & 3150
	15	38	3180 & 50	50 & 3150
	30	76	∞ & 17.5	0 & 9000
IEC: International Standards				
1/4 inch 6.3 mm	3.75	95	3180 & 90	50 & 1800
	7.5	190	∞ & 70	0 & 2240
	15	380	∞ & 35	0 & 4500

Figure: 4-6c. NAB and IEC Equalization Time Constants and Transition Frequencies

frequency response, distortion, and dropouts are more severe. In contrast, incorrectly set equalization, while hardly desirable, can be corrected to some extent by control board equalization settings. But a recording made with improper bias is pretty much hopeless.

Setting Bias Current:

Basically, the correct level of bias is that which gives the lowest distortion, best signal output at both high and low frequencies, widest signal-to-noise ratio and frequency response, and most freedom from dropouts. Figure 4-7 summarizes the effects that occur with under and over bias conditions. You'll note that it is not possible to optimize each parameter, but an excellent compromise can be reached.

Setting bias is relatively simple with a three-head professional machine since the effect of the bias adjustment can be monitored immediately by the playback head and seen on the VU meter. A built-in test

oscillator is also very handy. The procedure is as follows: Thoroughly demagnetize the tape you plan to use and thread it on the machine. Record a test signal of 1,000 Hz for 15 ips, or 500 Hz for 7 1/2 ips. (Bias is normally set at the highest speed regularly used.)

While recording the test signal, read the output off tape from the reproduce head on the VU meter, and adjust the bias level control (almost always front accessible on a professional machine) for peak signal. This will provide the best compromise between distortion, frequency response, and signal sensitivity.

Some recorder manufacturers recommend that you continue past the peak bias level to a point 1/2 to 1 dB (relative to peak) lower.

The purpose of this over bias is to reduce the modulation noise caused by surface irregularities.

These nodules or clumps move the tape away from the head and reduce signal output (a dropout). Slight overbias reduces modulation noise. Overbias also

may improve the distortion figure, but degrades the frequency response and sensitivity to higher frequencies. With recorders operating at 30 or 15 ips, this loss of high frequency response can perhaps be tolerated. However, continuing improvements in surface smoothness with the newer tapes also reduces dropouts by eliminating the problem in the first place. Whether to peak the bias, or slightly over-bias is an individual choice.

Recording Speed:

Frequency response is improved at each successively higher tape speed because the signal is recorded over a longer piece of tape. Other advantages of higher speed operation are these:

When recording at 15 ips as compared to 7 1/2, all audio frequencies can be recorded at full level without saturating the tape. Result is about a 6 dB improvement in signal-to-noise ratio at 8,000 Hz. Similarly, 30 ips offers another 3 dB over 15 ips at 8,000 Hz and 6 dB at 16,000 Hz. Thirty ips also improves transient response because of the spreading out of the wavelengths and reduces several high frequency problems as well, such as track-to-track phasing, dropouts, azimuth angle errors, and losses due to tape and bias differences.

On the flip side of the coin are higher tape costs, which at 30 ips are double those of 15 ips, reduced low frequency response because of head bump (which now occurs at 60 Hz instead of 30 Hz), and higher frequency of the print through. Absolute print through will also be increased if you use 30 ips and choose a thinner base tape to increase playing time. Besides, noise reduction systems like Dolby and dbx can get you a 10 dB to 30 dB signal-to-noise improvement at 15 ips, and most recording engineers seem to feel a signal-to-noise improvement nearly always buys more than some of these other fringe benefits (particularly with eight or sixteen channel recording

Bias Condition	Distortion	1,000 Hz Frequency Response	Signal Sensitivity	Dropout Sensitivity (Modulation Noise)
Too High (Over Bias)	Reduces Distortion. Then Levels Off	Erases High Frequencies	Reduces High Frequencies	Lessens Effects of Dropouts
Peak Bias (Maximum Sensitivity @ 1,000 Hz)	Near Optimum Distortion	Excellent Response	Highest Output	Acceptable Dropouts
Too Low (Under Bias)	Extreme Distortion	Improves High Response, Cuts Mid & Low	Reduces Mid & Low Outputs	Increases effect of Dropouts

Optimum

Figure: 4-7. Effects of Over and Under Biasing

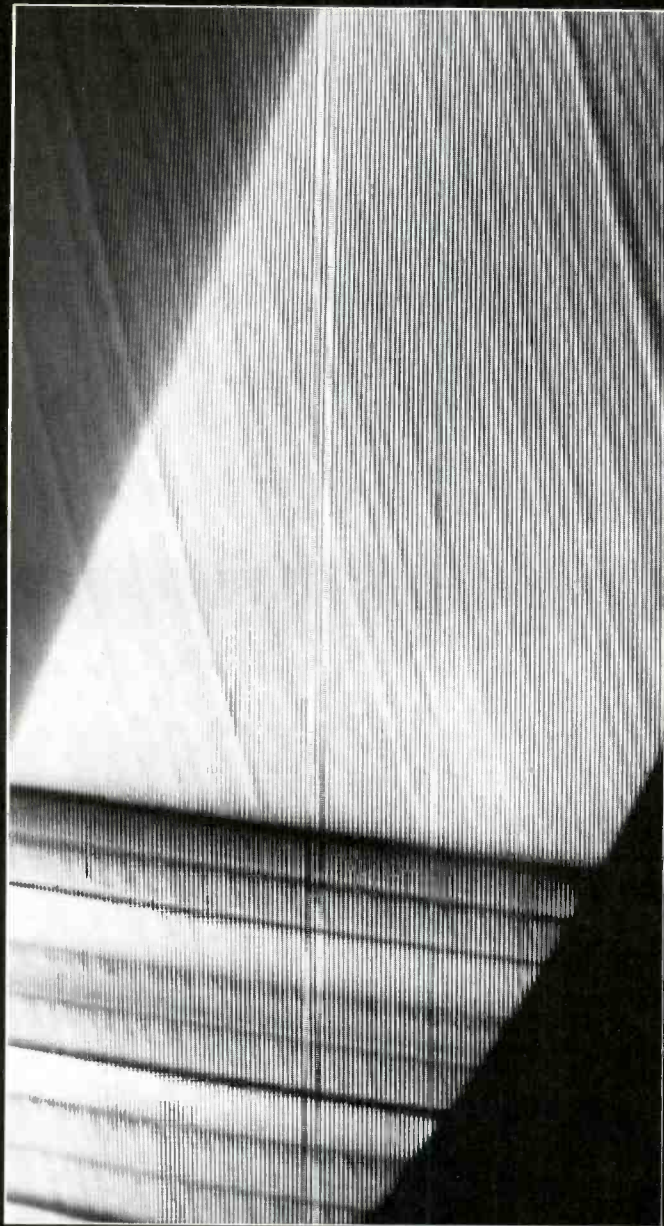

Master from Transco Products Corporation

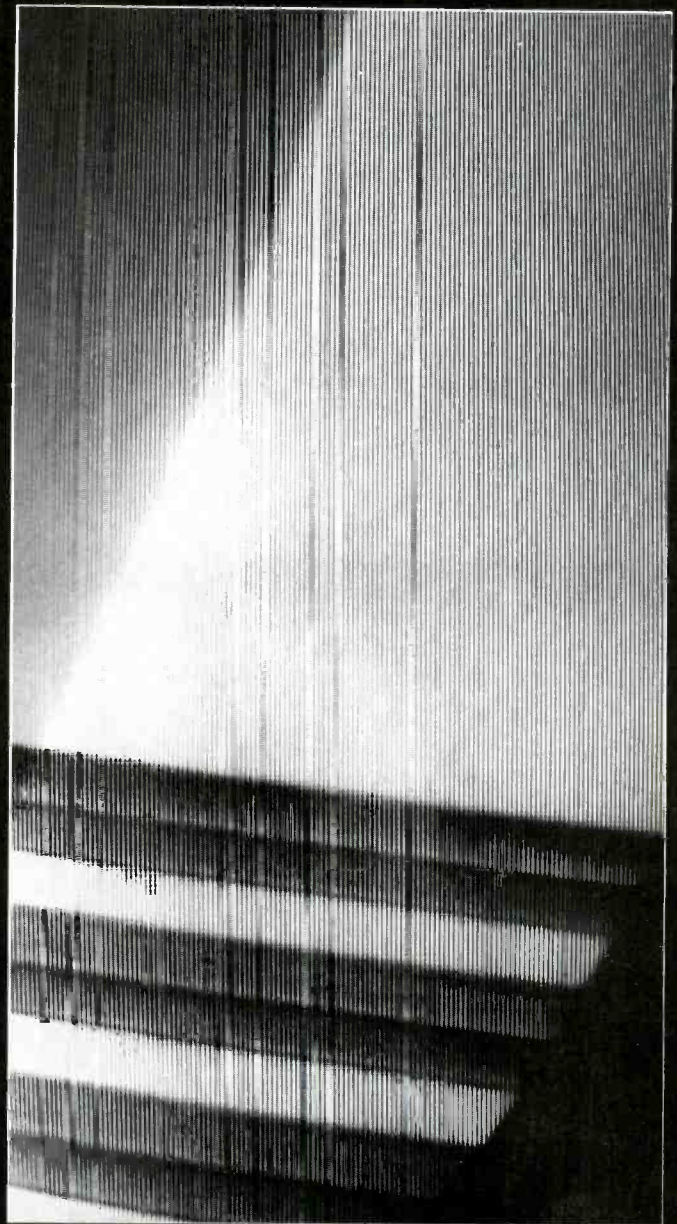

Master from Audiodiscs by Capitol

Your eyes are now a cutting stylus.

And with Audiodiscs® they've just cut a perfect master.

The Audiodiscs® master disc by Capitol is magnified 200 times as is the master from Transco Products Corporation. As this close-up reveals, there is a remarkable difference between the two. Even more exciting is the fact that these differences didn't exist 6 months ago.

What caused this remarkable superiority? Since early 1975 Audiodiscs by Capitol have been manufactured in the newest and most advanced disc plant in the world. All aspects connected with the manufacturing process, including cleanliness, have been optimized to

produce a superior master disc. With absolutely no compromise. This is apparent in the coating process where the exacting application of lacquer ensures a smoother disc.

At this point, look at the pictures again... they speak louder than words.

For a free sample and brochure, write on your company letter-head, or call Harry Preston at (213) 462-6252.

**ALDIODISCS® A PROFESSIONAL PRODUCT
MANUFACTURED BY THE SAME PEOPLE THAT MAKE
ALDIOTAPE®, AUDIOFILM™, AUDIOPAK® BROADCAST
CARTRIDGES, AND THE LEARNING TAPE™ BY CAPITOL.**

audiodiscs

BY CAPITOL

Capitol™ CAPITOL MAGNETIC PRODUCTS A DIVISION OF CAPITOL RECORDS, INC. 1750 NORTH VINE STREET, LOS ANGELES, CALIFORNIA 90028

For more information circle No. 143

R-e/p 75

where signal-to-noise and cross talk are more of a problem).

**SPECIFICATIONS
and
WHAT THEY MEAN**

Interrelationship of Basic Specifications:

Signal-to-noise ratio, distortion, and frequency response are not independent values. They are so closely related that each actually depends on the definition of the other rather than on any absolute measured value. If a manufacturer doesn't state how the measurements were taken, it's possible to make a given machine appear far superior in one or more of the specifications without pointing out that the others may have been degraded.

For instance: Signal-to-noise can be dramatically improved (6 to 9 dB) by letting distortion and frequency response (not to mention headroom) go to pot. Or, frequency response can be extended from 15,000 Hz to 20,000 Hz at 7½ ips if the user can tolerate increased distortion and decreased signal-to-noise ratio that goes

along with it.

Recalling the discussion of Bias in the preceding paragraphs (see Figure 4-7) it was pointed out that to cite a better frequency response figure you simply decrease the bias current a little to reduce the depth of the recording caused by the bias. Since reducing the bias current effectively improves the treble response, it would appear that you have magically extended the frequency response of the machine. However, you don't get something for nothing in the recorder world (or any other for that matter), because the distortion rises quite sharply. But you can reduce distortion by simply recording at a lower level. This turns out to be a mixed blessing too, because when you reduce the recording level, you cut down the signal on the tape and the signal-to-noise ratio goes bad.

What it boils down to is that these three basic specifications are compromises based on trade-offs between each. If you change one, you change the others.

An analysis of each of these ought to be profitable:

0 VU and Distortion:

Signal-to-noise and distortion are not only interrelated but their definitions are tied closely to yet another basic concept, that of average recording level or 0 VU. This is called standard operating level on alignment tapes and standard reference level in NAB specifications. It means the average recording level permissible without causing a certain level of distortion, most often less than 1% harmonic.

But, what exactly does a particular recorder identify as 0 VU? In the consumer world, 0 VU is often unspecified and can range all over the landscape. But for professional recorders, the NAB standard calls for it to be set at -8 dB below the level that causes 3% distortion, or at 1%, which is essentially the same thing. A 400, 700, or 1,000 Hz signal is used. With most professional recorders, when the VU meter is set to 0 (0 dB), the output voltage is 1.25 volts (2.5mW into 600 Ohms), which is called +4dBm. [In some recorders, it may be 0.8 volt which is 1mW into 600 Ohms and called 0dBm, or 2.0 volts (6.3mW into 600 Ohms) which is called

HAECO HAS IT TOGETHER
INTRODUCING THE PNM-24 PHASE METER

CONVENIENT SIZE
PORTABLE

STANDARD RT S
JACK INPUTS

1 KHz ROL-OFF
FOR DISC MASTERING



VU METER BALISTICS

AZIMUTH INDICATOR
LED

AVAILABLE BALANCED
OR UNBALANCED INPUT

a true phase measurement instrument



*A sound investment
dedicated to the advancement of the audio industry.*

HOLZER AUDIO ENG. CORP., 14110 AETNA ST., VAN NUYS, CALIFORNIA 91401 • call (213) 787-7733

+8dBm.]

To be meaningful, reference fluxivity per meter (nWb/m) used to set 0 VU must be specified. The reference fluxivity or 0 VU is critical in recorder performance because it's the first calibration you make when aligning a recorder and nearly all other specs are tied in one way or another. Specifically, you take a 15 or 7½ ips calibration tape and reproduce from it (at the correct speed) the reference fluxivity signal, usually 700 Hz if from Ampex or STL, or 1,000 Hz if from Magnetic Reference Lab or a European source. This signal is precisely recorded at a standard fluxivity (See Figure 5-3).

With the reference fluxivity, you set the reproduce electronics gain to read 0 VU. Then, without changing this reproduce level setting, the other checks for frequency response, reproduce equalization, bias, record equalization and record level are set with this calibrated fluxivity as a reference.

Signal-To-Noise:

To determine signal-to-noise ratio (S/N), the value of signal level that produces 0 VU is noted. Then this is compared with the biased noise level of the tape and record/reproduce electronics when no signal is present. You must be sure the published figure includes all three sources of noise: tape (including bias noise), record electronics, and reproduce electronics. Some recorders specify only record electronics noise.

In addition, many recorder specification sheets now state S/N as being referenced to a specific fluxivity level *above* 0 VU. Usually the fluxivity level at 0 VU (185, 200, or 250 for example) is stated under the distortion or frequency response heading. Then under S/N, a higher fluxivity level is referenced for the S/N measurement, such as 520 nWb/m (9 dB over 185). To compare S/N figures, use the values in Figure 5-1 so you can be sure you're considering the ratio at the same level. Referencing S/N to a higher fluxivity level has the effect of quoting S/N ratio at a higher distortion level, such as 3% higher. (9 dB above 0 VU is the 3%

distortion point with the Otari MX-5050 recorders, for example; 15 dB or 1040 nWb/m is 3% with the Ampex ATR-100.)

Other manufacturers may not quote a higher level of fluxivity at which S/N was taken, but may say instead at which distortion level the measurement was taken. Most professional measurements are at 3% which is 8 to 9 dB (standard tape) above the 0 VU level. Occasionally, you may see a 5% distortion figure used for S/N. In this case, subtract about 6 to 8 dB from a figure taken at a 3%, or 14 to 16 dB for 1%.

Typically a good professional recorder will exhibit signal-to-noise ratios on the order of 55 to 65 dB depending on the number of tracks and the tape speed. This is called unweighted signal-to-noise. However, since the human ear hears the middle range better than the low or high ranges, it is often desirable to express signal-to-noise specifications on a weighted basis (reduced sensitivity to frequencies below 800 Hz and above 7,500 Hz).

This is perfectly valid, if the weighting curve is cited. Usually, a weighted signal-

**INTERFACE
STEVENS**

SERIES 104 AND 108

PROFESSIONAL MIXING

CONSOLES



INTERFACE ELECTRONICS

3810 WESTHEIMER • HOUSTON, TEXAS 77027 • (713) 626-1190

SPECIFICATION	PROFESSIONAL	CONSUMER	CASSETTE
Signal-to-Noise Unweighted: Weighted:	55 to 65 dB 62 to 72 dB	45 to 55 dB 50 to 60 dB	40 to 50 dB 45 to 55 dB
Frequency Response <i>ips</i> 15 7-1/2 3-3/4 1-7/8	± 2 dB 35 or 50 to 22,000 35 or 50 to 18,000 50 to 12,000 NA	± 3 dB NA 40 to 18,000 40 to 16,000	± 3 dB NA NA NA 40 to 14,000
Tolerance in % of Frequency Response (10 log)	63 to 159 %	50 to 200 %	50 to 200 %
Distortion at Standard Operating or Reference Level	<< 1 %	< or 3 % (some times 5%)	3%

Figure: 5-2. Typical Recorder Performance Specifications

to-noise ratio is on the order of 3 to 4 dB higher than an unweighted figure. In the U.S., the most common curve is the ANSI "A" curve (ANSI Standard S1.4-1961) adopted by the NAB in 1965. For cassettes, and in Europe, a slightly different curve is used.

VU Meters:

Nearly all recorders, professional and consumer, now incorporate a meter, many of which are labeled VU. However, in some machines, the only similarity with a true VU meter is the calibration scale. The professional standard set up by

IEEE/ANSI for VU meters covers both the frequency response and dynamic response (rise time and overshoot) characteristics of the meter. These call for a frequency response within ±0.5 dB from 25 to 16,000 Hz and a zero VU reading equal to one milliwatt at a specific impedance which is usually 600 Ohms. When a signal is applied to the meter which will result in a zero dB reading, the pointer of the meter must read 99% of that reading within 300 milliseconds (±30msec) with overshoot of at least 1% and no more than 1.5%. Furthermore, it should return to rest in approximately the same time when the signal is removed.

Because of this standardization of meter characteristics, professional recording engineers learn how to judge quite accurately what the overload characteristics are of the music or speech they are recording. However, skill and experience are required since some music has a lot of transients and the VU meter is basically an averaging device. To read transients more accurately, one approach, used more in Europe than in the United States, is to use a peak reading meter. However, peak meters have two problems: they don't indicate overall level and they are often set so that 0 VU equals 3% distortion instead of 1%. A better solution than trying to adapt to a different kind of meter is to include a peak reading indicator such as an LED display with a standard VU meter either on the recorder or control board.

Headroom and Dynamic Range:

Any discussion of overload leads quickly to headroom and dynamic range. Every recorder has a maximum dynamic range from its inherent noise to tape saturation. Signal-to-noise occupies the portion from noise to average recording level (0 VU). Headroom is the safety margin above that from 0 VU to extreme distortion or clipping.

Most good quality consumer reel-to-reel recorders provide something like 6 to 8 dB of headroom above their chosen 0 VU level. However cassette recorders only have 2 or 3 dB of headroom. This is because their 0 dB level has been pushed as high as possible, sacrificing headroom so that signal-to-noise will appear respectable.

On the contrary, a good professional recorder will have something on the order of 15 to 25 dB of head room above 0 VU before signals will begin to clip. Figure 5-4 shows how within the overall recorder dynamic range, the choice of the 0 VU level has an effect both on head room and

COMPLIMITER™



MODEL 610

Used in recording studios; disc mastering studios; sound reinforcement systems; TV, AM, FM broadcast stations to maintain a sustained average signal at a level significantly higher than that possible in conventional limiters, and with performance that is seldom attained by most linear amplifiers.

Rack mounted, solid state, new functional styling, the Model 610 is in stock for immediate shipment.

Specifications are available from:

SPECTRA SONICS

770 WALL AVENUE, OGDEN, UTAH 84404
(801) 392-7531



Audio from the Magnetic Recorder's Point of View

signal-to-noise specifications. The result is that headroom suffers and the safety margin, which the amateur actually needs more than the professional, is reduced.

Frequency Response:

Turning to frequency response specifications, two things should be checked: The level at which the measurements were taken and the decibel tolerance range. Our discussion in previous paragraphs compared tolerance values in percentages for different decibel figures.

Many professional recorders today easily deliver a performance of 35 or 50 Hz to 22,000 Hz at 15 ips, 30 to 50 Hz to 18,000 Hz at 7½ ips, or 50 to 12,000 Hz at 3¾ ips within ±2 dB over the entire range. Consumer machines usually cite response at ±3 dB (or sometimes omit tolerances) which enables them to quote a wider response.

As with signal-to-noise, check to be sure the bandwidth numbers reflect the overall record/reproduce function including tape. Frequency response test conditions, including the type of tape used

Fluxivity Level in (nWb/m)	Difference from 185 (dB)	APPLICATION
150	1.82	The NAB standard for cartridges.
185	0	Original Ampex standard; still a very commonly used level for general purposes.
200	0.68	A newer standard from MRL for general purpose tapes such as 3M 177 or Ampex 345.
250	2.62	For 3M 206 and Ampex 406 high-output low noise tapes.
320	4.76	The IEC (International) and DIN (German) standard.
370	6.02	Double the 185 nWb/m fluxivity for the newer high density tapes like 3M 250 or Ampex Grand Master 456.
500	8.64	These levels are not used to set 0 VU, but are quoted by several manufacturers when specifying Signal-to-Noise (500, Scully; 520, Ampex and Otari; 1040, Ampex ATR-100).
520	8.89	
720	11.80	
1040	15.00	

Figure: 5-3. Reference Fluxivity Levels for 0 VU (at 700 Hz).

Check
our

Multi-TRACK RECORDers

The goal of every studio owner is to have the most reliable recording equipment available, knowing well that "down time" because of equipment failure costs him money. We at **STUDER** proudly feel that we not only have the most reliable recorders but that we also have a service philosophy that other companies envy. Let us tell you about it.

Write or call, Willi Studer America, Inc., 1819 Broadway, Nashville, TN. 37203. Phone 615-329-9576, Telex 55-4453. In Canada, Studer Revox Canada Ltd. Phone 416-423-2831, Telex 06-23310.

STUDER

a standard
of excellence.



"Carl Rowatti, Chief Engineer, adjusting the Program limiters prior to cutting a master lacquer".

According to TRUTONE RECORDS... "The Stanton calibrated 681 series is our total point of reference in our Disc Mastering Operation"

Trutone Records in Northvale, New Jersey always uses the calibrated Stanton Triple-E for A-B comparisons between tape and disc. They also use the Triple-E to check the frequency response of the cutter head (they'll record a 1,000 Hz tone and a 10 kHz tone twice a day to check the condition of the cutting stylus and the high end frequency response of the cutter head).

They make test cuts and play them back, using the Triple-E for reference, as high as 15 kHz all the way down to 30 Hz. Carl Rowatti says "We use the Stanton Calibrated 681 series as our total point of reference in our disc mastering operation. Everything in the studio is judged — and we think perfectly judged for quality — with this great cartridge".

Professionals can't afford to take chances with quality. That's why they depend on Stanton in their operations.

Each Stanton 681 Triple-E is guaranteed to meet its specifications within exacting limits, and each one boasts the most meaningful warranty possible. An individually calibrated test result is packed with each unit.

Whether your usage involves recording, broadcasting, disco or home entertainment your choice should be the choice of the professionals... the Stanton 681 TRIPLE-E.

Write today for further information to:
Stanton Magnetics, Terminal Drive,
Plainview, New York 11803

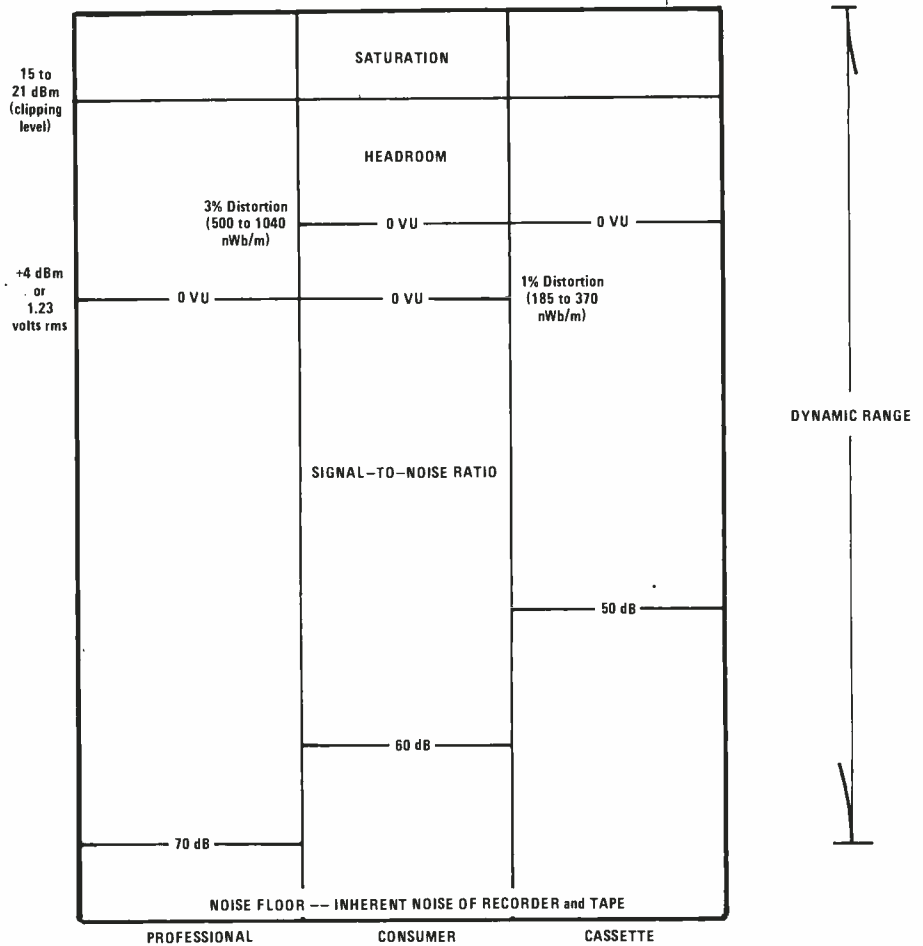

Figure 5-4. Typical S/N and Headroom Within Total Dynamic Range of Recorder. Note that choice of 0 VU level changes S/N or Headroom at the expense of the other.

and the level at which the measurements were taken are important, too. Because all recorders at speeds below 30 and 15 ips tend to saturate with higher frequency signals (beginning about 3,000 Hz), it is customary to measure frequency response not at 0 VU but at -10 dB re: 0 VU at 7½ ips and at -20 dB for 3¼ ips. The level is -20 dB or more for cassette recorders which are far more subject to saturation problems than higher speed reel-to-reel recorders.

As a final note, keep in mind that total dynamic range, including both signal-to-noise and headroom are probably more significant in evaluating a recorder's noise handling capability than signal-to-noise ratio alone.

Flutter:

Another important measure of recorder performance is expressed in the specification for flutter, the short term speed variations that cause audible changes in pitch. In a broad sense, flutter includes

the effects of all motion perturbations caused by motors, belts, pulleys, bearings, idlers, pinch rollers, reels, tape pack, and unsupported lengths of tape. Wow and flutter are so named because that's what you hear when the speed is unsteady. Piano and woodwinds are affected the most. The common flutter ranges are shown in Figure 5-6.

Drift: 0 to 0.1 Hz
Wow: 0.1 to 10 Hz.
Flutter: 10 to 200 Hz
Scrape Flutter: 3000 to 5000 Hz

Figure 5-6. Flutter Ranges

Of these four, wow (0.1 to 10 Hz) is the most objectionable. Many recorder manufacturers use a weighting filter that emphasizes this range by a factor of

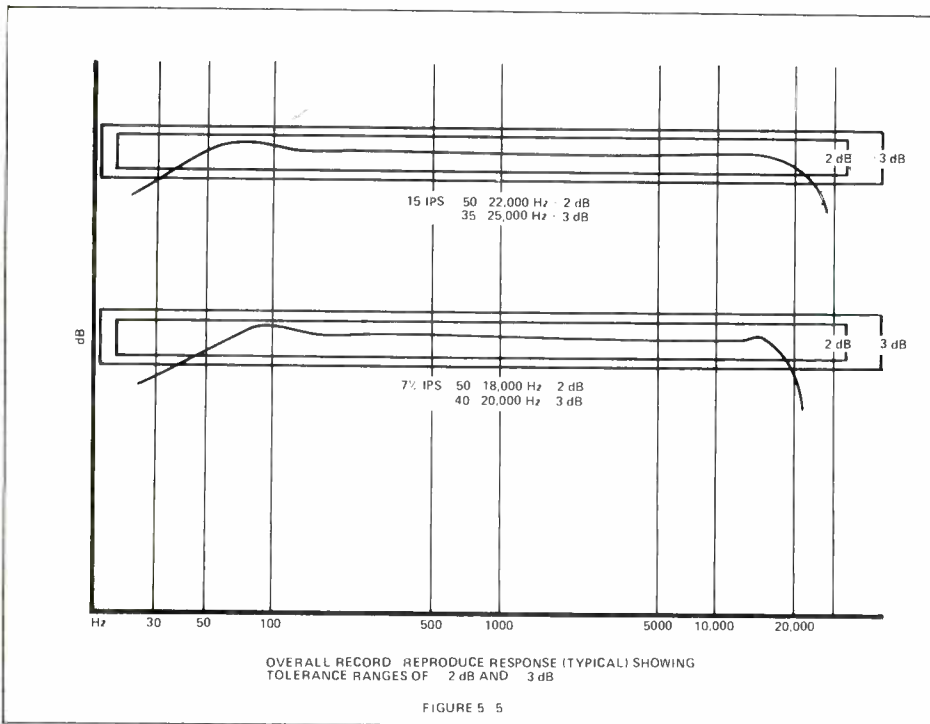

Figure 5-7 gives the maximum values from NAB specifications.

Scrape Flutter:

Scrape Flutter is a different breed of beast. It comes from longitudinal oscillations of unsupported tape lengths in the head and capstan area. If the unsupported lengths are kept short, the frequencies of the oscillations are higher and they are more likely to be masked by the program sound or be beyond audibility. Scrape flutter can be minimized by good transport design, by the use of special idlers, or by closed loop tape drives.

Scrape flutter affects transients the most. It dulls the overall sound causing fuzziness and weak attacks. However, scrape flutter is not that much of a problem in a well designed professional recorder, unless masters are being made specifically for high speed duplication of premium quality reel-to-reel music tapes. High speed duping of a 3 3/4 ips tape at an eight or sixteen to one duplication ratio will bring the 3,500 Hz scrape flutter down to about the center of the piano keyboard where it is much more audible.

about ten while reducing the readings from the other frequencies. Effect of flutter (200 Hz and up), if severe, is to give the sound a *grainy* characteristic, which is far less objectionable than the warbles and vibrato of wow. Wow and flutter are measured by playing back a special test tape that has an extremely stable 3,150 Hz signal with very low flutter (below 0.02%).

UNWEIGHTED FLUTTER	
Tape Speed	Flutter
15 ips	0.15%
7 1/2 ips	0.20%
3 3/4 ips	0.25%

WEIGHTED FLUTTER	
Tape Speed	Flutter
15 ips	0.05%
7 1/2 ips	0.25%
3 3/4 ips	0.10%

Figure 5-7. MAXIMUM FLUTTER CONTENT PER NAB SPECIFICATION

The reproduced 3,150 Hz signal is then fed into a flutter bridge consisting of a limiter, discriminator, time and frequency weighting networks, and meter. Measurements are taken in the range from 0.1 to 200 Hz. Any short term speed variations will frequency modulate the 3,000 Hz signal. Thus, a 0.2% reading means that the basic center frequency is made to vary ± 6 Hz or from 2994 to 3006 Hz.

NEW AUDIO SPECTRUM MONITOR!

1/3 OCTAVE REAL TIME ANALYSIS MODEL 142

- PEAK READING • TWO MEMORIES: CUMULATIVE OR SAMPLE • VARIABLE TIME CONSTANTS (0.1 - 2 SEC.) • CALIBRATED IN DBM • 10-20-30 DB DISPLAY RANGE • 40 HZ to 16 KHZ ON 1/3 OCTAVE ISO CENTERS • 11 x 28 LED ARRAY • BUILT-IN PINK NOISE SOURCE • 3 1/2" x 8" DEEP RACK MOUNT.
- PROGRAM MATERIAL MONITORING • RECORDING AND MIX-DOWN ANALYSIS • PORTABLE SYSTEM ADJUSTMENT • TAPE EQUALIZATION AND CALIBRATION • TRANSMISSION LINE EQUALIZATION • BEFORE-AFTER COMPARISONS • FREQUENCY RESPONSE TESTING

USES

Suggested List Price \$3200

ALSO: Active and passive equalizers • Other real time analyzers
Dealer inquiries invited

White

Call or write today: WHITE INSTRUMENTS, INC.
P.O. BOX 698 512/892-0752 Austin, Texas 78767

New Products



OCTOBER AVAILABILITY OF THE NEW ORBAN/PARASOUND MODEL 418A STEREO LIMITER/COMPRESSOR

The 418A features program-controlled attack and release times, which enable the device to work quite subtly with all types of program material without the necessity for critical manual adjustment.

The 418A is a complete limiting system consisting of a pair of stereo-ganged broadband compressor/limiters with exceptionally smooth and subtle characteristics, followed by a high frequency limiter with four different time constants, user-selectable by means of a front panel switch. This variable time constant feature is unique in the industry and permits the characteristics of the high-frequency limiter to be tailored to the recording medium following the limiter, such as disc, cassette, or 7.5 ips tape.

The 418A is a modification of the highly-successful ORBAN/BROADCAST Optimod-FM Limiter, which is being used by many top FM stations and has been acclaimed for its highly "natural" and clean sound.

Because of the operating simplicity of the 418A, it is particularly well suited as a "mixdown machine", to be used in situations where time is a problem. Most decisions are made for the operator on the basis of an automatic analysis of the input program, therefore the 418A can be used effectively for rough mixes, broadcast production, commercials, and the like. It is also ideal for cassette duplication and for single-channel limiting chores.

The 418A comes in a 19" rack panel and sells for \$950.00.

ORBAN/PARASOUND, WHARFISIDE, 680 BEACH STREET, SAN FRANCISCO, CA 94109, (415) 673-4544.

For more information circle No. 151

"MASTER AUDIO METER" FROM MICMIX AUDIO PRODUCTS.

The Master Audio Meter is a dual-channel LED-bar display unit having exceptional features which should prove

to be a significant step in obtaining highest performance from consoles and other recording and broadcast equipment, according to the company.

The adjustable brightness display is selectable for either PEAK or RMS values on smooth, flowing bars having a 55 dB display range in 1 dB increments from +5 to -7, and in 5 dB increments from -10 to -55. In the RMS mode, the display has the same rise and fall characteristics as a ballistic type VU meter (300 msec for 20 dB), while timing in the PEAK mode is 130 msec to capture transients and yet provide a very comfortable viewing display.

An unusual feature of the MASTER AUDIO METER is that each display channel can also be readily switched (manually or by remote control) to either of two independent and externally adjustable reference levels, permitting exact matching to more than one recording device or media without recalibration or guesswork. PEAK mode reference levels are changed automatically from RMS reference levels by 10 dB to permit full display range usage in either mode without readjustment. In the PEAK mode, the unit will capture and display to within ± 0.5 dB, the peak level of a one-half

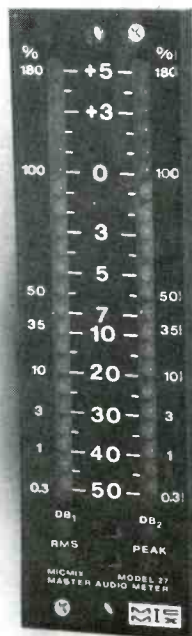

Soundcraftsmen "TOTAL-SYSTEM" EQUALIZATION AIDS

NEW FULL-SPECTRUM 18dB
LEVEL CONTROLS; LED's
for ZERO-GAIN and OVERLOAD
MONITORING; 1dB MARKINGS

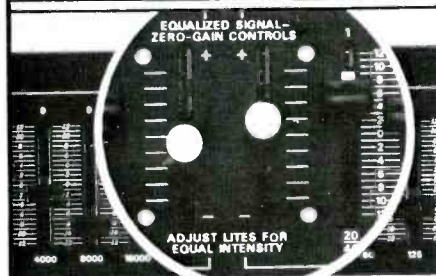

Soundcraftsmen
SPECTRUM/BALANCED OCTAVE EQUALIZER
PROFESSIONAL TWIN - GRAPHIC MODEL TG 2209-800

NEW 1/3 OCTAVE PINK NOISE
INSTRUCTIONAL TEST
RECORD for OCTAVE-WIDE
ENVIRONMENTAL SET-UP

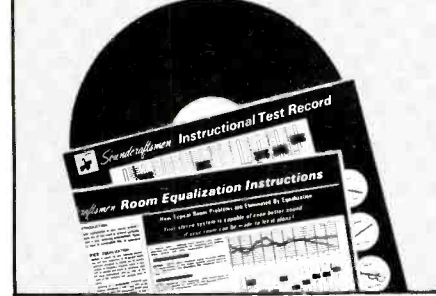

FOR THE STUDIO



600-OHM BALANCED IN/OUT

FOR THE ROAD



SG-2205-600 less case - \$399.50

GUARANTEED SPECIFICATIONS

FREQUENCY RESPONSE: ± 0.25 dB 20 to 20,480 Hz at zero setting.
THD: Less than .05% at 1 volt.
SIGNAL-TO-NOISE: Better than 90 dB.
INDIVIDUAL OCTAVE-CONTROL RANGE: Minimum ± 12 dB (Typ. ± 14 dB), each octave centered at 30, 60, 120, 240, 480, 960, 1920, 3840, 7680, and 15,360 Hz.

CIRCLE SERVICE CARD # OR WRITE TO:
SOUNDCRAFTSMEN
1721 NEWPORT CIRCLE, SANTA ANA, CA 92705

For more information circle No. 150

A MASTER OF THE ART TALKS ABOUT MASTER-ROOM™

"We have used Master-Room reverberation with Stevie Wonder, Neil Diamond, Joe Walsh, Petula Clark, Rufus, Fleetwood Mac, Tower of Power, Billy Preston, Sergio Mendez, Isley Brothers, Ramsey Lewis and a number of others. In fact we have used our Master-Room chambers on virtually every record we've done here.

"What I like about Master-Room sound primarily is the relatively clean first order echo. It's a real smooth system.

"We like it especially on electronic instruments, and the Master-Room can even take drums and sound good. It's much better than any other comparable type reverb and costs much less.



"Here at Kendun Recorders we have unlimited funds for equipment and we can afford the best. So, along with our live chambers, there are two or three Master-Room units in each of my rooms.

"I would feel incomplete without my Master-Room chambers."

Kent Duncan
President
Kendun Recorders
Burbank, California



Master-Room reverberation chambers alone won't make you a Master of the Art, but they will provide you with the very finest in Natural Sound Ambience.

Models available to suit every need.
See your dealer or write direct.



MICMIX AUDIO PRODUCTS, INC.

For more information circle No. 152
9990 MONROE DRIVE, SUITE 222 • DALLAS, TEXAS 75220

(214) 352-3611

www.americanradiohistory.com

R-e/p 83

cycle sine wave burst up to 15 kHz, and out to 30 kHz with slightly greater tolerance.

For balanced and unbalanced applications, input impedance is 12k Ohms, and an optional power supply is available which is capable of operating up to two MASTER AUDIO METERS. The bezel measures 1.5 x 5 inches (38 x 127 mm) and the unit is approximately 5 inches deep. A pin-and-socket type external connector is utilized for highest reliability. A total of 24 integrated circuits are contained in the unit.

Price: \$595 (Meter), \$85. (Optional Power Supply).

MICMIX AUDIO PRODUCTS, INC.,
SUITE 222, 9990 MONROE DR., DAL-
LAS, TX 75220 (214) 352-3811

For more information circle No. 153

INTERFACE ELECTRONICS NEW SERIES 104, 108 PROFESSIONAL MODULAR MIXING CONSOLES.

This newly introduced line includes mainframes for eight, sixteen, twenty-four or thirty two inputs, and four (Series 104 or eight (Series 108) stereo or mono mixes plus equalizers, panpot, four cue/echo sends, six step gain adjust with two input pad positions, monitor-only solo button, and several output section options including mixdowns, talk-slate, graphic equalizers, dual three-way tunable crossover, and others. Rugged



mainframes are fully black anodized and fitted with four inch lighted inclined VU meters.

These flexible mixers can be configured for recording studio or sound system application, and can be supplied with foam lined trunk or walnut furniture housing.

All microphone inputs are transformer coupled, slider attenuator is long-life conductive plastic, condensers are ceramic, tantalum, or computer grade, integrated circuits plug in, and all sections are modular and plug in. Output transformers are optional, input and output connectors

are XLR type. All input modules have mike and line inputs plus module output and preslider break-in jacks.

Despite their low cost, these new mixers are said to meet the highest professional standards of performance, including distortion under 0.1% at +3VU, 400 Hz., low noise, 20 dB headroom, and wide frequency response.

Illustrated is the Model 104-16X4A-16D, priced at \$3,900.

INTERFACE ELECTRONICS, 3810 WESTHEIMER, HOUSTON TX 77027 (713) 626-1190

For more information circle No. 154

RL 500 UNIVERSAL CONSOLE INTRODUCED

The Rus Lang Corporation recently introduced a new console which accepts any 19" x 15 3/4" tape transport including Ampex, MCI, Scully, Tascam, Electro Sound, etc. Designated the RL 500, this console is constructed with the same care as the Scully consoles which Rus Lang has manufactured for the past 12 years.



TWO FORTY TWO A

The Sound Workshop 242 has been the industry standard for low cost reverberation... until now!



Introducing the **Sound Workshop 242A** Stereo Reverberation System. The same great sound and reliability that made the 242 famous, now with added features to make it a must in the studio, on the road, at the disco, or on the air.

The **242A** features line and mic inputs, peak reading LEDs, independent channel equalization, stereo return from a mono send, full control of dry to reverb mix, plus more. And of course it's **Sound Workshop** quality. We guarantee it. For 2 years parts and labor.

The **Sound Workshop 242A** Stereo Reverberation System.
\$450.

bringing the technology
within everyone's reach

Sound Workshop
PROFESSIONAL AUDIO PRODUCTS

1038 Northern Blvd., Roslyn, New York 11576

(516) 621-6710

HARDWARE

ANYBODY CAN GET IT...WE GOT IT...
(in stock)



Call Claude Hill or Dave Purple



Loudspeakers and
Power Amplifiers



CROWN

Power Amplifiers and
Electronic Crossovers

urban/parasound

Parametric Equalizers, De' Esser's,
Reverbs, Stereo Synthesizers



Consoles
and
Recorders

dbx inc.

Noise Reduction Systems and Limiters

BEYER DYNAMIC

Microphones and Accessories



Microphones and
Echo Chambers

Dolby

Noise Reduction Systems for Recording,
Film and Broadcasting



Power Amplifiers
and Preamplifiers



Limiters, Time Cubes,
Metronomes, Filters, Equalizers
and other peripheral items

Audio Consultants, Inc.

7 Music Circle North · Nashville, Tennessee 37203 · (615) 256-6900

For more information circle No. 157

Change Sound to Silence with a **TABERASER**



This rugged, heavy duty bulk tape eraser wipes sound from all magnetic tapes, cartridges, cassettes and magnetic film stock; handling up to 2".

It erases with minimum residual noise because the field automatically diminishes at the end of each 30-second cycle.

A thermal control and blower keeps the unit below 71° C.

For the distributor in your area—Call or write:

TABER Manufacturing & Engineering Company
2081 Edison Ave. • San Leandro, Ca. 94577 • (415) 635-3831

For more information circle No. 158

Trouper Series



The Trouper Series — Permanent Yet Portable

You're looking for a live music mixer to fit your budget, yet performs like a million bucks. It's got to meet your specifications but you don't have a fortune to spend. Look at the Trouper Series. You can start small and add on at any time. We've got a wide variety of expandable mixers, and a complete selection of accessory packages, direct boxes, mic splitters and more. Our equipment bolts and plugs together making it the most flexible, and completely customizable mixing system available today. So whether you've got a fortune to spend or not, check out the Trouper Series — We've got a sound for you. Write for catalog.



DESIGNERS & MANUFACTURERS OF PROFESSIONAL AUDIO SYSTEMS & EQUIPMENT
5559 CAHUENGA BLVD., NORTH HOLLYWOOD, CALIFORNIA 91601 / (213) 985-9501

The RL 500 incorporates all of the newest design features including front panel access in both horizontal and vertical positions and a rear shelf for power supplies. The base section is 32" high, 25" wide and 29" deep, while the instrumentation riser on top is 19" wide by any height that suits your needs.

Constructed with the quality materials, including 1/6" high pressure laminates, this compact console is both stylish and sturdy. It retails at \$350.00 and delivery takes approximately 2 weeks if not in stock at an audio dealer.

The Rus Lang Corporation manufactures portable carrying cases for electronic equipment and other custom consoles besides the RL 500. **THE RUS LANG CORPORATION, 247 ASH STREET, BRIDGEPORT, CT 06605 (203) 384-1266**

For more information circle No. 159

MODULAR AUDIO ANNOUNCES NEW PRECISION OSCILLATOR

Designated Model 3600, the device provides accurate selection of 33 frequencies, covering the entire audio spectrum from 20 to 20 kHz. Distortion is extremely low (typically 0.02%) and the output level is stable over the full frequency range.

Other features include a built-in output transformer, selectable output impedance of 600 or 150 Ohms, and adjustable output level from -80 to +80 dBm.

Attractively packaged in a standard size case, with brushed aluminum front

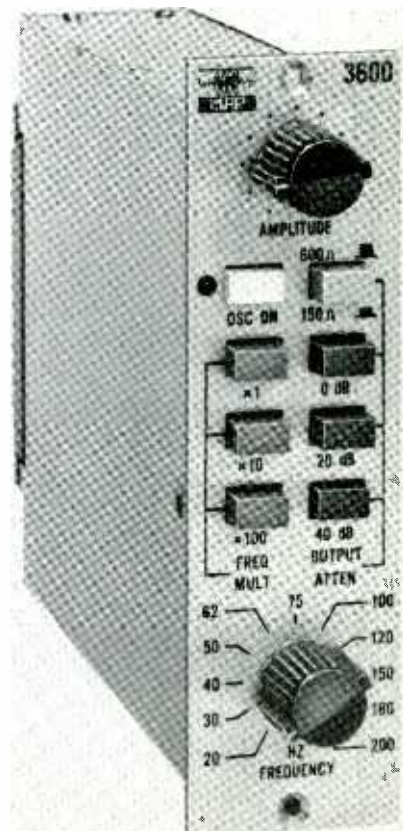

panel, the module may be installed in a console, or rack mounted using the new Model 3900 Rack Mounting Enclosure. A mating PC connector is supplied with each unit.

Overall dimensions are 1½" W x 5¼ H x 5¼ D. Weight is approximately 2 lbs. Power requirements: ±15 VDC @ 40mA max.

Professional price: \$248.50. Immediately available.

MODULAR AUDIO PRODUCTS, 1385 LAKELAND AV., BOHEMIA, NY 11716 (516) 567-9620

For more information circle No. 160

CHAPPELL BACKGROUND MUSIC LIBRARY RELEASES SIX NEW L.P.'s THROUGH MUSIC EYES

MusiCues Corporation, announces the release of six new stereo LP's of the Chappell Background Music Library. The rapidly expanding Chappell Library is now adding single-category sides to meet the current demands of producers for nostalgia, 'mod' styles, dramatic synthesizers, new comedy music and rock sounds. New Release Sheets describing the music in detail are available free from MusiCues by writing or by phone, (212) 757-3641.

LPC 1078 - Piano music featuring Joplin-style rags, jangle rags and jazz - all by Roger Webb.

LPC 1079 - Dramatic backgrounds for orchestra by Mike Hankinson.

LPC 1080 - Happy and sweet, and comedy music by Robert Farnon.

LPC 1081 - Nostalgia from the 20's, 30's, early 40's and from the rag-time era.

LPC 1082 - Electronic music (some after Bach) and exciting new synthesizer effects by Roger Roger and Nino Nardini.

LPC 1083 - Pop sounds in today's style by David Holland.

The Chappell Library will have a total of about 36 discs released by the end of the year. This is by far the largest number ever to appear in a 12-month period.

MUSICUES CORPORATION, 1156 AVENUE OF THE AMERICAS' NEW YORK, N.Y. 10036

For more information circle No. 161

TIME WARP AUDIO DELAY UNIT AND EFFECTS GENERATOR

MICMIX Audio Products has expanded its product line to include a moderately priced time delay and effects generator. Called the TIME WARP because of its versatile time-domain capabilities, the unit incorporates a special design analog delay to provide up to 100 milliseconds of continuously variable delay in three selectable ranges of 1.5 to 6, 6 to 25, and 25 to 100 msec over a usable frequency range of 20 Hz to 10 kHz.

In addition to basic delay, the TW-1 can produce many special effects, includ-



ing true vibrato with control of both rate and depth of deviation using its internal function generator, while an external ramp input can provide pitch change. Polytone is another effect which produces frequency deviation correspond-

ing to a musical scale, and there is recycling capability with continuously variable control from zero to oscillation on all time ranges for slap back echo and reverberation effects, as well as all forms of flanging, phasing, Doppler shifting

THE LOGICAL CHOICE

the MCI JH-110

NO RELAYS • NO HEAT • NO GRIEF

JUST LOGICAL PRODUCTION:

- Three speeds
- Equalization and bias automatically selected for each speed
- Fast wind control "joystick"
- DC capstan servo with built-in variable speed control
- Digital real-time tape timer (optional)
- Return to zero search (optional)
- Constant tape tension on both reels
- Plug-in head assemblies

represented by:

PACIFIC RECORDERS AND ENGINEERING CORPORATION
 11100 ROSELLE ST., SAN DIEGO, CALIFORNIA 92121
 TELEPHONE (714) 453-3255 TELEX 695008

HOLDS UP ON THE ROAD



COUNTRYMAN ASSOCIATES
424 UNIVERSITY AVE. - PALO ALTO, CA. - 94301 - PHONE 415-326-6880

For more information circle No. 163

TWO FOR ONE



With the **Sound Workshop 220** Doubler/Limiter you get two for one.

An electronic delay system capable of delaying audio signals from 5 to 40 milliseconds to give you 2 sounds from 1. 2 voices, 2 drum sets, 2 guitars, 2 anything.

And... a sophisticated peak limiter to add punch to your sounds, and keep a hold on your levels so you can keep a hold on your music.

Two for one—a doubler; a limiter. And of course it's **Sound Workshop** quality. We guarantee it. For 2 years parts and labor.

The **Sound Workshop 220** Doubler/Limiter \$500.

bringing the technology
within everyone's reach

Sound Workshop
PROFESSIONAL AUDIO PRODUCTS

1038 Northern Blvd., Roslyn, New York 11576

(516) 621-6710

For more information circle No. 164

(Doppling), tunneling, double tracking, and even true chorus effects.

A mix control provides up to 100% mix of the delayed and direct signals, and operation of the different controls in various combinations can completely transform and multiply the harmonic structure of an input signal into many strange and different forms. Complete in a standard 1-3/4 inch rack panel, the TIME WARP features XLR type connectors and will operate with input signals from -10 dBm to +20 dBm and has an 80 dB dynamic range.

Price: \$1195.

MICMIX AUDIO PRODUCTS, INC.,
9990 MONROE DRIVE, SUITE 222,
DALLAS, TX 75220, (214) 352-3811.

For more information circle No. 165

BEYER SUBMINIATURE AUDIO TRANSFORMERS

For applications requiring studio-grade miniature audio transformers, Beyer Dynamic has a wide range of standard types available from stock.

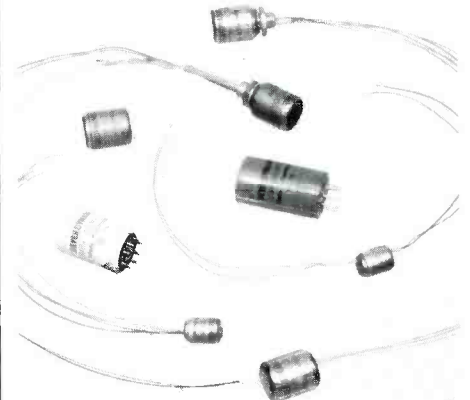

All units feature unique semi-toroidal construction, low distortion and wide frequency range, and are the end product of over fifty years experience in the audio field. Non-standard transformers can be made to customer specifications, and private labeling is available on quantity orders.

BEYER DYNAMIC, 155 MICHAEL DRIVE, SYOSSET, NY 11791, (516) 364-1900 (213) 846-0500.

For more information circle No. 166

EVERYTHING AUDIO DISTRIBUTES HELIOS CONSOLES IN THE U.S.

Everything Audio, as the sole U.S. distributor, announces the availability of the Helios family of consoles.

These mixing systems are supplied with from 24 to 32 input channels, each with 3 or 4 section sweep frequency equalization, plus high and low pass filters. Up to 16 submaster busses can each have a slide fader and switch insertion point. Track monitoring for 24 tracks has small slide faders, echo and cue sends. Combined echo send/return modules have stereo returns. Cue mixes from channels



and tracks are matrixed to up to four separate studio feeds.

Up to 8 compressors and various effects devices can be built into the console and accessed to any channel or submaster through the compact jackfield, which also handles all the recorder and outboard patching of an average multi-track studio at the console. Digital clock, phase correlation meter, machine remotes and small monitor speakers are provided as standard equipment.

Helios is a London based company, and has been supplying sophisticated mixing systems for 7 years. Their consoles are used internationally.

EVERYTHING AUDIO, 7037 LAUREL CANYON BL., NORTH HOLLYWOOD, CA 91605 (213) 982-6200

For more information circle No. 167

STUDER ADDS POWER AMPLIFIER

Willi Studer America, Inc. is proud to announce the introduction of the A-68

Power Amplifier.

The amplifier provides 100 watts per channel into 8 ohms and is easily converted to mono operation through the use of input bridging.

The primary design consideration was to provide the industry with a "state of the art" solid state amplifier with minimum transient intermodulation distortion. This was carried out by utilizing fully complimentary circuitry throughout with a minimum of overall negative feedback.

WILLI STUDER AMERICA, INC., 1819 BROADWAY, NASHVILLE, TN 37203, (615) 329-9576.

For more information circle No. 168

SELECTAKE II INTRODUCED BY 3M, MINCOM DIVISION

A sophisticated location and selection device, Selectake II is a powerful micro-processor in a compact, self-contained calculator-style case to be used remotely with the professional Series 79 multi-track recorders.

Programming a cue during a session simply requires entering a "store" command and the digitally displayed time on a keyboard. Up to nine separate cues can be stored in the unit's memory. No information is placed on the tape.

Cue recall is accomplished by touching the recall key, number key corresponding

F769X-R VOCAL STRESSER combines the E900 Sweep Equalizer with the F760X Complex-Limiter in a unique audio package that has found an enthusiastic reception among so many balance engineers. The equalizer can be routed 'before' (PRE); 'after' (POST) or into the side-chain of the compressor section (S.C.) where it is possible to establish one's own particular frequency conscious side-chain. An alternative input and output are provided so that the equalizer can be used to process a different signal when not in use with the F760X section. The name VOCAL STRESSER was coined since the package proved so successful in handling difficult vocals; it is of course ideally suited to all instrumental work.

The combination COMPEX-LIMITER-EQUALIZER is a most versatile and useful package and can be relied upon to produce *new* sounds from instruments; improving final program material, and is ideal for use in telecommunication applications; equalizing telephone lines, improving mean-level and attenuating noise.

- | | |
|---|---|
| ★ PEAK LEVEL LIMITING | ★ TWO CUE OPTIONS |
| ★ VARIABLE THRESHOLD, MULTI-SLOPE COMPRESSOR | ★ 40 dB EQUALIZER CONTROL RANGE |
| ★ NOISE ELIMINATING EXPANDER/GATE | ★ ROUTING OF EQUALIZER - 'PRE'; 'POST' OR INTO SIDE-CHAIN OF COMPRESSOR |
| ★ CONTINUOUSLY VARIABLE FREQUENCY SELECTION | ★ REDUCTION OF MODULATION EFFECTS |
| ★ FOUR SIMULTANEOUSLY VARIABLE EQUALIZER SECTIONS | ★ SEPARATE OR COMBINED USE OF F760X AND E900 SECTIONS |

**audio & design
recording Ltd**



in the U.S. - GREGG AUDIO DISTRIBUTORS, 1019 No. Winchester, Chicago, IL 60622 (312) 252-8144
in Canada - NORESCO MANUFACTURING, 100 Floral Parkway, Toronto, Ontario (416) 249-7316

For more information circle No. 169

R-e/p 89

When You're Trying to Put a 10 lb. Sound Into a 5 lb. Bag.

The Model LA-5 is ideal for the protection of amplifiers and speakers from power overload. It has smooth, natural RMS action to monitor the audio signal level and limit power output to a safe value preset by the user, without destroying natural transient peaks. It also helps the mixer who must continually watch for poor microphone technique and large dynamic ranges during live performances. Inputs and outputs are balanced, or may be used single ended. High input impedance and low output impedance allow patching flexibility. Half rack size, under \$300.00. Available from your UREI dealer.



11922 Valerio Street, No. Hollywood, Calif. 91605
(213) 764-1500

Exclusive export agent:
Gotham Export Corporation, New York

For more information circle No. 170

85% Of Our Graduates ARE Working In The Record/Music Industry

It's not by chance that the College for Recording Arts is fully accredited by the National Academy of Recording Arts and Sciences Institute.

It's because our curriculum has one main purpose: to prepare you for a Music Industry job. Our graduates got jobs because they were persistent and didn't give up. And because they gained enough experience to be immediately valuable to a potential employer. This is what the College for Recording Arts is all about.

You'll learn from professionals who are active in the Music Industry.

You'll learn by experience in our many studios: a 16-track studio, a radio broadcast studio, a disc mastering studio with the latest Neumann disc mastering system, and a separate 8-track studio with one of the most sophisticated synthesizer systems available today.

You'll learn the principles of Audio Engineering, Music Production, Music Law, Music Business and Finance, Studio Electronics, Disc Mastering, and Electronic music synthesis.

If you are seriously interested in starting a career in this industry, and have the desire to work hard for it, call or write for our Catalog.



College for Recording Arts
665 Harrison Street
San Francisco, California 94107
(415) 781-6306

SEMESTERS BEGIN OCTOBER,
FEBRUARY, AND JUNE.

For more information circle No. 171



to store position and locate key which moves the tape drive to the specified location at high speed, stopping within one count of the cue point, thus eliminating overshoot.

Control panel contains full tape control functions including rewind, forward, record, stop, play and locate.

Tape motion driven, both digital time and locate readouts cover minutes from 0.00 through 99.99. Display is "frozen" upon tape run out allowing rethreading without loss of location.

Unit features automatic "hi-low" speed switching with manual select for 7½ - 15 and 15 - 30 ips ranges. Logic pushbuttons are backlighted.

The unit will be available in the fourth quarter of 1976, and is priced at \$1,750. 3M COMPANY, MINCOM DIV., DEPT. MN6-19, BOX 33600, ST. PAUL, MN 55133

For more information circle No. 172

OPAMP LAMPS INTRODUCES NEW WIDEBAND AMPLIFIER MODULE

The Opamp Labs Model 34 Audio Amplifier-100 kHz Magnetic Tape Bias Oscillator-Buffer is a dual-purpose module



used for general signal processing. It may be used to provide up to 34 dB gain (X50) as an earphone-speaker amplifier, distribution amplifier, combining amplifier, microphone amplifier, magnetic tape recording amplifier, and magnetic tape recording bias and erase driver service.

The device is short-circuit protected and will tolerate capacitive loads up to one micro-Farad. Weighing only 2 ounces, the amplifier is packaged in the form of a one-inch diameter by two-inch high cylinder with octal plug that is standard OpAmp Labs products. A power source of eight to thirty Volts is required for operation of the Model 34.

Price: \$20.00

OPAMP LABS, INC., 1033 NORTH SYCAMORE AVE., LOS ANGELES, CA 90038, (213) 934-3566

For more information circle No. 173

FRAP 'MODEL T' PICKUP

The Frap Co. is now producing a patented 3-dimensional pickup, the Model T



Frap, for guitar and other acoustic instruments at a price a working musician can afford. This cost effectively engineered Frap system features:

- a three-dimensional Frap transducer

for detecting all the vibrations (up/down, right/left, back/forth) on virtually any resonating instrument.

— A *low noise, low distortion, high performance preamp* for interfacing the Frap transducer with any amplification or recording equipment.

— an *adhesive wax* for attaching the transducer to an instrument in seconds with no danger to the finish.

The Model T Frap system utilizes a plus and minus power supply powered by two 9-volt batteries, a high reliability *long frame phone jack* with *integral on/off switch*, and self-cleaning cross paladium contacts. This unit gives super fast, rulerline *flat response* from 40 to 100,000 Hz. It utilizes state-of-the-art IC circuitry. The input noise level is below 12 nanovolts per root Hz.

The Model T Frap is sold as a complete system: *transducer, preamp, and Frap wax* with complete instruction guide.

Manufacturers suggested list: \$135.00. FRAP, P.O. BOX 40097, SAN FRANCISCO, CA 94140, (415) 543-5458.

For more information circle No. 174

WHITE INSTRUMENTS MODEL 4100 STEREO EQUALIZER.

White Instruments' new Model 4100 Stereo Equalizer is based on a combination of LC-tuned circuits and the latest integrated circuit operational amplifiers to assure high linearity and stability. Each channel has ten bands on I.S.O. octave centers from 31.5 Hz to 16 kHz. 10 dB of boost or cut is provided on continuously variable controls. A unique circuit utilizing all negative feedback provides equal Q in both boost and cut conditions. In addition, each channel has a variable low-cut control to provide 12 dB per octave of roll-off adjustable from 20 Hz to 160 Hz. Input level attenuators and overload indicators are provided on the front panel for each channel. An EQ IN-OUT switch and POWER switch control both channels simultaneously.

The model 4100 has an input impedance of greater than 40 kilohms and a recommended operating level of about 0 dBm. Maximum output before clipping is +18 dBm. Output impedance is about 100 Ohms, and the output circuits can drive loads as low as 600 Ohms. Noise and hum are better than -92 dBm due to low noise circuitry and magnetic shielding. Distortion is less than 0.1% to +18 dBm.

An accessory socket is provided on the rear panel for the insertion of low-level crossover networks for bi-amp systems. Crossover networks of either 12 dB/octave or 18 dB/octave may be ordered for virtually any frequency.

Sealed Mil-spec rotary potentiometers are used throughout for long noise-free operation. Dials are calibrated for ease in logging or repeating settings. The unit is

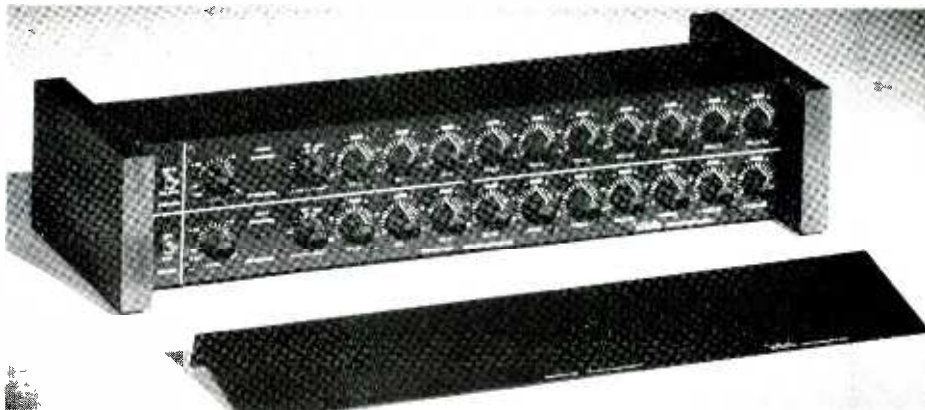

No other tape cartridge machine can do so much for so little



Recorder/reproducer \$775

PD II SERIES

At last—a machine that records and plays mono tapes in the "A" size cartridge, stops automatically on the 1kHz cue tone and—offers you longer life, less maintenance and better performance than any other cartridge machine at an economy price.

Compare for yourself

- ITC's famous air-damped solenoid with Teflon coated plunger assures super-quiet operation.
- Deck is milled from a solid block of ½ inch thick aluminum. It won't warp... presents the same flat, stable surface to cartridges every time. Assures correct azimuth of heads.
- Heavy-duty micro adjustment head assembly with adjustable tape guides. Designed for easy, accurate adjustments.
- Direct-capstan, 450 RPM, hysteresis-synchronous drive motor—with an electrolyzed shaft—minimizes wow and flutter. Eliminates need for rubber belts and separate flywheel assembly.
- New trim-line design lets you place *three* units side-by-side in a 19 inch rack. Each unit is only 5¾ inches wide, 5¼ inches high and 15 inches deep.
- Features latest solid state components, even for switching applications. No relays. Printed circuit cards plug in.



Reproducer \$550



Call us and we'll prove it to you

For complete information call us collect at 309/828-1381. You'll be talking to experienced broadcasters who not only know what ITC equipment can do—but know what you want it to do.

INTERNATIONAL TAPETRONICS CORPORATION

P.O. Box 241 • 2425 South Main St., Bloomington, IL 61701

For more information circle No. 175

Cut the Noise



Program-Controlled Filter/Expander

Suppresses mechanical, electronic, and tape system noise, or restores program dynamic range by linear broadband expansion. Variable threshold adjustment allows precise selection of restoration point. Visual indication of threshold coincidence and full expansion.

Model 240, \$260.



1630 Dell Avenue, Campbell, CA 95008 (408) 374-8300

For more information circle No. 176

An ALL MODULAR pro mixing board true studio spec's on the road reliability — a system to meet your changing needs with versatile plug-in units

COMING ATTRACTION

three ma inframes
12 in, 16 in, 24 in
with outputs from
2 to 16 channels



all thoughtfully engineered for maximum creative potential yet very affordable

LOFT MODULAR DEVICES SERIES 440 & 400

Active Crossover
tunable cross point
high and low gain

ALSO FEATURING

Graphic EQ's
six and nine bands
THD 005 w/ 7 volt in
minimal noise

AND

Phasers Flanger
Limiter Compressor
Stereo Delay Line
AND MORE!

Get the details—

MODULAR DEVICES
Manchester Ct 06040/203-646-7806
Order Inquiries Welcome

For more information circle No. 178

furnished with a security cover.

The Model 4100 is finished in black anodized aluminum with solid walnut trim. The unit measures 18½ inches by 6¾ inches by 3½ inches and weighs about 7½ pounds. It may be powered from either 115 or 230 VAC, 50 to 60 Hz. A rack mount model is also available.

Price: \$599.

WHITE INSTRUMENTS, INC., P.O. BOX 698, AUSTIN, TX 78767 (512) 892-0752

For more information circle No. 177

SUPER "C" MASTER-ROOM REVERBERATION UNIT

MICMIX Audio Products has developed a new electronics unit to complement its line of 'C' Series Master-Room Reverberation Chambers, which it calls the SUPER "C" models. As in the regular 'C' Series units, SUPER "C" chambers are full two-channel stereo with separate Sound Columns (not shown in the photo) incorporating the exclusive delay and ambience characteristics of all Master-Room units. Also included in the SUPER "C" models are variable decay controls and independent reverb and direct signal mix controls on each channel for optimum mixing capability.

In addition, SUPER "C" chambers feature both high and low shelf equalization plus selective frequency peak EQ to provide the utmost in reverberation sound tailoring. Shelf controls provide 17 dB boost and 18 dB cut at 150 Hz and +14 to -12 dB at 20 kHz, while the peak controls permit up to 10 dB boost at selective frequencies of 1.5, 2.2, 3.4, 4.5 and 6.0 kHz.

With the EQ controls in the 'flat' position, SUPER "C" models provide the typical smoothness and flat response (without internal or external limiting) for which Master-Room units have become so well known. The new models with equalization controls now permit a substantial variation of that Natural Sound Ambience for both subtle and unusual effects.

The electronics are mounted in a standard 3-1/2 inch rack panel and brackets are provided for the Sound Columns. Options include balanced line transformers and cabling for remoting the Sound Columns.

Price: From \$1995.

MICMIX AUDIO PRODUCTS, INC., 9990 MONROE DRIVE, SUITE 222, DALLAS, TX 75220, (214) 352-3811.

For more information circle No. 179

DELTA GRAPH MODEL EQ-10 EQUALIZER KIT

The Model EQ-10 Graphic Equalization system is a unique product line based on individual-channel ten band octave equalizer modules, which can be used to form mono, stereo, quad, eight-channel and multi-track equalization systems. Offering fully guaranteed specifications, not only at the center detented 'flat' position, but at all equalization settings, the manufacturer claims these graphic equalizer modules will not degrade the noise or distortion performance of any consumer or professional audio system with any available program material. The EQ-10M kit, a single-channel unit priced at only \$56 complete with all components and instructions. No special skills, tools or test equipment is required, and construction time is only a few hours per module.

The units utilize state-of-the-art gyrator inductor-simulation techniques with all active circuitry confined to three monolithic IC packages. Provisions for both balanced and unbalanced lines are standard, as well as full length 60mm sliders with metal-enclosed, metal-shafted construction and center 'click' detent reference points at the flat response setting. Due to the absence of low and mid-frequency wound coils, the manufacturer claims, the equalizers are immune to hum-pickup, saturation and 'ringing' at all settings. The individual octave-band controls allow up to 15 dB of symmetrical boost and cut at each of ten ISO-standard octave bandcenters, and the claimed frequency response at the center position is flat within ±¼ dB from 20 Hz to 20 kHz, without any phase angle deviations.

Each individual channel equalizer module is housed in a rugged die-cast enclosure that, besides being only 2" deep behind the mounting surface, is specifically designed for standard EIA and RETMA 19" rack mounting. The individual modules are 5¼"H by 9½"W, the standard half rack size, with mounting holes on 3½" centers. Delta Graph also

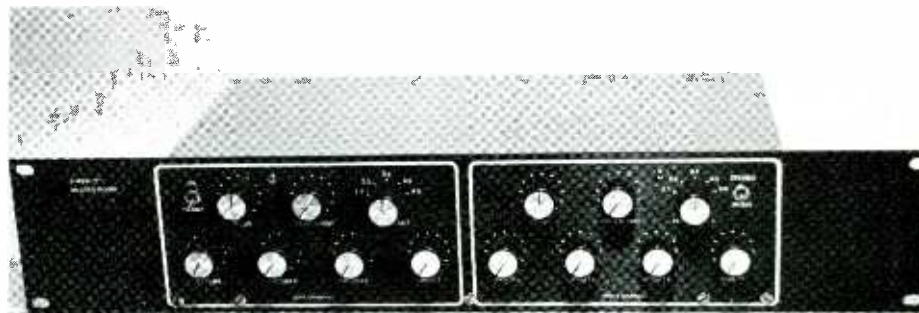

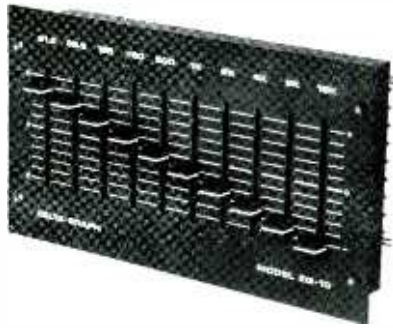

offers a walnut-veneer cabinet for mounting module pairs, along with the required external power supply.

The modules and several complete systems are available directly from the manufacturer.

DELTA-GRAPH ELECTRONICS, P.O. BOX 741, PASCO, WN 99301

For more information circle No. 180

SAE MODEL 2400L POWER AMP

Using the new LED Power Display system, this new power system instantly displays output power in 3 dB increments from 40 milliwatts to full power plus overload. The fast response circuitry and the side by side layout offers immediate indication of channel or response imbalances and checking stereo imaging. The power range covered is so broad that accurate power indication can be realized even at the lowest power levels. Coupled to this display is one of the most successful amplifiers in SAE's history; the Model 2400. This amplifier offers 200 Watts RMS per channel with less than .05% IM and THD, greater than 100 dB S/N and a slew rate of over 40 volts per micro second.

"To ensure the ultimate in sonic performance from the 2400L", according to National Marketing Manager Michael Joseph, "the fully complimentary circuit is used with its famous series output configuration to result in an amplifier stable into the most reactive loads. To further ensure clarity we incorporated our unique feedback level control system which has no affect on noise level, frequency response, or input impedance, all of which are often affected by conventional vol-

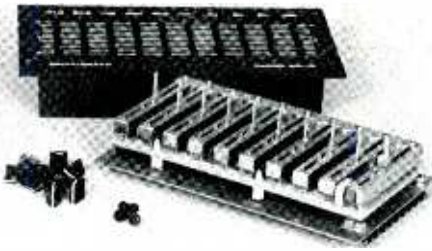

ume controls."

Product availability: October 1976. Suggested value: \$800.

SAE (SCIENTIFIC AUDIO ELECTRONICS), 701 E. MACY STREET, LOS ANGELES, CA 90012 (213) 489-7600

For more information circle No. 181

NAKAMICHI ANNOUNCES MODEL 620 POWER AMPLIFIER

The 620 is Nakamichi's newest entry in its Recording Director Series, a group of products already comprised of the Model 600 Cassette Console and Model 610 Control Preamplifier, both released earlier this year.

The most striking aspect of the Nakamichi 620 power amplifier is the fact that its barely measurable Total Harmonic and Intermodulation distortion figures said to be an entire order of magnitude lower than those of most high quality pre-amplifiers at all power levels right up to and beyond its conservatively rated maximum output of 100 watts continuous sine wave per channel. According to the company this is the result of a radically new circuit referred to as a "tetra-linear differential amplifier." It is a pure class B design that virtually eliminates crossover and switching distortions found in all popular class AB power amplifiers.

This new circuit design is said to increase temperature stability and efficiency. The idling current of the 620 is claimed to be 1/25 that of other power amplifiers of comparable output ratings. Nakamichi's tests show, that the 620's performance is independent of ambient or operating temperature.

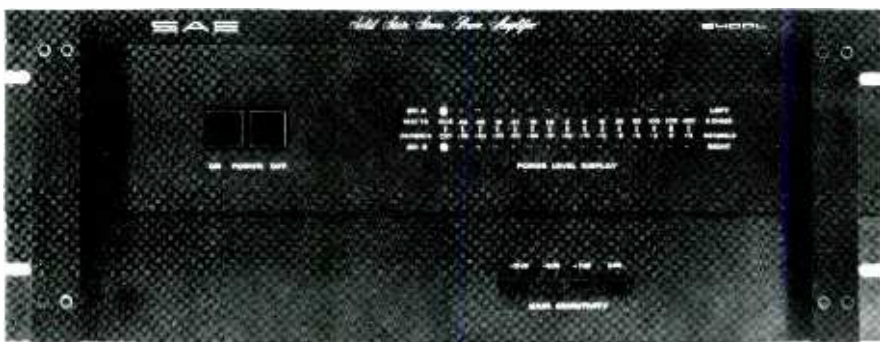

WANTED!



For the very best Studio Construction available . . . usually wears nail bags - carries hammer and tape - drives crew very hard and smiles all the while !!! Occasionally, he's caught looking at plans. Is also known for doing work all over North America - giving firm estimates - exacting dates of completion and No BULL!

He leaves a trail of 'Happy Customers', and is easy to follow !!!

CALL FOR INFORMATION AND DETAILS.

805 / 273-3792

RUDOLF A. BREUER

Lic. No. 238315

For more information circle No. 182



Just off press!

MARTIN Pro Audio-Video Product Directory Volume I

Compiled by John M. Woram

All the comparative technical specs you need, with prices, before you buy

- EQUALIZERS • EXPANDERS AND NOISE GATES • REVERBERATION SYSTEMS • MICROPHONES
- MICROPHONES ACCESSORIES

Over 40 pages covering over 300 products from 30 manufacturers of pro equipment - all the facts you need before you buy. Only \$2, refunded on first purchase of \$25 or more.

Send \$2 to:

Martin Audio/Video Corporation
320 W. 46 St., New York, N.Y. 10036

For more information circle No. 183

The single supply of the Nakamichi 620, which utilizes large filter capacitors and a massive toroidal power transformer that equals the performance of conventional transformers many times its size with much lower flux leakage, is capable of such tremendous reserve that performance with only one channel driven does not significantly differ from that with both channels driven. Nakamichi believes this method to be superior to using an independent power supply for each channel.

The amplifier is reportedly stable into all types of loads, including reactive



loads. Protection of the output transistors and loudspeakers is accomplished without the use of relays or current limiting devices. Short-circuiting the outputs will not cause any damage to the Nakamichi 620.

Dub faster



Dub easier

Garner Model 1056 updates your dubbing operation. Five 1200' professional copies in four minutes. Threads fast. Rewinds in 60 seconds. Single capstan drive and solid state electronics guarantee unvarying high quality. Priced low enough for quick payout. Write for brochure and names of users.



GARNER INDUSTRIES

4200 North 48th St.
Lincoln, NE 68504
Phone 402-464-5911



The stunning panel of the 620 power amplifier features peak indicating lamps that are integrated into the heat sink fins. With rear panel switches these lamps may be programmed to light green at 1, 5 or 25 watts and red at 25, 50 watts or clipping. The lamps indicate the true preset peak value at any frequency.

The Nakamichi 620 will carry a suggested retail price of \$600.00. NAKAMICHI RESEARCH (U.S.A.), INC. 220 WESTBURY AVE., CARIE PLACE, NY 11514, (516) 333-5440.

For more information circle No. 186

MALATCHI SYSTEMS PANORAMIC MIXER WITH EFFECTS CONTROL

This newly introduced unit is designed for from four to twenty input channels with low and high frequency equalization ± 20 dB, LED overload indicators, stereo pan, effects send level and preamp output per channel are available in the PM54E/PE54 mixing system.

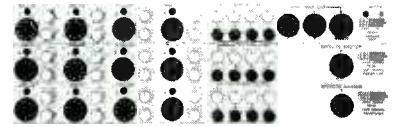

Each channel has two line inputs with switchable sensitivity and one transformer balanced, microphone input with phantom power for condenser microphones. "A" output has balanced XLR mic/line and unbalanced phone jack line outputs. Effects output has microphone and line sends. Up to five separate effects mixes plus individual channel patching in a twenty channel system.

The unit is said to be ideal for portable sound reinforcement, keyboard mixing and recording (20 channels in an 8 1/4" X 19" rack).

Price: From \$449.

MALATCHI SYSTEMS, 3731 EAST COLFAX, DENVER, CO 80206 (303) 321-3520

For more information circle No. 187

OVERHEIM 4-VOICE POLYPHONIC SYNTHESIZER WITH PROGRAMMER

The new Oberheim Polyphonic Synthesizer Programmer allows the most crucial parameter settings to be made from a central panel and also allows sets of these settings (called 'programs') to be stored in a memory. The controllable parameters can be set and stored separately for each Expander Module in Oberheim Four and Eight Voice Polyphonic Synthesizers. Sixteen complete programs can be stored.

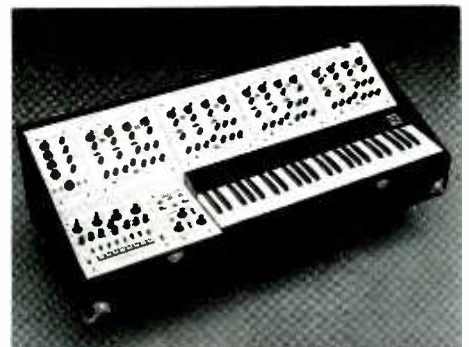

The Oberheim Four Voice Polyphonic Synthesizer is the first commercially available synthesizer on which four notes can be played simultaneously. Using versatile Synthesizer Expander Modules as its major elements, it is actually four complete synthesizers controlled by a single keyboard. The 49-note keyboard utilizes advanced technology to generate independent control signals for each Ex-

Check Audiotechniques First

... FOR DOLBY

We're one of the world's largest Dolby dealers . . . offering sales, service, rentals and consultations on specific applications. FM broadcasters, film makers, universities, recording studios . . . all depend on us for prompt service and accurate information.

Official Dolby Service Center



audiotechniques, inc.

142 Hamilton Avenue, Stamford, CT 06902 Telephone: 203 359 2312

For more information circle No. 185

pander Module. A variety of keyboard controls are provided to enhance polyphonic 'playability'. An output mixer allows a stereo pan to be generated producing an unusually live sound. With the aid of the Pan Pots, a stereo spread of the Expander module outputs can be produced. Additionally, the keyboard electronics can be expanded to eight voices.

OBERHEIM ELECTRONICS, 1549 9th STREET, SANTA MONICA, CA 91401

For more information circle No. 188

PULSE DYNAMICS NEW LED V-U METER

Pulse Dynamics Manufacturing Corporation has announced the availability of a compact LED-type volume indicator, the Model M-241A. Guaranteed unconditionally for five years, the meter features an instantaneous peak response characteristic to program levels with a slow decay. Indications of -15 to +3 VU are displayed in 3 dB steps by flashing light-emitting diodes.



The M-241A has an output sensitivity of 0.775 Volts RMS (sine), ±10% trimmable, for a zero VU indication. The input impedance presented to the signal source is 80 kOhms. Short duration overload capability is 1,000% with built-in circuit saturation. Horizontal or vertical-reading scales are available. The units operate from an external 12 to 15 Volt supply and draw 30 mA typically. The metered signal must share the DC supply negative common for proper operation.

Unit dimensions are 2.7 inches width by 0.88 inches height by 3 inches depth.

Price: \$30., quantity 1-9.

PULSE DYNAMICS MANUFACTURING CORP., BOX 355, COLCHESTER, IL 62326 (309) 776-4111

For more information circle No. 189

Perform a death-defying act.

Give Heart Fund.

American Heart Association 

Classified

CLASSIFIED ADVERTISING RATES

Prepaid* with submitted copy:

One column inch (1" X 2 1/4") . . . \$35.00
 1/2 column inch (1/2" x 2 1/4") . . . 20.00

* (If billing is required add 20%)

BOOKS

HOW TO BE A MUSIC PUBLISHER

by Walter Hurst & Don Rico

Extensively illustrated. Basic text, outlines, forms, contracts . . . \$10.00
 Film/TV Law \$10.00
 Music/Record Business & Law \$10.00
 How To Sell Your Song . . . \$5.00
 The Income Tax Comic Book . \$10.00

FREE

Book & Spoken Word Cassette Catalog
 7 ARTS PRESS, INC.
 BOX 649
 LOS ANGELES, CA 90028

SOUND SYSTEM ENGINEERING

by Don & Carolyn Davis

296 pages 8 1/2 x 11

Hardbound \$19.95

R-e/p BOOKS

P.O. Box 2449

HOLLYWOOD, CA 90028

MICROPHONES: DESIGN and APPLICATION . . .

by Lou Burroughs

A practical, non-theoretical reference manual for those involved in the application of microphones for recording, TV, motion pictures, sound reinforcement.

Hardcover \$20.00

R-e/p BOOKS

P.O. Box 2449

HOLLYWOOD, CA 90028

HANDBOOK OF MULTICHANNEL RECORDING

by F. Alton Everest

320 pages 201 illustrations

The book that covers it all . . . a comprehensive guide to all facets of multi-track recording . . . acoustics . . . construction . . . studio design . . . equipment . . . techniques . . . and much, much more.

Hardbound \$10.95 Paperback \$7.95

send check or money order to:

R-e/p BOOKS

P.O. BOX 2449

HOLLYWOOD, CA 90028

Erase faster



Erase cleaner



Erase easier



Garner Erasers cut man-hours spent erasing audio and video tapes. Simple, safe continuous belt operation gives you "hands-off" professional erasures in only four seconds. Handles up to 10 1/2" reels, cartridges, and cassettes. Acclaimed by major users, yet priced low enough for the smallest studio or station to afford.



GARNER INDUSTRIES

4200 N. 48th St.
 Lincoln, NE 68504
 402-464-5911

For more information circle No. 190

Check Audiotechniques First

. . . FOR NEUMANN

We're one of the nation's largest Neumann dealers. Our microphone specialists can recommend the Neumann mikes best suited to your requirements.



NEUMANN MICROPHONE SALES AND RENTALS

audiotechniques, inc.

142 Hamilton Avenue, Stamford, CT 06902 Telephone: 203 359 2312

For more information circle No. 191

R-e/p 97

BOOKS

MICROPHONE RECORDING TECHNIQUES

New handbook covers professional microphone techniques for all types of musical instruments. Also sections on microphone principles, types and connections. \$3.95
 MTA-Dept. RE
 4260 Lankershim Blvd.
 No. Hollywood, CA. 91602
 California residents add .24 tax.

SERVICES

PROFESSIONAL MONITOR TUNING

Even the finest control room designs require speaker line tuning for accurate response. Milam Audio uses only the finest Real Time Equipment to read and correctly perform monitor tuning. For information contact:

MILAM AUDIO CO.
 1504 N. 8th Street
 Pekin, IL 61554 (309) 346-3161

Producer-engineers 8-track studio time available, mid-Manhattan, fully equipped.
 (212) 852-3295

HIGH INTENSITY turned sound reinforcement + disco + 4-24 track studios, including narrow band (5 Hz!) feedback and ring mode suppression, detailed regenerative response environmental equalization ± 1 dB at your ears, room design/measurement/treatment, 15% articulation loss of consonants, our 18 dB computer designed crossovers and enclosures. 1000's of customized and expandable professional products including: splayed fiberglass horns, consoles, comp/rms/peak limiters, continuously variable electronic crossovers, digital/acoustic/analog delays, omnipressors, flangers, reverb, echo, doubling, tripling, p.a. noise reduction, piezo transducers, frequency shifters, notch filters, etc. All shipped prepaid + insured. Sonic Engineering Labs, 11 1/2 Old York Rd., Willow Grove, Pa. 19090, (215) 659-9251.

+Anechoic Chamber+
 Inventors/Engineers

EQUIPMENT

FREE CATALOG & AUDIO APPLICATIONS



CONSOLES
 KITS & WIRED
 AMPLIFIERS
 MIC. EQ. ACN.
 LINE, TAPE, DISC,
 POWER
 OSCILLATORS
 AUDIO
 TAPE BIAS
 POWER SUPPLIES

OPAMP LABS, INC.
 1033 N. SYCAMORE AVE.
 LOS ANGELES, CALIF. 90038
 (213) 934-3300

For more information circle No. 192

EQUIPMENT

ONE STOP FOR ALL YOUR
 PROFESSIONAL AUDIO REQUIREMENTS
 BOTTOM LINE ORIENTED
F. T. C. BREWER COMPANY
 P.O. Box 8057 Pensacola, Florida 32505

FOR SALE
 16 track studio; successful operation for
 14 years

Owner will remain until transition is
 complete

For confidential replies write:

R-e/p
 Dept. MD
 BOX 2449
 Hollywood, CA 90028

3M Series M-23 8 Track Tape Recorder,
 6 years old, replaced heads (minimal wear),
 very good condition. Specifications and
 pictures available upon request.

(8) Dolby 361-A noise reduction units.
 Excellent condition. \$600 each.

call
 W. Ramsey, (515) 478-9294

**MCI . . . Now the best selling multi-track
 recorder!**

MCI . . . only from Audiotechniques, Inc.
 in the great northeast!

Tape recorders from one track to 24
 track

Recording consoles up to 40 input

MCI sales-service
 factory trained technicians
 Studio design and
 construction service

AUDIOTECHNIQUES, INC.
 142 Hamilton Avenue
 Stamford, Conn. 06902
 (203) 359-2312

EQUIPMENT AVAILABLE

DYMA builds roll around console mounts
 for any tape recorder. DYMA builds beautiful
 studio cabinetry.

DYMA
 Box 1697
 Taos, NM 87571

New York's leading dealer specializing in Semi-Pro and Professional Recording and P.A. Equipment. Teac, Tascam, Sound Workshop, Nakamichi, DBX, MXR, Dynaco, ADS, Frazier, Eventide, Electro-Voice, Shure, Scotch, Maxell, and more. We go both ways: Lowest prices in sealed factory cartons, or complete laboratory check-out and installation. All equipment on display.

AUDIO BY ZIMET
 1038 Northern Blvd.
 Roslyn, L.I., New York 11576
 (516) 621-0138

SMALL 4-16 TRACK STUDIOS
 Detailed technical assistance + acoustical
 consultation, from our engineering division
 to our clients - either here or via phone &
 included FREE.

+

Tascam Warranty Service Station + Sales
 Sonic Engineering Lab, 11 1/2 Old York
 Road, Willow Grove, PA 19090, Phone
 (215) 659-9251.

The Only One

WHITE BOX RECORDING TAPES

Scotch 201-1200'x1/4"--@\$.75 per roll per
 100; Scotch 202-1800'x1/4"--@\$1.00 per
 roll per 100; Scotch 206-1200'x1/4"--\$1.50
 per roll per 100; Scotch 207-1800'x1/4"--
 \$2.00 per roll per 100; 1/4", 1/2" and 1' also
 available on hub in bulk, w/wo box.
 Write/call:

AAA Tape Supply Co.
 1214 Page Ave.
 Jackson, Mich. 49203
 (517) 787-4020

FOR SALE

3M - 4 Track in Console, 15-30ips
 Excellent condition . . . \$3,900
Countryman 967 Phase shifter . . . \$190.
VSO McIntosh 200 Watt . . . \$400.
**4 Studer A-80 Mark 1 electronics (100 hrs
 use) . . . \$800 each**
AKG-BX 20E Reverb w/remote
 \$2,500 or best offer
JBL 4350 Speakers . . . \$1050 each
 (still in Warranty)
**Stephens 24 Track Recorder, Latest
 Model, Like New . . . \$20,000**
Call: (213) 461-3717
Ask for BRIAN

Studio Closing Equipment Sale
 Chicago Recording Company has closed
 its studio in the country. All remaining
 items are in new or like new
 condition and available at 1/2 price or
 less. For sale are: 1-3M Selectake
 search & cue, 16-MCI noise gates,
 2-Altec 9846B Bi-amp monitors,
 1-Mellotron 400, and 2-custom
 Formica equipment cabinets. If in-
 terested contact:

Alan Kubicka or Cleon Wells
 (312) 822-9333

MCI . . . The finest name in Audio Re-
 corders and Consoles, now offers 1 to
 24 track Master recorders and up to 40
 in, 40 out Automated Consoles. For
 Midwest Factory representation contact:
MILAM AUDIO CO.
 1504 N. 8th Street
 Pekin, IL 61554 (309) 346-3161

FOR SALE
 2 Ampex MM 1000 16-track recorders
 wired for 24 and spares.
RECORD PLANT STUDIOS
 (212) 581-6505

LIKE NEW and USED EQUIPMENT RECORDERS (unmounted)
AMPEX AG-440-B8; deck excellent condition, heads and electronics good
 \$5,500.
AMPEX 354 stereo; good condition
 \$1,000.

MIXERS
INTERFACE series 300; 20 in/8 out, expandable to 24, excellent condition
 \$6,500.
INTERFACE Series 100; Stevenson 8X4 main frame w/o modules, like new condition
 \$350.

MISCELLANEOUS
AR LIST speakers (2); excellent condition
 \$450. each
PATCH BAYS (2); 48 position, tiny telephone, pre-wired w/terminal blocks
 \$200. each

BILL KASTNER
2419 ILLINOIS, FLINT, MICH 48506
(313) 767-5096

Now in the S. W. Area the new **SPECK** console is in use and ready for you to hear. Also dealing Sennheiser, Tapco, Sony, DBX, ect. at super low prices. Call us first. Noon to 8 pm.

TEXAS STUDIO SUPPLY COMPANY
 2036 Pasket
 Houston, Texas 77092
 (713) 688-8067

PRO AUDIO EQUIPMENT AND SERVICES

Custom touring sound, 2-, 4- and 8-track studios, disco systems. Representing Akai, AKG, Altec, Beyer, BGW, Cetec, Cerwin-Vega, Community Light & Sound, dbx, Dynaco, Dokorder, E-V, Gauss, Lamb, Langevin, 3M, Martex PM, Maxell, Meteoc, Russound, Revox, Sennheiser, Shure, Sony, Soundcraftsman, Sound Workshop, Spectra Sonics, Switchcraft, TDK, TAPCO, TEAC, Technics, Thorens, and more. Offering these professional services: custom cabinet design, room equalization, loudspeaker testing, custom crossover design, electronics modification, and custom road cases. Call or write for quotes, or drop us a line for our latest catalogue.

K&L SOUND
 75 N. Beacon Street
 Watertown, Mass. 02172
 (617) 787-4073
 (Att: Ken Berger)

PINK NOISE TAPES
 Equalize with professional accuracy.
 1/3 octave bands ± 1 dB 31.5 Hz - 16 kHz
 15 ips at OP. level (185 nWb/m \$28 ppd
 7 1/2 ips at 10 dB below OP. level \$23 ppd
 Both 1/4" 2 track. **STATEX**, Audio Div.
 Box 5334-X, San Antonio, Texas 78201
Quality Products Since 1929

FOR SALE: Electro-Sound ES-505 2-track in console. Less than 200 hours, full warranty. \$3300.
 (415) 654-6630

STUDIO SALE
 We have purchased two studios and offer all equipment for sale. Scully lathes, recorders, microphones, consoles, and film equipment. Trades and lease will be considered immediately.

UNIVERSAL AUDIO SALES
 40 East Thomas
 Phoenix, Arizona 85012
 (602) 263-9072

FOR SALE
MCI JH-114 16-track with Auto Locator
 \$15,750

ITI Parametric equalizers
MEP-230 \$925
MEP-130 \$425

Audio Techniques Mastering Labs Monitors
Big Reds \$475
Super Reds \$675

Pandora Time Line \$2,500

Used tape with reel and box
 1/2" \$5.00
 1" \$10.00
 2" \$20.00

SOUND 80 INC.
 2709 East 25th Street
 Minneapolis, MN 55406
 (612) 721-6341

EXCELLENT CONDITION
SPECTRA SONICS 1020, 20 in by 16 out Console, rebuilt for 110 audio amps for 1/2 the noise and twice the headroom (as compared to 101 amps). All resistors changed to 1%. All amplifiers and power supplies **NEW** Spectra Sonics—Scully 16 channels recorder/reproducer, Spectra electronics and heads, Oliver Audio Engineering transport logic, and search and cue, Scully transport dbx 216-16 channel noise reduction . . . Eventide digital delay JBL 4333 monitor w/ Spectra Sonics tri-amp

PACKAGE PRICE - \$20,000
RAYMAX RECORDERS
 (213) 273-3894
 Todd or Art

FOR SALE
 (2) DBX 160 Limiters in 19" rack mount
EXCELLENT CONDITION
 \$480.00
 (312) 944-7724
 Stew or Ken

FOR SALE
ELECTRODYNE CUSTOM ACC 2416
 Control Console W/Producers desk, 24-IN, 16-OUT Quad, 2Trk, plus Mono Mixdown capabilities, 4-Echo Sends and Returns, Plus many other features.
 Cost \$52,293 - Asking \$18,000
MOTHER MUSIC SOUND RECORDERS
 415 N. Tustin Avenue
 Orange, CA 92667
 (714) 639-6420

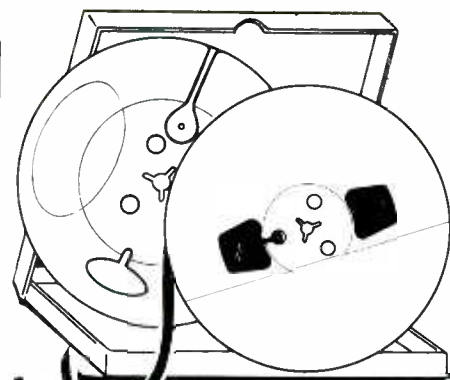

complete supplies for reel to reel audio recording

TAPE **AMPEX and Scotch** all professional grades on reels or on hubs

EMPTY REELS all sizes, widths and hub types

BOXES for all reels, in various colors

LEADER, TIMING & SPLICING TAPES
 Top Quality Competitive Pricing
 Immediate Shipment

Recording supply corp.
 1291 RAND RD -DES PLAINES, IL 60016
 312/297-0955

A+R presents . . .

"THE PACKAGE"

- 1000 Pure Vinyl 45 RPM Records.
- Labels—Black & White at this Price.
- All Metal Parts & Processing.
- Mastering by Dick McGrew using Neumann VMS 70 Lathe and SX 74 Cutter.
- Guaranteed Delivery.

COMPLETE PACKAGE... \$19900
 (FOB DALLAS)

DELIVERY GUARANTEE
 A+R Record Manufacturing Corp. guarantees that for everyday your order is delayed past our promised shipping date we will give you 50-extra records at no additional cost.

Call Toll Free for more information.
800-527-3260

A+R record manufacturing corp.
 902 N. Industrial Blvd.
 Dallas, Texas 75207 (214) 741-2027

For more information circle No. 193

For more information circle No. 194

great advantage is that not only will it give much greater control of the mixdown process, it cannot in anyway downgrade the signal. Moreover, in the event of a fault developing, one could instantly revert to a manual mix with no loss of valuable studio time."

Peter Harries, Technical Director of the Music Centre, comments that, "the NECAM system will add efficiency to the mixdown operation whilst significantly extending the boundaries of the art of mixing. It will ensure that we can continue to offer our clients the best of everything."

GEORG NEUMANN, AUDIO PIONEER, DEAD AT 77 IN BERLIN

Georg Neumann, a pioneer in the field of audio recording and the inventor of the gastight nickel cadmium battery died at his home in Berlin (West) on 30, August 1976 at the age of 77.

Georg Neumann was born on October 13, 1898 and has been closely associated with the development of sound recording and reproduction techniques since the middle twenties. As a young engineer he developed a carbon microphone, known as the Reisz microphone, displaying remarkable improvement over carbon granule types then in common use. In 1928 Georg Neumann produced the first commercial condenser microphones, and since then these have been preeminent in their field. The high fidelity recording was born with the advent in 1948 of the Long Playing Record recorded with the now classic Neumann U47 condenser microphone.

In 1930 Georg Neumann developed the first of a long line of disk mastering lathes as well as one of the first electro-mechanical disk cutting heads, and in 1957 his company introduced the world's first stereophonic disk recording system.

Some of his other inventions covered the first linear motion pen level recorder — a device used by all manufacturers of such recorders today. During the war, Mr. Neumann developed and soon after the end of the war patented the world's first gastight rechargeable nickel cadmium battery without which space exploration would not be possible.



Georg Neumann was awarded Honorary Membership in the Audio Engineering Society in 1973, and was awarded the Society's highest honor, its Gold Medal, which he accepted in person at the Society's European Convention held in Zurich, Switzerland this past March.

LIVE MUSIC BROADCASTS AGAIN EMANATING FROM WASHINGTON D.C. STUDIO

Sounds Reasonable, Inc., (SRI), has once again opened its studio doors to local groups and musicians for broadcasts to be aired live over the facilities of WGTB-FM, the non-commercial radio station owned by Georgetown University.

The show is sponsored by Sounds Reasonable, Inc. and Techniarts Professional Audio Supply, which provide various pieces of equipment and technical backup.

Performers may obtain a taped copy of the broadcast.

CONTACT: LYN KIRCHMYER OR TERRY KNIGHT, SOUNDS REASONABLE INC., 2000 P ST., N.W., WASHINGTON, D.C. 20036, (202) 833-1976.

AUDIO RENTS' HARMONIZER SCHOOL ANNOUNCED

The Los Angeles based equipment rental company has announced a Harmonizer School to be held during the weeks of December 6 to 17, to help familiarize engineers and producers with the capabilities and effects of the Eventide Harmonizer.

The school is organized by Audio Rents in conjunction with Recording Services Company, who have furnished the tape machines; Sunset Sound, who have furnished their

Studio '3'.

The school will operate from 9:00AM — 6:00PM, Monday through Friday, at 6656 Sunset Bl. (at Cherokee), Hollywood. For further information call: Allen Byers at (213) 461-3351.

RECORDING FOR THE BLIND ASKS: CAN YOU SPARE TWO HOURS A WEEK?

Your skills are greatly needed! Recording for the Blind, Inc. is a national, non-profit organization which records and circulates educational textbooks and material free of charge, for blind and handicapped students from elementary through post-graduate levels. Presently the need is for technical readers, as well volunteers to duplicate, check and correct tapes. There is also a need for anyone who is familiar with Ampex 440B reel-to-reel tape recorders, to listen for errors, control voice level and make corrections (Monitoring — for which training is provided).

Recording for the Blind, Inc. is the outgrowth of a New York committee formed to record books for blinded veterans of World War II. It became a national organization in 1951 and there are now 28 studios across the country. Each Unit operates on its own funds, without support by United Way or government grants. The RFB Library in New York contains over 35,000 titles in all major fields of study and in 27 foreign languages. Each title represents a specific request from a blind or handicapped student. Two college students recently wrote: "Without your assistance I could not possibly have succeeded in Graduate School . . ." and "A tremendous service! The recordings made available to me have opened up a new world of opportunity for me, allowing me to continue my education."

If you can spare two hours a week, we urge you to call at (213) 664-5525 or 660-1391 now!! RFB is located at 5022 Hollywood Boulevard, on the second floor of the National Charity League Building — ample parking off Mariposa. Hours of operation are Monday through Saturday — 9.00 a.m. — 10.00 p.m. Monday thru Thursday; 9.00 — 4 p.m. Friday and 9.00 — 3 p.m. Saturday.

Still No Compromise Just a lil' bit less of the best

U.S.A.

Studio Supply Co.

P.O. Box 280
Nashville, Tenn. 37202
Tel. (615) 327-3075 Telex 555133

Westlake Audio, Inc.

6311 Wilshire Blvd
Los Angeles, Calif. 90048
Tel. (213) 655-0303 Telex 698645

Exclusive Export Agent

Audio Systems International

146 North Orange Drive
Los Angeles, Calif. 90036

Scenic Sounds Equipment

London W1H7AB, England

Audio Products International

Milan, Italy

Neotecnica, s.a.e.

Madrid, Spain

Ingenieros Electronica Asociados S.A.

Mexico 10 DF

Franz-Vertriebsgesellschaft mbH

West Germany

Studer France

Paris, France

Shindenshi Manufacturing Corp.

Tokyo, Japan

Heijnen B.V.

NL-6940 Genneep, Netherlands

INTO OY

Helsinki 17, Finland

Quali-Fi A/S

Klampenborg, Denmark

Electronica O.E.

Athens 134, Greece

Studer International A.G.

CH-5430 Weitingen, Switzerland

Harrison

Factory

Harrison S

P.O. Box 280

Nashville, Tenn. 37202

Tel. (615) 834-1184 Telex 555133

For more information circle No. 1

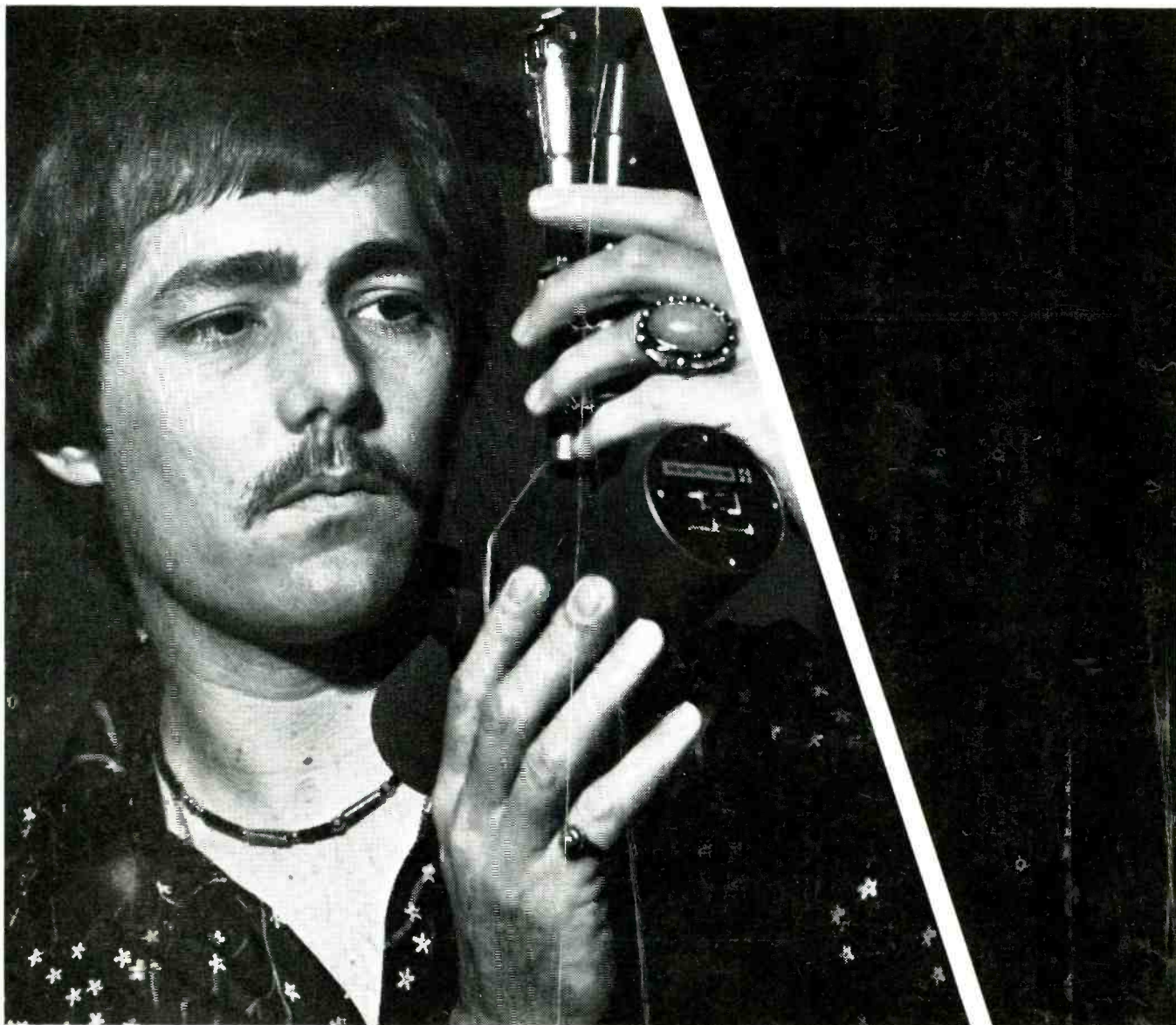

Gold prospecting with Chips Davis.



Chips Davis has gold fever as badly as any 49'er. The gold he's looking for is in the recording industry's gold records—and he prospects for it electronically in his Las Vegas recording studio. Because he works with top recording and performing stars like Paul Anka and Wayne Newton, Chips knows the importance of using the right gear for either recording or sound reinforcement work. And he knows that for this kind of prospecting, Shure microphones, audio control components, accessories, and disc reproducers represent the ultimate in quality. Their superb performance characteristics and versatility make them among the most popular and consistent choices of the most demanding professionals. Settling for anything less than the best would be like wasting time on fool's gold. For data on Shure studio equipment, write:

Shure Brothers Inc.
222 Hartrey Ave., Evanston, IL 60204
In Canada: A. C. Simmonds & Sons Limited



Manufacturers of high fidelity components, microphones, sound systems and related circuitry.

For more information circle No. 196

www.americanradiohistory.com