

SEPTEMBER/OCTOBER 1971
VOLUME 2 — NUMBER 5

\$1.00

RECORDING engineer/producer

relating recording science • to recording art • to recording equipment



11201PMEBL93DD
DOUG POMEROY
COLUMBIA RERDS
193 BAL TIC ST
BRDOKLYN

NY 11201

in this issue,
an Re/p session report:
CAROLE KING
LOU ADLER
HANK CICALO
at A&M's Studio B

MOD-N-D

SOLID STATE SWITCHING
DC CONTROL for AUTOMATION
24 OUTPUT PLUS SIMULTANEOUS
QUAD-STEREO-MONO OUTPUTS
FULL 24 INPUT ASSIGN TO ANY TRACK
78 INCHES WIDE, 45.6 INCHES WORKING AREA

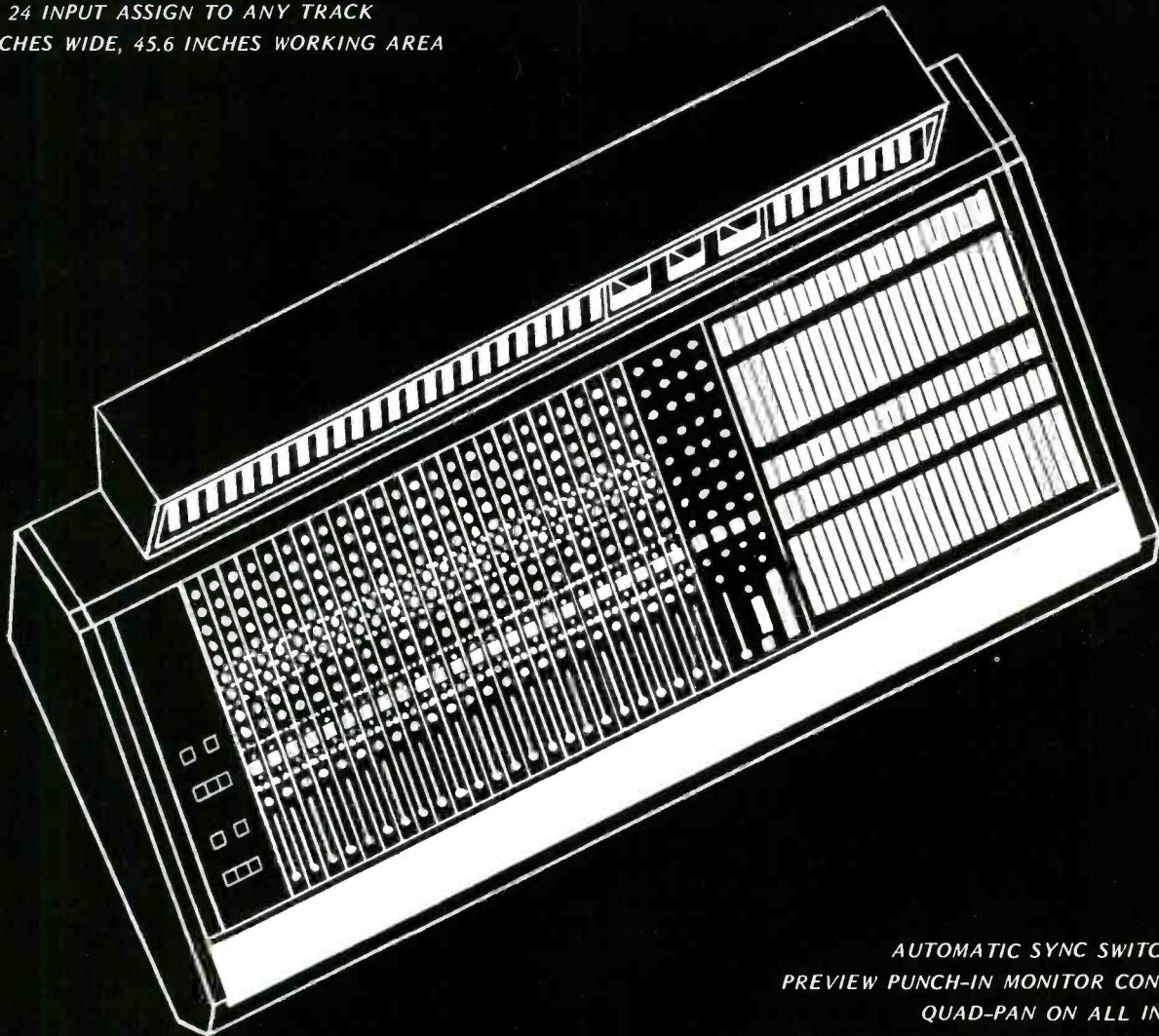

AUTOMATIC SYNC SWITCHING
PREVIEW PUNCH-IN MONITOR CONTROL
QUAD-PAN ON ALL INPUTS
SOLO INPUT-SOLO MONITOR-MUTE INPUTS
SELECTABLE PROGRAMMABLE MUTING
3 RANGE STEPLESS RECIPROCAL AND SHELving EQ
FOUR CUE SYSTEMS
PEAK OR RMS LEVELITES
FULL PLUG-IN CONSTRUCTION
SOLID STATE 24 TRACK BOARD & MONITOR MASTERS

DANIEL N. FLICKINGER & ASSOCIATES, INC.

40 SOUTH OVIATT STREET

HUDSON, OHIO 44236

(216) 655-2400

Exclusive West Coast Distributor:
WESTLAKE AUDIO, INC.

6311 WILSHIRE BLVD.

LOS ANGELES, CA 90048

655-0303



RECORDING

engineer/producer

—the magazine to exclusively serve the recording studio market... all those whose work involves the recording of commercially marketable sound.

—the magazine produced to relate... RECORDING ART to RECORDING SCIENCE... to RECORDING EQUIPMENT.

Editor/Publisher... MARTIN GALLAY
Associate Editor... GEORGE KOCH
Engineering Editors... RON MALO
WILLIAM ROBINSON
CHUCK DAVIS
Business/Circulation
Manager... V. L. GAFFNEY
Art Director... GERRY SADOWSKI

RECORDING engineer/producer is published bi-monthly and is sent free to qualified recipients in the United States. Subscriptions for other than qualified individuals or companies may be purchased at \$5.00 per year. (All foreign subscriptions: \$6.00 per year.) Material appearing in Re/p may not be reproduced without written permission of the Publisher. Copyright © by RECORDING engineer/producer 1971.

RECORDING engineer/producer is not responsible for any claim made by any person based upon the publication by RECORDING engineer/producer of material submitted for publication.

Controlled circulation postage paid at Los Angeles, California.
RECORDING engineer/producer
6430 Sunset Boulevard
P.O. Box 2287
Hollywood, CA 90028
(213) 461-7907

an Re/p in-session report: CAROLE KING, LOU ADLER, HANK CICALO at A&M STUDIOS	9	George Koch
WITCHDOCTORS of the JINGLE JUNGLE	15	A Staff Report
August/September 'RECOGNITION'	25	
41st 'AES' CONVENTION PROGRAM	26	
A PHASE CORRELATION INDICATOR	31	William Robinson
Letters and Late News	6	
FIGHTING MURPHY'S LAW	28	
New Products	35	
Classified and Advertisers Index	40	

credits — cover: TRICI VENOLA
cartoon: GARY KENTGEN

Play at 15 i.p.s.

Yamaha C7 Grand.

When you're laying down the master, you'd better be sure your piano is air quality. That's what the Yamaha C7 Grand is all about. It's a 7'4" concert instrument that ranks among the world's great pianos. Just ask the talent at your next session.

Yamaha U1-D Upright.

The closest you can come to a grand piano without a grand piano. Four feet high and nearly five feet wide, it has full, rich tone and response crisp enough to please the most finicky talent. It stays that



way through month after month of masters, rehearsals and spilled drinks, too.

Yamaha Electone E-3.

It's a symphony orchestra in a box. With fewer controls, the E-3 gives you

more sounds, more music. What's more, it's a regular sound effects machine. Think about *that* the next time you have to synthesize some sounds.

from A. Brakhan, manager
AKG Products
North American Philips
Corporation

In connection with your recent, very interesting, article "Remote Recording" (July, August 1971), we note Reice Hamel's ingenuity in developing a circuit from which both available phantom powering systems may be operated.

To any one who has 50 v available and wishes to operate with both systems, we have recommended the following circuit:

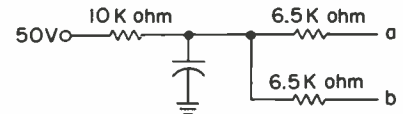

The effective series resistance is 10 K ohm plus the two 6.5 K ohm resistors in parallel, for a total of 13.25 K ohm. For microphones with a load current of 3 mA, the voltage drop will be 39.75 v, resulting in a microphone operating voltage of 10.25 v, required for the AKG C-451E.

For microphones with a load of 0.4 mA, the voltage drop will be 5.3 v, resulting in a microphone operating voltage of 44.7 v and is, therefore, suitable to operate F.E.T. condenser microphones requiring 48 v (+6v, -8v) operating voltage.

It may also be of interest that the AKG C-451E may be phantom powered off any standard 24v B+ supply available in most consoles by simply using two 4.7 K ohm dropping resistors and the current consumption is 2.8 mA; with a pair of 6.8 K ohm resistors the draw is 5.5 mA.

From Leslie F. Cooley
Engineering Manager
CBS Tape Div.

After reading William Cara's digital recording article in your May/June issue and the concerning letters in your July/August issue, I would like to express my feelings on the public stoning of Mr. Cara.

Agreed, Mr. Cara has promoted some free advertising. He has also presented an article which I feel fulfills the purpose of this publication; "—to relate recording art to recording science . . . to recording equipment". Too bad Bill did not supply more technical information on the ADAmag process, but then that is the



YAMAHA

YAMAHA INTERNATIONAL CORPORATION
P.O. Box 6600 • Buena Park, California 90620

Send for complete specifications and dealer information.

- C7 Grand Piano Name _____
- U1-D Upright Piano Business _____
- E-3 Organ Address _____
- Other _____ City _____ State _____ Zip _____

patent game. As I have no reason to discredit Mr. Cara's claims, I give him the benefit of the doubt.

It amazes me that intelligent men like Stephen Temmer and Michael McLean find it necessary to judge what we should or should not read. These gentlemen must feel that anyone who is not an executive of a well known corporation will be "led down the garden path" and lack the ability to decide what is and is not "technical bunk" and "pure junk". Your readers deserve more credit than that.

And what magic theorem of engineering says "some totally unknown California manufacturer" cannot come up with a "revolutionary development". Is there some rule that you must be a Gotham or Motown (or CBS) to design, invent and develop? If this were the case, the Audio Industry would not have advanced to the point it has reached today.

Samuels Engineering claims it has developed a digital recording system. If they have discovered nothing more than how to take the present technology and "get it all together" at a price the industry can afford, then I will concede this to be an outstanding achievement.

Thank you, Paul Buff, for being critical of Mr. Cara's article while using good taste.

The distortion Mr. Buff refers to is known as quantizing distortion and can be reduced in several ways. One common method is to utilize non-linear quantum steps in the A-D conversion. By progressively tapering the quantum steps so that low level signals are processed in small steps and high levels in larger steps, the quantizing distortion is reduced for low level signals.

From the READERS

An editorial material rating of the most useful feature article, as gathered from the Reader Service Cards received prior to press time.

JULY/AUGUST ISSUE:

REMOTE RECORDING . . 52.6%
MONITORING 36.6%
AUDIO SPECTOMETRY. . 06.5%
OVERLOAD INDICATOR . 03.9%

NOTES ON SELECTING YOUR NEXT CONSOLE, and YOUR NEXT CONSOLE BUILDER.

by Bob Bushnell

BUSHNELL CUSTOM CONSOLES vs. STOCK BOARDS:

In planning for the acquisition of a new console for your studio the alternatives rapidly reduce to two courses of action. Other than opting to go-it-alone and build a board yourself, it is a case of:

- 1) being sold one or another of somebody's stock boards (admittedly, stock boards do come in any number of outline configurations and cabinet finishes.)

OR . . .

- 2) choosing a console engineering and fabricating partner to, along with you, develop, build and install the perfect custom console for your studio.

DELIVERY and PRICE — CUSTOM vs. STOCK:

Amazingly, the advantages usually associated with the purchase of stock equipment, delivery time, and to a lesser degree, price, are a lot less significant than you may have been led to believe.

We, BUSHNELL . . . the console partner people, would be delighted to show you case histories to prove the point. Here is an example:



WARNER BROTHERS

. . . just 11 weeks from acceptance of the complete competitive bid . . . to installation, acceptance and operation . . . and, complete satisfaction.

COMPONENT FLEXIBILITY:

Does BUSHNELL have an axe to grind? Just one. Wanting to design and build the console you want.

Between you and us, as project partners, we can select the components and systems for your board which meet the most rigid quality and performance requirements. BUSHNELL does not manufacturer components . . . because of this BUSHNELL as your console partner is not forced into an allegiance with its own component production line.

BUYING A CONSOLE vs. BEING SOLD A CONSOLE:

In deciding on a custom console development partnership with BUSHNELL the difference is that you are not being sold a console . . . You are buying what you need.

What it comes down to is that your next console can be everything you want it to be.

Make us prove the point!

We would be delighted to prepare a firm quote for you

BUSHNELL

ELECTRONICS CORPORATION
15210 STAGG STREET, VAN NUYS, CALIFORNIA 91405 (213) 989-2740



Bill Porter and friend.

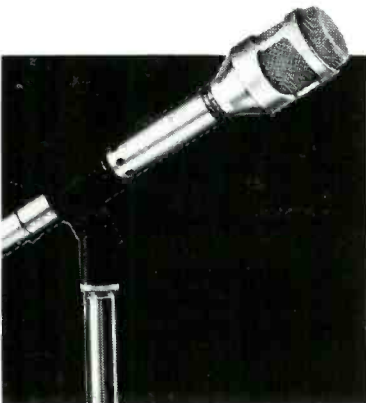

"We are using nothing but Shure SM53 microphones—at my request." That's Bill Porter, master sound engineer for his *United Recording Corp. of Nevada* out in Vegas, telling us about a recent series of live concerts at which he officiated as the man in charge of sound. "I've been using Shure microphones in recording sessions for quite a few years. We used SM60's for Buddy Rich's 'Mercy, Mercy' live recording at Caesar's Palace . . . and have had numerous comments on the drum sound. We use the 545 and 546 on all live and recording sessions for guitar, drums, and piano." We're proud of the fact that with all the equipment from which he can choose, Bill calls on his "tried and true" friends from Shure.

Shure Brothers Inc.,
222 Hartrey Ave., Evanston, Illinois 60204.





an Re/p Session Report

CAROLE KING - LOU ADLER - HANK CICALO

in session at A & M

By GEORGE KOCH

The door of Studio B at A&M in Hollywood sports a sign which reads, "CLOSED SESSION—NO ADMITTANCE PLEASE". Inside, Carole King, looking much more like a friend than the superstar she is these days, is recording her third album. At this writing her last album, "Tapestry", has been #1 on the charts for twenty weeks.

The sign on the door is indicative of a refreshing professionalism going on in the studio. The people in there are working. Doing what they enjoy, but working nonetheless. There is little of the temperament that often acts as an excuse for lack of skill. In the first two days of these sessions, eight tracks were cut for the album.

The pace obviously is very quick. It is quick not because the people involved are rushing, but because they are not fooling around. They don't need ten takes to get a vocal part or a guitar lick right. They know what they're after, and they get it.

There are no secret techniques being used here. The success of the albums is based on a combination of experience and openness.

"YOU HAVE TO BE OPEN TO NEW IDEAS. I've been

around this business for seventeen years, and I could be set in my ways. But that's wrong. I'll try anything. I learn something everyday."—Hank Cicalo.

Hank is the engineer on this session, as he was on "Tapestry." His words are confirmed by Lou Adler, the producer:

"I've only worked with two complete engineers. A lot of engineers are complete electronically, but more important, there's a disposition, a compatibility, and a knowledge and feeling for the kind of music we're doing that's necessary. Bones Howe and Hank are the only two complete engineers I know."

What distinguishes Hank? His use of microphones, although not terribly strange, is certainly creative. He mikes the piano with a Sennheiser 421 D, inside and with the lid closed. The piano is then enveloped with **two** covers. This is done for isolation's sake, as Carol sings for the band during recording. The bottom end of the piano is rolled off slightly to compensate for the boominess caused by the piano being closed and covered.

And at \$16,500, the JH-16 is worth fighting over.

Combining the total logic and the constant tape tension of the JH-10 Transport with proven MCI electronics, the JH-16 is a triumph of both lower cost *and* higher quality.

MCI has eliminated the costly hand-wiring found in other comparable units and substituted channel strip printed circuit boards

in conjunction with non-redundant functions. Yet, there's no sacrifice of world-renowned MCI quality—in fact, serviceability and reliability are improved.

The JH-16 is a complete 3-head 16-track recorder that can be changed in minutes for one- or two-inch tape capability, for 8-, 12- or 16-track operation.

Remote overdub and transport motion control are standard equipment. Space is available in the

attractive aluminum housing of the JH-16 remote control for the optional Auto-Locator (\$1,200).

Atlantic Records' Tommy Dowd and Criteria Recording Studio's Mack Emerman aren't the only ones fighting for the first JH-16. To join the fray, contact MCI, 1140 N. Flagler Drive, Ft. Lauderdale, Fla. 33304 (phone 305/763-5433).

The big problem that MCI has with its JH-16 is:

**WHO'LL
GET THE
FIRST
ONE?**



MCI DISTRIBUTORS: Tom Hidley, Westlake Audio, 6311 Wilshire Blvd., Los Angeles, Calif. 90048 • Dan Fleckinger, Dan Fleckinger Associates, P.O. Box 628, Hudson, Ohio 44236 • Dave Harrison, Studio Supply Co., 112 Cloverdale Court, Hendersonville, Tenn. 37075 • Paul Kelly, Kelly's Audio Engineers, 704 Elmhurst, Muscle Shoals, Ala. 35660.



Circle No. 105



On Carole's vocal is an AKG 202 E. Although most of her vocals are done in their final version after the instrument tracks are down, some of the cuts on her last album were actually the vocals she sang to the band while doing the instrument tracks.

Two AKG C-12s are used on the drums, one for both the toms and ride cymbal, and one overhead. An RE-15 picks up the hi hat, and another the snare. The bass drum also uses an RE-15, placed deep inside near the head. The head is deadened by two heavy sandbags placed against it, giving a "tight" sound to the drum.

A lot of instruments and overdubs are used in this session, robbing the engineer of the luxury of several tracks for drums. But Hank is not that enamored with multi-track drums sounds anyway: "A lot of times I'm against that sort of thing. I've seen guys mix drums across 5 tracks of a 16 track, and the stereo effect was horrible. The guy got so wrapped up on the effect that it sounded like an eighteen foot set of drums. Who has an eighteen foot set of drums? I would rather work to a tighter sound."

That tighter sound happens on two tracks, one for a complete drum mix, and the other for bass drum alone. This allows the bass guitar and the bass drum to be mixed against each other, independent of the total drum mix.

When the drums are limited, it is often just the tom. A touch of echo is sometimes added, especially if the part requires a slow rolling sound.

Bass guitar is taken both direct and with a microphone (a U-87), with a ratio between the two of about 85/15. The direct feed is limited 2 to 5 db.

Electric guitar employs a U-87, and acoustic guitar a Sony C-22.

Percussion and conga come through a U-87 feeding an Allison Gain Brain, resulting in a tight sound with a great deal of presence, as well as an even ratio between the high and low conga. Such a ratio is often quite difficult to obtain with a set of congas.

A Fender Rhodes utilizes an RE-15, and a Wurlitzer Electric Piano is taken direct.

The Wurlitzer seems to have some electrical noise problems through its own amplifier, but when taken direct and EQ'd properly, produces a very warm sound. The Rhodes sound quite good through its own amplifier, resulting in its being miked, and not taken direct.

INSIDE THE CONTROL ROOM, the producer has at his disposal a "playback panel" which allows him to mix, independent of the engineer, and without affecting the recording. Thus the producer can begin getting a perspective on a final mix while the recording is still in progress.

Lou, as producer, takes full advantage of this, a fact which certainly contributes to the success of his work. In his words, "From the time I start an album, I'm mixing. Every day and every night I'm always thinking about a mix. Sometimes in my sleep I'll hear the machines re-winding. But I'm always sure what I'm after. I'm always mixing for myself, but taking into consideration the likes and dislikes of the artist, which I've picked up during the session. If Carole says, 'Can you turn the bongoes down?' while she's listening to a playback, I remember it when I get to the mixdown. All those things are programmed in my head".

"Recording is important. I do that more than anything else in my life. I work more than I sleep. I work more than I socialize. But it's a complete enjoyment when I do it."

"I like to get the best sound out of an artist. I don't have my own sound. I think it's entirely possible that a person could play all of my albums and not identify them as mine."

Lou is in control of the session from the time it starts. He feels that as long as he is open-minded, and the artist knows he can be communicated with, his control is both accepted and appreciated.

The sessions are closed for several reasons: the fewer people there are around, the more work gets done. And the fewer people there are around, the less confusion there is for the artist. Lou does not like anyone standing behind the console: "An artist should always have one person to look to when they have a question. If they say, 'What do you think?', and there are four different expressions, they have no idea where they are".

"They should look to me . . . but if there's a person in the booth, and he's happy just to be there, and the artist comes into the room, sees the person beaming, and I say, 'We'd better do it again', it's confusing."



The music ranges from ballads to rollicking rock and roll. The musicians and the atmosphere are cheerful. The musicians are not sidemen; they come with Carole.

They have to be interested and involved in the music. Otherwise, they are not on the next date.

The arrangements are written by Carole, as well as being made up as the session rolls along. Every number seems to "cook", in large part due to the closeness of the people involved, and the fact that Carol sings during the recording of instrument tracks.

The cheerfulness is in part maintained by the unwillingness of the engineer, Hank, to put equipment problems on the shoulders of the musicians. Rather than tell a bass player that his amp sounds bad, or that there is something wrong with his sound, he'll explore every avenue open to him, and try to solve the problem for the musician, before even mentioning it.

Hank dislikes "button freaks" who feel the need to constantly prove that they are aware of everything happening in the studio. Usually, if a musician plays a bad note, he's more than aware of it. Jumping on him immediately and telling him so destroys the atmosphere. Cicalo feels it's wiser to let the track run and retake that instrument later.

Sweetening is Lou Adler's responsibility, but his decisions in that realm are a result of the artist's music, rather than his own likes and dislikes. The sound of the final product is the artist's. Still, these things seem mostly to go unspoken. "There are no confrontations as far as sweetening goes. If that happened, it would be time for us to go our separate ways."

OVERDUBBING GOES JUST AS SWIFTLY AS THE BASIC TRACKS. Once again, experience and openness seem to be the key. Lou works like he knows a lot about it, and his track record certainly confirms this conclusion: "I was at the beginning of independent production, where most of the rules just came out of trying. I've learned a lot about overdubbing, especially when it comes to vocals. The training I had with the Mamas And Papas you can't buy. There hadn't ever been any vocal groups with the amount of counter melodies that John Phillips had running through his head."

Mixing requires as much, if not more skill than overdubbing. It is interesting to note that in the midst of all the discussions these days about proper monitoring, using several systems for listening, and several mixes before choosing a final one, Lou Adler is remarkably unconcerned with the difficulties pointed out by many others:

"I mix by the speaker I'm listening to. If I listened to more than one speaker system, I'd go crazy. Whatever speaker it is, I'm mixing off of that speaker. I mixed Carole's album on small speakers."

"Mixes are very personal things. The most personal part of a producer's role in recording. How could I do several final mixes, and choose one? You can only mix your best possible mix. It's like saying, 'Now I'll make a bad mix'."

A good mix only comes from good tracks. In Hank's words, "I hate that saying, 'We'll fix it later'. You can't fix it later. You can touch up, but the basic stuff you have to get up front, or it's never going to sound right."

"I never like to do things that really lock me in. If I compress, limit, or whatever, I'm always careful about doing it to a degree."

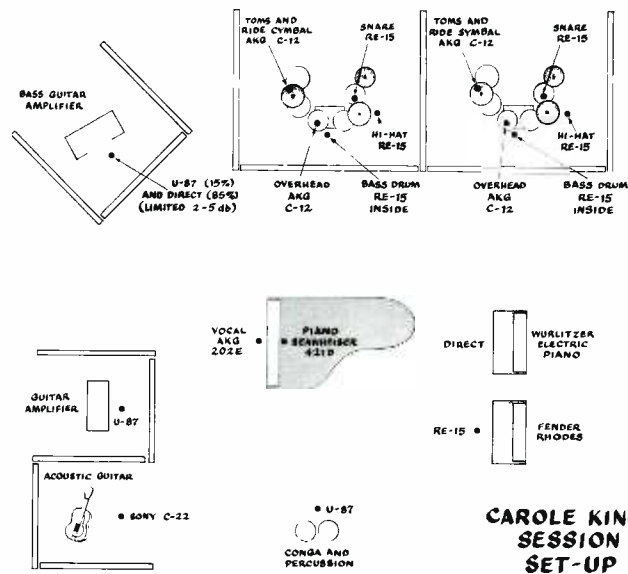

CONTROL ROOM

A & M RECORDS - STUDIO B

"You have to be open to new ideas. Some engineers aren't, and that's a hassle. Some guys have got one set up and they're not going to change it. They've got to be insecure."

"For instance, we don't have many leakage problems so we don't need a Kepex for that, but we do use it for effects. You can get a tremelo sound off of it by keying it with an oscillator. Have the oscillator at five cycles, which is inaudible. By putting an organ through it, and beating the music against it, you get a very unusual tremelo effect."

In making those good tracks, the choice of mikes is up to Hank. Limiting and compressing usually happens without even a request from Lou.

All of these things give testimony to an easy rapport which exists during these sessions.

"FIRST COMES THE ARTIST, THEN THE PRODUCER, THEN THE ENGINEER. IT'S GOT TO BE A MARRIAGE OF ALL THESE PEOPLE."

This triangle is more than just Hank's words. It is working.

There are a lot of pros in this business, and a lot of perfectionists. Carole King, Lou Adler, and Hank Cicalo are certainly among them. But they have the added beauty of not only being good, but being easy about it as well.

A sign on the console reads, "Anything that is not quite right, is wrong."

The philosophy is not wholly unique. What is more unique is the lack of anxiety and tension that normally accompanies so absolute an approach. If something is not quite right, nobody gets upset. They just change it, and make it better.

Maybe they've got something there.

END

1968

1969

1970

1971

DC 300

POWER AMPLIFIER

THE STANDARD STANDS

In 1968, Crown introduced a laboratory power amplifier that set new standards for the audio equipment industry. It was so unique it was put in a class by itself. It became the "yardstick" against which many other types of equipment were measured, thus earning the title LAB STANDARD.

That was over three years ago. Today the DC300 amplifier is still acknowledged as The Standard. This is due to the unique combination of features made possible by its highly advanced patented circuitry. This circuitry provides for the exclusive combination of high power with complete protection and low distortion at low power levels.

So today, where does Crown's DC300 stand, when compared side-by-side with all major commercially available amplifiers? Here's the record:

(1) The DC300 delivers the **most continuous power** of any commercially available power amplifier -- guaranteed at 150 watts per channel rms with 8 Ω loads; typically 300 watts per channel rms with 4 Ω loads. In actual laboratory testing, it has produced over 900 watts rms continuously for four hours, with only a single whisper fan for cooling.

(2) The DC300 has the **lowest distortion level** of any commercially available power amplifier -- guaranteed at 0.1% IM distortion across the entire power spectrum; typically under 0.01%.

(3) The DC300 has the **most complete protection** of all commercially available power amplifiers. It is fully protected against shorts, mismatching, open circuits, RF overload and overheating.

(4) The DC300 has the **lowest noise level** of any commercially available power amplifier -- guaranteed

at 100db S/N below 150 watts output; typically better than 115db.

(5) The DC300 is backed by a **complete three-year warranty** covering all expenses -- parts, labor and round-trip shipping. This warranty covers every unit ever made and has been in effect from the initial unit, providing ample record of DC300 reliability.

That's the record, and what it all means is purer, more reliable sound for your system. Audio professionals have proved the DC300 in hundreds of applications, from recording studios to stadiums. Ask the men who use them.

We'll also be happy to send you detailed specifications, performance graphs and independent laboratory test reports. For an explanation of the DC300 design, send 25¢ for "Functional Protection of High-Power Amplifiers," a technical paper presented at the Audio Engineering Society 39th Convention.



*Unique in
Dependable Power
and Purity*

MADE ONLY
IN AMERICA

Crown[®]

BOX 1000, ELKHART, INDIANA 46514, U.S.A.

There was only one thing left to improve:



When we introduced our 8-Track and 16-Track Recorder/Reproducers, they rounded out the most advanced line of professional audio recorders made.

And, with engineering changes and improvements, we've kept our lead.

But with another AES Show coming up, we felt that we had to do something special. So we've come up with the ultimate change: new, improved price tags.

Check the tags, then drop by Booths 46-48 at the Show.

You'll find the same 3M Brand Professional Audio

Equipment that's in major recording studios across the country. Equipment with the most precise tape handling and the highest tape speed accuracy of any recorder made. With the lowest flutter and wow in the industry. With signal-to-noise specs that are still state-of-the-art.

You'll find the finest professional audio equipment made. But you'll never find a better value.

PROFESSIONAL AUDIO PRODUCTS

Mincom Division **3M**
COMPANY
300 SO. LEWIS RD., CAMARILLO, CALIF. 93010 • TEL. (805) 482-1911

Circle No. 107

"We are the last people the advertisers think about. We get into it after the film is done. The lab work and everything else is completed, and then they say, 'Oh yes, we need music!'"

"They've cut the negative. That's the point of no return. The movie is locked up. They can't go back and fix it."

"The music must marry to the picture, so the creative freedom is limited. It's our job to make everything fit into this 'box', and there are many specifics you have to service. Not only is it the picture we're concerned with, but the announcer. Every time we play the melody the announcer is saying something. Everything has to match."

"Your scope gets more and more compressed."

"Even before we get to the studio there are many meetings about what the music is trying to instill, and what the function of music is."

"You try to establish the need for a real customization, where you get a better thing by scoring, so all the elements are exploited to their full advantage. But we are the last people they think about . . ."

—**Marty Rubenstein**

Musical Director
Shield Productions

WITCHDOCTORS of the JINGLE JUNGLE

an Re/p interview-discussion

The Jingle Jungle, home of crass commercialism, and hotbed of Keynesian Economics. Electronic nursemaid of an entire generation of Americans. Sustainer and justifier of Madison Avenue, and lifeblood of the corner supermarket.

Amidst the tangled vines of this often strange and eerie subculture, lurks a gifted clan of creative beings: commercial engineers and producers — Witchdoctors of the Jingle Jungle.

Recently, Re/p visited one of the tropical paradises of commercial recording, Chicago, and spoke with several of the local practitioners. Time was limited, and we missed a few of the folks we'd like to have seen, but those we found gave us a pretty good insight into the commercial business, and how it differs from the record industry. Marty Rubenstein, Bruce Swedien, Murray Allen and Marty Feldman each has his own brand of creative Voodoo. We tried to find the similarities and differences:

Rubenstein: "It all begins when we analyze the film for the commercial on a moviola. We study the picture and the announcer track. As the picture is expressed in terms of feet and frames, we can go through and measure, and find out where various things are happening. We create a (musical) bar sheet, which is actually a dia-

gram of the spot as it rolls along. On it we have cues for both picture and announcer, and where each one changes. Then we choose an appropriate click, so there's a constant tempo for the whole score . . ."

Re/p: "An appropriate click?"

Allen: "Click track. It's really a metronome. We use it in 99% of all commercial dates. By using the same tempo on each track we record, every take comes out with the same time."

Rubenstein: "It also gives me a guarantee so that the things which happen in the studio when we record will exactly match the picture."

Allen: "Originally, people thought click track hampered the 'feel', the swing of the music."

"But today, the really good studio musicians get the same sound. It's to the point now where a lot of record dates that are done with strictly studio musicians are done with click track."

"What this accomplishes is that every take has the same tempo, and you can intercut, or do what you want, and there's no variation there."

total tape duplicating with "BUILDING BLOCK" simplicity

CASSETTE TO CASSETTE, REEL TO CASSETTE, REEL TO REEL

The Telex series 235-1 is more than just another tape duplicating system. It is a concept based on modular "building blocks" which complement each other and provide total flexibility for tape duplicating. It solves the problems of interfacing between open reels and cassettes. It is a system designed for future expansion. Engineered to make tapes of true, professional quality. And it's priced within your budget.

The Telex system consists of only five basic units.

1. Solid state modular electronics containing amplifiers, meters and controls. This unit works with any combination of ten cassette or reel slaves.
2. Cassette master play transport.
3. Open-reel master play transport.
4. Cassette slave record transport. Records three cassettes simultaneously.
5. Open-reel slave record transport.

The five units are totally compatible. Intermix cassette and open-reel master or slave transports to suit your duplicating requirements: cassette to cassette, reel to cassette, reel to reel, or even cassette to reel. All units fit into table top consoles of uniform size so when your requirements change, you just add more units. It's that simple. Telex series 235-1 is heavy duty equipment with hysteresis synchronous motor tape drives, momentary push button controls and time delay circuits for smooth, positive tape handling. Selected premium grade duplicator heads provide long life and excellent frequency response. And fail safe, automatic features enable non-technical personnel to operate the system efficiently. Telex "building blocks" make a totally flexible and complete duplicating system. It's the sensible approach, designed to meet your needs today, next month and in the years to come. Made in the U.S. to professional standards.



Solid State Electronics. Bias oscillator module and two or four channel amplifiers.

Open Reel Slave, 7.5 - 15 IPS. Full track. Half track 1 or 2 channel. Quarter track 2 or 4 channel.

Cassette Slave, 3.75 - 7.5 or 7.5 - 15 IPS. Half track 1 or 2 channel. Quarter track 2 or 4 channel.

Open Reel Master, 7.5 - 15 IPS. Full track. Half track 1 or 2 channel. Quarter track 2 or 4 channel.

Cassette Master, 7.5 - 15 IPS. Half track 2 channel. Quarter track 2 or 4 channel.

TELEX COMMUNICATIONS DIVISION
9600 ALDRICH AVE. SO. • MINNEAPOLIS, MINN. 55420
REP
PLEASE SEND INFORMATION ON DUPLICATOR.

NAME _____

TITLE _____

INSTITUTION _____

ADDRESS _____

CITY _____ STATE _____ ZIP _____

PRODUCTS OF SOUND RESEARCH
TELEX[®]
COMMUNICATIONS DIVISION

9600 ALDRICH AVENUE SOUTH • MINNEAPOLIS, MINNESOTA 55420

CANADA: DOUBLE DIAMOND ELECTRONICS, LTD. 34 Progress Avenue, Scarborough 4, Ontario
EXPORT: ROYAL SOUND COMPANY, INC. 409 North Main Street, Freeport, N.Y. 11520

Re/p: "What is the direction of the business, musically? Can we expect any improvement over the rather synthetic sound of the past?"

Allen: "Commercial recording is more and more approaching the feeling of records — seriously. It used to be that they wanted to sell the product and only the words were important. Now the whole feeling, the whole concept, is becoming important."

Feldman: "There are a lot of nice things happening, musically, in jingles. More and more there's a tendency to get legitimate record-type sounds, or I should say legitimate rock rounds. The rock *has* always been a very synthetic sound, and it's starting to go more and more in the direction of trying to capture the type of sounds that you get in record work. They're also using record talent. They're using recording artists for singers and voice-overs."

"It's nice too, because it's giving everyone involved work in areas they weren't into before."

Allen: "Also, if we are doing a commercial for a Top 40 station, we will do it in such a manner that it fits the program matter of the station."

"There's a big movement in commercials to simulate whatever is in the Top 40."

"If a customer wants a Blood, Sweat and Tears sound, we mike the way we feel BS&T was miked when they did the record. With good studio musicians, ones who really know how to copy, we can simulate the record we're trying to copy. We're good imitators."

Re/p: "How does commercial recording differ from record work?"

Allen: "In a sense, commercial recording is somewhat of a forerunner of the record business. When the Beatles were fooling around with miking techniques, instrumentation and effects, whatever they did, we did the next day. We lead the record business in other ways too. In overdubbing, for instance. Before we used 16 track for a record session, I'll bet we did a hundred sessions in advertising."

"Further, on record dates you can run two and a half or three minutes, but on spot dates, film dates, you have to run 58½ seconds, and that's including echo hang-over. Radio commercials should be 60 seconds, no more, and preferably no less. So timing is very important."

Feldman: "There's also a great deal of difference in economics. You're dealing with a situation in jingle recording where they have to have something really fast. Much faster than in record recording. *Speed* is the main consideration. Also, it's a different type of sound. Although there are some record-type sounds used in jingles today, the sound itself is mixed differently than a record."

Swedien: "Music and recording technique is a small part in all the elements of the broadcast media, especially compared to records. On a phonograph record

the music is virtually the whole thing, whereas in a commercial spot, it is only a part of the total audio-visual package."

Feldman: "The agency wants to hear the words. That's very important to them, because they're selling a product."

"The music producer wants to hear his music, too. He wants to let some of his music come through."

"There are times when you literally bury the music, because you want to get the vocal so far out in front to please the agency."

"But I think there's more of a tendency now to write music so you don't have to do that."

Rubenstein: "What you're trying to achieve is to have the musical material significant in parts where the announcer is not talking. You write it around the announcer, so it comes down by its own devices. You don't have to artificially bring it down."



MARTY FELDMAN, Paragon Recorders

Re/p: "Do you ever use a compressor/limiter, actuated by the announcer's voice, to bring the music down?"

Swedien: "No, I wouldn't. I hear that all the time, and I find it extremely irritating."

Rubenstein: "When the announcer's talking, the music should be, internally, something you wouldn't compress."

Swedien: "I compress the vocal on a jingle in an effort to get maximum information on the tape. Intelligibility in the vocal is very important. But the only things I really use a compressor on are bass and vocals. Otherwise, everything goes through straight."

Allen: "When we send out radio commercials that we know are going to heavy compression stations, we compress them ourselves. If I know a spot is going to a heavy compression station, and you can tell by the copy, I'll compress everything so hard during recording and during dub-down, that there's nothing left that they can compress. When it leaves our studio there are no peaks and no bottoms."

ELECTRIC LADY and MEDIASOUND
can now record silence as well as
sound. (Both have the Dolby System
on 16-tracks)



\$30,000 worth of session is worth keeping quiet.

It's easy to record sound; any studio can do it. It's just as easy to add noise to the music you're recording; whether you like it or not, the tape itself does that. To make matters worse, tape noise increases by about 10 dB when sixteen tracks are mixed down to two.

At Mediasound or Electric Lady the Dolby System puts you 10 dB ahead of the quietest tape money can buy. Print-through, crosstalk, modulation noise and even some distortion components are all reduced, quite apart from the dramatic reduction of tape hiss.



You'll get better technical quality in your next New York recording by calling:

MEDIASOUND (212) 765-4700
ELECTRIC LADY (212) 777-0150
DOLBY LABORATORIES INC. (212) 243-2525

 AND "DOLBY" ARE TRADE MARKS OF DOLBY LABORATORIES

Circle No. 109

"Also, if our client wants too much dynamic range, that we know won't go on the air, we talk him out of it."

Feldman: "I've heard compression misused. Also, you can get into double limiting problems when the station compresses it, and end up with no dynamic range at all. I like dynamic range. I think that's what makes recordings exciting."

Re/p: "Do you mix or equalize for the small 8" speakers that most people will hear the commercials on?"

Swedien: "I've tried a couple of times to mix on small speakers, and it's been disastrous. We consider the small speaker just another point of view."

Allen: "Most of the commercials, when we get done recording, we play back over small speakers — the type you might find in radio and televisions. And they normally sound good, because the engineers are experienced enough to know how it will sound on a small speaker. But we don't actually equalize for it."

"We also make the recording worthwhile, so that if it's played on FM, and goes through some kind of decent amplifier and speaker, it will sound like a quality product."

"Ninety-nine percent of the time, if it sounds good in the studio, it'll sound good on the radio. If something is missing, we will remix it."

Feldman: "We have half a dozen different types of monitoring systems on these premises, so we have a pretty good idea what things are going to sound like on a small speaker, a home system, on a really powerful system, on good studio monitors, etc. I think that's helpful, as it helps keep your objectivity."

Re/p: "Do clients ask you to record their own spots a little hotter than the rest, so they will stand out?"

Allen: "Our medium is 16 mm film, and it's hard to record that hot. It can be done, but it's an art, and doesn't relate to sheer volume."

"There is a very sophisticated equalization necessary. There is nothing below one hundred fifty cycles, and nothing above eight thousand. Yet when you listen to it, it sounds like the highest fidelity you've ever heard. And it's loud. It's the kind of commercial that knocks you out of your chair."

"Although usually it isn't the producer that wants the volume. It's the company. And usually the company is big enough, and buys enough spots, that they won't get any trouble from the station."

Re/p: Speaking of high-fidelity, do you use any noise reduction equipment in the recording process?"

Allen: "We use Dolbys for commercials. There is a very good reason: there is no comparison to the sound. Dolbys make everything superior."

Feldman: "We don't use Dolby. We have a Kepex-type system built into our Flickinger board. It's in the system at all times. It has threshold and release, and works very well for what we do. But you have to learn how to use it."

"Certain horn notes, for instance, attack very slowly. As a result, you have to back off on the threshold so you don't lose the beginning of the note."

"We call it our third hand, because it keeps the engineer from having to pull down tracks when there's nothing on them. It gets rid of any log 10 noise, and any leakage there might have been."

Re/p: "What about drum miking? Do your techniques differ for a jingle session?"

Feldman: "Not really. I mike with two mikes even for a lot of record work. When somebody has a big drum kit, and plays all over it, I'll use more mikes. But I use stereo miking techniques, as opposed to close miking. Rather than recording five mikes and panning each one into position, the stereo miking gives the natural movement across the drum kit."

"I believe in going out and helping the drummer tune his drums, but I like to keep the mikes to a minimum, and let the musician produce the sound."



Allen: "Very often the problem is not with the mikes or where they're placed, but has to do with the tone quality of the instrument being played at the time."

"We have drummers we work with that in three, four or five minutes, can sound like any one we suggest, just by tuning the drums, and adjusting to that specific sound. All this with one mike over them, a U-47, and an RE-15 or 545 on the bass drum."

"We do on occasion use several mikes, as when a client reads a magazine such as yours and says, 'So and so used five mikes on drums. I want to too.'"

"Well, we used five mikes on drums nine years ago. It's good for particular things, but we've gotten away from it."

"A good drummer, with one mike overhead, will balance his sound as he plays. There will be no need for several mikes. And when you're going for radio, you're just kidding yourself with that many mikes."

MURRAY ALLEN, Universal Recorders

ALTEC'S NEW REAL TIME AUDIO ANALYZER



A major price breakthrough at \$3018!

The same acoustical display that you get with instruments costing many thousands of dollars more is yours with the new Altec model 8050A Real Time Audio Analyzer. Altec quality, through and through, this fine precision instrument offers you these important features.

Frequency range: 40 Hz to 16 kHz in 27 contiguous 1/3 octave bands.

Dynamic range: (3.16 mV to 3.16 V rms)

Display range: 20 dB on self contained 1½" high by 2½" wide cathode ray tube screen.

Continuously adjustable by means of a front panel control.

Detection Mode: RMS SLOW or RMS FAST

The dynamic characteristics are in accordance with IEC 179.

Detector accuracy: For tone burst signals with crest factors of less than or equal to 3: ±0.5 dB with respect to the steady sine wave indication.

For Gaussian random noise ±0.2 dB with respect to steady sine wave indication.

Input: Input impedance is 100 kilohms. For steady sine wave signals the preamplifier will accept levels up to 30 dB above full scale indication.

Scanning: Internal scan covers the 27 channels in approx. 30 ms.

Dimensions: 16¾" wide, 5" high, 11" deep.
Weight: 18.7 lbs.

This instrument is available FOB your nearest Altec Acoustics-Voicing Sound Contractor where you may see it in action. Fill out the coupon and we'll send you his name and address and complete details.



ALTEC DIVISION OF LTV LING ALTEC, INC.

To: Altec, Attention Don Davis
1515 S. Manchester Ave., Anaheim, CA 92803

Please send me complete information — including a specification data sheet — on the new Altec 8050A Real Time Audio Analyzer.

Also, send me the name of the nearest Altec Acoustics-Voicing Sound Contractor where I can see the new 8050A in action.

name

company affiliation

address

city

state

zip

The world's largest exclusive manufacturer of sound equipment: stereo components & speaker systems, complete public address systems, broadcast & recording equipment, musical entertainment equipment, telephone products, and intercom systems.

Circle No. 110



Re/p: "What is the relationship between a producer and an engineer on a jingle date? How does it differ from a record session?"

Swedien: "I would say that normally in commercials the producer relies a little more on the engineer than in record sessions. There is so much previous knowledge and information about the broadcast medium and film that the engineer is required to know in order to make a good product."

Rubenstein: "I would have to agree. Yes, a producer does rely more on the engineer."

Allen: "The producers are the arrangers and writers. Generally speaking, when they come into a studio, the engineer acts more like an A&R man. In other words, no one tells the engineer how to make his mix, or how to get the sounds out of the instruments. He's expected to know that."

Feldman: "I think you'll find that there are no producer/engineers. I don't think an engineer, with his normal duties, and those kinds of pressure that a producer is under, could handle it. I really don't. I think it's just too much."

"It's a full time job being a producer. There's an additional party involved: a producer has to deal with a

client in a jingle session, one who may have a different point of view, or who may change his mind."

"In record work, it's a tighter knit thing. You all have the same goal in mind, at least. There's more rapport. Although there's a lot more rapport these days in jingle sessions too. The agency types are getting more into music and knowing what they want. And that helps. It's good. That kind of communication is positive."



Re/p: "Some people seem to feel that bands don't perform quite as well on 16 track because they know they can take any mistake out in the mix. How do you feel about that?"

Swedien: "There's quite a truth to that. But I think 16 does give us some advantages that we didn't have before. Being able to mult, for instance, and add tracks."

Rubenstein: "I don't think it's important for a band to "cook" in making a commercial. I think there are other things that are more important that you serve by having the ability to use 16 tracks."

Allen: "I'm on a big move now to get away from 16 track recording and get back to two track and mono, because the musicians realize they're all there at one crack, and they all know what they're going for."

"The minute 16 track came in, and you started having string sections, rhythm sections, each recorded on a different day, the musicians stopped associating with the final product. They were only there for their job. It's a different atmosphere."

"We would rather spend the time recording than mixing. You can bring a guy up in the mix, but it'll never sound as good as if he brought himself up. You record in two track and tell the band, 'This is it baby, you can't change it in the mix. This is it!' and there's a whole different atmosphere. The guys suddenly become concerned that they are a part of the finished product. There's a big psychological thing there. Everyone plays better."

straight talk about the new urban/parasound spring reverb



In the past, we have heard some of our competitors make marvelous claims for their spring reverbs. Famous engineers liken them to live chambers. Other miracles are claimed.

Frankly, if we heard an engineer say that any spring (including ours) sounded like a good live chamber, we'd have serious doubts about his hearing or his ethics. We all know that springs have certain classic problems, including noise, distortion, flutter, response peaks, and popping on transients. These were the problems that we concentrated on in the design stage of the new O/P Reverb—not on frills, but on fundamental performance considerations.

For example, our exclusive "floating threshold peak limiter" limits the risetime of the input envelope, so pop-producing transients are prevented from reaching the spring. In addition to dramatically reducing spring popping, the FTPL also protects the reverb from overload distortion from excessive input levels. Noise is attacked by preemphasis and deemphasis as well as by sophisticated ultra-low noise amplifiers. The other problems have received similar effective treatment.

We decided that equalizers and mixers are redundant frills that have no place in an economy reverb generator. Variable decay time would result in excessive performance deterioration. Our final product is a simple electronic echo chamber with an echo send input and pure echo return output. The only control is a switch which defeats the envelope risetime limiting, but retains the input overload protection. The whole thing concentrates on essentials—it's clean . . . efficient . . . inexpensive (around \$595/channel) . . . and ultra-compact: you can get a channel of electronics on a 1 1/2" x 9" console mount or up to two channels on a 1 3/4" by 19" rack mount.

Performance? It's not as good as a metal plate, or as a good echo-room. It's better than any other spring we know of, and probably represents the best cost/performance ratio in the reverb field today. If you're a small studio on a tight budget, you can probably live happily with it as your primary reverb source. If you're large and rich, you can add channels of independent reverb with our unit for a comparatively modest capital outlay. You will find its performance fully satisfactory for many (although not all) sound sources.

The O/P I Don't Believe It But My Mind Is Open Plan: Order an O/P Reverb and use it for 15 days. If it does the job for you, keep it and pay for it. If not, send it back.

In any event, our brochure is available for the asking.

Ask: Parasound, Inc.
680 Beach Street, suite 495
San Francisco, Calif. 94109

**THE ORBAN / PARASOUND REVERBERATION GENERATOR:
CHEAP AND GOOD (WHAT MORE CAN YOU ASK?)**

Circle No. 111

Feldman: "I think that's really what it's all about. Nowadays people split everything up. They record strings at one time, voice at another, and suffer because of it. We designed our board to do mono and stereo recording. It's what we believe in."

"I really believe there's a lot to musicians being in the room and playing at the same time, and getting the band together."

"Just today we did a job with an eight track as a safety! We did a mono recording with an eight track safety. We did everything at once, with a simultaneous mix."

"I think the reason they've gone to more tracks may be economics. If you have a particular singer and a twenty piece band, the band may get it right, and the singer won't. With multiple track recording you don't have to pay the band to play it over and over again."

Re/p "Are there any other techniques you use in commercial recording which might be of interest to others?"

Feldman: "I use a lot more omni microphones than other studios use. I don't like the effects of cardioids up close. On piano I use the Sony ECM-51, close in near the strings. I don't have any isolation problems with it, and it picks up the whole piano very well."

"On our board we use variable gain preamps. Instead of padding, we vary the feedback. It helps the noise reduction greatly."

"We have very flexible equalization on our EMT's. Preset settings as well as flexible ones. We're able to

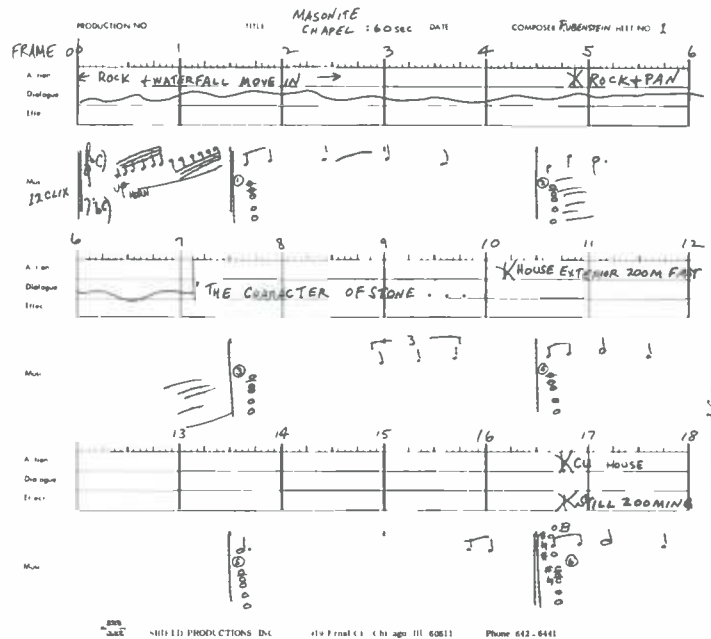

Typical Bar Sheet

get a dozen distinct sounds, which we have nomenclatures for. The client can identify them by asking for the 'bright' sound, the 'de-essing' sound, the 'warm' sound, or whatever."

Allen: "Everything we do is pulsed. If we send it to New York, make a copy, or whatever, the speed is always the same. We put a 60 Hz pulse on the tape, out of phase with itself. You can't hear it unless you put it

Continued on page 32



You can afford all this if you cut just one stereo side per day.

Lease the new Westrex DiskMaster system for less than \$1,500 per month. Cutting just one stereo side per day pays for all of it...the Westrex 3DII StereoDisk recorder, new Westrex solid state drive system, automated Scully lathe, advanced Westrex mastering console, Scully T/M tape reproducer, and complete monitor system.

Attract creative, discriminating customers with the superior, truly exciting performance of the new Westrex 3DII/solid state system. Select the complete DiskMaster system, a modernizing system designed around your present equipment, a supplementary basic system, or any unit. Purchase or 5-year lease.



New Westrex 3DII Recorder

There are more Westrex StereoDisk recorders in use than all others combined.
WESTREX, 390 N. Alpine Dr., Beverly Hills, Cal. 90213 • (213) 274-9303



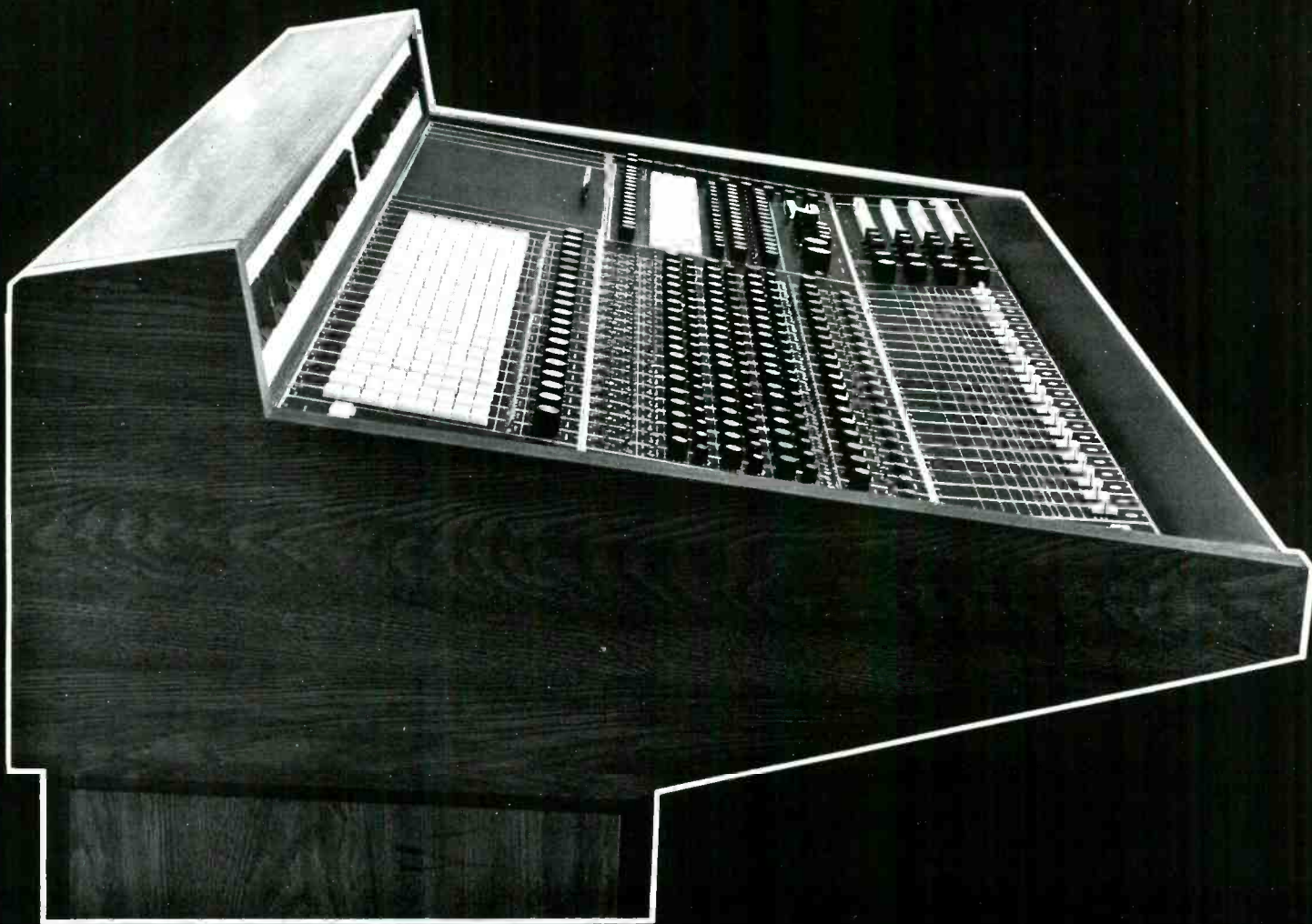

n e w : SPECTRA SONICS announces an all new audio control console — now in full production. The Model 1020-8/16 offers the ultimate in electronic performance and functional capability, and is available for shipment to your studio today. Among the completely new features of this 20 input — 8/16 output console, are 3 range equalizers with 15 separate frequencies, and an integral 16 channel monitor console that includes echo facilities. A detailed brochure of the advanced functions and performance is available upon request.

For custom consoles at production prices and immediate delivery, contact SPECTRA SONICS at 770 Wall Avenue, Ogden, Utah 84404 (801/392-7531) or at 6430 Sunset Boulevard, Hollywood, California 90028 (213/461-4321).

SPECTRA SONICS

LEADER IN ADVANCED TECHNOLOGY



Beginning in this issue, and with each succeeding issue, RECORDING Engineer/Producer will give special recognition to the producers and engineers of the top selling records in the nation for the eight week period prior to publication. We recognize that the artist, producer, and engineer make up an important triad in the success of any record. In the past, the artist was the only member of this triad to receive any recognition. We strive for balance.

JAZZ L.P.

"Second Movement"

Engineer:

JIMMY DOUGLAS

Producer: **JOEL DORN**

Atlantic Records/
Atlantic Studios, New York

Artists: Eddie Harris &
Les McCann

SOUL SINGLE

"Spanish Harlem"

Engineers:

**RON ALBERT,
HOWIE ALBERT**

Producers:

**JERRY WEXLER,
TOM DOWD,
ARIF MARDIN**

Atlantic Records/Atlantic
South Criteria Studios,
Miami

Artist: Aretha Franklin

COUNTRY SINGLE

"Good Lovin' "

Engineer: **LOUIS BRADLEY**

Producer: **BILLY SHERILL**

Epic Records/Columbia
Studios, Nashville

Artist: Tammy Wynette

TOP L.P.

"Tapestry"

Engineer: **HANK CICALO**

Producer: **LOU ADLER**

Ode Records/A&M Studios,
Hollywood

Artist: Carole King

SOUL L.P.

"What's Goin' On"

Engineers:

Session—

**NATHANIEL JENNINGS,
STEVE SMITH**

Remix—

LAWRENCE MILES

Producer: **MARVIN GAYE**

Motown Records/
Motown Studios, Detroit

Artist: Marvin Gaye

TOP SINGLE

"Take Me Home"

Engineer: **RAY HALL**

Producer: **MILT OKUN**

RCA Records/RCA Studios,
New York

Artist: John Denver with
Fat City

COUNTRY L.P.

"You're My Man"

Engineers:

**CHARLIE BRAGG,
LOU BRADLEY**

Producer: **GLENN SUTTON**

Columbia Records/Columbia
Studios, Nashville

Artist: Lynn Anderson

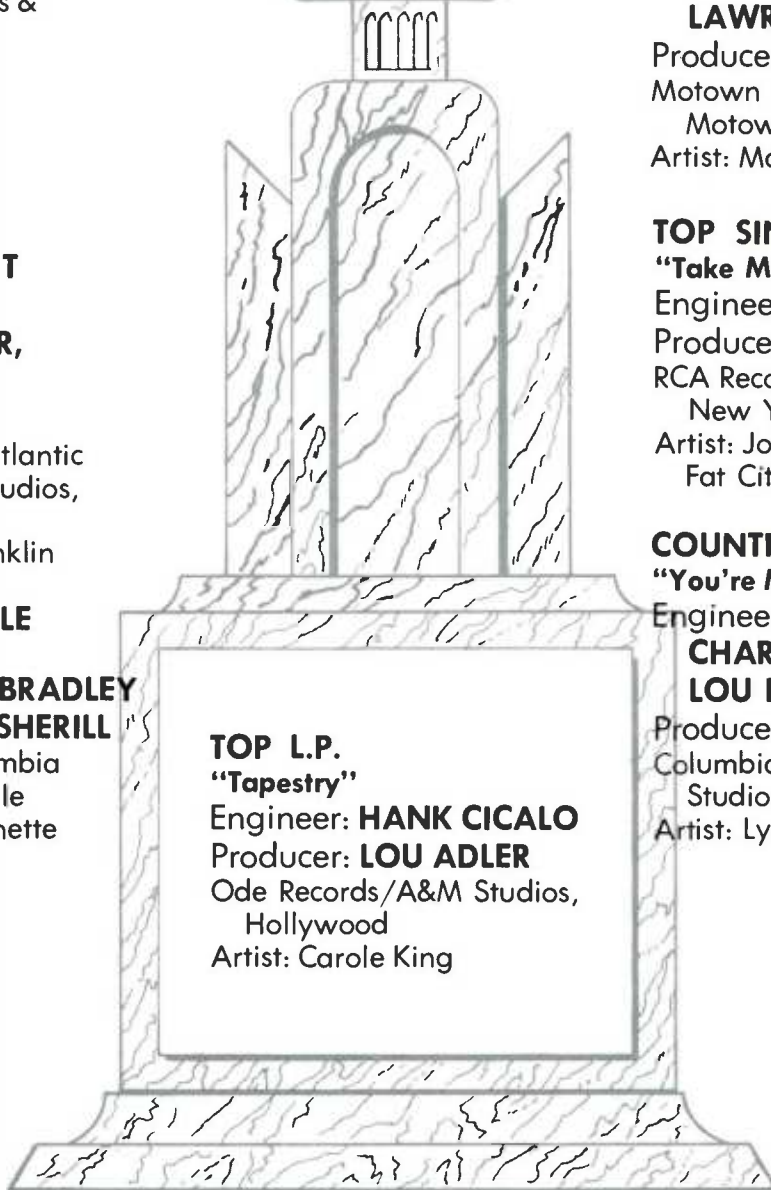
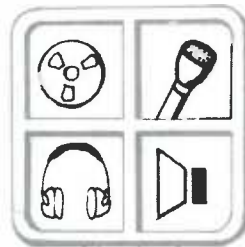



AUDIO ENGINEERING SOCIETY

Forty First Convention . . . Exhibition of Professional Products . . .

Hotel New Yorker
34th Street at
8th Avenue
New York, N.Y.

Oct. 5 through 8, 1971

Registration Hours

Tuesday, Oct. 5th — 8:00 A.M. to 8:00 P.M.
Wednesday, Oct. 6th — 8:30 A.M. to 8:00 P.M.
Thursday, Oct. 7th — 9:00 A.M. to 5:00 P.M.
Friday, Oct. 8th — 9:00 A.M. to 5:00 P.M.

SESSION A

TUESDAY, OCTOBER 5, 9:30 A.M.
TERRACE ROOM

TRANSDUCERS

- A-1 MODULATED AIR FLOW DIRECT RADIATOR LOUDSPEAKER
- A-2 "TUNNEL-REFLEX": A MINIATURIZED SPEAKER SYSTEM USING FOLDED COLUMN RESONATOR ENCLOSURES
- A-3 PREDICTED VS. MEASURED BEHAVIOR OF A DIRECT RADIATOR IN A VENTED ENCLOSURE
- A-4 SIMPLIFIED LOUDSPEAKER MEASUREMENTS AT LOW FREQUENCIES
- A-5 ERROR-FREE PASSIVE CROSSOVER NETWORKS
- A-6 MAXI-BASS AND MARVELOUS-MIDI FROM MINI-WOOF-WOOF
- A-7 MINIATURE TRANSDUCERS ILLUSTRATING SEVERAL METHODS OF EXCLUDING WATER

SESSION B

TUESDAY, OCTOBER 5, 2:00 P.M.
TERRACE ROOM

MAGNETIC RECORDING AND REPRODUCTION

- B-1 VELOCITY SENSING—THE PARAMETER FOR A COMPLETE TAPE TRANSPORT MOTION CONTROL
- B-2 THE STICK-SLIP PHENOMENON AT LOW MAGNETIC TAPE SPEEDS
- B-3 SOME CONSIDERATIONS ABOUT IMPROVEMENT OF THE TONE QUALITY OF CASSETTE TAPE RECORDERS
- B-4 CHROMIUM DIOXIDE AUDIO CASSETTE TAPE
- B-5 A STUDY TO ESTABLISH OPTIMUM LEVEL ON CASSETTE COPIES
- B-6 DYNAMIC NOISE LIMITER
- B-7 A REAL TIME SPECTRUM DISPLAY FOR MASTER TAPE EVALUATION
- B-8 DESIGN OF A NOISE ELIMINATOR SYSTEM

AUDIO ENGINEERING SOCIETY EXHIBIT

	BOOTH Nos.
Acoustic Research	Room 723
AKG Microphones, North American Philips Corporation	3/4
Allison Research Inc.	87
Ampex Corporation	92-98
Audio Designs and Manufacturing Inc.	78/79/80
Automated Processes, Inc.	58/59
BASF Systems, Inc.	13/14
The R. T. Bozak Manufacturing Company	19
Burwen Laboratories	Room 726
Capps & Company, Inc.	20
CBS Laboratories	Room 732
CCA Electronics Corporation	67/68
Crown International	49
DBX, Inc.	Room 735
Dolby Laboratories, Inc.	27/28
Dukane Corporation	42/43
Electro-Sound, Inc.	36/37/38
Electro-Voice, Inc.	Parlor B & C
ELPA Marketing Industries, Inc.	2
Eventide Clock Works	91
Fairchild Sound Equipment Corporation	88
Daniel N. Flickinger & Associates, Inc.	65/66
Gately Electronics	60/61
Gotham Audio Corporation	Parlor A
Harvey Radio Company, Inc.	26
HAECO	52
Hitachi Maxell Ltd.	5
International Telecomm Inc.	76
JVC America, Inc.	Room 729
Koss Electronics Inc.	50
Lipps, Inc.	18
Martin Audio Corporation	57
MCA Technology, Inc.	89/90
Multitrack	85
Nagra Magnetic Recorders, Inc.	55
Rupert Neve Incorporated	45/46
Olive Electro Dynamics Inc.	71/72/73
Ortofon	62
Otari of America Ltd.	83
Pentagon Industries, Inc.	77
Philips Broadcast Equipment Corporation	33/34/35
Pratt Sales Corporation	12
Quad-Eight Sound Corporation	63/64
RCA Commercial Electronics Systems	15/16
Recortec, Inc.	70
Revox Corporation	17
Sansui Electronics Corp.	Room 736
Scientific Electronic Systems	1
Scully Recording Instruments	31/32
Sennheiser Electronic Corp.	21
Shure Brothers, Inc.	30
Spectra Sonics	74/75
Stanton Magnetics, Inc.	22
Superscope, Inc.	53/54
Systron-Donner Corporation	29
TEAC Corporation	56
3M Company	39/40/41
	46/47/48
Tonus, Inc.	Room 731
United Research Laboratories Corp.	51
Vega Associates	Rooms 718/719

SESSION C
TUESDAY, OCTOBER 5, 2:00 P.M.
NEW ORLEANS ROOM

MEDICAL ELECTRONICS

- C-1 INNOCENT MURMURS IN CHILDREN:
SELF TEACHING PROGRAM FOR
PHYSICIANS
- C-2 ACOUSTIC EVALUATION OF PROSTHETIC
CARDIAC VALVE PERFORMANCE
- C-3 ULTRASONIC DIAGNOSIS IN MEDICINE
- C-4 SEEING WITH SOUND
- C-5 COMPUTER MODELLING FOR PREDICTING
OPTIMUM ANESTHESIA
- C-6 THE EDUCATION AND ROLE OF THE
AUDIO ENGINEER IN BIOELECTRONIC/
MEDICAL ENGINEERING
- C-7 SURVEY OF PRESSURE MEASUREMENT
INTERFACES IN SOCKETS

SESSION D
TUESDAY, OCTOBER 5, 7:30 P.M.
TERRACE ROOM

DIGITAL TECHNIQUES IN AUDIO
JOINT SESSION WITH IEEE AUDIO AND
ELECTROACOUSTICS GROUP

- D-1 A/D AND D/A CONVERTORS: THEIR
EFFECT ON DIGITAL AUDIO FIDELITY
- D-2 APPLYING DIGITAL TECHNOLOGY TO
AUDIO: DELAY, TRANSMISSION, STORAGE,
AND OTHER FORMS OF PROCESSING
- D-3 PRINCIPLES OF DIGITAL SIGNAL
PROCESSING
- D-4 RESTORATION OF OLD ACOUSTIC
RECORDINGS BY MEANS OF DIGITAL
SIGNAL PROCESSING
- D-5 SYNTHESIS OF UNLIMITED VOCABULARY
SPEECH USING A COMPUTER
CONTROLLED CHANNEL VOCODER

SESSION E
WEDNESDAY, OCTOBER 6, 1971
9:00 A.M. TO 5:00 P.M.
TERRACE ROOM

WORKSHOP ON STUDIO TAPE RECORDERS
MORNING SESSION: 9:00 A.M. TO 12 NOON
AFTERNOON SESSION: 1:30 TO 5:00 P.M.

AUDIO ENGINEERING SOCIETY
A day-long "hands on" approach on how to optimize
mechanical and electrical functions of professional tape
recorders. There will be a prepaid special registration
fee of \$5 for this workshop, and attendance will be
limited to 100. A portfolio of supporting literature is
included. Registration card enclosed.

SESSION F
WEDNESDAY, OCTOBER 6, 1971, 7:30 P.M.
TERRACE ROOM

A SPECIAL EVENING:
THE CARE AND FEEDING OF
TAPE RECORDERS

The New York Section is presenting a special program
for those interested in the inner workings and proper care
of tape recorders. Mr. Muncy, with his many years of
practical experience in maintaining tape recorders, will
discuss and demonstrate the locating, diagnosing, and
repairing of common faults in tape machines with the aid
of basic test equipment. The format will be informal
and open-ended so that questions may be answered by
participating panelists as they arrive. There will be no
registration fee for this evening session.

SESSION G
WEDNESDAY, OCTOBER 6, 2:00 P.M.
NEW ORLEANS ROOM
ACOUSTICAL NOISE CONTROL

- G-1 ROOM ACOUSTICS
- G-2 NOISE CONTROL FOR STUDIOS
- G-3 SOUND INSULATING WINDOWS
- G-4 ACOUSTICAL FLOATING FLOOR SYSTEMS
- G-5 BUILDING DESIGN FOR HIGH NOISE
LEVEL AREAS IN RECORDING STUDIOS
- G-6 ACOUSTICAL REQUIREMENTS
BUROLANDSCHAFTEN (LARGE-AREA
OFFICES)—THE NECESSITY OF
SOUND-MASKING SYSTEMS

SESSION H
THURSDAY, OCTOBER 7, 9:30 A.M.
TERRACE ROOM

DISC RECORDING AND REPRODUCTION

- H-1 A PRACTICAL HIGH-FREQUENCY
TRACKABILITY TEST FOR PHONO
PICKUPS
- H-2 PLAYBACK LOSSES AND THE DESIGN
OF WIDEBAND PHONOGRAPH PICKUPS
- H-3 A MULTIELEMENT STEREO CARTRIDGE
FOR DERIVED CENTER AND ROOM
AMBIENT SURROUND PLAYBACK
- H-4 A NEW DYNAMIC FEEDBACK STEREO
CUTTER-HEAD WITH ASSOCIATED SOLID
STATE DRIVING SYSTEM
- H-5 RECORD CHANGER DESIGN
CONSIDERATIONS
- H-6 SIGNAL SYNCHRONOUS VARIABLE
PITCH COMPUTER
- H-7 A COMPATIBLE STEREO-QUADRAPHONIC
(SQ) RECORD SYSTEM

SESSION I
THURSDAY, OCTOBER 7, 9:30 A.M.
NEW ORLEANS ROOM

AUDIO INSTRUMENTATION AND
MEASUREMENTS

- I-1 INSTRUMENTATION AND METHODS FOR
VIOLIN TESTING
- I-2 A DIGITAL ϕ -H METER
- I-3 WEIGHTED PEAK FLUTTER
MEASUREMENT: A SUMMARY OF THE
NEW IEEE STANDARD
- I-4 TRANSMISSION LINK TOLERANCES FOR
STEREO/MONO COMPATIBILITY
- I-5 AUTOMATIC DETECTION OF IMPULSE
NOISE
- I-6 INSTANTANEOUS POWER SPECTRA—
FOURIER ANALYSIS IN REAL TIME
- I-7 TONEBURSTS, TRANSIENTS, AND
TROUBLES

SESSION J
THURSDAY, OCTOBER 7, 2:00 P.M.
TERRACE ROOM
DESIGN OF AUDIO TRANSMISSION
SYSTEMS

- J-1 COMPARATIVE STEREOPHONIC
LISTENING TESTS
- J-2 A SIMPLIFIED CONSOLE MONITOR MIX
SYSTEM USING STATE OF THE ART
TECHNOLOGY
- J-3 A QUADRASONIC MIXDOWN CONSOLE
WITH VISUAL INDICATION OF AUDIO
DISTRIBUTION
- J-4 MULTICHANNEL MATRIX ENCODING
- J-5 ANALYSING PHASE-AMPLITUDE MATRICES
- J-6 NOISE REDUCTION FOR FM
BROADCASTING
- J-7 PROPOSED UNIVERSAL ENCODING
STANDARDS FOR COMPATIBLE
FOUR-CHANNEL MATRIXING

SESSION K
THURSDAY, OCTOBER 7, 2:00 P.M.
NEW ORLEANS ROOM

SOUND REINFORCEMENT AND
ARCHITECTURAL ACOUSTICS

- K-1 MICROPHONE TECHNIQUES FOR
IMPROVED PICKUP OF STAGE
PERFORMANCES
- K-2 MICROPHONE CONSIDERATIONS IN
FEEDBACK-PRONE ENVIRONMENTS
- K-3 DISCRETE FIELD MEASUREMENT OF
HOWLBACK PROBABILITY IN
MICROPHONES
- K-4 ELEVEN DAY SOUND SYSTEM FOR
325,000 PEOPLE
- K-5 ACOUSTICS AND SOUND SYSTEM DESIGN
FOR SAO PAULO EXHIBITION HALL
- K-6 ACOUSTICS AND SOUND SYSTEMS AT
THE WALNUT STREET THEATRE
- K-7 IMPROVED ELECTRONIC BACKGROUND
NOISE GENERATION AND
DISTRIBUTION SYSTEMS

SESSION L
FRIDAY, OCTOBER 8, 9:30 A.M.
TERRACE ROOM

AMPLIFIERS AND SIGNAL PROCESSING
DEVICES

- L-1 THE MONOLITHIC BALANCED
MODULATOR AS A VERSATILE AUDIO
SWITCHING ELEMENT
- L-2 A QUANTITATIVE COMPARISON OF
DEVICES FOR ELECTRONICALLY
PROGRAMMED ATTENUATION OF AUDIO
SIGNALS
- L-3 AUTOMATION AS APPLIED TO THE
MIXDOWN PROCESS
- L-4 AN ULTRAMINIATURE CONSOLE
COMPRESSION SYSTEM WITH MAXIMUM
USER FLEXIBILITY
- L-5 A FAIL-SAFE AUDIO POWER AMPLIFIER
- L-6 APPLICATION OF SUM AND DIFFERENCE
SIGNAL PROCESSING IN STEREOPHONIC
BROADCASTING
- L-7 A STEREO PROGRAM PHASE CHECKER

Continued on page 33



All together now...

Every beat, every note, tone, nuance faithfully reproduced. Every machine faithfully reproducing in sync. Ampex, leader of the 16-channel revolution, strikes again!

Now! The MM-1000 gives recording studios and teleproduction houses a new spectrum of creativity and quality. Now! The MM-1000 provides time and money-saving features offered by no other multichannel recorder.

Recording studios can lay it down like never before with the MM-1000's exclusive Capstan Servo accessories. Through the reel timing accuracy. Precise pitch. Variable speeds. Every sound the same because record and playback are exactly matched: whether standard 7½, 15, 30 ips, or varied. *Plus*, 16 fully calibrated channels and the rugged reliability of the recording world's most popular multichannel recorder.

Teleproduction houses can attain multichannel sync like never before with the MM-1000's new Auditec System. Auditec, coupled with an automatic programmer provides direct synchronized linking of multichannel audio recorders with videotape recorders and station sync pulse. For the first time, multichannel audio can be recorded, programmed, and played back in automatic broadcast sync with other video and audio recorders. Producers and clients can change, correct, and approve synchronized sound and picture in one quick, convenient session.

Get right on with the MM-1000's. Ask your Ampex Representative about a Lease/Purchase Option, or write:

AMPEX

Ampex Corporation, Professional Audio Products Division
M.S. 7-13, 401 Broadway
Redwood City, California 94063

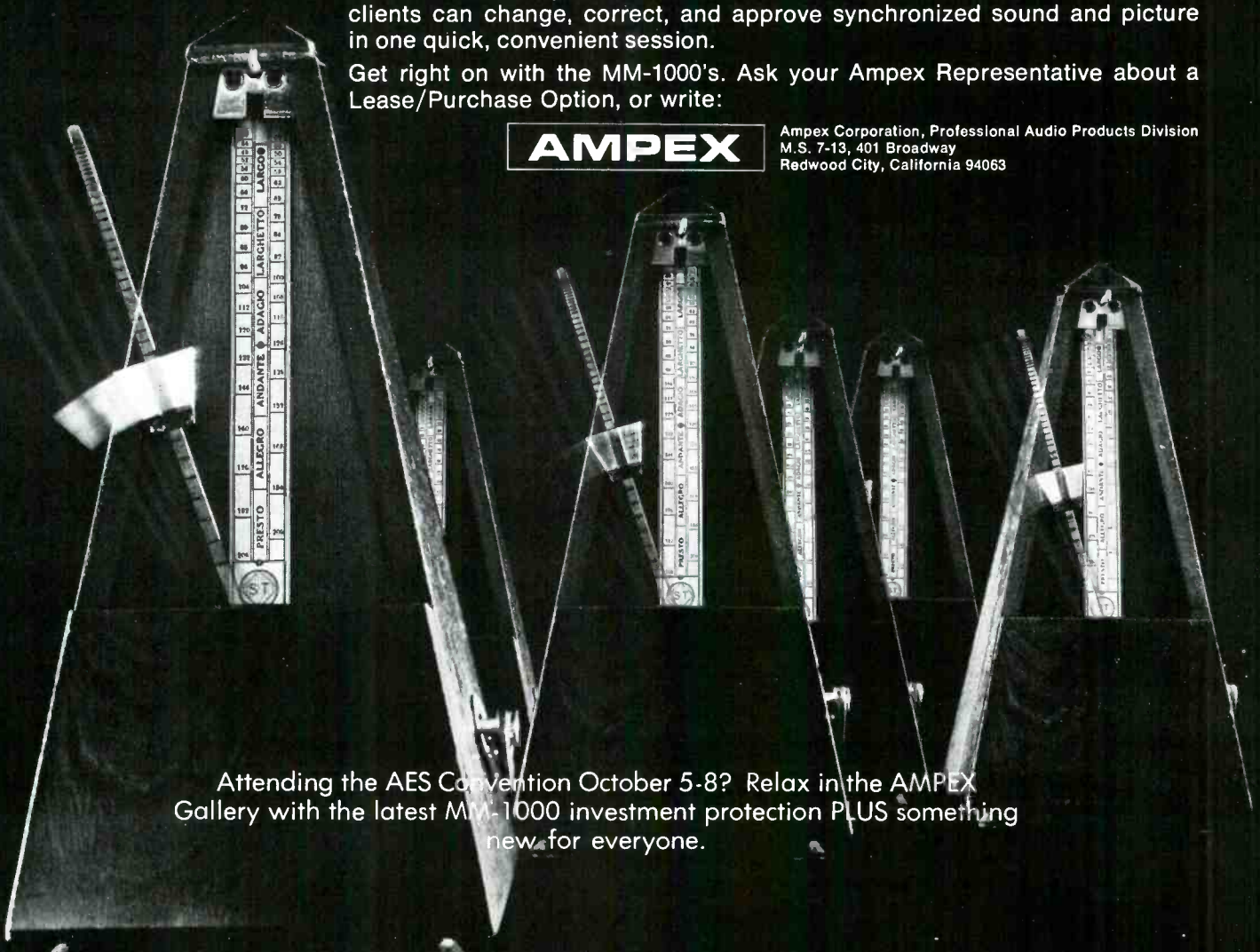

Attending the AES Convention October 5-8? Relax in the AMPEX Gallery with the latest MM-1000 investment protection PLUS something new for everyone.

FIGHTING MURPHY'S LAW

A column of tips and techniques to aid in the struggle against the physical principle, "If anything can go wrong, it will." (Murphy's Law)

Every producer and engineer has, sleeping somewhere deep in his second nature, a number of short cuts and techniques that he uses day to day in order to make life a little easier. This column will act as a medium for communicating those short cuts and techniques to other engineers and producers still suffering under Murphy's Law's oppressive influence. By spreading the word on time and energy conserving methods, perhaps we can bring the great demi-god to his knees.

How good this column is will in large measure depend on you folks struggling out there in the battlefield. You are the ones we will look to for tips and techniques in our common effort against "the Law." We'll even pay \$10 apiece for everyone we print.

There are no restrictions other than that the techniques should relate to some phase of the recording industry. Drop us a line on a couple of your favorites, and include a picture if you can.

To start things off, we've got three interesting little ideas:

SOLVING THE "ALL THUMBS" SYNDROME IN TAPE EDITING: This is an old and handy technique that, amazingly, many people haven't heard of. Instead of holding a piece of splicing tape between the thumb and index finger of both hands while trying to eyeball it straight onto an edit-all block (necessitating X-Ray vision), hold the splicing tape with the corner of a razor blade (see picture), and guide it down carefully and properly to the splice. You'll find this method quicker, easier, and more accurate than using thumbs and fingers.

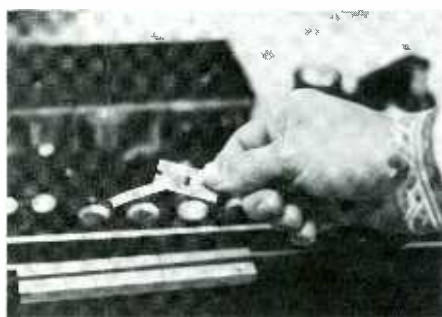

PREVENTING SUDDEN PART DEMATERIALIZATION: Many engineers are today convinced of the reality of black magic, due to the sudden and mysterious vanishing of parts (most notably critical nuts and bolts) into the ether. This is, in fact, what often happens to them, but there is a solution . . .

Fold a ten inch piece of masking tape back on itself, forming a loop with the sticky side out. Place this on the piece of equipment on which you are working (see picture), and stick your nuts and bolts to it. It is next to impossible to knock them off accidentally, and the fact that they are secured in the physical world makes it impossible for old Murphy to pull them through into the ether of the "other side."

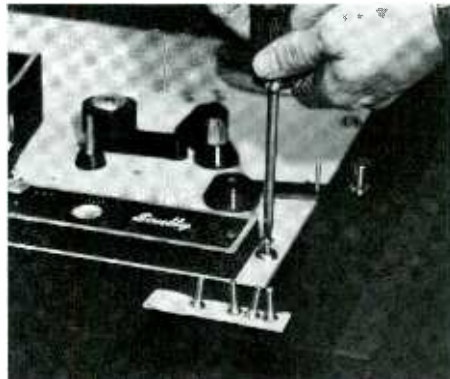

DOES EVERYBODY KNOW ABOUT GAFFERS' TAPE? No, everyone doesn't, it seems. And many of those that do, don't know where to get it.

Gaffers' tape is one of mankind's greatest inventions. Normally, it is two to three inches wide, and either silver or green. It sticks anything to anything. Heavy cables can be taped right to walls with a six-inch piece of this remarkable stuff (think of what that can do on remotes!). Cost is about \$3 per hundred feet. It can be obtained at Army Surplus stores (the green variety), and at wholesale plumbing stores (the silver variety).

If you buy from the plumbing wholesaler, ask for "ducting tape." If you ask for gaffers' tape, you'll be lucky to get a blank look.

Well, that's about it for this issue. We welcome your comments and your ideas. Anything that makes life in this business a little easier interests us. Recording tricks, editing techniques, repair hints, and the like . . . send them along.

And look out for Murphy!

FREE from AKG

48-page technical brochure on Field Effect Transistor condenser microphones and describing in detail:

- A.** Structural details of new type miniature condenser microphone capsules with various pick-up pattern, complete with performance and comparison charts.
- B.** F.E.T. condenser microphone preamplifier technology, including schematics and specifications.
- C.** Modern powering techniques of F.E.T. condenser microphones.
- D.** Application hints, including illustrations and descriptions of recording accessories.



This booklet is of interest to every innovative recording and broadcast engineer. Please fill out coupon below or send us your request on your organization's stationery. AKG-113

NAME _____
 TITLE _____
 FIRM _____
 ADDRESS _____
 CITY _____
 STATE _____ ZIP _____



AKG CANADA • DIVISION OF DOUBLE DIAMOND ELECTRONICS • SCARBOROUGH, ONTARIO
 Circle No. 115

THE NEW SCULLY 100 MOVES 2" TAPE BETTER THAN ANY OTHER RECORDER ON THE MARKET...

Regardless of Price

That's a big statement. But the facts are in. After months of rugged use, studios rate the 100 transport ahead of all others . . . a spill proof transport that silently moves 2" tape with unmatched precision.

It's all there. The first truly modular recording system that allows you to buy all the accessories you need . . . or none at all. Add them later when (or if) you need them. And the basic price is only \$13,750.

No more sync problems or switching noise either. Scully's new combined record/playback head lets you punch in and out, go from play to record to sync. Never worry about performance loss or transient noise.

And the 100 is from Scully . . . the name that's been the industry standard for years.

Service? To augment the nation-wide distributor organization, company-operated Service Centers are being opened coast to coast. Our first four (with more to come) are strategically located in the major music areas. For a demo . . . or merely some specs . . . call Dave Nicholls, Nashville (615 327-1747); Mike Faulkner or Doug Oliver, L.A. (213 387-8354); Ham Brosious or Bob Berliner, N.Y. (212 688-0030); Gareth Nelson, Chicago (312 583-7878); or write Scully, 480 Bunnell St., Bridgeport, Conn. 06607 (203 335-5146)



two heads are better than three



*we stand behind our product
Circle No. 116*



the 100 . . . for today's sound

▶ Dictaphone
Scully Division

A PHASE CORRELATION INDICATOR

by WILLIAM L. ROBINSON
ENGINEERING DIRECTOR
SUNSET SOUND RECORDING

One of the many problems confronting the recording engineer is signal loss due to improper phase relationship. Whether during recording or mixdown, the proper relationship of the sum and difference signals is important if the quality and compatibility of the finished product is to be acceptable. Each of us, at one time or another, has been met with the problem of an out-of-phase signal on the final product. This is especially problematic in this day of multi-track recording.

One of the most popular of the many methods of indicating phase relationships is the use of the oscilloscope.

The sum and difference signals are fed to the horizontal and vertical inputs of the scope, and the resultant pattern is displayed.

The pattern on the scope when oriented from upper right to lower left indicates an in-phase condition. However, when working with full orchestration where only one or possibly two pieces may be out of phase the blossom effect of the scope display might easily conceal the out of phase signals. So, while using an oscilloscope may be effective, the design described here tends to be more decisive and is certainly more convenient to use in seeing any out of phase signal.

A simple circuit was developed several years ago to indicate, on a continuous basis, the phase relationships of program material. Several improvements have been made on this original circuit, primarily to provide better frequency response, and to utilize components which are readily available. The circuit as shown requires no external power supply and uses only passive devices.

EACH INPUT ENTERS THE PRIMARY OF A step down transformer with two equal secondary windings (a UTC H-14). Each secondary winding is connected to its twin in the other transformer, one connected **series-aiding**, and one **series-opposing**, thus forming sum and difference voltages.

The two diodes and the non-polarized electrolytic capacitor serve to rectify the sum and difference voltages and produce the average peak voltage. If the sum voltage is consistently larger than the difference voltage, the voltage across the capacitor will be positive. If the voltages are the same, the capacitor voltage will be zero. If the difference voltage is greater than the sum, the voltage at the capacitor will be negative.

A zero-center microammeter is connected across the capacitor and indicates the polarity and amplitude of the capacitor voltage. The input impedance of the unit is high enough to bridge a program buss. About .2 volts at both inputs will deflect the meter full scale. In order to minimize the loss of sensitivity with the low impedance meter used in this circuit, diodes of the high forward conductance type should be employed.

Connect each signal channel to the input terminals, being careful to use the same terminal of both inputs. Depending on the character of the input signals, the meter pointer will either move from the center position into the in-phase (right) or out-of-phase (left)

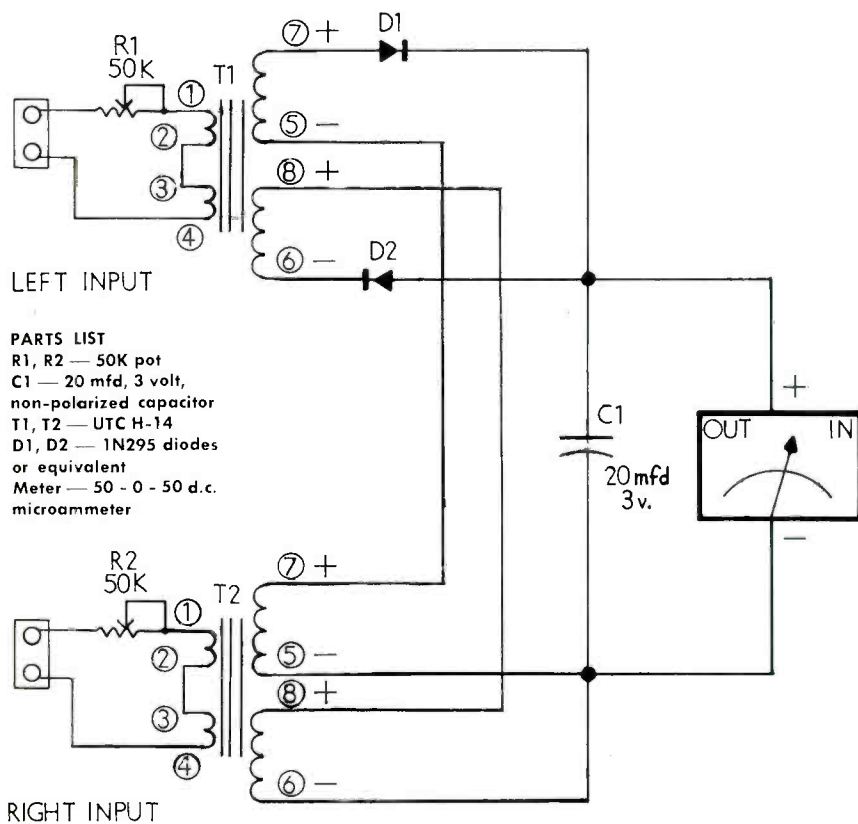

PARTS LIST

R1, R2 — 50K pot
C1 — 20 mfd, 3 volt,
non-polarized capacitor
T1, T2 — UTC H-14
D1, D2 — 1N295 diodes
or equivalent
Meter — 50 - 0 - 50 d.c.
microammeter

The GREAT Equalizer

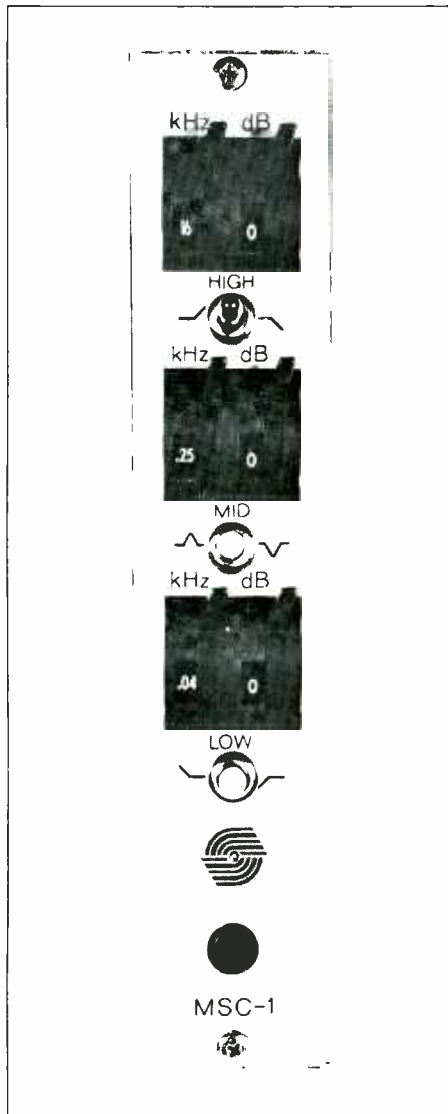

- * 60 AVAILABLE CURVES
- * RECIPROCAL BOOST/CUT
- * LED INDICATOR
- * CUSTOM FOR YOU WITH YOUR LOGO!

AUDIO INDUSTRIES LIMITED

2 THORNCLIFFE PARK DRIVE
TORONTO 354, ONTARIO, CANADA
AREA CODE 416-425-9229
Circle No. 117

Re/p 32

region of the meter scale. If the meter remains in the center, the input signals are completely uncorrelated, and their phase has no significance.

Deflection of the meter pointer in the positive direction indicates a highly correlated or monophonic signal, while any consistent deflection of the meter to the left, or negative half of the meter indicates an undesirable out-of-phase condition.

CAUSES AND EFFECTS OF AN OUT-OF-PHASE CONDITION: The most common cause of an out-of-phase condition is the miswiring of a microphone connector, or microphone extension cable. Any wiring system used in a studio should be consistent and followed through on all microphones and extension cables. One may use, for instance (as in the Cannon XL series), pin #1 as shield, pin #2 as high side, and pin #3 as low side of the audio pair.

Although not as common as an electrical out-of-phase condition, it is possible to be confronted with an acoustical out-of-phase condition. If two bi-directional microphones are closer than ten feet together, or in a "live" room, some acoustical phasing may be experienced. Moving the microphone a foot or so may solve the problem.

In monitoring, one of the simplest ways to determine whether or not a

signal is out-of-phase is to combine the two signals to monophonic, either through the mixer channel, or in the monitoring system itself. Usually the first thing that is noticeable is a lack of bass or low frequencies. Sometimes the signal completely disappears. High frequencies sound as if they're coming from overseas on a radio broadcast with a "swishing" sound.

The technique of recording drums with multiple microphones can be a source of an out-of-phase condition if any one of the microphones is out-of-phase. Little can be done with a two channel product if a portion of the program material is out-of-phase, except to remix the original material and correct the problem at the source. This can be accomplished with the use of a "turned-over" patch cord, or a 1 to 1 isolation transformer with one of the windings reversed.

In any event, the phase correlation meter will give a quick and positive indication of phasing problems, either during recording or mixdown. We have used the unit in all of our stereo locations, in the studios, editing rooms, and disc recording rooms.

Although there are many methods of determining phase relationships, this unit will provide the information at a reasonable cost. END



Allen: "Everything we do is pulsed. If we send it to New York, make a copy, or whatever, the speed is always the same. We put a 60 Hz pulse on the tape, out of phase with itself. You can't hear it unless you put it on a half track head. If you play it on a full track head, you won't hear it at all."

"By employing a resolver during rerecording or playback, the speed and time is always the same."

"Also there are several units available that can shrink a 60 second spot to 30 seconds, or expand it to two minutes. But I'll tell you, the quality really gets bad when you go that far. For a few seconds one way or the other though, it's fine. We often stretch a 58½ second T.V. spot to 60 seconds for the radio."

Feldman: "Just as you have equalization built into each input, I think it's important to have a wide variety of microphones, which are your best equalizers. We try and avoid using too much equalization. We rather go for the right mike for the right instrument, and the right application."

Re/p: "How do you see this business? What is your outlook on this whole process?"

Swedien: "We've learned over the years I think, that the whole thing should be conceived, rather than just two pieces thrown together. You get a better product by scoring, rather than by pulling some music from the library."

Allen: "We have a saying: 'This commercial isn't going in the time capsule'. By that we mean it's not going to be studied in the year 2000. It doesn't have to stand on its own. All it has to do is sell the product it was made for. You have to stay in reality."

Feldman: "If it isn't happening on that side of the glass, we can't make it happen in here. All we can do is complement what's going on out there."

"That's why lighting and acoustics are specifically designed for the sake of the musician as well as the engineer."

"If you make it comfortable for the musicians, and you make it a nice room to play in . . . not just somewhere they come to work, then you

get a better performance out of them. And it makes the engineer and studio look better too."

Re/p: "Thank you gentlemen, for sharing some of your magic and trickery with us. One last question, though . . . Witchdoctors have traditionally lived close to nature; in this age of ecology, has there been any resistance by producers and engineers to certain kinds of commercials? Refusing to do a commercial for a detergent that's a high polluter, for instance? Has there been any of that sort of consciousness in the Jingle Jungle?"

Rubenstein: "I haven't run across any. I refuse to do cigarette commercials, but then again . . . nobody's asked me to either!" END

SESSION M
FRIDAY, OCTOBER 8, 2:00 P.M.
TERRACE ROOM

ELECTRONIC MUSIC

- M-1 A COMPOSER'S VIEW OF MITSYN
- M-2 DIGITAL COMPOSITION AND CONTROL OF AN ELECTRONIC MUSIC SYNTHESIZER
- M-3 RECENT DEVELOPMENT IN THE DESIGN OF VOLTAGE CONTROLLED OSCILLATORS FOR ELECTRONIC MUSIC
- M-4 PRESET PROGRAMMING OF ELECTRONIC MUSIC SYNTHESIZERS
- M-5 TEMPERED SCALE GENERATION FROM A SINGLE FREQUENCY SOURCE
- M-6 LARGE SCALE INTEGRATION IN ORGAN DESIGN
- M-7 DIGITAL SYSTEM FOR REALISTIC ORGAN TONE GENERATOR

ELECTRONIC MUSIC CONCERT
FRIDAY, OCTOBER 8, 7:30 P.M.
TERRACE ROOM

Please include a Recording engineer/producer address label whenever you write to us about your subscription. The numbers on your address label are essential to insure prompt and accurate service.

(attach label here)

MAIL TO: Recording engineer/producer
Box 2287 hollywood, calif. 90028

YOU-SHAPED SOUND...

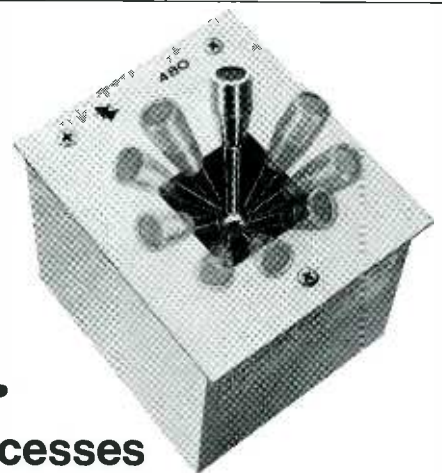

with Automated Processes Quadrasonic Stereo Panner Model 480

Precise, finger-tip, 360° control of a sound source into 4-channels is yours with the Model 480 Quadrasonic Stereo Panner. It lets you create any type of motion pattern; sequeways between stereo programs; reverb sound combinations; or static positioning (if that's all you want).

The single-knob "joystick" provides infinite resolution . . . stepless movement, noiseless and accurate. It also acts as a visual indicator for the phantom sound source.

We designed the Model 480 to meet the demanding requirements of 4-channel sound positioning...low noise conductive plastic elements, precious metal contacts, connections for splitting 1 channel into 4, or simultaneous 2 into 2.

No power supply required. Occupies only 3" x 3½" of panel space, 3¾" deep. To put "you" in the 4-channel driver's seat, contact us at once for technical literature.

AUTOMATED PROCESSES, INC.
35 CENTRAL DRIVE, FARMINGDALE, NEW YORK 11735-516-694-9212
In Canada: PERCEPTION INDUSTRIES, INC.

Circle No. 118

Re/p 33

Sony makes a case for its professional microphones.

Sony has six professionals ready to go to work for you. And each one is unqualifiedly the best microphone money can buy. Contact your nearest Sony/Superscope Special Applications Dealer or write: Sony/Superscope, 8132 Sunland Blvd., Sun Valley, Calif. 91352.



A. ECM-53 CARDIOID CONDENSER: 40-16k Hz \pm 3dB; MAX. SPL: 126dB @ 1% THD; -53.2dB SENS. @ 250 Ω IMP. \$149.50.

D. *C-500 CARDIOID CONDENSER: 20-20k Hz \pm 3dB; MAX. SPL: 154dB @ 1% THD; -56dB SENS. @ 250 Ω IMP. \$395.

B. *ECM-377 CARDIOID CONDENSER: 20-20k Hz \pm 3dB; MAX. SPL: 140dB @ 1% THD; -49dB SENS. @ 250 Ω IMP. \$195.

E. ECM-50 OMNI LAPE CONDENSER: 50-16k Hz; MAX. SPL: 126dB @ 1% THD; -53.2dB SENS. @ 250 Ω IMP. \$129.95.

C. *C-37P OMNI/CARDIOID CONDENSER: 30-16k Hz \pm 2.5dB; MAX. SPL: 154dB @ 1% THD; -49.3B SENS. @ 250 Ω IMP. \$325.

F. ECM-51 TELESCOPIC OMNI CONDENSER: 50-16k Hz; MAX. SPL: 126dB @ 1% THD; -53.2dB SENS. @ 250 Ω IMP. \$129.95.

*AC-1484 PHANTOM POWER SUPPLY: 49 V.D.C. = 1 VOLT; BUILT-IN CONNECTORS FOR 2 MICROPHONES. UP TO 10 ADDITIONAL MICS WITH EXTERNAL ADAPTORS. \$99.95.



NEW PRODUCT NEWS

AKG ANNOUNCES TWO NEW MICROPHONES: THE C-412 F.E.T. condenser microphone system with 1" diaphragm capsule. The unit incorporates a pattern selector switch to vary polar pattern from omni-directional to cardioid to figure-eight. In addition, it is equipped with a 20 dB switchable output pad. The C-412 may be phantom



Circle No. 120

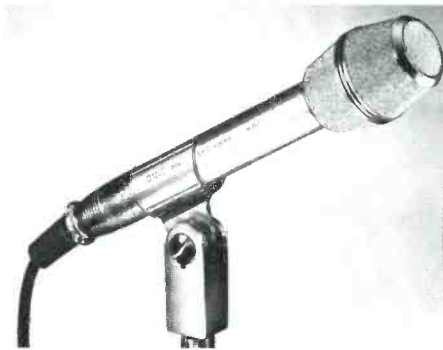

powered by utilizing the commonly available 24 v B+ supply or with the AKG a.c. or d.c. power supplies available for the AKG C-451E.

THE D-124E Studio cardioid dynamic microphone is based on a new transducer element. The unit exceeds the acoustical properties normally expected from a cardioid dynamic microphone, particularly in smoothness of response and by a well maintained directional pattern at all frequencies.

NORTH AMERICAN PHILLIPS CORP.,
100 E. 42ND STREET, NEW YORK,
NEW YORK 10017.



THE ALTEC 8050A IS A COMPACT REAL-TIME ANALYZER for the audio spectrum. The instrument covers the frequency range from 40 Hz to 16 kHz with 27 parallel bandpass filters. Detectors following the filters convert the ac filter outputs to dc levels proportional to the rms value of the ac signals. An internal scanner sequentially connects the 27 detector outputs to the CRT display screen of the instrument through a log converter and simultaneously generates a linear ramp at the "X" deflection. The gain

Circle No. 121

of the preamplifier circuit in the 8050A is continuously variable from -20 dB to +20 dB, permitting shifting of the 20 dB display from the range of 70-90 to 110-130 dB. An overload lamp on the front panel of the instrument indicates preamplifier overloads as brief as 100 microseconds. The unit contains a built-in power supply to operate a condenser type microphone.

ALTEC LANSING, 1515 SO. MANCHESTER AVENUE, ANAHEIM, CA. 92803.

Circle No. 119

NEW!

PANNING AND SLIDERS ON A BUDGET

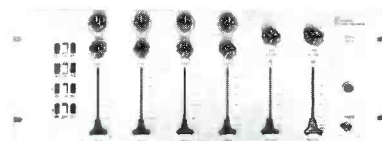

EM-7S Four Input Stereo Echo Mixer

All features of our regular EM-7 Mixer plus slide pots, panning active mixing and IC circuitry. Duplicates all big board effects when used with ES-7 echo unit and PEQ-7 equalizer.

FOUR CHANNEL ACTIVE PEAKING TYPE EQUALIZER

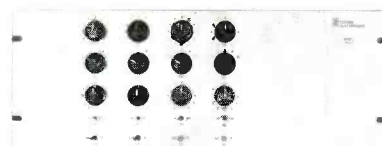

PEQ-7 Four Channel Equalizer

Update your EM-7 system or use with new EM-7S Mixer. Five Hi freq. peaking type curves, 1.5, 3, 5, 10, and 20 kHz. Boost or cut in steps of 2, 4, 6, 9, or 12 dB. EQ in-out switch. Zero insertion loss.

GATELY ELECTRONICS

57 WEST HILLCREST AVENUE
HAVERTOWN, PENNA. 19083
AREA CODE 215 • HI 6-1415
...have you checked Gately lately?

Circle No. 141

HEAR
BURWEN LABORATORIES

**STOP NOISE
POLLUTION**

IN PROGRAM MATERIAL

2000 NOISE ELIMINATOR

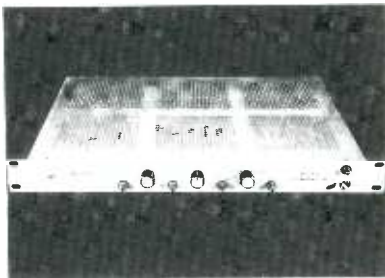

110 DB Dynamic Range
For Tape Mastering

1000 DYNAMIC NOISE FILTER

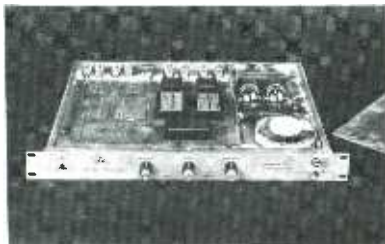

For Existing Records, Tapes or
FM. 10 DB Noise Reduction in
Multitrack Mix.

1030 AMPLIFIER - NOISE FILTER
6 CHANNEL LABORATORY or
STUDIO AMPLIFIER & HUM FILTER

MODULES

AT200 ACTIVE TRANSFORMER
GC101 WIDEBAND GAIN
CONTROLLER

DEMONSTRATIONS AT THE
AUDIO ENGINEERING SOCIETY
CONVENTION, OCTOBER 5-8, 1971
HOTEL NEW YORKER, N.Y.C.

**BURWEN
LABORATORIES™**

12 Holmes Road
Lexington, Mass. 02173

(617) 861-0242
Circle No. 122

LATEST ENTRY FROM MCI IS THE JH-16 RECORDER, LISTING AT \$16,500. Features include 15- and 30-IPS speeds; three heads adjustable for height, Zenith and Azimuth; one- and two-inch capability; quick-change heads and guides; automatic tape lifter; automatic head shield; rigid roller guides; constant tape tension via Servo System for outstanding speed stability; full logic system; cast jig plate deck; dynamic braking; silicon solid state construction; all critical components mounted on plug-in circuit boards; automatic switching from sync head to input when over-dubbing; plug-in equalizers; central meter grouping; easily accessible screwdriver adjustments for tape tension, idle null, fast forward and re-wind speed, reproduce, sync and record level controls, erase, bias and equalization trimmers.

Also full motion, mode and logic remote control; spaceage designed compact housing on heavy duty four-inch casters; four doors for easy accessibility to any portion of recorder; JH-10 transport swivels over 90 degrees for ease of service; convenient



XL strip on rear of housing; and two ultra-quiet fans. Size: 32" wide, 30" deep, 35" high (to top of transport), 44" (to top of meter).

MCI IS A MANUFACTURER OF PROFESSIONAL RECORDING EQUIPMENT LOCATED AT 1140 NORTH FLAGLER DRIVE, FORT LAUDERDALE, FLORIDA 33304.

Circle No. 123

NORELCO ANNOUNCES THE MODEL PRO' 36 STUDIO TAPE RECORDER for use in Broadcasting and TV studios,



theatres, sound and film production studios, and recording studios. The unit features all electronics incorporated into one unit, mountable under or in front of the deck, plug in record and playback amplifiers, equalization filters for both CCIR and NAB standards, an asynchronous motor with damping circuitry utilizing the Foucault principle, and a starting time of .1 seconds. Wow and flutter (weighted RMS) at 15 ips is a maximum $\pm .05\%$.

PHILIPS BROADCAST EQUIPMENT COMPANY, ONE PHILIPS PARKWAY, MONTVALE, NEW JERSEY 07645.

Circle No. 124

NEW ORYX MODEL 50 SOLDERING IRON features close control of soldering temperature, from 400 to 750° F.



It is ideal for soldering delicate components, including semiconductors, that can be damaged by high temperatures . . . as well as for any use where it is desirable to maintain close control over temperature.

A thermostat built into the handle of the iron keeps the temperature constant, regardless of the size of the point, amount of solder applied, speed of soldering, fluctuations in line voltage, or other variables. The husky 50-watt element provides fast initial heating and almost instantaneous recovery from heavy joint loads.

PRICE \$16.95. TELVAC INSTRUMENT CO., 14614 RAYMER STREET, VAN NUYS, CALIFORNIA 91405.

Circle No. 125

OTARI OF AMERICA INTRODUCES NEW QUAD DECK — A built-in test oscillator makes Otari's new MX7000-QX Quad Deck ideal for both remote and studio recording. The professional three-speed equipment with automatic equalization has four separate sets of electronics. The Quad Deck features sound on sound and sound with sound. With its 10½-inch reel and tape transport, it is designed to fit into a standard 19-inch rack.

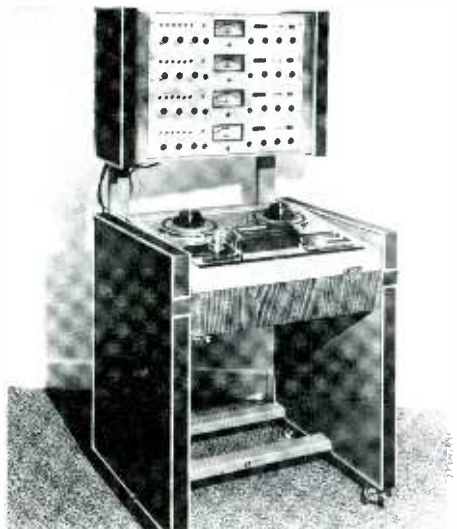

Priced at \$3,600, it comes complete in a studio console.

OTARI OF AMERICA, 8295 SO. LA CIENEGA BLVD., INGLEWOOD, CALIF.

Circle No. 126

THE PHASE TPG-200 is a high quality, solid state general purpose pulse generator. The TPG-200 has a continuously adjustable repetition rate, pulse width, and amplitude that is triggered by your sine or square wave generator. This unit also features ultra-fast rise and fall times to meet demanding test requirements. The TPG-200 has proven itself as a quality control unit to test amplifier response. The unit is also used to trigger logic circuits and to control chopper circuits.



PHASE CORP., 315A BOSTON AVENUE, MEDFORD, MASS. 02155.

Circle No. 127

THE AUTOMATED PROCESS MODEL 340 PEAK LEVEL INDICATOR provides a simple and convenient means of calling attention to audio peaks of either polarity in excess of a pre-set level to prevent amplifier overload, tape print-through and other undesirable effects.

Firing thresholds can be selected within a wide range, and it is also possible to connect two or more Model 340 modules to the same group of audio lines and to set each of the thresholds to a different level, producing in effect a group of peak program meters with as many levels of indication as desired.



The virtually infinite life light emitting diode (LED) indicators furnished are easily mounted in any desired front panel location, usually above the appropriate VU meters or faders.

AUTOMATED PROCESSES, 35 CENTRAL DRIVE, FARMINGDALE, NEW YORK 11735.

Circle No. 128

DYNAMIC NOISE FILTER FROM BURWEN LABS. The Model 1000 Dynamic Noise Filter reduces noise when playing master tapes, prerecorded tapes, records, cassettes, or FM. By varying its bandwidth automatically in response to the music it is able to reduce noise with negligible audible effect on the program content. For low levels attenuation is 25 dB at 30 cps and 22 dB at 10 kc. At high levels frequency response is flat within .2 dB from 20 cps to 20 kc and harmonic distortion is typically .01% at +18 dBm. The chassis accommodates one, two, three, or four channels ganged in pairs for stereo and the number of channels can be varied by plugging in epoxy encapsulated modules.



BURWEN LABORATORIES, 12 HOLMES ROAD, LEXINGTON, MASSACHUSETTS 02173.

Circle No. 129

THE PHASER

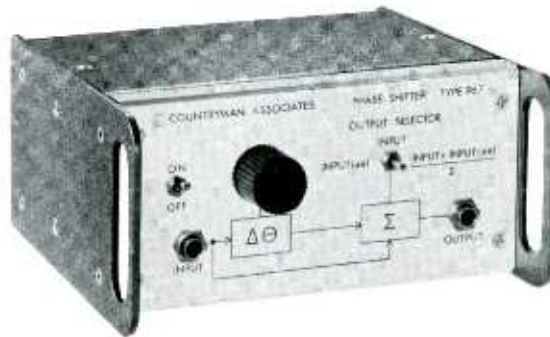

Would you use phasing and flanging effects more often if they were less difficult to obtain? Now you can produce these effects without tape machines, reproducibly and with complete control.

The Type 967 Phase Shifter electronically delays an input signal and then mixes the delayed and undelayed versions together. It allows you to add the striking "turning inside out" effect of Phase cancellation to any audio signal live or recorded, in the studio or in performance, in minutes instead of hours.



COUNTRYMAN ASSOCIATES

424 University Avenue
Palo Alto, Calif. 94302
Phone 415-326-6980

Circle No. 130



See If you can walk away unaffected.

If you ever have an opportunity, sit down at the controls of an Olive console and play a tape through it. The flexibility and experimental freedom may be overwhelming when you realize all of the features you have always wanted in a console are at your fingertips.

Surrounded by human-engineered, technically sophisticated equipment that is this easy to operate, you enter a new dimension of confidence. Setup is fast and easy with immediate response to your touch plus visual

displays that provide instant feedback on complete console status.

Try an experiment: pick out an instrument on the tape and enhance it with our unique four-section equalizer. Now you can begin to understand why everyone's talking about it. If you like this kind of excitement then play the master tape back and watch the Remix Programmer duplicate your manual mix . . . automatically.

Further modification is very simple and the last recorded "memory" is

permanently stored right on the original master. Amazing? This console is designed for the computer age.

Stop by for the "Olive experience" at Booths 70, 71 and 72 during the AES Convention in October. It may have an effect on you. If you would like further information on the Olive Series 2000 Automated Console or the smaller Series 2500, contact our US distributor or write direct. Either way your request will receive personal attention.

olive 
WHENEVER THERE IS A NEED

OLIVE ELECTRO DYNAMICS INC.
2670 Paulus
Montréal 386, Québec
Canada
(514) 332-0331
Cable Olive1, Montréal

US Distributor
WESTLAKE AUDIO INC.
6511 Wilshire Boulevard
Los Angeles, California
90045
(213) 655-0303

THE MODEL 515 Input Module is another in a series of AUTOMATED PROCESSES components designed for specific functions, which can be easily integrated into total system concepts. The Model 515 is front panel mounting and contains a microphone pre-amplifier and booster amplifier along with switch and level controls providing outputs to four independent echo feeds, two independent cue feeds, a channel "solo" feed, and a stereo pan feed as well as three frequency high pass filter, a microphone preamplifier gain control, a 20 dB switchable input pad, a mic/line switch, a phase reversal switch, and a channel on/off switch. The Model 515 is designed to plug-in from the front and requires 7"x 1 1/2" of panel space with approximately 4 1/2" behind the panel.

See it at Booth 58-59 at the A.E.S. Convention, Hotel New Yorker, October 5th through 8th.

AUTOMATED PROCESSES, INC., 35 CENTRAL DRIVE, FARMINGDALE, NEW YORK 11735.

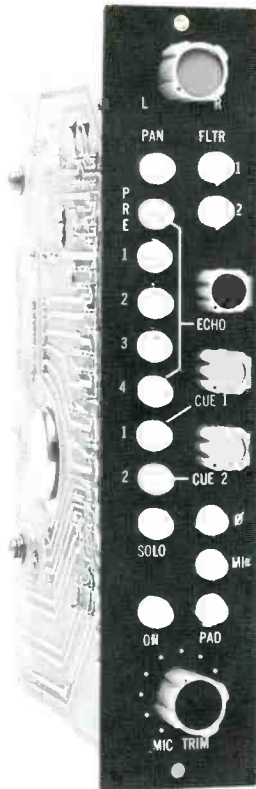

Circle No. 132

NEW PHASE COMPARATIVE ANALYZER FOUR TRACE PRE-AMP is a highly flexible unit used in conjunction with an ordinary oscilloscope. It provides the capability to compare up to four separate waveforms at a glance through the use of time sharing techniques. The PCA will be found useful in checking and testing logic circuits, digital systems, audio equipment, and television.



In kit or fully assembled; 3 models from about \$55.

PHASE CORPORATION, 315A BOSTON AVENUE, MEDFORD, MASSACHUSETTS 02155.

Circle No. 133

LAST YEAR
AT THE 39TH AES
CONVENTION, NEW YORK,
WE DISPLAYED
KEPEX
SERIAL
NUMBER 0036

THIS YEAR
AT THE 41ST AES
CONVENTION, NEW YORK,
WE'RE SHOWING
KEPEX
SERIAL
NUMBER 1000

GAIN-BRAIN
IS
BLOSSOMING
P.O.P.

AND WE'VE
PLANTED A
NEW
FLOWER



ALLISON RESEARCH, INC.
7120 SUNSET BOULEVARD
HOLLYWOOD, CALIF. 90046

(213) 874-6615

BOOTH # 87

Exclusive export agent: GOTHAM AUDIO DEVELOPMENT CORP., NEW YORK, N.Y.

← Circle No. 131

Circle No. 135



Cut it in half

Half the cost, time, and worry, at Dick McGrew Recording Service in Dallas.

Dick beats the competition with record master costs like \$30 per side for stereo 12 inch 33 1/3 rpm, and \$10 per side for 45's. The day he receives your tape, he'll groove your master with the Neumann SX 68 cutter, the ultimate in cutting machines. Dick'll give it the individual and expert attention of a man who does a lot of producing himself.

For no extra charge, Dick will provide equalization, reverberation, or other special services at your request. And he's used to giving attention to problem tapes.

Interested in album pressing or singles? Dick's got a competitive price list for these services, too. Let us hear you!

Dick McGrew recording service

7027 TWIN HILLS AVE. • DALLAS 75231 • 214 691-5107

Circle No. 136

for that heavy studio sound!

1176 LZ

limiting amplifier

the Industry's most popular limiter!
over 2000 in use!

- Push buttons for four compression ratios
- Ultra fast attack time, adjustable
- Independent release time, adjustable
- Compact: 3 1/2" x 19" rack

See your dealer or write for complete specifications.

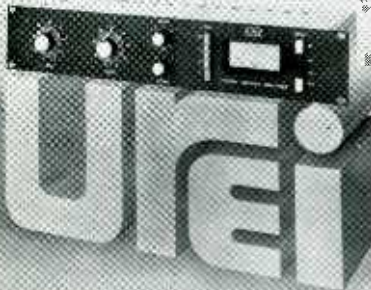

11922 Valero Street, No. Hollywood, California 91605
(213) 794-1500

Exclusive export agent
BOTHAM AUDIO DEVELOPMENT CORP. NEW YORK, N.Y.
Telex 423353 BADC UR

Circle No. 137

CLASSIFIED

Send for FREE Catalog and Audio Applications



OPAMP LABS
172 S. Alta Vista Blvd.
Los Angeles, Calif. 90036
(213) 934-3566



Circle No. 138

EQUIPMENT AVAILABLE

America's Largest Selection of New and Used RECORDING EQUIPMENT

Bought, Sold, Traded — Write for Free Listing

THE MAZE CORPORATION

P. O. Box 6636, Birmingham, Alabama 35210

ONE STOP FOR ALL YOUR PROFESSIONAL AUDIO REQUIREMENTS. BOTTOM LINE ORIENTED.

F. T. C. BREWER COMPANY

P. O. Box 8057, Pensacola, Florida, 32505

PROFESSIONAL NATIONWIDE STUDIO DESIGN, INSTALLATION, AND SERVICING. PLAN BEFORE YOU SPEND!

THE MAZE CORPORATION

P. O. Box 6636, Birmingham, Alabama 35210

USED RECORDING EQUIPMENT

Wide range of recording equipment including recorders, amplifiers, speakers, microphones, etc. All items in good used condition, most at 50% off new prices. For complete detailed listing with prices, drop a card to:

P.O. Box 2646 Hollywood, Calif. 90028

Ampex 8-Track—300 Series
Ampex Sel Sync Ampex Heads
New 8-Track motors
Transport reconditioned

P. R. 10 electronics—Good condition, quiet
Beautiful cabinet

FOR QUICK SALE

\$3,500.00 much more invested

A D RECORDING STUDIO

1012 Oak Street, Burbank, California 91506
(213) 848-9004

NOTICE

INDIVIDUALS seeking employment in the recording industry may submit their qualifications for FREE publication in *RECORDING engineer/producer*.

Listings will be limited to 30 words, and will be limited by available space. Listings will be selected for publication on the basis of earliest postmark. Listings will not be automatically repeated or carried over to the succeeding issue.

ENGINEER-PRODUCER, CURRENTLY ASSISTANT CHIEF ENGINEER NYC STATION, FORMERLY CHIEF MULTITRACK RECORDING STUDIO. MIXING, MAINTENANCE, CONSTRUCTION, PRODUCTION: REINFORCEMENT RECORDING, AND FILM. CONTACT RVR ASSOCIATES, 23-20 BELL BOULEVARD, BAYSIDE, NEW YORK 11360

EDWARD J. GATELY OF GATELY ELECTRONICS announces the formation of a wholly owned subsidiary to manufacture professional audio equipment in kit form. This new subsidiary will be known as PROKIT. These kits using professional parts, techniques and circuits will be of interest to amateur and semi-professional as well as professional audio personnel.

The first kit will be a 6 input stereo mike mixer with integral VU meters. Kits for a companion six channel equalizer and echo unit are also planned.

It is expected these kits will be available by the first of the year.

to join/for information/for help write: National PSORIASIS Foundation
S. F. V. C. P.O. Box 1466
Reseda, California 91335

ADVERTISERS INDEX

PAGE

AKG DIV. OF NORTH AMERICAN PHILIPS CORP.	29
ALLISON RESEARCH	39
ALTEC-LANSING	20
AMPEX CORPORATION	28
AUTOMATED PROCESSES	33
BUSHNELL ELECTRONICS	7
COUNTRYMAN ASSOCIATES	37
CROWN INTERNATIONAL	13
DOLBY LABORATORIES	18
ELECTRO-VOICE INC.	Back Cover
FLICKINGER ASSOCIATES	Cover 2
GATELY ELECTRONICS	35
DICK MCGREW RECORDING	40
MCI	10
MINCOM DIV, 3-M COMPANY	14
PHILIPS BROADCAST EQUIPMENT COMPANY DIV. OF NORTH AMERICAN PHILIPS CORP. ...	Cover 3
OLIVE ELECTRODYNAMICS	38
PARASOUND	22
SCULLY RECORDING EQUIPMENT DIV OF DICTAPHONE CORP.	30
SHURE BROTHERS	8
SPECTRA SONICS	24
SUPERSCOPE, INC.	34
TELEX	16
TEMPO AUDIO INDUSTRIES	32
UREI	40
WESTREX	23
YAMAHA INTERNATIONAL	6

Announcing the recorder with 10 times normal head life.

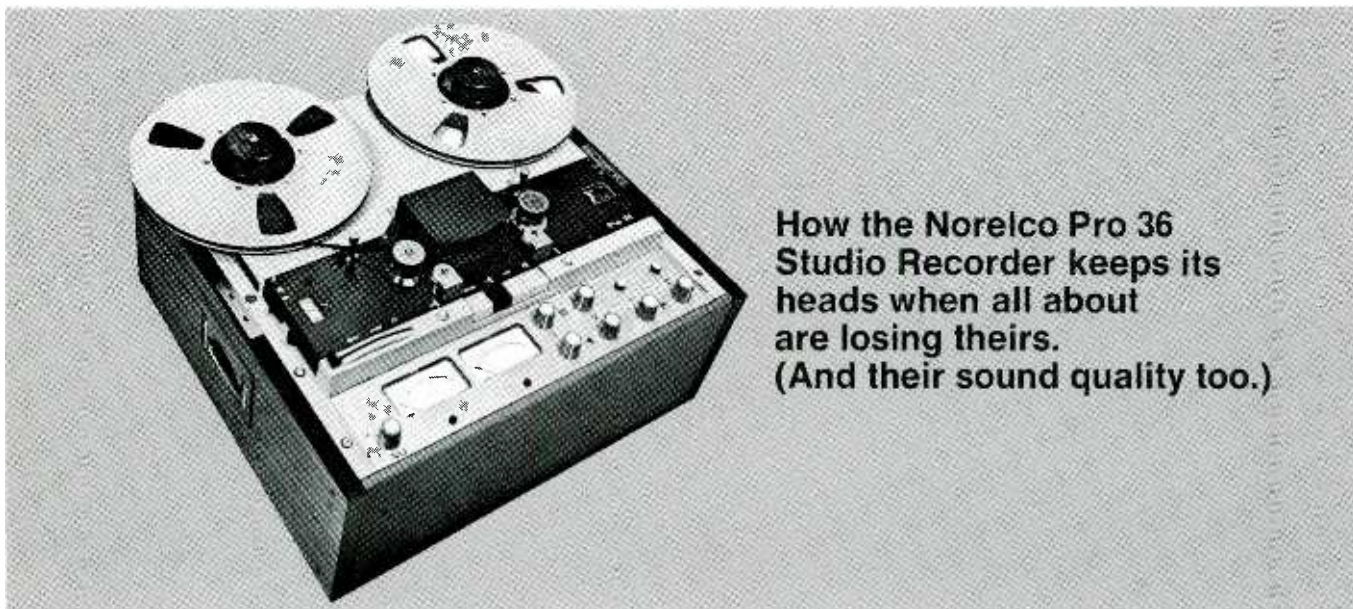

How the Norelco Pro 36 Studio Recorder keeps its heads when all about are losing theirs. (And their sound quality too.)

Conventional recording and playback heads wear out within a couple of thousand hours of use. But long before then, their electrical characteristics change . . . so your sound changes too. With the Pro 36 studio tape recorder, these problems are non-existent.

Reason: Norelco's exclusive glass-bonded Ferroxcube heads. Made of material almost diamond-hard, they take 10 times the wear of conventional heads. But that's not all. The unique glass-bonded construction maintains precise gap width and electrical characteristics in spite of wear. Amplifier adjustments are virtually never needed. And precision head mounting also makes azimuth adjustment a thing of the past.

The rest of the Pro 36 lives up to the heads. It's the only professional tape recorder with 3 speeds. You get 15, 7½ and 3¾ IPS. Electronically switchable.

Then there's the new ultra-stable Servo tape transport control. A photocell counts capstan revolutions, compares them to line frequency, (or external 1 volt reference source) and provides instantaneous speed-correction signals. To this, Norelco adds constant capstan loading. Plus automatic tape tension control. All together, they hold wow and flutter down to 0.04% maximum.

Other features: total remote control, push-button semiconductor switching, NAB and CCIR equalization, provision for fourth head, controlled tape lifters, horizontal or vertical operation, and much more.

Every broadcast studio, production studio, and sound studio deserves the tape recorder that keeps its head...so you won't lose yours. The Pro 36! Contact Norelco for all the technical data now.

PERFORMANCE SPECIFICATIONS

Wow and Flutter:

weighted peak value at 15 in/s: max. 0.04%

Overall Frequency Response (NAB Specs):

at 15 in/s: 30 . . . 15,000 Hz ±2 dB

at 7½ in/s: 30 . . . 15,000 Hz ±2 dB

at 3¾ in/s: 50 . . . 10,000 Hz ±2 dB

Signal-to-Noise Ratio: NAB unweighted (reference standard operating level)

62 dB at 15 in/s

60 dB at 7½ in/s

56 dB at 3¾ in/s



Glass-bonded Ferroxcube heads make possible an incredibly precise gap width and hold that precision throughout a wear life 10 times longer than conventional heads. The Pro 36 is the only studio tape recorder that has them.

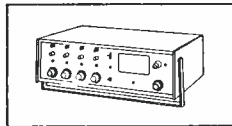
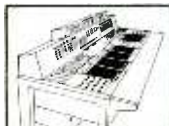

One Philips Parkway, Montvale, N.J. 07645 (201) 391-1000

Circle No. 139



More U.S. recording studios use Electro-Voice microphones than any other brand*

* Based on a study of all 600 U.S. recording studios listed in the 1971 Billboard International Directory of Recording Studios.

Model RE20 Recording Cardioid Dynamic Microphones photographed in the studios of Glenn Glenn Sound, Hollywood, California.

For literature on E-V professional microphones, write:
ELECTRO-VOICE, INC., Dept. 911RP, 674 Cecil St., Buchanan, Michigan 49107
In Europe: Electro-Voice, S.A., Lyss-Strasse 55, 2560 Nidau, Switzerland

Electro-Voice[®]

a GULTON subsidiary

Circle No. 140

www.americanradiohistory.com