

DISPLAY UNTIL SEPTEMBER 26

VIDEO & SOUND

A HIGH FIDELITY PUBLICATION

\$2.95

1845



SPECIAL! A COMPLETE GUIDE TO
ELECTRONIC HOME ENTERTAINMENT
 EXPERT ADVICE ON DIGITAL COMPACT DISCS
 AMAZING NEW AUDIO & VIDEO GEAR FOR '85
 FIRST STEREO HI-FI VIDEOCASSETTE DECKS



0

ONLY NEC OFFERS THE BEST OF BOTH FORMATS.

Whether you're watching the movie that won the Academy Award's "Best Picture" or want to make your own video movie with the best picture possible, NEC has the video cassette recorder that's exactly right for you.

Now, you've probably heard pretty convincing arguments for the superiority of VHS



THE NEC VC-N833EU VHS VIDEO CASSETTE RECORDER. Add Dolby stereo to a high performance four-head, CATV-ready VCR and double your recording pleasure.



THE NEC VC-N895EU VHS HI-FI VCR. This state-of-the-art VCR's features include true hi-fi audio; a 139 channel, CATV-ready PLL Quartz tuner; 14 day, 8 event programmable timer; 4 heads for clear special effects; stereo recording and playback with Dolby Noise Reduction; segment recording; variable speed control; automatic editing system; picture sharpness control; electronic tape counter and full function infrared wireless remote control.

versus Beta and vice versa. That's because each format has its respective strengths.

While VHS decks play longer, which saves tape costs; Beta cassettes are smaller and more portable, making possible home video equipment such as the integrated NEC Video Camera/Recorder BetaMovie.



THE NEC BM-11EU BETAMOVIE. NEC put it all together with an integrated Color Video Camera/Video Cassette Recorder that only weighs 5.5 lbs including its battery.



THE NEC VC-N40EU BETA SLIMLINE VIDEO CASSETTE RECORDER. Whatever the recording speed, it produces the best possible VCR picture available.

This is why NEC became the only VCR

manufacturer to offer both formats under its own name in the United

States. This includes the very finest Beta and VHS models in each category.

Suddenly, the answer to the question "Which VCR is best?" becomes very simple. NEC.

NEC

THE ONES TO WATCH.
NEC Corporation, Tokyo, Japan



THE NEC VC-739E BETA HI-FI VCR. The VCR with the picture that sounds as good as it looks. It features studio quality hi-fi audio; a 134 channel, CATV-ready PLL Quartz tuner; 21 day, 8 event programmable timer; 4 heads for clear, special effects; three slow motion speeds; picture sharpness control; segment recording; electronic tape counter and full function infrared wireless remote control.

Proton. Performance you can see, hear and feel.



Now high resolution Proton Video is complemented and enhanced by high resolution Proton Audio. In performance and styling, the audio components perfectly match our line of monitor/receivers and monitors. Monitors which *Video* magazine consistently rates "the best."

For audio *and* video of incomparable clarity, detail and depth, choose pure black, pure Proton components. And own the ultimate home entertainment system.

VIDEO & SOUND

A HIGH FIDELITY PUBLICATION

1984 EDITION

NEW TECHNOLOGIES

**Japan '85
A Special Preview** 11
by Peter Dobbin and Michael Riggs

Our editors return from Tokyo and Osaka with news of the next wave of home entertainment technology. Among the goodies you can expect are digital cassette decks and portable Compact Disc players.

COMPACT DISCS

**Key Facts About
Compact Discs** 16
by Peter Dobbin and Michael Riggs

Answers to the most commonly asked questions

Inside the CD System 17
by Peter Mitchell

The magic of this new medium is revealed in a basic guide to what a CD is and how a CD player works.

Do CDs Sound Better? 23
by Sam Sutherland

A critical look at the new challenges posed by CDs to recording engineers and record companies

**Compact Disc
Reviews** 26

A sampler of popular and classical releases

A New Era for Radio? 31
by Charline Allen

Technologies associated with the Compact Disc may result in music transmitted digitally to your home AM/FM receiver.

VIDEO

**Key Facts About
Home Video** 35
by Michael Riggs

Hi-Fi for Your Eyes! 37
by William Mowrer

Offering ultrasharp images with the impact of film, high-definition TV may revolutionize home video.

How Beta Hi-Fi Works 41
by Peter Mitchell

An in-depth look at an analog audio recording technique that gives digital sound a run for its money

**Lab Test #1: Sony
SL-2700 Beta Hi-Fi VCR** 45

How VHS Hi-Fi Works 50
by Peter Mitchell

Though nearly identical to Beta Hi-Fi in performance, VHS Hi-Fi uses quite different techniques to accomplish its goal.

**Lab Test #2: Hitachi
VT-88A VHS Hi-Fi VCR** 53

Stereo TV Now 58
by William Mowrer

Though a stereo TV broadcasting system has only recently been approved, you can already receive numerous programs in stereo on a backyard satellite dish.

**A New Dimension in
Video Sound** 60
by Ralph Hodges

Video versions of Dolby Stereo films spring to life with surround-sound realism, and all it takes is a simple outboard decoder.

Stereo Video to Go 63
by Frank Lovece

A guide to portable VCRs that can record in stereo

**Video Music
Reviews** 67

A sampler of popular and classical musical performances on videodisc and videocassette

COMPUTERS

Computers & Music 72
by Dr. Robert Moog

Computer programs enable you to design your own sounds or instruments.

Say Hello to SID 73
by Paul D. Lehrman

Programs for harnessing the music-making power of SID—the Commodore 64's Sound Interface Device

Sample and Hold 76
by Paul D. Lehrman

Digital sound recording, real-time playback, and sequencer functions in an add-on package for the Apple II computer

The Alpha and the Apple 79
by Paul D. Lehrman

An affordable approach for turning your Apple computer into a sophisticated synthesizer

DEPARTMENTS

About This Issue 4

**Glossary of 74 New
Technology Terms** 5

System Solutions 83
by Alexander N. Retsoff

How to get the best performance from your home entertainment setup

About This Issue

WELCOME TO VIDEO & SOUND. The home entertainment world of the 1980s is rapidly evolving. Within the past two years we've seen the introduction of the digital Compact Disc, component video systems, and high fidelity video sound, and we look forward this fall to the first generation of television sets that can take full advantage of the recently approved stereo TV broadcasting system.

The digital revolution, as it often is called, has touched hardware and software, giving us laser video and audio discs—even computer software that enables you to create electronic music at home. On the horizon are further advancements, such as high-definition television and digital cassette decks.

This special edition of VIDEO & SOUND has been assembled by HIGH FIDELITY magazine to bring you up to date on the new entertainment technologies—to outfit you to take full advantage of the home audio and video systems of today and tomorrow. You'll find separate sections on COMPACT DISCS, VIDEO, COMPUTERS, NEW TECHNOLOGY MUSIC REVIEWS, and SYSTEM CARE.

For the articles and lab tests in this issue, we turned to our HIGH FIDELITY staff and the writers and critics who appear regularly in its pages. HF's Technical Editor Michael Riggs and Electronics Features Editor Peter Dobbins wrote our lead piece on the new technologies and coordinated our test report coverage with HF Consulting Technical Editors Robert Long and Edward J. Foster. HF's testing facility, Diversified Science Laboratories, conducted the lab tests.

Other contributors to VIDEO & SOUND are Peter Mitchell, a prolific writer on science and technology and proprietor of Mystic Valley Audio, a design and consulting firm in West Medford, Massachusetts; Dr. Robert Moog, a well-known pioneer in the field of electronic music synthesis whose article—in its full-length version—will be published in a forthcoming anthology of computer-related essays (*Digital Deli*, Workman Publishing); Ralph Hodges, a San Francisco-based writer who has been covering the audio scene for many years and who is a regular contributor to HF; William Mower, another HF contributor, who lives in rural Massachusetts and who regularly reports on satellite TV and video; Paul D. Lehrman, a Boston-based musician who covers the pro sound industry for *The Boston Phoenix* and who frequently writes for HF on topics linking music and computers; Charline Allen, a New York City-based free-lance writer with a special interest in the new communications technologies; Frank Lovece, a free-lance writer specializing in video; E. Brad Meyer, a member of the Boston Audio Society and the Audio Engineering Society; and Alexander N. Retsoff, whose "Retsoff's Remedies" column appears regularly in HF.

Our music reviewers include Sam Sutherland, Los Angeles bureau chief for *Billboard* magazine; Ira Meyer, managing editor of *Video Marketing Newsletter*; Thomas W. Russell III, contributor to *Connoisseur*, *The Wall Street Journal*, and HF; and two New York City-based critics, Crispin Cioe and Matthew Gurewitsch.

—W.T.

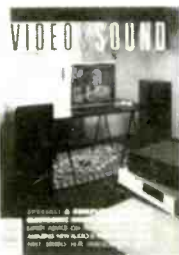

COVER DESIGN: Skip Johnston

Cover Photo: Jeffrey McNamara

On the Cover: RCA VJM-2023 receiver/monitor; Canton CT-2000 speakers; JVC HR-D725U VHS Hi-Fi VCR; Toshiba XR-Z70 Compact Disc player

Video Image: Pioneer videodisc player courtesy Pioneer Video, Inc. *Still Life with Plate, Glasses and Wine Bottle*, Vincent Van Gogh, from laserdisc "Vincent Van Gogh: A Portrait in Two Parts," North American Philips Corporation. Table courtesy Conrans, New York; rug courtesy Zona, New York; plant courtesy Florida Plants, New York

Publisher
Steven I. Rosenbaum
Editor-in-Chief/Associate Publisher
William Tynan
Senior Editor
Michael Riggs
Managing Editor
Peter Dobbins
Art Director
Skip Johnston
Copy Editor
Ken Richardson

Technical Department
Technical Editor: **Michael Riggs**
Electronics Features Editor: **Peter Dobbins**
Assistant Editors
Lida A. Silverman, Randy Brozen
Consulting Technical Editors
Edward J. Foster, Robert Long
Technical Art
Roy Lindstrom

Music Department
Classical Music Editor: **Theodore W. Libbey, Jr.**
Popular Music Editor: **Georgia Christgau**
Assistant Editors: **Mildred Camacho-Castillo,**
Susan E. Fingerhut

Assistant to the Publisher: **Randi Goldman**
Assistant to the Editor-in-Chief: **Janet Wolf**

Director of Production: **Kathleen Davis**
Editorial Production Manager: **Kathleen Green**
Advertising Production Manager: **Janet Cermak**
Production Assistant: **Paula Ballan**

Circulation
Vice President, Circulation
Stephen J. Bernard
Circulation Director/V.P., Newsstand Marketing
Dominic Mustello
Circulation Director/Subscriptions
Lillian Gmitruk
Circulation Subscription Staff: **Mary Beth Colucci,**
Barbara Donlon, Timothy Farrell,
William Johnson, Gene Stittenfeld
Customer Service: **Mary Losi**



HIGH FIDELITY'S VIDEO & SOUND is published by ABC Leisure Magazines, Inc., a division of ABC Publishing, Inc., and a subsidiary of American Broadcasting Companies, Inc. © 1984 ABC Leisure Magazines, Inc. ABC Publishing, Inc.: Robert G. Burton, President; ABC Leisure Magazines, Inc.: Ronald Stuart, President; Steven I. Rosenbaum, Vice President, High Fidelity Group; Herbert Keppler, Senior Vice President, Photographic Publishing Division; Roger Canavan, Controller; Ernest G. Scarfone, Vice President, Graphics and Production; Stephen Bernard, Vice President, Circulation; Dominic Mustello, Vice President, Newsstand Marketing; Member Audit Bureau of Circulation. The design and contents of this publication are fully protected by copyright and must not be reproduced in any manner. Some of the articles appearing herein have been adapted from material previously published in *High Fidelity* magazine.

Advertising Offices
New York: ABC Leisure Magazines, Inc., 825 7th Ave., 8th Floor, New York, N.Y. 10019. Tel.: (212) 265-8360. James A. Casella, Advertising Director; Richard J. Marino, Associate Director of Advertising; Michael H. Goldberg, Eastern Advertising Manager; James R. McCallum, Record Advertising Manager; Cecelia M. Giunta, Classified Advertising Manager; Kathleen Davis, Director of Production; Janet Cermak, Advertising Production Manager.

Midwest: High Fidelity, Hltchcock Building, Wheaton, Ill. 60157. Tel.: (312) 653-8020. Starr Lane, Midwest Advertising Manager.

Los Angeles: ABC Leisure Magazines, Inc., 2020 Avenue of the Stars, Suite 245, Century City, Calif. 90067. Tel.: (213) 557-6482. Rita Weitzen, Western Advertising Manager.

Editorial correspondence should be addressed to The Editor, HIGH FIDELITY'S VIDEO & SOUND, 825 7th Ave., New York, N.Y. 10019. Editorial contributions will be welcomed, and payment for articles accepted will be arranged prior to publication. Submissions must be accompanied by return postage and will be handled with reasonable care; however, the publisher assumes no responsibility for return of unsolicited photographs or manuscripts.

GLOSSARY

AFM (audio frequency modulation) In video, a method of encoding soundtracks for high reproduction quality. In VCRs, it's known as VHS Hi-Fi or Beta Hi-Fi; it's also used on videodiscs.

aliasing In digital audio, the creation of a false signal by one whose frequency is greater than half the **sampling rate**. Because of this phenomenon, digital systems incorporate very sharp antialiasing filters to exclude all potentially troublesome frequencies.

amplitude modulation (AM) A technique of modulating a high-frequency carrier with an audio signal by varying the carrier's amplitude (its positive-to-negative swing) so that its **envelope** follows the waveshape of the modulating signal. What we call AM broadcasting (with carriers in the 100-kHz region) is known as "medium wave" in Europe.

azimuth recording In video, the use of alternating positive and negative azimuth angles (the perpendicularity of the headgap to its path across the tape) to prevent crosstalk between adjacent tracks in **helical recording**. If one pass has an azimuth of +6 degrees, for example, both of its neighbors will be recorded at -6 degrees.

Beta I/II/III In video, the three transport speeds of Beta tape decks. The very earliest models offered only Beta I; no current models will record at this speed and some will not play Beta I. Beta II is half the transport speed of Beta I, will record or play for three hours on an L-750 cassette, and is the standard speed for commercial Beta prerecorded cassettes. Beta III is one-third the Beta I transport speed and will record or play for as long as four and a half hours on an L-750 cassette.

bit In digital technology, the irreducible logic or information element—a "yes" or a "no," or a "1" or a "0"; literally, a binary digit.

byte In digital technology, a unit composed of **bits**, capable of representing any of 256 discrete values.

CCIR In open-reel audio recording, an equalization standard proposed by the International Radio Consultative Committee (CCIR is its French abbreviation) and commonly used in Europe.

channel separation The ratio, expressed in decibels (dB), between the reproduction level of a signal in the channel for which it is intended and its level in the other (or another) channel.

chroma In video, the **color saturation** or color purity of the image. Often used more broadly to refer to the color element of a picture.

chroma differential gain In video, changes in color saturation occasioned by changes in brightness (**luminance**) level.

chroma differential phase In video, changes in hue occasioned by changes in brightness (**luminance**) level.

chrominance In video, the color element in the picture and the signal that controls it—as opposed to **luminance**.

color saturation Intensity or purity of hue. The more saturated a color is, the less white it contains; among greens, for example, those that are "greenest" are the most saturated.

Compact Disc (CD) The most widely accepted form of digital audio disc (DAD), developed initially by Philips and Sony and now available from most major record labels.

compander A device that compresses dynamic range (usually during recording) and expands it reciprocally (in playback). Its action often is expressed as a ratio: A 2:1:2 compander reduces dynamic range by half during recording and then doubles it again by expansion during playback.

DBX A **compander** noise-reduction system covering the full audio range and named after the company that invented it. DBX Type 1 is used in professional audio recording. The similar but incompatible

Type II system is used in consumer recorders and in DBX-encoded cassettes and LPs. A customized version is used as an intrinsic part of the U.S. stereo-sound TV broadcast system.

decibel (dB) A unit expressing a ratio of two quantities, used as the basis for many acoustic and electrical measurements. Literally, it is one tenth of a Bel (named after Alexander Graham Bell) with 1 Bel (10 dB) representing a voltage factor of 20 (a 20:1 or 1:20 ratio), a power factor of 10 (a 10:1 or 1:10 ratio), and a subjective loudness factor of approximately 2. The decibel thus is a small difference subjectively, but often a significant one. Because the dB scale is logarithmic (rather than arithmetic), 20 dB constitutes a hundred-fold difference in power, 30 dB a thousand-fold.

de-emphasis A rolloff (usually at high frequencies) intended as a precise compensation for a boost (pre-emphasis) that has been applied to help the signal override potential noise. The degree of rolloff normally is expressed as a time constant: 75 microseconds (μ sec) in U.S. FM receivers, 70 or 120 microseconds in cassette playback, and so on.

deviation In **frequency modulation**, the instantaneous departure of the carrier from its center frequency. In U.S. FM broadcasting, maximum allowable deviation is ± 75 kHz—for a total bandwidth of 150 kHz within the station's 200-kHz (0.2-MHz) allotted band.

digital filter One in which the waveform alteration is made while it is in digital form—by manipulation of the data stream representing it—as opposed to a filter designed to alter analog waveforms.

distortion In its broadest sense, any unwanted change in a sound or waveform. Thus, the addition of noise or the compression of dynamic range by incipient tape saturation are forms of distortion. More usually, however, it implies some specific and measurable by-product of nonlinear circuit behavior, such as harmonic distortion or intermodulation. (See **THD** and **IM**).

Dolby A series of **compander** noise reduction systems named after the company (and its founder) that invented them. Dolby A is used only for professional applications. Dolby B (which generally is assumed if no version is specified) is a single-band system influencing the high end of the spectrum only and is found in most consumer cassette decks. Dolby C is a more advanced consumer version, with two overlapping bands covering the highs and midrange. A related circuit, Dolby HX (now improved to Dolby HX Pro), avoids premature self-

erasure at high frequencies and cassette recording levels by adjusting bias to instantaneous signal conditions.

dynamic range The difference, expressed in dB, between the loudest and softest sounds in a sound or recording, or between the distortion "ceiling" (overload) and noise "floor" in a recording medium or electronic component.

envelope A curve drawn through the peaks of a waveform. Viewing the envelope of a modulated oscillation, rather than the oscillation itself, is comparable to seeing the shape of a hedge and ignoring the shape of the individual bushes which comprise it.

EP (extended play) In video, the slowest transport speed available (one third that of SP) on VHS tape decks. It will record for six hours on a T-120 cassette. It is not available on early deck models.

equalization Electronic alteration of frequency response, either to depart from or to restore "flat" response, in which all frequencies are reproduced equally. Tone controls are a simple form of equalizer. Tape recorders use equalization (EQ) both in recording and in playback (see de-

emphasis).

error concealment In digital audio, any technique for mitigating the effects of lost waveform data short of reconstructing it. (See **error correction**.)

error correction In digital audio, the exact reconstruction of lost bits or bytes from "redundant" codes (which are redundant with the main code stream only as long as the latter is intact.)

expander An electrical device or circuit that exaggerates existing differences in signal level to expand dynamic range. It normally is used to counteract the compression regularly applied to audio signals intended for home reproduction. (See also **compressor**.)

filter An electrical circuit that "removes"—actually, attenuates—some portion of the frequency response range. Infrasonic filters inhibit passage of frequencies below the audible range (nominally, below 20 Hz) and ultrasonic filters those above it (above 20 kHz); low ("rumble") filters work on the bottom end of the audible range, and high ("hiss") filters on the top end. Filters that reduce

response at low frequencies and pass the high ones unaltered also are called "high-pass" filters; the converse is called "low-pass." Notch filters attenuate a very narrow frequency band and pass the spectrum both above and below it.

floppy disk In computing, a flexible magnetic data-storage disk encased in a protective cover. The disk is similar to recording tape except that the magnetic coating may be applied to both sides of the plastic substrate. Sometimes the word "disk" is applied to the 8-inch size and "diskette" to the 5¼-inch size. Still smaller disks of similar structure now are coming into use.

flutter A relatively rapid fluctuation in pitch, most often caused by a variation in drive speed of a turntable or tape deck. (See also **wow**.)

frequency modulation (FM) A signal encoding technique in which a carrier is shifted above and below a center frequency according to the instantaneous amplitude of the original audio signal. The rate of change of the deviation is identical to the frequency of the original signal.

frequency response The relative strengths with which different parts of the audio (or other) spectrum are reproduced. If all frequencies are reproduced equally (see **equalizer**), response is said to be "flat." If not, it usually is characterized as the frequency range over which all portions are within so many dB of an assumed reference level.

fundamental In audio and acoustics, the basic pitch or frequency on which a harmonic series is based.

helical scan In video, a tape recording system in which the heads are mounted in a drum that rotates rapidly at an angle to the tape. As a result, the heads describe a diagonal path along the tape wrapped around the drum. All video information in current ½-inch home cassette systems (VHS and Beta) is recorded this way.

Hertz (Hz) A unit of frequency named for physicist Heinrich Hertz and equal to one cycle per second (cps). A kilohertz (kHz) is equal to 1,000 Hz. By common consent, the audible band is conceived as reaching from 20 Hz to 20 kHz, though individual hearing varies. Radio and other communications reach into the range of megahertz (MHz) and gigahertz (GHz)—millions and billions of Hertz, respectively.

IM (intermodulation) A form of signal distortion. It creates tones whose frequencies are the sum or difference of those already present in the program



McIntosh

STEREO CATALOG and FM DIRECTORY



Get all the newest and latest information on the new McIntosh stereo equipment in the McIntosh catalog. In addition you will receive an FM station directory that covers all of North America.





SEND TODAY!

McIntosh Laboratory, Inc. VS684
 East Side Station P.O. Box 96
 Binghamton, N.Y. 13904-0096

NAME _____

ADDRESS _____

CITY _____ STATE _____ ZIP _____



PERHAPS THE ONLY PIECE OF HOME ENTERTAINMENT EQUIPMENT THAT CAN'T BE CONTROLLED BY THE SX-V90 RECEIVER.

One look at the diagram to the right should convince you that the SX-V90 audio receiver isn't merely an audio receiver.

In fact, it might just be the most revolutionary piece of equipment in the entire home entertainment revolution.

Because it serves as a control center for more pieces of audio and video equipment than any other competitive product of its type.

Through the SX-V90, you can channel two VCRs (of any format), one TV monitor, one regular TV, one video disc, one compact disc, two cassette decks, two turntables, and one video game or one computer.

But not only does the SX-V90 have the best connections in the business, it also has ingenuity. Because as well as reproducing video sourced signals (such as MTV), it creates simulated-stereo imaging from any mono signal (such as regular TV).

In short, it turns your television into a stereo.

As for the quality of the stereo, with its advanced DDD tuner technology, and 125 watts of power

per channel minimum (at 8 chms, from 20-20,000 Hz with no more than 0.005% THD), the

SX-V90 ranks at the top of audio receivers.

Which is a very important point.

Because there's no sense in investing in a control center, only to have it sound like it has a built-in popcorn popper.

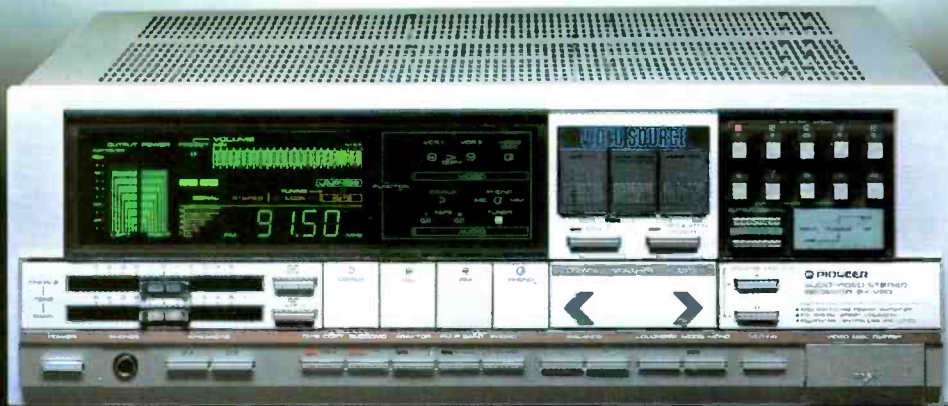
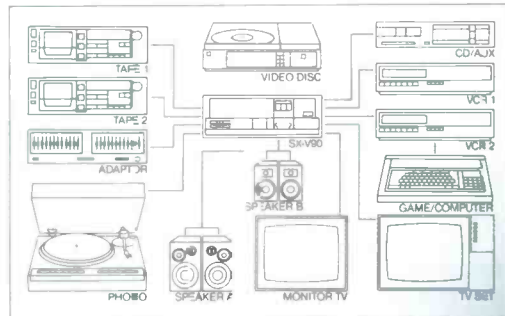

PIONEER
Because the music matters.

signal—or of multiples of those frequencies. Tones at 60 and 100 Hz, for instance, may intermodulate to create distortion products at 160 and 40 Hz, plus second-order products (usually at lower levels) at 260, 220, 140, and 20 Hz, and so on. Because these products may be unrelated to the natural **harmonics** generated by acoustic instruments and resonances, they often prove more audible and annoying than the products of harmonic distortion. (See **THD**.)

impedance The resistance of a circuit element to the passage of current. In electrical terms, however, "resistance" properly applies only to the component of impedance that affects current at all frequencies equally. The reactive component, consisting of capacitance, inductance, or both, is frequency dependent. Inductors impede high frequencies more than lows, whereas capacitors have the opposite effect. Reactance applies only to AC current; resistance applies to both AC and DC.

intermodulation Interference, between two or more tones in a program signal that generates a new tone or tones, known as "beat frequencies." Radio tuners use this principle to translate carrier frequencies down toward the audio band by beating them against a tone generated by a "local oscillator" within the tuner. When the phenomenon is unintentional and unwanted, it is called intermodulation distortion, or **IM**.

interpolation In digital-audio **error concealment**, the use of a median between two correct data values to "fake" the missing intervening datum.

laser A device that produces high coherent light, which (among other things) makes it a precise tool for reading the codes in audio **Compact Discs** and optical videodiscs.

line In video, one horizontal scan of the electron beam or beams forming the picture. A full frame of the image—equivalent to one frame or picture in a movie film—is composed of 525 lines in the U.S. (NTSC) system. Half of these are scanned, from top to bottom, in one field; then the beam is returned to the top of the picture and the remaining half are interlaced with (scanned in between) the lines of the first field.

line level An audio signal whose maximum swings run to roughly ± 1 volt, and therefore the standard signal level for most audio connections that use regular pin ("RCA," or "phono") jacks. Inputs for signals from tuners, Compact Disc players, video equipment, separate phono preamps, and other equipment intended for use with

an aux input are presumed to deliver line-level signals; tape equipment and most signal processors such as equalizers, expanders, and so on, accept line-level inputs as well. (Note that European DIN standards assume lower line levels. If your equipment is fitted with DIN connectors, it presumably is designed to these standards.)

LP (long play, or long-playing) In audio, the most familiar sort of disc record—normally 12 inches in diameter, with a microgroove (usually, stereo) cut holding a maximum of about 30 minutes of music per side. Originally a trade style of Columbia (now CBS) Records, the term LP has been freely licensed to other record manufacturers.

LP (long play) In video, the medium (formerly, slower) transport speed on VHS tape decks—one-half that of **SP**. It will record or play for four hours on a T-120 cassette. Some VHS decks will play but not record at this speed.

luminance In video, the brightness, or black-and-white element in the picture, and the signal that controls this element—as opposed to **chrominance**.

multiburst response In video, the reproduction of a special test signal that includes signal bursts at increasing frequencies (usually from 500 kHz to 4.2 MHz). A frequency beyond the reproduction capabilities of the video equipment will be greatly attenuated. Maximum horizontal picture resolution can be calculated from the highest burst frequency that is adequately reproduced.

multiplex A means of "piggybacking" one signal or signal complex on another through the use of subcarriers so that the original signals can be recovered independently.

noise In electronics, any randomly generated, unwanted signal component. It appears as hiss in FM broadcasts and tape recordings, as rumble in analog disc playback, as "snow" in TV reception, or as false data in digital transmissions.

overscan In video, the degree to which the edges of the picture fall outside the visible portion of the picture tube. Some overscan is necessary to ensure that the picture never appears with a black border on the screen.

oversampling In digital audio, a digital-to-analog (D/A) conversion technique in which the digital information is read repeatedly and treated as though the **sampling rate** were correspondingly higher. This makes it possible to use **digital**

filtering and a 14-bit D/A converter for performance equivalent to that of a 16-bit converter in more conventional systems.

overtone In acoustics or music, an upper **harmonic** of the **fundamental** that determines the note, or **pitch**, of the sound.

PCM (pulse code modulation) A digital encoding system in which a pattern of pulses replaces continuous voltages or other analogs of signal fluctuations.

pitch For most practical purposes, acoustic frequency. In modern nominal (if not always actual) practice, the A natural above middle C is tuned to 440 Hz. Because an octave is a 10:1 frequency ratio, other A's are at 44 Hz, 4.4 kHz, and so on. The remaining notes on the scale are pitched proportionately.

port In computers, an input or output connection by means of which the computer can communicate with other equipment.

power In audio, the electrical output used to drive loudspeakers. It can be measured in watts (the product of the amplifier's output voltage times the current dissipated—which is largely a function of the load impedance presented by the loudspeakers) or in dBW, a logarithmic scale (see decibel) in which 0 dBW represents one watt, 10 dBW 10 watts, 20 dBW 100 watts, and so on.

RAM (random access memory) In computers, the portion of memory to which programs or data can be loaded to establish the processes and applications that are available for use.

ROM (read-only memory) In computers, the "permanently-learned" functions that are built in for immediate use when the device is turned on.

sample-and-hold A circuit that retains instantaneous signal values, as for quantification in an analog-to-digital (A/D) converter.

sampling rate In digital audio, the frequency with which the fluctuating analog waveform is quantified digitally. This rate must always be more than twice the highest frequency to be preserved. (See **aliasing**.)

sensitivity The minimum input signal level that will achieve certain specified results. Thus, the lower the rating or measurement, the more sensitive the input. For example, a tape deck whose line input sensitivity is 50 millivolts (mV) for a recording level of 0 dB is more sensitive than one requiring 150 millivolts for the same recording level.

(Continued on page 88)

**YOU'RE GOING
TO LOVE THE SOUND
OF THIS...**

**50%
SAVINGS
ON**

TAKE ADVANTAGE
OF THIS SPECIAL
OFFER

GET 12 SOUNDSATIONAL
ISSUES DELIVERED
TO YOUR DOOR EACH
MONTH AT THE SPECIAL
RATE OF JUST \$6.98

THAT'S 50% OFF THE REG-
ULAR SUBSCRIPTION PRICE!

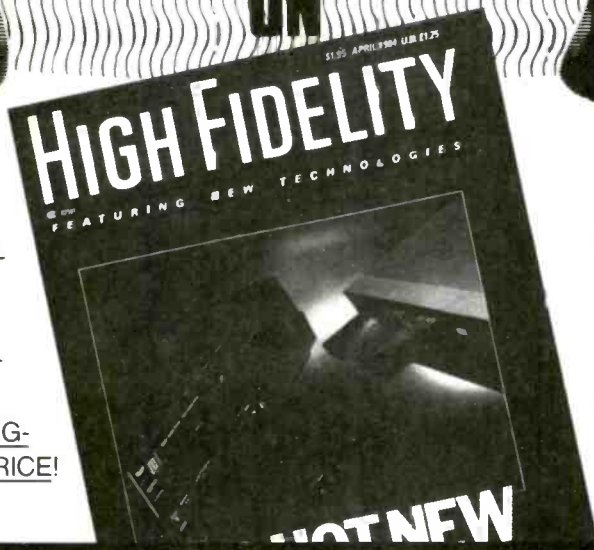

**ENJOY THE BEST IN
AUDIO/VIDEO • MUSIC •
RECORD AND TAPE
REVIEWS • COMPACT
DISCS • LAB REPORTS •
NEW TECHNOLOGIES
BUYING TIPS AND
TECHNIQUES THAT
ARE GUARANTEED TO
IMPROVE YOUR
LISTENING PLEASURE.**

Complete the coupon below and
mail it back today. Your order will
be processed immediately.

High Fidelity

POST OFFICE BOX 10078 • DES MOINES, IA 50340

- YES!** I want to improve my sound and
save 50% too! Send me one full year (12
issues) of HIGH FIDELITY for just \$6.98
- I want to double my savings now and protect
myself against a possible future increase.
Send me 2 years (24 issues) for \$13.95.
- BILL ME PAYMENT ENCLOSED

Name _____
(Please Print)

Address _____ Apt _____

City _____

State _____ Zip _____

Please allow 5-8 weeks for delivery G3049

REDEFINITION.

THE CARVER RECEIVER

Redefines your expectations of receiver performance with the power you need for Digital Audio Discs plus virtually noise-free stereo FM reception. A receiver with astonishing performance incorporating two highly significant technological breakthroughs: Bob Carver's Magnetic Field Power Amplifier and his Asymmetrical Charge Coupled FM Detector.

ESSENTIAL POWER: Your system needs an abundance of power to reproduce, without distortion, the dynamic range of music on Digital Audio Discs and fine analog recordings.

The Magnetic Field Amplifier in the CARVER Receiver gives you 130 watts per channel* of pure, clean power with superbly defined, high fidelity reproduction.

The Magnetic Field Amplifier produces large amounts of power (absolutely necessary for the accurate reproduction of music at realistic listening levels) without the need for heavy heat sinks, massive transformers, and enormous power capacitors required by conventional amplifier design.

Unlike conventional amplifiers which produce a constant, high voltage level at all times, irrespective of the demands of the ever-changing audio signal (Even when there is no audio signal in the circuit at all!), the Magnetic Field Amplifier's power supply is signal responsive. Highly efficient, it produces exactly and only the power needed to carry the signal with complete accuracy and fidelity.

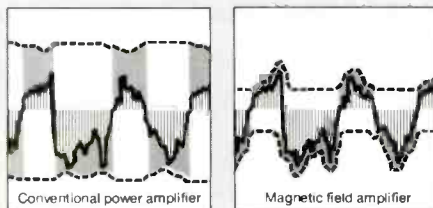

Solid line: audio output signal. Broken line: power supply voltage. Shaded area: wasted power. Vertical lines: power to speakers.

The 130 watts-per-channel* CARVER Receiver is about the same size and weight of conventional receivers having merely 30 watts per channel!

NOISE-FREE RECEPTION: The AM-FM CARVER Receiver gives you FM stereo performance unmatched by that of any other receiver.

As it is transmitted from the station, the stereo FM signal is extremely vulnerable to distortion, noise, hiss and multipath interference.

However, when you engage CARVER's Asymmetrical Charge Coupled FM Detector circuit, the stereo signal arrives at your ears virtually noise-free. You hear fully separated stereo with space, depth and ambience!

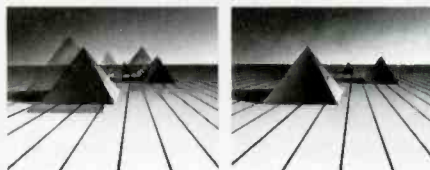

Reflected multi-path signals cause audible distortion.

Asymmetrical Charge Coupled FM Detector gives your ears a true sonic image.

The Asymmetrical Charge Coupled FM Detector was first introduced in CARVER's TX-11 Stereo Tuner, receiving unparalleled critical acclaim:

"A major advance... Its noise reduction for stereo reception ranged from appreciable to tremendous. It makes the majority of stereo signals sound virtually as quiet as mono signals, yet it does not dilute the stereo effect."

Julian D. Hirsch, STEREO REVIEW (December, 1982)

"Separation was still there; only the background noise had been diminished, and with it, much of the sibilance and hissy edginess so characteristic of multipath interference."

Leonard Feldman, AUDIO (December, 1982)

"What distinguishes the TX-11 is its ability to pull clean, noise-free sound out of weak or multipath ridden signals that would have you lunging for the mono switch on any other tuner we know of."

HIGH FIDELITY (January, 1983)

The CARVER Receiver has been designed for fidelity, accuracy and musicality. You will want to visit your CARVER dealer for a personal audition of this remarkable instrument.

*130 watts per channel RMS into 8 ohms, 20 Hz to 20 kHz with no more than 0.05% total harmonic distortion.



CARVER Powerful Musical Accurate

Carver Corporation P.O. Box 1237 19210 33rd Avenue West Lynnwood, WA 98036

Distributed in Canada by Evolution Audio, Ltd.

JAPAN

'85

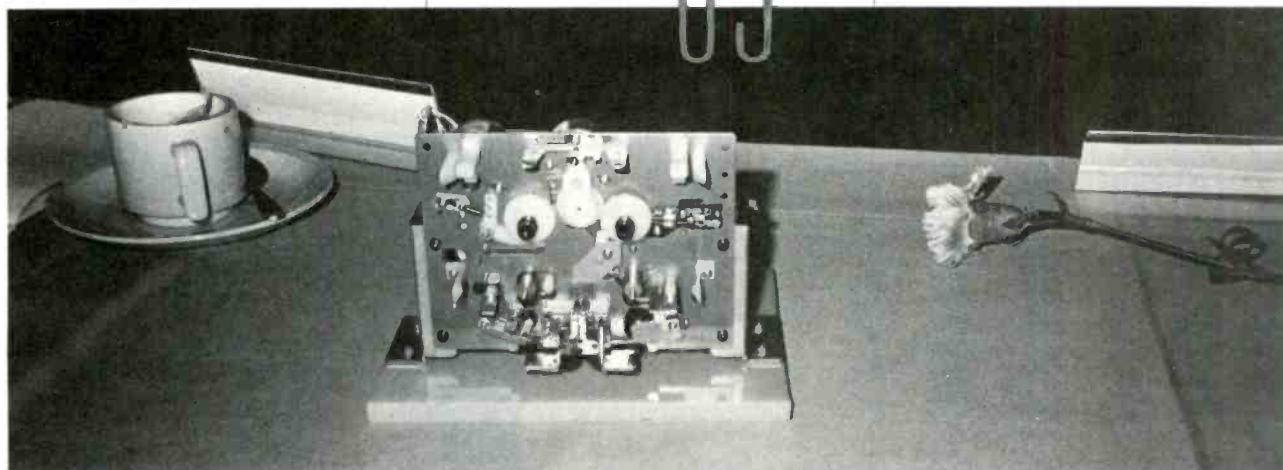

Previewing the next wave of home entertainment technology

AFTER SPENDING A WEEK with the digital wizards at Sony in the company's Tokyo headquarters, I am more convinced than ever that digital technology will have as revolutionary an effect on home entertainment as it has had on the more mundane field of data processing. A small company in comparison to giants like Hitachi and Matsushita (Panasonic, Technics, and Quasar in the U.S.), Sony has been forced to compete by balancing on the leading edge of consumer electronics technology. And by its successful effort with Philips in perfecting the Compact Disc system, it has shown that it can combine a knack for innovative product concepts (home videocassette recorders and the Walkman, to name just two) with engineering excellence and integrated-circuit manufacturing know-how.

This combination of talents was apparent at a meeting into which Sony engineers wheeled a cart swathed in drop cloths. With some flourish and a stern injunction against picture-taking

Editors Peter Dobbin and Michael Riggs return from Japan with first-hand looks at what the engineers at Sony and Technics are planning for the future. Served up at a Technics breakfast seminar were the bare bones of a prototype digital cassette recorder, pictured above.

(the photo on page 12 is all I could manage), the world's first portable Compact Disc player was unveiled. Only slightly larger than a CD itself and about two inches high, the 9-volt battery-operated device should cost less than \$500 when it appears in stores this fall. Two car CD players are also being prepared for introduction this year—a dedicated model and a combined player/tuner. If you think a CD player represents something of overkill as a mobile music source, you may be interested to learn that the earliest prototype CD player was built for car, not home, use.

The situation with digital cassette recorders is a lot more uncertain. An industry-wide standards committee is

trying to sort out the issues relating to two proposed methods—one using a fixed, multitrack head assembly and the other a rotating, VCR-style head. Each approach has its benefits and shortcomings, and each has its particular supporters among manufacturers. Although most companies are eager to bring a digital cassette recorder to market, none wants to jump the gun and introduce what may become the Elcaset of the digital age. Sony is prepared for any eventuality and has developed prototypes in both formats.

To be frank, however, the Sony fixed- and rotary-head decks I saw seemed far from finished. Though they both worked, each compact chassis was

firmly anchored to a suitcase-size box of electronics under the table. Once the green flag is lowered, work will have to begin on shrinking the discrete parts of the prototypes into VLSIs (very-large-scale integrated circuits).

Though the Sony people may be keeping a relatively low profile in the area of digital cassette recorders, they'll stop anyone who passes to extol the virtues of their digital multitrack professional recorders. Only a few companies are involved in this heady arena—where machines can cost upwards of \$150,000—but the need for digital multitrack equipment with the flexibility of current analog gear is great. Sony's proposal is based on a format it calls Digital Audio Stationary Head recording, or DASH for short.

The DASH format achieves compatibility between 8- and 16-track recorders (using ¼-inch tape) and 24- and 48-track versions (using ½-inch tape) by adhering to a standard head layout while taking advantage of the trade-off between packing density and tape speed. Thus, a machine equipped to make 16-track recordings at a fast speed of 30 ips could double as an 8-track recorder at 15 ips or a 4-track at 7.5 ips. DASH-format recordings are also upwardly compatible: That is, a ½-inch tape made on the new 24-track PCM-3324 could be played back on a future 48-track version.

Sony is not content to stop with multitrack digital recorders, however. In the works is a whole new generation of fully digital mixers, effects generators, and editors that will make it possible for a recording engineer to keep his mix in the digital domain all the way down to the final 2-track CD master.

THE DESIGNERS AT SONY are also exploring the capabilities and possible applications of Compact Disc technology. While 97 percent of the usable information-bearing area on a CD is taken up with music, there is still room for some 156 megabits in what is called the "user's bits area." Sony's DAE-1100 Compact Disc cue editor opens the door to the grafting of low-resolution graphics, titles, and liner notes onto the CD itself. Of course, you'll need a player capable of recognizing this extra data and equipped with a video interface, but companies like Sony and Philips are presumably ready to introduce such



High-density storage on erasable disks is the idea behind Sony's magneto-optical data recording system (above). "No pictures," said Sony officials as they prepared to unveil a prototype of the CD Walkman (right).



third-generation machines.

A bit further in the future is a system that Sony and Philips call "CD-ROM." Computer hackers know that "ROM" stands for "read-only memory," and that's exactly where Sony sees Compact Disc technology heading. As a mass-storage device, a CD-ROM can hold as much as 552.96 megabytes of data (from 500 to 1,000 times the capacity of a floppy disk). And the data need not all be apportioned to computer programs and electronic dictionaries. A CD-ROM should be able to display five graphic frames per second and one high-resolution video image per second. You might even encounter CD-ROMs that combine computer data, graphics,

and sound. Sony says that the players necessary to read CD-ROMs will be very similar to current players, which I take to mean that a single all-purpose player with connections for a stereo system (for reproduction of standard CDs) and a computer (for CD-ROMs) is probably on the drafting board.

To compete with traditional magnetic mass-storage devices, the Compact Disc will have to be made capable of accepting data, not just storing it. To that end, Sony proudly demonstrated two recent advances that promise to make CD-like hardware a standard fixture in offices. The first is a data-storage device the company calls a direct-read-after-write system (or DRAW). The small DRAW unit holds

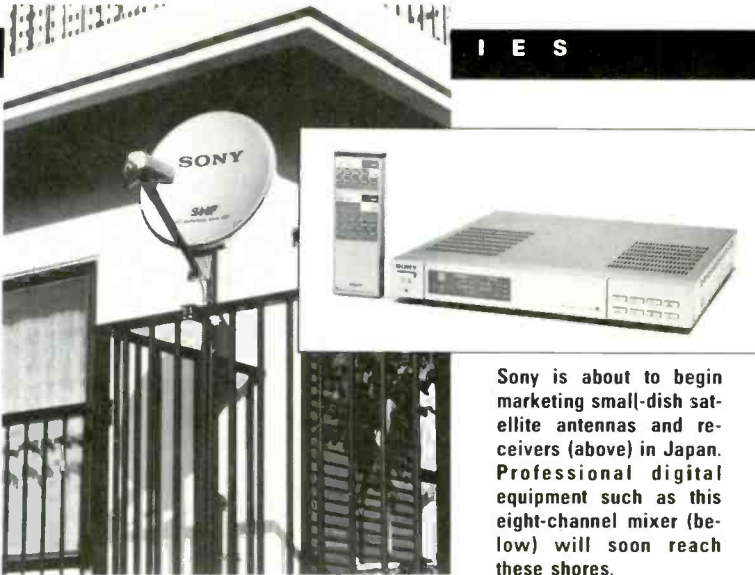

Sony is about to begin marketing small-dish satellite antennas and receivers (above) in Japan. Professional digital equipment such as this eight-channel mixer (below) will soon reach these shores.

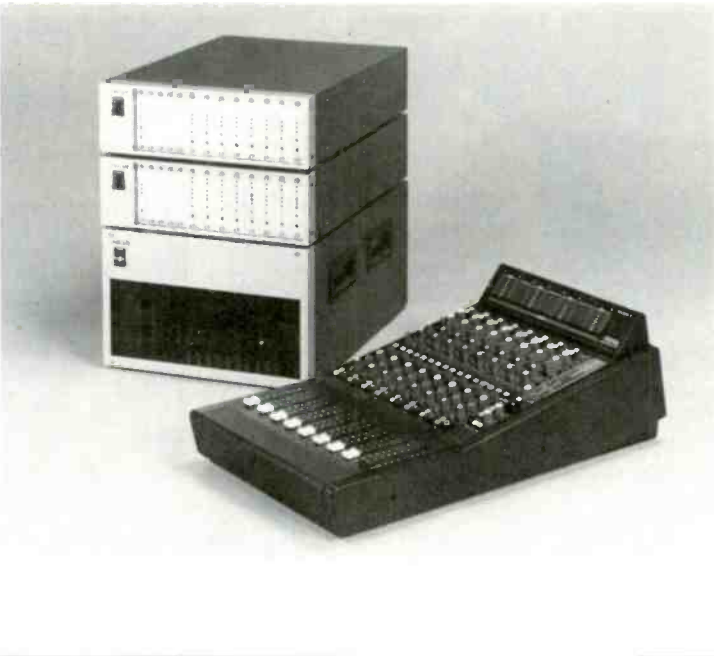

either an 8- or 12-inch bilayer disc. The signal-recording process is based on an increase in reflectivity that occurs when the disc's substrate material is heated to 170 degrees Celsius by a sharply focused laser. However, this increase in reflectivity cannot proceed in the reverse direction (the material used changes in physical state from amorphous to crystalline), so the 6 billion bits on an 8-inch disc and the 15 billion on a 12-inch "LP" are there for good.

Not to worry, though. Working in cooperation with Kokusai Den Shin Denwa Co., Sony has developed a prototype erasable magneto-optical system with even more data-recording capacity than DRAW. In this system,

magnetism and heat (generated by a laser) impart vertical magnetic charges to a thin film of terbium, iron, and cobalt for a recording density of 12 billion bits on an 8-inch disc. That amount of data translates into enough digital code to hold the equivalent of 20,000 typewritten pages.

Combining entertainment and data applications is another digital system under development by Sony. The Cable Digital Audio/Data Transmission system (CADA) uses a standard cable-TV channel to transmit a variety of services to subscribers' homes. A CADA transmission carries a total of four 32-bit data channels, each of which can be apportioned in various ways. For instance, one data channel

can be divided in two for the transmission of a 16-bit stereo audio program (at a sampling frequency of 44.1 kHz). Or it can be divided further to carry two 8-bit companded stereo programs (at 44.1 kHz), eight mono programs (at 22.05 kHz), or a combination of, say, one 8-bit stereo broadcast (44.1 kHz) and four mono programs (22.05 kHz). And that still leaves three 32-bit channels, which can be used for computer data and program transmission. Sony says that installation of a CADA system would cost a cable-TV operator very little and that CADA's powerful error-correction system is good enough to guarantee error-free transmissions through even the noisiest cable.

My Japan trip continued with a visit to the CBS/Sony Compact Disc pressing facility. (I had previously been shown one of the CD mastering machines intended for delivery to the new CBS/Sony facility in Terre Haute, Indiana, which is scheduled to go on-line in August.) To get the flavor of the clean-room atmosphere necessary for high-yield CD manufacture, I was asked to pull on some lint-free pajamas and a pair of disposable slippers that were never intended for size 12EEE feet. So dressed, I was eager to wander around the injection molders and Rube Goldberg-ish contraptions that apply the protective lacquer coating to a CD. But the wiser heads at CBS/Sony weren't taking any chances of contamination, and all viewing was done through windows. For the record, the CBS/Sony plant currently produces 750,000 CDs a month, or about 25,000 a day.

The trip concluded back at the company's headquarters with a seminar devoted to what Sony calls "new technologies," as though what I had already seen were old hat. High-resolution TV, DBS (direct broadcast from satellite) systems, and "digital" TV sets are all on the agenda. But what Sony is up to is only part of the worldwide action in high-technology consumer electronics. Michael Riggs's report on his visit to Technics reveals still more.

—PETER DOBBIN

OSAKA IS SOMETIMES CALLED the Chicago of Japan because it is that country's "second city" and a major commercial center. Among the many

manufacturers that call Osaka home is Matsushita Electric Industrial Company, the world's largest maker of consumer electronics. Its brands include Technics, Panasonic, Quasar, and (mainly in Japan) National. That's rather a big meal for one sitting, so all my time was devoted to Technics—the branch responsible for high fidelity audio equipment.

The most impressive thing about Matsushita as a whole (besides its size) is its advanced manufacturing capability, which is apparent everywhere in Technics's factories. Circuit boards are stuffed with components by high-speed automatic insertion machines (designed and built by Matsushita's robotics division) and passed on to equally automatic soldering machines. The robots even detect and mark their own errors—on the very rare occasions that they make any. Defective boards are shuttled off the line and fixed before they have a chance to cause problems further on in the assembly process.

Minimizing the number of human workers involved in manufacturing thus serves to improve product reliability as well as to reduce costs, both key goals at Technics. The company attributes much of its strong market position to these factors, particularly the ability to add attractive features with little or no increase in retail price. This is just another way of taking advantage of the falling costs brought by automation and technologically based design improvements.

I got a good look at how the latter come about in the engineering department, where CAD (computer-aided design) speeds the development of everything from advanced large-scale integrated circuits (LSIs) to turntable chassis. For this, Technics uses a roomful of American-made Calma graphics terminals linked to Calma and DEC VAX 11/780 minicomputers. Workers can examine and modify schematics, circuit board layouts, and so on. When complete, even very complex designs can be transferred to paper by a huge plotter for use by the departments responsible for the actual fabrication of parts and prototypes.

The payoff is in new and often improved audio products, such as the Technics SL-P7 and SL-P8 Compact Disc players. Making these relatively low-price, high-performance units

At right, the author's face is recorded for posterity on videodisc at the Matsushita Museum of Technology. Below, an assembly-line robot inserts parts in a circuit board. Such machines increase manufacturing efficiency and product reliability.

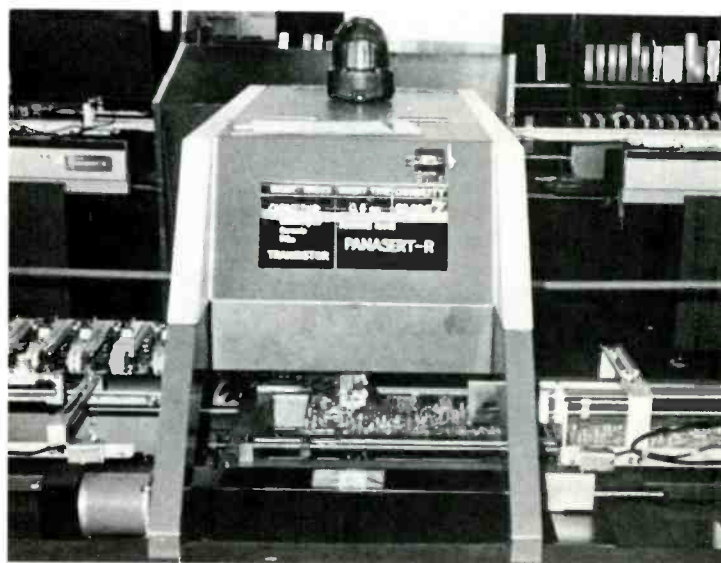

required completely new LSIs, which were designed and are now produced entirely in-house. (Matsushita's corporate philosophy decrees that the company should buy only raw materials, from which it manufactures everything required for the assembly of a finished product.) Company representatives proudly demonstrated the outstanding performance of the "Ultra Super" error-correction system embodied in these new machines, pitting them against other highly regarded players in a contest to see which could read through the worst disc defects and surface flaws. I wasn't surprised that the Technics units won, but I was impressed, for I knew the other models in the test to be very fine

performers in this regard.

In another demonstration, one of the engineers switched in and out a steep-slope low-pass filter (of the type used in Technics CD players) to show that such filters cause no sonic degradation. Here, too, the results were unsurprising, it having long been known that high-frequency phase shift much worse than that caused by these filters is completely inaudible on normal audio signals: You just have to make sure that they don't change the frequency response significantly within the audio band. In light of that, however, I was a little amazed to hear the difference made by a phase-correction network incorporated in the company's forthcoming RS-B100

Inside the large anechoic chamber at the Technics loudspeaker research and development laboratory in Osaka, Japan



cassette deck. One possibility is that the effect is caused by a frequency response change, since that's what it sounded like. Another possibility is that the correction is in the midrange, where phase shift does not have to be so extreme to be audible—and where analog tape recorders do have problems. Or it may simply have been the artificiality of the test signal, which was a square wave rather than music or speech.

DIGITAL CASSETTE RECORDING also was on the agenda. Although the Japanese digital standards committee has yet to issue its report, Technics and other major manufacturers are hard at work readying themselves for whatever

decision comes down. The two main alternatives are a fixed-head system and a rotary-head system. The former would use thin-film multitrack heads and a cassette similar to that envisioned for 8mm VCRs (about the size of a standard audio cassette). The latter would be a helical-scan system using a miniaturized VCR-type head drum and a tape cartridge not much larger than a microcassette.

Each approach has its pros and cons. Rotary provides about three hours of playing time on a single, tiny cassette and enables you to scan through it very rapidly to find specific sections. On the other hand, off-tape monitoring during recording would be very difficult to achieve with a rotary-

head system, whereas it's pretty straightforward using fixed heads. And though this may sound paradoxical, a fixed-head system would have the advantage of using a larger cassette that would hold only about as much music as a conventional analog cassette. Most people would find such a cassette much easier to handle and label; certainly it would be harder to lose.

However, the final decision may be based on an even more practical consideration: Most manufacturers can make the rotary heads, whereas only a few now have the capability to build the advanced thin-film heads needed for fixed-head digital cassette recorders. Technics is among those that can do both. While I was there, they showed me the transports being used in their research prototypes. Each, in its own way, is a marvel, with the helical-scan mechanism being especially impressive for its miniaturization and complexity—like a VCR for Munchkins.

An interesting byway on my tour was through Technics's speaker development facilities, including a visit to one of the largest anechoic (literally, "echo-free") test chambers I've ever been in. One of the company's goals is to use its "Honeycomb Disc" flat-diaphragm driver technology to build loudspeakers capable of competing sonically with the American and British loudspeakers that now dominate the U.S. market. (Most Japanese loudspeakers have a thin sound that doesn't sit well with Western ears.) Computer-aided design comes into play here as much as in the development of other products. Given the characteristics of the drivers, the desired frequency response, and certain basic attributes of the crossover network, the computer figures out what parts values should be used.

I heard many flavors of loudspeakers designed with the aid of this system. Some clearly would not be acceptable here (and probably would not be sold here, either), whereas others were quite respectable. Particularly impressive was a model only a few inches thick designed for wall mounting. This suggests that Technics could become a major force not only in the turntable and electronics arenas (where it already is a strong presence) but in loudspeakers as well.

—MICHAEL RIGGS

KEY FACTS

about

COMPACT DISCS

BY

 MICHAEL RIGGS
 AND PETER DOBBIN

ANSWERS TO THE MOST COMMONLY ASKED QUESTIONS

Q. What are Compact Discs?

A. THE COMPACT DISC is a revolutionary system for music playback in the home, offering better sound quality and greater convenience than anything that has come before. The discs are hard plastic, $4\frac{3}{4}$ inches in diameter, with music digitally encoded on a reflective layer below a smooth, clear protective surface. A special player reads them with a low-power laser and converts the digital codes into an electrical signal that can be fed directly to your amplifier or receiver. Compact Discs—or CDs, as they are commonly called—are less than half the width of conventional long-playing phonograph records (and have only about one-sixth the surface area), yet they can hold as much as 75 minutes of stereo music on one side. They are not harmed by dust or small scratches, do not wear out, and have no surface noise.

Q. What do Compact Discs sound like?

A. THEY SOUND EXACTLY like the studio master tapes from which they are made. The Compact Disc system can't turn a sow's ear into a silk purse, however: A poorly made recording will still sound bad. But a good recording

will retain the quality of the original master tape and therefore sound better than a regular record made from the same source. Typically, the CD version will be cleaner, quieter, and more detailed, with more clearly defined highs and deeper, richer bass. It will also have a greater range between the loudest and the softest sounds (that is, a greater dynamic range).

Q. Will I need any special equipment to use a Compact Disc player at home?

A. NO. ALL AMPLIFIERS and receivers (and even many all-in-one systems) have input jacks that can be used for connecting a CD player. These are usually labeled "aux," but you can also use tuner or tape inputs—anything but a phono input. You won't need special "digital-ready" loudspeakers, either. In fact, it's amazing how much better sound you can get from Compact Discs even on relatively modest equipment. Nonetheless, the better your system, the more benefit you will get from a CD player.

Q. How many watts of power will I need in my receiver or amplifier to handle CDs?

A. THERE'S REALLY NO simple answer to this question: It depends on your

speakers, the room you listen in, and how loud you like your music. In general, however, the more power, the better the sound. And though you can get listenable reproduction with very little power, we would encourage the use of an amplifier or receiver capable of delivering at least 30 watts per channel. One thing to remember if you plan to replace your present amp with something huskier is that to obtain a significant audible improvement you must get at least twice as much power as you already have. So if you want to step up from a 20-watt receiver, for example, you should look at models rated at 40 watts per channel or more.

Q. Can I make tape recordings of Compact Discs?

A. YES, IN THE SAME WAY that you would copy an ordinary record or tape. For best results, however, you should use a good deck and high-quality tape. All high fidelity cassette decks have Dolby B noise reduction, and most recent models also include a more powerful system, such as Dolby C or DBX. You may find one of the latter necessary to get quiet, low-distortion recordings of the most dynamic CDs, but for most you probably will find that you can do pretty well with just Dolby B. Cassettes made without any noise reduction will be annoyingly hissy on quiet passages.

Q. How durable are Compact Discs themselves?

A. A CD IS FAR MORE durable than a phonograph record, but still is not completely immune to ill effects caused by dirt and scratches. A large scratch or obstruction on a CD's clear protective surface can cause the laser pickup to mistrack or generate a signal that is simply too fouled up for the player's on-board error-correction circuits to fix. Though severe scratches cannot be healed, dust, fingerprints, and other surface pollutants are easily removed: Just rub a soft, clean cloth over the disc, moving it radially from the spindle hole to the outer edge. One major problem with ordinary records that should never appear with CDs is warpage. Because CDs are made of superhard Lexan plastic, they will resist warping even at great temperature extremes.

V&S

INSIDE

the

COMPACT DISC SYSTEM



THE MYSTERIES OF THE MEDIUM ARE REVEALED IN THIS
GUIDE TO THE BRAVE NEW WORLD OF COMPACT DISCS.

BY

PETER MITCHELL

THE MAGIC of Compact Disc (CD) playback—its broad dynamic range and freedom from background noise, wow and flutter, inner-groove distortion, and ticks and pops—has been well documented.

Understanding this magic, however, may seem daunting, especially since we are used to the CD's less complicated analog precursors. But if examined on a "bit by bit" basis (pardon the pun)—from disc mastering and pressing to final playback—the CD

can eventually be understood.

The CD is a product of two very different technologies: the optical video disc and the digital computer. Extensive research and development enabled the CD to evolve from a figment of science fiction to a mass producible item. Even then, the project required extraordinary cooperation between the European-based Philips/Phonogram conglomerate—which specializes in plastics, optics, electronics, and record

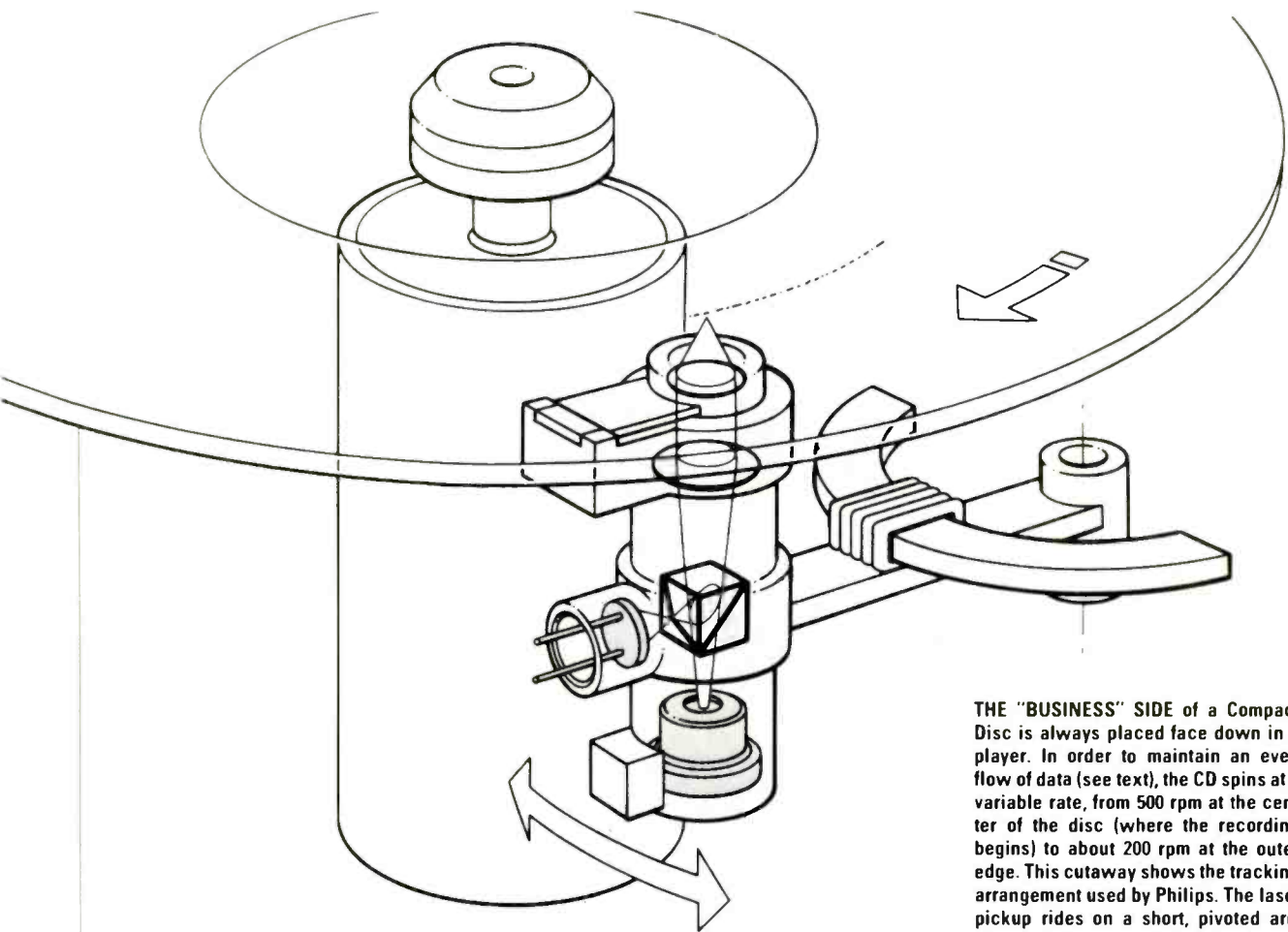

THE "BUSINESS" SIDE of a Compact Disc is always placed face down in a player. In order to maintain an even flow of data (see text), the CD spins at a variable rate, from 500 rpm at the center of the disc (where the recording begins) to about 200 rpm at the outer edge. This cutaway shows the tracking arrangement used by Philips. The laser pickup rides on a short, pivoted arm that describes an arc over the disc.

NINA WALLACE

manufacturing—and the entire Japanese consumer electronics industry, led by Sony.

Basically, Philips developed the laser-tracking optical videodisc system and created a compact version for digital audio. Sony's engineers then perfected the elaborate and sophisticated data-coding and error-correction circuitry that ensures accurate reproduction of the original audio signal despite dust, fingerprints, scratches, and minor manufacturing flaws.

FROM PCM TO EFM

The first step in the creation of a Compact Disc is the conversion of the original audio waveform into a digital signal. Among the several ways this could be done, the one that was chosen is called linear pulse code modulation, or PCM.

Converting an analog signal to

digital is a two-stage process: sampling and quantization. At regular intervals, a sample-and-hold circuit instantaneously freezes the audio waveform voltage and holds it steady while the quantizing circuit selects the binary code that most closely represents the sampled voltage. Since the CD is based on a 16-bit PCM system, the quantizer has 65,536 (2^{16}) possible signal values to choose from, each represented by a unique sequence of 16 ones and zeroes. At a sampling rate of 88,200 16-bit conversions per second (44,100 alternating left/right pairs for the two channels), a total of 1.4 million code bits are generated during each second of music—or five billion bits per hour.

In principle, these digital codes could be engraved directly on the CD, with a pit representing each 1 and a flat area for each 0. But in practice it is impossible to guarantee the correct

reproduction of every one of these billions of bits in playback, and PCM playback is a "go or no-go" process: The code is either exactly right or it's wrong, and when a bit is wrong, the effect can be startling—like misreading one letter in a printed word. A *mouse* and a *house* are objects of very different size, and in PCM playback the digital code "10000100 11111111" corresponds to an amplifier output power a thousand times greater than "00000100 11111111." Incidentally, the 16-bit PCM codes are processed as pairs of eight-bit "bytes" in the circuitry, just as in a computer. (To add to the confusion, in the jargon of error correction the bytes are called symbols.)

Because of PCM's sensitivity to bit errors, much of the recording and playback circuitry is devoted to error detection and correction. A detailed analysis of this subject could fill a full-

semester college course, but, in brief, the process is handled in four stages: parity checking, interleaving, EFM (eight-to-fourteen modulation), and—when all else fails—interpolation.

Parity Checking

The basic idea in parity-checking is simple. When a recording is made, the number of ones in each digital code is counted, and an extra bit indicating whether an even or odd number of ones was found is appended to the code. If even, the parity bit is a zero; if odd, it's a one. Thus the entire code, including the added parity bit, will have an even number of ones in it. In playback, the total number of ones in each code is counted again; if it isn't an even number, there's an error.

You can now begin to see how efficient this process is: Merely by adding one bit to the code, the system can detect all playback errors involving the misreading of one or any other odd number of bits. But it is impossible to know at this stage which bit was misread, and a single-bit parity check can be fooled if two bits (or another even number of bits) are misread during playback.

To overcome these obstacles, a more elaborate procedure is used: The parity test is performed not on the entire code but on several combinations of the bits in each code, yielding several added parity bits. The combinations are selected so that each bit in the code is involved in more than one parity test. By cross-checking the results of the parity tests, it is possible not only to detect multiple-bit errors, but also to identify exactly which bits are wrong and correct them—and thus to reconstruct the original code accurately. This may sound like a complex procedure, but it's simply a matter of doing a lot of high-speed sums.

Interleaving

Of course, if all the bits in a code are misread or destroyed because of a dropout in a digital tape or a scratch on a digital disc, nothing can be done to recover them. Interleaving prevents this problem by scrambling the order of the data samples before they are recorded on the disc and then restoring the correct order during playback. CD players do this by briefly storing the digital data in a random-access memory (RAM) and reading it back in a

different order. (It involves a slight delay, so you actually hear the music a fraction of a second after it comes off the disc.)

As a result, the data samples that originally were contiguous in time are not adjacent to each other on the disc, so a scratch can't destroy consecutive signals. Conversely, if a scratch destroys a series of adjacent samples of data on the disc, the de-interleaving process splits the loss into individual samples of bad data interspersed between good data samples, making it

easy for the parity-checking system to identify and correct the lost data bits. Incidentally, as I noted earlier, each 16-bit digital code is processed as two 8-bit bytes, or symbols, and, during interleaving, it is the order of the symbols that is scrambled; thus, even the two halves of each sample are recorded separately on the disc, so a scratch or disc defect typically won't damage more than half the bits in any single data sample. This system, using multiple parity-checking and data interleaving, is called the Cross

THE PCM PROCESS

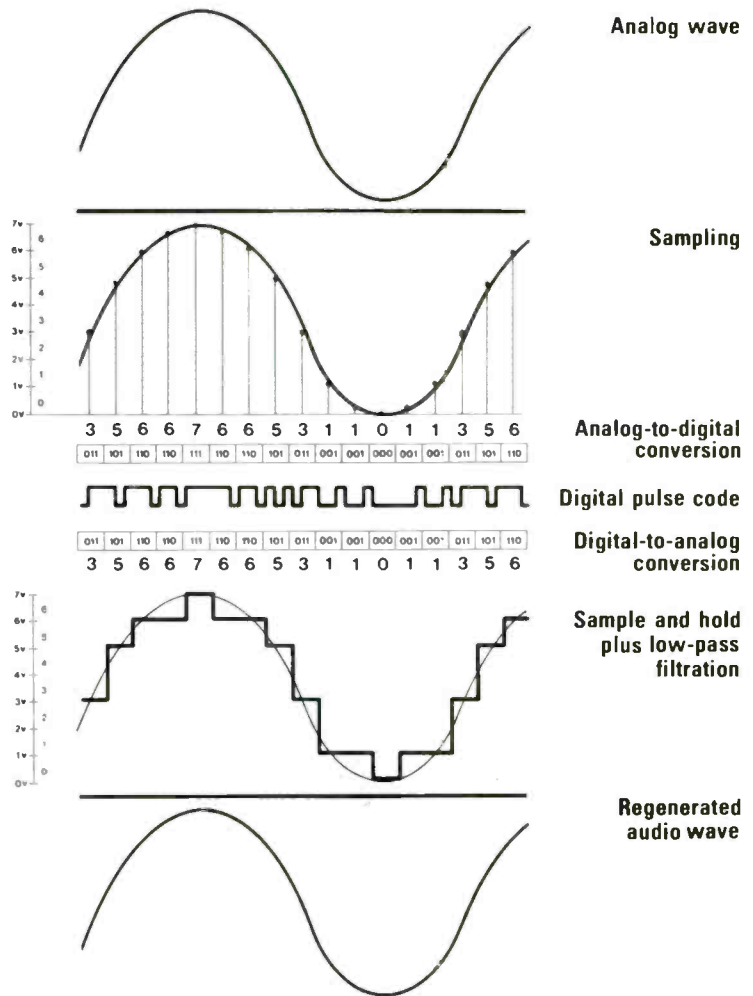

CONVERSION OF A CD'S DIGITAL CODES back into an analog waveform is a mirror image of the process used in the original analog-to-digital conversion. Above, a simple analog waveform is sampled sixteen times and a binary code (ones and zeroes) is assigned to describe the voltage level corresponding to each sample. These codes are part of the digital information pressed into a CD and in playback provide the data points necessary to recreate the original analog waveform.

LASER OPTICAL PICKUP

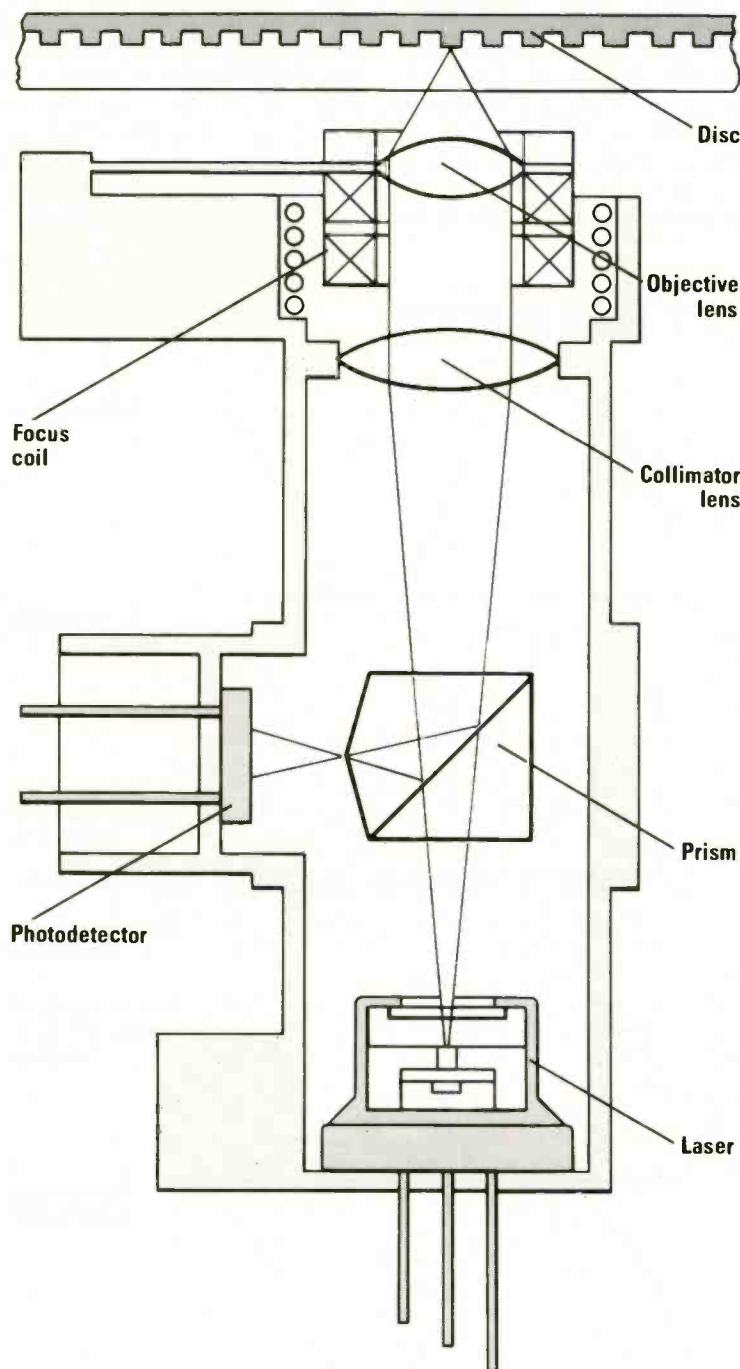

THIS CUTAWAY VIEW of the laser optical pickup used by Philips depicts the path of the laser beam as it reads a CD. Light from a small semiconductor laser passes through a semireflecting prism and is brought to sharp focus on the surface of the CD. Reflections return through the lens system to the prism, where they are diverted into the photodetector. The weak reflection caused by a raised area on the disc excites a low voltage in the photodetector's output; this translates into a binary zero. Strong reflections from non-raised areas on the CD are read as binary ones.

Interleave Reed-Solomon Code (CIRC).

What this all means is that a CD player will be able to correct completely as many as 3,500 data bits destroyed by a disc defect or scratch as much as 2.4-millimeters wide. Consequently, when you are cleaning dust or fingerprints off a CD you should wipe it with *radial* strokes from center to edge, so that if you cause a scratch it will run across the circular data tracks, damaging only a small (and easily reconstructed) part of each track. If you wipe the disc in a circular motion, as you are accustomed to doing with LPs, you might produce a long scratch running along a single track, destroying more bits than the CIRC system can correct.

EFM

In eight-to-fourteen modulation, every 8-bit byte is replaced by a selected 14-bit code. This is done to avoid codes in which ones and zeroes alternate in rapid sequence (e.g., 10101010). In the substitute 14-bit sequences, every pair of ones is separated by at least two or three zeroes, effectively reducing the rate at which the transitions from zero to one occur. This improves the reliability of the playback process, and it's one of the steps that made it possible to put an entire hour of music on one side of a 4.7-inch disc.

Interpolation

When errors occur that are too large for the CIRC system to correct, the playback processor ignores the data samples that are known to be bad and tries to make a smooth transition from the last bit of good data to the next known good sample. Most of the time this works so well that you don't hear it happening. The combined effect of the error correction and interpolation is that, on the average, audible ticks will occur at a rate of less than one per record.

CD Manufacture

Before a CD is cut, extra digital codes are added to the signal on the digital master tape. These include control and display signals that enable the player to cue instantly to the beginning of each song or movement, show the song's number and running time, provide a continuous display of elapsed time, and switch on a treble de-emphasis circuit

CD DECODING

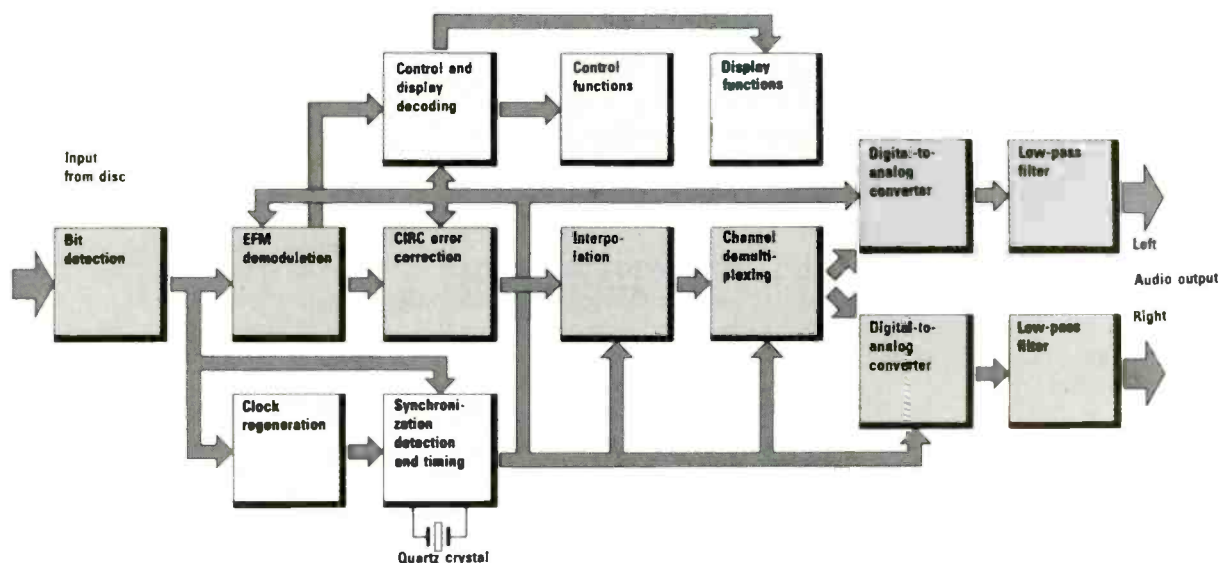

THIS SIMPLIFIED BLOCK DIAGRAM shows the processes that must occur during CD decoding. Not all manufacturers, however, do it the same way. Some supplement the output filters with digital filtration before digital-to-analog (D/A) conversion, and most use only one D/A chip, performing channel demultiplexing on its analog output, rather than on the digital bit stream . .

if a corresponding 10-dB treble boost has been applied to the recorded signal. Additional subcode space is reserved for future use, to display song lyrics, opera librettos, and other text, for instance.

The production of a master disc uses technology first developed for creating the intricate microscopic patterns in integrated-circuit (IC) chips. A precisely polished glass disc, coated with light-sensitive photo resist, is rotated on a turntable under a high-power laser, which is rapidly switched on and off by the ones and zeroes in the digital code. The exposed areas are etched away in a chemical bath, yielding a string of pits along a spiral track that begins near the center of the disc and ends near its rim. The pits are about 0.1 micrometer deep and 0.5 micrometer wide. (A micrometer is a millionth of a meter, or one twenty-five-thousandth of an inch.) They vary in length from 1 to 3 micrometers, with a spacing of 1.6 micrometers between tracks. This small spacing causes the finished discs to behave like a diffraction grating, scattering light in a rainbow.

In a sequence of nickel-plating and

molding operations, like those used to produce LPs, matching metal stampers are created and used to impress the spiral pattern of pits on one surface of the final transparent acrylic plastic disc. The pitted surface is coated with a reflective, molecule-thick layer of aluminum, a thin protective coating of lacquer is applied over the aluminum, and the printed label is then applied over the lacquer. In playback, the pattern of pits is read by a low-power laser that looks at the disc through its transparent *rear* surface. This laser's light, at a wavelength of 7800 angstroms, is invisible to the naked eye, since normal vision extends from about 4000 angstroms (blue-violet) to 7000 angstroms (deep red).

In contrast to LPs, the signal surface of a CD is completely protected from dust, fingerprints, and other contamination. The laser is focused on the pits, where it forms a scanning spot only 1 micrometer in diameter. But at the out-of-focus rear surface of the disc, the laser beam is nearly a millimeter in diameter, so only a large scratch or dirt particle could significantly obstruct the beam. That doesn't mean you have license to

handle the disc carelessly, though: A sharp object could easily penetrate through the label and the thin lacquer coating to damage the signal surface beneath.

PLAYBACK

Unlike an LP, which rotates at a constant 33 rpm, a CD spins clockwise at a variable rate. It begins at about 500 rpm for the "inner grooves" close to the center and gradually slows to about 200 rpm as the spiral track moves outward toward the edge, so that the disc is scanned at a constant linear speed of about four feet per second.

To read a CD, light produced by a laser diode passes through a polarizing beam splitter and is focused onto the signal surface, where the aluminum coating reflects the light straight back along the same axis. The polarized returning beam is reflected laterally by the beam splitter and then focused onto light-sensitive photodiodes that produce an output voltage proportional to the intensity of the light falling on them.

As the disc rotates, the illuminated laser spot falls alternately on the pits and on the flat areas between them.

The flat areas reflect the light beam back at full intensity and thus produce a high output from the photodiodes. When the laser spot falls on the pits (which appear as raised bumps since they are being viewed through the rear surface of the disc), they scatter some of the light. Since the height of the bumps is a quarter-wavelength, they also reflect some light back a half-wavelength out of phase with respect to the light that is reflected off the adjacent flat areas. The combination of scattering and out-of-phase cancellation produces a weak return beam and thus a low output from the photodiodes. This ensures a well-defined, high-low output signal that corresponds to the alternating flat and pit areas.

THE PHOTODIODE ARRAY is divided into several sensitive areas. The relative balance of their outputs is amplified and used to control the focusing and tracking servos, while their total output is used for the digital data. The focusing servo drives a coil/magnet assembly located around the focusing lens (similar to the voice-coil system in a loudspeaker), moving the lens rapidly up and down in order to keep the laser beam focused precisely on the reflective surface.

The entire optical assembly is carried on a tracking mechanism that follows the row of bumps from the center of the disc to its rim. As the laser spot moves off the center of the track more light is reflected from one side of each bump than the other, yielding an unbalanced output from the photodiodes that is used to control the tracking in the original "one-spot" system devised by Philips. An alternative "three-spot" system used in many Japanese players uses a diffraction grating near the laser to produce two extra illuminated spots bracketing the main scanning spot on the disc. Supporters of the three-spot system claim that it provides more reliable tracking, especially of flawed discs that may be slightly off-center or have imperfectly formed pits.

Not surprisingly, the processing of the digital playback signal is complicated. First the bit rate is compared to a crystal-controlled reference frequency, and the difference is used to regulate the speed of the motor that spins the disc. Then the bit stream is synchronized with the reference frequency, eliminating any

wow and flutter that might have been caused by slight motor speed variations. The 14-bit EFM codes are converted back to 8-bit bytes, the control/display codes are separated from the signal data, and the parity bits are used by the CIRC error-correction circuit to restore lost or misread data bits. Finally, the alternating left- and right-channel data samples in the bit stream are separated and fed to two DACs (digital-to-analog converters) that recreate the original audio signal.

DIGITAL-TO-ANALOG CONVERSION

Two quite different approaches are used for converting the 16-bit digital codes back into a continuous audio waveform. In the majority of Japanese-made players (Sony, Hitachi, Technics, et al) the D/A conversion is exactly the inverse of the A/D process that was used to make the digital recording. A complete 16-bit DAC is contained in a single IC. Since its output contains ultrasonic energy in "sidebands" surrounding the 44.1-kHz sampling rate—energy that could cause intermodulation distortion if not removed—the converter is followed by a nine-pole (54-dB-per-octave) filter that rolls off very steeply above 20 kHz.

In the D/A system developed by Philips and used in the Magnavox line of CD equipment, the 44.1-kHz playback signal is oversampled by a circuit that produces four copies of each bit, yielding a 176.4-kHz effective sampling rate. Then the bit stream is fed through a 96-tap digital transversal filter to eliminate unwanted ultrasonic noise. Philips then uses a 14-bit DAC to decode the 176-kHz digital signal and recover the original audio waveform, plus a simple three-pole (18-dB-per-octave) output filter to eliminate the residual 176-kHz noise. Ordinarily the use of a 14-bit rather than 16-bit DAC would cause a 12-dB degradation in the signal-to-noise ratio, but the oversampling and filtering provide a 13-dB improvement, so the final result is that the Philips system is equally noise-free.

Incidentally, a transversal filter is one in which the signal is mixed with slightly delayed versions of itself, producing cancellations at frequencies related to the delay times. For instance, if you delay a 1-kHz signal by one two-thousandth of a second, the delayed version will be going down

when the original signal is going up, and vice-versa, so they exactly cancel out. With multiple delays a broad range of frequencies can be cancelled.

What does all this mean when the technical jargon is translated? The Japanese approach uses direct 16-bit decoding plus elaborate and costly analog filters whose component tolerances must be tightly controlled in order to prevent audible frequency-response errors. The Philips approach uses a more arcane digital circuit, with digital signal filtering, but that allows the use of a low-cost 14-bit DAC and a simple analog filter.

Philips says that there are two main advantages to its approach: one, that at the present state of the manufacturing art, it is easier to make reliable, low-distortion DACs in 14-bit than in 16-bit form; two, that the steep output filters of the 16-bit systems cause much greater phase shift than Philips' simple filter. Only time will tell whether either of these points makes any difference to the sound, but the question of phase shift is likely to provoke discussion among audiophiles.

Any filter adds phase shift, or "group delay," to the audio signal, and the steeper the filter's rolloff, the greater is this time-smearing. The 20-kHz filters used in digital recording and playback typically cause the high frequencies in any transient sound to be spread out over about one ten-thousandth of a second instead of arriving together. Even if this is audible (which is unlikely), it is a small and subtle loss of fidelity. In any case, it may prove hard to hear any improvement from simpler playback filtering as long as most digital recordings are being made on PCM tape recorders that contain steep anti-aliasing filters.

A MORE LIKELY SOURCE of audible differences among CD players is the treble de-emphasis circuit. Most digital recordings are made with a 10-dB treble boost, and CD players contain a complementary 10-dB treble cut that spans the entire range above 3 kHz. Ordinary production tolerance in this circuit may cause one CD player to be half a dB brighter or duller than another, and, since this small deviation spans 2½ octaves of the audio spectrum, it is likely to be more audible than any imperfections above 10 kHz caused by nonideal filters. **V&S**



DO
CDs
SOUND
BETTER?

NOT
ALWAYS

BY

SAM SUTHERLAND

RECORD COMPANIES ARE LEARNING THE HARD WAY THAT MAKING SUPERIOR-SOUNDING COMPACT DISCS DEMANDS NEW ATTITUDES, NEW APPROACHES, AND EXTRA CARE.

THOUGH THE COMPACT DISC system has been heralded as a technological breakthrough, the Year of the CD has not gone by without an undercurrent of critical concern. The theoretical advantages of the new

digital medium aside, several critics have found that some CDs sound worse than their corresponding LPs.

There have been complaints of a harsh, fatiguing treble sound, a flattened or unstable stereo image, and

shifts in the overall ambience of familiar performances. A vocal minority of hard-core analog loyalists damn the Compact Disc for these effects, claiming that they are somehow tied to the digital process itself and are therefore insurmountable. Several recording engineers and producers, however, believe the problem can be traced back to sloppy handling of original analog master tapes—a sloppiness that becomes audible in the transfer to an unforgiving digital medium. My investigation over the past few months tends to confirm the latter view.

The majority of fully digital CDs—performances recorded, mixed, and mastered digitally, then transferred to CD—have acquitted themselves impressively. Most of the flaws are in CD reissues of analog recordings. Bernie Grundman, who oversees A&M records' top-rated mastering facility in Los Angeles, thinks the problem stems from CD transfer tapes: "Record companies have taken file copies of master tapes and sent them over, rather than going back to the mastering room to pull an exact digital copy of the original."

The file copy is suspect because "an analog generation represents light years of degradation over the original recording," says Elliot Mazer, a veteran engineer and producer whose early interest in digital audio culminated in his production of Elektra's ambitious new demonstration CD, "The Digital Domain." To Mazer, use of an inferior production dub may easily place the resulting CD in an unflattering light compared to an analog disc made from the same program's true master.

The hazards in relying on an analog copy are legion. Inherent anomalies in conventional analog recording and disc cutting have prompted the use of compensatory techniques to doctor tapes for optimum LP or cassette transfer. Heading the list, and cited by every producer and engineer I spoke with, is program equalization, applied during mastering to correct frequency response problems on the LP.

"There are very few studios equipped with exactly the same equalizers and tape equipment," explains Grundman. So even the detailed production notes listed on

master tapes to assist in future tape and disc transfers may not provide an adequate blueprint. "If they read in our notes that we added 2 dB at 5,000 Hz [to the LP lacquer] and try to do the same with a differently sloped equalizer, the result could be a completely different sound."

The variances among analog tape machines cause more complications. "Analog recorders all have low-frequency head bumps," Mazer notes, "and because of that I haven't seen two machines that had the same bass response, even from a single manufacturer." For instance, a specific deck may yield a frequency-response curve in which the program is down by several decibels at 40 Hz, up by an equal or greater amount at 45 Hz, yet ruler flat at 100 Hz. Played back on a unit with different peaks and valleys in the same region, even an unequalized tape would be in trouble. The problem is in fact exacerbated when an engineer follows the production notes and applies the equalization that was intended only for the original tape recorder.

Why, then, are CDs made from any source other than the original master tape played on the original two-track analog recorder? The answer, unfortunately, is that record companies are simply following procedures already set up to create conventional LPs and cassettes. Most major labels are accustomed to supplying later-generation tape copies to their overseas licensees (and, in many cases, to U.S. plants when replenishing stocks of old catalog titles). For pop music, such dubs are typically Dolby-encoded quarter-inch reels recorded at 15 ips—even if the original master was produced on half-inch tape at twice that speed.

Al McPherson, Warner Bros. Records' chief of engineering and shepherd for the label's CD transfers, acknowledges that this practice may have dominated production of the first CDs in Japan and Germany. Agreeing that original masters remain the best source, he also argues that "the producers of the original recordings are as much at fault as the record companies." By their tight-fisted insistence on keeping the master tape, McPherson claims, producers are forcing record companies to rely on later-generation dubs. He cites Warner's own frustrating experience

CD vs. LP: LITTLE THINGS MATTER

The accuracy with which a Compact Disc reproduces the sound of a master tape is no guarantee of listening satisfaction. A case in point is the Dire Straits release "Love Over Gold." The LP (Warner Bros. 23728-1) has been deservedly praised for its excellent frequency range, dynamics, and stereo image. But the CD (Vertigo 800-088-2), despite its lower noise and more solid bass, has a harsh, metallic quality that is very fatiguing.



These impressions come from a direct comparison of the LP and CD. Reports of this kind mean very little, however, unless the playback equipment is specified. I listened to the CD on a Sony CDP-101; the LP was played with a Denon DL-103D cartridge mounted in a special lightweight headshell on a Technics SL-500 integrated turntable with a custom isolation base. My preamp was an Apt/Holman One, whose moving-coil module was designed specifically for cartridges like the Denon. And I listened to both the CD and LP through early vintage Snell Type A loudspeakers.

To investigate the source of the difference in sound between the analog and digital releases, I used a CBS STR-100 test record and a Ballantine precision AC voltmeter to

measure the frequency response of the Denon/Apt combination at the Apt's external-processor-loop output. Channel balance was within 1 dB over the entire audible range, so Fig. 1 shows the averaged response of the two channels.

I then attempted to duplicate the cartridge's response curve using two equalizers in series: an octave-band unit and a parametric equalizer. (The combination of the two is much more versatile than either type alone.) Instead of trying to match the individual cartridge channels, I decided to split the already small difference, and the resulting EQ curve appears in Fig. 2.

Though not perfect, the equalization is as close as 15 minutes of careful tweaking could make it. As the curve illustrates, it is slight indeed. Of the 15 equalizer controls in each channel, none was moved by more than $\frac{3}{16}$ inch from its center position, and most by less than half that. To confirm the accuracy of the settings, I applied the equalization to the Compact Disc and compared the one-third-octave spectra of the CD and LP over the same musical passage. Within the 1-dB resolution of the spectrum analyzer, everything checked out okay.

The next step was to determine how the "corrected" CD of "Love Over Gold" sounded in comparison to the LP. Interestingly, the CD was almost identical to the record. But the digital version's lower noise, rock-solid pitch, and superior cleanness at both frequency extremes made it the preferred choice. The difference between the equalized and unequalized CD sounds was not overwhelming in direct comparison, but the subjective effect of the improvement became very important during extended listening. The test suggests that the LP and CD were both created from the same master tape—the one that was EQed specifically for LP use—and that the LP was cut with considerable care.

I also evaluated several other records

with "The Nightfly," Donald Fagen's digitally recorded solo debut.

But according to engineer Roger Nichols, Fagen and producer Gary Katz were so eager to make a Compact Disc version that they even allowed Sony to use the original tracks in creating demonstration CDs. Nichols recalls their dismay when reports surfaced that "The Nightfly" sounded off-kilter in its European CD version. "I borrowed a copy of the CD—Stevie Wonder's, in fact—and compared it to a digital cassette copy of the master tape that I made with my own Sony digital processor. The imaging had all but disappeared, and Donald's vocal sounded more distant." Warner was contacted, and the label agreed to scrap the stock of CDs already received from

Polygram's West German plant, postponing American release until Nichols could remaster the album from the original digital tape.

McPherson counters that a primary reason for Warner's failure to catch the mistake was the lack of a true digital copy in the record company's vaults: "We didn't have a digital version of the album to compare the CD to." As a result, the first versions of "Nightfly" offered abroad represented an ironic subversion of the work—a CD derived from a later-generation analog dub that had been used for mastering the LP.

A similar fate befell Billy Joel's "The Nylon Curtain," also digitally recorded and mixed but unwittingly mastered for CD from an EQed analog

and their Compact Disc counterparts, using the same correction settings. The results were similar, but not quite as consistent. When I tried the test with the two versions of "The Best of Manhattan Transfer" (Atlantic SD-19319 and 80085-2 for the LP and CD, respectively), I found that the upper midrange and treble on both the LP and CD sounded unpleasantly bright near the outside of the recording, but that the highs on the LP became progressively more attenuated as the

But why should we bother with the Compact Disc if some analog productions sound better than their counterparts? The answer depends on your outlook. You can't tell someone who has just paid close to \$1,000 for a player and \$20 for each disc to spend another several hundred dollars for an equalizer just to make it all sound "right." Still, the CD is inherently more accurate and more consistent a medium than the LP. Mastering techniques and playback systems must

FIG. 1. PHONO PICKUP RESPONSE

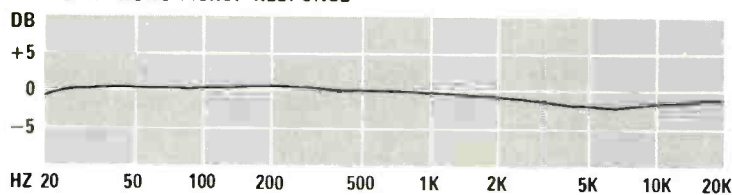
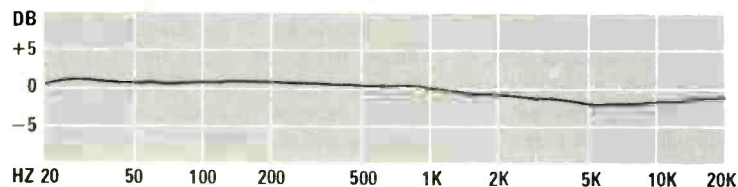

FIG. 2. COMPACT DISC "CORRECTION"



stylus made its way inward. This improved the sound of the LP, but in comparison made the equalized CD sound even brighter and more irritating.

What practical conclusions can be drawn from this exercise? My test results reconfirm the importance of small alterations in frequency response that extend over two or more octaves. With source material that is well recorded except for its frequency balance, subtle corrections can make a subjective difference out of all apparent proportion to their size.

change somewhat for the full potential of CD to be realized, but this experiment suggests that small changes can bring large benefits.

Ultimately, the responsibility for solving this problem lies with the record companies, who must change the way they record the music and exercise greater care in post-production. Until then, a good octave-band equalizer, especially one that has a high-resolution mode in which the range of its controls is reduced, can improve much of the current software.—E. Brad Meyer

copy sent to Japan by CBS. In this case, the mixup wasn't detected until after CBS had started selling the flawed version in the U.S. "It's just spilled water at this point, because it has been corrected," says longtime Joel producer Phil Ramone. Still, he notes that in its finished form, the CD actually represented three additional analog generations.

Most CD engineers now require that an LP's original producers and engineers be contacted prior to CD mastering so that the best possible tapes can be used for the transfer. Bruce Swedien, Quincy Jones's engineer of choice for years, admits his own irritation when he learned that Jones's multiple-Grammy hit "The Dude" had been issued by A&M on

Compact Disc without either his or Jones's knowledge. Swedien says that he now insists on readying his own digital copies, usually from the original 30-ips half-inch master tape.

There's already evidence that such production lapses are causing the major labels to be more diligent, too. Several are using the services of Bruce Botnick, an engineer and producer who operates the high-tech consulting company Digital Magnetics. Botnick agrees that the first CDs produced abroad apparently were made from later tape generations, but he's convinced that U.S. labels are moving quickly to avoid future gaffes.

CBS's response to the need for tighter quality control was, according to Botnick, incredibly rapid: "I

brought the problem to their attention, and they began checking the product immediately." Botnick's company was subsequently enlisted by CBS to take over digital mastering of old analog recordings, and he travels to the original studios to make properly equalized digital copies. Warner's McPherson says that similar measures are being taken with his company's CD transfers. Digital cassette copies, for instance, are now employed to track quality control, with McPherson supplying them to producers and engineers of the original works as needed.

MEANWHILE, A&M's Grundman uses his Los Angeles mastering facility as a CD crow's nest, supervising digital transfers on the premises. Because most of the label's albums are mastered there, he has easy access to the correct master tapes and knows the specific requirements of each. In handling albums mastered elsewhere, he insists on the best available tape generation before pulling a digital copy for CD production.

Engineers are unanimous, however, in suggesting that CDs can really only strive to be a mirror image of what's on the master. Consequently, if people continue to expect sonic perfection from CDs, then perhaps some recordings should be deemed unsuitable for CD release—at least until effective cosmetic techniques evolve to permit digital touchups. And exaggerated expectations will not diminish until consumers realize that not all CDs are true digital products. The Society of Professional Audio Recording Studios has urged record companies to distinguish between analog-conversion CDs and digitally recorded, mixed, and mastered titles by stating the appropriate information on the packages themselves.

So far, manufacturers have resisted adopting such labeling, but they have at least started using liner booklets and external merchandising materials to identify true digital products more clearly. As more all-digital recordings are made and engineers learn to tailor their CD remakes of analog masters more consistently, the incidence of digital disappointments should diminish. In the meantime, keep reading CD reviews and pay heed to that ancient admonition: Let the buyer beware.

V&S

Compact Disc REVIEWS

A SAMPLER OF RECENTLY RELEASED COMPACT DISCS

POPULAR COMPACT DISC

ABBA:

Greatest Hits, Vol. 2.

Benny Andersson & Bjorn Ulvaeus, producers. Polygram 800 012-2 (analog recording, digital Compact Disc) LP: ATLANTIC 16009.

Producers Benny Andersson and Bjorn Ulvaeus have always made their rich pop confections durable enough to survive the unforgiving squeeze of AM radio transmission. They carefully layer their songs' lusty choral harmonies and myriad, often subtle details to survive the indignities of poor playback.

Ironically, that attention to low-fi reproduction pays dividends for these high-tech renderings. The rather dry and overly brilliant sound on many CDs seems to have been prevented by strategies that probably arose from anticipating mono single mixes: The key voices and orchestral textures are generally placed around the center of the stereo array, with far right and far left positions used more for percussive accents.

This English import is yet to be scheduled for American release. With luck, an even stronger, more definitive Abba anthology, "The Singles," might emerge in CD once the quartet's U.S. label maps out its strategy for the new format. —SAM SUTHERLAND

PATTI AUSTIN:

Every Home Should Have One.

Quincy Jones, producer. QWEST 3591-2 (analog recording, digital Compact Disc) LP: QWEST/WARNER BROS 3591.

A commercial also-ran in the months following its release, this 1981 album became a late bloomer, thanks to the unlikely intervention of the soap opera *General Hospital*, which adopted

Baby, Come to Me as one of its themes. But "Every Home Should Have One," a collaboration between seasoned studio vocalist Patti Austin and producer Quincy Jones, was and is a classy, satisfying pop venture. And its virtues are enhanced, if modestly so, in this Compact Disc version.

Jones's typically immaculate production finish has been so fully realized on conventional LPs that subsequent audiophile renderings, as well as early CDs, have presented only marginal improvements, even in such usually vulnerable areas as signal-to-noise ratio. While this outing is no exception to that somewhat paradoxical trend, it does emerge with an appreciable reduction in background noise and a bit more crispness overall. The digital transfer extracts more presence from various keyboards, and likewise imparts greater clarity to Austin's own voice, as well as to the background vocals.

These gains, although individually slight, combine to backlight Jones's penchant for fugal vocal and rhythm parts, as on the ebullient title cut and the driving *Do You Love Me*. Synthesizer voicings, both on solos and in countermelodies, attain a somewhat more sculptured quality, and his intricate use of percussion effects is also well served. —S.S.

DONALD FAGEN:

The Nightfly.

Gary Katz, producer. WARNER BROS 23696-2 (fully digital Compact Disc) LP: 23696-1.

The original sessions for this solo bow by former Steely Dan partner Donald Fagen were themselves commitments to digital audio. Fagen and producer Gary Katz had tried without success to record the final Dan

album, "Gaucho," with digital gear; but for "The Nightfly" they sent chief engineer Roger Nichols to Minneapolis to learn 3M's multichannel system from the inside out. That thoroughness yielded a sonic triumph that pays off handsomely as a Compact Disc.

Ironically, "The Nightfly" was slated to be among the first CD releases from Warner Bros. only to be pulled from the schedule when it was discovered that the label had mistakenly shipped an analog copy for digital CD mastering. The true digital disc should be of particular interest to those bemused by some of the less

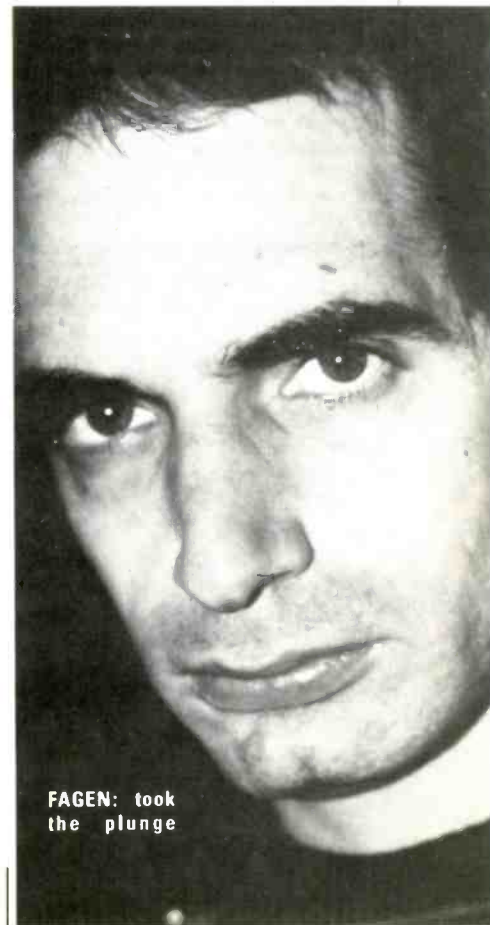

FAGEN: took the plunge

JAMES HAMILTON/COURTESY WARNER BROS.

successful, early analog-to-digital transfers.

An impressive production in conventional LP, this sleek pop masterpiece exacts fresh nuance and palpably greater presence on Compact Disc. The opening track alone inventories many of the subtle improvements with its swarms of keyboard notes, shimmering cymbals, and effortless, deep bass. Likewise, *I.G.Y.*'s backing vocals remain silken while gaining bite, and Fagen's synthesized harmonica is clean and piercing, its counterpoint to the lyrics' starry-eyed optimism all the more mocking.

From the pure acoustic piano intro on *Maxine* to the throaty Hammond organ accents in *Walk Between the Raindrops*, the broad palette of keyboard timbres is rendered with greater precision. Backing voices, especially where Fagen's arrangements call for a creamy closeness, achieve better definition without unraveling.

Fagen's deft extension of Steely Dan's astute fusion of pop, jazz, rock, and r&b made "The Nightfly" one of last year's best albums. As a Compact Disc, it's irresistible. —S.S.

AL DI MEOLA, JOHN McLAUGHLIN, PACO DELUCIA:

Friday Night in San Francisco.

Al Di Meola, John McLaughlin, & Paco DeLucia, producers. CBS/Sony 35DP 9 (analog recording, digital Compact Disc). LP: CBS FC 37152

MILES DAVIS:

The Man with the Horn.

Teo Macero, producer. CBS/Sony 84708 (analog recording, digital Compact Disc). LP: CBS FC 36790

BRUCE SPRINGSTEEN:

Born to Run.

Bruce Springsteen, Jon Landau, & Mike Appel, producers. CBS/Sony 80959 (analog recording, digital Compact Disc). LP: CBS JC 33795

BOB JAMES & EARL KLUGH:

One on One.

Bob James, producer. CBS/Sony 35DP 10 (analog recording, digital Compact Disc). LP: CBS/TAPPAN ZEE FC 36241

Recently, I spent a long afternoon sequestered in our listening room, comparing Compact Discs with their LP counterparts. All four CBS/Sony discs were mastered in Japan from their original analog master tapes: "Born to Run" was recorded in 1975, making it the oldest of the lot.

I listened to the LPs first to get an idea of the original production values: The slightly bland jazz of "One on One" is superbly engineered, particularly in terms of equalization and stereo imaging. At the other extreme, "Born to Run" packs a lot



MILES: probing the nether regions

more wallop into a production that is sometimes a bit muddy in the low end. Then I started on the CDs. I was startled. The most immediately obvious improvements are, of course, the absence of surface noise and wow and flutter. But "improvements" is the wrong word. The changes in frequency response, dynamic range, and timbral expansion make the CD listening experience different in character than its analog or even its live counterpart. This may raise objections in some quarters, especially among classical listeners. But if you're a pop music aficionado, for whom a recording is a listening experience in and of itself—rather than an acoustical representation of a particular performance—then CD will undoubtedly figure in your future.

"Friday Night in San Francisco," which documents a live concert with guitarists John McLaughlin, Al DiMeola, and Paco DeLucia, was recorded at San Francisco's Warfield Theater. The material is Spanish-tinged, and both the trio and the duo performance configurations tend toward deft thirty-second-note runs. In the analog-to-CD comparison, the former sounds compressed and smaller than the latter; indeed, the CD's concert-hall ambience feels larger than life, with the notes reverberating off into space. That overriding spaciousness and depth contributes to several other differences: Attacks on notes sound crisper, vibratos are more vibrant, and there seem to be more overtones in the bass and midrange. On the Egberto Gismonti composition *Frevo Rasgado*, a duet by McLaughlin and DeLucia that contains some of the album's most

stirring moments, the ascending lines in unison, octaves, and thirds generate some beautiful overtones that simply cannot be heard on the LP. In fact, I'm not at all sure they were even audible at the concert; they may be entirely a product of the digital process.

Miles Davis's "The Man with the Horn" was a fine comeback filled with deceptively casual compositions; several brilliant, storytelling solos; and a panoramic sense of rhythmic space. It was recorded in CBS's mammoth midtown Manhattan studio, once a huge church, so the space is no accident. In fact, the LP sounds full and airy, even compared with the CD. But individual instrument sounds differ widely between formats. On *Fat Time*, drummer Al Foster's New Orleans-style second-line beat sounds much further back in the analog mix, while his tom-toms resonate more deeply on the CD; similarly, Marcus Miller's pulsing bass probes and extends much further down into the aural nether regions on the digital disc. Even Miles's trumpet, recorded and equalized by Teo Macero with the utmost care, has more depth, especially during his Harmon-muted soloing. And though *Backseat Betty*'s crashing ride cymbals hold up quite well on LP, the CD has a slightly cleaner edge and a timbral shimmer that aren't on the LP.

The Bruce Springsteen album offered an acid test. While "Born to Run" could in no way be called abrasive hard rock, it is nonetheless quintessential rock & roll. Such tunes as *Thunder Road* and the title track feature a classic rock combo sound whose careening aural wash epitomizes what Springsteen and producer Jon Landau had in mind. That quality, partly achieved by (intentional) bleed-through of the instrumental tracks, remains intact on the CD. And once again, the most dramatic improvement is in the individual sounds—even compared to the CBS half-speed remaster audiophile pressing. There, the piano intro to *Thunder Road* sounds boxed-in and fuzzy next to the CD, where it seems to peel. The rim-shot drumming during the song's first verse cuts through the guitars with much greater definition, while in the last verse the glockenspiel leaps above the mix, rather than peeps over the top. On a quieter, cleaner track like *Tenth Avenue Freeze-out*, the horn section sounds more focused in attack. A note

to rock & roll listeners: These CDs have a "hotter" high end than their LP counterparts, and this one still sounds more cohesive and centered at high volumes than the LP. In other words, the oft-cited argument that digital isn't suitable for gritty rock music doesn't hold up on this classic '70s recording.

Bob James and Earl Klugh's "One on One" is an outrageously clean and carefully produced recording—each instrument has superb definition. Again, the CD differences are dramatic: Neal Jason's bass is full-bodied and carpet-like, deeper and more pleasing in effect; the already complex and impressive stereo imaging seems almost cinematic in dimension; Ralph MacDonald's percussion instruments subtly nudge, but never intrude on, Klugh's glistening guitar arpeggios. The listener feels witness to a true juxtaposition of sounds in space, rather than against a flat wall.

Perhaps the only real barrier to the CD's potential stampede into the marketplace is the nature of its sound. Its differences may in fact be due to enhanced overtones that are either inaudible or less apparent in an analog recording or live performance. But with these four albums I enjoyed that quality; it was anything but artificial.

—CRISPIN CIOE

MICHAEL JACKSON:
Off the Wall.

Quincy Jones, producer. Epic CDEPC 83468 (analog recording; digital Compact Disc) LP: PE 35745

MICHAEL JACKSON:
Thriller.

Quincy Jones, producer. Epic CDEPC 85930 (analog recording; digital Compact Disc) LP: OE 38112

BILLY JOEL:
The Stranger.

Phil Ramone, producer. CBS 35DP 2 (analog recording; digital Compact Disc) LP: JC 34987

BILLY JOEL:
The Nylon Curtain.

Phil Ramone, producer. CBS CDCBS 85959 (digitally mastered analog recording; digital Compact Disc) LP: TC 38200

Among the most common theories offered in advance of the Compact Disc's general availability is that purely digital programs provide the best showcase for CD's benefits. But this sampling of albums in CD form argues against the all-digital notion and, in the process, supports the technology's mass-market goals. Although commercial pop recordings generally don't afford dramatic foil for the CD's gains in dynamic range, they still benefit from improvements in stereo

separation, imaging, and distortion, and often sidestep the issue some skeptics are still fretting over—namely, high-frequency reproduction of acoustic-instrument timbres.

Michael Jackson's LP "Off the Wall" exemplified producer Quincy Jones's expertise at extracting power and nuance from conventionally manufactured records. CBS's half-speed version of that album eked out modest improvements over the already dazzling mass-market version, but the CD adds new weight and detail. The benefits of precise imaging are apparent from the opening bass figure on *Don't Stop Till You Get Enough*, which offers a richly swirling, dynamic arrangement spiced with kinetic percussion, shuttling horn choruses, and mesmerizing bass and drums. The new richness gained in Jackson's ebullient vocals is typical of the CD's consistent superiority, even over the recording's most pristine analog version. The only jarring effect I first heard, a shift in tonal balance for the repeating synthesizer riff on *Rock with You*, eventually proved more a correction than an aberration.

The standard set by the "Thriller" LP, however, leaves minimum room for improvement in a digital conversion. The fundamental CD virtues of vanishingly low noise and distortion touch up the glossy surfaces of Jones's and Jackson's ebullient pop/funk. But beyond that, any refinements escape notice behind the sheer strutting richness of the deceptively large ensembles.

Dancefloor enthusiasts may even object to the deeper, less punchy bass and bass synthesizer lines, particularly on *Billie Jean*, although it can be argued that the digital rendering is more open in character. That said, "Thriller" still stacks up mightily against other analog-derived CDs. Its improvements are slight, but the basic work is already an earful. In other words, if you're one of the few people left in the world who doesn't already own the LP, buy the CD.

Ironically, the catalog of one artist who has several titles on CD is also one of the few examples of digital's mixed blessings. Billy Joel's "The Nylon Curtain" does gain clarity, but that high-frequency issue comes to the foreground on *Laura*. Hard cymbal strikes by drummer Liberty DeVitto veer toward a harsh, clanging attack

that on CD proves even more jolting. The slightly veiled character of Joel's vocals on his earlier, pivotal "The Stranger" remains in CD, but refinements are obvious in presence, imaging, and separation. —S.S.

VAN MORRISON:
Into the Music.

Van Morrison, producer. Mercury 800 057-2 (analog recording; digital Compact Disc) LP: WARNER BROS. HS 3390

VAN MORRISON:
Beautiful Vision.

Van Morrison, producer. Mercury 800 036-2 (analog recording; digital Compact Disc) WARNER BROS. 3652

These two imports are examples of how analog masters can benefit from the transfer to the digital configuration. Van Morrison's penchant for comparatively large but closely reined ensembles has long invested his albums with an abundance of subtle details that CD helps to clarify.

On "Into the Music," solid, cleanly defined stereo positioning enables the spread of acoustic and electric string instruments to achieve an even more spacious character. Exemplifying the gains are Toni Marcus's stately fiddle lines and Ry Cooder's sinewy bottleneck guitar. Elsewhere, as on *Troubadours*, the balance of violin, trumpets, and penny whistle is dramatized attractively.

"Beautiful Vision," a later, jazzier work, also sounds impressive in the CD format. The quietly bristling dissonances of *Dweller on the Threshold's* horn figure shimmer seductively, and *Cleaning Windows*, with its substructure of sly guitar lines, achieves new clarity. —S.S.

PRETENDERS.

Chris Thomas, producer. Sire 6082-2 (analog recording; digital Compact Disc) LP: SRK 6083

The rough-and-tumble verve of this 1979 debut stemmed in part from its defiant rejection of squeaky-clean studio sonics to resuscitate the virtues of raucous, guitar-dominated rock. A subsequent Nautilus half-speed audiophile LP suffered from too much spit-and-polish during remastering, enhancing Chrissie Hynde's laconic vocal presence at the expense of the band's driving instrumental work.

But this latest incarnation is just dandy, adding clarity to the performances without dulling that slashing, high-decibel attack. Here, the

original LP's sense of a pitched battle between the snarling singer and her no-holds-barred partners survives. Background noise is sharply reduced, stereo separation is improved, deep bass taps a more visceral punch, and drummer Martin Chambers's splashy cymbals sound crisper and cleaner without the brittle edge sometimes interposed through digital recording. "Pretenders" is good news indeed for CD enthusiasts in search of no-nonsense rock. —S.S.

**SONNY ROLLINS:
Way Out West.**

Lester Koenig, producer. MOBILE FIDELITY SOUND LAB MFCD 801 (digitally mastered analog recording; digital Compact Disc). LP: CONTEMPORARY 7530.

Way Out West" signals the CD debut for the analog audiophile mavens at Mobile Fidelity. There are three other titles in the company's first batch of digital discs, but executives there confide that this 1957 album is the standout. It also serves as a timely reminder that basic engineering technique is as crucial to good sound as any specific piece of equipment.

The session, teaming saxophonist Sonny Rollins with bassist Ray Brown and drummer Shelly Manne, demonstrates just how accurate early documentary stereo recordings could be. It was taped live, without overdubs—only a two-track Ampex 350 was used—and the resulting tracks are immaculate. Rollins's jabbing, playful phrases and mercurial tone are captured with a presence unsurpassed on more recent multitrack analog and digital dates; angular, vibrato-less lines, guttural asides, and sultry, lyrical phrases are all reproduced with stunning naturalism.

Inevitably, some details betray the vintage of the technology, notably in the slightly muffled timbre of Manne's snare and tom-tom in spots, but on balance the sonics, like the performance, are terrific. Any tape hiss from the original is all but inaudible; at normal playback, vanishingly low noise floor duplicates the quality of true digital-to-digital CDs. —S.S.

**VARIOUS ARTISTS:
Real Hot Jazz.**

Ken Kreisel, CD producer. REAL TIME RT 2002 (fully digital Compact Disc). LPs: RT 301, 303, 304, 305.

RealTime's "Real Hot Jazz" is a sampler of true digital audio. A

prelude to this small, California-based audiophile label's upcoming CD catalog, it is excerpted from masters originally recorded on the company's customized Sony digital master recorder.

Included here are Don Menza's '80s Big Band, John Dentz Reunion (a quartet teaming drummer Dentz with Ernie Watts on reeds, Chick Corea on piano, and Andy Simpkins on bass), Jack Sheldon's Late Show All-Stars, and a triumphant bop ensemble fronted by Freddie Hubbard and featuring Richie Cole on alto, George Cables on piano, and the Simpkins/Dentz rhythm section. Menza's lusty, big-band charts and a lineup of crack players render *Burnin'* all the more aptly titled, its brass timbres fat and warm. And even a slightly creaky reading of *That Old Feeling* by Sheldon's band is dazzling in its presence. The Dentz Reunion is at least as fruitful, the sinewy interplay in this quartet even more arresting than on the already superb LP pressings the label achieved through its ties to Teldec. Hubbard's romping *Shaw Nuff* showcases CD sonics through its machine-gun trumpet lines and crashing cymbal work from Dentz.

Overall, the sonic presence on "Real Hot Jazz" achieves an oft-mentioned ideal: the illusion that the performers are little more than an arm's length away. Anyone who has ever had the dubious privilege of catching a jazz group in full cry from the front row of a club will realize this effect isn't without its drawbacks. But I, for one, don't mind fiddling with the volume to find a workable compromise. —S.S.

**NEIL YOUNG:
Harvest.**

Elliot Mazer, Neil Young, Jack Nitzsche, & Henry Lewy, producers. REPRIS: 2277-2 (analog recording; digital Compact Disc). LP: REPRIS 2277-1.

Since much of its character rests with the comparatively rustic style and uncluttered, intimate production finish, there's little sonic drama on "Harvest." Coproducer Elliot Mazer, who supervised the preparation of the digital sub-master needed for CD manufacturing, admits that the analog master tape is burdened with hiss. While some may be detected at high volume, fans familiar with either the conventional LP release or the subsequent Nautilus half-speed etching won't complain; this new version still



PRETENDERS: founder and survivor Hynde

triumphs. It also offers a cleaner, better-defined stereo image and boasts improved presence to the vocals. At the same time, the recording's considerable acoustic ambience—often a casualty in analog/digital transfers—is preserved intact.

There are instances where the added clarity reveals slight flaws in the master. On two orchestrated tracks produced by Jack Nitzsche, for example, the violins suffer from a rather grainy character. But instrumental details are otherwise captured beautifully, the lean, atmospheric playing of the Stray Gators shining throughout. Cleaner sonics buttress Neil Young's harmonica lines, Ben Keith's mournful pedal steel accents, and Tim Drummond's terse bass.

Thus, "Harvest" offers heartening proof that careful preparation of original analog recordings by their creators is very worthwhile. This CD not only does justice to the original; it yields audible improvements that will repay the home listener. And with such a classic, the format's durability will be an obvious additional benefit. —S.S.

PAUL COX/PETNA

CLASSICAL
COMPACT DISC

BEETHOVEN:

Symphonies:
No. 5, in C minor, Op. 67*;
No. 6, in F, Op. 68 (*Pastoral*)†.
Leonore Overture No. 3, Op. 72b.‡

Philharmonia Orchestra, Vladimir Ashkenazy, cond. [Andrew Cornell, prod.] LONDON 400 060*†, 410 0031 (fully digital Compact Discs) [prices at dealer's option]; LPs (2): LDR 72015*†. Cassettes (2): LDR5 72015*†.

There are more sophisticated performances of these works—and competition is undoubtedly imminent, even in the brand-new CD format—but all the essentials are here, delivered in agreeable sound and playing. The Fifth, as Vladimir Ashkenazy oversees it, is broad and generalized. Apart from a quite lively finale, the tempos are leisurely with the apparent Furtwängler-isms kept within reasonable limits. The *Pastoral* is similarly deliberate and quite bucolic. A fine Leonore No. 3 is offered with the Fifth. —HARRIS GOLDSMITH

BEETHOVEN:

Symphony No. 7, in A, Op. 92.

Berlin State Orchestra, Otmar Suitner, cond. DENON 38C37 7032 (fully digital Compact Disc).

On the whole, this is a reliable, orthodox reading that, despite the ostensibly small orchestra, goes all out for monolithic weight and a deliberation reminiscent of Klemperer and Sanderling. The most injurious thing about the performance is its obsessive inclusion of repeats: The one in the first movement suggests Orpheus's mistake of looking backward at the wrong time, and the same applies to the finale. There will doubtless be other—and better—Sevenths in the new medium. My advice is to sit tight and wait. —H.G.

JESSYE NORMAN:

Sacred Songs.

Jessye Norman, soprano; Christopher Bowers-Broadbent, organ*; Ambrosian Singers†, Royal Philharmonic Orchestra‡, Alexander Gibson, cond. PHILIPS 400 019 (fully digital Compact Disc). LP: 6514 151. Cassette: 7337 151.

ADAMS, S.: *The Holy City*.* FRANCK: *Panis angelicus*‡ GOUNOD: *Messe solennelle de Ste Cécile*; *Sanctus*.†‡ O Divine Redeemer (*Repenit*).‡ MACGIMSEY: *Sweet little Jesus boy*. SCHUBERT: *Ave Maria*.* YON: *Gesú bambino*.†‡ ANON: *Amazing grace*‡; *I wonder as I wandert*; *Let us break bread together*‡; *What child is this*.

Jessye Norman's recital of so-called sacred songs is a model of its kind. The selections, in themselves diverse enough to prevent interest from

flagging, are imaginatively presented. Gounod's operatic effusions, the Victorian uplift of Stephen Adams, the homespun serenity of "Amazing Grace," the gospel asceticism of Robert MacGimsey's "Sweet Little Jesus Boy" (sung without accompaniment)—all appear in apt arrangements.

The soloist's radiant instrument, serenity, and expansive phrasing impose all the unity her recital requires. —MATTHEW GUREWITSCH

OFFENBACH:

Overtures (5);
Les Contes d'Hoffmann;
Barcarolle (arr. Rosenthal).

Berlin Philharmonic Orchestra, Herbert von Karajan, cond. [Michel Glotz and Günther Breest, prods.] DEUTSCHE GRAMMOPHON 400 044 (fully digital Compact Disc). LP: 2532 006. Cassette: 3302 006.

Barbe-bleue (arr. anon.); La belle Hélène (arr. Haensch); La Grande-Duchesse de Gérolstein (arr. Hoffmann); Orphée aux enfers (arr. Binder); Vert-vert.

However often one may have been told before, the fizz never quite goes out of the surprise that Offenbach's evergreen overtures are mostly by other hands. Of the five given here, only the one to *Vert-vert* (the dark horse of the lineup) is from the composer's own pen.

Karajan does not make a particularly congenial exponent of Offenbach's foxy frivolities. In softer passages, as in the Overture to *Barbe-bleue*, he elicits so delicate a touch that the sonic experience is practically subliminal; a feather borne on the breezes could never whisk the triangle so lightly. In the great swirls, such as the *Orphée* cancan, he charges like a storm trooper. There are lilting moments in the Overture to *La Grande-Duchesse*, though Karajan makes heavy weather of its parade-ground militarism. And despite very smart intercutting from waltz to galop, the Overture to *La Belle Hélène*, as executed here, is cold-hearted and not much fun. Of the five offerings, the Overture to *Vert-vert*—the single genuine article—proves the most beguiling in itself and the most beguiling in performance. —M.G.

PROKOFIEV:

Symphony No. 5, in B flat, Op. 100.

Israel Philharmonic Orchestra, Leonard Bernstein, cond. [John McClure, prod.] CBS MASTERWORKS CD 35877 (fully digital Compact Disc). LP: IM 35877. Cassette: HMT 35877.

The Fifth Symphony has been called Prokofiev's *Eroica*, and Bernstein—assuming the mantle of

Koussevitzky and adding some girth of his own—takes a very portentous (and, if you like, heroic) view here. The Israelis, while still a bit drab and scruffy of tone, are at their best, with better discipline than in many of their (or Bernstein's) other recordings. The CD sound is detailed and wide-ranging, if not particularly alluring. —H.G.

TCHAIKOVSKY:

Symphony No. 6, in B minor,
Op. 74 (*Pathétique*).

Los Angeles Philharmonic Orchestra, Carlo Maria Giulini, cond. [Hans Weber and Günther Breest, prods.] DEUTSCHE GRAMMOPHON 400 029 (fully digital Compact Disc). LP: 2532 013. Cassette: 3302 013.

As the first CD version, this is certainly a satisfactory *Pathétique*, but there will doubtless be others. In comparison with Giulini's earlier LP version with the Philharmonia—one of the best things this conductor has given us—the Los Angeles remake is more matter-of-fact, with plainer phrasing, good but less polished execution, and dryish reproduction.

Giulini never falsifies sentiment, but neither does he generate crackling electricity. The orchestra plays sturdily, if without the lustrous blend and unanimity of its more recent recordings. The CD is not terribly alluring; the soft playing is sparsely reproduced, but when climaxes come, a certain constriction sets in. —H.G.

WAGNER:

Tannhäuser: Overture and
Bacchanale. Overtures to Die Feen
and Der fliegende Holländer.

Concertgebouw Orchestra, Edo de Waart, cond. PHILIPS 400 089 (analog recording; digital Compact Disc). LP: 9500 746. Cassette: 7300 831.

In the first hand of the new audio deal, this disc is a low card. Of Edo de Waart's conducting, the best one can say is that he does not interfere. In *Die Feen* the energetic potpourri of successive ideas rattles along garrulous and uninflected. The more familiar pieces fare little better.

The conductor's leadership registers, to the extent it does so at all, in his exploitation of the full dynamic scale—from bone-chattering multiple fortissimos to pianissimo lulls just this side of inaudibility. The CD engineers have served his limited concerns well, especially at low volumes, where no background noise intervenes. There are diaphanous tremolandos and laser-clear flourishes that show off the new technology to good advantage. —M.G.

DIGITAL AUDIO

A
NEW
ERA
FOR

R
A
D
I
O

?

DIGITAL AUDIO'S NEXT STEP MAY BE THE AIRWAVES, AS FULLY DIGITAL RADIO TRANSMISSION NEARS REALITY.

BY

CHARLINE ALLEN

BY NOW, MOST MUSIC LOVERS have either read about or heard for themselves the incredible reproduction offered by digital Compact Discs. But that's only part of the digital-audio story. The technology that makes CDs possible—digital encoding and error-corrected playback—is also being applied to a variety of broadcasting techniques. In the not too distant future, it should be possible to get high-quality digital programming over the airwaves.

You probably won't be listening to fully digital FM broadcasts, however.

Transmitting digital audio information requires at least 20 to 50 times more bandwidth than is needed for analog signals. And since FM station allocations are already in place and millions of radio receivers are set for them, it's not likely that digital audio will ever appear on the FM band. Some FM stations are now broadcasting CD recordings, but in many cases it's hard to hear any improvement in sound quality at the receiving end. No matter what the source, the signal must still be routed through the station's compressor.

limiter, and often antiquated transmitter.

One medium that does have the bandwidth necessary for digital audio transmission is the coaxial cable used in cable television. If you have a cable, all you would need is a special digital-to-analog (D/A) converter, a stereo amplifier, and speakers. Such was the theory behind the Home Music Store (HMS), a direct-to-home digital service that died on the vine in June of 1982.

HMS was the brainchild of William Von Meister, the developer of

The Source, a popular videotex service. His idea was that HMS would operate like a record store, with subscribers paying \$10 a month to receive five cable-fed channels of commercial-free audio programming via a leased digital tuner/decoder. In addition, two extra channels would be available for taping of specially requested recordings.

By calling a central computer via a Touchtone telephone, an HMS subscriber could choose from some 400 albums each month. The central computer would send a signal to the

decoder box, which would receive and decode the signal and even activate the subscriber's tape deck.

HMS intended to use first-generation digital copies of master tapes, so if the subscriber owned a tape deck capable of doing justice to the quality of the transmission—the specs for the system cited a maximum dynamic range of 96 dB—he would end up with a more faithful recording than that offered on LP. Moreover, HMS was to charge from \$2 to \$3 less than the cost of an album for each

THE SATELLITE CONNECTION

Several radio networks are distributing their programs to local stations using satellite-relayed digital transmissions. Originating in New York, a program is converted to digital and relayed via a fiber-optic cable to a rooftop digital microwave transmitter (1). The signal is received by RCA Americom in New Jersey (2), where it is multiplexed with other network feeds and relayed to a transponder on the Satcom I-R satellite (3). The satellite's geosynchronous orbit permits local stations (4) throughout the country to receive the network feeds, provided they have the proper dish antenna.

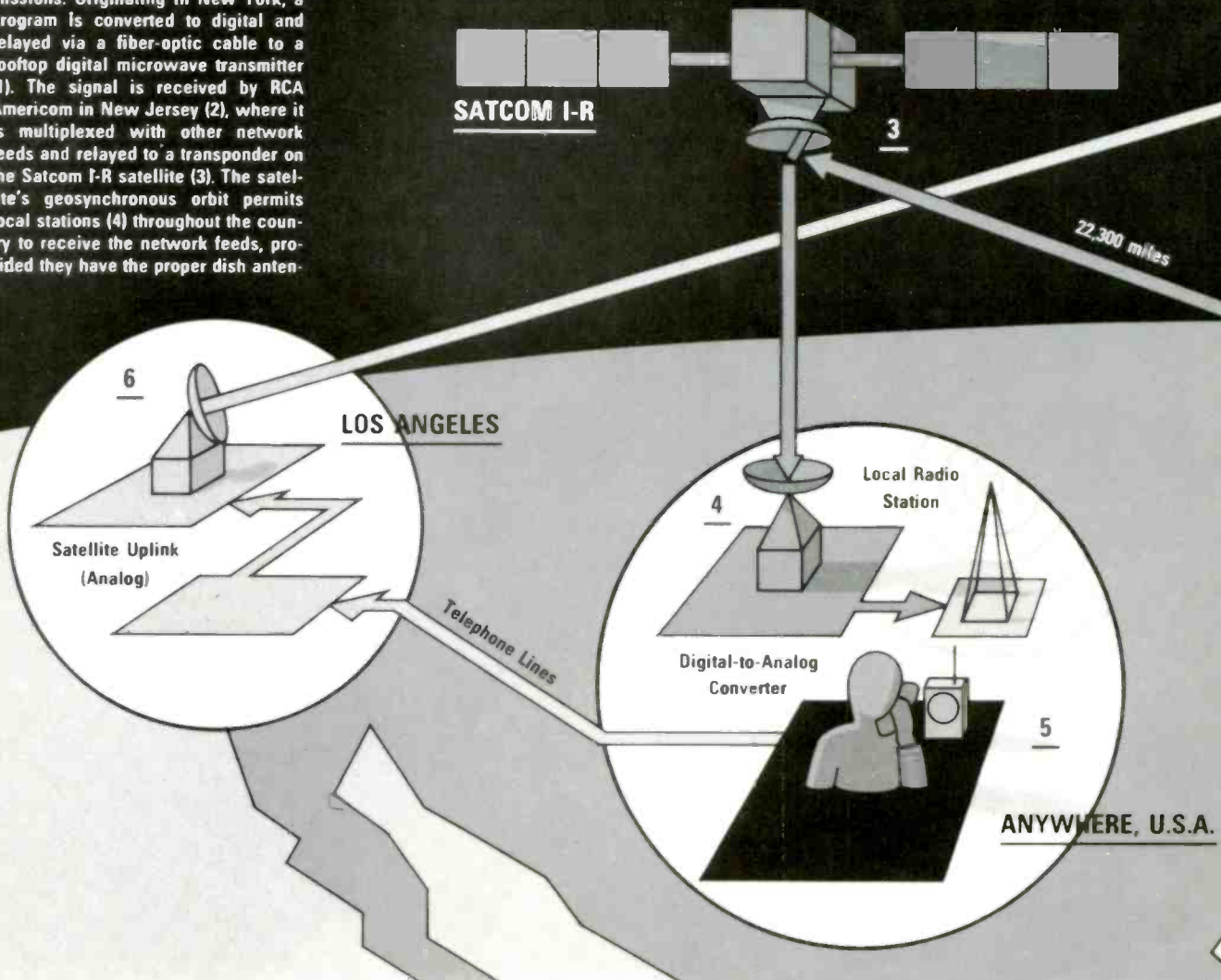

transmission. And there lay the rub. Retailers, understandably, howled their complaints to the record labels that had expressed interest in Von Mesiter's scheme, and HMS slowly faded into oblivion. Von Meister still argues that store owners would have profited from the sale of blank cassettes, but that's hardly compensation enough for the retailer, whose major stock-in-trade was being threatened.

If FM and—at least for the time being—cable are ruled out as digital-audio media, what's left? The answer

may very well lie in the heavens—by way of satellites. In fact, satellite-relayed digital audio transmissions from the major radio networks are probably already reaching your home, albeit in an analog form. ABC Radio, for instance, began digitally transmitting six of its network feeds to some of its local affiliates in 1983 and promises that just about all 2,000 of them will be equipped to receive digital transmissions by the end of the year. CBS, NBC, and RKO are also going digital, and all have agreed on one

encode-decode and satellite transmission system: RCA Americom's Audio Digital Distribution Service (ADDS).

There are many impetuses for this very expensive undertaking. One is quality. For many years, radio network programs have been distributed via telephone land lines, which are notoriously low-fi (the bandwidth is less than 5 kHz) and noisy—especially when the signal must be diverted to microwave relays for part of its journey. Digital transmission cures the

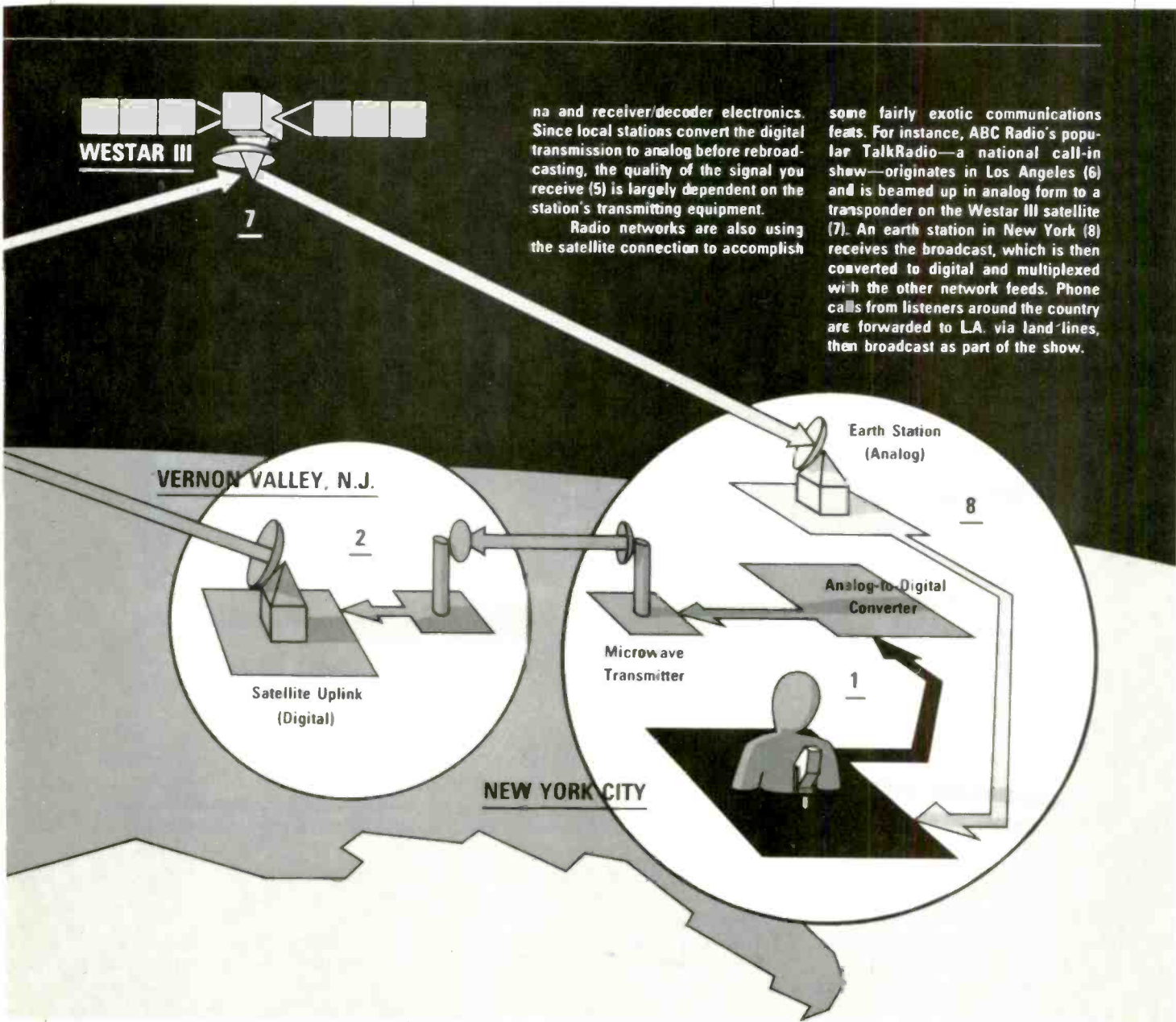

na and receiver/decoder electronics. Since local stations convert the digital transmission to analog before rebroadcasting, the quality of the signal you receive (5) is largely dependent on the station's transmitting equipment.

Radio networks are also using the satellite connection to accomplish

some fairly exotic communications feats. For instance, ABC Radio's popular TalkRadio—a national call-in show—originates in Los Angeles (6) and is beamed up in analog form to a transponder on the Westar III satellite (7). An earth station in New York (8) receives the broadcast, which is then converted to digital and multiplexed with the other network feeds. Phone calls from listeners around the country are forwarded to L.A. via land lines, then broadcast as part of the show.

quality problem right off: The ADDS system's specified frequency response is 20 Hz to 15 kHz, ± 0.1 dB, and its companded digital encoding is said to be capable of handling a dynamic range in excess of 80 dB.

The other major problem with land-line transmission is that just one program at a time can be fed to a local station. For a network that offers several different program options, that means that different feeds must be staggered; the local station, therefore, is forced to either schedule its broadcasts around the network or rebroadcast from taped material. The situation for a local station gets even more complex when it chooses to subscribe to several networks, each of which is carried on a separate telephone line. Digital transmissions, however, can carry several programs at once: ABC says it will broadcast 19 feeds simultaneously, while CBS, NBC, and RKO will each program six channels. The affiliate will be able to choose between them with a flick of a switch on his satellite receiver.

AND THANKS to the Satcom I-R satellite, placed in a geosynchronous orbit around the earth by the Challenger space shuttle in 1983, reaching local affiliates is no problem. Beamed up to one of the satellite's transponders from an uplink station in New Jersey, the multiplexed network programs are amplified and rebroadcast in a footprint that reaches all of the nation's radio stations. Receiving the broadcasts is simple: Scientific-Atlanta, a company specializing in digital communication systems, offers complete earth-station packages consisting of a 9½-foot-diameter dish antenna, a low-noise amplifier, receiver electronics, and a digital processing unit. The \$10,000 to \$15,000 radio stations have to part with to buy these downlinks was an initial stumbling block to the implementation of the system, but late reports indicate that most stations have seen the light.

Will digital networking make an audible difference in your radio reception? In terms of what programming will be available, the answer is yes. Because of the poor quality of land-line transmission, some networks gradually shifted their emphasis from music to talk shows. But, with the satellite-relay system now

available, many network executives are promising more high-quality music programming. It may well be that access to high-quality audio feeds will also spur radio stations to upgrade their broadcasting equipment. If that happens, the basic quality of your radio reception should improve as well.

Can you tap into the network feeds yourself, bypassing your local radio station? Perhaps, but it's an ambitious undertaking. If you already own a backyard dish antenna for receiving satellite-relayed analog video broadcasts, you are only half way

dish, DBS subscribers need purchase only a smaller 3½-foot rooftop antenna because of special high-power satellite transponders that demand less gain at the receiving end.

Seven companies have received licenses from the Federal Communications Commission for the DBS system, and all are planning to start out with video broadcasts aimed at homes that are not currently reached by cable television systems. When questioned about the likelihood of digital audio on DBS, representatives of United Satellite Communications

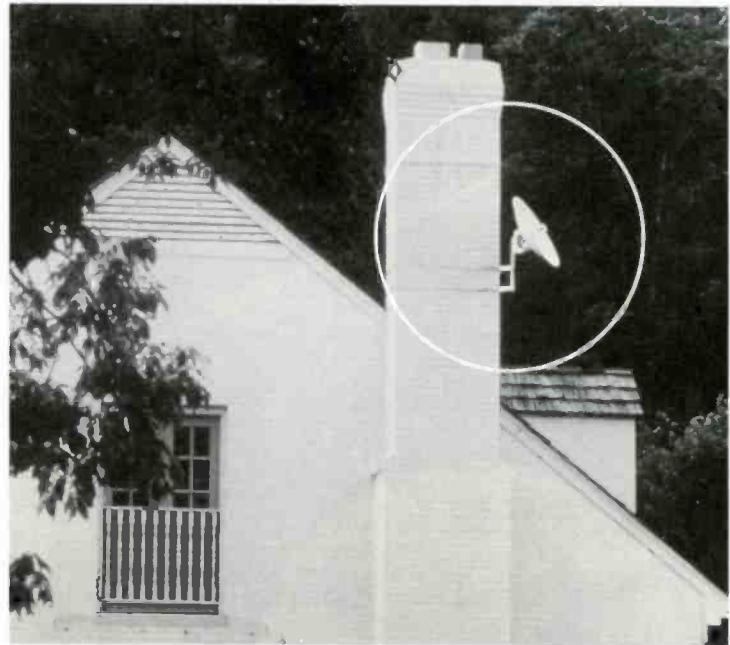

IN THE NEAR FUTURE it will be possible to receive satellite-relayed broadcasts at home with a small, rooftop-mounted dish antenna.

there. The Scientific-Atlanta receiver and decoder electronics necessary to tune in the digital transmissions are incredibly complex, and it will probably be some time before some enterprising manufacturer offers affordable home versions.

A much more likely option for receiving digital transmissions at home is scheduled to begin operation next year. Its name is self-descriptive: direct-broadcast (from) satellite, or DBS. The transmission scheme of DBS is identical to that used by the radio networks, but instead of a 9½-foot

and Satellite Television Corp.—the two companies that plan to implement the system first—noted that it is certainly feasible to broadcast digitally on DBS, but that primary channel allocations will be for video.

Considering the pace of change in broadcasting today, it's entirely possible that the limitations we commonly associate with radio may soon disappear. As the Compact Disc points the way to a new era of home-music playback, digital networking and DBS promise a profound change in music delivery systems. **V&S**

KEY FACTS

about

HOME VIDEO

BY

MICHAEL RIGGS

ANSWERS TO 12 COMMONLY ASKED QUESTIONS ON HOME VIDEO COMPONENTS AND TECHNOLOGY

Q. How are component TV systems better than traditional all-in-one TV sets?

A. THE ADVANTAGES ARE basically the same as those of component audio systems over consoles and compacts: performance and flexibility. Component television systems typically provide higher resolution (greater sharpness and detail), lower geometric distortion, and more accurate color than do standard TV sets. They also permit the use of a separate high fidelity amplifier and speakers for much improved sound quality. In addition, component TV tuners usually include switching facilities and direct audio and video inputs and outputs for two or three additional sources, such as VCRs and videodisc players. Besides simplifying the setup and operation of an audio-video system, this also contributes to picture and sound quality by substituting straight audio and video connections for the RF (radio-

frequency) links that otherwise would be necessary.

But why, you may ask, can't this be done in an integrated unit? The fact is that it can, as witness the many "monitor/receivers" now on the market. These combine a high-resolution video monitor and a high-performance TV tuner on a single chassis with multiple inputs and outputs for attaching ancillary equipment, such as VCRs. All you surrender in buying such a unit is the last measure of flexibility. With separates, you can select the best tuner and monitor for your needs, even if they're not the same brand (just like with audio components). And if tuner technology advances (for example), you can upgrade without having to replace your monitor, as well.

Q. What's the difference between VHS Stereo and VHS Hi-Fi?

A. SOUND QUALITY. VHS Stereo just splits in two the standard audio edge

track, recording one channel on each with Dolby B to keep the noise from getting any worse than it already is on a mono edge track. Distortion is still relatively high, and both bass and treble response are fairly poor. VHS Hi-Fi does away with all these problems, providing full-range, low-noise, low-distortion stereo recording and playback. This is achieved by frequency-modulating the audio information onto the tape along with the video. For complete details, see "How VHS Hi-Fi Works" on page 51.

Q. Are video recordings you make yourself better than commercially duplicated tapes?

A. THEY CAN BE. For example, a recording made on good tape directly from a good video camera at your VCR's highest speed (SP in VHS, Beta II in Beta) should be better than anything you can buy—at least in picture quality. And you have a good shot at exceeding store-bought quality

when you record from a good, clear broadcast or a laserdisc, again provided that you use good cassettes and the highest available tape speed. Otherwise, it can go either way, depending on the quality of your source material and the recording speed you use, not to mention the prerecorded tapes that you use for comparison. The latter can make a dramatic difference: It's not too hard to make a tape that's better than a shoddily duplicated or bootleg cassette.

Q. Is it true that cable subscribers will not be able to receive stereo TV transmissions?

A. REGRETTABLY, YES. At least for the time being. But most systems probably will be modified eventually to accommodate the new standard.

Q. If a manufacturer includes automatic color and tint circuits on a TV set, why does it bother to include manual overrides? Can you get better color by making the adjustments yourself?

A. OFTEN YOU CAN. Remember, somebody at the factory had to calibrate the automatic controls, and the circuits themselves may be less than perfect. To find out, follow this procedure:

Turn off any automatic color controls and remove all color from the picture by turning the set's color (chroma) control counterclockwise until you get a black-and-white image. Then turn the brightness control up fairly high and rotate the contrast control counterclockwise until the picture disappears from the screen. Now, slowly turn the contrast control clockwise again until you get an image containing clean whites, solid blacks, and a gradation of middle gray tones in between. You'll probably have to tweak the control back and forth a bit before achieving the best scale.

Once the contrast is set, adjust the brightness control in accordance with the room lighting. The correct setting is simply the one that yields the most pleasing black-and-white picture. Now you're ready for color. Slowly advance the color control clockwise until all elements in the television picture have a natural appearance. Too high a setting will cause oversaturation: The colors will seem to jump off the

screen.

Whereas the color control adjusts intensity (saturation), the tint (hue) control varies the color balance. Set the tint control for natural flesh tones. Misadjustment makes people look green and sickly or gives them a purple cast. Now that you've adjusted all the controls, flip the automatic circuits on and off to compare their settings with yours. There's a good chance you'll prefer your own.

Q. How often should I clean the heads on my VCR?

A. WHENEVER YOU START to notice an increase in video noise (snow) on taped programs. You may find that the need never arises.

Q. Why can I make digital recordings (via an adapter) on my VCR but not on my audio cassette recorder?

A. DIGITAL RECORDING requires a bandwidth of approximately 1.5 MHz—almost a hundred times greater than a standard audio cassette recorder is capable of handling. VCRs, on the other hand, hang in to about 2 MHz and are thus well suited to the purpose.

Q. A friend told me that my VCR won't work in Europe. If that's true, what's the point of portable VCRs?

A. THE REASON YOUR VCR won't work in Europe is that the TV broadcasting methods used there (PAL and SECAM) are incompatible with the NTSC system used in North America and Japan. You would need a VCR designed for one or both of those systems or that can be switched to accept any of the three. Such units are available, but they are rather expensive. The main reason for owning a portable is to make recordings in the field with your own video camera.

Q. Why is cable reception so much better than what you get using an antenna?

A. ACTUALLY, DIRECT RECEPTION OF broadcasts is better (sometimes by a wide margin) than cable reception provided you can get a clear signal. But except in suburbs, where signals are still strong and there typically are few tall buildings or hills to cause

multipath interference (ghosts), this often is difficult to achieve. Even in a good location, you usually will need a properly aimed, directional outdoor antenna. In fringe reception areas, hilly or mountainous terrain, or cities with tall buildings, cable may be the only way to get a decent signal, and in that case, it definitely will be better, delivering adequate signal strength and (if the system is properly set up) no ghost-producing signal reflections.

Q. What exactly does "cable ready" mean in reference to a TV set or VCR?

A. IT MEANS THAT YOU can tune it to cable channels that are outside the VHF and UHF broadcast bands—the so-called midband, superband, and hyperband channels. Not all cable-ready models work with all cable systems, however, and none will descramble scrambled pay transmissions. Also, some will receive more channels than others, though this seldom constitutes a real advantage over seemingly less capable units.

Q. What sort of signal switcher should I buy if I want to add a couple of VCRs and a video stabilizer to my video system, which presently consists of just an old TV set?

A. YOU'LL NEED A UNIT that switches direct audio and video inputs and that has a built-in RF modulator for feeding your television set's antenna terminals.

Q. I've read about video laserdisc players, but what's the point of getting one when it can't record? Doesn't it make more sense to get a VCR?

A. THERE ARE TWO REASONS for wanting a laserdisc player in addition to a VCR (or even instead of one, if you're not interested in timeshifting). One is picture quality. The stability and resolution of a laserdisc image are superior to anything you can get from a videocassette recorder. The other is access time. It is possible to move from place to place on a disc much faster than on a tape. And some discs are recorded so that you can go directly to any frame you choose or even play games. **V&S**

VIDEO

HIFI FOR YOUR EYES!

BY

WILLIAM MOWRER



COMPARING THE READABILITY of the NTSC (top) and HDTV images gives you an idea of the extraordinary resolution capabilities of the new broadcast technology.

OFFERING ULTRASHARP IMAGES WITH THE IMPACT OF FILM, HIGH-DEFINITION TV MAY REVOLUTIONIZE HOME VIDEO.

WHEN COMMERCIAL broadcast television in the U.S. celebrates its 50th birthday in 1989, it's not likely that the current NTSC system will be the sole honoree at the party. A newcomer with resolution and color fidelity rivaling those of 35mm film should steal a good share of the limelight. Named after the improvement it offers, high-definition television (HDTV) is the logical and, say broadcast engineers and receiver manufacturers, inevitable successor to a color TV system whose inadequacies we've so long accepted.

Work on an HDTV system began almost ten years ago in Japan. NHK,

the government-owned TV network, developed a system that displays a picture with 1,125 scanning lines, in contrast to the modest 525 lines of our NTSC system and the 625 lines of Europe's PAL and SECAM techniques. The Japanese network also found that viewers prefer a wider screen than the one offered by the 4:3 aspect ratio of standard television. Its solution is an image width-to-height ratio of 5:3, close to that of movie screens.

But alas, such improvements come at a very dear cost: increased video bandwidth. NTSC system broadcasts occupy channels that are 6 MHz wide, with 4.2 MHz for the video and the

Since AD 70

Generations

Best Idea for Math Book Is Multiplying

By PAMELA MORSE

School Algebra Textbooks, 1980-1982, seem to be the country's leading edge in high school math. In a recent Air Force survey and follow-up study, the Air Force's Office of Education Research, located at Wright-Patterson Air Force Base in Dayton, Ohio, found that the best idea for a new algebra textbook is to multiply the number of problems in each chapter by 10. The study, which is the first of a series of reports on the state of high school math education, was conducted by the Air Force's Office of Education Research, located at Wright-Patterson Air Force Base in Dayton, Ohio. The study, which is the first of a series of reports on the state of high school math education, was conducted by the Air Force's Office of Education Research, located at Wright-Patterson Air Force Base in Dayton, Ohio.

Family in Village Since AD 70

Matris, 80 Generations

FBI Given Key Role in Fight on Illegal Drugs

By PAMELA MORSE

Priority & Control Co. one of the nation's largest consumer products manufacturers, said Thursday that it has signed a contract with the FBI to help fight illegal drugs. The contract, which is the first of a series of reports on the state of high school math education, was conducted by the Air Force's Office of Education Research, located at Wright-Patterson Air Force Base in Dayton, Ohio.

FBI Given Key Role in Fight on Illegal Drugs

By PAMELA MORSE

Priority & Control Co. one of the nation's largest consumer products manufacturers, said Thursday that it has signed a contract with the FBI to help fight illegal drugs. The contract, which is the first of a series of reports on the state of high school math education, was conducted by the Air Force's Office of Education Research, located at Wright-Patterson Air Force Base in Dayton, Ohio.

Decision on Excise Taxes

By WILLIAM J. RAY

WASHINGTON—Appropriations Committee Chairman Dan Rostenkowski said Thursday that the House will vote on whether to cut excise taxes on alcohol and tobacco. The vote is expected to take place in the next few days. The House is expected to vote on whether to cut excise taxes on alcohol and tobacco. The vote is expected to take place in the next few days.

Mailer Protege Guilt-Stricken

By NICHOLAS...

NEW YORK—Jack Henry Adams, the president of the American Restaurant Association, said Thursday that he is "guilt-stricken" over the death of a man who was his protégé. Adams said that he had a close relationship with the man and that he was responsible for his death. Adams said that he was "guilt-stricken" over the death of a man who was his protégé.

Risky, Disputed Rescue Project

By NICHOLAS...

WASHINGTON—The House of Representatives is expected to vote on whether to fund a risky and disputed rescue project. The project, which is the first of a series of reports on the state of high school math education, was conducted by the Air Force's Office of Education Research, located at Wright-Patterson Air Force Base in Dayton, Ohio.

Mailer Protege Guilt-Stricken

By NICHOLAS...

NEW YORK—Jack Henry Adams, the president of the American Restaurant Association, said Thursday that he is "guilt-stricken" over the death of a man who was his protégé. Adams said that he had a close relationship with the man and that he was responsible for his death. Adams said that he was "guilt-stricken" over the death of a man who was his protégé.

Risky, Disputed Rescue Project

By NICHOLAS...

WASHINGTON—The House of Representatives is expected to vote on whether to fund a risky and disputed rescue project. The project, which is the first of a series of reports on the state of high school math education, was conducted by the Air Force's Office of Education Research, located at Wright-Patterson Air Force Base in Dayton, Ohio.

rest for audio and guard bands. NHK's high-definition television will need a bandwidth of 20 MHz just for the luminance information, and perhaps as much as 10 MHz more if the color (chroma) information is kept separate. (Chroma signals could be assigned a subcarrier frequency and combined with the luminance, as is currently done to squeeze a broadcast into the very limited bandwidth capabilities of a videocassette recorder. But such folding-in could cause annoying color interference.) CBS, which already has applied for an HDTV cable franchise in Alameda, California, will be forced to use two cable channels to transmit just one broadcast.

Actually, CBS's involvement in HDTV is symptomatic of another problem facing the new technology—corporate and international competition over standards. At first, Japanese equipment makers dreamed of a universal HDTV standard. This would solve the incompatibility problems stemming from the world's current use of three television systems. But that dream may never become reality. CBS, an early backer of NHK's 1,125-line "standard," has recently deserted in favor of 1,050 lines—which just happens to be twice the number required to make up an NTSC picture. Thus, the CBS technique would allow any existing 525-line receiver to show 1,050-line images simply by ignoring every other line in the transmission. Conversely, a 1,050-line receiver would have no trouble reproducing a low-fi NTSC signal.

However, the Europeans aren't happy with either 1,125 or 1,050 lines. The British have proposed an interim 925-line system they call Multiplexed Analog Components (MAC), but the French and Germans have turned thumbs down on it. Sony and Panasonic are still betting that the Continent will embrace the Japanese NHK approach, but they readily concede that there would be grave compatibility problems with current receivers.

If you think compatibility isn't much of a problem, consider these numbers: There are approximately 500 million television sets in use around the world, not to mention some 21 million videocassette recorders. Engineers might be willing to write these units off in quest of the perfect video system, but politicians can't afford to.

Hence the strong likelihood that whatever system ultimately triumphs in Europe, the Soviet Union, and the Middle East will have to be compatible with the PAL and SECAM techniques.

Even in the U.S., there are two de facto HDTV standards. The so-called production standard, intended for professional users such as movie studios, remains at 1,125 lines because its resolution is even greater than that of 35mm film. For these users, high-definition television offers some obvious advantages over film, including economy, easy editing, and the fact that the director can see what has been shot without waiting for the lab to return processed film. Before his Zoetrope Studios hit the boards, Francis Ford Coppola used production-standard HDTV equipment for some of his projects, and 20th Century Fox is now using the system to tape its TV series *The Fall Guy*.

The other U.S. technique is the 1,050-line broadcast standard, which will be used for HDTV transmissions. Compared to the production standard,

it represents a slight compromise in vertical resolution (though horizontal resolution is improved, provided that the bandwidth remains the same). But most people who have seen the broadcast standard agree that its pictures are a giant improvement over NTSC images. Aside from its entertainment value, HDTV combined with videotext and teletext services would enable viewers to examine a video image of, say, a full page from a telephone book. And with closed-circuit distribution systems, first-run feature films could be delivered to movie theaters for projection on giant high-definition video screens, bypassing the costly and inefficient motor-freight round-robin system now used to ferry movie prints from one theater to another.

Though the wider aspect ratio of HDTV will make home video viewing more like a movie theater experience, broadcasters and receiver manufacturers are curiously silent about the compatibility problems this brings. Though CBS offers the explanations I

DIGITAL BAND-AIDS FOR STANDARD TV

THOUGH MANY INDUSTRY observers are wagering that high-definition TV technology will ultimately replace the NTSC standard, receiver manufacturers are not content to wait for that day and are readying a new generation of 525-line sets with performance rivaling that of HDTV. The key is digital signal processing performed by a handful of VLSIs (very large-scale integrated circuits) developed by ITT.

The company says its Digivision chips will be able to enhance picture detail and eliminate ghosts and graininess; with the addition of full-field video memory chips, they also will reduce video noise (snow) and perform a variety of special effects, such as freeze frame, split screen, and zoom. Sony, Sanyo, GE, and Zenith will be among the first to offer "digital" TV sets next year. And though Digivision-equipped models will be more expensive at first than current top units, the VLSIs replace upwards of 300 components in a conventional set and the savings in parts should eventually lead to dramatic price cuts.

In sets equipped with the

Digivision chips, the incoming RF signal is tuned by conventional means, after which its audio, video, and control components are individually converted to digital form. Once in the digital domain, the signal is corrected for color inaccuracies and picture jitter with mathematical precision. Other processors then perform like digital comb filters, separating the color and detail information with far greater accuracy than is possible with analog filters. An optional circuit could also be included to interpolate an additional scanning line between each pair of the standard 525 lines, making a pseudo-high-definition image with 1,050 lines. Ultimately, the digital signals are reconverted to analog form for viewing.

Digivision-equipped receivers can also handle all three broadcast systems (NTSC, PAL, and SECAM), which gives them universal reception capability. And when digital DBS (direct broadcast from satellite) transmissions begin, Digivision receivers should be able to decode the signals without the addition of outboard circuitry.

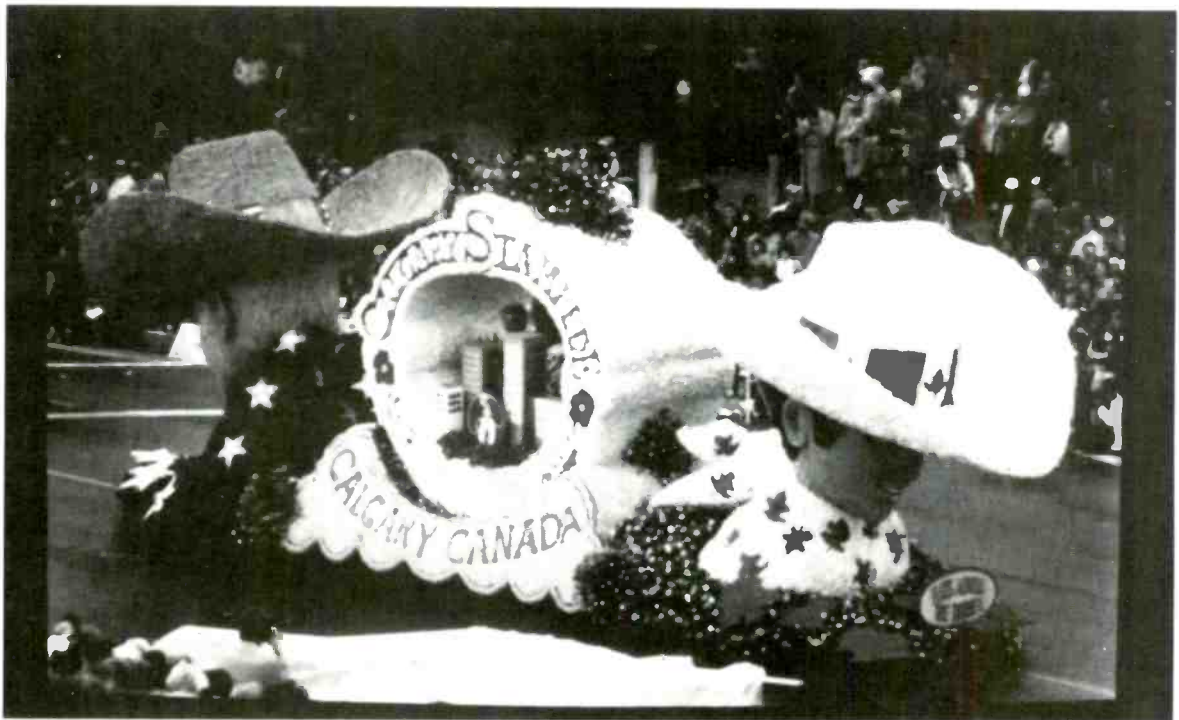
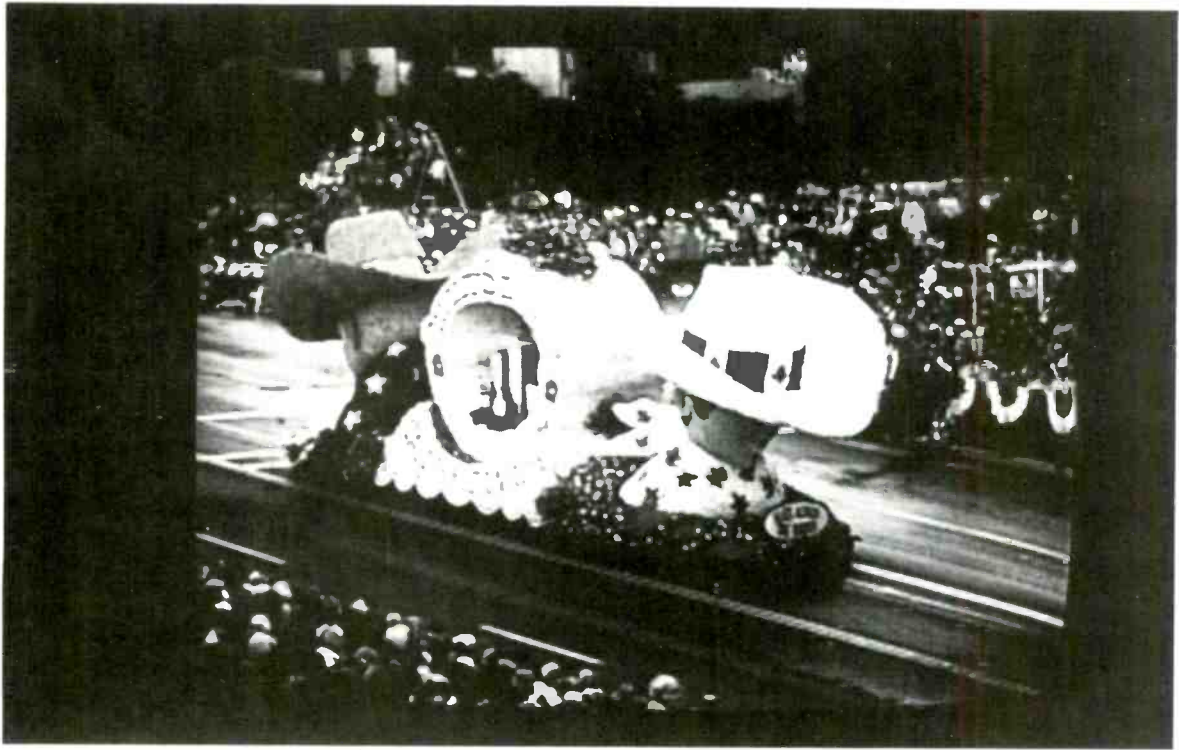

THE EYES HAVE IT: In this scene from a Tournament of Roses parade, the differences between standard 525-line NTSC video (top) and NHK's 1,125-line high-definition system are immediately apparent. (The original offscreen photos were color-corrected by us to black and white for publication.) The increased width of the HDTV image is appealing in itself, but take a close look at the details in both pictures. In the HDTV image the lettering in the center of the float is clearly readable, and the individual flowers and shapes have increased texture and definition. Note, too, the absence of visible scanning lines in the HDTV picture.

COURTESY CBS

outlined earlier about 525-line and 1,050-line systems, it has no satisfactory solution to the problem of cramming a picture that's 25 percent too wide onto a standard screen.

transmissions. The CBS satellite will broadcast three HDTV channels, each of which will demand the simultaneous use of two transponders. One channel will carry traditional network fare,

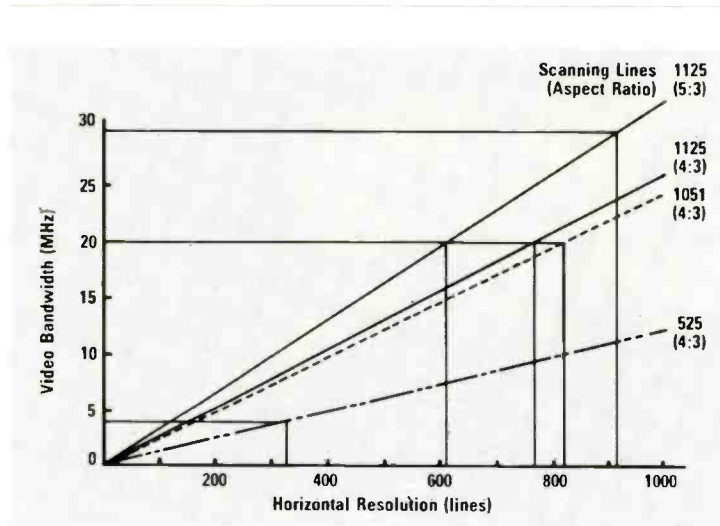

THE 525-LINE NTSC SYSTEM yields a horizontal resolution of 330 lines at 4.2 MHz, while NHK's 1,125-line HDTV system gives you more than 900 lines of resolution at 30 MHz and more than 600 lines at 20 MHz. Decreasing the aspect ratio or the number of scanning lines maintains horizontal resolution with less bandwidth.

Stripes could be added to the top and bottom of the picture, thereby reducing its effective height, but anyone who has seen a bootleg video copy of a first-run film knows how awful that looks. The other solution—chopping off the action on either side of a scene—is equally unappealing. Unless the cropping is performed by a skilled technician using computerized equipment, the televised film could end up showing actors at the sides of the screen conversing with invisible partners. What could happen, of course, is that the aspect ratio could be reduced to the NTSC 4:3 standard.

Although HDTV doesn't require satellite transmission, the first signals probably will reach your home in this manner because it's unlikely that the FCC will open up additional channel space in the TV broadcast band. (Cable transmission is possible if your local company dedicates two or more channels to an HDTV broadcast). CBS, in fact, is augmenting its Alameda cable project with a plan to launch a DBS (direct broadcast from satellite) bird in 1985 dedicated solely to HDTV

including advertising. The other two will provide, in the words of CBS's petition to the FCC, "innovative entertainment and educational, cultural, and informational high-definition services to institutional, business, and residential users on a subscriber basis." If some of that sounds like a description of CBS's ill-fated venture into cable TV programming, it's just a coincidence, at least according to CBS representatives.

Just as DBS is not essential to the development of high-definition television, so HDTV is not vital to the development of three-dimensional video. Nonetheless, the two have been linked in various demonstrations. Typical of these is Matsushita's "time-sharing" system, in which signals from two color cameras are combined in a synchronized multiplexer and then recorded on videocassette. During playback, the combined image appears on the screen, along with a synchronizing signal that opens and closes the left and right lenses of a pair of special eyeglasses. If the synchronization is correct, the viewer

sees 3-D video with minimum flicker. A viewer not wearing the glasses sees a normal-looking picture composed of the sum of the two images—mono video, if you will.

Dismissing the added appeal of the 3-D video/HDTV combination (no one really believes depth-video will catch on as long as eyeglasses are necessary), what are the prospects for HDTV itself? British market researcher Tim Johnson recently authored a report ("Strategies for Higher-Definition Television," published by Ovum, Ltd.) in which he contends that HDTV will be firmly in place worldwide by the year 2000. Meanwhile, he says, there will be incremental improvements in the existing NTSC, PAL, and SECAM systems and receivers, paving the way for true HDTV. (See "Digital Band-Aids.") Johnson stresses that the trick is to make it possible for viewers to move smoothly from present systems to the new one without requiring everyone to invest in new equipment all at once.

Johnson and CBS agree that satellite transmission is the key to HDTV. When affluent viewers step up to small-dish satellite reception, they may also be willing to invest in HDTV tuners and monitors. Since DBS should be commonplace in North America, Europe, and Japan by the end of the decade, the transition to HDTV should be a fairly easy one. Johnson even goes so far as to opine that the DBS/HDTV combination ultimately might bring about the demise of cable television. Many cable subscribers are vociferous about the poor quality of the picture they receive. Given the immediately evident superiority of the DBS/HDTV picture, he explains, quality-conscious subscribers might desert cable in droves.

Concerning the battle over HDTV standards, Johnson estimates that it should not delay the shift to high-definition television by more than five years or so. However, like anything else in our increasingly high-technology world, his conclusions may be far off the mark. The growing acceptance of component television and the move from film-based photography to video imaging for home movies might raise the general appetite for high-quality video faster than expected. If that does occur in time for the 50th anniversary of commercial television, the birthday cake on the screen really will look good enough to eat. **v&s**

NINA WALLACE

HOW BETA HI-FI WORKS

BY

PETER MITCHELL

AN IN-DEPTH LOOK AT THE ANALOG AUDIO RECORDING
TECHNIQUE THAT GIVES DIGITAL SOUND A RUN FOR ITS MONEY

AMID EXPECTATIONS of an all-digital future for audio, the appearance of Beta Hi-Fi came as something of a bombshell. A videocassette recorder with an *analog* audio recording system capable of stereo reproduction with almost perfectly flat frequency response and a dynamic range of 80 dB is competition indeed for the far more expensive PCM processor-VCR combination.

The problems of conventional analog audio recording in a VCR are plain enough. Because of the tape's slow travel past the fixed audio head, bandwidth is severely limited. Noise and distortion are also compromised in a system optimized for video reproduction.

Though Beta Hi-Fi is an analog recording technique, it shares little with conventional high fidelity taping systems. These mix the audio signal with an ultrasonic bias signal and



record *directly* onto the tape, so any imperfections in the tape or the recorder are translated into flaws in the reproduced sound. Small variations in tape speed are heard as wow and flutter; the nonuniformities of the

THE NTSC BROADCAST SPECTRUM

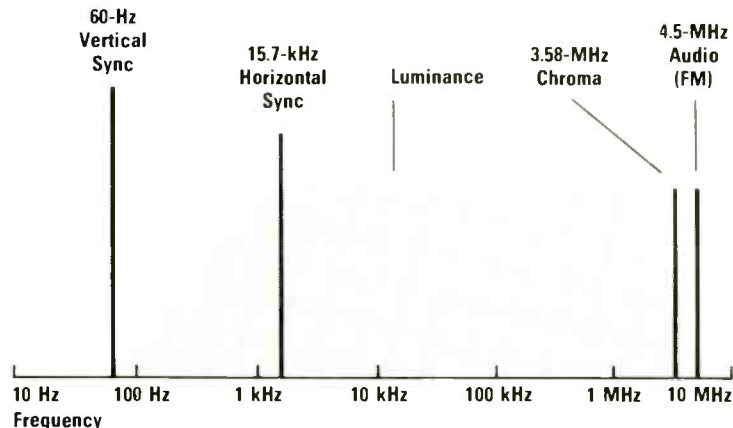

FIG. 1. THIS GRAPH uses a logarithmic scale to show the 75,000-to-one range of frequencies—from 60 Hz to 4.5 MHz—that make up an NTSC broadcast channel. Though a VCR can record a very wide bandwidth, the NTSC signal must still be squeezed down or reformatted for recording (Fig. 2).

tape's oxide coating produce hiss; and a small change in the bias level or in the tape formulation causes a rise or fall in the high-frequency response, making the sound duller or brighter. These problems have posed a continual challenge to recordists.

Beta Hi-Fi avoids them by taking an *indirect* route to recording: What goes onto the tape is not the audio signal itself, but an elaborately processed version of it. This radically alters the relationship between physical flaws in the recording process and the quality of the sound: The processing removes the audio signal from the vagaries of the physical world, so to speak, and transposes it to the electronic realm, where performance parameters can be better controlled.

The means by which this is achieved is frequency modulation, or FM: The audio signal causes a carrier frequency to shift up and down at a rate equal to the audio signal's frequency and by an amount that depends on the signal's level. Thus, if the signal is a 400-Hz tone, the frequency of the FM carrier will shift up and down 400 times per second. The amount of the carrier's frequency shift—its "deviation"—is directly

proportional to the level of the audio signal, with louder sounds causing greater deviations than softer ones.

Beta Hi-Fi's FM carriers are at radio frequencies (near the top of the AM broadcast band, in fact). They are mixed with the video signal in the VCR, fed to the spinning video heads, and recorded on tape as part of the video. In playback, the FM signals are extracted from the composite video signal and are demodulated by the same sort of circuitry that is used in an FM tuner, giving you back a virtually exact replica of the original stereo sound that was fed into the recorder.

Incidentally, although Beta Hi-Fi is a stereo FM recording system, it does not employ the multiplex method used for stereo broadcasts. The two channels of audio are recorded as separate mono FM signals, which avoids the noise and the distortion problems that arise in multiplex stereo. And since there's no multiplex subcarrier, there's no need for a 15-kHz bandwidth limit, so the frequency response in Beta Hi-Fi can extend all the way to 20 kHz. The channel separation is greater than 60 dB, which not only yields rock-steady stereo imaging but also enables the system to record two unrelated mono soundtracks without interference—for example, English dialogue on one channel and Spanish on the other.

Using FM for recording instead of broadcast is not a new idea. In fact, scientists have long used FM taping for satellite telemetry and for recording the outputs of transducers and laboratory instruments. And both currently available consumer videodisc systems, CED and LaserVision, use FM recording for their stereo soundtracks.

The potential advantages of FM recording for audio have been well-known for many years. The obstacle to its implementation was the required bandwidth. FM carrier signals must be much higher than the highest audio frequency, and in Beta Hi-Fi they are between 1 and 2 MHz. It wouldn't make commercial sense to develop a recorder with a 2-MHz bandwidth simply for high fidelity use: It's unlikely that enough could be sold to recoup the expense. The breakthrough came with the mass-marketing of helical-scan video recorders, in which wide bandwidth is obtained by spinning the heads past the tape instead of

moving the tape past a fixed head.

For the serious music recordist, the greatest blessing of FM recording is its constancy: Frequency response is always flat, regardless of the tape you use, and there's no need for fussy bias settings or level matching. Signal level is stable, too, without the dropouts and the continual small instabilities that plague analog tapes. As for the pitch variations caused by wow and flutter, they are virtually nonexistent in the output signal.

Nevertheless, flutter is one reason why there has been little incentive to create an FM music recorder. Any wow and flutter in the system will cause random shifts in the carrier frequency during playback. These shifts are demodulated as unwanted audio signals—that is, noise. Therefore, the signal-to-noise (S/N) ratio of an FM recorder is typically limited to about 50–55 dB. You may recall that the first generation of LaserVision and CED videodisc players, which also employed FM recording for their audio, had S/N ratios of about 56 dB. The newer stereo players use CX noise reduction to add 14 dB of quieting, bringing the total S/N ratio up to around 70 dB.

The wow and flutter of an ordinary VCR's audio track is usually not very good. But to prevent visible picture jitter, there is a complex servo system tied into the video sync signal that better controls video-head flutter. (In fact, the tape movements caused by this system actually *cause* some of the audio flutter by jiggling the tape back and forth across the fixed audio head downstream.) Still, the "natural" S/N ratio of the FM playback in Beta Hi-Fi is limited to about 60 dB, which is improved to approximately 80 dB by a built-in noise-reduction circuit that compresses the signal's dynamic range in recording and expands it in playback. Unfortunately, specific information on this noise-reduction system is not available from Sony at press time.

To understand how the audio FM (AFM) carriers are integrated with the video signal for Beta Hi-Fi recording, we must first comprehend the restructuring of the TV signal for recording in a VCR. Standard NTSC-type TV broadcasts actually consist of several signals shoehorned into a 6-

MHz-wide TV channel (Fig. 1). There is a strong 60-Hz synchronization pulse that your TV set uses to lock the picture in sync with the broadcast, so that the picture won't roll. An amplitude-modulated (AM) luminance

REFORMATTING FOR STANDARD BETA

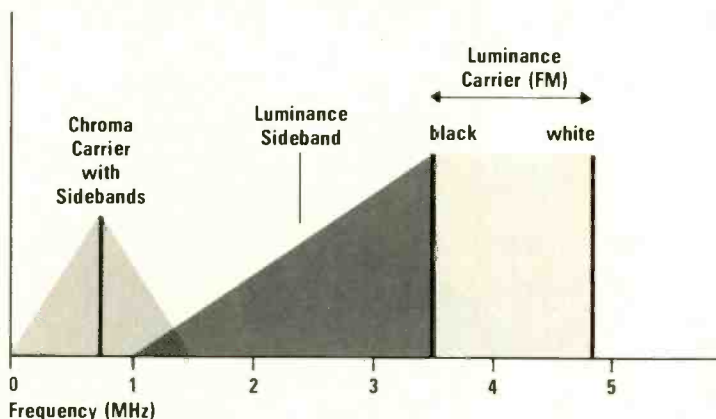

FIG. 2. DOWN-CONVERTING and reformatting are necessary to squeeze a video broadcast into the bandwidth limitations of a VCR. With the restructured signal, the video heads need handle a signal with just an eight-to-one frequency span.

signal contains all of the black-and-white picture-forming information, with its details, shapes, and variations in brightness. Luminance information is conveyed by signals varying from audio frequencies up to 4.2 MHz. There is a chroma subcarrier at 3.58 MHz that is phase-modulated with all of the color information in the picture. And there is an FM audio subcarrier at 4.5 MHz.

To record this signal directly onto tape, the recorder would need to have reasonably flat response from 60 Hz to 4.5 MHz, which is virtually impossible. It is difficult enough to obtain flat response over the 1,000-to-1 ratio of frequencies in an audio recorder (from 20 Hz to 20 kHz), let alone this 75,000-to-1 range. To make video recording practical, the TV signal is restructured as follows.

First, the 60-Hz sync signal is split off and recorded by a separate head on its own control track at one edge of the tape. The 4.5-MHz broadcast audio signal is demodulated to recover the original 30-Hz to 15-kHz audio waveform, which is then directly recorded by a separate head onto a narrow track at the opposite edge of the tape. Then the luminance signal is used to modulate an FM carrier in the

VCR, varying its frequency from 4.8 MHz for white picture highlights down to 3.5 MHz for the black band that separates successive video frames. The modulation process also produces "sidebands" related to the frequencies

REFORMATTING FOR BETA HI-FI

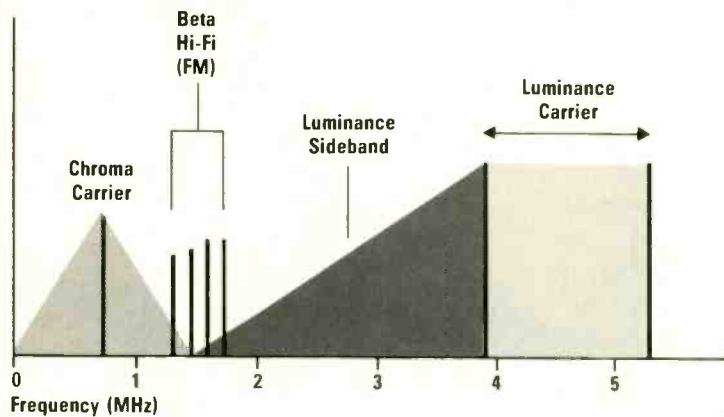

FIG. 3. BETA HI-FI's four FM carriers (two each for the left and right channels) are sandwiched between the chroma and luminance signals. To make room for them, the luminance carrier is shifted up in frequency by 400 kHz so that it ranges between 3.9 and 5.2 MHz.

in the luminance signal. The lower sideband information is included in the recording, so that the total recorded luminance signal spectrum extends from 4.8 MHz down to about 1 MHz. Finally, the 3.58-MHz color signal in the broadcast is "down-converted" to shift its frequency to 688 kHz, combined with the FM luminance signal, and fed to the spinning video heads for recording. The resulting VCR video spectrum is shown in Fig. 2.

Although this system is complicated, its advantages are clear. The independent control track ensures a stable, precisely synchronized picture (except when the sync track has been deliberately altered, as in commercially prerecorded tapes, to cause rolling in illegally duplicated copies of the tape). Color reproduction is quite stable. The video heads are required to handle only an eight-to-one frequency span, and their response doesn't even have to be flat over that range. Since the recorded luminance signal is FM, nonlinearities in the video head's output will merely cause amplitude modulation of the FM carrier, which has no effect as long as the FM detector has good AM rejection.

As you can see from Fig. 2, there is a region between 1 and 2 MHz, on the fringes of the chroma and luminance sidebands, where relatively little signal is recorded, and this is where Beta Hi-Fi's FM carriers are placed. To open up this gap and minimize the potential for mutual interference between the audio FM and the sidebands of the luminance signal, the system's designers moved the luminance carrier up by 400 kHz so that it ranges between 3.9 and 5.2 MHz. To further reduce interference, they took advantage of a characteristic of the luminance sidebands: The sideband energy is not uniform but is concentrated at multiples of the 15.7-kHz rate at which the horizontal lines in the TV picture are scanned. The AFM carriers are interleaved between these sideband frequencies.

One problem remained. VCRs record on diagonal tracks across the tape with no blank guard bands to prevent crosstalk between adjacent tracks. In fact, at slow speeds, the tracks actually overlap. For video recording, this interference is minimized by two factors. First, each 525-line TV picture consists of an interlaced pair of 262.5-line "fields," and in a VCR the alternating fields are recorded on adjacent tracks. Thus, crosstalk between tracks will affect only adjacent lines in the picture. And second, the alternating fields are recorded by separate heads located 180 degrees apart on the spinning drum, with their head gaps tilted at different angles to weaken the crosstalk.

In the case of Beta Hi-Fi's FM signal, the crosstalk problem is solved by using two alternating pairs of FM carrier frequencies for successive tracks. With video field "A," the audio signal is modulated onto FM carriers at 1.38 MHz (left channel) and 1.68 MHz (right channel). For the next track, (video field "B," recorded by the opposite head), the FM carriers are at 1.53 and 1.83 MHz. In playback, head A and head B alternately feed the demodulator, which is switched between the appropriate carrier frequencies.

Considering how complex Beta Hi-Fi really is, it seems miraculous that it works at all. But for the audiophile seeking PCM-like performance at an affordable price, the appearance of Beta Hi-Fi may be a godsend. **V&S**

VIDEO EQUIPMENT REPORT

SONY SL-2700 BETA HI-FI VCR

Sony SL-2700 Betamax videocassette recorder, with Beta Hi-Fi stereo audio and wireless remote control. Dimensions: 17 by 4¼ inches (front panel), 14 inches deep plus clearance for controls and connections. AC convenience outlets: one unswitched (400 watts max.). Price: \$1,500. Warranty: "limited," one year parts, 90 days labor. Manufacturer: Sony Corp., Japan; U.S. distributor: Sony Corp. of America, Consumer Products Div., Sony Dr., Park Ridge, N.J. 07656.

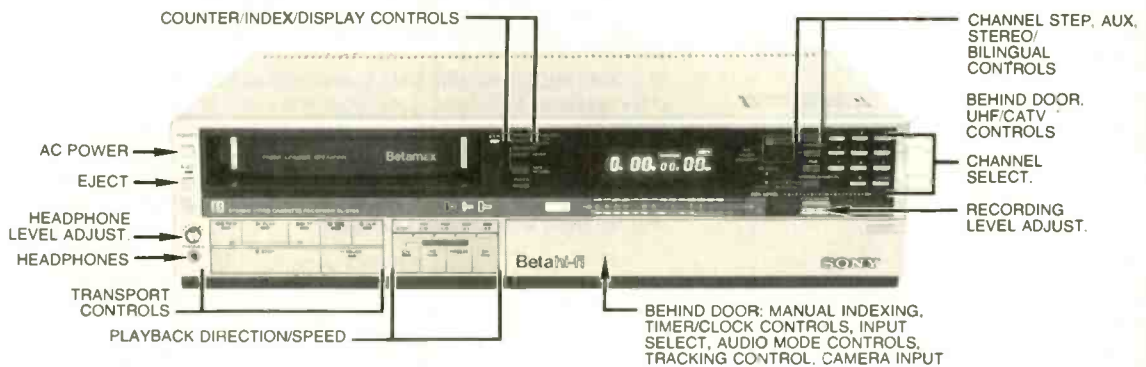

STEVEN MARK NEEDHAM

Except where otherwise indicated, all data are for both speeds (Beta II and III). All data were taken at the direct audio and video outputs.

VCR SECTION

AUDIO RECORD/PLAY RESPONSE, BETA HI-FI (stereo)

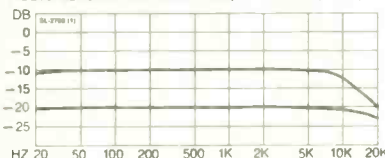

at -10 dB input*

— Beta II +0, -3 dB, <20 Hz to 11 kHz
 - - - - Beta III +0, -3 dB, <20 Hz to 11 kHz

at -20 dB input*

— Beta II +0, -3 dB, <20 Hz to 19.5 kHz
 - - - - Beta III +0, -3 dB, <20 Hz to 19.5 kHz

SONY'S SL-2700 VCR is the second of that company's Beta Hi-Fi recorders, and it has even more features than the SL-5200 that launched the era of high fidelity VCR sound. The front-loading home deck includes a 107-channel cable-ready tuner with random-access and scan modes, Betascan high-speed picture search, automatic and manual indexing, and a nifty feature called Swing Search

that provides virtually perfect freeze-frame, slow-motion, and double-speed operation. But the crowning glory is Beta Hi-Fi, which affords truly outstanding stereo recording and playback.

How Beta Hi-Fi works is explained elsewhere in this magazine. How well it works was determined by Diversified Science Laboratories' bench tests—and that's very well

Laboratory data for VIDEO & SOUND's video equipment reports are supplied by Diversified Science Laboratories. Preparation is supervised by Michael Riggs, Peter Dobbin, and Edward J. Foster. All reports should be construed as applying to the specific samples tested. VIDEO & SOUND and Diversified Science Laboratories assume no responsibility for product performance or quality.

AUDIO RECORD/PLAY RESPONSE, STANDARD (mono)

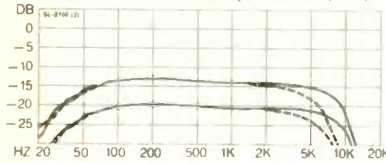

at -10 dB input*		
Beta II	+ 1/4, -3 dB, 50 Hz to 6.8 kHz	
Beta III	+ 1/4, -3 dB, 50 Hz to 3.8 kHz	
at -20 dB input*		
Beta II	+ 1/4, -3 dB, 50 Hz to 7.6 kHz	
Beta III	+ 1/4, -3 dB, 50 Hz to 4.3 kHz	

AUDIO S/N RATIO (re 0 dB output; R/P: A-weighted)*

	Beta II	Beta III
Beta Hi-Fi (stereo)	82 dB	81 1/4 dB
standard (mono)	42 3/4 dB	41 1/2 dB

INDICATOR CALIBRATION (315 Hz)

for 0 dB input (3% distortion)	> +5 dB
for -10 dB input	-2 dB

DISTORTION (THD at -10 dB, 50 Hz to 5 kHz)*

	Beta II	Beta III
Beta Hi-Fi (stereo)	≤ 0.41%	≤ 0.37%
standard (mono)	≤ 3.3%	≤ 3.3%

CHANNEL SEPARATION (Beta Hi-Fi)

	Beta II	Beta III
at 100 Hz	64 dB	63 dB
at 1 kHz	56 1/2 dB	55 dB
at 10 kHz	38 dB	38 dB

INDICATOR "BALLISTICS"

Response time	115 msec
Decay time	~750 msec
Overshoot	0 dB

FLUTTER (ANSI weighted peak, R/P)

	Beta II	Beta III
Beta Hi-Fi (stereo)	< 0.01%	< 0.01%
standard (mono)	~0.15% avg	~0.35% avg.

SENSITIVITY (for 0 dB output, 315 Hz; Beta Hi-Fi)*

line input	550 mV
mike input	1.7 mV

AUDIO OUTPUT (from 0 dB input; 315 Hz)*

Beta Hi-Fi (stereo)	1.4 volts
standard (mono)	0.22 volt

VIDEO RECORD/PLAY RESPONSE

	Beta II	Beta III
at 500 kHz	+1 dB	+1 dB
at 1.5 MHz	-4 dB	-4 dB
at 2.0 MHz	-7 1/4 dB	-6 1/2 dB

LUMINANCE LEVEL

Beta II	~4% high
Beta III	~5% high

GRAY-SCALE NONLINEARITY (worst case)

	~11%
--	------

CHROMA LEVEL

	~1 1/2 dB low
--	---------------

CHROMA DIFFERENTIAL GAIN

Beta II	~7%
Beta III	~10%

CHROMA DIFFERENTIAL PHASE

	~+5°
--	------

MEDIAN CHROMA PHASE ERROR

	~+3°
--	------

VIDEO TRANSIENT RESPONSE (window display)

	~7% overshoot with 2% tilt
--	----------------------------

*The 0 dB input level for Beta Hi-Fi measurements is the voltage required to produce 3-percent third harmonic distortion at 315 Hz. For the standard audio recording mode, it is 10 dB above the level at which the automatic level control (ALC) produces 3-dB compression at 315 Hz. In both cases, the 0-dB output level is the voltage produced by a 0-dB input. All Beta Hi-Fi measurements were made with the ALC off and the recording level controls set for meter zero at 500 millivolts in.

indeed. Flutter is below measurement limits, distortion is very low, channel separation is very wide, and dynamic range is comfortably over 80 dB. Moreover, performance is essentially the same whether you choose "standard" Beta-II recording or the more economical Beta-III speed. This is true of the frequency response as well, which is the same in either mode, extending from 20 Hz to almost 20 kHz within 3 dB when the recording level is 20 dB below the midrange input required to produce 3-percent distortion. Cranking up the level causes

Despite its apparent complexity, the SL-2700 is quite simple to operate. Controls are color-coded and logically grouped, normal settings are indicated by (somewhat hard-to-see) green stripes, and the operating manual is, for the most part, written clearly.

The input selector array enables you to choose video and audio sources independently so that you can record a stereo simulcast in Beta Hi-Fi with the video from the TV tuner and the audio from your stereo system's FM tuner. There are three video choices—TUNER, CAMERA, and LINE/PCM; you can leave

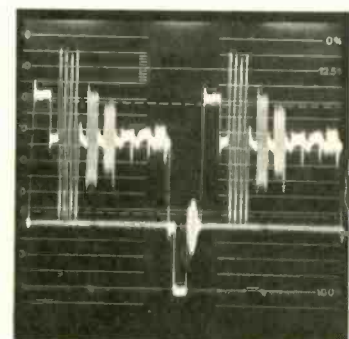
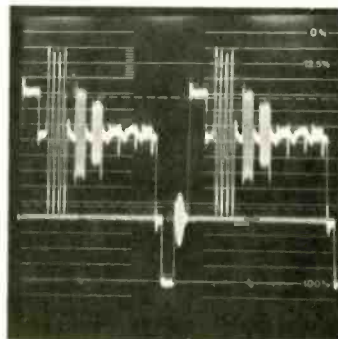

VCR MULTIBURST RESPONSE in Beta II (left) and Beta III (right). Surprisingly, the video response holds up slightly better at the slower speed. In both, however, the 500-kHz burst is up just a smidgen, while the 1.5- and 2.0-MHz bursts are down a little and the last three bursts (at 3.0, 3.58, and 4.2 MHz) are all but obliterated. This steep rolloff at high frequencies is typical of VCRs and is responsible for their somewhat limited horizontal resolution compared to that of the very best video sources (such as broadcast television).

some high-frequency rolloff, just as it would in an ordinary audio tape recorder. Why this happens, we're not sure—perhaps because of the built-in noise reduction system—but it shouldn't become apparent on music at any recording level below 0 dB.

Because of its many features, the SL-2700 has more switches and buttons than you'd want to count. Many of these are concealed behind a flip-down door that locks open, displaying its array on an easily accessible slanted panel. Here is where you'll find video and audio output selectors; tracking controls for normal, accelerated, and slow-motion playback; the clock and timer controls (the SL-2700 has a four-event/14-day programmer with an "every day" option); and the manual index markers (of which more later).

auxiliary equipment hooked up and select whichever one you want by switch. This is much better than the usual arrangement, whereby inserting a plug into the line jack automatically disconnects the tuner.

The audio recording controls permit you to suppress Beta Hi-Fi recording if you wish, to record left and right channels together or independently (to make a bilingual tape), and to choose either manual recording-level adjustment or automatic level control (ALC). No matter which level-control mode you choose, the ALC always is active on the standard longitudinal audio track to eke the most out of its limited dynamic range. And that edge track is always recorded, so that the tapes you make will be compatible with Beta VCRs that lack

the Beta Hi-Fi feature.

The green stripe suggests that you normally use ALC during recording. This may be good advice for the uninitiated but we think most of you will want to ride the gain yourselves. DSL found that the ALC is very "tight." (Once ALC action begins, recording level increases by only 1/8 dB for every 1-dB increase in input.) This virtually precludes overloading the conventional audio track, while achieving the best possible dynamic range. But such strong measures are hardly necessary with Beta Hi-Fi's

takes some getting used to. The usual setting is AUTO, which chooses Beta Hi-Fi playback if the tape has such a signal and standard audio if it doesn't. The other setting enables you to monitor the sound going onto the conventional track during audio dubbing, together with the existing Beta Hi-Fi recording. (Since Beta Hi-Fi is recorded by the video heads and therefore cannot be re-recorded without destroying video information, audio dubbing is possible *only* onto the conventional track.)

Although not as obviously



VCR COLOR ACCURACY in Beta II (left) and Beta III (right). The fuzziness of the color vectors (the white dots in the six target squares) is caused by chroma noise. Even so, the SL-2700's superb performance is clearly evident, bettering that of any TV tuner we have yet tested. Chroma level (color saturation) is indicated by a dot's radial distance from the center of its target, while chroma phase (hue) accuracy is indicated by its angular displacement. Both are just about right on the money, in Beta III as well as Beta II.

wider than 80-dB range. And Sony's recording indicators, which have a 55-dB range, make level setting easier on the SL-2700 than on many conventional audio recorders. They are calibrated with a healthy safety factor (the 3-percent distortion point is well off-scale), respond reasonably quickly, and hold the peak reading long enough for the eye to react.

The audio output switches are the most confusing. One chooses L, R, or B HI FI OFF. The normal position is L, which routes Beta Hi-Fi stereo to the audio line-out jacks when the switch is in the stereo position; when it is set for bilingual, only the left-channel sound track is presented. With an R setting, only the right track is presented. And in B HI FI OFF, the conventional mono track becomes the source. NORM also

distinguished as Beta Hi-Fi, the SL-2700's video-recording performance is also excellent. In fact, it is the best we have yet encountered, and DSL's bench tests suggest why. Video response (which determines horizontal resolution) is down only 7 1/4 dB at 2 MHz at the Beta-II speed and is actually *better* at the slower Beta-III speed. Chroma phase (hue) accuracy is exceptionally good—better than that of many receivers and separate tuners. Chroma level (color saturation) is just a trifle low and easily corrected with a monitor's color control. Luminance level is almost perfect, and the gray-scale linearity is very good. Chroma differential gain and phase also are exceptionally low, suggesting constant tint and saturation independent of scene brightness. And video

TV TUNER SECTION

Except where otherwise noted, all audio measurements were made with the automatic level control (ALC) defeated.

AUDIO FREQUENCY RESPONSE

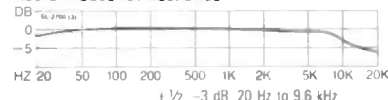

AUDIO S/N RATIO (A-weighted)

best case (no video signal)	44 3/4 dB
worst case (staircase with chroma)	25 3/4 dB

RESIDUAL HORIZONTAL SCAN COMPONENT (115.7 kHz)

	-54 1/2 dB
--	------------

MAXIMUM AUDIO OUTPUT

ALC off	1.13 volts
ALC on	0.36 volt

VIDEO FREQUENCY RESPONSE

at 500 kHz	flat
at 1.5 MHz	-2 dB
at 2.0 MHz	-2 1/2 dB
at 3.0 MHz	-3 1/2 dB
at 3.58 MHz	-5 dB
at 4.2 MHz	-17 1/2 dB

LUMINANCE LEVEL

	standard
--	----------

GRAY-SCALE NONLINEARITY (worst case)

	~39%
--	------

CHROMA LEVEL

	=7 dB low
--	-----------

CHROMA DIFFERENTIAL GAIN

	=32%
--	------

CHROMA DIFFERENTIAL PHASE

	=+5°
--	------

CHROMA PHASE ERROR

red	+4°
magenta	+4°
blue	0°
cyan	+10°
green	+7°
yellow	+9°
median	+5°

transient response is excellent, with negligible ringing and uniform brightness.

What's extraordinary is obtaining practically identical test results—as we did—at the two recording speeds. With

Nor is the SL-2700 short on features, which include not only Betasec (high-speed forward and reverse playback) but also Indexing, Auto Play, and Swing Search. Betasec is accessed by pressing FAST

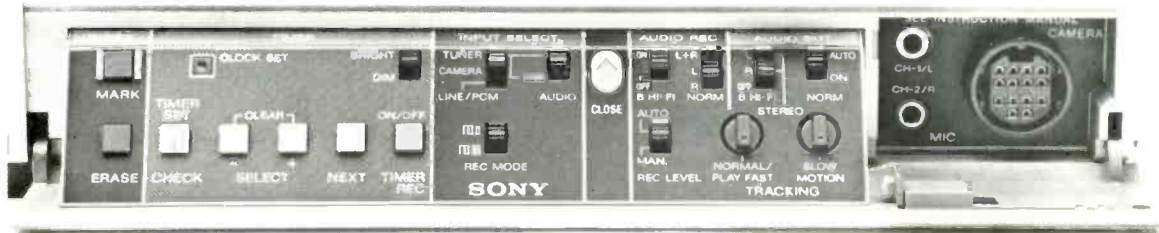

SECONDARY CONTROLS for the SL-2700 are behind a door at the bottom right of the front panel. They include switches for tape indexing, timer programming, setting the brightness of the front-panel display, input selection, recording speed selection, audio recording mode, and audio output selection. The two rotary controls are for tracking adjustments in normal or accelerated playback and in slow motion or freeze-frame. To the far right are a pair of mini-jack microphone inputs and a 14-pin K-type socket for connecting a video camera for live recording.

the exception of chroma noise (indicated by the size of the "fuzz balls" in the vectorscope photos), we simply can't tell at which speed a tape was recorded without looking at the indicator. And since Beta Hi-Fi performance is virtually identical in both modes, there is no audible clue, either. Chroma noise is slightly worse in Beta III than in Beta II, but is still far better than average.

FORWARD or **REWIND** while in **PLAY**. If you're in **REWIND** and press **PLAY** (while holding **REWIND** depressed), the tape shuttles back to counter zero and automatically replays from that point. The counter, by the way, reads in minutes and seconds and is not fooled by fast-winds or changes in recording speed: You always know the precise elapsed time on the tape.

TAPE RETURN brings you back to counter zero at a single touch, and a nine-program index enables you to find the beginning of any program quickly. Each time recording begins, an "index mark" is recorded on the tape. All you have to do to find that point again is enter its index number and press **PLAY**. The tape then rewinds or fast-forwards to the desired position and commences playback. You also can use the system in the same way you would one of the program-skipping systems found on some audio cassette recorders. You can manually insert an index mark by pressing **INDEX MARK** or erase an index mark with **INDEX ERASE**.

Swing Search is the best freeze-frame, slow-motion, double-speed system we've seen. It works equally well on tapes recorded in Beta II or Beta III but does not function on Beta-I tapes (which the SL-2700 will play but not record). Freeze-frame is absolutely free of video noise, and the picture

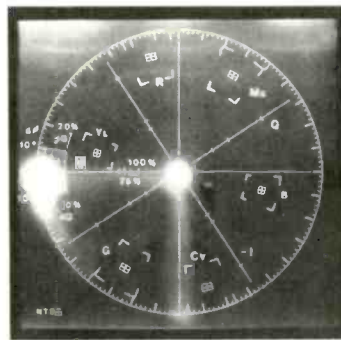

VCR COLOR CONSISTENCY in Beta II (left) and Beta III (right) is excellent. Ideally, the white blob at the left (its diffuseness is caused by chroma noise) would be a single dot centered on the intersection of the nine-o'clock axis with the circumference of the grid. The radial spread indicates the chroma differential gain, which is a measure of how much color saturation varies with changes in brightness. The angular spread shows the chroma differential phase, which tells how much hue shifts with changes in brightness.

definition is excellent. You can move frame by frame in either forward or reverse, or you can get slow motion in either direction at one-fifth or one-tenth normal speed. Each frame is cleanly presented with a noise bar occurring



TUNER COLOR CONSISTENCY. The narrow angular spread of the color vectors (the white dots near the periphery of the grid) indicates low chroma differential phase: Hues shift very little with changes in brightness on the SL-2700's tuner. Chroma differential gain, indicated by the dots' radial spread, is not as good. But since the only significant drop in color saturation occurs at the top of the luminance scale, there will be little change in color saturation, except in the brightest scenes.

only at the point of frame-change. You also can advance or back up at double-speed, and *with* audio in the forward direction on tapes recorded in Beta Hi-Fi. Although the sound is at double speed, it remains at normal pitch and therefore is not subject to the Donald Duck effect that would occur if you tried this with a conventional tape recorder. You can even start recording from the Swing Search mode for tight video editing.

Swing Search can be operated from your armchair via an infrared remote-control unit, which can also be used to turn the system on and off, change channels, switch the TV feed from antenna to VCR, and operate the transport controls. You can even activate a sort of external processor loop that sends the RF input through an external pay-TV or captions decoder on its way to the SL-2700's tuner.

DSL's tests on that tuner suggest good, if not exceptional, performance. Luminance level is perfect, chroma

level, fairly low. Chroma phase (tint) accuracy is perfect on blue, excellent on red and magenta, and very acceptable on green, yellow, and cyan. Chroma differential phase (a measure of how much tints change with brightness) is very stable, and chroma differential gain (how much color saturation changes with brightness) is excellent up to the brightest level, where a fairly substantial decrease in saturation occurs. There is also a fair degree of luminance (gray-scale) nonlinearity, but the eye seems very tolerant of these foibles.

The video frequency response (which determines picture resolution) is good to the chroma-burst frequency, dropping off quite quickly at 4.2 MHz (the upper limit of the NTSC system). Audio response is within 3 dB of nominal to almost 10 kHz, which we consider quite good for a TV tuner. The audio signal-to-noise (S/N) ratio depends on the video program being transmitted; subjectively, we find it par for the course—not exceptional, but free of the annoying scan whistle that sometimes occurs. Sensitivity is about average.

The Sony SL-2700 sets a new standard in home video recording. Picture quality rivals that of a Laser Disc, and Beta Hi-Fi sound is, frankly, better. It even gives the Compact Disc a run for its money. Add all that to an extensive and very useful range of special features, and you've got one whale of a VCR. **V&S**



UHF AND CABLE channels can be selected for scan tuning by means of these controls, located beneath a small door on top of the VCR. (VHF Channels 2 through 13 are always included in scan tuning and do not have to be programmed.) To add a channel, you first set the slide switch at the top to "NOR" (if it is a UHF channel) or "CATV" (if it is a cable channel). You then punch up the desired channel number on the front-panel keypad and press ADD. To remove a channel, you follow the same procedure, except that you push ERASE instead of ADD. AUX PRESET is used to program the VCR for reception looped through a decoder box whenever the front-panel or remote Aux is pressed.

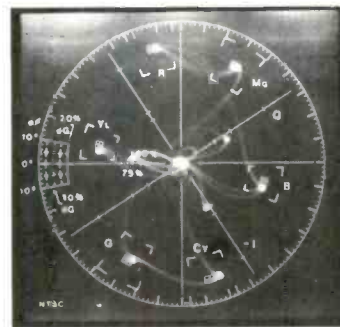
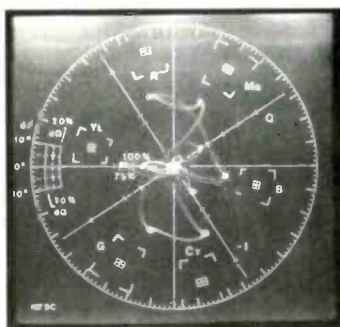

TUNER COLOR ACCURACY. The vectorscope photo at left indicates low color saturation (chroma level) and a small amount of hue (chroma phase) inaccuracy. The photo at right was made with increased chroma gain and a slight clockwise phase rotation to simulate the best color one could obtain using the color and tint controls on a monitor. As you can see, the results are excellent.

How VHS Hi-Fi Works

BY

PETER MITCHELL

AFTER MORE THAN A YEAR, the VHS camp has caught up with the Beta group, bringing audio FM recording to home videocassette decks. Though VHS Hi-Fi should be nearly identical to Beta Hi-Fi in performance, the techniques it uses are quite different in several respects.

The video head drum in VHS machines is 16 percent smaller than the one in Beta decks. Consequently, the writing speed of the VHS heads across the tape is 16 percent slower, making the available recording bandwidth narrower than in Beta. The modulation range of the VHS luminance carrier, for instance, is from 3.4 to 4.4 MHz. Unfortunately, this leaves no gap between the chroma and the luminance

Audio frequency modulation brings near-digital-quality sound to VHS decks.

sidebands in the VHS spectrum where audio FM carriers could be conveniently added.

In VHS Hi-Fi, audio FM carriers are recorded at 1.3 and 1.7 MHz for the left and right channels, respectively. This initially posed two problems: crosstalk between the audio carriers and the luminance sideband (which would produce herringbone interference patterns in the picture) and crosstalk between the FM signals in overlapping adjacent tracks (the same problem that forces Beta Hi-Fi to use two carrier frequencies for each

channel). Both problems were solved in one bold stroke—by using a separate pair of heads for VHS Hi-Fi's audio FM carriers.

Tilting the two audio-only gaps at plus and minus 30 degrees reduces crosstalk between audio and video to negligible levels. And even though the video is recorded directly over the audio on the tape, the two are effectively separated in playback by their azimuth angles.

That's right: The video is recorded directly on top of the audio. As the head drum spins, it records the audio FM signal and then overwrites the

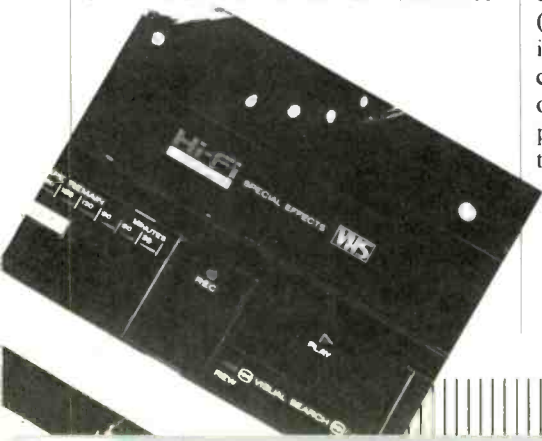
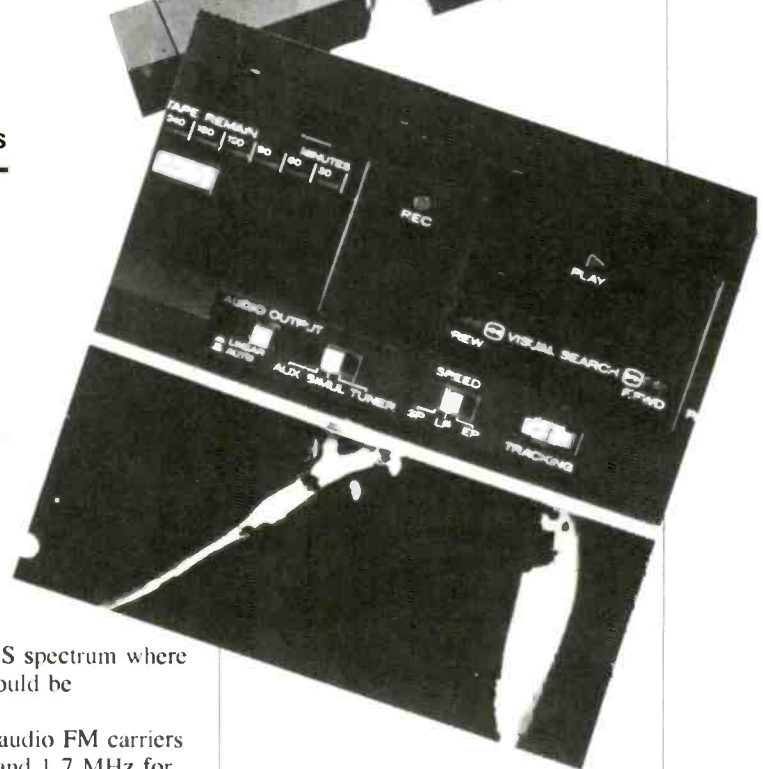
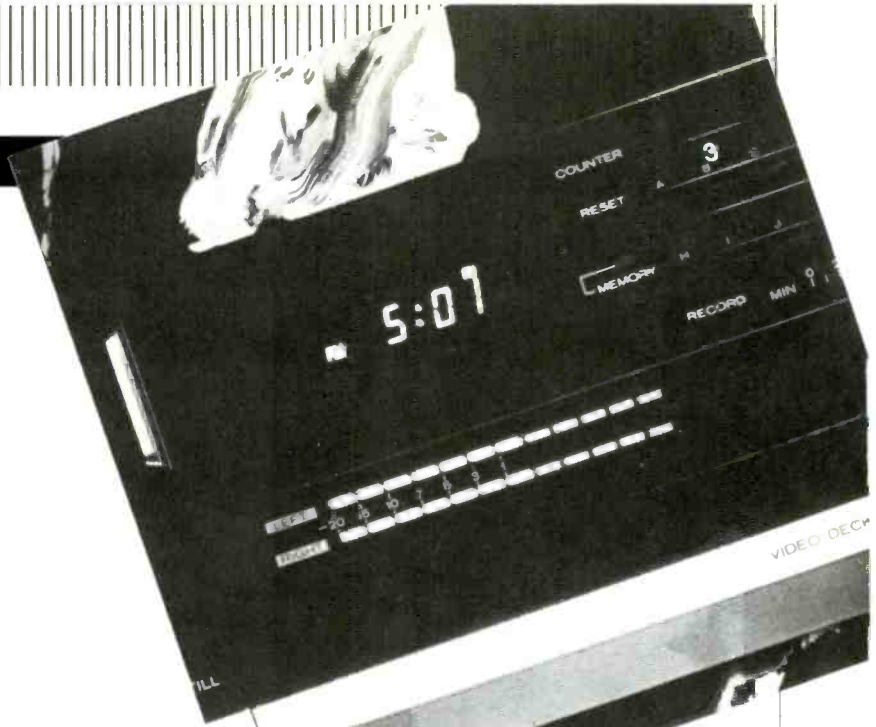

video signal on the same track, without erasing the audio! This technique has been christened with an exceedingly high-tech name—"depth multiplex recording"—but there's actually nothing particularly novel about it.

If you were to disable the erase head in a conventional audio recorder and deliberately record a new musical selection on an old one, you would find that the high frequencies in the first recording were erased (because they tend to be recorded near the surface of the tape). But the low-frequency portions of the earlier recording would still be there, mixed with the new signal.

Similarly, in VHS Hi-Fi the audio FM carriers (which are at relatively low frequencies) are recorded with enough strength to penetrate the full depth of the tape's oxide layer. The video signal is then written on top, with the critical high-frequency luminance signal tending to be captured in the tape's surface layer. Even if the overrecording causes some weakening of the VHS Hi-Fi carriers, it doesn't matter, because it's FM. And as in FM broadcasting, the quality of the recovered audio signal stays the same as long as the FM carrier is strong enough for full quieting.

And that brings us to the final problem: noise reduction. In any FM recording system the flutter of the tape mechanism produces frequency deviations of the carrier that are demodulated in playback as background noise; the S/N ratio of practical FM recorders is typically limited to 55 or 60 dB. VHS Hi-Fi gains about 6 dB in S/N by setting its maximum carrier deviation at ± 150 kHz (instead of the ± 75 kHz used in FM broadcasting). But to gain their advertised 80-dB S/N ratios, both Beta and VHS Hi-Fi rely on *compression* in recording and *expansion* in playback for noise reduction. Matsushita and JVC experimented with DBX, but the VHS manufacturing group finally agreed to adopt a new "HD" compander developed especially for VHS Hi-Fi.

As is often the case in VCR history, the two formats are again at parity, and you can pick the one you prefer. Both Beta and VHS now offer audio FM recording for wide-range stereo sound, differing in details but, theoretically at least, comparable in overall performance.

V&S

VHS HI-FI RECORDING FORMAT

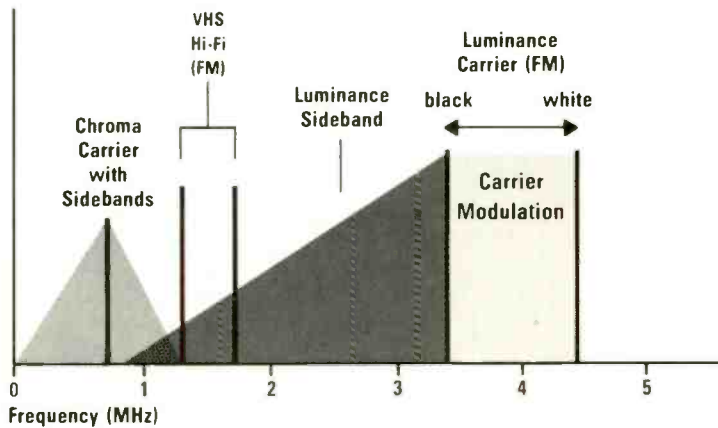

THE VHS RECORDING format has no convenient space for the audio FM carriers. VHS Hi-Fi, therefore, uses only a single carrier each for the left and right audio channels (at 1.3 and 1.7 MHz, respectively) and minimizes crosstalk and video interference by using differently canted audio and video recording heads.

AZIMUTH RECORDING

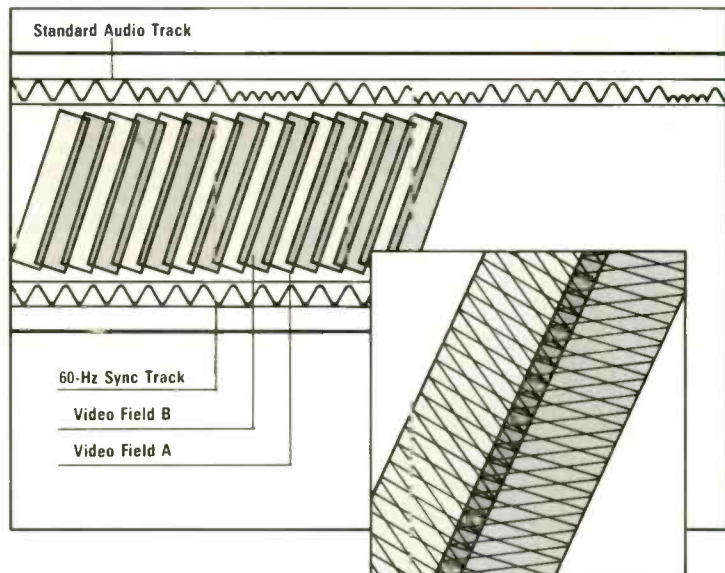

THE LOW-SPEED HELICAL-SCAN recording used in VCRs creates some overlap of adjacent tracks, or fields. To minimize the resulting crosstalk in a VHS Hi-Fi VCR, audio information on adjacent tracks is recorded at $\pm 30^\circ$, video at $\pm 6^\circ$ (inset). The left and right channels, modulated on FM carriers, are recorded consecutively.

INVEST \$3.95
BEFORE YOU BUY
ANOTHER PIECE OF
EQUIPMENT...

MODERN
PHOTOGRAPHY'S

Photo '84 Buying Guide

*and buy the Right
equipment*

BIGGER THAN EVER!
ALL-NEW
15TH Edition
Just \$3⁹⁵

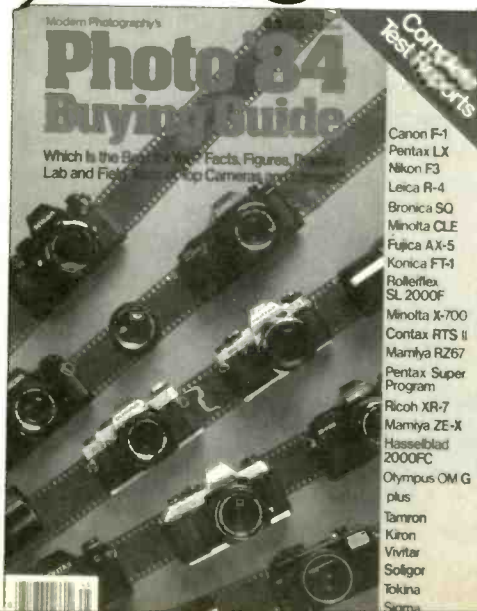

Complete facts and figures to help you buy right!
Compiled by the editors of America's foremost
Photographic magazine **MODERN PHOTOGRAPHY**

More on what you need to know. What's right for you and what isn't. Detailed field and laboratory test reports on **CAMERAS • CAMERA LENSES • SINGLE LENS REFLEX • NON REFLEX • INTERCHANGE-ABLE LENSES AND MUCH MORE.**

A must for everyone who takes photography seriously. Hundreds of easy to read charts and clearly labeled illustrations. No holds barred comparisons that will help **you** make your next equipment buy **right** for you.

RESERVE YOUR COPY NOW! FILL OUT THE COUPON BELOW

1984 Photo Buying Guide, ABC Single Copy Sales

VS84

8th Floor, 825 Seventh Ave., New York, N.Y. 10019

Please send me _____ Photo Buying Guide(s) @ \$3.95 each plus \$1.00 for shipping and handling.

Enclosed is my check/money order for \$ _____
Payment must accompany order.

NAME _____
(Please Print)

ADDRESS _____ APT # _____

CITY _____ STATE _____ ZIP _____

Please allow 5-6 weeks for delivery.

VIDEO
EQUIPMENT
REPORT

HITACHI VT-88A VHS HI-FI VCR

Hitachi VT-88A VHS videocassette recorder, with 14-day/6-event programmable tuner/timer and VHS Hi-Fi stereo audio. Dimensions: 17¼ by 4¼ inches (front panel), 14¼ inches deep plus clearance for connections. Price: \$1,095. Warranty: "limited," two years parts, 90 days labor. Manufacturer: Hitachi, Ltd., Japan; U.S. distributor: Hitachi Sales Corp. of America, 401 W. Artesia Blvd., Compton, Calif. 90220.

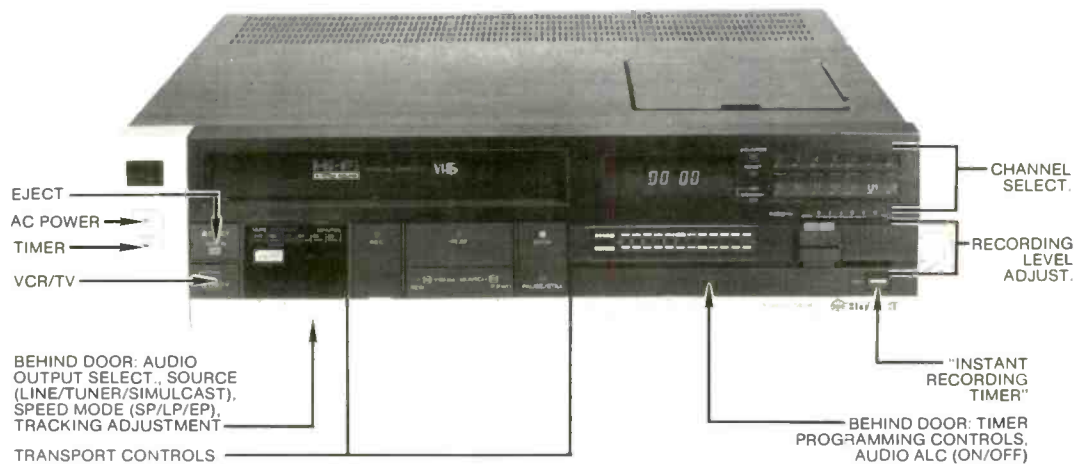

THE VHS CAMP has at last responded to the Beta Hi-Fi challenge with an improved VCR audio recording system of its own, not surprisingly called VHS Hi-Fi. The Hitachi VT-88A is the first VCR using the new system to come into our hands.

The main distinction between VHS Hi-Fi and Beta Hi-Fi is that the VHS technique uses an extra set of recording heads on the rotating drum to lay down the audio information, after which the video heads "overwrite" it with picture information. (In the Beta Hi-Fi

system, audio and video information are recorded simultaneously by the same set of heads.) The VHS group calls its technique "depth multiplex," because the audio information lies in a deeper portion of the tape coating than the video information. In a sense, that's true, but what really keeps the two apart is a different recording azimuth for audio than for video information—±30 degrees for audio, ±6 degrees for video.

The alternation between positive and negative azimuth angles serves to

VCR SECTION

Except where otherwise indicated, data are for all speeds—SP, LP, and EP (SLP). All measurements were made at the direct audio and video outputs, with test signals applied to the direct audio and video inputs. For VHS Hi-Fi, the 0-dB reference input level is the voltage required to produce 3 percent third-harmonic distortion at 315 Hz; for the standard audio recording mode, it is 10 dB above the voltage at which the automatic level control (ALC) produces 3 dB compression at 315 Hz. The 0-dB reference output level is the output voltage from a 0-dB input.

VHS HI-FI RECORD/PLAY RESPONSE (-20 dB; stereo)

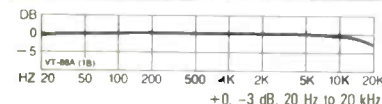

STANDARD RECORD/PLAY RESPONSE (-20 dB; mono)

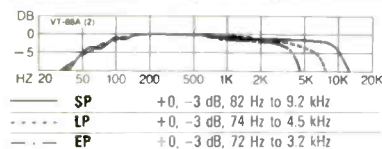

	SP	LP	EP
Standard	+0, -3 dB, 82 Hz to 9.2 kHz	+0, -3 dB, 74 Hz to 4.5 kHz	+0, -3 dB, 72 Hz to 3.2 kHz
AUDIO S/N RATIO (re 0-dB output, R/P, A-weighted)	47 dB	45 dB	46 1/2 dB
VHS Hi-Fi	84 dB	84 1/2 dB	80 1/4 dB

INDICATOR CALIBRATION (315 Hz; VHS Hi-Fi)	Standard	VHS Hi-Fi
for 0-dB input	> +8 dB	0 dB
for -10-dB input	0 dB	0 dB

DISTORTION (THD at -10 dB input; 50 Hz to 5 kHz)	Standard	VHS Hi-Fi
SP	≤ 3.2%	≤ 0.75%
LP	≤ 3.9%	≤ 0.71%
EP	≤ 4.5%	≤ 0.75%

CHANNEL SEPARATION (315 Hz; VHS Hi-Fi)	Standard	VHS Hi-Fi
	60 dB	60 dB

INDICATOR "BALLISTICS"	Standard	VHS Hi-Fi
Response time	1.6 msec	1.6 msec
Decay time	≈ 250 msec*	≈ 250 msec*
Overshoot	0 dB	0 dB

FLUTTER (ANSI weighted peak; R/P)	Standard	VHS Hi-Fi
SP	± 0.13% avg.	< ± 0.01%
LP	± 0.35% avg.	< ± 0.01%
EP	± 0.35% avg.	< ± 0.01%

SENSITIVITY (for 0-dB output; 315 Hz)	Standard	VHS Hi-Fi
VHS Hi-Fi	440 mV	440 mV
Standard	1,200 mV	1,200 mV

AUDIO OUTPUT LEVEL (from 0-dB input; 315 Hz)	Standard	VHS Hi-Fi
VHS Hi-Fi	1.7 volts	1.7 volts
Standard	0.56 volt	0.56 volt

AUDIO INPUT IMPEDANCE	Standard	VHS Hi-Fi
	41k ohms	41k ohms

VIDEO RECORD/PLAY RESPONSE	SP	LP	EP
at 500 kHz	+ 1/4 dB	+ 1/4 dB	- 1/4 dB
at 1.5 MHz	- 4 1/4 dB	- 4 1/4 dB	- 7 3/4 dB
at 2.0 MHz	- 7 3/4 dB	- 7 3/4 dB	- 11 1/4 dB
at 3.0 MHz	- 16 1/4 dB	- 16 1/4 dB	- 14 dB*
at 3.58 MHz	- 21 dB	- 21 dB	- 5 dB*
at 4.2 MHz	**	**	**

LUMINANCE LEVEL	Standard	VHS Hi-Fi
	6% high	6% high

GRAY-SCALE NONLINEARITY (worst case)	Standard	VHS Hi-Fi
	≈ 11%	≈ 11%

CHROMA LEVEL	Standard	VHS Hi-Fi
	2 1/2 dB low*	2 1/2 dB low*

CHROMA DIFFERENTIAL GAIN	Standard	VHS Hi-Fi
	≈ 8%	≈ 8%

CHROMA DIFFERENTIAL PHASE	Standard	VHS Hi-Fi
	≈ ± 4°	≈ ± 4°

MEDIAN CHROMA PHASE ERROR	Standard	VHS Hi-Fi
	0°	0°

*See text.
**Too low to measure

prevent crosstalk between adjacent tracks (successive fields). So, unlike the Beta Hi-Fi system, which uses a different set of FM carriers for adjoining tracks to keep them apart, VHS Hi-Fi can use the same set of carriers on both and rely on the azimuth difference to prevent interference. The single pair of carriers—one for the left channel, one for the right—not only simplifies the demodulation process (the FM "receiver" needn't be "retuned" 60 times a second) but also allows the use of a wider deviation ratio to improve the signal-to-noise (S/N) ratio.

In describing the specifics of the Hitachi VT-88A, we are handicapped by the lack of an owner's manual or full technical information, neither of which was available in time for this review. But here's our best effort at doping out what it does (and doesn't) do. The front end is electronically tuned and covers 105 VHF, UHF, and CATV channels. You can preset any 14 channels via controls under a top-panel lid and tune them via front-panel pushbuttons. There's a 14-day/6-event timer, plus an "Instant Recording Timer" (IRT) to quickly set taping time and length in simple 30-minute increments. You adjust clock and program times with plus and minus pushbuttons behind a door at the lower-right portion of the front panel. Here too are a dimmer switch for the display and an ALC (automatic level control) on/off button.

Like Beta Hi-Fi, VHS Hi-Fi maintains compatibility with conventional systems of its kind by recording audio information on the standard edge track as well. Thus, tapes made on the VT-88A can be played on non-Hi-Fi decks, and regular VHS tapes will play on the VT-88A, albeit in neither case with Hi-Fi sound. According to Hitachi, the VT-88A reproduces a stereo edge-track recording in stereo but records the edge track in mono, so Diversified Science Laboratories could not check stereo performance in this mode. The company also informs us that the VHS Hi-Fi noise reduction system—a new development called PNR—is used both on the edge track and for the Hi-Fi recording. Because technical details on this system have not been released, we cannot comment on its compatibility with the Dolby B system used for normal VHS Stereo edge-track

recording.

When the ALC button is pressed, recording levels for both VHS Hi-Fi and edge-track recording are automatically controlled. With the button released, you set recording level with dual sliders, guided by 12-segment LED indicators calibrated from -20 to +8 dB. Above 0 dB, the LEDs change from green to red and the decay time increases from 250 to almost 1,250 milliseconds (msec). DSL's tests suggest that in the VHS Hi-Fi mode you can record well into the red without fear of overload. Total harmonic distortion (THD) doesn't reach 3 percent until the indicator is off scale, and the 0-dB reading (the first red LED) is a full 10 dB below 3 percent THD at 315 Hz. At this level, midband distortion is less than 0.25 percent, rising to 0.75 percent at 50 Hz and 5 kHz. By 10 kHz it's up to 2.5 percent, but with normal program material, you'll never have that much high-frequency energy to contend with.

Undoubtedly, you'll want to set recording level manually in the VHS Hi-Fi mode to make optimum use of its wide dynamic range—more than 80 dB even at the slowest (EP) speed and 84 dB or more at LP or SP. The limited dynamic range on the edge track (45 to 47 dB, depending on speed) makes use of ALC advisable, so DSL measured edge-track performance with the ALC engaged. (As far as we can tell, Hitachi's arrangement precludes simultaneously using the ALC on the edge track and setting VHS Hi-Fi level manually.)

DSL measured edge-track distortion at the "knee" of the ALC curve, above which the recording level is kept virtually constant regardless of the input voltage. (A 1-dB increase in input causes less than a 1/4-dB change in recorded level.) Midband distortion is 2 to 2.25 percent, depending on speed, and 3.25 to 4.25 percent at 50 Hz. This is at least three to five times as great as in VHS Hi-Fi. Flutter also is much greater on the edge track, with peaks of ± 0.15 percent at the SP speed and ± 0.45 percent at LP and EP, whereas the flutter in VHS Hi-Fi is below our measurement limit of ± 0.01 percent at any speed.

Another big difference is in frequency response, although in the SP mode the bandwidth of the VT-88A's

edge track is about the best we've measured, being only 4 dB down at 10 kHz. The top end drops off rapidly above 6.5 kHz in LP and is limited to about 4 kHz in EP. In VHS Hi-Fi, on the other hand, bandwidth extends from below 20 Hz to beyond 20 kHz and is essentially independent of recording speed.

On the first samples we tested, however, the response uniformity varied according to the recording level. For example, at -10 dB (relative to the level at which 3 percent THD is reached at 315 Hz), which corresponds

head downstream. Hitachi has instituted a modification to eliminate this effect from production models, which yield flat response at all recording levels. Even at -40 dB, it is within $\pm 1/2$, $-2 1/2$ dB from 20 Hz to 20 kHz, which is excellent.

In playback, the VT-88A automatically senses the presence of a VHS Hi-Fi recording, lights the Hi-Fi logo, and chooses that reproduction mode when the audio output switch is in AUTO. You can override the feature by pressing the switch to select the edge track in all cases. This switch, the

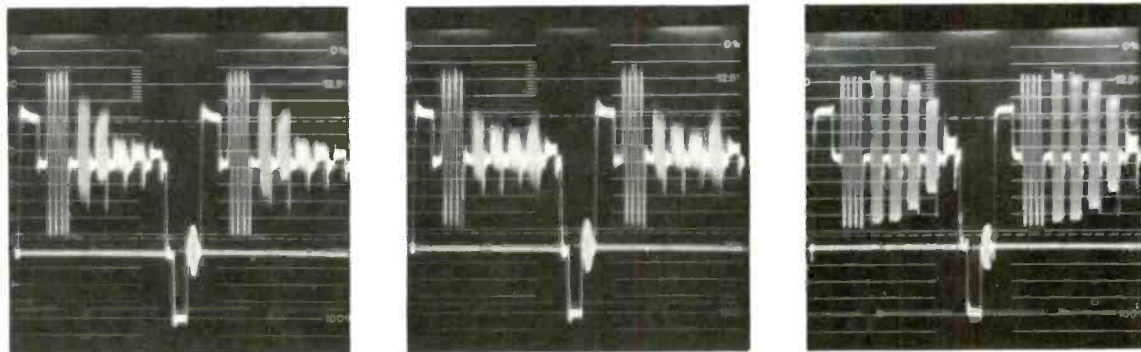

MULTIBURST RESPONSE for the VT-88A's recorder section running at SP (left), for the recorder at EP (middle), and for the TV tuner section (right). (The VCR's response at the LP speed is virtually identical to that in SP.) The test signal consists of a reference "white bar" (far left) followed by bursts at 500 kHz, 1.5 MHz, 2.0 MHz, 3.0 MHz, 3.58 MHz (the color-carrier frequency), and 4.2 MHz (the upper limit of the NTSC broadcast system). Each photo shows two complete multibursts. It is the video frequency response that determines horizontal resolution, or sharpness.

In SP, the VCR's response is down slightly at 1.5 and 2.0 MHz and drops off severely at higher frequencies. Nonetheless, this is excellent performance for a VCR. In EP, its response rolls off more swiftly (as one would expect) but bounces back up at 3.58 MHz. Output at that frequency is not stable enough for this apparent improvement to enhance the quality of recorded images, however. The tuner section's response is unusually extended, remaining essentially flat out to 3.0 MHz and showing just a slight dip at 3.58 MHz before falling off sharply at the upper edge of the NTSC band.

to a reading of 0 dB on the recording-level indicators, response was within $\pm 1/4$, $-1 1/4$ dB from 20 Hz to 20 kHz. At our standard response measurement level of -20 dB, the tolerance broadened to $\pm 1 1/2$ dB, and 10 dB further down it widened to ± 4 , -1 dB. Close examination of the response curves suggested that this was caused by mistracking of the noise reduction system—something that should not occur in an FM recording system.

We therefore contacted Hitachi, which was likewise puzzled by the problem. Ultimately, the company discovered that the culprit was indeed compander mistracking, caused by bias leakage from the standard fixed audio

three-position recording-speed selector, the tracking control, and a three-position input selector (AUX).

SIMULCAST, and TUNER) lie behind a flip-down door at the lower left of the front panel. (In playback, the correct speed is selected automatically.)

In AUX, the VT-88A can be used as a high-performance audio recorder. That's also the position you'd use for making home movies: There's no camera input as such, but a camera could be connected to the video line-input pin jack on the rear via a power-supply adapter. (There's no microphone input, either, so you'd need a microphone preamp to drive the audio line-input jacks; because audio

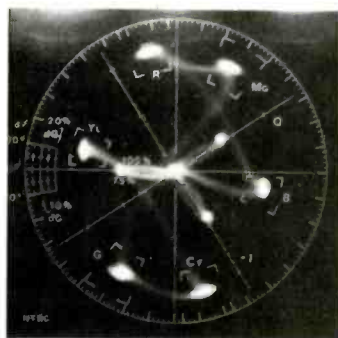

VCR COLOR ACCURACY is very good and essentially identical at all three speeds. (The vectorscope photos shown here are for SP, which is the fastest.) The left-hand photo shows the uncorrected color. A 2½-dB increase in chroma gain puts all six color vectors (the small white blobs near the circumference of the grid) onto their targets, as shown in the right-hand photo. This simulates the best results one could obtain using the color control on a monitor—in this case, virtually perfect. The diffuseness of the color vectors is caused by chroma noise, which would show up in a video image as flecks of colored snow. Chroma noise is lowest in SP, slightly greater in LP, and considerably greater in EP. This is the usual pattern, and in no case is the noise worse than average. Indeed, at the two higher speeds, it is quite low for a VCR.

input sensitivity is rather low, the preamp's gain is an important consideration.) **TUNER** is the usual setting, enabling you to record cable or TV broadcasts via the built-in TV front end, and **SIMULCAST** makes it possible for you to record video from the tuner and audio from an FM receiver connected to the audio input jacks.

The VT-88A is a front-loader with power-assisted operation. Its transport

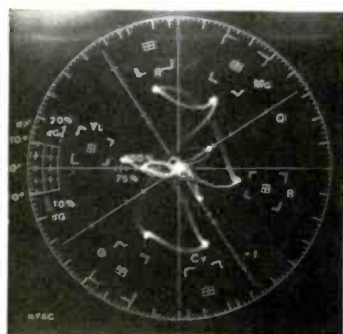

TUNER COLOR ACCURACY is very good. The vectorscope photo at left indicates low color saturation (chroma level) and a small amount of hue (chroma phase) error. The photo at right—made with 3¼ dB additional chroma gain and approximately 4 degrees of clockwise phase rotation—simulates the best results one could obtain using the color and tint controls on a monitor. This adjustment brings all six color vectors (the small white dots near the circumference of the grid) onto or very near their targets, which is excellent performance. In fact, the spread is actually $\pm 2\frac{1}{2}$ degrees or less.

controls respond to a light touch and are duplicated on a small infrared remote control. The remote also enables you to scan through the channels sequentially and to activate **FRAME ADVANCE** and **FAST PLAY**. The display doubles as both clock and footage counter, alternated by sequential taps on **COUNTER**. When **MEMORY** is engaged, the VT-88A rewinds and stops the tape at "9999." When the tape runs out, rewind and shutoff are automatic. A six-segment tape-remaining indicator senses tape and hub speed and suggests how much time you have left, in 30-minute increments to 120 minutes and then hourly to 240 minutes.

DSL'S TESTS on the VT-88A's tuner section indicate very flat video response to 3.0 MHz and a slight rolloff at the color-burst frequency (3.58 MHz). Although the tuner does not manage the full 4.2-MHz bandwidth of the NTSC system (no TV tuner we've seen does), it should provide close to 300 lines of horizontal resolution on a good monitor. Luminance level is very accurate, gray-scale nonlinearity fair but not outstanding. Chroma level is shy of the mark but not to the extent that it can't be corrected at the monitor. Chroma differential phase (hue variation with scene brightness) is very well controlled, but there's substantial chroma differential gain. Fortunately, most of it occurs only at the highest luminance level, so the color washout that it implies should rarely be noticeable. Color accuracy itself is very good, a 4-degree touch-up on the tint control being sufficient to bring all color vectors within $\pm 2\frac{1}{2}$ degrees of perfection.

Audio response is almost dead flat out to 20 kHz. Obviously, there's no 15.7-kHz notch filter in this system, so we're not surprised at the relatively high level of the horizontal-scan component in the output. Taking that into account, the A-weighted signal-to-noise figures are quite respectable.

Video recording performance in the SP and LP modes is first-rate, with response down less than 8 dB at 2 MHz. At the slowest speed (EP), video response is down an equivalent amount at 1.5 MHz. (The apparent improvement in response at 3.58 MHz in the EP mode is not significant: The signal is too unstable to add anything

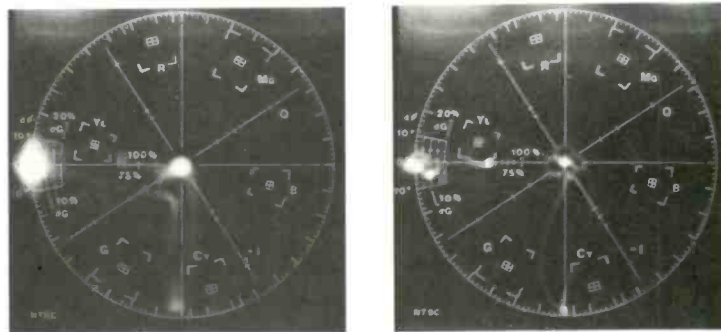

COLOR CONSISTENCY for the VT-88A's recorder section running at SP (left) and for its TV tuner (right). (The results for the VCR in LP and EP are essentially identical to those in SP, so we have omitted the photos for the slower speeds.) In each case, the ideal would be for the cluster of dots toward the left edge of the grid to be a single dot at the intersection of the nine-o'clock axis with the circumference. The radial spread of the dots indicates chroma differential gain, which is a measure of how much color saturation (chroma level) varies with changes in scene brightness (luminance). Their angular spread shows the chroma differential phase, which tells how much hue (chroma phase) shifts with changes in brightness. The VCR performs excellently in this test. The tuner also has very low differential phase, and its differential gain, though rather high, is mainly at the highest luminance level.

TV TUNER SECTION

All measurements were taken at the direct audio and video outputs.

AUDIO FREQUENCY RESPONSE

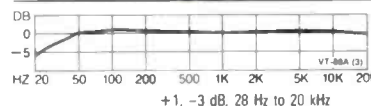

AUDIO S/N RATIO (A-weighted)

best case (no video signal)	50 dB
worst case (window display)	36 3/4 dB

RESIDUAL HORIZONTAL SCAN COMPONENT (15.7 kHz)

	-39 1/4 dB
--	------------

MAXIMUM AUDIO OUTPUT (100% modulation)

ALC off	1.0 volt
ALC on	0.25 volt

AUDIO OUTPUT IMPEDANCE

	930 ohms
--	----------

VIDEO FREQUENCY RESPONSE

at 500 kHz	-1/4 dB
at 1.5 MHz	-1/2 dB
at 2.0 MHz	-3/4 dB
at 3.0 MHz	-1 1/4 dB
at 3.58 MHz	-4 1/4 dB
at 4.2 MHz	≈ -19 dB

LUMINANCE LEVEL

	4% high
--	---------

GRAY-SCALE NONLINEARITY (worst case)

	≈ 22%
--	-------

CHROMA LEVEL

	33 3/4 dB low
--	---------------

CHROMA DIFFERENTIAL GAIN

	≈ 50%
--	-------

CHROMA DIFFERENTIAL PHASE

	≈ ± 2 1/2°
--	------------

CHROMA PHASE ERROR

red	+3 1/2°
magenta	+3 1/2°
blue	+1 1/2°
cyan	+6 1/2°
green	+5°
yellow	+5 1/2°
median error	+4°

to the picture.) Luminance level, gray-scale nonlinearity, and chroma differential gain and phase are identical and excellent at all three speeds, and at none of them is there any measurable color error. Chroma level is on the low side at all speeds, but not unduly so: on our sample, however, it was somewhat unstable in EP, which could produce an annoying flickering of color intensity. And as usually is the case, chroma noise is substantially higher at the slowest recording speed than at SP and LP, which are quite good in this respect.

In our hands-on evaluation, we were mightily impressed with the VT-88A's tuner. It is noticeably more sensitive and noise-free (especially on Channels 2 through 7) than most. The gray-scale nonlinearity is barely noticeable, the chroma differential gain only in the very brightest scenes. Video record/playback performance is equally noteworthy at the SP and LP speeds. Unfortunately, the VT-88A's special video features do not work as well at those speeds as at EP. Still-frame in the SP mode is virtually useless: A wide noise bar is likely to cover more than half the picture. Fast-scan operation at that speed produces barely enough information to make the picture content discernible. LP special effects are a good bit better. There's

some bending at the top of the screen in still-frame, but it's livable, and you can follow the action in fast-scan. At the EP speed, the special effects are excellent. Still-frame couldn't be better, and the fast-scan is clear enough to follow with ease. Normal operation at the EP speed is at least up to snuff—better than on some other VCRs—but no match in definition, color noise, and color stability for the excellent performance at SP and LP.

TV-broadcast sound being what it is, we couldn't hear the problems DSL uncovered in the VHS Hi-Fi noise reduction system with that source, so we tried taping a high-quality piano recording on the VT-88A and playing it back over our reference high fidelity system. With this (admittedly taxing) test, we could readily distinguish between source and copy. The piano seemed to lose bass in the quiet passages, and there was a noticeable surging character to the VCR tape copy. Once the bias-leakage problem was eliminated, however, these effects disappeared entirely. With that proviso, we certainly would rank VHS Hi-Fi the equal of Beta Hi-Fi as a great step forward in VCR sound quality, bringing it almost up to the performance level of digital recording. And with stereo TV almost ready to roll, the timing couldn't be better. **V&S**

STEREO TV Now



BY

WILLIAM MOWRER

AFFORDABLE DECODERS LET YOU RECEIVE SATELLITE STEREO BROADCASTS WITH YOUR BACKYARD DISH ANTENNA.

OVER THE PAST YEAR or so, many of the television programs available to owners of backyard dish antennas have acquired stereo voices. The Movie Channel, MTV, Spotlight, Home Theatre Network (HTN), Bravo, the Disney Channel, and the Nashville Network are now broadcast with stereo soundtracks. And, if you're disappointed with the quality of the FM programming in your area, you'll be pleased to know that some 22 FM stations—including Chicago's much admired classical music station, WFMT—are accessible via satellite.

If you own a backyard dish antenna, then presumably you've already wrestled with the legality of tapping satellite-relayed broadcasts. But if the possibility of obtaining stereo audio via satellite is the incentive you need to invest in a complete earth station, then you should be aware of

the legal implications of owning and operating a satellite dish. Is it legal to receive broadcasts that your neighbor down the road is paying upwards of \$20 a month to "buy" from a cable company? The answer, at least for the moment, is yes.

No law on the books states that private reception of satellite signals is a crime, and no lawsuit has ever been brought against a home-earth-station owner. However, new legislation or an adverse court ruling could in the future make it illegal to receive such broadcasts without permission. Bills to accomplish just that have been introduced in Congress over the past few years, but they have been defeated each time. One such bill even recommended that private ownership of an earth station be made unlawful.

But for now the coast is clear for the reception of satellite-relayed

television and audio programs. And for those of us who live in rural areas not serviced by a cable operator or a decent-quality FM station, the backyard earth station has become somewhat of a necessity. I wouldn't part with mine without a fight.

WHAT YOU NEED to tune into satellite stereo transmissions is a special decoder capable of dealing with the four incompatible stereo encoding systems currently in use. Hooking up the decoder is simple: You route the output of your satellite receiver through the decoder and out to the aux inputs on your stereo amplifier. I evaluated two of the most popular and affordable of these devices—Channel Master's Model 6140 (\$340) and KLM's Stereo Processor (\$465)—and found both welcome additions to my satellite antenna/receiver setup.

The diversity of audio programming available on satellite is remarkable. If you have a teenager in the house and are a cable-TV subscriber, you have probably already heard the offerings on MTV—pop-music videos with a stereo soundtrack simulcast over an unused FM frequency. Warner Amex, the producer of MTV, supplies this program as well as The Movie Channel to local cable operators via a satellite feed complete with a matrixed stereo soundtrack; the cable company decodes the stereo information and usually charges an extra fee to deliver the simulcast to subscribers via a hookup to an FM tuner. Both the Channel Master and KLM processors scored high marks in decoding these matrixed broadcasts. With the pop material, the sound was about what you'd expect from a quality-conscious FM station, while the movie soundtracks had that crisp, full-range quality you usually hear only in a first-run movie theater.

Spotlight, another movie channel, broadcasts its stereo information on discrete carriers. The Channel Master and KLM processors are equipped to handle such transmissions, and the results are terrific. Both Home Theatre Network, which broadcasts family-oriented feature films and travel programs, and Bravo, which specializes in foreign films and the fine arts, use a multiplex system developed by the Leaming Corp. Again, both processors are equipped with the proper decoding circuits, and the stereo audio



PICKING UP SATELLITE stereo broadcasts often involves tuning in two subcarriers. Meters on the KLM (top) and presets on the Channel Master simplify the process.

they produce is first-rate.

And then there's the Wegener system, first selected by WFMT and since adopted by the Disney Channel, the Nashville Network, the Satellite Radio Network, Moody Broadcasting, and others. In fact, the Wegener system is by far the most popular of the four stereo-transmission techniques. The Wegener approach uses separate carriers for the left and right channels and lots of compression to arrive at a specified signal-to-noise ratio of 63 dB—provided, of course, that you apply the correct expansion at the receiving end.

I conducted two listening tests of the processors in decoding Wegener-encoded broadcasts—the first on the now defunct Entertainment Channel and the second on WFMT. In an A/B trial using the Entertainment Channel, it was impossible to tell which processor was in use. The sound was good overall; but the real test for audiophiles must be the reception of WFMT, and I would be less than candid if I didn't admit that both the KLM and Channel Master decoders leave a great deal to be desired here. They both produced stereo sound from the broadcast, but with far more noise than I could tolerate. The Channel Master's reception was worse than the KLM's, but even the better of the two reminded me of FM reception in deep-fringe areas. Also rather disappointing was the broadcast's tonal balance: The outputs from both processors lacked bass while emphasizing the treble. The processors' DNR circuits made some dent in the noise, but were, of course, powerless to correct the frequency imbalance.

A phone call to WFMT shed some

light on the situation. In fact, Ray Nordstrand, the station's president and general manager, is none too thrilled about the attention his station is getting from the processor makers. "To be received properly in the home, the WFMT broadcast should undergo the appropriate decoding process," he noted. "And to the best of my knowledge, none of these multipurpose satellite signal processors duplicates Wegener's technique sufficiently to deliver a clean signal." Nordstrand said that special home decoders are available from Wegener, and without the right equipment "trying to listen to WFMT via a backyard dish is like listening to an undecoded DBX recording." Unfortunately for those of us who've already sunk anywhere from \$2,000 to \$10,000 for a dish and receiver, the additional \$1,400 for the Wegener decoder may seem a bit taxing.

WFMT aside, both the Channel Master and KLM processors generally produced excellent results. Some of the stereo FM stations share transponders with other audio and TV channels. Transponder 3 on Satcom's F3 satellite, for example, carries not only the audio and video signals of WGN-TV in Chicago, but also seven stereo audio signals (one of which is WFMT's). The number of audio offerings is really staggering, but suffice it to say that they range from channels devoted to nonstop show tunes, country music, and "golden oldies" to big bands and comedy.

But tuning in these broadcasts with these processors can be tricky. In most cases, it's necessary to tune two subcarriers separately. Sometimes one subcarrier contains the sum of the left and right channels, the other the difference, as in FM multiplex broadcasts, while other broadcasts put the left-channel signal on one carrier and the right on the other. There are tuning scales and knobs on each processor for this task, but the process is none too precise on either unit. To simplify matters somewhat, KLM provides two illuminated center-channel tuning meters, while Channel Master includes four presets to store commonly used settings.

Despite these caveats, both the Channel Master 6140 and KLM Stereo Processor do a yeomanlike job of coping with a difficult situation. There are more expensive units available, but you'd be hard pressed to find models capable of similar performance at such attractive prices. **V&S**

SATELLITE STEREO BROADCASTS*

Program	Service	Satellite	Transponder	Broadcast Method
ARTS	Cultural	Westar 5	12	Wegener Discrete
BRAVO	Cultural	Satcom F4	2	Learning Multiplex
MTV	Rock Music	Satcom F3	11	Warner Matrix
Nashville Network	Country Entertainment	Westar 5	17	Wegener Discrete
Satellite Jazz Network	Jazz (audio only)	Satcom F4	17	Wegener Discrete
Black Entertainment Network	Variety	Westar 5	24	Wegener Discrete
Star Station	Popular Music (audio only)	Satcom F3	3	Wegener Discrete
Moody Broadcasting	Gospel (audio only)	Satcom F3	3	Wegener Discrete
Movie Channel	Movies	Satcom F3	5	Warner Matrix
WFMT	Classical Music (audio only)	Satcom F3	3	Wegener Discrete
Stardust Network	Big Band Hits (audio only)	Satcom F3	3	Wegener Discrete

*This is only a partial listing of the stereo programs available on satellite. For a more comprehensive list, including each broadcast's subcarrier frequencies, send us your request with a self-addressed envelope and a check for \$2.00 for postage and handling.

A NEW DIMENSION

FOR

VIDEO SOUND

 DOLBY STEREO

BY

RALPH HODGES

WITH AN OUTBOARD DECODER, DOLBY STEREO FILMS ON VIDEO
SPRING TO LIFE WITH SURROUND-SOUND REALISM.

THE SONIC EFFECTS offered by today's major motion pictures are nothing short of amazing. The Dolby Stereo logo on theater marquees and film ads tells you that sound will be an integral part of the on- and off-screen action. Much of the impact of a Dolby Stereo film derives from the surround-sound information it contains, which creates aurally what the various 3-D processes try to do visually—that is, add realism and dimension to a flat, illusionary world.

The good news is that you can recreate this extra dimension at home—provided that the film was originally produced in Dolby Stereo and that your copy (on either videocassette or videodisc) has a stereo soundtrack. I'll explain what hardware you need and comment on my own experience with Dolby Stereo at home, but first you should understand the nature and limitations of the technique itself.

The Dolby Stereo optical print (referred to in the trade as Dolby

Stereo Variable Area, or SVA) really has only two audio tracks—left and right—from which both a center and a rear "surround" channel must be derived. The center channel is easy: It can be created by summing the left and right channels. The fourth channel presents more of a challenge. It is decoded from information encoded in the two basic tracks with a matrixing scheme similar to the SQ and QS techniques used in the old quadriphonic days.

The soundtrack you get when you buy a stereo videocassette or videodisc of a Dolby Stereo film is exactly the same as that carried by a Dolby SVA release print—that is, it contains all the information you need to extract the surround channel. The hardware necessary to reproduce it is quite straightforward: a stereo VCR or videodisc player, a decoder such as the Fosgate Research 101A or the

Surround Sound M-360, an extra channel of amplification, and a rear speaker. You can even make your own matrix decoder with some wire and a potentiometer (see box).

The Fosgate 101A incorporates the latest evolution of the technology developed for the SQ four-channel matrix system and, fittingly, has a switch position for SQ as well as for cinema surround sound. The unit's decoding circuits are logic-steered and rather complex. SSI's M-360 is a somewhat different animal that conforms closely to the reproduction scheme used by Dolby in theaters to decode surrounds.

The decoding circuitry in Dolby cinema processors is not very complex: Basically, it detects out-of-phase information and throws it into the surround channel. The M-360 uses a similar dematrixing circuit. However, the M-360 also includes Dolby B decoding for the surround channel. The reason for this is that the surround information on Dolby Stereo films receives B-type noise reduction in addition to the A-type encoding used for the whole soundtrack. (The soundtrack goes through a Dolby-A decoder before being put on videocassette or videodisc, so you don't have to worry about that part of it.) The M-360 also includes a variable delay line for the rear channel, as do the cinema processors. In fact, the SSI device adheres so closely to all the strictures necessary for accurate Dolby Stereo decoding that it is entitled to bear the new Dolby MP Matrix logo. (Video material suitable for this sort of processing at home may start appearing with this logo.) Finally, there's even a 10-watt mono amplifier built into the unit to drive a rear speaker.

The centerpiece of the surround-sound system I assembled was a Kloss Novabeam Two video projector. The Novabeam provides a considerably bigger picture than most people have access to at home; but having viewed films with stereo and surround-sound on conventional TV sets, I was curious to see how much difference a large-screen presentation would make. The difference turned out to be dramatic, but the increased realism it offers does not invalidate the use of stereo/surround techniques with smaller screens. Although a foot-wide picture of a symphony orchestra with a 12-foot-wide stereo sound image makes

little sense, the situation with motion pictures is quite different. In most films, dialogue and the sounds from on-screen action are panned dead center (or close to it) in the mix so that they will "fit" almost any screen. If music and off-screen action are heard as coming from off-screen, then that's probably how it's supposed to be.

SURROUND-SOUND FOR LESS THAN \$5

A DEDICATED DOLBY STEREO DECODER is not essential for demonstrating to yourself that there is surround-sound information on many stereo video films. (See list of recent Dolby Stereo films on video.) If you have a four-channel matrix processor (SQ or QS) left over from the '70s, try it as a decoder. The sound may not be exactly right,

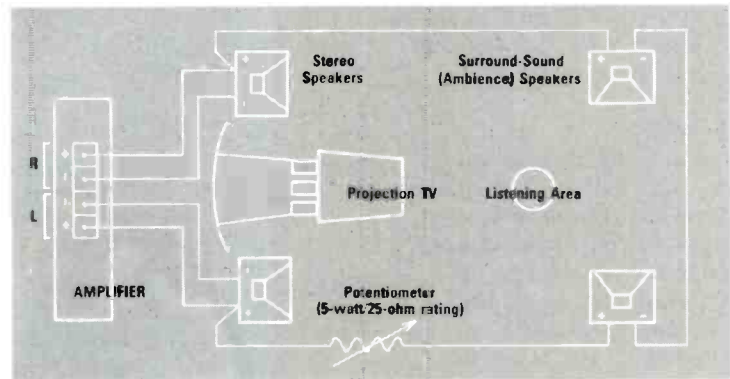

but it will be close enough to make you sorry that you hadn't tried it before.

If you don't have an old quad decoder but can scare up a second pair of loudspeakers, a simple homemade Hafler dematrixing circuit—consisting of a length of lamp cord and a potentiometer to control the level of the rear speakers—will put you in business. Total parts cost well under \$5. The diagram shows you how to wire everything together. Note that you do not need an extra amplifier for the rear speakers: The out-of-phase surround information and the power necessary to drive the rear speakers are obtained by tapping the amplifier's positive speaker outputs and wiring the rear speakers' ground terminals together.

Although Dolby SVA film prints provide just one channel of surround, I chose to use two rear loudspeakers to reproduce it. A single speaker, particularly if it's close behind you, yields too much localization for surround effects that are intended to be diffuse. The two front speakers were positioned about five feet apart, which put them just to the sides of the Novabeam screen. Here is where a large picture did prove advantageous: Some of the source material at my disposal turned out to have dialogue and on-screen effects that were panned from side to side. Positioning the speakers right at the edges of the video image caused the sound to track the screen action perfectly and yet

provided enough spacing for a satisfactory stereo effect.

For source material, I depended on Beta Hi-Fi tapes of *The Road Warrior* (*Mad Max 2*, outside of the U.S.) and *Creepshow*, both Warner releases. I chose Beta Hi-Fi (reproduced on a Sony SL-2700 VCR) because I was curious to see it up close and suspected that its remarkable audio reproduction would suit the needs of surround-sound decoding. There have been reports that conventional stereo videocassettes weave as they pass over the stationary playback head, causing enough intertrack phase shift to impair Dolby Stereo decoding. Beta Hi-Fi's FM audio recording system is fairly resistant to such problems. (See "How Beta Hi-Fi Works," page 41.) The LV or CED videodisc formats should be just as good for this purpose.

HOW IT SOUNDS

I can sum up the experience of surround-sound movies at home in one word: involving. *The Road Warrior*, despite its on-screen visual excesses, turns out to have an effective, but fairly conservative surround track. There are some quiet scenes with the wind sighing its way across the Australian Outback, splendid flyovers and flash-bys of motorized contraptions in the air and on the ground, and several explosions in which debris falls around and behind you. Overall, the surround effects add punch and realism to the film without distracting from the on-screen action. *Creepshow*, on the other hand, has a rather flamboyant surround track. Especially during ugly and violent moments, much of the music drifts from the front toward the back, getting very big and loud in the transition. This effect, which for lack of a better term I've dubbed "audio zoom," gives you the sense of being forcibly pushed into the often gruesome on-screen action.

I was generally happy with the performance of both the Fosgate and SSI decoders. The SSI's delay line was not much of an asset in my room, and I ended up setting it for minimum delay. (In cinema processors, the surround sounds are passed through the delay line so that people in the back of the theater won't hear the surround information before the on-screen sounds.) In fact, I couldn't understand why SSI bothered to include it at all. A Dolby spokesman explained that it

could alleviate the effects of tape weave on some VCRs.

The Fosgate decoder produced a bigger and somewhat less stable sound field. At first I wondered whether the lack of Dolby B decoding for the surround channel was causing the sound to pump dynamically. Further investigation, however, suggested that

A DOLBY STEREO SAMPLER

STEREO VIDEOCASSETTE and videodisc versions of these recent Dolby Stereo films will yield their surround-sound information at home when properly decoded. In the photo below, Adrienne Barbeau gets the squeeze from Hal Holbrook in a scene from *Creepshow*, a film with a gruesomely effective surround track.



- ALIEN
- ANNIE
- THE BLACK STALLION
- CAN'T STOP THE MUSIC
- CAT PEOPLE
- CHARIOTS OF FIRE
- FLASH OF THE TITANS
- AS BOOT

- THE DEER HUNTER
- DOGS OF WAR
- DRAGONSLAYER
- ELEPHANT MAN
- FAME
- FIREFOX
- FLASH GORDON
- FOR YOUR EYES ONLY
- THE GREAT MUPPET CAPER
- HALLOWEEN II
- THE ISLAND
- LORD OF THE RINGS
- MOONRAKER
- OUTLAND
- STAR WARS

the unit's decoding logic circuits may not match the Dolby encoding scheme precisely. The Fosgate's sound, however, is in no way objectionable, just different from that produced by the SSI decoder.

After living with my video/surround system for several weeks, I don't think I could happily return to "flat" stereo or—shudder—mono. Don't confuse the video surround sound with the quadriphonic music of the mid-Seventies. The music industry never really got the hang of quad before the whole four-channel edifice tumbled. Hollywood, however, has been using one form or another of surround sound for decades and knows how to use it effectively. Indeed, if enough of you become interested in video surround and hear for yourself how exciting it really is, then perhaps a case could be made for the return of four-channel audio—this time done the right way.

V&S

HOW TO CHOOSE ONE OF THE
NEW BREED OF PORTABLE
STEREO VHS RECORDERS AND
A MATCHING VIDEO CAMERA

PORTABLE VCRs WITH STEREO recording ability lately have skyrocketed in popularity. The reasons are straightforward: At home, a portable stereo VCR and companion tuner/timer can perform all the functions of a tabletop deck, including the reproduction of Dolby Stereo films [see "A New Dimension for Video Sound," page 60]; used in the field with a video camera and a pair of mikes, a portable stereo deck can capture events with natural-sounding ambience and a high level of intelligibility.

Your choice of formats in portable stereo VCRs is limited to VHS. The one stereo Beta portable—Aiwa's V-5 Beta Hi-Fi system—is capable of two-channel recording only when anchored to an AC-powered adapter. If you want to hold off buying a portable stereo until you can get one with VHS Hi-Fi (a frequency-modulation technique similar to Beta Hi-Fi that should approach digital audio fidelity), you might have a long wait. VHS Hi-Fi technology is appearing first in tabletop decks, and portables so equipped will probably not show up until late this year. And at least two companies—JVC and Hitachi—have announced that their VHS Hi-Fi recorders will be equipped with a pair of fixed audio heads for playback of all mono and stereo VHS recordings, thus ensuring compatibility with tapes recorded on current stereo VHS decks. (The VHS Hi-Fi stereo soundtrack is recorded along with the video via heads mounted on the deck's rotating head drum.)

Choosing a portable stereo deck from the 11 or so models available (see table) is a relatively simple process. Obviously, you'll want one with

STEREO VIDEO TO GO

BY

FRANK LOVECE



features that make sense both in the field and at home; for the latter application, be sure that the unit's companion tuner/timer has sufficient programming flexibility. Also, a deck with four heads—two optimized for SP and two for EP speeds—will ensure best-possible video recordings, all else being equal.

Finding the right video camera, however, is more challenging. In general, it makes sense to buy the same brand camera as VCR, as camera-VCR connectors are not standardized across brands and hooking up units by different manufacturers can be a problem. Since the large manufacturers usually offer a wide

assortment of cameras at varying prices, sticking to one brand is not all that limiting. The trick is to figure out which one satisfies your creative and budgetary requirements in terms of lens quality, pickup tube characteristics, and degree of automation. (The accompanying chart lists one or two of the top models from each manufacturer.)

The video pickup tube transforms light, transmitted through the lens, into electrical signals that can be used to record the image on tape. It is the heart of a video camera. Tubes differ by type in spectral sensitivity (inherent color balance) and in resistance to wear (Continued on page 66)

V



Canon VR-20A



Quasar VP-5435WQ

VHS STEREO PORTABLE VCRs

MODEL	VCR			TUNER/TIMER			PRICE
	PLAYBACK EFFECTS	FEATURES	SIZE & WEIGHT ¹	MODEL	PROGRAM	CHANNELS ²	
CANON VR-20A	Freeze frame, frame stepping, slow motion, scan (SP, EP)	Dolby B, 4 video heads, video dub, wired remote control	9¼ by 3½ by 9½; 8½ lbs.	VT-10A	14-day, 4-event	105/14	VCR: \$825 T/T: \$475
GE 1CVD-4020X	Freeze frame, frame stepping, slow motion, scan (SP, LP, EP)	Dolby B, 4 video heads, video dub, wireless remote control	9¼ by 3¾ by 9½; 8½ lbs.	1CVT-625	14-day, 8-event	128/128	VCR: NA T/T: NA
HITACHI VT-7P	Freeze frame, frame stepping, slow motion, scan (SP, EP)	High-frequency noise reduction, 5 video heads, video dub, headphone jack, wireless remote control	10 by 3¼ by 10¼; 8½ lbs.	Incl.*	21-day, 8-event	134/134	\$1,400
JVC HR-2650	Freeze frame, frame stepping, slow motion, scan (SP, EP)	Dolby B, 4 video heads, video dub, headphone jack, wireless remote control	10¼ by 4 by 10½; 10 lbs.	TU-26U	14-day, 8-event	105/14	VCR: \$1,150 T/T: \$375
MAGNAVOX VR-8480BK	Freeze frame, frame stepping, slow motion, scan	Dolby B, 4 video heads, video dub, wireless remote control	9½ by 3¾ by 9¾; 8½ lbs.	Incl.*	14-day, 4-event	105/14	\$1,400
MAGNAVOX VR-8481BK	Freeze frame, frame stepping, slow motion, scan	Dolby B, 4 video heads, video dub, wireless remote control	9½ by 3¾ by 9¾; 8½ lbs.	Incl.*	14-day, 4-event	188/188	\$1,500
MINOLTA V-770S	Freeze frame, frame stepping, slow motion, scan (SP, EP)	ANRS noise reduction, 5 video heads, video dub, wireless remote control	10 by 3½ by 10½; 8 lbs.	T-770S	14-day, 7-event	133/80	VCR: \$1,015 T/T: \$400
OLYMPUS VC-103	Freeze frame, frame stepping, slow motion, scan (SP, EP)	Dolby B, 4 video heads, video dub, headphone jack, wireless remote control	9½ by 3¾ by 9¾; 8½ lbs.	VR-201	14-day, 4-event	106/14	VCR: \$950 T/T: \$475
PANASONIC PV-6110	Freeze frame, frame stepping, slow motion, scan (SP, EP)	Dolby B, 4 video heads, video dub, wired remote control	9½ by 4½ by 10; 8½ lbs.	Incl.*	14-day, 4-event	105/14	\$1,100
PANASONIC PV-6500	Freeze frame, frame stepping, slow motion, scan (SP, LP, EP)	Dolby B, 4 video heads, video dub, wireless remote control	9½ by 4½ by 10; 8½ lbs.	Incl.* (PVA-500)	14-day, 4-event	105/14	\$1,300
QUASAR VP-5435WQ	Freeze frame, frame stepping, slow motion, scan (SP, LP, EP)	Noise filter, 4 video heads, video dub, wired remote control	9½ by 3½ by 9¼; 8½ lbs.	VA-531	14 day, 4-event	105/14	VCR: \$1,000 T/T: \$400
				VA-540	14-day, 4-event	128/128	VCR: \$1,000 T/T: \$485
RCA VJP-900	Freeze frame, frame stepping, slow motion, scan (SP, EP)	High-frequency noise reduction, 5 video heads, video dub, wireless remote control	10 by 3½ by 10¼; 8½ lbs.	Incl.*	21-day, 8-event	133/133	\$1,300
SYLVANIA VC-4530	Freeze frame, frame stepping, slow motion, scan	Dolby B, 4 video heads, video dub, wireless remote control	9½ by 3¾ by 9¾; 8½ lbs.	Incl.*	14-day, 4-event	188/188	\$1,500

¹Dimensions in inches, width by height by depth, weight with battery.²Total number of channels tuneable/total number preselectable.³Unless otherwise indicated, all have color temperature, automatic iris, and automatic white-balance controls, as well as a boom-mounted (rather than a built-in) mike.

*Tuner/timer included with VCR as one-price package.



Minolta K-800SAF camera, V-770S VCR and T-770S tuner/timer, K-770S camera



Sylvania VCC-130BK

COMPANION CAMERAS

MODEL	LENS	PICKUP TYPE	FEATURES ³	MIKE(S)	STEREO JACKS	VIEWFINDER	MIN. ILLUM.	WEIGHT	PRICE
CANON VC-20A	f/1.6, 8:1 (10-80mm) variable-speed power zoom, macrofocus	Saticon	Infrared autofocus, audio/video fade-in/out, character generator	Stereo	Yes	1 in. b&w, adjustable eyepiece	15 lux	5½ lbs.	\$1,400
GE 1CVC-4035E	f/1.6, 8:1 (12-96mm) variable-speed power zoom, macrofocus	Newwicon	Infrared autofocus, audio/video fade-in/out, character generator, VCR remote control	Stereo	Yes	1 in. b&w, adjustable eyepiece	10 lux	5½ lbs.	NA
HITACHI VKC-3400	f/1.2, 6:1 (10.5-62mm) 2-speed power zoom, macrofocus	Silicon chip	Edge-detection autofocus, black or white audio/video fade-in/out, character generator	Mono	No	1½ in. color, adjustable eyepiece	35 lux	5¾ lbs.	\$2,000
JVC GXN-70	f/1.4, 8:1 (9.8-80mm) 2-speed power zoom, macrofocus	Newwicon	Infrared autofocus, black or white audio/video fade-in/out, character generator, VCR remote control, timer-controlled recording	Mono	Yes	1 in. b&w, adjustable eyepiece	10 lux	5¾ lbs.	\$1,300
MAGNAVOX VR-8280BK	f/1.4, 8:1 (9.8-78mm) 2-speed power zoom, macrofocus	Newwicon	Infrared autofocus, black or white audio/video fade-in/out, character generator, VCR remote control	Mono	Yes	1 in. b&w, adjustable eyepiece	10 lux	5¾ lbs.	\$1,400
MINOLTA K-800SAF	f/1.4, 6:1 (8.5-51mm) 2-speed power zoom, macrofocus	Saticon	Contrast-comparison autofocus, audio/video fade-in/out, character generator, VCR remote control	Mono	No	1 in. b&w, adjustable eyepiece	10 lux	5¾ lbs.	\$1,330
OLYMPUS VX-303	f/1.6, 8:1 (12-96mm) variable-speed power zoom, macrofocus	Newwicon	Infrared autofocus, audio/video fade-in/out, character generator, VCR remote control	Stereo	Yes	1 in. b&w, adjustable eyepiece	10 lux	5½ lbs.	\$1,300
PANASONIC PK-957	f/1.6, 8:1 (12-96mm) variable-speed power zoom, macrofocus	Newwicon	Infrared autofocus, audio/video fade-in/out, character generator, VCR remote control	Stereo	Yes	1 in. b&w, adjustable eyepiece	10 lux	5½ lbs.	\$1,250
PANASONIC PK-973	f/2.0, 12:1 (9.5-114mm) power zoom, accepts C-mount lenses	Newwicon	Audio/video fade-in/out, character generator, VCR remote control	Stereo	Yes	1 in. b&w, adjustable eyepiece	30 lux	6 lbs.	\$1,300
QUASAR VK-747WE	f/1.6, 8:1 (12-96mm) manual zoom	Newwicon	Infrared autofocus, character generator	Stereo	Yes	1 in. b&w, adjustable eyepiece	10 lux	5½ lbs.	\$1,300
RCA CC-030	f/1.2, 6:1 (10.5-65mm) 2-speed power zoom, macrofocus	Silicon chip	Edge-detection autofocus, black or white audio/video fade-in/out, character generator	Mono	No	1 in. color, adjustable eyepiece	35 lux	5¾ lbs.	\$2,000
SYLVANIA VCC-120BK	f/1.3, 6:1 (11.5-70mm) 2-speed power zoom, macrofocus	Newwicon	Audio/video fade-in/out, character generator	Mono	Yes	1½ in. b&w, nonadjustable eyepiece	10 lux	3½ lbs.	\$1,000
SYLVANIA VCC-130BK	f/1.6, 8:1 (12-96mm) variable-speed power zoom, macrofocus	Newwicon	Infrared autofocus, audio/video fade-in/out, character generator, VCR remote control	Stereo	Yes	1½ in. b&w, adjustable	20 lux	5½ lbs.	\$1,300

Chart by Frank Lovece

(Continued from page 63)

and image retention, among other things. Most of the least expensive cameras use Vidicons. Rugged and reliable, but prone to image-retention problems, these were standard in home video cameras until recently. Of late, Saticon pickups have started appearing in higher-priced cameras. These pickups are more sensitive and less prone to image retention than Vidicons. (Some manufacturers offer proprietary versions of standard tube designs in their cameras: Sony, for one, calls its version of the Saticon a Trinicon.) One type, however, beats all the others in low-light sensitivity. Usually found in expensive cameras, the Newvicon tube is sensitive to both visible light and a portion of the infrared spectrum.

The newest variety of cameras does away with pickup tubes entirely. Priced from about \$1,500 to more than \$2,000, they use silicon-chip image sensors, which are virtually immune to image retention and burnout caused by prolonged exposure to very bright light. Unfortunately, these tubeless cameras require much more ambient light than traditional designs and so far haven't provided particularly high image quality.

On the accompanying chart, a camera's light sensitivity is measured in lux, defined as approximately one-tenth of a footcandle. In practical terms, a video camera rated at 100 lux (10 footcandles) will not reproduce images well in the ambient light of a normally-lit living room. A camera rated at 30 lux will do fine in the same room, and one with a rating of 10 lux should be able to record images on a lamp-lit sidewalk at night.

Virtually all video cameras are equipped with zoom lenses, which are usually specified in terms of zoom ratio, focal range, and "speed." The zoom ratio describes the relative size of an image captured at the lens's extreme settings. A 6:1 zoom ratio, for instance, means that an object would appear six times larger (or six times closer to you) with the lens adjusted to its maximum "length" than it would with the lens untelescoped. A lens's field-of-view characteristics are given via a focal-length range; the smaller the numbers (in millimeters), the wider the lens's maximum field of view. Zoom ratio, in fact, states the relationship between a lens's focal-length extremes. Two lenses, one with a range of 12-

72mm and one with a range of 8-48mm, can each be said to have a 6:1 ratio, but the former will be capable of greater magnification at its longest setting (72mm) while the latter will have a wider field of view over part of its range (8-12mm).

The f-stop is often referred to as the "speed" of the lens. It specifies the lens's maximum iris opening: The smaller the stop number, the larger the maximum iris opening and the "faster" the lens. Lenses rated at f/1.4 or f/1.6—as are many found on video cameras—should be quite sufficient for most lighting conditions. An automatic iris, which saves you the bother of manually adjusting the f-stop under changing light conditions, is standard on most video cameras.

Another convenience feature showing up with increasing regularity is automatic focus. There are several methods used by manufacturers to achieve an automatic focusing lens, and none is completely accurate all of the time. Cameras that bounce an ultrasonic beam off objects to gauge distance won't focus through a car window, for example. And cameras that use infrared echoing or light-based triangulation systems have a hard time focusing on dark objects. Whatever system you choose, make sure that it is defeatable.

All cameras include at least a single microphone. Some have a stereo pair of mikes, usually mounted side by side in a single housing. Many times you'll want to bypass the camera's own mikes and use outboard ones—a simple procedure because mikes plugged directly into the VCR's inputs will override the camera's mikes. (Some cameras even have inputs for outboard mikes.) And since microphones mounted on the body of a camera tend to pick up noise from motor-operated zoom lenses, it's best to select a camera equipped with a telescoping mike boom.

In our table we have included the suggested retail prices of VCRs and cameras. However, when you look at the video ads or walk into a discount outlet, you'll realize that these prices have little to do with actual sale prices. Discounts on video gear are remarkably deep—almost 50 percent in many instances. And you might even save a few dollars by buying the VCR, tuner/timer, and camera as a package. **V&S**

Video Music REVIEWS

A SAMPLER OF CURRENT VIDEODISCS AND VIDEOCASSETTES

POPULAR VIDEO

SHEENA EASTON.

Steve Barron & David Hillier, producers. SONY VIDEO 45 Beta 97W00038; VHS 97W50039.

IRON MAIDEN.

David Mallett & Jim Yukich, producers. SONY VIDEO 45 Beta 97W00030; VHS 97W50031.

BLOTTO:

Metalhead.

Blotto, producer. SONY VIDEO 45 Beta 97W00010; VHS 97W50011.

DAVID BOWIE.

David Mallett & Jim Yukich, producers. SONY VIDEO 45 Beta 97W00028; VHS 97W50029.

J. GEILS BAND.

Paul Justman, producer. SONY VIDEO 45 Beta 97W00036; VHS 97W50037.

Musically, Sheena Easton's pop fluff is too much white bread for me. Nor have I ever understood the appeal of heavy metal, which is what Iron Maiden doles out in stupefyingly generous doses. These videos, though, are for the most part great fun.

Easton is a lifeless performer: attractive, and charming sometimes, but dull. In the live footage, *Morning Train* (9-5), she prances about childishly. To dress her up, producer David Hillier slides screenlike boxes into place at the sides of the stage, flashing our star in various glamorous still poses.

But when she is transformed into a sophisticated young entertainer with a good sense of humor, the difference a producer (Steve Barron) can make is apparent. *Telefone*, shot in black and white, is the best of the lot. The Frankenstein monster stalks Easton in an old castle as she declares her anger over her lover's failure to call. Striding into a nearby cemetery, she is spirited away in a King Kong-like creature's hand, calmly singing all the while.

There is absolutely nothing bland

about Iron Maiden. Nor is there anything strikingly original about their video. Producers David Mallett and Jim Yukich have augmented the heavy metal concert clichés—blinding spotlights, leather and studs, a three-man guitar team working in unison at the foot of the stage—and spliced in plenty of classic, sepia-toned cowboy-and-Indian scenes and sci-fi monsters.

The idea is certainly appropriate as the band drones "run for the hills" over and over, but it seems to work just fine throughout the rest of the tape as well. Interestingly, there's little to differentiate between the two producers at work here, apart from the fact that Mallett sticks to the Wild West, Yukich to monsters.

Meanwhile, Blotto handles the 9-to-5-blues theme on *I Quit* with more humor and style than Easton musters on *Machinery*, and parodies Iron Maiden's brand of heavy metal brilliantly on *Metalhead*. The cuteness wears thin the second time through, but the video is worth an overnight rental.

If the Sheena Easton and Iron Maiden videos are examples of what happens when the music you start out with isn't very good, then what happens when you've got David Bowie singing *Let's Dance*, *China Girl*, and *Modern Love*? Or the J. Geils Band doing *Freeze-Frame*, *Angel in Blue*, and *Centerfold*?

Bowie is probably the most notable exception to all music video rules. An actor who has been experimenting with the visual aspects of music virtually since he began performing, he knows what "presence" means. In short, he is riveting. *China Girl* is the most fully developed cut conceptually; myriad fantasies, magic spells, and some

seaside lovemaking are acted out between Bowie and, naturally, a Chinese woman. *Let's Dance* is more of a fairy tale; the story line is built around a few poor kids and a pair of red dancing shoes. And where someone like Easton is at her worst in a concert setting, Bowie struts out as Mr. Charisma in *Modern Love*.

The Geils tape may be the best of all for the retrograde reason that it carries the spirit of the band's music so well. Director Paul Justman has a snare drum suddenly splashing milk. There are paint fights, and a whole classroom full of centerfolds in fancy lingerie. Fun, and the music holds its own. Which, when you get down to it, is how Phil Spector used to handle things, too.

—IRA MAYER

GIRL GROUPS:

The Story of a Sound.

Stephanie Bennett and Steve Alpert, producers. MGM/UA Home Video MV 600194.

We were doing what we loved best: getting dressed up at night, going on stage, and singing and

HEAVY METAL: For Blotto fans, imitation is better than the real thing.



dancing." That quotation from Arlene Smith, lead singer of the Chantels, perfectly sums up the spirit of the '50s and '60s girl groups captured in this documentary. Many of these performers were fifteen years old or less and had no experience in the music business. Although their groups often faded as quickly as their last hit, that ephemeral quality was exactly what made them fresh and exciting to watch.

While a 65-minute videotape cannot duplicate the comprehensiveness of Alan Betrock's meticulously researched book of the same name, "Girl Groups" does include 25 songs by 17 groups. Concert and television footage provides a fast-paced performance montage, interspersed with brief discussions with songwriters and singers from the era. Among the best interviews is that with the Supremes' Mary Wilson, who reflects eloquently on her career without the cloying nostalgia that mars the memory of many former stars.

That the Go-Go's and other contemporary female groups got some of their boys-and-parties inspiration from these ensembles is without question. What is perhaps a little more surprising is the way film was used for illustration when the songs were performed on camera. It appears that there was music video before there was MTV. Long before. On *Tell Him*, for example, the Exciters roam around a zoo, singing to the obvious delight of polar bears, lions, swans, and deer. For *Dancin' in the Streets*, Martha & the Vandellas go romping through a Detroit auto assembly line, climbing into unfinished convertibles.

As "Girl Groups" points out, many of these groups were faceless, with the same musicians and singers used from one recording session to the next. Prolific producer Phil Spector, for example, often worked with Darlene Love (shown here singing *He's a Rebel*), even though she was primarily known as the lead singer of the Crystals. In some cases—Ronnie Spector, Diana Ross, Martha Reeves—individuals eventually went on to break out of the group mold. (Those who started out as soloists, such as Dionne Warwick, are not represented.) But figuring out who's who among the girl groups is an academic exercise; the material and the sound are what count.

—I. M.

MAKING MICHAEL JACKSON'S THRILLER.

Jerry Kramer, director; Michael Jackson, John Landis, & George Folsey, producers. VESTRON Video V 1000 (VHS stereo). Beta Hi-Fi. VB 1000. CED. VC 1000; Laserdisc. VL 1000.

All during 1983, Michael Jackson had people buzzing. The morning after the *Motown 25* television special, the talk centered on his spinning, skating dance to *Billie Jean*. And it was his riveting presence as a peacekeeper/dance-instructor that made the *Beat It* video repeatedly watchable. Excerpts from both of these performances are included in "Making Michael Jackson's *Thriller*," which is based on the ambitious 14-minute video of the album's title track.

The hour-long program begins with the John Landis-directed *Thriller* and then goes on, in some detail, to show how it was put together. (Landis's film credits also include *Trading Places*, *The Blues Brothers*, and *An American Werewolf in London*.) But the documentary footage almost has the effect of undercutting *Thriller*'s impact and demystifying its star. This is the first Jackson video material made available to the home market, and it chooses to show him being fitted for yellow contact lenses, tentatively working out dance routines, being effusively praised by fans and colleagues, and being lifted in the air and tickled (?) by Landis.

The *Thriller* short is a film-within-a-film, as Jackson asks costar Ola Ray, a former *Playboy* Playmate, to be his girl, then warns her that he's "different." The moon comes out from behind a cloud, and he turns into a werewolf. Their alter egos have been watching this scene and get up to leave the theater as he starts to sing *Thriller* to her; despite the fact that it isn't much of a song, it's a great moment. We've never gotten to see Jackson turn on his charm in a romantic-sexual context before, and in this long dolly shot he's teasingly seductive.

One major reason why "Thriller" has become the best-selling LP in history is that Jackson is so telegenic. So it's odd that this program contains more of Jackson in a makeup chair than on stage. A compilation of the *Thriller*, *Beat It*, and *Billie Jean* videos, the *Motown 25* segment, and more Jackson 5 television and concert performances (there's a brief clip from *The Ed Sullivan Show* in 1970) would have been a much more auspicious home-video debut. —MITCHELL COHEN

BETTE MIDLER: Divine Madness.

Michael Ritchie, producer & director. RCA/WARNER HOME VIDEO 13148

The ways Bette Midler uses a stage and plays an audience are as much a trademark as the high emotional pitch she brings to a variety of musical styles, jokes, and dead-on parodies. On a TV screen you can see her "divineness," but you can't fully appreciate how she fills a theater with her presence. "Divine Madness" features shattering performances of *The Rose*, *Stay with Me*, and *I Shall Be Released*, and her Dolores DeLago medley, sung and "danced" from a motorized wheelchair, is as hysterical as ever. An excellent memento of a fine Broadway show, but don't mistake it for the real thing. —I.M.

THE UTOPIA SAMPLER.

Todd Rundgren, video director & audio producer. Sony 97W 00007 (Beta Hi-Fi); 97W 50004 (VHS Stereo).

TODD RUNDGREN.

Todd Rundgren, video director & audio producer. Sony 97W 00009 (Beta Hi-Fi); 97W 50006 (VHS Stereo).

Back in 1975, Todd Rundgren created several 3/4-inch videotapes in his home library, using a custom-made video synthesizer and recordings of works by Stravinsky, Ravel, and Debussy. He took the tapes to the Sony Corporation, where he was told, thanks, but there simply is no market for music video. Call it fate or call it a fake-out, but Sony has apparently changed its mind, for Rundgren produced, directed, or served in a consultatory role for three of the company's first six Video 45s, the 12- to 15-minute videocassettes.

Rundgren has long been something of a techno-freak. His instrument, whether in audio or video, is the recording studio. Having started out as an audio engineer in his teens, he went on to lead his own groups (Nazz, Utopia), produce various artists (the Band, Hall & Oates, Grand Funk), and record and tour as a soloist. Many of his 20 albums are one-man-band, self-produced affairs. Among the most memorable is 1976's "Faithful," on which he exactly replicated half a dozen hits by the Beach Boys, the Beatles, and other artists, playing all the instruments and singing all the vocals himself.

After fully mastering the art and craft of audio recording, Rundgren



UTOPIA, or the Four Rodents: Kasim Sulton, Rundgren, Roger Powell, John Wilcox

moved on to video, sinking most of his album royalties into the construction of Utopia Studios (in Bearsville, New York), where several of the Sony 45s were taped. Upon its completion in 1979, he received his first major commission—from a very young RCA Selecta-Vision—to program Tomita's version of Gustav Holst's *The Planets*. RCA planned to use the work as a demonstration of its brand-new CED system and of its commitment to original music-video programming.

Rundgren illustrated half of the score and screened it at several conventions. It was mostly dreamy stuff—floating images and computer-generated graphics all put together on Bearsville's Rutt-Etra video synthesizer. Unfortunately, the project became far more expensive than anyone had anticipated, and Rundgren ran out of funds. *The Planets* was destined for obscurity anyway, since the Holst estate refused to grant the synchronization rights for Tomita's version of the original work.

Rundgren continued with his own projects. In the late Seventies, he was among the first to use video with his live performances, accompanying them with a dozen or so strategically placed monitors that displayed oozing color patterns reminiscent of mid-Sixties light shows. His inventive, almost homemade-looking work bears very little resemblance to the slick, expensive productions of such acts as Devo, Billy Joel, or Duran Duran. As with his best audio recordings, his video performance and direction are wry and playful, his visual images

meeting and mating with the lyrics with rhythmic precision and conceptual accuracy. Unlike Duran Duran's, his cassettes contain no violence, and his attitude toward the female anatomy is more celebratory than sexist. His animations are brightly colored and swirling, and he tends to favor odd juxtapositions of different-sized shapes and images.

On *Feet Don't Fail Me Now* (not to be confused with Little Feat's LP "Feats Don't Fail Me Now") from "The Utopia Sampler," the band members are dressed up as giant rodents. As the cut starts, they peer over the edge of a bathtub; later they dance atop red-checked, then black-checked floors. Backed by an infectious melody, they fret over their eventual fate from inside a sink, a drain looming ominously at the center of the screen.

But Rundgren isn't out to be just cute. On the same cassette, he takes Utopia's *Hammer in My Heart* and by rapidly repeating single frames of various activities—a hand strumming a guitar, a stick hitting a drum—creates clipped, hammerlike images, all timed precisely to the song's bubblegum-pop beat.

Hideaway, from "Todd Rundgren," finds the artist as a tiny figure climbing up the side of an enormous torso. He lands just below its navel and sings, "I'm not trying to invade your privacy." It's a suggestive image, but it's funny and tasteful. On *Time Heals the Wounds That No One Can See*, Rundgren's image fades in

and out of a series of René Magritte-like animations. On *Can We Still Be Friends*, a miniature ballerina dances atop Rundgren's grand piano, and is then multiplied and superimposed on his face, where he watches her intently. Unfortunately, Rundgren's voice comes off poorly here and throughout the 45. In this case, the problem stems partly from the milking, which emphasizes his nasal tone, and partly from the off-screen band, which sounds as though it was recorded inside a garbage can. The audience applause at the end of *Friends* doesn't help matters; the whole clip seems like a classic example of TV overdubbing at its worst.

In fact the Rundgren solo tape has exceptionally poor sound—the synthesizer and piano parts drag along as though played back ever-so-slightly slower than the speed at which they were recorded. "The Utopia Sampler" is better, though still not as good as one would expect. The songs on both cassettes are among the less adventurous of their respective artists' work: Strong melodies, straightforward lyrics, and simple rhythms. They're all a kind of bubblegum pop, updated with new-wave trappings. In light of his ability to successfully illustrate a challenging score like *The Planets*, it's surprising that Rundgren didn't choose at least one number from his real hard-rock repertory. The most interesting cut is Utopia's *You Make Me Crazy*, though even here it seems as though the primary consideration was visual potential rather than musical integrity.

The Video 45 is a great concept: With little of the video music currently available in full-length cassette or disc sufficiently interesting to warrant an hour's viewing time, 10 or 12 minutes seems just about right.

Pioneer should have laser disc video singles out in Japan this summer. Watch for an excellent light-show accompaniment to live footage of Jimi Hendrix, programmed by Steve Bech, a West Coast computer-freak counterpart to Rundgren. —I. M.

THE WEAVERS:

Wasn't That a Time.

Jim Brown, director; Jim Brown, Harold Leventhal & George Stoney, producers. MGM/UA Home Video MD 100218.

I remember watching "Wasn't That a Time" in the small movie house beneath New York's Plaza Hotel and

thinking that this was the first contemporary musical film I would want to own. A documentary that provides just enough history for those unfamiliar with the Weavers—the late '40s and '50s folksong quartet featuring Pete Seeger, Ronnie Gilbert, Lee Hays, and Fred Hellerman—it is charged with memories for those who "knew them when" and with music that transcends generations.

It was the Weavers whose carefully structured four-part harmonies put *On Top of Old Smokey* at the top of the charts, who made Leadbelly's *Goodnight Irene* a national singalong and who, had they not been victims of Senator Joe McCarthy's blacklist, would have had a good chance at changing the national anthem from *The Star Spangled Banner* to Woody Guthrie's *This Land Is Your Land*.

"Wasn't That a Time" is built around a 30th (or so) anniversary reunion concert held at Carnegie Hall in 1981. It opens with the wheelchair-bound Hays leafing through scrapbooks with *Darlin' Cory* playing in the background. There are scenes from the Weavers' own reunion-picnic where the idea for a concert and documentary first came up, as well as glimpses of each of the Weavers' individual careers and ever-so-brief testimonials by Mary Travers, Don McLean, and Arlo Guthrie. An a cappella duet (*Hay Una Mujer*) between Gilbert and feminist writer-singer Holly Near is among the most dramatic moments, both in its musicality and in the intensity of the communion between the two artists.

The sound is mono but nonetheless outstanding, and the balance of the four voices, guitars, and banjos is quite natural. Simple overhead miking at the picnic and rehearsal segments, in particular, results in a warm, lifelike blend of their distinctive harmonies. The camera work is equally straightforward; there is no fast cutting to keep "the action" going. Beautifully restored television clips are artfully inserted.

The script was written by Hays, who also serves as narrator and wry critic. A fitting spokesman, he epitomizes all that the Weavers stood for: a combination of left-wing politics, good humor, and a propensity for good times. Though subtle, the humanity and humor throughout "Wasn't That a Time" are truly overwhelming—no more so than at the end, when a simple

title on the screen indicates that Hays died nine months after the Carnegie Hall concert. The closing numbers of that historic performance are almost as cathartic as the concert itself. —I. M.

CLASSICAL VIDEO

TCHAIKOVSKY:
The Sleeping Beauty.

PRINCIPAL CAST:

Princess Aurora	Irina Kolpakova
Prince Désiré	Sergei Berezhnoi
The Lilac Fairy	Lubov Kunakova
Carabosse	Vladimir Lopukhov
Catalabutte	Gennadi Selyutski
Bluebird	Andrei Garbuz

Students of the Vaganova School of Ballet; Orchestra of the Leningrad Theater of Opera and Ballet, Viktor Fedotov, cond. Choreography by Marius Petipa; staged by Konstantin Sergeev. [Elena Macheret, director; Svetlana Kononchuk, producer.] PIONEER ARTISTS PA 83-055 (CX-encoded laser disc)

MASSENET:

Manon.

CAST:

Manon	Jennifer Penney
Des Grieux	Anthony Dowell
Lescaut	David Wall
Monsieur G. M.	Derek Rencher
Lescaut's Mistress	Monica Mason
The Gaoler	David Drew
Madame	Gerd Larsen
Beggar Chief	David Peden

Artists of the Royal Ballet; Orchestra of the Royal Opera House, Ashley Lawrence, cond. Choreography by Kenneth MacMillan; music orchestrated and arranged by Leighton Lucas with Hilda Gaunt. [Colin Nears, director; Vic Godrich and Graham Haines, sound producers.] PIONEER ARTISTS PA 83-047

Tchaikovsky's *Sleeping Beauty* is for many the summit of Russian classical ballet. As Lincoln Kirstein suggests, "it remains academy, ritual, reminder." Its particular historical resonance lies in its subtext, which carries the flattering suggestion (in the "sleep of a hundred years") that the court of the Sun King has been recreated in that of the Romanovs.

A few will find the ballet a bit too crystalline. There's not much suspense in a story whose happy outcome is predicted before the heroine is out of her cradle—predicted, at least, for those schooled in the baffled intricacies of traditional balletic mime. A dance whose strongest feeling is a pinprick, a hero and heroine whose faces are never crossed by anything as disfiguring as an emotion, will have less appeal for some than the passionate masochism of a *Giselle*.

Yet *Sleeping Beauty* can deeply move those not immune to the clarity of its form. Its stately pace elevates pose over movement, posture over gesture, poise over passion. Its rhythms

are those of risk and balance; its signature attitudes and arabesques extend the body in a sort of sculptural legibility that is one of the glories of the danse d'école.

The outstanding *Sleeping Beauty* today is probably the current Royal Ballet version seen occasionally on Metromedia television stations (and whose possible LaserDisc release is effectively forestalled by this Kirov performance). Still, the production here is an important one, the Kirov being the direct heir to the Maryinsky, the Imperial Theater for which Marius Petipa first staged *Sleeping Beauty*. If the court sets seem a bit unevocative compared to the Bibiena extravaganzas of the Royal, and the frequent blonde wigs ludicrously dispensable, the chance to watch a production of such pedigree more than compensates.

Russian ballet careers develop slowly and last long. Those used to Balanchine's coltish nymphets may be put off by a few of the Kirov's superannuated fairies, their calcified techniques sometimes brittle and unyielding. (Their loyal fans don't seem to notice, bringing them back for bow upon bow after the slightest exertion.) Irina Kolpakova herself was nearly fifty when this was filmed, but if the Kirov's long-reigning prima ballerina no longer commands the liquid ease of youth, her impeccable schooling goes a long way for a role as sharply etched as Aurora. If the working leg doesn't get quite as high as it probably once did, the poses are reached quickly and held securely. Only the rockiness of her bourrées, those hopping walks on point, betrays the weakness in feet and ankles.

The highlight of her performance is not the Rose Adagio, but the Act III grand pas de deux, of a musicality not always so evident elsewhere. (Unexpected reserves of strength suggest that the act may have been filmed on a different night.) As her cavalier, Sergei Berezhnoi is supplely buoyant, while Lubov Kunakova, as the Lilac Fairy, is securely long-limbed, with marvelously expressive hands. A worthy production, if not the freshest today.

Kenneth MacMillan's Royal Ballet *Manon*—set to a score skillfully patched together by Leighton Lucas and Hilda Gaunt using bits and pieces of non-*Manon* Massenet—is a smart

addition to Pioneer's line. An honorable contemporary ballet of the kind that audiences like more than critics, its appeal nicely complements that of *Sleeping Beauty*. Part of that attraction lies in the accessibility of its story. MacMillan's deepest instincts have always run toward plot and character; his gift is for ballets whose shifting emotions are easy to read, and here he makes it possible to follow *Manon* without a program.

MacMillan has characteristically been generous in the lush choreography he provides his ballerinas. It's not the novel's hero Des Grieux but Manon herself who is most richly developed—vulnerable, selfish but beguiling, devoted if inconstant. MacMillan is at his most cunning in depicting her sexual allure. She's a tease, but a largely unconscious one, as if seducing men were something she just did by nature. When she gets off the boat at Le Havre, she almost can't help provoking the jailer, with predictably disastrous results.

Elsewhere, MacMillan is not so successful. His consciously restricted palette can become repetitious. The pas de deux (usually one of his strengths) offer some elegant poses but are otherwise rather generalized, emotionally unparticular—the real characterization lies elsewhere. The extensive crowd scenes, whether in town or brothel, don't really illuminate the lovers' story as the feud scenes in MacMillan's *Romeo and Juliet* do. Giving so much of the ballet to Manon does create problems; structurally, after all, this remains Des Grieux's tragedy.

Still, Jennifer Penney's performance redeems everything MacMillan has thrown his heroine, and then some. She eclipses even Anthony Dowell (LaserDisc's *Swan Lake* Prince), despite the clarity of his line and the nobility of his dancing. Whether in her delicate, almost filmy arabesques, the expressive warmth of her arms, or the supple fluidity of her floating-on-air point work, Penney's dancing clinches her position as *prima assoluta* of the Royal Ballet. It's a breathtaking star performance, on a level she has only hinted at before, and by itself sufficient reason to acquire the videodisc.

The problems of televising ballets are vast, enforcing a series of Solomonic decisions in which all

choices are suspect, all victories Pyrrhic. Do you keep the stage composition by staying far away, only to lose focus and personal warmth? Do you come in close, but tantalize us with glimpses of what's clearly just out of the frame?

The former method, so often necessary in *Sleeping Beauty* to embrace the rich tapestry of that ballet's pageantry, reduces dancers to participants in a flea circus, even in the comparative clarity of LaserDisc. The close-in solution gives us in *Manon* the heroine's lover dancing for and yearning toward someone—we can only guess it's her—and in *Sleeping Beauty* the wicked Carabosse casting her spell on Aurora after the pinprick as the director's crosscutting isolates each in separate shots. In neither case do we *feel* the energy, erotic or malignant, traveling from one character to another.

In general, the Covent Garden filming of *Manon* is the more invisible, the camera usually convincing us it's looking where we would choose to. The Russians' technique for *Sleeping Beauty* is less fluent, the transitions jerkier. (The comparative technical leanness of the Soviet cameras does mean that we are spared things like the cacophony of dissolves that so ravaged Baryshnikov's *Nutcracker*, dissolves so frequent they set up their own competitive visual rhythm, entirely independent of that of the music or the dancing.)

The particular drawbacks of this *Sleeping Beauty* are subtle ones; they include shapeless pictorial compositions and full-view cameras set just a shade too low to present any true three-dimensional sense of the stage picture. More important, the often awkward cutting from one view to another, from a full corps of fairies to a close shot of the Lilac Fairy herself, sets each in a separate *kind* of space. We miss that symbiosis so central to classic ballet, where a ballerina is said to dance not "the swan queen" but *Swan Lake*, her style ideally epitomizing that of the ballet, of the company.

Some problems are the defects of the Russians' rather chaste virtues. The comparative absence of arty perspectives puts most shots at something of a middle distance, leaving the eye unsure where to focus. Curiously, offering only half a stage composition, while permitting a closer

view, may deprive the eye of precisely those clues the choreographer has provided to direct our attention, particularly in the mannered precision of Petipa's work in *Sleeping Beauty*. Among the brief glimpses we get of the awakened court that ends Act II, it's the long-hot of the whole grouping, some kneeling, some bowing—a symphony of angles—that resonates most deeply. (In *Manon*, MacMillan's more naturalistic, less



MANON: Royal Ballet's Dowell and Penney in an elegant pas de deux

formal groupings offer fewer problems.)

Given the difficulties of recording a pit orchestra in live performance, the sonic quality of the *Manon* is particularly impressive, Manon's own theme emerging with remarkable delicacy, first on flute and harp, later in the solo violin. The sound of *Sleeping Beauty*, despite a few odd moments (plucked strings are overprominent, the harp oddly percussive), is only slightly less impressive. It's fuller and more relaxed than many of the Melodiya releases we've all groaned through.

—THOMAS W. RUSSELL III

COMPUTERS & MUSIC

BY

DR. ROBERT MOOG

FOR A GROWING number of musicians, computer technology is the greatest advance since the invention of catgut. That computers should be capable of making music is not surprising at all. Music is, after all, a form of communication—of organizing and transmitting data. The alphabet of music consists of notes. Melodies, chords, and rhythmic patterns are the words and phrases of music. And just as computers can generate characters to make text or a graphic design, they can also produce a stream of numbers to represent a musical waveform.

In their simplest form, digital music circuits make sounds by switching a speaker on and off. A simple program that instructs the computer to turn a speaker on, wait a very short while, then turn it off, wait again, and then repeat the procedure a specified number of times will create a tone. The waiting time determines its pitch, while the number of cycles of repetition determines the tone's duration. If the on and off times are the same, the resulting waveform is called a square wave, and the musical quality is somewhat hollow. If the on and off times are not the same, the waveform is called rectangular, and the sound may be saxophone- or oboe-like in quality. If the on and off times are programmed to change randomly, you'll hear a pitchless noise.

Although any computer can

produce square and rectangular waves, only those equipped with sound synthesizer circuits can produce other waveforms. Some sound synthesizers are built on single integrated circuit chips that can be programmed to produce a wide variety of waveforms and envelopes. (The envelope of a sound is its outline as it builds up, sustains, and dies away.) Other synthesizers are built on circuit cards that plug into the computer, or they may be completely separate peripherals.

Computer-controlled sound synthesizers may be all-digital (the waveform itself is generated from digital data), all-analog (waveforms are produced continuously by analog circuitry that responds to digital instructions), or a combination of the two (the waveform is converted from digital to analog, then passed through more analog circuitry). Digital sound-synthesizer circuits handle numbers that represent a succession of points along a waveform. Analog circuits, on the other hand, manipulate voltages that change continuously to generate the desired waveform.

Digital synthesizer circuits are more accurate and reliable than their analog counterparts. However, since they produce waveforms from a series of numbers in time, the resultant waveforms are made up of discrete steps, the "choppiness" of which can

sometimes be audible. Both methods of synthesis have their advantages and limitations. Some musicians prefer the smooth, distortion-free analog waveforms, while others favor the accuracy and versatility of digital generators.

Computer programs enable you to design your own sounds or instruments. Since such instruments exist as data that define waveforms and envelopes, they can be stored in libraries on disk or tape. Simple music-creation programs enable you to play scales and melodies through the computer's speaker. To use a typical program of this kind, you type in codes for the pitches and durations of the notes.

More sophisticated programs let you vary a rectangular wave's tone color, adjust the overall tempo, produce trills and glides, and store tunes that you have programmed on disk or cassette tape.

Using a computer with a built-in sound synthesizer or adding a digitally controlled synthesizer peripheral to a computer, you can make music with a wide variety of interesting tone colors. The Commodore 64 has one of the most versatile built-in synthesizers of any personal computer. (See "Say Hello to SID," next page.) The 64 uses a proprietary chip that produces three tones, each with programmable waveform and envelope.

Some of the most musically advanced computer programs are designed around the Mountain Computer MusicSystem, an eight-voice digital tone generator for the Apple II. Among the most popular of these programs are the Alpha Syntauri (see "The Alpha and the Apple," page 79) and Soundchaser systems. Both use the MusicSystem in combination with a four- or five-octave music keyboard and their own operating software.

Lately, manufacturers have even started adapting dedicated electronic synthesizers to operate under computer control. An interface called MIDI (Musical Instrument Digital Interface) allows electronic instruments, computers, and similar devices to be connected together with a minimum of fuss. This means that you can use your computer to control any MIDI-equipped electronic musical instrument. You can even combine a group of instruments into a computer-controlled orchestra.

V&S

Were it just for its music-making capabilities, the Commodore 64 personal computer would still prove remarkable. By dint of its built-in three-voice music synthesizer chip, this \$300 computer has as much potential for music creation as synthesizers selling for upwards of \$1,000.

The 64's nine-octave music-synthesis chip is dubbed a Sound Interface Device, or SID. It can generate four waveforms—triangle, sawtooth, noise, and variable-width pulse. A programmable filter can be selected for each voice, providing high-pass, low-pass, bandpass, and notch filtering. SID also provides a programmable envelope generator (attack, decay, sustain, release), along with variable resonance and master volume controls.

But an integrated circuit that generates nice sounds is only part of the battle. To use it, you have to be able to control it. With an analog synthesizer that's relatively easy: Make each parameter respond to a voltage-controlled oscillator (VCO) or amplifier (VCA), and have lots of knobs and maybe a piano-type keyboard to manipulate the voltages feeding the VCOs and VCAs. A computer doesn't have knobs, however, nor does it have voltage control. Everything is digital, so the chip has to be told what to do by those strings of ones and zeroes known as binary words.

The most direct way of controlling a digital device is to feed it binary instructions directly from a terminal's keyboard, but this can get incredibly cumbersome for an error-prone human with a limited attention span. The solution is software that provides a set of English-language commands that the computer can interpret into the proper binary codes. Each of the three music-creation programs available from Commodore—Music Machine, Music Composer, and a Basic-language program described in the computer owner's manual—provide such an interpreted control scheme.

The Music Machine program (\$20) comes in a cartridge that plugs into a slot on the 64. Turn on the computer, and the program announces itself on your TV screen by displaying a blank music staff (sans clef) and the controllable parameters. Press a couple of keys and you discover something else in the program: Two rows of keys are now functioning as a piano-type

SAY HELLO TO SID

BY

PAUL D. LEHRMAN

PROGRAMS FOR HARNESSING THE MUSIC-MAKING POWER OF
SID—THE COMMODORE 64'S SOUND INTERFACE DEVICE



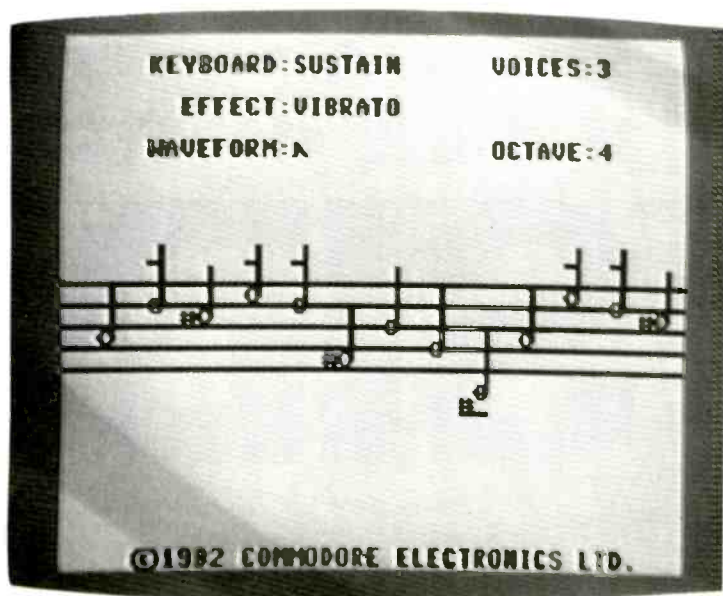

WITH MUSIC MACHINE, the notes you play on the computer's keyboard are visually represented on screen, along with the status of the controllable parameters.

MICHAEL ROMANOS

keyboard, black keys on top and white below. Press a key, and a note sounds (through your TV speaker or through your home audio setup if you've made the proper connection) as well as showing up on the staff displayed on the TV screen. Sharp signs appear before each note wherever appropriate; there are no flats. Also, regardless of their duration, all notes are depicted as half-notes.

The controllable parameters are labelled Keyboard, Waveform, Effect, Octave, and Voice Select. Keyboard gives you a choice of three rudimentary envelopes: One causes a note to sound until the next is played, the second holds the played note as long as its key is pressed, and the third gives each note a piano-like attack and decay. Waveform lets you switch among triangle, sawtooth, square, and pulse waves. Effect will give you either a glide between notes (portamento), an FM-type vibrato, or, if you like, a chorusing effect. Octave shifts the keyboard up or down over a range of almost six octaves.

You can also order the computer to generate a rhythm line as accompaniment to a melody you're creating—à la the band boxes built into organs from the '60s. This feature is controlled by the four function keys on

the right side of the keyboard. One turns the effect on and off, two change the tempo (which can also be controlled with an optional game paddle), and one cycles through seven rhythm patterns.

Although the rhythms are limited (the patterns are all variants of 4/4 time, except for one that comes close

to 3/4), the rest of the program is quite good. There are no signs of the high-frequency distortion that you can hear in some far more expensive dedicated digital synthesizers. Overall, the sounds are very clean, and some are quite pleasant. The major drawback of the program is that it doesn't provide any means for storing compositions or parameter settings. Nor is it fast enough to convert the 64 to a performance instrument. But as an educational tool or a rudimentary introduction to the principles of digital music synthesis, it scores high marks. Remember, too, the Music Machine costs only \$20.

The Basic-language program described in the 64 owner's manual solves the problem of storing your music, but it's not intended for the casual computerist. The manual is exhaustive in explaining the capabilities of the SID chip and how to control them, a process that—at least in Basic—entails sticking numerical values into specific memory locations via "poke" commands. The memory locations are all expressed as five-digit numbers, and each of them relates to a single function—waveform, envelope, pitch, filtering, or number of voices. Needless to say, creating a sound this way can get very complicated. Here is a program for playing a high C with no special effects:

THE HOOK-UP



A DIN ADAPTER lets you route the 64's audio and composite video outputs separately, as above. A built-in RF modulator allows direct connection to a TV set.

```

5 FORL=54272T054296:POKEL.0: NEXT
10 POKE 54296,15
20 POKE 54277,190
30 POKE 54278,89
40 POKE 54273,34
50 POKE 54272,75
60 POKE 54276,33
70 FORT=ITO300: NEXT
80 POKE 54276,32

```

The first line clears all the memory locations; the next five lines set the volume, waveform, envelope, and pitch; and the last three start the note, determine its duration, and stop it. A program in the manual for playing one bar of "Michael Row the Boat Ashore" consists of 15 lines—some of which are 64 characters long. Programs can get much more complex when you try to play more than one note at a time or engage a special effect. The chief advantage of such a program is that it can be customized to do a certain job well: If you like scales, for instance, you can write a 16-line program that will play them forever. And you can save programs on an external mass-storage device, such as a cassette recorder.

The Music Composer program (\$20), which also comes in a plug-in cartridge, is similar to Basic in that it is more of a music-creation language than a real-time instrument program. A choice on the initial menu gives you a brief version of Bach's *Jesu, Joy of Man's Desiring*. As it plays its three voices, notes appear on a grand staff (again, sans clefs) on the screen, with each voice highlighted in a different color. The menu also lets you assign different instruments to each voice. You choose from a list of ten sounds: Nine are predefined, and one you can design yourself.

Creating a new instrument is simple. The program takes you through a series of steps in which you choose the sound's various parameters. You can listen to it by calling up a routine that turns the middle and top rows of the computer keyboard into an octave-length piano-type keyboard or by using it as one or more of the voices in a stored tune.

But the heart of the program is its edit mode, which lets you compose by entering sequences of notes. And here is where things start to get complicated. Although it is simpler than Basic, the Music Composer language, which includes commands for pitch, duration, and special effects, still takes a lot of getting used to. A

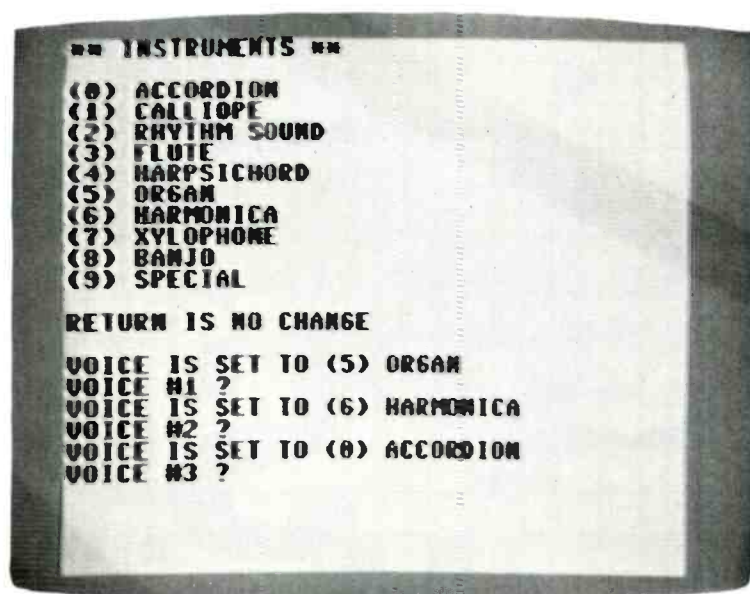

MUSIC COMPOSER OFFERS nine preset instrument sounds and one that you can design yourself. Each voice can be assigned a different instrument.

sample line of code looks like this:

```
0010V104QCEFG(3V104HGV203EV3C)
```

The first four digits make up the program line number. Since each program line can contain only 40 characters, you may need many lines for one composition. "V1" is voice one, "04" signifies the fourth octave, "Q" is the length of the notes to follow (in this case, a quarter-note), and "CEFG" are the notes themselves. The first "3" following the open parenthesis means repeat the next segment three times. "V2" and "V3" turn on the second and third voices, and "H" orders a half-note value.

If you followed the above explanation, you now know this line will play C, E, F, and G as quarter-notes followed by four half-note repetitions of a C-major triad played in first inversion, open position. You can check the accuracy of your codes via a playback feature that causes each note, voiced appropriately and with the proper duration, to sound as you enter it.

Other letter commands are used to create special effects via a variety of techniques, including pulse-width modulation, ring modulation, dynamic filtering, and something called sync modulation. (The last, which I had never encountered before, seems to enable you to play a single note in two

voices, detuning them far enough so that they beat against each other.) The rate and depth for some of the effects are set using a separate special effects menu. Since all of the effects use the SID's third voice as a low-frequency oscillator, you are limited to two voices when you call in a special effect.

Music Composer is a flexible programming language, and programs created with it can be stored on cassette tape. (Because of a unique connecting scheme, you will need Commodore's own \$75 Datasette cassette recorder to do so.) But Music Composer has its negative aspects, as well. Without hours and hours of practice, it's very slow and difficult to use. And it has one particularly annoying quirk. When you reach the end of an edit line, the program doesn't warn you or cause the cursor to jump to the next line. Instead, as you continue typing, the last character in the line continues to be replaced.

While these programs may not have much appeal for the serious musician, music students and computer hobbyists will find them fascinating tools. And despite our complaints about the software, we remain convinced that the Commodore 64 is one of the most useful and affordable music synthesizers ever.

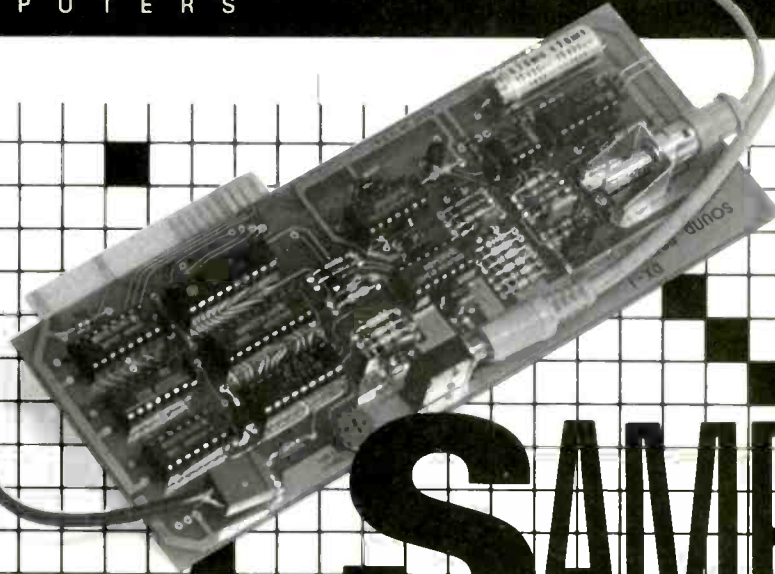

SAMPLE and HOLD

BY

PAUL D. LEHRMAN

A FASCINATING AND inexpensive introduction to digital sound creation, the DX-1 sound processing system from Decillionix differs from most other computer music-making systems by virtue of its ability to record real sounds, which then become the digital building blocks for a variety of interesting effects. You need an Apple II computer to use the system, but the combination gives you a degree of creative control usually found only in dedicated professional devices.

The DX-1 package (\$239) consists of a circuit card, which plugs into one of the expansion slots inside the Apple, and several disk-based programs. The circuit board contains the necessary analog-to-digital (A/D) and digital-to-analog (D/A) converters, a mini jack for line-level or microphone inputs, and a rotary control to adjust the sensitivity of the system for different inputs. Audio output appears at a standard RCA phono jack, and a cable is provided for routing the signal to an amplifier or tape recorder.

You begin your session with the DX-1 by booting the program disk, which automatically loads the Apple's memory with the control program and a preset library, or "soundbase," of

Digital sound recording, real-time playback, and sequencer functions in an add-on package for the Apple II computer

eight high-quality percussion instruments—snare drum, bass drum, wood block, cowbell, two tom-toms, and two cymbals. The main program menu then offers you three options for accessing the percussion sounds.

First, you can tie the sounds to one of 12 rhythm patterns and adjust speed and volume to your liking. In the second option, you can arrange the sounds into any of eight special-effects patterns, three of which I found particularly interesting. "Cycle" plays each of the preset instruments in sequence with increasing speed and pitch. "Falling Object" repeats one sound faster and faster, as if it were a ball bouncing on the floor. And "Forward/Backward" plays a sound normally and then in reverse, an effect similar to that obtained by rocking an open-reel tape back and forth.

"Real Time Record/Play," the

third menu option, is where things really start to get exciting. In this mode, an individual sound can be played in real time by tapping the Apple's keyboard. The sound appears on a pair of keys, enabling you to trill or "roll" it quickly.

The two-key approach is also integral to the recording feature. With the system in the recording mode,





THE DX-1 CIRCUIT CARD fits into one of the computer's expansion slots (opposite, bottom). Author Lehrman tests the system's fidelity with a pitch pipe (above).

striking the left-hand key of a pair turns on the recording function for a specific chunk of memory. The system waits until it "hears" a sound, either from a microphone or an external line-level source. The sound is then digitized and loaded into memory. When the allocated memory space is full, the Apple's speaker beeps and the recording stops. Striking the right-hand key of the pair then lets you play back your digital recording. Loading a sound into a section of memory erases what's already in there, but since each new sound can be saved on disk, nothing need be lost.

THE SOFTWARE gives you a great deal of control over the recording and playback functions. The amount of memory set aside for each sound can be specified individually—anywhere from one byte to a maximum of 24,000 bytes (the total amount of memory left after the DX-1 control program has been loaded). The sampling rate also is adjustable, from 780 Hz to 23.2 kHz (for a maximum signal bandwidth of 11.6 kHz). At the slowest sampling rate, the system can store about 31 seconds of sound, but with very poor quality. At the fastest speed, maximum recording time is slightly more than one second.

The playback rate for each sound can be specified as well, which enables you to alter pitch over a range of more than five octaves. The "trigger" level

of the recording input is adjustable so that stray noises do not accidentally activate the recording function.

But recording and real-time playback are just part of the DX-1's appeal. The system's built-in sequencer program helps you create some fairly complex compositions. As many as eight sounds can be individually controlled in pitch, duration, volume, and direction. You can order the whole sound or just a part of it to be played, or string it together with another sound. Once all that's done, the sequencer gives you 16 control steps. Each is capable of ordering one of the eight sound events to repeat as many as 254 times before moving on to the next one. Sequences can be stored on disk, and because they are handled separately from the soundbases, they can be used to play any group of sounds.

Another program available for use with the DX-1 hardware has been developed by Paul Swearingen, an independent software writer.

Decillionix sells his single-disk program, called Echo, for \$150. Echo takes incoming analog sounds and loops them through the Apple's memory in a variety of ways to create real-time sound effects—some of which can be very complex and spacey. Its functions are adjusted with game paddles or the Apple's keyboard, or you can even set the program so that it operates randomly. The Echo documentation is sketchy, but Swearingen says that's the point: The program can make sound jump through literally an infinite number of hoops, and it's up to you to discover them.

The DX-1 is a remarkable device for computer hobbyists and those of you who are looking for an economical way to experiment with digital sound recording. With the proper interface, sounds recorded by the DX-1 could be passed on to more complex synthesizer programs, such as the AlphaSyntauri, for elaborate modification and keyboard-based playback (see "The Alpha and the Apple," page 79). And it's not hard to imagine some enterprising "hacker" coming up with a whole generation of special-effects devices built around the system, including phasers, flangers, digital delays, and reverberators.

For more information about the DX-1, you can call Decillionix at (408) 735-0410. The prerecorded message you'll hear gives you a guided tour through the DX-1's functions. **V&S**

**A SPECIAL ANNOUNCEMENT TO ALL THOSE
WHO LOVE MUSIC AND COLLECT RECORDS
THE SCHWANN RECORD & TAPE GUIDE IS NOW AVAILABLE BY
SUBSCRIPTION**

12 MONTHLY ISSUES COVERING THE LATEST INFORMATION ON LP RECORDS, TAPES, COMPOSERS, ARTISTS AND LABELS IN CLASSICAL, ROCK, POPULAR, JAZZ, COUNTRY, FOLK, OPERA AND MORE!

Includes A SPECIAL DELUXE YEAR-END ISSUE COVERING thousands of recordings including popular music over 2 years old, mono and simulated stereo classical, pop, and jazz, as well as educational, religious and specialized categories, and recordings on digital Compact Discs. New releases, record and tape price lists, and more.



- **LOCATE RECORDS & TAPES IN SECONDS**
- **TRACK DOWN MUSICAL WORKS IN CONCERT AND FM**
- **SNATCH UP "COLLECTOR'S ITEM" RECORDINGS**
- **ADD TO YOUR KNOWLEDGE ABOUT MUSIC, COMPOSERS and ARTISTS—when they lived, what they wrote or recorded...and when.**

Over 25,000 listings at your fingertips and hundreds added each month! All subscriptions include a special year-end deluxe edition covering specialized categories, educational, religious, pre-stereo era and more.

HUNDREDS ADDED EACH MONTH!

Schwann Record & Tape Guide

The most comprehensive guide on recorded music ever published.
Take advantage of the special rate shown and enter your subscription today.

ABC Schwann Record & Tape Guide
Subscription Department
P.O. Box 41094
Nashville, TN 37204

YES! Enter my subscription to the
**NEW Schwann Record & Tape Guide for
\$30.00 for one year (12 issues).**
\$ _____ Payment is enclosed

NAME _____
(Please print)

ADDRESS _____ APT _____

CITY _____ STATE _____ ZIP _____

Canada—\$40.00 per year
All Foreign (Surface Mail)—
\$45.00 per year
All Foreign (Air Printed Matter)—
\$80.00 per year.

PAYMENT (IN U.S. FUNDS)
MUST ACCOMPANY ORDER
Allow 5-8 weeks for receipt of first copy.

A40601

AN AFFORDABLE APPROACH
FOR TURNING YOUR APPLE INTO
A SOPHISTICATED SYNTHESIZER

BARRY MANILOW is hardly controversial, yet a concert he gave last year in London's Royal Albert Hall sparked a movement by the musicians' union in England to ban synthesizers from both the stage and the recording studio. Manilow, it seems, managed to achieve the sound of a full orchestra with just two synthesizer players.

Though Mr. *Copacabana* was using super models that can cost

THE ALPHA AND THE APPLE

A M U S I C A L T E A M

upward of \$40,000, you don't need a superstar's bankroll to own a multifunctional synthesizer. For the past two years, Syntauri Corporation of Los Altos, California, has been making



BY

PAUL D. LEHRMAN

a sophisticated system that uses an Apple computer as a storage and manipulation device. Known as the AlphaSyntauri Computer Music System, it is not only a versatile

analog waveform appears at a pair of RCA jacks on one of the cards. The signals can be routed to a stereo system, an instrument amplifier, a recording-studio console, or even a pair

keyboard makes that voice sound immediately, while typing "PR:40" gives it a gradual entrance. Other parameters that can be adjusted at this stage include pitch (adjustable in quarter-tones over a range of more than eight octaves), touch sensitivity on the piano keyboard (a feature only available with the five-octave keyboard), and number of tone repetitions from one keyboard stroke. In addition, the primary and percussion voices can be tuned to separate pitches, which offers a chorus effect from just one note; each note can be tuned to two distinct pitches over a range from one thirty-second to a major tenth. If you want some vibrato, you set its depth and rate either from the computer keyboard or by dialing it in via the rotary control on a pair of game "paddles."

Built into the system are programs for generating standard waves—sine, sawtooth, triangle, and square—as well as a multitude of more complex forms. Using the program Quickwave, you can call up any waveform, adjust the relative levels of its first 16 overtones, and then store that for future performance or further modification. Using a somewhat slower program called Wave, any of several waveforms (standard or custom) and their harmonics can be layered on top of each other to create a new wave, while the video screen displays a picture of the combined result.

The Alpha stores and loads its instruments in groups of 10. One floppy disk can hold over 200 separate waveforms, and it takes only a few seconds to get to any particular sound you need. For real-time performances, Ensemble lets you trigger up to eight instruments simultaneously with one keystroke; and Timbre Sweep moves each note through several instruments at a rate controlled via the game paddles. There's even an option for splitting the keyboard into eight separate instruments.

There are two foot pedals—one for sustain (if the envelope parameters of the voice are set up for it), the other for glissandos between notes. While in the performance mode, the computer's video screen displays a matrix of flashing bars that show which notes are being played. Though fun to watch, the display serves little practical purpose.

But using the AlphaSyntauri as a

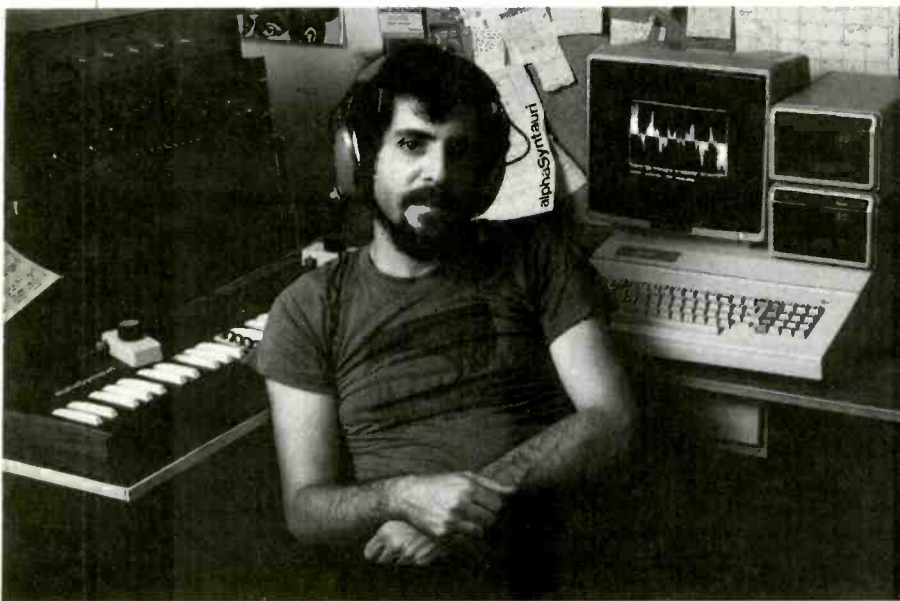

AUTHOR LEHRMAN chose to install the AlphaSyntauri system into his Apple-compatible Franklin Ace 1000 computer. Note the game paddles atop the Alpha keyboard at left. The rotary pots on the paddles govern some of the program's functions.

performance instrument, but it also records and, with an option called Composer's Assistant, prints music. The Alpha (as it's known) costs about \$2,000; with the computer, a single disk drive, a monitor, and a printer, the price approaches \$5,000.

The Alpha comes with either a four- or five-octave keyboard that plugs into one of the expansion slots inside the Apple. (The five-octave keyboard is velocity sensitive, to boot.) A pair of music-synthesizer circuit cards, manufactured by Mountain Computer, take up two more slots. The programs necessary to run the system are supplied on floppy disks.

The synthesizer cards are what make the sounds. They contain 16 digital oscillators—devices that duplicate waveforms via a complex additive process. Their output is passed to three digital-to-analog converters—one each for frequency, envelope, and overall volume—and the resulting

of headphones.

When you place the disk containing the basic synthesizer program, known as AlphaPlus, in your disk drive and turn on the computer, 10 "instruments" are loaded into the computer's memory. The instrument sound you want to use is chosen via a number key (0 to 9) on the computer keyboard. Every instrument contains two voices—"primary" and "percussion"—each of which has its own waveform and envelope controls. The voices are routed through different audio outputs, giving the system a semblance of stereo.

The envelope parameters—attack, decay, sustain, and release—are displayed on the computer monitor screen as combinations of letters and numbers. For example, "PR" is the attack rate of the percussion voice. The rate is variable over a range of 255 steps, the maximum allowed by the Apple's eight-bit microprocessor. Typing "PR:255" on the computer

live-performance instrument isn't the whole story. The system's recording program, Metatrak, allows a performance to be recorded, played back, and even "looped." A 16-bar bass pattern can be played on the keyboard, entered into the computer, and saved on a disk. As accompaniment to a melodic line, the bass pattern can be ordered to replay continuously in perfect time.

In fact, as many as 16 separate tracks, each with its own instrument, can be recorded and overdubbed in perfect synchronization—just like in a recording studio. While each new voice is being laid down, you monitor the previously recorded tracks. The volume of each one is adjustable, so that you can perform studio-type mixdowns without a mixer or a tape deck. A metronome function is included in the software to help keep everything together, and each track has punch-in/punch-out editing capability. There are provisions for "fast-forwarding" the playback and for instant return-to-zero. The system lets you change the speed of the playback without altering pitch and even allows for tempo changes within the body of a piece.

There is also a sync-to-tape feature that permits every track in a Metatrak recording to be transferred individually to a multitrack tape deck in perfect synchronization. The system accomplishes this by writing a data word known as a synchro-start pulse onto the tape. When the tape is played back, the computer recognizes the word and locks onto it.

In addition, the AlphaSyntauri has provisions for interfacing with a Roland, Linn, or Oberheim drum machine. The metronome signal is fed through a special cable to the trigger input on the drum machine and acts as a timing pulse for it. The drum machine can be programmed to play any kind of beat, but the downbeat will be synchronized with the Alpha's metronome. This feature is particularly handy because, as the manual admits, percussion sounds are not the easiest to produce on the Alpha.

With the AlphaSyntauri, you can do just about anything that you can on any synthesizer. And fortunately, the designers have made the system very easy to use: A computer neophyte can have it up and running in a few minutes, and anyone experienced in

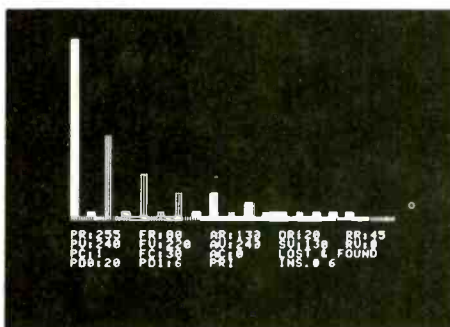

A SIMPLE visualization mode offered by the Alpha shows a C major triad topped with a C above middle C as four short horizontal bars (top). The Quickwave routine lets you create sounds by changing the relative levels of a note's first 16 harmonics. A predominance of higher harmonics (middle) gives a nasal, raspy sound. To create a warmer, richer tone, the lower harmonics are emphasized (bottom).

multitrack recording can adjust to the Metatrak program in an afternoon. Of the 100 preset voices that come with it, quite a few are unappealing, but enough of them are sufficiently interesting to engage the mind of a professional synthesist.

The waveform and envelope generators are a bit more difficult to use. Though the system offers a remarkable amount of creative control, digital control is very different from analog control, and the instrument-synthesis program will seem very clumsy until you've had some practice.

Within a month of acquiring the Alpha, I had recorded two Bach fugues four ways: an organ on which each voice had its own distinct set of stops; a string orchestra (with instruments of my own design); a woodwind quintet; and an ensemble of frogs, crickets, and birds called Nature. A composition can be orchestrated an infinite number of ways in seconds. I also recorded a respectable version of the second

movement of Mendelssohn's *Italian* Symphony, a couple of pop tunes I wrote (which several years ago cost me hundreds of dollars to make demo tapes of), and an electronic improvisation. I spent about 20 minutes on this last piece; had I attempted the same thing during my student days at music school, it would have taken me a month.

As if all this weren't enough, the latest addition to the AlphaSyntauri software repertoire is something of a dream come true for anyone who grew up, as I did, trying to figure out a way to make a piano behave like a typewriter and print out compositions in perfect score form. The extra-cost Composer's Assistant is not quite as fast or as elegant as my imagination, but it will certainly do for now.

Composer's Assistant starts by analyzing your prerecorded note files. It then asks you to define some parameters: tempo, key signature, time

signature, and resolution of the smallest note or rest (such as eighth or sixteenth). The computer then analyzes the note file and displays each bar on the video screen, where you can edit if you wish before printing. During the analysis and edit phases, you can tell the computer to print out any or all of the recorded tracks, on either a single or double staff. You can also transpose the tracks, add performance direction such as dynamics or tempo alterations, as well as shift the note values slightly to compensate for keyboard technique.

There are a few limitations with the Composer's Assistant program. It will not beam eighth or sixteenth notes; each note gets its own flag, and all stems point up. If two notes pitched a second apart are played simultaneously, it will not shift the printed position of one of them; instead, it will simply print them on top of each other. Ties are indicated by straight (not curved) lines. And there are only three available time signatures: 4/4, 3/4, and "free-time." This is less of a disadvantage than it might at first seem. In the free-time mode, faint dotted vertical lines appear at each quarter-note division, which allows you to draw in the bar lines after the score is printed out. But even with these drawbacks, Composer's Assistant is a terrific aid to the musician, and the printout is very readable.

Some further deficiencies must be noted. Although the piano keyboard's response is instantaneous, responses to instructions from the computer keyboard are fairly slow. This is because different parts of the software

are written in different languages: The real-time music instructions are written in assembly language, which is very fast, while the storage and design programs are written in Basic, which takes the computer a bit longer to digest. Also, the number of notes that can be maintained in any note file is limited. In Metatrak, storage is 3,000 notes (less if you are also storing key-velocity information). A new hardware and software option, MetaExtender, will address this problem by offering a 20,000-note capacity and should be available presently. And the Composer's Assistant program can handle only about 1,000 notes, so longer pieces have to be broken down into 1,000-note segments for notation.

Still, the capabilities of the AlphaSyntauri music synthesizer system are truly amazing, given its price, and overall I'm delighted with it. Moreover, it promises to get better and better: Because the system is totally under software control, improvements can be made easily via updated program disks. Syntauri keeps a list of system owners and offers updates to them at reasonable cost. And finally, unlike synthesizers built around dedicated microcomputers, the Alpha's modular design lets you use your Apple for more mundane chores, as well, such as word processing. In fact, now that I've finished this article on my computer, it's free to start making music again.

V&S

#1 HIGH FIDELITY
BACH PRELUDE #22 WTC BK I

A#MIN
LENTO

PP MF

CRESCENDO

THE COMPOSER'S ASSISTANT program will automatically score a composition entered on the Alpha's piano keyboard. Bach's Prelude in B flat minor is enharmonically changed to A sharp minor in the off-screen photo above.

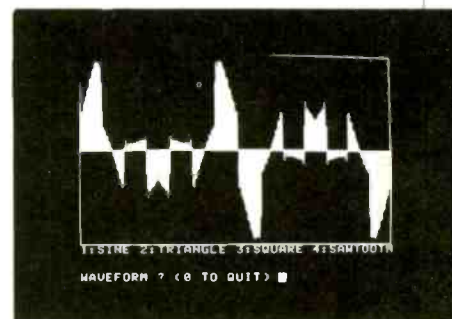
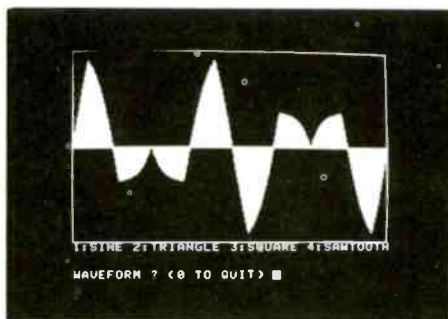
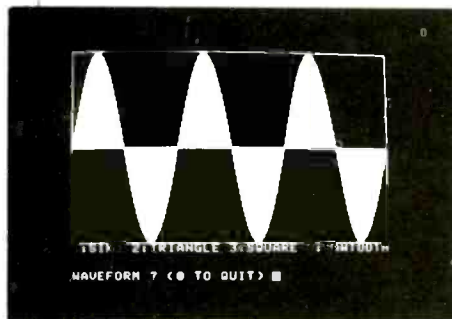

THE ALPHA lets you create fairly exotic sounds by shaping a note's harmonic waveforms. The off-screen photos above depict some of the additive wave-shaping capabilities, as a sine-wave third harmonic (left) receives a triangle wave at the fifth harmonic (middle) and a square wave at the seventh harmonic.

TOM BLOOM



SYSTEM SOLUTIONS

How to get the best performance from your home entertainment setup.

BY

ALEXANDER N. RETSOFF

HOOK-UP HELP

Connecting speakers to an amplifier properly is a simple procedure, but it's remarkable how many people do it incorrectly. Here's all it takes: The voltages from the positive (red) terminals on the amplifier must end up at the positive (red) terminals on the speakers; likewise, the negative terminals on each channel must be properly connected (black to black).

If you use special speaker wire (the heavy, thick kind, not the narrow gauge junk that dealers often pass off as speaker wire) coded with red and

black insulators, there's very little chance for confusion. Most people, however, opt for the altogether satisfactory alternative of 18-gauge zip cord (or lamp wire). This variety of two-conductor cable has no color coding, so the trick is to examine it under strong light to find the cable that has a ridge along its plastic insulation. Once you've spotted that ridge, take a red pen and mark it at both ends. Make sure your markings do not get removed when you strip the tips of the wires.

There is a simple test to check whether your speakers are connected correctly, and it doesn't involve

disassembling your whole system. But first you should understand why a correct hook-up is so important. We perceive the stereo illusion by differences in the strength and relative timing of the left- and right-channel sound waves. Suppose one loudspeaker is connected out of phase—that is, that the leads to it are reversed (red to black). If identical signals are fed to both speakers—a situation that should create a solid center-stage image—the sound waves coming from one will be 180 degrees out of phase with those from the other. Because phase and timing are related, the sounds reaching your ears from the two speakers will differ in relative arrival time: For example, a phase error of 180 degrees (one half of a full cycle) translates into a 2½-millisecond discrepancy at 200 Hz and a 1⅓-millisecond difference at 300 Hz. So even though the sound waves from the two speakers reach your ears at the same *absolute* time, their *relative* timing seems to change with frequency.

The brain, thoroughly confused by the differences in arrival times, cannot locate the sound, which takes on what has been called "a diffuse and directionless quality." That's a very apt description of what to listen for in an out-of-phase system.

Play a mono record, or switch your system to the mono mode using any music source. Stand equidistant from the two speakers and close your eyes. You should perceive the sound as coming from directly in front of you. If you can't locate the sound—if it seems to be surrounding you—your system is out of phase.

Turn it off, and reverse *one* set of speaker connections, switching the wires either at the speaker or at the



MAXELL XLI-S AND TDK HX-90 are among the new crop of premium tapes that promise wide dynamic range.

amplifier. (Don't do it at both places or you will cancel out your efforts altogether.) It should make no difference which speaker gets your attention (purists might disagree, but we'll get to that in a moment): Just don't reverse the connections to both speakers, or they'll still be out of phase with each other. Now, fire up the system and try again. The image should be solidly placed in the center.

You can also use bass response to test phasing. When left and right loudspeakers are wired out of phase with each other, the same signal fed to both causes one cone to move out while the other moves back. The two fight each other: One is compressing the air in the room while the other is rarifying it. As a result, the net sound level diminishes—something you can perceive only at low frequencies.

Reverse one set of connections as described above, and use a mono source with plenty of bass content. The test will be more sensitive if you place the speakers close to each other to minimize the time it takes the sound to travel between them and thus raise the maximum frequency at which cancellation occurs. Listen carefully, and if the bass gets louder with the speaker leads reversed, you have cured the problem.

Aside from the loudspeaker connections, the only other point at which the phase between the left and right channels can be upset is at the phono cartridge. But if you are careful to match the color dots on the cartridge to the color of each lead in the headshell, that part of your system should be in phase as well.

PICKING THE RIGHT AUDIO CASSETTE...

Audio cassette tape comes in four general classes: Type 1, the gamma-ferric-oxide formulations; Type 2, the chromium-dioxide formulations and cobalt-treated ferric-oxide tapes that have recording characteristics similar to those of the chromes; Type 3, the so-called ferrichromes; and Type 4, the pure metal-alloy tapes. There are also the garden-variety ferric tapes that follow the original Philips-based DIN spec. VIDEO & SOUND has called this group Type 0. Each tape type requires a different bias level and a somewhat different recording equalization to achieve best results.

Note that the differences mainly affect recording. There are only two standard playback equalizations: 120 microseconds, used for Type 0 and 1 tapes, and 70 microseconds, for Types 2, 3, and 4. So even if your deck is not set up to record on ferrichrome or metal, it can reproduce such tapes made on another machine via its chrome (Type 2) equalization setting. I'm always amused to read ad copy for a car-stereo deck or a personal-portable player that touts its "metal compatibility": If the player is chrome compatible, it is ipso facto metal compatible.

Decks of recent vintage are, at minimum, usually equipped to make recordings on Type 1, 2, and 4 tapes. Although I have used decks that do an excellent job with ferrichrome (Type 3) tape, the majority do not, so I tend to stick with the three major tape types.

Metal tape is substantially more expensive than ferric or chrome/ferricobalt, and I reserve it for the

most demanding situations—a live session or dubbing an audiophile disc that has a lot of treble energy. Metal's strong suit is its superior high-frequency headroom—not lower noise, as is generally thought. To take advantage of that headroom requires a superior cassette recorder that will not limit tape performance by premature head saturation or electronic overload. If you can't afford such a deck, why waste your money on exotic tape?

The workhorses remain the ferrics and chrome/ferricobalts. Ferric tapes span a wide price range. The least expensive (Type 0) tend to have limited high-end response and higher noise, but they're fine for speech recording. The premium ferrics (Type 1) have wider response and lower noise. Some recordists use them mainly for recording rock and pop music, which usually have a rather limited dynamic range. The best Type 1 tapes overload very gracefully and have remarkably stable response. Chromes and ferricobalts are quieter than straight ferrics, mainly because of the change in playback equalization. True chromes may be the quietest tapes, but they don't quite match the "chrome-equivalent" ferricobalts in the high-frequency headroom. Both are appropriate for recording classical music. You may want to choose between them on the basis of the particular piece and its instrumentation.

Do not assume that all tapes will work equally well on your deck. If your deck relies on fixed internal bias and EQ settings, you're wise to stay with the tapes its manufacturer recommends. These are usually outlined in the owner's manual. If not, call the manufacturer and demand specific guidance.

... AND VIDEO CASSETTE

Selecting a video tape is less of a hassle than choosing an audio cassette tape. Video information is recorded without bias current, thus eliminating one variable; tape sensitivity is also relatively unimportant in obtaining a good picture. On the audio track, bias *is* used, and on those VCRs with Dolby noise reduction, sensitivity should theoretically be important. But since little attention has been devoted to the audio characteristics of most VCRs (though that situation is about to change), they lack the appropriate controls to redress the sensitivity

problem.

For the best possible picture quality, you should try to find a tape that yields few dropouts, low chroma noise, and low luminance noise. Most VCR users tend to record at the slowest speed possible to give the longest recording time. The myth that this makes extraordinary demands on the tape has convinced many video recordists that only a high-grade tape will do. As far as dropouts are concerned, that's true. But in general, any top-brand video tape is adequate for slow-speed recording; indeed, whatever differences might exist among various tapes in color purity, chroma noise, and luminance noise are unlikely to show up except at the *faster* speeds. So when making visual comparisons, record at the highest speed available to you.

Dropouts appear as a momentary loss of picture, with a horizontal streak extending partially or completely across the screen. They occur most often at the very beginning and end of a tape, so those may be the best places to look. For that very reason, avoid recording valuable programs on the first or last minutes of any video cassette. Luminance (or video) noise shows itself as grain or snow in the picture. Chroma noise shows up in two ways: as a black streak or blotchy character in the background color, most noticeable in solid-red areas, or as

random shifting of colors from their nominal hues.

No advice on selecting magnetic tape would be complete without the following advice: Choose a name brand and avoid apparent bargains. A manufacturer with a reputation to uphold usually enforces stringent quality control. The product, therefore, can be counted on to be uniform in quality. With off-brand tape, the name on the box offers no such assurances; in fact, it is possible that the tape is some other company's reject or overrun. A once-in-a-lifetime recording is too valuable to risk on such a product.

CARING FOR YOUR CASSETTE DECK

Getting the best possible performance from any tape recorder means adopting a proper cleaning regimen. Even microscopic particles of debris adhering to a tape head will cause severe dropouts and impair high-frequency response.

The most likely source of debris is the tape coating itself. Microscopic particles of oxide can flake off and adhere to the heads quite tenaciously. Off-brands are particularly prone to shedding, but even the best-quality tapes will shed some, especially the first time they are used. You can see the debris as a discoloration of the rubber pinch roller, the wheel that presses the tape against the capstan.

Whenever you probe about inside a tape recorder, be very careful not to scratch the surface of the heads or upset their delicate alignment. Any tool that you insert should be nonmagnetic, have a soft plastic surface, and be used gently. All sorts of gizmos designed specifically to clean the heads, capstans, and pinch rollers are available. Some use an abrasive tape to scour the debris away; others have solvent-soaked pads that automatically scrub the heads as the deck is set into motion. And there are a variety of cleaning solvents on the market.

The simple do-it-yourself approach is fine: Just use cotton-tipped swabs soaked in either Freon or pure isopropyl alcohol. Both are fairly gentle and reasonably effective. They do not attack most plastics and head materials, although it's wise to check the restrictions and recommendations in your owner's manual. Do not use acetone, toluene, or any other strong solvent. And don't use head lubricants: They may gum up the works, and good-quality tape has a built-in dry lubricant, anyway.

Cleaning using a cotton swab is fairly simple. Soak the swab (preferably a good brand that won't shed) in solvent and gently rub it across the surface of the head. Rotate it as you scrub, and discard it as soon as it becomes discolored. Continue working on the same head until a swab comes away clean, then go on to the next. Clean each head, capstan, and pinch roller, as well as any guide post that contacts the tape.

Don't let solvent drip into the pinch roller and capstan bearings, or it may wash away lubricants. Be sure to rotate the pinch roller and capstan so you clean their entire circumference. (If you have the power on and the deck in the play mode, the motor will turn them for you.) After you've cleaned all of the parts, wait a few moments for the solvent to evaporate and then inspect the tape path carefully for debris or lint.

NO CHARGE

A magnetized head in an audio deck increases tape hiss and can permanently diminish the high-frequency level of the recording. So it's important that the heads be magnetically "clean."

The need for demagnetization depends entirely on the deck's

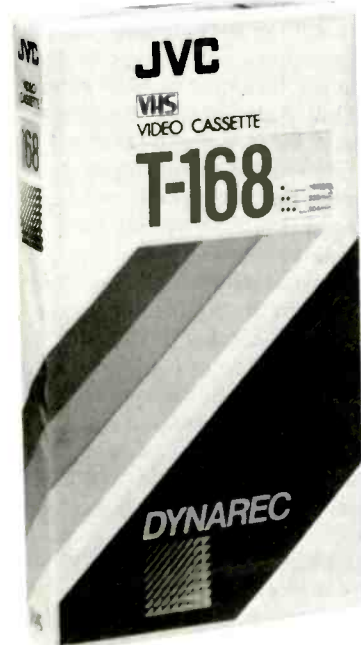

SUPER LONG RECORDING TIMES (left) and low-dropout formulations are available in today's videocassettes.



electronics and the design of the heads. A well-designed head—one that's shielded and made with a core material of very low coercivity—connected to properly designed electronics should not become magnetized under normal circumstances and so should never require demagnetization.

However, if the bias supply or the recording amplifier allows even a small amount of direct current to flow through the head, or if there is a strong turn-on transient, or if the playback preamp leaks DC into the playback winding—either continuously or at turn-on—the heads can become magnetized. And if the heads are subjected to a strong external magnetic field, they can retain some of that magnetization.

If you are quite sure that demagnetizing is necessary, here's the procedure to follow. First, select a powerful demagnetizer whose probe is long enough to reach into the recorder's head compartment. The tip of the demagnetizer should be covered with soft plastic (electrician's tape will do) so that it does not scratch the surface of the head.

With the deck switched *off*, energize the demagnetizer while it is at least a foot or two away from the heads. Slowly bring the demagnetizer's probe up to one head, move it back and forth so that the entire surface is covered, and withdraw it slowly. Do not switch it off until it is a foot or two away from the deck. There is no need to keep the demagnetizer in contact with the head for more than a second or so, and there is no need to press it firmly against the head. Just keep it in contact.

The most important step in the procedure is withdrawal, which must be done *slowly*. If you remove the demagnetizer too quickly or switch it off prematurely, you may leave the head in a greater state of magnetization than it was to begin with. Do each head in turn, following the full approach/withdrawal procedure. Unless you have a particularly powerful professional demagnetizer, do not bother trying to demagnetize the capstan or guide posts. They are usually made from non-magnetic stainless steel (in which case the procedure is unnecessary) or conventional steel (which requires a very strong field to demagnetize it).

I consider head demagnetization a

risky procedure. I do it only when it's absolutely necessary. For safety's sake, you might want to investigate the battery operated cassette-head demagnetizer available from TDK (Model HD-01). Within the cassette housing is an electronic circuit and a coil that together induce a smoothly decaying field in close proximity to the head. The complete operation takes place with the cassette in place, making it ideal for demagnetizing a car stereo's play head.

TUNING YOUR WOOFERS AND TWEETERS

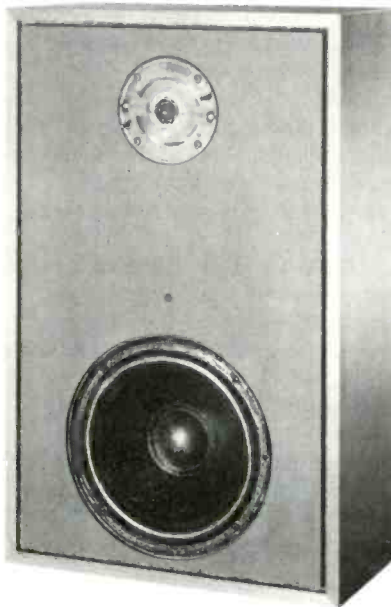

If you're dissatisfied with the sound of your speakers, try removing their grilles. This will often brighten their sound, since almost every foam or cloth grille attenuates sound to some extent—and more so at high frequencies than at low. Of course, be sure that there is a clear path between each speaker and your listening area. One way to kill the high end almost entirely is to aim the speaker at an overstuffed chair or sofa.

Try angling them in toward the listening area. Every speaker is directional to some extent and more so at high frequencies than at low. If you listen too far off-axis, the high end is likely to be down. And don't forget the reverse side of that coin. If your speakers are presently angled in toward the listening area and they sound too bright and peaky, they may sound better balanced if toed out a bit.

You may also find that your speakers produce a more stable stereo stage (i.e., image better) with their grilles off. Many grilles have hard edges and internal struts that can interfere with high frequencies, causing the sound to reflect or diffract off and radiate as separate sound sources. These secondary sound sources may reduce your ability to recreate the single, desired sonic image.

To reduce such interference without having to live with a naked loudspeaker, try applying felt to the front surface of the speaker so that sound propagating along the baffle board is absorbed before it reaches a sharp edge. Felt needn't be applied around the woofer (these problems occur only at short wavelengths), but try to surround the midrange and tweeter. Of course, be sure not to let the felt interfere with the diaphragm. If you apply it with double-sided sticky tape, you can remove it easily if you find it has no effect.

WHERE'S THE HUM?

A very common source of hum (and of intermittent sound) is a faulty connection. If you experience either problem when playing a disc, first check the cables between the turntable and preamp or receiver. Be sure to turn your system off (to protect your speakers) before disconnecting the cables. Check the center pin and surrounding sleeve as well as the jacks on the amplifier for corrosion. As long as the connectors are not gold-plated, you can use fine steel wool to polish them: Only a slight bit of pressure is necessary. Be sure not to leave any metal fibers in the plug or jack.

Gold-plated connectors and jacks require a different treatment: Steel wool would probably remove the precious metal. Gold connectors shouldn't tarnish, but if they do, use pure isopropyl alcohol to clean them. (Don't use rubbing alcohol, which can leave a residue from the aromatic ingredients that it contains.) Most electronics stores carry special sprays for cleaning contacts—many containing lubricants that you may be better off without.

Connectors should fit tightly, because a loose connection can result in intermittent sound, hum, or noise. You should feel some resistance as you insert the plug's center pin and even more as the surrounding sleeve mates

with the outer rim of the jack. If the split outer ring of the plug is loose, squeeze it slightly with pliers and see if that solves the problem. If the center pin is not gripped securely, try another cable.

Your problem may also lie in the cables themselves. With the system on and the volume set at a low level, wiggle the cables where they enter the molded-on connectors. This is a prime area for an internal short or open circuit, which can produce the same symptoms as a corroded connection. If the sound comes and goes or gets noisy or hummy, replace the cable. Also, check the cable along its length to be sure it hasn't been accidentally flattened at some point and damaged internally. If you suspect a cable is defective, replace it. It's a good idea to have a spare test cable handy so you can easily substitute it for a questionable one.

If the hum persists, the wire that grounds the turntable frame to the amplifier chassis may be at fault. Usually, this connection minimizes hum, but some cartridges have the ground side of one channel connected to the cartridge body. If the cartridge body is metal and it touches the arm, two ground paths may be established—one from the cartridge coil to its case, through the arm to the turntable frame, and then through the grounding wire to the amplifier; the other, the normal direct connection through the signal cables. The result of this double path is a ground loop that can pick up hum. If you suspect this is the problem, disconnect the grounding wire. Alternatively, you can insulate the cartridge body from the arm with a thin plastic shield and nylon mounting hardware.

It's time to check the cartridge/ tonearm connections if hum, noise, or intermittent sound persists at this point. With cartridges that are mounted in a removable headshell, flip down the stylus guard (or put on the protective plastic cage) and remove the headshell, cartridge and all, from the tonearm. (Usually this is done by unscrewing a knurled ring.) Check the connections between the headshell and tonearm for corrosion. (They should be okay, because the connection is almost invariably gold-plated.) Invert the headshell on a flat surface, and with tweezers or needle-nose pliers, gently tug on each sleeve that connects the

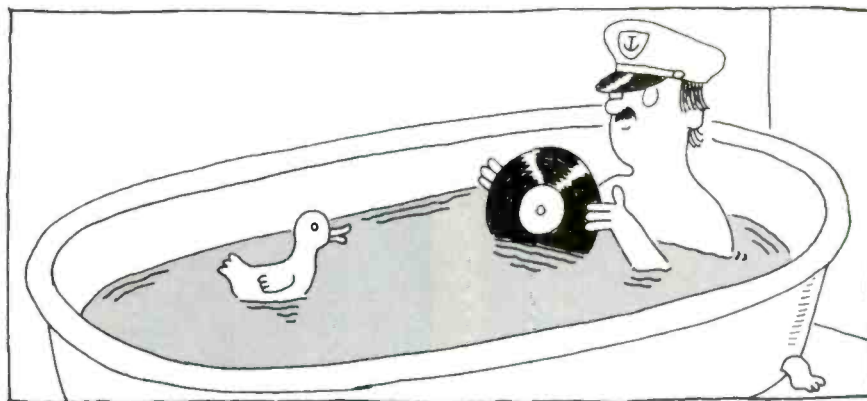

tonearm wiring to the cartridge. Don't pull on the wires: They're fragile. Just verify that each wire is firmly soldered to its connecting sleeve. Sleeves should fit tightly on the cartridge pins. (This doesn't always happen, because there's more than one "standard" diameter for cartridge pins.) Squeeze any loose sleeves gently with pliers.

RUB-A-DUB-DUB, AN LP IN THE TUB

As a last resort, soap and water can be sonic lifesavers. Sure, the soap may leave a residue on LPs—but not if you rinse the disc well. And yes, it may leach plasticizers out of the vinyl and cause the record to become brittle eventually, but you'll never have one self-destruct in the tub. In fact, records always emerge from their baths a good deal quieter than before. And after such drastic measures, you might make it a practice to tape the disc immediately and then lay it to rest.

If other cleaning methods fail and you want to try this final solution, here's how. Go to the hardware store and buy two soft plastic dish basins (at least 6 inches deep) and a few feet of ¼-inch dowling. Fill each basin with lukewarm water to within 2½ to 3 inches of the rim. You can use ordinary tap water if it's not loaded with minerals. The fastidious might prefer to buy distilled water (not the bottled drinking water whose claim to fame is its mineral content). Add a drop of a mild dishwashing soap (such as Ivory Liquid) to one basin. Use only a drop—you don't want a lot of suds, which can be hard to rinse off. The soap cleans the record by lowering the water's surface tension, making it "slippery" enough to penetrate the tiny grooves.

Slip the dowel through the disc's

spindle hole and lower the record into the suds. The dowel should rest on the sides of the basin, supporting the disc so that only the groove area is submerged. A grommet on either side will hold it upright and keep it from sliding back and forth. Slowly rotate the record and work the solution into the grooves with a soft brush. I treasure my old Watts Record Wash Brush, which was designed specifically for this purpose. Its nylon bristles have a 0.00025-inch average tip radius, small enough to get to the bottom of the groove where the crud lurks. A soft sponge also works nicely.

Once you've given the disc a good but gentle scrubbing, rinse it well in the second basin. Groove dimensions are so small that pure water's surface tension may prevent complete penetration without some gentle assistance. So use a second brush or sponge to force clean water to the bottom of the groove. After rinsing, gently pat the disc dry with a lint-free cloth and hang it on its dowel in a dust-free area to dry. A blower will help speed the drying process, but don't use a hot-air hair dryer. To remove dust that has landed on the record during the drying process, reclean it with the Discwasher system (or an equivalent) before returning it to its jacket.

Remember: This is a last resort, designed to remove Coke and the remains of a peanut-butter-and-jelly sandwich. If you treat your records with the respect they deserve, you should seldom, if ever, have to invoke such stern measures. For normal cleaning—preventive maintenance, if you will—I use a Discwasher brush and D-4 fluid, an ionization gun, and an antistatic brush, in that order. V&S

WHAT TV COLOR AND "TINT" CONTROLS DO



COLOR ACCURACY varies among video components. The primary elements are color saturation (chroma level), which can be varied by a TV monitor's color control, and hue (chroma phase), which is varied by the "tint" control. The vectorscope photo at the top left shows acceptable color accuracy with low saturation and some hue error; photo at bottom left shows excellent color accuracy. Photos on right show how TV monitor controls can adjust the six color vectors (white dots) so that the TV picture appears nearly perfect in both cases.

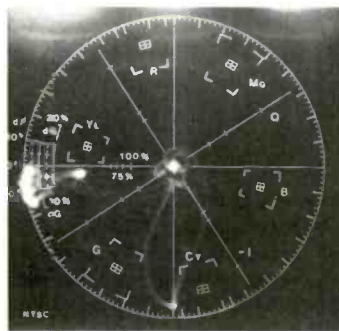
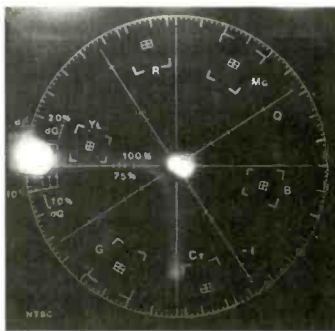

(Continued from page 8)

signal-to-noise (S/N) ratio The difference, in dB, between the maximum assumed signal level (in some instances, a 0-dB reference) and inherent noise. The signal may be measured unweighted or weighted; "A" weighting—which approximates, in simplified electrical form, human aural sensitivity across the audible frequency band—is frequently used.

sine wave The fundamental oscillation pattern of acoustic and electronic systems, so called because it can be generated in coordinate geometry by plotting sine values vs. the corresponding angles. A single-frequency sine wave has a sound that may be described as a very pure hum or whistle, depending on the frequency.

SLP (super long play) In video, an alternate designation for the VHS EP transport speed.

software In computers or recording media, the program (including music) needed for actual operation—as opposed to the hardware (the computer or recorders themselves).

SP (standard play) In video, the highest—and therefore the highest-quality—transport speed in VHS tape decks. It will record or play for two hours on a T-120 cassette and is used for all commercial prerecorded VHS issues.

square wave An oscillation consisting entirely of sharp transients (voltage changes) separated by brief, sustained positive and negative voltages. Square waves can be generated by adding to a **fundamental** all of its odd **harmonics**—the third, fifth, seventh, and so on. It has a very raspy sound, is useful for certain kinds of testing, and is more likely to damage tweeters than sine waves of comparable frequency and amplitude.

stereo images The spatial illusion created by multichannel recordings that are correctly made and reproduced, enabling instruments or voices to be localized.

synthesizer Any of a variety of electronic musical instruments. Originally the term implied that the instrument was designed to create artificial replicas of (that is, synthesize) the sounds of acoustic instruments. Synthesizers now can create a wide range of sonic effects, many of which bear no relationship to acoustically generated sounds.

tape head Essentially, a wire coil wound around a core and used as a transducer between electrical signals and magnetic recordings. An electrical signal in the coil creates a magnetic field in the core, which is focused by a narrow gap between pole pieces. This field creates a corresponding field in the magnetic coating of the tape as it passes the gap, preserving a record of the instantaneous signal level. When the tape then is moved past a similar gap, its magnetic flux induces a magnetic response in the pole pieces and therefore a current in the coil, reversing the transduction process. A similar head, normally carrying only a very high-frequency current, is used to erase the tape before recording.

THD (total harmonic distortion) The most common of all distortion measurements, expressing the rms (root-mean-square) sum of all spurious **harmonics** generated when a pure **sine-wave** test tone is passed through a circuit or device. Usual practice is to express the distortion as a percentage of the original tone (3 percent distortion has three-hundredths the energy in the tone); sometimes it is expressed as so many decibels down from the test tone (-30 dB in this case).

tint In video, hue. Because color information is encoded by phase modulation, the entire "color wheel" can be "rotated" by adding a phase shift. Thus, for example, red can be shifted toward yellow, green toward cyan, and blue toward magenta. For obscure reasons, the receiver control to achieve this often is labeled "tint," though this term has long been used in the fine arts to specify a color to which white has been added.

VLSI (very large-scale integration) The process by which the elements of many integrated circuits (each the equivalent of a great many individual circuit elements) can be combined on a single "superchip."

wow A slow variation in pitch, usually caused by inconsistent speed in tape or disc equipment. Other frequent causes: warped LPs or off-center spindle holes. **V&S**

HITACHI



...like Captain Brooke Knapp, is dedicated to nothing less than excellence in its performance.

Captain Brooke Knapp is soaring to new heights, breaking every flight record in the books—currently 103 records to her credit, including the fastest time ever around the world—and championing the worldwide UNICEF charity for the world's children. That's what being the best is all about. It means outperforming the competition. Going above and beyond the expected. And knowing that "good enough" never is. That philosophy is behind every Hitachi product. Which is why it was no surprise we were the first to introduce a consumer color camera with no tubes. Powered by an MOS image sensor chip, we revolutionized video camera performance forever.

Our color televisions are among the finest in the world, due in great part to "Signal Tracker Control," another Hitachi exclusive. For better video recording, we developed our 5-head PORTADECK VCR, Hitachi's smallest, lightest, most advanced ever. It's a portable VCR that truly is one. And our Compact Disc Player is a technological breakthrough in audio history. Virtual perfection in sound reproduction. This is just the beginning. We're setting a new standard in quality home electronics. And it's all up from here.



20th Anniversary
in America



"Year of
the Champion"



HITACHI
A World Leader in Technology

Hitachi Sales Corporation of America • 401 W. Artesia Blvd., Compton, CA 90220 • (213) 537-8383

discwasher® SpikeMaster™

Surge Suppressor

Superior protection for your electronics

All electronic equipment needs protection. Computers, televisions and audio systems are all damaged by periodic electrical surges in standard wall current.

The Discwasher SpikeMaster is THE superior suppressor to protect your mega-dollars in equipment.

SpikeMaster incorporates these desirable features.

- Multimode suppression systems protect against fast rise time surges, absorbing high power surges quickly.
- Multistage suppression systems guarantee protection whether the "hot" wire, ground wire or both deliver destructive surges.
- RFI filtering isolates your equipment from interfering radio signals on the power line.

The heavy duty Discwasher SpikeMaster is attractively designed for home or office. SpikeMaster incorporates four widely spaced outlets, an on/off switch with indicator light and a 6 1/2 foot power cord.

Independent laboratory tests (to stringent I.E.E.E. standards) confirm that SpikeMaster out performs and out protects suppression devices costing twice as much.

The following oscilloscope tracings measure a 1000 volt surge imposed onto a power line.

Surge

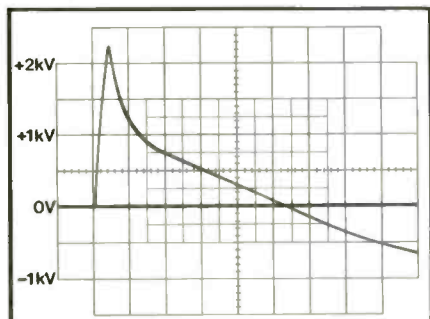

The unsuppressed surge reaches a peak of 2,200 volts.

\$150 suppressor

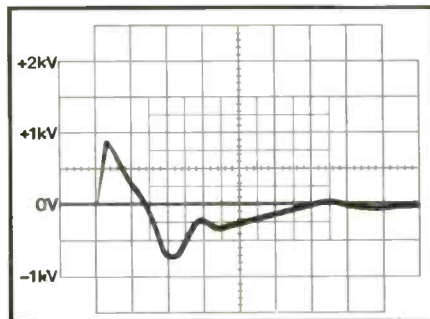

Protection from a unit costing over \$150 allows an 870 volt surge through the line with a 750 volt residual surge close behind.

SpikeMaster

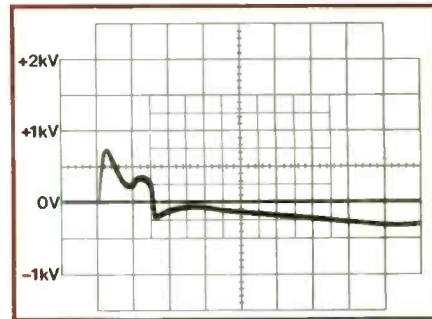

SpikeMaster clamps the surge in 30 microseconds. WITH SPIKEMASTER, A LOWER PEAK VOLTAGE AND QUICKER RESPONSE TIME MEANS BETTER PROTECTION FOR ALL YOUR DELICATE ELECTRONIC EQUIPMENT.



discwasher