

DECEMBER 1984

HIGH FIDELITY

Q2581

\$1.95

FEATURING NEW TECHNOLOGIES

AT LAST! THE ANSWERS

HOW TO BUY THE RIGHT COMPONENTS FOR LESS. HOW MUCH **PERFORMANCE**

IS TOO MUCH? HOW TO TEST BEFORE YOU BUY. THE KEY **FEATURES** YOU MUST HAVE.

ARE ALL CD PLAYERS THE SAME? HOW MUCH POWER IS

ENOUGH? THE ONLY WAY TO

EVALUATE SPEAKERS. WHICH SPECS

MATTER? HOW TO PLAN FOR **VIDEO**.

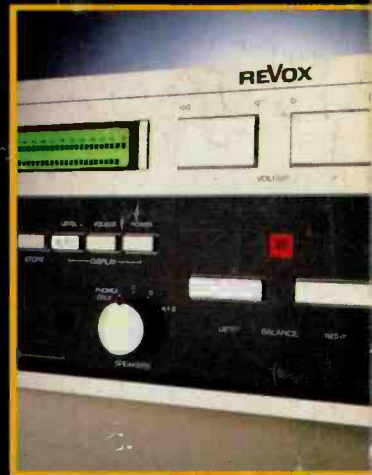

*****3-DIGIT 281
2RBES.3&&&9 64D99 FEB85
L3KID
546 012 1 H
GR 964
NC 2813



*You'll know why we're
first, the second
you hear us.*

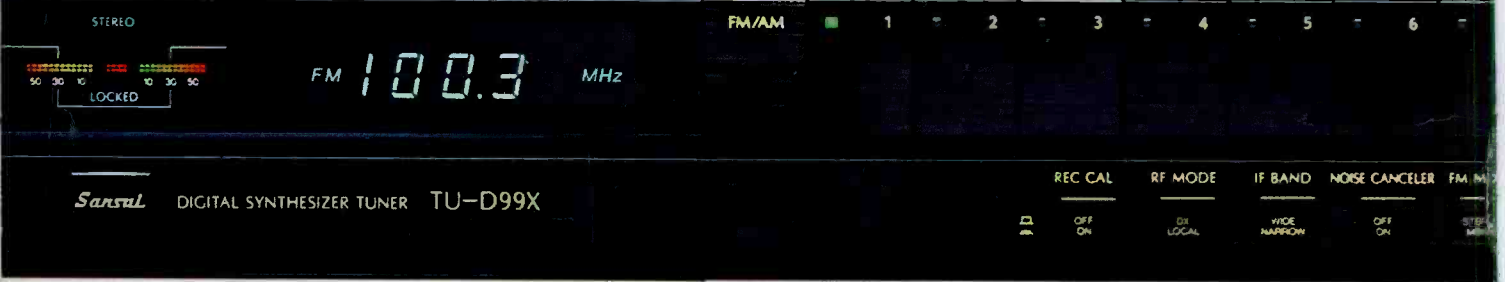

First it was DC. Then DD/DC and Super Feed-forward. Now Sansui astounds the audiophile with the greatest improvement in an amp. X-Balanced circuitry. It cancels out external distortion by eliminating the transformer to chassis ground; and decisively removes IHM.

You'll find X-Balanced circuitry in a wide range of superior Sansui products, like our AU-G99X amp, shown with TU-D99X quartz-PLL synthesizer tuner which incorporates our new Super Linear Digital Decoder for improved rejection of spurious signals and interference. Another version of this tuner has AM stereo capability.

When it comes to digital sound, our new PC-X11 Tri-code PCM Processor is the world's finest for any VCR. With 100 times the accuracy of any other PCM processor, it even reads blurred sections of digital material and lets you record up to eight hours of music on one VHS video cassette.

Our ingenious new XL-900C digital/analog speakers handle broad dynamic range with incredibly quick response to energy flow. Patented Tri-composite Carbon Fiber multi-layer diaphragms, plus high-polymer air-tight cores deliver higher resonance, fewer breakups and overall flat response.

There's more worth hearing about these great Sansui components. Write: Consumer Service Dept., Sansui Electronics Corp., Lyndhurst, NJ 07071, Carson, CA 90746, Sansui Electric Co., Ltd., Tokyo, Japan.

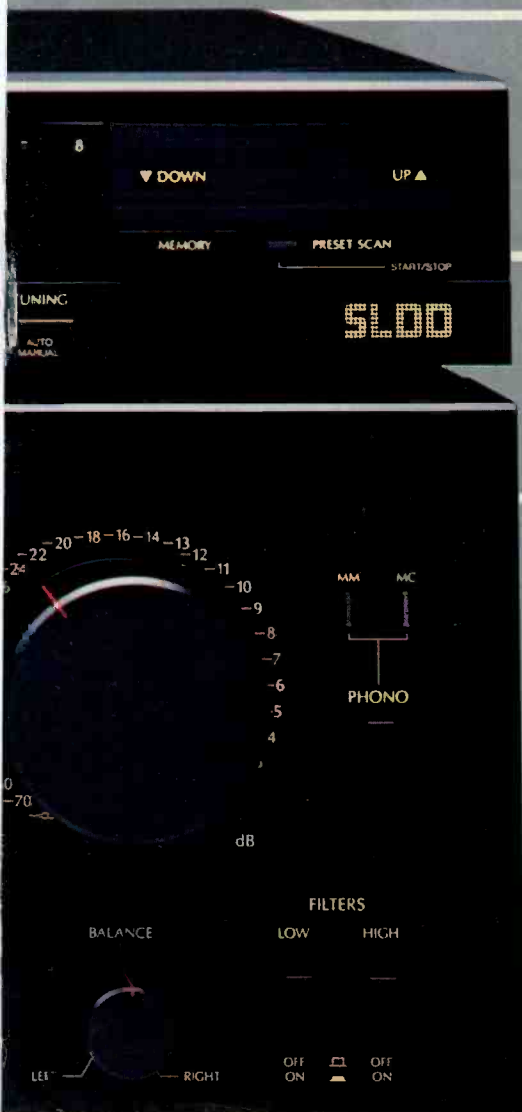

Putting More Pleasure in Sound.

PC-X11

H I G H F I D E L I T Y V I D E O

ONLY NEC OFFERS THE BEST OF BOTH FORMATS.

Whether you're watching the movie that won the Academy Award's "Best Picture" or want to make your own video movie with the best picture possible, NEC has the video cassette recorder that's exactly right for you.

Now, you've probably heard pretty convincing arguments for the superiority of VHS versus Beta and vice versa.



THE NEC VC-N833EU VHS VIDEO CASSETTE RECORDER. Add Dolby stereo to a high performance four-head, CATV-ready VCR and double your recording pleasure.



THE NEC VC-N895EU VHS HI-FI VCR. This state-of-the-art VCR's features include true hi-fi audio; a 139 channel, CATV-ready PLL Quartz tuner; 14 day, 8 event programmable timer; 4 heads for clear special effects; stereo recording and playback with Dolby Noise Reduction; segment recording; variable speed control; automatic editing system; picture sharpness control; electronic tape counter and full function infrared wireless remote control.

The Paramount Home Video Videocassettes pictured are \$39.95 each suggested retail price and are supplied courtesy of Paramount Home Video.

That's because each format has its respective strengths.

While VHS decks play longer, which saves tape costs; Beta video cassettes are smaller and employ a faster writing speed, making Beta the favorite of serious field and home video recordists.

This is why NEC became the only VCR manufacturer to offer both formats under its own name in the United States. This includes the very finest Beta and VHS models in each category.



THE NEC BM-11EU BETAMOVIE. NEC put it all together with an integrated Color Video Camera/Video Cassette Recorder that only weighs 5.5 lbs. including its battery.



THE NEC VC-N40EU BETA SLIMLINE VIDEO CASSETTE RECORDER. Whatever the recording speed, it produces the best possible VCR picture available.

Suddenly, the answer to the question, "Which VCR is best?" becomes very simple.

NEC.

NEC

THE ONES TO WATCH.

NEC Corporation, Tokyo, Japan



THE NEC VC-739E BETA HI-FI VCR. The VCR with the picture that sounds as good as it looks. It features studio quality hi-fi audio; a 134 channel, CATV-ready PLL Quartz tuner; 21 day, 8 event programmable timer; 4 heads for clear, special effects; three slow motion speeds; picture sharpness control; segment recording; electronic tape counter and full function infrared wireless remote control.

HIGH FIDELITY™

VOLUME 34 NUMBER 12

DECEMBER 1984

AUDIO

Currents Edited by Peter Dobbin	14
Basically Speaking by Michael Riggs	21
Vertical resolution—picture sharpness from top to bottom	
CrossTalk by Robert Long	22
Noise reduction; Aligning cassette deck heads; Tape and disc care in humid regions	
The Autophile by Gary Stock	25
Shopping strategies for choosing a front end	
New Equipment Reports	
Bose 201 Series II loudspeaker	26
Revox B-252 preamplifier	32
Pioneer SX-V90 receiver	35
Shure V-15 Type V-MR phono cartridge	38
Harman Kardon HK-870 power amplifier	41
* High Fidelity from A to Z: A Special 10-Page Report	47
What Is High Fidelity? by Robert Long	48
Decisions, Decisions: What to Buy First by Robert Long	48
How to Buy the Components of Your System	
Amps and Preamps by Robert Long	49
Tuners and Receivers by Robert Long	50
Cassette Decks by Robert Long	55
Caring for Your System: Tape and Disc Care Products by Peter Dobbin	56
Turntables and Cartridges by Michael Riggs and Peter Dobbin	58
Compact Disc Players by Peter Dobbin	59
Loudspeakers by Tim Holl	60

NEW TECHNOLOGIES

Video Lab Test: Panasonic PV-1730 VHS Hi-Fi videocassette recorder	61
Music Reviews	
Popular Video: "Stop Making Sense"; "The Harder They Come"	66
Popular Compact Disc: Art Blakey; Helen Merrill; "Heavy Weather"	68
Classical Compact Disc: Three new <i>Messiahs</i> from Shaw, Hogwood, and Gardiner	69

CLASSICAL MUSIC

Something New from New World Records by Noah André Trudeau	72
A small label begins Phase 2 of its documentation of American music	
Reviews: Four Chausson discs; Honegger's Third and Fifth; Callas sings <i>Nabucco</i> excerpts	74
Critics' Choice	76
The Tape Deck by R. D. Darrell	88

BACKBEAT/Popular Music

Giovanni Bonandrini: Labor of Love by Francis Davis	89
The jazz producer talks about his craft and his labels, Soul Note and Black Saint	
Pop Reviews: Joan Jett; King Sunny Ade; Rickie Lee Jones; Richard Thompson; U2	91
Strange Birds: Reissues of the Orioles and other warblers Reviewed by Crispin Cioe	94
Jazz Reviews: Abdullah Ibrahim; Modern Jazz Quartet; Maxine Sullivan; Watson and Lundy	96

DEPARTMENTS

About This Issue	10	Reader-Action Page	104
Letters	10	Advertising Index	104
		*Cover Story	

Simulated TV Picture



JVC'S LATEST BREAKTHROUGH IN VIDEO IS AUDIO.

Listen to this.

Introducing the Hi-Fi VHS system from JVC®—a video deck that not only gives you a picture of astounding clarity, but also sound of such high fidelity that it surpasses even the most advanced analog systems.

JVC set out to develop a revolutionary recording process that would give listeners the feeling of being in

signal is recorded on a shallower level. JVC's Hi-Fi VHS has a frequency response of 20-20,000 Hz and a dynamic range of more than 80 dB.

When played through your speakers, the resulting sound represents a true quantum leap in audio performance. It's a lot more than a VCR stereo system. It can actually enhance the quality of your current audio equipment.

The Hi-Fi VHS system is perhaps the most complete video deck JVC has ever made. Beyond the audio advances, its video capabilities are also highly evolved. You will enjoy time shift viewing, one touch immediate recording and a collection of special effects.

When you see it, you won't believe your ears.

HR-D725U



a live performance. And do it without affecting picture quality.

We designed a way to record the audio portion deep into the tape's magnetic coating. Then, the video

Hi-Fi **VIDSTAR** VHS



Even this Infinity
RS11 speaker

has the soul
of our \$32,000
Infinity Reference
Standard

All our home and automotive speakers share technology developed for our no-compromise state-of-the-art systems.

And every Infinity achievement—from polypropylene cones and domes to our world-famous EMIT™ tweeter—shares the goal of greater musical accuracy. The way the musicians meant you to hear it.

 **Infinity**®

We get you back to what
it's all about. Music.

DENON

DL-110 AND DL-160
MOVING COIL CARTRIDGES.

DENON USED HIGH OUTPUT TO LOWER THE PRICE.

To make the high performance of their ML-Series Moving Coil cartridges highly affordable, Denon took into account the other equipment in your system. Most value-oriented electronics do not feature MC pre-amp stages. The high output of the DL-110 and DL-160 eliminates the need for costly head units or transformers and are thus compatible with virtually all phono inputs.

Now, systems of all prices can benefit from Denon MC technology (one-point suspension systems; two-piece tapered cantilever; cross-coil armature and high density samarium cobalt magnet structure) to deliver unprecedented accuracy and inner detail.

Denon products share more than name alone.

Denon America, Inc., 27 Law Drive, Fairfield, New Jersey 07006

Publisher

Steven I. Rosenbaum

Editor-in-Chief/Associate Publisher

William Tynan

Editor, Musical America

Shirley Fleming

Senior Editor

Michael Riggs

Managing Editor

Peter Dobbin

Art Director

Skip Johnston

Copy Editor

Ken Richardson

Proofreader

Stephen Calvert

Technical Department

Technical Editor: Michael Riggs

Electronics Features Editor: Peter Dobbin

Assistant Editor: Randy Brozen (Administration)

Consulting Technical Editors:

Edward J. Foster, Robert Long

Contributing Editors:

Paul D. Lehrman, Gary Stock

Music Department

Classical Music Editor: Theodore W. Libbey, Jr.

Popular Music Editor: Georgia Christgau

Assistant Music Editor: Mildred Camacho

Photo Editor: Susan E. Fingerhut

Contributing Editors: Robert E. Benson, Crispin

Cioe, Mitchell Cohen, R. D. Darrell, The Rev.

Thomas L. Dixon, Edward Greenfield, Paul Hume,

Joyce Millman, Paul Moor, John Morthland,

George Movshon, Thomas W. Russell III,

James Wierzbicki, John S. Wilson

Art Department

Assistant Art Director: Pamela Byer

Technical Art: Roy Lindstrom, Nina Wallace

Assistant to the Publisher: Randi Goldman

Assistant to the Editor-in-Chief: Janet Wolf

Production

Director of Production: Kathleen Davis

Advertising Production Manager: Janet Cermak

Associate Production Editor: Susan E. Fingerhut

Production Assistant: Paula Ballan

Circulation

Vice President, Circulation

Stephen J. Bernard

Circulation Director/V.P., Newsstand Marketing

Dominic Mustello

Circulation Director/Subscriptions

Lillian Gmitruk

Circulation Subscription Staff: Mary Beth Colucci,

Barbara Donlon, Timothy Farrell,

William Johnson, Janice Raiford

Customer Service: Mary Losi

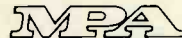

HIGH FIDELITY and HIGH FIDELITY/MUSICAL AMERICA are published monthly by ABC Leisure Magazines, Inc., a division of ABC Publishing, Inc., and a subsidiary of American Broadcasting Companies, Inc. ABC Publishing, Inc.: Robert G. Burton, President; ABC Leisure Magazines, Inc.: Ronald Stuart, President; Steven I. Rosenbaum, Vice President; High Fidelity Group: Herbert Keppler, Senior Vice President; Photographic Publishing Division: Roger Canavan, Controller; Ernest G. Scarfone, Vice President, Graphics and Production; Stephen Bernard, Vice President, Circulation; Dominic Mustello, Vice President, Newsstand Marketing. Member Audit Bureau of Circulation. Indexed in Reader's Guide to Periodical Literature. Current and back copies of HIGH FIDELITY and HIGH FIDELITY/MUSICAL AMERICA are available on microfilm from University Microfilms, Ann Arbor, Mich. 48106. Microfiche copies (1973 forward) are available through Bell & Howell Micro Photo Division, Old Mansfield Road, Wooster, Ohio 44691.

Advertising Offices

New York: ABC Leisure Magazines, Inc., 825 7th Ave., 7th Floor, New York, N.Y. 10019. Tel.: (212) 265-8360. James A. Casella, Advertising Director; Richard J. Marino, Associate Director of Advertising; Michael H. Goldberg, Eastern Advertising Manager; James R. McCallum, Record Advertising Manager; Cecelia M. Giunta, Classified Advertising Manager; Kathleen Davis, Director of Production; Janet Cermak, Advertising Production Manager.

Midwest: High Fidelity, Hitchcock Building, Wheaton, Ill. 60187. Tel.: (312) 653-8020. Starr Lane, Midwest Advertising Manager.

Los Angeles: ABC Leisure Magazines, Inc., 2020 Avenue of the Stars, Suite 245, Century City, Calif. 90067. Tel.: (213) 557-8482. Rita Weitzen, Western Advertising Manager.

Editorial correspondence should be addressed to The Editor, HIGH FIDELITY, 825 7th Ave., New York, N.Y. 10019. Editorial contributions will be welcomed, and payment for articles accepted will be arranged prior to publication. Submissions must be accompanied by return postage and will be handled with reasonable care; however, the publisher assumes no responsibility for return of unsolicited photographs or manuscripts.

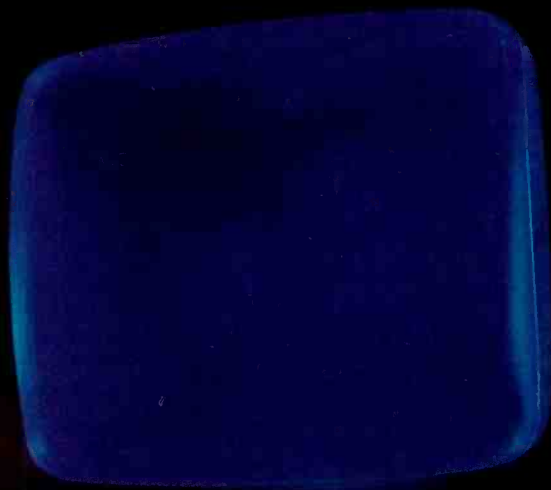

Will your next AM/FM Receiver also give you Stereoplex™ television sound? Only if it's Technics.

Now Technics brings you stereo receivers that are so technologically advanced, they give you more than dramatically clean AM. More than brilliant FM. Now Technics receivers also tune in television sound. And electronically expand it into Stereoplex television sound.

So with Technics Stereoplex receivers, ordinary TV shows now sound extraordinary. Special effects now sound truly spectacular. And there's more.

Every new Technics Stereoplex receiver contains two microprocessors. The first controls Technics innovative Computer-Drive circuitry. To actually stop distortion before it starts. For music of astonishing clarity.

The second microprocessor controls and monitors the quartz synthesis tuner. The most accurate tuning system in the world. For locked-in, drift-free reception.

In addition, there's an input to connect a Compact Disc player, a VCR or a video monitor.

The new Technics stereo receivers. More than AM. More than FM. Even more than television sound. Because they're more than ordinary stereo receivers. They're Technics.

Technics
The science of sound



Mitsubishi Brings
New Meaning To The Term
Stereo Separation.



What separates the Mitsubishi E-404 from conventional systems isn't the fact that it includes a digital audio disc player, or a linear-tracking programmable turntable, or a dual-transport cassette recorder, or, for that matter, a digitally-synthesized tuner/receiver with graphic equalizer.

No, what makes this system unlike any other is a full-function wireless remote control, providing total access, total control of an astonishing number of operations, all from the comfort of your easy chair.

AUDIO TECHNOLOGY TAKES A GIANT STEP BACKWARDS.

The E-404's detachable control panel, called appropriately enough the System Commander, integrates the convenience of infrared remote control with the



intelligence of micro-processor technology. (The result is

not unlike having a computer run your stereo for you.)

With the System Commander cradled conveniently in your lap, you can select a "program" of up to 9 cuts from the phonograph. Or you can punch in a 9-selection program from a pre-recorded audio cassette. And from the compact disc, you can choose a program of another 9 selections.

From any of these sources, you can pick your selections to play in any sequence you wish — last cut first, first last, whatever.

You can even arrange to have a program of up to 9 selections recorded on a blank cassette, each cut evenly spaced for professional sounding results.

A MEANINGFUL DIALOGUE.

Though the possibilities presented by the E-404 may at first seem overwhelming, its operation is, in fact, quite simple.

Mitsubishi Electric Sales America, Inc., 3030 E. Victoria St., Rancho Dominguez, CA 90221. Dolby is a registered trademark of Dolby Laboratories. *35 watts per channel, min. RMS, both channels driven into 8 ohms from 50 Hz to 20 kHz with no more than 0.5% total harmonic distortion.



Selections are entered via the System Commander touchpad. When a command is given, the function requested is visually displayed on the tuner/receiver, accompanied by an affirmative "beep" response (if a mistake is made, two "beeps" are sounded).

Once the E-404 has been programmed, playback is fully automatic, randomly selecting the cuts you've chosen from the source you've chosen — be it phono, cassette, or compact disc.

HEARING IS BELIEVING.

If you're impressed by what the E-404 can do, you'll be equally impressed by how it does it.

The E-404 is designed to interface with a personal computer. It even offers a self-test program that lets you know if every function is performing properly.

The AM/FM stereo receiver, delivering 35 watts minimum RMS per channel,* offers auto search with 18 station presets.

The compact disc player employs a three-beam optical pickup (in place of the conventional single beam) ensuring stable, error-free tracking.

Its speakers are three-way bookshelf type capable of frequency response from 40 to 25,000 Hz.

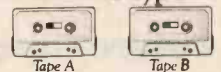

The E-404's twin cassette decks feature Dolby[®] B noise reduction with logic-controlled transport and cassette-to-cassette dubbing at double speed.

With its completeness and full programmability, you can guess the price of the Mitsubishi E-404 audio system. Or you can visit your Mitsubishi audio dealer.

And be very pleasantly surprised.



About This Issue

NUMBERS ALONE can't tell the whole story. They never did; they never will. And when it comes to buying an audio system in the '80s, this is more true than ever. One reason is the greatly improved technical performance of today's components, relative to what you could get twenty or even ten years ago. Putting another zero to the right of the decimal point in a distortion spec isn't an audibly significant achievement anymore. Another reason is the advent of the Compact Disc and the confluence of audio and video. New sound sources have complicated the task of assembling a system that can serve all your audio needs. Thus, the focus has turned increasingly to the element of control: switching and signal processing. What features do you need to get the sound you want from all the sources at your disposal?

As we compiled the special ten-page report "High Fidelity from A to Z," it

quickly became apparent that choosing specific brands is secondary to developing an overall strategy for buying and assembling a new audio system. Providing this perspective is Consulting Technical Editor Robert Long with his introductory sections "What Is High Fidelity?" and "Decisions, Decisions."

Turning to the components themselves, we decided to spotlight the important specs and point out those that can be misleading. Similarly, we have provided the framework for deciding which features are truly useful and which you can do without. Also included is information on some simple tests you can perform in the store before you buy.

In this month's NEW TECHNOLOGIES, we continue our tests of VHS Hi-Fi VCRs with a look at Panasonic's first. The music reviews offer a comparison of three new *Messiah* CDs, while on the pop side you'll find video coverage of the Talking Heads' "Stop Making Sense" and the reggae classic "The Harder They Come," in addition to several CD reviews.

Our MUSICAL AMERICA edition leads off with a feature review of a new digital

version of Smetana's *Má Vlast*, recorded in Japan by the Czech Philharmonic Orchestra on the 100th anniversary of the cycle's premiere. Regular classical coverage includes a look at New World Records—created as a nonprofit label at the time of our Bicentennial to compile a 100-disc anthology of American music and now trying to survive as a profit-making venture. And BACKBEAT goes behind-the-scenes with one of the most powerful producers in jazz today: Giovanni Bonandrini.

A final note: Our general index to articles that were published in HIGH FIDELITY over the past year will appear in next month's issue.—W.T.

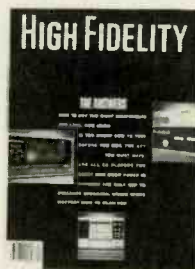

COVER DESIGN:
Skip Johnston
Cover Photo: Grant Roberts

ON THE COVER (clockwise from right): Revox B-252 preamp, Pioneer SX-V90 receiver, Onkyo Integra TA-2090 cassette deck

Letters

Future Tape

I do not agree with Michael Riggs that high-end analog tape decks (either open-reel or cassette) will easily be supplanted by AFM or PCM units ("Basically Speaking," August). He fails to mention the one major drawback to these systems: Only Beta I and VHS videocassettes can be electronically edited, and the technology for doing so is not frame-accurate. We have found PCM excellent for recording live performances

and for storage; but for preparing an edited master tape, rerecording the digital source onto a sophisticated open-reel deck with DBX I noise reduction (for razor-blade or punch-in editing) or onto a cassette deck with DBX II (punch-in editing only) is far easier—not to mention much less expensive—and works quite well. We subsequently transfer the recording to a digital cassette for storage to prevent generation loss.

Only when stationary-head digital recorders that permit both razor-blade and electronic insert editing become cheaper and more readily available will the open-reel analog tape deck be replaced. And only after DASH technology is brought down to 1/4-inch tape running at 1 1/2 ips

will the high-end cassette deck become obsolete.

Thomas Hsu
BioComm Associates
Whittier, Calif.

Technical Editor Michael Riggs replies: *I agree with you about open-reel decks (and never said otherwise), at least for professional and semipro applications. But as far as consumer equipment is concerned, the open-reel recorder already is close to death, mainly because of the greater convenience afforded by cassette decks. Very few nonprofessional users do any kind of sophisticated editing, so I don't think they will*



Presenting the TT2A Turntable and available soon, Heybrook's C2 Pre Amplifier and P2 Power Amplifier. When integrated with your favorite Heybrook Loudspeakers, you'll agree that this new system from Heybrook is MADE FOR MUSIC.

the HEYBROOK SYSTEM



D'Ascanio Audio
Importers & Distributors of Heybrook in the U.S.

11450 Overseas Highway, Marathon, FL 33050

FOR INFORMATION ON HEYBROOK COMPONENTS, WRITE or PHONE: (305) 743-7130

Speaker Tweaker from TDK

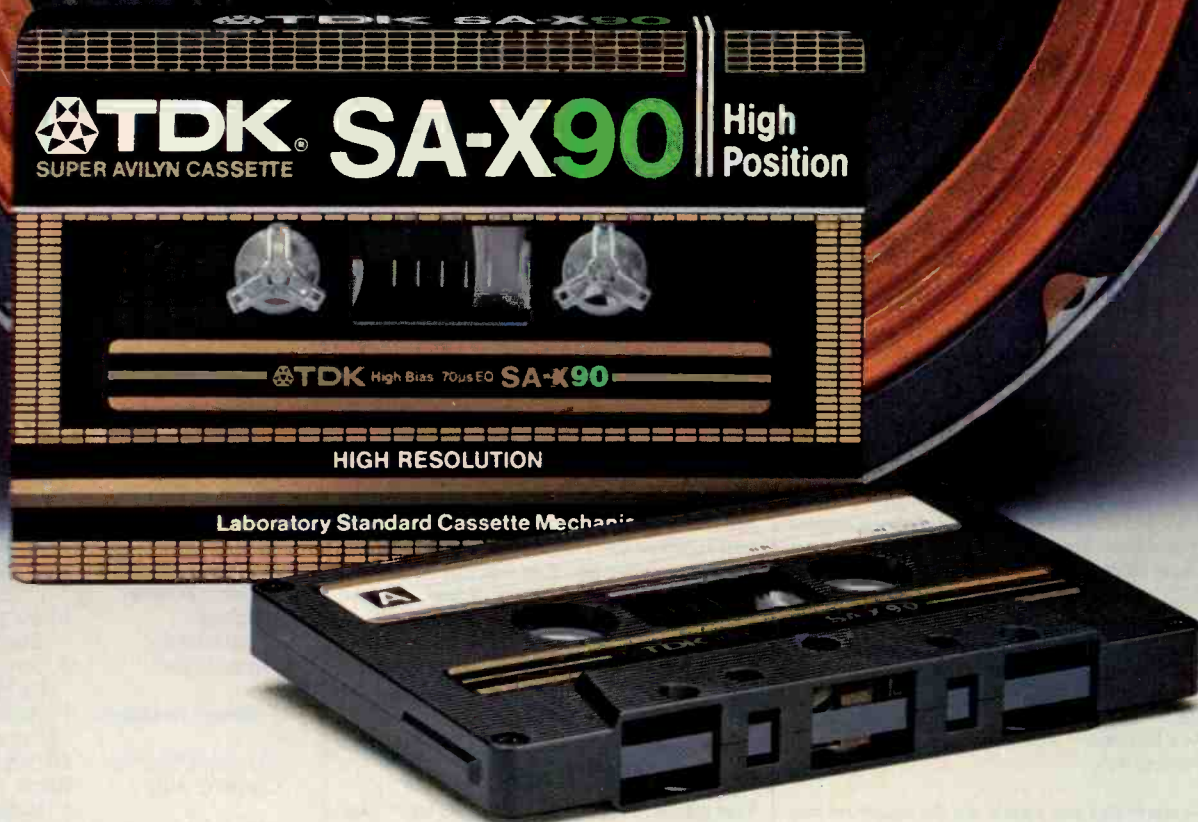

You bought a high-powered, quality audio system with speakers to match for only one purpose. Total performance. To maximize its potential, you need the ultimate high-bias audio cassette. TDK SA-X.

It's one of our Pro Reference cassettes designed to deliver unmatched performance.

Surpassing all other conventional cassettes in its class, SA-X delivers a level of sound quality, clarity and fidelity that you have never obtained before. Unless, of course, you're already using it.

SA-X's exclusive dual coating of Super Avilyn magnetic particles pro-

vides optimum performance at all frequency ranges. You get crisp, clean highs and rich, solid lows. With pure sonic pleasure in between.

SA-X will also handle high signal levels without distortion or saturation, thanks to its super-wide dynamic range and higher MOL.

And we make sure SA-X keeps on tweaking without squeaking (as some other cassettes do). Our specially-engineered Laboratory Standard Mechanism provides a smoother tape transport to assure total reliability and trouble-free performance.

It should also come as no surprise that you'll get incredible perform-

ances from two other TDK Pro Reference cassettes: MA-R metal and AD-X Avilyn-based normal bias cassettes.

Each is designed to deliver pure performance pleasure and long-time reliability...each backed by our Lifetime Warranty.

So maximize the performance of your equipment. Pick up TDK Pro Reference audio cassettes today. We've never met a speaker we couldn't tweak!

 **TDK**[®]
THE MACHINE FOR YOUR MACHINE.

care whether the capability is incorporated into digital cassette decks. And given that nonprofessionals make up the great bulk of the market for cassette machines, their word will be law for that format.

What's the Story?

I would be happier about the debate over the "missing" aria sung by Teresa Stich-Randall ["Letters," August] if her name were spelled correctly. I hope that the error was perpetrated upon Joe Pearce and Will Crutchfield by an editor. Meanwhile, is there indeed more than one version of the "Martini & Rossi" disc in question?

Jon Muller
Carbondale, Ill.

The spelling error, which originated with Mr. Crutchfield, slipped by the editor who handled the story. When we last heard from Mr. Pearce, he still could not find the aria on his copy of the disc.—Ed.

True to Life

Audio equipment should be judged by how neutral it is (neither adding nor subtracting from the input) and how faithfully it reproduces the live performance. Any intermediate step between performance and playback will degrade the sound. Tape recorders provide one example (including digital units, unless they encode in the same format as the Compact Disc, for pure digital-to-digital disc mastering).

Many proponents of digital audio fail to consider its imperfections. Analog-to-digital (A/D) and digital-to-analog (D/A) converters are at work here. Musical instruments create analog signals, and ears (last time I checked) also are analog devices. Every time a laser reads a bit string, it may be exactly the same, but was the A/D converter in the recording studio perfect? What about the D/A converter in your Compact Disc player? There is a difference between what digital recording does do and what we want it to do.

Digital and analog discs have their individual strengths and weaknesses as playback media. If you hear a difference, choose the one that sounds right to you. The truth is in the listening.

Ken Rihanek
Omaha, Neb.

We agree that you should use the equipment that sounds best to you, but there are problems with other points in your argument. For example, given the way most commercial recordings are made, playback neutrality often is in conflict with the goal of achieving lifelike reproduction. An overmiked, compressed recording with a lot of treble boost is not going to sound right on an accurate system and at the very least will require some compensatory equalization. Even if the recording is good, it will be difficult to judge whether a system or component is neutral by comparing what comes out of it with the sound of live music, simply because that sound is so inconsistent. Concert halls, pianos, even drumsticks sound different from one another, often to a degree greater than that of sonic differences between good loudspeakers. The only ironclad test of neutrality is a controlled bypass in which the input to a device is compared instantaneously

with its level-matched output. And in the case of most electronics, for example, careful laboratory measurement will tell you most of what you need to know to judge fidelity.

Bypass listening tests have proved that many modern audio components do not (or need not) audibly degrade the signals passing through them, so long as they are not overloaded or otherwise operated beyond their design limits. Most amplifiers, preamps, and digital tape recorders are in this category. (Peter Walker of Quad used to chain half a dozen or more of his 303 power amps in series, with the padded-down output of one feeding the input of the next, to demonstrate that the sound coming out the end was the same as that going in at the front.) All such devices have measurable imperfections, but they normally are small enough to be below the threshold of audibility.—Ed.

The Critic's Choice

As a recent subscriber to HIGH FIDELITY, I want to compliment your staff on the quality of the equipment test reports and record reviews, which are excellent and well prepared. I read your magazine cover to cover as soon as I get it; some articles, I read two or three times. But one question stands out in my mind: How do you decide what to review? Some items that I would particularly like to see covered never seem to make it into your pages.

Mike Darnowski
Grosvenordale, Conn.

Unfortunately (or fortunately, depending on how you look at it), we have nowhere near enough space to cover all of the new components and recordings that come onto the market. A good sampling is the best we can hope to achieve. The first thing we look for is significance: Anything that breaks new ground, technically or musically, has a high priority. Another important consideration is perceived reader interest, which boils down to what we think you and other subscribers do or don't want to see reviewed. Here, our decisions are based on impressions gleaned from perusing the latest batch of mail, what we find interesting, manufacturers' comments regarding what's especially hot in their product lines, or just plain intuition. Complete success is impossible, but we do try. Suggestions are always welcome.—Ed.

Not Caught Up

Your article "Have Cassettes Caught Up?" [August] won't send me running out to buy a prerecorded cassette. A \$10 investment in a cassette is economic shortsightedness! I can buy an LP for the same price, tape it, and then put it to sleep. When my home dub goes bad, I just make a new one; with a prerecorded tape, your only option is to throw it away and spend \$10 on another cassette. And as far as sound quality is concerned, Crispin Cioe is totally wrong in concluding that prerecorded tapes sound better than home-recorded versions. His reasoning is more a reflection of the inadequate nature of his ears, his equipment, or both.

Joseph Centofanti
Tucson, Ariz.

Letters should be addressed to The Editor, HIGH FIDELITY, 825 7th Ave., New York, N.Y. 10019. All letters are subject to editing for brevity.

Finally, compact discs at a compact price. \$7.99.

Sony® brings you a compact disc offer that's music to your ears and an ode to joy for your wallet. Compact discs for no more than you'd pay for an ordinary LP or cassette tape. Just \$7.99* each.

For a limited time only, Sony in cooperation with CBS is offering 30 of the most popular titles at a great low price. If you purchase any Sony home, car, or portable Compact Disc Player between Nov. 1, 1984 and Feb. 28, 1985, you can choose any or all of these great CBS titles:

ARTIST	TITLE
Bruce Springsteen	Born in the U.S.A.
The Jacksons	Victory
Scandal	Warrior
Cyndi Lauper	She's So Unusual
Footloose	Soundtrack
Billy Joel	Innocent Man
Willie Nelson	Always on My Mind
Journey	Escape
Kenny Loggins	High Adventure
Miles Davis	Decoy
Jeff Beck	Wired
Meatloaf	Bat out of Hell
Bruce Springsteen	Darkness on the Edge of Town
Dan Fogelberg	Phoenix
ELO	Discovery
Billy Joel	Glass Houses
Toto	Turn Back
Men at Work	Business as Usual
The Jacksons	Triumph
John Williams	Rodrigo: Concierto de Aranjuez
Yo-Yo Ma/ Lorin Maazel	Laio: Cello Concerto
Pinchas Zukerman	Mozart: Violin Concerti Nos. 3&5
Zubin Mehta	R. Strauss: Ein Heldenleben
Leonard Bernstein	Prokofiev: Symphony No. 5
Placido Domingo	Perhaps Love
Glenn Gould	Bach: Goldberg Variations
Wynton Marsalis	Haydn: Trumpet Concerto
Stevie Ray Vaughan	Couldn't Stand the Weather
Elvis Costello	My Aim Is True
Bob James & Earl Klugh	One on One

To take advantage of this great offer, just return a copy of your sales receipt and owner's registration card along with the special order form available only at a participating Sony CD Dealer. Payment must be made by check, money order, MasterCard or Visa before April 30, 1985.

SONY®
THE LEADER IN DIGITAL AUDIO™

*Plus postage and handling. See your participating dealer for details. © 1984 Sony Corp. of America. Sony is a reg. trademark of the Sony Corp., 1 Sony Dr., Park Ridge, NJ 07656. "CBS" is a trademark of CBS, Inc. 1984, CBS, Inc.



Please
accept Sony's
sincerest
apology for
making all
car stereos
obsolete.

**SONY INTRODUCES THE
WORLD'S FIRST
CAR COMPACT DISC PLAYER.**

To state it bluntly, the difference in sound quality between the new Sony Car Compact Disc Player and everything else is like the difference in performance between a Ferrari and a Model T.

One noted audio critic at *High Fidelity* magazine said, "In all my road testing to date, I've never heard it so good... It can stand comparison against the best home CD players we've tested... The new Sony Car Compact Disc Player is the real thing in every sense."

And not only are wow and flutter unmeasurable, but its phenomenal 90dB dynamic range will sound that way forever. Because Compact Discs are played by a laser beam. Not a tape head. So you can't wear them out.

To test-drive the Sony Car CD Player, visit your nearest authorized Sony autosound dealer.

And once again, accept our regrets for rendering your present system an antique.

SONY.
THE LEADER IN DIGITAL AUDIO.

Currents

News, new products, and new technologies Edited by Peter Dobbin

Have CD, Will Travel

Sony seems unstoppable in its effort to broaden the audience for Compact Disc players. Its latest crowd pleaser is the D-5, a portable player small enough to fit in the palm of your hand and priced at just \$300—\$100 less than the least expensive home unit. The D-5, which no doubt will find its way into many home systems, is a 9-volt DC unit, but an AC adapter is included. Headphones and an optional carrying case/battery holder (for six C cells or a rechargeable battery pack) transform it into a personal portable. The D-5 has a fairly flexible array of music-access and display features. Its LCD screen shows battery condition, the track being played, the elapsed and remaining disc times, and the number of tracks remaining. Music-access features include sequential steppers to move the laser from selection to selection and high-speed audible scan. For more information, write to Sony Consumer Products (Sony Dr., Park Ridge, N.J. 07656).



Slip the Sony D-5 into its carrying case/battery holder (left), and you have a personal-portable CD player. Adapters (rear) enable it to be used at home and in the car.

Born in the U. S. A.

It took more than \$20 million to do it, but the Digital Audio Disc Corporation (a subsidiary of the Japan-based CBS/Sony record group) is finally manufacturing Compact Discs in the U.S. The Terre Haute, Indiana, plant is said to have a monthly production capacity of 300,000 discs. First off the production line, appropriately, was Bruce Springsteen's "Born in the U.S.A."

Software for Collectors

Though we haven't had time yet to put McGraw-Hill's "Record Collection Manager" through its paces, a quick reading of the documentation (computerese for "owner's manual") reveals it to be a fairly flexible program for both classical and pop music collectors. Available on diskette for the Apple II+ and IIe, the IBM PC, and the Radio Shack TRS-80 Models III and 4, it offers a choice of two preformatted data screens—one for classical and one for pop. The 21 field entries possible for a single classical recording range from the composer's name to whether the recording was made in a concert hall or studio; as with most database-manager programs, you can

choose to fill in all the data or just the fields pertinent to your needs. The procedures necessary to sort the data appear somewhat complex and the program's report formats seem to rule out the printing of labels or index cards, but for \$30 you can't expect everything. For more information, write to McGraw-Hill Book Co. (1221 Avenue of the Americas, New York, N.Y. 10020).



Balanced Approach

The first in a new line of car speakers, EPI's LS-70X is built with the same drivers used in the company's Time/Energy series of home speakers. The tweeter in this two-way system is said to have very wide dispersion, which should make it possible to place the speakers (\$200 per pair) in a variety of locations and still maintain adequate high-frequency response. The LS-70X can be installed in the rear deck or in a door that provides at least 2¼ inches of mounting depth; its perforated steel grille protrudes 1¼ inches above the mounting surface. For more information, write to Epicure Products, Inc. (25 Hale St., Newburyport, Mass. 01950).

Have a Danish

You won't find Dali speakers in your local hi-fi store: To hear them, you'll have to go to a friend's house. That's because the company has chosen to sell its Danish-made products—three speaker systems, ranging in price from \$62 to \$160 each—via its customers. In other words, if someone buys Dali speakers after hearing them in your house, you get a commission. The model pictured here, the Dali II, is the company's least expensive speaker. A two-way design, its driver complement consists of a 1-inch dome tweeter and a 6½-inch woofer. For more information, write to Dali (Danish American Ltd., Inc., P.O. Box 55386, Valencia, Calif. 91355).

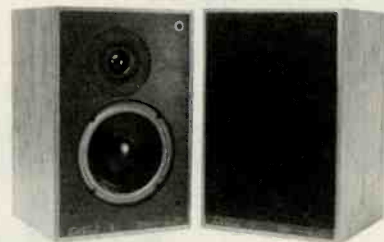

EQ with Finesse

If you need a very flexible equalizer, Soundcraftsmen's DC-4415 (\$600) deserves serious consideration. It gives you a total of 21 control bands per channel. Below 1 kHz, the bands are centered on frequencies spaced a third of an octave apart; above 1 kHz, the spacing increases to



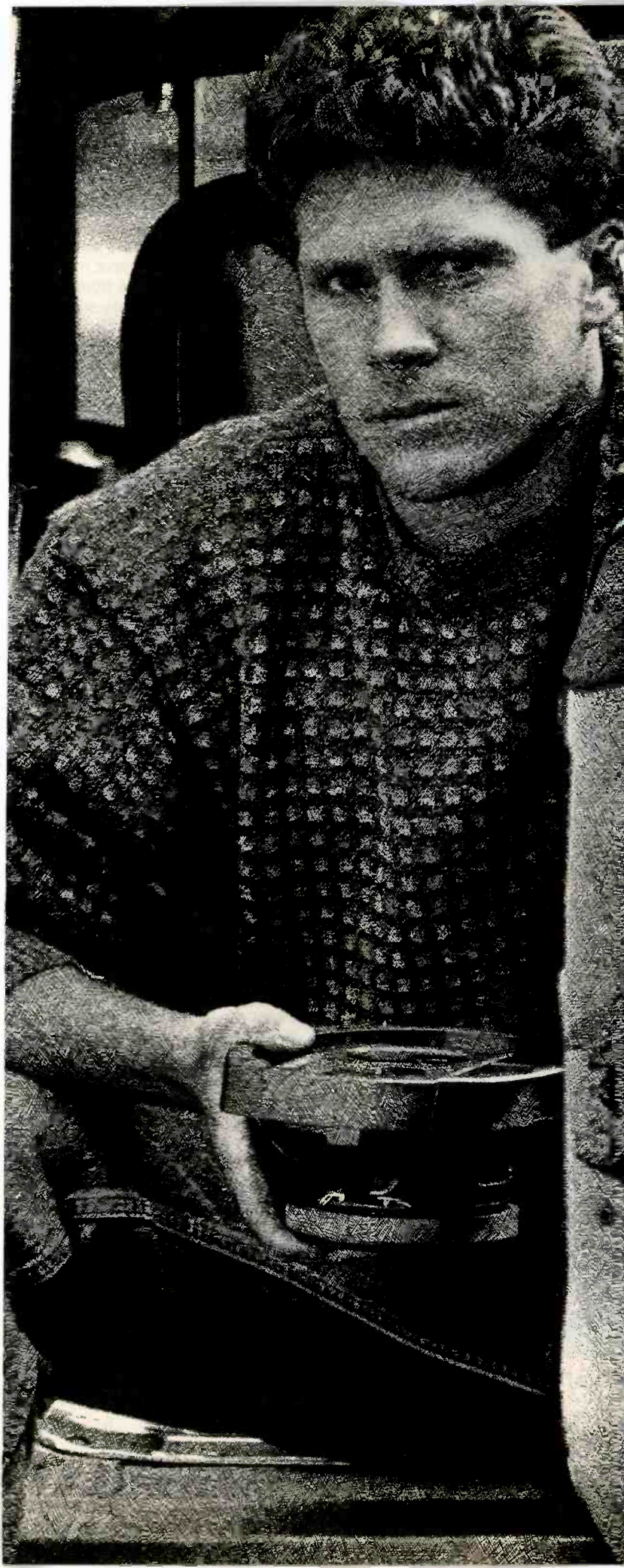

I didn't buy my car stereo backwards.

Why should you?

My car stereo dealer told me if you want clean, clear accurate sound—choose your speakers first. Because if the speakers can't handle it, you won't hear it. No matter what kind of sound your receiver pulls in.

Then he told me: Jensen.[®]

If you want to hear it the way they played it, choose Jensen speakers first. Jensen invented car speakers in the first place. And they're a leader today. Simply because they know how to deliver the goods.

Naturally I got a Jensen receiver to go with my Jensen speakers. Great team, designed to play best together. Makes sense. Makes great sound, too. I want to hear it all. With Jensen, I do.



JENSEN[®]

When you want it all.

alternate one-third octaves. To ensure unity gain in the device, Soundcraftsmen includes a comparator circuit that enables you to balance input and output levels to within a tenth of a dB. Other features of the DC-4415 include an infrasonic filter and pre/post tape switching. For more information, write to Soundcraftsmen (2200 S. Ritchey, Santa Ana, Calif. 92075).

On-the-Spot Analysis

A professional-quality real-time spectrum



analyzer, the Heath AD-1308 is available in either kit or factory-built versions (for \$280 or \$400, respectively). This portable device displays signal levels on a 20-column, half-

octave fluorescent bar-graph readout. It can be set to show 1- or 3-dB increments within each band, and an averaged one-octave, ten-band display mode is available. An additional display column provides selectable flat, A-, or C-weighted sound pressure level (SPL) measurements. Four memories enable you to make comparisons among various EQ settings, and a difference mode subtracts a stored reference curve from the current input. The analyzer comes with a calibrated electret microphone and individually programmed ROM (read-only memory) chip that ensures a mike accuracy of ± 2 dB. Finally, a thumbwheel attenuator switch enables you to scale the display in 10-dB steps from 50 to 120 dB, for a total SPL measurement range of 23 to 126 dB. A rack-mount/power-supply adapter (Model AD-1308-1, \$120, which comes standard with the factory-built analyzer) converts the device to a home-based unit. As part of your stereo system, the analyzer can monitor left, right, left-plus-right (L+R), or left-minus-right (L-R) line-level signals. The adapter's built-in charger will bring the analyzer's NiCad batteries up to full power overnight. For more information, request the Heathkit catalog from Heath Co. (Dept. 150-235, Benton Harbor, Mich. 49022).



Sansui On the Road

A \$400 car-stereo front end—the CX-700 from Sansui—has a bidirectional cassette transport with music search, Dolby B noise reduction, and switchable EQ. The tuner section has presets for 18 FM stations and 6 AM, with automatic scanning of all 24, sampling each for 5 seconds. Its ASRC (automatic stereo reception controller) circuit is designed to reduce noise from ignition, multipath, and comparable sources. For more information, write to Sansui Electronics Car Audio Div. (1250 Valley Brook Ave., Lyndhurst, N.J. 07071).



Moderate-Price Yamaha Reverser

Automatic reversing in both recording and playback are major features of the \$379 Yamaha K-600 cassette deck. The most unusual, however, is "car equalization," which introduces 6 dB of emphasis at 75 Hz

DALI

NEW from DALI: High Quality European Speaker System...and an Opportunity to Make Money in Your Spare Time!

Denon, NAD, Micro Seiki, DALI, Cerwin Vega... these are just a few of the well-known brands we have been successfully marketing in Europe for several years. Now Danish American Ltd., Inc. (DALI) offers our well-proven direct to consumer marketing concept to you.

We sell factory direct, offering high-quality, European-manufactured, real-wood walnut-veneer speaker systems at prices you simply will not believe. Yet, DALI does not compromise on quality. These systems use the same superb drivers found in other brand name speakers selling for \$250 and more!

How can DALI charge so little for so much quality? Because we design, manufacture, import, and sell *only* through our own organization. We eliminate the 30% importer/distributor markup, the 7% to 10% sales-representative commission, and the 70% to 120% retailer profit markup. We've replaced all of that with an operating margin of only 30%!

DALI offers four world class systems, all sold on an unconditional, 30-day, risk-free, guaranteed-satisfaction basis...or your money back. More, we offer every DALI customer an opportunity to become a DALI distributor.

For your free brochure describing our systems and the opportunity to combine your hobby with a chance to earn additional income in your spare time as a DALI distributor, complete and mail the coupon today. Or call (805) 252-7203.

Mail Coupon to: **DALI • P.O. BOX 55386 • VALENCIA, CALIFORNIA 91355**

Please send me full details about:

DALI Speaker Systems. Money-making opportunities as a DALI distributor.

NAME _____ ADDRESS _____

CITY _____ STATE _____ ZIP _____ PHONE (____) _____

Luxman brings music home to Burt Bacharach and Carole Bayer Sager



The living room of Burt Bacharach and Carole Bayer Sager with the Luxman T-240, K-240 and L-430 High Fidelity Components

For those whose lives are music, there is Luxman. Our uncompromising Luxman. Precise, elegant Luxman. The Luxman of legendary innovation and handcrafted quality; of sound pure, rich and real. If you value such music, Luxman belongs in your life.

For the dealer nearest you, call 1-800-257-4631.

The Touch of Luxury



LUXMAN
HIGH FIDELITY SYSTEMS

and 4 dB of attenuation at 200 Hz to customize the sound to typical car acoustics. Dolby B and C noise reduction are included. Among the convenience features are an automatic fader, intro-scan, automatic mute, selection repeat, blank skip, automatic tape-tape selection, and "record return," which rewinds to the point where you last started recording. For more information, write to Yamaha Electronics Corp., U.S.A. (6660 Orangethorpe Ave., Buena Park, Calif. 90620).



Hookup Help From NEC

A combination video switcher, audio amplifier, and signal processor, NEC's AV-200E (\$200) may be just what you need to complete your video component setup. The unit's audio-only features include a single tone control, a tape monitor loop, a stereo synthesizer circuit, and a power amp section rated at 12 watts (10 1/4 dBW) per side. As a video switcher, the device can be used to route any of four inputs to three receivers; each video input is accompanied by a pair of audio inputs. Finally, a built-in vid-

eo enhancer circuit enables you to increase picture sharpness. For more information, write to NEC Home Electronics (1401 Estes Ave., Elk Grove Village, Ill. 60007).



A Patient Teacher

Add Waveform's Colortone keyboard (\$80) to your Commodore 64 computer and you create an "intelligent" music-teaching system for children or novice musicians. The flat-membrane keyboard has 25 piano-like keys and comes with disk-based software that enables the student to play along with 12 preset songs, practice scales, and create compositions for later playback. The student is guided with on-screen function and notation displays. Waveform says that the keyboard can also be used with its Musi-calc series of programs for more sophisticated music-synthesizer functions. For more information, write to Waveform Corp. (1912 Bonita Way, Berkeley, Calif. 94704).



VHS Hi-Fi with Stereo Decoding

It's appropriate that Harman Kardon's first video product would be a knockout in audio as well. Its VCD-1000 (\$1,250) is a VHS Hi-Fi deck with BTSC stereo decoding circuitry built into its TV tuner section. The VCD-1000 includes a 14-day/4-event programmable timer, visual-search and still-frame capabilities, and a 105-channel cable-ready tuner. Presets for 16 channels are provided on the deck's wireless remote, which also duplicates all of the VCR's front-panel controls. For more information, write to Harman Kardon (240 Crossways Park West, Woodbury, N.Y. 11797).

Correction

Pioneer has informed us that its KE-A880 car receiver/tape player is not equipped with a clock function or Dolby C noise reduction, as we claimed in our October test report. We were also incorrect in stating that the owner's manual lacks instructions on using the AM and FM station presets.

Sound Perfection. You can't get any closer than this.

Power. Purity. Startling realism and depth.

This is the sound you demand. And no one delivers it quite like Kenwood.



KENWOOD
STEREO FOR YOUR CAR

Car buyers have a choice. When shopping for a new car, you may be able to have the factory radio omitted. For the Kenwood Car Stereo dealer nearest you, call 1 (800) 821-7700 and ask for extension 102.

SOLID

Introducing the Canton CT 2000 floor standing speaker - our first using proprietary vent technology. The result is sound reproduction so fast, natural and free of coloration you must hear it to appreciate the acoustic achievement it represents.

Engineered to meet the most exacting demands of digital technology, the CT 2000's superior dynamic range, resolution and transient response stem from Canton's solid technical expertise.

And, like the entire Canton product line, every element of the new CT 2000 is designed, engineered and manufactured within Canton's factory...this gives us the solid quality for which we are known worldwide.

Solid Detailing goes into every Canton speaker as well. That's why we offer our speakers in a variety of fine finishes, like walnut and oak veneers, rich black,



bronze and white lacquers and now a premium finish, gloss mahogany. For at Canton, we believe speakers should look as good as they sound.

And what about the CT 2000's technical specs? We think you'll find these solid as well:

Efficiency:

92dB (1 meter/1 watt)

Frequency Response:

18-30KHz

Power Handling:

300 Watts (music spectrum)

Distortion:

0.1% (DIN Standard)

Dimensions (WxHxD):

14" x 38" x 14"

Solid acoustic technology & design principles, solid detailing & quality. For you it means it means a solid investment. Visit your local Canton dealer today.

Canton

North America, Inc.
254 First Avenue North
Minneapolis, MN 55401

CANTON

Die reine Musik

A FACE THAT ONLY AN AUDIO BUFF COULD LOVE.

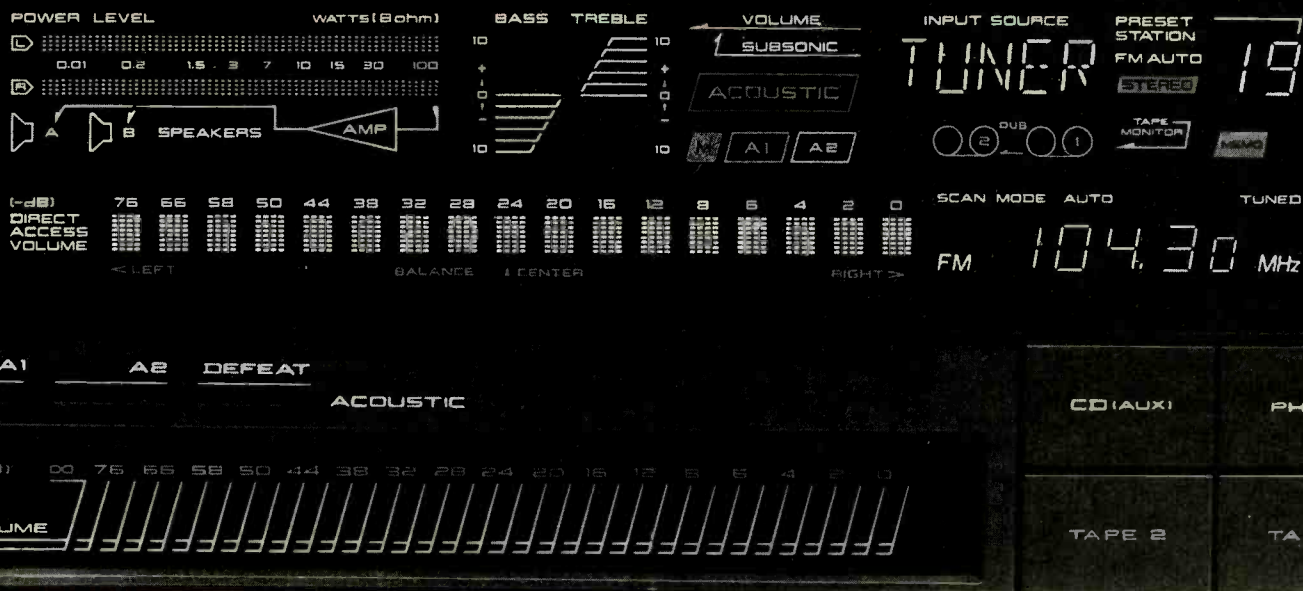

This isn't just another pretty face. It's a masterpiece of electronic sophistication and technical wizardry.

One look at its dazzling FL display gives you instant verification of station frequency, memory program number, output and input source, Acoustic Memory settings and virtually every other AA-A45 receiver operating function.

You'll find AKAI innovations like Direct Access Volume Control. Just one of many computer-controlled functions, it responds with instantaneous volume settings at the touch of a bar. A special safety circuit automatically prevents

abrupt volume increases and resulting performance problems.

Tuning is also at your fingertips, thanks to 20 Station Random Pre-Set Memory. An advanced tuner section that incorporates quartz frequency synthesis for continuous, drift-free reception.

There's even a Zero-Drive circuit that eliminates distortion and negative feedback. A Dual Pole DC Servo Circuit for greater signal resolution and musical fidelity. And an MC head amp with Moving Coil Cartridge compatibility.

But the thing you'll really love about the AA-A45 is its reasonable price.

Because while a lot of companies can design a receiver that an audio buff would love, AKAI's also designed one that you can afford.

For more information on AKAI's full line of receivers, write to AKAI America, Ltd., P.O. Box 6010, Compton, CA 90024.

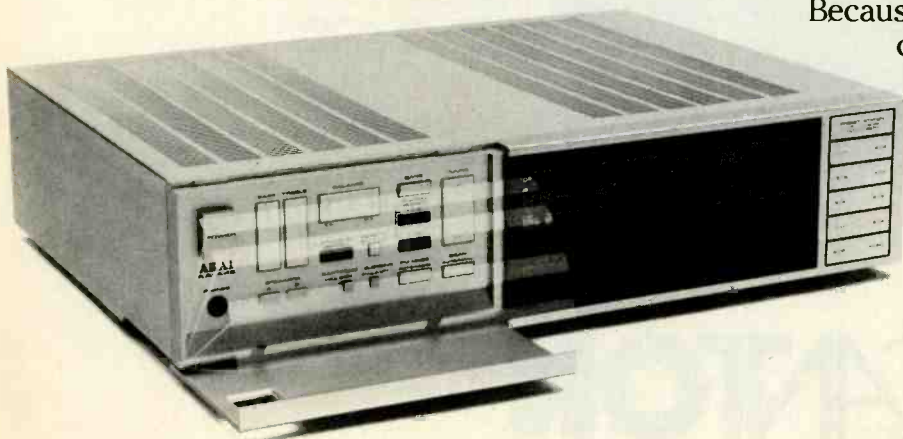

AKAI

Basically Speaking

Audio and video concepts and terms explained by Michael Riggs

Vertical Resolution

AMONG THE TERMS most frequently bandied in discussions of high-performance video equipment is "resolution," usually specified in lines. A system's resolution determines how sharp and detailed the picture looks. It comes in three flavors: vertical, horizontal, and diagonal. However, the last is mainly a function of the other two and is less important perceptually.

Like film, television gives the illusion of motion by presenting a series of still pictures (called frames) in such rapid succession that the eye cannot distinguish them as separate scenes. Each frame comprises a large number of closely spaced horizontal lines, which usually are created by an electron beam scanning across the inner surface of a phosphor-coated screen. (See "Basically Speaking," May.) The vertical resolution is the amount of information that can be portrayed from top to bottom on the screen and thus depends primarily on the number of scanning lines used to generate the display. The NTSC television system—the standard in North America and Japan—employs 525 such lines per frame, of which 41 are dedicated to the vertical synchronization pulse (the horizontal black bar you see when the vertical hold on your set is misadjusted). That leaves 484 "active" lines.

But the effective vertical resolution is significantly degraded by what is called the Kell factor (after its discoverer), which accounts for the loss of sharpness that occurs when some of the fine (high-frequency) details in a scene fall between scanning lines, causing them either to vanish or to appear attenuated. (This is related to a phenomenon known as aliasing, in which such details twinkle in and out of the picture or create moiré patterns as they move across scanning lines.) Measured values of the Kell factor range from approximately 0.5 to about 0.8. The most widely quoted figure is 0.7, which brings the effective resolution down to about 340 lines. This is the accepted value for the vertical luminance resolution of the NTSC system.

Unfortunately, it's still not an accurate representation of the system's subjective performance, because it does not take into account the effect of the interlaced scan technique employed in all present-day broadcast television. Thirty NTSC frames

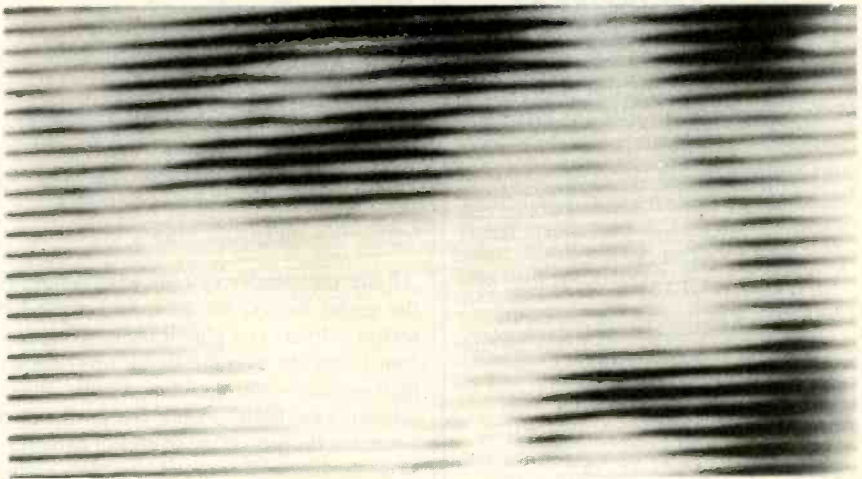

This blowup of a small portion of a television picture clearly shows its scanning-line structure. Increasing the vertical resolution would involve increasing the density of these lines, giving the image a smoother look. Although such an improvement would make a relatively small difference in the apparent picture quality on a normal-size set, the change for the better would be obvious on a large-screen projection system.

are transmitted every second—a frequency high enough to simulate motion, but not to prevent the screen from flickering. One solution would be to use phosphors with a slower luminance decay (greater persistence), to hold the image longer, but that could cause blurring in the transitions between frames. Instead, each frame is built out of two 262½-line fields, scanned one after the other in such a way that the lines of the second field fall between those of the first.

Thus, a new field appears on the screen 60 times every second, which is fast enough to prevent gross flicker under any but extreme circumstances. (The European PAL and SECAM systems operate at a 50-Hz field rate, with 625 lines per frame, yielding slightly higher vertical resolution at the expense of some increase in flicker.) Although one might suppose—as the standards-makers surely did—that this trick would preserve the vertical resolution of the frame, it doesn't entirely. At best, you get about 70 percent, or 240 lines, subjectively; if the receiver does not interlace perfectly (i.e., if the fields overlap each other on the screen) or if there is substantial vertical motion, you may get as little as 50 percent. And though this technique does prevent obvious flicker, some still is visible between adjacent lines as a subtle rippling effect, called interline flicker.

It is interesting to note that both interline flicker and aliasing would be more obvious if standard video cameras took full advantage of the NTSC system's theoretical

vertical resolution. This is not the case, however. A video pickup tube works in a way that is basically the reverse of the way a display tube operates. At each point on its surface, the pickup target accumulates incident light until a scanning beam reads and discharges it. But to prevent excessive motion smearing, the entire target normally is discharged every sixtieth of a second. This is achieved by making the spot size of the beam large enough to cover at least one adjacent line in the opposite field as well as the nominally current line. Thus, the camera serves as a low-pass antialiasing filter, which also reduces the apparent interline flicker by minimizing differences between the two fields. In so doing, however, it sacrifices vertical resolution to a degree similar to that which otherwise would result from the Kell factor, although without the obvious distortions that aliasing can create.

The final link in the chain is color. Although every scanning line carries chrominance information encoded on a subcarrier, the filtering required to separate the color properly from the luminance reduces the vertical color resolution to about half the vertical luminance resolution. Fortunately, the eye sees the black-and-white part of an image—simple variations in relative lightness or darkness between adjacent elements—more sharply than the color, so the difference is not particularly important.

Next month, I'll take up horizontal resolution and some future developments that may bring better picture quality. **HF**

IF YOU'RE OBSESSIVE ABOUT DIGITAL AUDIO, WELCOME TO THE CLUB.

It's the Sony Digital Audio Club. The world's first club dedicated to creating awareness and understanding of the remarkable technology behind compact disc players—from the company most qualified to provide it.

This year, to welcome you to the club, you'll receive special promotions on compact discs; discounts on digital accessories; our quarterly newsletter, "The Sony Pulse"; *The Sony Book of Digital Audio Technology* (over 300 pages of facts and details); a 30" x 40" digital audio poster; a digitally-recorded compact disc; and extensive information about the latest advances in digital products from Sony—the leader in digital audio.

To become a member, simply mail the coupon below, along with a check or money order for \$15* to Sony Digital Audio Club, P.O. Box 161, Lowell, Mass. 01852.**

And join the thousands of people who are already well on their way to satisfying their obsessions.

Name _____

Address _____

City _____

State _____ Zip _____

*\$3.00 additional for postage and handling outside the U.S.** Please allow 4-6 weeks for delivery.



SONY
THE LEADER IN DIGITAL AUDIO™

HFM-12/84

AUDIO/VIDEO

CrossTalk

Practical answers to your audio and video questions by Robert Long

Noise Reduction Ad Absurdum

Please explain in plain English what the difference in noise reduction is between Dolby B, Dolby C, and DBX and why some decks have all three.—Lloyd G. Lutey, Sr., San Jose, Calif.

All are compander systems that compress the signal as you record it and expand it reciprocally as you play it back. Compression keeps the average signal level higher than normal—and therefore farther above inherent tape noise—while it's in recorded form, but the greater the degree of compression, the harder it is to achieve truly reciprocal expansion on playback. Dolby B (which is included in all decks with any sort of high fidelity pretensions) is the mildest, taking a bite of about 10 dB out of tape noise in the treble, where it is most audible. Dolby C removes some 20 dB in the treble and midrange. DBX gives you about 30 dB across the entire frequency band. Because of the progressive technical difficulty of achieving correct playback, you're probably well advised to avoid Dolby C in inexpensive decks and DBX in models at moderate prices as well, but these are only rough guidelines.

Squeaky

Recently I've been having trouble with a three-year-old Kenwood KX-500 cassette deck. First it began squeaking, apparently because the takeup hub drive was rubbing. Then it started losing highs after a few seconds of play. When I stop the tape and restart it, the highs are back but quickly fade away once again. I've been cleaning and demagnetizing the heads regularly. What could be the problem?—Christopher J. Pattacini, Storrs, Conn.

I've had similar problems, but only on certain cassettes, whereas you imply that your deck is to blame. Actually, it's a question of interaction. I've talked to cassette manufacturers without getting concrete answers, but it appears that a combination of the wrong tape tension (supplied by the deck) with the wrong internal cassette-shell design can cause severe skewing of the tape path with a resulting loss in highs as the tape skews farther and farther from correct azimuth. The squeak in the takeup drive of your Ken-

wood suggests the kind of malfunction that can upset the tensioning, and you certainly should have it corrected before secondary damage—perhaps to drive bearings, for instance—makes the prognosis worse than it already is.

In Search of Dolby

I have a Sansui QR-6500 quadriphonic receiver and a Teac A-2340 four-channel open-reel tape deck. Where can I find an add-on Dolby B noise reduction unit to use with them?—R. Eustace, Darby, Mont.

Only in a second-hand department, so far as I know. Teac used to make a lovely four-channel model to complement the 2340, but it's long gone. The most recent add-on I can think of was the Nakamichi NR-200, which included Dolby C as well as the more familiar Dolby B. Nakamichi says that it should still be in some stores, even though it's no longer in production. But it was a two-channel model, so you'd need two NR-200s for your setup.

Crumbling Suspensions

The foam suspension around the woofers of my ESS AMT-1 speakers is beginning to crack. The same thing happened to a pair of Scott bookshelf speakers, whose woofer surrounds eventually separated from the cones completely. I "repaired" the Scotts with diluted contact cement, which I brushed onto the foam. It kept the drivers from falling apart, but I'm afraid the bass response will never be the same. I don't wish to experiment with the more expensive AMT-1s. I don't want to have them repaired or rebuilt, either, because the cost would be close to that of replacement. I'll try anything before I'll replace them. What home remedies have you tested?—Paul J. Kallman, Lynbrook, N.Y.

None. As far as I can see, the drivers are a dead loss. Adding glues changes the damping and mass of the woofer even if it prevents further deterioration of the foam surround, so the sound is bound to change.

We regret that the volume of reader mail is too great for us to answer all questions individually.



**THE EXPERTS SAID THEY HEARD EXCELLENT FREQUENCY RESPONSE,
A HIGHER MOL, AND GREATER DYNAMIC RANGE.**

BUT NOT IN THOSE WORDS.

Wicked lows. Manic highs. Nasty passages.
It all translates the same.

Music sounds better when it's recorded
on Maxell XL-S cassettes.

That's because we've improved our crystallization process. So we can now produce magnetic particles that are both smaller in size and more uniform in shape. Which allows us to pack more of these particles on the tape's surface, in turn, making it possible to record more information within a given area of tape.

AC bias noise is reduced by 1dB. And maximum output levels are increased by 1.5dB on XLI-S and 2dB on XLII-S.

As a result, XL-S delivers a significantly expanded dynamic range. A noticeably improved signal to noise ratio. And a fuller impact of dynamic transients.

So if you want to hear your music the way it was meant to be heard, put it on Maxell XL-S.

Because recording tapes just don't get any better.

Or any badder.



IT'S WORTH IT.

© 1984 Maxell Corporation of America, 60 Oxford Drive, Moonachie, N.J. 07074



Until you experience a Blaupunkt car stereo system,
you'll never know how alive sound can be.

That's why Blaupunkt car stereo systems come as
standard equipment in some of the finest cars in the world.

Yet it's surprising how easy it is to afford one.

For the Blaupunkt dealer near you, call 1-800-228-5333.
In Nebraska, 1-800-642-8788.

Sound so alive you can feel it.™ ● **BLAUPUNKT**

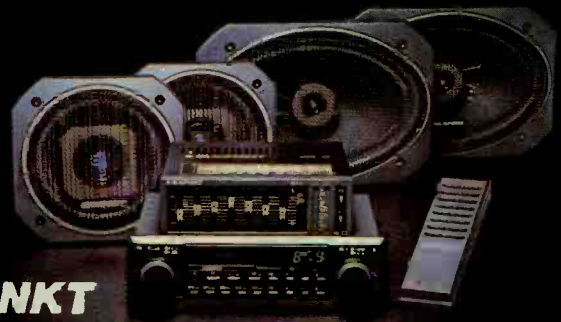

The Autophile

Going on the road with stereo by Gary Stock

The Heart of Your System

IT'S SATURDAY MORNING. Sunny, mild, and shaping up to be a gorgeous midwinter day. The holiday bonus check is tucked away in your pocket—along with a cluster of ads for radio/cassette players that you clipped from the local newspaper. Today's the day you're going to buy a front end, the heart of your new car-stereo system.

The only problem is figuring out which front end to buy. What you need to do first is answer a number of basic questions, thereby whittling down hundreds of potential options to a manageable few.

An obvious starting point is assuring that the front end will fit physically and work electrically in your car. Answering the electrical question is fairly easy: Unless you have an esoteric British sports car or a prewar classic, your car's electrical system is the almost universal negative 12-volt system. If you're unsure, check your owner's manual.

The issue of fit is a bit more complicated. Dashboard or console apertures come in a variety of sizes. Most American cars have the so-called full-size aperture—a nice big opening (about 2 by 7 inches, with shaft holes 5¾ to 6¼ inches apart) that will accept any size of front end. Smaller domestic and most Japanese autos have a mini-aperture (about 2½ by 6¼ inches, with shaft holes 5½ to 5¾ inches apart), while many European cars have a squared-off DIN opening (1¾ by 4¾ inches, with no shaft mounting holes) that accepts a snap-in bracket.

If there's already some form of front end installed in your car, measure the faceplate's dimensions and the center-to-center spacing of the shaft knobs. If your car is unequipped, all the better; measure the aperture and the space between the shaft holes.

A few rules of thumb apply to the sticky question of price. Reasonably well made, reliable front ends from reputable manufacturers like Sanyo, Sparkomatic, Pioneer, and Clarion can be bought for as little as \$90, particularly in regions where list-price discounting is common. At the other end of the scale, companies such as Nakamichi and Blaupunkt offer front ends costing several hundred dollars. One way to locate the dollar amount that matches your needs is by ratio: When buying a completely new dealer-installed system, allot about one third of the final purchase price to the

front end and other electronics (if any); thus, a \$900 system would incorporate about \$300 worth of electronics, including front end, amplifier, and equalizer. For a self-installed system, that proportion rises to about half the total price. If you're buying just a front end, estimate the cost of the rest of your system and apply the same ratio.

You can also deal with price by anticipating how you plan to use your front end. If you'll be dropping it into a summer jalopy or your around-town clunker, make a minimum investment. For your road machine or a car you intend to keep for many years, it pays to get a more serious front end—not only because you'll be listening to it for a long time, but because the best

To build a great system, buy a new front end first.

way to assemble a first-rate sound system without going bankrupt is to expand it piece by piece around the core component. A top-flight front end with automated features will cost from \$300 to \$600, but investing in it *first* will make it possible to obtain exotic-quality sound in affordable stages.

Now you must consider your options in features. One of the most important is the front end's tape-loading system. Basic decks often require you to shove the cassette into the slot before the mechanism clamps it in place. More expensive models have what is called "soft" loading (and eject), where the loading mechanism gently grasps the cassette and pulls it in. In my experience, soft loading is desirable.

Within the past year or two, program search functions have gained wide popularity. Essentially, these enable the deck to advance (or reverse) automatically to the next selection on a tape by sensing the unrecorded spots between songs. This function is especially welcome if you play a lot of commercially recorded tapes, which may have some songs you want to skip over.

These days, virtually all home cassette decks are equipped with Dolby B noise reduction; many also include Dolby C or DBX. Presumably you've recorded your home cassette library using the best noise reduction system your deck has to offer, so you'll want to use the same tapes—and therefore the same noise reduction sys-

tem—in your car.

With regard to the radio portion of a front end, expect to see a frequency-synthesized tuner section in mid- to high-priced units. Without going into the details of tuner design, let's just say that frequency-synthesized front ends have a number of virtues: They give you easily readable digital frequency displays, they enable you to tune stations without any knob twiddling, and they're amenable to all sorts of neat convenience features.

Most frequency-synthesized front ends offer a seek tuning mode that hunts for the next receivable station each time you tap a button; some even have an "audition" feature that plays a second or so of each station on the dial until you instruct it to stop scanning. Both features are handy and a boon to safe driving in that they eliminate the distractions of manual station prowling. Virtually all such tuners can "memorize" four or five AM and FM stations, and a good proportion incorporate digital clocks. More traditional capacitor-tuned front ends—recognizable by their analog dials and large station-selector buttons—are usually incapable of these technical gymnastics. Obviously, the frequency-synthesized approach has a great many advantages over its traditional counterpart, and since such units are available today for as little as \$200, I'd recommend them for all but the most budget-oriented systems.

A front end's power output capabilities and amplifier configuration also must be considered. Most budget and mid-priced units are rated at between 4 and 8 watts per channel; a car's 12-volt electrical system won't permit a conventional amplifier to put out more. Some sophisticated front ends and almost all separate car amplifiers use a step-up power supply to overcome the 12-volt limitation. You also will encounter front ends with no amplifier section. These no-compromise units are designed for use in expensive setups, along with one or possibly more outboard amps.

If your budget only allows for an inexpensive front end, don't try to drive more than one pair of reasonably efficient door or rear-deck speakers. If you want more punch or intend to use four speakers, you'll need a separate power amplifier rated at about 20 watts per channel.

Armed with the facts and features you've just categorized, specify your precise requirements and priorities to the salespeople you visit. Chances are, you'll be able to boil down the options to a manageable handful quickly.

HF

New Equipment Reports

Preparation supervised by Michael Riggs, Peter Dobbin, Robert Long, and Edward J. Foster. Laboratory data (unless otherwise noted) supplied by Diversified Science Laboratories.

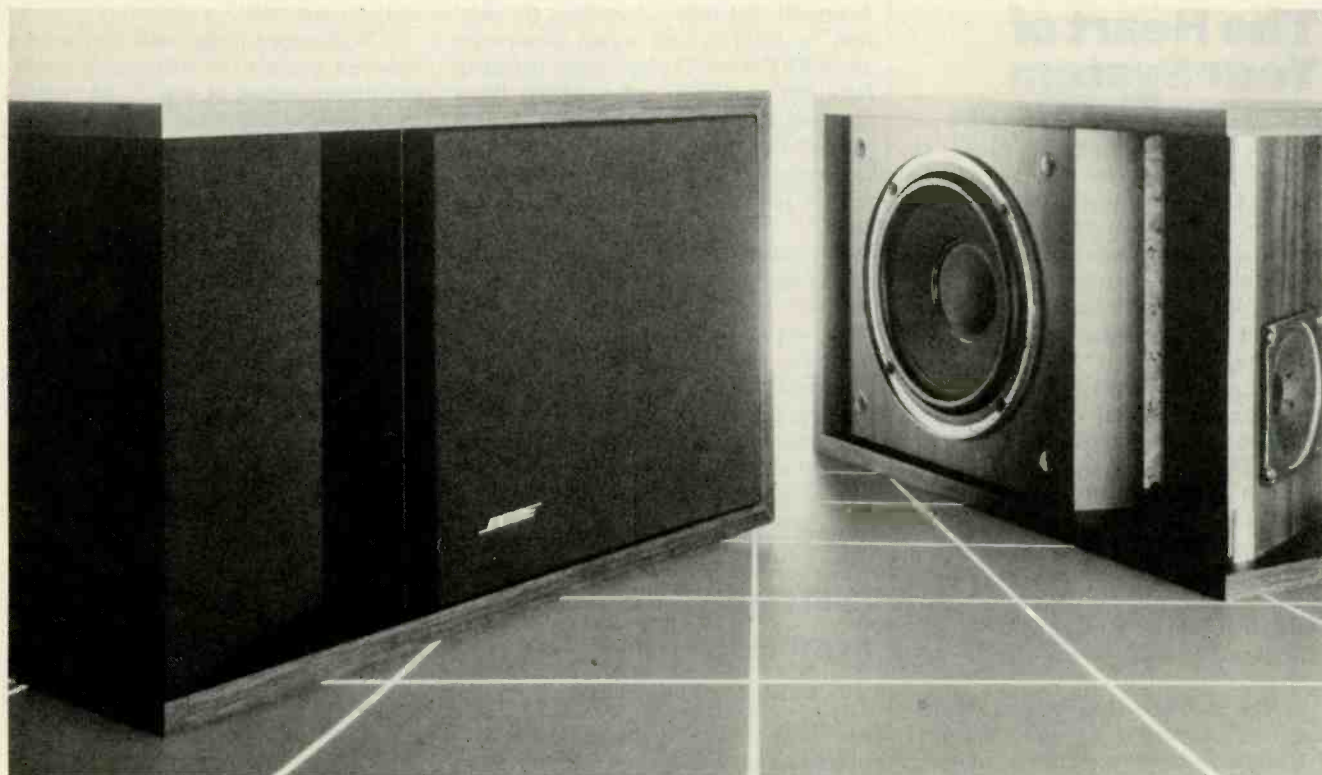

HALLEY GANGES

Bouncing Baby Bose

Bose Model 201 Series II Direct/Reflecting loudspeaker system, in particleboard enclosure with wood-grain vinyl finish. Dimensions: 14½ by 9 inches (front), 7¾ inches deep. Price: \$240 per pair. Warranty: "full," five years parts and labor. Manufacturer: Bose Corp., 100 The Mountain Rd., Framingham, Mass. 01701.

THE FIRST COMPACT SPEAKER to embody the Bose Direct/Reflecting sound-propagation principle was the Model 301 (test report, November 1975), which came in mirror-image pairs. Its tweeter fired diagonally outward—that is, away from the listening area—into a movable vane that could apportion the highs between direct (bounced forward, toward the listener) and reflecting (sideways or back, so that the sound would bounce off at least one wall before reaching the listener). About two years ago, Bose introduced the still smaller Model 201. It substituted black plastic for the 301's furniture-style enclosure, acoustically transparent foam for the fabric grille, and a plastic vane in front of the grille for the 301's metal one behind. But the operating principle was basically the same.

The Model 201 Series II borrows a little from both of its predecessors and retains their fundamental idea. The Direct/Reflecting principle, for instance, dictates that a

large portion of the sound should be reflected from room boundaries in imitation of the way it propagates from natural sources, such as musical instruments; otherwise, it is claimed, the sound may all too palpably emanate from the loudspeaker enclosures, constricting the stereo image. The big Bose (the classic Model 901, in all its incarnations) does this by means of multiple full-range drivers aimed in three directions. Its offspring, which use somewhat more conventional driver configurations, rely on the relatively omnidirectional propagation of sound at low frequencies and divert only the treble.

The new version of the Model 201 has a front-firing 6-inch woofer loaded by a ducted port on the outside of the enclosure proper, near the tweeter. Instead of a movable vane to redirect the treble energy, there is a freestanding angled baffle on which the tweeter is mounted so that it faces outward and somewhat back—in the general direc-

Report Policy: Equipment reports are based on laboratory measurements and controlled listening tests. Unless otherwise noted, test data and measurements are obtained by Diversified Science Laboratories. The choice of equipment to be tested rests with the editors of HIGH FIDELITY. Samples normally are supplied on loan from the manufacturer. Manufacturers are not permitted to read

reports in advance of publication, and no report or portion thereof may be reproduced for any purpose or in any form without written permission of the publisher. All reports should be construed as applying to the specific samples tested. HIGH FIDELITY and Diversified Science Laboratories assume no responsibility for product performance or quality.

TEAC SPEAKS.

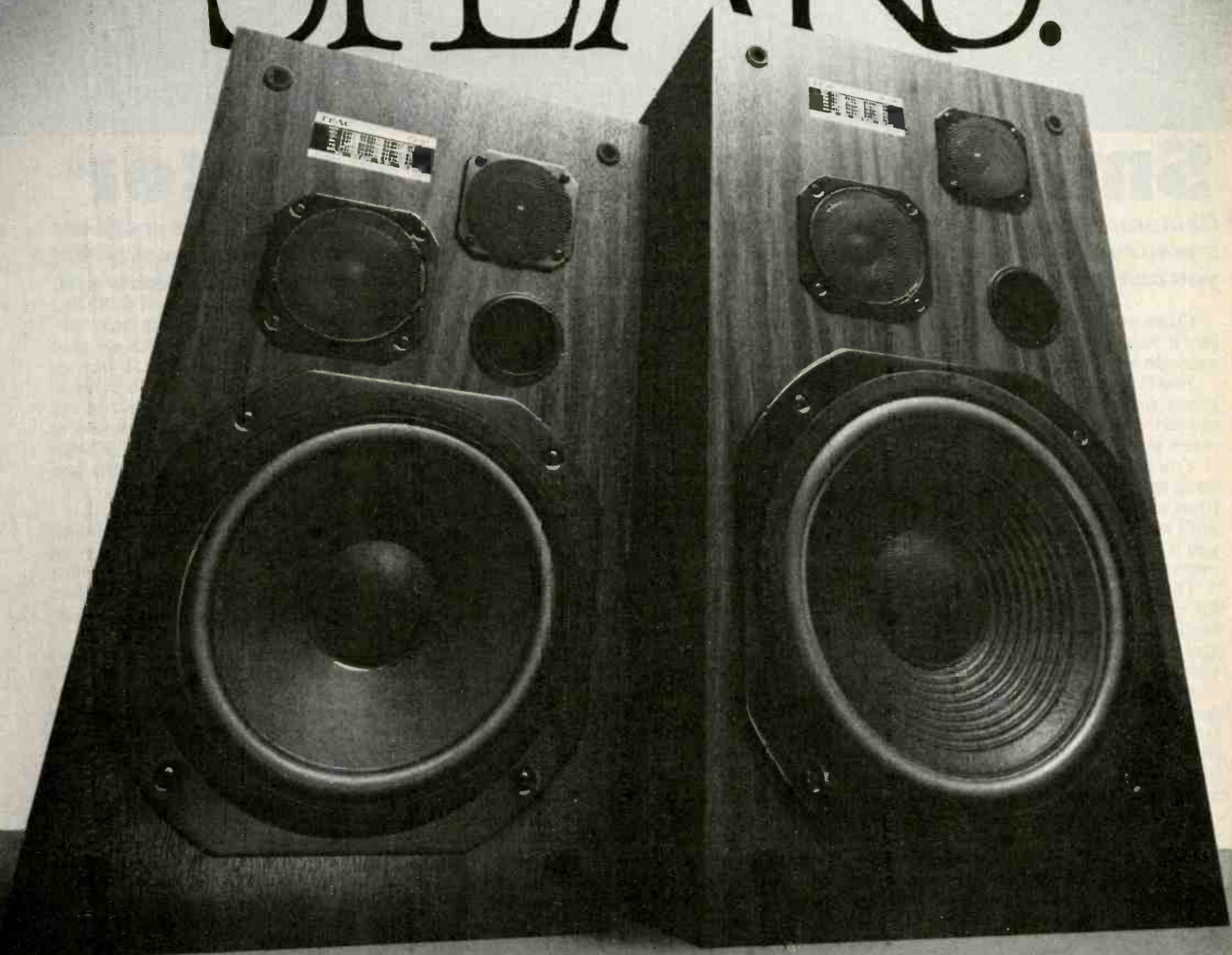

Teac, the voice of authority in the precision reproduction of sound from tape, introduces the 6110 and 6112 Speakers.

We've eliminated the middle man, so to speak, between our playback heads

and your waiting ears. So now you can hear what a Teac does so well, just the way the maker intended.

We could reel off a series of quite impressive specs for you right here. But

those abstractions aren't equal to the sound itself. So, instead, we suggest you visit a Teac dealer where you can hear them with your own ears. And we'll let our speakers do the talking.

TEAC MADE IN JAPAN BY FANATICS.

COPYRIGHT 1984, TEAC CORPORATION OF AMERICA, 1733 TELEGRAPH ROAD, MONTEBELLO, CA 90640

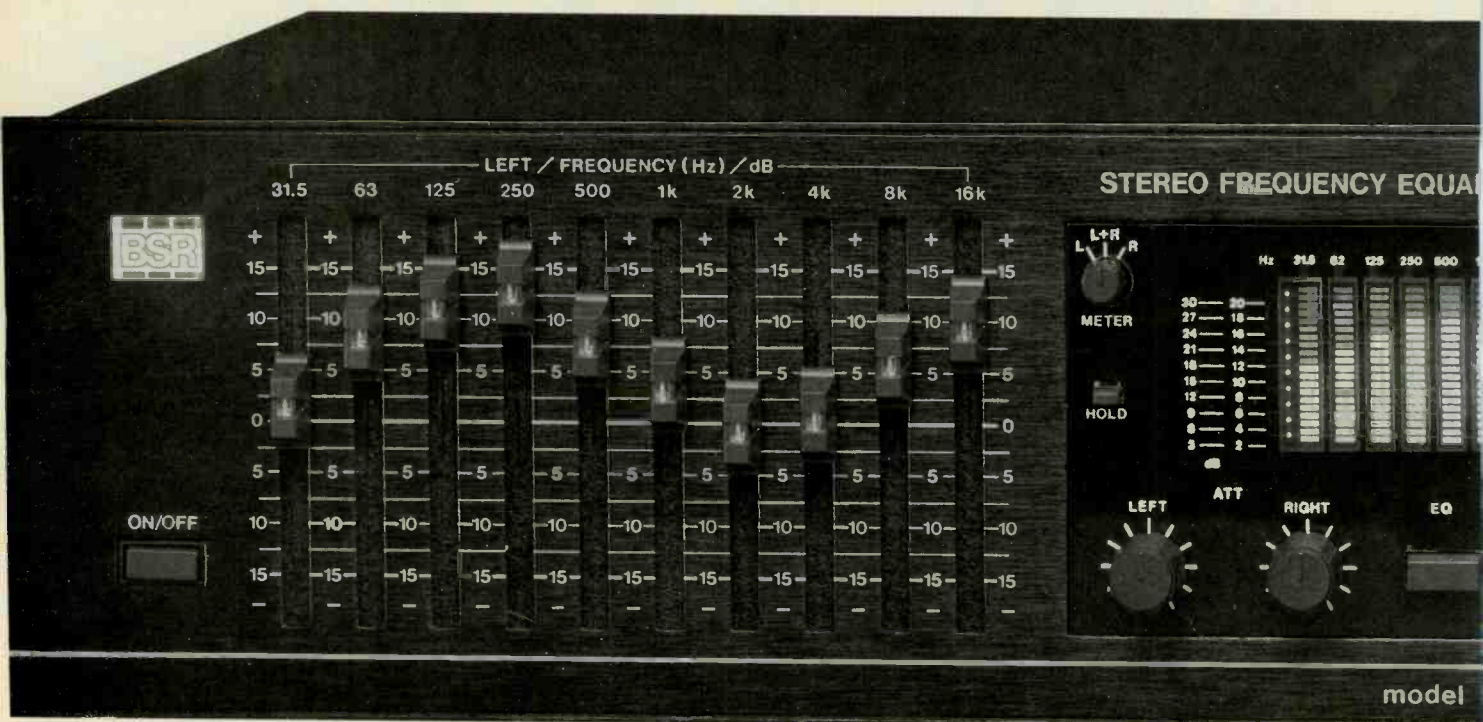

Smart Sound Detonator

Obliterate the wall between you and the individual instruments in your music. Infuse your own stereo system's sound with a breathtakingly vibrant 30 to 50% improvement in sound quality that you can measure with this super BSR Equalizer/Spectrum Analyzer limited \$149 close-out.

By Drew Kaplan

Close your eyes. Touch a button. And you'll hear your stereo system literally explode with life.

You'll hear the gentle brushes on a snare drum, the startling bone-jarring realism of a thunder clap, or the excitement of a full cymbal crash.

You'll hear string basses and other deep low instruments emerge from bass (that will sound murky by comparison), with such clarity and such definition that you'll feel you can almost touch each instrument.

This astoundingly distinct yet powerful bass adds such a full bodied warm feeling to your music, you'll feel as if you've been lovingly wrapped in a warm soft blanket on a cold winter's night.

But don't take my word for the sound quality improvement. With the Pink Noise Generator, Calibrated Electret Condenser Mike and the 220 Element Spectrum Analyzer, you can instantly measure each and every improvement you make.

Plus, there's more. A subsonic filter effectively adds the equivalent of many watts onto the power of your amplifier.

Plus, with its provision for two separate tape decks including two way dubbing, you'll have much more than just greatly improved sound.

You can count on great sound from this top of the line Equalizer/Analyzer. It has a frequency response from 5hz to 100,000hz \pm 1 db. And, it has an incredible 100db signal to noise ratio.

BSR, the ADC equalizer people, make this super Equalizer/Analyzer and back it with a 2 year standard limited warranty. Our \$149 close-out price is just a fraction of its true \$379 retail value.

FIRST THE EQUALIZER

YOUR STEREO'S HIDDEN SOUNDS

Your stereo can sound incredibly bet-

ter. Just a 5db roll-off at the high end, up around 14,000hz to 16,000hz, can just decimate the harmonics that give you the open feeling you'd experience at a live concert. A similar roll-off at 60hz, causes the fundamental bass notes to just fade away into the 'murk'.

An equalizer isn't some magical device that manufactures sounds that don't exist. Most of the frequencies that will make your music really vibrant, are actually already recorded in your music.

You'll be able to prove this with a few simple tests we'll try when we discuss the Spectrum Analyzer.

You see, certain frequencies are simply not reproduced with as much volume as are the mid-range frequencies which stretch from about 800hz to 2,000hz.

An equalizer simply lets you establish accurate control of all frequencies to fit your equipment, your recordings, your taste, and your listening environment.

TOTAL MUSICAL CONTROL

And, what a job it can do. It's totally unlike bass and treble controls which simply boost everything from the mid-range down for bass, or everything up for treble. You can boost the low-bass at 31.5hz, 63hz and/or 125hz to animate specific areas or instruments.

And, when you boost the part of the bass you like, you don't disturb the mid-range frequencies and make your favorite singer sound like he has a sore throat.

The high frequencies really determine the clarity and brilliance of your music. The problem is that highs are very directional. Wherever you move in your listening room, you'll find a big difference in high end response, as you'll see when we test the Analyzer.

No recording engineer or equipment manufacturer can even begin to control your listening environment.

You can control the highs at 4,000hz, 8,000hz and/or 16,000hz, to bring crashing cymbals to life at 16,000hz while at the same time you can cut tape hiss or annoying record scratches at 8,000hz.

But there's more. Don't leave out the mid-range. You can boost trumpets at 300 to 500hz or a clarinet at 1000hz. You can boost or cut any part of the frequency spectrum a full \pm 15db.

TAPE DECK HEAVEN

You can push a button and transfer all the equalization power to the inputs of two tape decks. Now you can pre-equalize your cassettes as you record them and get all the dramatically enhanced sound recorded right on your cassettes.

This is an especially great feature when you play your cassettes on bass-starved portables or high-end starved car stereos.



SIMPLY PLUG IT IN

Use your tape monitor circuit, but don't lose it. Now your one tape monitor circuit lets you connect two tape decks.

Just plug the equalizer into the tape 'in' and 'out' jacks on your receiver or preamp. We even supply the cables.

As you listen to your records, FM or any 'Aux', any time you push the tape monitor switch on your receiver you'll hear your music jump to life.

The output from your receiver is always fed directly to your tape deck(s) for recording, and with the touch of a button, you can choose to send equalized or non-equalized signal to your deck(s).

When you want to listen to a tape deck, just select which tape deck you want, turn the switch on the equalizer,

/SPECTRUM ANALYZER

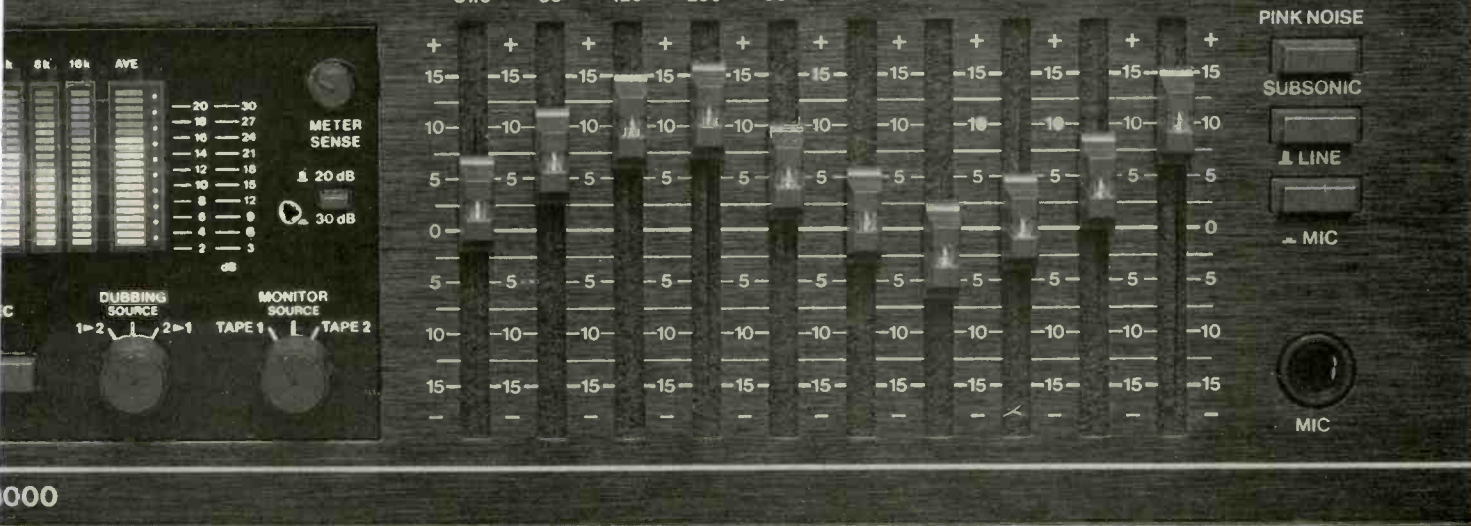

and your tape deck will work exactly as it did before. Except, now you can listen with or without equalization.

Look at this. You can dub tapes from deck 1 to deck 2, or from deck 2 to deck 1 with or without equalization.

THE SUBSONIC FILTER

Much of the power drawn from your amplifier is used to drive your woofers. When you drive the amplifier too hard, it clips and you end up with distortion.

A subsonic filter removes a lot of non-musical material you can't hear that exists below 20hz. So, it relieves your amplifier of a lot of work. It doesn't actually create more watts (Please, no letters from my 'technical' friends) for your amplifier.

But, it's like turning off the air conditioning in your car. It saves you using about 7hp of what you have. And therefore, you'll have more watts for clean powerful sounding music.

THE SPECTRUM ANALYZER

Now you can scientifically analyze your stereo listening room and test your equipment by using BSR's Real Time Frequency Spectrum Analyzer.

Plus, you'll see your music not as a single level on a VU meter, but as a kaleidoscopic parade of 10 individual 20 element VU meters.

Each is tuned to a specific octave of the sound spectrum. An eleventh 20 element meter averages all levels.

The effect is awesome. You can visually isolate a string bass or cymbal, and actually see each individual instrument almost as a wave moving across the 220 individual florescent elements.

THE MOUTH AND EARS

It talks. The Analyzer speaks with a voice of pure calibrated Pink Noise. Pink Noise is the standard composite 'sound' of all frequencies used for testing in labs around the world. All frequencies from 20hz to 20,000hz are generated at the exact same level at the exact same time.

It listens too. If you are testing a cassette or a component in your system, use the 'Line Button'. If you're testing your whole system with speakers, use the matched calibrated electret condenser

microphone (included). Either way, you'll have a quick, easy and accurate way to evaluate the total sound of your system.

HOW TO TEST SPEAKERS, EQUIPMENT AND TAPE

Testing your speakers in your listening room is the really crucial test. Simply place the calibrated microphone where you normally sit to listen to your stereo.



At the end of an 18 foot cord is the ear of the system. Just clip the mike wherever you sit and test your room.

Turn on the Pink Noise. You can switch to Left Channel, Right Channel or both. There's a meter range button, a sensitivity control, and even a switch that lets you freeze the meter.

Just sit down at the equalizer. Start with one channel. You'll see all 10 octave bands on the meter. Just slide the corresponding controls to increase or decrease any area that needs help.

You have now set up your system to its maximum capability. But as you'll see, location is very important. Move the microphone 5 feet to the left or right.

Then turn on the Pink Noise and check the Spectrum Analyzer. Now you can see why the specifications that come with your system are only a starting point.

Here's a way to test your tape deck and tape. First record Pink Noise for 3 minutes at -20VU. Then play it back and note the readings on the meters.

Now, record the Pink Noise again at 0VU or +3. Wait till you see how much the high end falls off. Now you'll see why all specifications are listed at -20VU.

With the Equalizer/Analyzer you can enjoy the finest stereo sound from your system and be a test lab too.

WHY SO CHEAP

BSR now only sells equalizers under their ADC name. Well, as Detroit comes out with new cars each year, ADC comes out with new equalizers. We got them to supply us with just 30,000 of last year's

ADC model before they shut it down.

They had already paid for all the tooling, all the research and design, so we were able to buy these for less than half the normal price, for cold hard cash.

THE FINAL FACTS

There are 20 slide controls, each with a bright LED to clearly show its position. Each control will add or subtract up to 15db. (That's a 30db range!)

There are separate sound detonation slide controls for each channel at 31.5hz, 63hz, 125hz, 250hz, 500hz, 1,000hz, 2,000hz, 4,000hz, 8,000hz, and 16,000hz.

BSR backs this top of the line Graphic Equalizer/Spectrum Analyzer with a 2 year standard limited warranty. It is 1 7/8" wide, 3 1/2" tall and 8 3/4" deep.

MAKE YOUR MUSIC EXPLODE RISK FREE

It's startling. Music so vibrant with life you'll swear it's 3 dimensional. Sculpture your music any way you want it. If you're not 100% satisfied for any reason, simply return it to DAK within 30 days in its original box for a courteous refund.

To order your BSR EQ3000 Smart Sound Detonator 10 Band Graphic Equalizer with Real Time Spectrum Analyzer and Calibrated Mike, with Subsonic Filter and Two Way Tape Dubbing risk free with your credit card, call toll free, or send your check, not for the \$379 retail value. Don't even send the \$227.97 dealer cost. Send just \$149 plus \$8 for postage and handling. Order No. 4100. CA res add sales tax.

The sound of your stereo will explode with life as you detonate each frequency band with new musical life. And, you can see and measure exactly what you've done.

11429

DAK
INDUSTRIES INCORPORATED

TOLL-FREE ORDER LINE
For credit card orders call 24 hours a day 7 days a week
CALL TOLL-FREE. 1-800-325-0800
8200 Remmet Ave., Canoga Park, CA 91304

ROOM RESPONSE CHARACTERISTICS

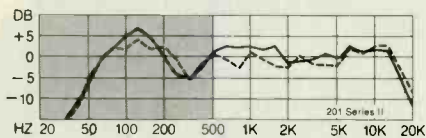

— boundary-dependent region
 — on-axis response
 - - - off-axis (30°) response

SENSITIVITY (at 1 meter; 2.8-volt pink noise, 250 Hz to 6 kHz) 87 dB SPL

AVERAGE IMPEDANCE (250 Hz to 6 kHz) 13 ohms

tion of the closest room corner in typical setups. Its back is open, leaving the rear radiation free to travel directly toward the listening area. Some of this output also is reflected off the cabinet's ported face, which is angled to reflect the sound toward the room's side walls. Thus, the tweeter actually is used as a bipolar radiator—and which surface of the diaphragm should be considered its back and which its front is moot.

The enclosure is finished in convincingly simulated walnut veneer, with brown stretch grille fabric. Spring-loaded clips for the power leads are in a shallow back-panel recess. There are no controls of any sort.

The crossover is described by Bose as more gradual than in conventional designs, to avoid their roughness, coloration, and phase anomalies. As measured near-field by Diversified Science Laboratories, woofer output drops off quite steeply above 2 kHz, while tweeter response rolls off more gradually (at approximately 6 dB per octave) below 4 kHz. The woofer's direct output dominates the low frequencies down to about 125 Hz, where the port takes over.

The combination melds well, as the room measurements in our graph demonstrate. Because of the speaker's asymmetry, DSL measured off-axis in both directions, with extremely (and surprisingly) similar results. And both off-axis curves (that for the inward measurement is shown) match the on-axis curve nicely. On-axis response is within $+6\frac{3}{4}$, -5 dB from the 63-Hz band to that centered at 12.5 kHz; off-axis response falls between $+4$ and $-5\frac{1}{4}$ dB over the same range. The curves reach their maximum in the 125-Hz measurement band (the crossover, so to speak, between the woofer's direct radiation and that via the port) and have a marked dip centered on the 320-Hz band—doubtless caused by interference from a floor reflection. (In the lab tests, the 201 was placed against the wall on a 22-inch stand.) For such a small, inexpensive speaker, both the bass and the relatively unbeamy treble are distinctly better than average.

The latter quality is certainly to be expected, given the Bose philosophy. In this particular design, one objective was to direct the treble toward the front of the opposite speaker so that, as you move toward either one, the high frequencies from its companion are emphasized. This redresses the imbalance that otherwise would mar the stereo image by making the source seem to collapse into the near speaker. This, added to the sense of openness created by the Direct/Reflecting design itself, should deliver a bigger, more stable

image than we're used to. And indeed, as you walk around the normal listening area, the imaging is unusually attractive. We've heard relatively small speakers that give a more specific sense of instrumental placement with some recordings, but none in which everything stays put any better as you move about. If you place the speakers and their stands away from the wall and wander out of the normal listening area (that is, well beyond DSL's off-axis mike position), the high end becomes somewhat hot and beamy because you're intercepting energy that is intended to be heard indirectly, via reflection. Otherwise, we liked the sound with the speakers away from the wall, which lends a little extra sense of ambience. In some problem rooms, you might also try standing the speakers on their woofer ends and using the ceiling instead of the side walls as a major reflecting surface. But that goes even farther afield in terms of the design intent.

We consider the sound to be well balanced and both relatively smooth and quite extended for a speaker in this class. Naturally, Bose (and others) can get wider range and smoother output in larger, more expensive models, but that comparison is beside the point. Some sensitivity also must be given up, but adequate amplifier power will compensate for that. And distortion, too, shows the 201's limitations, averaging $\frac{1}{2}$ percent at 80 Hz and above for a sound pressure level (SPL) of 85 dB, increasing gradually to more than 1 percent as the test level was raised to 100 dB.

The speaker accepted the full output of the test amplifier without complaint—the equivalent of $26\frac{3}{4}$ dBW, or 480 watts, into 8 ohms—delivering a calculated peak output of $113\frac{3}{4}$ dB SPL. The output may be influenced by the 201's protection circuitry, however. As drive levels reach some (unspecified) threshold, resistance increases—in effect, introducing a sort of peak compression or soft clipping. Both in the lab and in listening, we perceived no direct consequences of this design feature, which presumably has no effect except under truly threatening circumstances.

The impedance is fairly flat, fluctuating between 7.2 and 25 ohms across the audio band. The 201 should thus present no major difficulties to a good amp, even if you run paralleled pairs. This, plus its diminutive size, argues in favor of extension use, though it probably is most attractive for systems in which larger models are precluded by budget or space restrictions. In fact, if either consideration is drawing you toward minispeakers, you owe it to yourself to give these a listen. We think they're the best *little* Boses to date.

Test Report Reprints

Test Report Reprints cost \$2 each, \$5 for three, and \$1.50 for each additional one, prepaid. To fill your request, we need the following information: the type of product, the name of

the product, the model number, the manufacturer, and the issue in which the test report appeared. Send your request, your check or money order, and a self-addressed stamped envelope to Test Report Reprints, High Fidelity, 825 Seventh Ave., New York, N.Y. 10019.

Cable Controller Plus

Get all the cable channels on any TV or video recorder with this all new wireless infrared remote control cable tuning system. And at just \$88, we're sure to break the cable market wide open.

If you've got cable, we've got it all. Now you can tune in up to 60 cable channels from your easy chair.

The Universal Cable Controller receives all VHF Low Band channels 2-13 and VHF Midband 14(A)-22(I).

Plus it tunes the Super Band VHF channels 23(J)-36(W) and Hyper Band channels from 37-58. It even captures the A1 and A2 Sub Band.

MOVIE CHANNELS

If there are movie channels on your cable and they're not scrambled, the Controller is all you need. If they're scrambled, you'll need the cable company's box.

Note: Check with your cable company before viewing anything at all, to see if they require you to pay a fee.

SPORTS PLUS

There are lots of 'Super Channels' broadcast on cable. On the all sports channel you'll watch 'World Class Sports' whenever you wish. All Movie Channels give you entertainment at all hours.

And 'Super Stations' from New York and Atlanta give you major city TV for cities other than your own. Plus, there's Cable News Network for a world wide perspective on the news and much more. Why not see what's on your cable?

ONLY FOR CABLE

If you don't have cable, the Cable Controller isn't for you. It only finds you extra channels when you are connected to a cable. And, it doesn't tune in UHF.

But, if you're on cable, your cable company is rebroadcasting UHF over unused VHF channels. So with the Cable Controller tuner, you'll get it all.

TOTAL RANDOM ACCESS TUNING

The wireless infrared remote hand controller does it all. It switches both the TV and the Controller on and off and selects your channels. **And, look at this.** You can select your favorite channels (up to 6) and store them in a special section.

Then just touch the special 'RCL' Recall Button and you'll be able to sequence through only your favorite channels. This is especially convenient if you like to flip through movie channels during commercials on regular TV.

For the other channels, you'll enjoy total random access tuning. You can go directly from channel 2 to 28. Or you can step tune one channel at a time.

Once you've set your own TV to channel 3, you can just forget it. Any fine tuning is handled from the wireless infrared remote handset. And you'll have crystal controlled frequency phase lock loop synthesizer tuning for the finest picture.

You'll see the number of the station that you have selected displayed on the command base. And, you can tune channels either from the remote or the base.

Color tints, volume, brightness and contrast are all controlled by whatever method you now use.

INSTALLATION

Nothing to it. All cable systems use 75 ohm round cable. Simply unscrew the end from your TV and screw it into the Controller base input.

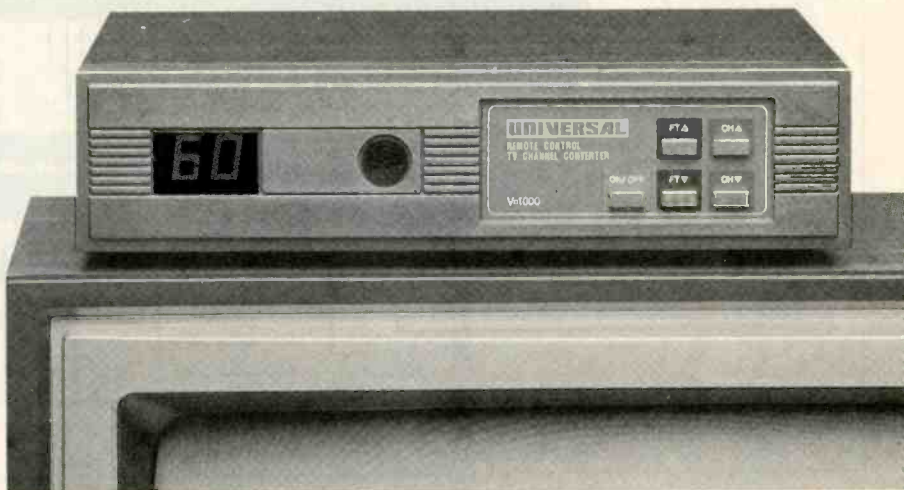

Then screw in an identical cable (included) between the Cable Controller and your TV. Finally, plug your TV's AC plug into the Controller and the Controller's AC plug into the wall.

WHAT IT IS

The Cable Controller is actually a very sophisticated, all electronic VHF TV tuner/receiver. It's really like a TV set without a picture tube.

Since it's all electronic, you won't be getting snow from dirty tuning contacts and loss of fine tuning as the set ages.

The Controller tunes all the possible stations that your cable can broadcast, something that would be very expensive to build into standard TVs, because not all TVs are going to be used on cable.

dreds of dollars extra. You can feed both your TV and video recorder. Or, you can separate them so that you can easily watch one thing and record another.

WHAT IT ISN'T

It isn't one of the infamous 'black boxes' you might have read about that illegally decode various 'Pay TV' channels. On cable, most of the programming isn't scrambled, it's just found outside the tuning range of the average TV.

So, if there is a Pay TV channel that is scrambled, or is only unscrambled on one TV in your house, the Controller is not made and should not be used to tune it in without paying.

Actually 'Cable Ready' TVs and video recorders do basically the same thing as the Cable Controller, but cable tuning is usually an added on feature that often doesn't cover as many channels.

The Cable Controller is made and backed by a standard limited warranty from Universal Security Instruments Inc.

TRY THE WORLD OF CABLE RISK FREE

Relax up to 20 feet away. Change channels, adjust the fine tuning or turn your set on or off. Explore the vast number of cable channels available to you.

Try it risk free. If you aren't 100% satisfied, simply return it in its original box within 30 days for a refund.

To order your Universal 60 Channel Cable Controller with Wireless Infrared Remote Control, risk free with your credit card, call toll free or send your check for DAK's market breaking price of just \$88 plus \$5 for postage and handling. Order Number 4147. CA res add tax.

There's a whole new world of entertainment waiting for you just off your normal TV tuning range. With the Cable Controller, you can sit back in your favorite easy chair and tune in the world.



GREAT FOR VIDEO RECORDERS

Now you can record off cable. With the Cable Controller hooked to your video recorder you can open the world of cable to your video recorder too.

Cable ready video recorders that don't even tune in 60 channels can cost hun-

DAK
INDUSTRIES INCORPORATED
TOLL-FREE ORDER LINE
For credit card orders call 24 hours a day 7 days a week
CALL TOLL-FREE. . . 1-800-325-0800
8200 Remmet Ave., Canoga Park, CA 91304

11437

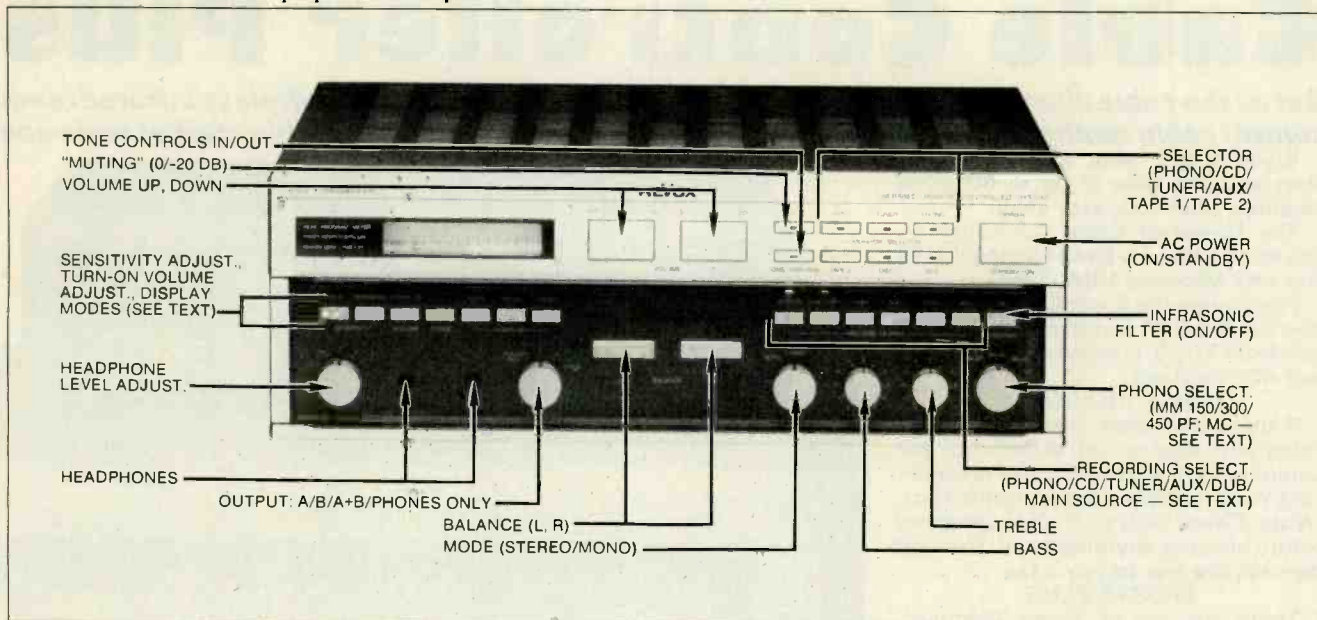

Revox's Posh Preamplifier

Revox B-252 preamplifier. Dimensions: 17½ by 6 inches (front panel), 13 inches deep plus clearance for dust cover and connections. Price: \$1,200; optional moving-coil input kit (retrofit head amp), \$95; optional rack-mounting brackets, \$35. Warranty: "limited," two years parts and labor. Manufacturer: Studer Revox GmbH, West Germany; U.S. distributor: Studer Revox America, Inc., 1425 Elm Hill Pike, Nashville, Tenn. 37210.

All measurements made to the "high" outputs (unless otherwise indicated) and with input sensitivities at median settings. See text.

OUTPUT AT CLIPPING (at 1 kHz)
 high output 15.2 volts
 low output 3.0 volts
 headphone output (into 50 ohms) 2.6 volts (135 mW)

HARMONIC DISTORTION (THD; 20 Hz to 20 kHz)
 aux or phono input <0.01%

FREQUENCY RESPONSE
 +0, -1/4 dB, <10 Hz to 24.0 kHz;
 +0, -3 dB, <10 Hz to 87.5 kHz

THOUGH MOST FAMOUS for its tape equipment, Revox has developed an enviable reputation in turntables and electronics as well. Nonetheless, we were astonished when, some months ago, the company announced a one-brand "rack system" of luxurious capabilities—and price. The 200 Series system even included speakers, a wireless remote control, and a Compact Disc player, although the last was then still in the planning stage. The heart of that system is the B-251 integrated amplifier, from which Revox now has spun off the B-252 preamplifier. Except for the omission of the power section, the preamp is almost identical to the B-251. In fact, Revox supplies the B-251 owner's manual with it, supplemented by a folder that takes up the few differences between the two models.

The controls on the lower part of the front panel—which include tone, balance, and the recording source selectors—are treated as ancillary and protected from casual use by a clear plastic pop-off cover. The "regular" operating controls, ranged along the top edge of the panel, include a standby/on switch (designed as a light sleeper so that it can be awakened at a moment's notice by the accessory remote control), input selectors, tone defeat, a 20-dB output attenuator switch, and volume. All of these "primary" controls are duplicated on the B-201CD infrared remote control (\$125), which also has a button that sends the source selected for listening to the recording outputs. (The remaining two thirds of the remote's functions are for other 200 Series components.)

Among the selector options and back-panel inputs are "disc"—intended for a Compact Disc player—as well as aux. And two phono options are indicated: for fixed-coil ("MM") and moving-coil ("MC") pickups. Circuitry for the latter wasn't actually included in the basic preamp we tested,

but a plug-in head-amp card is available for this purpose at additional cost, providing the needed supplementary gain and appropriate termination.

Revox uses the word "monitor" in two ways, one of which is potentially confusing. There are two extra pairs of "monitor" jacks (OUT and IN) on the back panel. The preamplifier folder doesn't mention them, and the amplifier manual (which is trilingual and sometimes rather obscure) says they come just ahead of the power stage. Actually, they constitute a processor loop—complete with a switch to open the "gap" in the circuitry—that affects both sets of main outputs (intended for two separate power amplifiers and speaker pairs).

"Monitor" is somewhat more conventionally applied to a tape monitor button—next to the recording source selectors—that switches the tape recording feed between the input selected at this group and the one chosen for listening at the upper group. The recording selector group also has a dubbing button, which permits copying in either direction between the two tape decks for which connections are provided.

The display panel and its controls offer some interesting options. There are three modes: power, peak signal, and volume/balance settings. The first registers the voltage at the main outputs and can be calibrated to the sensitivity of the A amplifier. Trimmers for this purpose are ingeniously hidden behind and accessible through the two headphone outputs. (There was no need for this adjustment in the B-251, so no provision for it was made in the original panel design.)

The peak-signal mode is used to calibrate the sensitivities of all the inputs so that they will sound equally loud (with similar program material) when you switch between them. The method involves playing a

A to B in 0.2 secs!

CONTINUOUS PLAYBACK AND RECORDING.

Auto-reverse was a great idea. Quick-Reverse is a better one. It not only changes tape sides, it does something even more miraculous. It eliminates interruption between sides!

Aiwa engineers achieved this remarkable feat two ways: First, Aiwa's AD-R550 does its changing act fast: just 0.2 of a second from one side to the other! That's just half the story.

Just before the tape leader reaches the heads, a photo-electric sensor activates Aiwa's Quick-Reverse mechanism. That way, instead of giving you 15 seconds of leader, Aiwa gives you something unheard of...continuous playback and recording!

DOLBY HX PROFESSIONAL

With Dolby® HX Professional, normal bias cassettes you record on the AD-R550 will actually outperform expensive chrome position tapes recorded on conventional decks! What's more, they can be played back on any deck, with the same superior results. UNPARALLELED PERFORMANCE

MATCHED BY

UNEQUALLED CONVENIENCE.

Activate Aiwa's unique Blank Skip feature and the AD-R550 will automatically move into Fast Forward mode when it senses more than 12 seconds of blank tape. That way it skips any long pauses.

The Aiwa Quick-Reverse AD-R550. Catch it at your Aiwa dealer.

*Dolby is a trademark of Dolby Labs.

AIWA®

SIMPLY ADVANCED

35 Oxford Dr., Moonachie, N.J. 07074
In Canada, Shrirro (Canada) Ltd.

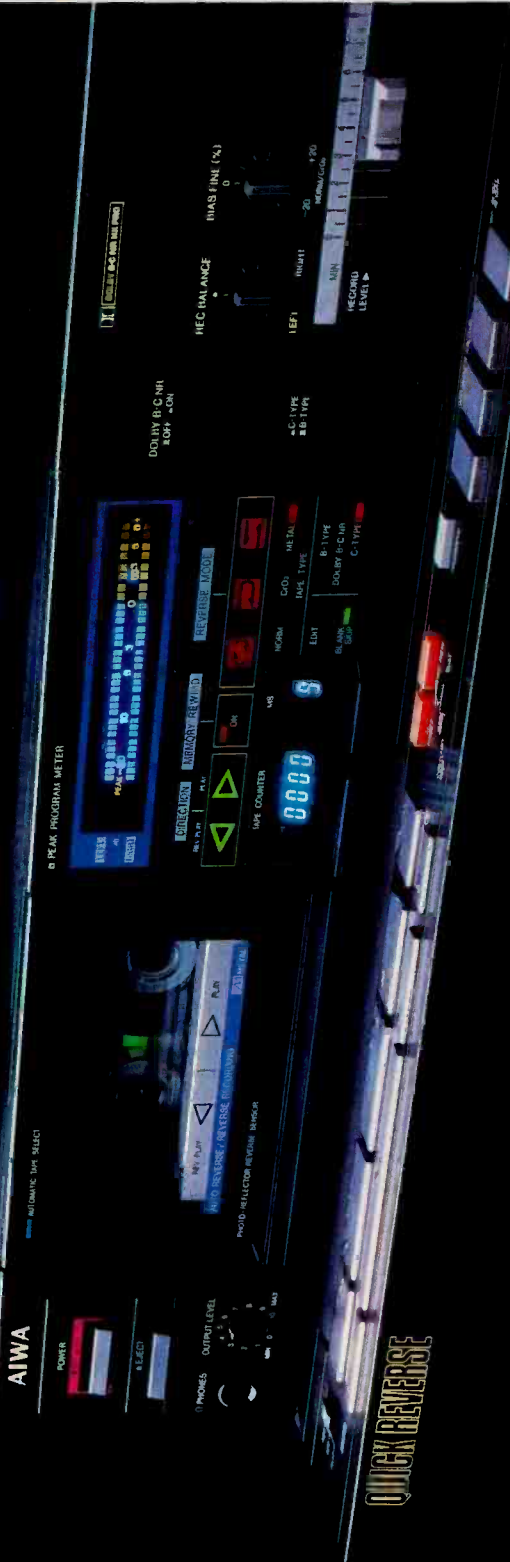

Quick-Reverse: Aiwa's latest innovation in digital-ready cassette decks.

STEREO CASSETTE DECK R550

The Sight and Sound of
QUALITY

YOU CAN SEE AND HEAR

When you're this good, you put your warranties where your mouth is. That's why, overall, Hitachi probably has the finest limited warranty protection ever offered in home electronics products. Products that perform so well, you may never get a chance to see how good our warranties really are.



NEW SIGNAL TRACKER COMPONENT TV

Backed by Hitachi's incomparable 10/2/1 limited warranty, this state-of-the-art 20" diagonal flat square tube receiver/monitor integrates all your home entertainment functions. VCR, VideoDisc Player, stereo system, video games, home computer and total TV reception. Enjoy more on-screen picture and less distortion. And only Hitachi has Signal Tracker control, our most advanced color control system ever. With the handy wireless remote control and wood cabinetry you get ease of operation, great sound and quality good looks. Simulated TV picture.



NEW COMPACT DIGITAL AUDIO DISC PLAYER

Hitachi leads the way in compact disc performance with Laser Life, a two-year limited parts warranty, twice as long as our major competition. Introducing the DA-600. Three spot laser pick-up servo system; wireless remote control that reads, selects, repeats, skips and scans; memory programming for up to 15 selections; slim-line, front load design.

NEW 5 + 2 HEAD HI-FI VCR

With Adjustomatic, a limited warranty superior to industry standards, the exceptional VT-89A VCR from Hitachi has brought hi-fi technology to video sound. Sound finer than any turntable or conventional tape deck... far superior to ordinary VCRs, it's sound you have to see to believe. Five video heads, two audio heads, cable ready, with a computer brain that guides you through every program function. Each step is displayed on your TV screen.



HITACHI

401 W. Artesia Blvd., Compton, CA 90220. (213) 537-8383

AUDIO New Equipment Reports

RIAA EQUALIZATION	+1/4, -3 dB, 21 Hz to 20 kHz; -13 1/2 dB at 5 Hz
SENSITIVITY & NOISE (re 0.5 volt; A-weighting)	
	sensitivity S/N ratio
aux input	32.6 mV 96 1/2 dB
phono input	0.39 mV 79 dB
PHONO OVERLOAD (1-kHz clipping)	295 mV
INPUT IMPEDANCE	
aux input	48.7k ohms
phono input	46.2k ohms; complex
OUTPUT IMPEDANCE	
main output	600 ohms
tape output (aux or phono input)	630 ohms
headphone output	235 ohms
CHANNEL SEPARATION (at 1 kHz)	94 dB
INFRASONIC FILTER	-3 dB at 20 Hz; 18 dB/octave

loud passage with SENSITIVITY pressed in, watching the display while adjusting the VOLUME, and then pressing STORE. Similarly, the output to amplifier B can be adjusted relative to that of amplifier A. Diversified Science Laboratories found that AUX and PHONO—the inputs used for bench testing—could be raised or lowered by 12 dB, in 1/2-dB steps, with respect to the median value that was used for measurement. Also stored is the setting of the infrasonic filter, which thereafter is switched automatically with the input. Another button stores the turn-on volume setting.

The volume/balance display (which Revox calls "static" because it responds to the control settings rather than to the signals) is necessary because both functions are adjusted at control-stepper touchplates: Unlike knobs or sliders, they don't tell you how you have them set. You may also prefer this display mode if (like us) you don't appreciate flickering lights while you listen, though the soft green glow of the Revox panel is as unobjectionable in this respect as any other power display on the market. The VOLUME touchplates are constructed so that loudness will change gradually if you press their inside edges; the change occurs more rapidly if you press the outer edges.

Four options are offered by the front-panel "speaker" switch: headphones only, main outputs A or B, or main outputs A and B. The headphone outputs have their own volume control and more than sufficient output for any headsets we know. Two sets of connections are provided for the back-panel A and B outputs. The preamp folder tells you to use "high" if your amplifier's input-stage overload point is not below 2 volts—which it shouldn't be for most of the equipment sold in this country. The lab therefore used these outputs for most of its measurements. (We presume that the "low" alternative, which has 14 dB less gain, is to match DIN levels.)

Also on the back panel are two sockets for convenience features that can be invoked (with the aid of accessory cables available from Revox) if you go for a 200

Series system. One passes on to the tape deck the signals from the remote control. The other is for timer remote in conjunction with the deck's timer-recording function. Regrettably, perhaps, there are no accessory AC outlets, switched or unswitched. (They are outlawed in some countries using 220-volt AC supplies, and Revox evidently decided to offer one design worldwide.)

The tone controls are very unusual, leaving response almost completely unperturbed between about 200 Hz and 3 kHz. The BASS peaks sharply below 40 Hz (the exact frequency depends on the control setting), yielding a maximum boost or cut of 12 dB. The TREBLE attains only $\pm 6\frac{1}{2}$ dB and has maximum effect near 15 kHz. Thus, only the real problem areas at the extremes of the audio range are addressed. If your program material or speakers aren't up to the standards of flatness presupposed by such an approach, you may want to add an equalizer at the back-panel "monitor" jacks.

The phono section has an inherent infrasonic rolloff, so even if you ignore Revox's suggestion that you use the filter with phono sources, you'll get significant attenuation of warp-induced noise (more than 13 dB at 5 Hz). The filter is unusually steep, adding some 25 dB more attenuation at that frequency, for exceptionally effective suppression. Less useful is the front-panel capacitive-loading control for the fixed-coil phono input. Although calibrated for values of 150, 300, and 450 picofarads (pF), the actual capacitance varies with frequency, preventing unequivocal measurement or adjustment.

Outside of that, the measurements are all superb. And the preamp behaved flawlessly in our listening tests, once we mastered its unusual design and behavior. Admittedly, this is a complicated preamp—a factor Revox seems to have recognized in putting "under glass" those controls that a casual user might find confusing. Essentially, however, Revox doesn't build equipment for novices. Despite the rack-system format, the B-252 is a preamp for the discerning.

Pioneer's Can-Do Receiver

TEN MONTHS AGO, under the heading "A Multimedia Receiver from Pioneer," we reviewed the SX-50. If, in December 1983, we had chosen to speculate on how Pioneer could follow that act, we might have guessed at some, but certainly not all, of the SX-V90's features. Except for a TV tuner, it contains just about everything you might expect in a modern home-entertainment center, including passive video-switching

circuitry that works even when the receiver is turned off.

The display panel has indicators for such functions as LOUDNESS and MUTING (the usual 20-dB attenuation), a signal-strength "meter" (with five elements that trigger at progressive levels from 30 to 56 dBf—a useful range), indicators for level and balance settings, and a "power meter" (which unfortunately can't be turned off).

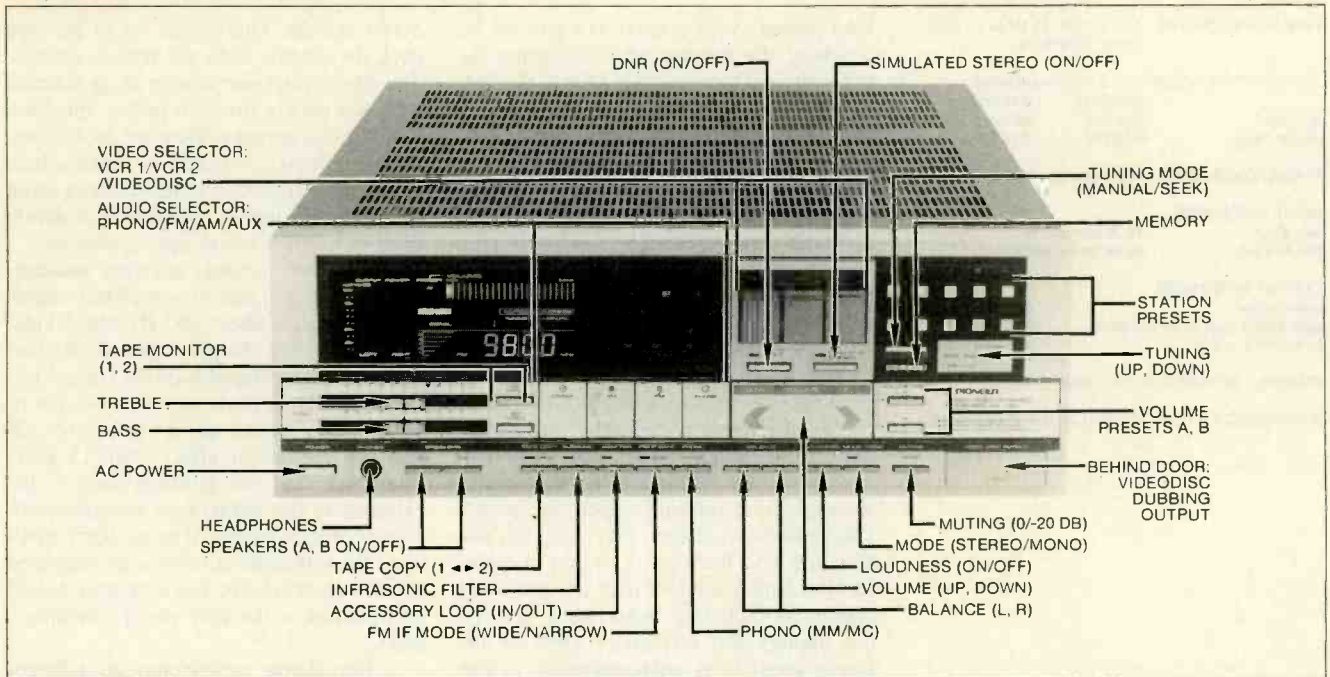

Pioneer SX-V90 AM/FM receiver, with connections and switching for RF video signals, direct (demodulated) video, and demodulated stereo audio, and with stereo-simulation and DNR noise-filter options. Dimensions: 16½ by 5½ inches (front panel), 16½ inches deep plus clearance for connections. AC convenience outlets: one switched (100 watts max.), two unswitched (200 watts max. total). Price: \$800. Warranty: "limited," two years parts and labor. Manufacturer: Pioneer Electronic Corp., Japan; U.S. distributor: Pioneer Electronics (U.S.A.), Inc., P.O. Box 1760, Long Beach, Calif. 90801.

FM tuner section

Data measured in the wide IF mode except as noted.

STEREO RESPONSE & CHANNEL SEPARATION

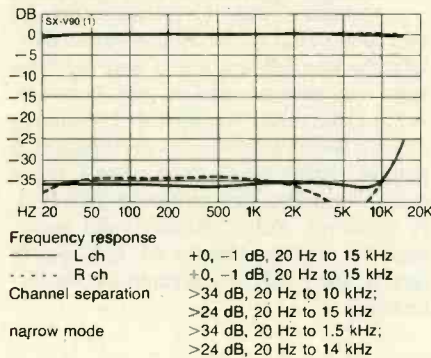

An additional panel nearer the center tells you which inputs (including the tape monitors) have been selected. The remaining status indicators are next to their associated controls.

The back panel has its own, rather involved story to tell. The antenna inputs are the usual screw terminals. (Though F connectors are used for VHF TV signals, there is none for 75-ohm coaxial FM downleads.) A switch is provided for European or North American FM de-emphasis, another for the step width of manual tuning. The U.S. position of the latter offers 100-kHz (half-channel) increments for FM, 10-kHz (full-channel) steps for AM. There also is a back-panel switch for the usual AC power-line options. If you expect a peripatetic future, this model might be a good choice.

Also on the back panel, in addition to switched connections for an outboard processor, are jumpered jacks that enable you to insert ancillary equipment (say, a speaker equalizer) between the receiver's preamp and power-amp sections. A single jack supplies an AM detector signal for a stereo adapter, should you want one. For a receiver that will accept so many outboards, the SX-V90's sole switched AC outlet is rather stingy, though there are two unswitched.

The video connections comprise five groups: input from VCR 1 and its tuner, input from VCR 2 (or a game console or computer), input from a videodisc player, output to VCR 2 (for recording from VCR 1), and output to a video monitor. All except the dubbing output to VCR 2 have an F connector for the RF signal; all have a pin jack for direct video; and all but the monitor output have a stereo pair of audio pin jacks, with a mono switch in all but the videodisc group to force the input jack for the left channel to feed both.

Behind a tiny removable plastic plate at the lower right corner of the front panel is yet another set of pin-jack outputs, for dubbing to a VCR from the back-panel videodisc inputs. This is the only video dubbing option other than from VCR 1 to VCR 2. If you want to record just the audio from a video source, the video selector delivers the sound to the two sets of audio tape output jacks.

Two options are available at switches just below the video selector panel: simulated stereo and DNR dynamic noise filtering. The stereo simulation will work with audio from any source. It's basically the same system we encountered (and were unimpressed by) in the SX-50—a delay that amounts to a 180-degree phase shift between channels at about 1.6 kHz. When you turn it on, it colors the sound somewhat and either shifts it toward one speaker (this time, the right one, reversing the SX-50 pattern) or blurs its apparent position, depending on where you are relative to the speakers.

DNR is an effective "denoiser" based on the Burwen dynamic filter and now available as an integrated circuit from National Semiconductor, which is touting it as a panacea for all hiss-related ills. Pioneer evidently disagrees, and so do we. In the SX-V90, it can be used only for the two videotape sources. On fairly poor signals, with little in the way of real highs but a good deal of noise—such as the linear-track (not "Hi-Fi") sound from VCRs and much broadcast TV audio—it will take the edge off the hiss without significant side effects. However, when we fed it a moderately noisy but otherwise sparkling FM signal, the DNR (at least with Pioneer's factory-set sensitivity) audibly dulled the program content along with the hiss.

The SX-V90's memory functions are

FM SENSITIVITY & QUIETING

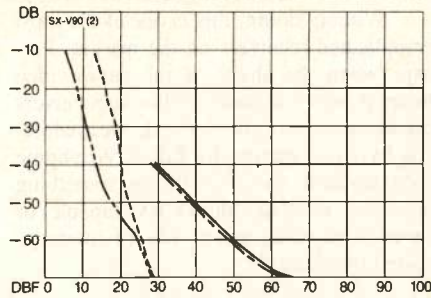

—	stereo quieting (noise), wide mode	
- - -	mono quieting (noise), wide mode	
· · ·	stereo quieting (noise), narrow mode	
- · -	mono quieting (noise), narrow mode	
Stereo sensitivity (for 50-dB noise suppression)		
wide	39 3/4 dBf at 98 MHz, with 0.35% THD+N	
	(41 1/4 dBf at 90 MHz; 39 1/2 dBf at 106 MHz)	
narrow	38 1/4 dBf at 98 MHz, with 0.76% THD+N	
	(39 1/2 dBf at 90 MHz; 38 dBf at 106 MHz)	
Mono sensitivity (for 50-dB noise suppression)		
wide mode	22 dBf at 98 MHz	
narrow mode	17 1/2 dBf at 98 MHz	
Muting threshold	see text	
Stereo threshold	29 dBf	
Stereo S/N ratio (at 65 dBf)	69 3/4 dB	
Mono S/N ratio (at 65 dBf)	75 1/4 dB	

CAPTURE RATIO	
wide mode	1 dB
narrow mode	1 1/2 dB

SELECTIVITY	
alternate-channel	wide 23 1/2 dB, narrow 63 1/4 dB
adjacent-channel	wide 2 1/4 dB, narrow 12 dB

HARMONIC DISTORTION (THD+N)			
wide mode	stereo	mono	
at 100 Hz	0.18%	0.20%	
at 1 kHz	0.043%	0.074%	
at 6 kHz	0.145%	0.072%	
narrow mode			
at 100 Hz	0.42%	0.25%	
at 1 kHz	0.25%	0.15%	
at 6 kHz	0.29%	0.15%	

STEREO PILOT INTERMODULATION	
wide mode	0.018%
narrow mode	0.27%

IM DISTORTION (mono)	
wide mode	0.030%
narrow mode	0.087%

AM SUPPRESSION	62 3/4 dB
PILOT (19 kHz) SUPPRESSION	65 dB
SUBCARRIER (38 kHz) SUPPR.	84 1/2 dB

Amplifier section

RATED POWER	21 dBW (125 watts)/channel
-------------	----------------------------

OUTPUT AT CLIPPING (at 1 kHz; both channels driven)	
8-ohm load	21 3/4 dBW (150 watts)/channel
4-ohm load	23 1/2 dBW (225 watts)/channel

DYNAMIC POWER (at 1 kHz)	
8-ohm load	21 3/4 dBW
4-ohm load	24 dBW
2-ohm load	23 1/4 dBW

DYNAMIC HEADROOM (re rated power, 8-ohm load)	
	+3 3/4 dB

HARMONIC DISTORTION (THD; 20 Hz to 20 kHz)	
at 21 dBW (125 watts)	≦ 0.10%
at 0 dBW (1 watt)	≦ 0.015%

FREQUENCY RESPONSE	
	+0, -1/2 dB, 19 Hz to 39.7 kHz;
	+0, -3 dB, <10 Hz to 103 kHz

RIAA EQUALIZATION	
fixed-coil phono	± 1/4 dB, 20 Hz to 20 kHz;
	-7 dB at 5 Hz
moving-coil phono	± 1 1/4 dB, 37 Hz to 20 kHz;
	-23 1/2 dB at 5 Hz

SENSITIVITY & NOISE (re 0 dBW; A-weighting)	
	sensitivity S/N ratio
aux input	13 mV 74 1/2 dB*
fixed-coil phono	0.21 mV 77 1/4 dB
moving-coil phono	21 μV 72 1/2 dB

*See text.

unusually comprehensive, assured by three supplied AA cells in a compartment in the bottom of the chassis. The tuner presets retain a total of ten stations on each band, including (on FM) the setting of the IF-bandwidth switch. There are two memorized volume presets, each of which can include loudness compensation or the -20-dB muting option. And you can adjust the level of each source individually over a range of approximately ±6 dB. Thus, the input sensitivities can be varied, roughly, from half to double the values shown in our data column.

The VOLUME is not quite as smooth and predictable as we would like, though it's acceptable. Most steps measure about 2 dB (perhaps a little coarse), but some are a bit larger, while others are less than 1/2 dB. The loudness compensation is unaffected by the volume setting over Diversified Science Laboratories' test range. It shelves the bass below 100 Hz, keeping it about 6 dB above the level at 1 kHz. We rather liked the results, which are more appropriately moderate than usual; if you prefer a more powerful fix, you can use the tone controls. The BASS offers maximum boost or cut of approximately 11 dB in the region around 40 Hz; the TREBLE shelves at about ±9 dB above 10 kHz, with some effect reaching well below 1 kHz, particularly at the boost settings.

The phono preamp, which can be switched for either moving- or fixed-coil pickups at the front panel, offers appropriate loading and sensitivity for typical cartridges, despite somewhat greater capacitance than we'd prefer at the fixed-coil setting. Phono overload levels are more generous than average, so they should pose no restriction.

Frequency response is very flat (within 1/2 dB) through the fixed-coil input. The moving-coil option includes an infrasonic filter that peaks by 1/4 dB at around 70 Hz before dropping off at about 12 dB per octave below 35 Hz. The switchable infrasonic filter, which is only moderate in slope and therefore of limited effectiveness by itself, adds to the cut in the moving-coil section and to the much gentler rolloff for fixed-coil pickups.

Input and output impedances and sensitivities are generally good. The output impedances to the tape connections admittedly are a little higher than we like to see, but most decks have input impedances high enough to prevent mismatches. The signal-to-noise (S/N) ratio shown for the aux input looks rather meager, particularly when you consider that this input is specifically earmarked for a Compact Disc player. However, the standard test conditions (DSL follows EIA conventions in such matters) turn out to be worst-case for the SX-V90's volume adjustment system. At both higher and lower settings, the figures improve dramatically—by 8 1/2 dB when volume is raised only one step. So perhaps 80 dB is a more

representative figure under the spirit, if not the letter, of the EIA rules.

The SX-V90's amplifier section is astonishingly muscular for a receiver, exceeding its not inconsiderable rated power by 3/4 dB into 8 ohms. Into 4 ohms, continuous power measures 50 percent (1 1/4 dB) greater still, suggesting relatively generous current capability. This is confirmed by the 2-ohm dynamic power, which is down slightly (3/4 dB) from the equivalent 4-ohm reading but shows no sign of severe limiting. It is therefore surprising that Pioneer has chosen to connect in series (rather than parallel) the two speaker pairs for which provision is made when both are switched on. This will help protect the output stage when multiple pairs of low-impedance speakers are used (and the owner's manual makes plain that the company doesn't want you to tempt fate in this respect), but at the expense of some possible loss of fidelity. Pioneer's recommendation is that you use no speaker rated at less than 6 ohms; ours is that you not plan on running two speaker pairs simultaneously.

The SX-V90 uses Pioneer's Non-Switching Vari-Bias amplifier circuitry for low distortion. At 0 dBW (1 watt), the lab could detect only the second harmonic (the least objectionable component of THD), and only in quantities that barely exceeded our 0.01-percent reporting threshold, even at very high frequencies. At rated power, some third harmonic creeps in, and the total figure rises by a factor of ten, but even at this level we're not dealing with audible distortion.

However, it is the FM tuner section that impresses us most. What Pioneer calls its Digital Direct Decoder, introduced in the F-90 tuner (test report, October 1983), has been incorporated in the form of an IC chip. There are two IF (intermediate frequency) filter options. The wide mode is preferred, as always, for best reproduction of clearly received channels; the narrow option reduces interference with powerful neighboring stations by increasing selectivity dramatically, but at some theoretical expense in distortion, channel separation, and, perhaps, audio bandwidth.

Much of this proves out in practice here, as the data show. Audio bandwidth (frequency response) is virtually identical between the two modes, however, and separation actually improves somewhat at low frequencies in NARROW, though it's good enough in both modes that the audible consequences of the change are nil. There also is an improvement in noise suppression in NARROW at moderately low signal strengths, which improves sensitivity figures in this mode. Actually, the ultimate quieting (S/N) figures are more impressive than those for sensitivity, yet in the listening room we particularly noticed the absence of noise on some borderline stations.

No muting threshold is listed because

PHONO OVERLOAD (1-kHz clipping)	
fixed-coil phono	190 mV
moving-coil phono	19 mV
INPUT IMPEDANCE	
aux input	100k ohms
fixed-coil phono	47.4k ohms; 230 pF
moving-coil phono	100 ohms
OUTPUT IMPEDANCE (to tape)	
from aux input	2,700 ohms
from tuner section	3,700 ohms
from phono inputs	2,900 ohms
DAMPING FACTOR (at 50 Hz)	110
CHANNEL SEPARATION (at 1 kHz)	68½ dB
INFRASONIC FILTER	-3 dB at 21 Hz; 6 dB/octave

there is none. When you're tuning, the SX-V90 goes mute, but once you've decided to leave it where it is and are in the manual mode, the audio comes on whether a station is there or not. If you're in SEEK, it will continue its search until it finds a signal of at least 29 dBf—which could be defined as the lock threshold. Tuning is quite easy and, with so many presets, is more of an initial-setup chore than a regular preoccupation. The IF-mode memorization is a fur-

ther aid to carefree reception.

Without doubt, this is one of the most complicated receivers on the market. Perhaps when the shape of the audio-video future is better defined, all-in-one receivers can become more streamlined. Meanwhile, you have two options for full-service home entertainment: the SX-V90 (or something like it but, in all likelihood, less capable) or an even more complex web of interconnected outboards.

Shure Makes Its Best Better



Shure V-15 Type V-MR fixed-coil (moving-magnet) phono cartridge, with user-replaceable Micro-Ridge multiradial diamond stylus. Price: \$275. Warranty: "full," one year parts and labor. Manufacturer: Shure Brothers, Inc., 222 Hartrey Ave., Evanston, Ill. 60204.

WHEN WE REVIEWED the original V-15 Type V (July 1982), we remarked that it was Shure's best cartridge to date—and therefore one of the best pickups ever, period. Nothing has happened since then to change our opinion, except that Shure has refitted its flagship—now dubbed the Type V-MR—for even higher performance. "MR" stands for the Micro-Ridge stylus that has displaced the company's Hyperelliptical tip in its top model. (The old version is still available, as the Type V-B, at a lower price.) The benefits, Shure says, are reduced distortion and record wear.

For the last ten years, the design of premium pickup styli has been moving ever further toward emulating the shape of the styli used to cut record masters. The closer the match, the lower the tracing distortion. On the other hand, it is important that the pickup stylus not actually *become* a cutting stylus and destroy records as it plays them—a pretty problem that has defied easy solution. Today's line-contact tips are therefore both harder to manufacture and more critical of alignment than the spherical or even plain elliptical configurations that once dominated the cartridge landscape. The Micro-Ridge is one of the most sophisticated efforts yet in this direction. It's even supposed to wear in such a way that it main-

tains its shape.

In other respects, the Type V is largely unchanged. Its major innovation—the thin-walled, low-mass beryllium cantilever tube—remains, as does the damped Dynamic Stabilizer brush that has been a fixture of Shure cartridges since the Type IV. A highly efficient moving-magnet generator system provides adequate output with a minimum number of coil windings, keeping inductance low. This in turn makes the cartridge's response relatively insensitive to capacitive loading. And Shure's Side-Guard stylus-protection system prevents damage from the most common forms of mishandling.

One of the Type V's most appealing features really isn't part of the cartridge proper: It's the complete set of alignment tools bundled into the package. Among other things, they enable you to make all the necessary adjustments except tracking force without having the real stylus in place, where it might easily be harmed. Instead, you insert a plastic substitute that serves as a leveling gauge for adjusting the pickup's azimuth (lateral tilt). When it rests flat on a record, you know you've got the angle right. Not only is this much easier than the usual mirror-and-eyeball routine, but it's also more accurate. Indeed, Diver-

Tonearm/Cartridge Matching Graph

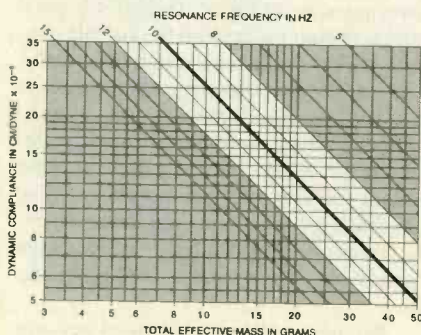

By means of this nomograph, you can quickly and easily determine the compatibility of any cartridge and tonearm we have tested. Ideally, the arm/cartridge resonance frequency (indicated by the diagonal lines) should fall at 10 Hz, but anywhere between 8 and 12 Hz will assure good warp tracking and accurate bass response. (It is usually okay to let the resonance rise as high as 15 Hz, although we don't normally recommend this.)

Begin by looking up the weight and dynamic compliance shown in the cartridge report and the effective mass listed in the turntable or tonearm report. Add the weight of the cartridge to the effective mass of the tonearm to get the total effective mass. Then find the point on the graph where the vertical line for the total effective mass intersects the horizontal line for the cartridge's dynamic compliance. For a good match, this point should fall in the white region, between the 8- and 12-Hz diagonal lines.

When necessary, you can back-figure compliances and effective masses for cartridges and tonearms tested before we began reporting these figures directly (in January 1983). For cartridges, look up the vertical resonance

frequency (measured in the SME 3009 Series II Improved tonearm) and the cartridge's weight. Add 15 grams (the SME's effective mass) to the cartridge weight to get the total effective mass. Then find the intersection of the vertical line representing that mass with the diagonal line representing the measured resonance frequency. Now you can read off the compliance from the horizontal line passing through the point of intersection.

For tonearms, look up the vertical resonance frequency as measured with the Shure V-15 Type III cartridge. Find the intersection of the diagonal line for that frequency with the horizontal line representing the Shure's dynamic compliance of 22.5×10^{-6} cm/dyne. Reading down the vertical line on which the point of intersection lies will give you the total effective mass of the arm with the Shure V-15 Type III mounted in it. Then subtract 6.3 grams (the weight of the V-15 Type III) to get the tonearm's effective mass.

Because of differences in measurement techniques, manufacturers' specifications for compliance and effective mass often differ from our findings and may therefore yield inconsistent results if used with this graph.

STRAWBERRY FIELDS FOREVER



We believe Memorex High Bias II will deliver the finest true-to-life reproduction you'll ever hear on any high bias cassette. And thanks to Permapass™, our unique oxide bonding process, your music will continue to sound live. Not just the 1st play. Or the 1000th. But forever. Or we'll replace it free.

YOU'LL FOREVER WONDER.

**IS IT LIVE,
OR IS IT
MEMOREX™**





NOW YOU DON'T HAVE TO BE ON YOUR TOES TO MAKE PERFECT RECORDINGS.

Until now, making serious recordings was a matter that couldn't be taken lying down.

But now, there's the CT-90R, a tape deck so automatic you can practically make perfect recordings in your sleep.

To begin with, the CT-90R will automatically reverse direction, allowing you to record in both directions without stopping to turn the cassette over. Because an IC Sensor detects the leader at the tape's end, it can reverse directions so fast (0.5 seconds) that you hardly miss a beat of music.

An Auto BLE system measures the first eight seconds of tape and automatically sets the correct tape bias, level and equalization, for the specific type and brand you're using. This assures wide, flat

frequency response and the lowest distortion.

A Real Time Counter displays the exact minutes and seconds of remaining recording time, digitally. So you never run out of tape or music or patience.

As for the CT-90R's music reproduction quality, Pioneer's exclusive three-head design guarantees optimum recordings because each head is designed for a specific function.

The CT-90R also features Pioneer's exclusive Ribbon Sendust Heads for wide dynamic range, extended high frequency response, and high signal-to-noise ratio. Dolby*C noise reduction minimizes tape noise.

A sophisticated 3-Direct-Drive-Motor Tape Transport features our own smooth, cog-free, DC Servo Hall design motors for low wow and flutter. Then there's C.A.C. (Computer Aided Convenience), a system that provides a unique ease-of-operation package that includes Blank Search, Index Scan, Blank Skip and Reverse, and Music Repeat.

Together, all these features give you a cassette deck that's so automatic, you only have to do one thing.

Go out and buy it.



 **PIONEER**
Because the music matters.

AUDIO New Equipment Reports

FREQUENCY RESPONSE & CHANNEL SEPARATION
(test record: JVC TRS-1007 Mk. II)

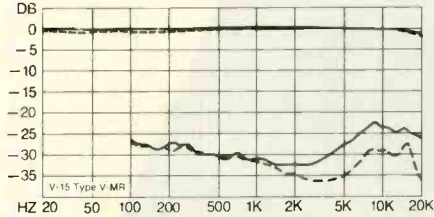

Frequency response
 — L ch +1/4, -1/4 dB, 30 Hz to 20 kHz
 - - - R ch +1/4, -2 dB, 30 Hz to 20 kHz
 Channel separation
 ≧ 30 dB, 700 Hz to 3.7 kHz;
 ≧ 24 dB, 100 Hz to 20 kHz

SENSITIVITY (at 1 kHz) 0.81 mV/cm/sec

CHANNEL BALANCE (at 1 kHz) ±1/4 dB

VERTICAL TRACKING ANGLE ≈17°

MAX. TRACKING LEVEL (re RIAA 0 VU; 1 gram)
 lateral >+18 dB
 vertical >+12 dB

DYNAMIC COMPLIANCE (vertical)*
 ≈20 x 10⁻⁶ cm/dyne

RECOMMENDED EFFECTIVE TONEARM MASS*
 optimum ≈6 grams
 acceptable ≈2 to ≈13 grams

WEIGHT 6.8 grams

SQUARE-WAVE
 RESPONSE (1 kHz)

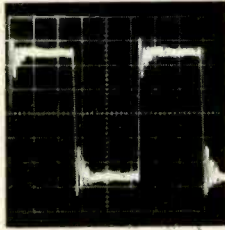

*With Dynamic Stabilizer up; see text.

sified Science Laboratories found that it couldn't do significantly better using lab instruments.

The other tool is what Shure calls a Duo-Point alignment gauge. With the pick-up loosely installed in your tonearm's headshell, you snap its body into a cradle on the gauge. A couple of easy steps later, and overhang and offset angle are set for minimum lateral tracing distortion, almost regardless of how far off the tonearm's own geometry might be. This, too, is a large and welcome advance over the methods one usually must rely on.

DSL tested the V-15 Type V-MR at the manufacturer's recommended effective tracking force of 1 gram (after compensation for the brush) and with the recommended load of 47,000 (47k) ohms in parallel with 250 picofarads (pF). The results were, to say the least, stunning. Frequency response is flat out to 15 kHz, dropping off just slightly above; the high-frequency peak that mars the performance of most lesser cartridges is entirely absent. Separation is equally impressive, remaining greater than 20 dB over the entire audible band and reaching more than 35 dB at some points. This consistency confirms the implication of the response curves that there are no mechanical resonances at or near audio frequencies.

Sensitivity is a shade lower than average, but not by enough to be of any concern, and the balance between channels is essentially perfect. Vertical tracking angle (VTA) is close to the 20-degree DIN standard, measuring just a few degrees low on the low-frequency twin-tone test. Results on the mid-frequency tones are in good agreement, indicating that the more important stylus rake angle (SRA) is almost right on the mark. DSL measured compliance

with the Dynamic Stabilizer up. The result is a fairly high figure, which together with the cartridge's weight normally would indicate that best results could be obtained only with a low- or medium-mass tonearm. Putting the brush down, however, reduced the amplitude of the infrasonic arm/cartridge resonance by 19 dB, effectively eliminating it. Thus, the Type V-MR should work well in virtually any good arm on the market today.

Tracking ability is the best DSL has ever measured. In fact, the lab reports that the Type V-MR tracks better at 1/2 gram than do many other cartridges at a full gram or more. Since Shure claims lower distortion for the MR stylus, we pulled out the lab report on the original Type V for comparison. The results for everything, including low-level and low- and mid-frequency distortion, turned out to be remarkably similar. If nothing else, this suggests good quality control. However, differences did emerge in the demanding 10.8-kHz tone-burst intermodulation test, where the MR version produced only about half as much distortion as the original Type V had. That's an impressive achievement, considering how excellently the first cartridge performed on this test.

We were hardly surprised to find that the V-15 Type V-MR is a sterling performer in the listening room as well. Its sound is smooth and uncolored, with unsurpassed clarity and freedom from distortion. Stereo imaging is both convincing and stable. And as far as tracking is concerned, we couldn't find anything that it wouldn't. In short, Shure has made one of the world's best cartridges even better without making it unduly expensive (at least by current standards). We therefore have no doubt that it will find legions of enthusiastic admirers.

HK's Power Performer

Harman Kardon HK-870 power amplifier. Dimensions: 17 1/2 by 5 1/4 inches (front), 14 1/4 inches deep plus clearance for connections. Price: \$525. Warranty: "limited," two years parts and labor. Manufacturer: made in Japan for Harman Kardon, Inc., 240 Crossways Park West, Woodbury, N.Y. 11797.

RATED POWER 20 dBW (100 watts)/channel

OUTPUT AT CLIPPING (at 1 kHz; both channels driven)
 8-ohm load 21 dBW (125 watts)/channel
 4-ohm load 22 3/4 dBW (190 watts)/channel

DYNAMIC POWER
 8-ohm load 22 dBW
 4-ohm load 24 dBW
 2-ohm load 25 dBW

DYNAMIC HEADROOM (re rated power, 8-ohm load)
 +2 dB

LIKE ALL OTHER Harman Kardon electronics of recent vintage, the HK-870 follows the design precepts of Finnish academician and engineer Dr. Matti Ojala. Although best known for his work on TIM (transient intermodulation distortion), Ojala has lately been making a strong case for high output current capability in amplifiers. His concern springs from the peculiarities of loudspeaker impedances, which seldom resemble the simple 8-ohm resistors on which power-amp specifications usually are based. (See "The Uneasy Symbiosis," October 1980.) They often are substantially less than 8 ohms over much of the audio band and contain inductive and capacitive elements that cannot be modeled as pure resistances.

What all this means for an amplifier is

more work—which is to say, more current. That's fine if the power supply can deliver it and the output stage can handle it, but all too often at least one of them can't. As a result, the amp runs out of steam into low impedances and fails to produce its rated power into loudspeakers. (See "Basically Speaking," December 1982.) Indeed, this is exactly why we began using 2-ohm loads in our dynamic-power tests—to find out what happens when the going gets tough.

Harman Kardon meets this issue head-on in the HK-870, using a large toroidal power transformer and heavy-duty bipolar output transistors said to be capable of pumping out peak currents of as much as 60 amps. The circuitry is designed to have wide frequency response and low distortion before negative feedback is applied, so that

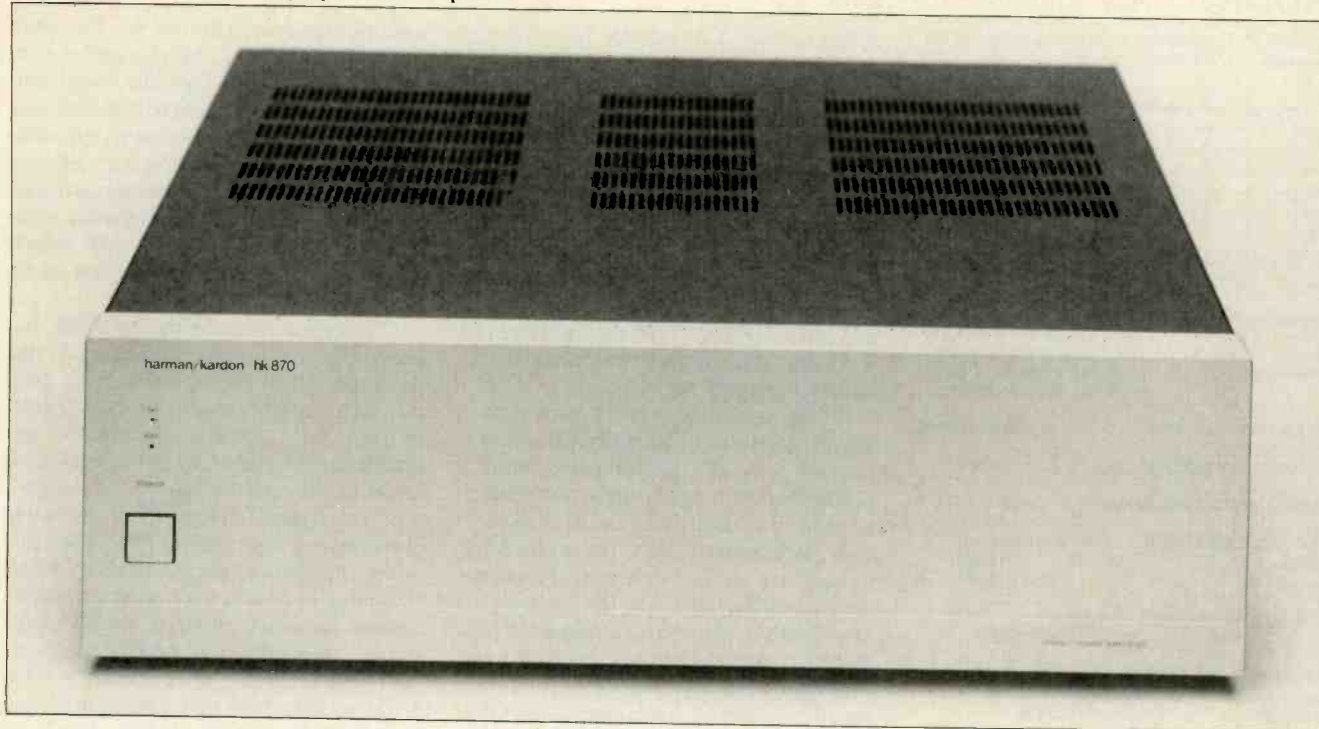

HARMONIC DISTORTION (THD; 20 Hz to 20 kHz)
 at 20 dBW (100 watts) \leq 0.05%
 at 0 dBW (1 watt) \leq 0.011%

FREQUENCY RESPONSE
 +0, -1/4 dB, <10 Hz to 29.1 kHz;
 +0, -3 dB, <10 Hz to 125 kHz

S/N RATIO (re 0 dBW; A-weighted) 100 dB
 SENSITIVITY (re 0 dBW) 105 mV
 INPUT IMPEDANCE 22k ohms
 DAMPING FACTOR (at 50 Hz) 155
 CHANNEL SEPARATION (at 1 kHz) 100 dB

About the dBW . . .

We currently are expressing power in terms of dBW—meaning power in dB with a reference (0 dBW) of 1 watt. The conversion table will enable you to use the advantages of dBW in comparing these products to others for which you have no dBW figures.

WATTS	dBW	WATTS	dBW
1.00	0	32	15
1.25	1	40	16
1.6	2	50	17
2.0	3	63	18
2.5	4	80	19
3.2	5	100	20
4.0	6	125	21
5.0	7	160	22
6.3	8	200	23
8.0	9	250	24
10.0	10	320	25
12.5	11	400	26
16	12	500	27
20	13	630	28
25	14	800	29

only a small amount is necessary to achieve the desired performance. HK feels that this gives better behavior on signals consisting largely of transients, such as music, than does conventional high-feedback operation. If nothing else, it should make the amplifier more stable (that is, less prone to oscillation into capacitive loads).

Physically, the amp is as self-effacing as one could want. Its brushed aluminum faceplate is perfectly clean except for a large pushbutton power switch, a pilot LED, and a "wait" LED that lights for approximately eight seconds after the unit is turned on, indicating that the output is disconnected from the speakers to protect them from turn-on transients. This lamp also comes on whenever the protection circuit senses an unsafe condition, such as overheating, short-circuiting of the outputs, or a load of less than 2 ohms. In the latter two situations, the output will remain muted eight seconds, then the amp will try again; in the case of excessive temperature, it will stay muted until the internal heat sink cools off. The back panel has convenient color-coded screw-down binding posts that accept bare-wire speaker leads, plus gold-plated pin-jack inputs and a grounding lug that has no obvious purpose (it is not mentioned in the owner's manual).

Diversified Science Laboratories' measurements support Harman Kardon's claim of high current capability. The HK-870 delivers 1 dB more than its continuous rated output into 8 ohms and almost another 2 dB above that into 4 ohms. In the dynamic-power test, which more nearly approximates the requirements of music reproduction, another dB is added at both those impedances (for 160 and 250 watts, respectively), and the output continues rising to a

whopping 25 dBW (315 watts) into 2 ohms. Damping factor is much more than adequate at low frequencies and stays high all the way to the top of the audio band, dropping by less than 25 percent at 10 kHz and less than 50 percent at 20 kHz. This, too, is exceptionally fine performance and should contribute to the HK-870's ability to drive difficult loads without loss of power or fidelity.

Another particularly strong point is the signal-to-noise (S/N) ratio, which is unusually high. Frequency response is perfectly flat across the audio band and extends well below and beyond—a hallmark of HK electronics for 20 years. But the designers have not taken the ultrasonic bandwidth to an extreme that would court instability and radio-frequency interference (RFI).

Distortion, which consists mainly of the third harmonic with traces of the second at high outputs, is very low—certainly inaudible—at all power levels short of clipping and is unusually constant with frequency. (At low levels, it actually drops slightly as the frequency increases.) Separation is more than wide enough and also is well maintained across the band, from 116 1/4 dB at 100 Hz to 83 1/2 dB at 10 kHz. And both the sensitivity and the input impedance are good choices for typical audio systems.

We are happy to say that the HK-870 performs every bit as well in the listening room as in the lab: Its sound cannot be faulted in any respect. Even when driven into clipping, it behaves as gracefully as one could hope. And under normal operating conditions, the case remains cool to the touch. Given such excellent performance and so reasonable a price, we don't see how you could go wrong.

The **Only** Amplifiers and Receivers
with Wide Dynamic Range
And Low Impedance Drive Capability.

The Onkyo Delta Power Supply



In order to properly reproduce the dynamic range of today's music, your amplifier must be capable of similar dynamic range. For example, the Compact Disc has a dynamic range of over 90 db, and this can place severe demands on your amplifier. By the same token, the impedance of your speaker system is constantly changing from one moment to the next (as the dynamics of the music change), so your amplifier must also be capable of driving a wide impedance range.

Onkyo's patented Delta Power Supply is the only answer to all of these critical requirements. First, our oversize power transformers provide additional power for substantial headroom. The ultra quiet background essential for noise-free reproduction is provided by the Delta circuitry, and substantial Low Impedance Drive Capability means that Onkyo amplifiers will comfortably handle low impedance speaker loads. In fact, our latest series of amplifiers and receivers are IHF Dynamic Power rated

into 8, 4, and 2 ohms, further evidence of the outstanding power capabilities of the Delta Power Supply.

Because the Delta Power Supply effectively satisfies these critical power supply requirements, true high fidelity is possible with any source material, and choice of loudspeaker. As the name Integra suggests, Onkyo components equipped with the Delta Power Supply give the listener a sound as close as possible to the original, with all of the integrity of the live performance retained.

Shown is our new Integra TX-85 receiver. In addition to incorporating the Delta Power Supply, the TX-85 features dbx Type II Noise Reduction (Encode/Decode), APR Automatic Precision Reception, Dynamic Bass Expansion, Computer Controlled Logic Input Selection.

dbx is a registered trademark of dbx Inc.

ONKYO[®]
Artistry in Sound
200 Williams Drive, Ramsey, NJ 07446
(201) 825-7950



Nakamichi Sound Research Center Concert Hall

This is Nakamichi

Nakamichi—The *first* name in cassette recording

In 1973 we shocked the world by introducing the Nakamichi 1000—the first “Discrete 3-Head” cassette deck—the first cassette recorder that *outperformed* the open-reel decks of its day.

In the past decade, Nakamichi has shattered one technological barrier after another with such innovations as NAAC, our Auto Azimuth Correction system, UDAR, our unique *Unidirectional Auto Reverse*

mechanism, and our exclusive Asymmetrical Dual-Capstan Diffused-Resonance transport, quite simply, the world's most *precise* tape drive.

As impressive as these technological breakthroughs are, they are merely means to an end—*sound purity!* Hearing is believing. Listen to *any* of our decks and you'll be convinced that Nakamichi Sound is in a class by itself—pure, clean,

transparent, utterly refreshing, and quite unlike ordinary cassette sound.

Nakamichi Sound characterizes our entire line from the inexpensive BX-1 to the exotic DRAGON. When you pay less for a Nakamichi deck, you get fewer features—not inferior sound! Each Nakamichi design must pass the *ultimate* test—critical live vs. recorded listening in our Sound Research Center Concert Hall.



DRAGON Auto Reverse Cassette Deck

The world's first Discrete 3-Head Dual-Capstan Direct-Drive Auto-Reverse Cassette Deck. Nakamichi's unique Auto Azimuth Correction system—NAAC—guarantees 20-22,000 Hz response in *both* playback directions!



ZX-9 Discrete 3-Head Cassette Deck

The *perfectionist's* cassette recorder. Azimuth, bias, and sensitivity calibration controls for perfect recording on virtually any tape and our unique SLT direct-drive motor for flutter-free reproduction.



RX-505 Unidirectional Auto-Reverse Discrete 3-Head Cassette Deck

Our exclusive UDAR mechanism combines unidirectional performance with auto-reverse convenience. Discrete 3-Head recording and playback on both sides! The 2-Head RX-303 and RX-202 offer UDAR performance and many unique features.



LX-5 Discrete 3-Head Cassette Deck

Revel in the aesthetic luxury of the LX-5 and companion 2-Head LX-3. Tap the right panel to reveal the hidden controls, then sit back and enjoy the unique purity of Nakamichi Sound. A feast for the eyes and ears!



BX-150 2-Head Cassette Deck

Designed for those who appreciate simple virtuosity, the BX-150 and BX-100 demonstrate the sound purity that can be realized at an economical price. Compare them with decks costing much more. You'll be surprised!



BX-1 2-Head Cassette Deck

Think you can't afford Nakamichi Sound? Think again! The remarkable BX-1 costs less than \$300, but outperforms decks at twice the price. Hearing is believing so audition one now and convince yourself!

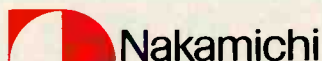

Nakamichi U.S.A. Corporation 19701 South Vermont Ave., Torrance, CA 90502 (213) 538-8150
In Canada: W. Carsen Co., Ltd., 25 Scarsdale Road, Don Mills, Ontario M3B 3G7

For Accurate and Efficient Reproduction



Loudspeaker efficiency dictates how much power you need to reproduce music accurately at the desired volume. Because Scott speakers are highly efficient, your amplifier has more headroom to meet the demands of today's digital programs, to drive a second pair of speakers and to bring a large room alive with sound.

When compared with many other major brands, Scott speakers will deliver cleaner sound and optimum dynamic range while using substantially less power. It's an audible difference—maximum accuracy and efficiency—all at lower distortion. That's why Scott is consistently rated among the very best by leading consumer publications throughout the world.

Every Scott speaker is a product of over 35 years of outstanding technical achievement. They're designed and manufactured in our U.S. plants, and undergo demanding quality assurance testing to guarantee your satisfaction. And Scott speakers are reasonably priced to fit any budget. Scott—we're ears ahead of our time.

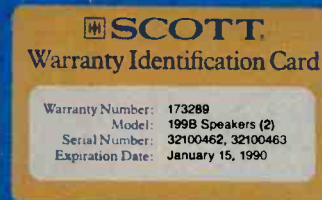

Scott's unique Gold Warranty Card. Scott's fully transferable 5-year parts and labor limited warranty is your assurance of lasting pleasure.

SCOTT

Makers of high quality high fidelity equipment since 1947.

For the name of your nearest Authorized Dealer contact:
H.H. Scott, Inc., 20 Commerce Way, Woburn, MA 01888, (617) 933-8800, Telex: 949302, 200265.



High Fidelity

High fidelity in the '80s is rapidly expanding to encompass signal sources that were barely dreamed of ten years ago. Compact Discs, videodiscs, hi-fi videotapes, and stereo TV broadcasts are changing our expectations of a home-entertainment system. Indeed, a receiver capable of dealing with just three sources (phono, tape, and one auxiliary input) seems an impossibly limiting link in a modern system. But we can't tell you what sort of system would be right for you: Your taste in playback media ultimately will determine how much flexibility you must have. What we can do, how-

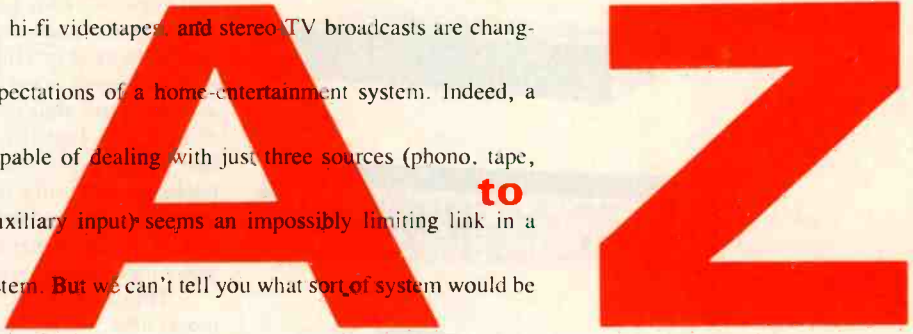

ever, is tell you what's important in performance and features for your "core" system. In the next nine pages, you'll learn how to listen to loudspeakers in the store, which specs differentiate a good cassette deck from a mediocre one, and much more. Whether

you're updating your whole system or just replacing one piece, our coverage will help you choose from the scores of competing products. Contributors to this article include HIGH FIDELITY regulars Robert Long, consulting technical editor; Michael Riggs, technical editor; and Peter Dobbin, electronics features editor. New to these pages is Tim Holl, whose advice on selecting loudspeakers reflects his expertise as a speaker designer.

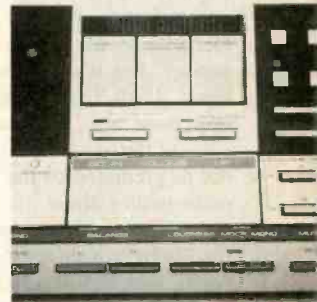
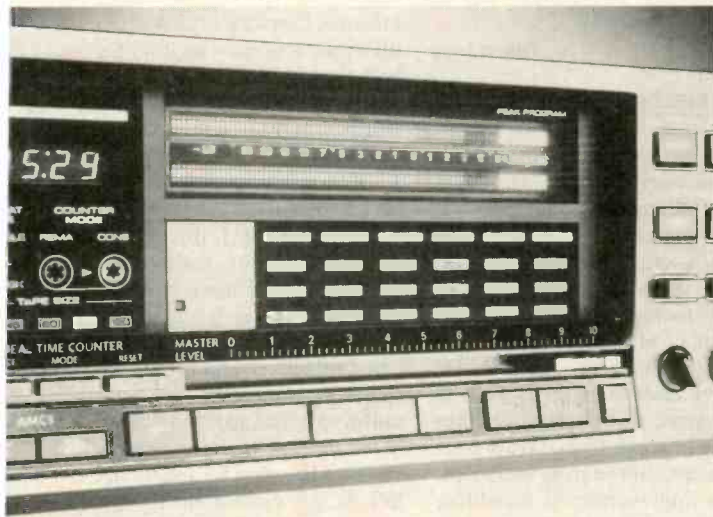



WHAT IS HIGH FIDELITY?

Fidelity in music reproduction usually is defined in terms of accuracy, with numbers assigned to describe a component's freedom from distortion, noise, and frequency-response errors. That certainly is an important part of high fidelity and the part on which modern technology has made a vast impact. But it's not the whole story. High fidelity reproduction must also be true to the spirit of the music, and this cannot be predicted on the basis of mathematics alone.

If technical accuracy were the only consideration, you could conceivably base your purchases on a single number of merit. In a given brand, for example, you might buy a sound system that is 99.95 percent accurate for \$800 or one that is 99.98 percent accurate

for \$1,300. To use such a system, you would do nothing more than turn it on: Controls would be worse than redundant because they could only decrease the accuracy of the design-mandated approach to perfection.

Right off the bat, however, you'd want a volume control. Your neighbors would complain if every note were reproduced at concert-hall levels, and some sounds (clavichord, for example) would be partially lost in the ambient noise of a typical home if they weren't reproduced louder than acoustically accurate levels. How loud should sounds be in the home? That's a matter of taste, inaccessible to any concept of accuracy.

It is the job of high fidelity components, therefore, not only to supply you with the astonishing precision that mod-

RECEIVERS VS. SEPARATES

A receiver incorporates the functions of at least five components—preamp, tuner, equalizer, power amp, and switcher—making it a cost- and space-effective alternative to separates. Individual components, on the other hand, can offer more control flexibility. Shown at left, from top: JVC R-X500B receiver, Harman Kardon TU-915 tuner, Apt 2 preamp, Audio Control D-520 graphic equalizer, Adcom GFA-2 power amp, DBX 400 switcher.

ern circuitry is capable of, but also to give you controls for adjusting the reproduction. And because music comes from several sources—FM, LPs, Compact Discs, tapes—a component system must embrace the media you plan to use as well as accommodate your methods of using them. That is why separate components that can be hooked together in a number of ways have retained their appeal despite the potential cost savings of all-in-one systems.

Thus, in tailoring your stereo system to your needs, the flexibility of components is an inherent part of their fidelity. Your job as an intelligent consumer is to decide how much flexibility you require and to buy accordingly.

Robert Long

DECISIONS, DECISIONS

Among the basic determinations you must make when buying electronic components is the degree of "separateness" you want. In general, the cost goes up as the number of "boxes" multiplies, but so do the number of control options and their refinement. Performance level tends to go up as well, in the sense that distortion ratings may improve from 0.05 to 0.01 percent. But in most instances, this improvement is inaudible, so the gain is moot.

In choosing electronics, amplifier power is the most obvious of performance options. If the amp is part of a receiver, power may be tied to control sophistication, with both stepping upward as you move from the least to the most expensive models of a given brand. Separates, on the other hand, give you the option of choosing sophisticated controls and low power or simple ones plus the strength of the Incredible Hulk.

Rule of thumb dictates that 20 watts per channel is about

the minimum you can get away with if you want clean peaks at reasonably loud listening levels. And even then, a small room and relatively sensitive speakers may be required if the system is not to be overtaxed. The biggest single variable in this equation, however, is your taste. If you insist on generating the sound levels that a conductor hears on the podium, you'll need sound pressure levels 10 or 20 dB louder than those at which most music lovers listen to symphonic recordings. And that translates to a factor of 10 to 100 in wattage ratings. Thus, if 20 watts (13 dBW) will satisfy a music lover, 200 to 2,000 watts (23 to 33 dBW) might be demanded by the would-be maestro. Conversely, 2 watts (3 dBW) or less may be fine for background music.

Loudspeaker sensitivity—which usually is referred to as "efficiency"—often is stated as the sound pressure level (SPL) generated at 1 meter when the speaker is driven by 1 watt. (Since this doesn't address the sort of space in which the measurement is made, the numbers can't always be compared reliably.) The higher the sound pressure level, the more sensitive (efficient) the speaker. In our test reports, most models measure between 85 and 92 dB SPL in this evaluation, though some are in the low 80s and therefore require several dB more power to achieve the same loudness as an average speaker with a sensitivity of about 90 dB SPL.

In general, the smaller the speaker, the lower the sensitivity you should expect. And since the sensitivities of typical speakers cover a range of 10 dB or so, you might find when you compare different models that 13 dBW (20 watts) is enough for a floor-standing model but that you need 23 dBW (200 watts) to get clean peaks of equal loudness from a mini-

speaker (provided you can find one capable of accepting that much power). Such a difference is somewhat extreme, however. Usually, the ratio would be more like 6 dB (1:4, in watts), making 19 dBW (80 watts) enough for the small speaker.

According to many experts, the precise maximum power requirements of the sound system you select will be influenced by your choice of source—FM, LP, Compact Disc, or tape. The signals from most have routinely been subjected to compression of one sort or another to insure that peaks won't overload and that quiet sounds won't get lost in residual noise. Compact Discs are least likely to suffer this sonic indignity, partly because their inherent noise is lower than that of traditional sources. As a result, the digital sound of CDs can have more "punch." Its transients often exceed the average signal level by great margins, and the amplifiers and speakers that reproduce these signals may need extra power capabilities if they are to pass the transients without distortion—even for the same average reproduction level.

In terms of both reproduction accuracy and random access (the ease with which an individual track can be picked out and played by itself), the Compact Disc is certainly the medium of choice today. But it's also the most expensive of the standard forms in which music is marketed, and the total repertory on CD is still only a

fraction of what is available elsewhere. LPs and audio cassettes run neck and neck in cost, at one-quarter to two-thirds that of Compact Discs. However, both require much more care than CDs if they are to be kept near their sonic best. They can be damaged by dust and finger oils, and LPs are easily scratched (particularly if you cue the pickup to individual cuts). LPs do, however, offer the greatest range of repertory (exotic items often are unavailable on tape).

The quality of FM varies more than that of the competing media because of reception vagaries and extreme disparities in technical competence and outlook from one station to another—or even between personnel at the same station. At its best, it brings you "live" (usually taped) events that you can hear no other way and plays records with great care and on superb equipment, so that they sound better than they might if you played them at home. At its worst, FM imposes gross compression and distortion on its programs and often is overburdened with commercials and promotional announcements.

There's one more program source you'll have to consider when you go shopping: AM. Most high fidelity tuners and receivers that include AM sections don't offer AM performance that is even relatively competent. If you want the best the medium has to offer, shop for a good multiband radio.

Robert Lpng

AMPS AND PREAMPS

A preamp section—be it a separate component or one built into an integrated amplifier or receiver—is the heart of any stereo system. Its capabilities determine the range of possibilities open to you in assembling and using the system, so choosing the right preamp features is fundamental if you're to get the most out of your audio setup.

Take the tone controls. Most preamp designs include bass and treble knobs or sliders. There are differences (often quite subtle ones) in how they add or subtract energy in their respective frequency ranges. For some purposes, shelving (relatively evenhanded raising or lowering of all frequencies within the control band) achieves more pleasing results than controls that peak or dip sharply to a central frequency.

In the store, check for even action: If a control has no audible effect in part of its adjustment range and a radical one elsewhere, it's poorly designed. If the control is stepped, the audible change should be no more than barely perceptible from one step to the next. From this point of view (and to avoid really gross settings), a control

range of only ± 10 dB probably is preferable to the more usual ± 15 dB. And calibrations, though hardly essential, can be helpful; you might, for instance, want to preset the tone controls for the known shortcomings of a recording.

But there are lots of options beyond the usual bass-and-treble scheme. Some preamps and receivers offer a midrange control as well. The next step in that direction is a rudimentary "graphic equalizer," with four or five sliders, each representing frequency bands. Tone controls may also have switchable turnovers (the frequencies below which or above which the controls become effective) that enable you to tailor their frequency-contouring actions. The next step in that direction is a "parametric equalizer," which varies the breadth of the frequency band, the "position" of the center frequency, and the degree of boost or cut for each control band.

Elaborate graphic or parametric equalizers usually aren't built into preamps or receivers. You can buy such devices as separate components, which allows you to choose the preamp features independent of those in the equalizer. A few preamps

ANY WAY YOU LIKE 'EM

Preamps offer a variety of control and switching options. Haffer's no-frills DH-100 (top right; \$200 assembled, \$150 in kit form) supplies amplification for a fixed-coil phono pickup, switching for two line-level sources, one tape loop, and basic controls. The Yamaha C-80 preamp (\$750) adds a two-band parametric equalizer, a second tape loop, dubbing controls, and selectable gain for moving- and fixed-coil pickups.

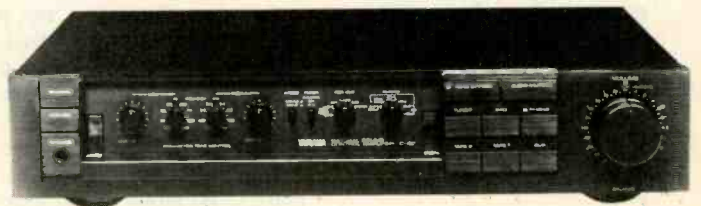

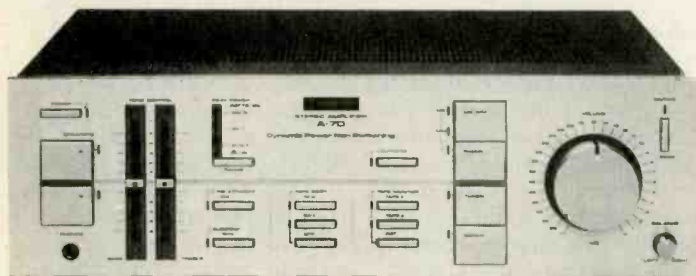

If lots of power is what you need, a separate power amp is the answer. At 250 watts per channel, the

Carver M-500T (top left, \$580), is one of the dreadnoughts. Integrated amps, which combine preamp and power amp in one chassis, frequently offer high power output and good control flexibility.

Pioneer's A-70 (\$520) gives you an extensive array of inputs and switching options plus a hefty power amp section rated at 120 watts per side.

even presuppose this scheme of things and embody no tone controls of their own. The "purist" approach, in fact, argues that tone controls have the potential to degrade signal quality. For that reason, some preamps include a DEFEAT that switches such equalization out altogether.

In most cases, an equalizer—or any other separate signal-processing component—should be hooked into a preamp's tape loop. Almost all preamps have at least one tape loop, which consists of a pair of output jacks for delivering the stereo signal from the preamp to the recorder (or other outboard device), a pair of input jacks for accepting the playback, and a monitor switch that selects either the source signal or the signal from the deck. Some preamps also have a "processor loop," which is identical except that it is labeled to route the signals through an equalizer or other outboard instead of a tape deck.

Many preamplifiers can accommodate more than one tape deck (plus a processor, in some cases), and they usually have switching so that you can copy ("dub") a tape from deck to deck. The simplest will permit you to dub only from Tape 1 to Tape 2; bidirectional dubbing increases your options. If you need a third set of tape connections, you'll probably have to use an outboard switching box to control monitoring and dubbing.

Built-in processor-loop connections can be pressed into service for a third deck. You can hook some types of processors into the system between the output of the preamp and the input of the power amp. Many components that combine a preamp with other electronics have back-panel options that give you access to these connection points, which would otherwise be buried within the circuitry.

In some ways, the most critical portion of the preamplifier is the phono section. Most phono preamps accommodate only fixed-coil pickups and those moving-coil models that imitate their sensitivity and impedance.

If you want to use a more characteristic moving-coil model, with very low impedance and sensitivity, you'll need a head amp (pre-preamplifier) or step-up transformer. Many preamps provide for these low-output cartridges; otherwise, you'll have to add an outboard device between the turntable's signal leads and the preamp's phono input. Neither option has a clear advantage over the other.

Serious worries about technical performance are a thing of the past in electronics—which is to say that although there may be subtle performance differences between models, outright misbehavior is unusual. Signal-to-noise (S/N) ratios should mea-

sure greater than 60 dB even in phono preamps and should routinely come in at about 80 dB or more—sometimes much more—in other preamp circuits. Because most signal sources have no more than 60 dB of dynamic range, these figures are adequate, no matter how you look at them. An obvious exception is the Compact Disc, with (potentially) about 90 dB. On most CDs, the music is deliberately limited to considerably less than that, however, so that playback won't exceed the dynamic range of the home listening environment.

Similarly, you need not worry about distortion that is below 0.1 percent, but you'll seldom find distortion ratings any higher than half that figure, or 0.05 percent. Overload in high-level (nonphono) preamp circuitry should be at least at 2 volts and routinely is near or above 10 volts, so don't be concerned about clipped transients or other peaks. Phono overload of around 200 millivolts (mV) for fixed-coil inputs (or 20 mV for moving-coil) is fairly typical and more than adequate for most pickups. Occasionally you may find a phono input whose relatively high capacitance—above 200 picofarads (pF) or so—or whose reactive loading (an impedance that varies significantly with frequency) will compromise the performance of some fixed-coil pickups, but this is increasingly rare these days.

Overload figures are related to sensitivity, which is a harder matter to assess because of gross disparities between measurement techniques. Again, your best assurance is in the consistency of modern components, in which input and output levels—and therefore sensitivities—are well standardized. Phono-cartridge output is one exception, so if the model you choose is less sensitive (has less output for a given

recorded level) than average, you might want more sensitivity than average in your phono input to match the sound level of LPs to other sources. In our test reports, about 1 millivolt is par for both fixed-coil cartridge output and preamp sensitivity, but beware of comparing these figures with those from other sources.

Whether you buy a separate power amplifier, one combined with a preamp to form an integrated amplifier, or one built into a receiver, you'll also have to consider its power rating. Most models on the American market today deliver somewhere between 20 and 200 watts. If you exclude budget models and those aimed at the price-is-no-object audiophile, the range is whittled down to about 35 to 85 watts. You're better off if you can train yourself to think in dBW, however. (A dBW conversion chart appears on page 42.) That range translates to 15½ to 19¼ dBW—a spread of about 4 dB, which is not a large difference in audible level or peak handling.

Again, other subtle differences are possible, despite the very low distortion routinely encountered in power amplifiers, but don't expect to hear all of the dramatic differences implied by partisans of the various viable approaches to circuitry design. Anything as radical as the purpler of the audio prose suggests would have to be worse, given the high overall development of today's amplifier technology.

Robert Long

TUNERS AND RECEIVERS

Even inexpensive tuners—and tuner sections built into receivers—offer astonishing FM performance by the standards of yesteryear. But to select the best tuner at a given price, you should be aware of some basic

DOUBLE-FLOAT SUSPENSION. TWIN PIPES. TAKE IT FOR A SPIN.

From the ground up, our new Yamaha PF-800 was engineered to eliminate the most common and annoying problems inherent in turntable performance. In terms of tracking accuracy and isolation from vibration, the PF-800 is the most advanced way yet to spin a record.

To eliminate unwanted vibrations, we designed a double-float suspension system.

It starts with the feet. Through a special combination spring/rubber damping system, they stop practically all external vibrations in their tracks.

Next, we mount the sub-chassis by a three-point spring suspension to absorb any chassis vibrations before they reach the platter.

And instead of being mounted on top of the springs, the sub-chassis is suspended from the springs. This lowers the center of gravity to give you the best possible record handling in the curves.

To avoid creating internal vibrations that could reach the platter, we use an FG servo motor and a vibration-absorbing rubber drive belt.

So now you don't have any vibrations but the good ones from the music.

And to keep that music precisely on track, the PF-800 uses our latest model tonearm.

It's dynamically balanced to remain

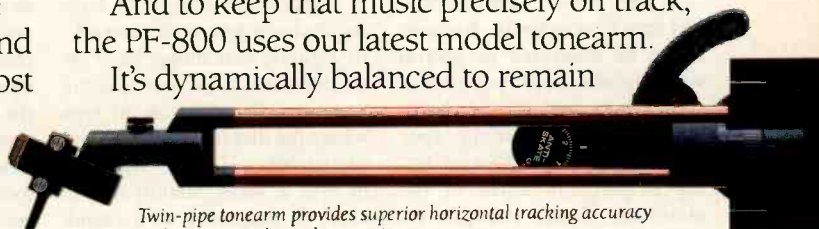

Twin-pipe tonearm provides superior horizontal tracking accuracy and maximum channel separation.

unaffected by sudden vertical acceleration (such as from record warp). It has optimum mass/minimum resonance to provide maximum performance from any type of cartridge. And unique twin pipes to resist flex and provide the widest signal separation possible.

There's a lot more we could say about the PF-800. But why not visit your Yamaha dealer and take one for a spin? Your mileage may vary. But your satisfaction will be consistent.



Double Float Suspension System effectively isolates turntable chassis from virtually all vibrations.

 **YAMAHA**

Yamaha Electronics Corporation, USA, P.O. Box 6660, Buena Park, CA 90622

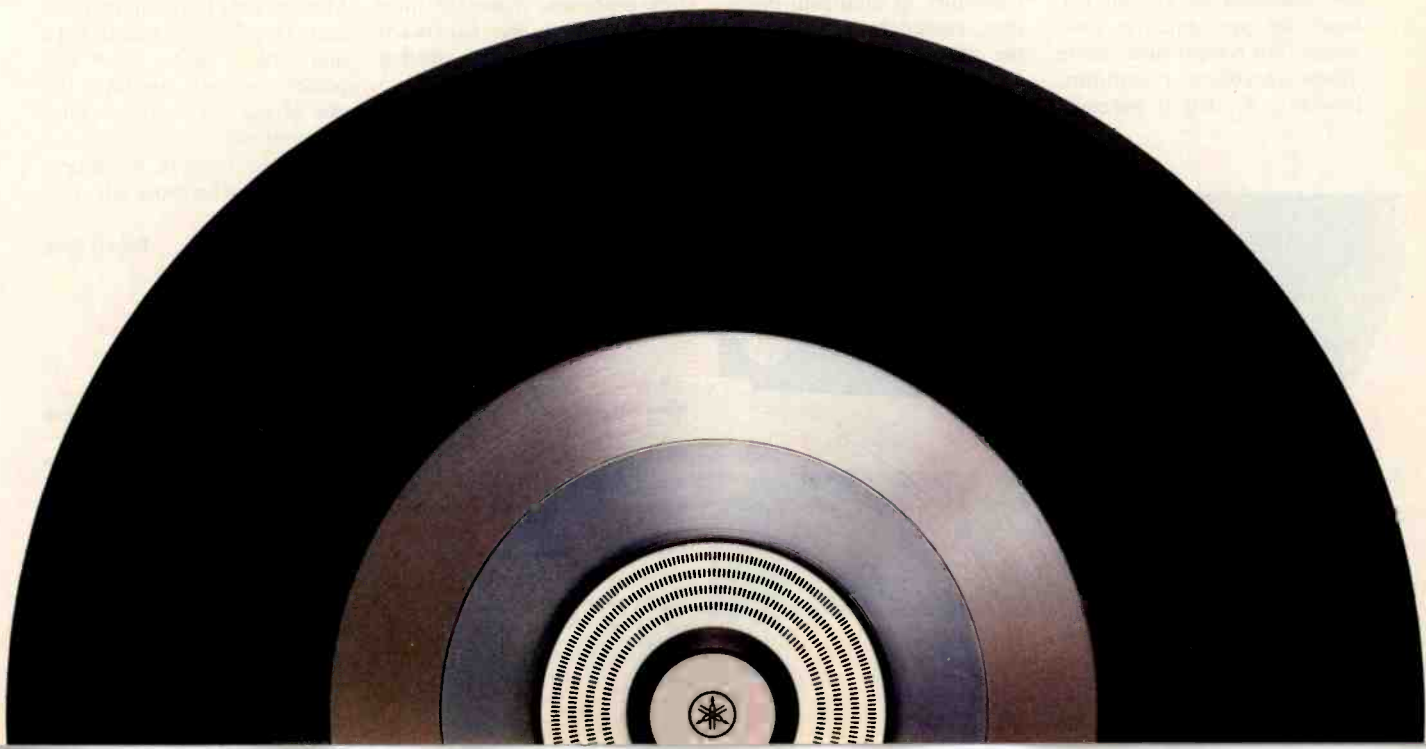

performance specifications.

The most "prominent" FM spec is sensitivity. Because it can be measured in several ways, make sure you're not comparing apples and kumquats when examining spec sheets. The old-fashioned rating is given in terms of the minimum signal strength required at the antenna terminals for a quieting (in this case, suppression of the combined noise and total harmonic distortion) of 30 dB. Such a specification is meaningless for various reasons, not the least of which are that it usually refers to mono and that 30 dB of quieting represents barely listenable reception.

More useful, as well as more modern, is the sensitivity rating based on a quieting of 50 dB. (In this case, quieting refers to the suppression of noise alone.) If the rating follows the appropriate standard, it should be stated in dBf (decibel femtowatts), with separate mono and stereo figures. Par for a good design is around 37 dBf in stereo and 14 dBf in mono. Some very attractive models run a few dB poorer (higher) than that but are redeemed by special features or performance elsewhere. For typical suburban or urban reception conditions, however, 37 dBf is normally

better than you really need.

But don't base your buying decision just on the sensitivity figures, which may have little importance for your specific situation. If you're in an area where the dial is crowded—and particularly if you want to receive a weak station that is close in frequency to a strong one—selectivity is the first spec you should look at. The selectivity rating expresses in dB how much stronger the more powerful one can be before it preempts reception of the weaker broadcast. For alternate-channel measurements (with the two stations 400 kHz apart), 60 dB or higher is commonplace and desirable. Adjacent-channel measurements (with the stations 200 kHz apart) are seldom shown on spec sheets. Most tuners come in at less than 10 dB here; 20 dB or more is spectacular.

Also important for clean reception is capture ratio. It expresses in dB how much stronger a signal must be if it is not to receive interference from another on the *same* frequency. Among other things, capture ratio addresses the tuner's susceptibility to multipath distortion, caused by reflections of the signal you're tuned to. Because the reflected path is longer than the distance trav-

eled by the direct signal, the two (or more) carriers won't arrive simultaneously. This creates a phase difference between them, which is demodulated in the tuner as noise and distortion. The lower the capture ratio, the firmer the tuner will lock onto the direct broadcast, making for quieter reception. In most fine units, it measures less than 2 dB; occasionally a model will come in at less than 1 dB.

There are several specifications that refer to rejection of unwanted signal components: AM suppression, suppression of the 19-kHz pilot tone and 38-kHz subcarrier that are part of all stereo broadcasts, and image rejection. All should be higher than 60 dB in a first-rate design. The lower the distortion the better, of course, though few tuners measure worse than 1 percent, and the figures in most are below 0.1 percent.

If you're investigating the fancier tuners—in either separate components or all-in-one receivers—you're sure to come across models with an IF bandwidth switch. This feature can be a significant help if you need to straighten out kinky reception problems. When IF filter characteristics are narrowed, selectivity is improved, albeit at some expense in distortion.

Most models give you some sort of signal-strength indication. Unless you have an antenna rotator, this information will be of only academic interest. And even if you do

have a rotator, the indicators on most tuners are likely to be inadequate. In the first place, most are no more than a series of LEDs—sometimes only three or four. When signal strength lights a certain number of LEDs, there's no way of telling how near it comes to lighting the next one and therefore of finding the point of absolute maximum. Moreover, for best possible reception, it's often more important to reduce multipath than to increase signal strength. You'd be well advised, therefore, to look for a tuner whose meter has many LEDs and a multipath indication.

Another by-product of IC-based digital-style circuitry is a whole bevy of convenience tuning features. The number of stations that can be memorized in presets is growing. Some models will scan these presets as well as all receivable stations (or all frequencies on the dial) to help you find something you feel like listening to. Scan tuning can be bidirectional, reversing at the band ends, or unidirectional, jumping from the top of the band back to the bottom. Most models have digital read-outs. Occasionally you'll find a unit with a tuning knob and pointer—either because it's one of the few models with a conventional rotary tuning capacitor or because it imitates such designs for those who prefer their "feel."

Robert Long



THE QUEST FOR BETTER RECEPTION

One of the best reasons for assembling a system of separates is the ability it gives you to select the right tuner for your reception area. The Tandberg TPT-3011A (top right, \$700) offers impressive sensitivity and selectivity specs plus useful signal-strength and tuning meters. The economical NAD 4155 (\$350) has a clever high-blend circuit that limits noise (by reducing separation) only when the program cannot effectively mask it.

JBL Introduces Titanium Series loudspeakers. To tell the truth.

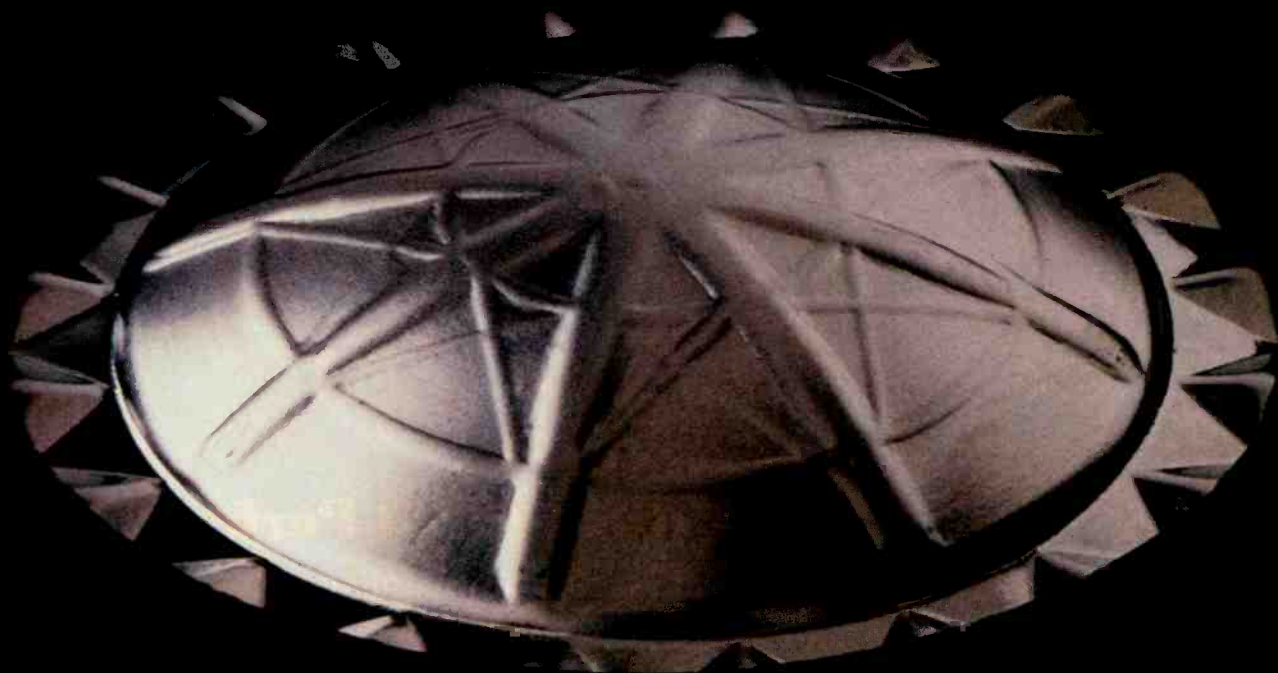

A team of specialists at JBL labored nearly five years to develop a unique manufacturing process, a patented design, a significant advance in materials application, and four stunning new loudspeaker systems.

The new Titanium Series takes its name from a truly revolutionary high frequency driver. A blast of nitrogen gas against a sheet of pure titanium creates a dome thinner than a human hair yet capable of withstanding the crushing force of more than 1000 Gs.

The new titanium high frequency driver easily copes with the

musical transients and wide dynamic range of the most demanding digital recordings, generates undistorted sound well beyond the audible range, and handles very high power without stress.

Coupled with a new midrange driver, a new dividing network, and other major and minor innovations, the resulting new Titanium Series loudspeakers are the most neutral, the most detailed, the most pleasing loudspeakers you're likely to hear. And the very best from JBL.

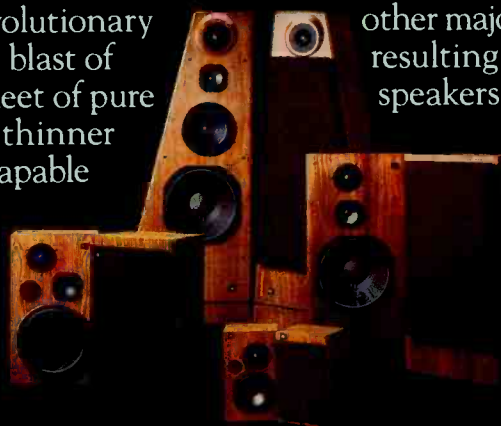

JBL

harman international
6500 Balboa Blvd. P.O. Box 2200
Northridge, California 91329

Pictured above: JBL's new pure titanium high frequency driver with patented diamond surround.



State-of-the-Artist Performance

Bring a cassette tape recording of your favorite artist to any Ford or Lincoln-Mercury dealer and hear it for yourself.

The Ford Electronic Stereo Cassette System heads an all star cast of high performance sound systems with sophisticated audio features.

Only Ford factory installed sound systems are designed, manufactured and quality tested specifically for your new Ford, Mercury or Lincoln.



Electrical and Electronics Division

Performance varies widely in cassette decks, but a thorough reading of manufacturers' specifications and test reports will help you find a model that is up to par. The \$500 Nakamichi BX-150 (top) is a high-performance deck with a minimum of conveniences. Teac's Z-6000 (center), at \$1,400, combines convenience with extensive tape-tuning capabilities. The \$300 Akai HX-R44 gives you autoreverse plus music-search and music-scan functions.

CASSETTE DECKS

Unlike electronics products, cassette decks display frequency-response anomalies ranging from slight to gross. Some decks roll off the very deep bass, and all show a certain amount of bass contour effect—the rippling response (sometimes called head bumps) that results from the physical relationship between the playback head gap and the tape. Neither of these bass phenomena is likely to cause serious audible misbehavior. Unfortunately, the same cannot be said for the various mechanisms that disturb response at the other end of the spectrum.

Very few cassette decks are flat within ± 1 dB to beyond 20 kHz—even when measured with a tape of the manufacturer's choice and with all features that might compromise the figures (noise reduction and multiplex filter, in particular) turned off—and it's unfortunately all downhill from there. Many of the features offered in modern decks are intended to minimize such response irregularities. Others are designed to combat cassette tape's other major bugaboo: noise.

Unless the deck matches the tape precisely in bias and recording equalization, the two together cannot create a recording that will play back flat. Bias is an ultrasonic signal "additive" that makes the magnetic recording process work far better than it did before the technique was introduced, almost a half-century ago. It can be adjusted for maximum output at any given frequency; distortion may be reduced by increasing bias somewhat beyond that maximum-output setting. But the higher the frequency, the lower the bias current at which maximum output occurs, so you can't alter bias without affecting frequency response.

Recording equalization can compensate for bias-induced response changes, but only up to a point.

Most decks have a tape-matching feature that, either automatically (by sensing the "keyways" at the back of the cassette shell) or manually, adjusts for the basic tape type; fine-tuning the mechanism for a particular brand can only be done internally, by a qualified technician. Such decks rely on the standardization of tape types to produce closely equivalent results if you switch among major brands. (Off-brand tapes are something else.)

This standardization is a relatively recent phenomenon, however, and mutants still are created by the tape manufacturers despite clear tape-type indications on the packaging. Adjustable bias (and, preferably, recording equalization) will limit the damage if your tape is one that doesn't match what your deck's manufacturer presupposed. Ease of adjustment ranges from manual and awkward to automatic and incredibly fast.

Dolby noise reduction—either the virtually standard Dolby B, which reduces tape hiss by about 10 dB, or the newer 20-dB variant called Dolby C—depends on precise matching of record/playback levels for spot-on playback accuracy. Consequently, many decks also have an adjustment for tape sensitivity (or "Dolby tracking"), which can vary by several dB from brand to brand. Again, if the tape you're using is a close match to whatever the deck manufacturer expected you to use, adjustment may be unnecessary. But tape manufacturers do change their formulations, and significant disparities in performance tend to be exaggerated to some extent by noise reduction systems. That is, if a

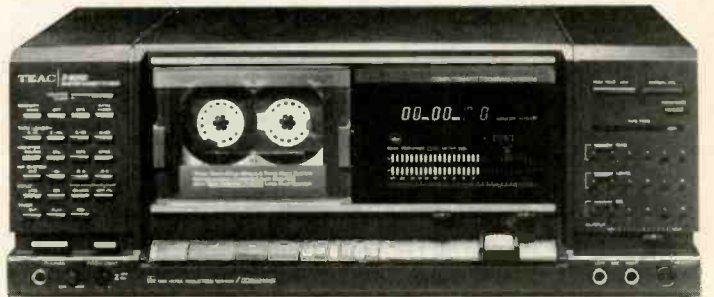

signal component is altered between recording and playback, that change may cause the noise reduction system to add still more change.

That's why there's always a multiplex filter in Dolby cassette decks to take out FM's 19-kHz pilot tone, which most decks can't reproduce accurately at all. If it were left in, the Dolby processor might find much less high-frequency energy in playback than in recording (because of the lost pilot tone) and alter playback accordingly. Sometimes the filter can be switched out. One school of thought says this approach is good because it maintains the broadest, flattest possible response; another says it's better to keep the filter on to reduce intermodulation between the music and any stray ultrasonics. Take your pick.

DBX noise reduction, the only other major option, isn't level-sensitive and therefore will accept even gross sensitivity mismatches without ill effect. It is inherently band-limited, so response rolls off at both extremes of the audible range,

making frequency-response specs look marginally less attractive with DBX than without. But it will give you about 30 dB of noise reduction—the most you can hope for in today's cassette technology.

Another significant performance factor is the metering. Modern "bar graph" level displays are prodigies of accuracy compared with the mechanical meters of the past, but some are better than others. Functional divisions of 2 dB or less at the upper end of the scale are desirable to help you fine-tune recording levels. A peak-hold feature may make it easier to read maximum values. If calibration extends down to only -20 dB or so, quiet passages (particularly in classical music) won't register at all, making it look as though the deck is turned off. All these factors are best judged by looking at the meters while the deck is in use.

"Equalized metering," which displays levels with respect to the overload characteristics of the tape, can be a real help in allowing for the differ-

ences in musical spectral balance. Jazz, for example, tends to be loaded with treble transients that can be dulled before the midrange runs into overload, while a string orchestra produces much more energy in the midrange than elsewhere. The Dolby HX Pro (or HX Professional) circuit built into some decks also is very effective in maintaining the highs in signals that strain the limited high-frequency headroom of cassette tapes.

HIGH FIDELITY's test reports are your best source of information about a deck's performance. But keep in mind that there is a very complex relationship between level, frequency, distortion, bias, equalization, noise, dynamic range, headroom, and tape saturation—which means that no performance measurement should be taken as an absolute. That said, look for midrange headroom (limited by the level at which 3 percent distortion occurs) of at least 2 or 3 dB, measured above DIN reference 0 dB (250 nanowebers per meter). That's about 4 or 5 dB above Dolby reference level (200 nanowebers per meter), which is sometimes used in manufacturers' specs. And if the deck is to be considered "true high fidelity," response should reach to at least 15 kHz, measured at -20 dB DIN, without rolling off by more than 3 dB. (Be aware that many manufacturers specify frequency response within a ± 3 dB window—which often really means +0, -6 dB—so the frequency at which response drops to -3 dB often is lower than that shown in the spec.)

A crucial consideration in the reproduction of high frequencies is azimuth angle: the perpendicularity of the head gap to the tape path. If the azimuth during playback doesn't match that during recording, the playback head won't be able to resolve the shortest wave-

lengths, dulling the sound. Some very sophisticated decks offer special controls or automatic adjustments to ensure a good match—either to an assumed standard or to the tape that's being played. But any deck should supply a virtually perfect match to the tapes you record on it; the problems, if there are any, occur with commercially recorded tapes or in playing home-recorded tapes on a deck other than the one used to create them.

So-called two-head decks have an erase head and a combination record/play head. Though they're generally capable of very good performance, some compromise is necessary between the gap characteristics desirable for optimum recording and those for optimum playback. The separate heads of "three-head" designs solve this problem and also (usually) let you listen to the tape an instant after it is recorded to check recorded quality—monitoring, as this feature sometimes is called. There are several ways of building head clusters for this purpose, each with its own advantages.

There may actually be more heads than this nomenclature suggests, however. Reversing decks may use extra heads for the second direction. More often, a single set is flipped over in a rotating head assembly. And in a few models from one manufacturer, the tape is flipped instead so that head alignment won't be compromised.

When you come to consider automatic reversing and the host of other convenience features made possible and even inexpensive by microprocessors, your own tastes and needs must be your guide. One recordist may delight in a feature that another will consider a nuisance, so accept the advice of others circumspectly.

Robert Long

CARING FOR YOUR SYSTEM

Adequate maintenance is vital to the sound of your system. At minimum, this means keeping your records, stylus, and tape deck clean—an easy-enough process with the scores of record and tape products available today.

Proper LP hygiene is the simplest of tasks. Train yourself to use a record brush before each play, even if the disc looks clean. Bits of gritty dust lodged deep in the groove can easily deform the vinyl as the stylus jams them into the groove wall, resulting in ticks and pops that will forever haunt the recording. The brushes from Discwasher and Audio-Technica, used in conjunction with the supplied cleaning fluids, are designed to remove these deposits. One or two wipes across the surface of a rotating LP is all it takes. To remove heavier buildups, I've had some success with the Allsop Orbitrac approach. Comprised of a rubber pad, a bottle of spray-on cleaning solution, and a pivoting circular brush, the Orbitrac system enables you to apply more pressure to an LP than is possible with brushes designed for on-platter use.

If you've checked the cost of replacement styli recently, you know why it makes so much sense to clean your stylus carefully. Never, never use your fingers to remove dust; aside from the grease and dirt you may inadvertently deposit, it's all too easy to bend the cantilever or damage the tip with too much pressure. The only way to clean a diamond stylus is with a brush designed just for that purpose. Moisten the brush with a drop of the supplied fluid, then pull it gently over the "needle" from back to front; any other motion may bend the cantilever. And stay away from gimmicky stylus cleaners. A couple of years ago, a manufacturer was advising people to use the striking strip on a book of matches. The procedure supposedly worked on that company's cartridges, but a HIGH FIDELITY staffer who tried it on his pickup found that the matchbook removed the stylus on the first pass.

Cassette-deck maintenance is equally important. Even microscopic particles of debris adhering to a tape head will cause dropouts and impair high-frequency response. You can see the debris (small particles of oxide shed by the tape) as a discoloration of the rubber pinch roller, the wheel that presses the tape against the capstan. If you spot that kind of discoloration and suspect that the sound of your deck is not up to par, it's time to clean things up. Some people make a practice of cleaning their decks every month or so, which makes good sense if you use the deck a lot.

The easiest and most foolproof way to "wash" the tape heads, capstan, and pinch roller is with one of the commercial cleaning systems. (If you're comfortable probing about the insides of your deck, you could use cotton swabs and pure isopropyl alcohol.) These gizmos are all housed in a cassette shell and use solvent-soaked pads (or, less desirably, abrasive tape) to scrub the dirty parts automatically when the deck is set into motion.

Peter Dobbin

Nothing you buy will do more for the sound of your stereo system than a quality phono cartridge.

It's the smallest component in your system, but in terms of sound the phono cartridge is one of the biggest contributors. It's the only point at which the record is linked to the rest of your stereo system. So without a good cartridge, the world's most sophisticated turntable, amplifier and speakers will provide poor sound. In fact, they'll merely amplify the shortcomings of an inferior cartridge.

A WINDOW TO YOUR SOUND.

At Shure, we believe a phono cartridge should reproduce the sound of a record with crystal clarity. Like a window admitting light, a cartridge should convey the signal from your record to the rest of your stereo system without adding any color of its own. So instead of listening to sound with a predetermined character, you have the option of using your system's tone controls to tailor the sound to your personal taste.

A CARTRIDGE IS A TINY GENERATOR.

The cartridge is a miniature, precision-made stereo component that produces colossal results. Let's look inside a moving magnet cartridge (an innovation introduced by Shure). Sound reproduction begins when the (1) diamond stylus tip is put into motion by the record groove walls. This tip motion is then faithfully transmitted to a (2) miniature but powerful magnet by the (3) stylus shank. Inside the cartridge, this magnet is surrounded by (4) pole pieces, each wrapped with a (5) coil of copper wire. As the magnet moves, corresponding to the motion of the stylus tip, its magnetic field generates an electrical signal in the coil. This is the audio signal fed to the other components of your stereo system by (6) terminal pins bonded to the ends of the coils.

LITTLE MISTAKES MAKE BIG PROBLEMS.

Any electrical or mechanical error pro-

duced or transmitted by your cartridge will be amplified by your stereo system. That's why it's crucial that you choose a cartridge capable of handling all the sonic subtleties and sudden transients engineered into today's records—and able to overcome common playback problems like dust, static electricity, and record warp. A cartridge that does not have these capabilities will transmit sound which is distorted and fatiguing to the ear.

to triumph over harmonic distortion and raspy, unnatural sound. Poor trackability can cause permanent damage to your records. Shure originated the concept of trackability, and we've set the standard for others with our Total Trackability Index (TTI).

Shure is also famous for its research into tracing distortion, channel separation, and noise reduction—all crucial factors in distortion-free cartridge performance. The results are readily apparent in the world's finest phono-graph cartridges.

THE RIGHT WAY TO UPGRADE.

If the phono cartridge you're using isn't a Shure, it's time you switched. An inferior cartridge can cause permanent damage to your records and limit your listening enjoyment. A new Shure cartridge will protect the investment you've made in your record collection. It's designed to get the most out of today's sophisticated recordings, including digitally mastered, half-speed mastered, and direct-to-disc albums. To find out how your present cartridge measures up, ask your Shure dealer about our TTR117 Audio Obstacle Course record.

WHY SHURE?

For more than three decades, Shure has been the uncontested leader in phono cartridge design and development. We've introduced scores of innovations, like the dynamic stabilizer, the destatizer, and the Side-Guard Stylus Protector. Every Shure cartridge is carefully tested and retested at all stages of manufacture. There's a Shure cartridge made to match your system and your budget. For a free copy of our catalog, call or write Shure Brothers Inc., 222 Hartrey Ave., Evanston, IL 60204. (312) 866-2553.

DISTORTION IS NO SIMPLE MATTER.

Phonograph reproduction is a surprisingly complex process. Each aspect must be carefully controlled in order to achieve distortion-free reproduction. One major aspect is frequency response. Flawless frequency response accounts for Shure's superior tonal balance. Shure's superiority in trackability is recognized worldwide. It is this ability to faithfully follow the complex undulations of the sound-encoded groove walls which allows Shure pickups

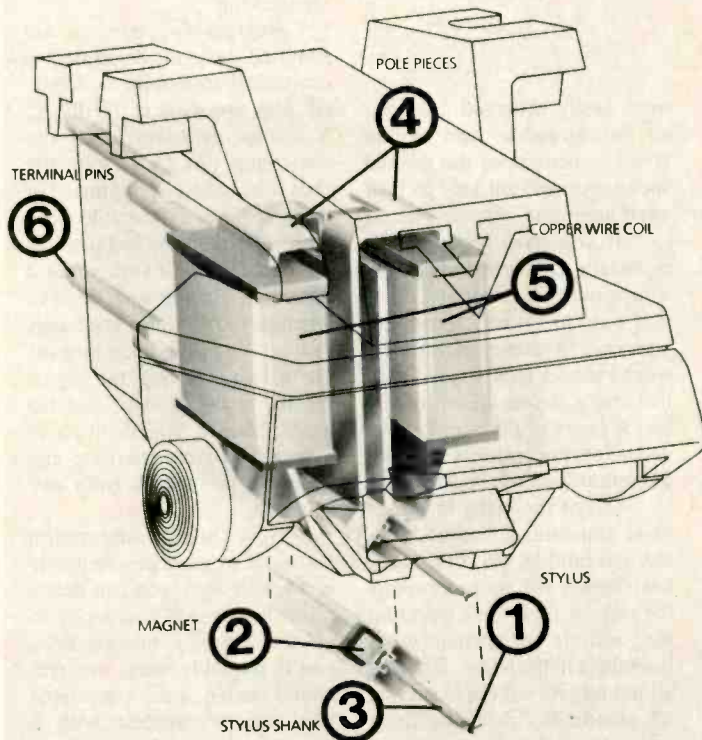

SHURE[®]
You'll Hear More From Us.

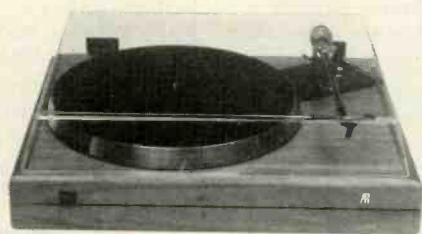
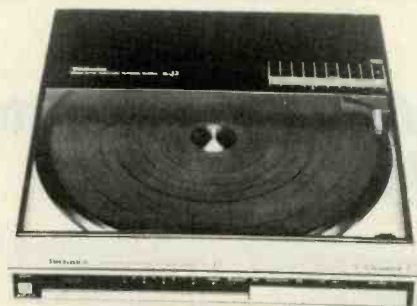

TURNTABLES AND CARTRIDGES

If you're planning on buying a new turntable this year, you're in for a surprise: Prices of high-quality record-playing equipment have never been lower. Indeed, whether you're willing to spend \$150, \$350, or more for a record-playing system (turntable and cartridge), you should be able to buy a setup with more features and better performance than you could have gotten at the same price just two years ago.

When selecting a turntable, you *don't* have to worry about its drive system. The direct-drive technique, in which the platter attaches directly to the spindle of a motor mounted beneath it, has proven such an economical alternative to belt drive that the latter is now used mainly in very expensive high-end designs and in bottom-of-the-line models. The costly units include some of the best turntables available, but the bargain-basement stuff usually is best avoided.

Direct-drive and belt-drive mechanisms have some generic strengths and weaknesses, but both excellent and mediocre turntables can be built with each. When shopping, focus on performance—not theory. You want three things: accurate speed, low wow and flutter, and low rumble. The first is the

most easily achieved. As long as the turntable runs within about 1/2 percent of the desired speed, you are unlikely to hear anything amiss.

If you have reason to be especially concerned about absolute pitch accuracy (e.g., if you want to "tune" records to your own instrument), you may want a model with a speed control and a strobe speed indicator. A range of 6 percent above and below the basic pitch (about a semitone) should be adequate.

Out of the many measurement standards for wow, flutter, and rumble, HIGH FIDELITY has chosen for its test reports the ones it feels best represent the audible performance of turntables in the home. Because all the reports adhere to one set of standards, they facilitate comparisons between reviewed components. Unfortunately, the situation with manufacturers' specifications is rather chaotic: The various standards are significantly different from one another, and direct comparisons between turntables from different companies often are impossible. Nonetheless, you should expect to see wow and flutter figures below 0.1 percent for normal gear and below 0.05 percent for premium equipment. Rumble should be less than -60 dB.

A good turntable also will resist acoustic and mechanical feedback. The former occurs

when sound from your speakers is picked up by the turntable base and transmitted through the stylus back into the system and out the speakers. At its worst, acoustic feedback produces a howling noise, but even low levels tend to muddy the sound. Mechanical feedback is transmitted through solid objects, such as the floor, and when very bad can cause gross mistracking.

Regrettably, there is no standard test to determine a turntable's immunity to acoustic and mechanical feedback. You can, however, find out something just by kicking the tires a bit while shopping. Try thumping on a turntable base with your knuckles and listen to the results. Do it first while a record is playing and observe whether the tonearm continues to track steadily. Then turn off the player, leaving the stylus resting in the groove, and tap again. Ideally, you should hear a dull thud from the base and little or no sound from the speakers.

How much automation you want or need in a turntable is a matter only you can determine, but even if you decide to go for a totally manual unit, you'll probably want an integrated design, i.e., a turntable that comes complete with a tonearm. (It is still possible to buy an armless unit and separate tonearm, but such ensembles are usually more expensive and difficult to set up.) In fact, the trend in turntables today is toward an even greater degree of integration, where in the tonearm (be it pivoted or lateral-tracking) is designed to mate directly with a plug-in cartridge of the correct mass and compliance—the P-mount system. P-mount tonearms are quickly becoming the rule in moderate-price turntables, and just about all cartridge manufacturers offer compatible pickups.

Like a loudspeaker, a pho-

no cartridge must transform energy from one state to another—in this case, from mechanical to electrical. A cartridge is judged by how well it follows a record's groove modulations and by how accurately its electrical output corresponds to the information contained in them. But also like a loudspeaker, a cartridge can have its own coloration, so you'd be wise to buy one only after hearing how it performs in your own system. Since most dealers will not cooperate with such a try-it-first approach, your best guides when shopping for a top-quality cartridge (say, \$150 and up) are HIGH FIDELITY's test reports, which present in-depth lab and listening evaluations.

We can, however, offer some general advice on cartridge selection. If your turntable comes with a pickup, try it at home and see if you're satisfied with the sound of the ensemble. If not, it's probably a junky little cartridge that the manufacturer (or dealer) threw in to help sell the turntable. To upgrade the sound, you'll have to spend \$50 or more on a decent pickup. When shopping, take a favorite record with you and play it on a variety of turntables (provided that the dealer has a different cartridge in each one). Make sure that the amplifier and speakers in the demo system are similar, preferably identical, to your own. A good cartridge will produce a smooth, natural tonal balance and will track even the loudest, most complex musical passages with a sense of effortlessness.

Finally, no matter what anyone tells you about coils or cantilevers or styli, there is no magic. If two cartridges have a similar frequency response and adequate separation (15 dB or more at midband), it is unlikely that they will sound very different in any respect unless one of them mistracks.

Michael Riggs, Peter Dobbin

COMPACT DISC PLAYERS

The Compact Disc system as envisioned by its co-creators, Philips and Sony, was meant to surpass the LP both in fidelity and in flexibility. Every CD player we have tested to date confirms the medium's superiority to the LP in performance, but the same cannot be said for their ability to zero in on the music you want to hear. In fact, so diverse are CD players in their roster of features and capabilities that finding the right model for your needs can take some hunting.

With an LP, it's relatively easy to find a specific cut: Just eyeball the grooves, then move the tonearm to the desired band. A Compact Disc has no visible delineations to guide you; instead, the data referring to what's on the disc are contained in a directory coded into its beginning. Several decks will display some of this information, giving you the total number of selections and the full playing time. And during play, some machines will show you the elapsed or remaining time.

But that's only part of the story. The universe of CD players is divided, rather roughly, into three music-access categories: players that let you skip across bands (forward or backward) via a stepper, those that combine sequential stepping with a programmable memory for automatic playback of desired selections, and those that provide a keypad for direct access to any band and that are

capable of programming selections via band number.

Which music-access system is preferable? In our experience, classical music CDs rarely contain more than a handful of banded selections, so steppers are easy to live with. But for pop CDs, most of which have at least ten selections, steppers can be a nuisance. Programmability can be thought of in a similar way, as pop music listeners may feel hamstrung without a way to separate the wheat from the chaff on a typical recording. Classical listeners, however, must also consider the vexing situation of CD indexing.

According to standards formulated by Philips and Sony, electronic index marks can be used by the producer of a Compact Disc to identify passages contained within a long, banded work. An opera recording, for example, might contain a band for each scene and index numbers for quick access to favorite arias. Without index-search capabilities, a CD player is blind to these notations, and finding the desired passage (via fast forward, a standard feature on all decks) can be painfully slow. Even more frustrating is attempting to locate such selections without the help of an audible search function that lets you know when you're getting close. And there are CD players that will display index numbers but give you no way to reach them automatically.

Other features are less critical to the music lover—

except, in some cases, remote control. In several decks, the numerical keypad for direct access and programming is built into the remote, not the player itself. Instead of (or sometimes in addition to) random-access programmability, certain CD players have a sequential memory function that enables you to play or repeat any continuous segment of a disc. With such a feature, you can even order a deck to replay a phrase just two or three seconds long. A repeat button serves a different purpose, causing the whole disc, a band, or a programmed sequence to replay indefinitely. Pitch control is a rare feature, but if playing or singing along to recorded music is your thing, you might want such adjustability. And whether you intend to stack your player among other components or keep it separate (or atop the stack) is the important factor when deciding between a deck with a horizontal front-loading drawer or one with a top-mounted disc well. Players with vertical front-loading systems are disappearing.

Finally, if you encounter a

Compact Disc player that seems right for you, ask the dealer to show you the owner's manual. CD decks are complex devices, and often the only place to find corroboration of a particular feature or function is in the manual. Also, try to keep an eye open for truly exceptional machines by reading test reports. Toshiba's XR-Z70, for instance, is a standout for its programming ease and flexibility (via keypad or stepper), attributes that we discovered during the testing procedure for our July report.

Peter Dobbin

THE WHOLE STORY

In October, we published a features-oriented guide to 58 Compact Disc players, some highlights of which appear here. Those of you who missed it can receive a copy of "CD Players: How They Compare" by sending your request—along with a stamped, self-addressed envelope—to HIGH FIDELITY (825 7th Ave., New York, N.Y. 10019).

CLOSER TO THE SOURCE

As a playback medium, Compact Discs and their laser-based players represent the state of the art in home audio. The music on a properly mastered CD is an exact duplicate of that on the master tape, and variations in performance from player to player are small enough to be inaudible. These three models—from top) Sharp DX-100, \$400; Marantz CD-54, \$650; Luxman DX-103, \$1,000—are all capable of playing back a programmed roster of selections.

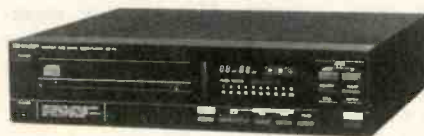

HOW MUCH POWER DO YOU NEED?

Provided your listening room is neither excessively live (bare walls, no carpeting) nor acoustically dead (heavy draperies, carpeting, upholstered furniture), this chart should help you determine how much power you'll need to achieve loud peak sound pressure levels (106 dB) with speakers of different sensitivities. Start by calculating your room's volume in cubic feet (length by width by height). Chart by Tim Holl.

LOUDSPEAKERS

Selecting a pair of loudspeakers is a time-consuming task. The range of options is immense, and choosing among them requires a willingness to listen long and hard to as many models as possible. You will spend countless hours with your speakers after you get them home, and nothing is more frustrating than to find yourself becoming aggravated by an unpleasant sound.

That good sound can only be achieved with very expensive loudspeakers is by no means axiomatic. It is true, however, that some compromises are made as the price goes down. The trick—for speaker designers and shoppers alike—is to ensure that any compromises are intelligent ones. High-quality sound can be obtained even with models that cost less than \$250 a pair. For that amount, you'd be wise to choose a small bookshelf speaker with two drivers (woofer and tweeter) instead of a large system (which, because of cabinet costs, must contain cheap drivers). By using more costly elements in a smaller, less expensive cabinet, a speaker designer can create a system with remarkably smooth frequency response. But because of the smaller enclosure, deep bass output will be limited.

Above \$250 per pair, the limitations lessen. Larger cabinets start to appear, and some include a third driver to help smooth out the midrange and to

give better power handling. For about \$500 per pair, you can buy a large bookshelf speaker, with significantly more low-frequency output than its half-price cousin. From \$500 to approximately \$950 per pair, speakers start to diverge in size and driver complement. Depending on taste and theoretical bent, a speaker designer may choose where to allocate the additional cost. The result may be systems with larger, floor-standing enclosures for extra bass extension, modest cabinets with pricey midrange drivers and tweeters for more smoothness, or merely expensive wood-veneer finishes.

Loudspeakers are the one component in the audio chain where specifications seem to bear little relationship to sound quality. Flat response means only one thing: Under some special test conditions, a curve that will look good in advertisements can be generated. In real-world use, the listening room and the position of the speakers are largely responsible for the final sound quality.

As specifications rarely, if ever, allow for room effects, the only way to judge loudspeakers is to listen. Make sure, however, that the way the speakers are placed in the store is similar to the way you intend to use them at home. If you plan to put them on a shelf at home, don't listen to them at floor level in the store. And when switching between different pairs, make certain that they are close to each other. If two sets

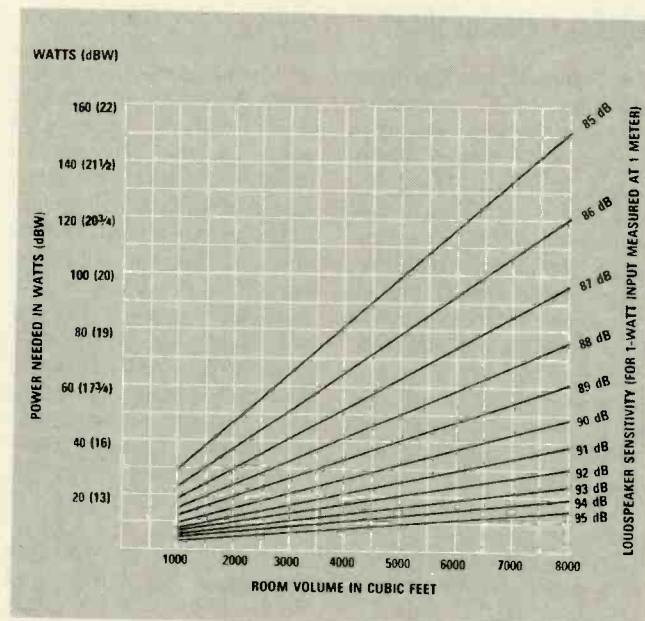

of speakers are on different walls, or if one pair is midway along a wall and the other is nearer a corner, a meaningful comparison cannot be made.

Make sure, too, that the levels of all the models you are comparing are adjusted so that each pair plays at the same volume. If not, you will invariably prefer the loudest pair—despite its real sonic merits. And don't forget to take along a variety of your favorite recordings.

Resist a loudspeaker that is impressive in just one area, such as the bass. Listen instead for well-balanced output. The bass should extend smoothly down to a point that is acceptable to your ears; overwhelming or thumpy bass is unacceptable. Low-frequency extension can be checked with organ music; bass-drum sounds will disclose any tendency to loose or uncontrolled behavior. Equally as important as bass is a smooth, well-extended treble, which can be judged with music containing snare drums or cymbals. The treble is also crucial because it determines the transient response of the entire sys-

tem. Interestingly enough, a realistic bass performance depends on both the woofer and the tweeter, with the high-frequency driver handling the attack portion of the bass notes. Lastly, to check the midrange, play some solo voice recordings and listen for any harshness.

You should also take note of how well the speakers create a stereo image; solo voices that wander across the soundstage are a no-no. Next, check the speakers' dispersion pattern. Move around in front of them; if the sound changes dramatically with position, then only one person at a time will be able to listen to the best sound that your system can achieve.

One final point—don't let your budget stop you from listening to pricey speakers. If you find a very expensive model with a sound you like, use it as a yardstick to help you find affordable speakers with a similar sound. And do not be swayed by other people's opinions. The whole point of the exercise is to find a speaker that you enjoy.

Tim Holl

PANASONIC PV-1730 VHS HI-FI VCR

Special features: cable-ready 14-day/8-event programmable tuner/timer, wireless remote control, and VHS Hi-Fi high fidelity stereo audio recording and playback capability. **Dimensions:** 17 by 4 inches (front panel), 14 inches deep plus clearance for connections. **Price:** \$1,400; optional PV-CT2 pay-TV decoder adapter, \$110. **Warranty:** "limited," one year parts, 90 days labor. **Manufacturer:** Matsushita Electric Industrial Co., Japan; **U.S. distributor:** Panasonic Co., 1 Panasonic Way, Secaucus, N.J. 07094.

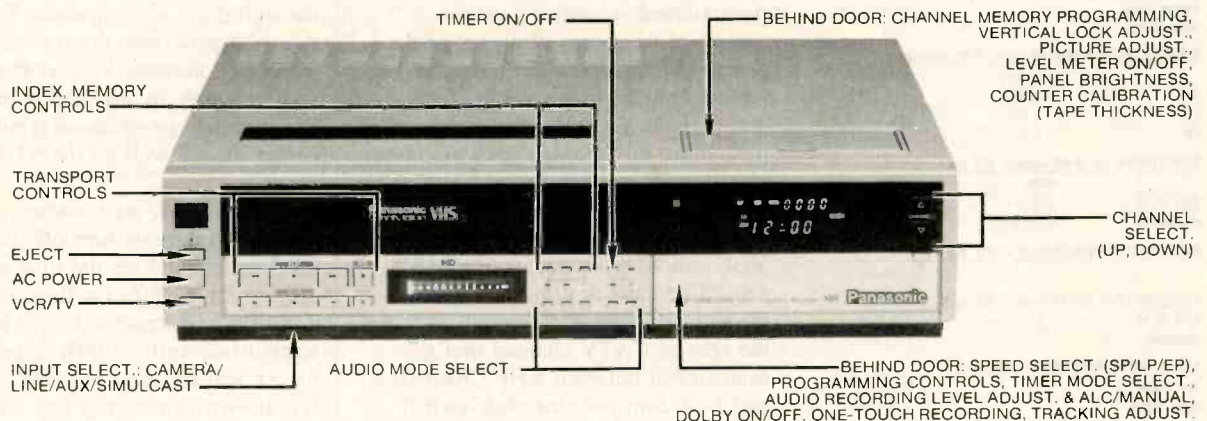

PANASONIC IS PROBABLY the most popular VCR brand on the market, so we were especially eager to evaluate its first VHS Hi-Fi entry, the PV-1730. It turns out to be a remarkably flexible unit, easily lending

itself to a variety of audio-video applications.

If it's just sound you want, you can use the PV-1730 as a straight two-channel audio recorder, either by capitalizing on the 80-dB-plus signal-

Laboratory data for HIGH FIDELITY's video equipment reports are supplied by Diversified Science Laboratories. Preparation is supervised by Michael Riggs, Peter Dobbin, and Edward J. Foster. All reports should be construed as applying to the specific samples tested. HIGH FIDELITY and Diversified Science Laboratories assume no responsibility for product performance or quality.

VCR SECTION

Except where indicated otherwise, the recording data shown here apply to all three speeds—SP, LP, and EP (SLP); data listed for standard edge-track audio recording were taken with the Dolby B noise reduction engaged. All measurements were made at the direct audio and video outputs, with test signals applied to the direct audio and video inputs. For VHS Hi-Fi, the 0-dB reference input level is the voltage required to produce 3 percent third-harmonic distortion at 315 Hz, for the standard audio recording mode, it is 10 dB above the voltage at which the automatic level control (ALC) produces 3 dB of compression at 315 Hz. The 0-dB reference output level is the output voltage from a 0-dB input.

VHS HI-FI RECORD/PLAY RESPONSE (-20 dB)

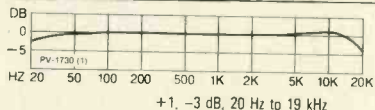

STANDARD RECORD/PLAY RESPONSE (-20 dB)*

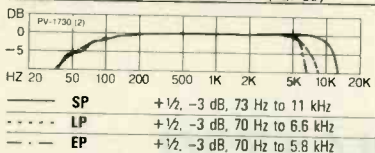

AUDIO S/N RATIO (re 0-dB output; R/P; A-weighted)

	standard**	VHS Hi-Fi
SP	52 dB	83 dB
LP	51 dB	83 dB
EP	48 3/4 dB	82 dB

INDICATOR CALIBRATION (315 Hz; VHS Hi-Fi)

for 0-dB input	+2
for -10-dB input	-2

DISTORTION (THD at -10-dB input; 50 Hz to 5 kHz)

	standard	VHS Hi-Fi
SP	≤ 1.98%	≤ 0.67%
LP	≤ 3.57%	≤ 0.68%
EP	≤ 3.81%†	≤ 0.71%

CHANNEL SEPARATION (315 Hz)

VHS Hi-Fi	69 dB
standard	≈50 dB

INDICATOR "BALLISTICS"

Response time	2.2 msec
Decay time	≈280 msec
Overshoot	2 dB

FLUTTER (ANSI weighted peak; R/P; average)

	standard	VHS Hi-Fi
SP	±0.085%	< ±0.01%
LP	±0.18%	< ±0.01%
EP	±0.26%	< ±0.01%

SENSITIVITY (for 0-dB output; 315 Hz)

	mike	line
VHS Hi-Fi	0.80 mV	215 mV
standard	1.7 mV	470 mV

MIKE INPUT OVERLOAD (at 1 kHz; for 5% THD)

	≈50 mV
--	--------

AUDIO OUTPUT LEVEL (from 0-dB input; 315 Hz)

VHS Hi-Fi	1.6 volts
standard	0.43 volt

AUDIO INPUT IMPEDANCE (VHS Hi-Fi)

line input	69k ohms
mike input	3.9k ohms

*With Dolby on. Response with Dolby off is within 1/2 dB of the response shown over the ranges specified.

**Signal-to-noise (S/N) ratios without Dolby B are 44 dB in SP, 42 dB in LP, and 39 3/4 dB in EP—a deterioration of 8 to 9 dB.

†Distortion could not be reliably measured at 5 kHz in EP.

to-noise (S/N) ratio offered by VHS Hi-Fi or by connecting it to a PCM adapter for even greater dynamic range (and ruler-flat frequency response). More conventional uses include taping simulcasts with stereo sound (on both the VHS Hi-Fi and edge tracks), ordinary TV or cable transmissions (in

connectors, while a separate control cable plugs into a five-pin jack on the VCR to preserve remote-control capability. A switch on the VCR's back panel matches it to the channel the converter delivers at its output.

Tuning is assisted by a programmable channel memory. Once



SECONDARY CONTROLS are behind a flip-down door at the bottom of the front panel. They include an ALC (automatic level control) switch, manual recording-level controls, tracking adjustments, Dolby B and recording-speed switches, an OTR (one-touch recording) button, and, to the right, the timer programming controls.

mono), and even pay-TV channels, with the VCR's remote-control and programmed-recording features preserved by means of an optional descrambler adapter box. You can record from a video camera if you like, and you can go back later and overdub new audio on the edge tracks (without affecting the picture or the VHS Hi-Fi soundtrack).

The PV-1730's tuner covers all VHF and UHF broadcast channels; cable Channels A through W, AA through EE, and A-5 through A-1; and the special CATV channel that's sandwiched between VHF Channels 4 and 5. A four-position slide switch under a hinged cover on the deck's top panel enables you to choose standard broadcast reception or one of three CATV reception modes: "normal," HRC, or IRC. So no matter where you live, the PV-1730 probably will accommodate the local cable system.

Panasonic's optional PV-CT2 adapter enables you to receive pay-TV channels that must be routed through a decoder box yet still retain the ability to record one channel while viewing another. The PV-CT2 attaches to the deck's VHF input and output F

you've loaded it with the channels available in your area, you can scan through them with up/down keys on the front panel and the remote, which also has a numeric keypad that enables you to punch up any station directly. The memory programming buttons are in the control well on the VCR's top panel.

There, too, are switches to adjust display brightness, turn off the audio level meter, and set the time-remaining display for T-160 cassettes, along with a playback sharpness control and screwdriver vertical-lock trimmers for the SP and EP (SLP) speeds. These last are for eliminating any vertical jitter you might encounter. It is unlikely that you will want frequent access to any of these controls, but if you do, you probably will not want to stack any other equipment on top of the VCR.

The PV-1730's 14-day/8-event timer can be set for individual programs or to record the same program every day or week. A one-touch recording (OTR) button allows impromptu recording (with an automatic shutoff) in 30-minute increments up to four hours. In this

mode, the display's OTR legend lights and the clock switches from regular time to time remaining until turnoff. A battery backs up the clock and memory for as long as an hour in case of a power failure. The controls for these functions are behind a convenient front-panel door.

Also behind this door are normal and slow-speed tracking controls, a three-position recording-speed selector, a Dolby B switch for the audio edge tracks, an automatic level control (ALC) switch, and a pair of small recording-level adjustments for manual control, guided by a pair of 12-segment bar-graph indicators calibrated from -50 to +10 dB. Panasonic recommends that you shoot for a level of 0 dB, but Diversified Science Laboratories' measurements suggest that's precariously close to the point at which the PV-1730's recording electronics clip (+2 on the meters). And the level meters themselves are far from accurate: A level reduction of 10 dB from the overload point shifts the indication only from +2 to -2. This is regrettable in light of VHS Hi-Fi's potential performance.

Front-panel buttons enable you to choose Hi-Fi or standard audio playback; pressing both mixes the soundtracks. If you select the Hi-Fi mode and the VCR can't find a VHS Hi-Fi signal, it automatically switches to the edge track. The actual playback mode is indicated by lamps. We found that the PV-1730 takes several seconds to recognize a Hi-Fi recording, so expect to hear low-fi on startup. Another set of front-panel buttons enables you to pick stereo playback or send the left or the right channel to both outputs (a handy option for tapes that use the two channels for bilingual recording).

The PV-1730 has a conventional memory-rewind function as well as a feature Panasonic calls "auto index search." When the latter is on, the deck finds the starting point of the next or current recording automatically when you enter FAST FORWARD or REWIND from STOP (provided the recording was made on the PV-1730 or another machine with this feature). Pressing either of the fast-wind buttons while in PLAY enables you to view the tape at high speed.

A four-position slide switch below the main transport controls selects the input: camera, line, tuner, or "audio 2-

channel" for simulcast recording (video from the TV tuner, sound from the audio-input jacks). To use the PV-1730 as a strictly audio recorder, Panasonic suggests you choose the line setting and change a back-panel switch from A/V (audio-video) to A (audio-only). This causes the VCR to generate the video synchronization signals necessary for Hi-Fi recording.

Miniature phone jacks on the back panel serve as microphone inputs, which override the line inputs when a plug is inserted. There's also a subminiature back-panel headphone jack, a multipin jack compatible with the Panasonic line of video cameras, a camera stereo/mono switch, and a separate remote jack that enables you to engage the PAUSE from a camera. Direct audio and video inputs and outputs are via standard pin jacks.

To keep track of this plethora of features, the deck is outfitted with a multifunction display panel that shows the channel number and VCR mode in letters large enough to see from across the room. Search modes are indicated by blinking left or right arrows accompanied by the play legend, freeze frame by "play" and a solid square between the arrows. The clock numerals are smaller than the channel numbers—the counter numbers smaller yet—but all can be read at a reasonable distance. Smaller legends and symbols (too small to see from a normal viewing distance) indicate when a tape is in the machine, the operating speed, and so on.

The PV-1730's remote is one of the most complete we've seen, giving you total command of the VCR from your easy chair. And if you're using any of certain Panasonic television sets (the CT-5379R and CT-3700, in particular), the same remote governs many of its functions as well. A slide switch enables you to swap control between the two.

FOLLOWING ITS standard procedure, Diversified Science Laboratories tested VHS Hi-Fi performance using the manual level-setting controls but opted for automatic level control when checking the edge track. Unlike some other VHS decks, the PV-1730 records stereo on the edge track as well as on the Hi-Fi track, so all our measurements were made in the stereo mode. And because some form of noise reduction is virtually essential

VIDEO RECORD/PLAY RESPONSE

	SP	LP	EP
at 500 kHz	+34 dB	+34 dB	+1 dB
at 1.5 MHz	-4 1/4 dB	-6 dB	-6 dB
at 2.0 MHz	-11 dB	-13 1/4 dB	-13 1/2 dB
at 3.0 MHz	-16 1/2 dB	-17 1/4 dB	-17 1/2 dB
at 3.58 MHz	-18 dB	-19 3/4 dB	-3 1/4 dB*
at 4.2 MHz			

SHARPNESS CONTROL RANGE

at 500 kHz	±2 1/2 dB
at 1.5 MHz	+4 1/2, -7 1/2 dB
at 2.0 MHz	+4 1/4, -8 1/4 dB
at 3.0 MHz	+1/2, -2 1/4 dB
3.58 to 4.2 MHz	no measurable effect

LUMINANCE LEVEL

5% high

GRAY-SCALE NONLINEARITY (worst case)

≈17%

CHROMA LEVEL

standard

CHROMA DIFFERENTIAL GAIN

none

CHROMA DIFFERENTIAL PHASE

±0°

MEDIAN CHROMA PHASE ERROR

0°

*Level was too low to measure at 4.2 MHz. Output at 3.58 MHz was unstable in EP; the figure given is a peak reading.

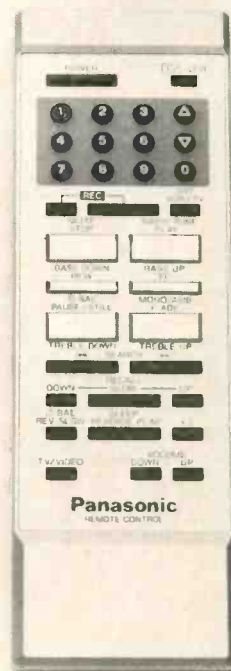

The PV-1730's wireless remote control can also be used to operate certain Panasonic television sets.

TV TUNER SECTION

All measurements were taken at the direct audio and video outputs. Except where noted, the automatic level control (ALC) was turned off.

AUDIO FREQUENCY RESPONSE

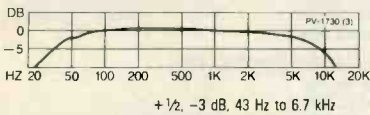

AUDIO S/N RATIO (A-weighted; 100% modulation)

best case (no color or luminance)	62 dB
worst case (crosshatch pattern)	38 dB

RESIDUAL HORIZONTAL SCAN COMPONENT (15.7 kHz)

< -100 dB

MAXIMUM AUDIO OUTPUT (100% modulation)

ALC off	1.0 volt
ALC on	0.36 volt

AUDIO OUTPUT IMPEDANCE

990 ohms

for getting tolerably quiet stereo recordings on the narrow edge track, DSL engaged the Dolby B circuits for all the edge-track measurements reported in our data column.

Edge-track performance is remarkably good, especially at standard speed (SP), where response is ruler-flat

For example, the PV-1730's flutter is below DSL's measurement limit, its dynamic range exceeds 80 dB at all three speeds, and distortion is nearly invariant with speed and well below that of a conventional VCR. Frequency response is identical at all speeds and is much smoother and wider than that

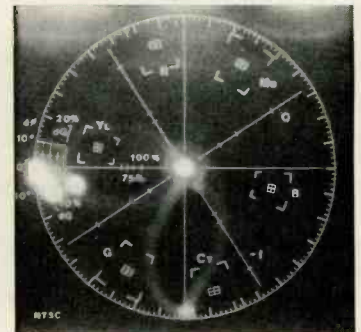

COLOR CONSISTENCY of the PV-1730's recorder section (left) and for its TV tuner (right). In each case, the ideal would be for the cluster of dots toward the left edge of the grid to be a single dot at the intersection of the nine-o'clock axis with the circumference. The radial spread of the dots indicates chroma differential gain—a measure of how much chroma level (color saturation) varies with changes in scene brightness (luminance). The angular spread shows the chroma differential phase, which tells how much chroma phase (hue) shifts with changes in brightness. The VCR's performance is, again, perfect, and the tuner's is excellent, with nearly all of the error concentrated at the highest brightness level.

from 200 Hz to 6 kHz and down only 3 dB at 73 Hz and 11 kHz. The low-frequency cutoff is about the same at all speeds, but as expected, the high-frequency limit decreases by half in LP. At the slowest speed (EP), response is flat to almost the same frequency as in LP, but it drops off much more quickly above. Flutter is unusually low, distortion is about average, the S/N ratios are all one could reasonably expect, and separation is surprisingly good. The ALC holds levels very tightly once it kicks in, which tends to squash musical dynamics. However, it also makes recording almost foolproof.

But even when edge-track recording is as good as this (relatively speaking), on a Hi-Fi VCR it is of interest mainly for making tapes that will be played back on less sophisticated machines. VHS Hi-Fi virtually eliminates flutter—the bane of conventional VCR audio recording—and greatly reduces distortion while providing wide dynamic range and extended frequency response.

obtained with edge-track recording. Nonetheless, it is not as good as it might be. There's a slight prominence at 10 kHz and a rolloff above 15 kHz. And the low end droops by 3 dB at 20 Hz. This is by no means bad performance, but FM recording theoretically is capable of perfectly flat response.

VHS Hi-Fi incorporates a level-sensitive noise reduction system, which therefore can be subject to mistracking. Although the lab did detect traces of error on low-level response sweeps, the amounts were negligible. In either mode, standard or VHS Hi-Fi, the PV-1730's input and output levels and impedances should make for easy interfacing with other components.

According to DSL, the overload characteristics of the PV-1730's VHS Hi-Fi system suggest that the audio circuitry may be clipping before the FM recording system does. If so, some dynamic range is being needlessly wasted. But with 83 dB to play with, the loss of a decibel or two is not of paramount importance. More

significant is the calibration of the recording-level indicators. Clipping sets in at the +2 mark, but the scale extends well beyond, which may encourage overzealous recordists to push for too much level and unknowingly get severe distortion in return. (VCRs do not provide off-tape

luminance level. Some chroma differential phase also is present, but not to a noticeable degree.

Median chroma phase error is quite low, with yellow and cyan being farthest off the mark. But DSL noted a peculiarity in its chroma-level testing. When receiving solid rasters of

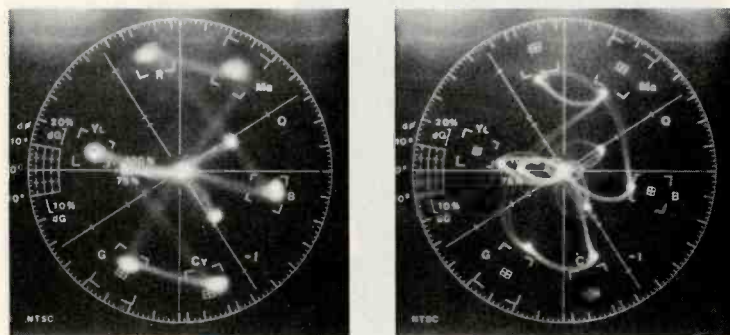

COLOR ACCURACY of the VCR section (left) is among the best we have seen, with all six color vectors (the white blobs near the edge of the grid) almost precisely on their targets. The tuner's performance (right) is less impressive, but still good. Some loss of chroma level (color saturation) is evident, as is a small to moderate amount of phase (hue) error. However, most of this (the attenuation, especially) can be eliminated with a monitor's color and tint controls.

monitoring during recording.) Forewarned is forearmed.

The deck's color accuracy is nearly perfect at all speeds, with no measurable chroma level (saturation) or phase (hue) errors and no discernible differential gain or phase (variation in color saturation or hue with changes in scene brightness). Luminance level also is very accurate, and gray-scale linearity is quite good. However, video frequency response (which determines horizontal resolution) is not up to the best we've seen. You can snap up the picture noticeably with the sharpness control, but at the expense of some increase in video noise (snow).

The tuner section's video response holds up well to the color-burst frequency (3.58 MHz), and there's a boost of a few dB in the 2-MHz region that adds a little extra detail. If connected directly to a good monitor, it could deliver a horizontal resolution of approximately 300 lines. Luminance level is right on target, and gray-scale linearity is better than average. There is a slight falloff in color saturation as scene brightness increases, but it's negligible except at the highest

individual colors, the tuner's output was remarkably accurate, but when receiving a standard color-bar pattern at full luminance, chroma level was down about 2¼ dB, which is only average performance. Reducing the luminance 25 percent increased the chroma level considerably, however.

In a VCR equipped with VHS Hi-Fi, we would prefer to see better audio performance from the tuner. Both bass and treble response fall off prematurely, and distortion is higher than average (though consisting mostly of the relatively benign second harmonic). On the other hand, the limited high-frequency response helps the S/N ratio and reduces the horizontal-scan whistle to an unmeasurably low level.

Despite its imperfections, the PV-1730's audio performance is, overall, far better than one could obtain from a conventional VCR. This, combined with generally excellent video performance and exceptional control flexibility, makes Panasonic's premier VHS Hi-Fi deck a serious contender among today's top-rank videocassette recorders.

VIDEO FREQUENCY RESPONSE

at 500 kHz	+ ¼ dB
at 1.5 MHz	+ 1¼ dB
at 2.0 MHz	+ 2 dB
at 3.0 MHz	+ 1¼ dB
at 3.58 MHz	- 2¼ dB
at 4.2 MHz	- 16¼ dB

LUMINANCE LEVEL standard

GRAY-SCALE NONLINEARITY (worst case) ≈ 10%

CHROMA DIFFERENTIAL GAIN ≈ 25%

CHROMA DIFFERENTIAL PHASE ≈ ± 5°

CHROMA ERROR

	level*	phase
red	+ ½ dB	+ 4°
magenta	+ ½ dB	+ 5°
blue	+ ¾ dB	+ 1°
cyan	- ¼ dB	+ 7°
green	+ ¼ dB	+ 6°
yellow	- 1½ dB	+ 8°
median error	- ½ dB	+ 4½°
uncorrectable error	± 1 dB	± 3½°

*See text.

*Pop and classical
music releases
on videodisc,
videocassette,
and digital
Compact Disc*

POPULAR VIDEO

**TALKING HEADS:
Stop Making Sense.**

Jonathan Demme, director; Talking Heads, producers. A Cinecom/Island Alive film. LP: SIRE 25121-1.

David Byrne's whimsical ideas about lighting, backdrops, costuming, and body language make the Talking Heads' performances, beginning with their 1980 "Remain in Light" tour, more than just ordinary concerts. To Byrne, live rock and roll is an avant-garde storytelling form: He tosses out images that defy immediate rationalization, forcing the audience instead to make emotional and subconscious connections. And it's the savvy premeditation behind every Talking Heads movement (no matter how odd) that helps "Stop Making Sense," Jonathan Demme's fascinating movie of the band's December 1983 Hollywood concerts, transcend the filmed-rock-show genre.

In a winsome opening, Demme focuses on Byrne's white-sneakered feet approaching a bare stage; a huge ghetto blaster drops into the frame, and we hear Byrne say, "I have a tape I'd like to play for you." He then switches on the rhythm track to *Psycho Killer*, which he sings while strumming an acoustic guitar and bobbing his gaunt, dark head as if he were some gawky long-necked bird. The sight of this guy-in-the-next-dorm type making like Chuck Berry is appealingly absurd: When I saw the film at a sneak preview, fans erupted into waves of affectionate laughter at the first shot of Byrne's earnest, bug-eyed face.

By first showing us the skeleton of performance, Byrne bridges the traditional distance between artist and audience, as if to say, "Look, no tricks." Which makes the show that follows a marvel of the best kind of special effects. These are people transported by the playing of music into feats of seemingly superhuman dazzle. For instance, there's Byrne's transformation into a possessed preacher during *Once in a Lifetime*; he jerks about with such force that you look for the puppet strings. Then there's the famous Big Suit, padded out to

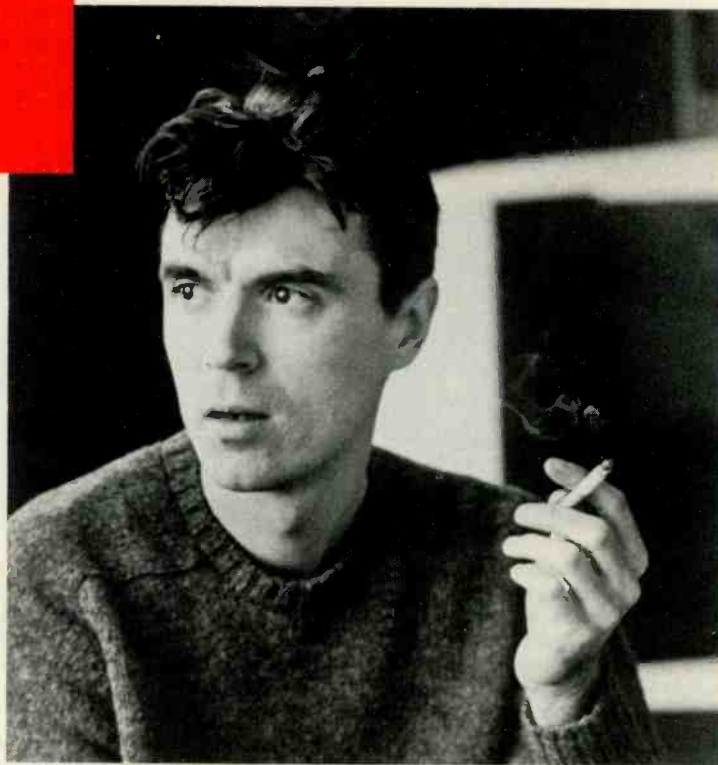

BYRNE: This lovable idiot savant runs the Talking Heads' extended family.

make him appear five feet wide, that he dons halfway through the show, giving the first line of *Crosseyed and Painless* ("Lost my shape, trying to act casual") a hilariously literal meaning.

With their extended family of funk pros—keyboardist Bernie Worrell, guitarist Alex Weir, percussionist Steve Scales, vocalists Lynn Mabry and Ednah Holt—Byrne and the rest of the Heads (bassist Tina Weymouth, drummer Chris Frantz, and guitarist Jerry Harrison) look and sound like a jam session uniting uptown and downtown. Perhaps it's the revamped lineup's easy togetherness (they've lasted through two studio albums now) that gives the "Stop Making Sense" soundtrack an edge over the group's initial big band forays included on 1982's career-spanning live compilation, "The Name of This Band Is Talking Heads." True, *Take Me to the River*, *Psycho Killer*, and *Life During Wartime* appear on both, but the only song that feels like an unnecessary duplication is the last one. Byrne's solo *Psycho Killer* is a must, as is the band's definitive version of *Take Me to the River*, performed at a brisker, raunchier clip closer to Al Green's original.

Because "Stop Making Sense" is

heavy on material from "Speaking in Tongues," the group's latest and most commercially successful studio album, it's also fair to assume that the soundtrack is geared toward newer fans. Nevertheless, this is as good as live albums get, a stunning digital recording mixed (by Frantz and Harrison with Sugar Hill producer E. T. Thorngren) to provide a better-than-being-there clarity. In nearly every case, these live takes outsparkle their originals. This *Burning Down the House*, propelled by Frantz's massive backbeat and the fevered call-and-response of Byrne, Mabry, and Holt, is the version I'll play at my parties; the same goes for *Girlfriend Is Better*, driven hard by Worrell's chattering, screaming synths. I also wouldn't give up the live *Swamp*, since Byrne's marvelously decrepit croaking infects the song with a fuller aura of Southern Gothic menace, or the glowing *What a Day That Was*, a song from Byrne's score to *The Catherine Wheel* that the band seldom performs.

Inspired by their leader's idiot savant posturing, the Talking Heads have always personified a mischievous Id trying to sneak past a vigilant Superego. In funk, they found a wonder drug to loosen stodgy limbs and unbind overwound intellects. This film



offers us the Heads' most vibrantly played—and endearingly dippy—inducements to stop making sense of everything we see and hear, and just dance.

[Although "Stop Making Sense" is expected to be a popular home video, at press time cinecom had not signed a contract for distribution in that market.

—Ed.] —JOYCE MILLMAN

THE HARDER THEY COME.

Perry Henzell, director and producer. THORN EMI VIDEO TVB 1120 (VHS); TXB 1120 (Beta); \$69.95. LP: MANGO MLP5 9202.

A dozen years after the film's debut in theaters, the release of "The Harder They Come" on videocassette provides us with another opportunity to embrace Jamaica's version of the rock and roll dream and to see how much more the dream costs in that island country. The reggae music at the core of this movie has always thrived on an enthusiastic dialogue between West Indian rhythms and American r&b's elaborations on those rhythms; listening to Jimmy Cliff's feisty, good-humored *You Can Get It If You Really Want*, you can hear how Caribbean shuffles influenced New Orleans's parade beats, and how they, in turn, were then affecting reggae. The movie itself works as an emulation of our own cult of the rebel, but it is a much harsher vision than, say, *Jailhouse Rock*.

The story, simple and sharp as myth, follows a country boy named Ivan Martin (played by Cliff) to the ghetto of West Kingston. After a long search, he finds work as a handyman for a preacher (Basil Keane), who is the guardian of a young woman Ivan has been eyeing, Elsa (Janet Bartley). But Ivan, like every third Jamaican male in Kingston, really wants to make reggae records. He finally cuts a single, *The Harder They Come*, for a mercenary producer, Hilton (Bobby Charlton, in a performance that seems to parody reggae mogul Joe Gibbs). Trying to hawk the record himself, he ends up selling the rights to Hilton for \$20. Ivan starts running ganja to earn money, but when he refuses to pay one of the protection men that the corrupt Jamaican police are supporting, three police are sent after him—all of whom he kills. He becomes a fugitive as his single hits the top of the charts: No. 1 with a bullet, indeed.

Translated to the small screen, "The Harder They Come" loses little of its careering momentum. The grit and brashness of director Perry Henzell's footage of Kingston life have little to do with wide-screen grandstanding and everything to do with capturing small details precisely. With its patois chatter so thick it often needs subtitles and with the constant shifting of its soundtrack songs in and out of aural focus, "The Harder They Come" frequently feels like a textural analogue to the reggae music it pivots

PRECEDENT

Never, in the history of audio, has response to a tuner equalled the acclaim received by the CARVER TX-11 FM Stereo Tuner with the Asymmetrical Charge Coupled FM Stereo Detector.

"Breakthrough in FM tuner performance: Carver TX-11"

"The significance of its design can only be fully appreciated by setting up the unit, tuning to the weakest, most unacceptable stereo signals you can find, then pushing those two magic buttons."

"Separation was still there; only the background noise had been diminished, and with it, much of the sibilance and hiss edginess so characteristic of multipath interference."

"A tuner which long-suffering fringe area residents and those plagued by multi-path distortion and interference have probably been praying for." *Leonard Feldman Audio* (December, 1982)

"It is by a wide margin the best tuner we have tested to date."

"What distinguishes the TX-11 is its ability to pull clean noise-free sound out of weak or multi-path ridden signals that would have you lunging for the mono switch on any other tuner we know of." *High Fidelity* (January, 1983)

"...enjoy the music and forget about noise and distortion."

"under conditions of weak signal stereo reception the effectiveness is almost magical!" *Ovation* (December 1982)

"A major advance... "Its noise reduction for stereo reception ranged from appreciable to tremendous." "It makes the majority of stereo signals sound virtually as quiet as mono signals, yet it does not dilute the stereoeffect." *Julian D. Hirsch, Stereo Review* (December, 1982)

Audition this superlative instrument incorporating Bob Carver's latest circuit refinements at your authorized CARVER dealer.

And Now...

If you have substantially invested in another stereo FM tuner—or perhaps in a receiver—you will appreciate the CARVER TX-11.

The TX-11 embodies Asymmetrical Charge-Coupled technology in a sophisticated add-on high fidelity component.

For a 20 dB improvement of the stereo quieting (that's 10 times quieter!) and a 10dB improvement in multipath noise reduction, simply connect the CARVER TX-11 between your FM stereo tuner and the pre-amplifier or through the tape monitor/external processor loop of present system. Hear fully separated stereo FM reception with space, depth and ambience—only hiss, noise and distortion is eliminated.



CARVER

POWERFUL

CORPORATION P.O. Box 1237, Lynnwood, WA 98036

MUSICAL

ACCURATE



upon—rough, wildly amped-up, often willfully impenetrable and, just as often, full of open-armed invitation. Cliff, with the knowing look of someone facing down his own dreams, has a sly, hemmed-in fury that lights up a number of scenes: absorbed in a spaghetti western, his profile ignited by the glow of the screen; surveying himself in the mirror in all his dandyish finery; driving a stolen white convertible across an endless expanse of clipped green lawn. And the music that this movie is all about—songs like the Slickers' prophetic *Johnny Too Bad* and the Melodians' *Rivers of Babylon* that cemented an audience for reggae in the U.S.—retains all of its force and lyricism. None of the performers here (except Toots and the Maytals, whose studio version of "Sweet and Dandy" is one of the film's highlights) have equaled their work since, not even the star. Then again, as Ivan Martin, Cliff lived out pop stardom in extremes more magnificent and more terrifying than a real-life career could ever reach.

—MARK MOSES

POPULAR COMPACT DISC

ART BLAKEY AND THE JAZZ MESSENGERS: *Night in Tunisia.*

Masahiko Asakura, producer. PHILIPS 800 064-2 (fully digital Compact Disc). LP: 638 5943. (Distributed by Polygram Special Imports.)

This 1979 recording captures Art Blakey's Jazz Messengers playing three songs they're most noted for. Blakey first recorded *Night in Tunisia* in 1954, when the group included trumpeter Clifford Brown and pianist Horace Silver. *Moanin'* was a hit in 1958, as was Benny Golson's *Blues March*. The solos are superior on the earlier recordings, but those fans who want to hear Blakey precisely will be interested in the CD. The cymbals have a nice ting, the bass drum is solid but not overwhelming, and the snare has firm definition. In his solo on the title cut, Blakey brings in a woodblock, cowbell, maracas, and tom-tom; on CD, each is accurate and perfectly placed. Dennis Irwin's bass feels like it is in the room, not coming through speakers. James Williams's piano has a steely, treble tinge: Is it a Baldwin?

Simple, eloquent arrangements bring out this group's cohesive swing. The Messengers sound less attractive on the string of solos on *Night in Tunisia*. Alto saxophonist Robert Watson begins with a ripping, fast passage that leaves him nowhere to go, and trumpeter Valery Ponomarev rushes into a tangle of eighth notes without phrasing them into meaningful segments. Dave Schnitter has more sense of purpose, but the usually organized Williams seems lost. They all sound more relaxed on *Moanin'*, but Blakey takes *Blues March* for too brisk a walk. Blakey, it should be noted, remains the star

of the show, even when playing accompaniments. He is the most interesting member of his band, and you can hear him better in this format than ever before.

—MICHAEL ULLMAN

HELEN MERRILL.

Bob Shad, producer. EMARCY 814 643-2 (analog recording, digital Compact Disc). LP: EXPR 1038. (Distributed by Polygram Special Imports.)

This 1954 recording by singer Helen Merrill was her first LP. Originally

voice is also cushioned, there is somehow more space around it. The sound of the CD is barer and smaller, though more carefully defined. Both versions are vastly superior to the cheap Trip reissue, but some listeners might prefer (as I do) the sound of the imported record.

In either case, the music more than justifies the purchase. Merrill is an important, undervalued singer with a flexible, penetrating voice and a keen sense



MERRILL: Her 1954 debut is legendary; above, at a Stockholm broadcast, 1983.

released by Emarcy, it has been reissued in America (on a tinny-sounding Trip LP) and Japan. Now this session—in which Merrill's wispy yet expressive voice is backed by horns, including the brilliant trumpeter Clifford Brown—is available as part of a Compact Disc series that will encompass all of Brown's recordings for Emarcy.

The contrasts between the Japanese reissue and this Compact Disc are startling. The CD clearly separates the instruments and vocalist and extends high frequencies; as a result, Merrill sounds a little sibilant, as if she were singing too close to the microphone. Brown's solos have a fine brassy tinge to them not audible on the LP, but his tone is less rich.

More importantly, Merrill's voice has greater amplitude on the Japanese record. True, she seems removed, but because her

of drama: She manages to make Billie Holiday's *Don't Explain* her own. The arrangements by the then twenty-one-year-old Quincy Jones are sensitive, and Brown is typically warm, intelligent, and fluent.

—MICHAEL ULLMAN

WEATHER REPORT: *Heavy Weather.*

Zawinul, producer. COLUMBIA CK 34418 (analog recording, digital Compact Disc). LP: PC 34418. Cassette: PCT 34418.

This Compact Disc version of their best-known studio album finally gives Weather Report a worthy CD showcase. It isn't a radical improvement over earlier analog versions, but the digital mastering is satisfactory and the material is, simply, great.

"Heavy Weather" stresses melodic shape and harmonic development. Instead of open-ended grooves, the pieces here are

fully developed songs; unlike the denser, layered synthesizer orchestrations favored by Joe Zawinul on "Night Passage" and "Weather Report," these settings balance his subtly grained electronic washes with space and even silence.

The CD difference is apparent from the opening bars of *Birdland*, the band's signature tune. Zawinul's ringing synthesized bass figure has more depth, and there is a crisper presence to the simmering rhythm work of drummer Alex Acuna and percussionist Manolo Badrena. While the album's multitracked production limits any wholesale gains in the realism of the stereo image, separation is enhanced, and reduced distortion helps clarify Wayne Shorter's tenor and soprano saxophone solos and overdubbed choruses. Smoother bass response improves on what was already a good thing indeed—the pyrotechnics of Jaco Pastorius on fretless bass.

Comparison with CBS Mastersound's half-speed mastered LP shows that most of these virtues were already close to the surface. The CD simply adds focus.

—SAM SUTHERLAND

CLASSICAL COMPACT DISC

HANDEL: Messiah.

Kaaren Erickson, soprano; Sylvia McNair, soprano; Alfreda Hodgson, mezzo-soprano; Jon Humphrey, tenor; Richard Stilwell, baritone; Layton James, harpsichord; Atlanta Symphony Orchestra and Chamber Chorus, Robert Shaw, cond. [Robert Woods, prod.] TELARC CD 80093-2 (two fully digital Compact Discs), LPs (2): DG 10093-2.

HANDEL: Messiah.

Judith Nelson, soprano; Emma Kirkby, soprano; Carolyn Watkinson, contralto; Paul Elliott, tenor; David Thomas, bass; Choir of Christ Church Cathedral, Oxford; Academy of Ancient Music, Christopher Hogwood, dir. [Peter Wadland, prod.] OISEAU-LYRE 411 858-2 (three fully digital Compact Discs), LPs (3): D 189D3, Cassettes (3): K 189K33.

HANDEL: Messiah.

Margaret Marshall, soprano; Saul Quirke, boy soprano; Catherine Robbin, mezzo-soprano; Charles Brett, countertenor; Anthony Rolfe Johnson, tenor; Robert Hale, bass; Monteverdi Choir; English Baroque Soloists, John Eliot Gardiner, cond. [Erik Smith, prod.] PHILIPS 411 041-2 (three fully digital Compact Discs), LPs (3): 6769 107, Cassettes (3): 7654 107.

Is musical scholarship a bit like pornography? There is at least a structural similarity in their histories. To explain: Back when I was a senior in college, I was dragged to a double bill of two sex films made five years apart by the same director. What was astonishing was not how much was displayed in the current (1969) effort, but how little in a supposedly risqué number from the recent past. You saw nothing. Raunchy situations, lubricious dialogue, big breasts locked in skimpy bikinis—that was about it. In light of the new permissiveness of movies c. 1969—when each new entry seemed to be reviewed with the line, "makes [its immediate predecessor] look like *Rebecca*

of *Sunnybrook Farm*"—one couldn't help being astonished at what had passed for Hot Stuff only five years earlier.

These thoughts are occasioned by the release of Robert Shaw's new *Messiah*, a modern-instruments performance that feels oddly, if mildly, dated—which is interesting and perhaps a bit unfair, considering its honorable antecedent. That earlier version by Shaw (which this closely echoes) came out on RCA in the mid-1960s. With the Colin Davis performance on Philips, the Mackerras on

Angel, and the Dunn/Boston Handel and Haydn Society on an Advent cassette, it inaugurated a new generation of *Messiah* recordings and helped alter the way we thought about Handel's masterpiece. (For a thorough discussion of those versions, see the articles by Teri Noel Towe in the January and February 1983 issues of HIGH FIDELITY.) Smaller forces and lighter textures, combined with more authentic texts and a newfound joy in ornamentation, gave evidence of life behind academic conjecture. No longer was it clear that for

Boston Acoustics

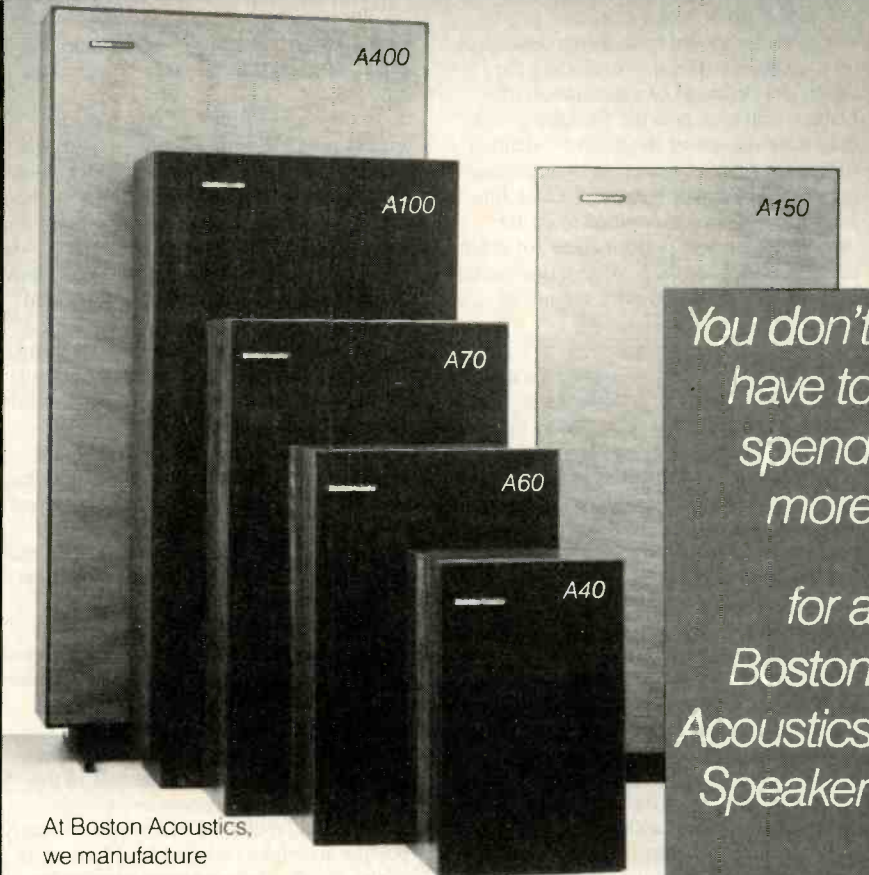

You don't
have to
spend
more
for a
Boston
Acoustics
Speaker
than
makes
sense
to you.

At Boston Acoustics, we manufacture high-performance loudspeakers that sell from \$75 to \$450 each.* While each costlier model provides a genuine improvement over the model below, they are all designed and built to the same high standards. As a result, each model provides long-term listening satisfaction unprecedented in its price range.

Only you can decide what makes sense for you to spend on loudspeakers. Once you have, be sure to visit your Boston Acoustics dealer and audition the appropriate Boston system. We think you'll be genuinely and pleasantly surprised at what you hear — both in the store and for years afterwards at home.

*Suggested retail prices. Actual selling prices are determined by your Boston Acoustics dealer.

Boston Acoustics, Inc. 247 Lynnfield Street Peabody, MA 01960 (617) 532-2111

Handel, the more the merrier. The battle was not won overnight—even today there are fervent champions of Thomas Beecham, whose enthusiastic reorchestration includes harps, triangles, and cymbals—but the trend was clear. Indeed, it's probably true that the popularity of those *Messiahs* allowed a widespread audience to see for the first time the benefits of scholarly attention, making such research suddenly look less dusty than, well, sexy.

But time marches on, and last year's stylish scholarly cut has softened into this year's comfortable old tweed. There's no doubt that the new chic involves not only a generalized attention to early performance practice, but a return to original instruments (though what that might mean in the case of the human voice is less obvious). Although the notion is not a new one, its marketability probably is, being dependent on a number of factors—including the recent development of a generation of players skilled at coaxing something more than squawks out of the often recalcitrant instruments. At any rate, the interpretations here by Christopher Hogwood and John Eliot Gardiner seem destined to do for original-instrument performances (of much more than just *Messiah*) what those earlier versions did for mid-Sixties notions of authenticity.

Which is not to cast aspersions on Shaw's approach to the work, but merely to suggest that what seems light and bright and sparkling in one era may look securely pastel in another. For we now live in an era of Day-Glo scholarship, and our escalating demands for novelty give today's old-instrument performances the look of something like Manifest Destiny.

Shaw's new version is at the advanced edge of mainstream modern-instrument performances, and it contains many impressive moments. The soprano runs in "For unto us" beat the competition hands down for facility and grace, while "All we, like sheep" goes astray indeed, upper voices dancing off into the ether in a way that perfectly evokes the giddiness of lost direction. But then that's the kind of skill that, together with superb articulation, we might expect from a Shaw-trained chorus. The soloists are up to their tasks—with Richard Stilwell considerably more than that, ranging easily from the depressed, priestly tone of "Behold, darkness shall cover" to the God-like disappointment at the nations so furiously raging together. The solo quartet offers a nice American directness of feeling while never straying very far from a canonical British purity of sound.

Still, it is in the all-important area of orchestral color that the early-instruments Mafia really has captured the high ground. We've been spoiled. By contrast, Shaw's string playing is undifferentiated, respondent phrases sounding too much like

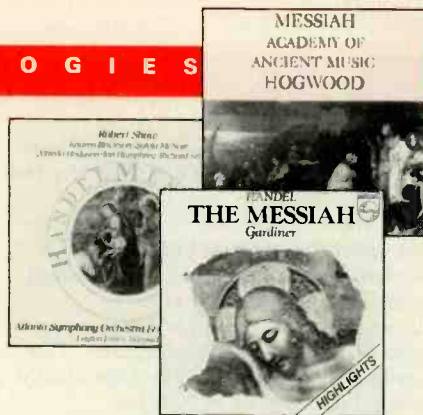

the originals they are answering, and his trumpets and oboes lack the pungency of their ancestors. Overall, the canvas is simply too monochromatic, an effect increased by the vagueness of Telarc's sound. Yet in the final "Amen," Shaw does manage to top his British rivals. There his forces display the naked enthusiasm of a crowd whose champion has just won them point, set, and match—as, of course, theirs has.

In the eager display of the coloristic effects possible with a Baroque ensemble, Hogwood's historic recording really shines. It is his enthusiastically vibrant palette here that has done so much—more, I think, than even his complete Mozart Symphonies—to spread the gospel of "authenticity." From the magical air of expectation, suggested merely by held chords under "Behold, a virgin shall conceive," through the string figures ushering in the hushed mystery of darkness covering the earth, to the painful effect of "He gave his back to the smiters," Hogwood offers an orchestral kaleidoscope of one brightly colored effect after another—shimmers turning to shakes seemingly at the flick of his baton. The "Halleluja" chorus has never sounded more jubilant, the descending horn and trumpet figure at measure 57 a moment of the deepest musical ecstasy. Indeed, this extroverted joy is perhaps Hogwood's most convincing tonality; the more contemplative segments aren't always delivered with equivalent conviction.

What an original-instruments maven can do to establish his credentials in the vocal arena has often been more problematic. (Nikolaus Harnoncourt's early popular triumphs included his Monteverdi cycle, an odd claim to fame because the orchestral reconstructions for most of the operas remain entirely conjectural.) In addition to the now-traditional countertenor soloist, Hogwood chooses an all-male chorus, soprano and alto parts sung by boys. Here the musical gains are less certain. Several moments do achieve added resonance: The sound of youthful trebles rejoicing that "unto us [another] child is born" is enormously moving. But that kind of innocence does not really lie at the emotional heart of this work, authenticity notwithstanding. For me, the boys' breathiness, whiteness of tone, and trained avoidance of individual dramatic expression conspire to flatten out the contours of a

work that is nothing if not a series of *personal* musical responses to the coming of a savior. I am more persuaded by Gardiner, who defends his choice of adult chorus (with countertenor altos) by citing "the extraordinary dramatic and rhetorical demands" of the work, arguing, "It is crucial that all the singers as well as the players can identify with—and thus convey—the full range of moods encompassed by Handel."

Gardiner's own performance is nicely complementary to Hogwood's; anyone responding at all to original instruments will want both. The approaches are not entirely distinct, but neither are the two groups. I count ten players in common (including the concertmaster), plus others who participate in later Hogwood efforts—what a small world is that of London Early Music! That the same players can produce such convincingly divergent performances reminds us that the search for authenticity may take many different paths.

If Gardiner's interpretation seems finally the more imaginative and original, that may be because he has had Hogwood to play off of. At any rate, his virtues are usefully reciprocal to Hogwood's, balancing the latter's exuberance with a highlighted introversion, throwing more emphasis on the chorus, and focusing in for a close-up more often than out for wide-angled dazzle.

There's no doubt that Gardiner's approach is smaller-scaled than Hogwood's, though that's not just a matter of numbers. Hogwood, good proselytizer that he is, seems intent on demonstrating that Aulde Instrumentes can offer greater vibrancy than even cymbals and triangles. (A section like "Why do the nations rage" presents such an excitingly hectic depiction of sin as to make it almost too attractive; and symptomatically, it is Hogwood who uses horns to double the trumpet parts throughout.) Gardiner, by contrast, looks inward. Partly, this is a matter of differing interpretations of the evidence. Thus, while Hogwood—or his annotator, Anthony Hicks—believes Handel's frequent "*con senza ripieni*" markings refer to *extra* players and largely disregards them, Gardiner takes them seriously, to often incisive effect. Treating the orchestra as in a concerto grosso, he approaches many moments almost soloistically: He seems particularly fond of giving lightweight beginnings to choruses ("For unto us," "Halleluja") and of offering a contrasting swell when the *ripieni* enter just before or after the vocalists. The technique is even more effective when applied to a solo aria. "If God be for us" becomes a dialogue for soprano and a few delicately articulated strings.

Throughout, one senses Gardiner responding not merely to scholarship but to a rival, deep-rooted conviction about the nature of the work, or at least the nature

of individual moments. Where he triumphs is in the work's many passages of introspection, in those sections often excluded from the generally upbeat "highlights" albums. Thus, in the G minor "If God be for us," it is Gardiner who most significantly inflects the magnificently simple orchestral writing under the lines about Christ as the one "who makes intercession for us," slowing down as if in prayer. In the similarly lambent "He shall speak peace unto the heathen" section of the soprano's "Rejoice greatly," Gardiner's poised calm suggests the birth of a radically new kind of tranquility.

Not surprisingly, it is in Part 2—that third of the work dealing with Christ's passion—that Gardiner's inward glance proves most revelatory. No one in my experience has found quite as much drama in the sections from "Surely he hath borne our griefs" through "But thou didst not leave his soul in hell." Perhaps that's because Gardiner makes more imaginative use of the chorus than Hogwood, whose most telling and original effects are largely orchestral and whose use of boys, as I suggested, reduces the range of expression open to him. Where Hogwood emphasizes the pear-shaped Baroque accent on individual string notes, Gardiner offers a freer (less terraced) dynamic range, subtly swelling and contracting on phrases rather than single notes. This couples with an elastic rubato to create a superbly expressive passage, climaxing in a very adagio ending to "All we like sheep"—where the words "the Lord hath laid on him the iniquity of us all" are slowed down to suggest something like a laying on of hands, an almost telepathic transfer of our burden. A similar halt makes the staccato close of "He trusted in God" despairingly chilling, perfectly setting up the tenor's "Thy rebuke hath broken his heart." (Hogwood views the adagio markings as simple reminders of lengthened note values rather than as indications of tempo change.)

Gardiner is a masterful colorist as well, giving us a Vivaldi-like "refiner's fire," a "He is the king of glory" of pointed rhythmic charms, and an arrival of the angels that produces a genuine celestial flicker. Nor does he lack power, offering buoyant "Halleluja"s and a "For unto us" whose shouted epithets have all the energy of a college cheer: Gimme a WONDERFUL! Still, what lances deepest is a focused urgency to his reading that would not be out of place in a Bach passion, and that I find in no other recorded *Messiah*. In this, Gardiner is aided by a special directness in his soloists, from the quiet intensity of the tenor's "Thy rebuke hath broken his heart" to the warmth of Margaret Marshall everywhere. Though some may prefer the cooler tone of the superb Emma Kirkby for Hogwood, I find Marshall's subdued vibrato—the "tear" in her voice—utterly melting and

indescribably winning. Alastair Ross's continuo, played more often on organ than harpsichord, is delightful.

Appropriately, Hogwood's sound is brighter, Gardiner's warmer. Oiseau Lyre's Compact Disc is suitably glittering, with every string accountable. Still, since the original tapes are analog, there can be only a certain amount of improvement on CD, and in truth the solo voices sound a shade more human on vinyl. Gardiner's sound is befittingly more close-up on his soloists and orchestra, and if his chorus occasionally

feels a trifle remote, the effect overall is appealing.

Finally, I must admit I was a bit daunted at the prospect of listening to nine hours of *Messiah* over a weekend. I shouldn't have worried. Not only the variety of the performances but the inexhaustible richness of the work itself left me eager to begin again. Pagans beware: You'll be in danger of converting!

—THOMAS W. RUSSELL III

For additional reviews of classical recordings, see Classical Reviews.

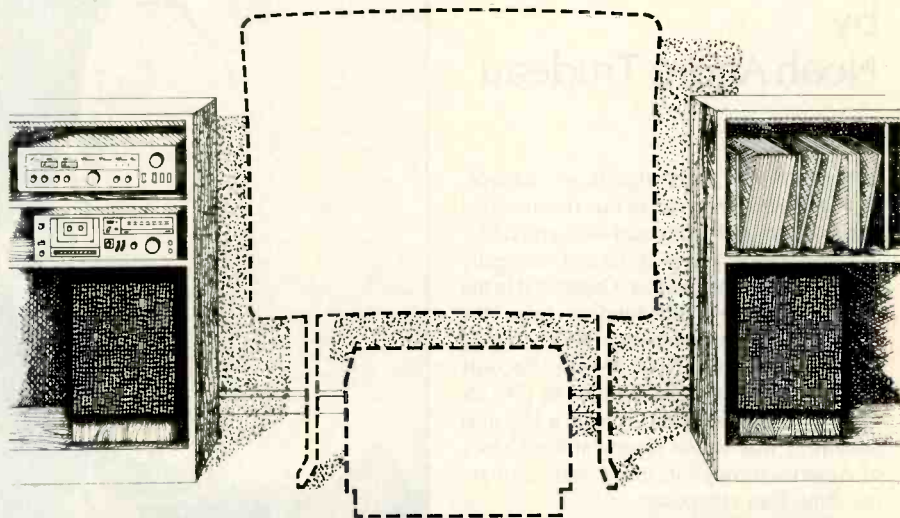

IS SOMETHING MISSING FROM YOUR LIFE?

If performance audio equipment is important to you, it stands to reason that you're probably fussy about your video components. Especially with all the video options available these days from tapes to cable TV.

So why are you still watching your tiny TV? You're missing out on the most incredible television viewing experience ever. Novabeam television. It's so exciting and involving, you'll feel like a participant in whatever you're watching, instead of just an observer.

And if it's quality you're after, you won't find a better picture. It's what *Video Review* magazine called "by far the most impressive projection TV we have ever seen." For matching sound, all Novabeam monitors hook up easily to your

stereo system.

There simply isn't enough room here to detail Henry Kloss' developments over 15 years that resulted in Novabeam TV, the state-of-the-art in projection television. It's something you've got to see for yourself. And you won't know what you're missing until you do.

For complete information (including specific installation details on over 20 Novabeam variations) and the name of your nearest Novabeam dealer and for more information, call 1-800-343-1155 (in Massachusetts call collect 1-617-547-6363). Or write Kloss Video Corporation, 640 Memorial Drive, Cambridge, MA 02139.

Kloss Video Corporation

NOVABEAM[®]

WHAT TELEVISION SHOULD HAVE BEEN ALL ALONG.

Something New from New World Records

An adventurous label sets out to prove there's life after 100.

by
Noah André Trudeau

ONE OF THE MOST significant achievements to come out of our Bicentennial celebrations (red-white-and-blue end tables notwithstanding) was a record company with an important mission. Organized in the spring of 1975 with funding from the Rockefeller Foundation, New World Records (or, the New World Records Anthology of Recorded Music, to give its full name) was assigned to create a 100-disc anthology that would represent the history of America through its music and celebrate the American composer.

To the surprise of some, the upstart little company proceeded to do exactly that. In less than three years the anthology was completed, covering a gamut so broad as to befuddle any critic who tried to come to terms with it. There was classical music: everything from major works by such living masters as Virgil Thomson and Roger Sessions to important rediscoveries of music by Anthony Philip Heinrich, John Knowles Paine, and composers from the Federal and Colonial eras. There were jazz albums, a country music disc, blues, rock and roll, folk, band music, shape note, gospel, and ethnic records. There were also several "theme" issues with names like "Come Josephine in My Flying Machine: Inventions and Topics in Popular Song, 1910-1929." Pedantic titles, perhaps, but thoroughly enjoyable albums.

With the appearance of NW 300 in the fall of 1978 (American art songs performed by William Parker), New World completed its transition from visionary proposal to diverse anthology, a collection without precedent in this country. At that point the scenario was supposed to read, "Cheers, Bows, Fade to Black"—New World goes into history books alongside the American Recording Society and The Society for the

Noah André Trudeau is a music producer for National Public Radio.

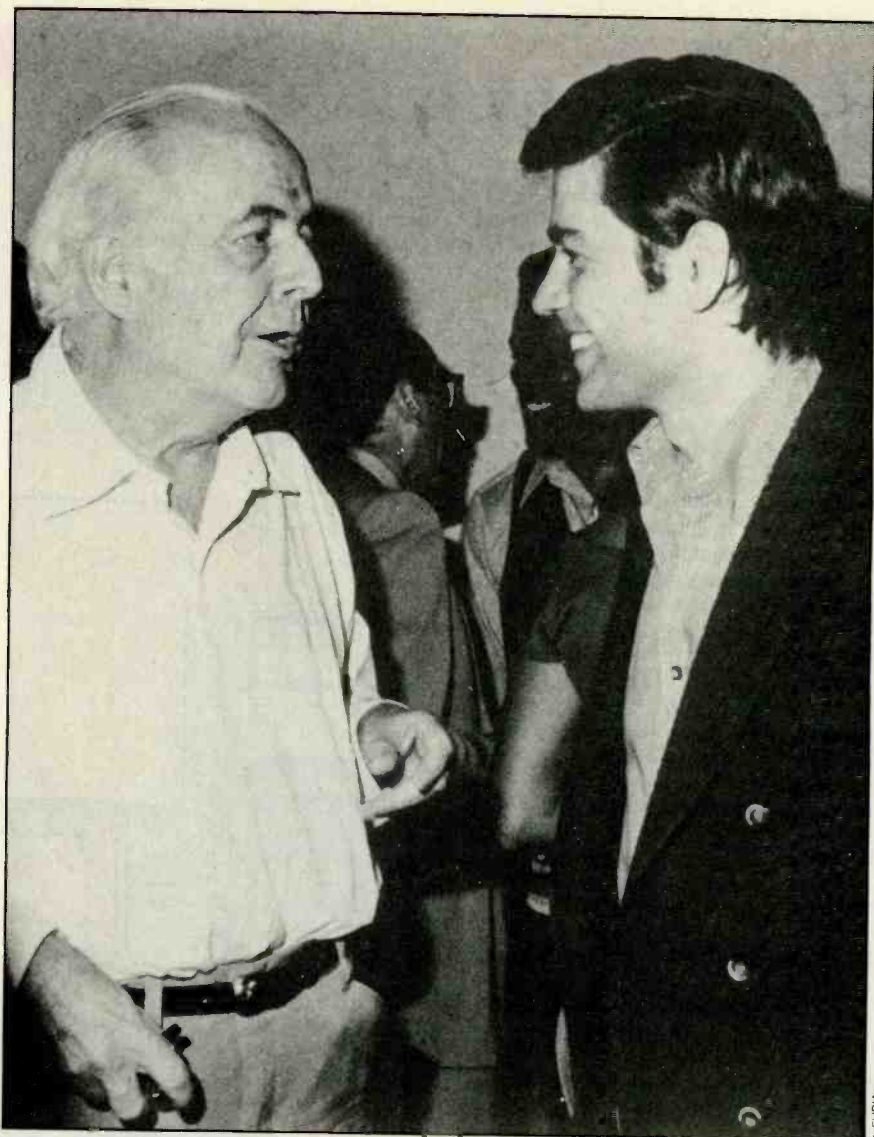

Antony and Cleopatra, by Samuel Barber (l.), performed under the direction of Christian Badea (r.) at the 1979 Spoleto Festival, is among the latest releases from New World.

Preservation of the American Musical Heritage. But that's not what happened.

About a year before its initial mandate was met, New World decided to go past the 100-record ceiling. According to label vice-president Elizabeth Ostrow, the reasoning was twofold. First, it was felt that the 100 records could not fully represent the history of American music, and second, there was ample evidence to suggest that the anthology was only just beginning to attract the attention of music lovers, educators, and funders. So, instead of bringing down the curtain, the 100th disc merely marked the end of New World Records, Phase I.

However, the company's original guidelines now worked against it. Because the label had been intended to exist as a nonprofit entity for a specific period of time, no thought had been given to building any self-sufficiency into its design. Therefore, when New World decided to go on, it had to trim down and learn to live in the unkind commercial world.

Today, almost six years after it was to have been packed away into revered memory, New World is alive and, if not in bounding health, at least facing its second decade with solid optimism. About 16 albums have been added to the first hundred: two in the folk vein, one jazz, and the remainder classical. Almost incredibly, the label is maintaining the high standards of the fat days in matters of pressing, recording, and packaging. A new distribution network has been put together, almost from scratch, and a subscriber list (open to individuals and institutions) has been built back up to where it was at the end of Phase I, when New World began charging institutions a nominal cost for its recordings.

There have been changes. The list of composers recorded now includes immigrants such as Stefan Wolpe and Mario Davidovsky. Packaging for selected future issues will be less elaborate, and in some cases the customary double-fold jacket will (Continued on page 103)

Honey,

This is the place Bob told us about. He says they're great. Let's do our Holiday shopping here. They're open till midnight and look at these prices.

EVEREST ELECTRONICS INC.

THE BEST PRICES ANYWHERE

Prices and Info.
-(718)-438-3007

Orders Only
1-(800)-232-1818

SUNDAY 11 A.M. - 5 P.M.

MON.-THUR. 9 A.M.-MIDNIGHT

FRI. 9 A.M. - 3 P.M.

RECEIVERS

TECHNICS SA 550	329.95
TECHNICS SA 120	119.95
SANSUI SX 1070	279.95
SANSUI SX 1130	669.95
JVC RX-500B	429.95
JVC RK 100	119.95
AKAI AAR 22	129.95
AKAI AAR 32	219.95

TAPE DECKS

TEAC V900X	445.95
TEAC V300	129.95
SANSUI D 990	439.95
SANSUI D 290	169.95
JVC DD-VR 9J	499.95
JVC KD-V100J	99.95
TECHNICS RSB 18	139.95
TECHNICS RSB 12	95.95
TECHNICS RSB 48R	179.95

TURNTABLES

TECHNICS SLQX-200	149.95
TECHNICS SLB-300	89.95
TECHNICS SLQL-5	129.95
JVC LA-120	69.95
JVC QLY-66F	299.95
SANSUI XRQ-7	349.95
SANSUI XP-99	299.95
SANSUI PD-11	89.95

TAPES

AUDIO (Min 20)	
Maxell UDXLII 90	2.19
Maxell XLIIS 90	2.75
TDK D 60	.99
Sony LNX 60	.99
VIDEO (Min 10)	
TDK T-120	5.69
JVC T-120	6.29
Maxell T-120	5.99
Fuji T-120	6.39
Maxell, TDK,	
Fuji, JVC T-120 High Grades	8.29
TDK, JVC Hi-Fi T-120	11.49
Sony L-500	5.29
Sony L-500 HG	6.29
Sony L-750	5.99
Sony L-750 HG	6.99
Maxell T-120 or L-750 Gold	10.95

HI FI VIDEO

VHS	
PANASONIC PV1730	959.95
PANASONIC PV 9600 Port	1090.95
JVC HRD-725	925.95
ZENITH VR-4000	895.95

BETA

SANYO VCR-7200	519.95
TOSHIBA VS-36	649.95
NEC VC 739	659.95

VIDEO SPECIALS

SANYO BETA 4400	269.95
NEC BETA 40	339.95
SHARP VHS 481	359.95
MAGNAVOX VHS	369.95
PANASONIC VHS 1231	419.95
JVC VHS D-120	429.95
PAN VHS 1530	589.95

KRAMER PROFESSIONAL ENCHANCERS

VS 1010 STEREO A/V	399.95
VS 10EX MONO A/V	369.95
VX 18 VIDEO ENH.	259.95

FULL LINE IN STOCK

EXTENDED HOURS MON. - THURS. 9 AM - MIDNIGHT SAT. NIGHT 9 PM - MIDNIGHT

THE M-360 MOTION PICTURE SOUND EFFECTS DECODER

One of only three products chosen by both Video Magazine and Video Review in their 1984 Best Equipment of the Year issues. "If there is a standout, it is the M-360 Surround Sound Decoder." Video Magazine, Best Equipment of the Year issue, February 1984

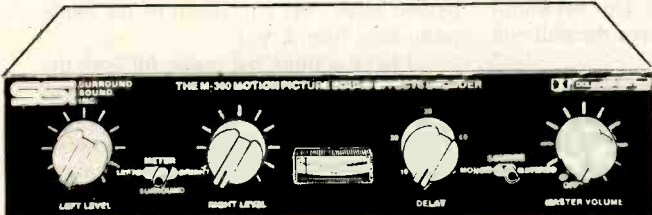

"To say that the M-360 made an improvement would be a massive understatement. . . . In short, run, don't walk to your dealer for a demonstration of the SSI M-360."

Hi Fidelity Magazine, August 1984

THE NEXT BEST THING TO BEING THERE.

M-360 Decoder with Matched Surround Speakers **Only 339⁹⁵**



YOUR TOLL FREE ORDER LINE 1-(800)-232-1818 for info. and prices 1-(718)-438-3007



TO ORDER - Dial Toll Free 1-(800) 232-1818 and order with either your Visa or MasterCard. Or send a certified check or money order to: EVEREST ELECTRONICS, INC. Please include approximate shipping, insurance and handling charges. Inquiries and customer service please call 438-3007. All prices and availability subject to change without notice. FAST DELIVERY. Special express service available. All merchandise is brand new and with manufacturers warranty. DEALER AND VOLUME INQUIRIES INVITED. No sales tax for out-of-state orders. Not responsible for typo. errors.

EVEREST ELECTRONICS, INC. 1601 47th St. Brooklyn, N.Y. 11204

CLASSICAL Reviews

Poignant Reminders

Reviewed by
Paul Moor

CHAUSSON: Piano Trio, in G minor, Op. 3; Pièce for Cello and Piano, Op. 39.

Les Musiciens. [Michele Bernard, prod.] HARMONIA MUNDI HMC 1115.

CHAUSSON: Concert for Violin, Piano, and String Quartet, in D, Op. 21.

Sylvia Rosenberg, violin; Maria Luisa Faini, piano; The Chester Quartet. [Eastman School of Music, prod.] PANTHEON PFN 2101.

CHAUSSON: Concert for Violin, Piano, and String Quartet, in D, Op. 21.

Itzhak Perlman, violin; Jorge Bolet, piano; The Juilliard Quartet. [Steven Epstein, prod.] CBS IM 37814 (digital recording). Cassette: IMT 37814.

CHAUSSON: Piano Quartet, in A, Op. 30.

Les Musiciens. [Michele Bernard, prod.] HARMONIA MUNDI HM 1116.

For me, no other composer can match Chausson when it comes to consistently expressing poignancy in music. I find irresistible a composer who attained such a melancholy intensity of tenderness, only to die young in an accident both tragic and absurd. The four new recordings examined here encompass 16 years of Chausson's brief life, and they provide occasion for a closer look at him and his work.

His family's relative wealth helped and hindered Chausson: He had no need to work for a living (and was able to take a law degree before entering the Paris Conservatory), but the fear of being dismissed by colleagues as a mere rich dilettante tortured him and made him agonize over his compositions, note by painfully slow note. His teachers included Massenet and, more importantly, Franck; friends included Massenet and Mallarmé; admiring colleagues included Debussy, seven years his junior. Chausson's contemporaries credited him with a highly developed intellect, great personal charm, and auxiliary talents as writer and graphic artist. He apparently found



Itzhak Perlman (seated, left) and Jorge Bolet, with the Juilliard Quartet (standing, from left): Robert Mann, Earl Carlyss, Joel Krosnick, and Samuel Rhodes.

adult happiness in a marriage that produced five children. Only one of Chausson's works, the Opus 25 *Poème* for violin and orchestra, appears regularly today on concert programs (what a pity to no longer hear his only symphony!), but his admirers, to whom I fervently belong, love his music with a special ardor. It certainly merits rediscovery.

Chausson wrote his Trio at the age of twenty-six, and even then his music bore a characteristic stamp—contemplative, lyrical, sensitive, brooding, at times passionate, but almost always (to borrow Shakespeare's phrase) with a dying fall. He must have mastered the piano totally, for this piece, much more than later works, incorporates feats of showy pianistic virtuosity reminiscent of Liszt. All four movements display the kind of unexpected, unconventional, "false" relationships in harmonic and chordal progressions that Chausson learned from Franck—relationships that, about a generation later and with polytonal colorations, became the aesthetic trademark of Oklahoma's Roy Harris. This delightful composition does not deserve the oblivion into which it has fallen.

The *Pièce* for cello and piano, which completes the first Harmonia Mundi recording, blends modal colorations with smoothly gliding harmonic progressions in leisurely 5/4 meter and teams the two instruments as equal partners. Particularly in view of the comparative scarcity of good original literature for cello and piano, today's cellists would certainly benefit from introducing this substantial work to their audiences.

The *Concert* (not, *nota bene*, Concerto) for solo violin with piano and string quartet, finished in 1891, remains reasonably well known, for Chausson wrote a fat solo part for Eugène Ysaÿe that has won the attention of most violinists ever since—including Jascha Heifetz, whose recording of it is still available (in RCA's four-disc set

ARM 4-0945). The Pantheon LP listed above offers no big names, and the CBS record has them to spare—but not much separates the two qualitatively. The Pantheon artists, European fashion, subjugate virtuosity to musicality; the CBS players, while by no means unmusical, at times let their technical fluency become a detriment, especially out of place in the third movement, marked *Grave*. One wonders which of these two performances Chausson would have preferred. (Such guessing games can shock and surprise: For instance, in Prades some 30 years ago, I heard Pablo Casals say he preferred Heifetz to Kreisler in recordings of the Brahms Violin Concerto!)

Two years before his death, Chausson wrote his Piano Quartet during a summer vacation in sunny Savoy, and some of that cheerful atmosphere atypically infuses its pages. Chausson himself called it "*presque folâtre*"—"almost frolicsome." Sensual and radiant, it has pentatonic, archaic, modal characteristics; in fact, Chausson cast the third movement, a 3/4 sort of dance, in the Lydian mode, the equivalent of the white piano keys from E to E.

I have nothing but praise for both the musical and technical aspects of all these recordings. (I ought to mention, though, that my copy of the Trio developed a rather severe warp.) One must admire the *chut-pa* of the performers on the two Harmonia Mundi releases, who call themselves, with awesome simplicity, Les Musiciens—evocative of Eugene Istomin's story that when the Festival of Israel first brought him, Isaac Stern, and Leonard Rose together for their public debut as a trio, they considered (but reluctantly discarded) a variety of tempting names, including The Tel Aviv Tigers, The Stern Gang, The Two and a

For additional reviews of classical music on Compact Disc and videodisc, see NEW TECHNOLOGIES.

Half Jews, and, simply, *The Trio*.

At the age of only forty-four, in the Parisian suburb of Limay, Seine-et-Oise, Ernest Chausson died in a bicycle accident that fractured his skull. The quality of the works he left us makes one grieve for the masterpieces that surely would have followed, and hope that some adventurous recording firm will finally give us his three-act opera, *Le roi Arthus*, unveiled at Brussels's Théâtre de la Monnaie four years after the composer's death. [Editor's note: Erato plans to do just that, in 1985.]

BRAHMS: Concerto for Piano, No. 1, in D minor, Op. 15.

Alexis Weissenberg, piano; Philadelphia Orchestra, Riccardo Muti, cond. [John Mordler, prod.] ANGEL DS 38008 (digital recording). Cassette: 4XS 38008

BRAHMS: Concerto for Piano, No. 1, in D minor, Op. 15.

Emanuel Ax, piano; Chicago Symphony Orchestra, James Levine, cond. [Jay David Saks, prod.] RCA ARC 1-4962 (digital recording). Cassette: ARE 1-4962. CD: RCD 1-4962.

The second of these records presents very little beyond a routine run-through. If one heard this sort of performance in a concert, the effect would be pleasant and one's applause would show due appreciation (no more), but by the time any real Brahms addict left the hall, conversation would likely have turned to different things. In other words, it is essentially a tepid effort that tells us nothing at all distinctive or new. Is so mild a D minor Brahms really a *Brahms D minor*? At least Alexis Weissenberg and Riccardo Muti offer us a conception worth thinking about. Here Muti provides a sumptuous framework, and the reading by the soloist completely eclipses his former account, a London performance that suffered from Carlo Maria Giulini's muggy accompaniment. Weissenberg's interpretation of this gigantic concerto will surely not be to everyone's taste, but what performance of his is? The conception is cool, calculated, and less warmly passionate than many, but within those limitations it offers much to value, think about, and discuss well after the record has ended. And these days, with so many useless versions of the standard classics being poured out, the kind of healthy provocation Weissenberg always provides becomes as self-recommending as it is rare. THOMAS L. DIXON

DEL TREDICI: Syzygy (Joyce)*. ROCHBERG: Symphony No. 2†.

Phyllis Bryn-Julson, soprano; Festival Chamber Orchestra, Richard Dufallo, cond.*; New York Philharmonic, Werner Torkanowsky, cond.† [Carter Harman, reissue prod.] COMPOSERS RECORDINGS INC. SD 492.

CRI's reissue of these works by David Del Tredici and George Rochberg is a fascinating document because it allows us to perceive the roots of these composers' present

neo-Romantic tendencies in their earlier atonal pieces. Though of two different generations—Rochberg was born in 1918, Del Tredici in 1937—both composers until recently worked within a firmly modernist, atonal idiom. They spoke with idiosyncratic voices—voices that tugged restlessly at the boundaries of what was acceptable to the musical avant-garde and that sought to convey something more personal and compelling. By the 1970s, however, Del Tredici and Rochberg had become (in the words of critic Tim Page) "apostate modernists." Both rejected their serial pasts and leaped headlong into highly individualized sorts of neo-Romanticism that two decades before

would have produced only ridicule in the music world.

Del Tredici is best known for his huge, hyper-expressive scores based on various portions of Lewis Carroll's *Alice in Wonderland*. Yet before the Carroll material grabbed his fancy—and gradually forced him to realize that only a broadly tonal manner could do justice to *Alice*—Del Tredici had a similar fixation with the writings of James Joyce. Several early pieces written to Joyce texts (all composed between 1959 and 1966) utilized a musical language easily distinguishable from that of the *Alice* works. In many ways, the Joycean scores were close to the academic, modernist

A New Generation of Polk Monitors Redefines Incredible Sound/Affordable Price!



"Vastly superior to the competition."

Musician Magazine

Polk Speakers Sound Better

Polk Monitor Series loudspeakers have a well deserved reputation for state-of-the-art technology and performance usually found only in systems which sell for many times the Polk's modest cost. A new generation of Polk Monitors is now available which incorporates the same Polk manufactured high definition polymer dome tweeter and Optimized Flux Density drivers originally developed for Polk's top of the line SCAs. Now they sound better than ever!

A Polk Monitor Perfect for You

All six incredible sounding, affordable priced Polk Monitors offer state-of-the-art technology, performance and value. There's one which is perfect for you.

For nearest dealer call 1-800-843-3800

We are The Speaker Specialists®

Speakers ultimately determine the sound quality that you hear. At Polk Audio, speakers are our business, our only business. We specialize in speakers and our speakers sound better because of it. That's why Polk speakers have won the prestigious Audio Video® Grand Prix Award for four years in a row! No wonder *Musician Magazine* said "Our advice is not to buy speakers until you hear the Polks."

Polk Audio, Inc., 1515 Annapolis Fd.
Baltimore, MD 21220.

Digital Disc Ready

polk audio®
The Speaker Specialists®

Critics' Choice

The most noteworthy releases reviewed recently

BACH: *The French Suites (6)*, B.W.V. 812-817. Koopman. CALIG VERLAG CAL 30 442/43, Sept.
BARTÓK: *Divertimento; Music for Strings, Percussion, and Celesta*. Franz Liszt Chamber Orchestra, Rolla. HUNGAROTON SLPD 12531, Nov.
BLOCH: *String Quartet No. 1**. *String Quartet No. 2; Prelude; Night; Two Pieces for String Quartet†*. Pro Arte Quartet. LAUREL LR 120*, LR 126†, Aug.
DEBUSSY: *Reflets dans l'eau*. **RAVEL:** *Sonatine*. **SCHOENBERG:** *Six Little Piano Pieces, Op. 19*. **STRAVINSKY:** *Sonata*. Boyk. PERFORMANCE RECORDINGS PR 4, Nov.
DOWLAND: *Lute Music*. O'Dette. ASTRÉE AS 90, Oct.
MOZART: *Divertimento in D, K. 334; March in D, K. 445*. Academy of St. Martin-in-the-Fields Chamber Ens. PHILIPS 411 102-1, Sept.
SATIE: *Aperçus désagréables; La belle excentrique; En habit de cheval; Parade; Trois*

morceaux en forme de poire; Trois petites pièces montées. Jordans, Doeselaar. ETCETERA ETC 1015, Oct.
SCHUMANN: *Konzertstück in F, Op. 86*.
MENDELSSOHN: *Concerto for Piano and Orchestra, No. 2, in D minor, Op. 40*. Frankl; Cincinnati Symphony Orchestra, Nelson. Vox CUM LAUDE VCL 9071, Oct.
RAMEAU: *Orchestral Suite from "Les Indes galantes"*. Orchestre de la Chapelle Royale, Herreweghe. HARMONIA MUNDI HM 1130, Oct.
STRAUSS, R.: *Orchestral Songs (12)*. Jerusalem; Leipzig Gewandhaus Orchestra, Masur. PHILIPS 6514 321, Sept.
THE EARLY VIENNESE SCHOOL. Holliger, Fürti, Demenga; Camerata Bern, Fürti. ARCHIV 410 599-1, Oct.
BENNETT LERNER: *American Piano Music*. ETCETERA ETC 1019, Sept.
SUNDAY IN THE PARK WITH GEORGE: *Original Broadway cast recording*. Sondheim, Gemignani. RCA HBC 1-5042, Nov.

Werner Torkanowsky, gives a less successful performance of the Rochberg symphony. The strings are the weak element here, frequently unable to negotiate the rapid, leaping lines, and in the process losing accuracy both of intonation and ensemble. But this is a small point; we must be grateful to CRI for bringing these important works back into the catalog. K. ROBERT SCHWARZ

GLUCK: *Iphigénie en Tauride*.

CAST:

Iphigénie	Pilar Lorengar (s)
Pylades	Franco Bonisoli (t)
Oreste	Walton Groenroos (t)
Thoas	Dietrich Fischer-Dieskau (b)

Chorus and Symphony Orchestra of the Bavarian Radio, Lamberto Gardelli, cond. [F. Axel Mehrle, Dieter Sinn, and Diether G. Warneck, prods.] ORFEO S 052823 (digital recording, three discs). Cassettes (3): M 052823. (Distributed by Harmonia Mundi, U.S.A., 2351 Westwood Blvd., Los Angeles, Calif. 90064.)

GLUCK: *Iphigénie en Tauride*.

CAST:

Iphigénie	Patricia Neway (s)
Pylades	Léopold Simoneau (t)
Oreste	Pierre Mollet (b)
Thoas	Robert Massard (b)

Ensemble Vocal de Paris; Orchestre de la Société des Concerts du Conservatoire de Paris, Carlo Maria Giulini, cond. EMI ELECTROLA 1C 137 1731713 (two discs). (Distributed by German News Co., 220 E. 86th St., New York, N.Y. 10028.)

GLUCK: *Iphigénie en Tauride*.

CAST:

Iphigénie	Regine Crespin (s)
Pylades	Guy Chauvet (t)
Oreste	Robert Massard (b)
Thoas	Victor de Narke (bsb)

Chorus and Orchestra of the Teatro Colón de Buenos Aires, Georges Sébastian, cond. LE CHANT DU MONDE LDX 78769-70. (Distributed by Harmonia Mundi, U.S.A.)

The current state of *Iphigénie en Tauride* on record is enough to drive even the most serene, dignified Gluck admirer crazy—and perhaps into debt. After years of no recordings of the composer's greatest work, suddenly we have three; but all of them have such significant faults that none can be recommended without qualification.

With almost Gluckian symmetry, these recordings complement each other's strengths and weaknesses. The Orfeo version is beautifully recorded, but the performance is frequently lifeless. EMI's rerelease of the 1952 Aix-en-Provence production has passable mono sound, but by today's standards the drama seems almost overheated. The *Chant du Monde* set, recorded live in Buenos Aires, is the most convincing and idiomatic performance of the lot, in large part because Regine Crespin sings the title role. However, the sonics are far worse than one would expect from a 1964 live recording. It sounds like 1934.

This opera on the subject of Iphigenia in her post-Aulis exile deserves better. Gluck employed a varied arsenal of musical and dramatic techniques—from an Italian-

statements so typical of the period, cast in a jagged, disjunct melodic style that eschewed both a regular rhythmic sense and a tonal harmonic foundation.

Del Tredici's *Szygy* (composed in 1966 and originally released by Columbia in 1969 on MS 7281) is a far cry from that era's bloodless, cliché-ridden serial pieces. It shares with the later *Alice* works a manic response to the text that results in music of incredible virtuosity and urgency. Those familiar with the immense vocal demands of the *Alice* compositions will not be surprised to find the same sort of writing here: an almost unsingable, unrelenting effusion replete with huge leaps, a two-and-a-half-octave range, searing chromaticism, and daunting rhythmic complexities. Joyce's text is frequently rendered unintelligible, reduced to pure sound in a manner comparable to what the author himself did to the English language.

Szygy is in many ways an almost pervasively eccentric work. Scored for soprano, solo horn, and chamber ensemble, its orchestration deliberately avoids blended sonorities, emphasizing instead the contrasts between the instrumental extremes of piccolo and contrabassoon/double bass. Yet all the del Tredici hallmarks are present: the obsessive repetition of small melodic phrases (often in progressive diminution or augmentation), the virtuosity, the emotion. The step from here to *Final Alice* (1976) is not as large as it might seem.

Rochberg abandoned his past for reasons very different from Del Tredici's. Faced with the death of his son from a brain tumor in 1965, Rochberg—after a period of intense self-examination—decided that the impersonal rigors of an atonal, serial approach could no longer meet his emotion-

al needs. His subsequent works have featured both stylistic imitation and direct quotation, often of 19th-century music, in an effort to forge a new Romanticism that reinterprets the musical values of the past in the light of the present.

Yet the *Second Symphony* (composed in 1955-56 and released by Columbia in 1962 on MS 6379) shows more kinship to Rochberg's recent music than differences. Despite its strict twelve-tone approach to composition, the four-movement work sounds uninhibitedly expressive and well within the Romantic tradition. Rochberg's models here are Mahler and Schoenberg; this is not the dry, icy, pointillistic musing of a Webern camp follower, but rather the surging, yearning intensity of a Berg disciple. Thick contrapuntal textures, propulsive and wide-ranging chromatic lines, and a tightly integrated motivic structure combine to make the 29-minute symphony whirl by the listener in what seems a brief moment. Rochberg evidently had already reconciled himself to the Romantic tradition—all that remained for him to do after 1965 was to embrace tonality. And there are plenty of tonal, triadic references in the score, since the twelve-tone row is skillfully constructed to favor such sonorities.

Soprano Phyllis Bryn-Julson has linked her career with Del Tredici's, becoming one of the foremost interpreters of his music, and she must be one of the few singers in the world capable of singing *Szygy* with the freedom and musical accuracy it deserves. The result is an incredible display of vocal prowess. The Festival Chamber Orchestra, under Richard Dufallo, is equal to the technical and rhythmic demands of the instrumental parts. The New York Philharmonic, conducted by

ate bel canto that matches the most sublime creations of Bellini to a more heavily rhetorical utterance—creating a marriage of music and theater that easily paves the way for *Fidelio*. Indeed, Iphigénie is Leonora's Franco-Grecian grandmother, both in the lofty ideals for which the two characters stand and by dint of Gluck's arioso style, which so obviously inspired Beethoven's great "*Komm, Hoffnung*."

The profundity of Gluck's influence is difficult to overestimate. Never was Berlioz's debt to him more apparent than in the great monologues of *Les Troyens*. Similarly, *Lohengrin* is Gluck filtered (not so heavily) through Wagner's sensibility. The common denominator between Richard Strauss's override sophistication and his fascination with Greek operatic subjects like Daphne and Helen of Troy is purely and simply Gluck.

The sort of conductor needed to put Gluck in proper perspective must be imaginative enough to recognize what lies behind the simple, if not Spartan, arpeggios and scales that are so much a part of this composer's language. Yet his ego must be sufficiently in control to let the music bloom with its own natural symmetry. Carlo Maria Giulini seems bent on giving Gluck the blood and thunder of Verdi, but he does this with formidable insight and vision. Lamberto Gardelli's treatment, by contrast, is ultra-refined, unduly prettified, frequently boring. Pages that in Giulini's account form a dramatic apex are often conducted with exasperating nonchalance by Gardelli, though he and his cast do wake up enough to give a quite satisfying performance of the last two acts. Still, while I prefer to hear Giulini turn Gluck's carefully graded peaks and valleys into craggy Alps—rather than have them reduced to gently rolling hills by Gardelli—the best-conducted performance of all strikes me as being that of Georges Sébastian, who seems to understand Gluck from the inside out and who achieves the big gestures without sacrificing details. With the sound quality as poor as it is, it's difficult to tell what Sébastian may or may not be doing with the orchestral textures, though certainly it is to his credit that his cast is stylistically uniform and meticulously prepared, resulting in a far better statement of the opera as a whole than on either of the other two recordings.

Patricia Neway has the vocal weight for the title role in Giulini's recording, but the labored sounds she produces above the staff occasionally amount to screeching. Pilar Lorengar's wide vibrato is at times annoying, but she makes for far more palatable listening. However, her voice is too light—not only for Gluck's orchestration, but also for the rhetorical weight of the role, even in Gardelli's low-key conception. (Maria Callas didn't sound so great, either, in Luchino Visconti's 1957 production at La Scala—heard on Volume 16 of *Gli Dei*

Della Musica, DMC 16—but the fact that the role falls between the lyric and spinto repertoires is little excuse for its poor representation on record.)

What makes Crespin's characterization work so well? The unique Crespin voice has both the weight and the technique to handle Iphigénie's frequently high range, but the most important thing is her ability to use the language—making it conversational yet highly musical during the recitatives and then shading the words discreetly but eloquently in the airs, without fussing with the innate simplicity of the music. The lengthy soliloquies never seem long here; in fact, one wishes they were longer. Cres-

pin's acting also strikes a meticulous balance—contemplative serenity on one hand and subterranean passion on the other. She achieves a tragic nobility without losing her humanity and femininity.

The rest of Sébastian's cast may not necessarily be great vocalists, but they're certainly capable ones and convincing actors, while the other two casts are maddeningly patchy. Léopold Simoneau is Giulini's ace in the part of Pylades, singing with style, conviction, and a honeyed tone; Franco Bonisolli, who takes on the role under Gardelli, is vocally quite proficient, but oblivious to style. Though Gardelli's Oreste, Walton Groenroos, is listed as a

NOW AVAILABLE!



THE 11TH EDITION OF SCHWANN ARTIST ISSUE

The unique classical music guide. Presenting over 25,000 classical recordings listed by orchestra, trio, quartet, conductor, soloist, vocalist, choral group and operatic company.

ORDER NOW

● Reserve my copy of the new Schwann Artist Issue. SAD

● I enclose just \$6.95 (plus \$1 for postage and handling—a total of \$7.95 for each copy.

● Number of copies _____

● Amount enclosed \$ _____

NAME _____

ADDRESS _____

CITY/STATE/ZIP _____

(PAYMENT MUST ACCOMPANY ORDER

PAYMENT IN U.S. CURRENCY ONLY.)

SCHWANN ARTIST ISSUE SINGLE COPY SALES, 825 SEVENTH AVE., NEW YORK, NY 10019

tenor, he sounds more like the sort of high baritone the composer called for. After a few shaky moments with the high F's in the second act, he rises to heroic heights; Pierre Mollet, despite his identification with the role, is so labored on the Giulini record that it's difficult to determine his "fach." As Thoas, Dietrich Fischer-Dieskau is in unusually wheezy form for Gardelli, while Giulini's Thoas, Robert Massard, was perhaps having an extraordinarily bad day in the studio, for 12 years later in the Buenos Aires set he comes across as a very good Oreste.

The EMI recording sounds boxy even by 1952 standards, which has the effect of magnifying the vocal problems and drawing attention to the unrefined orchestra playing. It's a bit like presenting a damaged Greek statue under fluorescent light. The Orfeo recording goes too far in the opposite direction: Everything is heard through such a gauze of atmospheric studio effects that it's difficult to tell exactly what is going on, especially in the choral writing. Even the orchestra is reduced too often to indistinct musical upholstery. The Buenos Aires sound is so bad that headphones are almost mandatory, though the ears do adjust after the first act.

Now that the early music movement has reached a point where we have first-class performances of Rameau, it is time to correct the fact that we don't have either of

Gluck's *Iphigénie* operas on authentic instruments. Gluck's orchestration isn't as bland as modern instruments often make it sound, and perhaps the high tessitura of the roles would be more manageable at the lower authentic tuning. One can hope that such a project may emerge from John Eliot Gardiner's ongoing Gluck cycle at the Opéra de Lyon. For now, Gluck neophytes might be happiest with the Orfeo set, while those who know the composer but not *Iphigénie* might be better off with the Giulini. Although problematic, the Chant du Monde performance is essential for anyone who knows and cares deeply about this opera—at least until something better comes along.

DAVID PATRICK STEARNS

HONEGGER: Symphony No. 3 ("Liturgique"); Symphony No. 5 ("Di tre re").

Bavarian Radio Symphony Orchestra, Charles Dutoit, cond. [Michael Kempff, prod.] RCA ERATO NUM 75117 (digital recording). Cassette: MCE 75117. CD: ECD 88045.

Arthur Honegger has never seemed to really fit in with his five colleagues in *Les Six*, the group that took Erik Satie's and Jean Cocteau's aspirations toward simplicity as the foundation of its artistic credo. In general (with certain noteworthy exceptions), Georges Auric, Darius Milhaud, Francis Poulenc, and Germaine Tailleferre kept things on the light side. (Louis Durey, the



Swiss composer Arthur Honegger

least-known member, abandoned composition early for political activism, which he apparently found more important and rewarding.) By contrast, Honegger wrote little or no music you can truly smile over, except for that locomotive prank, *Pacific 231*. And in spite of his French birth, his surname reminds us of his Swiss nationality and Alemannic heritage. (You find a variation of that surname attached to the German Democratic Republic's present leader, Er-

HIGH FIDELITY ARCHIVES

TRY & BEAT OUR PRICES & SERVICE

WE CARRY OVER 80 MAJOR BRANDS

<p>SONY WM-10 WORLD'S SMALLEST WALKMAN! • Dolby® N.R. • deluxe headphones • below cost! \$63 <small>Limited Quantities</small></p>	<p>TEAC V-900X CASSETTE DECK • Dolby® B&C N.R. • DBX® • 3-head \$449</p>	<p>YOUR CHOICE BASF FUJI PRO II C-90 FR II C90 \$1.69 each <small>\$25 minimum purchase</small></p>	<p>Sansui S-X1130 AUDIO/VIDEO RECEIVER • 100 watts/channel • digital tuner • video ready Call for Price!</p>
<p>SONY CFS-3000 • 3 pc. am/fm stereo radio cass. • detachable speakers \$99</p>	<p>JVC R-X400 RECEIVER • 70 watts/channel • digital tuner • computer-controlled Call for Price!</p>	<p>Technics RS-B48R CASSETTE DECK • Dolby® B&C N.R. • DBX® • auto-reverse \$165</p>	<p>BOSE SPEAKERS! Complete line of Bose speakers now available. Call for price!</p>
<p>Technics SL-P8 CD PLAYER! • Remote Control • Random Access • Program Repeat Call for price!</p>	<p>SHURE V15-5MR CARTRIDGE • top-of-the-line • micro-ridge stylus \$138</p>	<p>Sansui Z-7000X RECEIVER • 100 watts/channel • digital tuning \$379 <small>\$117 Below Wholesale Cost Limited Quantities.</small></p>	<p>Panasonic PV-9600 • 4-head VHS hi-fi • 2 week/8 program • portable stacking unit Call for price!</p>
<p>Technics SL-QL5 TURNTABLE • linear tracking • direct-drive • quartz-locked \$119</p>	<p>SONY VIDEO TAPE T-120 or L-750 Our Price\$5.68 Mfr. Rebate\$1.00 Your Net Cost\$4.68 <small>Offer expires 12/31/84</small></p>		

This is just a small sampling of our great prices.

Call or write for FREE catalog.

All merchandise is brand new & fully warranted. Quantities limited. Prices subject to change. Minimum shipping and handling charge \$5.

STEREO CORPORATION OF AMERICA

Dept. 212 1629 Flatbush Avenue Brooklyn, N.Y. 11210

CALL TOLL FREE! 800-221-0974 (ex. N.Y., AK, HI)
Mon-Sat 9AM-5:30PM E.S.T.
In N.Y. State Call: (718) 253-8888

NIGHT-OWL LINE CALL: 800-327-1531
(Mon-Fri 5:30PM-10PM E.S.T.)

MASTERCARD & VISA ACCEPTED

ich Honecker.)

Honegger wrote all but the first of his five symphonies between 1941 and 1950—hardly a tranquil period in European history. He concluded his Second (for string orchestra) on a triumphant, optimistic note, with the surprising entrance of a solo trumpet sounding a chorale melody borrowed from Bach; in his Fourth, completed the year after the end of World War II, he hymned the delights of the city of Basel. But Honegger's two most substantial symphonies, the Third and the Fifth, show him in a more serious, not to say somber, vein. The Third is called *Symphonie liturgique*. He began it the last year of the war, and his troubled, concerned state of mind shows itself in the titles of the violent, raging first movement, *Dies irae* (Day of Wrath); the agonized second, *De profundis* (Out of the Depths [I Cry]); and the tentatively hopeful third, *Dona nobis pacem* (Give Us Peace). By the autumn of 1950, when Honegger composed his Fifth Symphony, the world had changed again for the worse; after five ephemeral years of uneasy peace, Korea saw East and West confront each other in a war that stopped short only of nuclear weapons. Harry Halbreich, in his album notes, calls the Fifth "a reflection of a sick and embittered man and the expression of his firm conviction of the imminent ending of the world."

Erato has had the commendable idea of coupling these two weighty works on one disc, and the readings are sensitive, forceful, possibly definitive. Because performances of Honegger's larger compositions have fallen off in this country, this release comes at an opportune time. If you don't know these impressive scores, you should.

Between pages 86 and 105 in the orchestral score of the Third, trend-spotters will find Honegger (in the third movement) writing for 12 rapidly, chromatically descending woodwinds in a manner that foreshadows Krzysztof Penderecki; only on page 108, a scant five pages before the end, does the prayed-for, celestial peace finally descend. The opening movement of the Fifth has long struck me as particularly electrifying. On page 7, for the first time, the third trumpet mutters an ominous little chromatic motif, ascending gradually with each entrance; this becomes the musical equivalent of that most disquieting sentence in any language, *It is later than you think*. Incidentally, Honegger's subtitle for this symphony, *Di tre re*, refers to the note D: Throughout the score, the tympanist has nothing to do except tap a soft D as the final sound of all three movements. For Honegger, as for T.S. Eliot, the world ends here not with a bang, but with a whimper.

The fine Bavarian Radio Symphony Orchestra has a long tradition of mastering the most difficult modern works, thanks to the superb *Musica viva* concert series founded immediately after the war by Karl

Amadeus Hartmann, an admirable man and today an unfairly neglected composer. Charles Dutoit leads carefully thought-out, well-constructed performances that present both symphonies at their imposing best.

PAUL MOOR

JANÁČEK: Zapisník zmizelého (The Diary of One Who Disappeared).

Grayson Hirst, tenor; Shirley Love, mezzo-soprano; Antonín Kubalek, piano; Women's Ensemble of the Columbia Pro Cantare, Frances Motyca Dawson, cond. [Ward Boisford, prod.] ARABESQUE 6513. Cassette: 7513. CD: Z-6513.

Grayson Hirst and Shirley Love sing their

hearts out in this brilliant recording; they both have a lot to give, and they give it all. Antonín Kubalek, a prizewinning graduate of the Prague Conservatory and a Canadian resident since 1968, plays the demanding piano part brilliantly, and in true Janáček tradition.

Robert T. Jones, a Janáček expert, provides excellent notes, and his co-worker Yveta Synek Graff has apparently coached the singers. Jones and Graff have already translated three Janáček operas into English, and they have plans to translate all the others. Why, then, did they not translate this great song cycle, in which the communication of the poems plays such an unusu-

"Almost unbelievable stereo imaging"

Julian Hirsch
From the special feature-length test
report in Stereo Review, July 1984.

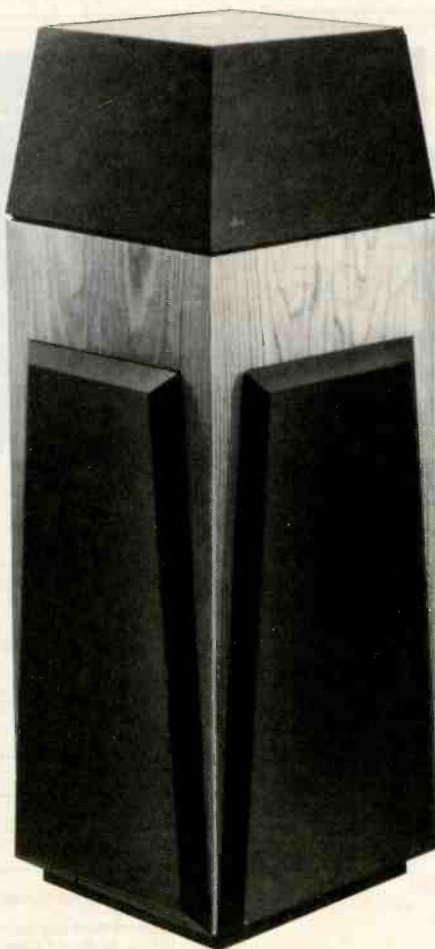

"Listening to the Soundfield One speaker system can be very addictive. The speakers seem to vanish, leaving the listener gratefully immersed in a sea of music. Almost any complimentary adjective could be applied to the sound of these speakers without undue

exaggeration." "The apparent volume and stereo-stage configuration were practically independent of the listening location. This quality alone would be sufficient to set them apart from conventional speakers—and, in our opinion, above most of those on the market."

"The dbx Soundfield One is a great and important speaker system. Hear it for yourself, but be prepared for dissatisfaction with your present loudspeaker system after you do."

Now, a word from us.

For the first time, you can enjoy the full sonic potential of your stereo system, with proper tonal balance and a convincing stereo image experienced throughout the entire listening area. We encourage you to audition the dbx Soundfield One speaker system, and learn how it can turn your living room into a total listening environment.

The Soundfield One speaker system.

For more information, mail this coupon to dbx, Dept. HFSF. We'll reply promptly.

Please send me the following information:

- Free. The complete Stereo review report and a list of dbx Soundfield speaker dealers.
- For the \$3.00 enclosed: All the above, plus an owner's manual (a \$4.00 value) and three technical papers on psychoacoustics and speaker design by Dr. Mark Davis, inventor of Soundfield Imaging technology.

NAME _____ (Please print)

ADDRESS _____

CITY _____

STATE _____ ZIP _____

dbx®
71 Chapel St., Newton, Mass. 02195

ally important part? This recording, preposterously, offers us gifted American singers doing their damndest to sing in Czech—a difficult language, bristling with clusters of consonants and palatalized vowels, which they manifestly have not mastered—on an album that will come into the hands of only a negligible number of auditors with even a working knowledge of that language.

This stunning, ravishing cycle of 22 numbers tells a poignant, ostensibly true story of erotic infatuation coming into conflict with racism, central European style: A Czech boy loses his heart to a *černa cigánka*, a “black” Gypsy girl, and finally vanishes from his home and parents to join her, their newly born son, and her tribe. The music has passion, power, and tremendous impact, and these artists realize it impressively. With Carl Nielsen, Leoš Janáček seems to me one of the two greatest composers most unjustly neglected in this country. If you do not yet know this masterpiece, I commend this recording to you in spite of its appalling linguistic wrong-headedness. At least you will get, enclosed with it, the Czech text with a line-by-line English translation; that helps, but it doesn’t even begin to approach the impact this excellent performance would have had in a good translation.

One inadvertently racist overtone: I feel sure Arabesque Records would not have referred to “negroes” or “jews,” but

the text refers to “gypsies” throughout instead of the proper “Gypsies.”

PAUL MOOR

RAMEAU: Pygmalion.

CAST:

Pygmalion	Michael Goldthorpe (t)
Statue	Marilyn Hill Smith (s)
Céphise	Marilyn Hill Smith (s)
Amour	Anne-Marie Rodde (s)

English Bach Festival Baroque Orchestra and Singers, Nicholas McGegan, cond. [Guy Chesnais, prod.] ERATO STU 71507 (digital recording). Cassette: MCE 71507.

This album was conceived under trying circumstances. Recording it in the Opéra Royal du Château de Versailles, Erato’s team was robbed of a full day of session time because of a bomb scare. *Mon dieu!* Even Rameau’s nemesis, J. J. Rousseau, never resorted to such tactics!

Just as Rameau weathered two generations of controversy in his own lifetime, so this recording came through the crisis to become a substantial addition to the Rameau discography. Conductor Nicholas McGegan, who achieved prominence as a major Rameau interpreter with his Erato recording of *Nais* a few years ago, combines musicological integrity with a keen sense of theater that could perhaps exist only in a conductor who frequently doubles as a stage director.

That element is particularly welcome

in *Pygmalion*, a 45-minute one-act opera premiered in 1748 at the Paris Opéra. Though one of the most popular and accessible works from the composer’s middle period, it has one of the most slender plot lines Rameau ever had to work with. The sculptor Pygmalion rejects his girlfriend Céphise because he is in love with the statue he has created. The statue comes to life, everybody is happy, and that’s that. And while McGegan certainly can’t make more of the theatrical aspects than what is there, he does have one up on the current alternative, conducted by Gustav Leonhardt (Harmonia Mundi Germany and Pro Arte), in that he is able to balance musicological concerns with a willingness to entertain.

McGegan’s fleet tempos in the overture do not support the music’s programmatic implications as fully as Leonhardt’s, but they make more sense musically, and these pages brim with energy and life. In other orchestral passages (especially the dances)—where Leonhardt occasionally sounds tentative and baffled by the abrupt key changes and by musical ideas that seem to be cut off in mid-sentence—McGegan plows right through, often finding more than a bit of humor in this reputedly humorless composer. Also notable is the rhythmic spring McGegan brings to the music, which makes the Tambourin infectiously raucous and gives *Pygmalion*’s final air the true sense of celebration that Leonhardt misses.

The SOURCE

THE ALL NEW
1985 EDITION OF
MUSICAL AMERICA
INTERNATIONAL DIRECTORY
OF THE PERFORMING ARTS

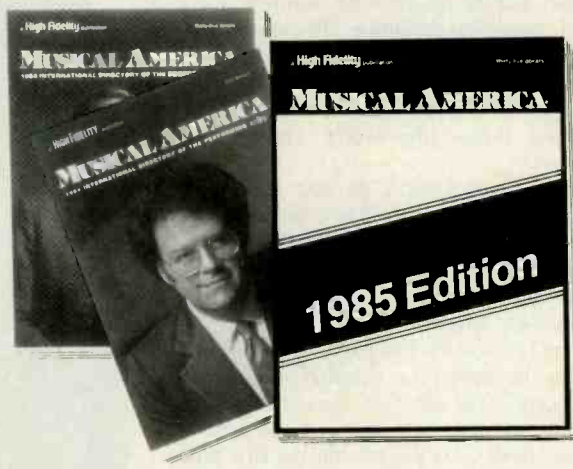

The most encompassing and informative Directory of the Performing Arts in America.

Listings of orchestras, opera companies, publishers and artists’ managers. Competitions, foundations and awards; performances, performers and organizations.

More than 600 pages of complete national and international performing arts information with both a categorical and alphabetical advertisers index in the rear.

It is the one Directory of The Performing Arts that can and will be referred to all year long. It is *The Source*.

Musical America Directory 1985 MAD85D
 ABC Single Copy Sales
 8th floor
 825 7th Avenue, New York, NY 10019

Please send me _____ copies of The 1985 Musical America Directory at \$40.00 each (postage and handling included).

NAME _____
 ADDRESS _____ APT # _____
 CITY _____ STATE _____ ZIP _____

Enclosed is my check/money order for \$ _____

Payment must accompany order. For postage and handling outside the U.S.A., add \$10.00 (Air Printed Matter, add \$20.00)

Generally, McGegan shows there can be great eloquence in Rameau's simplest and most spasmodic rhythms.

This is not to say that the McGegan set supercedes Leonhardt's, which has its special charms; too; the difference in them is mostly a matter of two highly creative teams finding their own solutions to the same problems. For example, the spacious engineering of the Leonhardt set reveals the music with greater clarity. Erato's more closely miked production tends to concentrate the textures and to make them more dense.

Many of Leonhardt's colleagues on his *Pygmalion* recording have since become

noted early-music figures in their own right, particularly Philippe Herreweghe and his Choeur de la Chapelle Royale, and Sigiswald Kuijken and La Petite Bande. Along with the superb cast of vocal soloists, they represent Rameau performance practice at its most refined.

As for McGegan's forces, the English Bach Festival Baroque Orchestra and Singers play in a fairly aggressive style, but are nonetheless first-class. His soloists don't fare so well. Michael Goldthorpe's tenor is entirely too heavy for as light and high-lying a role as Pygmalion. Anne-Marie Rodde is an adept but rather dramatically detached *Amour*, while Marilyn Hill

Smith, doing double duty as the spurned *Céphise* and beloved *Statue*, lacks clear vocal focus.

This bit of double casting is rather intriguing. Is McGegan trying to underscore a dramatic theme so obvious as to be taken for granted and yet too endearing to be missed? Is he saying that the ideal and the mundane are different sides of the same coin? It's fun to think about.

DAVID PATRICK STEARNS

REIMANN: Requiem.

Julia Varady, soprano; Helga Dernesch, mezzo-soprano; Dietrich Fischer-Dieskau, baritone; RIAS Chamber Choir; Berlin Radio Symphony Orchestra, Gerd Albrecht, cond. [Peter Bockelmann, prod.] EMI ELECTROLA IC 165 1467 403 (digital recording, two discs). (Distributed by German News Co., 220 E. 86th St., New York, N.Y. 10028.)

Having survived the international acclaim and skepticism that greeted his prodigious first opera, *Lear*, German composer Aribert Reimann has plunged back into the critical shark tank with no less than a full-scale Requiem. Brought to us by the same singers and conductor who premiered its Shakespearean predecessor, the Requiem has so many musical and dramatic similarities to the older work that it could easily be called *Lear II—The Oratorio*. No condescension is intended: Like *Lear*, the Requiem is a substantial, viable work that, despite its shortcomings, could wake up the stodgy programming of any number of major musical organizations. Unfortunately, it is perhaps not so monumental or fashionable that it will completely escape the condition of being more talked about than heard.

As Britten did in the *War Requiem* and Penderecki is doing in his still-in-progress *Polish Requiem*, Reimann attempts to find a more personal meaning in the Latin text by augmenting it with nonliturgical verse—which in this case is taken from the Book of Job, creating a central character circumstantially similar to *Lear*. But unlike the archetypal monarch driven mad by tragedies of his own making, Job is of sound mind and has an all-too-keen awareness of his own misery, which requires (and receives) more subtle treatment from the composer.

This Requiem is divided into two parts. The first, including the *Introit*, *Kyrie*, and *Dies irae*, dramatizes Job's crisis of faith; the objectivity of these pages results from Reimann's refusal to portray him as a victim. Job's fall from grace is a loss not of wealth and family, but of humility. In his egocentric preoccupation with his own blamelessness, he is perilously ill-equipped to deal with the demise of his physical world and thus cannot help but alienate himself from the God in whom he claims to believe. Though never so baldly stated, the implications are clear: Modern civilization is merely a house of cards whose destruction is only an atom bomb away. The

COMPACT STORAGE. DISCBOX™



This new storage system for the Compact Disc is a unique method of housing your expanding record collection. Discbox modules may be arranged in rows or stacks, using the exclusive interlocking feature.

Each module, which may be shelf or wall mounted, holds up to ten Compact Discs complete with their cases. Quick, easy access to your Compacts is assured no matter how large your library grows.

DISCBOX SYSTEM®. GROWS WITH YOUR COLLECTION.

ibor CLASSICS INTERNATIONAL BOOK & RECORD DIST.
40-11 24th Street, L.I.C., N.Y. 11101
(212) 784-3929

We also accept American Express!!
*Registered Design.
Trade enquiries invited.



Circle amount below	Total
4 Discboxes @ \$6.98 Each . . . Shipping \$1.75	\$29.67
8 Discboxes @ \$6.48 Each . . . Shipping \$3.00	\$54.84
16 Discboxes @ \$5.98 Each . . . Shipping \$4.75	\$100.43
24 Discboxes @ \$5.48 Each . . . Shipping \$7.75	\$139.27

Name _____

Address _____

Charge Card # _____

Signature _____ Exp. _____

Kindly enclose check/money order or complete charge card information below.



NOW AVAILABLE

THE NEW SCHWANN ARTIST ISSUE

The unique classical music guide. Presenting over 25,000 classical recordings listed by orchestra, trio, quartet, conductor, soloist, vocalist, choral group and operatic company.

Reserve my copy of the new Schwann Artist Issue. I enclose just \$6.95 (plus \$1 for postage and handling) for each copy. Number of copies _____ Amount enclosed \$ _____

SCHWANN ARTIST ISSUE Circulation Dept., 825 Seventh Ave., New York, NY 10019

NAME _____

ADDRESS _____ APT. # _____

CITY/STATE/ZIP _____

PAYMENT MUST ACCOMPANY ORDER. PAYMENT IN U.S. CURRENCY ONLY PLEASE ALLOW 6-8 WEEKS FOR DELIVERY SAHD

damned are confounded by their tragedy, while the survivors are those who question but accept the will of God, however baffling and unpleasant that may be.

The second half dispenses with this scenario and ruminates on a more universal sense of spiritual crisis, contrasting the liturgical texts with questions paraphrased from Job. How could a Supreme Being be so invisible? If God makes no guarantees, what rational reason is there for hope? Reimann wisely refuses to answer universal questions for which there are only personal answers. "Where, then, is my hope?" queries Job in the final moments of the piece. "Shall we descend together into the dust?" Yes, it does sound like a fever chart for an agnostic, or a plea for blind faith in the absence of anything better to live by.

Reimann's eclectic musical language—alternately tonal and atonal, tightly organized and seemingly aleatoric—is considerably pared down from the denser textures of *Lear*. Shorn of treble instruments in the brass and string sections, the newer score seems unusually accessible, thanks to the composer's expansive, unembellished musical ideas. His style can be dissonant, but more in the manner of Ligeti than Zimmermann. And unlike some contemporary German composers, Reimann isn't afraid to make his music beautiful—not in the Straussian sense, but in a way that suggests a more hard-won beauty by juxtaposing soft

but gnawing microtones with whole-tone chords.

Reimann's Achilles' heel, though, is his tendency to use the same musical techniques so frequently, and with so little variation, that he reaches a point of diminishing returns. Vocal and orchestral passages are rigidly compartmentalized, which lends an ambience of primitive ritual—sometimes with such predictability that it's easy to guess what will come next, even on first hearing. Also problematic is Reimann's setting of the Job texts in four different languages—English, German, Hungarian, and French—in the interest of creating a cosmopolitan expression. This might sound magnanimous on paper, but in execution it is somewhat bewildering, particularly since the recording provides only a German translation.

Though it would appear that this piece is given first-class recorded treatment—with excellent Direct Metal Mastering and a starry lineup of soloists—the performers, under the direction of Gerd Albrecht, seem at times to labor, though they remain fiercely committed and communicative throughout. Best of all is the RIAS Chamber Choir, whose specialty in 20th-century choral music is apparent in its ability to sing Reimann's strange harmonies with more than a fair amount of accuracy—even in a cappella passages.

The soloists make the expressive most

of the reflective passages, but the unfocused wobbling that often passes for singing can't always be chalked up to the difficulty of the vocal lines (which, it should be said, frequently lie well within the voice). Despite his considerable ability as a tragedian, Dietrich Fischer-Dieskau, the recording's Job, would do well to quit barking his way through heroic vocal assignments he can no longer sing, and stick to *Lieder*. Helga Dernesch makes a commanding priestess in the *Sanctus*, but elsewhere sounds like a screaming banshee. Julia Varady is the most satisfying of the three soloists, especially in her melting account of the *Agnus Dei*, but she, too, sounds as if she has gotten in over her head from time to time. It is difficult to fault the soloists for their frequently poor pronunciation of non-Germanic text, nor is it fair in the case of Varady, whose Hungarian is just fine. Who can be expected to switch between all these languages in a single performance?

The final question, of course, is whether Reimann is a major voice whose *Lear* and Requiem will come to be seen as important early works, or a minor figure with a viable post-serial style and a talent for organizing large-scale compositions. The Requiem implies as much promise as not, and I intend to give him the benefit of my doubts and will continue to watch with great interest. After all, we Americans know him mostly through recordings. And,

illinois audio

SAVE MONEY • TIME • FREIGHT ON NAME BRAND STEREO

COMPONENTS

AKAI AAA-35 NEW! AM-FM DIGITAL RECEIVER (48x2)	\$225.00
AKAI GX-7 3 HEAD DOLBY B & C CASSETTE DECK	259.00
AKAI GXR-99 NEW AUTO-REVERSE 3 HD COMPUTER RECORD	CALL
AKAI GXR-66 DOLBY B&C, dbx W/AUTO. REV. CASS.	CALL
KENWOOD KR-950B COMPUTERIZED HI-SPEED RCVR. (80x2)	278.00
KENWOOD KR-930B 60x2 DIGITAL RECEIVER SPECIAL	200.00
ADC SS-315X 10 BD PER CH. EQUALIZER with ANALYZER	CALL
SANSUI DW-9 SANSUI'S BEST DOUBLE CASSETTE DECK	CALL
SANSUI Z-7000 (90x2) AM-FM DIGITAL RECEIVER	425.00
TEAC EQ-A10 10 BAND/CHN. EQUALIZER W/ANALYZER	90.00
TEAC EQ-A20 SAME AS ABOVE WITH MORE FEATURES	110.00
TEAC V-909RX AUTO-REV. DOLBY B, C, & dbx CASSETTE DK.	395.00
TECHNICS SBX-700 12" 3-WAY LOUDSPEAKER SYS. (PAIR)	260.00
TECHNICS SA-450 'NEW' (50x2) DIGITAL RECEIVER	199.00
TECHNICS SLQ-300 FULLY AUTO. QUARTZ DD TURNTABLE	86.00
TECHNICS RSB-78R AUTO-REV. DOLBY B,C, & dbx CASS. DK.	CALL

PORTABLES

SONY WM-F10 SUPER WALKMAN CASS. WITH DOLBY & FM	95.00
JVC PC-200 3-PIECE PORTABLE SYSTEM W/AUTO. REV.	210.00
AIWA HSP-02 II AUTO-REV. CASSETTE PLAYER	89.00
AIWA HSJ-300 AM/FM AUTO-REV. CASS. RECORDER	110.00

AUTOMOTIVE

JENSEN ATZ-300 NEW! AM/FM COMP. CONTROLLED CASS.	275.00
JENSEN EQA-5000 7 BAND GRAPHIC EQUAL./40 WATT AMP	89.95
JENSEN J-3033 6x9 TRIAX SPEAKERS (PAIR)	79.95
SANYO FTE-D7 'NEW' AM/FM, DOLBY B&C, CASSETTE DECK	218.00
SANYO FTU-52 AM/FM CASS. W/DOLBY B&C, METAL CAPABLE	145.00

VIDEO RECORDER

SANYO VCR-7200 BETA HI-FI STEREO W/WIRELESS REMOTE	550.00
--	--------

HEADPHONES

KOSS PORTA PRO NEW HEADPHONE	\$44.95
SONY MDR-CD5 'NEW' DIGITAL READY	65.00
SENNHEISER HD-414 LIGHT WT., OPEN AIR	44.00

TAPE—AUDIO & VIDEO

SONY UCXS-90 NEW HIGH BIAS CASSETTE TAPE	26.00/10
SONY UCX-90 TYPE I POSITION, HIGH BIAS	20.00/10
TDK SA-90 SUPER AVILYN CASSETTE TAPE	19.00/10
TDK SAX-90 DOUBLE COATED 'SA' TYPE CASSETTE	30.00/10
TDK D-90 LOW NOISE CASSETTE TAPE	15.00/10
BASF PRO II-90 "WORLD'S QUIETEST HIGH BIAS TAPE"	21.00/10
FUJI M-90 METAL CASSETTE	34.00/10
MAXELL XL-90 TYPE I OR II (PLEASE SPECIFY)	22.00/10
MAXELL XL 'S' 90 TYPE I OR II (PLEASE SPECIFY)	35.00/12
JVC T-120 VHS	5.50 ea. or 54.00/10
FUJI T-120 OR L-750 VIDEO CASSETTES	68.00/10

CARTRIDGES

SHURE V-15 TYPE 5 MR NEW TYPE "5"	CALL
SHURE V-15 VP TYPE 5 "P" MOUNT	CALL
AUDIO-TECHNICA AT-132EP "P" MOUNT	34.95
AUDIO-TECHNICA AT-122LP "P" MOUNT	28.95

COMPACT DISC PLAYERS

TECHNICS SL-P7 COMPACT SIZE CD PLAYER	CALL
TECHNICS SL-P8 WIRELESS REMOTE, PROGRAMMABLE	CALL
FREE ASK ABOUT REBATE ON TECHNICS CD PLAYERS	100.00 VALUE

8 BRANDS OF CD PLAYERS IN STOCK CALL FOR INFORMATION

SEE A BETTER PRICE? CALL US! WE WANT YOUR BUSINESS!!

UPS rates apply on these units.

Prices and Availability Subject to Change



illinois audio

12 E. Delaware Pl., Chicago 60611

Hours:
10:00-5:00
Mon. thru Sat.

TOLL FREE
1-800-621-8042

Phone Now
1-312-664-0020



— send for free price list —

Name _____
Address _____
City _____
State _____ Zip _____

or use your address label

as second- and third-generation recordings of works from Mahler to Britten have proven, performers with some distance and perspective can transform what previously sounded like a bitter pill for the intellectually ravenous into something emotionally satisfying on the gut level of *Le Sacre du printemps*. If nothing else, Reimann's music clearly has the conviction to encourage just that. DAVID PATRICK STEARNS

SORABJI: Opus clavicembalisticum.

Geoffrey Douglas Madge, piano. [Piet Hein van de Poel, prod.] KEYTONE RECORDS, ROYAL CONSERVATORY SERIES RCS 4-800 (four discs). (Distributed by International Book and Record Dist., 40-11 24th St., Long Island City, N.Y. 11101.)

It was four and a half decades ago that the acidulous British-born composer Kaikhosru Shapurji Sorabji (b. 1892) gave his last public piano recital and then declared his music off-limits to all other performers. "He had had enough of audiences, critics, concert managers, performers, etc., most of whom he found offensively unintelligent, dull, unmusical, and unwilling and unable to understand him," writes Paul Rapoport in the chapter on Sorabji included in his 1979 book, *Opus Est: Six Composers from Northern Europe*—and that seems like an example of word-mincing compared with the generally misanthropic sentiments expressed by Sorabji himself in the autobiographical sections of his 1947 *Mi contra fa: The Innovations of a Machiavellian Musician*.

Prolific by temperament, Sorabji hardly slowed his pace during his years of seclusion: Between 1940 and 1978, he produced more than 20 large-scale compositions, most of them for solo piano and most of them featuring long stretches of counterpoint so complex it needs to be spread out over five or six staves in order to be clearly notated. In the 1960s, he consented to record some of his more recent music to illustrate a radio talk prepared by the British musicologist Erik Chisholm. The BBC was not allowed to broadcast the program, but versions of it were aired in the U.S. in the early 1970s, and the musical examples—short excerpts mostly, and (according to Rapoport) rather perfunctorily performed—were enough to inspire several adventurous virtuosos to hunt up those few of Sorabji's works that had been published at the composer's expense prior to 1930. Doubtless impressed by the private tapes that came his way and perhaps mellowed by age, Sorabji relaxed the embargo, which by the mid-Seventies had become more legendary than the music itself.

The first pianist to be given the go-ahead was Yonty Solomon, a South African who presumably had been introduced to the forbidden fruits of Sorabji's labor during his studies with Chisholm at the University of Cape Town. Solomon's first public performance of Sorabji repertoire took place in



A young, powerful, and dramatic Callas

HIGH FIDELITY ARCHIVES

London's Wigmore Hall in December 1976. Six months later the French pianist Michael Habermann, then a doctoral student at the Peabody Conservatory in Baltimore, launched an American Sorabji campaign that to date has included numerous recitals, several NPR broadcasts, and two all-Sorabji recordings on the Musicmasters label (MM 20015 and MM 20019). The Australian pianist Geoffrey Douglas Madge is the third artist invited to join the exclusive club of Sorabji champions. Although as early as 1977 Solomon was planning to play the gargantuan *Opus clavicembalisticum*, Madge was in fact the first to tackle the piece since Sorabji himself gave the one and only previous performance in Glasgow in 1930; the momentous event occurred on June 11, 1982, as part of that year's Holland Festival, and it's the entirety of that marathon concert in Utrecht's Muziekcentrum Vredenburg that makes up this four-disc set.

For most listeners, the mere thought of a nonrepeating piano composition that lasts nearly four hours is enough to trigger numbness. But predisposition to torpor is likely to vanish as soon as one hears Madge pound out the opening motto. The *Opus clavicembalisticum* is every bit as intoxicating as the shorter pieces (from the 1920s) that Habermann recorded, but its potency results less from harmonic richness than from awesome and relentless dynamic energy. Parts of it are indeed as thickly textured as any keyboard music in existence, so dense and turbulent that they call to mind images of a stage full of pianists battling for attention at the ultimate climax of a manic Scriabin-esque improvisation. However, much of the work is transparently scored—cast in the form of a two- or three-part invention, for example, or a single melody shrouded in vapory impressionistic resonances. Throughout the piece the shifting of sonic weight from one extreme to the other seems as packed with momentum as the movement of a giant pendulum.

The vastness of territory surveyed by Sorabji's tour de force makes it easy to lose sight of the music's basically simple micro- and macro-structures: The *Opus* consists of 12 sections, four of them fugues and two of them lengthy sets of variations, and the material for the whole of it is drawn from a catalog of only two dozen thematic kernels. Still, even if one is not always sure precisely where the music is headed, one at least knows that the music is headed *somewhere*, and the constant awareness that goals are being reached is quite enough to offset the occasional feeling of auditory vertigo. Sorabji likens his intricately ornamented music to the traditional visual artwork of Iran and Byzantine-Arabic Sicily, the homelands of his father and mother, respectively. A predilection for things exotic is perhaps a requirement for a fully enthusiastic appreciation of the *Opus clavicembalisticum*, but even the most jingoistic devotees of mainstream Western piano music are likely to be fascinated in one way or another by this titanic showpiece.

Madge's playing consistently seems as purposeful—as driven—as Sorabji's 248-page score. Notwithstanding a generally murky recorded sound, breaks that seldom correspond to the composer's lines of demarcation, and the frequent intrusions of audience noise, this album constitutes an astounding document. It lends credibility to the Sorabji mystique, and doubtless establishes a world's record for pianistic endurance. JAMES WIERZBICKI

VERDI: Nabucco (excerpts).

CAST:	
Abigaille	Maria Callas (s)
Fenena	Amalia Pini (ms)
Anna	Silvana Tenti (ms)
Ismaele	Gino Sinimberghi (t)
Nabucco	Gino Bechi (b)
Zaccaria	Luciano Neroni (bs)
High Priest	Igino Ricco (bs)

Chorus and Orchestra of the San Carlo Theater of Naples, Vittorio Gui, cond. RODOLPHE RP 12 409. Cassette: RPK 22 409. (Distributed by Harmonia Mundi, USA; 2351 Westwood Blvd., Los Angeles, Calif. 90064.)

Guerreri é preso il tempio; Ben io t'invenni anch'io dischiuso un giorno; Uscite, o fidi miei!; Va! la palma del martiro.

Maria Callas had turned twenty-six two weeks before this, the first of three performances she gave in one of the most demanding roles Verdi ever wrote. At the time, she had been receiving guidance from Tullio Serafin for a little more than a year and, taking his advice, was moving into the great roles of Bellini, Donizetti, and Rossini that required heroic vocalism and genuine dramatic power. Abigaille is exactly that kind of part: Leonie Rysanek once admitted that it was a mistake for her to have sung the role, and Elena Suliotis, the Greek soprano who sang it with disastrous effect to her voice, said, "Abigaille has to shout."

This welcome disc offers four scenes

from the performance given in the San Carlo. There is a complete recording of that same evening available on the Turnabout/Vox Historical Series (THS 65137/39), but the present LP, according to the liner notes, was made from "an original wire recording in the archives of Teatro San Carlo . . . which, by the standards of 1949, is above average." Comparing the new release with the complete recording, I must agree. The sound on this disc is superior (if hardly more than marginally) in balance, in fidelity to the voices that are so well known from other finer albums, and in pitch, though there are a couple of disturbing alterations of pitch during the first band.

What is significant here is that the surfaces of the Rodolphe release are notably better than those of the Turnabout, enabling us to hear the two most central elements in what was an evening of flaming excitement: Callas in her great, early glory, and the moving conducting of Vittorio Gui, which is far more impressive than Lamberto Gardelli's on the complete studio recording with Callas (London 1382).

Abigail has little on her mind during the course of the opera except to cry out for vengeance. Yet with Verdi's music—some of the most inspired of his early operas, along with the later *Macbeth*—Callas is in her finest element. There is a single episode of pathos, in the aria "Anch'io dischiuso un giorno ebbi alla gioia il core." Here, as in the brief death scene, Callas lets us glimpse the Violetta soon to come from Verdi. But this touching aria of Abigail is preceded by a dramatic recitative filled with anger, hatred, and an implacable determination to avenge herself for the shameful life she has been forced to lead. In the recitative, Callas moves—as she does several times in these scenes—over a two-octave range at full speed, and with an accuracy and blazing sound that have not been equaled in the more than 30 years since she gave up the role. Her top C's are defiant and fearless, perfectly placed, and with no hint of the beat that would invade them in a few years. And, just as she would do five months later in her famous *Aida* in Mexico City, Callas tops off the opening scene of Act III in *Nabucco* with an electrifying high E flat.

Technical differences aside, one factor that is largely missing from this disc of excerpts is the huge, vociferous, prolonged shouting by the San Carlo audience after each of Callas's great moments. Those "Bravi!" were for a singer who was still to make her great international reputation. There is not another singer on this disc worth mentioning. (Gino Bechi, in some ways and in some operas a useful baritone, is here only vulgar and lacking in any hint of style.) However, for its incomparable reminders of one of the greatest legends in opera history, and for the vivid testimony it leaves us of Callas as an artist without a precise parallel, I would not be without this record.

PAUL HUME



THE VIDEO CONNECTION
FRAZIER

An amazingly accurate sound. Speakers so efficient that they can be connected directly to your T.V. receiver. Designed to bring you all the full, rich sound your system can transmit. Speakers so tuned in with the latest technology that they are also designed to work with the new digital equipment now on the market. The Frazier Mark V-D available now from Frazier Incorporated, the people who have been making fine speakers for more than 30 years.

The Frazier Mark V-D

FRAZIER

Frazier Inc., 1930 Valley View Lane, Dallas, Texas 75234. Telephone: (214) 241-3441.
Factory inquiries welcome. Contact: Sales Coordinator

STEREO HOME and CAR VIDEO SATELLITE TV

We sell to hundreds of dealers coast-to-coast—Now you can buy stereo, video and satellite equipment for the

SAME PRICE DEALERS PAY

INTERNATIONAL'S NO RISK POLICY

1-No Deposit
2-90 Day No-Lemon replacement warranty
3-SAME DAY SHIPPING

Call or write for our free booklet, "Ultra Hi-Fi Digital at Half the Cost."

Daily 9am to 9pm
1(301) 488-9600

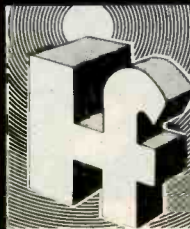

INTERNATIONAL HI-FI DISTRIBUTORS, INC.

Moravia Center
Industrial Park
Baltimore, Md.
21206

Cartridges & Styli

TOP 40 arranged by increasing price order.

STANDARD MOUNTS

Osawa OS102	\$ 12.95
Audio-Technica AT105	\$ 14.95
Shure M44E	\$ 18.95
Audio-Technica AT110E	\$ 18.95
Ortofon OM10	\$ 24.95
Audio-Technica AT120E	\$ 26.95
Audio-Technica AT125LC	\$ 32.95
Bang & Olufsen MMC5	\$ 39.95
Ortofon OM20	\$ 44.95
ADC XLM Mk III	\$ 45.95
Audio-Technica AT140LC	\$ 47.95
Ortofon VMS20E Mk II	\$ 53.95
Audio-Technica AT30HE (ME)	\$ 58.95
Bang & Olufsen MMC4	\$ 59.95
Audio-Technica AT31E (MC)	\$ 63.95
ADC ZLM Improved	\$ 69.95
Ortofon VMS30 Mk II	\$ 73.95
AKG P10ED (with free headshell)	\$ 79.95
Audio-Technica AT155LC	\$ 82.95
Ortofon OM30	\$ 82.95
Bang & Olufsen MMC3	\$ 99.95
AKG P15MD (with free headshell)	\$ 99.95
Audio-Technica AT3100E (MC)	\$ 109.95
Audio-Technica AT3200XE (MC)	\$ 112.95
Ortofon MC100U (MC)	\$ 149.95
Bang & Olufsen MMC2	\$ 149.95
Technics EPC205C Mk III	\$ 154.95
AKG P25MD (24 or 35)	\$ 159.95
Ortofon MC200U (MC)	\$ 199.95
Bang & Olufsen MMC1 (incl. free MMC5R)	\$ 249.95

"10 best" P-MOUNT CARTRIDGES

Audio-Technica AT112EP	\$ 14.75
Ortofon OMP10	\$ 25.95
Audio-Technica AT122LP	\$ 28.95
Ortofon OMP20	\$ 44.95
AT152LP (gold)	\$ 82.95
Ortofon OMP30	\$ 82.95
AKG P4PD	\$ 99.95
Audio-Technica AT312EP (MC)	\$ 109.95
Technics EPC-P205C Mk III	\$ 149.95
Ortofon TMC200 (MC)	\$ 199.95

DJ's

SL1200 Mk II	\$ 265.00
Ortofon LM Pro	\$ 47.00
Auron Sp-7 Stikphone	\$ 84.95

To order by mail: for immediate and courteous shipment, send cash or check or postal order. Personal business checks require clearance before processing. Shipping, insurance & handling charge \$2.95 per order within USA. \$4.95 for N. Calif., Hk. Ak. P.R. \$5.95 per shipment.

(Cartridges & Styli (Needles))
For quotes & COD Orders (• 24hr. Shipment)

1-800-431-3232
(212) 438-6400
for advice and service

audiofon

P.O. BOX 37, Brooklyn, NY 11204
Hours 10AM - 6PM EST
Free Catalog: send self-addressed stamped envelope

STANTON ADC audio-technica ortofon PICKERING

AKG Bang & Olufsen Technics stylus SHURE

When the Hollywood Bowl wanted music in the round they chose B.E.S. speakers.

Conventional speakers that use cones, horns, and box enclosures have distortion built in.

When the Hollywood Bowl wanted the world's most advanced sound system, the choice was B.E.S. speakers, with their light-weight computer-designed planar diaphragms. They respond instantly to every shading and mood in the music, and deliver a three-dimensional stereo image wherever you sit.

That's music in the round, the special talent of B.E.S. speakers. Performing now at the Hollywood Bowl—and available now for your living room.



SM 100

B.E.S.
Music in the round.™

© 1984 by BES, 345 Fischer Street, Costa Mesa, Ca. 92626 • (714) 549-3833

Recitals and Miscellany

ROBYN ARCHER SINGS BRECHT: Vol. 2.

Robyn Archer, mezzo-soprano; Dominic Muldowney, piano; London Sinfonietta, Dominic Muldowney, cond. [John Mordler, prod.] ANGEL DS 38062 (digital recording). Cassette: 4XS 38062.

EISLER: To Those Born Later; Song of the Moldau; Nanna's Song; Supply and Demand; "Falada, Falada, there thou art hanging"; The Mask of Evil; All of Us or None; Ballade of Marie Sanders, the "Jew's Whore"; To a Portable Radio; On Sprinkling the Garden; The Song of the Nazi Soldier's Wife; The Way the Wind Blows. WEILL: Cannon Song; Polly's Song; Ballad of Mac the Knife; Second Threepenny Finale; Barbara's Song; Bilbao Song. UMLAUFT: Remembering Marie A. DESSAU: Song of the Flow of Things; Mother Courage's Song. MULDOWNEY: The Moment Before Impact; The Play Is Over.

This follows by three years an earlier selection (Angel S 37909) that included eight settings by Eisler, six by Weill, one by Dessau, and one by Brecht himself as arranged by Dominic Muldowney, the conductor for both discs. The name Muldowney crops up more prominently on this album—as composer of two songs and arranger of no less than eight others, including five by Eisler and one each by Dessau and Weill; the need to "arrange" those punctilious composers' originals goes unexplained. John Willett once again provides imaginative, generally faithful translations and scholarly, unusually informative notes. During 25 years in Berlin, I went to countless performances at Brecht's famous Berliner Ensemble, enjoyed friendships with several people close to him, and attended the *Threepenny Opera* recording sessions supervised by Lotte Lenya; but it remained for Willett to inform me that in "Polly's Song" (from that "opera") the text is "word for word the refrain of Kipling's poem 'Mary, pity women,' which Brecht translated with Elisabeth Hauptmann. . . ."

Robyn Archer brings to these songs the requisite mixture of earthy toughness and lyricism—but she does come from Australia, and Willett from England, so an occasional turn of phrase (e.g., "not to give a bugger") may, for American ears, evoke Limehouse more than *Neukölln*. Otherwise, this album contains many delights.

In general, I congratulate all concerned, but I do take sharp exception at two points. First, in his poem entitled "Remembering Marie A.," Brecht placed a hard-hearted vengeer of lyric language over an event that exemplified the contempt and hostility he ultimately directed toward most (if not all) of the many women in his life. For the psychologically enlightened listen-

LISTEN TO WHAT 50 YEARS OF EXPERIENCE CAN SOUND LIKE....

TANDBERG

Tandberg's world-famous audio products, highly regarded by professional musicians as well as discriminating consumers for more than 50 years, now include two of the most advanced high fidelity components available today: the TIA 3012 Integrated Amplifier & TPT 3001A Programmable Tuner.

These units, which were individually given a "rave" review by AUDIO magazine, can be joined together with their optional rosewood sidepanels to become "...the finest 'receiver' we have ever tested" (HIGH FIDELITY) and "a receiver of exceptional quality" (STEREO REVIEW).

It is a stereo receiver capable of exceeding the demands of today's... and tomorrow's most advanced digital program material.

For literature, test reports and the name of your local dealer, contact: Tandberg of America, Labriola Court, Armonk, NY 10504. (914) 273-9150

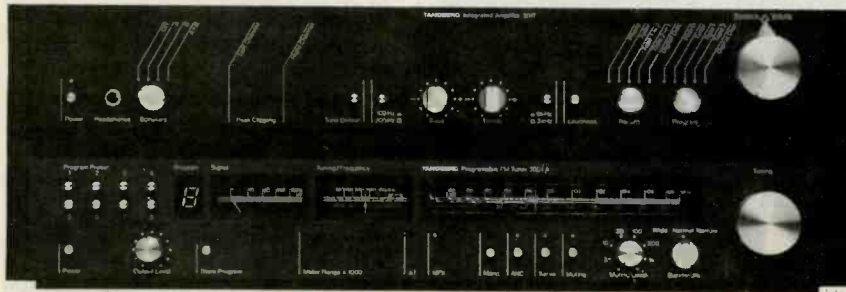

er, hearing that poem sung to Unlaufi's stupidly sentimental tune compounds the cruelty and tastelessness. (It doesn't exactly help to know that the encounter, so ostentatiously meaningless for Brecht, produced a son in whom he took no interest and who fell, a German soldier, in World War II.) Second, Archer sings "Mother Courage's Song" (incorrectly described by Willett as Dessau's "5/4 arrangement") like a triumphant bat out of hell, instead of slogging through it with implacable, indomitable determination, as I saw Brecht's wife Helene Wiegel do it numerous times in the Berliner Ensemble production staged by Brecht with Dessau, the composer, on hand. A comparison of Weigel (in the play's complete recording, Eterna 860122-4) with Archer shows a startling contrast: 120 beats per minute as opposed to 168, respectively. So much for Brechtian authenticity—at least in this particular number.

Since Vol. I appeared, Angel's text people have learned that Brecht spelled his first name not Bertold but Bertolt. Congratulations!
PAUL MOOR

BERLIN PHILHARMONIC BRASS ENSEMBLE: Eine Kleine Biermusik.

Berlin Philharmonic Brass Ensemble. [John Mordler, prod.] ANGEL DS 38070 (digital recording). Cassette: 4XS 38070. MAURICE ANDRÉ: Trompetissimo. Maurice André, flugelhorn, with instru-

mental ensemble. [Maurice André, prod.] ANGEL S 38068 (digital recording). Cassette: 4XS 38068.

If you are in the mood for some lighter listening, you may wish to investigate both of these discs. What a pleasure it is to hear the powerful sound of the Berlin Philharmonic brass in an assortment of beer-garden and cafe melodies, played with tremendous "country band" verve. The sonics are outstanding, with a brilliant "bite." The only negative feature is Angel's policy of not listing the music on the record label. If you want to cue a specific band, you have to look at the jacket. (Is there any excuse whatever for not identifying individual selections on the label?)

Maurice André's LP is equally captivating, with the distinguished soloist accompanied by a small ensemble in a collection of French, Austrian, German, and Swiss folksongs and novelty tunes. If you enjoy this sort of thing, you'll not find it done better elsewhere. Superb sound.

ROBERT E. BENSON

SEQUENTIA: Trouvères: Courtney Love Songs from Northern France.

Sequentia. HARMONIA MUNDI GERMANY 1695013 (digital recording, three discs). (Distributed by Intersound, Inc., 14025 23rd Ave. N., Minneapolis, Minn. 55441.)

Songs by Adam de la Halle, Blondel de Nesle, Conon de Béthune, Gace Brulé, Jehannot de Lescurel, Petrus de Cruce, and anonymous

composers.

The realization of the monophonic music of the Middle Ages is the ultimate—and perhaps insoluble—problem for musicology. At present, most of the important manuscripts are available in facsimile or transcription; contemporary theorists have been translated, annotated, and endlessly discussed; and scholars are squeezing drops of information from paintings, sculptures, and illuminated manuscripts that depict musical performance. Still, it seems unlikely that we shall ever claim the same degree of authenticity for a rendition of a trouvère song that we now do for a Handel oratorio. Each performance of this elusive repertoire is an experiment, a personal re-creation that relies as much on inspired guesswork as on scholarship.

Sequentia was formed in 1977 by Barbara Thornton, Benjamin Bagby, and Margriet Tindemans; the first two are vocalists and instrumentalists, the third a player of various stringed instruments. In their previous recordings, they have demonstrated an unerring ability to get to the heart of medieval music and to communicate its essence to the modern listener, without extraneous gussying-up. Joined here by five assisting artists, they are equally persuasive, striking a balance between austerity and ostentation. For the listener with even a flicker of historical curiosity, this is a fascinating (Continued on page 103)

"RATED #1 FOR SERVICE & RELIABILITY"

CALL TOLL-FREE
800-221-8180
IN NEW YORK STATE
CALL (212) 732-8600



SPECIALS OF THE MONTH

discwasher \$495
Infinite Head Cleaner
discwasher D Mag \$1295
Cassette Deck Demagnetizer

- AUDIO RECEIVERS**
- AKAI AAA25 30w/ch Digital \$179.95
 - AKAI AAA35 48 w/ch Digital \$249.95
 - AKAI AAA45 65 w/ch Digital \$339.95
 - TECHNICS SA120 35 w/ch Digital \$124.95
 - TECHNICS SA850 50w/wk AM/FM/TV \$219.95
 - SANSUI SX1030 75 w/ch Digital Call
 - HITACHI HTA4R 40 w/ch Digital \$179.95
 - HITACHI HTA4R 60w/ch Digital \$239.95
 - MARANTZ SR225 25 w/ch AM/VID \$99.95

TECHNICS RS-B14
Soft Touch Control Cassette Deck
Dolby B/C NR Metal Tape
Fluorescent Meter \$109.95

- CASSETTE DECKS**
- TEAC VS30X Dolby B/C Deck Memory \$234.95
 - TEAC VS90XB1 & B/C & D Deck Black \$439.95
 - AKAI CX-7 3-Head Dolby B/C \$259.95
 - AKAI CX88B AIR SHD B/C \$399.95
 - AKAI HX3 Feather Touch Dolby B/C \$199.95
 - TECHNICS RS868R AIR Dolby B/C \$229.95
 - TECHNICS RS878R AIR B/C Deck Prog \$269.95
 - TECHNICS RS811W Double Cassette \$179.95
 - HITACHI DS Jonye B/C Log Control \$134.95
 - SANSUI DW9 Duplicating Deck Call

PANASONIC NX-T2200
Slim-Line Telephone
Pulse Dialing, Last 3 Redial
Mute, Ringer Volume Control \$1995

TELEPHONES/DIALERS

- Cobra CP355 Cordless 1000' HD Dial \$179.95
- danMARK Touch-Tone Four Choice Of Back \$89.95
- AT&T 01418 Desk Trimee FT Non \$4.95
- PANASONIC KX-T2203 Phone 10-Dial \$89.95
- UNIDEN EXT3800 Cordless \$139.95
- UNIDEN FRT4800 Cordless \$169.95
- NORTHERN TELECOM HARMONY your choice of Almond, Blue, Bisquit, Gray, Brown \$44.95

ANSWERING MACHINES

- PANASONIC KX-T1425 Sleepers Rem \$129.95
- CODE-A-PHONE 2530 Sleepers Rem \$144.95
- PANASONIC KX-T1420 Remote \$114.95
- RECORD-A-CALL 675 VHS Remote \$139.95
- PANASONIC VAB220 Print, Ans. Dial \$159.95
- PANASONIC VAB303 Print Ans. Rem \$179.95

HOW TO ORDER BY MAIL: FOR PROMPT AND COURTEOUS SHIPMENT SEND MONEY ORDER, CERTIFIED CHECK, CASHIER'S CHECK, MASTERCARD VISA INCLUDE CARD NUMBER. INTERBANK NO. EXPIRATION DATE AND SIGNATURE. DO NOT SEND CASH, PERSONAL AND BUSINESS CHECKS MUST CLEAR OUR BANK BEFORE PROCESSING.

MONSTER CABLE

- Monster Cable Interlink #1 \$2250
- Monster Cable Interlink #2 \$3199

A New Cable Technology That Offers High Audio Performance At Low Cost...
\$89.95

- ACCESSORIES**
- AUDIO TECHNICA Safety Sparer \$18.95
 - AUDIO TECHNICA AT605 Audio Feet \$19.95
 - DISC WASHERS \$14.95
 - DISC WASHERS \$10.95
 - DISC WASHERS Cass. Demag. \$12.95
 - TDK HD-01 Exp. Cass. Demag. \$13.95
 - TECHNICS SH-101 Elec. Antenna \$69.95
 - NORTONICS OM202 Prog. HD Mag. \$17.95
 - SHURE SF62 Stylus Pressure Gauge \$7.95
 - CARTALING Cartridge Alignment Kit \$24.95

**23 PARK ROW DEPT. HF-12
NEW YORK, NY 10038**

**23 PARK ROW
NEW YORK CITY
NEW YORK
10038**

SANYO FTE-25
Auto Reverse Car Stereo
Digital 90.5 w/ch
12 Preset Stations \$19995

- CAR STEREO**
- BLAUPUNKT MANHATTAN A R Dolby \$219.95
 - CLARION BS50R Dig. A R A P C \$169.95
 - CONCORD HPL122K Dolby Digital \$229.95
 - JENSEN RE80 2MR Tape Search Ch. \$199.95
 - SANYO FTU12 AIR 95w/ch Metal \$64.95

- CAR SPEAKERS**
- JENSEN J3033 6" x 9" Trunk \$84.95
 - CLARION SE-970 6" x 9" Coax. \$99.95
 - CONCORD HPS152 5" Coax. \$44.95

SONY WM-F10
Super Walkman
Hi-Fi Cassette
Body & Ear Metal Tape \$89.95

- SONY TO-DO**
- AIWA HSP01MKII Cassette Player \$59.95
 - AIWA HS4000 A R AM FM Rec. Dolby \$144.95
 - SONY WMDF Sports FM Cass. Walkman \$99.95
 - SONY WM10 Super Walkman \$89.95
 - SONY WAF004 A/B Dolby Metal \$99.95
 - SONY WMDC2 Quartz Dolby B/C \$148.95
 - SONY WMDC6 Pro Walkman Dolby B \$1249.95
 - SONY WMR15 A/B Rec. Dolby \$119.95
 - SANYO MC-41 AM FM Cass. Metal Tape \$44.95
 - PANASONIC RX555M Cass. Dolby Metal \$74.95

SONY
SONY T-120 or L-750 Video Tape
Your Choice \$4.49
AFTER MANUFACTURER'S MAIL-IN \$1.00 REBATE
New SONY L-750UHC Ultra High Grade Video Tape \$6.99 Each

- AUDIO TAPES**
- TDK SAC-90 Super Avium \$1.99
 - MAXELL UDXL10 or UDXL19E \$4.99
 - MAXELL UDXL1 or UDXL9E \$2.99
 - MINIMUM ORDER 12 AUDIO TAPES \$1.99
 - MAXELL XLI 1 or II-90 \$2.99
 - MAXELL UDX90 \$4.99
 - MAXELL UL35-90 (Reel To Reel) \$2.79
 - TDK ADX90 \$2.99
 - TDK SAX-90 \$2.99
 - TDK HX550 Metal Particle Bulk \$14.79
 - SONY HXS90 2 1/2" Normal Bias \$13.99
 - TEAC CDC90 Reel-to-Reel Cassette Normal \$2.99
 - TEAC CDC90 High Bias Reel-to-Reel Cassette \$3.49
 - TDK DC-90 Dynamic \$1.18
 - TDK MAR-90 Metal \$5.99

- VIDEO RECORDERS**
- PANASONIC PV6500 Portable VHS \$929.95
 - PANASONIC PV15100 Portable VHS \$549.95
 - PANASONIC PV16130 1AD B Ev Rem \$679.95
 - SHARP VC481 3 1/2" Rev. VHS \$399.95
 - RCA VKT550 VHS Hi-Fi \$599.95
 - RCA VKT550 VHS Hi-Fi Stereo \$769.95
 - SONY VPX900 Modular VHS \$879.95
 - JVC HRD220 1/2" Rev. Rem. SHD \$899.95
 - JVC GR11 1 1/2" VHS Camera Recorder \$1349.95
 - JVC HR7100 3/4" Remote \$399.95
 - TOSHIBA VS355 Reel-to-Reel \$749.95
 - SANYO VC4400 30 1 Ev. Remote \$269.95
 - SANYO VC7200 Beta Hi-Fi \$499.95
 - SONY SL650 2 Day Rev. 50-Min. Cap. \$489.95
 - SONY SL90 21 Day Rev. Scan Sld. \$589.95
 - ZENITH VM6000 1 1/2" VHS Camcorder \$1349.95

- VIDEO TAPE**
- ANY BRAND T-120 Except HD \$5.99
 - ANY BRAND T-160 \$11.49
 - ANY BRAND L-750 \$5.49
 - ANY BRAND L-830 \$7.79
 - ANY BRAND High Grade T-120 \$7.99
 - ANY BRAND High Grade L-500 \$6.49
 - ANY BRAND High Grade L-750 \$7.99
- SUPER SPECIALS**
- TDK T-120 \$5.79
 - MEMOREX T-120 \$5.49
 - BASF Super High Grade T-160 \$8.99
 - SONY L750UHC Ultra High Grade \$7.49
 - JVC T-120 \$5.39

The Tape Deck

Critiques of new cassette and open-reel releases by R. D. Darrell

Xenophobia

THE FEAR OF FOREIGNERS—and, by extension, of anything alien or unfamiliar—plays a more influential role in our musical lives than we realize. (For avant-gardists, the phobia sometimes is inverted into xenomania: a craze for anything exotic, as in turn-of-the-century France for Russian and Oriental art.) Either negatively or positively, the degree to which we are already acquainted with specific compositions and performers tends to determine our initial reactions to new recordings.

There may even be a mild form of xenophobia, as well as reasonable caution, in some record buyers' reluctance to sample labels that are new to them, especially one as foreign-looking (to Americans) as Erato, with its distinctive logo's Greek lettering. It may help to be reminded that *Erato* was the name of the sixth Muse, the goddess of erotic poetry, music, and the lyre. Also that the eponymous record company is a long-established one, notable for many years as a leading French independent often represented by reissues on American labels (especially Musical Heritage Society and RCA). Currently, RCA is distributing Erato's own pressings and tapings, now digital recordings all; the cassettes feature chrome tape and full multilingual annotations. I've missed the first, mostly novel, opera releases, but the present batch of orchestral programs proves to be consistently first-rate in technical quality as well as magnetically attractive for musical choices, performers, or both.

First honors go to Charles Dutoit, with the Bavarian Radio Symphony, for his valuable reminder of Honegger's too-quickly-forgotten achievements: the magnificent Third Symphony (*Liturgique*) and the more enigmatic, rarely heard Fifth (*Ditire re*) (MCE 75117). [See review in this issue.] Next, four widely varied programs document the maturing of the young American conductor James Conlon. These range from an idiomatic, if sonically lightweight, Berlioz *Symphonie fantastique* with the Orchestre National de France (MCE 75106), through the more sonically substantial Scottish Chamber Orchestra performances of Mozart's *Paris* (first version) and *Jupiter* Symphonies (MCE 75107) and Schubert's delectable Third and Sixth (MCE 75121), to London Philharmonic accompaniments for virtuoso François-René Duchable's bravura Liszt Piano Con-

certos Nos. 1 and 2 and Hungarian Fantasia (MCE 75111). Conlon's versatility and skill are arresting; though he remains an often overcautious interpreter, he is surely a star in the making.

Claudio Scimone, on the other hand, is a well-established Italian Baroque specialist with his own Solisti di Veneti, and he continues his Vivaldi explorations with three new concerto programs (MCE 75108, 75109, 75110). These feature, in order, works for one or two mandolins, plus the great R. 558 for diverse soloists; R. 234 (*L'Inquietudine*) for solo violin and R. 553 for four violins, with the R. 118 and 143 Concertos and R. 116 and 137 Sinfonias for strings and continuo; and five oboe concertos (R. 447, 453, 457, 461, 463) with soloist Maurice Bourgue. Scimone and his 14-strong ensemble flaunt their expertise, general lack of subtlety, and unflagging energy in gleamingly bright, transparent recordings, but gruffer tonal qualities and less novel fare, in the rival Nuovi Virtuosi di Roma's versions of Vivaldi Concertos R. 180, 253, 271, 523, 551, and 565 (RCA digital/chrome ARE 1-5013).

A new name to most Americans is Venetian-born, Viennese-trained Giuseppe Sinopoli. First acclaimed abroad as an operatic (and Mahler) conductor, he takes a bow as a magisterial Romanticist in Deutsche Grammophon's digital/chrome offerings of Schumann orchestral fare (410 863-4) and Brahms choral/orchestral works (410 864-4). Because the relatively unappreciated Schumann Second Symphony is a special favorite of mine, my expectations for the Sinopoli/Vienna Philharmonic versions of both it and the *Manfred* Overture are more demanding than usual. Nevertheless, I find these readings among the most effective I know, and certainly the most warmly and richly recorded. Contrariwise, my Brahmsian affinities fall short of the choral works, yet even in the mawkishly yearning *Nänie* and stridently jingoistic *Triumphlied*, as well as in the far more distinctive Alto Rhapsody, Sinopoli commands my reluctant admiration. Alto soloist Brigitte Fassbaender—recorded in auditorium-authentic spacing—sings brilliantly, if *molto vibrato*, and the Czech choral and orchestral forces respond earnestly. I hope it's personal aesthetic bias, not xenophobia, that accounts for my preferring Bernard Haitink's more Apollonian accounts of the Rhapsody and *Nänie* (Orfeo/Pantheon digital/chrome M 025821). His alto soloist, Alfreda Hodgson, is well-nigh ideal, the

Bavarian Radio Chorus and Orchestra first-rate, the recording more dramatically vivid. But the dolefulness and "muscular Christianity" of the appended Opus 13 Funeral Ode and Opus 89 *Gesang der Parzen* only fuel my worst Brahmsian prejudices!

Lures of exoticism. The Mighty Handful's founder and guru, Mily Balakirev, reminds us—in his kaleidoscopic First Symphony—of the West's initial thrilling discovery of quintessentially Russian music. Its first recording in years stars a sensational new conductor, Estonian-born Neeme Järvi, who bowls me over by making the City of Birmingham Orchestra, as dazzlingly recorded here, sound world-class in both the alluring Symphony and an unexpectedly festive Liadov Polonaise (Angel digital/chrome 4XS 38090). More densely exotic is Roussel's legendary opera, *Padmâvatî* (Angel digital/chrome prestige-box 4X2X 3948). But my delight in this extraordinary work is soured by a performance (involving Marilyn Horne and Nicolai Gedda, as well as Michel Plasson's Orchestre du Capitole de Toulouse) that, despite radiant recording, does scant justice either to the music drama itself or to its fabulously rich scoring.

Realigned perspectives. Experienced listeners, less likely than novices to find difficulties in unfamiliar music, may be more likely to find them in radically reshaped standard works—such as Schoenberg's super-Stokowskian orchestral inflation of the Brahms First Piano Quartet. Sergio Comissiona and the Baltimore Symphony Orchestra try their damndest, but even with the warmest of sonics fail to persuade us that this is more a Brahms Fifth Symphony than a Schoenbergian curio-monstrosity (Vox Cum Laude digital/chrome D-VCS 9066).

However, there is another, infinitely more rewarding example of new and different slants on a relatively well-known and occasionally recorded work: Mozart's K. Anhang 9 (297b) *Sinfonia concertante* with four wind soloists. The autograph score has long been lost, but our previous dependence on a partially inauthentic version finally has been relieved by a superb Neville Marriner/St. Martin Academy performance of Robert D. Levin's reconstruction for the composer's original choice of solo instruments (Philips digital/chrome 411 134-4). But that mind-blowing resurrection warrants more detailed discussion than space permits here. Later! **HF**

BACKBEAT[®]



Bonandrini (l.), with David Murray: "I knew nothing when I started, but I knew jazz."

Labor of Love

Giovanni Bonandrini is a businessman, not an altruist. He's also the most powerful producer in jazz.

by Francis Davis

"PART OF WHAT has deranged American life in this past decade is the change in book publishing and in magazines and newspapers and in the movies as they have passed out of the control of those whose lives were bound up in them and into the control of conglomerates, financiers, and managers who treat them as ordinary commodities," *New Yorker* film critic Pauline Kael wrote in 1980. "This isn't a reversible process; even if there were Supreme Court rulings that split some of the holdings from these conglomerates, the traditions that developed inside many of these businesses have been ruptured. And the continuity is gone."

Kael's lament is just as applicable to the jazz record business. As they fell into the hands of corporate lawyers and accountants, the small, independent labels of the '40s and '50s folded or lost their identities. The industry has become a high-stakes numbers game, and the big numbers just aren't there for jazz. Of course, pop is a gamble, too, but the payoff can be enormous. The most a hard-core jazz album can hope for is slow but steady sales, and that simply isn't what excites corporate decision-makers, few of whom have any personal enthusiasm for the genre anyway. Every so often—usually as a perk to a company executive who happens to be a fan—one of the majors will announce a custom label. Generally, they last only two or three years.

It's a gloomy picture, all right, but jazz still has a few things going for it. It's much cheaper to produce than pop, and thanks to decades of neglect, even some of its top names can be had for a song. New labels have sprouted and survived after a fashion: Muse, Xanadu, Gramavision, and India Navigation in New York; Pablo, Concord, and Palo Alto on the West Coast; Timeless, Steeplechase, and HatHut, among others, in Europe and Scandinavia. These upstarts are rarely able to conduct business in the grand style they might wish, and their life expectancy is anybody's guess. But for the time being, they set the tone for jazz in the '80s, much as Blue Note, Prestige, Riverside, Contemporary, Atlantic, and Savoy set the tone in the '50s and '60s.

The feistiest and most prolific of the new independents are the Milan-based sister labels Soul Note and Black Saint. Producer Giovanni Bonandrini—padrone and

Francis Davis is a contributing editor of Musician magazine and writes about jazz for The Boston Phoenix.

sole arbiter of taste for both—came to New York earlier this year to talk sales strategy with his American distributors and to supervise recordings by a number of artists, including Archie Shepp, Jimmy Knepper, and Ray Anderson. We met at a Clifford Jordan and Barry Harris session. As he stood tapping his foot to a Harris piano solo, it was plain to see that this is a labor of love for him. Sooner or later, jazz seems to demand active participation from everyone who falls under its sway; to hear Bonandrini tell the story in his serviceable, Mediterranean English, his transformation from collector to producer was the logical consummation of an enduring passion.

A scholarly-looking type who did in fact teach French and English literature in Italian high schools for 25 years, Bonandrini began collecting 78s in the late Forties. Jazz remained a hobby, though, until 1974, when he pooled resources with four other investors to start IREC, a record distribution company that eventually came to represent over a hundred small American and European labels in Italy. Shortly before he retired from teaching in 1978, Bonandrini and his partners purchased Black Saint, a three-year-old Italian label with an adventurous international image and a checkered financial history.

At the time of sale, the label had a mere 13 releases in circulation. Six years later, the catalog has burgeoned to more than 60 titles, including landmark releases by David Murray, Muhal Richard Abrams, Anthony Braxton, Roscoe Mitchell, Leroy Jenkins, Sam Rivers, John Carter, and the World Saxophone Quartet. No label, foreign or domestic, has been more vigilant in tracing the movements of the post-AACM Chicago diaspora and the post-Coltrane New York avant-garde. But Bonandrini's interest in jazz does not begin with the avant-garde, nor have his contributions to the welfare of contemporary jazz ended there. "Giacomo Pellicciotti, who was in charge of production from the beginning and is now no longer with the company, wanted to go only in the direction of the avant-garde," Bonandrini explains. "He thought that to record mainstream artists like Billy Harper and Max Roach was to regress—Max Roach with Anthony Braxton was okay, you see, but not Max's quartet. I agreed with him that if you love jazz you follow its progress. But you also have to remember jazz is everything, from the beginnings on."

So one of Bonandrini's first moves after taking control of Black Saint was to launch a mainstream affiliate he christened Soul Note (in memory of Blue Note). With just over 60 releases to its credit since 1979, Soul Note has borne witness to the resurgence of hard bop, in addition to providing a badly needed outlet for such uncategorized mavericks as George Russell, Jaki Byard, Bill Dixon, Walt Dickerson, and Ran Blake. Bonandrini admits that the dis-

inction between his two labels is often fuzzy. "Many artists today, you take them into the studio with no way of knowing whether they will want to play bop or free." But the point is that in addition to nurturing revolutionary new talents, Bonandrini has also been ensuring that marginally more familiar yet scarcely less incendiary voices will not be ignored. Two years ago, he proved himself as shrewd a businessman as he is a talent scout, signing a worldwide distribution pact with Polygram that has resulted in greater visibility for his labels and his constellation of recording artists.

"I knew nothing about record production when I started, but I knew jazz," Bonandrini says. More important, he knew what he liked. There are producers who think of themselves as facilitators (Norman Granz, for example, or Blue Note's team of Alfred Lion and Francis Wolff), and those who think of themselves as *auteurs* (ECM's

"Musicians are skeptical by nature. They have good reason to be."

Manfred Eicher or CTI's Creed Taylor). Bonandrini counts himself among the former, which means that his productions are recognizable by their standard, not by their sound. While no one is likely to mistake a Soul Note or a Black Saint for a state-of-the-art recording, their evident lack of varnish belies the forethought that goes into them every step of the way.

First come the decisions: whom to record, when to record them, and where. "Musicians are skeptical by nature," Bonandrini points out, "and in dealing with record companies, they have had good reason to be." At first Bonandrini had to cajole artists into working with him; now that he has established a reputation as a square dealer, musicians approach him.

The last two decades have witnessed a proliferation of European import recordings by American jazz artists, as foreign labels have endeavored to take up the slack left by the demise of American independents. Many of these releases, particularly those from France and Italy, are poorly mastered, indifferently edited concert performances. Realizing that great concerts don't necessarily yield quality recordings, Bonandrini prefers studio dates, though he has released live tapes submitted to him by musicians whom he wanted in his catalog (usually with the tacit understanding that a studio date would follow at some unspecified point). Unlike many European producers, he

will not record a band at the beginning of a tour, before it has had a chance to hone its material. And with American musicians becoming less eager to play in Italy as the dollar value of the lira continues to plummet, Bonandrini works more frequently in the U.S.

In Milan, the engineer he swears by is Giancarlo Baragozzi, who meets the one prerequisite Bonandrini has for that job: some experience as a working musician. "He must be able to think like a musician in order to splice without interrupting the flow of the rhythm." Bonandrini admits his own knowledge of music is rudimentary, but claims that's no drawback to being a producer. "Artists will listen to your objections as long as you have sound reasons for them," he says. Matters such as sidemen and choice of material are discussed months in advance, and there is usually a rehearsal the day before—prudent measures overlooked by a surprising number of his peers. He's not easily persuaded to make "saleable" records, either. Owners of small jazz labels tend to be idealists these days, and artists often suffer their own quaint illusions about what the public wants; on two or three occasions, Bonandrini has had to dissuade musicians from recording material he deemed "too commercial." Yet he has never supervised a session that did not yield a release.

Such pragmatism is crucial: While Black Saint and Soul Note may qualify as the growth story of the '80s in the downscale world of jazz, they are still marginal enterprises in the larger scheme of things. Bonandrini's production costs per record range from \$7,000 to \$20,000 (studio time, advances for leaders and session fees for sidemen, covers, pressings, labels, graphics, and liner notes). Sales reach 3,000 to 7,000 copies worldwide, with North America accounting for no more than 30 percent of that paltry sum; five chartbusters have passed the 10,000 mark.

Although the affiliation with Polygram will no doubt increase American penetration, it also entails compromise: The conglomerate has persuaded Bonandrini to stagger his release schedule here in order to allow more time for promotion. As a result, some titles are now available in Europe and Asia months before they reach the U.S. And one of Bonandrini's artists (unofficial sources say it's David Murray) is under exclusive contract to him because Polygram would not flex its promotional muscle without such an arrangement.

Clearly, no one is getting rich from Soul Note or Black Saint, not the artists who record for the labels (they draw 6 percent royalty of list price on every unit sold—roughly sixty cents), nor Bonandrini himself. But the first function of music is pleasure, not profit, and the pleasure of taking matters into your own hands to document the music you love is inestimable. At (Continued on page 102)

Reviews

**Joan Jett and the Blackhearts:
Glorious Results of a Misspent Youth**
Kenny Laguna & various producers
Blackheart/MCA 5476

Joan Jett opens her fourth LP, "Glorious Results of a Misspent Youth," by reviving the Runaways' nasty-girls anthem, *Cherry Bomb*, a song that will be forever notorious (in my mind, at least) as the TV movie theme from *Dawn: Portrait of a Teenage Runaway*, in which Eve Plumb of *The Brady Bunch* got down-and-dirty. It doesn't merely serve as a tongue-in-cheek reminder of Jett's prefab rock band past, though. *Cherry Bomb* describes the once and future Joan: She has never really changed, she simply breathed real life into her tough-chick role.

The Runaways were a cartoon vision of bad-seed glamour, a collision of glitter and punk concocted for profit by L.A. would-be trendmaker Kim Fowley that also launched the checkered careers of Cherie Currie, Dyan Diamond, and Lita Ford. After she abandoned the group, Jett kept the aggression, as well as the leather, and developed an earthy humor and a repertoire of her favorite golden oldies to create a hard-playin', hard-partyin' style. She made it seem as if avoiding sex-role clichés was no sweat. This scrappy approach lent her one major hit, *I Love Rock 'n' Roll*, an authority and conviction it would not have contained had it been sung by a man; she turned a routine bit of pop boosterism into nothing less than an act of defiance.

Jett steadfastly stuck with her fresh-out-of-the-garage formula after her initial brush with the big time, and "Album," the followup to the best-selling "I Love Rock 'n' Roll" LP, was something of a commercial flop (although her rambunctious version of Sly Stone's *Everyday People*, released as a single, should have been huge). Jett is less of a purist, however, than an artist still hell-bent on pop stardom who insists on doing it her way. That never-say-die persona has made her successes seem hard-earned and her failures somehow noble.

Her way, on "Glorious Results," is once again a blend of classic covers, including the requisite Gary Glitter number (*I*



Joan Jett: No Sweat

LAURA LEVINE

Love You Love Me Love), and cranky originals usually co-written with Jett's longtime producer and mentor, Kenny Laguna. Since her debut, "Bad Reputation," some things *have* changed: Her voice, though never exactly ingenuous, is more of a rough-edged sneer; her arrangements are now closer to early-Seventies Rolling Stones than late-Seventies Ramones; her own material, while as gutsy as ever, feels more labored—and Laguna, perhaps hedging his bets after "Album," has enlisted the help of several market-tested coproducers. But the spirit remains the same. Like the twisted-sister lyrics of *Cherry Bomb*, "Glorious

Results" is a love-it-or-leave-it proposition that ultimately sounds more inviting than threatening.

Some of Jett's best moments here are the most potentially ridiculous: her broad, delinquent-with-a-heart-of-gold delivery of *Hold Me*, touching almost in spite of itself; her affectionate trashing of Dion's *I Need Someone*; her half-hearted attempt at supplying a moral to her life story, *I Got No Answers*. Then there's the sly giggle on *Love Like Mine* that precedes a rehashing of the details of her bad reputation; her confession on *Frustrated* that "I wake up in the morning and reality really blows"; and the wonderfully silly clap-and-dance-along, *Push and Stomp*, during which it's impossible to remain seated. It's only rock and roll—but she likes it. MICHAEL HILL

For additional reviews of Pop and Jazz music on videodisc and Compact Disc, see NEW TECHNOLOGIES.



ANN FISHER/RETNA

King Sunny Ade: 16 solos at once

King Sunny Ade: *Aura*

Martin Meissonnier & King Sunny Ade, producers. Island 90177-1

My initial response to the modern touches of King Sunny Ade's third American release, "*Aura*," was that the snake had snuck into the garden again, defeating the pure, sweet allure of Ade's juju orchestrations. This reaction was largely due to the presence of Stevie Wonder's grainy harp and the incorporation of some hip-hop rhythms on the title and opening cut. A more thorough listening left me disabused, however. I've also found staccato, Meters-like clavinet licks and a choral refrain on *Oremi*, a string-popping, soft-funk guitar figure of *Iro*, and myriad synth whines, squiggles, and scratches, but these bits of sound just surface and recede in Ade's richly detailed, densely layered concoction.

Ade orchestrates his 16-piece band for sound and choreography. Though the multiple meters and cross drumming give the impression that everyone is soloing at once, an irresistible, danceable inner pulse always comes through. Sometimes the anchor is the throb and wobble of the talking drums (which seem to grunt and gulp out rhythms), as on the surging, down-home, call-and-response chants of *Ire* or on the plaintive, nearly a cappella *Ogunja*. Elsewhere the five guitars carry the pulse, playing complementary and interlocking rhythm and lead lines in distinctly different pitches, as on the high-steppin' jam *Gboromiro*. On any song, Ade may intersperse phrases of loopy steel guitar, handclaps, and even solo vocal breaks, but every move reinforces the rhythmic impetus.

"*Aura*," perhaps more so than the hooky, Balkanized "*Synchro System*" or the more open-ended best-of introduction, *Juju Music*, reflects the sophisticated, all-encompassing cosmology of the Yoruba. The music is thoroughly eclectic, simultaneously inferring Africa's position as a source for both Afro-American and Afro-American-derived styles. DON PALMER

George Cromarty: *Wind in the Heather*

George Winston, producer
Dancing Cat DC 3001
(distributed by Windham Hill)

Pianist George Winston is the star of Windham Hill Records, the acoustic music label of the '80s. "*Wind in the Heather*" introduces his own subsidiary label, and it's easy to hear why he coaxed George Cromarty out of semiretirement for this auspicious debut. They met in the early '70s when both were associated with guitarist/archivist John Fahey's Takoma Records; Cromarty shares Fahey's love for the instrumental folk tradition. But where his mentor sometimes reveled in the music's melancholic possibilities, Cromarty (on nylon-string guitar) projects a wistful, lightly bittersweet sound, his innocent grace only slightly camouflaging his formidable technique.

Cromarty's style is stripped-down, melding Spanish classical, French romantic, Brazilian, and American folk influences—with melody always up front. On *Bittersweet*, he cycles a phrase through major and minor sections, and these harmonic changes form scenic, almost seasonal, backdrops to the song's keening melodic line. The spare beauty of *Satie*, a delicate waltz, evokes the French composer in spirit and Gallic folk themes in substance. On *Laurindo*, Cromarty's homage to the South American guitarist, the rhythmic inflections are his own, his impressions of Almeida more painterly than photographic.

Music this well executed often veers perilously close to being pretty aural wallpaper. But Cromarty conveys his emotion throughout, allowing virtuosity to serve expression and not the other way around. His simplicity is deceptive; on the Mexican-flavored *Angelique*, he changes timbre and vibrato in successive verses, gliding easily from sing-song to florid passion. While not as innovative or wide-ranging as Fahey, Leo Kottke, or Ry Cooder, Cromarty certainly ranks among them as one of the more gifted nouveau-traditionalists playing acoustic guitar today. CRISPIN CIOE

The Hoodoo Gurus: *Stoneage Romeos*

Alan Throne, producer
A&M SP 5012

As I write, "*Stoneage Romeos*" is the No. 1 album on American college radio. Australia's Hoodoo Gurus would seem to be tailor-made for that self-congratulatory medium: They're kinda weird without being really weird, they're just pop enough to sell themselves, and they're chock full of smug references to glitter, garage rock, and cheesy rockabilly.

Proud pirates, the Gurus seem to plunder the corpse of rock and roll with some wit and a decent eye for the choice meat. At its weakest, their music is still bouncy, sol-

id, crooning pop-rock; and when they find their groove, they can whip up a rich acoustic/electric churn with a nice rhythmic wallop. Heck, it's practically punk. And that's cool, too, but . . .

Each one of these songs sounds a lot like something that came out of punk and postpunk between 1976 and 1980. Every little nuance, every stroke of the guitar and trick of the voice, every element of style belongs to someone else. Strangely, the group's sources are pretty narrow: We're mostly hearing an accurate synthesis of the Saints (Australian punk pioneers, c. 1976, and absolutely legendary down under) and Generation X (great Anglos who will forever be praised or damned for spawning Billy Idol). It's clear that the Gurus know their Rezillos, Count Bishops, and Original Mirrors records, too. That's still no big deal; it tells us that they have good taste, but . . .

The Gurus are taking advantage of our ignorance: They're putting one over on a public that, for the most part, doesn't share their esoteric tastes. Outwardly, they only acknowledge American kitsch icons, coming on as garage revivalists who have found a cool twist; but in fact, they have digested a slim period of English and Australian punk, sweetened it up a bit, added a little camp and corn, and passed it off as their own.

Sure, that stinks—yet, in a way, I'm almost happy to see someone do this. Most new guitar-based pop music pointlessly imitates R.E.M. or U2. The Hoodoo Gurus have chosen a great, unheralded period to emulate—okay, rip off—and they do it damn well. I even occasionally detect some real soul in their stuff, especially on *My Girl* and *Arthur*. It's just that . . . it's one thing to rip people off for a laugh; it's quite another to do it and hope people don't notice. TIM SOMMER

Rickie Lee Jones: *The Magazine*

Rickie Lee Jones & James Newton
Howard, producers
Warner Bros. 25117-1

Unfortunately, Rickie Lee Jones really set herself up for comparison by making such a stunning debut in 1979. Her second album, "*Pirates*," was unevenly written, yet flowed conceptually; "*Girl at Her Volcano*" was inconsequential not because it was an EP, but because it lacked originals. "*The Magazine*" tops "*Volcano*," but it's an erratic, jumbled anthology. Even the songs that work sound like they don't belong on the same album. Concerted mood-altering begins with *Prelude to Gravity*, an overlong instrumental where lush strings and Jones's piano usher us into her cast of cops, carnivals, jukeboxes, boy-friends, and "bad" girls who run through the night setting fires. But what is Jones setting up?

On the boppy *Juke Box Fury*, little girl lost switches into her trademark slur. *The Real End* finds Jones rocking out with her

characteristic harmonic send-offs. Another winner for its clever vocal overdubbing is the punch *Gravity*, whose phrasings recall Laura Nyro. However, on "The Magazine" Jones has dropped her stable of male backup vocalists, adding the layers herself. *The Real End*, with its rehashed *Chuck E's in Love* riffs, is hit-song material, but I hope no one takes the lyrics too seriously. "Maybe a woman just acts like that," she sings, dismissing her unkind treatment of a boyfriend; her traditional role-posturing is beginning to get on my nerves.

These three successful cuts have little in common with Side 2's dabbings on the three-part *Rorschachs*. *Theme for the Pope*, in which Jones's la-la-las dance through delicate guitar and mandolin, could be background scoring for a film romance. This rhapsodic departure precedes *The Unsigned Painting*, where Jones's wispy, poetic voice talks over her eerie, spacey synthesizer in a mixed media piece that crosses poetry and music more directly than on previous albums, portending new directions.

The title cut and *Deep Space* try hard, but neither ballad comes near the poignancy of *The Last Chance Texaco* or *Company*. *Runaround* has a pseudo c&w air, more suited for Ronstadt than Jones, and *It Must Be Love* is a throwaway. It's about fifty-fifty for Jones this time around. After four albums, I'm getting impatient with someone who originally showed such promise.

KATE WALTER

**Lee "Scratch" Perry:
History, Mystery & Prophecy**
Lee Perry, producer
Mango MLPS 9774

Though Jamaican Lee Perry was a recording artist in the Sixties, it was as producer and co-writer of some of Bob Marley's most potent early tracks that he rose to prominence. "History, Mystery & Prophecy," as modern-sounding as the latest record out of the South Bronx, does maintain the feel of early reggae. That's not the only reason I like it, however. I like it because it's also the horniest reggae album in years.

Sure, it delves into a little history, a little mystery, and a little prophecy. But we're talking about a man who, on *Mr. Music*, finds the blue sky "sexy," who defines a *Nice Time* as "rockin' all night" and little more. And I won't even try to get away with quoting the gleefully vulgar lyrics from *Bed-Jamming*.

As a singer, Perry is most influenced—probably too much so—by Marley, though *Nice Time* does evolve into a goofy Marley-meets-Louis Armstrong vocal. As his own producer, Perry has brought together the sounds of early reggae and contemporary street funk seamlessly. Though he initially appears to have little of the

OPEN SUNDAY 10-5

FOR CUSTOMER SERVICE & INFO
CALL (718) 387-7770

Store Hours: Mon - Thurs: 9 to 6; Fri: 9 to 2; Sun: 10 to 5; Sat: closed

\$CALL = UP TO 50% OFF SUG. RETAIL!
DEC. SPECIAL • T-120 CASSETTES \$5.19 • HI-GRADES \$7.49

SINCE 1970 BEST PRICES & SERVICE 1-800-223-6779 TOLL FREE OUTSIDE N.Y.S.		
VCR'S (VHS) PANASONIC PV 1225 349.00 PANASONIC PV 1231R 405.00 PANASONIC PV1530 549.00 PANASONIC PV1830 639.00 PANASONIC PV1730 \$ CALL PANASONIC PV5800 (port) 639.00 PANASONIC PV8800 (port) 799.00 PANASONIC PV8110 (port) \$ CALL PANASONIC PV8500 (port) 969.00 PANASONIC PV8900 (hi-fi) \$ CALL JVC HRD220 479.00 JVC HRD225 535.00 JVC HRD120 408.00 JVC HRD725 (hi-fi) \$ CALL JVC HR5 100 (port) 759.00 SHARP VC481 349.00 SHARP VC365 469.00 SHARP VC368 809.00 SHARP VC 462 399.00 SHARP VC465 499.00 SHARP VC489 (hi-fi) 899.00 SHARP VC365AGB (system) 639.00 RCA VKT275 \$ CALL RCA VKT300 \$ CALL RCA VKT400 \$ CALL RCA VKT550 (hi-fi) \$ CALL RCA VKT650 \$ CALL RCA VKP170 (new wireless rem port) \$ CALL RCA VKP900 \$ CALL RCA VKP950 (port hi-fi) \$ CALL QUASAR VHS041 \$ CALL QUASAR VHS145 \$ CALL QUASAR VCS245 \$ CALL QUASAR S645 (hi-fi) \$ CALL QUASAR VCS645 \$ CALL	QUASAR VP5230 \$ CALL QUASAR VP5435/VA540 \$ CALL QUASAR VP5747 (hi-fi port) \$ CALL HITACHI VT33A \$ CALL HITACHI VT34A \$ CALL HITACHI VT35A \$ CALL HITACHI VT36A \$ CALL HITACHI VT88A \$ CALL HITACHI VT89A \$ CALL HITACHI SP \$ CALL HITACHI 8P \$ CALL G.E. IVCRS002X \$ CALL G.E. IVCRS003X \$ CALL G.E. IVCRS010X \$ CALL G.E. IVCRS011X \$ CALL G.E. IVCRS014X \$ CALL G.E. IVCRS018X (hi-fi) \$ CALL G.E. IVCPS028X (port) \$ CALL G.E. IVCPS028X (port) \$ CALL NEC VCN831 409.00 NEC VCN833 529.00 NEC VCN895 (hi-fi) \$ CALL MINOLTA VT70 (port) \$ CALL VCR's (BETA) SANYO VCR4600 245.00 SANYO VCR4650 299.00 SANYO VCR4670 399.99 SANYO VCR4750 519.00 SANYO VCR7200 (hi-fi) 479.00 SONY SL2200 299.00 SONY SL2005/TT2005 (port) 499.00 SONY SLFM300 (hi-fi) 575.00 NEC VCN20 325.00 NEC VCN40 425.00 NEC VCN739 (hi-fi) \$ CALL	CAMERAS (VHS) PANASONIC PK558 639.00 PANASONIC PK958 759.00 PANASONIC PK975 \$ CALL PANASONIC PK410 459.00 PANASONIC PK450 569.00 JVC GKN70 759.00 JVC GKN7 639.00 RCA CKC017 \$ CALL RCA CKC018 \$ CALL RCA CKC019 \$ CALL RCA CKC020 \$ CALL RCA CKC021 \$ CALL G.E. IVCRS039E \$ CALL CAMERAS (BETA) SANYO VCR100 869.00 SANYO VSC800 (auto focus) 939.00 SONY BMC110 949.00 SONY BMC220K \$ CALL SONY HVC2500 899.00 SONY HVC2800 999.00 WE ALSO CARRY A FULL LINE OF BRAND NAME CASSETTES, TRIPODS, DUST COVERS, LENSES, FILTERS, HEAD CLEANERS AND OTHER VIDEO ACCESSORIES AT MAJOR SAVINGS! TV'S & MONITORS PANASONIC TR1030P 129.00 PANASONIC TR4060P 145.00 SONY KV4100 (4 in. col.) 339.00 SONY KV5300 (5 in. col.) 399.00 RCA EKR338 235.00 PLUS DOZENS MORE—TOO NUMEROUS TO LIST!

S n W

ELECTRONICS & APPLIANCES
NOW IN OUR 15th YEAR!
187 Ross St • Brooklyn, NY 11211

Master Charge, Visa & C.O.D.'s accepted; credit card accounts charged at time of order. Add shipping, handling & insurance. Prices subject to change without notice. We are not responsible for typographical errors.

WE DELIVER SAVINGS

WDS

WISCONSIN DISCOUNT STEREO
2417 w. Badger rd madison wi 53713

<p style="text-align: center;">SANYO DAD8</p> <p style="text-align: center; font-weight: bold; font-size: 1.2em;">CLOSE OUT \$299</p> <p style="text-align: center;">Digital Audio Disc</p>	<p style="text-align: center;">SANYO 4650</p> <p style="text-align: center; font-weight: bold; font-size: 1.2em;">Wireless Remote \$292</p> <p style="text-align: center;">Cable Ready Front Load 7-Day</p>	<p style="text-align: center;">SHARP RT-1010B</p> <p style="text-align: center; font-weight: bold; font-size: 1.2em;">NEW 1985 MODEL \$159</p> <p style="text-align: center;">High Speed Dubbing Deck</p>
<p style="text-align: center;">Sansui Z-5000</p> <p style="text-align: center; font-weight: bold; font-size: 1.2em;">CLOSE OUT \$235</p> <p style="text-align: center;">75 Watt/Channel</p>	<p style="text-align: center;">JENSEN 3033</p> <p style="text-align: center; font-weight: bold; font-size: 1.2em;">\$79</p> <p style="text-align: center;">6x9 Triax II</p>	<p style="text-align: center;">Sansui DA & 55 Floor Standing</p> <p style="text-align: center; font-weight: bold; font-size: 1.2em;">3-Speaker System \$45</p>
<p style="text-align: center;">AIWA CAW20</p> <p style="text-align: center; font-weight: bold; font-size: 1.2em;">\$329</p> <p style="text-align: center;">Dubbing Portable Stereo</p>	<p style="text-align: center;">Clarion 4700</p> <p style="text-align: center; font-weight: bold; font-size: 1.2em;">with 75 watt/ch. Amp. \$149</p> <p style="text-align: center;">COMPLETE PACKAGE</p>	<p style="text-align: center;">SHARP GFA-2</p> <p style="text-align: center; font-weight: bold; font-size: 1.2em;">\$99</p> <p style="text-align: center;">3-Piece with Graphic Equalizer</p>

★ These are just a few of our Monthly Specials. Call!!
 ★ One of the oldest mail orders in the country.
 ★ Best consultants in the business
 ★ Most orders shipped within 48 hours
 ★ Call about our famous Buyer Protection Plan
 ★ CALL FOR PRICES ON OTHER SPECIALS. CALL

TOLL FREE 800-356-9514
 or Call 608 271-6889
 Weekdays 9-9 Saturdays 10-6

DECEMBER 1984

93

Strange Birds

Reviewed by
Crispin Cioe

**The Orioles (featuring Sonny Til):
For Collectors Only**

Murray Hill M 61277 (five discs)

The Best of the Orioles, Vols. 1 & 2
Murray Hill M 61234, 61242

The Cadillacs: For Collectors Only
Murray Hill M 61285 (five discs)

The Best of the Cadillacs, Vols. 1 & 2
Murray Hill M 61250, 61269

The Best of the Dramatics
Stax MPS 8526

The Best of the Temprees
Stax MPS 8524

THEY HAVE ALMOST disappeared from the charts today, but for nearly three decades male rhythm-and-blues vocal groups were a staple of pop music life. Drawing on sources as varied as gospel, barbershop quartet harmony, and jazz, they managed to cover a much wider emotional range than solo singers. They were the Greek chorus of postwar America.

Except to faithful believers, however, the early doo-wop groups, as epitomized by the Orioles, and their rock and roll successors, such as the Cadillacs, are largely unknown. So perhaps it's best to begin this roundup with the more familiar (and primarily gospel-influenced) '60s groups. Two Stax retrospectives reflect that Memphis label's orientation as "soul music" incarnate—the successor to rhythm and blues.

The Temptations were the last great group of this period, dominating the charts between 1964 and '73 with their ferocious harmonies and drive. One of the few groups to emerge from their shadow was the Dramatics, also a Detroit-based quintet; after toiling several years, they scored in 1971 with *Whatcha See Is Whatcha Get*. Announcing its Latin-tinged funk groove, Ron Banks sings, "Some people are made of plastic, you know some people are made of wood." Then, after citing several paranoid forms that human life can take, he assures his girl, "Baby, I'm for real. . . ."



Orioles (l. to r.) Sonny Til, Johnny Reed, Tommy Gaither, George Nelson, and Alexander Sharpe were the epitome of laid-back cool in 1948.

The song's manic but controlled energy helped define early '70s soul, giving the Dramatics an identity they unfortunately could never sustain. But this "Best Of" LP has several strong, rhythmic cuts, as well as the transcendent *In the Rain*.

Not surprisingly, an equally popular and totally dissimilar type of vocal sound also evolved during this time—the falsettoed singing of such groups as the Philadelphia-based Stylistics and the Delphonics. Stax's entry into this field was a trio called the Temprees, whose vocals were superbly tight and well executed. Though they never assaulted the charts with their wafting style, the Stax retrospective—which features an unusual, moving version of the '50s chestnut *Dedicated to the One I Love*—will undoubtedly be valuable to fans of high harmony. The Temprees obviously deserved better than they got.

The high energy of the '50s doo-wop groups was key to rock and roll's formative years. Groups named after cars became the rage thanks to the hit *Speedo*, a frenzied charger by the Cadillacs. Earl Carroll's nasal delivery helped define doo-wop; the group's precision choreography and string of seminovelty hits also were trendsetting. "The Best of the Cadillacs" contains all their recordings through 1958 plus several previously unreleased sides. Some are ballads, like their first hit, *Gloria*, but more often their sizzling tracks spotlight celebrated studio musicians—guitarist Mickey Baker and sax titans King Curtis and Sam "The Man" Taylor, for example.

But there was only one original doo-wop group. The Orioles blended church and street singing, and mixed jazz and r&b; "The Best of the Orioles" (19 previously unissued tracks plus all their hits and impor-

tant releases) documents this quintet's strange beauty. Originally from (where else?) Baltimore, they first attracted attention as regular performers at Harlem's Apollo Theater, and their debut single, *It's Too Soon to Know*, was a big r&b hit in 1948. The song established a new sound that remained popular with a young, urban, black audience for several years. A sparse, lonely-sounding guitar the sole accompaniment, it begins with heartfelt, four-part "oh"s as Sonny Til asks, with a rare combination of ineffable sadness and outright sexual longing. "Am I the fire or just a flame?" The Orioles were the epitome of laid-back cool; even their stage show, calculated to drive girls wild, centered on Til's slow gyrations and dramatically suave gestures. As their technique developed, *Crying in the Chapel* became a huge crossover hit in 1953, although Til's deliberately pristine delivery on this weeper isn't nearly as appealing as his lazy, offhand phrasing on almost every other ballad. *Please Give My Heart a Break* reaches the zenith of this style as Til tosses off the line "You've become in-diff'rent" with an insouciance that borders on sleep; his voice melts like butter in a skillet.

The two "Best Of" LPs don't feature uptempo material as extensively as the boxed five-record set, which contains several unreleased classics of primeval rock and roll at its peak, especially the near-salacious stomper *Good Looking Baby*. The Orioles are a rare, half-forgotten jewel from the fast-fading era of *film noir*, a must-see for anyone interested in a musical counterpart to those private, intense readings of postwar America.

(Murray Hill Records's address is 1 Park Ave., New York, N.Y. 10016.) **HF**

(Continued from page 93)

finesse of, say, Sly and Robbie, or little of the experimental bent of a Black Uhuru, his fusion ultimately sounds more natural—and more sensual—than anyone else's work in this area. Perry has his own brand of subtlety. That synth washing under the beat on *Mr. Music* is obvious enough, but is the exploding noise that punctuates the melody yet another synth, or is it a fuzz guitar? How does he get that trademark drum sound that resembles a loosely tuned snare with sand in it being slapped lazily on the off-beat? And on *Daniel*, how did he ever build such a fat, throbbing groove out of so few instruments?

Answers will undoubtedly remain a secret between Perry and his beat box. But none of the new technology prevents the man from summoning up reggae's pre-Rasta spirit of the '60s, when it had to be party music before it could be anything else. I'd rate this LP alongside the angry, ambitious polemics of Linton Kwesi Johnson's "Making History" as reggae album of the year. You couldn't ask for two more dissimilar sets, but they're like opposite sides of the same coin.

JOHN MORTHLAND

**Richard Thompson:
Small Town Romance**
Hannibal 1316

Richard Thompson's personal life has been well documented in lyrics of regret and release; most recently, several songs on "Hand of Kindness" revealed the breakup of his marriage and singing partnership with Linda Thompson. "Small Town Romance" was recorded in 1982 during solo appearances at Folk City and The Bottom Line in New York. In 14 songs sparsely performed on acoustic guitar, Thompson sings more plainly than ever of the conflicting impulses that would result in the breakup, building a portrait of his pain and pleading his case. And in reworking these old songs for solo performance, he provides a few insights into his ambivalence about leaving.

Opening with *Time to Ring Some Changes* and pacing through *Beat the Retreat* and *For Shame of Doing Wrong* ("I

wish I was a fool for you again"), Thompson expresses his own disappointment at the failure of love to hold fast, his wish to wipe away time and history and, most of all, their divisiveness. In *Love Is Bad for Business* and *Don't Let a Thief Steal Into Your Heart*—two cautions against giving over to a new passion, uptempo numbers underscoring the paradox that love contains its own defeat—he admits his own helplessness and the possibility of a new love burning itself out. The transitional sound of his music here—his band's familiar rhythms and traditional, rolling folk riffs thinned here to alternating bass lines, bluesy chords, and a filigree of harmonic doubles—hints that Thompson is between a love made of history and a love made of exploration. There is enough release on "Small Town Romance" to help him, and us, move on to a new beginning.

LESLIE BERMAN

U2: The Unforgettable Fire
Brian Eno & Daniel Lanois, producers
Island 90231-1

U2's declaration of "War" last year was a breakthrough for the Irish quartet. The record's stirring antiwar and Christian love anthems had never been more powerful. And the group was clearly seen as the prototype for guitar bands such as Big Country and the Alarm, who sold a back-to-basics sound with an upbeat message. Too good and too quirky to be so conveniently typed, however, U2 drew on its inherent progressive inclinations and called up oblique strategist Brian Eno to produce "The Unforgettable Fire."

The input of Eno and his current partner, Daniel Lanois, is more substantial to U2's music than studio ace Steve Lillywhite's was: They're credited with "vocals, instruments, and treatment." To maintain the sense of space essential to U2's interplay, such an addition means a subtraction of some other elements—in this case, the contributions of guitar hero Dave "The Edge" Evans. His scorching riffs, which dominated "War," are doused on most of "Unforgettable Fire"; while that leaves ample room for his subtler side, the

U2's current flirtation with mysticism obscures their solidness as a quartet.



rich acoustic
Loudspeaker Systems

MONITOR SERIES
STATE-OF-THE-ART
TECHNOLOGY, PERFORMANCE
AND STYLE



THE MODEL 9B
STUNNING CRAFTSMANSHIP

Rich Acoustic Loudspeakers offer the finest in performance as well as style. Visit your Rich Acoustic Authorized Dealer and audition the Model 9B.

For the first time, you can enjoy the full sonic potential of your stereo system, with proper tonal balance and a convincing stereo image experienced throughout the entire listening area.

See us in Las Vegas at the WCES — Riviera Hotel, Suites 470-472. Dealer inquiries welcome.

DIGITAL DISC READY

Return coupon for more information.

Name _____

Address _____

City _____ State _____ Zip _____

Rich Acoustic Labs, Inc.
2401 Ross Clark Circle
Dothan, AL 36301

result is that too many tracks lack the solid base he once provided.

Singer/lyricist Bono Vox's allusive-ness compounds this problem. In the standard pop construction of the glorious single, *Pride (In the Name of Love)*, U2's ideas and sound match the group's finest recorded moments—in fact, all of Side 1 stacks up well. The flip, however, is another

story. It feels like an extended elegy (ending with references to Elvis Presley and Martin Luther King, Jr., whose loss is more keenly felt in *Pride's* lyrics than in this epilogue), but achieves no gripping musical momentum. Bono's muddled mysticism furthers the album's sense of disunity, of missed connections.

Like "October," U2's 1981 followup

to its stunning "Boy" debut, "The Unforgettable Fire" is vinyl evidence of a band in transition. If much of the album is as out of focus as the photo on the inner sleeve, U2 remains, on the strength of Side 1, the most instrumentally articulate outfit operating in rock. Maybe next time they can find the spark to make a new conflagration truly unforgettable.

WAYNE KING

Jazz

Abdullah Ibrahim (Dollar Brand): Zimbabwe

Horst Weber & Matthias Winkelmann, producers. Enja/Polygram Classics 4056

Abdullah Ibrahim (Dollar Brand): Autobiography

Plainisphere & Abdullah Ibrahim, producers. Plainisphere PL 1267-6/7 (two discs)

South African pianist and soprano saxophonist Dollar Brand has one foot in his homeland and the other in the U.S.A.; he has no problems moving from a traditional vamp to a Broadway standard. Which, of course, is a major part of his appeal: He proves you can love Cole Porter and Gus Kahn and still be African.

On "Zimbabwe," a quartet date featuring reedman Carlos Ward, Brand adapts most of his original material from folk melodies. He then adds Western harmony, enlivening each song with unexpected instrumentation and musical references. *Kramat's* charming melody is scored for the striking combination of soprano sax, flute, and bowed bass; the piano ostinato Brand later brings in is so gospel-coated it could have come from Ray Charles. The title track uses a funky and infectious backbeat to offset a haunting melody line, achieved by staggering the three lead instruments. Every risk Brand takes as an arranger pays off.

Although it may seem politically unfashionable, I must admit I enjoy listening to Brand's standard readings even more than his African songs. The solo piano rendition of Kahn's rarely played *Guilty* is stark and moving, the ghosts of Monk and Ellington dancing about the keys. The overdubbed piano-sax duet on *Don't Blame Me* is classic; I can't think of a comparable musician who is as fluent and distinctive on two such dissimilar instruments. And by turning *It Never Entered My Mind* into a dirge, Brand proves that his knack for off-kilter arrangements is pancultural.

Because of its variety of compositional sources and instrumental settings, "Zim-



Ibrahim: Africa and Cole Porter, too

babwe" is the perfect introduction to Brand. The sprawling "Autobiography," on the other hand, is for committed fans. During this concert, Brand reveled in his love of gospel music. His heavy touch and reliance on repetitious but swinging left-hand figures remind me of Ray Bryant, another jazz pianist whose black church roots are the marrow of his style.

Three sides are devoted to Brand's instantly accessible originals. These aren't stream-of-consciousness performances à la Keith Jarrett. Each lengthy selection is a self-contained composition that never drifts into rambling introspection. The ringer on this record is the side-long medley of songs by Ellington, Monk, and Billy Strayhorn and the album's only standard, *I Surrender, Dear*. Strangely, I found this homage to Brand's Western influences more self-conscious and less convincing than "Zimbabwe"'s counterparts.

Despite the LP's length and nearly consistent inventiveness, "Autobiography" is still a misnomer. Without a display of his talents as bandleader, this record misses an important part of the Dollar Brand story.

[*"Autobiography"* is available from New Music Distribution Service, Jazz Composer's Orchestra Association, Inc., 800 Broadway, New York, N.Y. 10012.]

STEVE FUTTERMAN

The Modern Jazz Quartet: Echoes The Modern Jazz Quartet, producers Pablo D 2312-142

The Modern Jazz Quartet broke up ten years ago and went through a series of tentative, brief reunions. Now, as "Echoes" documents, the four musicians are on the road nine or ten months a year, more certain than ever of their work and of their relationships to each other. John Lewis, Milt Jackson, Percy Heath, and Connie Kay had been together again for a year when this record was made. Refreshed, full of bounce and balance, they don't just pick up where they left off; they create what has become the idiomatic MJQ consonance of lines and rhythm.

Drummer Kay's rare, extended solo is essential to the structure, development, and color of *Sacha's March*, Lewis's charming snapshot of his son. (Lewis is still the dominant composer, though not by much.) Heath, who with Kay is the least likely soloist, gets top billing on *Watergate Blues*, an expertly supported exercise that might be more effective at half its length.

The Quartet has played Jackson's *Echoes* before, but never recorded it. The interplay of vibes and piano is fascinating, weaving through both solos to underline the group's full, pliant rhythm.

After 30 years, MJQ is now such an institution that everything it plays takes on an aura. But there is more than that to this collection. "Echoes" balances the musicians' range, individually and collectively; it is a statement celebrating their return.

JOHN S. WILSON

Maxine Sullivan: On Tour with the Allegheny Jazz Quartet

Joe Boughton, producer
Jump L 12-14 (Hermosa Record Sales,
P.O. Box 382, Hermosa Beach, Calif.
90254)

The repertoire and records of Maxine Sullivan, who resumed her career in the 1970s, could scarcely be called adventurous. Pos-



Sullivan: new assurance and rapport

sibly because she has had no steady accompanists, not even a regular pianist, she has stayed with a small core of songs. When an audience hopes to hear one of its favorites in concert, a limited repertoire can work well. But when the same songs turn up again and again on vinyl, interest is bound to dwindle.

"On Tour with the Allegheny Jazz Quartet" is the exception to this rule. Sullivan is still singing *The Lady Is a Tramp*, *I Thought About You*, and *As Long As I Live*, but she is much more relaxed, outgoing, and expressive. And her sameness is alleviated by the playing of this excellent quartet, which has almost half the album to itself.

The group was assembled by Joe Boughton for a five-day tour last March. (Boughton produces the annual Conneaut Lake Jazz Festival in northwestern Pennsylvania.) Only drummer John Von Ohlen has had wide exposure, playing with Woody Herman and Stan Kenton. But it is pianist Keith Ingham, Susannah McCorkle's accompanist for several years, who leaps out of this recording. His presence brightens every performance, allowing Sullivan to stretch out from those earlier, careful but mannered readings and sing with real assurance and rapport.

JOHN S. WILSON

Robert Watson and Curtis Lundy: Beatitudes

Robert Watson & Curtis Lundy, producers

New Note 1 (New Music Distribution Service, 500 Broadway, New York, N.Y. 10012)

Robert Watson and Curtis Lundy, former members of the Art Blakey and Betty Carter bands, respectively, should be steeped in the age-old tradition of jazz that swings. When they are joined by Mulgrew Miller and Kenny Washington, also former Carterites, the result is a no-frills, straight-ahead date. "Beatitudes" isn't marked by

WE SHIP ALL PHONE ORDERS WITHIN 48 HOURS

F O O C U S S

TELEVISIONS



- Pan 13 Color 229.95
- Pan 19 Color 218.95
- Pan 19 Color rmt cable ready 399.95
- Sharp 13 Color 189.95
- Sharp 13 remote 249.95
- Sharp 19 rmt 229.95
- Sanyo 12" B&W 59.95

SONY watchman POKET TV'S

- FD-20 124.95
- FD-30 w AM FM Stereo and Headphones 169.95
- FD-20 AEB 3 system Voyager for worldwide use 199.95
- FD-30A w AM-FM stereo radio and Headphones 159.95

Canon (PC) PERSONAL COPIERS

- PC10 - Perfect for Office or Home Compact uses Regular paper 489.95
- PC 20 Auto paper feed makes 8 copies a minute uses reg paper 689.95
- PC 25 Makes copies as large as 10 x 11 reduce by 67% to 78% enlarges up to 100% CALL

ANSWERING MACH.

- Records & Call 84.95
- 625 VOX Monitor 99.95
- 675 VOX Remote 144.95
- 690 VOX wSpecial Remote 144.95

VIDEO



Sharp VC 481 VHS Video w/rmt front load electronic tuner now only 329.95

EVERY VIDEO MACHINE IN STOCK PRICED BELOW COST

Parasonic SONY JVC Zenith RCA

COMPUTERS



COMMODORE 64 OUTFIT SYSTEM
COMM 64 KEYBOARD • COMM PRINTER • 12" GREEN MONITOR DATASET • PRINTER INTERFACE • MONITOR CABLE • FREE SOFTWARE
ALL FOR ONLY \$569.95

ATARI WORD PROCESSING OUTFIT
800XL COMPUTER KEYBOARD ATARI PRINTER • 12" GREEN MONITOR • ATARI DATASET MONITOR CABLE • ATARI WRITER
ALL FOR ONLY \$39.95

ALL PRICES IN THIS AD FOR MAIL ORDER ONLY

For information and FREE 10 day trial orders call (718) 871-7800. All items subject to availability and price changes. Mail and phone orders C.O.D. Money Order, Visa Accepted. Shipping handling extra.

Call Toll Free **1-800-223-3411**

CORDLESS PHONES



AT UP TO 75% SAVINGS

- Pacer 7800 1000 ft 49.95
- Pacer 7800 T T 59.95
- Pacer 7800 TD w 9 memory 98.95
- Pacer 8800 39.95
- Pacer 9800 Switchable w intercom 110-220V 98.95
- Sanyo TH 1015 110-220 V 700 ft 38.95

CASIO WATCHES

- J-30 Ladies Jogger 21.95
- J-50 Mens Jogger 24.95
- MQ 50 Water Sport Diver 29.95
- MQ 30Water Sports Diver 29.95
- CD 40 Data Bank 37.95
- TS 1001 Thermometer 31.95
- Div 5000 G Shock 44.95
- CL 30 Solar Calc 29.95
- AQ 340 Fancy ANA DIGI 29.95
- W11 Compass Watch 24.95

FREE

McIntosh STEREO CATALOG and FM DIRECTORY

Get all the newest and latest information on the new McIntosh stereo equipment in the McIntosh catalog. In addition you will receive an FM station directory that covers all of North America.



SEND TODAY!

McIntosh Laboratory Inc. HF1284
East Side Station P.O. Box 96
Binghamton, N.Y. 13904-0096

NAME _____
ADDRESS _____
CITY _____ STATE _____ ZIP _____

the fancy tempo changes, mood shifts, and orchestral aspirations of today's rightfully acclaimed gutbucket- and New Orleans-influenced nontraditionalists (David Murray, for one). Nor is it a mere re-creation of music from a bygone era. Instead, Watson and company are busy re-exploring some previously introduced ensemble forms to make them fresh, invigorating, and soulful without resorting to the clichés and pretensions of the grittier-than-thou brotherhood, as typified by Hank Crawford.

Altoist Watson's bright, compact tone and rhythmic finesse are feather-edged like Charlie Parker's and angular like Gigi Gryce's. He effortlessly skips through the registers of his instrument, slashing and elbowing his way with clean articulation. On Lundy's ballad *Orange Blossom*, Watson builds phrases incrementally, throws in



Watson and Lundy: smooth and swinging

a gospel inflection, and sustains notes to pinched, tart conclusions. On Lundy's arrangement of Gryce's *Minority*, he plays droopy, minor-key modulations over the insistent, unison stop-time of the rhythm section before transforming this exotic Sun Ra-ish melody into an uptempo smoker.

Pianist Miller complements Watson with fleet, economical lines that balance between the two-fisted bombast of the post-Tyner school and the overdone sentimentality of those who follow a more Tatumesque approach. In an introduction to Watson's caterwauling, breakneck, boppish alto on a *Giant Steps* spinoff, *E.T.A.*, Miller evokes the incantatory spirit of Coltrane's quartet. Lundy's smooth, vibrant tone and rhythmic variations combined with Washington's whacking, clatter-trap drumming buoy the soloists, nimbly responding to their improvisations.

There are weak spots on the album: The samba *Karita* lacks momentum, and the title cut, which shifts between an Afro-Carib waltz and a straight four, could benefit from a harder Watson solo. Nonetheless, "Beatitudes" is a fine example of ensemble playing from four solid musicians.

DON PALMER

U.S. Postal Service
STATEMENT OF OWNERSHIP, MANAGEMENT, AND CIRCULATION (Required by 39 U.S.C. 3685)

1. Title of Publication: High Fidelity
- 1B. Publication No.: 243820
2. Date of Filing: Sept. 26, 1984
3. Frequency of Issue: Monthly
- 3A. No. of Issues Published Annually: 12
- 3B. Annual Subscription Price: \$13.95
4. Location of Known Office of Publication: 825 Seventh Ave., New York, New York County, N.Y. 10019
5. Location of Headquarters of General Business Offices of the Publisher: 825 Seventh Ave., New York, N.Y. 10019
6. Names and Complete Addresses of Publisher, Editor, and Managing Editor:
 Publisher: Steven I. Rosenbaum 825 Seventh Avenue New York, N.Y. 10019
 Editor: William Tynan 825 Seventh Avenue New York, N.Y. 10019
 Managing Editor: Peter Dobbin 825 Seventh Avenue New York, N.Y. 10019
7. Owner: ABC LEISURE MAGAZINES, INC., 825 Seventh Avenue, New York, N.Y. 10019. (Sole stockholder: American Broadcasting Companies, Inc., 1330 Avenue of the Americas, New York, N.Y. 10019)
8. Known Bondholders, Mortgagees, and Other Security Holders Owning or Holding 1 Per Cent or More of Total Amount of Bonds, Mortgages or Other Securities: None
9. For Completion by Nonprofit Organizations Authorized to Mail at Special Rates: Not Applicable

10. Extent and Nature of Circulation	Average No. of Copies Each Issue During Preceding 12 Months	Actual No. of Copies of Single Issue Published Nearest to Filing Date
A. Total No. Copies Printed (<i>Net Press Run</i>)	443,583	464,736
B. Paid Circulation		
1. Sales through Dealers and Carriers, Street Vendors and Counter Sales	32,932	33,996
2. Mail Subscriptions	340,477	363,983
C. Total Paid Circulation (<i>Sum of 10B1 and 10B2</i>)	373,409	397,989
D. Free Distribution by Mail, Carrier or Other Means Samples, Complimentary, and Other Free Copies	1,815	1,157
E. Total Distribution (<i>Sum of C and D</i>)	375,224	399,146
F. Copies Not Distributed		
1. Office Use, Left Over, Unaccounted, Spoiled after Printing	7,470	5,152
2. Return from News Agents	60,889	60,438
G. TOTAL (<i>Sum of E, F 1 and 2—Should equal net press run shown in A</i>)	443,583	464,736

11. I certify that the statements made by me above are correct and complete. Signature and Title of Editor, Publisher, Business Manager, or Owner
(Signed) Steven I. Rosenbaum, Publisher

12. For Completion by Publishers Mailing at the Regular Rates: (Section 132.121, *Postal Service Manual*)
 39 U.S.C. 3626 provides in pertinent part: "No person who would have been entitled to mail matter under former section 4359 of this title shall mail such matter at the rates provided under this subsection unless he files annually with the Postal Service a written request for permission to mail matter at such rates."
 In accordance with the provisions of this statute, I hereby request permission to mail the publication named in Item 1 at the phased postage rates presently authorized by 39 U.S.C. 3626.
 (Signature and title of publisher)
 (Signed) Steven I. Rosenbaum, Publisher

**SEND FOR OUR NEW
FREE 40 PAGE
HI-FI DISCOUNT
CATALOG No. 65**

- Lowest prices on audio components!
- Fast service!
- Fully insured!
- In factory sealed cartons!

SOUND REPRODUCTION, inc.
(201) 227-6720

CLIP & MAIL TODAY!

Sound Reproduction, Inc.
7 Industrial Rd., Fairfield, N.J. 07006

Please rush your free Hi-Fi Discount Catalog

Name _____

Address _____

City _____

State _____ Zip _____

Moving?

Be sure and send us your new address 8 weeks before you move so you won't miss any copies of HIGH FIDELITY.

And please include an old mailing label from our magazine when writing us about your subscription.

Write to: HIGH FIDELITY,
P. O. Box 10759, Des Moines, Iowa 50340

Change of address.
 Enter new subscription. 1 yr. \$13.95
 payment enclosed bill me

Add'l postage: \$6 per year outside U.S., its poss.

AFFIX LABEL

If you have no label handy, print OLD address here

name _____ please print
 address _____
 city _____
 state _____ zip-code _____

New Address

name _____ please print
 address _____
 city _____
 state _____ zip-code _____

**FOR EVEN FASTER SERVICE
CALL TOLL FREE
1-(800)-247-5470**

G3031

High Fidelity Classified

MAIL TO: 825 7th Ave., 6th Floor, New York, N.Y. 10019. Phone: 1-800-ABC-MAGS. In New York call: (212) 265-8360 GENERAL: all copy subject to publisher approval. Users of P.O. Box MUST supply permanent address and telephone number before ad can run. CLOSING DATE: 1st of second month preceding cover date. 15 Word minimum No charge for Zip Code. CLASSIFIED RATES: regular type, per word: 1x—\$2.75; 3x—\$2.65; 6x—\$2.55; 12x—\$2.45. Words in caps—15c extra each. IMPERIAL type, per word: 1x—\$3.75; 3x—\$3.65; 6x—\$3.55; 12x—\$3.45. Words in caps—15c extra each. Minimum 15 words. Box numbers: \$3.00 additional per insertion to cover cost of handling and postage. Display, per inch: 1x—\$350; 3x—\$340; 6x—\$330; 12x—\$315. PAYMENT WITH ORDER: Send check, M.O., MASTERCARD or VISA No. and expiration date to: Cecelia Giunta Classified Dept., HIGH FIDELITY, 825 7th Ave., 6th Floor, New York, NY 10019.

For Sale

1-800-431-3232
specializing only in
cartridges + stylus + mics + headphones

B&O • audio-technica • AKG • Ortolon
Dynavector • Grace • PICKERING • Stanton
ADC • SIGNET • SHURE • Sennheiser

We quote pro advice - lowest price
24 Hr. Shipment on all our equipment
COD's are Okay - call us - ext 1, telax
P.O. Box 37, Brooklyn, NY 11204 (212) 438-6400

audioipn

SEE OUR ENLARGED AD IN THE MAIN SECTION.

HARMAN/KARDON, NAKAMICHI, CROWN, CARVER, HAFNER, THORENS, TANDBERG, REVOX, NAD, LUXMAN, DCM, DBX, ELECTRO-VOICE, VANDERSTEIN, AND OTHER QUALITY COMPONENTS, BEST PRICES - PROFESSIONAL SERVICE, EAST (904) 262-4000; WEST (818) 840-0878.

CALL US!! HARMAN-KARDON, PERREAUX, SAE, STAX, ADCOM, KEF, HEYBROOK, PYRAMID, AUDIO PRO, VSP LABS, HAFNER, NAD, AMBER, DENON, TANDBERG, ADS, DCM, CONRAD-JOHNSON, GRACE, DBX, PS AUDIO, OHM ACOUSTICS, GRADO, DYNAVECTOR, INFINITY, NITTY GRITTY, MONSTER ALPHA, AKG, CELESTION, AUTOMOTIVE, SONY, THORENS, KENWOOD, ZAPCO, CRIMESTOPPERS SECURITY, MORE! FRIENDLY, EXPERT CONSULTATION. FAST, FREE SHIPPING!! MC/VISA. REFERENCE AUDIO SYSTEMS, 18214 DALTON AVENUE, GARDENA, CA 90248. (213) 398-4205, (213) 391-2679.

Quality Tapes

THIS MONTH'S SUPER SPECIALS

SA 90	1.85	MA 90	4.19	UDXL II 90	2.09
SA 60	1.80	MA 60	3.89	UDXL II 60	1.85
SAX 90	2.69	HX-5 90 New	4.19	XL II 5 90	2.65
SAX 60	2.49	HX-5 60 New	3.89	MX 90	4.69
ADX 90	2.55	MAR 90	5.99	UD 90	1.95
AD 90	1.85	MAR 60	4.79	UD 60	1.85
AD 60	1.45	LX 35-90	4.79	LN 90	1.15
D 90	1.05	LX 35-90B	5.85	LN 60	1.05
D 60	.95	T-120	5.49	UD 35-90	4.89
HD-01 D'mag	13.49	T-120 Ex Hg	7.49	XL I 35-90B	6.39
				T-120	5.49
				T-120 HCX	7.49

SONY	FR METAL	FUJI	DISC WASHER		
UCXS 90	2.25	FR II 90	3.49		
LNK 90	1.05	FR II 90	1.99		
LNK 60	.85	TRAC	DISCKIT	33.95	
L-750	5.49	Reels in Casset	SYSTEM	9.99	
L-750 HG	7.49	CDC 90	Tape Care Set	11.49	
T-120	5.49	CRC 90	3.19	16 oz. Fluid	9.99

CALL NOW 718-434-3417 OR ORDER BY MAIL
in Continental USA add \$3.50 for shipping on orders up to \$70. Over \$70 add 3% of total order. Elsewhere in USA add \$7 on orders up to \$70. Over \$70 add 10%. Outside USA write. MC/VISA additional 3%.

QUALITY TAPES
884 East 7th Street, Dept. HP12, Brooklyn, NY 11230

PEOPLE WHO KNOW STEREO BUY THEIR SOUND DIRECT. Now you can buy the finest in High Fidelity components, including esoterics and autosound, at unheard of prices. DIRECT SOUND MARKETING provides sensible expert advice, in-house service facilities and factory fresh components on an in-stock basis. Discover America's best kept audio secret. Send \$1.00 for our informative catalog to DIRECT SOUND MARKETING, Dept. H, 3095 Bolling Way, Atlanta, GA 30305, or call 404-233-9500. M/C, VISA and AMEX accepted.

SHAMEFULLY LOW PRICES: Nakamichi, Quad, Grace, ETC. Serious Buyers Only. VISA/MC, COD. AudioWorkShop 1-206/323-4987, 1-206/323-2676

EXCEPTIONAL AUDIO REPRODUCTION SYSTEMS... REASONABLY PRICED!! E.A.R.S., P.O. BOX 658-H, WEST COVINA, CA 91790. 818/961-6158, EVENINGS, WEEKENDS. STAMP BRINGS MONTHLY SPECIALS. MC/VISA.

AUDIO PRO POWERED SUBWOOFERS. The Most Accurate Powered Subwoofer Available Today. Call For The Dealer Nearest You. Sonic Research, 27 Sugar Hollow Road, Danbury, CT 06810, (203) 792-8824.

Q. Are dbx Program-Route Selectors really the best switchers I can get?

A. Yes.

With the dbx 400X or 200X you can add up to three tape decks, three signal processors and a noise-reduction unit—and route them with push-button ease. What's more, they're affordable and attractive. Write for details. Better yet, visit your dbx dealer.

dbx®...High-Performance Options for Home Stereo Systems
dbx Inc., Dept. HSWL, 71 Chapel St., Newton, Mass. 02195 Tel. 617-964-3210



FACTORY ORIGINAL DIAMOND NEEDLES & PHONO CARTRIDGES. MOST POPULAR LINES AT DISCOUNT PRICES. FOR FREE CATALOG SEND SELF ADDRESSED STAMPED ENVELOPE. LYLE CARTRIDGES, BOX 69H, BROOKLYN, NY 11218. CALL TOLL FREE (800) 221-0906, N.Y. (718) 871-3303. VISA/MC.

SAVE 50% BUILD YOUR OWN SPEAKER SYSTEM. Write McGee Radio Electronics. 1901 McGee Street, Kansas City, Missouri 61408.

LOWEST POSSIBLE PRICES ANYWHERE! FULL WARRANTY-FAST DELIVERY AUDIO-VIDEO-CAR STEREO-COMPUTERS-SOFTWARE VIDEO GAME-TELEPHONE-MORE!! ELECTRIFIED DISCOUNTERS 996 ORANGE AVE., WEST HAVEN, CT 06516-MC/VISA 203-937-0106

ALL JAPANESE HIGH-END DISCOUNTED
America's Largest Selection
OVER 100 CARTRIDGES, 50 TONEARMS, 30 TURNTABLES, 100 ACCESSORIES, & MORE
40 PAGE CATALOG - \$3.00
JAPANESE STEREO
990 N. La Cienega Blvd.
Los Angeles, CA 90059 (213) 859-8550

CALL TOLL FREE 1-800-826-0520 FOR ACOUSTAT, DAHLQUIST, NAD, HAFNER, DENON, dbx, 3D, PROTON, TANDBERG, BELLES, ORACLE, M&K, GRADO, NITTY GRITTY, AUDIOQUEST, NEC, DUNTEC, MONSTER, SUMIKO PERREAUX, CWD, SNELL, B&W, DCM, THORENS, VSP, STAX, SOTA, GRACE, ASTATIC, DYNAVECTOR. THE SOUND SELLER, 1706 MAIN STREET, MARINETTE, WI 54143, (715) 735-9002.

BANG & OLUFSEN FULL LINE, ADS, B&W AND BOSE SPEAKERS AND OTHER QUALITY PRODUCTS AT REASONABLE PRICES. SOUNDCREST, INC., (201) 756-4858



A SINGER'S DREAM!

REMOVES VOCALS FROM RECORDS!
 Now You can sing with the world's best bands!
 The Thompson Vocal Eliminator can remove most or virtually all of a lead vocal from a standard stereo record and leave the background!
 Write or call for a free brochure and demo record.
LT Sound, Dept. HF, P.O. Box 338, Stone Mountain, GA 30086 (404)493-1258

THEY DON'T DISCOUNT IT? WE DO!
GET LOW PRICES ON ALL types of audio equipment—including high-end and even esoteric products not normally discounted! Now we can save you money on the equipment you REALLY WANT. Extensive selection—no need to settle for second choice.
 Thousands of satisfied customers nationwide. Call us for price quotes or friendly, expert advice. Catalog \$1. 616-451-3868. VISA/MC/AMEX. **THE AUDIO ADVISOR, INC., BOX 6202, Grand Rapids, MI 49506.**

CONVERSION, DUPLICATION VIDEOTAPES FOREIGN U.S., 8 M.M./VIDEO, 110-220 AUDIO, VIDEO, T.Vs, COPYING MACHINES. APPLE AUDIO, 74-18 37th Avenue, Jackson Heights, NY 11372, (718) 507-5800.

ALTEC-LANSING AND ELECTRO-VOICE Speaker Systems, E-V Speaker Components, Microphones. Low Prices. Rick Marder, (201) 561-8123.

NEW!!!! Stereo Wireless Headsets 35' Range Studio Quality Only \$80.00pp. Send MO to: WINDROSE, 633 Almond Street, Vineland, NJ 08360

NOTICE TO REVOX BUYERS: Unauthorized dealers are selling Revox products not designated for sale in the USA. **STUDER REVOX AMERICA CANNOT BE RESPONSIBLE FOR ANY WARRANTY SERVICING OF PRODUCTS SOLD BY THESE DEALERS.** For the location of your nearest authorized Revox dealer, call or write: **Studer Revox America, 1425 Elm Hill Pike, Nashville, TN 37210; (615) 254-5651.**

FREE ALBUMS
 IN EXCHANGE FOR YOUR OPINION.
 We need Record Raters. Your opportunity to build a substantial album collection. Small membership fee. Write **EARS, Dept. HF, Box 10245, Milwaukee, WI 53210.**

AMPEX PROFESSIONAL SERIES AUDIO TAPE SALE. High Quality Open Reel 1800' or 2400' on 7" Reels, Used Once. Case of 40, \$45.00. 10 1/2" x 3600' and Cassettes. **MC/Visa. Valtech Electronics, Box 6-H, Richboro, PA 18954. (215) 322-4866.**

RAVI SHANKAR MUSIC CIRCLE. Indian Classical Music Cassette Tapes, Records. Free Catalog. 7911 Willoughby Avenue, Los Angeles, CA 90046.

GOLDEN AGE RADIO—your best source for radio tapes. Free Catalog. Box 25215-J, Portland, Oregon 97225.

23,000 LP ALBUMS & 1500 78 RPM SETS FOR SALE. Send Wants List. Bernstein, Pine Valley Road, Oyster Bay, NY 11771.

PIXOFF BY SONIC RESEARCH. Dry Clean Your Records. No Messy Liquids. Call For The Dealer Nearest You. **Sonic Research, Inc., 27 Sugar Hollow Road, Danbury, CT 06810, (203) 792-8824.**

WE BUY AND SELL LIKE NEW LP's, PreRecorded Reel Tapes, Cassettes. Catalog \$2.50. Pre-Your LP's. Poly, Paper, Cardboard Jackets. Free Catalog. Record Care, Hillburn, NY 10931.

1930-1962 RADIO PROGRAMS \$1.00 HOUR! Informative 275 Page Catalog \$1.25. AM Treasures, Box 192HF, Babylon, NY 11702.

FREE RECORD CATALOG. New releases at discount prices and huge selection of classical, soundtrack, popular and jazz special values; complete line of Compact Discs! **Rose Records, Dept. H, 214 S. Wabash, Chicago, IL 60604**

SEARCHING FOR OUT-OF-PRINTS? Try for Discontinued Records, 444 South Victory, Burbank, California 91502 (213) 849-4791.

OPEN REEL TAPE-MOSTLY AMPEX 641/671, used once, unspliced, unboxed. 7" 1800' or 2400' Reels; 50 for \$60.00. Sample: \$2.00. Ten 3600' 10 1/2" Reels: \$37.50. Sample: \$3.50. New, High-Bias cassettes; Sample: \$1.00. AUDIO TAPES, BOX 9584-J, ALEXANDRIA, VA 22304. (703) 370-5555 VISA/MC

"**SOUNDTRACKS, SHOW, NOSTALGIA & JAZZ—FREE Catalog & Offering List—A-1 Record Finders, P.O. Box 75071-H, L.A. CAL. 90075.**"

ORGAN AND CHORAL RECORDS. For free catalog write Gothic Records, PO Box 1576-A Tustin, Calif. 92681.

OPERA-HISTORICAL PERFORMANCES ON DISC. Most comprehensive selection anywhere. Send \$1.00 for catalog-refundable. **LYRIC, 162 B. Cabot, West Babylon, NY 11704.**

Tapes & Records

TAPE WORLD TOLL FREE 1-800-245-6000

TKR	MARXEL	SCOTCH T1201/750	6.49
MAR-90 6.05	MX-90 .79	TDK T1204/750HQ	7.69
AD-90 4.25	XLH90 2.79	JMC T120	6.49
SA-90 2.85	UDK90 2.19	MAARELL T1204/750	6.95
ADX-90 2.39	LDK90 1.99	QUASAR T120	6.99
SA-90 1.89	UDK90 1.89	RIK T120	6.49
SA-60 1.89	UDK60 1.53	FUJI T120/750	5.75
AD-60 1.69	UDK60 1.19	SONY T120/750	6.49
AD-50 1.49	UDK50 1.09	SONY UCX5 90	2.29
D-60 1.07	REDAK90 4.99	FUJI RE190	2.29
D-60	99 UDK90	4.99	RE190

WE WILL BEAT ANY COMPETITOR'S PRICE OF THE TOTAL ORDER INCLUDING ALL SHIPPING AND HANDLING CHARGES BY 1%.

3.75 Shipping only size order in US, VISA, MC no extra charge COD Add \$1.65 Minimum COD order 40.00. PA. add Sales Tax. All orders shipped within 48 hours. M-F 9-5 300

313 Brown Avenue Suite 261 Butler, PA 16001 412-283-8621

- ALABAMA**
Lakis Audio
McDowell Electronics
- ALASKA**
Ataska Music
C.G. Elect.
Horit's Stereo
Pyramid Audio
- ARKANSAS**
Stereo Buff
- ARIZONA**
Jerry's Audio
- CALIFORNIA**
Absolute Audio
Ametron
Audio Consultants
Audio Gallery
Audio Specialty
Audio Today
Calif. Sound Works
Catania
Century Stereo
C & M Stereo Unlimited
Deister's Hi-Fi
Eber Elec.
El Dorado Audio
Executive Sound
GNP Showcase
Genesis Audio, Inc.
Hawars & Hardesty Audio
Hermans
Jack Hanna
Lombard's Electronics of California, Inc.
Long Ear
Monterey Stereo
Newport Audio
Paris Audio
Peninsula Audio
Sound Factor
Sounding Board
Sounds By Dave
Stereo Horizon
Stereo Solution
Stereo Store
Sunnyvale Elec.
Systems Design Group
Turntable Unit
Western Olympic Audio
World of Sound
The Works
- FLORIDA**
All Pro Sound
Audio Encounters
Audio Labs
Audio Spectrum, Inc.
Audio Tech
Audio Video
Brandmart
Broadcast International
Electronic Equip
The Elec. Store
Exclusive Elec.
Harris Audio
House of Hi-Fi
Joyful Noise Snd
Kuban's
Lake Audio
M & E
Neco
Oversea's Elect.
Pyramid Audio, Inc.
Ritz Shop Las Fabrics
Sensuous Sound
The Sound Factory
Sounds Great
Sound Shack
Southern Audio
Stereo World
Team Electronics
T.M. Sound & Lighting
Tern's Stereo & Elect.
World Wide Stereo
21st Century Sound
- GEORGIA**
Georgia Music
Hi-Fi Buys
- HAWAII**
Mid Pacific Stereo, Inc.
- IDAHO**
Sound Co
Stereo Shop
- ILLINOIS**
Appletree Stereo
August Systems
Gulf Custom House
Hi-Fi Hub
Mr. D's
Musicaart
Stereo Designs
United Audio
- INDIANA**
American Audio
Audio Connection
Audio Junction
Audio Specialists
Lehman Elect.
Pro Audio
Riskey Elect.
Sound Prod.
- ISOWA**
Audio Emporium
John's Hi-Fi
Hawkeye Electronics of Iowa
Pflanz Electronics
Sound
Stereo Sound Studios, Inc.
Tnad Productions, Inc.
World Radio
- KANSAS**
Accent Sound
Audio Etc.
Audio Junction
Audio Systems
Elect. Inc.
Hayes Sound
KC Music & Pro Sound
Kell's Gramophone
World Radio
- KENTUCKY**
Bowling Gm Audio
FM Hi-Fi
Fidelity
Ovation Audio
Riskey Elec.
- LOUISIANA**
Kadairs
Sound Advice
Sound Trek Audio
Unlimited Sounds
- MAINE**
Hi-Fi Each
- MARYLAND**
Audio Assn
Myer-Emco
Soundscapes
Sound Studio
Spaceways Sounds
- MASSACHUSETTS**
Natural Sound
Sound Dynamics
Sound Studio
Sound Track Audio
Tweeter
- MICHIGAN**
Gramophone
Hi-Fi Buys
Kurtz Music Ctr.
Listening Room
Pointe Elect.
Stereo Showcase
The Stereo Center
- MINNESOTA**
Audio King
Mel's TV Audio
Sound Elect.
- MISSISSIPPI**
Hooper's Sound
- MISSOURI**
Antech Labs, Inc.
Best Sound
Stereo Buff
Stereo Lab
Video Westport
World Radio
Rocky Mt. Hi-Fi
Sound West
Stereo Shop
- NEBRASKA**
Good Music
Stereo Studio
World Radio
- NEVADA**
Sound Emporium
- NEW HAMPSHIRE**
Cuomo's
Hawaii Audio
Tweeter
- NEW JERSEY**
Bryn Mawr Stereo
Conklin's
CSA Audio
Hai's Stereo
Hi-Fi Connection
Hi-Fi Haven
Leonard Radio
Rand's Camera Hi-Fi
Sight & Sound
Sound Environments, Inc.
Sound Inc.
Sounding Board
- NEW MEXICO**
Candyman
Sound Ideas
Sound Room
West Coast Sound
- NEW YORK**
Adirondak Music
Audio Exchange
Audio Experts
Audio Genesis
Designation
Earrium
Gordon Elec.
Grand Central Radio
Harvey Sound
Innovative Audio
Jencho Audio
JSG Audio
Leonard Radio
Lynn Hi-Fi
Marr Elec.
Media Room
Nom's Stereo
Northern Music Co
- NORTH CAROLINA**
Rainbow Audio
Sound One
Stereo Lab
Stereo Station
Stereo Village
Tels
Tri City Electronics
- NORTH DAKOTA**
Midwest Audio
- OHIO**
Audio Corner
Audio Craft
Audio Force
Carlin Audio
Digital Sights & Sound
Electronics Ltd
Golden Gramophone
Grassco Audio, Inc.
Hari's Audio
Lahmers Natural Hi-Fi
Palmer Elec.
Phil Reddish Stereo
Swallen's
Threshold Audio
- OKLAHOMA**
Coppeland
Rave Electronics Sound Systems
World Wide Stereo
- OREGON**
Audio Video Labs
Chelsea Audio
Good Guys Stereo
LaGrande Stereo
Larson's
Hermington's Audio
Sheckell's Stereo
Sound Chamber
- PENNSYLVANIA**
Abeko Korner
Bryn Mawr Stereo
D.S. Audio, Inc.
House of Records
Listening Post
Mack Audio Elec.
M & M Stereo
Pat's Stereo
Pro Audio
Shepard Stereo
Stereo-Land
Stereo Outlet
- RHODE ISLAND**
Tweeter
- SOUTH CAROLINA**
John B. Lee "For Music"
Read Brothers Stereo
- SOUTH DAKOTA**
Stereo Town
Team Elect.
- TENNESSEE**
Pro Audio
College City
Lindsay Ward
Sound Concept
- TEXAS**
Audio Center
Audio Video
Austin Audio One, Inc.
Blauhorn Sound
B & M Electronics
Branch Patton
Century Sound
Electric Ear
El Centro Sound
Harold's Electronics
Marvin Elect.
Melody Shops
Meller
San Antonio Audio
Sheffield Audio
Soundquest
Stereo Den
Stereo Int'l
Tabor-Town Audio Video
Western Audio
- UTAH**
Allen's Sound
Audio Works
Cruman Audio
The Hi-Fi Shop
Lynn's Audio
- VERMONT**
Audio Den
- VIRGINIA**
Audible Image
Audio Assoc.
Audio Connection
Digital Sound
Gary's Stereo
Lindsay Ward
Myer-Emco
Sound Machine
- WASHINGTON**
Audio Northwest
Bremmen Stereo
Definitive Audio
Hoffman Music
Huggins Hi-Fi
Magnolia Hi-Fi
Paulson's
QC Stereo Elect
Port of Sound
Ray's World of Elect.
Saon I
Sound Seller
Sound Investments
- WEST VIRGINIA**
Mack & Dave's
Sound Investments
- WISCONSIN**
American TV
Engandela Musical
Hi-Fi Heaven
Mountain Elect
Port of Sound
Ray's World of Elect.
Saon I
Sound Seller
Sound Investments
- WYOMING**
Crisman Audio

CARVER CORPORATION

A relatively, but not completely, accurate listing of AUTHORIZED CARVER DEALERS.

SHOW ALBUMS—Rare, out-of-print lps, 64-page list \$1.00. Broadway-Hollywood Recordings, Georgetown, CT. 06829.

OPEN REEL TAPES from Studio masters. Catalogue \$1.00. Barclay-Crocker, 313-H Mill Street, Poughkeepsie, NY 12601.

RARE CLASSICAL AND JAZZ. 150,000 LP's. The Record Collector, 1158 N. Highland, Los Angeles, CA 90038 (213) 467-2875.

TOSCENINI, great conductors, instrumentalists. LIVE CONCERTS. Reels, cassettes. Free lists, request artists. CRAA, BOX 1112HF, El Cerrito, CA. 94530.

1,000,000 SOUNDTRACKS/BROADWAY/VIDEOTAPES! Catalogue—\$1.00. RTSHG, Box 1829, Novato, California 94948. Soundtrack Valueguide: \$5.50.

DISCONTINUED RECORDS, CLASSICAL, POPULAR, All Speeds, Free Lists. Fred Steinmetz, One Seaview Avenue, Massapequa, NY 11758.

RECORDS BY GASPARO. Chamber music, solo, baroque—We have something for you! Write for free catalog. P.O. Box 120069, Nashville, TN 37212.

OPERAS & CONCERTS LIVE ON TAPE. Cassette/Video/Reel-Reel. Visa-M.C.-Amx. Free Catalog: Tardoin, P.O. Box 210255, San Francisco, CA 94121-0255.

LIVE OPERA TAPES, CASSETTES, DISCS. Incredible Selection. Free Catalogue. Live Opera, Box 3141, Steinway Station, L.I.C., NY 11103

JAZZ BLUES, BUDGET ROCK. BELOW LIST. Free Catalog. Rutabaga Records, 437 N. 5th Street, Stroudsburg, PA 18360

VIDEO/FILMS

"TDK or MAXELL VIDEOCASSETTES, T-120 or L-750, \$6.49. \$2.00 Shipping. Accessory Distributors, Box 11, 121 Murrah Road, North Augusta, SC 29841."

Music Workshop

ATLANTIC CENTER FOR THE ARTS. Concentrated Study Opportunity with MORTON FELDMAN, Feb. 4-22, 1985. For Brochure Write: 1414 Art Center Ave., New Smyrna Beach, FL 32069 or Call (904) 427-6975.

Compact Discs

COMPACT DISCS & ACCESSORIES. Call TOLL FREE 1-800-ALL-DISC (in Connecticut 1-452-0203) For FREE CATALOG M-F, 10-8, Saturday 10-7, Sunday 10-4. All Disc Music Inc., 133 Wheeler Road, Monroe, CT 06468.

COMPACT DIGITAL DISCS exclusively-in stock-classical, opera, jazz, film-catalog \$1.00, refundable with order-Ethel Enterprises, P.O. Box 3301, Dept. HF, Falls Church, VA 22043.

COMPACT DISCS! FREE CATALOG—Over 2,000 Titles Listed. Same Day Shipping. Laury's Records, 9800 North Milwaukee Avenue, Des Plaines, IL 60016. (312) 296-0420.

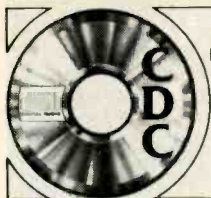

COMPACT DISC CENTER
P.O. Box 616, Clifton Park, NY 12065
(518) 664-2550
Many Discs \$13.99
Quantity 10 and over only \$12.99
\$2.00 Cont. U.S. shipping
FREE CATALOGUE

JAZZ COMPACT DISCS—Recorded totally digital—Free Catalog—DMP, Box 2317, New York, NY 10185

COMPACT DISCS—Most \$11.99-\$13.99. 1,600 Plus Titles in Stock. Free Catalog Plus Monthly Updates. OZ Records, 5246H Memorial Drive, Stone Mountain, GA 30083, (404) 292-5452.

COMPACT DISCS. \$9.95. Introductory Offer. Free Lists. No Problems Airmail Service. Europadisc, 91 North Street, Sudbury, Suffolk, UK.

COMPACT DISCS!!!! Imports And Domestic Titles Available. \$11.99 to \$15.50. For Free Catalogue Or To Place Order, Call (301) 731-0099, or Write To: Washington CD, PO Box 44055, Washington DC 20026. MasterCard and Visa Accepted.

COMPACT DIGITAL DISCS & PLAYERS, MITSUBISHI, SAE, HAFLER, NAKAMICHI, KLIPSCH, THORENS, FRIED, ADCOM, MIRAGE, PROTON, More. Immediate, FREE Shipping! READ BROTHERS STEREO, 593-C King Street, Charleston, South Carolina 29403. (803) 723-7276.

"COMPACT DISCS AT COMPACT PRICES!!!! Over 1700 Discs From \$10.49. Send \$1.00 For Catalogue (Refundable with Order). DISC HAVEN, Box 16H, Storrs, CT 06268."

LOWEST COMPACT DISC PRICES ANYWHERE! Low as \$9.99. London-DG-Philips \$12.99 per Disc. All Labels Discounted Sharply. Order by Label, Number. Send MO, Check, MC/Visa. Add \$2.25 UPS 1st Disc. \$50c Each Additional. Send \$2.00 For Greatest CD Catalogue and Discount Coupons. Classic Diversions, Box 1923, Dept. HF, Evanston, IL 60204, (312) 475-4010.

Equipment for Sale

SONUS SUPER BLUE LAMBDA BY SONIC RESEARCH. The World's Most Phase Coherent Cartridge. Call For The Dealer Nearest You. Sonic Research Inc., 27 Sugar Hollow Road, Danbury, CT 06810, (203) 792-8824.

DJ's; BANDS; NIGHTCLUBS
Disco-Stage Lighting and Effects (Fog, Bubbles, Etc.). Professional Sound Equipment. Send \$1.00 For Large Catalog. H&M Productions Inc., PO Box 20395-H, Bowling Green, Kentucky 42102. (502) 781-2448

DYNACO OWNERS: 60,000# Buyout Dyna's Remaining Inventory! Free Bargain Catalog. SCC, Box 551 (HF), Dublin, OH 43017, (614) 889-2117.

HIGH PERFORMANCE AUDIO PLUS CAR STEREO AT A LOW, LOW PRICE. Featuring: ADS, Advent, Aiwa, Alphasonik, Alpine, Amber, AR, Audio Source, Blaupunkt, Bose, Celestion, Clarion-Audia, Concord, DBX, Denon, Dual, Dynavector, Energy, Grace, Grado, Harman-Kardon, JBL, Kenwood, Kyocera, Mitsubishi, Monster-Alpha, Onkyo, Pioneer, Pyramid, Robertson Audio, Scott, Sherwood, Signet, Soundcraftsmen, Sound Dynamics, Sony, Systemdek, Tandberg, Thorens, Vampire Wire, Wharfedale Diamond, Walker, others. Providing: professional advice, personal service, "no rush" showroom, prompt shipments, free delivery and set up trade-ins, extended warranty. RETAIL-MAIL ORDER-EXPORT. Call 12 Noon to 7PM E.S.T., or write today (regarding specific make and models), HAROLD MINTO, PERFORMANCE AUDIO/VIDEO LTD. 365 South Bayview Avenue, Dept. HF, Freeport, LI., NY 11520. (516) 378-4389. Financing, MC/VISA, AMEX. NO SALES TAX CHARGED TO OUT OF STATE RESIDENTS.

Q. Can I get "digital" dynamic range from my existing records and tapes?

A. Yes,

with any of the dbx dynamic-range expanders. They increase music dynamics of your present analog records and tapes by up to 50%, and also restore sonic impact that's lost in recording. The result is music realism that's more than just "digital"! Write for details. Better yet, visit your dbx dealer.

dbx ... High-Performance Options for Home Stereo Systems
dbx Inc., Dept. HBXL 71 Chapel St, Newton, Mass. 02195 Tel. 617-964-3210

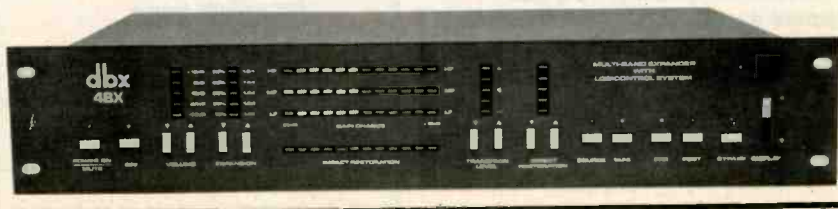

Instruction

BE A RECORDING ENGINEER! New Classes quarterly. INSTITUTE OF AUDIO/VIDEO ENGINEERING. (213) 666-3003, 1831 Hyperion Dept. C, Hollywood, CA 90027.

LEARN RECORDING ENGINEERING.

Top Pro Instructors. Check With Us Before Deciding. Free Brochure. JTM Workshop, (814) 797-5883, Knox, PA 16232.

Business Opportunities

YOUR OWN RADIO STATION! AM, FM, licensed, unlicensed, low cost transmitters! Free information. BROADCASTING, Box 130-D12, Paradise, CA 95969.

ELECTRONIC REPRESENTATIVES NEEDED!!

Lowest Possible Prices!! Over 100 Brands! Audio-Video-Car Stereo-Computers. Electronic Experts, 1000 Orange Ave., West Haven, CT 06516

SEEKING A DYNAMIC OPPORTUNITY?

Nationwide Company offers secrets to financial success! Details. Newlife Enterprises, 70-34 72nd Street-A, Glendale, NY 11385

\$2,000 AND MORE POSSIBLE IN YOUR MAILBOX
Everyday by Mailing Envelopes. No Personal Contact.
Complete Details \$2.00. Newsletter-124, 6545 Addison, Unit H, Chicago 60634.

Inventions Wanted

Inventions, ideas, new products wanted for presentation to industry and exhibition at national technology exposition. Call 1-800-528-6050. Arizona 1-800-352-0458. X831

Miscellaneous

TERMPAPER catalog—306 pages—15,278 papers available. Rush \$1.00. RESEARCH, 11322 Idaho, #206HT, Los Angeles, 90025. (213) 477-8226.

National Consumer Music magazine interested in obtaining classical and opera photographs. Rush reply to: Photo Research Department, High Fidelity, 825 Seventh Avenue, New York, N.Y. 10019.

CLASSICAL MUSIC LOVERS' EXCHANGE.

Nationwide Link Between Unattached Music Lovers. Write CMLE, Box 31, Pelham, NY 10803.

What a GREAT Idea to Use CLASSIFIED Advertising to INCREASE YOUR SALES! The HIGH FIDELITY Reader is a PURCHASING PACESETTER Who Depends on HIGH FIDELITY Each Month for the Most In-Depth & Complete Coverage Available in the Home Entertainment Industry. YOU Can Capture the Sphere of our Pacesetters for as little as \$36.75 each Month (12 Time Rate)! For More Information on this Marketing Opportunity, call Cecelia Giunta, 212/887-8451. Classified Deadline: February '85 issue closes December 3rd in New York.

Place Your Own Ad!

HIGH FIDELITY CLASSIFIED ORDER FORM

RATES PER WORD: 15 word minimum
No charge for zip code

Regular Type: \$2.75 per word.
Imperial Type: \$3.75 per word.
Discounts for 3 times; 6 times; & 12 times.

Check one: Regular Imperial
3x 6x 12x

Please print or type message below or on separate paper.

Name _____

Company _____

Address _____

City/State/Zip _____

Phone _____

Signature _____

Payment must accompany order.

Send to: Cecelia Giunta
HIGH FIDELITY
825 Seventh Avenue
New York, N.Y. 10019
(212) 265-8360

Payment enclosed \$ _____

MASTER Card # _____

VISA Card # _____

BONANDRINI

(Continued from page 90)

one time or another, every jazz fan dreams of owning his own label, and those who realize that ambition often do so only by risking financial disaster and the enmity of the musicians they most admire. Bonandrini has somehow found a way to make it all work. His labels are solvent and show no signs of swerving from their commitment to quality. And he is trusted: Most musicians conduct business with him on the basis of a handshake.

In an industry where scruples are often regarded as a luxury, Bonandrini sounds almost too good to be true. But before canonizing him, it is wise to remember that he is an entrepreneur, not an altruist. In fact, at least one of his American business associates, a fellow small-label owner whose records Bonandrini distributes in Italy, characterizes him as "aggressive and opportunistic. He took advantage of circumstances that existed in jazz in the mid-1970s, when no one else was recording the music—and when those few of us who were scrambling. He begged all of us to sell him our records at the lowest possible price so that he could get his distributorship started, and then he took the money he made and started his own labels, which he imports to the United States in direct competition with us. It's conflict of interest." The label owner in question was hesitant to be identified in print "because Bonandrini has a virtual monopoly on jazz record distribution in Italy, and it could be costly for me if I were to antagonize him. He's a very powerful man in jazz."

Yet within the jungles of commerce, aggressiveness and an ability to recognize opportunity when it arises are not necessarily deplorable traits. If Bonandrini is a businessman, at least he is a good businessman, which is more than can be said for most of the small-timers in jazz. And at least it is his sole business, not merely a foolproof tax write-off or a temporary bid to diversify. Indeed, the lesson to be learned from CBS's decision to drop James Blood Ulmer despite rave notices and slowly building sales is that the problem of hooking up with a major label is nothing compared to the problem of staying with one. No matter. One suspects that Giovanni Bonandrini and others like him—Xanadu's Don Schlitten, Steeplechase's Nils Winter, India Navigation's Bob Cummings, Concord's Cal Jefferson, to name a few—will tough out the hard times, just as Blue Note's Alfred Lion and Francis Wolff and Prestige's Bob Weinstock did before them, and for much the same reason: They can't afford not to. Bonandrini has too much invested in jazz to pull out now, and money is only half of it. In the long run, jazz figures to prosper from the willingness of fans like Bonandrini to let money follow faith, even if they and the artists who record for them fail to prosper here and now.

HF

CLASSICAL REVIEWS

(Continued from page 87)

voyage through a repertoire that is more varied than it appears on the printed page—from frank imitation of the troubadours by Conon de Béthune and Gace Brulé (and the prolific Anonymous) to the tuneful works of Adam de la Halle and the more citified music of Jehannot de Lescurel and Petrus de Cruce.

As Bagby explains in his liner notes, Sequentia assumes a non-doctrinaire attitude toward the controversial issue of rhythm. In these accounts, a free, declamatory delivery is the norm, but the performers allow themselves to apply preconceived rhythmic patterns where appropriate. Likewise, some of the songs are accompanied, others executed by voices alone. All the devices used by the instrumentalists are familiar—drones, heterophony, some polyphony—but they are employed here with taste and imagination, pointing up the vocal line, not challenging its supremacy. Of the two principal singers, Thornton is the more keenly attuned to the nuances of the text. Bagby is a fluent and versatile vocalist (he sings both tenor and countertenor), but sometimes a shade dull.

The performances of the polyphonic works are equally stimulating, and the juxtaposition of homophony and polyphony makes clear the dependence of the latter on the former. Here, instruments are used discreetly, mostly to play the untexted tenor part in motets. So deeply have the musi-

cians entered into the style of the period that most of the interspersed instrumental pieces are not medieval at all, but instead become their own compositions (or improvisations), based on the melodic patterns of the song repertoire.

The recording, made at St. Peter's Church in Blansingen, Germany, is clear but unresonant. Since an understanding of the words is so important in this repertoire, it is disturbing that the texts and translations are inconveniently laid out in the accompanying booklet. The Old French texts and the English and German translations are clumped together by language, thus necessitating much page turning for the dedicated listener who wishes to follow word by word.

MICHAEL FLEMING

Theater and Film

NEWMAN: *The Natural*.

Randy Newman, cond. [Russ Titelman and Lenny Waronker, prods.] WARNER BROS. 1-25116. Cassette: 4-25116.

There's a delightful subgenre of film music that for lack of a better term I'd call "Americana" scores. Aaron Copland established the style with his work for *Our Town* and *The Red Pony*. Here is symphonic music of

flute, and percussion, it draws upon haiku texts to create a series of delicately shaded, even fragile, vignettes. Brooks draws loving—I am tempted to say *definitive*—performances from her choir. The recording is all one could ask for, and the annotations are a cut above the pack. In sum, this is an album of solid, non-sensational pieces that require (and improve with) repeated hearings. Much the same can be said of the Da Capo disc. First recordings of vocal music by Copland and Cowell guarantee its documentary value, while the inclusion of larger works by Miriam Gideon and Louise Talma is an important gesture to two composers of uncompromising individuality.

Both albums are long-term treasures. This is difficult repertoire for a label to survive on, and were the issues to come from one of the major commercial companies, my advice would be to pick them up fast because they won't remain in print for long. Not to worry, though: New World is holding to its policy of not deleting any title in its catalog. Recording music of this caliber—and holding it in print, however necessary and admirable—will not make business life easier for New World, and it points up the difficulty the company will have surviving in the commercial world.

Some splashy items have recently been announced. The major event of the fall (both for American music and, possibly,

open spaces and transparent textures, with colors that are bright, rhythms that dance, melodies that are folk-flavored and occasionally heroic. Everything is big, but not larger than life. The secret of a great Americana score is moderation; too much of anything, and the fragile mood is broken.

Among the Americana classics since Copland's, I'd list Elmer Bernstein's *To Kill a Mockingbird*, Jerry Goldsmith's *Wild Rovers*, Henry Mancini's *The Molly Maguires*, Alex North's *Bite the Bullet*, and John Williams's *The Reivers*. Now we can add one more, Randy Newman's *The Natural*. This is a wonderfully evocative, richly American score that I thoroughly enjoy. Newman (nephew to film music veterans Alfred and Lionel) is a moderately popular singer and songwriter who prior to this had only dabbled in the film idiom. I'm aware of (but haven't heard) two previous scores, *Cold Turkey* and *Ragtime*; on the basis of *The Natural*, I intend to pick up *Ragtime* a.s.a.p.

In *The Natural*, Newman and veteran orchestrator Jack Hayes effectively update the Americana tradition with tastefully added electronics for some cues. A bit of pseudo 1930s jazz (which is fun) and a bluesy feel to other passages further lend variety to the whole. What sounds like a fleeting reminiscence of Copland's *Fanfare for the Common Man* opens a cue titled "The Whammer Strikes Out," thus bringing things nicely full circle.

NOAH ANDRÉ TRUDEAU

SOMETHING NEW

(Continued from page 72)

not be offered. When a composer or topic has been treated in full annotation previously, a new recording will refer the listener back to the older one in lieu of providing fresh notes. There will be fewer collections encompassing material derived from other labels, due to the high cost of clearance research and licensing.

There are other changes coming as well. This fall will usher in New World's first digital releases (four different recordings, each utilizing a different digital process), and plans are under way to issue Compact Discs by the end of 1985. Finally, a few items from the first hundred not previously available over-the-counter have been cleared for sale.

How do New World's most recent releases measure up? The two newest additions to the catalog are an album of Vincent Persichetti's choral music (NW 316) and one by the Da Capo Chamber Players and guest vocalists (NW 317). (NW 318, an album of orchestral works by Michael Colgrass and Jacob Druckman [see review, April], was issued before these two recordings.) The Persichetti disc features the Mendelssohn Club of Philadelphia conducted by Tamara Brooks and offers three pieces, the major one being the *Winter Cantata*, Op. 97; scored for women's voices,

opera on record) is Samuel Barber's *Antony and Cleopatra* in a Spoleto Festival performance. A two-record set of piano music by John Alden Carpenter may well provide the impetus for a long overdue reevaluation of this neglected businessman/composer. Recordings of major new orchestral pieces by George Crumb, William Schuman, and Peter Lieberson are slated, along with an album of performances by upstate New York's best-kept secret, the Albany Symphony Orchestra, in works by Carpenter, Henry Hadley, David Gregory Mason, and Quincy Porter.

Looking beyond 1984, plans are also being made for a recording of John Harbison's *Symphony No. 1*, a pair of albums with the Indianapolis Symphony Orchestra featuring works by Charles Martin Loeffler and Ellen Taaffe Zwilich, a minstrel show album, and some new jazz recordings.

Although other labels do important service to the cause of American music, none is more committed to such a wide scope of coverage than New World Records. As the company prepares for a regular schedule of 12 releases a year—and the original hundred begins to reach meaningfully toward two hundred—music lovers in this country should have reason to rejoice.

(New World's address is 701 7th Ave., New York, N.Y. 10036.) **HF**

READER-ACTION PAGE

Many manufacturers who advertise in HIGH FIDELITY offer additional literature on their products free of charge to our readers. For more information on specific products advertised in this issue, drop a postcard, care of Dept. HF-1284 unless otherwise noted, to the addresses listed below. If an address does not appear, literature is available through the company's dealers only

Advertising Index

AIWA America, Inc.,
35 Oxford Drive, Moonachie, N.J. 07074, Att: Dept. HF 1284

Alpine/Luxman,
19145 Gramercy Pl., Torrance, CA 90509, Att: Dept. HF 1284

Audiofon,
P.O. Box 37, Brooklyn, N.Y. 11204, Att: Dept. HF 1284

BES,
345 Fisher Ave., Costa Mesa, CA 92626, Att: Dept. HF 1284

Blaupunkt,
Sound so alive you can feel it. For information call 1-800-228-5333.

Boston Acoustics,
247 Lynnfield, Peabody, Mass. 01960, Att: Dept. HF 1284

Canton North America,
254 First Avenue North, Minneapolis, MN 55401, 612-333-1150, Att: Dept. HF 1284

Carver Corporation,
P.O. Box 1237, Lynnwood, WA 98046, Att: Dept. HF 1284

Dali/Danish American LTD, Inc.,
P.O. Box 55386, Valencia, CA 91355, Att: Mike Gerutto, Dept. HF 1284, (805) 252-7203

D'Ascanio Audio,
11450 Overseas Highway, Marathon, Fl. 33050, Att: Dept. HF 1284

DBX Inc.,
71 Chapel St., Newton, MA 02195, Att: Dept. HF 1284

Denon America,
27 Law Dr., Fairfield, N.J. 07006, Att: Dept. HF 1284

Discwasher,
1407 North Providence Rd., P.O. Box 6021, Columbia, MD 65205, 314-449-0941, Att: Dept. HF 1284

Everest Electronics,
5024 Fort Hamilton Parkway, Brooklyn, N.Y. 11219, Att: Dept. HF 1284

Focus Electronics,
4523 13th Ave., Brooklyn, N.Y. 11219, Att: Dept. HF 1284

Frazier Incorporated,
1930 Valley View Lane, Dallas, TX 75234, 214-241-3441, Att: Dept. HF 1284

Hitachi Sales Corp.,
401 West Artesia Blvd., Compton, CA 90220, Att: Advertising Dept. HF 1284

Illinois Audio,
12 East Delaware Place, Chicago, Ill 60611, 800-621-8042, Att: Dept. HF 1284

Infinity Systems Inc.,
9409 Owensmouth Ave., Chatsworth, CA 91311 Dept. HF 1284

International Book & Record Distributors,
40-11 24th Street, Long Island City, N.Y. 11011, 212-784-3929, Att: HF 1284

International Hi Fi,
Moravia Industrial Park, 6330 Frankford Ave., Baltimore, MD 21206 Att: Dept. HF 1284

J&R Music World,
23 Park Row, New York, N.Y. 10038, Customer Service Dept. HF 1284

JBL,
8500 Balboa Blvd. Northridge, CA 91329, Att: HF 1284

Jensen Car Audio,
4136 N. United Parkway, Schiller Park, Ill 60176, Att: HF 1284

Kenwood,
1315 East Watsoncenter Rd., Carson, CA 90745, Att: Dept. HF 1284

LaBelle Camera & Stereo of Maine,
155 Main St., Biddeford, MA 04005, 800-341-0783, In ME, HI, Alaska 207-281-1401, Att. Dept. HF 1284

Maxell Corp. of America,
60 Oxford Dr., Moonachie, N.J. 07074, Att: Dept. HF 1284

McIntosh Laboratory, Inc.,
East Side Station, P.O. Box 96, Binghamton, NY 13904, Att: Dept. HF 1284

Mitsubishi Electronics Sales,
3010 East Victoria St., Compton, CA 90221, Att: Dept. HF 1284

Nakamichi USA Corp.,
19701 South Vermont Ave., Torrence, CA 90502 Dept. HF 1284

NEC Home Electronics USA,
1401 Estes Ave., Elk Grove Village, Ill 60007, 312-228-5900, Att: Dept HF 1284

Onkyo USA Corp.,
200 Williams Drive, Ramsey, New York 07446, Att: Dept. HF 1284

Polk Audio Inc.,
1915 Annapolis Rd., Baltimore, MD 21230, 301-837-4300, Att: Dept. HF 1284

Rich Acoustics Labs,
2401 Ross Clark Circle, Dothan, Alabama, 36301, Att: Dept. HF 1284

S&W Electronics,
187 Ross Street, Brooklyn, N.Y. 11211, Att: Dept. HF 1284

Sansui Electronics Corp.,
Lyndhurst, N.J. 07071, 201-460-9710, Carson, CA 213-604-7300, Att: Dept. HF 1284

H.H. Scott Inc.,
20 Commerce Way, Woburn, MA 01888, Att: Dept. HF 1284

Shure Brothers Inc.,
222 Hartrey Ave., Evanston, Ill., 60204, 312-866-2553, Att: Dept. HF 1284

Sound Reproduction,
7 Industrial Rd., Fairfield, N.J. 07006, Att: Dept. HF 1284

Sony Corp. of America
Sony Drive, Park Ridge, N.J. 07656, Att: Dept. HF 1284

Stereo Corp. of America,
1629 Flatbush Ave., Brooklyn, N.Y. 11210, 212-338-8555, Att: Dept. HF 1284

Tandberg of America Inc.,
1 Labriola Court, Armonk, N.Y. 10504, Att: Dept. HF 1284

TDK Electronics Corp.,
12 Harbor Park Dr., Port Washington, N.Y. 10050, Att: Dept. HF 1284

TEAC Corporation of America,
7733 Telegraph Rd., Montebello, CA 90640, Att: Dept HF 1284

Technics
One Panasonic Way, Secaucus, N.J. 07094, Att: Dept. HF 1284

Yamaha Electronics Corp. USA,
6660 Orangethorp Ave., Buena Park, CA. 90620, Att: Dept. HF 1284

Page No.

33	Aiwa America, Inc.
20	Akai America, LTD
17	Alpine/Luxman
95	Audiofon
86	BES
24	Blaupunkt
69	Boston Acoustics
19	Canton North America
67	Carver Corp.
16	DALI
28,29,31	DAK
10	D'Ascanio Audio
79	dbx, Inc.
6	Denon America, Inc.
IV	Discwasher, Inc.
73	Everest Electronics
97	Focus Electronics
54	Ford Electrical & Electronics Division
85	Frazier Inc.
34	Hitachi Sales Corp.
83	Illinois Audio
6	Infinity Systems, Inc.
82	International Book & Record Distributors
95	International HiFi
53	JBL
15	Jensen Car Audio
87	J&R Music World
5	JVC Co. of America
18	Kenwood Electronics
71	Kloss
81	LaBelle Camera & Stereo
23	Maxell Corp.
97	McIntosh Laboratory, Inc.
39	MEMTEK
8,9	Mitsubishi Electronic Sales
44,45	Nakamichi U.S.A. Corp.
2,3	NEC Home Electronics USA
43	Onkyo
40	Pioneer Electronics U.S.A.
75	Polk Audio Inc.
85	Rich Acoustics
Cover II, 1	Sansui Electronics Corp.
46	Scott Inc., H.H.
57	Shure Brothers Inc.
Cover III,	Sony Corp. of America
12,13,22	
98	Sound Reproduction
78	Stereo Corp. of America
93	S&W Electronics
86	Tandberg of America Inc.
11	TDK Electronics Corp.
27	Teac Corp. of America
7	Technics
93	Wisconsin Discount
51	Yamaha

Advertising Offices

New York: ABC Leisure Magazines, Inc., 825 7th Ave., 7th Floor, New York, N.Y. 10019. Tel: (212) 265-8360. James A. Casella, Advertising Director; Richard J. Marino, National Accounts Manager; Michael Goldberg, Eastern Advertising Manager; James R. McCallum, Record Advertising Manager; Cecelia M. Giunta, Classified Advertising Manager; Kathleen Davis, Director of Production; Janet Cermak, Advertising Production Manager

Midwest: High Fidelity, Hitchcock Building, Wheaton, Ill. 60187. Tel: (312) 653-8020. Starr Lane, Midwest Advertising Manager.

Los Angeles: ABC Leisure Magazines, Inc., 2020 Avenue of the Stars, Suite 245, Century City, Calif. 90067. Tel: (213) 557-6482. Rita Weitzen, Western Advertising Manager

National Reps: Kathleen Charla, Kathleen G. Charla Associates, 21000 W. Fourteen Mile Road, Birmingham, Mich. 48010. Tel.: (313) 642-3482. Frank LaVerne, Frank LaVerne Associates, 922 Crenshaw Blvd., Los Angeles, Calif. 90019 (213) 932-1742

Tokyo: Japan Advertising Communications, Inc., New Ginza Bldg., 7-3-13 Ginza, Chuo-ku, Tokyo 104, Japan. Tel: (03) 571-8748. Shigeru Kobayashi, President.



Sony revolutionizes the compact disc revolution.

If there are still a few among you who have any lingering doubts as to who the leader in digital audio really is, consider the following:

On October 1, 1982, Sony* set the music industry on its ear with the creation of the world's first compact digital audio disc player.

Today, with over 30 companies joining the revolution, Sony is starting two others. The Car Compact Disc Player and the Portable Compact Disc Player.*

Combine that with the fact that the CDP-111, shown above, represents another addition to the world's largest family of

home compact disc players, and one thing should become abundantly clear:

While other companies are claiming advanced circuits, Sony has taken a somewhat different course.

Advanced products.

SONY.
THE LEADER IN DIGITAL AUDIO.™

*Initial supplies may be limited. © 1984 Sony Corp. of America. Sony is a registered trademark of the Sony Corporation, 1 Sony Drive, Park Ridge, NJ 07656. Optional headphones and battery pack case may vary where purchased.

A dirty record sounds
worse than fingernails
across a blackboard.

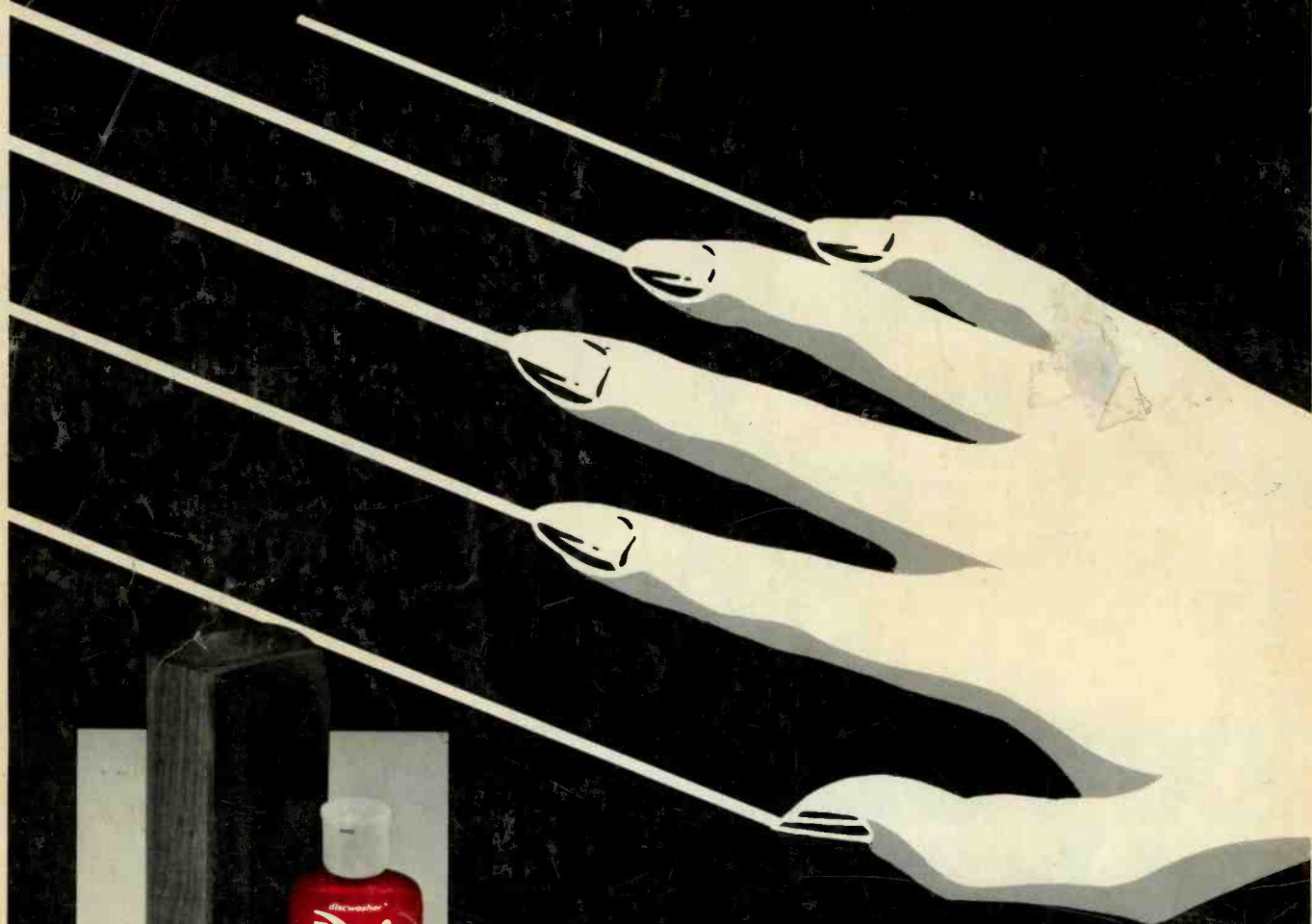

D4+ Record Care System
SC-2 Stylus Care System

Chalk up another reason to trust Discwasher.

In less than 30 seconds, a Discwasher® D4+™ Record Care System soaks up surface snap, crackle and pop. So records of any age (even brand new ones) sound cleaner and last longer.

And with the Discwasher® SC-2™ Stylus Care System, Discwasher offers you the best record care and protection in the history of clean sound. Available anywhere you buy records or stereo equipment.

discwasher

1407 North Providence Road, P.O. Box 6021, Columbia, Missouri 65205 USA

a division of International Jensen Inc.