

Spring New Component Survey

HIGH FIDELITY

ICD ® 08398

Snap, Crackle, Sizzle, Dazzle-

New Products, Prices, Trends at the Consumer Electronics Show & Beyond

Classical Recording: Is the End in Sight?

Backbeat: Rodgers "Sail On" Second Decade Track Studio Makes the Most

0



ONEUNTA N V
ZNTON ST
2CT 37039AUC 86
1-03
1980



7482008398

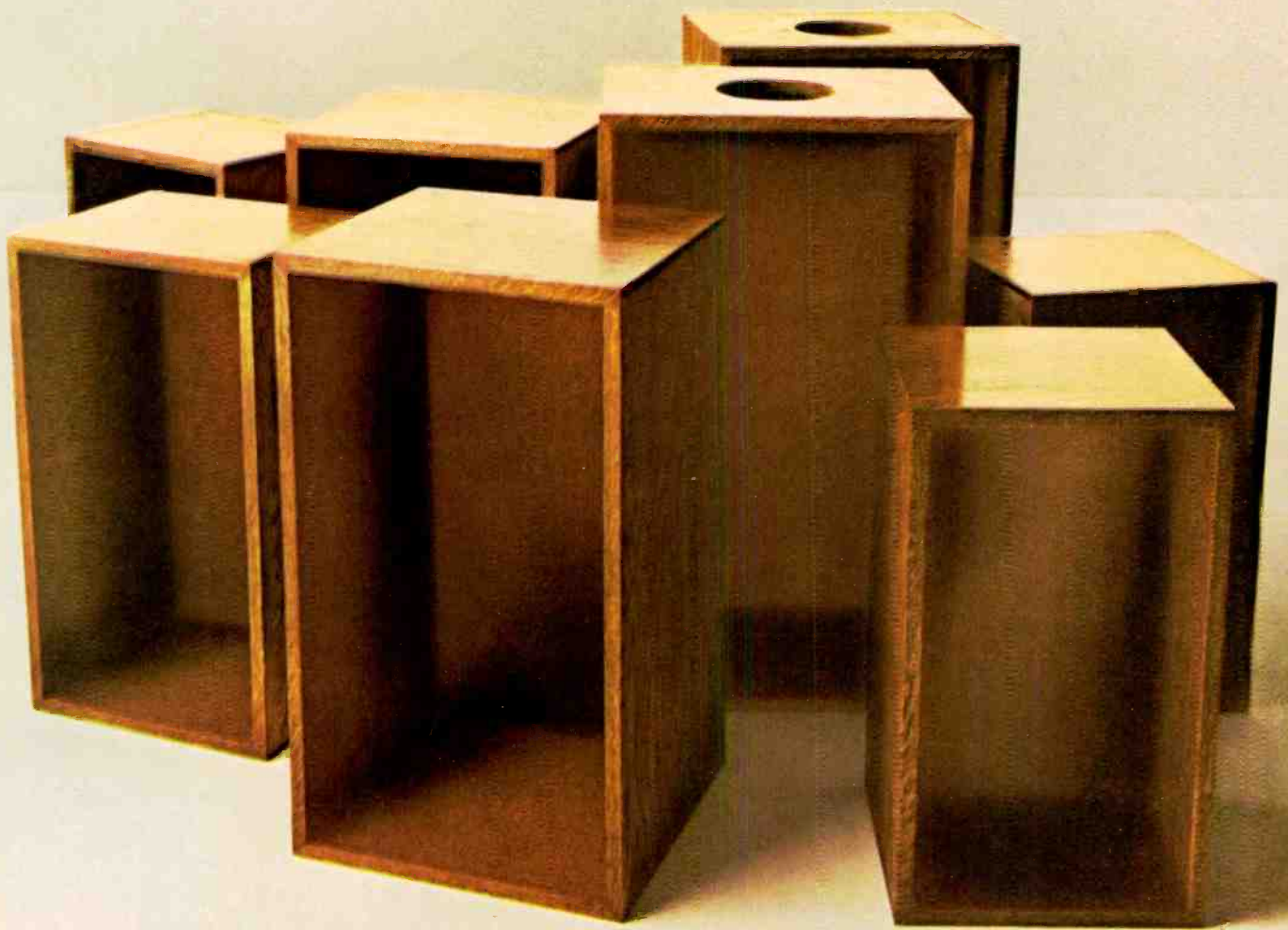

**WHAT COMES OUT
OF A SPEAKER IS ONLY
AS IMPRESSIVE AS
WHAT GOES INTO IT.**

MEMOREX HIGH BIAS TEST NO. 5.

WHICH HIGH BIAS TAPE STANDS UP TO A GENRAD REAL-TIME ANALYZER?

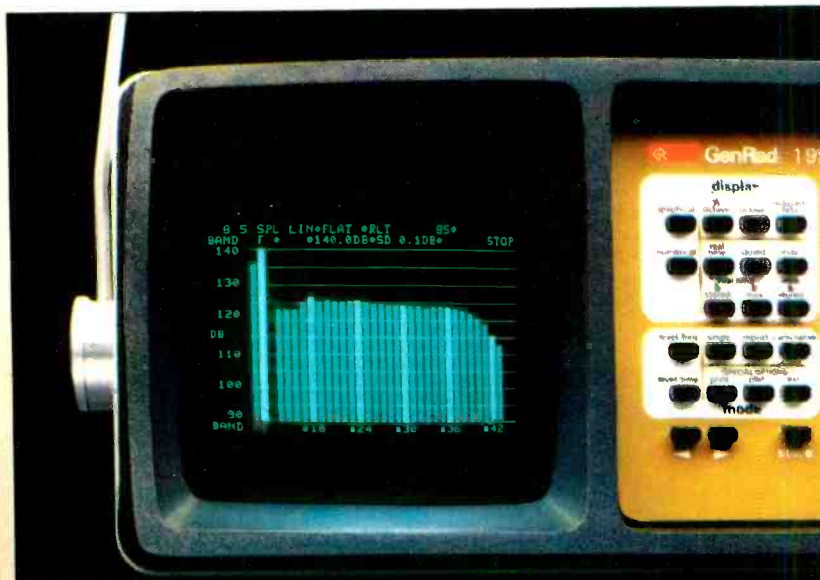

The GenRad 1995 Real-Time Analyzer is among today's state-of-the-art devices for accurately measuring and displaying audio signals. That's why we used it to show that MEMOREX HIGH BIAS is today's state-of-the-art high bias cassette tape.

When tested at standard recording levels against other high bias tapes, none had a flatter frequency response than MEMOREX HIGH BIAS.

And, the signal/noise ratio of MEMOREX HIGH BIAS proved to be unsurpassed at the critical high end.

Proof you can't buy a high bias cassette that gives you truer reproduction. And isn't that what you buy a high bias tape for?

Is it live, or is it
MEMOREX



The GenRad 1995 Integrating Real-Time Analyzer measured signals from a Nakamichi 582 cassette deck. Input signal source was "pink noise" at 0dB (200 nanowebers—standard record level). If you'd like a copy of the test results, please send a self-addressed, stamped business-size envelope to the address below. Ask for the GenRad Test.



For unbeatable performance in a normal bias tape, look for Memorex with MRX₃ Oxide, in the black package.

HIGH FIDELITY

Leonard Marcus
Editor

Shirley Fleming
Editor, Musical America

James R. Oestreich
Classical Music Editor

Susan Elliott
Editor, Backbeat

Robert Long
Audio-Video Editor

Peter Dobbin
Associate
Audio-Video Editor

Rebecca Abbott
Associate Editor

Lynda Carlotta
Isabel Parker
Cynthia Pease
Assistant Editors

Diane Albano
Editorial Assistant

Edward J. Foster
Consulting Audio Editor

Edward Greenfield
European Editor

Abram Chipman
John Culshaw
R. D. Darrell
Harris Goldsmith
David Hamilton
Dale Harris
Paul Henry Lang
Irving Lowens
Robert C. Marsh
Fred Miller
Andrew Porter
Susan Thiemann Sommer
Contributing Editors

Robert S. Clark
Editorial Director

Sarina Bromberg
Art Director

Wayne Armentrout
Production Director

David Lee
Circulation Director

Susan Allyn
Circulation Manager

William P. Johnson
Circulation Service Manager

Leonard Levine
Publisher

HIGH FIDELITY is published monthly at The Publishing House, Great Barrington, Mass. 01230 by ABC Leisure Magazines, Inc., a subsidiary of American Broadcasting Companies, Inc. Copyright © by 1980 ABC Leisure Magazines, Inc. The design and contents are fully protected by copyright and must not be reproduced in any manner. Second-class postage paid at New York, New York, and at additional mailing offices. Authorized as second-class mail by the Post Office Department, Ottawa, and for payment of postage in cash. Yearly subscription in U.S.A. and Possessions \$13.95; elsewhere \$18.95. Single copies \$1.50. Subscribers: Send subscriptions, inquiries, and address changes to High Fidelity, 1 Sound Ave., Marion, Ohio 43302. Change of Address: Give old and new addresses, including ZIP Code. Enclose address label from last issue and allow five weeks for change to become effective. **Postmaster: Send Form 3579 to High Fidelity, 1 Sound Ave., Marion, Ohio 43302. Postal Identification Number 243820.**

Audio/Video

- 6 Too High Fidelity?**
by Leonard Marcus
- 11 CrossTalk**
- 18 Equipment Reports**
Vector Research VRX-9000 receiver
Dynavector 20A Type 2 cartridge
Dynaco A-250 speaker
Onkyo TA-2080 cassette deck
Koss HV/X headphones
ADC Sound Shaper Three equalizer
- 43 Cautious Entry into the '80s**
New equipment consolidates gains
by Robert Long and Peter Dobbin

Music/Musicians

- 53 Predictable Crises in Classical Music Recording**
by Allan Kozinn
- 61 Culshaw at Large**
My darlin' Leontyne
by John Culshaw
- 62 Behind the Scenes**
- 67 Massenet en Masse**
The boom continues with four opera recordings
by Peter G. Davis
- 71 The "New Generation" of Mahler Conductors**
Duplication need not mean redundancy
by Abram Chipman
- 75 Classical Records**
P.D.Q. Bach and Peter Schickele
Karajan's Don Carlos
Shostakovich song cycles
- 78 Critics' Choice**
- 104 The Tape Deck**
by R. D. Darrell

Backbeat

- 107 The Commodores**
"Easy" like \$60 million
by Steven X. Rea
- 110 Studio Circuit**
Back in the home studio:
The \$2,000 difference
by Bennett Evans
- 116 Report from the Winter NAMM**
Less hype, more substance
by Fred Miller
- 118 Pop-Pourri**
"Rock & Roll for a Desert Island"
by Stephen Holden
- 120 Zevon Strikes Again**
by Crispin Cioe
- 120 Records**
The Clash
The Ramones
Cecil Taylor
- 124 Breakaway**
Bruce Woolley,
musical Frankenstein
by Steven X. Rea
- 126 SpinOffs: New Acts**
by Steven X. Rea

Et Cetera

- 37 Letters**
- 99 Reader-Service Cards**
- 132 Advertising Index**

No matter how good your present stereo system, we can improve it! Here's proof.

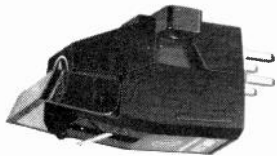

 Add effortless clarity and transparency with our new Omnitec™ series Vector-Aligned™ dual magnet cartridge or AT30E moving coil cartridge with user-replaceable stylus.



Laboratory precision is the hallmark of every A-T tone arm for home, studio, or disco.



You might pay \$1000 or more for speakers almost as good as these remarkable electret stereophones.

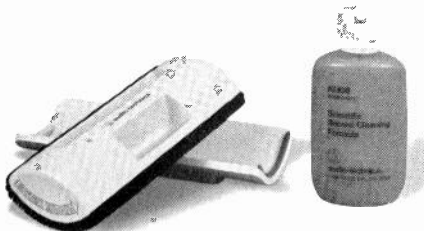

Use our complete line of record and stylus cleaners to keep your collection sounding great years from now.



LIFESAVER is the first truly complete record preservative. Stops static and record wear for years.



Create your own "Grammy award-winning" tapes with studio-quality Audio-Technica microphones.



Make it all worthwhile with thrilling direct-to-disc and digitally-mastered performances from around the world.

When you add Audio-Technica, you multiply listening enjoyment. At leading audio stores. Write for catalog and dealer list, today.

audio-technica
INNOVATION □ PRECISION □ INTEGRITY

AUDIO-TECHNICA U.S., INC., Dept. 40H
33 Shawassee Avenue, Fairlawn, Ohio 44313

4 HIGH FIDELITY

ART CREDITS

Cover	Bob Brody
18	Bob Brody
53-58	Randall Enos
68	Kraus and Troyanos photo—Angel; Bacquier photo—Erika Davidson
72-74	Drawings—Randall Enos
72	Morris photo—Peters International; Neumann photo—Herbert Breslin
73	Tennstedt photo—Lauterwasser/Angel
76-77	Lawrence Widdoes
82	Alix B. Williamson

SOLUTION TO HIFI-CROSTIC NO. 52

Irving Kolodin: The Opera Omnibus

If you can at least pronounce "Gesamtkunstwerk," a case can be made for opera as the "combined art form." But where is dance in Wagner? The one ballet associated with his name was imposed upon the Paris production of "Tannhaeuser" as the price of having it done at all.

ADVERTISING

Main Office: Robert J. Ur Sr., Director of Advertising Sales, The Publishing House, Great Barrington, Mass. 01230. Telephone: 413-528-1300.

New York: ABC Leisure Magazines, Inc., 825 7th Avenue, 6th Floor, New York, N.Y. 10019. Telephone: 212-265-8360. Seymour Resnick, National Advertising Manager; George Dickey, Record Advertising Manager; Ruth Elliott, Eastern Advertising Manager; Janet Cermak, Administrative Assistant; Yetta Peltzman, Classified Advertising Department.

Midwest: ABC Leisure Magazines, Inc., 190 N. State St., Room 632, Chicago, Ill. 60601. Telephone: 312-782-1173. William P. Gordon, Midwest Advertising Manager; Osbert Bruno, Advertising Representative.

Los Angeles: ABC Leisure Magazines, Inc., 2020 Avenue of the Stars, Suite 245, Century City, Calif. 90067. Telephone: 213-553-2000. Andrew Spanberger, Western Advertising Manager; Janet Endrijonas, Associate Western Advertising Manager.

Tokyo: Japan Advertising Communications, Inc., New Ginza Bldg., 7-3-13 Ginza, Chuo-ku, Tokyo 104, Japan. Telephone: (03) 571-8748, Shigeru Kobayashi, President.

HIGH FIDELITY and **HIGH FIDELITY/MUSICAL AMERICA** are published monthly by ABC Leisure Magazines, Inc., a subsidiary of American Broadcasting Companies, Inc. Herbert Keppler, Senior Vice President, Photographic Publishing Division; Leonard Levine, Executive Vice President, High Fidelity Group; Warren Tuohy, Vice President, Finance; David Lee, Circulation Director; Cathleen Aloisi, Personnel Director; Wayne Armentrout, Director of Manufacturing, Member Audit Bureau of Circulation. Indexed in Reader's Guide to Periodical Literature. Current and back copies of High Fidelity and High Fidelity/Musical America are available on microfilm from University Microfilms, Ann Arbor, Mich. 48106. Microfiche copies of these magazines (1973 forward) are available through Bell & Howell Micro Photo Division, Old Mansfield Road, Wooster, O. 44691.

Editorial correspondence should be addressed to The Editor, High Fidelity, Great Barrington, Mass. 01230. Editorial contributions will be welcomed, and payment for articles accepted will be arranged prior to publication. Unsolicited manuscripts should be accompanied by return postage.

Technics

Performance and reliability. That's why 73 of the top 100 radio stations that use turntables use Technics direct drive turntables. In fact, of those stations surveyed by Opinion Research Corporation, Technics was chosen 6 to 1 over the nearest competitor.

Why did station engineers choose Technics direct drive: "Latest state of the art." "Reliability and past experience." "Low rumble, fast start." "Wow and flutter, direct drive and constant speed." To quote just a few. And you'll choose Technics for the same reasons.

The D-Series. Three turntables that start at \$125.* Each with 0.03% wow and flutter and -75 dB rumble. That's unsurpassed performance for the price.

The Q-Series. Two turntables with speed accuracy of 99.998%, wow and flutter of 0.025% and -73 dB rumble. No wonder so many radio stations choose Technics quartz-locked turntables.

The MK2 Series. Three turntables with a start-up time of 0.7 seconds, or 1/4 of a revolution. And the accuracy of Technics quartz-locked pitch control. That's performance good enough for the most demanding professional.

Then there's the SL-10 (\$600). The turntable of the 80's. Not much bigger than a record jacket, it has a quartz-locked direct-drive motor and a servo-controlled linear tracking arm. But what really makes it unique is what it can do: Play with all the accuracy Technics is so famous for, even on its side or upside down.

Technics direct drive. The turntables that top radio stations use. * Technics recommended prices, but actual price will be set by dealers.

You should buy a Technics direct drive turntable for the same reasons 73 of the top 100 radio stations did.



The Evolution of Excellence

In 1976 Pickering launched a new modern high fidelity era by introducing the first of a new generation of phono cartridges, the Pickering XSV/3000, acclaimed a top performer by critics and reviewers worldwide. Now Pickering takes the Stereohedron® Series one step beyond excellence with the new XSV/4000. A lightweight, high energy, samarium cobalt magnet and shaped-for-sound Stereohedron Stylus tip are major innovations that eclipse previous performance standards in four crucial areas. Improved tracking ability. Expanded frequency response range. Wider channel separation. And featherlight treatment of the record groove.

XSV/4000... the next generation of sound.



For further information write to:
Pickering & Co. Inc., Sunnyside Blvd.,
Plainview, N.Y. 11803

© 1979 PICKERING & CO. INC.



"for those who can hear the difference"

Circle 38 on Page 99

Too High Fidelity?

I don't know about you, but I've become fed up with recordings of gasps, pants, finger-poundings, hand-slidings, and all the other aural paraphernalia that is incident—and incidental—to a performer's technique for producing music. Music students practice for years to tame these extraneous noises. But if they progress to such virtuoso class that they are asked to make recordings, these days they find that all their practicing has gone for naught and that all the sonic garbage they thought they had disposed of has been not only returned, but amplified.

Groans, humming, and other expressive sounds—well, maybe okay, since they result from a musician's personal, emotional involvement with his music. I still treasure memories of Toscanini singing along with his soloists and orchestra in perhaps the most moving *Bohème* I ever heard, of Glenn Gould humming to accompany his fingers. These at least were musical expressions.

But why, when I want to hear a world-famous flutist playing Tartini, do I have to put up with the sounds of the keys hitting the flute and with such loud and obvious grasps at air that one can imagine Rich Little mimicking Raymond Burr? Why, to hear a guitar virtuoso I admire playing some Spanish classics, do I also have to tolerate the sounds of his fingers not only hitting, but leaving the strings, his hand sliding up and down the fingerboard, and what sounds like his guitar rubbing arrhythmically against his shirt? Or why, if I want to sample a new Russian cellist playing Bach, must I also take the grunts of effort he produces as he tries to negotiate his instrument? These sounds of a musician's technical procedures and trials are just as irrelevant—and just as intrusive—to the music he is making as his stomach rumble would be.

The problem turned epidemic during the 1970s as more studios switched from four-track to sixteen-track tape recorders. With microphones available for nearly every voice or instrument in an ensemble, a new ideal emerged: "presence," which soon became for record albums what "natural" became for the decade's junk foods. And how does one get "presence"? Stick one or more of those microphones as close as possible to the performer, the one place he would never let you listen to him in a concert hall. Record producers also tended to emphasize "highs" in their mix, both to make their records "hotter" and more "brilliant" and to anticipate the loss of highs to be expected in the plating and manufacturing process—not to mention in the reproduction process over second-rate speakers in the average purchaser's home. Unfortunately, there is a greater proportion of highs in much of these obtrusive noises than in music, so the noise was further emphasized. (To make up for the loss of ambience in their tight miking, they added echo electronically.)

More recently we have seen the proliferation of "audiophile" recordings that have radically cut down the number of microphones. As a consequence, at least when there are large ensembles, the mikes are placed at a distance from the musicians. The result is a greater music-to-noise ratio. Soloists, however, still too often get the down-the-throat treatment. To quote one of them, whose analysis may have been inaccurate but at least was eloquently put: "The trouble with some of today's recordings is that they are too high fidelity."

Circle 22 on Page 99 ▶

**Now there's a two-way speaker
with remarkable midrange
without a midrange.**

The Infinity RS_a



It could only come from Infinity.

A two-way speaker with midrange (as well as tweeter) controls—yet there's no midrange driver!

A new and unique crossover in the RS_a allows adjustment of the midrange. This unprecedented control actually permits you to vary depth as well as projection of the musical image; accommodating the program material, your room acoustics and your personal taste.

This flexibility, clarity and detail of midrange is unachieved by even much more expensive three-ways.

Why is this important? Because the fundamental tones of most instruments lie in the midrange: 350 to 5000 Hz. When this musical information is poorly reproduced, you're not hearing the whole truth.

Listen to a traditional speaker system: characteristically the overall sound is thin, veiled and lifeless. You hear notes, not musicians.

Then listen to the Infinity RS_a. It breathes life. It has warmth.

Infinity scientists and musicians were determined to create a modestly-priced speaker in the extravagant Reference Standard family tradition. So we gave it some of the family jewels.

We gave it EMIT™ acclaimed by audio critics world-wide for its delicacy, transparency and smoothness.

We gave it polypropylene, our new speaker cone material with acoustic properties making it superior to paper in every respect; it is ideally light, stiff, stable and acoustically inert. The meticulous amalgamation of these elements has produced the incomparable RS_a.

The feast is for your eyes as well. RS_a is crafted with the finest oak veneers available. The tab: about \$200.

To learn more about the peculiar Infinity alloy of music and science, please ask any Infinity dealer for our new brochure, "The Creative Technology of Infinity Speakers." It will tell you part of the story.

Then listen to the RS_a.

It will tell you the rest.

 **Infinity**™

We get you back to what it's all about. Music.

A toll-free call to (800) 423-5244—or from California, (800) 382-3372—will get you the nearest Infinity dealer's name and address.

© 1979 by Infinity Systems, Inc., 7930 Deering Ave., Canoga Park, CA 91304, (213) 883-4800.

The new



The micro processor controlled turntable that automatically selects and plays the tracks you want to hear.

Push the wireless remote control button and select track 1, track 3, track 6 or any other. The micro processor automatically moves the arm to play the selected track. You can repeat the same track, select another or play



the entire record over again all by wireless remote control. And there's an LED readout to indicate the track being played.

Since you can select the music you want to record, making tapes from your record collection becomes easier and more convenient than ever before.

The MT6660 Linear Drive turntable is not only great for really enjoying the music you like, but it's a sophisticated audio component with some extraordinary design features.

Fisher's exclusive Linear Drive. With Linear Drive, the only moving part is the platter itself. So, there's

FISHER



Standard BY FISHER

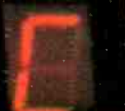

CUEING



REJECT



START
(PROGRAM BEL)



virtually nothing to go wrong. And, no inherent turntable noise. (For you audiophiles, wow and flutter is just 0.035% and rumble is a low -70dB).

There's a lot more There's a servo circuit that continuously monitors and locks in record

speed. Plus a strobe light and fine speed control so you can monitor the accuracy of speed and alter pitch.

The MT6360 has a viscous-damped "floating" tonearm with a specially designed integral stereo magnetic cartridge. And there's even a muting circuit to eliminate that annoying "pop" you hear when the tonearm touches down.

It's what you'd expect from the new Fisher. We invented high fidelity

over 40 years ago. And never stopped innovating. So check out the new MT6360 at your Fisher dealer. One demonstration of the automatic track selector will change, forever, the way you listen to records.

Fisher Corporation, 21314 Lassen Street,
Chatsworth, CA 91311
© Fisher Corporation, 1980



FISHER

The first name in high fidelity.

tech talk:

45 Watt RMS minimum per channel into 8 ohms.
From 20 to 20,000 Hz. With no more than 0.03% THD.

explained.

The tech talk you just read is a set of amplifier specifications, or specs. Specs for the remarkable MCS[®] Series Model 3248 45 Watt receiver. Most people think they need an engineering degree to understand specs so they usually don't even try. That's a mistake. Specs are intended to inform and protect you. With that in mind, we'd like to end some of the confusion.

The first sentence above tells you that 45 watts are the least amount of continuous (RMS) power the amplifier portion of the 3248 will deliver to each speaker channel when hooked up to 8 ohm speakers.

The second sentence states that at least 45 watts of power will be delivered over the entire audible range of sound frequencies. From 20 to 20,000 vibrations per second (20 to 20,000 Hz).

The last sentence contains the most important information of all. It tells you that under these conditions the unwanted overtones or harmonics will not exceed three hundredths of one percent of the output signal, (0.03% THD or total harmonic distortion).

Prices higher in Alaska, Hawaii and Puerto Rico

When you consider that THD of up to 3% is considered virtually inaudible you can understand just how remarkable the MCS Series 45 Watt receiver really is.

So come to your nearest JCPenney and see for yourself. See the LED power meters. The tape monitoring system that lets you compare what you're recording to the program source while you're recording. The tape dubbing control that lets you record from one tape deck to another, and back again, at the flick of a switch. The loudness switch that boosts bass and treble ranges when the volume is low. See all these features and much more. Or just come in and listen to the MCS Series 45 Watt receiver. You won't have to look any further. The MCS Series 45 Watt receiver only \$379.95* and only at JCPenney.

Full 5-Year Warranty on MCS[®] Series speakers. Full 3-Year Warranty on MCS Series receivers, turntables, tape decks, tuners and amplifiers. If any MCS Series component is defective in materials and workmanship during its warranty period, we will repair it—just return it to JCPenney.

MCS[®] Series Audio Components sold exclusively at JCPenney

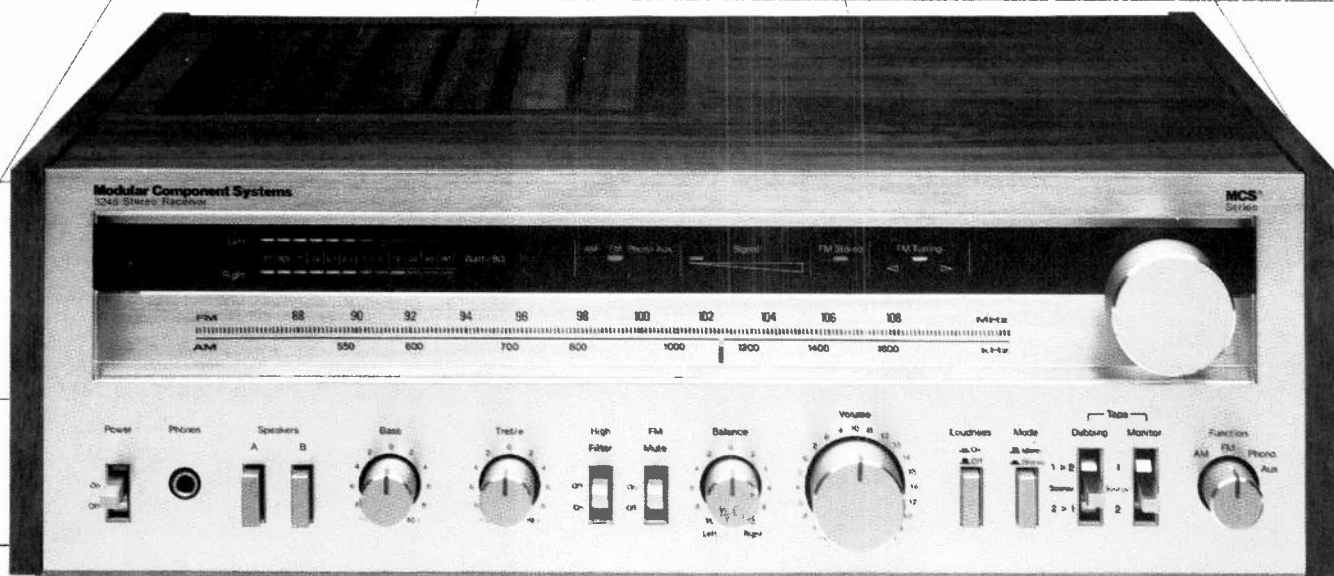

MCS[®]
Series

IT MAKES EVERYTHING CLEAR.

Sold exclusively at JCPenney.

CrossTalk

Q. I have a Philips 437 turntable with a Stanton 681EEE cartridge that is rated for a minimum tracking force of about $\frac{3}{4}$ to 1 gram. Unfortunately, I didn't know when I installed it that I should be compensating for the brush weight of 1 gram. Thus the effective tracking force was only about $\frac{1}{4}$ gram, and I played my records several times under these conditions. In addition, I had the antiskating set so that it was off by a full gram. How does the mistracking affect a record's sound? Is it really worth buying brand-new records if my cartridge was mistracking?—Pat Nilson, Philadelphia, Pa.

A. There evidently are two points of concern here: what reproduction sounds like if settings are too low, and what the effects on the record, and therefore on future playings, may be. Distortion rises rapidly as tracking force is decreased below an acceptable minimum, which will vary, with a given pickup, from arm to arm and from record to record. (The setting of the antiskating is a less important contributing factor.) In most setups you should hear nothing amiss if you're a little below the manufacturer's minimum recommendation. As you continue to decrease vertical tracking force, the peaks will distort, and at progressively lower recorded levels. The effect is quite obvious; if you don't hear it, the tracking presumably is okay. Since the audible distortion comes from loss of stylus/groove contact, leaving the stylus tip free to bang around in the groove much like a skidding car careening down an icy highway, it does imply groove damage. If you hear it, stop playing the record and find out what's wrong before you continue, or you may cause permanent damage.

Q. I recently purchased a Sansui G-7500 receiver. It is equipped with a mike mixing control, but the operating instructions give no indication whether or not this feature can be used to mix live material with another source (FM, phono) for recording. Is there a way this can be done?—Tom Grimner, Berger, Tex.

A. Since your manual doesn't address the recording question, we assume the G-7500, like most receivers with "mike mixing," is designed just for singalongs with accompaniment from any source including tape playback. This scheme puts the mixer after the tape connections and thus prevents record-

ing the mix via the normal tape-output jacks. By far, the easiest and most efficient way to mix live and recorded programs for taping is via an outboard mixer or through the mike mixer built into some cassette decks. If, however, the receiver is equipped with pre-out/main-in jacks, you can use them temporarily for your recording by connecting PRE-OUT to the deck's recording input. In order to monitor what you are doing, you will have to turn off your speakers (to avoid feedback) and listen on headphones. You can connect the deck's output to the MAIN-IN jacks. With this setup, however, the volume control is ahead of the deck input and now is acting as a master fader in your "mixer." If your deck has an output level control, it can be used to adjust headphone listening levels; if not, the deck's jack.

Q. My system consists of a Fisher 450-T receiver, a pair of KLH 5 speakers, a B.I.C. 980 turntable with a Shure M-95ED cartridge, and an Akai GXC-706D cassette deck. When I play a record, I am disturbed by an annoying sibilance in the left channel. It is not severe enough to be heard all the time, at all program levels. I've reversed the speakers, but the sibilance stays in the left channel, and it doesn't appear at all on FM. Am I correct in assuming that the phono preamp is the culprit? If so, is it time to retire my ten-year-old receiver?—Joe Orlando, Bridgewater, N.J.

A. Don't be so hasty about putting your receiver out to pasture. Chances are the problem lies in the phono cartridge. First, check to make sure that the pickup is properly aligned and that the antiskating bias is set correctly. If the problem persists, remove the stylus assembly and inspect for signs of a bent stylus shank or, with a magnifier, tip wear. Whether you detect the source of the trouble or not, we'd still suggest you begin replacement plans with the cartridge; for one thing, it's the least expensive element in the system.

Q. Did I just lay out 180,000 yen for a metal-ready deck for nothing? According to Robert Angus in "My Own Christmas Shopping List" ["The Autophile," November 1979], it appears that one can record metal tape on a nonmetal machine and get good results. He states: "No matter that their car stereo units don't have sendust heads and metal playback equalization—or, for

Empire's EDR.9 The Phono Cartridge Designed for Today's Audiophile Recordings



Direct-to-Disc and digital recording have added a fantastic new dimension to the listening experience. Greater dynamic range, detail, stereo imaging, lower distortion and increased signal-to-noise ratio are just a few of the phrases used to describe the advantages of these new technologies.

In order to capture all the benefits of these recordings, you should have a phono cartridge specifically designed to reproduce every bit of information with utmost precision and clarity and the least amount of record wear.

The Empire EDR.9 is that cartridge. Although just recently introduced, it is already being hailed as a breakthrough by audiophiles, not only in the U.S., but in such foreign markets as Japan, Germany, England, France, Switzerland and Sweden.

At \$200, the EDR.9 is expensive, but then again, so are your records.

For more detailed information and test reports, write to:

Empire Scientific Corporation
1055 Stewart Avenue
Garden City, New York 11530

EMPIRE





IN ONE RESPECT, YOUR EXPENSIVE STEREO IS NOT MUCH BETTER THAN A DIME-STORE RECORD PLAYER.

Sure. Your system reproduces the tonal balance of live music, with flat frequency response from 20Hz to 20KHz.

And it gives you good spatial perspective, thanks to stereo and time-delay systems.

But those are only two of the elements that make live music sound live.

There's a third: Dynamic range.

Dynamic range is the difference in volume, measured in decibels, between the loudest and quietest passages in a piece of music. It's what gives live music depth, impact and drama.

And the simple fact is, your records don't provide the dynamic range they should. Due to conventional recording limitations, they fall at least 30dB short.

Buying the latest equipment may get you a little extra dynamic range. But no matter how much you spend, the best you can hope for is what's on the record.

Now, however, there's something you can do about the problem. Because at dbx, we've developed a new technology that lets you hear the full

dynamic range you've been missing.

We offer a range of products that you can take home right now. Connect to your system. And improve the sound of your music so dramatically, it's almost unbelievable.

THE STATE-OF-THE-ART IN DYNAMIC RANGE.

The most realistic sound ever achieved on record comes from our new Digital dbx Discs, which combine dbx technology with the state-of-the-art in studio recording – digital mastering.

The sound of these records will stun you.

Because they actually deliver the full dynamic range of a live performance—90dB or more. That's 50% better than the finest conventional audiophile records you've ever heard, whether direct-to-disc or digitally mastered.

And while our dynamic range reaches new highs, our record surface noise reaches new lows. Clear down to an unheard of -85dB (relative to 0dB, 7cm/sec peak velocity at 1KHz). Much quieter than any previous audiophile record.

So for the first time you can hear the full impact of live music. Everything that was on the digital master tape. Played against a background of virtual silence.

You'll find our first releases of Digital dbx Discs in stores right now. Along with our existing library of dbx Discs, which are stunning in their own right. Because they deliver the full dynamic range of conventional studio master tapes. And virtually no record surface noise.

Best of all, you don't need expensive new equipment to enjoy the incredible dbx sound. All you need is a dbx Model 21 Decoder, connected to the tape monitor loop of your receiver or amplifier. (You can also play dbx Records if you own a dbx Tape Noise Reduction System Model 122, 124, 128 or 224.)

THE MAXIMUM DYNAMIC RANGE YOU CAN GET ON TAPE.

If you're into recording, dbx offers the state-of-the-art for you, too: The new dbx Recording Technology Series Model 224.

It hooks right into your present tape system. And it lets you record a new level of dynamic range on tapes. Up to 85dB on open reel and 80dB

on cassette. So you can make live recordings that capture virtually all the dynamic range of the original music.

And the 224 is the only system that lets you tape fine audiophile records without losing any of their dynamic range.

The Model 224 also reduces tape noise far better than Dolby®* (30dB compared to just 10dB). And it includes the dbx Decoding System, so you can use it to play your dbx Discs as well as your tapes.

NEW REALISM FOR CONVENTIONAL RECORDS AND TAPES.

Of course, once you hear the impact of full dynamic range, you won't settle for ordinary music again. So dbx offers a line of Dynamic Range Expanders, starting at just \$259,** that can improve the realism of all the records and tapes you own.

dbx Dynamic Range Expanders work on the same principle as our dbx Recording Technology Series.

The difference is, they restore much of the dynamic range that's missing from ordinary records and tapes. Just add one of these components to your system, and you'll get as much as 75dB of sound or more. You can even use it to improve the realism of FM radio.

And not only will it improve dynamic range. But when you're playing records, it will also dramatically reduce disc surface noise.

HEAR IT TODAY.

Now that you know what dynamic range is, and the realism it can add to your stereo system, there's only one thing left to do.

Go listen for yourself at your authorized dbx retailer. And pick up a catalog of available dbx Discs and Components. Or write to us.

Because until you get full dynamic range from your stereo system, you won't be getting your money's worth.

dbx, Incorporated, 71 Chapel Street, Newton, MA. 02195. 617/964-3210.

dbx can supply the one element of live music missing from your stereo system: Full dynamic range. The Model 21 makes dbx Discs compatible with your present system. The Model 224 lets your home tapes approach the silence and dynamic range of digital recording. And dbx Dynamic Range Expanders enhance the realism of all your conventional records and tapes.

Model 21 Disc Decoder



Recording Technology Series Model 224



Rack-mount kit optional.

3BX Dynamic Range Expander

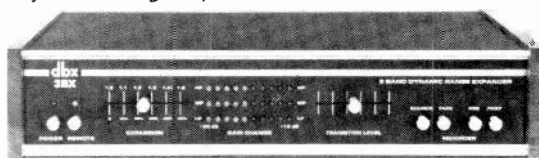

*Dolby® is a registered trademark of Dolby® Laboratories, Inc.

**Suggested U.S. retail price; actual price set by dealers.

dbx®

MAKING GOOD SOUND BETTER

HOW TO GET CONCERT HALL PRESENCE WITHOUT BEING PRESENT IN A CONCERT HALL.

Even the world's finest stereo equipment can't reproduce the realism of a live concert, unless your living room happens to be built like Carnegie Hall. But when you add Pioneer's SR-303 Reverberation Amplifier to your existing hi-fi system, you can bring that same sense of spaciousness back to your music. And you can bring it back without any "echo howling" and other distortions, thanks to our newly developed Bucket Brigade Device. Unlike similar units, the SR-303 won't cost more than your entire system. It'll just sound like it did.

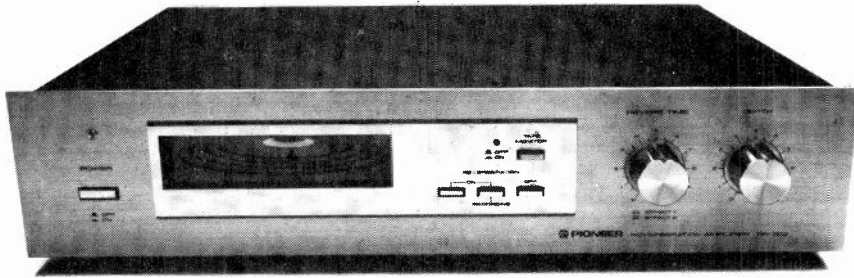

SYSTEM ENHANCERS

©1979 U.S. Pioneer Electronics Corp. 85 Oxford Drive, Moonachie, N.J. 07074

PIONEER
We bring it back alive.

Circle 40 on Page 99

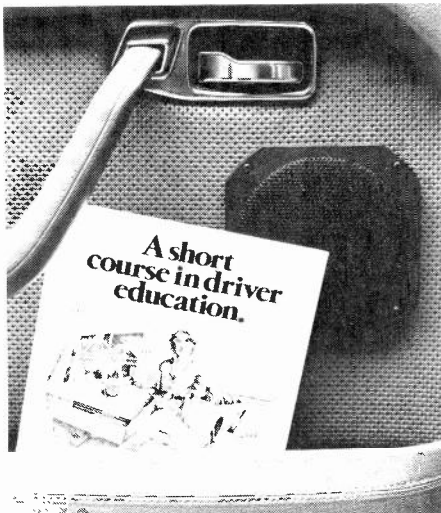

Free Drivers Manual.

Avid Expert Drivers are designed especially for your car, not adapted from your living room. Get our six-page free Drivers Manual and find out what makes Avid Expert Drivers the best car speakers on the road.

Write Avid Corporation,
10 Tripps Lane, East
Providence, RI 02914.

AVID 
Expert Drivers™

14 HIGH FIDELITY

that matter, that their home decks don't, either. I'm going to suggest that they record [with metal tape] on their existing equipment, then play the tapes back in the car. . . ." Could my older deck have recorded on metal tape and realized all the advantages of the pure metal formulation? Or is Mr. Angus confused?—William R. Haag, Niigata, Japan.

A. You seem to overlook the fact that Mr. Angus was addressing himself to the subject of car stereo. The underbiasing that metal tape experiences in a nonmetal deck will introduce some peakiness into the high end—a zing that some people find appropriate for the acoustics of an automobile. Also, the metal tape will allow somewhat higher recording levels, helping to override both ambient noise and tape hiss for better subjective sound. But we would not suggest such a practice for home listening, where accuracy of reproduction is the overriding criterion.

Q. Why is it that all (yes, all) manufacturers who produce racks and rack-mountable equipment show their products with the tuner mounted above the amplifier? All this does is create heat in the tuner. My Kenwood KT-8300 was suffering from drift problems. After a few round trips to the factory to have it repaired, I was asked how I have my equipment stacked. I said that the tuner was above a Kenwood KT-7300 amp. I was told to move the tuner below the amp and appraise the effect. When I did, the problem vanished. And when I asked why the racks are displayed with the tuner above the amp, I was told that this arrangement simply looks better. How can the advertising people get away with their skulduggery when the men who create the products know better?—Edward T. Dwyer, Manahawkin, N.J.

A. Actually, there's another and much better reason to keep the tuner as high as possible in racks: for easy visibility. Tuning can be very difficult if tuners and receivers are well below eye level, in our experience. This puts a premium on cool-running amps or those whose heat sinking is carefully devised for the available ventilation in rack mounts. Kenwood's manual, like most (except for some micros, where we have seen stacking priorities spelled out in detail), offers only general notes about the problem, even for rack-mountable models. That is where we would tend to put the blame. Of course, had your manuals contained caveats that you failed to heed, the moral would be obvious. **HF**



Today's hottest recording group.

Latest sales figures show that Maxell is the fastest-growing brand of recording tape in the country today.

It's not surprising.

Every type of Maxell tape, from LN to UD-XL is designed to give you the widest frequency response, the highest possible signal-to-noise ratio and the lowest distortion.

So no matter which tape you play in the group, you're assured of a great solo performance.

Pick up a few and put together a group of your own.



The secret of Onkyo.



An incredible sound experience awaits you. An experience that technology alone finds hard to explain. You'll hear music of such stunning purity and sensual richness, that you'll wonder how any audio system could make that much of a difference.



The Onkyo CP-1030F

That's the secret of Onkyo. The unique ability to take you several steps beyond pure technology ... to a world of more exciting sound. And we provide it in all our components ... beginning with turntables.

■ The Onkyo CP-1030F Fully-Automatic Turntable is an outstanding example. It takes far greater advantage of today's most sensitive high-compliance cartridges ... providing more precise record groove tracking, while silencing out vibrations from record warp, the turntable motors, even sound



The Onkyo TA-2080

waves produced by your speakers.

The CP-1030F is rich with important new concepts ... a low mass, straight line carbon-fiber tonearm ... infrared sensors for smoother automatic tonearm control ... Quartz-locked direct-drive accuracy ... and a new triple-insulated suspension. All combine to produce purer sound. And the CP-1030F is just one of five advanced new turntables from Onkyo.

■ In stereo cassette tape decks too, Onkyo achieves more perfect sound. The Onkyo TA-2080, for example, provides a computerized

control system called "Accu-Bias" ... which automatically assures that every recording you make is superior, including new metal tapes.

Every tape has a different bias setting requirement ... even two tapes of the same formulation from the same manufacturer. "Accu-Bias" automatically senses each tape's unique bias needs, then makes the precise system adjustments to provide it. Brighter, cleaner high notes are the reward.

The Onkyo TA-2080 also provides a rich and important array of other high performance features. 3-Heads with a 2-motor/2 capstan drive system ... a Dolby* noise reduction system with switchable MPX filter and two channel calibration controls ... both VU meters and 10-step LED peak indicators. And the TA-2080 is just one of four Onkyo cassette tape decks.

■ Onkyo integrated stereo amplifiers provide an extraordinary ... and unique ... sound experience. Their special Super-Servo circuitry totally eliminates the sonic "ghost signals" common to DC power amplifiers. As a result, each instrument and voice sounds purer and more individually real ... regardless of volume level. You'll experience—perhaps for the first time—stereo with a fully discernible third-dimension.

There are three Onkyo integrated stereo amplifiers to select from. All with Super-Servo, LED peak power indicators, and other advanced features. A companion series of three Onkyo stereo tuners is also available.

■ Of all our components, the most widely known are our stereo receivers. And with good reason. Their FM sections are clearly superior ... picking up weak stations noiselessly and strong stations without distortion. And Onkyo was the first to revolutionize receiver design with Quartz-Locked FM tuning and the unique



The Onkyo A-7090

"Human Touch Sensor" control.

In all, there are 6 Onkyo AM/FM stereo receivers ... with the incredibly advanced TX-8500 MK-II paramount among them. With 160 Watts per channel** ... digital FM frequency display ... a memory to preset up to seven FM stations ...

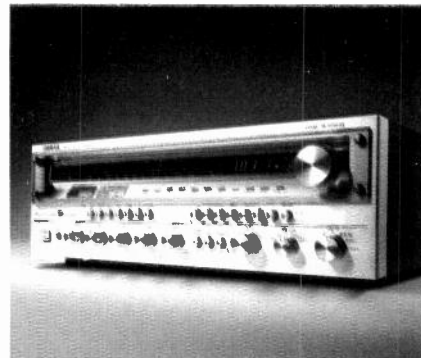

The Onkyo TX-8500 MKII

and a built-in Dolby* FM circuit ... the Onkyo TX-8500 MK-II is one of the most advanced receivers ever conceived. And it's just one of 6 Onkyo receivers to pick from.

■ In speaker systems, few are as innovative, accurate and impressive as the Onkyo F-5000 3-way, Phase Aligned Array™ Speaker System. The F-5000 delivers more exciting sound ... with precise three-dimensional imaging.

Speaker alignment is one of the reasons. Even more significant is the unique Onkyo planar woofer,



The Onkyo F-5000

planar midrange, and Direct Drive Membrane™ Tweeter.

Gone are the sound interference patterns and phase cancellations that cone shaped speakers always provide. Instead is a listening experience with the same true frequency relationships of the performance.

■ Experience "the secret of Onkyo" now, at your Onkyo dealer. Hear audio components so advanced, they transcend mere technology. Onkyo USA Corporation
42-07 20th Ave., Long Island City
N.Y. 11105 (212) 728-4639

**1M of Dolby Laboratories. **Min. RMS at 8 ohms both channels driven from 20 to 20,000 Hz with no more than 0.05% total harmonic distortion

New Equipment Reports

Preparation supervised by Robert Long, Peter Dobbin, and Edward J. Foster. Laboratory data (unless otherwise noted) supplied by CBS Technology Center or Diversified Science Laboratories.



Vector Aims at U.S.

Vector Research Model VRX-9000

Tuner Section

MONO FM FREQUENCY RESPONSE

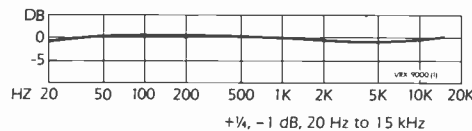

STEREO FM RESPONSE & CHANNEL SEPARATION

Frequency response	
—— L ch	+1/2, -1 dB, 20 Hz to 15 kHz
----- R ch	+0, -1 dB, 20 Hz to 15 kHz
Channel separation	
	≥ 30 dB, 110 Hz to 4.3 kHz;
	≥ 20 dB, 26 Hz to 15 kHz

FM SENSITIVITY & QUIETING

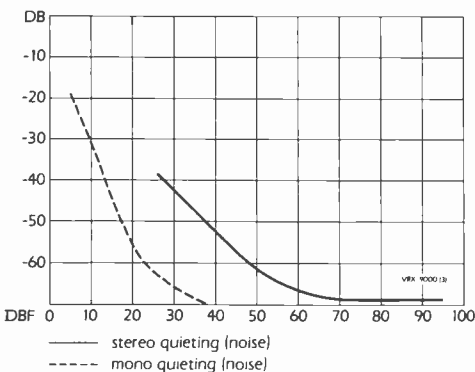

Vector Research Model VRX-9000 AM/FM receiver in metal case. Dimensions: 17¼ by 5½ inches (front), 13¼ inches deep plus clearance for connections. Convenience outlets: one switched (100 watts), one unswitched (200 watts). Price: \$750; optional VKD-1 wood case, \$25; optional VMA rack handles, \$35; optional VRC-1 wired remote control, \$75. Warranty: "limited," two years parts and labor. Manufacturer: made in Japan for Vector Research, Inc., 20600 Nordhoff St., Chatsworth, Calif. 91311.

Vector Research, a new American-based company with manufacturing facilities in Japan, is doing what some foreign-based companies find difficult: providing the U.S. market with sophisticated audio products that have carefully judged features at attractive price points. Its first offerings are three cassette decks and three receivers, of which the VRX-9000 is the flagship.

Though the purchase of separate audio electronics (tuner, preamp, and power amp) can still be justified by specific user needs, increased flexibility, and, sometimes, better performance, the VRX-9000 goes a long way toward blurring the distinctions between separates and receivers. One would have to spend a great deal more for separates with the features in this relatively compact receiver. The array of tiny buttons may give one pause, but a moment or two of examination reveals their neatly logical planning. Frequency-synthesized tuning is accomplished in discrete manual steps (0.1 MHz on FM, 1 kHz on AM) via the separate UP and DOWN buttons. To activate the automatic station scanning function, you simply depress HOLD SCAN and either UP or DOWN. With FM MUTE engaged, stations with a signal strength of at least 26 dBf in stereo or 19 dBf in mono (for quieting levels of 38½ and 53¼ dB, respectively) lock in and hold for several seconds. This can be a bit tedious in areas where there are many weak stations, because the stereo threshold is not adjustable and the circuit holds stations that, to our ears, are more noise than music. But once you receive a clear broadcast, you can enter it for retrieval by depressing STORE and any one of the six numbered presets. An LED above STORE illuminates for a few seconds, indicating the memory's willingness to cooperate; if you do not press a preset within a few seconds, it quietly blinks out. The owner's manual says that the memory circuits will retain presets for up to twenty-four hours even with external power disconnected but advises that two AA cells be loaded into the compartment on the rear of the unit for memory retention of up to one year.

Data from Diversified Science Labs prove the tuner section capable of very good overall performance. Frequency readout is almost dead-on accurate, showing a deviation of just 0.01 MHz at each of our FM test frequencies. Sensitivity is quite high, which leads us to question the usefulness of the five-segment LED signal-strength indicator. Like most of these devices, it is of little help for antenna orientation or for finding extremely weak stations; the most sensitive of the LEDs

Stereo sensitivity (for 50-dB noise suppression)
37½ dBf at 98 MHz, with 0.26% THD+N
(38½ dBf at 90, 39½ dBf at 106 MHz)

Mono sensitivity (for 50-dB noise suppression)
17¼ dBf at 98 MHz

Muting threshold 19½ dBf
Stereo threshold 26 dBf
Stereo S/N ratio (at 65 dBf) 68 dB
Mono S/N ratio (at 65 dBf) 70¼ dB

CAPTURE RATIO 1 dB

ALTERNATE-CHANNEL SELECTIVITY 58½ dB

HARMONIC DISTORTION (THD+N)

	stereo	mono
at 100 Hz	0.18%	0.15%
at 1 kHz	0.11%	0.096%
at 6 kHz	0.21%	0.13%

STEREO PILOT INTERMODULATION 0.20%

IM DISTORTION (mono) 0.078%

AM SUPPRESSION 62½ dB

PILOT (1.9 kHz) SUPPRESSION 69¼ dB

SUBCARRIER (39 kHz) SUPPRESSION >85 dB

Amplifier Section

RATED POWER 19 dBW (80 watts)/ ch.

OUTPUT AT CLIPPING (both channels driven)

8-ohm load	20¼ dBW (106 watts)/ch.
4-ohm load	21½ dBW (140 watts)/ ch.
16-ohm load	18 dBW (63 watts)/ ch.

DYNAMIC HEADROOM (8 ohms) 2½ dB

HARMONIC DISTORTION (THD; 20 Hz to 20 kHz)

at 19 dBW (80 watts)	≤0.035%
at 0 dBW (1 watt)	≤0.02%

FREQUENCY RESPONSE+0 dB, -1 dB, 15 Hz to 38 kHz;
-3 dB at 74 kHz

RIAA EQUALIZATION +½, -¼ dB, 20 Hz to 20 kHz;
-8¼ dB at 5 Hz

INPUT CHARACTERISTICS (re 0 dBW; A-weighting)

	sensitivity	S/N ratio
phono	0.31 mV	73¼ dB
aux	16 mV	77 dB

PHONO OVERLOAD (1-kHz clipping) 225 mV

PHONO IMPEDANCE 51k ohms at 1 kHz (complex)

DAMPING FACTOR (at 50 Hz) 110

HIGH FILTER -3 dB at 8.1 kHz; 12 dB/octave

INFRASONIC FILTER

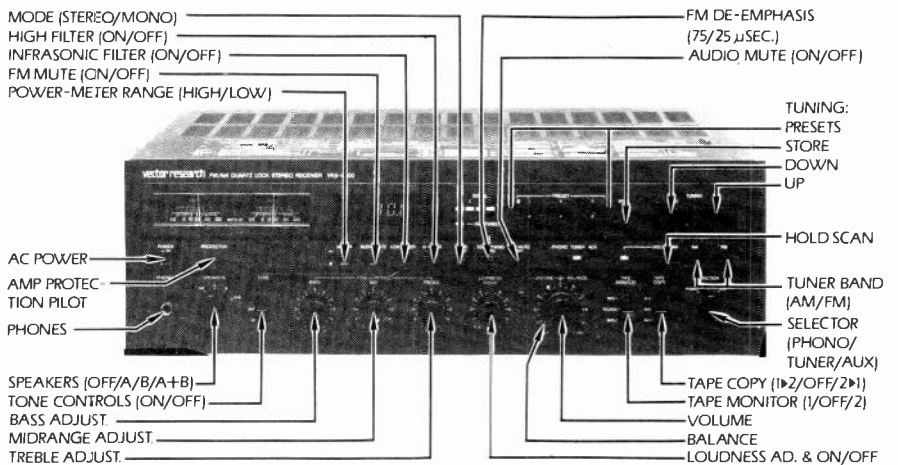
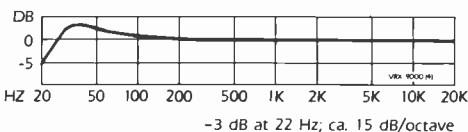

responds to a minimum signal of 25 dBf, which is almost exactly the stereo muting threshold and well above the minimum for useful mono reception.

The preamp section tests out quite nicely, too. RIAA equalization is accurate, particularly so for a receiver. Outstanding, in our opinion, is the flexibility in loudness contouring, which has its own adjustment knob and thus can be matched to any speaker efficiency. The lab's graphs show that the LOUDNESS control lowers levels throughout and beyond the midrange, thereby raising the relative level of the deep bass and, to some extent, the extreme treble. As you turn the knob clockwise, the absolute level diminishes somewhat. This may seem confusing at first, since volume controls work in the opposite direction; once you realize that its purpose is to increase the degree of compensation, all becomes clear. We could not wish for a more effective and gentle compensation scheme.

The bass and treble controls are fairly standard in their operation. So is that for the midrange; its boost/cut action is less extreme than that for the other two, as it should be. The lab discovered, however, that the TONE DEFEAT is not absolute: Some interaction remains if the bass has been left at its maximum setting.

Tests of the power amp section indicate the kind of real-world design that is inherent in the VRX-9000. Clipping of continuous tones does not occur until output is 20¼ dBW (106 watts)—a full 1¼ dBW above its 80-watt rating, and an additional 1¼ dB of output in the pulse test, for the equivalent of 140 watts on musical peaks. Low-frequency damping factor is extremely generous, and total harmonic distortion figures come in far below the rated 0.08% across the audible band at both 0 dBW and rated output. As we've said many times before, power meters on amplifiers or receivers are more cosmetic than useful, and those on the VRX-9000 confirm our contention. Though reasonably accurate at both the low and high scales, the ballistics are quite slow in responding to pulses, thereby obviating their use as clipping-level indicators.

As an alternative to separates, a receiver with such sophisticated performance and functions demands attention. The phono section and amplifier impressed us with their effortless reproduction. And, though we would have preferred an adjustable muting threshold, or at least a fast-scan mode in the tuner, it performed flawlessly—never losing its quartz-lock grip on a selected station. This is one of those receivers that seem to ask for eye-level placement; with so many buttons arranged along a matte black background and marked in very small print, only an unobstructed, head-on view prevents confusion. But as we have stated in the past, there are some products for which we'd be willing to reorganize our system and its lighting rather than pass up a good component. The VRX-9000 is such a product.

Circle 136 on Page 99

A Pickup for Those in Search of Perfection

Dynavector Model DV-20A Type 2 stereo phono pickup, with elliptical diamond stylus. Price: \$230. Warranty: "limited," one year parts and labor, excluding stylus wear. Manufacturer: Acosta Ginza, Japan; U.S. distributor: Dynavector Systems U.S.A., Inc., 30708 Lakefront Dr., Agoura, Calif. 91301.

Dynavector is rapidly distinguishing itself in the cartridge market for its continuing exploration of moving-coil pickup technology. While even rabid

Dynavector DV-20A Type 2 pickup

FREQUENCY RESPONSE & CHANNEL SEPARATION
(test records: STR-100 to 40 Hz; STR-170 above)

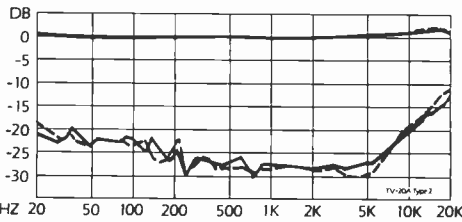

Frequency response

— L ch +2½, -¼ dB, 20 Hz to 20 kHz
 - - - R ch +2½, -¼ dB, 20 Hz to 20 kHz

Channel separation

≥ 25 dB, 230 Hz to 6.4 kHz;
 ≥ 15 dB, 20 Hz to 14.5 kHz

SENSITIVITY (at 1 kHz)

1.1 mV/cm/sec.

CHANNEL BALANCE (at 1 kHz)

± <¼ dB

VERTICAL TRACKING ANGLE

28½°

LOW-FREQUENCY RESONANCE (in SME 3009)

vertical 9.6 Hz; 1½ dB rise
 lateral negligible

MAXIMUM TRACKING LEVEL (re RIAA 0 VU; 1.6 grams)

at 300 Hz > +18 dB
 at 1 kHz +12 dB

WEIGHT

5.1 grams

TIP DIMENSIONS

tip radii 6.3 by 15.7 micrometers
 scanning radii 6.3 and 7.3 micrometers

SQUARE-WAVE RESPONSE (1 kHz)

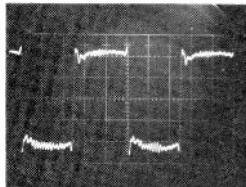

perfectionists may balk at a \$1,000 pickup equipped with a solid diamond cantilever, Dynavector has one available. The unit reviewed here, the DV-20A Type 2, is more affordable, but under its "tin can" hood lurk several noteworthy technical innovations. This is a high-output design; that is, the output voltage is sufficient to drive a preamp without a head amp stage or stepup transformer. The cartridge has the moving-coil's virtue of being essentially insensitive to reactive properties of the load it must operate into and thus should work equally well with a wide range of preamps, receivers, and integrated amps.

While many moving-coil pickups are rather massive affairs, this one is comparable to the familiar low-mass fixed-coil designs. Dynavector tells us that it was able to reduce mass by fabricating the main frame from polyester-reinforced glass fiber, instead of the usual aluminum, and by using rare-earth magnets for lowest possible weight/flux-density ratio. With the reduction in weight comes higher compliance than is usual for a moving-coil model and greater ability to mate successfully with low-mass tonearms. CBS Technology Center found that resonance with our "standard" SME arm was not only near ideal in frequency, but extremely low in amplitude—vanishingly low in the horizontal plane.

The frequency response curve is one of the flattest we've yet encountered with a moving-coil pickup, with the characteristic high-frequency peak of many such designs very well controlled here. Dynavector says that it uses a disc capacitor to damp out high-frequency peaks due to the mechanical resonance of the tapered aluminum cantilever. The nude-mounted stylus appears much like a multiradial or "line contact" type under the CBS microscope, which also reveals good polish and alignment. The pickup passed the CBS "torture test" at 1.4 grams—on the high side in comparison to fixed-coil models but about average among moving-coil designs. The lab ran the remaining tests at 1.6 grams, the bottom of Dynavector's recommended range, which extends to 2.3 grams. Channel balance is about as accurate as you can get; the output difference was barely measurable in the lab. Distortion measurements are also firmly in the good-to-excellent category.

In terms of the DV-20A's musical performance, we were simply delighted. The lucidity of tone offered by this pickup is outstanding. Its ability to reproduce nuance and detail leaves us wondering whether we have ever really heard our records before—even familiar ones. A satisfying sweetness replaces the high-end brightness so common to moving-coil pickups and evidenced by an etched string sound. Stereo imaging is precise and stable. Noteworthy too is the ability to track some of our worst record warps; one with a heavy bass-drum modulation was negotiated with nary a bump.

Considering the number of phono cartridges available and their wide divergence in price, recommending pickups is an ungrateful task; each has its own sonic character, and the law of diminishing returns sets in for one listener before another even becomes interested. But here is a cartridge that we can recommend to phonophiles in search of perfection—one that raises the question, "How much better can a \$1,000 pickup possibly be?"

Circle 133 on Page 99

A Speaker from the "New" Dynaco

Dynaco Model A-250 speaker system in walnut-veneer cabinet. Dimensions: 14¼ by 25 inches (front), 14½ inches deep. Price: \$250. Warranty: "limited," three years parts and labor. Manufacturer: Dynaco, Inc., 110 Shawmut Rd., Canton, Mass. 02021.

We who have admired the quality of and creativity inherent in so many Dynaco products over the years bid welcome to the "new" Dynaco. After the company's acquisition last year by the California-based ESS, we wondered what direction it would take. Its first offering is a trio of speakers; of these, we chose to test the A-250—the middle of the line.

Unlike its immediate predecessor, the A-25XL, this speaker is an acoustic-suspension design. The driver complement consists of a 10-inch woofer, 3-inch midrange, and 1-inch soft-dome tweeter. Two continuously variable controls, located just above the spring-loaded connectors in a recess of the rear of the enclosure, provide midrange and high-frequency contouring. The midrange control is calibrated from -4 to +2 dB, values that are unusually close to the response variation measured at CBS Technology Center; the tweeter brilliance control is calibrated from -50 to +3 dB. Here the measurements on our test sample show the indicated boost but a less extreme—and, therefore, more useful—maximum cut. With both controls at their flat (0-dB) settings, CBS found the A-250 capable of flat

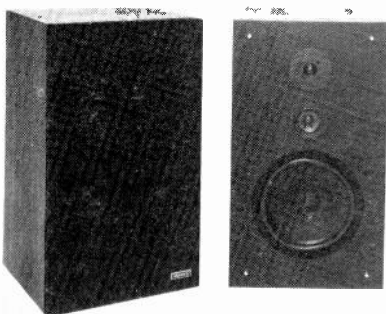

Reel Versatility At a Cassette Deck Price.

The New Realistic® Upgrader.

Upgrading is for music lovers who can hear the difference. For them, Radio Shack has made "the difference" affordable . . . for example 30-28,000 Hz (± 3 dB) frequency response, extended dynamic range, low distortion, low noise — you get it all in the easy-to-be-creative open reel format. Tape handling is no problem because the TR-3000 is totally logic controlled. A pushbutton-activated solenoid system controls all tape movement — you can switch functions instantly, without tape spills or snarls. Pause and mute controls even let you edit electronically, as you record.

The TR-3000 has three motors. A precision servo-controlled capstan motor reduces wow and flutter to less than 0.06% WRMS. And two high-torque reel motors maintain constant tape tension for smooth, fast winding. Separate play, record and erase heads give you "off-the-tape" monitoring. Individual mike and line input controls work like a built-in mixer. High/low bias and EQ switches for an optimum match with any tape. 7½ and 3¾ ips speeds. And lots more. Realistically priced at only \$499.95.* Check its superb sound and specs at one of our 7000 locations today!



Radio Shack®
The Nationwide Supermarket of Sound®

*Retail price may vary at individual stores and dealers, Cat. No. 14-700. Illustrated metal reels an extra option.

Dynaco A-250 loudspeaker

ANECHOIC RESPONSE CHARACTERISTICS (0-dBW input)

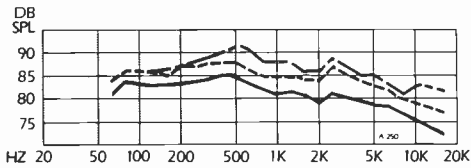

- ▤ boundary-dependent region
- average omnidirectional response
- - - average front hemispheric response
- - - on-axis response

AVERAGE OMNIDIRECTIONAL OUTPUT
(250 Hz to 6 kHz)
82 dB SPL for 0 dBW (1 watt) input

CONTINUOUS ON-AXIS OUTPUT (at 300 Hz)
109 dB SPL for 20 dBW (100 watts) input

PULSED OUTPUT (at 300 Hz)
122 dB SPL for 33 dBW (2,000 watts) peak

"NOMINAL" IMPEDANCE 7.3 ohms

APPROX. TWEETER CONTROL RANGE (re "flat")
+3, -10 dB above 3 kHz

APPROX. MIDRANGE CONTROL RANGE (re "flat")
+1, -3 dB, 1-2 kHz

and extended frequency response, the bottom end reaching down to around 40 Hz.

The data further disclose only moderate efficiency, as you would expect from an acoustic-suspension system. Power handling and dynamic range are excellent. The A-250 easily passed the continuous-tone test without exceeding distortion limits, and in pulsed-power tests, it handled almost 2 kilowatts before distortion became excessive. Only minor evidence of reflections or hangover in the pulses appears on the oscilloscope. Impedance values remain at or above the rated 8 ohms over most of the frequency spectrum, with the nominal 7.3 ohms occurring at 100 Hz.

At both moderately loud (89-dB) and loud (100-dB) sound pressure levels, third harmonic distortion remains quite low, averaging less than 1/2% over most of the audible band and just barely touching 1% at the highest frequencies at the loud level. At moderate levels, the "softer" second harmonics stay well below 1/2% across the midrange but rise to about 2% above 5 kHz; at the higher output, they average about twice these values.

In listening tests, we were unanimous in judging this a speaker that's easy to live with. Its tone is distinctly unboxy, with a minimum of midrange coloration. It projects an upfront stereo image that many find a dramatic plus. Bass response is quite good, and even deep organ fundamentals have fair definition. At higher frequencies, and even in very complex orchestral textures, definition is quite good, though our panel noted a certain harshness in occasional wind and bass passages.

Considered in toto, the A-250 is an admirable speaker of the sort traditionally associated with the Dynaco name. As that phrase implies, it cannot be called radical in any way, and it offers good value. Advance information hints that the new Dynaco electronics due to appear later this year will not be quite as tradition-minded, so perhaps this model should not be taken as a blueprint for things to come. It is, however, strong confirmation that Dynaco is not altogether abandoning its past under the new ownership.

Circle 134 on Page 99

A Successful First Deck Biases Itself

Onkyo TA-2080 cassette deck

PLAYBACK RESPONSE (TDK test tape; -20 dB DIN)

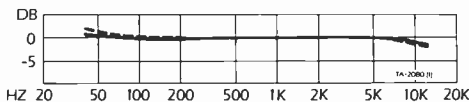

- L ch +1, -1 1/4 dB, 40 Hz to 12.5 kHz
- - - R ch +2, -2 1/4 dB, 40 Hz to 12.5 kHz

RECORD/PLAY RESPONSE, TYPE 2 TAPE (-20 dB)

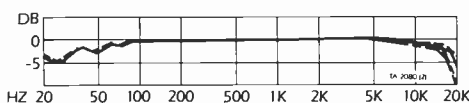

- L ch +1/4, -3 dB, 33 Hz to 18 kHz
- - - R ch +1/4, -3 dB, 32 Hz to 19 kHz
- with Dolby noise reduction
- L ch +1/4, -3 dB, 33 Hz to 15 kHz
- - - R ch +1/4, -3 dB, 32 Hz to 16 kHz

RECORD/PLAY RESPONSE, TYPE 4 TAPE (-20 dB)

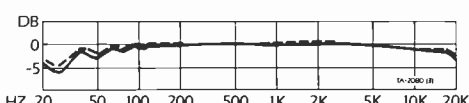

- L ch +1/4, -3 dB, 50 Hz to 18.5 kHz
- - - R ch +1/4, -3 dB, 32 Hz to 20 kHz

Onkyo TA-2080 cassette deck, in metal case. Dimensions: 17 1/4 by 6 inches (front panel), 1 3/4 inches deep plus clearance for controls and connections. Price: \$800. Warranty: "limited," two years parts and labor. Manufacturer: Onkyo Corp., Japan; U.S. distributor: Onkyo U.S.A. Corp., 42-07 20th Ave., Long Island City, N.Y. 11105.

A modern cassette deck is a complex device, particularly in terms of the interrelationship of its functional elements, and designing one that really works well presents a challenge that is not always met squarely even at companies with years of practice. When Onkyo announced its first line of decks last summer, we wondered how well a newcomer would do; on the basis of the TA-2080, and despite a couple of minor oddities, the answer is very well indeed.

In basic description it is a three-head deck (recording and playback heads are mounted in a single assembly fitting the main head opening in the cassette) with the virtually obligatory metal-tape capability, an automatic-biasing feature, and solenoid/logic controls for the two-motor transport with phase-locked servo capstan drive. Of these elements, the AccuBias feature is the most unusual. It is activated by a single button and records an alternating series of tones at 400 Hz and 10 kHz, adjusting bias until output level from the two matches precisely. When that is achieved (in only a few seconds), the MEMORY REWIND will return the tape to the starting point. The usual tape switching provides preprogrammed bias settings, but AccuBias is so quick and simple in use that it should be routine for all owners. If you move the main bias switch to a different position and forget to rerun the AccuBias for the new tape, the deck automatically reverts to the preprogrammed values to limit the "wrongness" of the setting. We appreciate this wrinkle after working with decks on which a single knob alters all tape-switch position biases, so that when you adjust one you necessarily misadjust all the others with respect to their standard settings.

There also is a sensitivity adjustment for Dolby tracking. The built-in oscillator, atypically, is wired ahead of the line-input level control, which therefore must be adjusted to bring the meters to their Dolby calibration mark in the SOURCE monitor position before the Dolby adjustment itself can be made. The fact that this system requires calibration may seem annoying; the fact that it permits calibration actually is a plus, since factory adjustment of the more standard post-control

Auto Sound Just Got Serious

The Voice of the Highway™ from Altec Lansing

Are you content to use toy loudspeakers with front-end gear that sells for \$300 and more? If you are, good luck. If you're not, read on.

Altec Lansing has been solving the world's most serious sound problems for 43 years. So when we turned our minds to the problem of putting quality sound on wheels, we meant business.

A quick look around showed us that it hadn't worked to merely adapt conventional speakers to car interiors or make miniature versions of hi-fi components. So we began with the *car*—not the components.

We thoroughly explored the car's uniquely difficult acoustical environment. Then we designed *The Voice of the Highway*: A group of speakers that work with *any* car sound system, are adaptable to a wide variety of body styles, and produce quality sound that, until now, was impossible to achieve in a car.

It's a system of options. Separate high-frequency (TK1), extended range (SK1), and sub-bass (SW1) speaker components that together produce optimum results. And they can be mixed or matched to fit a variety of space needs and sound desires, or enhance a currently installed system. Plus, there's a 6" x 9" full range Duplex speaker that *installs easily in the door*.

And we built all Voice of the Highway speakers to be efficient so their clean, clear, tight sound gets through traffic noise without pushing even modestly-powered amplifiers past their limits.

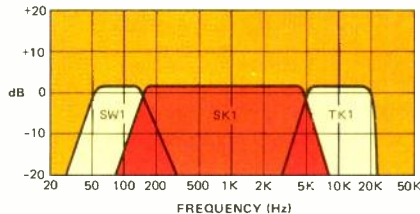

*The Power Bass and TK1
Restore the Music You're Missing.*

And they complement virtually all quality automotive stereo systems, either as a complete speaker system or as add-on accessories.



Rear view of the Power Bass, showing built-in amplifier. When added to any tape player or radio, the Subwoofer bi-amplifies the system, improving the dynamic range and reducing distortion.

*The AL1 System
includes a pair of TK1s,
a pair of SK1s and a SW1
Power Bass.*

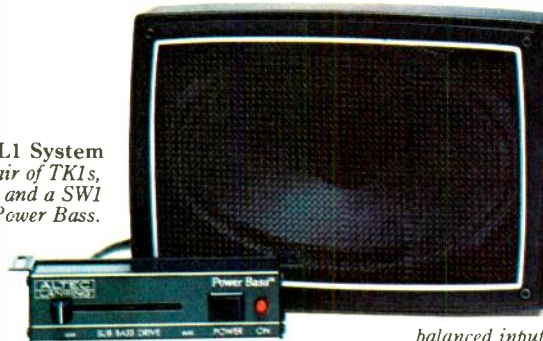

SW1 Power Bass

The SW1 Power Bass self-powered subwoofer gives deep bass to auto sound where none existed before. It is destined to become THE automotive sound accessory of the eighties. Its control module balances the bass output to the rest of the system. The Power Bass' unique die cast structure houses a 40-watt power amplifier, electronic crossover, balanced inputs and active equalizer, and functions as the amplifier's heat sink.

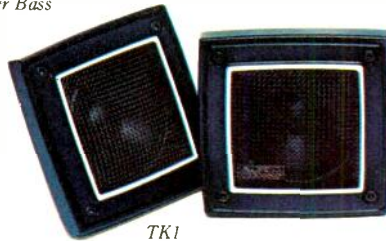

TK1

The TK1, 3" high frequency driver covers the very top of the musical spectrum adding brilliance and clarity.

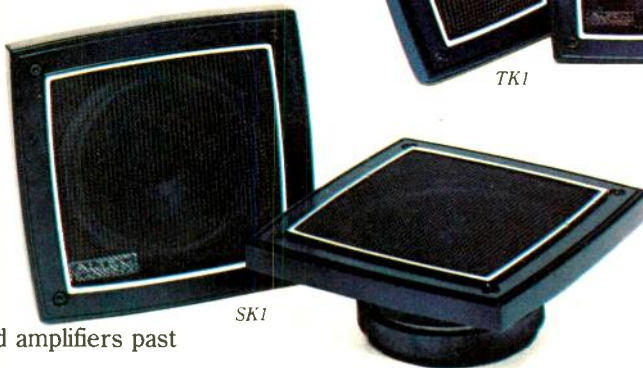

SK1

The SK1, 5 1/4" extended range speaker can stand on its own where installation space is extremely limited.

If you're serious about putting quality sound on your wheels, contact your local Altec Lansing dealer, or Altec Lansing.

The Voice of the Highway from Altec Lansing. Auto sound just got serious.



1515 SOUTH MANCHESTER AVENUE, ANAHEIM, CALIFORNIA 92803

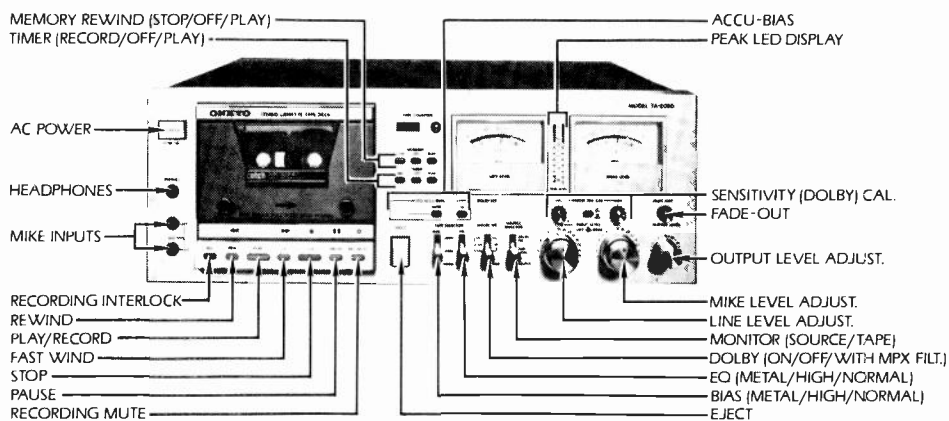

RECORD/PLAY RESPONSE, TYPE 1 TAPE (-20 dB)

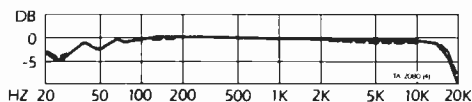

— L ch +0, -3 dB, 32 Hz to 15.5 kHz
 - - - R ch +0, -3 dB, 31 Hz to 16.5 kHz

S/N RATIO (re DIN 0 dB; A-weighting)

	Type 2	Type 4
playback	59½ dB	59 dB
Dolby playback	67½ dB	67 dB
record/play	56 dB	57 dB
Dolby record/play	64 dB	64½ dB

INDICATOR READINGS FOR DIN 0 DB

meters	+4 dB
LED display	+5 dB

METER READING FOR 3% DISTORTION (at 333 Hz)

Type 2 tape	+4½ dB
Type 4 or 1 tapes	>+5 dB

DISTORTION (third harmonic, at -10 dB)

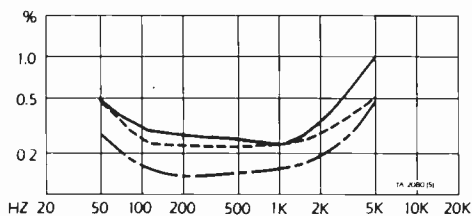

— Type 2 tape ≤1.0%, 50 Hz to 5 kHz
 - - - Type 4 tape ≤0.52%, 50 Hz to 5 kHz
 - · - Type 1 tape ≤0.49%, 50 Hz to 5 kHz

oscillators is not always precise. When you perform the operation, incidentally, you encounter one minor oddity of the design: The monitor switch is labeled SOURCE SELECTOR, which recordists used to the standard terminology may find momentarily confusing.

Of more moment is the evidence of indecision in the design of the metering system. Though a dual peak-LED display is provided, with one display for each channel, it is not calibrated finely enough for regular signal assessment. The meters are well calibrated—from +5 to -40 VU—but distinctly sluggish since they require pulse durations of ¼ second or so to come within 3 dB of reading full value of the pulse. Consequently the careful recordist must use the two meters for a general idea of signal behavior and, simultaneously, keep a "third eye" on the upper portion of the peak display, watching for transients loud enough to threaten overload and brief enough to slip by the meters. We found no practical use for the lower range of the LED display, which we considered redundant with the meters. We would have preferred a single, more capable display mode.

Onkyo's manual lists Maxell UDXL-II as the reference Type 2 tape (our basic reference in all cassette-deck tests), UDXL-I as the Type 1 ferric, and—with a little less emphasis—Scotch Metafine for Type 4. (In general, however, the list will only confuse most American owners since it is based strictly on the tapes and brand designations available in Japan.) Diversified Science Laboratories used these brands for the measurements and also checked out TDK D (a Type 0 ferric) in investigating the properties of AccuBias vs. the preset bias. The preset delivered almost identical results with Metafine, though AccuBias arguably improved performance by a tiny margin. With the other tapes AccuBias produced distinctly better results than the presets; in particular, that for ferric tapes is underbiased for UDXL-I and overbiased for D, delivering a peaky high end with the former and a severe rolloff with the latter. AccuBias gets excellent results from both tapes. Again, we would expect owners to make routine use of the AccuBias even if these tests had not proved the wisdom of doing so.

Results range from good to excellent for all the AccuBiased tapes. Distortion is low, but not quite as low as our distortion graphs indicate because appreciable quantities of the second harmonic (in addition to the documented third) are present; generally, however, the THD runs no more than about 0.1% higher than the values in the chart. Response with all the tested tapes is quite flat, and noise figures are down where they should be in a quality deck. Taking these considerations together, you will note that the Type 1 tape gives the others fairly stiff competition, though it is the least expensive. Its midrange headroom is almost as high as the metal, its response almost as extended as the Type 2, its noise not much higher than either, and its distortion curves the lowest of the three. In use we sometimes judged it the cleanest sounding, though the Type 4 metal tape, predictably, did best where high-frequency headroom was required.

Onkyo thus has done more than just avoid pitfalls in its first cassette decks: It has achieved genuine quality in its first try, judging from this flagship model. It contains a number of extras—a fadeout control for erasing the tail end of a recording that has been allowed to run a little too long (say, into the subsequent announcement on FM), both MEMORY STOP and MEMORY PLAY rewind options, a RECORDING MUTE, and so on—but none is particularly radical or arcane. Which is to say that, while the TA-2080 breaks no ground that is altogether new and caters to no special-interest group among recordists, it is a solid deck of well-accepted mold.

Circle 131 on Page 99

The new Sansui G-4700.



A double-digital receiver with all the right numbers.

Digital readouts and digital circuitry. Great specs. And the best price/performance ratio in the business. All the right numbers. That's the new Sansui G-4700. Just look what we offer:

Double-Digital Design: The front panel of the G-4700 has a bright electronic digital readout that shows the frequency of the station you've selected; and behind the front panel is one of the most advanced tuning systems in the world.



Sansui's patented Digitally Quartz-Locked Circuit uses a precise quartz crystal time base to keep your station locked in, even through many hours of listening or if you turn the receiver off and back on again.

Conventional quartz-controlled receivers use analog phase comparison circuits that can become inaccurate because of harmonic interference. Our system uses a new LSIC (Large Scale Integrated Circuit) digital processor that actually counts the vibrations of the quartz crystal to compare to the tuned frequency. The frequency is perfectly locked in the instant you find the station you want.

With this unique Digitally Quartz-Locked system, the G-4700 delivers high sensitivity (15dBf, mono); a better signal-to-noise ratio (75dB, mono);

and a better spurious rejection ratio (70dB).

DC power amplifier: Power is ample for almost any speaker made, with 50 watts per channel, min. RMS, both channels driven into 8 ohms from 20 to 20,000Hz with no more than 0.05% THD.

And the wide bandwidth DC power amp circuit responds quickly to transient music signals for the most accurate and pleasing music reproduction. What you hear is clean and sharp, just the way it was recorded.

Electronic LED power meters: Don't worry if your present speakers can't handle 50 watts. The array of fast-acting LED's (Light Emitting Diodes) on the Sansui G-4700 lets you monitor and control the output level so you don't damage your speakers.

Electronic tuning meters: Two fluorescent readouts help to zero-in on each station with accuracy and ease. Both the signal strength and center-tune indicators operate digitally for precise station selection, and the nearby LED verifies that the quartz circuit has locked in your station.

Superb human engineering: A full complement of genuinely useful knobs, switches and jacks gives you complete control over what you hear and how you hear it.

Ask your authorized Sansui dealer to demonstrate the G-4700. Listen to the music. You'll love what you hear. Look at the numbers. You'll love what you see.

SANSUI ELECTRONICS CORP.

Lyndhurst, New Jersey 07071 • Gardena, Ca. 90247
SANSUI ELECTRIC CO., LTD., Tokyo, Japan
SANSUI AUDIO EUROPE S.A., Antwerp, Belgium
In Canada: Electronic Distributors



Upgrade to...

AIWA

AIWA AD-M700 3-HEAD METAL TAPE COMPATIBLE CASSETTE DECKS

We'll go head to head with anyone

Aiwa's AD-M700 cassette decks in contemporary-styled silver or in a black rack-mount handle cabinets have a 3-head Double Dolby* NR configuration. So do some high-priced decks. What the high-priced decks don't have is Aiwa's unique V-cut head geometry to cancel out low-frequency contour effect, i.e., get rid of the roughness. While the record and playback heads are placed in single housing, they are completely separate, allowing each head to have the ideal gap width for its specific purpose. This provides low noise recordings with extended frequency response.

To match this supreme head-system performance, we've used a 2-motor tape transport for dependability and smoothness as well as a phenomenal 0.04% Wow and Flutter WRMS.

Finally, to make the most of Aiwa's superb heads and transport system, we've put in a continuous variable bias adjust control for the optimum flat response regardless of what—or whose—tape you use, including metal particle tape.

All of this gives you terrific sound with a frequency response of 20-19,000Hz with metal tape; S/N ratio of 65dB (Dolby* on, FeCr tape). Then we added these fine touches for convenience and versatility...feather-touch logic controls, continuous repeat and memory replay, 5-point multi-color peak reading LEDs, REC/MUTE edit replay and a host of other high-priced features that come with any Aiwa cassette deck. Look for Aiwa's AD-M700U in silver; AD-M700BU in rack-mounting black.

*Dolby is a trademark of Dolby Laboratories, Inc.

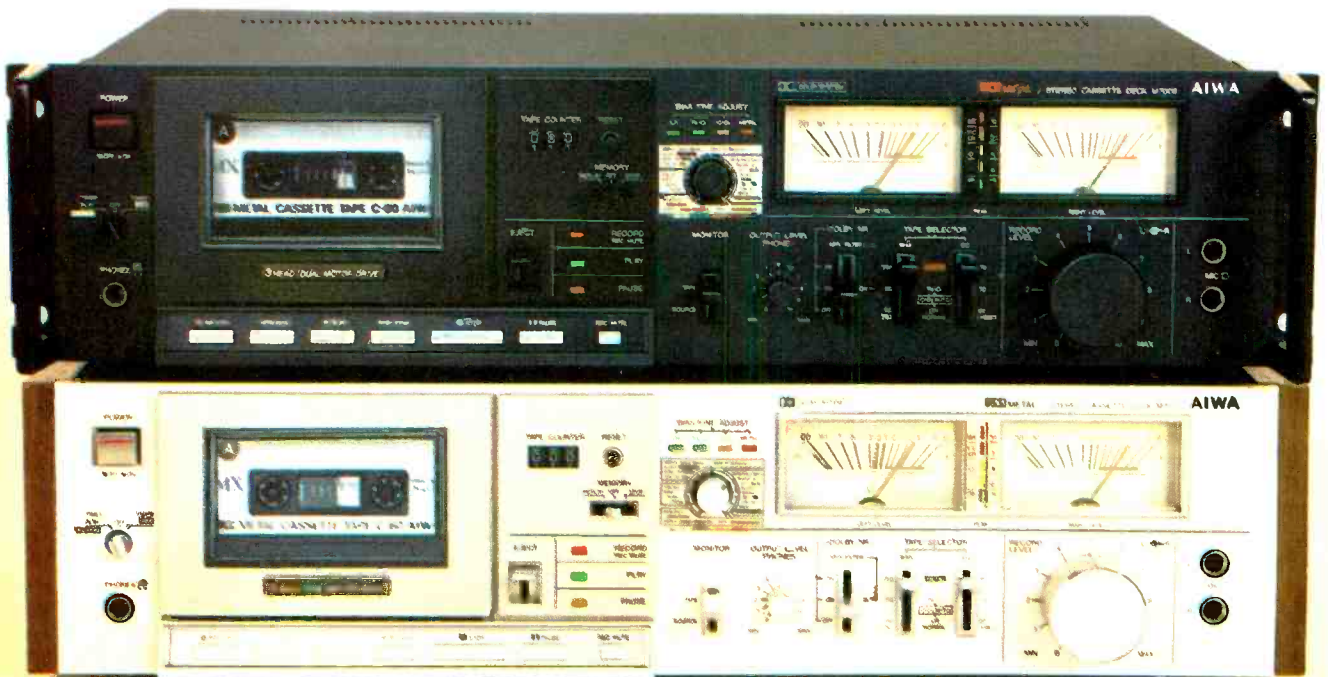

Upgrade to...

AIWA®

AMERICA, INC.

35 Oxford Drive

Moonachie, New Jersey 07074

A Quick Guide to Tape Types

Our classifications, Types 0 through 4, are based largely on those embodied in the measurement standards now in the process of ratification by the International Electrotechnical Commission. The higher the type number, the higher the tape price generally is in any given brand. Similarly, the higher type numbers imply superior performance, though—depending in part on the deck in which the tape is used—they do not guarantee it.

Type 0 tapes represent "ground zero" in that they follow the original Philips-based DIN spec. They are ferric tapes, called LN (low-noise) by some

manufacturers, requiring minimum (nominal 100%) bias and the original, "standard" 120-microsecond playback equalization. Though they include the "garden variety" formulations, the best are capable of excellent performance at moderate cost in decks that are well matched to them.

Type 1 (IEC Type I) tapes are ferrics requiring the same 120-microsecond playback EQ but somewhat higher bias. They sometimes are styled LH (low-noise, high output) formulations or "premium ferrics."

Type 2 (IEC Type II) tapes are intended for use with 70-microsecond

playback EQ and higher recording bias still (nominal 150%). The first formulations of this sort used chromium dioxide; today they also include chrome-compatible coatings such as the ferricobalts.

Type 3 (IEC Type III) tapes are dual-layered ferrichromes, implying the 70-microsecond ("chrome") playback EQ. Approaches to their biasing and recording EQ vary somewhat from one deck manufacturer to another.

Type 4 (IEC Type IV) are the metal-particle, or "alloy" tapes, requiring the highest bias of all and retaining the 70-microsecond EQ of Type 2.

Another Winner from Koss



Koss HV/X stereo headset, with 10-foot coiled cord. Price: \$70; also available as the HV/XLC with individual earpiece level controls, \$80. Warranty: "limited," one year parts and labor. Manufacturer: Koss Corp., 4129 N. Port Washington Ave., Milwaukee, Wis. 53212.

The Koss HV headphone series is designed around the premise that total isolation from your aural environment is undesirable in some kinds of listening. We agree both with that premise and with its obverse: that isolation (such as that provided by Koss's own classic Pro series) is desirable in other types of listening. Headphones got their start in audio as monitoring devices for recording locales without control rooms and therefore without the option of using loudspeakers to evaluate the sound pickup. High acoustic seal obviously is necessary for this purpose. In home listening, isolation may be needed where ambient noise levels are high or may be preferred just as a means of escape from the here and now through music. But we generally experience less listening fatigue with the so-called open-air designs like the HV, because they do not, in fact, subject the listener to a sense of total isolation. The choice thus is influenced by living conditions, life styles, musical tastes, and program material. And since virtually all commercially available program material is in stereo—that is, specifically intended for reproduction on a pair of speakers—purists will object that any use of headphones with programs not captured binaurally for this purpose is, at best, a compromise. Even so, there are circumstances (late-night listening, for example) under which it is a desirable compromise.

Like the HV-1 (test report, July 1974), the HV/X aims to satisfy the listener who objects to the weight as well as the acoustic isolation of sealed-cup phones yet misses the deep bass response lacking in some open-air designs. Koss's solution involves the use of variable-density foam ear cushions. Though the ear is surrounded completely by the circumaural cushion, the wearer notices immediately that normal ambient sounds are diminished only slightly. The cushion is made of a very porous foam that remains acoustically transparent at its low-density perimeter but is compressed, and therefore acoustically more opaque, toward the inner side. This variable density provides a pattern of acoustic resistance that controls dissipation of the bass frequency range without inhibiting the passage of mid and high frequencies. Koss also claims that the bass boost afforded by these earcups permitted a major modification to the drivers, lightening them considerably. In fact, at a featherweight 7.8 ounces and with the squishy foam cushions gently resting on (and warming) one's ears, the HV/X is among the most comfortable, least fatiguing headphones we've ever used.

But how does it sound? In a word, exceptional. Auditioning it with bands of pink noise, we could find little if any rolloff of high frequencies up to about 15 kHz, and bass response remains firm into the nether regions around 50 Hz. Reproduction in the lower registers has a sonorous richness usually associated with sealed-cup designs, and midrange presence is raised to an exciting, if slightly surreal, level. Also pleasing in this headset is the kindness with which it treats those ever-present extramusical details: The breathiness of the singer and the slip of the fingers

down the strings of the guitar are not exaggerated. We could find no evidence of distortion at any listening level short of our threshold of physical discomfort. (Koss rates the HV/X for 120 dB SPL, a fearsome figure.)

With a rated impedance of 90 ohms at 1 kHz, the HV/X should suit the headphone jacks of receivers, amplifiers, and most preamps and tape recorders. (But, again, the low-seal design is not essentially appropriate for critical monitoring during live recording, and the headphone output from many tape decks is, in any event, inadequate for high-level listening with most headphones.) The coiled cord extends from its 3-foot length to a maximum of around 10 feet, and in overall construction the set seems fairly rugged for such a lightweight unit. As an all-purpose headphone to delight and tickle you in your private moments, the HV/X can be heartily recommended.

Circle 132 on Page 99

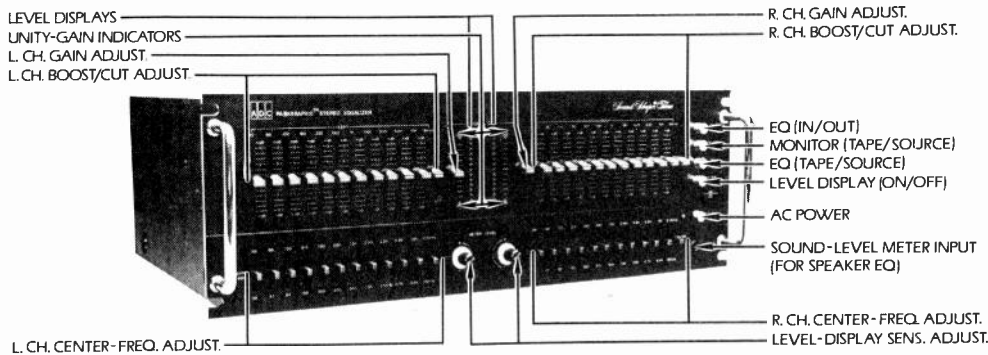

A Graphic-Plus Equalizer

ADC Sound Shaper Three Paraphrastic equalizer, in metal rack-mountable case. Dimensions: 19 by 6¼ inches (front panel), 12 inches deep plus clearance for handles, controls, and connections. AC convenience outlet: one unswitched (200 watts max.). Price: \$500; optional SLM-3 sound-level meter and calibration record, \$70. Warranty: "limited," two years parts and labor. Manufacturer: made in Taiwan for Audio Dynamics Corp. Professional Products Group, BSR (U.S.A.), Ltd., Route 303, Blauvelt, N.Y. 10913.

The ADC/BSR equalizer line has been growing more or less constantly ever since BSR acquired Metrotec some years back. In retrospect, that seems like a humble beginning; the little Metrotec graphic unit was a dandy accessory in its day, however, and it laid the foundation for the imposing Sound Shaper edifice. Until recently all models in the line were graphic equalizers, yet the numbers of control bands and the switching options have grown, producing ever more flexibility of use and sophistication of behavior. The Three, for example, has full pre/post-tape switching (a must, in our view, for recordists who want to equalize program material, though it took a long time for this feature to become commonplace), a level-matching display and trim controls (to prevent distortion from overdriving any portion of your system or noise from underdriving it, and to make EQ in/out A/B comparisons meaningful—and here employed as a reference for speaker equalization), and separate sliders for each stereo channel (sometimes desirable for program EQ, even more important for speaker EQ). The most striking innovation is the bottom rank of switches, which shift the bandpass frequencies of the twenty-four sliders—twelve for each channel, spaced a little less than an octave apart—upward or downward by approximately a quarter-octave.

This is what ADC calls its Paraphrastic design, a term that needs some explanation. In its main outlines, the Three is a graphic equalizer: Once set, frequency band by frequency band, the sliders give you a "graphic" display of the response curves they create. Parametric equalizers work not with manufacturer-mandated frequency bands, but with the individual parameters of response shaping: frequency (band centers), Q (bandwidth and band sharpness), and—like the graphics—level (cut or boost within the chosen band). ADC's Paraphrastic design includes no control of Q as such; to create a band broader than those controlled by its individual sliders, you must "construct" it with the aid of neighboring sliders. The

TEAC TODAY: THE X-SERIES.

You're looking at four new machines that have more in common with data recorders than audio recorders. Together they are called the X-Series. And they bring a totally new kind of technology to the open reel format.

Each X-Series transport is an instrumentation mechanism. For 15 years, this TEAC design has stood the grueling test of time in computer installations where dependability is worth millions.

The basic configuration is closed-loop dual capstan. It's extraordinarily quiet, stable and precise. Wow & flutter is very low. Speed accuracy very high.

Three DC motors drive the tape. They're used to keep changes in motor temperature to a minimum under different loads so constant torque is maintained.

Our Magnefloat flywheel assembly, a completely new concept, uses magnetics rather than mechanics to eliminate problem-causing springs and pressure plates. Axial variations between the tape and capstans are prevented so proper tracking is assured. The result is highly accurate audio reproduction even after years of hard use.

The X-Series transport maintains ideal tape-to-head contact. Audible drop-outs, level and frequency losses are absolutely minimized. Frequency response is wide and flat. And signal articulation is unusually clear.

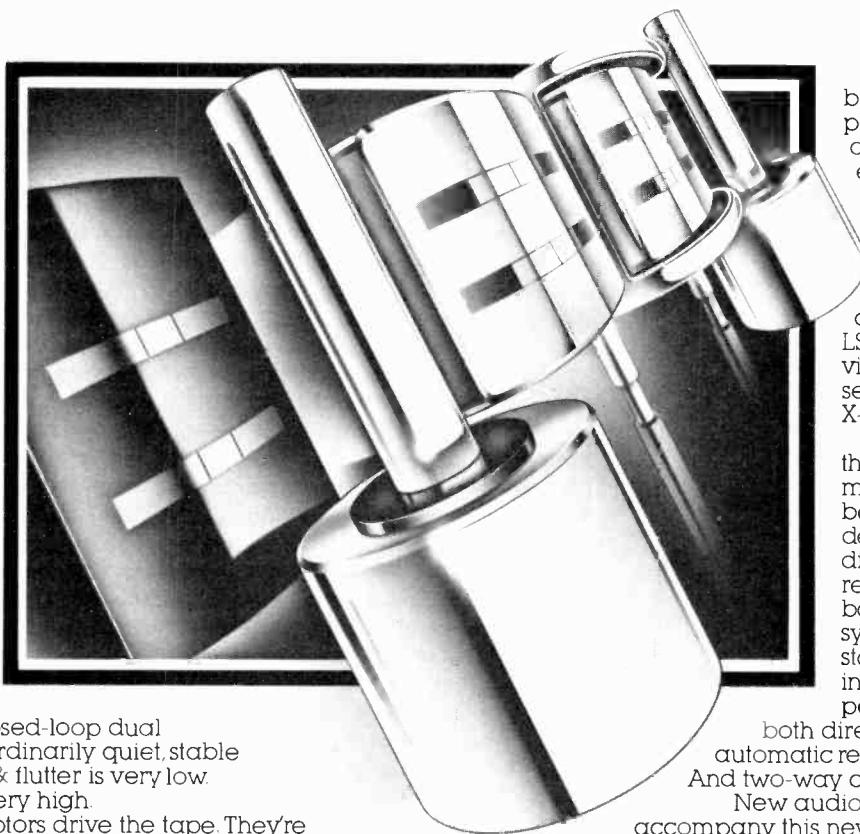

The brain behind the transport is our LSI control chip. It eliminates the need for mechanical relays so transport control is faster, more positive and reliable. The LSI also lets us provide full motion-sensing in the X-10 and X-10R.

Within the X-Series, machines have been specifically designed for bi-directional record and playback. Perfectly symmetrical head stacks (6 heads in all) assure top performance in

both directions. There's automatic reverse and repeat. And two-way cue monitoring.

New audio electronics accompany this new transport technology. Record and playback amplifiers are quieter and completely free of audible distortion. The sound is cleaner, more faithful to the source. The fidelity is unsurpassed.

An option previously available only on our professional recorders can now be added to any X-Series machine. Called dbx I, this noise elimination system adds 30dB to the already high S/N and over 10dB of headroom to give you master-quality recordings.

If your audio perception is critical, your listening standards high, audition an X-Series recorder. The performance is flawless. The sound peerless.

TEAC®



*dbx is a trademark of dbx, Inc.

ADC Sound Shaper Three equalizer

OUTPUT AT CLIPPING

9 volts

HARMONIC DISTORTION (THD; 20 Hz to 20 kHz)

0.5 V in, 2.0 V out (IHF) $\leq 0.15\%$
 1 V in, 1 V out (normal use) $\leq 0.028\%$

FREQUENCY RESPONSE

+0, -¼ dB, 10 Hz to 260 kHz;
 +0, -3 dB, < 10 Hz to 460 kHz

INPUT CHARACTERISTICS (IHF loading, A-weighting)

	sensitivity	S/N ratio
sliders centered	79 mV	101 dB
sliders at max.		90 dB

(sliders centered unless otherwise specified)

resulting envelope therefore may not be quite as smooth and regular as you would expect from a parametric model, but with modest degrees of boost or cut, the differences are vanishingly small, and even settings extreme enough to show band-to-band ripple on graphic-equalizer response curves may sound identical to their parametric equivalents. The Three does add the frequency-shift option not normally found on graphic designs—though in discrete positions, rather than the continuous variability of the parametrics. And, most important in practice, the basic layout and behavior of the Three is that of a graphic model. Thus we approach it as a graphic equalizer whose subtlety of control will deliver results comparable to those from a parametric. It is not, in our view, really the functional combination of parametric and graphic designs that the name might suggest.

Since the significance of the last statement goes to the way in which one thinks about and goes about using the device, it also goes to the dual applications to which the Three addresses itself. In the best of all possible worlds, where no regard for price is necessary, we would want to use one easily accessible equalizer to correct any response problems in the program signals and another—preferably hidden away where its “ideal” settings won’t be tampered with—to “fix” speaker response. ADC, like its competitors, realizes that this is a luxury few of us can afford; the Paragraphic design is intended to encompass both applications with as much grace and as little compromise as possible.

ADC also offers the SLM-3 sound-level meter and a calibration record to use in speaker setup, and we suggest that you do so. If you don’t want to lay out \$70 for an item that, at least in theory, you’ll never need again as long as you don’t change your speakers or your room, ask your ADC dealer about renting or borrowing one; he may be happy to accommodate you in view of the equalizer sale that will go with it. Without cataloging the always-onerous task, we found the process roughly comparable to that with most top-quality speaker equalizers—all of which make the simpler models look like the inadequate half measures they are. Conventional theory dictates that response anomalies cannot be heard unless they extend over at least a third of an octave and that third-octave filter bands are therefore ideal for this purpose. The Three’s bands are a little wider, but we’re satisfied that the frequency-tuning switches do, indeed, give you all the control you need. The calibration and adjustment process depends on the front-panel LED display, which runs in 2-dB steps, yielding information with an effective accuracy of ± 1 dB; if you want to chase after fractions of dB (and we see no real point in that), you’ll have to use more sophisticated measuring equipment.

As a program equalizer, the Three works very well indeed. It will do most of the things a parametric equalizer will do (the main difference being the even narrower bands usually available on a parametric, though they seldom are needed in home use) and some that it won’t; very complex response curves are simple on the ADC but might require more controls than most parametrics offer. This application is, of course, where the bank of switches at the right end of the front panel plus the level-matching controls at the center are invaluable.

The lab data turn up no disappointments. Bandpass (or bandsuppress) characteristics are quite consistent from slider to slider; the calibrations for frequency and for dB of boost or cut are reasonably accurate—more so, in fact, than usual. Distortion (which always is higher in an equalizer than in, say, a preamp) is well controlled. And, despite the wide latitude afforded by the level-matching controls, so is noise.

For those who want an exceptionally flexible graphic equalizer, the Sound Shaper Three strikes us as excellent in both conception and execution. (If you want something simpler, ADC has models to oblige, of course.) For program equalization, it may not offer quite the frontal attack of parametrics on some sorts of problems, but it’s no less capable when it comes to solutions. And it can be used for speaker equalization, where true parametrics are useless for all but the most rudimentary touchups.

Circle 135 on Page 99

Report Policy: Equipment reports are based on laboratory measurements and controlled listening tests. Unless otherwise noted, test data and measurements are obtained by CBS Technology Center, a division of Columbia Broadcasting System, Inc., and Diversified Science Laboratories. The choice of equipment to be tested rests with the editors of HIGH FIDELITY. Samples normally are supplied on loan from the manufacturer. Manufacturers are not permitted to read reports in advance of publication, and no report, or portion thereof, may be reproduced for any purpose or in any form without written permission of the publisher. All reports should be construed as applying to the specific samples tested; HIGH FIDELITY, CBS Technology Center, and Diversified Science Laboratories assume no responsibility for product performance or quality.

INVEST IN METAL.

AKAI's new metal decks with Super GX™ Heads significantly improve specs with all tape formulations.

Once in a great while, some truly important advancements in tape recording technology are introduced.

Metal tape is one of them. AKAI's new Super GX Head is another.

Found exclusively on all new AKAI metal-capability cassette decks, Super GX Heads reproduce unsurpassed, crisp sensitive sound.

Guaranteed* for 150,000 hours, Super GX Heads improve frequency response by up to 2,000 Hz, signal-to-noise ratio as much as 6 dB and expand dynamic range, as well. With every tape formulation you use.

With a head this impressive, we had to design a full complement of metal decks to match. The GX-F90 is our top-of-the-line, loaded-with-features edition. With the 3-head performance of our Super GX Combo Head, High Current Erase Head to accommodate metal tape,

*limited warranty
†™Dolby Labs, Inc.



Instant Program Location System, Dual Process Dolby† two-color fluorescent bar meters, tape/source monitoring, fine bias adjustment, mic/line mixing, memory rewind and auto-repeat, just to name a few. And take a look at these specs: Frequency Response 25-21,000 Hz (± 3 dB using metal tape), S/N Ratio 72 dB (Dolby on) at metal position, Wow/Flutter less than 0.03% WRMS.

The other three new decks share many of the same outstanding specs and features. But no matter which one you choose, you can feel confident that dollar-for-dollar, spec-for-spec, you've made a sound investment you'll want to live with for a long time.

See for yourself at your AKAI dealer, or write AKAI, P.O. Box 6010, Compton, CA 90224; in Canada, AKAI AUDIO VIDEO CANADA, 2776 East Broadway, Vancouver, B.C., Canada V5M 1Y8.

AKAI

You never heard it so good.



An important achievement in record quality

“PROOF-QUALITY” RECORDS THAT OFFER CLEARER SOUND, TRUE FIDELITY, ANTI-STATIC PERFORMANCE —AND ARE PRODUCED IN A DUST-FREE “CLEAN ROOM”

*Available only from The Franklin Mint Record Society in
The 100 Greatest Recordings of All Time. Not sold in any record stores.*

For the first time ever, the world's greatest works of music and the greatest recorded performances of those works have been brought together in one collection of unique *proof-quality* records. They form a record library unprecedented—and unsurpassed—in the entire history of music: *The 100 Greatest Recordings of All Time*.

An international panel of renowned music authorities was appointed to participate in the selection of these great recordings, which include immortal masterpieces by Beethoven, Brahms, Mozart, Tchaikovsky, Schubert, Rachmaninoff, Debussy, Verdi, Performed by Vladimir Horowitz, Jascha Heifetz, Enrico Caruso, Van Cliburn, Isaac Stern, Artur Rubinstein, Leontyne Price—with the world's great orchestras under the direction of Toscanini, Ormandy, Bernstein, Stokowski, von Karajan, among others.

In every sense, this is the ultimate private library of recorded music—a collection that

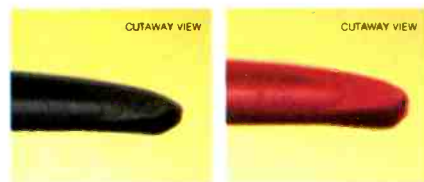

Ordinary records (left) may warp, causing “skipping” and distortions in sound. But Franklin Mint records (right) are 36% thicker and heavier than ordinary records and are less likely to warp.

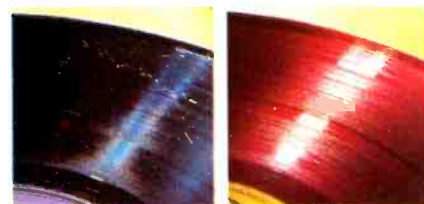

(left) Even when ordinary records are new, they can have dust particles embedded in their grooves—and the types of vinyls used in these records can increase surface noise. But Franklin Mint records (right) are pressed from an exclusive vinyl formula containing pure resins. This effectively resists dust and captures a fuller sound.

will provide unending enjoyment and cultural enrichment for everyone who appreciates the finest in recorded sound.

Produced to the highest standards

A superior vinyl material, containing its own anti-static element, is used in the production of these records. This *exclusive* vinyl, together with the careful process by which the pressing is made, results in a record that is more rigid, durable and resistant to dust. A record that has true fidelity, clearer sound quality and a long life.

To further assure their quality, the Franklin Mint records are pressed in a special “clean room,” similar to the facility in which the mint produces its flawless proof-quality



(left) Ordinary records being stacked in a typical record plant. (right) In the Franklin Mint “clean room,” a uniformed technician visually inspects a proof-quality record before it is released. Technicians wear vinyl gloves and take every precaution to ensure protection for every record.



Ordinary records (left), have static charges that attract dust, causing surface noise when the record is played. But the special vinyl used in Franklin Mint records (right) has a built-in *anti-static* element that assures clearer sound. Electrostatic meter tests show that the Franklin Mint record has only *one-fifth* the static charge of an ordinary record.



The most careful methods of production and control are used throughout to assure the high quality of all Franklin Mint records. (left) Technician sets up his instruments before cutting the master lacquer. (right) Meticulous attention is given to the electroforming of all stampers that will be used to press Franklin Mint records.



(left) You normally can't tell if the record you buy was the first or last to come from a record stamper, or if the stamper was made from a defective metal mold. But (right), The Franklin Mint Record Society aurally auditions a greater number of pressings than most other producers. And every metal mold is actually played, from start to finish, before it is used to produce stampers.

coins. Here, the most meticulous attention is paid to the pressing of the records—to make certain that the full quality of each original recording is faithfully preserved.

Each record in this collection is exceptional for its clarity as well as its tonal quality—capturing the beauty both of today's finest performances *and* of the historic performances of the past. Indeed, the recordings of legendary greats like Caruso and Ponselle have been remarkably *improved* by electronically removing imperfections in the earlier recordings, thus enabling you to now hear these glorious voices more nearly as they sounded in the actual performances.

Certification of proof quality

All of the important features shown and described on this page enable The Franklin Mint Record Society to create a collection of

proof-quality records—records that offer greater clarity of sound and are quieter and clearer. To attest to this high standard of proof quality, each record bears the distinctive mintmark of The Franklin Mint.

To house these magnificent proof-quality records, special library cases are provided for all 100 records in the collection. Each hardbound case holds two long-playing 12" records and is attractively designed. Displayed in a bookshelf or cabinet, these library cases make an impressive addition to any home. Also included are specially written commentaries discussing the great masterpieces and providing fascinating background on the conductors and soloists.

Rarely if ever have records of such distinction been produced. Rarely if ever has so much time and attention been devoted to their creation. Yet the price for each proof-quality record is just \$9.75 and the records will be sent at the rate of two per month. However, you have the right to cancel your subscription at any time upon 30 days' written notice.

The 100 Greatest Recordings of All Time is being produced exclusively for those who enter subscriptions to the series. It can be acquired *only* by subscription from The Franklin Mint Record Society, Franklin Center, Penna. 19091. To subscribe, please mail the application below by May 31, 1980.

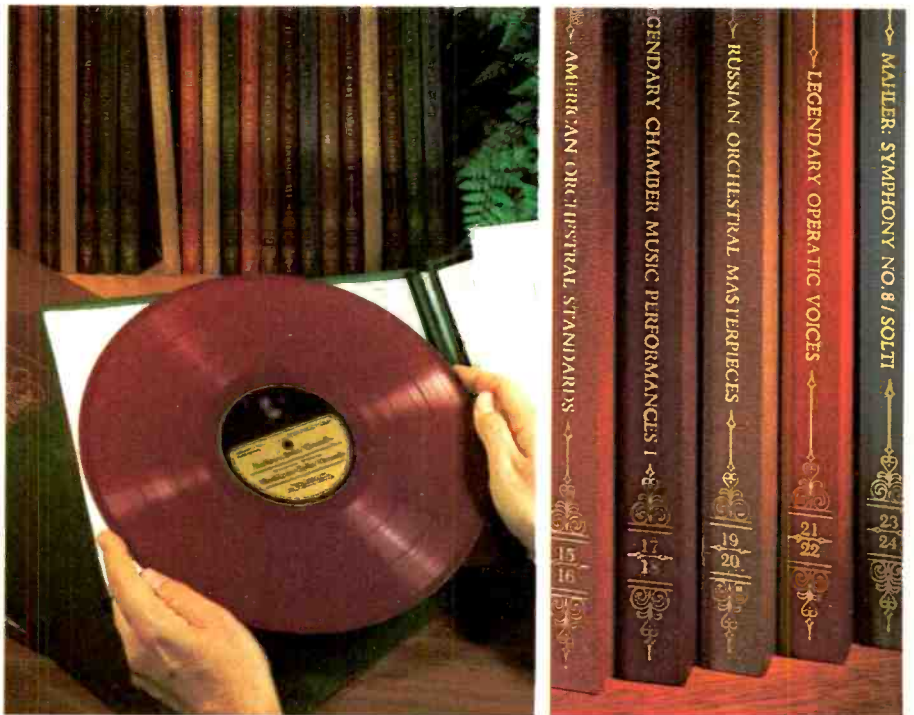

© 1980 FM

SUBSCRIPTION APPLICATION

The 100 Greatest Recordings of all time

The Franklin Mint Record Society
Franklin Center, Pennsylvania 19091

Please enter my subscription for *The 100 Greatest Recordings of All Time*, consisting of one hundred proof-quality records in specially designed library cases. I understand that I may discontinue my subscription at any time upon thirty days' written notice.

No payment is required at this time. I will be billed for each record in advance of shipment at \$9.75* plus \$1.75 for packaging, shipping and handling. My records will be sent to me at the rate of two per month.

**Plus my state sales tax*

Signature _____

ALL APPLICATIONS ARE SUBJECT TO ACCEPTANCE.

Limit: One collection per subscriber
Please mail by May 31, 1980

Mr. _____
Mrs. _____
Ms. _____
PLEASE PRINT CLEARLY

Address _____

City _____

State, Zip _____

GUARANTEED PRICE: In spite of strong inflationary pressures in the record industry, the price of \$9.75 per record will be *guaranteed* to each subscriber by The Franklin Mint Record Society for *every* record in the collection.

TAKE IT TO THE LIMIT.



Simulated
LED readout

Been misled into thinking that you're limited when it comes to factory-engineered auto sound systems? Well look again! Delco-GM has the sophisticated, high-technology receivers, tape players, speakers and equalizer/boosters that can take you right to your limits in auto sound. The Delco-GM ETR™ electronically tuned receiver — available on selected GM models — features Keyed Automatic Gain Control, Quadrature Detection, Phase Locked-Loop Stereo Decoder, Audio Processing, Impulse Noise Blanking and a Frequency Synthesized Tuner. Delco-GM circuitry handles adjustments on the inside. Automatically. It eliminates the need for things like separate local-distant or

stereo-mono switches.

With Delco-GM, you get sound. Not switches. Want to hear more? Try Delco Sound™ dual-cone extended range speakers for improved high-fidelity performance. And the Delco-GM Graphic Equalizer/Booster, which doubles the power output of our receivers.

Delco-GM has more than 40 years' experience in designing sound systems that move. We know there's a lot more to it than putting home hi-fi on wheels.

So if you're ready to take it to the limit, see your Chevrolet, Pontiac, Buick, Oldsmobile, Cadillac or GMC dealer and hear all of the sound Delco-GM has to offer.

Delco-GM Sound. A moving experience.



Letters



Record\$ and the IRS

It was heartening to see your article "Are Your Old Records Worth \$\$\$?" [January]. Messrs. Biel and Brooks are quite right in stating that price guides give relative, not absolute, values and that donating records to an institution will often be of more value than trying to sell them, especially if an accredited appraisal is made. I do not agree that the IRS presents undue difficulty in such cases, however; it has accepted substantiated (and substantial) evaluations I have made of private collections.

Julian M. Moses
American Record Collectors'
Exchange
New York, N.Y.

Expert Advice

In "A Personal Approach to Choosing Components" [December], Alfred Myers advises that "discounts of 25% or 30% are not at all uncommon." Well, we all know that no dealer can give such discounts and maintain a service facility for the benefit of those who cannot repair their own equipment. Servicing dealers would be eliminated if such discounts were really that common. Every such "expert" as Mr. Myers should have to operate a stereo shop; maybe he would reconsider his ideas about discounts.

Lonnie W. Vickers
Vickers Electronics
and Vickers Audio
Durham, N.C.

Mr. Myers replies: Within the city limits of White Plains, New York, there are no fewer than six audio dealers. They range from a high-end "salon" that never gives discounts, and also has no in-house servicing, to midpriced stores that provide knowledgeable help, attractive listening rooms, in-house servicing, and discounts. There is also a local dealer who, if his advertising is to be believed, will beat any price—and has a large, prominently displayed sign that states, "We Service What We Sell." All of these stores coexist quite nicely: The arrival of the "throat-cutter" did not drive the older firms into bankruptcy.

Though I certainly do not dispute the fact that a dealer must make up for the increased overhead of having a service department, surely part of those costs is cov-

ered by what he charges for service. And with the elimination of strict list pricing and the rising cost of audio gear (especially imported brands), shopping for the largest discount is the only way many can get what they want.

Having read your article, subtitled "Six Experts at Work Within Three Budgets," I wish to object strongly to the use of the word "experts" to describe these audibly handicapped and/or overpaid consultants. Peter E. Sutheim presented a sensible approach to buying a stereo system and, within the limits of the subjective method, chose a good \$3,000 system. However, the other five quasi-experts' selections leave much to be desired.

They failed to recognize some critical points in the selection of a good system, notably: 1) extracting as much information from the record as possible and 2) sound. A Denon DP-2500 turntable may have "astounding" speed accuracy, but how much information does it extract from the record groove? Unfortunately, not as much as a Connoisseur at less than half the cost, and not nearly as much as a Linn Sondek LP-12, which could and should be included in most \$5,000 systems.

Your experts failed to mention the majority of fine European and American products available. I suggest that they, and your readers, locate some of these and give them a good listen.

Alan Pratt
Temple Terrace, Fla.

To remind Mr. Pratt of the introduction to the article: "The purpose of this article is to help readers explore the reasoning that goes into the selection process; it is this process rather than the results that we believe to be of importance. It's of no real value to a reader to know what model a particular expert likes if they do not share the same high fidelity objectives and priorities." Naturally, there will always be discussion and argument when it comes down to picking specific pieces of equipment.—Ed.

Ambience, Reverb, Quad

The Aeolian Skinner reverberation system mentioned in "Ambience and Space: Six Experts on the State of the Stereo Art" [November] may have been exciting from a technical point of view in the 1950s, but it had deficiencies as a substitute for the real thing.

It was demonstrated at the 1957 national convention of the American Guild of Organists in Houston. Its artificial rever-

Interface: C Series II

It sounds like music.

Interface: C Series II is the fulfillment of our six-year association with optimally vented speakers based on the theories of A.N. Thiele—speaker designs first introduced by Electro-Voice in 1973. The Interface: C offers you a unique combination of high efficiency and high power capacity—the only way to accurately reproduce the 120+ dB peak sound pressure levels found in some types of live music.

The SuperDome™ tweeter, an E-V exclusive, and the VMR™ vented midrange driver, the first to apply optimally vented design to mid frequencies, ensure your music is reproduced without the coloration normally found in other high-efficiency drivers. An honest 30 Hz low end totally eliminates the need for expensive sub-woofer assemblies.

When you spend \$1,000 for a speaker system, get your money's worth. Audition the Interface: C Series II at your nearest Interface dealer. If you want a speaker that sounds like music, the Interface: C Series II is the one you'll buy.

EV Electro-Voice®
a **guitan** company

600 Cecil Street, Buchanan, Michigan 49107



THIS TIME MAKE THE RIGHT CONNECTION

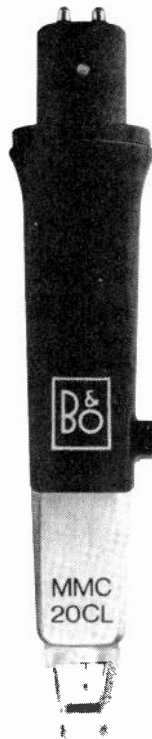

Only the new MMC 20CL can give your turntable the performance levels of our unique single crystal sapphire cantilever and a micro-polished Contact Line diamond stylus. And our new universal connector makes proper installation an effortless task while it eliminates the weight and mass of the common headshell. If you have a high quality turntable, it probably deserves the MMC 20CL. See your Bang & Olufsen dealer to make the connection.

Bang & Olufsen

For Information Write To: Harold Flemming

Bang & Olufsen of America, Inc., 515 Busse Road, Elk Grove Village, Illinois 60007

Circle 8 on Page 99

Recording engineers are trained... not born.



Complete the **Multi-track Recording Technology** program in one year, or the **B.S. Degree in Music Technology** via the joint Institute of Audio Research—New York University program.

Spring '80 Quarter starts March 31st.
Accelerated Summer '80 Quarter starts July 7th.

For further information write, call or visit:

Institute of Audio Research

64 University Place, Greenwich Village, New York, N.Y. 10003
(212) 677-7580

Established 1969

Licensed by N.Y. State Dept. of Education



beration made pipe organ sounds more pleasant than they were in the unaided dry room, but the effect was not natural to my own and to many others' ears. An explanation put forward at the time was that we were hearing a promotional setup rather than a custom installation. Yet a more sophisticated system would not have removed the incongruity of other sounds in the room. I remember feeling ill at ease, and in retrospect I think this was because audience sounds were not reverberant. I not only was isolated from the musical ambience, but was receiving conflicting cues about the room's characteristics.

In situations where ambience is supposed to be perceived as real—as in the kind of space in which classical music is performed—I suspect that artificially generated reverberation will never be entirely satisfactory.

Douglas Johnson
Athens, Ga.

After reading "Ambience and Space," I came to the same conclusion that HF's spokesman apparently did, i.e., that these people are trying to sell quad under a different name. And really, I don't know what is so bad about quad. Since acquiring a Sony SQ decoder, I have used it constantly for all program material.

The problem is lack of software: A few encoded records are still coming out, but no quad tapes are being produced. All that is needed is in the master tapes of the leading companies, and all that has to be done is to remaster them for quad. Why doesn't somebody do that? There must be a few others in the world who are willing to pay for quad.

Paul A. Elias
Greenwich, Conn.

Czech-mate

I can endorse everything Harris Goldsmith said about the *Harold in Italy* recording by Josef Suk on the viola with the Czech Philharmonic under Dietrich Fischer-Dieskau [November]. This is one of my favorite works, and I have never heard a better version—though, curiously enough, another of my favorites stems from the same source. This is the mono version featuring the great Czech violist Ladislav Cerný with the Czech Philharmonic under Václav Jiracek. Cerný, founder of the pre-war Prague Quartet, was a contemporary of Adolf Busch and Joseph Szigeti but, being a violist, was not as celebrated as they. In his role as a teacher, he was responsible for encouraging most of today's fine Czech chamber ensembles.

Though I usually distrust violinists

Why Yamaha speakers sound better than all the others. Even before you hear them.

To make a speaker that produces accurate sound is not simple. It requires painstaking attention to detail, precise craftsmanship, and advanced technology.

And that's where Yamaha comes in. We build all our speakers with the utmost precision in every detail.

As the premier examples of Yamaha loudspeaker craftsmanship, read what goes into the two speakers shown, the NS-690II and the NS-1000M. Then you'll understand why Yamaha loudspeakers sound better. Even before you hear them.

Precision Yamaha crafted cabinetry – (1) The walls on these, and all Yamaha speaker cabinets, are sturdily braced and crossbraced at every possible stress point. (2) The corner seam craftsmanship is so fine that it looks like the cabinet is made from one continuous piece of wood.

The back panels on these speakers are flush-mounted for maximum air volume within the cabinet. (3) Inside, a 3/4" felt lining "decouples" the cabinet from the drivers to achieve acoustic isolation of the woofer from the cabinet. (4) Thick glass-wool also aids in damping the woofer for maximum performance.

Lift one of these Yamaha speakers. It's uncommonly heavy and sturdy. (5) We even glue and screw the woofer cutout from the baffle to the inside rear panel for greater cabinet rigidity.

Now knock on the cabinet. It will sound as solid and substantial as it is.

Precision Yamaha Drivers – (6) The drivers are mounted on computer-cut baffle boards with exacting, critical tolerances to insure precision fit. All Yamaha speakers are acoustic suspension design, and this precise fit is critical for an airtight seal and optimum woofer recovery.

The drivers on these, and all Yamaha speakers, are flush-mounted on the baffle board to avoid unwanted diffraction of the sound waves. (7) This is especially important because all our tweeters and mid-high range drivers are the maximum-

dispersion dome type for the most natural reproduction of voice and instruments.

(8) We use chrome-plated machine screws (rather than wood screws) with two washers (regular and lock) to insure an unyielding mounting.

(9) The speaker frames shown are die cast rather than stamped. That's so they won't twist and alter the voice coil alignment during assembly and use.

Other Precision extras – All terminals are quick connect, screw-mounted assemblies.

(10) The wire leads are carefully soldered, not clipped.

All our speakers use full LRC crossover networks. These crossover networks are among the most advanced available.

Precision that stands alone – There's more. Much more. But, there is another fact of Yamaha loudspeaker construction that simply stands alone in the industry. Each component used in the two Yamaha speakers shown is manufactured by Yamaha. From the hefty die-cast speaker frames to the unique, ultra-low mass beryllium dome diaphragm.

That's a statement no other manufacturer can make.

And therein lies Yamaha's story. If we put this much care and craftsmanship into the making of our components and cabinet structures, then imagine the care, precision and craftsmanship that go into the quality of the final sound. A sound built upon Yamaha's unique 98-year heritage as the world's largest and most meticulous manufacturer of musical instruments. From our most economical loudspeaker to our top-of-the-line models shown here, Yamaha retains the same attention to detail and craftsmanship.

Look before you listen. You'll be convinced that Yamaha loudspeakers sound better than the rest. Even before you turn them on. Then ask for a personal demonstration of these and

other Yamaha loudspeakers at your Yamaha Audio Specialty Dealer, listed in the Yellow Pages. Or write us: Yamaha, Audio Div., P.O. Box 6600, Buena Park, CA 90622.



It whistles while it works

Listen to the Robins WhistleStop electronic head demagnetizer whistle as it eliminates performance-robbing residual magnetic build up from your tape head. Hear the difference in sound quality and reduced distortion. Simply insert like any cassette. Complete with batteries. At your hi-fi dealer.



Circle 41 on Page 99

who take up the viola, I make an exception for Suk, who plays the lower instrument so well. He has made three superb recordings with the Smetana Quartet playing the first viola part: Dvořák's quintet (Supraphon) and Mozart's C major and G minor Quintets (Denon).

Fischer-Dieskau, incidentally, goes from strength to strength as a conductor. I also have his fine Brahms Fourth Symphony on Supraphon and Schumann's Second and Third, both with the Bamberg Symphony on the German Acanta label.

But "the Viennese Bruno Walter"? Good gracious, Mr. Goldsmith, Bruno Walter was not only born and bred in Berlin, but was even trained at the Stern Conservatory there. Though I must admit that he found his true artistic home in Vienna, it was his rejection by his hometown in 1933 that almost broke his heart.

Tully Potter

Billericay, Essex, England

Korjus and Brünnhilde

In "Behind the Scenes" [December], HF mentioned that Miliza Korjus "is currently learning the role of Brünnhilde—not bad for a former light coloratura in her seventies." This is really not so surprising. During her concert career, Korjus often programmed the Wagner *Liebestod* with full symphony orchestra. She had the breadth of tone to do so. I remember one Chicago concert in which her singing of "Elsa's Dream" and the Liszt "Oh, quand je dors" were singled out by critics for special praise.

Not very many years ago she made a number of records on the Venus label, and the voice was remarkably fresh.

The Rev. Clifford Brier

Oswego, Ill.

Warp Woes

For my birthday, my wife bought me the Warner Bros. "Superman" album. The record was so badly warped that my Shure M95ED cartridge would not track it. We returned it to the store, which had no more copies, and bought another elsewhere. Same song, second verse: another trip to return the second album. Can you imagine the hassle if we had ordered it from a mail-order service?

I think it is a shame that music composed by John Williams and played by the London Symphony Orchestra ends up on a paper-thin record that is so badly warped that you cannot play it. What good does it do to acquire a good stereo system when the record companies are turning out junk?

D. Dickman

Los Alamos, N.M.

Circle 46 on Page 99

COMPARE PRICES !

Pioneer
Electronic Tuning
Am/Fm Cassette

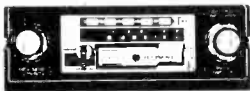

KE-2000

\$157

Sharp
Computerized
Cassette Deck



RT-3388

\$212

Remote Control
Turntable



Accutrac
4000

\$129



**CAR
STEREO**

We carry the full line of Pioneer, Craig, Clarion, Marantz, and more.

TOLL FREE 800-356-9514

Weekdays 9-9
Saturdays 9-5

Over 100 Brands like:

- | | | | | |
|----------|----------|------|----------|---------|
| Technics | Maxell | Sony | Cerwin | Nikon |
| Pioneer | Empire | Teac | Vega | Canon |
| Marantz | Altec | Akai | JBL | Minolta |
| Kenwood | Sharp | Dual | Audio | Pentax |
| Sansui | Phillips | Koss | Technica | Vivitar |
| Jensen | Shure | TDK | Clarion | Yashica |

WDS

WISCONSIN DISCOUNT STEREO

2517 Whalen Ln. Madison, WI. 53713

Circle 55 on Page 99

Is it possible to love a fatter tonearm?

Most sleek, graceful tonearms, including Sony's, are lovingly crafted precision instruments.

But even the most expensive beauties have a beast of a problem.

Tonearm resonance.

At low frequencies, feedback in the form of noise and wayward harmonics is added to your music. Bach with a tiny tuba in the background.

It's called the last big turntable problem.

Poof. Sony banished tonearm resonance at any frequency by putting a linear motor in the tonearm. And a linear motor under the tonearm.

That's why it's radically fatter and radically better. It's totally electronic.

We call our new tonearm the Biotracer and our new turntable is the PS-B80. It's the highest-fi you can buy for professional applications or critical home listening.

You select the stylus force by dialing an LED readout on the front panel and the microcomputer automatically makes the adjustment. Tracking force can be changed during record play.

Antiskating force is automatically and continuously applied by the horizontal linear motor. A sensor relays the tonearm's lateral position to the

flutter. The BSL motor in a major design breakthrough has no slots to cause uneven torque distribution.

A highly stable quartz-crystal oscillator and a magnedisc servo-controlled system lock turntable speed for precise platter rotation.

Consider the electronic automation.

Record play is automatic. Record size selection is automatic. Repeat and partial repeat are automatic. Even stylus cleaning is automatic.

The new all-electronic Sony PS-B80 redefines the limits of turntable technology.

Listen closely. You're going to love it.

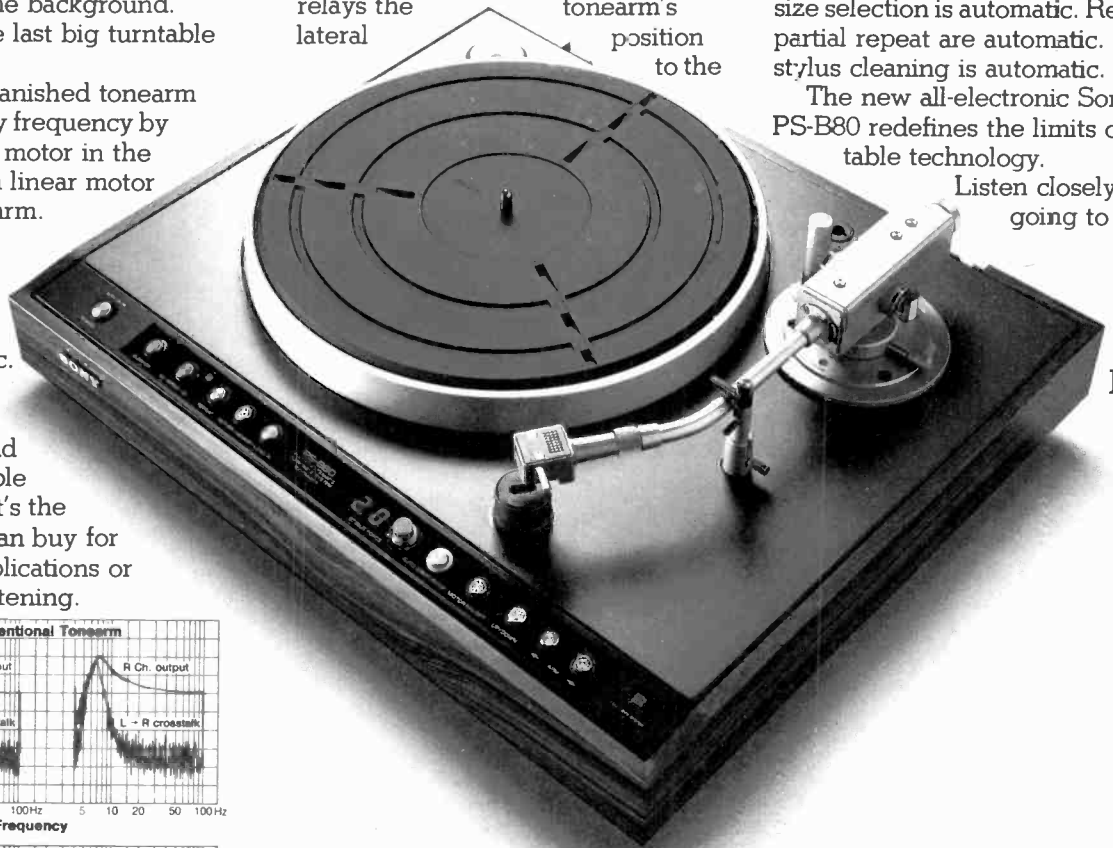

PS-B80

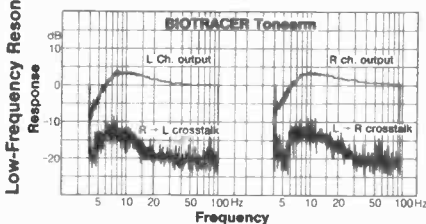
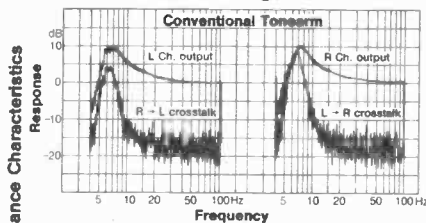

A microcomputer orchestrates every tonearm move. There are no counterweights, tracking force mechanisms or antiskating devices.

When the PS-B80 is first turned on, or when a new cartridge is installed, the microcomputer automatically adjusts the arm

for zero balance. A standby lamp on the arm base illuminates during this brief operation.

microcomputer and the selected tracking force is stored in its memory.

The linear torque BSL (Brushless & Slotless) turntable motor delivers an extremely high signal-to-noise ratio and virtually eliminates wow and

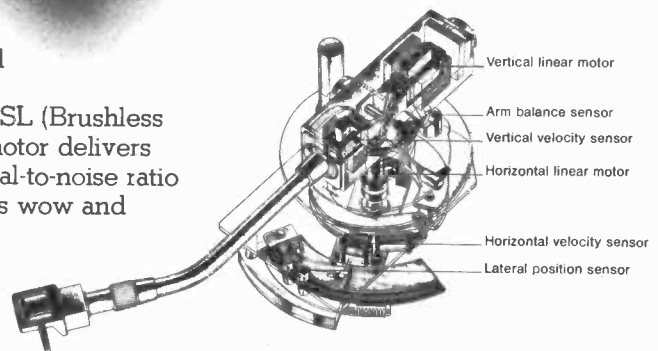

SONY

TDK's new improvement has nothing to do with the sound. It's the package.



Each TDK package is now designed to catch your eye as never before. Clean, modern lines. Bright new colors. Bolder designations in front. Full tape description in back, including sound characteristics, formulation, bias and a frequency response chart to let you know precisely what you're buying without having to hunt for a salesman.

And don't expect the improvements to stop there. Inside there are complete recording and cassette care tips. Invaluable for preserving the life of each cassette, even though each TDK cassette is protected by a full lifetime warranty.* There's also a convenient, tear-out index card to help you build a perfect reference system.

Once inside, TDK couldn't stop improving. There's now a wider cassette window.

Through it all, you'll be able to watch two red double hub clamps registering tape direction as they turn. Just when the improvements seem to end, TDK tape technology begins. TDK SA's cobalt adsorbed gamma ferric formulation continues to set the high bias standard around the world. TDK AD, the tape with the hot high end, is now Acoustic Dynamic. You'll see it in brand new blue and silver colors. TDK D, another member of TDK's dynamic series, makes many premium normal bias cassettes sound ordinary and overpriced.

That's all we have to report for now. But there will be more to come. Part of TDK's philosophy is: when every improvement has been made, improve again.



TDK
The machine for your machine

*In the unlikely event that any TDK cassette ever fails to perform due to a defect in materials or workmanship, simply return it to your local dealer or to TDK for a free replacement.



A Cautious Entry into the Eighties

Consolidation of past gains overshadows the bold new thrusts in the products announced so far this year.

by Robert Long
and Peter Dobbin

On the cover: 1. Fisher microcassette deck with Dolby HX; 2. Bose Spatial Expander time delay; 3. Logical Systems noise filter; 4. Harman Kardon hk705 deck with Dolby HX; 5. ADC tube preamp; 6. Ampzilla's new face; 7. Kenwood tuner-cum-computer; 8. Sony flat-driver APM-8; 9. Yamaha tangential tracking; 10. Dennesen air-suspension arm and turntable isolation base.

If home-entertainment product entries in recent years have sometimes suggested technology run amok, the first round of the new decade shares little of that tendency. The pace may pick up again at midyear—traditionally the time to sound out the market with new ideas—but in the meantime there is much evidence that the international economic climate is inhibiting high-risk projects among the major manufacturers. Many are displaying prototypes of some very advanced gear (and some of the smaller domestic manufacturers are going full tilt along roads that are anything but well trodden). The international companies, however, generally are very circumspect in stating their plans for production, pricing, and marketing of the more *outré* designs.

Instead they tend to be concentrating on "sure sellers" until the outlook becomes more settled. That means, for example, that some well-made, relatively inexpensive receivers with all the current "good stuff" will be showing up this year. Unfortunately, it also means a good deal of tinsel whose glitter is anything but sterling: Expect an overuse of LEDs, particularly for functions that might better be handled by meters (LEDs cost less and wink more seductively in the salesroom) or omitted altogether. If you try tuning your FM antenna for maximum signal strength or minimum multipath using a receiver whose signal-strength meter has been replaced by a few LEDs, you should see the folly of this trend.

Automatic, remote-control, and microprocessor-controlled features seem to be retaining their appeal for manufacturers of midpriced equipment in search of premium models. In some cases, the extra features—like the fabulous prototypes of indefinite introduction date—may represent an attempt to sell the sizzle, rather than the steak, to quote from a favorite aphorism of advertising folk. In this view, the glitter creates "brand awareness" that then can be converted into sales of plainer fare. A related phenomenon is taking place in video tape decks, where the models on display compete in programmability. The elaboration of these autorecording microprocessors has pushed list prices up from the original \$1,000 base toward the \$1,500 mark over the last year or so, yet manufacturers are talking of the need for broader appeal via simpler decks and lower prices. By summer, we may well find that many of the razzle-dazzle trends have run their course and have been replaced by a thrust toward simplicity and value.

Not that all expensive products betray a fast-tarnishing glitter, by any means. Indeed, the pursuit of sonic perfection at any price—a pursuit that, in some cases, implies simplicity through the elimination of what are believed to be the fidelity-inhibiting elements of standard designs (active tone controls, or any tone controls at all, for example)—remains untouched, as far as we can see, by the economic jitters that infect the mass-market companies. Amps, preamps, and loudspeakers are the most obviously active product categories in this respect, though turntables and phono cartridges also are under perfectionist scrutiny. Cassette deck designers, after setting a blistering pace of innovation in recent years, appear to be catching their breath.

They may be keeping a wary eye

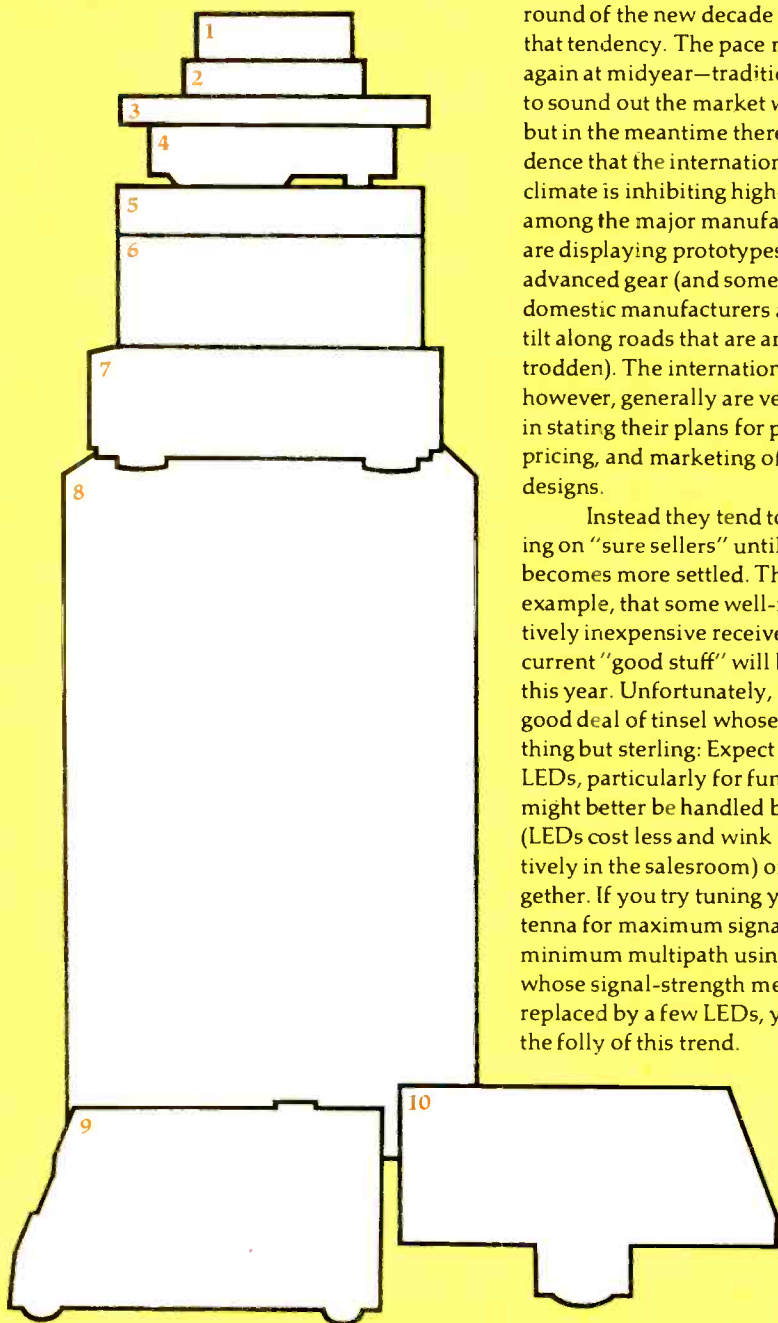

on what promises to be the major audio thrust of the Eighties: digital techniques. That this technology will be used more and more in professional applications is a foregone conclusion; domestication is another matter. Radical opinion may be summarized this way: "We all know that digital audio is taking over, so why are the producers of home equipment so slow to deliver?" A number of reasons are given in rebuttal: once again, the sluggish economy, in which the high entry prices for present digital gear severely limit its market; public satisfaction with the recordings and equipment it can buy now; the assumption that many consumers would see digital technology (as they saw quadraphonics) as an arbitrary attempt to generate sales; the lack of standardization in proposed consumer products; and, occasionally, questions about the quality of digital sound and whether it may not substitute new "infidelities" (as yet inadequately defined) for those of the analog systems it would replace. The long-term course of digital audio is thus anything but clear, though the short term should see still more digital studio recordings for playback on conventional phonographs and tape decks.

Electronics

Digital audio recording adapters for home use, first introduced by Sony two years ago with its PCM-1, sample an incoming analog audio signal and translate that information into digital (binary) bits to be recorded on a video cassette recorder. They are still extremely expensive (in the \$3,000-\$4,000 range) and still are most appropriate for live recording where they can make use of the increased dynamic range and high-frequency headroom of the digital medium. Sanyo, however, stresses the eventual use of digital adapters as the ultimate audiophile component: Packed in with its Plus 10 adapter (\$4,000) is a digitally encoded tape of Ry Cooder's album "Bop Till You Drop." Released on disc late in 1979 by Warner Bros. and billed as rock's first digitally mastered record, the album as supplied by Sanyo is a digital transcription of the original digital master tape onto a Beta-format video cassette; thus, there is no analog step in its reproduction. Sanyo promises to make this Beta version available separately at selected audio stores for about \$25; of course, you'll need a digital decoder to



Though standardization remains elusive, digital adapters like this Sanyo Plus 10 continue to appear.

play it. Also showing digital adapters are Toshiba, which claims that its Mk. II will be in dealers' hands sometime in 1981, and Sharp and Kenwood, both of which state that their units are still prototypes.

Ambience enhancers, those black boxes that attempt to re-create a sense of concert hall realism in the home setting, are being offered by Bose and KM Laboratories. The highly publicized Bose time-delay system is an add-on, bucket-brigade-type unit. Dubbed the Spatial Expander (\$450), it needs no external amplification when matched with a Bose Spatial Receiver, since it can make use of the receiver's built-in extra channels of amplification. It can, however, be used with other receivers and/or separates. The KM Laboratories system is described in language reminiscent of Carver Corporation's Sonic Holography preamp. This Belgian company claims that its A.I.R. model (for acoustic intermodulation reduction), operating with just two basic stereo speakers, can restore the acoustic environment in which the original recording was made. Like the Carver system, it needs no extra channels of amplification. It is priced at around \$350.

Though still in prototype, a device designed by Joel Cohen of Sound Concepts tackles the Sonic Holography preamp more directly, reportedly achieving a similar effect with the bonus of no-fuss setup. While the Carver unit assumes a single best listening position, that from Sound Concepts, tentatively labeled a stereo image enhancement system, will allow the user to dial in the correct speaker/listener angle in a range from less than 20 degrees to more than 90 degrees. Though work remains to be done on the cosmetics, Cohen says that the unit will cost less than \$200 and will operate with any existing stereo system.

Noise-reduction systems are also

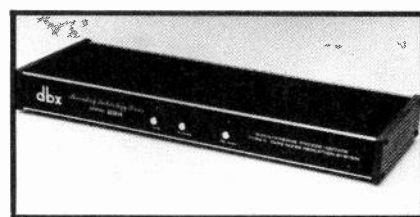

Newest noise reducer, DBX 224, both decodes discs and serves recordists as Type II simultaneous compander.

new this spring with DBX's introduction of the Model 224 Type II. This compander provides a claimed 40-dB increase in usable dynamic range when used with tape recorders and doubles as a decoder for DBX-encoded discs. Logical Systems has the Model 8801 (\$290) dynamic noise filter, a playback-only unit. The 8801 is a variable bandpass filter that lops a claimed 15 dB of hiss from tapes, disc, or radio. A mono bass circuit is also said to maintain low-frequency signal phasing while eliminating up to 20 dB of rumble and hum. Finally, SAE has announced a second generation of its impulse noise reducer, the Model 5000A (\$225). It is said to contain improved logic circuits for more accurate, less noticeable action while it removes clicks and pops from program material.

Frequency spectrum analyzers are also represented. Rotel offers the RY-1010 (\$430), a 10-band display device with built-in pink-noise generator. Logical Systems' Model 1081, also a 10-band display unit, can be purchased in kit form at a considerable saving (\$295). Of course, when used without a companion equalizer, a spectrum analyzer is of only limited use. Not to worry, though, for the crop of frequency equalizers at a variety of price points is ever increasing. Symmetric Sound Systems Model EQ-2 in kit form is the lowest-priced 12-band, two-channel equalizer we've yet seen (\$165). Marantz' EQ-10 is a highly styled single-channel, 10-band unit and comes in at around \$200. Others include Tamm's EB-100 (\$250), Rotel's RE-1010 (\$250), and Lux's G-120A, all two-channel, 10-band models.

Once again, preamps are the object of much technical refinement and innovation. For several years, Harman Kardon has been promising that its association with Finnish audio engineer Matti Ojala would result in some important new products. Its first Ojala-in-

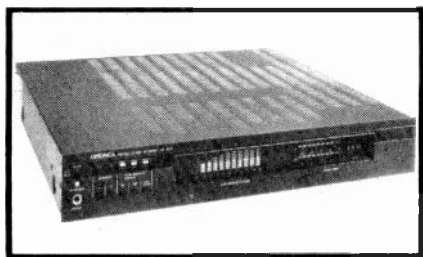

Power metering, now commonplace, is supplemented by spectrum display in Optonica SX-9305 power amp.

spired design is the Model 725 preamp (\$270), in which it claims to have cut negative feedback (one factor associated with dynamic intermodulation phenomena, originally identified by Otala) by some 30 dB. Harman Kardon has opted not to use integrated circuits in its construction, claiming that they were made unacceptable by discrete components' higher resistance to thermal distortion. Lux, too, addresses the issue of negative feedback in its two new preamps, the C-500A and the C-120A. Priced at \$1,400 and \$445, respectively, they employ Lux's Duo- β circuitry, which limits the negative feedback over most of the band and employs separate DC/infrasonic feedback.

Maintaining correct RIAA equalization without compromising cartridge loading is one of the claims for Hegeman Audio Products' Model Hapi 2 preamp (\$900), which relies on passive equalization. So does the \$325 Sirius preamp from Dennesen Electrostatic, which now has a full line of electronics. A company that we reported on back in September 1979, JSH Laboratories, has been reformed under the name MTI, Inc. Its Model 500 is an all-Class A design said to provide enough output to allow use of the line amp section as a separate power amp independent of the preamp functions; it will supply up to 50 watts per channel into an 8-ohm load. Also shipping their first preamps are Tandberg, with the \$1,000 Model TCA-3002, and ADC, whose tube model was demonstrated in prototype last year.

Audionics of Oregon incorporates a unique device into its RS-1 Class A preamp (\$1,200): An AXIAL TILT knob makes electronic corrections for up to seven degrees of vertical misalignment of the phono pickup to improve stereo imaging. One of the most flexible preamps offered comes from Soundcraftsmen in the SP-4001, which com-

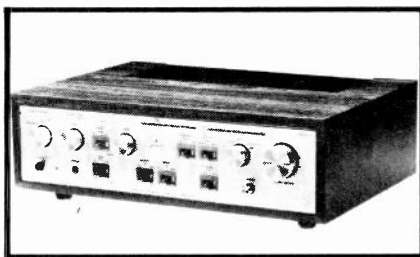

New circuitry appears in integrated as well as separate amps; this is Lux L-480 Duo- β model.

bins a 10-band dual-channel graphic equalizer with full preamp circuitry (\$550).

Finally, kit builders will appreciate the appearance of Audible Illusions. A spokesman told us that the new West Coast company plans to fill the void left when Dynaco stopped manufacturing high-quality tube amplifier kits. First offerings from Audible Illusions include a low-priced three-tube preamp, the Mini Mite I, the more sophisticated Dual Mono, and a solid-state model, the M-1.

In amplifiers, integrated and otherwise, the emphasis appears to be on moderate power output combined with subtle circuit refinements. Akai's three integrated amps range in output from 37 watts (15 $\frac{3}{4}$ dBW) to 68 watts (18 $\frac{1}{4}$ dBW) per channel. The top-of-the-line Model AM-U06 (\$350) features a pulsed power supply, three-step loudness contouring, and an independent recording-output defeat to prevent interference from unused decks. ReVox' integrated amp, the B-750 Mk. II (\$1,000), has a rated output of 75 watts (18 $\frac{3}{4}$ dBW) per channel with 1 dB of dynamic headroom. Lux has incorporated its Duo- β low-negative-feedback circuitry into its three integrateds, the L-580, L-480, and L-450.

Kenwood has put a lot of thought and engineering expertise into its L-01A integrated amplifier (\$1,500). Having determined that conventional amplifiers built on chassis formed of magnetic materials exhibit magnetically generated harmonic distortion, the company constructed this 100-watt model of non-magnetic materials and separate from its power-supply module. Somewhat more conventional in construction is the Kenwood KA-500 integrated amp, rated at 43 watts (16 $\frac{3}{4}$ dBW). With the KT-500 tuner and RC-500 remote control, it constitutes a full remote-controlled system.

Marantz' three new integrated

amps range in power output from 38 watts (15 $\frac{3}{4}$ dBW) to 87 watts (19 $\frac{3}{4}$ dBW). The top-of-the-line PM-700 is packed with features, including a dual-channel, 5-band graphic equalizer and a Freon cooling system. Prices for the Marantz's entry is the SB-445 (\$260), an integrated amp with a 45-watt (16 $\frac{1}{2}$ dBW) output. And Qysonic, now a division of—guess what!—Motown, has entered the electronics market with its M-1 integrated model. Rated at 85 watts per channel (19 $\frac{1}{4}$ dBW), the Qysonic is a high-speed, Class A design.

Gone are the days of power amps with enough output to run a washing machine, it would seem, though some pretty hefty models continue to appear. An English company, Esoteric Audio Research, has a 500-watt (27 dBW) mono tube amp for \$2,650. It also has one with an output of 100 watts (20 dBW) and a price tag of (just) \$1,000. Another unusual entry is from Spectron Electronics in California, whose Class D switching amp is said to pump out 500 watts (27 dBW) per channel from its 18-pound chassis. And Infinity, which was the first to introduce a Class D amp some years back, is now offering a hybrid Class A power amp. The Model HCA (\$4,000) employs tubes in the input stage and high-speed transistors in the output stage for a rated power output of 150 watts (21 $\frac{3}{4}$ dBW) per channel.

SAE's three power amps range in output from 100 watts (20 dBW) to 250 watts (24 dBW) and in price from \$550 to \$1,000. Dubbed the SAE 01 Series, each of these amps combines two amplifiers per channel—one to handle the positive slope of a musical waveform and the other the negative slope. SAE claims that this design handles complex speaker loads—even 2-ohm loads—more easily than conventional amps. Harman Kardon's approach to low negative feedback is reflected in its Model 770 amp (\$400). Though its output is a moderate 65 watts (18 dBW), the 770 employs separate toroidal power supplies for each channel. Two new Ampzilla amps sport refined faceplates and a toned-down logo but hefty outputs; the top-of-the-line Ampzilla Model 500L (\$1,600) is rated at 256 watts per channel.

Optonica's SX-9305 power amp (\$850), with an output of 100 watts (20 dBW) per channel, includes a unique three-color audio spectrum analyzer that displays the relative energy content of

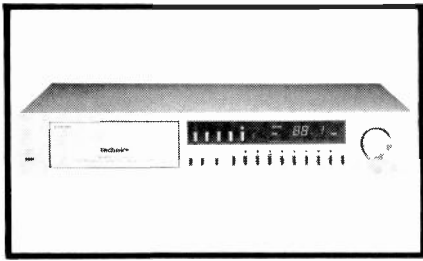

Tuner/preamp—a sensible idea, if seldom employed—is available again in Technics ST-K808.

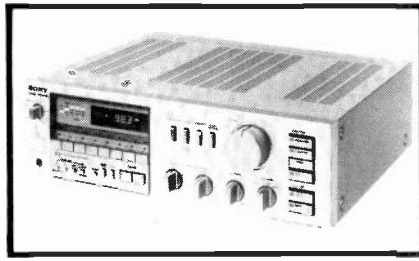

Several receiver designs seem influenced by companies' cassette decks: here, Sony STR-V55.

the music being reproduced in ten frequency bands. The Freon-based heat pump method of cooling output transistors (first shown last year in amps from Sony and Sanyo) is put to use here and in Eumig's M-1000 100-watt amp (\$800). MTI, Inc., has rated its Model 245 (\$600) at a modest 40 watts (16 dBW) output but claims transient handling to the equivalent of 250 watts—for a dynamic headroom of some 8 dB.

Technics' SE-A808 power amp joins integrated circuits and transistors in a hybrid configuration for an output of 40 watts (16 dBW) per channel. Also coming in at 40 watts per channel is the Model 335 Mk. II power amp, part of Toshiba's designer series of separates. And finally, we return to tube amps, which obviously have many admirers. Audible Illusions has its Mini Mite II, rated at 45 watts (16½ dBW) per channel and available in kit form or prewired. Conrad-Johnson Design has a 75-watt (18¾ dBW) tube amp for \$1,000. And Dennesen Electrostatic has two models: the DM-4 mono 50-watt (17 dBW) unit and the DM-73S at 35 watts (15½ dBW) per channel, priced at \$700 and \$1,000, respectively.

Digital quartz-referenced circuitry and digital displays are still the bywords in tuners, with price breakthroughs in this formerly high-end area. Kenwood, however, is demonstrating a prototype tuner called the L-X3 (on our cover) that promises much in the creative application of computer technology. It really is two tuners in one, plus a fully functioning computer (not just a microprocessor) and CRT display. While you're listening to one station, a press of a button can summon a CRT readout of the signal strengths of all FM stations in your area, expressed as a bar graph; another button summons up the IF range, percentage of multipath, and signal strength of the sta-

tion you are listening to; still another command brings an alphanumeric readout of ten preset FM stations with their call letters, frequencies, IF bands, and signal strengths.

But for today, Kenwood has applied its nonmagnetic concept for cleaner FM signals and emerged with the L-01T (\$1,000), incorporating a pulse-count FM detector and double IF conversion circuitry for better signal-to-noise ratios. Optonica's bid in the super-fi tuner area is the ST-9405 (\$1,000), a digitally synthesized tuner with digital display plus an analog scale with forty-four LEDs in place of a tuning needle. Sony's \$900 ST-J88B is a quartz-lock, frequency-synthesizer unit with nonvolatile MNOS memory circuits that will store seven FM stations indefinitely without external power.

Harman Kardon continues its slimline separates approach with two new tuners: the digitally synthesized Model 715 (\$370) and a more conventional design, the Model 710 (\$230). Qysonic's push into electronics includes the \$400 MT-4 FM/AM model. Lux's T-450 tuner (\$400) takes a different tack in helping assure positive center tuning. As the user rotates the tuning wheel to a desired station, a mechanical interlock prevents rotation of the wheel beyond the exact center-frequency point. Marantz' top-of-the-line ST-500 (\$375) foresees possible action by the FCC in tightening up FM spacing: Its frequency synthesized circuitry is adjusted to allow tuning in steps of 50 and 100 kHz, rather than the conventional 200-kHz increments. The step selector switch also provides compatibility with any future change in AM spacing from 9 to 10 kHz. Rounding out the Marantz line are the \$280 ST-400, with analog tuning scale and digital readout, and the ST-300 for \$225.

Tandberg's high-end separates

line is joined by the TPT-3001, a \$1,500 programmable device offering three-position IF bandwidth and adjustable muting. Akai has also entered the digitally synthesized tuner market with the AT-V04 (\$280) and the AT-K03 (\$230). Toshiba has expanded its roster of digitally synthesized tuners with the ST-445 (\$260), capable of storing six AM and six FM stations. And Technics has introduced a combination tuner/preamp, the ST-K808, as part of a total remote-controllable system. (The full Technics ensemble consists of the tuner, the SE-A808 power amp, the SL-D33 direct-drive turntable, and the RS-M45 cassette deck.)

Receivers, being the broadest segment of the high fidelity component market, tend to respond the quickest to prevailing economic conditions, and in this tight-money year manufacturers are concentrating on price points keyed to attract the greatest number of buyers. Sony packs lots of sophistication and good looks into its four new receivers—with the top model priced at just \$500. All are direct coupled, with power outputs of 28 watts (14½ dBW), 35 watts (15½ dBW), 40 watts (16 dBW), and 55 watts (17½ dBW). The top-of-the-line STR-V55 boasts low negative feedback circuitry, a pulse power supply, and frequency synthesized tuning. Pioneer has also introduced four receivers, each with Fluoroscanner power meters and, in the two top units, nonswitching DC amplifiers. Prices range from \$800 for the 120-watt (20¾-dBW) SC-3900 down to \$275 for the 30-watt SX-3600. Unique to each of the Pioneer receivers is an input that will accept an adapter for reception of AM stereo broadcasts when the FCC finally decides on one of the competing systems. The appropriate adapter will, of course, be available from Pioneer.

Toshiba's slimline-styled receivers include models rated at 25, 35, and 50 watts. As in its separate high-end tuner, Marantz' top-of-the-line SR-8000 receiver provides frequency synthesized tuning with a choice of 50 and 100 kHz tuning increments. This \$700 unit is rated for the same 88 watts (19½ dBW) per channel as the SR-6000, at \$550, which lacks the 8000's frequency-synthesized tuning. Three other receivers round out the Marantz line, with power ratings between 25 and 63 watts (14–18 dBW) and prices of \$275 to \$415.

Technics' receiver line contains

the lowest-priced unit we've seen this year, the SA-101 with an output of 18 watts (12½ dBW) for \$180. Other new Technics receivers range from the 30-watt (14¼ dBW) SA-202 at \$220 to the 63-watt (18 dBW) SA-505 at \$420. Sansui's three new receivers, called the Super Compo Series, are marketed either separately or as part of total systems. At the top of the line is the 64-watt R-70 (\$400); for \$230 you can get the 25-watt R-30. If this bevy of moderate-priced receivers leaves you thirsting for something, well, a bit less modest, there's always the ReVox B-780. With all sorts of goodies like frequency synthesized tuning, room for 18 preset stations in its electronic memory, and a power output of 75 watts (18¼ dBW) per channel, the B-780 is billed as "the world's most expensive receiver," and at \$2,700 we'd be hard pressed to disagree.

Speakers and Headphones

Designers are once again devoting their talents (and computers) to perfect-

ing the driver. If the Sony APM-8 (shown on this month's cover) looks a bit surprising, the square shape and flatness of the drivers are anything but cosmetic conceits. The flat, honeycomb-sandwiched diaphragms are said to move with unerring piston accuracy to produce coherent sound waves unmatched by conventional cones, with their inherent breakup patterns and phase cancellations. Each of these flat diaphragms is driven by standard voice coils, though the woofer's large surface area requires four voice coils—each at a specific node of vibration, as determined by laser holography. Sorry, but you won't find these speakers in your local stereo store. They are being marketed only in Japan and Germany, and when they reach the U.S. they will be sold—for \$14,000 a pair—only through professional audio dealers.

Onkyo, too, is concerned with maintaining accurate, piston diaphragm motion. The F-3000, its \$350 three-way system, makes use of a flat woofer and midrange driver, accom-

panied by a thin-membrane tweeter. Technics' exploration into driver design has led to a similar solution in its SB-10 and SB-7 systems. Currently marketed as professional products in its Recording and Broadcast Division, these speakers have flat woofers plus midrange diaphragms constructed of an aluminum honeycomb material.

Phase Linear enters the speaker market with three bass-reflex, three-way models. The top-of-the-line P-580 (\$1,200) mates a 15-inch woofer with concentric ribs for added stiffness with a 2-inch beryllium dome midrange and a ribbon tweeter. Joining the JVC series of ribbon-tweeter speakers is the Zero-3, a bookshelf-sized version of the Zero-5 and -9.

Accuracy in high-frequency and midrange reproduction has made the electrostatic driver an audiophile favorite for years, and Dennesen Electrostatic makes good on its name with the ESL-110. A hybrid system, it consists of three electrostatic elements and a dynamic woofer. Configured as a vertical line

Some of the mood in speaker design this year is reflected in models such as (from left to right) Onkyo's phase-aligned F-3000 with flat woofer and midrange diaphragms and thin-membrane tweeter, Infinity's Reference Studio Monitor with low-coloration polypropylene diaphragms, and Wharfedale's TSR-18, whose high efficiency breaks with English tradition.



source with phasing adjusted by in-depth placement of drivers, the ESL-110 is priced at \$250. Dayton-Wright, the Canadian company that (uniquely) seals its electrostatic drivers in a plastic bag filled with inert gas for minimum arcing with its very high biasing voltages, has produced the impressive XG-10. Not only is it intended to improve on the sound of the former model (XG-8), but big strides are claimed in reliability. If you have to ask about the \$3,500-per-pair price, perhaps you should be looking elsewhere.

Yamaha has introduced five speakers, ranging in price from \$190 to \$480. Each of these acoustic-suspension systems employs a newly designed soft-dome tweeter fabricated of a resin-impregnated fabric to provide rigidity for reproduction of sharp transients without harsh resonances. B&W, the English speaker manufacturer, has modified its well-known DM-7, which now carries the Mk. 2 suffix, with a redesigned crossover network and electronic protection circuitry. Another English company, Rank, has introduced the Total Sound Recall series of three systems that combine "English" tonal accuracy with "American" efficiency and power. To that end, materials such as polypropylene and mineral-filled homopolymer were used in the woofer and midrange drivers and computer-optimized techniques have been employed to wring as much sensitivity as possible from the mating of drivers, crossover, and enclosures. Still another British-based company, Celestion, is appealing to the part-time audio buyer with a line of four moderately priced speakers (\$100-\$330).

Infinity, too, has opted for polypropylene diaphragms in its new speakers: The three-way Reference Studio Monitor (\$300), the smaller three-way RSb (\$240), and two-way RSa (\$190) all use Infinity's Emit tweeter. Following the success of its floor-standing System B, Jensen has come up with a bookshelf version dubbed the System C. A three-way, four-driver system with a rear-firing tweeter, the System C carries a price tag of \$400. And JBL has announced that all the speakers in its Standard line—from the two-way L-19 bookshelf system to the three-piece L-212—feature symmetrical-field-geometry magnet structures for extremely low second harmonic distortion levels.

The trend toward "mini" speak-

ers, especially appropriate for the crowded apartment dweller, continues this year. Design Acoustics' shoe-box-sized Model LDM (\$175) features a beveled baffle board for minimum high-frequency diffraction. Essex Speaker Systems (a division of United Technologies), a new name in the field, is offering three minispeakers ranging in price from \$72 to \$114. Sansui's entry in the mini market is the SP-MI (\$250 a pair), consisting of a 4-inch woofer and 1-inch soft-dome tweeter in an acoustic-suspension enclosure. Technics continues its linear-phase concept with three small systems housed in heavy die-cast aluminum enclosures. Prices for the Technics SB series range from \$220 to \$340 a pair. Audiosource has expanded its LS line of compact, full-range speakers with three models priced at \$90, \$130, and \$160 each.

Separate subwoofers (low-bass extenders) and subwoofer/satellite systems are still increasing in popularity because of their flexibility and range. Sound Labs, Inc., has the Model R-2 with two 12-inch woofers loaded in their own sealed chambers. At \$450, the R-2 is said to complement Sound Lab's R-1 electrostatic array (\$1,100). A New Hampshire company, 3D Acoustics, has introduced the Model 3D610B, a complete three-piece approach consisting of a 10-inch woofer in its own cabinet crossed over at 100 Hz to two bookshelf-sized satellites (\$400 complete). SEAS, a Danish manufacturer, is marketing the DD Tower system. A stackable modular system, the DD Tower comprises two subwoofers and two three-way satellites.

ReVox rounds out its products with the Triton system, consisting of a subwoofer commode with two 10-inch drivers and two small bookshelf satellites (\$1,600 complete). DCM, whose Time Window speaker has developed a cultlike following, now has a companion piece called the Time Bass that connects to the Time Window via a built-in phase-correcting passive crossover. Fried Products' Model D is a dual subwoofer system employing a 10-inch driver, passive crossover, and ported enclosure. Cizek Audio Systems carries its lovely handcrafted construction methods into subwoofers with the KA-20. Complete with its own 250-watt amp, built-in electronic crossover, gain control, and subsonic filter, the \$2,000 KA-20 is intended to complement the highly

regarded KA-1 compact speaker system. And finally, Audio Pro of Sweden has a self-powered "baby subwoofer" system called the B2-14. A smaller version of the B2-50, it is priced at \$550.

Headphone introductions are few in number this spring. Sony claims that its MDR-3 headset (\$50) is the lightest ever made—only 1.8 ounces. A newly developed driver with samarium cobalt magnets and a high-compliance diaphragm is said to have made the weight reduction possible. Audio-Technica's ATH-2 headphone promises high performance at under \$50 and employs a light polyester diaphragm, photo-etched aluminum "voice coil," and two perforated circular magnets. GC Electronics has a whole new line of open-air and sealed-cup headsets, ranging in price from \$35 to \$100. And JVC has come up with three lightweight models with dual-band construction for minimum wearer fatigue.

Record-Playing Equipment

What used to be considered the workhorse of audio reproduction, the turntable, is now more properly regarded as a thoroughbred—beautiful in form and utterly graceful in function. With direct-drive motors and quartz-referenced speed controls already firmly entrenched in turntable design, some manufacturers are taking this opportunity to fill in their lines with units that add to or subtract from features of successful existing models.

There is some trend toward straight-line (tangential) tracking in premium turntables. Yamaha is showing a

Pioneer PL-600 is one of many high-spec quartz-locked direct-drive turntables with automatic features.

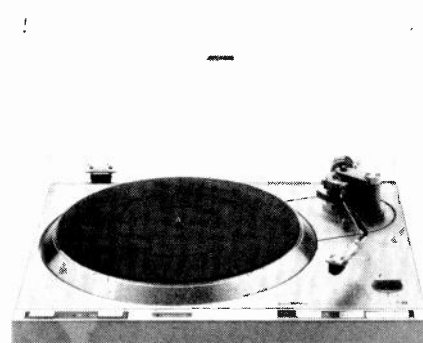

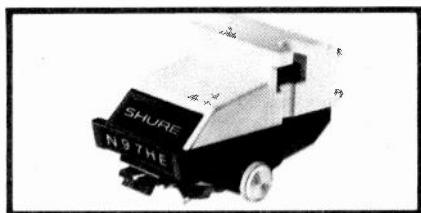

Shure has put technology from its top models into the more modest Era IV line of four pickups.

tangential prototype with direct drive and microprocessor control, the PY-2. ReVox' B-795, similar to the highly regarded B-790, has the same tangential-tracking tonearm and quartz lock for its direct-drive motor. But by omitting the digital speed readout and pitch adjust and by building its own motors, ReVox held the price of the B-795 to \$600. Other tangential models have been shown in Japan but not yet announced here.

Optonica, a company that never ceases to reveal to us the possibilities of automation in audio gear, has the \$950 RP-9705. This quartz-lock, direct-drive unit is capable of automatic track selection and stores up to ten separate commands in its electronic memory. Onkyo's newest, the CP-1280F, is a fully automatic single-play model with a separate motor to operate the tonearm's start and return mechanism. What used to be considered an audiophile extra, the carbon-fiber tonearm, is standard with the Onkyo. Fisher built its MT-6360 around a microprocessor for automatic track selection and cueing. Other features of the \$350 Fisher turntable include infrared wireless remote control and digital readout of the track being played.

Kenwood broadened its line with three models, ranging in price from \$170 for the fully automatic belt-drive KD-2100 to \$550 for the direct-drive, quartz-locked KD-850. Akai has also updated its offerings with two direct-drive units (for \$190 and \$150) and a budget-priced belt drive (\$100). Each of Pioneer's five turntables features a direct-drive motor and what it calls a coaxial suspension, in which the platter, motor, and arm are mounted on a single bottom plate suspended from the cabinet via four springs for increased immunity to feedback. The series starts with the \$150 semiautomatic PL-200 and advances to the fully automatic quartz-locked PL-600 for \$400. Garrard continues its Advance Design

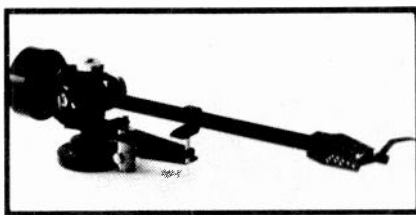

Among several sophisticated separate tonearms, Sumiko's premium model is called simply The Arm.

Group with five models: three with coreless, slotless, brushless direct-drive motors to prevent cogging and two with belt-drive mechanisms. Prices for these range from \$100 to \$250.

A low-mass, straight-line tonearm is incorporated in Scott's PS-18 belt-drive model (\$130) and in Lux's Model 264 direct-drive turntable (\$225). By far the greatest number of introductions comes from Toshiba, with five direct driven and four belt driven. Prices range from \$300 for the SR-Q300, a quartz-lock direct-drive with carbon-fiber arm, down to \$115 for the belt-driven SR-A100. Technics has added the SL-D33 to its extensive line of turntables. A direct-drive model, the \$260 SL-D33 features a newly developed double-layered base construction to minimize feedback.

Marantz' entries include the TT-4000, a fully automatic single-play with quartz-referenced speed control (\$250), and the TT-2000, a direct-drive unit without quartz lock (\$200). And finally, Hitachi has introduced two direct-drive turntables with photo-sensor arm return systems, the HT-466 with quartz lock for \$240 and the HT-464 without quartz for \$200.

Moving-coil phono pickups are gaining ever more popularity, and manufacturers have responded with several models that compete in price with fixed-coil designs. Sony's XL-44 (\$200) builds one into its own headshell. Sumiko has two moving-coil cartridges designed to be compatible with moderate-priced turntables or changers and priced accordingly, at \$110 and \$150. The high output of Adcom's XC-LT (\$240) obviates a stepup transformer or head amp. Technics' high-output EPC-305MC, being marketed through its Recording and Broadcast Division, comes mounted in its own headshell and is constructed with a boron pipe cantilever and a coreless twin ring coil. Osawa offers a new

low in moving-coil prices—the \$100 Satin M-117Z, a high-output design with a user-replaceable stylus.

In fixed-coil designs, Shure leads off with a new line of moderately priced pickups based on the V-15 Type IV's damping/brush design. The M-97 Era IV Series consists of four models ranging in price from \$68 to \$113, each with the viscous-damped dynamic stabilizer and a telescoping stylus shank to minimize the possibility of damage from lateral shocks. Ortofon has three low-mass models, the LM-10, LM-15, and Concorde 10. The LMs, designed for mounting in conventional headshells, weigh just 2.6 grams; the Concorde 10 (the LM-10 in its own headshell) comes in at 6.5 grams. Signet, marketed by Audio-Technica, has added the attractively priced TK-1E—\$40 unmounted or \$45 in its own headshell. Among budget-priced pickups are the Nagatronics 244DE for \$64 and the Osawa MP-10 at \$40.

Dennesen Electrostatic has a tangential air-bearing tonearm ensemble, constructed from such elements as a brass tube with small perforations, a lightweight arm (which rides across the brass tube on a cushion of air), an air pump, and lots of bionic-looking plastic tubing. At \$1,000 we thought that was the most expensive arm we had yet seen until we ran across what Sumiko calls simply The Arm, at \$1,250. It is a medium-mass dynamic type with nondetachable headshell and three separate counterweights to accommodate any pickup. Somewhat more affordable, perhaps, is the Lustre 801 for \$500, also from Sumiko, which applies vertical tracking force and antiskating bias through magnetic force rather than springs or counterweights. Its magnesium headshell allows for precise azimuth adjustment. Osawa claims that its AC-30 arm comes in at "just the right price"—\$300. For that you get an oil-damped unit with single needle-point support. Finally, Technics is introducing—once again through its Recording and Broadcast Division—its EPA-100 tonearm, which rotates on ruby ball bearings and offers variable dynamic damping so that the user can tune it for any cartridge available.

Tape and Tape Equipment

Last February we wondered in print whether the cassette's improvers

were its worst enemies; the growing incompatibility or only semicompatibility of the products in the field seemed, at best, to threaten confusion to prospective purchasers. Judging by the decks introduced so far, however, chaos will not reign in 1980 because one consideration has moved into the foreground and forced the others to assume subordinate roles: high-frequency headroom improvement—the virtue that distinguishes metal tapes above all others. From what we see, only superbudget models or portables will be appearing without the metal capability. Dolby Laboratories' HX headroom-extension option for its familiar noise-reduction circuit also is making headway, with several announced models already incorporating it. And none of these developments contributes to the incompatibility problems, of course. Metal tapes and/or HX recordings need nothing special for playback; HX will extend the high-frequency overload ceiling in metal tapes as well as ferric ones.

By contrast, the dynamic-range extenders that depend on special playback equipment—noise reducers that outstrip Dolby B in this respect and the high (3¾ ips) transport speed—are experiencing no comparably rapid growth in adherents. Machines with the double-speed option and such noise-reduction units as DBX's, Nakamichi's High-Com II, and Sanyo's Super-D generally are considered of interest primarily to recordists who want extra performance for live recording and are not really interested in whether their tapes will play well—or at all—on anyone else's equipment. Of these capabilities, only Super D has been incorporated into a new deck (not counting models that, like Marantz' extensive two-speed line, had already been announced last year for future delivery); Dolby B (with or without HX) plus 1⅞ ips remain essentially unchallenged standards. But in the long run, HX, metal tape, and even the more esoteric (and generally more expensive) noise-reduction systems may help one other cassette mutant: half speed. While no new cassette decks with 15/16 ips have appeared, we note with interest that Fisher has a prototype microcassette deck with Dolby HX.

Only a few years ago, \$1,000 was considered an outrageous price for a cassette deck and anything in that range fit only for professional use or the lunatic



Metal capability, standard in new decks, is added to previous ones: Hitachi D-5500 has become D-5500M.

fringe. "Better" decks seldom cost much over \$350; anything below \$200 was a make-do stripdown that might not qualify as high fidelity in some important respects. That bottom price category remains, but the equipment in it today has a degree of sophistication and a level of performance heretofore impossible. The middle ground stretches to approximately \$750, accumulating special features and performance refinements as it rises. This continues to be the most active range. The ultraperformance and luxury-featured decks at higher price points (reaching to about \$3,000) remain much as they were last year.

One obvious exception is the automatic azimuth-adjustment system developed by Nakamichi for its 600 Series decks. The two-speed model (still the only premium deck with the 15/16-ips option) announced last year will remain available without the new feature as the 680; with it, and called the 680ZX, it will cost \$1,550. Two single-speed models complete the series: the \$1,150 670ZX with full Dolby monitoring and the \$995 660ZX with all the same features except the simultaneous monitoring. All include Nakamichi's RAMM random-access feature. There also are new "music-lover" models that emphasize ease of use: the 482 (\$775) and 481 (\$655), again with and without simultaneous off-the-tape monitoring.

Tandberg's TCD-3004, which is expected to sell for about \$2,800, is the first break with the company's traditional cassette-deck styling and intended as the summation of all the technology that can be mustered on behalf of the cassette medium. Delivery date for the TCD-3004 will not be announced for

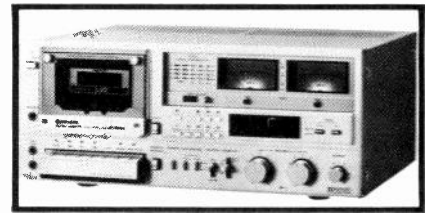

Among few new semipro open-reel models, Ferrograph SP-7 has so many options it can be "custom-built."

some months. For only \$1,200(!) you can buy Sony's TC-K88B, its most sophisticated model but one so small it almost looks like a microcomponent. The cassette "well" plus the tape adjustments and other technical controls are hidden in a drawer that slides open like that on a cash register when you push the eject button. We were much taken with the prototype when it was shown last year before Sony had made firm decisions about marketing it. Harman Kardon uses a similar drawer in its superbly styled hk705 (\$450). The 705 is, not incidentally, the first deck we encountered incorporating Dolby HX circuitry.

The Super D noise reduction is incorporated into the flagship Plus D64 in Sanyo's recently introduced Plus Series. So is Dolby B; the switching allows use of either system or neither, but not both simultaneously. Aside from the probable inadvisability of employing "cascaded" noise reduction, since any two systems tend to compromise each other, we understand that the Dolby license prohibits switching that would make the practice possible (just as the Philips cassette license prohibits noise reduction without a defeat switch).

Technics continues its low-profile rack-mount Professional Series (which are conventional front-loaders) with the \$700 direct-drive, metal-ready Mk. II version of its RS-M85; and it has a new micro—the \$500 RS-M02, also with direct drive. The Hitachi line, which also features direct drive in its top models, has metal-ready decks. At the top is the D-5500M, a reworking of the original auto-tape-matching D-5500 but selling for the same \$1,200 price. The ATRS tape-matching has been incorporated into the \$750 D-3300 as well. Teac has added the metal capability, at no increase in price, to its A-500 and A-510 decks and two new budget models, the \$230 CX-350 and \$250 CX-370.

Metal-tape handling plus such goodies as IC logic characterize Rotel's RD-1000M, at \$440. Kenwood has two more metal models—the KX-500, whose sophistication of features, controls, and styling belie its \$225 price tag, and the feature-laden KX-2060 at \$600. JVC has three, ranging from the three-head KD-A77 down to the inexpensive (and, like a budget-model predecessor, Dolby-equipped) KD-A2. Fisher has the \$350 direct-drive DD-300; Toshiba's several entries contrast the low price and full-size format of the \$170 PC-X10 with the \$550 D-15 micro, which is available anodized in black for \$10 extra. Akai's three range from \$180 to \$300. Technics' models cover an even wider price range—from a mere \$150 for the RS-M6 to the aforementioned \$700 model. Sansui's moderate-price metal-ready deck is the \$200 D-100, and Lux has its K-1 metal-ready model for \$230. H. H. Scott's is the impressively styled 671DM, whose specs and DC drive make the \$250 price very attractive. For even tighter budgets, \$200 is the cost of the similar 610D, one of the few new decks to dispense with the metal feature; while industry executives are openly pooh-poohing the metal capability in inexpensive decks on the ground that "if you can't afford a better deck, you can't afford the expensive tape," only Scott seems to be heeding that concept. But the lowest priced deck we know of from any component house this spring is the \$130 Sharp RT-10, which *will* record on metal tape.

And the scarcity of metal tape to use on such machines would appear to be a thing of the past. By year's end, Fuji claimed to be the first to be delivering C-90s to dealers, while TDK was readying a second shell type—conventional MA cassettes, as opposed to the MA-R metal-spined shells in which its metal-particle tape originally was housed. At the beginning of this year, Ampex and Memorex announced their metal formulations. The Ampex product will be styled MPT; initially, it will come in the C-60 length for about \$10. Maxell was said to be ready for shipment in C-46s and C-60s immediately, with C-90s to follow this month; selling prices for C-60s, again, are expected to be in the \$10 bracket. Hitachi also has announced metal tape, though its formulations generally are assumed to be interchangeable with those of its subsidiary, Maxell, and we have encountered no spokesman

willing to deny the relationship. In Hitachi's terminology, the metal is called MR, the premium ferric (UDXL-I) UDER, and the chrome-compatible ferric (UDXL-II) UDEX; both brands also offer "low-noise" ferric tapes.

In addition to MA, TDK has announced an improved formulation for its AD (Acoustic Dynamic) premium-ferric tape plus an even better (premiumer?) one of the same general description: OD (for Optimum Dynamic). AD remains available in all standard lengths from C-46 to C-120; OD will be available in C-60 and C-90 lengths only and at prices about \$1.00 higher than those for AD. EMI's Superchrome II, which costs about the same as OD, has been introduced here by Empire. A little lower in price is RKO's Ultrachrome (based on Du Pont's improved chromium dioxide formulation), which will be made in C-60 and C-90 lengths. A second new RKO formulation is the budget-priced ferric XD. (Its premium ferric Broadcast I was announced last summer.) Meanwhile, what is billed as a superperformance ferric otherwise unavailable on the U.S. consumer market can be purchased by mail order only from Tape 5.

For the video recordist there are a number of new cassette tapes. Maxell has a line for Beta decks in L-250 and L-500 lengths; VHS-deck owners can buy Maxell's new HG formulation in T-30, T-60, T-90, and T-120 lengths. The 3M Company has brought the shortest of these lengths into its Scotch VHS cassette line, while Memorex has added T-90s to its T-60s and T-120s. Ampex's new line covers both formats and is available in a choice of packagings: conventional sleeve or (at slightly higher prices) plastic boxes.

Open-reel recordists will find a new Scotch 1-mil tape this spring: Master XS, which replaces the Master of last year and is said to have exceptionally high sensitivity and resistance to print-through but remains compatible with decks biased for Scotch 206 or the original Master. New here from BASF (though not new in Europe) is Ferro LH DP 26, a low-noise open-reel tape selling for moderate prices in plastic library boxes and featuring sensing foil.

As usual in recent years, there are few new open-reel decks to record these tapes on, but there are some. Sony has three. The \$500 TC-399 is moderately priced by today's standards, but it in-

cludes such refinements as separate three-position switches for bias and recording EQ—the latter with a special position for ferrichrome tape, which Sony has made available in open-reel form. These options also are included in two semipro decks handling NAB reels. The \$1,200 TC-765 is a quarter-track stereo deck with 7½ and 3¾ ips; the \$1,500 TC-766-2 is a half-track deck in which 15 ips replaces the slow speed, but it has an extra playback head for quarter-track tapes. Neal-Ferrograph's SP-7 offers so broad a range of options that the company talks of custom-building models for specific applications. You can have any three contiguous standard speeds in the range from 15 to 15/16 ips; you can have NAB or CCIR/IEC playback equalization; Dolby B circuitry and rack-mounting kits are available, as are NAB-reel adapters; 10-watt amps and speakers can be built in; power supply options include the U.S. standard (110 VAC/60 Hz) plus two common in other countries, 50 Hz and either 220 or 240 VAC.

On the Video Front(s)

As we said earlier, the expected turn toward basics and lower prices in video cassette gear still was beyond the horizon as the year began. A dramatic harbinger came from Sanyo, however, with a reduction of \$200 on its VTC-9100 Beta deck. In the meantime, we continue to be regaled by luxury decks—modular portable home combinations, ultraprogrammables, models with nonreal-time playback options, and the like. The \$1,350 Mitsubishi HS-300U, for example, uses five direct-drive servo motors to achieve beltless operation in multiple real-time modes plus two slow-motion modes, freeze-frame, and single-

Among compact video decks, Quasar VH-5300 offers add-ons—here, "special-effects"/programmer.

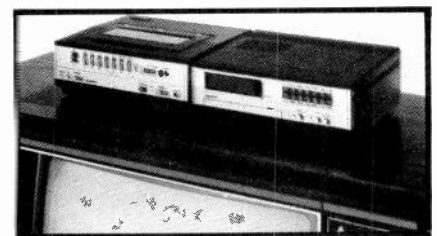

frame advance. The memory will accept complex seven-day programming; microprocessor logic can handle fifteen different commands from an optional (\$100) infrared remote control, and program search operates in either fast-wind direction. The RCA SelectaVision VDT-625 (\$1,395) and Quasar VH-5155 (\$1,350) share many of these features. All are VHS-format home decks.

A comparable thrust is evident in gear for the Beta format. Sony has announced the \$1,350 SL-5600 Betamax. It adds the sophistication of BetaScan (Sony's fast-wind visible cue/review feature) and fourteen-day programmability to the previous technological flagship of the line, the SL-5400, which costs \$100 less. Either can record for up to five hours with the L-830 Beta cassettes, brought out simultaneously by Sony.

The "special effects"—as several manufacturers style the freeze-frame, program search, and similar nonreal-time playback options—also are coming to more compact gear. Quasar has prototypes of a VH-5300 that includes them and that can be used either with a home AC power supply or, as a portable, working from a battery pack; in the home, a VA-520 tuner/programmer can be added. But the real news in compact equipment centers around the two very different LVR systems. Chez BASF, LVR stands for Linear Video Recording, a long-awaited system expected to be on the market this year. Toshiba, which began its move toward a 1980 introduction only last year, uses the term to represent Longitudinal Video Recording. (The basic differences between the two LVRs were outlined in "Video Recording: State of the Art—For Now," HF, November 1979.) The Toshiba system has undergone some refinement—in particular, to increase recording capacity—and is

Inherently compact longitudinal video tape systems include Toshiba's, shown here in prototype deck.

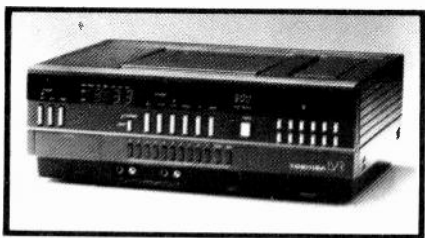

expected to sell for about \$500 in a basic deck when it appears this summer. There may be another longitudinal system from Funai in the offing, but no formal announcement or details have been forthcoming.

Impetus for the push to lower prices (whether via crash diets in the helical-scan cassette camps or via intrinsically simpler longitudinal-scan systems) is partly attributable to recent developments in video discs. Pioneer is, if anything, pursuing more avidly than ever its plans to provide home players for the Philips/MCA system this year, Kenwood (or, rather, its Japanese parent company, Trio) recently signed a license to make Philips-system players. Such events, plus IBM's entry into the Philips camp last year, give this design the appearance of strong front-runner, but that may change. Shortly after RCA announced its competing SelectaVision disc for marketing next year, CBS took out a license—a nonexclusive one, meaning that it could also sign a Philips license and actually produce discs with either or both (or neither) of the techniques. And a third contender is likely. Matsushita (Panasonic), which has been demonstrating its Visc system in prototype, early this year announced its shelving of Visc in favor of VHD, a different disc system from its subsidiary, JVC. (VHD resembles RCA's system in using a capacitance pickup.) This unanimity suggests greater likelihood that VHD will be available in the near future. History seems to be repeating itself here. If you have been following the labyrinthine unfolding of home video recording, you will remember that Matsushita a few years ago shelved its cassette system in favor of JVC's VHS and that, along with other licensees, it then lost no time in overcoming Beta's lead.

Monitors for video recordists often double as camera viewfinders; this is separate Akai RC-V10 "micromonitor."

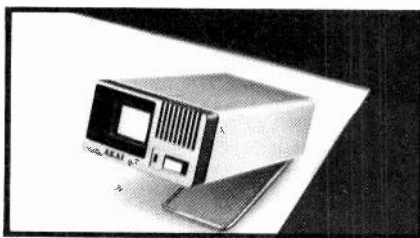

As though to emphasize the home recording capability that tape does not share with the disc media, manufacturers have presented a host of new products specifically for the recordist. Video cameras abound, though there are no major design breakthroughs so far. Sony has a "visuals" generator for creative home videophiles who want to mix, title, and so on: the \$150 HVS-2000. There are many inexpensive switching gadgets. The Superex VTRS-4 (\$60), for example, allows dubbing among four decks. Others switch RF inputs, and some are intended to edit out commercials automatically during taping by activating the deck's PAUSE whenever a cue signal is broadcast.

Akai has a minimonitor called the Peek-A-View (\$170) so that you can keep track of the program you're recording while you watch another on your main set. The alternative approach—multiple images on a single receiver screen—has spawned a Sharp unit that can handle nine images simultaneously, each from a different channel, if that's what you program it for. Toshiba, whose lineup includes several impressive innovations, has a model that will hold up to four 10-inch pictures on its 25-inch screen. It has a remote control and, like the Sharp, can freeze the motion on any one of the images.

Toshiba also is one of the companies offering new projection systems. Its one-piece unit with 45-inch screen is priced at \$3,500 including tuning electronics and can be bought without tuner as a monitor for recorded video. Among the add-on lens systems that use a conventional receiver as an image source for projection, Futurevision (from F&F Sales Company) comes in screen sizes from 4 to 7 feet, selling for between \$500 and \$1,000 plus the cost of the receiver (\$425 for a Sony Trinitron 1206 modified to accept the lens system).

And one last twist, again from Toshiba: a prototype TV receiver that not only will respond to voice commands, but will reply "okay" when a command has been accepted by its microprocessor logic system. (A similarly controlled microwave oven has been shown by Quasar.) The idea logically follows the "talking calculators" that were last year's showpieces. Perhaps your stereo system eventually will be able to improvise harmony to whatever tune you whistle for it. **HF**

Passages for the Eighties: Predictable Crises of the Classical Record Business

by Allan Kozinn

Toward the end of last summer, it dawned on the executives at most of this country's major record labels that their third-quarter earnings reports were going to be even more dismal than the first two and that the end of the proverbial tunnel was not getting any closer. Everything was going wrong: The polyvinyl chloride used to make discs was growing more expensive, artists were demanding higher and higher fees, foreign recording projects were becoming unconscionably costly as the dollar sank in value abroad, and with retail prices climbing steadily, it seemed that nobody was buying records anymore.

One particularly bleak day in August, a public relations spokesman for one of the large classical labels stared blankly out his office window and told me, "You know, we haven't had a year this bad since the Depression. I'm not sure we can afford to keep making records." This was several weeks before the press, tipped off by rounds of firings, began to report that all was not well with the record world, and at that point, the official word was that all *was* well—or at least no worse than could be expected, given the prevailing economic situation. Certainly, when public relations hyperbole was flung, it was of a more positive kind, especially in classical precincts, where sales are so embarrassingly low in comparison with pop sales that spokesmen routinely duck quoting actual figures.

Within a month, most labels had done some obvious belt-tightening. It seemed at first that the lion's share of firings took place at the pop labels. At Columbia, for instance, it was claimed early on that only a few secretaries had lost their jobs on the classical floors. But as the CBS firings continued sporadically throughout the fall, even Marvin Saines, vice president of U.S. Masterworks, was shown the door. About this step Columbia's new chief of staff, Simon Schmidt,

would say only that "he was a good, knowledgeable man. There was nothing wrong with him. It was just a question of building what I felt the organization required." Everyone else at Masterworks sat tight, unable to discuss plans for anything ranging from Mengelberg reissues on Odyssey to the release dates of the first CBS digital discs, originally set for January.

Probably most distressing for veteran industry-watchers was the dismissal at year's end of Teresa Sterne, for a decade and a half the driving force behind the adventuresome Nonesuch label. Even as executives of Elektra/Asylum, the parent company and itself part of the Warner Communications conglomerate, handed "Lady Nonesuch" her walking papers and abruptly canceled all her recording plans, they assured the press that they envisioned a bright future for the label.

Those in the business who managed to keep their jobs found that everything from the ordering of promotional LPs to the budgeting of major projects was being more closely scrutinized. At RCA Red Seal, the severest blow was the cancellation of the scheduled recording of Ponchielli's *La Gioconda* on the eve of the sessions, sacrificing an opportunity to take promotional advantage of the

San Francisco Opera's worldwide telecast of the work last September—just the sort of free potential sales boost record companies look for in planning such ventures.

Originally, RCA estimated that recording *Gioconda* in London would cost \$195,000, and the producers knew they could come up with another \$25,000 to cover emergencies. Well, the emergencies were more than RCA had banked on. In the weeks before the sessions were to begin, the British musicians' union voted itself a 25% rate hike. Chorus prices went up, too. Negotiations with principal singers moved slowly because RCA was intent on casting every leading role with a major name (Scotto, Domingo, Troyanos, Milnes), and these performers wanted healthy fees. Some of them were involved in European festival performances, which meant that RCA would be obliged to pay multiple transportation expenses (including, of course, limousines to and from the airports) to shuttle them between their stage dates and the fourteen scheduled recording sessions. And with all these expenses to be paid in British pounds but billed to the American company in dollars, every time the dollar dropped a point on the international exchange market, the production became several thousand dollars more expensive. By the time RCA balked, the cost of recording alone—that is, without pressing, artwork, librettos, packaging, and marketing—was estimated at \$300,000, more than 50% above the first estimate. And, as the prospective producer put it, "If I were going to spend that much of RCA's money, it would have to be for a hell of a lot better work than *La Gioconda*."

Meanwhile, Columbia had issued a list of 1979-80 releases [see HF, September 1979] that made it look as if the halls at Masterworks were paved with gold. But cynics pointed out that much of the material on the list was already in the can, some of it several years old. And others wondered if the cancellation of what could have been the prestige project of the year, the Boulez/Paris Opera *Lulu*, the first truly complete performance of Berg's opera, was related directly to financial setbacks. After all, Columbia's explanation that *Lulu* had to be dropped because Universal, the publisher of the score, would not guarantee the label could release the recording looked pretty silly when Deutsche Grammophon stepped in and saved the



project. [DG's recording was reviewed in the March issue.]

Oddly enough, Columbia's story survives close examination. The label had been planning the project for two years, hoping to record the opera between two Paris performances last February and have it in the stores by April. At the last minute, it was ascertained that Universal did not actually own the rights Columbia was hoping to buy from it and could not guarantee that the Berg estate, which had unsuccessfully tried to enjoin the Paris Opera from performing the work, would not sue to prevent distribution. Columbia backed out. DG learned of this and agreed to Universal's terms, recording the work without a firm guarantee that it would be free for release. Being better versed in the intricacies of Viennese musical politics than Columbia, DG was able to obtain the permission of the Berg estate after all. Nobody will talk about the details—but don't be surprised if a few new LPs of music by a certain older living Austrian composer who was instrumental in the arrangements turn up in the DG catalog soon.

While all this operatic juggling was going on, EMI, which owns Angel/Seraphim here and does a huge volume of classical business worldwide, began negotiating the sale of its music division, first with Gulf & Western/Paramount and finally with Thorn Electrical Industries, Ltd. And though it was widely suspected that British Decca, which markets London, Stereo Treasury, Argo, and L'Oiseau-Lyre among other labels here, was having financial difficulties, no one there would admit that the company was for sale until it was announced on October 30 that Decca/London would be acquired by Polygram. Such a fattening of the Dutch-German giant was symbolic: DG and Philips, both of them Polygram labels, seemed to be the only classical record operations voicing no complaints during the fall. So, while most of the public lamentations about recession in the record business came from producers of rock and disco LPs who were understandably depressed that nothing comparable to *Saturday Night Fever* and *Grease* had hit the bins in 1979, it was apparent that classical labels too were in a state of flux.

Yet positive notes were also sounded. Spokesmen for several classical labels argued compellingly that sales were steady and that their business was simply not as vulnerable as pop music to

The mix of increasing expenses, changing sales patterns, mergers, and new technologies suggests several possible scenarios for the Eighties.

the vagaries of trends or to the pinch of inflation. First, they pointed out, pop and classical buyers were entirely different animals: The classical buyer was, statistically, older and more affluent, with more mature (meaning less radically changeable) musical tastes and with the cash (or credit) available to cater to those tastes. He was also depicted as less impulsive, one who planned purchases to fill gaps in his permanent library—an assertion borne out by the steady sales of fifteen- and twenty-year-old catalog items, particularly in opera.

Furthermore, company spokesmen insisted, the growth of digital recording was pumping new life into the business by piquing the curiosity of regular customers and bringing into stores audiophiles contemplating their first classical purchases because of the promise of state-of-the-art sonics. As an example, companies point to the Robert Shaw/Atlanta Symphony *Firebird* on Telarc, reported to have sold 75,000 copies in only a few months, without benefit of a superstar conductor, a top-five orchestra, or a major-label marketing push.

A trump card is what the companies call crossover albums. Crossovers are recordings of varying seriousness that appeal not only to a reasonably large segment of the established classical market, but to people marginally interested in classics. These projects are regarded as attractive because they are usually produced at little cost and sell quickly and in large quantities, generating income that can be used to cover the deficits left by opera and symphony recordings, which often take several years to pay for themselves.

An example is the Claude Bolling/Jean-Pierre Rampal Suite for Flute and Jazz Piano. A Columbia Records computer printout of early October 1979 lists thirty-five current Masterworks LPs that had sold, altogether, 820,563 units since their release. Of that total, the Rampal/Bolling disc accounted for more than 50%, with 419,957 copies since 1975.

(Not listed on this printout is Wendy [Walter] Carlos' "Switched-on-Bach," which sold 400,000 copies in its first year [1968-69] and has since gone over a million.) Over the last ten years, crossover albums have included such shows as *A Little Night Music* and *Sweeney Todd*; such unashamedly popsy discs as James Galway's "Annie's Song," the Yehudi Menuhin/Stéphane Grappelli "Tea for Two," and the Beverly Sills/Sherrill Milnes "Up in Central Park"; operatic superstars singing spirituals; Koto ensembles playing Mozart, Handel, and Vivaldi; and synthesists tackling everything from Bach to Stravinsky (with varying degrees of sophistication). At any rate, the percentage of crossovers to "straight" classical releases is higher now than it has ever been.

Clearly, this complex mix of increasing expenses, changing sales patterns, corporate mergers, and new technologies suggests several possible scenarios for the classical record business in the Eighties. As with any series of predictions, some distinct possibilities may contradict others. Perhaps the best approach is to isolate and extend recent trends one by one, letting the contradictions fall where they may.

Let's begin with symphonic recording. It has for some time been significantly less expensive to record an orchestral work in Britain than in North America. Even taking the recent British rate hike into account, such a recording can cost as little as \$15,000 to \$20,000 in London; higher session base rates, the American Federation of Musicians' rule that each three-hour session may yield no more than forty-five recorded minutes in the final product, that each session hour may yield no more than fifteen recorded minutes, and a list of required extras (fees for stagehands and for players not needed for the work at hand, for instance) have pushed the cost of a comparable project in the States to between \$45,000 and \$60,000. Yet, while American labels are increasingly shifting their gaze to London, those in Europe have approached the American big five and a handful of other orchestras. We see RCA relinquishing its hold on the Philadelphia Orchestra, with its Philadelphia releases cut from eight to four LPs a year, and EMI moving in. Boston has gone from RCA to DG and thence to DG's sister label Philips. Chicago, on the RCA roster until Solti took over, now records for just about everyone, though mainly

for DG and London. Cleveland, exclusively in the CBS camp during the Szell years, has been doing most of its work for London since Maazel became music director in 1972. And London will be doing some recording with the New York Philharmonic now that Mehta is on the podium.

To the consumer, all of this label shuffling may seem to mean only that the best tradition of American orchestral playing will continue to be available on disc, and in superior, if slightly more expensive, European pressings. But what will become of our domestic companies' catalogs? Instead of giving us recordings of our best orchestras led by their principal conductors, the American labels are giving us documents of their pet artists' guest-conducting stints with British orchestras. Have the a&r men here forgotten that to survive it is necessary to keep the catalogs fresh with performances that have a distinctive quality that will make people want to buy them five or ten years hence? Have they forgotten that the source of this quality is a special communicative bond between a conductor and the orchestra with which he works regularly?

No, they haven't forgotten. But in reconciling their artistic philosophies with the financial strictures placed on them by the unions and by their own corporate accounting departments, they have arrived—through conviction or convenience—at the position that buyers are no longer interested in orchestras, only in conductors and works. In other words, forget all that stuff about the Chicago and Philadelphia sound—this is the age of jet-set personalities. After all, some company spokesmen have been heard to argue, the world median level of performance is pretty high these days, so if you take a great conductor and stick him in front of an orchestra that he conducts two, three, maybe half a dozen times a year, you can make a very good, possibly even an exciting, recording. Where the will of the conductor is strong and the orchestra flexible and perceptive, the results of such collaborations can be of lasting value. Everyone's list of favorite recordings includes examples. Think of Bernstein, Giulini, Colin Davis, and Abbado. Then will the tight finances of the early Eighties finally put an end to the domestic recording of conductors with their own orchestras? No. The orchestras themselves have come up with a way around the cost problem—by paying for



their own recordings.

Many of the conductors American labels are most interested in stand on relatively minor podiums. Take Eduardo Mata, for example. RCA is interested enough to send him to London to record and to pair him there with its prime seller, Galway. But RCA will record Mata's own orchestra, the Dallas Symphony, only on a subsidy basis—and with some justification. Another of the union-enforced hindrances to recording here is the Federation's insistence that all orchestra personnel, whether it be a major or a minor ensemble, be paid the same rates. If it is almost prohibitively expensive to record the Philadelphia Orchestra, why would RCA be willing to spend as much to record Dallas—unsubsidized?

Lesser-known orchestras, though, are more than happy to pay the major labels to come and record them, and they can look forward to *being* recorded, however infrequently, so long as they retain the services of a major conductor (or, in some cases, persuade major soloists to insist on recording with them). They hope, of course, that, through exposure on major labels, they can build a wider following and eventually *become* major orchestras: the Academy of St. Martin-in-the-Fields syndrome. And who's to say it's not possible? Perhaps some of these orchestras—Toronto, National Arts Centre (Ottawa), Dallas—will blossom into important symphonic entities and the Eighties will see the emergence of a "middle five." The possibility brings to mind a passage in Anthony Burgess' futuristic novel, *A Clockwork Orange*, in which the protagonist, a London roughneck, unwinds after an evening of ultraviolence by playing his favorite recording of the Macon (Georgia) Philharmonic.

Which raises another question.

The Macon Philharmonic may have a London following in Burgess' fiction, but will a provincial American orchestra ever sell enough in the *real* world to leave subsidization behind? The U.S. accounts for only 30 to 35% of the world classical record market, and spokesmen for all the labels agree that it is difficult, if not impossible, to make any money by selling expensively recorded discs to the U.S. market alone. A case in point: Columbia's Complete Works of Webern, Vol. I, conducted by Boulez, was released last June and, despite rave reviews, had sold only 4,012 copies here by October. In Europe, however, the set sold another 10,000 copies—enough, Columbia says, to cover the cost of its production. But can RCA ever count on selling Dallas to the French and Germans?

According to a rule of thumb used around the offices of some large classical companies, a project pays for itself when three discs are sold for every dollar spent on it—from recording sessions and artists' fees to pressing and packaging, promotion and advertising, distribution and overhead. An American-made symphonic disc, therefore, may have to sell more than 180,000 to break even. Obviously a world market is needed, and the performance must be something that will capture the imagination of an international audience.

Some international companies are better than others at providing for a classical disc's success. Deutsche Grammophon assumes that 90% of the discs it releases can be sold anywhere (the other 10% are aimed at specific national markets) and so sees to it that each national "territory" accepts nine out of ten releases. And DG counts on waiting five or more years for each release to reach its break-even point. Masterworks operates in somewhat the same way (but with a shorter break-even period—the target is one year), producing very few records that all Columbia affiliates are not committed to in advance. At EMI, while the major productions are funded by the International Classical Division and accepted by most or all affiliates, each national label (HMV, Electrola, Pathé Marconi, Odeon, Toshiba, Angel, etc.) pursues projects of its own. Of about eighty EMI discs released around the world each month, Angel can absorb only one-tenth, and the projects Angel funds itself are generally of the solo variety (Ransom Wilson, Angel Romero, Igor Kipnis, etc.), requiring a relatively

small cash outlay and little help from the foreign markets.

Of all the major labels, RCA seems faced with the toughest set of circumstances. Like Angel, Red Seal is part of a loosely organized international corporate amalgamation. But *unlike* Angel, it not only is responsible for funding major projects, but has virtually no guarantee that RCA's foreign affiliates will pick them up. So while the label's Levine-conducts-Mahler series and the occasional Chicago or Philadelphia disc will have broad international appeal, Red Seal now finds itself able to afford fewer symphonic projects, and those are of lesser worldwide sales potential!

No examination of the symphonic field is complete without a word about the dozens of smaller labels that have traditionally helped fill holes in the catalog and that apparently will continue to do so. Many get along by licensing European recordings, reissuing historical discs, and recording—with subsidy—smaller American orchestras (*with* their permanent conductors), all practices that allow them to avoid taking on the full cost burden. Perhaps the greatest service they provide is their continual chipping away at the iceberg of contemporary music; labels like CRI, New World, Opus One, and Finnadar explore musical ground the majors seldom tread.

On the contemporary music scene, though, it should be noted that the closing years of the Seventies have shown a decidedly conservative swing. Composers such as George Rochberg, David Del Tredici, John Corigliano, and Jacob Druckman have opted out (early or late) of the avant-garde, creating music that, if audience reaction at concerts is any indication, is communicative, exciting, and attractive to listeners normally outside the new-music fold. Major labels are aware of this: RCA has brought out works by Corigliano (for whom it has further plans) and has some Rochberg and Toru Takemitsu waiting in the wings. Last year Columbia released the Penderecki and Rochberg violin concertos (it should be noted that these were Isaac Stern's recording choices, however) and, on the heels of the increasing popularity of Steve Reich and Philip Glass, is planning to release a new Terry Riley disc. It would be nice to be able to predict that this populist shift in the composing world—should it gather steam—will bring about an involvement of one or more of the major

While American labels are shifting their gaze to London orchestras, the European labels have approached the American big five.

labels in contemporary music, on the order of that of, say, Columbia in the days of Goddard Lieberson's Stravinsky and Schoenberg recordings. Unfortunately, that would be only wishful thinking. There may be some flirtation with new music now and then. But ultimately, these companies will continue to live by their timeless maxim, "The only profitable composer is a dead composer."

Might the digital and/or video disc brighten up the symphonic recording scene? At the moment, the hybrid digital-recorded/analog-playback discs are causing excitement both in the studios and at the cash register, although as they become more commonplace sales will sink back toward normal levels. Major orchestras and conductors—Mehta, Solti, Bernstein, Ormandy, Maazel—are beginning to get into the act. If companies ever needed a justification for simply remaking all the old warhorses instead of exploring new ground, digital recording is it.

It has been suggested that the digital process may be the right thing at the wrong time—that its capabilities and its promise are exciting in theory, but that the economy may not be able to bear the major catalog-equipment overhaul required. Yet the people at Philips are predicting that its home digital player, to be introduced in 1983, will coexist with conventional analog players for about ten years, superseding them entirely early in the Nineties.

The video capabilities of these new systems are not likely to mean much to the symphony buyer, and I suspect that not much effort will be made in that direction. It is true that there are plenty of symphonic video tapes floating about. But are they interesting enough to attract buyers willing to pay a premium for them and to watch them over and over? Besides, if labels get into making symphonic video discs, there will have to be compromises somewhere. Either the performances will have to be filmed

and recorded in concert, where the sonic advantages of the studio will be compromised for the sake of a good show and theatrically minded conductors tempted to put showmanship above musicianship, or they will have to be recorded in the studio, as usual, and the video "faked." The latter technique has been used by Unitel in its many films of Karajan, et al., shown here on PBS. That kind of thing may be passable on television once, but who would want to *own* a copy?

There is a much better chance that the video disc will make its impact on opera, where the video presentation obviously would greatly enhance the listening experience and, if properly done, could bear repeated viewing. It can even be assumed that if labels institute a vigorous opera video disc program, marginal opera listeners will find the action of unfamiliar works easier to grasp when so graphically presented. The success of the ever more frequent "Live from . . ." (the Met, City Opera, San Francisco, Wolf Trap, and Spoleto U.S.A.) series and the already burgeoning underground market in pirated video tapes of these broadcasts indicate that an audience for video opera exists; and you can bet that where an audience is perceived, someone will sell it what it wants.

We have seen in recent years an increasing number of operas filmed for television (Unitel) or for theatrical showing (*The Magic Flute* a few years ago, the recent Joseph Losey *Don Giovanni*), and apparently this is only the beginning. By the time the video disc is ready for the market, our major singers will have had a taste of the film experience that may become a requisite of operatic careers in the Eighties.

But the problems presented are staggering: complex rights and contractual questions, the artistic pressures of producing performances of lasting value, both sonically and visually, and cost. Actually, record companies might find making video opera less expensive than conventional opera recording, depending on how the film company/record company cost accounting is done: Film companies might underwrite some of the recording costs in return for the right to use the "likenesses" of opera singers under contract to the record labels. In fact, one company spokesman points to such a coproduction as the Columbia/Losey *Don Giovanni*, reportedly already making money for both, as a

We don't like to brag. But with the new ADC Integra Series: Integra XLM-III, Integra XLM-II and Integra XLM-I, it's hard to resist.

Let's start with basic design. That's what our engineers did. Though what they finished up with is far from basic.

The new ADC Integra is the first all carbon-fibre integrated headshell/cartridge designed to minimize tracking angle distortion two ways.

OVERHANG DIMENSION ADJUSTMENT

As your tonearm "sweeps" a record, the angle the stylus makes with the record groove constantly changes. The result is offset angle error.

Is it serious? An error as little as 2° can more than double cartridge distortion! That's serious! And that's why the new ADC Integra

was designed so you can set the optimum offset angle simply by adjusting the overhang dimension. It's easy. We've even included a Tracking Angle Gauge.

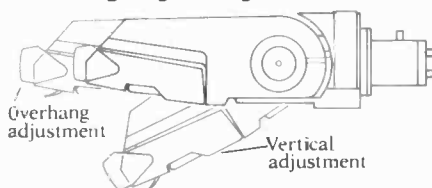

VERTICAL TRACKING ANGLE ADJUSTMENT

Nearly all records are cut with a vertical tracking angle of 20° . That's the way they're made. That's the way they're meant to be played. Sounds simple. But when you see how tonearm heights vary, from turntable to turntable, getting the exact vertical tracking angle suddenly isn't simple anymore. Unless of course you chose a new

ADC Integra. Its vertical tracking angle is adjustable. In calibrated degree increments from -8° to $+8^\circ$. Enough to compensate for all bayonet-type tonearm heights. Including changers.

If all that sounds impressive, wait until you hear how the new ADC Integra Series actually sounds. By minimizing what you don't want to hear, we've obviously maximized what you do want to hear. Music. The new ADC Integras' response is clean, effortless and often astonishing. But why listen to a description? Audition a new ADC Integra for yourself at your nearest ADC dealer.

After you've heard us, we'd like to hear from you. Write or call the Customer Service Dept., Audio Dynamics Corporation, Pickett District Road, New Milford, Connecticut 06776. 800-243-9544.

A LOT OF PEOPLE TALK ABOUT TRACKING ANGLE DISTORTION. THE NEW INTEGRA DOES SOMETHING ABOUT IT.



A D C
A BSR COMPANY

way of life for the future.

Even now opera is horrendously expensive to record, and using the three-discs-to-one-dollar-spent formula, lots of sets must be sold to break even. (Often, however, operas prove to have a much longer shelf life than orchestral works.) Because opera requires many more sessions than symphonic works, labels don't even *consider* recording it in the States (except for the odd concert performance). Most say they can record an opera in London for about \$150,000—which, assuming we're talking about a three-record set, still means it must sell more than 150,000 albums, when you throw in costs for manufacturing, advertising, and so forth.

Although other companies are sanguine about the future of opera recording, the *Gioconda* experience was bitter for RCA, one that left its staff wondering if it had a future in that end of the business. Red Seal has for some time been interested in recording the Metropolitan Opera but has not been able to work out the details of cost and logistics—the Met being a repertory company, scheduling studio sessions has proved impossible. The prospective solution? Live Met LPs. According to a new ruling by the Federation designed to encourage at least some opera recording in North America, record companies will be allowed to **tape** as many live performances of an **opera** as they want, paying the **performers** a one-hour studio fee for every **ten minutes** of the finished product. It's still pretty expensive; it can mean more than \$100,000 in orchestral fees alone. Compared with the old rates, though, it's a bargain, and RCA is seriously considering taping several performances from a Met run of a work and splicing the best parts together to make quasi-documentary recordings.

But this approach is rife with commercial and artistic problems. To begin with, whom does RCA expect to *buy* these sets? Anyone interested in live Met performances can tape them off the air Saturday afternoons. RCA must also be wondering whether the Met chorus and orchestra, generally agreed to be below recording-studio standards set by ensembles from Vienna, Berlin, and London, can be made to sound good enough for these sets to be competitive. And there are casting problems. Fortunately, the era of exclusive contracts for singers is coming to an end, but some major names still maintain strong ties to labels

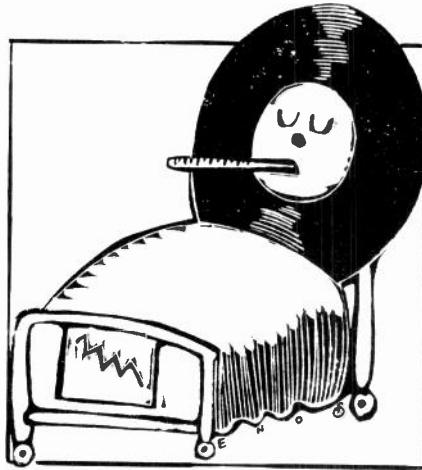

other than RCA, and the Met is not about to cast its operas with an eye to RCA's needs. Furthermore, though it can be argued that recording technology, especially with digital looming on the horizon, is capable of capturing the sound and some of the excitement of opera "on location" and that there is value in the documentation of actual performances, a stronger argument can be made for the near-perfection that can be achieved in the studio.

Columbia has put out several live opera discs in the last few years (the Eve Queler concert performance series), and the recent Federation rule change may lead other companies to set up their equipment right in the opera house, too. But it's not likely that this will be the predominant mode of opera recording of the Eighties. While there may be some short-term economic benefit to the documentary approach, it's likely that producers will continue to insist that studio opera recording is an art that should not be slighted, and record buyers (not to mention critics) will make the labels aware that they consider any large-scale move from studio to stage a leap in the wrong direction. The best solution would appear to be a compromise, with the labels still devoting most of their operatic energies to studio projects, recording the occasional live performance when the cast is right, and offering the live sets to the public on midpriced lines.

A word about prices. Since 1977, retail list prices have risen from \$6.98/\$7.98 to \$8.98/\$9.98. Considering the dramatic rise in the cost of raw materials—talent, petroleum, paper—this increase is not surprising, and we can probably count on prices jumping at least a dollar every twelve to eighteen months. Theoretically, the introduction of the digital playback disc can arrest

this trend, for Philips says that the manufacturing process for the 4½-inch disc will not be any more expensive than that for today's standard disc. As one record company executive put it, "By 1983 I'm going to have to charge \$20 for an analog record. Digital playback is the only hope for the business. You can put the digital signal on anything."

On the surface, it seems that most of the problems facing the classical record business are short-term financial ones. But they go deeper than that. In spite of widely publicized recent financial disappointments, pop labels will surely continue to wield infinitely more clout among company finance men than classical labels do. So, in the course of my research, I decided to stop at the offices of one of the larger pop labels for a chat with an old college friend who has been working in the rock recording business for the last few years. After he confirmed that even unknown pop groups are selling in the hundreds of thousands and that, by comparison, the classical affiliates are a drag on the corporation, I asked him why the companies bother maintaining them.

"Well, prestige is a nice way of putting it," he said. "Everybody knows that the big companies are whores; but with a classical line we look a bit *less* like whores than we might otherwise. After all, this is big business, and we're in it for the bucks, not for art. Right now the people sitting on the board of directors happen to think it's important to keep the classical lines going. They like classical music, and they like to be able to take advantage of some of the benefits that accrue from running classical record companies—good seats at the opera, good seats at symphony concerts, a certain *social* aura.

"But times are changing. When people *our* age are sitting on the board of directors, we're not going to care much about good seats at the opera. We're going to be more interested in good seats at the ballgame or in seeing whatever the big rock group is in 2000. Don't get me wrong—I don't want to see classical music disappear. But when the generation that grew up on rock and roll grows into those positions of power, things are really going to change."

By that time, of course, Polygram will have bought up the rest of the world's classical labels, and classical recording will continue happily ever after. **MF**

JBL'S NEW L150: ITS BOTTOM PUTS IT ON TOP.

JBL's new L150 takes you deeper into the low frequencies of music without taking you deeper into your budget.

This short-tower, floor-standing loudspeaker system produces bass with depth, power and transparency that comes incredibly close to a live performance.



A completely new 12" driver was created for the L150. It has an innovative magnetic assembly, the result of years of research at JBL. It

uses a stiff, heavy cone that's been coated with an exclusive damping formulation for optimum mass and density.

And it has an unusually large 3" voice coil, which aids the L150's efficiency and its ability to respond to transients



(peaks, climaxes and sudden spurts) in music.

There's even more to the L150's bottom—a 12" passive radiator. It looks like a driver but it's not. We use it to replace a large volume of air and contribute to the production of true, deep bass. Bass without boom.

If you're impressed with the L150's lows, you'll be equally impressed with its highs and mids. Its powerful 1" high-frequency

dome radiator provides wide dispersion throughout its range. And a 5" midrange transducer handles high volume levels without distorting. The maximum power recommended is 300 watts per channel.

The L150's other attributes include typical JBL accuracy—the kind that recording professionals rely on. Maximum power/flat frequency response. High efficiency. And extraordinary time/phase accuracy.

Before you believe that you can't afford a floor system, listen to an L150. While its bottom is tops, its price isn't.

James B. Lansing Sound, Inc., 8500 Balboa Boulevard, Northridge, CA 91329.

**FIRST
WITH THE
PROS.**



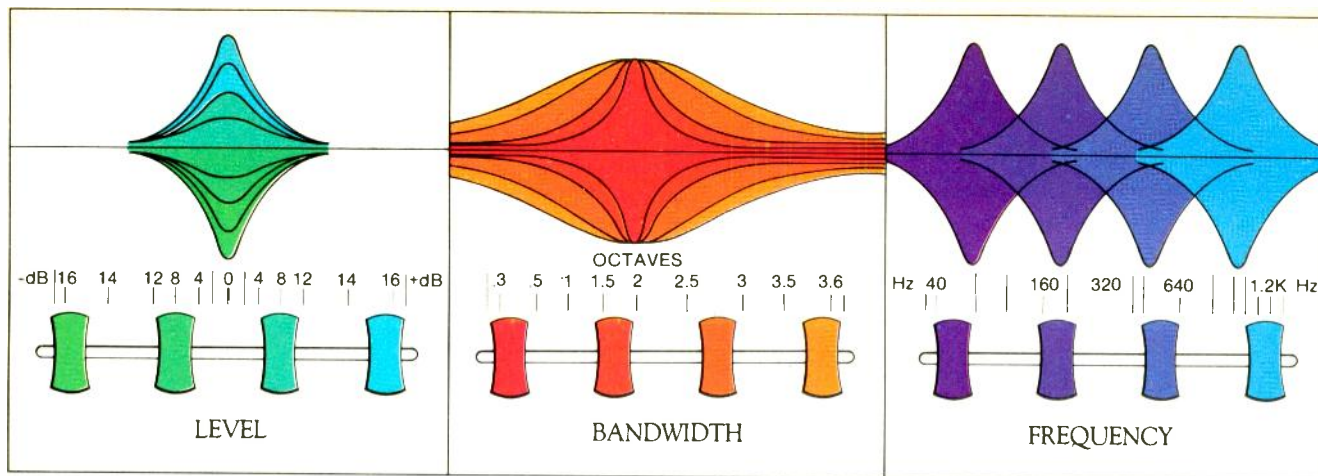

With the graphic equalizer, you have a limited number of chances to correct an infinite number of potential problems in a recording or listening environment. You're dealing with fixed bandwidths and fixed frequencies. You can only increase or decrease the level. When boosting or cutting frequencies,

you have to settle for the nearest one or two octaves. It's a compromise. With the parametric, you're provided an infinite number of solutions. Bandwidth, frequency and level are each determined by you. Any musical problem can be isolated and corrected. And that's what all the excitement's about.

The graphic reason to buy our parametric.

At SAE, the battle has always been for complete musical control. Control that would allow you to correct for any inadequacy in any recording or listening environment.

Now the battle is over. You won.

SAE introduces the 1800 and 2800 Parametric Equalizers.

Actually, if you work for a recording studio, "introducing" would hardly be appropriate. You'd be working with parametrics already. Very simply, it's a matter of flexibility and precision. And very simply,

with the SAE 1800 and 2800 the flexibility and precision of your sound control are absolutely limitless.

We should let the parametrics speak for themselves.

Problem: The lead singer is overpowered by the back-up group.

Solution: Set Level control to +10dB. Sweep Frequency control until the voice is

brought forward. Adjust Bandwidth control to encompass the full voice range. Tailor Level control to encompass the full voice range. Tailor Level control to exact voice presence desired.

How much does a machine like this cost? How can I afford a component that can acoustically correct a system? How can I buy an electronic box that can fix a listening room and a recording at the same time?

The SAE parametrics cost less than some turntables. That's how.

What we have is a small miracle that is also an attainable reality. Imagine: Compete, precise, musical control for the price of a common graphic.

Remember that word: Parametric. Remember those numbers: 1800 and 2800. Remember that name: SAE.

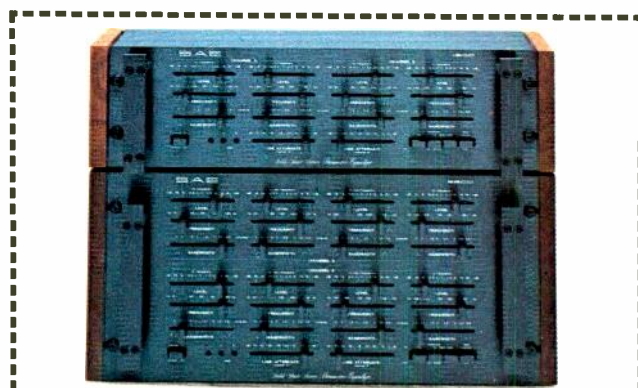

Name _____
 Address _____
 City _____ State _____ Zip _____

SEND TO: SAE, P.O. Box 60271, Terminal Annex,
 Los Angeles, California 90060

SAE

Scientific Audio Electronics

CULSHAW AT LARGE



My Darlin' Leontyne

by John Culshaw

NEW YORK—I am in a rare mood for celebration. Rare, because few singers as people arouse generous or even charitable responses in my heart. Many of them I would gladly see immersed in oil up to or slightly above the neck and then simmered until not even a trace of a flat top A remains. Of course, I accept that singers are as necessary to the balance of music as are sharks, crocodiles, and other disagreeable beasts to the balance of nature, but that doesn't mean that I have to love them. (I once knew an Italian record executive who went by choice every night of the season to La Scala and who kept an alligator in his bath, which struck me as a clear case of one form of insanity complementing another.)

But there are exceptions, and the largest of them—if she will forgive me the phrase—is Leontyne Price. When George Movshon, who numbers among his responsibilities the annual United Nations birthday concert, asked me whether I thought there was any chance of getting Price to sing with the Dresden State Orchestra during the 1979 concert, I told him something I could not have said about many other singers: namely, that he should ask her and that, if her reply was affirmative, then nothing short of illness, accident, or the U.N. building going up in flames would stop her from honoring her agreement. He asked her; she agreed. It was then that I realized I had not worked with Leontyne for something like fourteen years, al-

though it seemed like the day before yesterday.

I first heard her when, as an unknown, she had sung in *Porgy and Bess* at London's Stoll Theater in the early 1950s. I came into her orbit later in the decade, when Decca/London and RCA were sharing some of their exclusive artists. At that time, London had Karajan and RCA had Price, and the two of them shared an intense mutual admiration, which made working with them a special kind of joy. Karajan is the greatest operatic accompanist (in the highest sense of that word) in the world, and for the very good reason that he understands fine singers. (He likewise has no patience with bad ones: No simmerer he.) If you have any doubt about that, listen to the care he gives to the tone, weight, and intensity of the strings in the card aria in Act III of *Carmen*. That kind of attention to detail brings out the best in an artist as perceptive as Leontyne Price.

At around the same time as *Carmen* we made a Christmas record with Leontyne and Karajan, which was a piece of outright commercialism to which we devoted as much attention as to an opera. ("Anyway," the conductor said, "I love *schmaltz!*") The arrangement of Schubert's *Ave Maria* began with the whole tune played by the violins in unison, after which the voice came in. No stretch of my imagination, at least, could improve on the first take, but Karajan wanted to try again. "When she sings like that," he said, "then we simply have to play better." I did not think it possible, but it was. On the second attempt, which is the published version, the Vienna Philharmonic violins played as one man; and if it sounds easy, it isn't. Beecham with his "lollipops" used to make magic out of music that sounded like trash in other hands; Karajan did the same with the verse of *Ave Maria*, but with the additional motive that he was setting the stage for Leontyne.

It would be false to give the impression that Price was just a pussycat in the studio, although her sense of humor was irrepressible. I once asked her what she was going to wear for her first major concert appearance in Moscow. "Black on black, darlin'!" she came back, quick as a flash. But she was not inclined to tolerate self-indulgence by colleagues who had come up in a relatively easy way.

She knew all about Giuseppe di Stefano's compulsive gambling before we started *Tosca*, so she took his daily allowance and any other money he might have into safekeeping until the opera was finished. He would never have let another man do such a thing, but he couldn't refuse Leontyne, although I remember he looked wistful at the time.

Tougher moments lay ahead with Franco Corelli in *Carmen*, and the scorn that Price pours out in the passage that starts "Au quartier! pour l'appel!" in Act II is not merely a piece of precisely calculated vocal acting. Only a moment or so before we began, Leontyne had thrown a heavy chair at Corelli and missed him by an inch. She had reached a point of exasperation because he was not concerned with her or with Karajan or with correcting his abominable French, for which a tutor was at hand—or, indeed, with Bizet. All he wanted was to be louder than anybody or anything in sight. (In fairness, I should add that he gave a marvelous performance, bad French or no bad French.)

Yet not even Corelli was insensitive to Leontyne's beliefs and loyalties. On the evening of November 22, 1963, in the middle of the *Carmen* project in Vienna, my colleagues and I heard the first garbled reports on the radio about John F. Kennedy in Dallas. It was not at that stage clear that he was dead, nor how he had come by what the radio called "grievous injuries," but with the knowledge of Leontyne's feelings about what Kennedy stood for it was imperative to get to her quickly lest she hear the news with some snide Viennese distortion. We made for the State Opera, where we guessed she might be; there, at the stage entrance, we collided with an ashen-faced Corelli, who had rushed out of some ceremonial dinner or other on exactly the same mission. When eventually we found her she had already heard the news, and I offered the only decent gesture I could think of, which was to postpone *Carmen* for a day or two, or even for a week. Recording schedules have frequently been postponed for far less important reasons, but she would not hear of it. The show was going on.

Almost thirty years had passed since I heard her first, and now here we were again working together in 1979. Although inevitably the contact between an artist and a television director in what is virtually a live show is much more remote than that between an artist and a recording producer, she was still essentially the same person. After a touch of nerves in the first few measures, she sang the Strauss *Four Last Songs* to perfection. She said she'd like to record them again, and I hope that she does. She also said that whenever she felt low she played "our" *Carmen*; since then, I have played it again and know what she means.

All I hope is that it won't be another fourteen years before we work together again. Leontyne Price is not just a glorious singer, but a life-enhancing lady, and there are not many who fit both categories. She is a call, not an excuse, for celebration. **HF**

McIntosh

"A Technological Masterpiece..."



McIntosh C 32

"More Than a Preamplifier"

McIntosh has received peerless acclaim from prominent product testing laboratories and outstanding international recognition! You can learn why the "more than a preamplifier" C 32 has been selected for these unique honors.

Send us your name and address and we'll send you the complete product reviews and data on all McIntosh products, copies of the international awards, and a North American FM directory. You will understand why McIntosh product research and development always has the appearance and technological look to the future.

Keep up to date.
Send now - - -

McIntosh Laboratory Inc.
Box 96 East Side Station
Binghamton, NY 13904

Name _____

Address _____

City _____ State _____ Zip _____

If you are in a hurry for your catalog please send the coupon to McIntosh. For non-rush service send the Reader Service Card to the magazine.

Circle 30 on Page 99

Behind the Scenes

Though slow to climb aboard the digital bandwagon, Polygram will apparently not be tentative about it. Deutsche Grammophon recently made a digital recording of Wagner's *Parsifal*, no less, with Herbert von Karajan and the Berlin Philharmonic. As with previous Karajan Wagner recordings, the sessions were held in conjunction with preparation for a stage production, in the present case, for this month's Salzburg Easter Festival. The cast includes Peter Hofmann (*Parsifal*), José van Dam (*Amfortas*), Kurt Moll (*Gurnemanz*), Sigmund Nimsgern (*Klingsor*), and Dunja Vejzovic (*Kundry*). Even the minor roles are cast from strength, with Barbara Hendricks as the First Flower Maiden and Hanna Schwarz as the Voice from Heaven.

Elsewhere on the opera front, DG recently recorded Verdi's *Un Ballo in maschera*, with Claudio Abbado leading the La Scala Chorus and Orchestra and a cast that includes Plácido Domingo (*Riccardo*), Renato Bruson (*Renato*), Katia Ricciarelli (*Amelia*), and Elena Obraztsova (*Ulrica*). Among other DG projects are two with Lorin Maazel: the Tchaikovsky violin concerto, with the Berlin Philharmonic and soloist Gidon Kremer, and a live recording of a New Year's Day Concert in Vienna with the Vienna Philharmonic.

In London, Antal Dorati has recorded another in his Haydn oratorio series for Decca/London, *Il Ritorno di Tobia*, with the Brighton Festival Chorus and the Royal Philharmonic Orchestra. The work, with a libretto by Giovanni Boccherini based on the story of Tobias and the Angel from the Apocrypha, does not follow the Handelian form, but the Italian form—very long and rather like a religious opera seria, punctuated by five brilliant and contrasted choruses. The recording sessions followed the first complete British performance at Royal Festival Hall with the same cast: Hendricks (the Angel), Philip Langridge (Tobias), Linda Zoghby, Della Jones, and Benjamin Luxon.

The Library of Congress recently announced the acquisition of Jim Walsh's library, "one of the most significant private collections of early recordings ever assembled." Walsh, a retired *Variety* reporter and a columnist on early recordings for *Hobbies* magazine, had amassed some 40,000 discs and 500 cylinders dating back to an 1894

rendition of "God Save the Queen." Since most of the material predates 1926, it ideally complements the Library of Congress' own collection, begun in 1925. His collection is particularly strong in the area of popular entertainment, with virtually complete representations of Harry Lauder, Al Jolson, Peter Dawson, and Vernon Dalhart. According to a spokesman for the Library of Congress, Walsh's gift comes at a time when gifts to all libraries have declined markedly, due to the more restrictive provisions of the Tax Reform Act of 1969—restrictions that do not apply to this type of commercially acquired property. The material, now in storage, should be available to researchers in early 1981.

The Russian state-owned label Melodiya recently announced plans to release the complete works of Tchaikovsky, Prokofiev, Shostakovich, and Khachaturian on a record-club subscription basis—apparently the first time this method of distribution has been attempted in Russia. Though there is no word as to the number of discs any of those sets will contain, Melodiya also announced that it will release another "set," surveying the work of leading conductors, instrumentalists, and singers, comprising 175 albums. Start saving your rubles.

By coincidence, three of the country's major orchestra "marathons," in which local commercial FM stations devote a weekend to raising funds for their cities' symphonies, are occurring on the same three days this month. From Friday, April 18, through Sunday, April 20, WCLV will be holding its marathon for the Cleveland Orchestra, WCRB will conduct its for the Boston Symphony Orchestra, and WFMT will have one for the Chicago Symphony Orchestra. Expectation is that a total of nearly \$1 million will be generated for the three ensembles that weekend. The following weekend will find WQXR providing the same benefit for the New York Philharmonic.

Readers of Andrew Porter's *Don Carlos* review in this issue will want to mark their calendars: On April 12, PBS will broadcast a Metropolitan Opera production of the work taped on February 21. The performance, the third of this season, features a relative newcomer in the title role,

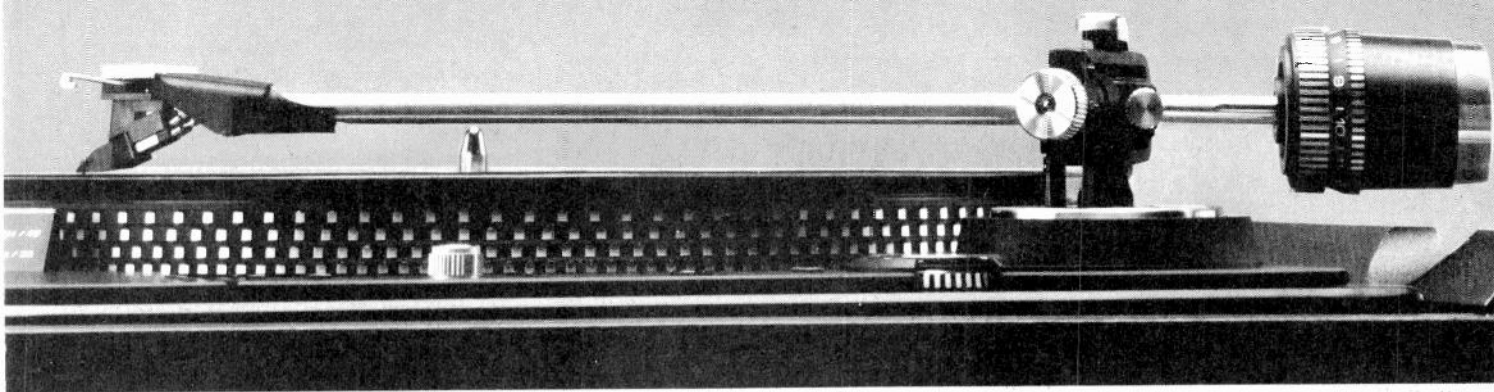

All your records will sound better
with Dual's new ULM tonearm and cartridge system.

Even if they look like this.

Although none of your records may be in such bad shape, many are probably warped enough to present serious problems to conventional turntables.

The high inertia of a typical tonearm and cartridge combination, with approximately 18 grams total effective mass, causes the stylus to dig in riding up the warp and to take off on the way down. Tracking angle and tracking force vary widely—as much as 30 percent. And a warp as small as 1.5mm (which is barely discernible) can generate harmonic distortion of 2.7 percent. That's audible!

These problems have now been solved by Dual's new Ultra Low Mass tonearm and cartridge system.

The potential for this solution has existed ever since the development of Dual's dynamically-balanced tonearm with its gyroscopic gimbal suspension and straight-line tubular design.

Dual's research into the effects of mass on record playback led to a collaboration with Ortofon. A cartridge was developed with substantially less mass than any in existence. It weighs just 2.5 grams, including mounting bracket and hardware.

At the same time, the mass of the Dual tonearm was further reduced so that a perfectly matched tonearm and cartridge system emerged. Its total effective mass is just 8 grams. That's less than half the mass of conventional tonearm and cartridge combinations.

Tracking a record with the same 1.5mm warp, the ULM system reduces harmonic distortion to only 0.01 percent. That's 270 times less than that produced by the conventional tonearm and cartridge.

Not only is the overall sound audibly improved, but stylus and record life are significantly extended.

To experience the demonstrable advantages of ULM, bring a badly warped record to your Dual dealer. Listen to it played with the ULM tonearm and cartridge. (All nine new Dual turntables feature this system.)

You will hear the difference that ULM can make on all your records.

For the complete ULM story, please write to United Audio directly.

ULM.

A major breakthrough in record playback technology.

Dual United Audio
120 So. Columbus Avenue
Mt. Vernon, New York 10553

SAVE MONEY!

THE BEST IN HI-FI / HOME ENTERTAINMENT BY MAIL!

Stereo Discounters' new 84 page Home Entertainment catalog is now available—FREE!

- WIDEST SELECTION—\$7MILLION INVENTORY
- NAME BRANDS—PIONEER, TECHNICS, KENWOOD, HITACHI, JENSEN, SONY—OVER 100 OTHERS
- HI-FI, VIDEO, CAR STEREO, MOVIES!

WRITE OR CALL TOLL FREE FOR YOUR COPY.
1-800-638-3920

STEREO DISCOUNTERS

6730 SANTA BARBARA COURT, BALTIMORE, MD. 21227

WAREHOUSE SOUND COMPANY
The Nation's only critically acclaimed distributor of Hi-Fi and Video products.

- 10 years old and goin' strong
- Tremendous selection of the best equipment
- The country's most knowledgeable salespeople
- Famous direct mail prices

Call toll free
(209) 344-7310

In California
(800) 742-1820



Send for the
FREE catalog



\$144
BIC T-1
2 speed cassette deck
Hi-Fi and Video products

Send a Free catalog

Name _____
Address _____
City _____
State _____ Zip _____
Telephone _____
Send to WAREHOUSE SOUND
742 Fulton, P.O. Box 1007
Fresno, CA 93714

Circle 54 on Page 99

Vasile Moldoveanu. The Romanian tenor gave one performance of the role as a last-minute substitute in February 1979, exactly a week after his Met debut as Pinkerton in *Madama Butterfly*. The more-established artists in the other roles include Renata Scotto (Elisabeth), Tatiana Troyanos (Princess Eboli), Sherrill Milnes (Rodrigo), Ruggero Raimondi (King Philip), and Jerome Hines (The Inquisitor). James Levine conducts.

Nimbus Records, a small British company with big plans to enter the American audiophile market, is wasting little time in doing so. Even before having settled upon an exclusive American distributor, Nimbus announced its first release: Vol. 1 in Bernard Roberts' complete series of Beethoven piano sonatas, a four-disc album of the first seven sonatas (\$60; distributed by Audio Source, 1185 Chess Drive, Foster City, Calif. 94404). The series was recorded direct-to-disc, with a single exception: Roberts' taped run-through of the *Hammerklavier*, a complete, uninterrupted performance like the others, was considered simply too good to pass up.

The label has also ventured into the quality 45-rpm LP market. The first British release featured Bulgarian pianist Marta Deyanova playing the four Chopin scherzos, with sides of about eighteen and twenty minutes. Future releases will include one with sides running more than thirty minutes. The higher speed reportedly results in great sonic improvement.

Nimbus purports to be the only record company with its entire operation—from recording studio through processing to finished product—in a single building. This allows for stricter quality control and greater economy, helping to keep the price down, at least on the British market. Americans will have to appreciate that fact from a distance.

A recent item in the trade publication *Billboard* lamented Pickwick's plight: Wanting to reissue Leopold Stokowski's Beethoven Seventh Symphony with the Symphony of the Air, the company was unable to locate the stereo master tapes and had resigned itself to a mono release. But reader Tom Null, whose own affiliation is with Varèse Sarabande, offered the use of his stereo copy of the United Artists 1958 pressing, still in mint condition, and Pickwick gratefully accepted. **HF**

For those who appreciate simple virtuosity

The 480 Series

With the 480 Series, Nakamichi again offers a more affordable cassette recorder—a deck that is simpler to operate, but that sacrifices neither Nakamichi sound nor Nakamichi excellence. The secret is simple. The Asymmetrical, Diffused-Resonance Transport—shared by all three models and closely akin to that of the highly acclaimed 582—is a 3-motor, dual-capstan drive so unique in its simplicity and elegance that it can be manufactured with virtually zero defects. Each 480-Series deck is factory calibrated to yield optimum performance with three types of tape—ferric, chrome-equivalent, and metal. Use products of equivalent quality, and you can experience Nakamichi sound and Nakamichi specifications—response to 20 kHz—in your home.



480

The 2-Head Model 480—fully metal-compatible thanks to our special, narrow-gap, Sendust R/P head and exclusive Direct-Flux erase head. Wide-range, peak-responding meters, professional sliding record-level controls, Dolby, and defeatable MPX filter, of course! Even an optional remote control.



481

Step up to the 481, a 3-Head deck utilizing Nakamichi's exclusive "Crystalloy" cores and "Discrete-Head" technology. All the features of the 480 plus the greater dynamic range of a discrete 3-Head format.



482

For those who demand "off-tape monitoring," the 482—a 3-Head deck similar to the 481 but with two complete sets of electronics and Double-Dolby so you can hear exactly what has been recorded as it is being recorded.



The 480-Series starts at under \$500. For more information, write to Nakamichi U.S.A. Corp., 1101 Colorado Avenue, Santa Monica, CA 90401.

Ohm's Law 9:

It is possible to make a loudspeaker that gets loud and still sounds good.

Ohm introduces another new loudspeaker that defies the traditional laws of loudspeaker design. The new Ohm I.



It used to be, if you liked listening to music as loud as life in your home, you had a tough choice to make. You could buy high efficiency "monster" systems, and put up with the boom and shriek. If you wanted something smoother (with really deep bass), you could buy low efficiency systems, but then you'd need an amplifier big enough to power Toledo.

The Ohm I solves the problem. It can achieve

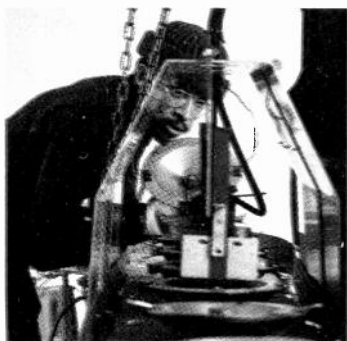

concert hall levels in your home effortlessly, with *no* sacrifice in bandwidth, linearity, or imaging abilities. While the Ohm I gets amazingly loud with as little as 10 watts input, it can handle 1000 watts comfortably.

It's the world's first *good and loud* loudspeaker.

Inside the Ohm I, you'll find everything we've learned about multi-driver dynamic loudspeaker design. It uses a total of five drivers, including a 12-inch, optimally-vented subwoofer with an incredible 72 ounce



magnet. Voice coils are cooled by magnetic fluid to increase power handling. The Ohm I's beautifully-finished, floor-standing enclosure is compact enough to fit gracefully into any home.

The new Ohm I's are already earning rave reviews from stereo critics. After listening to them, **The**



Complete Buyer's Guide to Stereo/Hifi Equipment

says, "The volume level was approaching the threshold of pain, but the speakers were showing no sign of strain. The response, regardless of level, was smooth and free from annoying colorations... Too often a loud loudspeaker is deficient in many other areas. Fortunately, this is not the case with the Ohm I..."

According to **Hifi Stereo Buyer's Guide** (8/79), the new Ohm I has "...a combination of efficiency and power handling that, as far as we know, is unmatched." They continue: "(The Ohm I) is one of the finest speakers we've ever heard. There is nothing it couldn't do and do it superbly...it thundered out the lowest pipe-organ pedal notes in a way that made us feel we were in a great cathedral...When appropriate, the bass was

discreet. It was all there, without saying 'Here I am'.... The treble filled the room with a spacious sweetness that seemed...downright seductive...(The Ohm I) will bring out the best from any program material and will also do justice to the coming glories of digital recording... this is a speaker with a future - for the future."

For a listening experience you've never enjoyed before except at a live performance, visit your local Ohm dealer. Ask to hear the world's first good and loud loudspeaker: the new Ohm I.



For 16 complete reviews, and full specifications, please write us at: Ohm Acoustics Corp., 241 Taaffe Place, Brooklyn, N.Y. 11205.

Ohm
We make loudspeakers correctly.

Record Reviews

Massenet en Masse

As the boom grows, the remarkable versatility of a composer long known for a single opera becomes ever more apparent.

by Peter G. Davis

Two new recordings of *Werther*, the first really adequate *Don Quichotte* on disc, and *Sapho*, an opera never recorded before—the Massenet revival shows no sign of losing momentum. Philips has just taped the recent Covent Garden *Werther* with Frederica von Stade and José Carreras, while London's Sutherland/Bonyngé performance of *Le Roi de Lahore*, awaiting release, will bring the total number of Massenet operas in SCHWANN to twelve. Who knows? From the remaining dozen works as yet unrecorded, we may one day hear *Hérodiade*, *Griséïdis*, *Ariane*, or *Chérubin*, all well

worth reviving, at least for the phonograph.

Perhaps the most significant fact to emerge from the Massenet boom—and this latest batch of recordings only confirms it—is the composer's extraordinary versatility, as evidenced by his sympathetic response to a wide range of subjects and his ability to individualize each opera. His seemingly endless fund of ingratiating melody, his sophisticated application of orchestral color to create atmosphere, and his elegant craftsmanship were never in doubt, even when *Manon* was the only work performed with any regularity a generation ago. But to say

that "to have heard *Manon* is to have heard the whole of him," as *Grove's* would have it, is arrant nonsense.

In fact, *Werther* has now become Massenet's most popular work—every opera house in the world seemed to be staging the piece last season—and this domestic tragedy, with *Werther's* single-minded obsession mirrored in a score of remarkable economy and unity, is worlds removed from the delicately perfumed sensuality of *Manon's* seventeenth-century France. How artfully and subtly Massenet eases us into the cozy bourgeois home of the Bailiff—his "petit royaume," as he tells *Werther*—and the tragedy to come. The light opening scene, cast in a flowing melodic conversational style, leads into the hero's first appearance and the gradual intensification of mood that continues to mount throughout the opera as *Werther's* hopeless love for the married Charlotte becomes more and more desperate. In a sense, this is Massenet's most Wagnerian opera, with its interlocking web of leitmotifs used both to paint the psychology of the characters and to give the score a shapely unity of almost symphonic proportions. All this is done without depriving the voice of its primary function in the texture, and Massenet inflects the vocal line with special care to reflect precisely the interior passions of his two protagonists.

The title role has always been an irresistible lure for lyric tenors, and the profusion of such voices today no doubt accounts for *Werther's* present popularity. Actually, this has always been Massenet's most frequently recorded work—the two new versions bring the total number made over the years to eight, as opposed to four for *Manon*. The overall quality level in all the previous *Werthers* is also impressive, beginning with the first recording, made for Pathé in the 1930s, featuring the superbly stylish Charlotte and *Werther* of Ninon Vallin and Georges Thill. The only performance to survive in the domestic catalog is an Angel album (SCL 3736), starring Victoria de los Angeles and Nicolai Gedda, that has served admirably for the past dozen years.

A choice between the newcomers is relatively simple, for the new Angel recording scores over its DG rival in almost every respect. Much of the performance's distinction stems from Michel Plasson's conducting of the London Philharmonic. He shapes the music with a lapidary concern for orchestral detail, especially in the conversa-

MASSENET: *Werther*.

CAST:

Sophie	Christiane Barbaux (s)
Charlotte	Tatiana Troyanos (ms)
Kätchen	Lynda Richardson (ms)
Werther	Alfredo Kraus (t)
Schmidt	Philip Langridge (t)
Albert	Matteo Manuguerra (b)
Brühlmann	Michael Lewis (b)
Johann	Jean-Philippe Lafont (b)
Le Bailli	Jules Bastin (bs)

Covent Garden Singers, London Philharmonic Orchestra, Michel Plasson, cond. [Eric Macleod, prod.] ANGEL SZCX 3894, \$27.94 (three discs, automatic sequence). Tape: 4Z3X 3894, \$27.94 (three cassettes).

CAST:

Sophie	Arleen Augér (s)
Charlotte	Elena Obraztsova (ms)
Kätchen	Gertrud von Ottenthal (ms)
Werther	Plácido Domingo (t)
Schmidt	Alejandro Vazquez (t)
Albert	Franz Grundheber (b)
Brühlmann	Wolfgang Vater (b)
Johann	Lázló Anderko (b)
Le Bailli	Kurt Moll (bs)

Cologne Children's Choir, Cologne Radio Symphony Orchestra, Riccardo Chailly, cond. [Rainer Brock and Michael Horwath, prod.] DEUTSCHE GRAMMOPHON

2709 091, \$29.94 (three discs, manual sequence). Tape: 3371 048, \$29.94 (three cassettes).

MASSENET: *Don Quichotte*.

CAST:

Dulcinée	Régine Crespin (s)
Pedro	Michèle Command (s)
Garcias	Annick Dutertre (s)
Rodriguez	Peyo Garazzi (t)
Juan	Jean-Marie Fremeau (t)
Sancho Panza	Gabriel Bacquier (b)
Don Quichotte	Nicholai Ghiaurov (bs)

Chorus of the Radio Suisse Romande, Orchestre de la Suisse Romande, Kazimierz Kord, cond. [Christopher Raeburn, prod.] LONDON OSA 13134, \$26.94 (three discs, automatic sequence).

MASSENET: *Sapho*.

CAST:

Fanny Legrand	Renée Doria (s)
Irène	Elya Waisman (s)
Divonne	Gisèle Ory (ms)
Jean Gaussin	Ginès Sirera (t)
La Borderie	Christian Baudéan (t)
Caoudal	René Gamboa (b)
Césaire	Adrien Legros (bs)
Le Patron	Jean-Jacques Doumène (bs)

Chorale Stéphane Caillat, Orchestre Symphonique de la Garde Républicaine, Roger Boutry, cond. [Gréco Casadesus, prod.] PETERS INTERNATIONAL PLE 129/31, \$23.94 (three discs, automatic sequence).



Alfredo Kraus and Tatiana Troyanos
For Massenet's most popular work, a refined Werther and a sympathetic Charlotte

tional bridge passages, where the interplay of solo winds becomes particularly ravishing. It is a leisurely performance, yet the music is never loved to death or allowed to drag. To the contrary, the love scenes pulsate vibrantly, the attacks are bitingly precise, the rhythmic pulse is always alive and forward-moving, the melodies are exquisitely savored and phrased.

As in most French opera recordings these days, the cast is international, but *Werther*, more than most Massenet operas, has responded to foreign singers ever since its Viennese premiere in 1892. Here the Spanish tenor Alfredo Kraus re-creates his interpretation of the title role, one he has sung in almost every major operatic center. Now in his fifties, Kraus has lost little vocal quality, and he sings with his customary taste, refinement, and care for integrating musical and dramatic values. His timbre may strike some as a bit too dry and his approach a trifle overrestrained, but his grasp of the style, the focused poise of his singing, and the dignity of his overall conception combine to make him today's preferred Werther.

Tatiana Troyanos' burnished mezzo-soprano is a gorgeous natural instrument, and she is a sympathetic Charlotte. While doing nothing especially out of the ordinary with the role, she still captures attention simply through the innate quality of her voice. Matteo Manuguerra makes a more positive figure out of Albert than most, while Christiane Barbaux as Sophie and Jules Bastin as the Bailiff leave little

room for improvement. Angel's wide-ranging reproduction and luxuriously cushioned sonics suit the score perfectly.

DG's performance need not detain us long—here is a case where ecumenical musical forces fail to convince. The young Italian conductor Riccardo Chailly makes his recording debut with a brisk, sensible reading that has many solid virtues. He gets expressive, committed, and alert playing out of the Cologne Radio Orchestra, although there is little of the felicitous attention to detail that distinguishes Plasson's conducting for Angel. Plácido Domingo is in fine voice, and his extrovert Werther scores points for broad tenor abandon if not for delicacy or finesse. Elena Obraztsova, on the other hand, is all wrong as Charlotte; her vibrato-laden mezzo, coarse phrasing, and weird French pronunciation turn the character into something quite repulsive. Arleen Augér's overly mature Sophie and the German singers in the cast sound distinctly out of their element.

Moving on to pleasanter things, London's *Don Quichotte* can be warmly recommended as a more than serviceable performance of an instantly lovable opera. Laid out in five compact acts, this treatment of Cervantes' novel depicts most of the familiar high points: the Don's wooing of Dulcinée, his battle with the windmills and confrontation with the bandits in an effort to retrieve his beloved lady's necklace, his gentle rejection by Dulcinée and lonely death with only the faithful Sancho Panza to mourn his passing.



Gabriel Bacquier
Touching and funny as Sancho

This is late Massenet, composed in 1910 for the great Russian bass Feodor Chaliapin, and the composer's last unequivocal success. Perhaps he projected something of himself into the character of the aging Don Quichotte—certainly both men pined for beautiful young creatures and were destined to see their passions unrequited. Massenet's affection for the Don is everywhere apparent, in the limpidly accompanied serenade to Dulcinée, his valor in the face of danger, his courtly dignity, the pathos of the death scene. The Don is the final great figure in the composer's gallery of singing/acting roles, a mellow portrait painted in delicate tints and with a depth of human perception unusual for Massenet.

Nor is Dulcinée neglected, a more complex figure than in Cervantes and a fun-loving, high-spirited girl capable of tenderness and passion. Sancho, too, is sharply delineated within a conventional but effective buffo tradition, and the colorful atmosphere of the Spanish setting is suggested by infectious dance rhythms and ornamental flicks, proving that Massenet's gift for piquant musical pastiche had lost none of its power to charm even at the end of his composing career.

If Nicolai Ghiaurov's interpretation of the title role does not overwhelm with any special insights, let alone efface memories of the recordings of Chaliapin or Vanni-Marcoux, the Bulgarian limns a sympathetic character, and for the most part, he sings splendidly. Régine Crespin

may be a bit past the point where she can toss off *Dulcinée's* more florid passages with complete ease and security, but how consummately she can turn a lyrical phrase and find meaning in the simplest line of text—here is a great artist at work, vocal flaws and all. Gabriel Bacquier is his own capital self, portraying a humorous yet warmly touching Sancho Panza, and Kazimierz Kord conducts the *Suisse Romande* with panache and sensibility. London's plush engineering is very much to the point, although spreading this short opera over six sides seems rather uneconomical. No matter. This is an infinitely superior account of the score as compared to the spotty, long-deleted Everest version from Belgrade.

Like *Werther* and *Don Quichotte*, *Sapho* is based on a novel, Alphonse Daudet's description of Bohemian artist life in Paris at the turn of the century. The plot ingredients are familiar enough: A slightly *passée* artist's model, Fanny Legrand, falls in love with an innocent young country swain named Jean, who is ignorant of her sordid past. When the facts eventually come out, there are quarrels and reconciliations until Fanny realizes that a shared life for people

of such disparate backgrounds is impossible, and she leaves Jean for good. Echoes of Verdi's *La Traviata* and presentiments of Puccini's *La Rondine* are obvious in this oft-used material, but Massenet has a way of making it all sound fresh.

Sapho is unique in the Massenet canon in that it depicts contemporary society, a *verismo* type of opera very fashionable in 1897. (Charpentier's *Louise*, which came three years later, is the most notable example of the "musical novel" genre.) He makes a virtue of this and takes care to provide a musical background redolent of the period. The brief opening act, for example, shows Fanny and Jean meeting at a party in the studio of the sculptor Caoudal, who had used Fanny as, among other things, a model for his statue of the Greek poetess Sapho. An on-stage gypsy salon orchestra sets the tone perfectly—its brittle, hectic, there's-no-tomorrow lilt sounds an ironic dramatic counterpoint to Jean's homesick reverie for the Provençal countryside and the future lovers' first glimpse of each other.

Massenet shows us every twist and turn in the affair, its delicate blossoming to idyllic bliss, raging fights, desperate at-

tempts to make up, and the final collapse of a tortured relationship. Each of these scenes is an object lesson in dramatic pacing and musical craft, shot through with a beguiling lyricism that never deserted the composer even when he was describing the most mundane activities of everyday life. Possibly one comes away feeling that Jean is something of a prig—and his simple, God-fearing parents, Divonne and Césaire, are a bit much—but Fanny's is a magnificent role, and a great singing actress can hardly fail to cause a sensation with it.

Unfortunately, the Peters recording fails in almost every department. The remnants of Renée Doria's voice can scarcely do justice to Fanny. Her intentions are sound, and she has the style well in hand, but her soprano is thin, pinched, and perilously unsteady. Ginès Sirera has a serviceable tenor, typically French in its attractively buzzing nasal timbre, but he is musically crude and has an annoying habit of anticipating the beat. The rest of the cast barely passes muster, and Roger Boutry conducts with a limp hand. *Sapho* deserves better than this, and with luck, the Massenet revival will provide something more worthy.

**Introducing
Nagaoka Accessories.**

**To preserve the
sound of music.**

For all the big advances in record pressing and record playing, record preservation and care hasn't gone very far. Now there's a company with new ways to conquer the old problems of noise, warpage and dirt. Nagaoka.

KILAVOLT is the first static eliminator that really works! It uses a battery-powered positive ion generator to completely neutralize dust-attracting static charges.

The CRYSTAL STABILIZER is a heavy non-resonant pure glass cylinder that sits on the center of a warped record, applying even downward pressure without contacting the grooves, to make the record playable.

NAGAOKA by
OSAWA

OSAWA & CO. (USA) Inc.,
521 Fifth Avenue, New York, New York 10017

There's no finer record cleaner than the SUPER CHEMICC, with two pads of fine velvet flanking a gentle cleaning brush. It's used with our special CHEMICC solution to loosen grit without harming the grooves.

You've probably spent a lot of money on records. Your Osawa dealer has a full line of Nagaoka products to help you preserve your investment.

don't be
penny-wise
and
sound
foolish

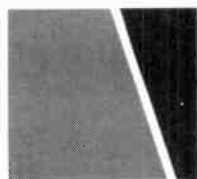

fact: a Shure stylus is a sound investment

A new stylus (needle) can actually save you money. Even a precision crafted diamond stylus eventually wears out, and a worn or broken stylus tip can damage your records in a single play! Protect your records by checking your stylus at least once a year. Your Shure dealer can inspect it, and if necessary, replace your stylus with a Genuine Shure replacement stylus that will bring your cartridge right back to its original specifications.

protect your
valuable
record
collection!

...and improve
your listening
pleasure

with a
GENUINE
SHURE
Replacement Stylus

**FREE! Shure
Music-Lovers Stylus Guide**

Cartridges don't wear out: styli do! This and many other helpful facts are discussed in a new pamphlet recently prepared by Shure. It includes everything you need to know to keep your Shure cartridge in perfect operating order. It even contains details on how you can improve the performance of some Shure cartridges beyond their original specifications. To get your copy, stop in at your Shure dealer, or write to Shure at the address listed below and ask for AL633.

GENUINE
SHURE

Shure Brothers Inc., 222 Hartrey Ave., Evanston, IL 60204

In Canada: A. C. Simmonds & Sons Limited Outside the U.S. or Canada, write to Shure Brothers Inc., Attn: Dept. J6 for information on your local Shure distributor.
Manufacturers of high fidelity components, microphones, sound systems and related circuitry.

The "New Generation" of Mahler Conductors

by Abram Chipman

A wealth of releases proves that duplication need not mean redundancy.

By the mid-Seventies, Maurice Abravanel, Leonard Bernstein, Bernard Haitink, Rafael Kubelik, and Georg Solti had all recorded the canonical nine symphonies of Mahler. By the mid-Eighties, these five—some of whom may offer remakes of their own—will probably be joined by at least as many others. Perhaps none of the current releases will form part of an "integral" edition in the most ambitious sense, including the completed Tenth and the "song symphony" *Das Lied von der Erde*, and in the strictest sense, featuring a single orchestra and a single label. Yet the recent windfall allows for a progress report on most of the probable contenders.

André Previn may appear to be an outsider in this company of Mahlerites. But

Václav Neumann recorded the later instrumental symphonies in his Leipzig days—most of the recordings are rare items these days—so the new Czech Philharmonic Fifth and Seventh (and an earlier Adagio from the Tenth) may well herald a cycle from Supraphon.

Zubin Mehta is definitely a candidate, though he has yet to garner strong endorsement from this corner. London has used both analog and digital techniques to record him with the Israel, Vienna, and Los Angeles Philharmonics. The new Third and the Lieder program with Marilyn Horne are fairly typical of the strengths and weaknesses of Mehta's Mahler.

DG is looking for a Mahlerite for the Eighties, and—to stretch the political analogy—has been conducting some suspense-

ful primaries in recent years. Seiji Ozawa seems to have bowed out of the race, as has Carlo Maria Giulini. While Claudio Abbado momentarily rests on impressive laurels with his Second and Fourth, Herbert von Karajan adds a Fourth to his variably received Fifth, Sixth, and *Das Lied*.

A powerful party supports Wyn Morris as a favorite son. His platform includes a stately, rounded lyrical style, consistent stereo separation of first and second violins, and advocacy of the five-movement Tenth (in Deryck Cooke's final realization) and the five-movement First (the only phonographic version of the 1893 edition). These appeared on the Philips and Pye labels with the New Philharmonia, though Morris' subsequent Mahler recordings have featured his handpicked Symphonica of London. RCA recently deleted the Eighth, while Peters' issue of the Second is now joined by the Ninth and a belated domestic issue of the Fifth.

As I read the polls, the front-running candidates are Klaus Tennstedt and James Levine. Clearly, Mahler's time has come, when a relatively obscure conductor can launch a major recording contract with a Mahler First, as Tennstedt did. EMI has promised a Tennstedt cycle with the London Philharmonic and herewith offers the Fifth, with the now standard filler, the Adagio of the Tenth. Levine, one tires of saying, belies his youth with each fresh proof that he has absorbed the staggering complexities of Mahler's demands possibly better than anyone. His cycle, now roughly at midpoint, uses the broadest definition of the symphonies and includes the London and Chicago Symphonies, as well as the Philadelphia Orchestra.

So much for the rival candidates. Now on to the music, starting with the vocal works and moving on to the symphonies, in order.

The songs Neumann adds to the Fifth satisfy no repertory needs, and bass Karel Berman shows no discernible sympathy for the idiom. He is out of his depth vocally in these oddly selected excerpts from two larger collections. "*Revelge*," from *Des Knaben Wunderhorn*, is cautious and reticent. As for the *Rückert-Lieder*, "*Blicke mir nicht in die Lieder*" suffers from Neumann's ill-defined rhythm, while the other two offered here patently require the special poignancy of the mezzo timbre.

Which brings us to Horne's *Rückert-Lieder*. Her rich, vibrant vocalism is fine in itself, but she pays insufficient attention to word meanings. Mehta, aided by a clear and powerful recording, revels in Mahler's spare but inspired scoring (e.g., the low winds and brass in "*Um Mitternacht*") and

MAHLER: Songs of a Wayfarer; Rückert-Lieder (5).

Marilyn Horne, mezzo-soprano; Los Angeles Philharmonic Orchestra, Zubin Mehta, cond. [Ray Minshull, prod.] LONDON OS 26578, \$8.98.

MAHLER: Symphony No. 3, in D minor.

Maureen Forrester, mezzo-soprano; California Boys' Choir, Los Angeles Master Chorale members, Los Angeles Philharmonic Orchestra, Zubin Mehta, cond. [Ray Minshull, prod.] LONDON CSA 2249, \$17.96 (two discs, automatic sequence).

MAHLER: Symphony No. 4, in G.

Elly Ameling, soprano; Pittsburgh Symphony Orchestra, André Previn, cond. [Suví Raj Grubb, prod.] ANGEL SZ 37576, \$8.98.

Edith Mathis, soprano; Berlin Philharmonic Orchestra, Herbert von Karajan, cond. [Hans Hirsch, prod.] DEUTSCHE GRAMMOPHON 2531 205, \$9.98. Tape: 3301 205, \$9.98 (cassette).

MAHLER: Symphony No. 5, in C sharp minor; Symphony No. 10: Adagio.

London Philharmonic Orchestra, Klaus Tennstedt, cond. [John Willan, prod.] ANGEL SZB 3883, \$17.96 (two discs, automatic sequence).

MAHLER: Symphony No. 5, in C sharp minor; Songs of a Wayfarer*.

Roland Hermann, baritone*; Symphonica of London, Wyn Morris, cond. [Isabella Wallich, prod.] PETERS INTERNATIONAL PLE 100/1, \$15.96 (two discs, manual sequence).

MAHLER: Symphony No. 5, in C sharp minor; Songs (4)*.

Karel Berman, bass*; Czech Philharmonic Orchestra, Václav Neumann, cond. [Milan Slavický, prod.] SUPRAPHON 4 10 2511/2, \$17.96 (two SQ-encoded discs, manual sequence).

Songs: Revelge; Blicke mir nicht in die Lieder; Ich bin der Welt abhanden gekommen; Um Mitternacht.

MAHLER: Symphony No. 7, in E minor.

Czech Philharmonic Orchestra, Václav Neumann, cond. [Milan Slavický, prod.] SUPRAPHON 4 10 2721/2, \$17.96 (two SQ-encoded discs, manual sequence).

MAHLER: Symphony No. 9, in D. Symphonica of London, Wyn Morris, cond. [Isabella Wallich, prod.] PETERS INTERNATIONAL PLÉ 116/7, \$15.96 (two discs, automatic sequence).

Philadelphia Orchestra, James Levine, cond. [Jay David Saks, prod.] RCA RED SEAL ARL 2-3461, \$17.96 (two discs, automatic sequence). Tape: ARK 2-3461, \$17.96 (two cassettes).



Wyn Morris
A stately, lyrical style

whips up a swaggering insolence in "*Blicke mir nicht*." Moreover, the sequence chosen for the songs is the most convincing I have yet encountered on discs. (Since this isn't a cycle, anything goes, presumably.) But in the intense privacy of these songs, the theatrical extroversion of Horne and Mehta is a deficit; for more profound involvement, I turn to Christa Ludwig and Karajan (DG 2707 082) or Janet Baker and John Barbirolli (Angel S 36796).

On the other hand, the exuberant rhetoric of Horne and Mehta well suits the upside *Songs of a Wayfarer*—that product of Mahler's youthful passion. What a contrast to the broadly spaced, static, and reflective rendition by Roland Hermann and Morris! As in the *Rückert-Lieder*, preference in these songs is tied to the sex of the singer. Women have essayed them many times on disc, of course, perhaps Ludwig most artfully (Seraphim S 60026). But I have long felt that these songs of a man's heartbreak ultimately call for a baritone voice. Thus, Hermann is at an obvious advantage, even though he never achieves quite the aching resignation of Heinrich Schlusnus (an elderly mono DG). Morris' conducting here is clearly modeled on Wilhelm Furtwängler's massive reading for Dietrich Fischer-Dieskau's EMI mono studio recording (Seraphim 60272). But, as I have argued elsewhere, imitating Furtwängler is risky business, for the earlier Fischer-Dieskau/Furtwängler *Wayfarer*, from a live Salzburg performance (Cetra LO 510), is far more volatile. The Fischer-Dieskau/Kubelik *Wayfarer* (DG 2530 630) still surpasses all comers in variety of text projection, management of the score's shifting pulses, and lucidity of orchestral textures.

Mehta could hardly care very deeply about Mahler's music and be so indifferent to the strictures of tempo the composer

placed throughout the Third Symphony to keep its immense contours in balance. In the opening movement the conductor is warned not to hurry in such treacherous places as the introduction to the carnival-like outburst at Universal score cue 43 and the later reappearance of the opening horn call, but Mehta's enthusiasm whips him into a rushing frenzy at both points. And why the unctuous *Luftpause* before No. 73 in that movement's coda? At the symphony's opposite end, the final Adagio, Mahler uses the initial, very slow, "restful and expressively singing" instruction as a primary pulse to which the music returns after numerous departures. In failing to consistently return to this (as James Levine does so impressively), Mehta deprives us of the sense of rootedness and destination through this unwieldy section. The ending of the second movement should likewise be carefully balanced between holding back and moving steadily, another distinction over which this interpretation rides roughshod. At least the scherzo has more pep than usual.

Mehta's control of the orchestra is little better than his slapdash self-control. The Angelenos play competently, but that isn't enough (at least on a record that one will presumably live with for a time) for a symphony scored with such shimmering nuance and dazzling pyrotechnics. An overly loud pianissimo here, some tonal crudeness there, slightly sour woodwind intonation in this place, and scraping strings in that—the effect accumulates, becoming more than the sum of its parts. Ensemble verges on confusion from time to time (e.g., between cues 12 and 13 of the second movement), and the trumpets fail to sound over the whole orchestra in the concluding pages. Maureen Forrester is ruthlessly overmiked in her solo movement, her

Herbert von Karajan
More commitment to Mahler



Václav Neumann
Few insights

every sign of strain painfully exposed. (Her voice was in better estate in the Haitink recording.) The only minor compensations for all this are a good, clearly recorded fifth (choral) movement and the use of what could well be a real posthorn in the scherzo.

In short, Mehta is a woefully inadequate guide through the wondrous universe of Mahler's Third. The breathtaking beauty of the work is slighted by all concerned, and the conductor's self-indulgent identification with the soul of Mahler—amounts to incomprehension, if not downright disrespect. For the rest of its Mahler recordings with Mehta, I hope London will stay away from Los Angeles and Israel and stick with the Vienna Philharmonic, which at least can play the music and exert some taming influence on the conductor.

Meanwhile, if you need a Third, take your pick of Haitink (Philips 802 711/2), Horenstein (Nonesuch HB 73023), Bernstein (Columbia M2S 675), or Levine (RCA ARL 2-1757; reviewed with extensive comparisons of the other three, March 1977).

At an earlier stage of Mahler performance, Previn's Fourth would have been perfectly acceptable. It is reasonably straightforward, taut, and dependably well played. But by the standards we take for granted today, it lacks meltingly beautiful violin tone, piercingly brilliant oboe and trumpet work, and range and power of recorded sound (e.g., the dampened climax at cue 11 in the Adagio). The many moods of the finale are weakly characterized by Previn's rigidly unsmiling approach, and, as with Forrester in the Mehta Third, Elly Ameling's vocal wear is mercilessly exposed by the miking; she, too, was heard to better advantage in a Haitink version of the Sixties (Philips 802 888).

Karajan, with each successive outing, seems to be turning into a real Mahler conductor. Granted, this Fourth shares some minor shortcomings with Previn's: inconsistent observance of string glissandos (sometimes omitted when marked, sometimes played when unmarked); failure to accelerate in the middle of the horn solo near the end of the first movement (thus minimizing the allusion to Beethoven's G major Piano Concerto); clarinets that are too timid in the grotesque "resounding" outburst near cue 4 in the scherzo. But what deeply committed playing by the Berliners! Horns are magnificent and powerful; strings glow passionately; rubato is instinctively felt. Edith Mathis provides ample tonal range, secure pitch, and a warm and fanciful shading of the text. DG's recording is beautifully detailed and focused, with spacious, heaven-storming climaxes in the slow movement.

There are two puzzling peculiarities, however: At both cues 21 and 22 in the opening movement, Karajan ignores the caesuras, shifting seamlessly into the new tempo before the string sound has died. (Perhaps he is overreacting to the exaggeration of this discontinuity by many other conductors.) And near the end of the Adagio, I don't hear the final *mf* timpani strokes over the pizzicato double basses.

Nevertheless, Karajan's takes its place among the very finest recorded performances of this music, fully the equal of the Von Stade/Abbado version (DG 2530 966, January 1979). My preference for that earlier edition is purely subjective: Abbado seems to re-create the piece afresh with unblushing, childlike wonderment. Karajan's is basically a sophisticated adult view.

Mahler's Fifth is heavy going in its formidable challenges to a conductor's powers of observation, concentration, and



André Previn
Straightforward but rigid

organization. Levine (RCA ARL 2-2905, February 1979) has negotiated those demands most successfully of anyone on disc. None of the three versions at hand adheres completely to the 1964 Critical Edition, which, for example, excludes percussion around cue 17 of the first movement (as does Levine). Neumann and Morris include timpani parts, and I faintly detect a snare drum from Tennstedt.

Neumann's older Gewandhaus Fifth (Vanguard C 10011/2), though never one of my favorites, was more vigorous than the remake in the scherzo and much of the finale. Predictably, the Czech Philharmonic plays better than the Leipzig aggregation. The opening trumpet solo, for instance, carefully heeds the dynamic markings, so the funeral procession seems to be moving toward the listener. Supraphon's sound surpasses Vanguard's primarily in woodwind clarity. But alas, Neumann offers few insights to compensate for his two disastrous miscalculations: When the funeral music recurs in the second movement with a return to original tempo indicated, he is absurdly fast; and in the finale, he jams on the brakes at cue 32, when he should maintain stride and build up to the work's real climax at the slightly later recurrence of the triumphal tune. As in his earlier version, there is an unwanted break between the Adagietto and the finale.

Morris' Fifth is longer than any I know of; this grandly valedictory, warmly flowing interpretation should appeal to admirers of the similarly expansive but more thickly textured Barbirolli (Angel, deleted). Also praiseworthy is the solid, enveloping richness of the Peters pressing, with quieter surfaces than the Supraphon and Angel review copies. There are controversial touches in the reading: At both the *più mosso subito* in the second movement (following

cue 16) and the *molto moderato* in the scherzo (following cue 14), Morris' tempos are so slow and sedate as to approach parody. Yet there is a rapidly flowing and detailed Adagietto to balance the prevalent solemnity. The orchestral playing is fair.

Tennstedt's Fifth (unlike his earlier First) evokes a sense of *déjà entendu* at re-encountering the Bruno Walter style of Mahler conducting so many of us grew up with. (Walter's classic Fifth is still available on Olysyse 32 26 0016, rechanneled.) If not deliberately slighted, virtuosity, textual exactitude, and linear transparency seem not so much obsessive ends in themselves as means to, or incidental by-products of, a native immersion in the singing, breathing, pulsating language of Mahler's cultural roots. The result is a performance of organic integrity and spirituality. Note the palpable "give" of the second pulse of the first movement ("*etwas gehaltener*"), so Walter-like in its cradling, consoling lilt; the starkly desolate shudder at the "*klagende*" climax of that movement; the bucolic gaiety of the winds' ornamental turns in the finale. The Adagietto flows lightly, never overbearingly, with utterly melting cello tone. Walter again comes to mind in the scherzo, with its completely natural feel for rubato and the bittersweet regretfulness of the string playing.

Yes, Tennstedt does anticipate ritards prematurely throughout the scherzo, and he creates a dizzy stretto in its final pages. Purists will also question the rhythmic liberty of the work's opening trumpet call. But these objections ultimately pall, for this is an interpretation of deep beauty and cultivation, even though somewhat flawed in realization. At times, either ensemble or recording balance is slightly askew. Moreover, the loudest climaxes tend to overload, the bass drum's whispers

Klaus Tennstedt
Immersion in Mahler's language



James Levine
The best Ninth yet?



at the end of the first movement are scarcely audible, and Tennstedt's conscientious *attacca* into the finale is compromised (like Morris') by pre-echo.

In recent years, the Seventh (*Song of the Night*) has begun to seem like a Cinderella among Mahler's symphonies. The current SCHWANN lists only the original cyclists (and not all of those). It is a tough nut to crack, because its scoring is thicker (less "chamber-music-like") than that of its companions and because it can verge on banality unless the conductor fully enters its eerie world of half-lights, spooks, and things that go bump in the night. Without that almost hallucinatory kinship, mere musicianship and brilliant playing can go for naught. With it, one can get away with less than perfect execution (e.g., the raw-edged intensity of Abravanel's still powerful stereo premiere with the Utah Symphony on Vanguard 71141/2) and even with outrageous eccentricity (e.g., the insanely absorbing and revelatory Otto Klemperer account recently deleted by Angel).

For all of these reasons, the new release is difficult to recommend. Neumann has a spectacular orchestra in the Czech Philharmonic, very nearly as responsive, on-target, and characterful as Haitink's Concertgebouw (Philips 6700 036). Supraphon has obliged with a recording of somewhat greater vividness than its Fifth. Neumann directs the flow of instrumental traffic with alertness and precision. (I have never heard, incidentally, his earlier Seventh with the Gewandhaus on German Eterna.)

But I miss everywhere a cutting edge of rhythmic tension, of springy articulation, of tautness in attacks and in hairpin dynamics. And there is too little rapt and mysterious soft playing. In the first movement, the buildup and release of the climactic tension should be positively teeth-grinding at the *grandioso* marking (cue 50) and again at the change from 3/2 to 4/4 after cue 65. Neumann understates the associated tempo changes. In the first *Nachtmusik* movement, the spectral march episode is so fast as to seem brightly and blandly cheerful, while the deadpan treatment of the seductive dance music suggests Neumann has never been to a Jewish wedding. The second *Nachtmusik* movement (*Andante amoroso*) is taken like a corpulent Adagio, thus slighting its anxiously tentative, frail, ambivalent love song. In the finale, Neumann is more attuned to the heady swagger than to the complacent, mincing moments of burgherlike deliberation.

True, Bernstein's and Solti's rendi-



Zubin Mehta
Indifferent to Mahler?

tions had some of these problems, but that does not lessen my disappointment in the symphony's first recording in a decade. Until the new cyclists swell the ranks, Haitink's remains the preferred version, with plenty of bite and urbanity, though it too could be more phantasmagorical.

Morris' and Levine's Ninths have only two points in common: They both opt for the slowest sustainable tempo in the final Adagio and for lateral division of first and second violins. The latter is no surprise from Morris, but is innovative from Levine. I only wish he had seated his strings that way from the start. RCA's recording also deploys the brass unconventionally (and, to my mind, ideally): Horns across the rear are flanked by trumpets on the right, trombones and tubas on the left.

In addition to its optimal stereo effectiveness, Levine's surpasses almost every other Ninth in fidelity to the printed page. Virtually every nuance of tempo, dynamics, articulation, and expression is scrupulously realized, right down to the closing pages, with their near-impossible demands for gradations of softness to the very threshold of inaudibility. The dazzling permutations of choir blending are all meticulously balanced so that everything "sounds" with vivid cogency and daring. The virtuosic Philadelphians take nothing for granted. In the middle movements particularly, each shrieking, wailing, flatulent, or maliciously snarling outburst from the winds and brass sounds as if the players were possessed.

One can argue, of course, that the whole of a performance is more than the sum of its parts, and there is much to a work like this that is written between the lines. Jascha Horenstein's great—if frequently ragged—1966 performance with the London Symphony (commercially unavailable) comes to mind, with its hesitant upbeats in the Ländler and its ineffable weariness. But

Levine's analytic scrutiny extracts most of the work's inherent eloquence and is absolutely compelling; this performance will not soon be duplicated.

Morris barely leaves off where Levine begins. Warmth, gentleness, and sincere effort are all there. In the attempt to capture the lyrical sweep of the first movement, however, essential details of tempo are passed over. In the second movement, the third of the alternating dance pulses is far too hasty. In the ensuing Rondo-Burleske, the main tempo is much slower at its "return" after the central lyrical section (which is played too loudly). Execution is too often slipshod: Horns fail to manage trills and grace notes, the solo violin gets ahead of the winds, triplets are wrongly phrased, etc.

Our earlier political analogy is particularly apt in discussing the Tenth. One cyclist, Solti, holds fast to the conservative position, refusing to touch an unfinished work. The radical Morris holds that a conjectural completion of all five movements is a legitimate—nay, essential—part of Mahler's symphonic output. One conservative, Bernstein, has lately shifted to the centrist position that the opening Adagio alone is performable as legitimate Mahler. Most of the past and future cyclists take this stand, though Levine, a onetime centrist who recorded the Adagio alone, is now moving to the radical camp and intends to record the realization of Cooke, whose rescorings he already accepted in the Adagio.

Tennstedt is one of the centrists, and, like most of his colleagues, he employs the Critical Edition of the Adagio, with none of Schalk's, Krenek's, or Zemlinsky's earlier additions to the manuscript or Cooke's later ones. Those wanting this movement alone will find fiercer attacks and weightier sonorities in the recordings of Bernstein (Columbia M 33532), Levine (RCA ARL 2-2905, with the Fifth), or Neumann (Quintessence 2700). By contrast, Tennstedt's reading is songful and leisurely, more a prelude than a climax. Except for some pre-echo before the dissonant fortissimo outburst, the sound is fine.

Some conclusions may be drawn. It is the prerogative of geniuses like Gustav Mahler to have their works looked at from so many vantage points, and competition for a nonexistent "chief executive" office serves to raise the general standards of performance and the range of our appreciation. The individual profiles of these conductors are beginning to emerge from the samplings described above. They are a varied lot indeed, and the one thing we need not fear from this abundance of duplication is artistic redundancy. **HF**

Classical Reviews

reviewed by

Scott Cantrell	Allan Kozinn
Abram Chipman	Paul Henry Lang
R. D. Darrell	Irving Lowens
Peter G. Davis	Robert C. Marsh
Robert Fiedel	Karen Monson
Kenneth Furie	Robert P. Morgan
Harris Goldsmith	Conrad L. Osborne
David Hamilton	Andrew Porter
Dale S. Harris	Patrick J. Smith
Philip Hart	Paul A. Snook
Nicholas Kenyon	Susan Thiemann Sommer

BACH: Cantatas, Vols. 22-24.

Wilhelm Wiedl (in Nos. 84-86, 93-97), Marcus Klein (Nos. 88, 89), Detlef Bratschke (Nos. 91, 92), and Claus Lengert (No. 98), boy sopranos; Paul Esswood, countertenor (Nos. 85-94, 96-98); Kurt Equiluz, tenor (Nos. 85-88, 90-98); Ruud van der Meer (Nos. 85-87, 93, 97), Max van Egmond (Nos. 88-92, 98), and Philippe Huttenlocher (Nos. 94-97), basses; Tölz Boy's Choir, Vienna Concentus Musicus, Nikolaus Harnoncourt, cond. (Nos. 84-87, 93-97); Hannover Boys Choir, Ghent Collegium Vocale, Leonhardt Consort, Gustav Leonhardt, cond. (Nos. 88-92, 98). TELEFUNKEN 26.35364/35441/35442, \$19.96 each (two discs).

Vol. 22: No. 84, *Ich bin vergnügt mit meinem Glücke*; No. 85, *Ich bin ein guter Hirt*; No. 86, *Wahrlich, wahrlich, ich sage euch*; No. 87, *Bisher habt ihr nichts gebeten in meinem Namen*; No. 88, *Siehe, ich will viel Fischer aussenden*; No. 89, *Was soll ich aus dir machen, Ephraim?*; No. 90, *Es reisset euch ein schrecklich Ende*.

Vol. 23: No. 91, *Gelobet seist du, Jesu Christ*; No. 92, *Ich hab in Gottes Herz und Sinn*; No. 93, *Wer nur den lieben Gott lässt walten*; No. 94, *Was frag ich nach der Welt*.

Vol. 24: No. 95, *Christus, der ist mein Leben*; No. 96, *Herr Christ, der einge Gottessohn*; No. 97, *In allen meinen Taten*; No. 98, *Was Gott tut, das ist wohlgetan*.

Telefunken's series of the complete Bach cantatas, directed jointly by Nikolaus Harnoncourt and Gustav Leonhardt, is one of the most important recording projects

under way. The revival of the rich and rewarding music, so little known except for a few oft-repeated popular cantatas and extracted arias, is one feature of the achievement. The other is the revelatory quality of the performances. Here are the world's foremost practitioners in the art of singing and playing baroque music with the original forces, showing that Bach's cantatas do not have to sound muddy, gloomy, draggy, or otherwise religiose: that they have lightness, grace, a dance-inspired bounce, and life-giving serenity. These performances clarify the immense complexities of the big choral movements (with baroque instruments and clear young male voices, every strand in the music can be distinguished separately) and give life and breath to the long solo arias by resolutely avoiding plodding bass lines and heavily sustained legato melodies. I can rarely restrain my enthusiasm when a new set comes along; when there are three, as here, enthusiasm amounts to obsession.

There have been recent criticisms of some aspects of the performances: of Harnoncourt's eccentricities of interpretation and of the less than ideal quality of the choral singing. Little of that is evident here. Harnoncourt now uses the superb Tölz Boy's Choir in place of the Vienna Boys, and Wilhelm Wiedl sings the treble arias with an effortful warmth that is deeply moving. Leonhardt has choirs from Hannover and Ghent, less incisive but beautifully supple. I am only occasionally irritated by Harnoncourt (as when he fades out a cadence before it has time to be heard, at the end of No. 95's first chorus); his players are brilliant in the big overturelike numbers, such as No. 97's opening. Leonhardt's performances are less thrilling (a pity he was given the large-scale *Gelobet seist du*, No. 91), but the playing is refined and the balance between voices and instruments in a lilting movement like *Ich hab in Gottes Herz* (No. 92) is perfectly poised.

What an infinite variety of responses to the texts and hymns of the Lutheran liturgy can be heard in these works! A brilliantly original aria in No. 95 depicts the tolling of a death knell (very cheerful—Bach's bells were always small and high-pitched) with pizzicato strings overlaid with sublime, echoing oboes d'amore. The shining star of No. 96's opening chorus is depicted by a warbling flauto piccolo over pastoral strings. In No. 97 there is an alto aria, "*Leg ich mich späte nieder*," wonderfully sung by

Paul Esswood, which has that unearthly peace and repose Bach always brings to his visions of eternal life.

The first of these volumes is devoted to cantatas for soloists only, with closing chorales. Wiedl is excellent in *Ich bin vergnügt* (No. 84), and a comparative newcomer to the series, Ruud van der Meer, is very fine in the intricate fugal writing of *Wahrlich, wahrlich* and *Bisher habt* (Nos. 86 and 87)—Bach here sounding just like Zelenka in the *Lamentations*. Kurt Equiluz, reliable as ever, makes exciting work of the tempestuous *Es reisset euch* (No. 90), and Max van Egmond has a powerful aria with trumpet (a good bash at an impossible part by Don Smithers) in the same cantata. There are great riches in this volume; but if you are tempted to begin collecting the series, then do start with a box containing some of the big choruses that are the backbone of these works. I especially recommend Vol. 24 from this group. And among those recently released, Vol. 20 is ideal: It includes magnificent accounts of two supreme masterpieces, *Jesu, der du meine Seele* (No. 78) and *Gott der Herr ist Sonn und Schild* (No. 79), than whose opening chorus I never hope to hear anything more inspiring. N.K.

BACH: Keyboard Works.

Blandine Verlet, harpsichord. PHILIPS 9500 588, \$9.98.

Italian Concerto, S. 971; French Overture (Partita in B minor), S. 831; Duets: No. 1, in E minor, S. 802; No. 2, in F, S. 803; No. 3, in G, S. 804; No. 4, in A minor, S. 805.

BACH: Goldberg Variations, S. 988.

Blandine Verlet, harpsichord. PHILIPS 6768 074, \$19.96 (two discs, manual sequence).

Blandine Verlet's playing is nothing if not exciting; hardly a phrase passes without calling attention to the sheer energy and intensity of her musical personality. She has a most compelling sense of rhythm (projected as much by bold articulation as by actual timing) and a healthy notion that even slow movements should maintain a strong feeling of forward motion.

With a work like the *Italian Concerto*, Verlet is in her glory, sending off sparks in every direction. The electricity is especially palpable in the last movement, but even in the *Andante* there is a concentration of energy that eludes all too many

Continued on page 78

B	Budget
H	Historical
R	Reissue
A	Audiophile
	(digital, direct-to-disc, etc.)



P.D.Q. Bach and

Recalling my early involvement in P.D.Q. Bach research, I approached this assignment with a feeling of mild paranoia. My working relationship with the redoubtable Prof. Schickele was, of course, a happy one—at first. But after a time I began to sense some rather alarming changes in myself. My musical consciousness had become cluttered with surrealistic images. To my horror, for example, I imagined Frédéric Chopin, small, pale, and coughing, loitering in the Place Vendôme, grinning, and pinching the rumps of carriage horses, making them cry out in pain. I saw Felix Mendelssohn, superbly accoutered but picking his nose in public. Perhaps most shocking of all was the vision of Richard Wagner, somewhat rueful of face, actually paying off a debt!

Shaken, I finally reported these disturbing visions to Prof. Schickele. He simply smiled seraphically (or maybe drunkenly, now that I look back on it) and congratulated me on my newfound maturity and realism. I knew then the time had come to take up other pursuits.

The professor's research goes forward, however, and the music of P.D.Q. Bach receives continued indecent exposure in concerts and recordings. What makes the phenomenon endure? Schickele has

been carrying on now for more than twenty-five years, if memory serves, yet the latest annual Christmas concerts at New York's Avery Fisher Hall were packed, as always. And this year's national tour will include no fewer than fifty-five concerts. Could Anna Russell have played to such audiences? After her great Wagner skit and a few minor tidbits, she had little more to offer. Victor Borge, with his five or six excellent routines, fills a Broadway theater, but not every year. Joshua Rifkin's short-lived foray into musical humor, the "Baroque Beatles Book," was well done—perhaps too well done, and a bit chilly. Schickele's only serious contender might have been Gerard Hoffnung, whose early death makes the point moot.

Schickele's admitted early inspiration was that fountainhead of American musical humor, Spike Jones, and Schickele's humor, like Jones's, is distinctly American. Russell, Borge, and Rifkin had about them a certain sophistication that Schickele, at his best, utterly lacks. His slapstick, pratfall sort of humor is often so terribly self-indulgent, outrageously sophomoric, and inexcusably bad that we find ourselves laughing not so much at the jokes themselves as at his nerve in trying to pull them off. Thus, the hiss and the boo have become accepted responses at the concerts, ultimately eliciting a deliciously crummy comeback from Schickele that might have come from a men's-room wall: "Truth is a statue, and all of you are just a bunch of pigeons."

Musically, too, the humor is unmistakably American: slipshod cadences, embarrassing country and western melodic

fragments, blue notes, unexpected dissonant clusters, outdated scat phrases such as "shoop-doo," Guy Lombardo endings, and ridiculous-sounding homemade instruments. All of these carefully calculated incongruities are familiar, of course, from the music of Spike Jones. But their use by Schickele in the context of baroque music is even more striking, because the general style of that era is by now so familiar, and it represents the epitome of periwigged musical dignity and sophistication.

The latest recording, the eighth in the P.D.Q. Bach research series, is the weakest, for some of the reasons already discussed: The music is almost too good and too careful. There is a slick quality to the "discoveries" and performances not in keeping with the composer's familiar sleazy style. The *Bluegrass Cantata* sounds a bit self-conscious, lacking the earthy clumsiness and mellow tackiness of earlier works. It is all too cool now. Gone are the gutsy slapstick of the "Hysteric Return" recording, the glorious wackiness of the Beethoven Fifth sportscast, the inspired lunacy of the fugue from the *Toot Suite*. The quotations from the *Brandenburg* Concertos seem dutiful, lacking the unstudied ease of previous plagiarisms. This is not to say that the cantata lacks all charm; the aria "Du bist im Land" is wonderful, and the work does have a rousing finish. The performances—especially those of Eric Weisberg (mandolin), Bill Keith (banjo), and tenor John Ferrante—are marvelously skilled.

The *No-No Nonette* features a single percussionist but a wide and peculiar array of percussion instruments. Though it occasionally offers some funny sounds, the in-

Lawrence Widdoes, a composer, was instrumental in early P.D.Q. Bach research; readers of the Definitive Biography will recall his devoted restorations of the beer-stained manuscripts. An artist to boot, he also takes responsibility for the rendering above.

Peter Schickele

by Lawrence Widdoes

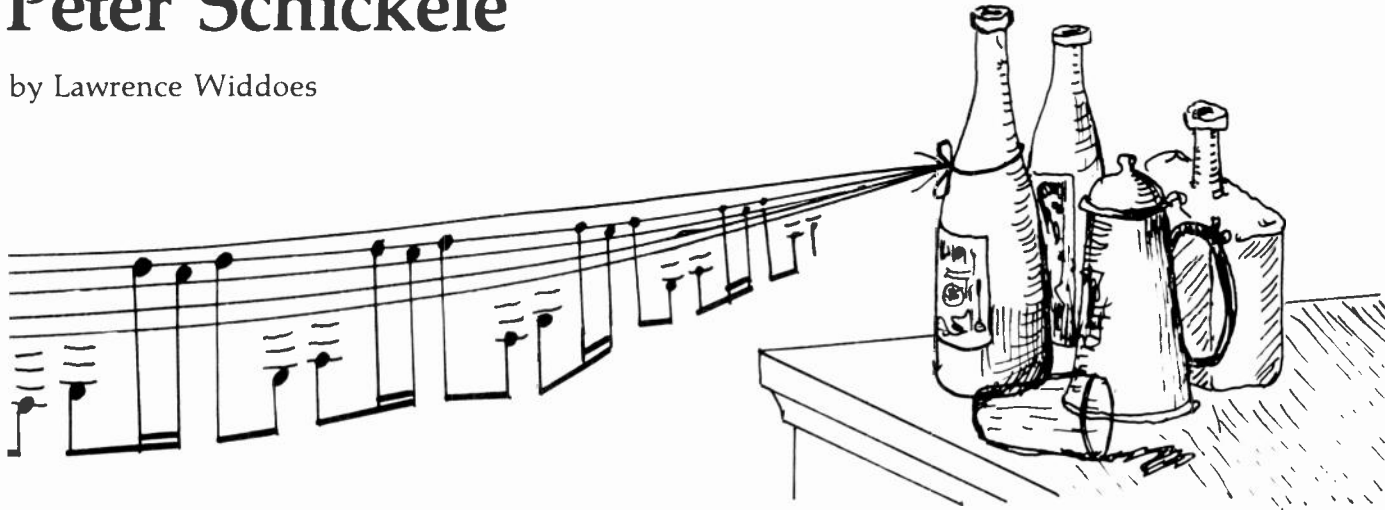

struments do not really fit the fabric of the music as do, for example, the unusual instruments in *The Seasonings*; here they are simply lined up and played one after the other. *Hear Me Through*, one of the singing commercials that reputedly made P.D.Q. Bach so wealthy, is a rather pale reworking of an earlier commercial from "P.D.Q. Bach on the Air" (Vanguard VSD 79268).

For all its faults, the new album will, of course, be indispensable to fellow camp followers, who have discovered that being slightly deranged is a wonderful and rewarding way of life. But it is not the best introduction to the music of this zany composer. The deprived few still to be initiated will do well to start with "On the Air" or "The Intimate P.D.Q. Bach" (Vanguard VSD 79335); from there on, you are perilously on your own.

Far more welcome at this point is a disc that affords us an all too rare sampling of the "straight" (I refuse to say "serious") music of Peter Schickele. He is currently represented in SCHWANN by only two listings: *Fantastic Garden (Three Views from the Open Window)*, with Jorge Mester and the Louisville Orchestra (Louisville S 691), and *The Lowest Trees Have Tops* for soprano, flute, harp, and viola, performed by the Jubal Trio and John Graham (Grenadilla I015). Another work, *Pentangle* for horn and orchestra, will also appear shortly on the Louisville Orchestra label. Schickele has, of course, written an enormous amount of non-P.D.Q. Bach music, and I have heard much of it. It is frequently strong and highly individual and always expert. Why has Vanguard been so slow to give it to us?

Schickele is a large, gentle, sensitive,

and often funny man, and these are precisely the qualities he exhibits in his compositions. Stylistically, he is quite versatile, as is apparent from the contrasting sides of this recording. A single style would be entirely too constricting for him.

The Knight of the Burning Pestle is a seventeenth-century play by Beaumont and Fletcher that was turned into a musical by Schickele and American director Brooks Jones in 1974. The nine songs presented here are broadly funny and occasionally lyric and touching. They are quite tonal, varied in character, with typically accomplished arrangements—direct, unfussy, and very attractive. "My Mother Told Me Not to Worry," the most beautiful of the lot, is very close to current pop and performed accordingly by Margot Rose. Elsewhere, there are faint reminders of Kurt Weill.

Side 2 is made up of sterner stuff. This is the facet of Schickele we would all like to hear more of. (Yes, we still love you, P.D.Q., but please take the backseat for a while.) The elegies for clarinet and piano represent him at his melodic best, with a wonderful liquid flow to the clarinet lines that proves irresistible. The first two are dedicated to a friend and a relative now deceased, and they must have been nice people; there is an affecting, slightly bluesy quality to both numbers, and the major/minor/dominant ninth tonal scheme is sufficiently varied. On the other hand, the repeated triads in the third number, characterized as a sort of "ritual . . . after the eulogies have been given," are a bit wearing.

The *Summer Trio* is the strongest work here. Less closely tied to major/minor

tonality, it has a bristly insistence. The slow music is lyrical but not gooey, and the jazz walking bass in the second movement is very well handled, without a trace of the archness such a device can fall prey to.

Though this music has no place in the avant-garde (whatever that means today), there is much enjoyment to be had here. It seems a pity that a composer of Schickele's obviously superior gifts should spend comparatively little time composing and promoting his own music.

P.D.Q. BACH: *Black Forest Bluegrass*.

John Ferrante, tenor; Peter Schickele, bass; New York Pick-Up Ensemble, Robert Bernhardt, cond.* Wind octet and percussion, Schickele, cond.† Ferrante, bargain counter tenor; Schickele, snake; instrumental ensemble.** [Seymour Solomon, Maynard Solomon, Peter Schickele, and William Crawford, prod.] VANGUARD VSD 79427, \$7.98.

Blaues Gras (*Bluegrass Cantata*)*; No-No Nonette*; *Hear Me Through***.

SCHICKELE: *The Knight of the Burning Pestle: Songs (9)*.* *Elegies*.† *Summer Trio***.

Lucy Shelton, soprano; Margot Rose, alto; Frank Hoffmeister, tenor; Robert Kuehn, baritone; instrumental ensemble, Peter Schickele, cond.* Richard Stoltzman, clarinet; Schickele, piano.† Walden Trio.** [Seymour Solomon, Peter Schickele, and William Crawford, prod.] VANGUARD VSD 71269, \$7.98.

Critics' Choice

The most noteworthy releases reviewed recently

BACH: Brandenburg Concertos, S. 1046-51. Aston Magna, Fuller. SMITHSONIAN RECORDINGS 3016 (2), Dec.

BACH: Suites for Orchestra, S. 1066-68, et al. English Concert, Pinnock. ARCHIV 2533 410/1 (2), Nov.

BARTÓK: Piano Concertos Nos. 1, 2. Pollini, Abbado. DG 2530 901, Feb.

BEETHOVEN: Missa Solemnis, Op. 123. Bernstein. DG 2707 110 (2), Jan.

BEETHOVEN: Piano Sonata Nos. 21, 31. Goldsmith. MUSICAL HERITAGE MHS 4005, March.

BERG: Lulu. Stratas, Boulez. DG 2711 024 (4), March.

BERLIOZ: Harold in Italy. Suk, Fischer-Dieskau. QUINTESSENCE PMC 7103, Nov.

BRAHMS: German Requiem. Kempe.

BRUCKNER: Te Deum. Forster. ARABESQUE 8007-2 (2), March.

DEBUSSY: Preludes, Book I. Rev. SAGA 5391, Feb.

DVOŘÁK: Cello Works. Sádlo, Holeček, Neumann. SUPRAPHON 1 10 2081/2 (2), Jan.

HAYDN: Armida. Norman, Burrowes, Dorati. PHILIPS 6769 021 (3), March.

HAYDN: Symphonies Nos. 82, 83. Marriner. PHILIPS 9500 519, Feb.

HINDEMITH: Mathis der Maler. Fischer-Dieskau, Kubelik. ANGEL SZCX 3869 (3), Feb.

MOZART: Don Giovanni. Raimondi, Maa-zel. COLUMBIA M3 35192 (3), Feb.

MOZART: Quintets for Strings (6). Budapest Quartet. ODYSSEY Y3 35233 (3), Feb.

SCHUMANN: Orchestral Works. Bavarian Radio Symphony, Kubelik. COLUMBIA M3 35199 (3), Jan.

SIBELIUS: Violin Concerto. SCHNITTKER: Concerto Grosso. Kremer, Rozhdestvensky. VANGUARD VSD 71255, March.

STRAUSS, J. II: Waltz Transcriptions. Boston Symphony Chamber Players. DG 2530 977, Dec.

STRAUSS, R.: Songs. Te Kanawa, A. Davis. COLUMBIA M 35140, Feb.

STRAVINSKY: Pulcinella. Abbado. DG 2531 087, Feb.

STRAVINSKY: The Wedding; Histoire du soldat. Levine. RCA ARL 1-3375, March.

TCHAIKOVSKY: Violin Concerto; Sérénade mélancolique. Perlman, Ormandy. ANGEL SZ 37640, March.

VLADIMIR HOROWITZ: The Horowitz Concerts 1978-79. RCA ARL 1-3433, Jan.

GERARD SCHWARZ: The Sound of Trumpets. DELOS DMS 3002, Feb.

harpichordists. The demands posed by the *French Overture* are rather different, of course, but Verlet's rhythmic impulse is no less gratifying. Welcome, too, is her marvelous way of shaping phrases, of accentuating climactic points and giving "breath" between them. That she is capable of great subtlety is richly revealed in the third of the four duets from Bach's *Clavierübung*, Part III. (Although this collection is expressly intended for organ, harpsichordists have long laid claim to these curious duets; I suspect Bach would have been happy to have heard them on any contemporary keyboard instrument.)

In the *Goldberg Variations* these qualities go a long way toward avoiding the numbing monotony that can so easily ruin a performance, especially when, as here, all repeats are played. Verlet's interpretation is one of the finest I've heard, in fact, and—no mean compliment—I found it arresting from beginning to end. That said, it must be added that the very virtues of her general approach are sometimes exaggerated to grotesque extremes.

At the outset, her insistence on forward motion prompts much too fast a tempo in the Aria, and in Variation 13 the character of the writing (evocative of the slow movement of an Italian violin concerto or even of a baroque operatic soliloquy) seems to imply a much slower basic pulse than it receives here; in Variation 15, moreover, Verlet's rather hurried pace does not allow one to savor the poignant chromaticism. In the opening Aria and Variation 26, there is a tendency to rush toward the end of measures and a consequent distortion of rhythms. The application of *inégalité* is generally tasteful, but I must confess serious reservations about the lurching, pointed inequality in Variations 23 and 29. I am also bothered by occasional attacks of "hen-peck" clipping of note values, as in Variations 4 and 22—and in the first movement of the *Italian Concerto*. My one other complaint is with the performance (or splicing) of groups of variations as continuous movements, a perverse decision evidently intended to highlight the performer's conception of the work's structure; the effect is sometimes extremely jarring.

Apart from the last point, the flaws are small details in performances otherwise immensely enjoyable and admirably recorded. Both releases feature the same pleasant-sounding harpsichord: a 1976 Dowd—from the Paris workshop—*d'après* Nicolas and François Blanchet, 1730. S.C.

BEETHOVEN: Sonatas for Violin and Piano (4).

Arthur Grumiaux, violin; Claudio Arrau, piano. PHILIPS 9500 055*/220*, \$9.98 each. Tape: 7300 473*/784*, \$9.98 each cassette.

Sonatas: No. 1, in D, Op. 12, No. 1*; No. 5, in F, Op. 24 (*Spring*)*; No. 7, in C minor, Op. 30, No. 2*; No. 8, in G, Op. 30, No. 3*.

A certain intangible quality in these recordings—the first of a projected set of the ten sonatas—augurs ill for this partnership of distinguished artists; apparently, the best one can hope for is a workable *entente cordiale* and, with luck, some flashes of inspired individual playing. Though there are no glaring ensemble lapses—the small ones are not necessarily fatal, as the successful collaborations of Szigeti/Schnabel, Morini/Firkusny, and Szeryng/Rubinstein demonstrate—neither is there any real meeting of minds.

After a long hiatus, Arrau seems to have lost the knack of playing true chamber music. Perhaps he never had that knack to the degree that Schnabel, Curzon, or Bauer did, but he certainly sounded more bodily involved in his Beethoven cycle with Szigeti (Vanguard Everyman SRV 300/3E). He seems reluctant to take a commanding lead, preferring instead to be gruffly meditative. But he doesn't really follow, either, and his stout, rich, bass-oriented touch resolutely refuses to blend or support, just as his unspontaneous phrases and rubatos never quite mesh purposefully. Grumiaux, with his seamless, suavely produced tone, tries to soar, but his flights of fancy are held down by Arrau's sobriety like a butterfly pinned to a mounting board. (The Op. 24 Adagio is a perfect case in point.) Not one of these performances comes close to the songful ones Grumiaux once recorded with Clara Haskil, nor do they have the range and searching forward drive of the ones Arrau recorded with Szigeti. The D major and C minor fare passably well, but the G major is utterly depressing in its clumsiness; a more charmless reading of this ebullient piece would be hard to imagine.

Philips' sound, to make matters worse, makes it seem that each artist is playing in his own hermetically sealed vacuum—engineers' balance with a vengeance. H.G.

BEETHOVEN: Symphony No. 6, in F, Op. 68 (*Pastoral*).

English Chamber Orchestra, Michael Tilson Thomas, cond. [Steven Epstein, prod.] COLUMBIA M 35169, \$8.98. Tape: MT 35169, \$8.98 (cassette).

This recording, billed as Vol. 1 of a Beethoven with Chamber Orchestra series,



An acknowledged world leader in loudspeaker design and engineering, KEF has developed a monitor-standard speaker system that is both small—only ¼-cubic foot in size—and truly “high” fidelity. While these objectives are not new, the Reference Series Model 101 speaker system represents the first time that both are available in one product.

The Model 101 is, therefore, ideal for use in locations where an accurate small speaker is required in keeping with the rest of a high quality audio system.

System Design

Despite all the ingenious ideas that have been proposed by various speaker manufacturers over the years, the three basic parameters of Enclosure Volume, Bass Response and Efficiency are still related by unchanged physical laws. What is different is the thorough manner in which KEF engineers have, with the use of advanced technology, optimized the relationships between these parameters.

Starting with the premise that prospective Model 101 users will have substantial amplification available, KEF engineers achieved a response from this small enclosure of 90Hz–30kHz \pm 2dB (–10dB at 47Hz).

KEF's leadership in computer-aided digital analysis techniques enabled them to optimize the design of the drivers, crossover network and enclosure to achieve a Target Acoustic Response without repetitious trial and error experimentation. Much of this technology, which did not previously exist, has been applied to the design and production of a small high fidelity speaker system for the first time in the Model 101.

Once the desired prototype was completed, KEF applied the same unique computer-aided techniques developed for the production of the critically acclaimed Model 105, so that the sound quality originally achieved in the laboratory prototype will be available to every user.

In addition, the high standards of the computer-aided production and assembly procedures enable precision-matched pairs of stereo loudspeakers to now be offered. For example: every Model 101 driver is tested and matched to tolerances of better than 0.5dB, and crossover networks to tolerances of 0.1dB; each pair of drive units is matched not only to each other, but to the other components in the system as well.

Loudspeaker Protection

The major problem with small, relatively less efficient loudspeakers is thermal overloading of the voice coils. KEF engineers have developed a unique self-powered electronic overload protection circuit, S-STOP (Steady State and Transient Overload Protector).

Musical peaks are generally of short duration, so tweeters can handle far in excess of their normal program rating. A similar situation exists with low frequencies and their effect on the bass unit. Consequently any form of fuse protection can reasonably limit the instantaneous peak handling ability of the system, yet fail to protect the system against a very high average power level. KEF's solution is to incorporate a protection circuit which takes into account the instantaneous power applied to each drive unit and also computes the length of time the signal is applied. The law under which it operates resembles very closely the temperature rise within the voice coil. A potentially damaging signal is immediately attenuated by about 30dB, and the full signal is automatically reconnected when it is safe to do so.

As a result, the Model 101, although only ¼-cubic foot in size, is fully protected against fault conditions when used with amplifiers of up to 100 watts per channel.

The Model 101 is obviously not your average “miniature” speaker system where the quality of sound or power handling capacity is compromised by the small size of the enclosure. Nor is it inexpensive. If you require a speaker system that is both small and truly high fidelity, visit your authorized KEF dealer for a thorough demonstration. For his name, write: KEF Electronics, Ltd., c/o Intratec, P.O. Box 17414, Dulles International Airport, Washington, DC 20041.



KEF Reference Series Model 101:

Accurate, Small, Protected.

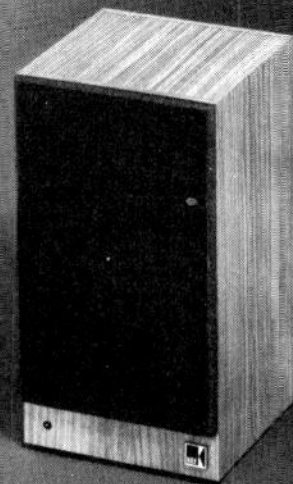

reduces the orchestral heft—which is to say, the string complement—to dimensions comparable to those of Beethoven's time and uses single woodwinds. Beethoven symphonies have been recorded by chamber orchestras before: Marriner gave us a few, and the Walter/Columbia Symphony and Scherchen/Vienna State Opera Orchestra performances suggest a cutback of personnel. But all of these accounts fudged the issue to some degree, Marriner's string tone beefed up with dubious reverb and Walter's and Scherchen's woodwind lines no more distinguishable than usual. In contrast to these mistaken attempts to simulate large-ensemble sonority, the present production wears its intimacy like a badge of honor.

One of the unexpected upshots is that, although the strings are fewer, more of the detail in their parts emerges from the tonal fabric: *Divisi* writing is far more telling than usual; dynamic inflections, such as the hairpin crescendos and diminuendos, make greater dramatic effect; ostinato and Alberti figurations come clearly to the fore; and when the double bass enters to reinforce the cello line at climactic moments, the listener becomes more acutely aware of the entrance because of the spareness of the forces.

There are, however, some losses as well. For all the keenness of the smaller dynamic inflections, a few of the larger climaxes inevitably lack lung power; predictably, the thunderstorm is disappointingly scrawny. Thomas has obvious affection for this genial music, and most of the playing is precise and admirably paced. Tempos are brisk, and rhythms are lean and kinetic. Once or twice, particularly in the outer movements, the direction verges on precious affectation, but in the main this is a loving, intelligent, and well-recorded *Pastoral*. H.G.

BRAHMS: Concerto for Violin and Orchestra, in D, Op. 77.

Herman Krebbers, violin; Concertgebouw Orchestra, Bernard Haitink, cond. PHILIPS FESTIVO 6570 172, \$6.98. Tape: 7310 172, \$6.98 (cassette).

If your local orchestra presented its concertmaster in a warhorse violin concerto, would you trouble to attend, let alone buy it on a record? The Concertgebouw isn't just a local orchestra, of course, and Herman Krebbers can hold center stage very well. He plays Brahms with utterly luminescent tone, an aristocratic confidence in the face of technical hurdles, and a terraced shaping of phrases and dynamics that freshly confronts expressive meanings. Even with modern tape splicing, many a su-



Michael Tilson Thomas
A pared-down *Pastoral*

perstar violinist has sounded less precisely on pitch (e.g., the exposed but utterly secure landing on the stratospheric A at measure 348 of the first movement). In the Adagio, Krebbers dovetails with the woodwind choir as if he were playing chamber music with friends.

Haitink is of a mind with Krebbers all the way, and the warmth, richness, and freedom from distortion of Philips' mastering (this is not a reissue, but a first U.S. appearance of a fairly recent recording) are unexcelled.

Don't get me wrong. I'm not throwing out my Heifetz/Reiner (RCA LSC 1903) or Neveu/Dobrowen (late Forties EMI, never issued here) recordings, both of which feature a vehemence and propulsion far removed from the serene breadth and poise of Krebbers and Haitink. I also retain my attachment to the warmly idiosyncratic first Ferras recording with Schuricht (early London mono). But nothing in the recent lists (including Haitink's other recording with Szeryng, Philips 6500 530) has so refreshed my joy in this work. A.C.

BRUCH: Works for Violin and Orchestra.

Salvatore Accardo, violin; Leipzig Gewandhaus Orchestra, Kurt Masur, cond. PHILIPS 9500 589*/90*, \$9.98 each. Tape: 7300 711*/12*, \$9.98 each cassette.

Concerto No. 3, in D minor, Op. 58; Adagio appassionato, Op. 57; Romance, Op. 42.* Serenade, Op. 75; In Memoriam, Op. 65.*

This pair of discs—containing first recordings of almost all of this material—completes the most extensive Bruch recording project ever, complementing the Accardo/Masur readings of the first two vio-

lin concertos (Philips 9500 422, March 1979) and the *Scottish Fantasia* and Op. 84 *Konzertstück* (Philips 9500 423, August 1979). The newest installments may well be the most important of all, since the Third Concerto and the serenade prove to be vintage Bruch.

Though his Second Concerto seems a stale rewrite, the Third is every bit as good as the First. Like No. 1, it was written for Joseph Joachim, and its pugnacious opening chords make clear that it is to be a large-scaled, tough-minded composition—as close to Brahms as Bruch ever came. To be sure, lyricism abounds, especially in the Adagio, but this work of 1890 shows that the composer had learned a thing or two in the twenty-two years that separate it from its hackneyed but lovable predecessor.

The character of the serenade, a very different work, also reflects the personality of its dedicatee. More sweetly introspective, it was composed in 1901 for Pablo Sarasate; Toscanini is reputed to have said that "Sarasate played like a lady." The shorter pieces are also quite lovely but are essentially sketches for the bigger essays.

A constant in the performances is excellent collaboration. Accardo's lean, pure style provides an excellent foil for this mostly somber music, and the dark, granitic orchestral backdrop (more forwardly miked than usual in this Philips/VEB Deutsche Schallplatten coproduction) gives strength and sentiment to what could easily sound merely turgid. H.G.

CAGE: The Seasons. WUORINEN: Two-Part Symphony.

American Composers Orchestra, Dennis Russell Davies, cond. [Carter Harman, prod.] COMPOSERS RECORDINGS SD 410, \$7.95 [recorded in concert, December 11, 1978].

These works represent the tame sides of both composers. To John Cage, tameness came early and naturally—one might almost say prehistorically, since *The Seasons* predates his experimentations with chance, silence, notation, and noise. Charles Wuorinen, on the other hand, has only recently discovered a docile side, and his move toward domestication has proved to be both a joy and a problem.

This novel direction makes Wuorinen's *Two-Part Symphony* the more interesting piece here, albeit not the more memorable one. Written in 1977-78, it might have been called *Symphony in C* or *Short Symphony*, but those titles had already been used, so the composer settled on *Two-Part*. The work is indeed in two parts, the second half prefaced by a slow section that could stand as an intervening

NOW THAT YOU'VE GOT THE COMPONENTS YOU WANT.. GET THE ONE YOU NEED.

A SCOTCH® CASSETTE IS THE ONE COMPONENT THAT LETS YOU GET IT ALL OUT OF YOUR SYSTEM.

There isn't another cassette made that can give you better sound than Scotch. Rich, true, pure sound. The best your stereo can deliver.

Take Scotch Master® Series for example. Three premium cassettes with three different oxide formulations designed to bring out the best in the type of music you record.

If you record music at high sound levels, like rock, choose Master I® for normal bias. It gives you the volume level you want without the distortion some low noise tapes can induce.

Master II® for chrome bias is ideal for classical or mood music. Sensitive and quiet, it can record the softest passages without interfering tape hiss.

Master III® (FeCr) will give you outstanding clarity for any recording, plus a high-end brilliance that delivers truly remarkable sound on your car stereo.

Every tape in the Scotch line is made with the same kind of care and precision that went into your other components, to give you all the performance your system can deliver.

SCOTCH METAFINE® THE ULTIMATE COMPONENT.

When Metafine metal particle tape was introduced, it was so advanced most decks couldn't record on it. Now, metal-compatible decks are available and Metafine is stretching cassette recording almost to the limits of the audible range.

NO TAPE COMES CLOSER TO THE TRUTH THAN SCOTCH.®

More than 30 years of research, technology and innovation go into each of our cassettes. What comes out is the truth. No more. No less.

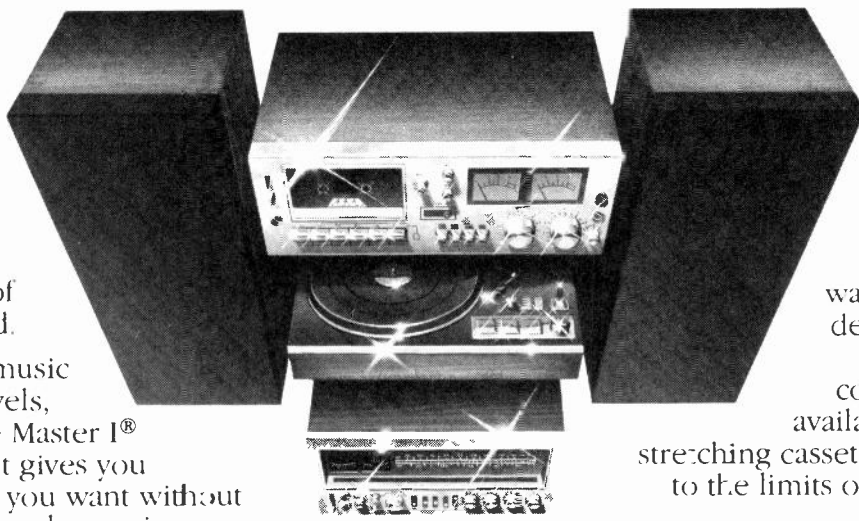

SCOTCH® RECORDING TAPE. THE TRUTH COMES OUT.

3M

middle movement. Had Wuorinen chosen to re-employ one of the other titles, however, it might have been even more significant, since his tendencies toward conventionality manifest themselves here in references, homages, and a distinct shortage of imagination.

Nevertheless, when he notes that he had "a very good time" writing the piece, one can easily believe him. Gone is the sense one had so often with the early Wuorinen that he was trying hard to be erudite and esoteric; this music has a welcome flow and a feeling of inevitability that were not companions of his previous creations. Yet the symphony brings to mind several names, including those of Stravinsky and Bartók, but not that of Wuorinen. Understandable as it is that such a switch in style could cause an identity crisis, one must conclude that the newly tamed composer still hasn't found a way to purr differently from anyone else.

Cage, however, is a natural-born musical pussycat, and though he would undoubtedly fight the idea, his early contributions have turned out to be every bit as important and influential as his more outrageous ones. *The Seasons*, written thirty-three years ago for the Ballet Society and dedicated to its director Lincoln Kirstein, has little to do with Vivaldi's famous work of the same name, but it is graphic, colorful, and, in the best old-fashioned sense of the word, charming.

Cage wrote, "*The Seasons* is an attempt to express the traditional Indian view of the seasons as quiescence (winter), creation (spring), preservation (summer), and destruction (fall)." One might relate this to Wuorinen's use of the Greek cosmological word *ylem* ("that on which form has not yet been imposed") in connection with his symphony, but Cage's four seasons make up a mild, temperate landscape.

He relaxes in his summertime so convincingly that one wants to get out the hammock and the beer and loll away the warm afternoon. Fall and its "destruction" come with the heavy march of determined soldiers, yet even this cold onslaught isn't particularly threatening. There are other theoretical and numerological bases to *The Seasons*, but frankly they don't matter. A third of a century after its premiere, the work has a delightful, almost pacifying effect.

Both works are performed by the American Composers Orchestra, conducted by Dennis Russell Davies, for whom the Wuorinen symphony was written. This ensemble could undoubtedly play Beethoven quite wonderfully, but the point is that it plays new music extraordinarily well, and that's more than enough reason



Anthony di Bonaventura
Pianism that's a joy to the ear

for its continuing to thrive. K.M.

CHOPIN: Sonata for Piano, No. 3, in B minor, Op. 58. PROKOFIEV: Sonata for Piano, No. 7, in B flat, Op. 83.

Anthony di Bonaventura, piano. [Marc Aubort, prod.] ULTRA FI ULDD 13, \$9.98 (distributed by Sine Qua Non Productions Ltd., 25 Mill St., Providence, R.I. 02904).

This fine-sounding recording is confusingly billed as "Ultra Fi-direct disc-digital-high technology tape," and a column on the back of the jacket discusses the assets and limitations of all these methods, implying that all are indeed used here. Not so: This is, in fact, an analog product, whose only departures from the norm are high-speed (30 ips) tape mastering and (apparently) careful processing and pressing. Which goes a long way toward confirming my nagging suspicion that the real reason audiophile products sound better is that more care is lavished on their production, not because of any intrinsic superiority in the method of capturing live sound.

If anyone can deliver note-perfect performances without benefit of retakes and splices, Di Bonaventura can. Years ago, I heard him do just that in a recital performance of Chopin's B minor Sonata. His recorded performance, presumably edited, is equally poised but considerably riper and more interesting. Without being in the least eccentric, the rendition abounds in noteworthy details. Di Bonaventura observes the exposition repeat in the first movement, as do Argerich and Weissenberg but, to my knowledge, no other artists. He has an acute ear for inner voice detail, without its being obtrusive. He is a master

at shifting gears and characterizing phrases without in any way departing from modern practice or violating the longer line; the sense of continuity is far stronger, for example, than in Ashkenazy's recent London version (CS 7030, February 1979), cultivated and well played though that was. Throughout, the purling passagework is a joy to the ear—and a perpetual source of despair, undoubtedly, to any rival practitioner.

The annotation states that Di Bonaventura made the first American recording of Prokofiev's Seventh Sonata, but I can find no evidence to disprove my belief that Horowitz claims that distinction. In any event, the present account, slightly understated but very spry and transparent, is more akin to the linear Richter interpretation (Turnabout TV 34359) than to the more massive and heroic readings of Horowitz (RCA ARM 1-2952) and Gould. Again, the pianistic finish is most impressive; only a bona fide virtuoso could clarify the onslaught of the finale to such a degree without sacrificing headlong momentum. The piano tone is a bit spikier on the second side, which contains the Prokofiev and the last movement of the Chopin, but the sound of this excellent release remains of demonstration caliber. H.G.

DEBUSSY: *La Mer*. SCRIBAN: Poem of Ecstasy, Op. 54.

Cleveland Orchestra, Lorin Maazel, cond. [James Mallinson, prod.] LONDON CS 7129, \$8.98.

Once again, the Clevelanders seem the ideal Debussy orchestra, playing with bejeweled tonal delicacy, millisecond exactitude of ensemble, and superhuman control. Maazel combines the virtues of previous Cleveland Orchestra recordings of *La Mer*, the surging impetuosity of Rodzinski's old 78 (variously transferred to LP) and the meticulous precision and transparency of Szell's (*Odyssey* Y 31928). Maazel's use of rhythmic distensions for emphasis is less problematic here than in his last Debussy recording (London CS 7128, November 1979).

London captures the vertical strands of *La Mer* as well as it did for Solti and the Chicago Symphony (CS 7033, August 1977). Notwithstanding my earlier praise for that version, upon rehearing it, I find the Mack truck power of the Chicagoans overbearing compared to the Alpha Romeo sportiness of the Clevelanders. Maazel's taut, brisk reading joins a select group that includes Ansermet (London, deleted), Boulez (Columbia MS 7361), and Haitink (Philips 9500 359).

Unlike *La Mer*, which can stand di-

Our best.



And here's why.

The Jensen R430 AM/FM Stereo/Cassette Car Stereo Receiver is our top-of-the-line. Our best. And for a lot of very good reasons.

Its functions.

Advanced functions that really make a difference in your music.

Functions like Dolby[®] Noise Reduction for clearer reproduction of Dolby-encoded cassettes and FM broadcasts.

And a function like Loudness Compensation of +6dB at 100 Hz to improve bass at low volumes.

Interstation FM Muting lets you tune out annoying between-station noise when tuning. While an FM Local/Distant switch allows you to optimize the receiver's sensitivity for strong or weak signals.

The R430 even offers separate bass and treble controls.

Bi-Amplification.

It's a function worth knowing about. Because of the real difference it can make in your music.

The Bi-Amplification func-

tion of the Jensen R430 uses a low level passive crossover to split the audio signal into low- and high-frequency bands. The low frequency signals are then sent to one set of amps. And the high signals are sent to another set of amps.

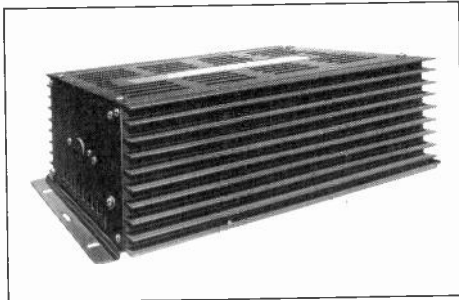

From these amps, the high signals are fed to one set of speakers. And the low signals are routed to another set of speakers. A

much more effective use of power.

But what does bi-amplification mean? It means the R430 will provide lower distortion...and higher listening levels...with a given power input. No small feat.

It gives you a second, completely different way of listening to your music. With the option right at your fingertip.

A separate power amp.

Actually four OTL amps; two for each channel. This trunk-mounted unit accompanies the R430 to deliver a Continuous Average Power Output of 30 watts per channel. Plenty of low-distortion power,

excellent heat dissipation, an ideally suited component to handle the R430's bi-amp mode.

More features.

Electronic feather-touch switches command a whole array of functions.

LED indicators glow when they're engaged.

And a unique Automatic Tape Alarm helps prevent damage that causes wow and flutter. If a cassette remains engaged when the ignition is turned off, lights flash and speakers beep, reminding you to remove it.

Respectable specs.

Great sounding music is the result of great specs. And with specs like the R430's you can imagine why we're so proud of its sound.

Total Harmonic Distortion is 0.4% at 52 watts; 1kHz. The Frequency Response measures out at 30 to 18,000 Hz (-3dB). And the Weighted FM Signal/Noise Ratio (less Dolby) is 68dB.

Is it any wonder why we say the R430 Receiver is our best?

JENSEN
SOUND LABORATORIES
AN ESMARK COMPANY

versity and repetition, Scriabin's *Poem of Ecstasy* doesn't wear well. I continue to find it loud, overorchestrated, and redundant, though I warm to the artistry of Stokowski (London Phase-4 SPC 21117) and admire the sanity and lucidity of Abbado (DG 2530 137). Maazel, less analytic about solo high-lightings, has one decisive advantage: That tiresome, fatuous trumpet tune is played with minimal vibrato and portamento. A.C.

DEBUSSY: *Pelléas et Mélisande*.

CAST:

Mélisande	Frederica von Stade (s)
Yniold	Christiane Barbaux (s)
Geneviève	Nadine Denize (ms)
Pelléas	Richard Stilwell (b)
Golaud	José van Dam (b)
Arkel	Ruggero Raimondi (bs)

A Shepherd /

The Doctor Pascal Thomas (bs)

Chorus of the Deutsche Oper, Berlin, Berlin Philharmonic Orchestra, Herbert von Karajan, cond. [Michel Glotz, prod.] ANGEL SZCX 3885, \$27.94 (three discs, automatic sequence).

COMPARISON:

Söderström, Shirley /

Boulez Col. M3 30119

To quickly characterize this new *Pelléas*: It is on the whole mellifluously sung by a cast whose voices and musical approaches share a general softness of attack and shadiness of timbre, thus according well with the homogeneity of orchestral sound obtained by the conductor. It is a thoroughly musical performance, by which I mean that it leaves the impression of a concert rendition, rather than a stage performance. Since its conductor is a strong-minded one in command of his own expert orchestra and the cast carefully selected, the reading has some very beautiful and powerful things about it and takes an identifiable stance on the work—so it is a contribution.

The nature of the performance inspires thoughts that run in ironic little circles. Maurice Maeterlinck, at the time of *Pelléas* and the other Symbolist plays that established his early reputation, wanted an actorless theater, one in which human normality could not intrude upon the symbolic progress of mystic communication. Or, to put it in terms of his personal predicament, he created out of a need to express a very intense, very private psychic world whose reality depends on the consistency and specificity of its unlikeness to more ordinary perception, yet whose embodiment can be accomplished only through creation of a stage-world in which the elements (especially people) are not always going to behave according to the laws of that private

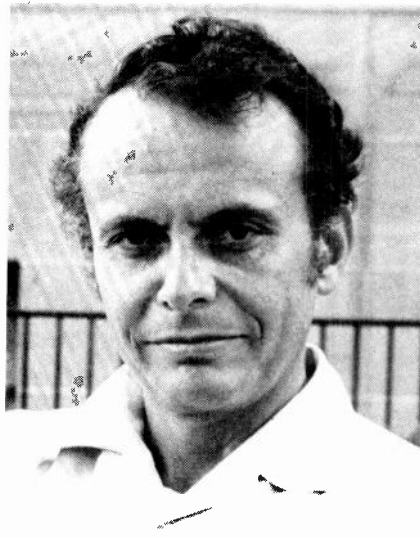

Lorin Maazel
Taut, brisk Debussy

universe. Can't live with 'em, can't live without 'em—a problem felt by most playwrights, but the young Maeterlinck was an extreme case, and of course except for a very limited life in small theaters of the *fin-de-siècle* Parisian avant-garde, these plays have remained largely objects of study rather than of performance.

Along happens young Debussy in search of a text that won't remind him of Wagner's. In a sense, his search parallels that of Maeterlinck: Let's have an opera without all that singing, to go along with this play without acting. This eagerness to eschew all the vocal forms of opera and all the developmental forms of Wagnerian music-drama, together with the peculiar appropriateness of the composer's harmonic language and timbral spectrum for the world of the play, is widely and properly understood as a vital portion of the composer's contribution to the opera.

But it is the practical, active effect of these attributes that accounts for the comparative workability of the opera (and I think "comparatively workable" is about the right designation) as opposed to the play. The musical language is more than suggestively shifty, it's sensually compelling, like a long sense-memory exercise on the environment of the drama—its outer world, much more than the inner. Oddly, though the musical description is sensuous, and as surely of the recognizable, natural world as a Rossini or Verdi storm scene, it has the effect of persuading audiences that it is about Maeterlinck's mystical inner world, and that this world may be worth entering. In fact, it appears to be more about the realms of light and beauty to which the characters' souls dimly aspire

than about the fleshly purgatory to which dualistic mysticism has us condemned, and which is such a powerful deterrent to audience sympathy.

And all this nonsinging, which is in operatic terms so mysteriously subtle and reticent, and seems to leave so much unexpressed, is upon examination just what Debussy intended it to be—a step toward a more realistic, dramatically justified mode of musical expression, by means of which the vocal line transcends our more normal forms of discourse by relatively minor degrees, and only in response to urgencies for which words will not suffice. (Debussy defined the necessity of singing in opera in virtually the same words as did Walter Felsenstein.) Naturally, this has the effect of magnifying, not reducing, the performer's role, of giving him more of the ammunition Maeterlinck would like to have taken from him.

So here is Debussy, giving to Maeterlinck's play generous measure of all the qualities the author would like to have kept out and, since these are precisely the ingredients needed to give the play performance life, lending the author his one continuing claim to theatrical attention.

And here further is Von Karajan, who in principle would appear to agree with Maeterlinck. That is (and this is the reason actors are so inconvenient), the characters are seen as beings whose consciousness does not contact the true reality, carrying on an unwitting struggle against forces that remain undefined. To act, to choose, is to assume a responsibility and freedom that destroy the reality of such a world. Marionettes are the perfect actors, and they are just what Maeterlinck wanted.

Herr v.K. is the perfect interpreter, not of Debussy, but of Maeterlinck. But of course whereas Maeterlinck's characters wandered through the castles and forests of his inner world, slaves to his psychic needs like Pirandello's six characters and controllable while unperformed, Karajan's singers are selected musical instruments that prowl amongst the shadowy glades and thickets of the Berlin Philharmonic, quite incapable of actions that do not accord with the master plan of the Higher. This is surely not what Maeterlinck had in mind (it was *he* who was to supervise the characters' fates), and as to whether Destiny should be named Maurice or Herbert, I wish we could drop in on that one, fortified with the amused program note I imagine Debussy would provide.

Maeterlinck's dream theater is evoked by any recording, for in this medium we are at last rid of the damned performers. True, they leave their scent. We track them through the grooves with styli



For less than \$400 Audiovox can put the sound of home stereo in your car.

With four power-coordinated components that will
"charge" your car with 30 watts per channel.

The COSC-5A. The incredibly slim (just 1¼" deep) coaxial speaker system that fits practically anywhere, in imported and domestic cars!

Shallow 1¼" design—special shallow depth provides easy installation in all door panels unable to accept bulkier coaxial speakers. 5" Woofer—Air-suspension design to allow free cone response. Produces deep Bass at extremely high input power levels. Special 1" heat-proof voice coil allows sustained operation at high power without voice coil distortion.

1" Tweeter—with TDK Summarium cobalt magnet, usually found only in costly home speaker systems. Provides unmatched high-frequency response combined with a wide-dispersion capability.

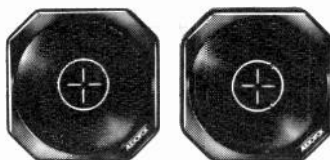

The Tryvox 30. A 3-way stereo speaker system built around 5¼" woofer, 2¼" mid-range and 1" horn tweeter speakers mounted on ⅝" particle board like quality home hi-fi speakers to give better baffling and solid bass response.

The Woofer—giant 20 ounce magnet combined with flex-edge air-suspension and a high temperature 1" voice coil for rich bass at maximum power.

The Mid-Range—A powerful ferrite magnet drives this incredibly responsive mid-range featuring a mylar dome and extra heavy cone for crisp audio.

The Tweeter—A full dispersion, wide angle short horn tweeter that captures all the highs and delivers them to you as brilliantly as the original recording.

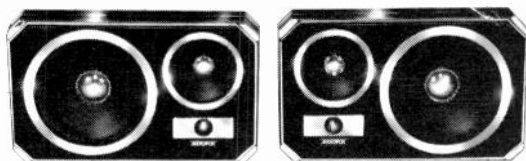

The AMP-600B. To make the sound fit the internal size and shape of your car with 30 watts per channel to boot. An impressive way to turn ordinary stereo into true hi-fidelity Super Power. It produces unbelievable power . . . up to a maximum of 60 watts RMS stereo output . . . with slide bar control of the entire audio reproduction range. You control the response from Bass through Treble, a total of five ranges, customizing the audio to your enjoyment and to the size and shape of your car.

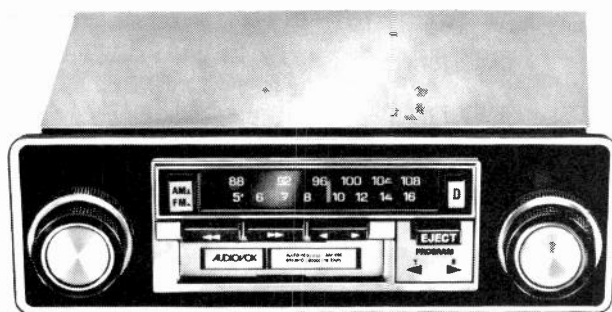
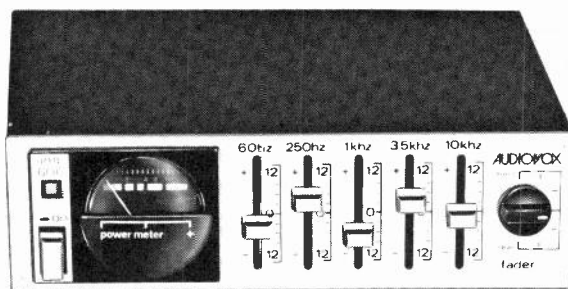

The ID-625. Just about everything you'd find in an in-home tuner/cassette deck plus auto-reverse. The Tuner: A super sensitive AM/FM/MPX radio with a local/distant switch for optimum FM reception; great FM stereo separation plus automatic frequency control. The Cassette Player: Featuring auto-reverse and tape direction indicator light, 4 speaker outputs and 4-way sound balancing controls.

For further information, write to: Robert Harris, Technical Director, Dept. 12L, Audiovox, 150 Marcus Blvd., Hauppauge, New York 11787
Audiovox autosound systems are designed and developed by the audio research laboratories of Shrirom Co., Ltd., Yokohama, Japan.

© 1980 Audiovox Corporation

sharpened and drawn, and if we're experienced hunters, a glimpse of the spoor is enough to conjure a magnificent vision of the beast. A whopper he always is, powerful and quick and alert, caught at the stretch of some mortal action in a lush or dizzying locale.

So how sobering it generally is when, thirty-dollar pasteboard in hand, we corner the prey at last and discover an entirely ordinary, vulnerable creature with a slight limp and a puny horn, exhaustedly foraging at the bottom of a gully amid the weeds and tin cans and beer bottles. Is this Alaska yet? No, it's only Mahagonny. And we feel the force of Maeterlinck's wish, for surely our illusions are wonderful, and it's not easy to surrender them for realities of which the best that can be said is that they have a certain presence, a certain unpredictability, a certain potential for interaction—that they are, in short, realities. Besides, we saw ourselves, bone-to-bone and steady in the sling, sending that single shot to the heart as he charged from the brake. It's hard to admit that the real question is whether or not we can hit a motionless target at fifty yards, and that the recoil left our shoulder aching for a fortnight.

How gratifying it can be, with just a spin of the platter, to at once indulge our illusions and to put these animals exactly where Maeterlinck saw them, endlessly and blindly repeating their actions in patterns whose end already exists at the beginning; and moreover to choose either to be overcome or to rise to the mastery of an objective view—a choice made much harder by the complexities of the theater. Karajan is truly an ally here, particularly if our wish is to be overcome and to experience, through the music, the Maeterlinckian notion that a half-apprehended environment (the orchestra) determines, absorbs, and eventually dominates every utterance of the individuals represented in the drama. The most obvious contrasts among recorded performances are with the Boulez and Desormière (long deleted) recordings. In the former, the textures are so much more opened out and exposed, and the musical gestures so precisely achieved, that they become easier to appreciate and understand on their individual terms rather than as ingredients of the whole. With our gain in understanding comes a diminishment of the ruling power of the mystery—that much is purely a question of taste or philosophy, not of quality. The elements of Boulez' environment are encouraged to lead their independent lives, and so are the characters themselves. Two of them (the *Mélisande* of Söderström, the *Pelléas* of Shirley) are given by far their most individual, strongly colored representations on



Frederica von Stade
An impeccably musical *Mélisande*

record—a fact I appreciate more thoroughly with the passage of time and repeated comparisons. The others are not, but that is through incompleteness of execution, and not through design.

The Desormière recording, whose age dictates a compression of orchestral sound and a simplicity of highlighting, preserves an age when French opera (emphasis on both words, please) was actually performed. The singers compel attention via their unfailing competence, their suitability for their roles, their easy stylistic agreement. The orchestra is firmly conducted by an experienced fellow who is content to be a master, not a Master.

We might say that Karajan's case against Debussy on behalf of the young Maeterlinck is fairly complete, for no other performance I've heard so mercilessly clarifies Debussy's connections with styles, both antecedent and descendant, he wouldn't have cared to be associated with. *Parsifal* hits us in the face in the early interludes, *Tristan* in the late ones. And in many of the accompanimental and descriptive passages, especially those for muted strings, we're given a bath in '30s easy listening of the sort that was cribbed from Debussy and Ravel—you can see that *blonde moderne* furniture, V-neck cocktail dresses, lipstick on the cigarette butts, the whole picture. All defensible, of course, mostly beautifully played if you accept the cushioned attacks and phrasing (as opposed to the sharpness of Boulez with the Covent Garden orchestra), and carried through with consistency and proportion. The interludes become the high points of the performance (Destiny at length swallowing the kit and caboodle), and the late ones, along

HIGH FIDELITY

with the second fountain scene, have stupendous weight and intensity—I was almost put in mind of Furtwängler's *Tristan*, the Act II pages embracing the entrance of the hero. While Karajan does not secure (or, I assume, seek) the amazing rhythmic lucidity of Boulez, there are points where his more basic sense of rhythmic line pays off, as in the 6/4 tread ("*Lourd et sombre*") of the beginning of the vault scene.

The cast is superbly chosen to carry through the concept: lovely, genteel voices and temperaments, refined and sensitive musical minds. Contrast is minimized—from the lyric "mezzo-soprano" of Von Stade's voice to the light high bass of Raymond's is not a wide span, particularly with a baritone *Pelléas* and a soft-textured bass-baritone Golaud in the middle reaches. Von Stade's performance is beautifully intoned and impeccably musical. Since on the one hand the role is low for a soprano and on the other Von Stade's timbre is by no stretch that of a mezzo but that of a medium-weight lyric soprano, the categorization is no problem at all. I am at times touched and charmed by her reading in the same way one is touched and charmed by a fine Debussy pianist. I am unable to derive from it the slightest definition of *Mélisande's* feelings, actions, or traits, beyond unquestionable good taste and superb manners (qualities it seems most unlikely *Mélisande* would possess) and an occasionally detectable *tristesse*.

Stilwell, a little more projective of personal qualities, employs his warm voice with the heady fluency of the true *baryton Martin*. I have come to a fairly clear preference for a tenor in this music—a voice like that of the young Jansen (on Desormière) or the young Maurane (on Fournet, and both these artists recorded the role second times, for Cluytens and Ansermet, to lesser effect), or the darker, more metallic tenor of Shirley, makes the best case for the music and brings welcome touches of textural relief. But Stilwell solves the role with admirable ease, never letting the voice overweight or cloud up in the area of the break, and though like all baritones he is pressed by the tessitura of his final scene, he doesn't let it defeat him.

I find Van Dam a boring Golaud, despite good musicianship and quite lovely vocalism. The sound of the voice is always a pleasure, and with so few singers nowadays in command of the even gradation and well-bound legato that goes with his deeply tanned tone, perhaps we oughtn't look the gift horse in the mouth. But this is a long role, and one of tremendous opportunities. Van Dam's assumption of it at the Met was, I thought, an uninformed walk-through, but it seemed unfair at the time to leap to

ANNOUNCING RECORDS IN REVIEW 1980 EDITION

Edited by Edith Carter

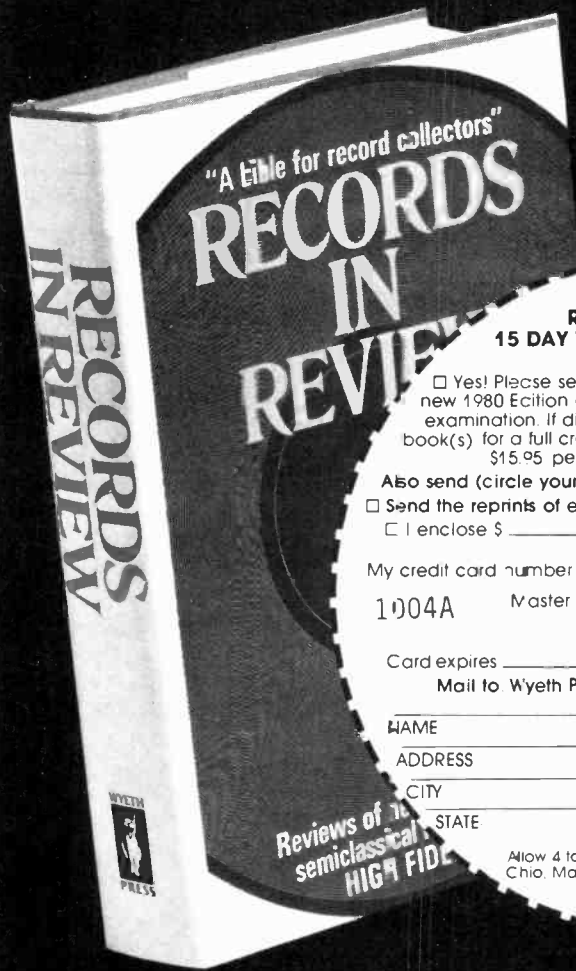

- It's new! The 25th comprehensive edition of the "bible for record collectors."
- This 400 page hardcover volume contains all review of classical and semi-classical music appearing in **HIGH FIDELITY** during the past year.
- Reviews cover all types of music — vocal, orchestral, chamber, and solo — medieval to contemporary.
- All available formats shown — discs, tape, cartridges, and cassettes, in stereo and quadriphonic.
- Written by **HIGH FIDELITY**'s staff of knowledgeable and noted critics.
- Arranged both alphabetically and by musical category for ready reference, including an index of performers.

RECORDS IN REVIEW 15 DAY TRIAL EXAMINATION FORM

Yes! Please send me _____ copy(ies) of the brand new 1980 Edition of **RECORDS IN REVIEW** for 15 days trial examination. If dissatisfied in any way, I may return the book(s) for a full credit or refund within 15 days. I pay only \$15.95 per book, plus \$1.25 for shipping.

Also send (circle your choice): 1979 1978 1977 1976 1975

Send the reprints of earlier volumes. State year(s) _____

I enclose \$ _____ Charge to Master Charge Visa

My credit card number is

1004A Master Charge Interbank

Card expires _____ Signature _____

Mail to: Wyeth Press, 1 Wyeth St., Marion, Ohio 43302

NAME _____

ADDRESS _____

CITY _____

STATE _____ ZIP _____

Allow 4 to 6 weeks for delivery. Residents of
Chio, Ma. & N.Y. add applicable sales tax.

ALSO AVAILABLE

- Volume 24 1979 Edition \$15.95 plus \$1.25 for shipping
- Volume 23, 1978 Edition \$15.95 plus \$1.25 for shipping
- Volume 22, 1977 Edition \$14.95 plus \$1.25 for shipping
- Volume 21, 1976 Edition \$16.95 plus \$1.25 for shipping
- Volume 20, 1975 Edition \$14.95 plus \$1.25 for shipping

All previous editions of **RECORDS IN REVIEW**, 1955 through 1974 (volumes 1 through 19), are available in hardcover reprint editions @ \$37.50 per volume plus \$1.25 for shipping. State year(s) desired.

COMMENTS ON EARLIER ANNUALS:

"Comprehensive coverage of each year's recordings gives a surprisingly well-rounded picture of what's available on records, and most reviews describe the work as well as the performance, providing each annual with a permanent use."
Saturday Review

"The record collector who is bewildered by the sheer number of discs which are issued each year will find this book valuable as a means of bringing order out of chaos."
Chicago Tribune

"**HIGH FIDELITY** has become something of a bible for record collectors and also for those who are simply interested in listening to music on records. One of the magazine's most attractive features is the long and complete section devoted each month to reviews of the new recordings, reviews that are complete, detailed, and authoritative. They are also honest, which is the best possible recommendation."
The Hartford Times

"The standard reference work for the review of long play classical and semi-classical records."
Berkshire Eagle
(Pittsfield, Mass.)

any conclusion, since the house production goes all the way with M.M. and eliminates acting *completely*. Here, though, the story is the same—a nicely equalized, almost casual vocalization, invariably round and soft in attack regardless of intent, and a lack of core or bite in the inflection that seems as much an absence of dramatic will and imagination as of vocal method. At the awful emotional climaxes of the late scenes with Yniold and Mélisande, he contributes only the most obvious indications. This is good singing, and possibly he is no more to

be blamed than the others, but his role is the most severely damaged by such lacks, and comes up monotonous.

Raimondi seems an odd choice for Arkel, but in fact he has clearly made quite an effort to find a solution for the role. He has a reasonable musical affinity for the style, and employs a gently touched *piano* that does indeed sound at moments like a French *voix couverte*. His opening scene is successful, and later, in the few moments where the singer of the role must open out, he has more to offer tonally than most. But

in Acts IV and V, where the role has its sustained passages, his attempt to deal softly and inwardly with the declamation that lies persistently around B and C becomes too croonish and gummy. A piece of work one must respect, but only partly successful.

Nadine Denize, yet another mezzo with attractive tone that has no trace of depth or darkness, deals straightforwardly with Geneviève. Her reading of the letter falls a bit flat because of the lack of character in the sound (I see one review believes the mike placement was disadvantageous—that's not how I hear it, but one way or another you get the idea); she is fine when she sings out by the seashore. The Yniold is a grownup soprano (Christiane Barbaux), the solution I favor, and quite good. The doctor's pleasant voice is rather light, and it sounds as if he has been ordered to not sing too much.

The recording does not capture the detail or the small balances as well as Columbia's for Boulez. But it's not intended to, and it does contain the remarkable dynamic range inherent in the reading. The surfaces of my copy were not very clean.

Pelléas is an opera that has been well served on recordings. None of the seven LP performances is, on balance, a failure. This one offers a slant on the work that is not my preference. Maeterlinck was wrong. I want a conductor who understands and projects the piece in a more than purely musical sense, and performers with marked individual qualities and strong feelings for the personal situations of their characters. It's a shame that the rest of Boulez' cast is not on a level with his leads, and that Desormière's could not have been recorded twenty years later. But if you were to own all three, you'd have the waterfront pretty well covered. C.L.O.

FERNEYHOUGH: *Transit*.

Rosemary Hardy, soprano; Linda Hurst and Elisabeth Harrison, mezzo-sopranos; Peter Hall, tenor; Brian Etheridge, baritone; Roderick Earle, bass; London Sinfonietta, Elgar Howarth, cond. [James Mallinson, prod.] DECCA HEADLINE HEAD 18, \$9.98 (distributed by London Records).

The thirty-six-year-old English composer Brian Ferneyhough is fast establishing himself as one of the major composers of the younger generation. His output, already totaling some twenty published works, has attracted growing attention in the world press, particularly in England and Germany (where Ferneyhough resides); *Transit* won the 1979 Koussevitzky International Record Award as the best new orchestral work to receive its premiere recording.

Continued on page 90

Four New Listening Experiences only on ORIGINAL MASTER RECORDINGS™



ALSO...
THE BEATLES
SUPERTRAMP
PINK FLOYD
FLEETWOOD MAC
POCO
AL JARREAU
AL STEWART
JOHN KLEMMER
LITTLE FEAT
STEVE MILLER BAND
AND MANY MORE!

The State Of The Art.

The key high fidelity component guaranteed to improve your stereo system. Super High Fidelity is achieved by total quality control, using only Original Stereo Master Tapes! Our exclusive Half-Speed Mastering technique insures natural musical clarity and impact; our high definition Super Vinyl disc is custom pressed overseas. Each pressing is protected by a Static Free Inner Sleeve and placed in a Special Heavy Duty Protective Package. The result is your favorite music by your favorite artists on the highest quality Limited Edition pressings. Your stereo system will come alive with the sounds of the original performance!

AVAILABLE AT SELECT STEREO AND RECORD STORES.



FREE CATALOG AVAILABLE
P.O. Box 919
Chatsworth, CA 91311
(213) 993-4945

We fit the same. But we perform so much better.

When it comes to fitting any audio or video recorder, there's no apparent difference between Fuji and any other brand of cassettes: we all fit the same.

But there, the resemblance ends. Because tapes are manufactured to very different quality standards with different materials and technologies, Fuji's performance is unique.

Take video. Our VHS and Beta cassettes improve performance on any recorder. Providing sharper pictures. More lifelike

color. And freedom from noise and distortion.

In audio, our premium FX-I, FX-II and low-noise FL set new standards for accurate sound reproduction. And extended response.

Our revolutionary new Fuji Metal Tape goes even further. With ultra-wide response. Dramatically-improved dynamic range and sound quality comparable to studio open reel recordings.

So, whatever you're recording—on whatever brand of recorder—discover how good your machine really is. With Fuji—the tape that helps it perform so much better.

FUJI TAPE

One brand fits all. Better.

Magnetic Tape Division
Fuji Photo Film U.S.A., Inc.
350 Fifth Avenue,
New York, New York 10001
(212) 736-3335



AR

ARABESQUE RECORDINGS

the *New Choice* in classical music

TRADITION, ah, tradition! Where would Opera be without it?

Certainly, the very grand Nineteenth Century tradition of singing style and operatic production is gone, along with those who personified it. Yet, certain performances will always be glowingly recalled as "classic," and many of them were heard in *The Barber of Seville*.

This ARABESQUE new release is history encapsulated — the 1929 first-ever recording of Rossini's comic masterpiece! We are treated to some of the greatest performances of the age . . . Mercedes Capsir, Dino Borgioli, Salvatore Baccaloni, and Ricardo Stracciari as *Figaro*, a role he sang more than 1,000 times.

These renowned singers knew no peer, and now, they are captured anew as if by magic, drawing upon the recording techniques used that day in Milan over 50 years ago. Then, there were no 32-channel digitals, no mixing or editing; singers, in fact, were often made to begin mid-aria for the direct-to-disc recording. The transfers we have made from the 16 original 78 rpm's are new and achieve the best possible fidelity.

So listen—and rejoice, Opera lovers — for although these voices no longer exist, you may nonetheless experience their fullest glory this very moment!

SPOTLIGHT RELEASE

ROSSINI:
THE BARBER OF SEVILLE
La Scala Orch. & Chorus



AR8029-3L • Records
AR9029-3L • Cassettes
\$21.94 Each, with Libretto

Make your *New Choice* now . . .
request catalog from

ARABESQUE RECORDINGS
caedmon

A Raytheon Company

Transit, completed in 1975, is a composition of vast conception and extended length (about forty-five minutes) for six voices and chamber orchestra. According to the liner notes, its initial impetus was visual: "a pastiche of a Renaissance woodcut from a nineteenth-century work on popular meteorology depicting a philosopher, his right arm outstretched in a dramatic gesture, in the moment of penetrating the crystalline sphere, which in the Aristotelian cosmology separates the Earth from the higher spheres, thus glimpsing the workings of the cosmos." The composition effectively conveys the sense of this striking image in its truly cosmic conception of multiple levels of instrumental groups and voices positioned in a cyclic structure of breathtaking expansiveness.

There are twelve principal sections, each with its own distinct character and instrumental sound. Vocal sections alternate regularly with purely instrumental ones, the only exceptions being the last two, which are vocal and linked together to form a kind of climactic finale. The voices, used almost exclusively in ensemble (although there is a very brief bass solo near the end), intone texts from Paracelsus, Heraclitus, and the *Corpus Hermeticum* ("a collection of writings, supposedly by the mythical ancient Egyptian sage Hermes Trismegistus, identified in the sixteenth century as forgeries from the Hellenistic period"). The words, however, are fragmented into their syllabic constituents and are for the most part intended to be incomprehensible. There are two basic, alternating types of instrumental music: "tuttis," relatively heavily scored, and "verses," more lightly orchestrated and featuring a solo woodwind (flute, clarinet, and oboe, respectively, in the three verses) in a concertante manner.

What most distinguishes *Transit* is how convincingly it moves through this sequence, communicating a sense of formal continuity and direction rather than seeming a mere series of isolated "movements." This accounts for at least one aspect of the title, as Ferneyhough consistently creates effective transitions from one segment to the next, so that one flows logically from the other despite its strongly contrasting character. The music itself is intensely personal and uncompromisingly serious. Technically, it features an interesting combination of strict serial procedures and more intuitively conceived modifications. Ferneyhough is especially accomplished at producing striking formations of timbre and texture that gradually change and become extended formal developments. The result is music that always sounds up to date but is by no means unreasonably diffi-

cult to follow. Moreover, the listener feels that he is hearing something important. This music communicates, no matter how difficult its message may be to decipher verbally.

Judging by this work, the first Ferneyhough composition I have heard, he has a remarkable gift for working with musical ideas of unusual scope and expressive power. His is clearly an important new voice. R.P.M.

HANDEL: Alexander's Feast.

Helen Donath and Sally Burgess, sopranos; Robert Tear, tenor; Thomas Allen, bass; King's College Choir (Cambridge), English Chamber Orchestra, Philip Ledger, cond. [Christopher Bishop, prod.] ANGEL SZB 3874, \$17.96 (two discs, automatic sequence).

COMPARISON:

Harnoncourt/Vienna

Con. Musicus Tel. 26.35440

In my recent encounter with Nikolaus Harnoncourt's recording of Handel's "oratorio" *Alexander's Feast* (May 1979), my delight in hearing this magnificent masterpiece overshadowed most of the reservations usually evoked by performances of the *Concentus Musicus*, with its weak orchestra of "original" instruments and a "leader" who apparently operates by remote control. Now there comes another recording, conducted by a knowledgeable professional presiding over a first-class modern orchestra.

The difference between the two versions is forcefully evident after a few measures of the fine overture: The violins are warm and expressive but never overpowering, their pianos soft yet substantial; the attacks and releases are precise, the dynamic nuances delicate, and the balances superlative. The minuet that concludes the French overture reveals the elegant Handel, whom we so seldom encounter in performances. There is no comparison between this kind of altogether musical playing and the ideologically encumbered performance of the Harnoncourt ensemble, despite the latter's undoubted competence. Philip Ledger does not rigidly follow uncertain rhythmic laws, does not overdot, and keeps everything clear and airy. The clarity, precision, and dynamic range proper to every occasion are maintained unflinchingly.

So far my prayers are answered, but now the singers enter. The first soprano and the tenor occupy such prominent places in the unfolding of the work that they can make or ruin a performance. Here Harnoncourt has the edge, because Ledger's singers let us down. Helen Donath, a soprano favorably known, is not at her best;

she has a nice voice, and she is an intelligent and fervent musician, but, at least in this recording, vocal control is missing. In quieter passages she does well, but most of the time her voice is tremulous; in fact, it wobbles almost to the extent of becoming an involuntary trill. On the other hand, her deliberate trills are poor. The tenor, Robert Tear, another singer widely known and well thought of, is equally unsatisfactory; in the fast passages he huffs a good deal, the vocalises do not seem to agree with him, and he has difficulties with low notes. Felicity Palmer and Anthony Rolfe Johnson, their counterparts in the Telefunken album, are solidly on pitch, comfortable vocally in all situations, and although perhaps a little mannered, distinctly superior to their competitors.

The less able Donath and Tear do, however, maintain a desirable heroic/dramatic tone. We must remember that in the center of Dryden's ode stands a triumphal campaign of Alexander the Great, with such other protagonists as Timotheus, a famous singer in antiquity, and Thais, the celebrated courtesan; the "gentle" St. Cecilia, to whom the work is dedicated, is dragged in rather preemptorily at the very

end as a near non sequitur. Fortunately, the tone of the poem and the richness of Dryden's language were congenial to Handel, and there is never a weak spot in this score full of wonderful melodies.

The choruses in both recordings are excellently trained, but Harnoncourt's mixed chorus sounds better than the Cambridge body, which relies on boy trebles and altos. The latter are very good, they are on pitch, and there is no hooting. Compared with the Stockholm Bach Choir's luminous trebles and altos, however, their voices are colorless. Both versions fail to supply enough harmonic support for the arias accompanied by concertante violins (all violins in unison) and bass; since the bass is figured, the continuo is obviously counted upon to replenish such two-part settings to complete the harmony.

In sum, both of these recordings have advantages and disadvantages, and they are not interchangeable. So it comes down to whether you want good singing and are willing to take Harnoncourt's tepid historicism as part of the bargain, or whether you want a live, vibrant background and will tolerate somewhat flawed singing. P.H.L.

LISZT: *Fantasia on Beethoven's Ruins of Athens*—See Schubert-Liszt: *Fantasia for Piano and Orchestra*.

MAHLER: *Symphonies (5); Symphony No. 10: Adagio; Songs*. For a review, see page 71.

MASSENET: *Werther; Don Quichotte; Sapho*. For a review, see page 67.

MENDELSSOHN: *Symphonies: No. 4, in A, Op. 90 (Italian); No. 5, in D, Op. 107 (Reformation)*.

Israel Philharmonic Orchestra, Leonard Bernstein, cond. [Günther Breest and Hanno Rinke, prod.] DEUTSCHE GRAMMOPHON 2531 097, \$9.98. Tape: 3301 097, \$9.98 (cassette) [recorded in concert].

COMPARISON—*Italian*: Muti/New Phil. Ang. S 37412

This is one of Leonard Bernstein's more unusual efforts, with many significant departures from his norm: strongly inflected readings that combine dynamic energy with lyric sentiment, a rather unsubtle orchestral timbre in which voices are nevertheless clearly defined and generally balanced, and a strong personal interpretive

Advertisement

The Watts Parastat

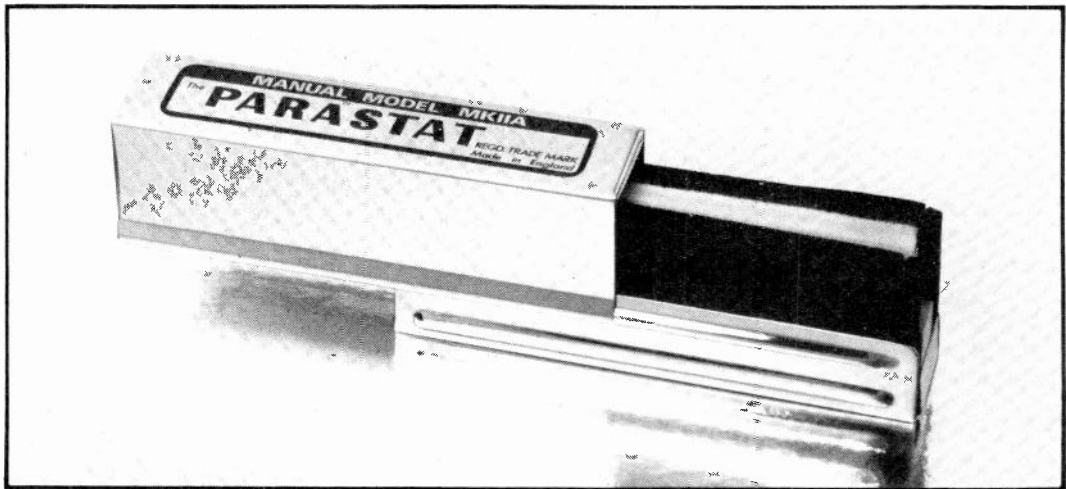

In 15 seconds your records are clean, dry and ready to play.

With some systems you pour liquid on your records (and rub it into the grooves), while with others you brush the dirt around (and rub it into the grooves). The Watts Parastat is neither of these.

By placing a plush velvet pad on either side of a soft nylon brush and adding a drop or two of Parastatik® fluid, a

remarkably efficient system is created.

The brush bristles lift the rubbish to the surface. The pads collect and remove it. And the Parastatik® fluid supplies just the right degree of humidity to relax dust collecting static without leaving any kind of film or deposit behind.

No other system does so much for

your records in so little time.

So when you want the best, ask for the original. The Parastat, by Cecil Watts.

Watts products are distributed exclusively in the U.S. by: Empire Scientific Corp., Garden City, NY 11530.

EMPIRE EMPIRE EMPIRE EMPIRE EMPIRE EMPIRE EMPIRE EMPIRE EMPIRE EMPIRE

Cecil & Watts Ltd

Power

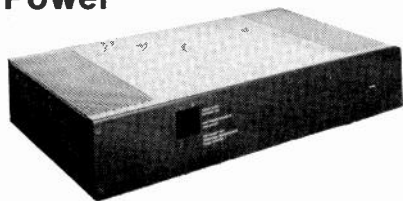

Is a crucial factor in determining the performance of an amplifier. One of the most important measures of power is a specification called *dynamic headroom*: the amount beyond continuous average power available to handle the peaks and transients of musical program material.

The Apt 1 Amplifier has unusually great dynamic headroom. It also has new approaches to power supply, driver circuit, and protection circuit designs, all working toward a single goal:

Sonics.

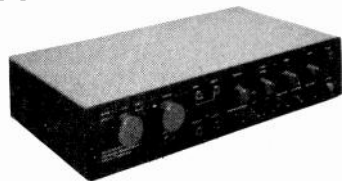

That, in the final analysis is what counts.

System interfacing problems account for most variations among otherwise fine equipment. Thanks to an unequalled combination of features and performance, the Holman Preamplifier is especially free from such problems.

Together,

The Holman Preamplifier and the Apt 1 Amplifier can eliminate the major interactions present in modern hi-fi systems. Separately, they can solve real-world problems, and so make real-world music systems work better and *sound* better.

Apt Corporation

Box 512
Cambridge, Massachusetts 02139

For an Apt 1 Amplifier brochure and the name of your local dealer.

For a Holman Preamplifier brochure and name of your dealer.

For an Apt 1 Owner's Manual, please send \$4 (\$5 foreign).

For review reprints.

Name _____

Address _____

92

profile. Perhaps we are hearing a new Bernstein.

The strings have always been the Israel Philharmonic's strongest element, and they respond to Bernstein's lyrical line even more markedly than did the New York Philharmonic's in his earlier versions of these symphonies (Columbia MS 7057, 7295). This is, I suspect, partly a matter of his own current stylistic concept, although one cannot rule out the possibility that he is responding sympathetically to the group's character.

The woodwinds and brass are distinctly inferior; except when spotlighted explicitly by Mendelssohn's scoring, they contribute little more than an amorphous background to the overall texture. Top and bottom predominate, without the detail and clarity Bernstein usually elicits. This may be due to the circumstances of live recording, circumstances beyond the conductor's immediate control. The acoustics of a well-filled hall, the effect of an audience on the performers, and a different recording team may all have contributed to a lighter, less forward sound, quite different from that which Bernstein has usually produced in his Columbia studio recordings with the New York Philharmonic. Yet he is a strong conductor, and if he is not here the energetically driving leader we have come to know so well, perhaps the difference does indicate a change in style. His infectious response to sentiment is better controlled than in the past—almost strangely introverted. His control of climax, so essential to his dramatic sense, is still evident, but the impact one expects from him isn't quite achieved.

Fascinating as this record is, it cannot receive unqualified recommendation because of the Israel Philharmonic's shortcomings. Bernstein fans may want to look into possible new facets of his approach, but they will probably prefer his earlier versions. The best account of the *Italian* is still Riccardo Muti's with the New Philharmonia, although for some the seduction of the wondrous digital sound of the Vienna Philharmonic under Christoph von Dohnányi (London LDR 10003) may compensate for a rather dull performance. P.H.

MESSIAEN: Quatuor pour le fin du temps.

Luben Yordanoff, violin; Albert Tétard, cello; Claude Desurmont, clarinet; Daniel Barenboim, piano. [Günther Breest, prod.] DEUTSCHE GRAMMOPHON 2531 093, \$9.98.

COMPARISON:

Tashi RCA ARL 1-1567

In 1972, DG missed a golden opportunity to record this work with the Boston

HIGH FIDELITY

Symphony Chamber Players. In the performance I heard that season by Silverstein, Eskin, Wright, and Kalish, Messiaen's transfigured vision of hope in the midst of desolation emitted a hypnotic radiance I have yet to encounter in any other interpretation.

Now DG has recorded this unique composition in Paris under the watchful eyes and ears of the composer, and that should count for something. Indeed, balances are impressive, and most of the tempos are very close to the metronome markings. An exception is the sixth section, "Dance of Fury, for Seven Trumpets," understandably below snuff, given its trickily syncopated unison writing.

The players work efficiently together, but limitations appear where individual contributions come to the fore. Tétard's slow vibrato becomes nerve-racking in "Praise to the Eternity of Jesus." At cue D in the final "Praise to the Immortality of Jesus," Yordanoff's landing on the G string sounds more syrupy than seraphic, while Barenboim's pianism is disconcertingly violent in the repetitive chord patterns of thirty-second notes followed by double-dotted eighths. Compare Peter Serkin in the Tashi performance: so coiled in rhythm, so terraced in the use of diminuendos. In the unaccompanied clarinet section, "Abyss of the Birds," Desurmont manages the one-measure swells from *ppp* to *ffff* nearly as smoothly as Tashi's Richard Stoltzman, but he also steals breaths and makes minor rhythmic errors.

Overall, the flaws of this new recording don't counteract its virtues, including of course that clear, rich DG recording job. I'd recommend it over the serviceable Gruenberg/Pleeth/De Peyer/Béroff version (Angel S 36587) or the somewhat rough and unsubtle Cohen/Eddy/Rabbai/Levin recording (Candide CE 31050), despite the latter's moderate price and inclusion of a filler (*Merle noir*, for flute and piano). Among commercial recordings, though, pride of place goes to Tashi, a group whose charter membership was defined by the unique scoring of this work; it repays the favor with playing of uncanny virtuosity, control, and musical acumen. A.C.

MOZART: Requiem, K. 626.

Helen Donath, soprano; Christa Ludwig, alto; Robert Tear, tenor; Robert Lloyd, bass; Philharmonia Chorus and Orchestra, Carlo Maria Giulini, cond. [Christopher Bishop, prod.] ANGEL SZ 37600, \$8.98.

So they are at it again, but the result is once more disappointing. Mozart's Requiem exacts a regrettable toll. It must be

the lack of rapport with that curious stylistic merger of the music of church and theater in the orchestral Mass of the eighteenth century, baffling to both musicians and churchmen ever since the Romantic era, that accounts for the dearth of really fine performances of this much-admired classic. The stylistic blend is even more problematic in Mozart's case because his Requiem is both highly personal and severely liturgical in spirit.

Still, a good musician, and especially an Italian, should find his way on purely musical grounds, and it is surprising that a conductor of Carlo Maria Giulini's stature should not have fulfilled our hopes—but then, he is in good company. In his defense, I must say at the outset that Angel's very poor sound must have thwarted his intentions; the excellent chorus in particular falls victim to faulty engineering. Nevertheless, there are things here that must be laid straight at Giulini's door.

While the great fugue and several other fast numbers move at a good clip, some tempos rival Klemperer's. The "Rex tremendae" is very slow, as is the "Recordare"—those fine soloists gasp a little in order to breathe at the right places—and that inef-fable choral song, the "Hostias," is down-

right funeral. The even flow of counterpoint in such places as the Introit is hampered by too much emphasis on downbeats; the conductor apparently fails to realize that Mozart deliberately opposed the *stile antico* ("Requiem aeternam dona eis, Domine") to the modern rhythmic homophony ("et lux perpetua"). This texture is quite different from such latter-day counterpoint as the heavily accented fugal "Quam olim Abraham." There are a number of such contrasts in the work, and they are not brought out. Nor is the even more subtle simultaneous employment of pared-down operatic accompaniment and almost Palestrinian polyphony, as in the otherworldly "Oro supplex," perhaps the most gripping passage in the Requiem.

The attacks are sometimes lazy, with basses and timpani the main offenders; the trombones are all over the place, though by now it is pretty well agreed that with a fully staffed chorus no *colla parte* playing is necessary, and the trombones should be restricted to obbligato passages, which are not difficult to locate. So we must consign this recording to the ranks of the many also-rans that offer decent enough performances of the score without touching on the mysterious depths of this last testament

of a genius already in sight of the Elysian Fields.

A brief postscript: Almost all recordings of musical settings of the Mass proceed from number to number either without pause or, at best, with a very slight one, even shorter than the rests observed between movements of a symphony. In this case, the recording launches the tremendous "Dies Irae" instantly after the Kyrie, which is disconcerting and blunts its explosive force. The liturgy prescribes several chanted prayers or readings between the two, as indeed between some of the other pieces, and the composer counted upon this separation. The "Dies Irae" would sound really apocalyptic if the shattering empty fifth that closes the Kyrie were permitted to evaporate from consciousness. P.H.L.

PROKOFIEV: Sonata for Piano, No. 7, in B flat, Op. 83—See Chopin: Sonata for Piano, No. 3, in B minor, Op. 58.

SAINT-SAËNS: Samson et Dalila.

CAST:

Dalila

Elena Obraztsova
(ms)

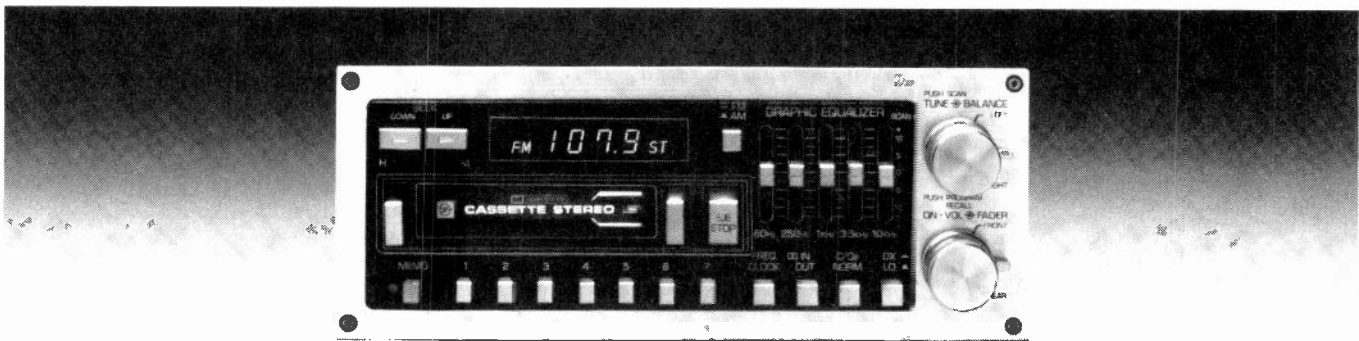

The Dashboard Wizard™. Before, there was only car stereo.

Put aside everything you've been told about car stereo. The Dashboard Wizard is with us!

He's the latest in-dash audio marvel from Fujitsu Ten. A preamp combination system that will transform your car. The precise digital electronic tuner memorizes your favorite 7 AM and 7 FM stations, with search up, search down and scan tuning, FM muting and local/distance switch. There's even a quartz clock.

Hit the equalization switch and, presto, the auto-reverse cassette deck accommodates chrome and metal tapes.

With a Life Time Metal (LTM) playback head that's built to last well into the future. His five-band graphic equalizer lets you match the music to your car.

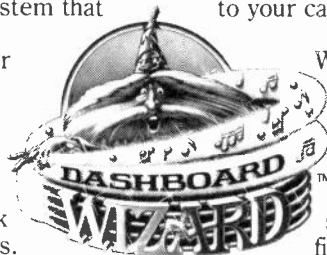

Performance? Miraculous, of course. Wow and flutter is .09% nominal—one of the best specs in car stereo. And with Dolby* on both FM and tape, hiss is a thing of the past.

Hear the Dashboard Wizard at your Fujitsu Ten dealer. Any resemblance to ordinary car stereo is a figment of your imagination.

Fujitsu Ten: The best sound on wheels.

TEN FUJITSU TEN CORP. OF AMERICA

19281 Pacific Gateway Drive, Torrance, CA 90502
In Canada: Noresco Canada Inc., Ontario

*Dolby is the trademark of Dolby Laboratories, Inc.

SUBSCRIBER SERVICE

To enter a subscription (new, renewal or gift), or to change your address, simply fill in the information indicated below.

- New or renewal subscription
 Gift subscription
 For those in the trade
 (Please check all that apply.)

DOZ II

Print name _____

Address _____

City _____ State _____ Zip _____

() 1 yr. \$9.98 () 2 yrs. \$19.96

() Bill me () Payment enclosed

For gift subscriptions, also fill in the following information:

Recipient's Name _____

Address _____

City _____ State _____ Zip _____

() 1 yr. \$9.98 () 2 yrs. \$19.96

() Bill me () Payment enclosed

(We'll send a handsome card to the recipient announcing your gift.)

In the audio or record trade?

If so, you qualify for a very special subscription rate. Enclose your business card or letterhead with this form and we'll send you the information for High Fidelity and our other publications.

CHANGE OF ADDRESS

Moved? Just send us your old magazine label (if available) and write in your new address. Or, fill out the information below:

Print name _____

Old address _____ Apt. # _____

City _____ State _____ Zip _____

Print new address _____ Apt. # _____

City _____ State _____ Zip _____

Please allow 4 weeks for us to correct our mailing labels.

Mail to:

High Fidelity
One Sound Ave.
Marion, Oh. 43302

Samson Placido Domingo (t)
 Messenger Gérard Friedmann (t)
 First Philistine Constantin Zaharia (t)
 High Priest Renato Bruson (b)
 Abimélech Pierre Thau (bs)
 An Old Hebrew Robert Lloyd (bs)
 Second Philistine Michel Hubert (bs)
 Chorus of the Orchestre de Paris, Orchestre de Paris, Daniel Barenboim, cond. [Günther Breest and Michael Horwath, prod.] DEUTSCHE GRAMMOPHON 2709 095, \$29.94 (three discs, manual sequence).
 Tape: 3371 050, \$29.94 (three cassettes).

COMPARISON:

Gorr, Vickers, Blanc/Prêtre Ang. S 3639

This brings to three the number of complete recordings of Saint-Saëns's most famous opera—hardly his only one—currently available. All are worthy performances, although in the final analysis the choice is between the earliest (1963) on Angel and the latest. This performance very much centers around Daniel Barenboim's warm and vibrant conception, spaciouly recorded, but choice will ultimately depend on one's reactions to the Dalila of Elena Obraztsova.

Samson et Dalila has often been "condemned" as an oratorio masquerading as opera—a charge that has some foundation but does not hold up if one equates "oratorio" with "antidramatic." The opera works musically, and it works on-stage; it always has, and I suspect it always will. Its oratorio overtones serve to channel Saint-Saëns's romanticism into a solid structure that is not static, but dynamic. Samson's character development, from leader of the oppressed through enslavement, lust, downfall, and enlightenment in blindness (the mill scene of Act III, perhaps Saint-Saëns's greatest dramatic writing) to the anguish and conviction of the final scene, provides the impetus for the drama. That character is superbly drawn, and its strength allows the more celebrated pages of the score to assume their proper significance: colorful, varied, musically ravishing, but dramatically secondary to Samson's plight.

That said, it must be noted that Barenboim's conception, although always dramatic, moves the work closer to oratorio than to opera. He adopts a leisurely pace throughout, emphasizing the sheerly sensuous aspects of the writing through phrasing and ritards. His excellent large chorus follows his lead very well but sounds more like an ordinary chorus than like an *opera* chorus. Its soft-grained singing in the first scene is quite beautiful, but that is its fault:

It is simply too comfortable to convey the idea of a populace crushed by misery and oppression, yearning for salvation. The yoke is too easy. Similarly, the last scene does not have the measure of fevered hysteria that delineates the Philistines in their wanton revelry before the disaster.

Placido Domingo's entrance ("*Arrêtez, o mes frères!*") is treated lyrically rather than as an expression of frustrated rage (compare it to Jon Vickers' hammer stroke), and his view of Samson is presented throughout from a lyric rather than a dramatic point of view. This can be justified if there is a consequent enlightenment in the third act, but I never felt anguish in Domingo's mill scene, and his final scene seemed outside the character rather than at one with it, as it must be. Domingo's lesser attention to firmness of vocal line and accuracy of note values adds to this more generalized treatment of Samson, one that robs the hero of his rightful stature.

Obraztsova is even more of a problem. On-stage the deficiencies of her large and romantic mezzo—a constant vibrato, an erratic equalization, a "covered" sound, as though sung into a brass cistern—are mitigated and even take on an intriguing individuality. But on records these faults are magnified and obscure her very real attention to sonority and characterization. She tries to compensate (as she does on-stage) by adopting a tigerish intensity, and this can be thrilling. Yet here, at Barenboim's slow tempos, and given her general indifference to legato (which is, as with so much French opera, of paramount importance), the declamatory outbursts stick out uncomfortably. Since records rob her of her considerable visual assets as an actress, her performance, conscientious as it is, lacks the unity it possesses on-stage and tends to dissolve into isolated moments.

Renato Bruson makes a dry-voiced High Priest, a bit uncomfortable in his French but nonetheless properly hectoring and implacable. The supporting cast is unremarkable, except for Robert Lloyd's well-sung Aged Hebrew.

Good, then, but not great. Its main competition, however, is close to being great. I have always felt that the Angel version stands as one of the finer opera recordings made—if not on the first list, certainly on the second. Rita Gorr, at the height of her vocal eminence in 1963, is a simply magnificent Dalila. Her vocal clarity and firmness are a joy, as are her attention to the vocal line and the variety of inflection she brings to it. One might want a bit more plushness and sexuality, but this is first-rate operatic singing. Ernest Blanc, if again a dry-voiced High Priest, is likewise excellent; the language is at the constant service

of the music, and the conception is fully dramatic.

Vickers' Samson is, admittedly, rough-edged: not by any means letter-perfect in French, given to his trademarked (but at this stage still incipient) croon in softer passages, and generally declamatory. But, *grand Dieu!* This is a Samson—a leader of his people—whose animal vitality leads inexorably to his enslavement and enlightenment. Vickers has rendered the final act better since 1963, but even then it was infused with the spirit demanded by the text and the music. His Samson eclipses Domingo's, despite the latter's greater lyric gifts.

Georges Prêtre's conducting career has been uneven, but from the start he has had a strong rapport with this score. His leadership—leaner, more propulsive, and more rhythmically alive than Barenboim's, yet luscious enough when the occasion warrants—is closer to the spirit and drama of the work, even though Barenboim brings out felicities that Prêtre does not.

The RCA recording (ARL 3-0662) is not in a class with either of these. James King sings a constricted, effortful Samson, Bernd Weikl is an acceptable High Priest, and Giuseppe Patané's conducting is little

better than routine. Its calling card is the Dalila of Christa Ludwig, sung with appropriate sensuousness, yet always dramatic. But Ludwig, alas, cannot carry the show. P.J.S.

SCHICKELE: *The Knight of the Burning Pestle: Songs (9); Elegies; Summer Trio.* For a featurette, see page 76.

SCHUBERT: *Sonata for Piano, in B flat, D. 960.*

Lili Kraus, piano. VANGUARD VSD 71267, \$7.98.

This just misses being a great performance. Never one to underplay, Kraus sees not only dreamy, drawn-out lyricism in this sonata, but also drama and tension. To express them, she inserts subito fortes, changes a dynamic from *ppp* to a hefty mezzo forte, stresses the big line at the expense of minute rhythmic detail, and favors explosive vehemence.

As applied to Schubert's companion opus, the A major Sonata, D. 959 (long a Kraus specialty, which Vanguard should invite her to re-record), her willfulness and vitality seem appropriate and even riveting, but the longer-breathed B flat Sonata needs

a more patient, less brusque treatment. The "excitement" seems artificial; after once being startled by Kraus's pouncing and driving, I longed for a wider range of color and a more beautiful sonority. Still, she is always interesting and often splendid, particularly in her heroic reading of the *Andante sostenuto*. This is easily one of the finest recordings of the work.

Vanguard's sound is adequate without being especially luminous or sonorous. The review copy had somewhat noisy surfaces and a little warpage. H.G.

SCHUBERT-LISZT: *Fantasia for Piano and Orchestra, in C, D. 760 (Wanderer).* **SCHUMANN:** *Concerto for Piano and Orchestra, in A minor, Op. 54.*

Ilan Rogoff, piano; Philharmonia Orchestra, Kurt Sanderling, cond. [Anthony Hodgson, prod.] UNICORN RHS 367, \$10.98 (distributed by Euroclass Record Distributors, Ltd., 155 Avenue of the Americas, New York, N.Y. 10013).

SCHUBERT-LISZT: *Fantasia for Piano and Orchestra, in C, D. 760 (Wanderer).* **WEBER-LISZT:** *Polonaise brillante, in E, Op. 72 (L'Hilarité).* **LISZT:** *Fantasia on Beethoven's Ruins of Athens.*

Jerome Rose, piano; Philharmonia

Back to reality.

Loud louds and soft softs. That's what your records and tapes can't give you. Current recording and broadcasting techniques just can't reproduce the wide dynamic range of live performance. That's why you need MXR's Dynamic Expander. You've got to hear it all.

The MXR Dynamic Expander restores a large portion of those lost musical dynamics. It puts power back into loud moments, and lets sensitive subtleties come through.

So get back to reality with the MXR Dynamic Expander.

MXR Innovations, Inc., 740 Driving Park Ave., Rochester, New York 14613, (716) 254-2910

MXR

Consumer
Products Group

MXR

POWER

RELEASE
TIME

EXPANSION

SLOW FAST

1.2 1.0 MAX

+6
+3
0
-3
-6
-9
-12
-15
-18
-21

LEVEL

Dynamic expander

IN OUT

Hungarica, Richard Kapp, cond. TURN-ABOUT QTV 34708, \$4.98 (SQ-encoded disc).

For the most part, Liszt's ministrations on behalf of other composers fall into two categories: fairly straight arrangements of orchestral and instrumental works for piano and more freely inspired piano paraphrases from operas. Of course, the boundaries are sometimes blurred, as in the six *Transcendental Etudes After Paganini*, where masterly violin writing is transformed into equally brilliant and idiomatic piano writing.

The *Wanderer Fantasy* eludes both categories, expanding an original piano solo into a less practical concerto format. Aside from a few added motifs, an expanded cadenza, and a few bowdlerized harmonies, Liszt does not consciously interfere with Schubert's trend of thought. But when he accompanies the piano with a stringed instrument in the middle of the slow movement (lacking a score, I cannot say for sure whether it's a low viola or, more probably, a high cello), it sounds for all the world like a fugitive passage from his own *A major Piano Concerto*. One wonders just what his intentions were in making this confection, which, though palatable enough, tends to soften Schubert's heroic proportions.

Both of the new editions supersede the clangorous old one by Brendel and Gieslen (Turnabout TH5 34265). The Unicorn is a luxury item offering a superlative imported pressing and a topflight orchestral framework. The performance is satisfying on all grounds, lyrical yet strong, and captured in beautifully clear, resonant acoustics. But then, orchestral finesse and careful rehearsal are less crucial here than in certain other concerted works, and the Philharmonia Hungarica, though raw sounding, is more than adequate in the Turnabout entry. Rose is perhaps even more persuasive than Rogoff, with a somewhat sterner, aggressively rhetorical approach. His performance triumphantly survives close-up reproduction, which flatters the bass line but imparts a wiry sound to the piano's middle range. Both versions are worthy, but Rose's, with processing better than average for Turnabout, is clearly the better value.

The companion works on the Turnabout disc are lots of fun. The Weber, fitted with an introduction culled from an earlier Weber polonaise, was dedicated to Henselt, one of Liszt's foremost pianistic rivals, and dates from around the same time (1850) as the *Wanderer* orchestration. The *Ruins of Athens Fantasia* of 1848-52 was Liszt's second outing with the Beethoven opus (pre-

ceded by a *Capriccio alla turca* for piano solo). Rose plays both to the hilt, and the slightly uncouth sound of the orchestra presents little problem.

Rogoff's disc offers another excellent account of the Schumann piano concerto, unaffected in its phrasing but with a few minuscule lapses in ensemble (in the first movement's A flat section, for example); in a masterpiece like this, such things *are* important. In addition, the pace of the third movement is slightly too comfortable.

H.G.

SCRIABIN: *Poem of Ecstasy*, Op. 54—See Debussy: *La Mer*.

SHOSTAKOVICH: *Song Cycles*.

Irina Bogacheva, mezzo-soprano*; Yevgeny Nesterenko, bass**; Moscow Chamber Orchestra, Rudolf Barshai, cond.*; Moscow Radio Symphony Orchestra, Maxim Shostakovich, cond.**. [A. Jung, V. Antonenko, Y. Kokzhayan, prod.] COLUMBIA/MELODYA M2 34594, \$17.98 (two discs, manual sequence).

Six Romances on Verses of English Poets, Op. 140** *; Six Songs to Poems by Marina Tsvetayeva, Op. 143* *; Suite on Verses by Michelangelo, Op. 145** **

Two of these cycles, *Suite on Verses by Michelangelo* (1975) and *Six Songs to Poems by Marina Tsvetayeva* (1974), date from the final phase of the composer's career; the third, *Six Romances on Verses of English Poets* (Shakespeare, Raleigh, Burns, and an anonymous versifier), though rescored for bass and chamber orchestra in 1971, was originally written for voice and piano in 1942. As one might imagine from the differences among the three collections of poems and from Shostakovich's well-established sensitivity to the nuances of poetic language, each of the cycles is distinctive. Yet all of them—even the one written more than thirty years earlier than the others—are marked by a mood of somber introspectiveness.

The songs as a whole betray a powerful, highly individual sense of moral disillusion, even of despair. Yet there is also a countervailing confidence. Not simply because the group of Michelangelo poems chosen by Shostakovich concludes with "Immortality" and the twice-repeated maestoso affirmation of its final line, "And in death, decay will not touch me." Nor because the English lyrics end on a note of satirical extroversion. Nor, again, because the last of the Tsvetayeva poems is a heartfelt statement of gratitude and dedication to the poet Anna Akhmatova, savagely attacked (and mostly silent) during the long night of Stalin's ascendancy.

LOW FIDELITY
Without fidelity in the *low* frequencies,
no speaker can deliver full *high* fidelity.

But the reason for adding the Audio Pro B2-50 Subwoofer to your system goes much deeper than having the bass essential to "life-like" sound reproduction. The powerful built-in amplifier and fully adjustable passive/electronic crossover of the B2-50 enable your main amp and speakers to operate more efficiently, with less distortion. Even the best of systems will become far better with the addition of a subwoofer. And the speed, accuracy and power of Audio Pro's patented "Ace-Bass" principle make the B2-50 the best of all the subwoofer systems.

audio pro
The total design approach to audio.

Model No. B2-50

For more information and your nearest dealer
CALL TOLL FREE 800-638-0228 Maryland 0-459-3292 COLLECT Metro D.C. 459-3292

The confidence glimpsed overtly in such places as these is more pervasive and implicit in all three cycles: It is to be found in Shostakovich's incomparable artistry, in the assurance and skill with which all of these poems have been transformed into music. In these cycles Shostakovich's mastery of orchestral effects—the variety of timbres, textures, and colors he conjures up—is especially notable, from the delicacy of the accompaniment to Burns's "Comin' Thro' the Rye," composed mostly of celesta, violins, and violas, to the unexpected flourishes of accentuation provided by the xylophone in Tsvetayeva's "Poet and Tsar" and the violence of the brass introduction to Michelangelo's sonnet "Rage."

But, above all, the confidence manifests itself in the conviction Shostakovich brings to the realization of his texts, the controlled but heartfelt emotion he creates through them. About the personal meaning of these songs there can be little doubt. Part of their impact is derived from the way they so memorably fuse art and politics: It is hard to miss the pertinence to the composer of Michelangelo's disgust at the Rome of Pope Julius II; of Burns's "Macpherson's Farewell," with its cry "Forgive my country!"; of the poem addressed to the persecuted Akhmatova by a poet who, not long after writing it, hanged herself in despair. All three works testify to the ennobling power of art and are as rewarding as any music I have heard for a very long time.

The highest praise I can give the performances (recorded, it would seem, between 1975 and 1976) is to say that they are entirely worthy of Shostakovich's songs. Yevgeny Nesterenko phrases with breadth and majesty, while at every point giving appropriate emphasis to inflections of the text. Irina Bogacheva is equally distinguished. Both orchestras and their conductors are admirable collaborators.

The sound, which naturally varies somewhat, is intimate without being aggressive. There are good notes, transliterations, and, I am glad to report, literal translations from the Russian. Not to be missed. D.S.H.

VERDI: Don Carlos.

CAST:

Elisabeth	Mirella Freni (s)
Thibault	Edita Gruberová (s)
A Voice from Heaven	Barbara Hendricks (s)
Princess Eboli	Agnes Baltsa (ms)
Don Carlos	José Carreras (t)
Count Lerma	Horst Nitsche (t)
Rodrigo, Marquis of Posa	Piero Cappuccilli (b)

King Philip	Nicolai Ghiaurov (bs)
The Grand Inquisitor	Ruggero Raimondi (bs)
A Friar	José van Dam (bs)
Chorus of the Deutsche Oper, Berlin, Berlin Philharmonic Orchestra, Herbert von Karajan, cond. [Michel Glotz, prod.] ANGEL SZDX 3875, \$36.92 (four discs, automatic sequence).	

Anyone who wants to buy a *Don Carlos* without the Fontainebleau act now has

the choice among this new Angel album, the 1951 Cetra set, still available in the Turnabout/Vox historical series (THS 65054/6), and the 1954 HMV set, now available on Seraphim (6C04). (The 1966 London [OSA 1432] and 1971 Angel [SDL 3774] sets include the Fontainebleau act, as did the 1962 Deutsche Grammophon version, now deleted.) The choice among the three four-acters is not quite as simple as might at first appear. Turnabout and Seraphim are more appropriately cast and much

The New Face of Automotive Audio

In 1975 ADS revolutionized mobile high-fidelity with the world's first studio-quality bi-amplified minispeaker, the ADS 2001. It spawned an entirely new industry virtually overnight.

Today, ADS continues to pave the way with the Power Plate 100 amplifier and the ADS 300i speaker system. Together they deliver a level of performance *never before attainable* in a permanently installed car stereo system.

The Power Plate 100 effortlessly produces 50 watts per channel* of clean, undistorted power. It actually outperforms many home-use amplifiers. The 300i is the first flush-mounting automotive speaker system with high sound pressure level capability *and* ADS' world-famous musical accuracy. The Power Plate fits under the seat or in the trunk. The 300i fits in the doors, panels or rear deck.

Supremely compact, easy to install, powerful, musical and durable, the system is an unexcelled value at \$299.50 for the Power Plate 100 amplifier and \$117.50 each for the 300i speakers.**

You can see *and* hear the ultimate automotive high-fidelity system at your ADS dealer today. But we warn you. You may never be able to live with ordinary car stereo again.

For more information, please write ADS, Dept. HF4, or call 1-800-824-7888 (California 1-800-852-7777) toll free and ask for Operator 483.

*at 4 ohms, 20-20,000 Hz with less than 0.08% THD **suggested retail prices

Where technology serves music

Analog & Digital Systems, Inc., One Progress Way, Wilmington, MA 01887 (617) 658-5100

cheaper; on the other hand, the recorded quality of the former is poor and of the latter fair; and in both the text is sadly disfigured by those "theater cuts," not acceptable in the theater anymore and unforgivable in a recorded performance. The album at hand presents no textual problems: It is a complete recording of the opera as Verdi revised and abridged it in 1882-83 and as he brought it to the stage of La Scala in 1884, in Italian translation, with his future Otello in the title role.

The problem is, rather, whether anyone still wants—on records—a *Don Carlos* shorn of the long, beautiful duet that forms most of the Fontainebleau act. In the theater, the case for the abridged version can be argued, and Karajan presented it powerfully in his famous Salzburg production. But that Salzburg performance was cruelly cut—it was a drastic abridgment of the already abridged version. In his recording, Karajan has reinstated the missing passages. I'm surprised he didn't add Act I as well, to make his set fully competitive with the Solti (London) and Giulini (Angel) versions, which give us more music, but also occupy only eight sides.

The Salzburg *Carlos*, which underlies this new recording, opened in 1975. Its stable elements have been Freni's Elisabeth, Cappuccilli's Posa, and Ghiaurov's Philip, but Placido Domingo was then the Carlos, and Christa Ludwig, followed by Eva Randova, sang Eboli. In the 1978 revival, Carreras, Gruberová, and Van Dam were in the cast; the recording was made in Berlin shortly after the 1978 festival, and Baltsa (who had been singing Eboli in Berlin) and Raimondi (who had sung one Philip in Salzburg) joined the studio cast. It was recorded in six days, two sessions a day.

The four-act version, it must be said, does suit Karajan's view of the work as a heavy, somber drama—massive, imposing, almost unrelieved in its noble earnestness. The Fontainebleau idyll has fled before it begins; the start is the stark funeral chant of the monks. Many of Karajan's tempos are slow—slower than those Verdi indicated. Eboli is no sparkling coquette. The "Veil Song"—marked *allegro brillante* with an *allegro giusto* refrain—is no glittering diversion tossed off by the court ladies while they await the Queen's return, but a grand display piece; instead of quasi-improvised flamenco cadenzas, Baltsa launches into something like a tremendous Valkyrie battle cry. The *galant* grace of the succeeding trio, where Eboli and Posa chat about Paris fashions, becomes something slow and labored. "O don fatale" is not *allegro*. Posa's "Per me giunto" is slow. The lovers' parting duet, "Ma lassù ci vedremo," is slower than the marked quarter-note 60, and the

tender 12/8 throbbing is dragged out.

The second scene of Act III (well, it's really Act II in this version, but to avoid confusion I'll stick to the five-act numbering) is well matched by Karajan's approach. Verdi once described this huge auto-da-fé finale as the heart of his opera, and it's the only scene of the 1867 original he left unaltered in his revision. Karajan catches the weight, the splendor, the terror, the excitement of these public confrontations—a Meyerbeer spectacular, added to the original *Carlos* scenario at Verdi's own request, but composed as if to show that massed forces and grand spectacle could serve more elevated ends than those Meyerbeer and Scribe had in mind. In carrying over something of these oppressive and hectic splendors into every other scene of the opera, Karajan is, of course, being true to one element, and an important one, of Verdi's drama. As one of the album essays puts it, "there is always a cloud over the bright Spanish sun." At Salzburg there was; the production was unremittently severe in its grandeur, and that sense comes across in the recording. But I think something Verdi also intended has been lost: contrasts, moments of lightness, and a kind of straightforward lyricism in which both the characters and the audience forget, for a moment, the terrible pressures of Church and State and, to put it too simply, "enjoy the music."

So there are times when I find something exaggerated about this powerful and deeply pondered reading. In the introduction to Act V, for example, the contrast between the soft-breathing horns and the loud-swelling strings is almost too much. The superb Berlin orchestra, which plays as if it were an extension of Karajan's thought, can at a touch, at a glance, surge into a *fff* of the utmost force and beauty, or sink to a scarce-audible *ppp* whisper. (The recording, in turn, is achieved across a very wide dynamic range; at a setting that makes one strain to catch the softest passages, the loudest passages may well have the neighbors complaining.) Have the drums ever banged so loudly at the Inquisitor's outburst "O Re, se non foss'io con te"? Have the chromatic string figures that frame Elisabeth's "Rendetemi la croce"—*ff*, then *ppp*, then *pppppp*—ever spanned so large a dynamic range? Has the crash at Posa's "la pace è dei sepolcri" ever been more hysterically violent? This is an extreme realization of the colors and the dynamic contrasts in Verdi's score. It is wonderful in a way; the deep, formidable growl of the Inquisitor's entrance music is filled with menace and power. But perhaps it goes too far. Certainly, it lacks naturalness.

Karajan is the dominating presence, and the Berlin Philharmonic holds the

HIGH FIDELITY'S

Free Armchair Shopping Service

On the card opposite, circle the number indicated at the bottom of the ad or at the end of the editorial mention of the product you're interested in. (Key numbers for advertised products also appear in the Advertising Index.)

Type or print your name, address, and zip code on the card. Postage is prepaid.

Mail the card today. You'll soon receive free product literature and specifications from manufacturers.

MAIL ORDER BUYER'S SERVICE

Three Great Buyer's Guides From HIGH FIDELITY Order Now!

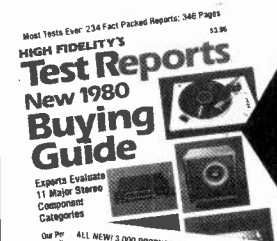

1980
HIGH
FIDELITY'S
Test
Reports
\$3.95
Circle
161



1980
Buying
Guide to
Stereo
Components
\$3.95
Circle
162

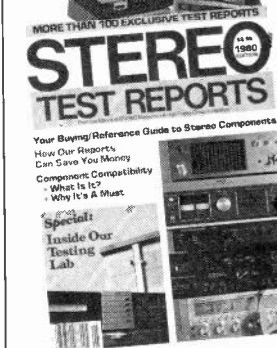

1980
Stereo
Test
Reports
\$2.95
Circle
164

To order, circle the number on the attached card that matches the number of the Buyer's Guide you want. Enclose payment plus \$1.00 for postage with your order and mail to:

HIGH FIDELITY
One Sound Avenue
Marion, Ohio 43302

(Enclose payment. No credit orders.)

Perfection for the Professional

Drawing upon their unequalled 30 year leadership in magnetic recording technology, Tandberg's TD 20A open reel tape recorder extends their traditionally superior level of performance to even further limits—to even beyond the present capabilities of today's magnetic recording tape! This is due to Tandberg's exclusive ACTILINEAR Recording System, which not only provides up to 20 dB headroom margin over existing tape, but is specifically designed to be used with the new high coercivity tapes that will appear in the market in the near future—including the soon-to-be-available metal particle tapes. No other quality open reel tape recorder can make this obsolescent-proof claim today.

The ACTILINEAR Recording System's extremely linear frequency response ("ruler flat" according to some test reviewers) not only makes the TD 20A essentially immune to slew-rate limiting and transient intermodulation distortion (TIM), but also means better transient response and lower distortion overall.

Adding to the TD 20A's superior level of quality & performance is its unique PROM computer-controlled four-motor transport, as well as its many standard operating features that permit a degree of performance and control flexibility that you would expect only from Tandberg—the world leader in tape recorders.

Visit your authorized Tandberg dealer for a demonstration of the TD 20A. Check our *guaranteed minimum specifications* and rate them against any other manufacturer. Combined with the unsurpassed ease of operation & control, the TD 20A is probably more tape deck than you actually need. Isn't it the way things should be?

For your nearest dealer write:
Tandberg of America, Inc.
Labriola Court
Armonk, N.Y. 10504

TANDBERG 

Tandberg's unique ACTILINEAR Recording System, offering up to 20 dB headroom margin over existing tape. And easily adjustable for use with the new high coercivity tapes to come, so your TD 20A is obsolescent-proof!

Tandberg's exclusive PROM computer-controlled four-motor transport that eliminates solenoids and relays. The unique fourth motor (behind the left reel) operates the pinch roller & servo brakes, achieving a smooth, noiseless and reliable operation simply not possible with the conventional solenoid-activated systems the fourth motor replaces. The ultimate touch to our "punch-in" record capability.

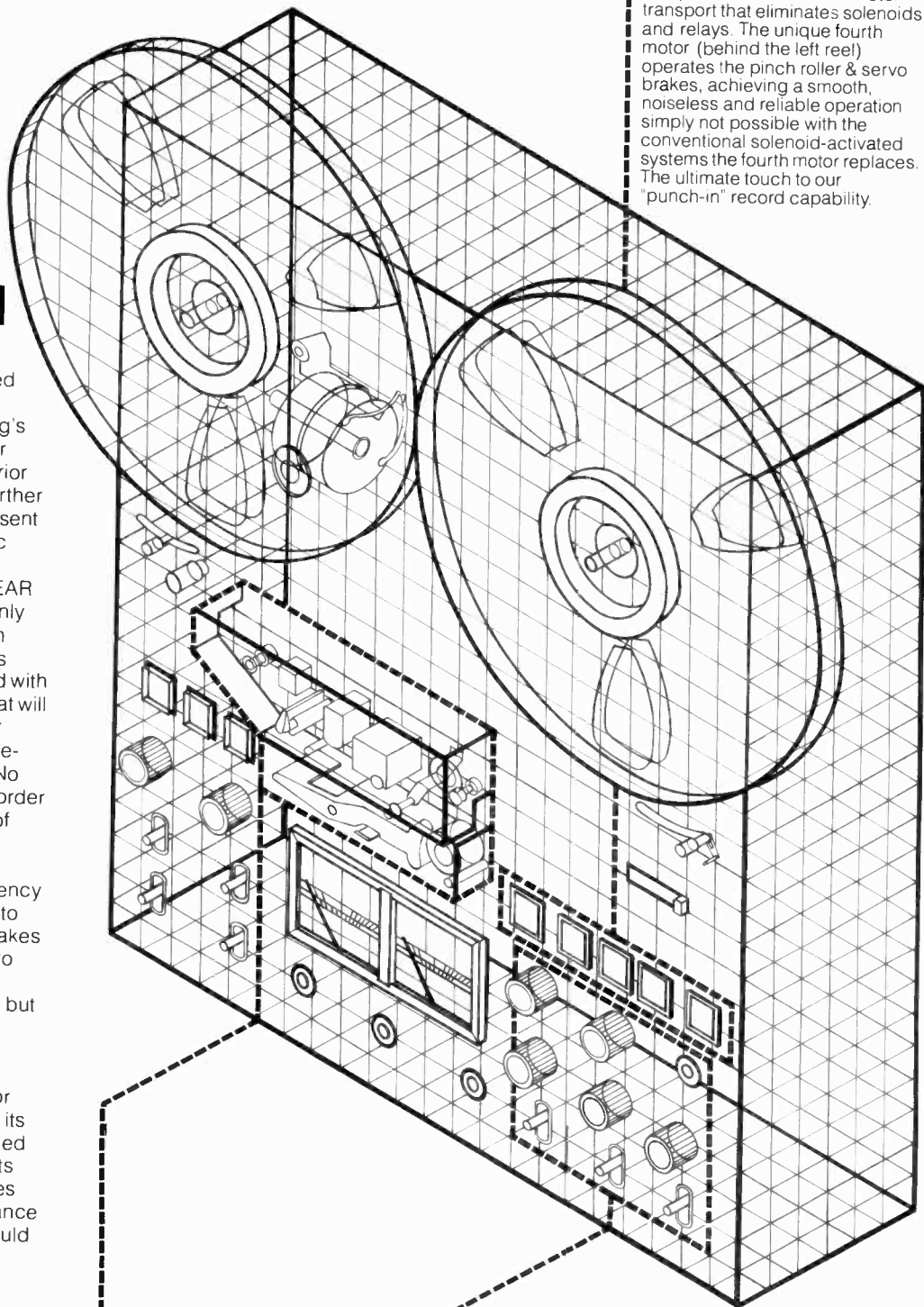

Still more features: Four line input mixer + Master gain control with pre-set. Self adjusting input amplifier. Front-panel bias adjustment, Mic sensitivity switch, Channel Sync & Sound-on-Sound, "Free" mode & Edit/Cue facilities, Infrared-controlled motion sensing device, Professional scrape-flutter filter, Separate power supplies for operational functions & audio functions, and Peak-reading equalized meters that have been graphically redesigned for easier reading.



Optional PCM infrared wireless remote control for an ease of operation that doesn't tie you down to the length of a cable. Plus automatic start & stop via a timer switch (optional).

Recent Record Releases

The following listings are excerpts from the "New Listings" section of the February Schwann Record and Tape Guide. Some listings contain a cross-reference (*) to other works on the recording. Letters in brackets refer to language used in vocal music (G, German; E, English, etc.). Cassette editions are indicated by the symbol \angle . Quadriphonic discs are indicated by a Q following the record number; digital discs are indicated by a D following the record number.

BACH, JOHANN SEBASTIAN

Cantatas

No. 91, Gelobet seist du, Jesu Christ

Bratschke, Esswood, Equiluz, Egmond, Leonhardt, Consort, Ghent Coll. Vocale, Hanover Boys Cho. [G] † Can. 92, 93, 94
2-Tel. 2635441

No. 92, Ich hab' in Gottes Herz und Sinn

Bratschke, Esswood, Equiluz, Egmond, Leonhardt, Consort, Ghent Coll. Vocale, Hanover Boys Cho. [G] † Can. 91, 93, 94
2-Tel. 2635441

No. 93, Wer nur den lieben Gott lässt walten

Wiedl, Esswood, Equiluz, Van der Meer, Harnoncourt, Concentus Musicus, Tölz Boys Cho. [G] † Can. 91, 92, 94
2-Tel. 2635441

No. 94, Was frag' ich nach der Welt

Wiedl, Esswood, Equiluz, Van der Meer, Harnoncourt, Concentus Musicus, Tölz Boys Cho. [G] † Can. 91, 92, 93
2-Tel. 2635441

BEETHOVEN, LUDWIG VAN

Concerti (5) for Piano & Orchestra

No. 2 in B \flat , Op. 19

Arrau, Haitink, Concertgebouw Orch. † Son. 21 Phi. Fest. 6570173; /7310173

No. 5 in E \flat , Op. 73, "Emperor"

Pollini, Böhm, Vienna Phil.
DG 2531194; /3301194

Overtures

Jochum, London Sym. (Coriolan, Egmont, Fidelio, Leonore 3) † Sym.
8-Ang. SZ-3890(Q)

Quartets (16)

Cleveland Qr (Op. 18) 3-RCA ARL3-3486

Sonatas (32) for Piano

No. 21 in C, Op. 53, "Waldstein"

Arrau † Con. 2
Phi. Fest. 6570173; /7310173

Symphonies (9) (complete)

Jochum, London Sym. † Over.
8-Ang. SZ-3890(Q)

BRAHMS, JOHANNES

Symphonies (4)

No. 1 in c, Op. 68

Karajan, Berlin Phil.
DG 2531131; /3301131

No. 2 in D, Op. 73

Karajan, Berlin Phil.
DG 2531132; /3301132

Variations on a Theme by Haydn, Op. 56a

Giulini, Phil. Orch. † Schubert:Sym. 8
Sera. S-60335

CHOPIN, FRÉDÉRIC

Ballades 1, 2, 3, 4 (Op. 23, 38, 47, 52)

Anievas † Impromptus Sera. S-60336

Impromptus (4)

Anievas † Ballades Sera. S-60336

ELGAR, EDWARD

The Dream of Gerontius, Op. 38

Hodgson, Tear, Luxon, Gibson, Scottish Nat'l Orch. & Cho. [E] 2-Van. 71258/9

GOUNOD, CHARLES

Symphonies (2): No. 1 in D, No. 2 in E \flat (1855)

Plasson, Capitole de Toulouse Orch.
Ang. SZ-37726

GRIEG, EDVARD

Sonata No. 2 in G for Violin & Piano, Op. 13

Bor, Lowenthal † Saint-Saëns:Vn Son. 1
Pel. 2014

HAYDN, (FRANZ) JOSEPH

Quartet in C, Op. 76, No. 3, "Emperor"

Italiano Qr † Mozart:Qr 17
Phi. 9500662; /7300762

Trios (4) for 2 Flutes & Cello, "London"

Douglas, Carstairs, Rosen † Pleyel; G. Sammartini Orion 78322

KRENEK, ERNST

Capriccio for Cello & Orchestra (1955)

Elsing, Stephens, Amer. Camerata † Dissembler; Moss Orion 79362

The Dissembler, for Baritone & Orchestra (1979)

Ingham, Stephens, Amer. Camerata † Capriccio; Moss Orion 79362

LISZT, FRANZ

Légendes (2)

Ciccolini (see Piano) Sera. S-60343

Piano Music

Ciccolini: Invocation & Funérailles; Deux Légendes; Venezia e Napoli

Sera. S-60343

Venezia e Napoli (Années, 2nd Year, Supplement)

Ciccolini (see Piano) Sera. S-60343

MAHLER, GUSTAV

Symphony No. 4 in G

Mathis, Karajan, Berlin Phil.
DG 2531205; /3301205

MOROSS, JEROME

Concerto for Flute with String Quartet

(1978); Sonata for Piano Duet & String Quartet (1975)

Zlotkin, Sortomme Qr; Arzruni, Gianattosio, Sortomme Qr Var./Sara. 81101

MOURAVIEFF, LEO (1905-

Nativité, for String Trio & Orchestra

Faerber, Württemberg Ch. Orch. † Shostakovich:Ch. Sym.; Tcherepnin

Turn. 34545

MOZART, WOLFGANG AMADEUS

Concerti (25) for Piano & Orchestra

No. 9 in E \flat , K.271

Brendel, Marriner, St. Martin's Acad. † 2-Piano Con. Phi. 9500408; /7300616

Concerto No. 10 in E \flat for 2 Pianos, K.365

Brendel, Cooper, Marriner, St. Martin's Acad. † Con. 9 Phi. 9500408; /7300616

La Clemenza di Tito, K.621

Mathis, Varady, Berganza, Schreier, Adam, Böhm, Dresden St. Orch., Leipzig Radio Cho. [I] 3-DG 2709092; /3371049

Quartet in F for Oboe & Strings, K.370

Piguët, Esterhazy Qr † Qn K.407
Tel. 642173; /442173

Quartets

No. 17 in B \flat , K.458, "Hunting"

Italiano Qr † Haydn:Qr Op. 76/3
Phi. 9500662; /7300762

Quintet in E \flat for Horn and Strings, K.407

Baumann, Esterhazy Qr † Oboe Qr
Tel. 642173; /442173

Symphonies (41)

No. 40 in g, K.550

Karajan, Berlin Phil. † Sym. 41
DG 2531138; /3301138

No. 41 in C, K.551, "Jupiter"

Karajan, Berlin Phil. † Sym. 40
DG 2531138; /3301138

PLEYEL, IGNAZ

Grand Duos (3) for 2 Flutes, Op. 68

Carstairs, Douglas † Haydn:2 Fl-Cello Trios; G. Sammartini Orion 78322

PUCCINI, GIACOMO

La Bohème

Ricciarelli, Putnam, Carreras, Wixell, Davis, Royal Op. [I]
2-Phi. 6769031; /7699116

RIMSKY-KORSAKOV, NIKOLAI

Scherherazade, Op. 35

Svetlanov, London Sym. Ang. SZ-37555

RUBINSTEIN, ANTON

Concerto No. 1 in e, Op. 25

Fardink, Freeman, Royal Phil.
Orion 79347

SAINT-SAËNS, CAMILLE

Sonata No. 1 in d for Violin, Op. 75

Bor, Lowenthal † Grieg:Son. 2 Pel. 2014

SAMMARTINI, GIUSEPPE

Trio Sonatas

Douglas, Carstairs (flutes), Gibson, Rosen (in F) † Haydn:2 Fl-Cello Trios; Pleyel Orion 78322

SCARLATTI, ALESSANDRO

Concerti grossi (12)

I Musici (Nos. 1-6)
Phi. 9500603; /7300725

Il giardino di amore (1700-5)

Gayer, Fassbaender, Stadlmair, Munich Ch. Orch. [I] DG 2535361; /3335361

SCHUBERT, FRANZ

Quartets

No. 12 in c, "Quartettsatz", D.703

Italiano Qr † Qr 14
Phi. Fest. 6570180; /7310180

No. 14 in d, "Death & the Maiden", D.810

Teach yourself the basics with ...

The Step-by-Step Guide to Photography

By Michael Langford

Here's the one volume every beginning photographer needs — a complete, basic guide, organized for understanding and absolute practicality, devoted to the essentials of taking and making good pictures. Clearly illustrated with over 800 drawings and photographs, many in color. At each step of the way, specific exercises and assignments test and extend the reader's understanding of procedures and principles, including:

- Fundamentals of Camera Operation
- Film-loading and Focusing
- Processing and Printing
- Techniques
- Equipment
- Color Photography
- Individual Photographic Style and Approach
- How to use Natural Lighting
- Making Enlargements
- Picture Building
- Darkroom Techniques
- And Much More

Produced by the same editors and designers responsible for the two great photographic best sellers, *The Book of Photography* and *The Photographer's Handbook*.

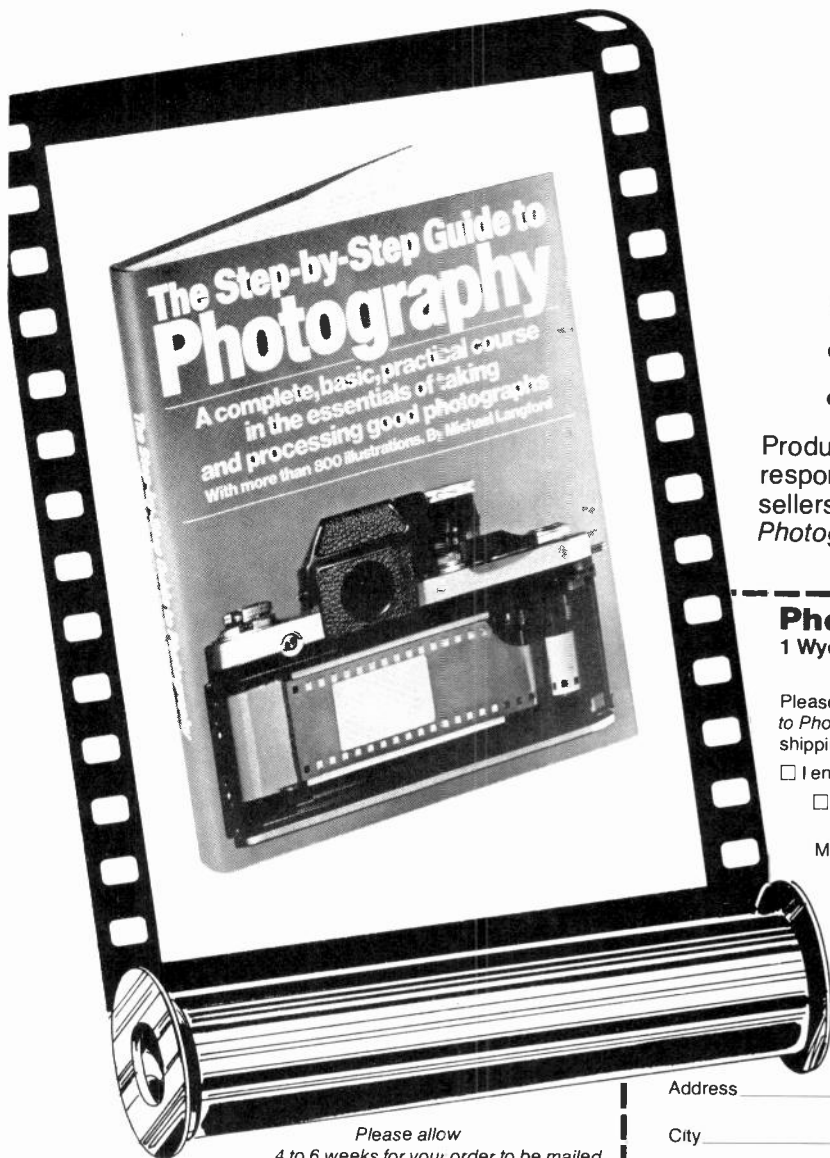

Photographer's Book Service

1 Wyeth Street, Marion, Ohio 43302

1009

Please send me _____ copy(ies) of *The Step-by-Step Guide to Photography* by Michael Langford @\$15.95 plus \$1.25 each for shipping. Residents of OH, NY, and MA add applicable sales tax.

I enclose \$_____ Charge to

VISA Master Charge

My Credit Card number is _____

Interbank number _____

Card Expires _____

Signature _____

Name _____

Address _____

City _____ State _____ Zip _____

Please allow
4 to 6 weeks for your order to be mailed.



Enjoy Music More

If the recorded music you purchase and listen to is important in the way you enjoy life . . . you ought to know about a goldmine of helpful information for every record collector.

Schwann Record & Tape Guide

is a compilation of information about records and tapes of many classifications. This wonderfully useful catalog uncovers titles you didn't know were available, helps you select versions by conductors and artists whose work you prefer . . . shows you money-saving reprints on budget labels . . . and much, much more.

More than 65,000 records and 8-track and cassette tapes are listed in the monthly *Schwann-1* and its semi-annual companion, *Schwann-2*. All are available through your record dealer if you ask for them by Schwann title and number. Schwann opens up rich rewards in your record collecting hobby. See your record dealer for latest copies.

Schwann-1 Monthly. Lists the month's new releases in every category. Also nearly 45,000 available recordings on 702 record labels, 231 tape labels, 82 quadraphonic labels, in classical, recent popular, rock, jazz, musical shows, country, opera, ballet, electronic, etc. \$1.25 at your dealer's.

Schwann-2 The semi-annual companion catalog for specialized categories: pop more than two years old, classic jazz, classical classics of the pre-stereo era, also the great re-issue catalogs; international pop & folk on domestic labels, spoken, educational, religious, etc. \$1.25 at your dealer's.

SPECIAL PRICE SAMPLE OFFER

If your favorite store doesn't carry Schwann, order samples by mail, but please try your dealer first. Prices include postage and handling.

- Latest Schwann-1 (monthly) \$2.50
- Latest Schwann-2 (semi-annual) \$2.50
- Combination Offer: latest Schwann-1 (monthly) and latest Schwann-2 (semi-annual) \$4.50
- Basic Record Library booklet.
Lists 1,000 suggestions in classical music by musical periods for your enjoyment.
Send 75¢ for cost of handling and postage.

I enclose \$ _____ for the items checked above.

Name _____

Address _____

City _____ State _____ Zip _____

Dealer's Name & Address _____

ABC Schwann Publications, Inc.

2160 Patterson St., Cincinnati, OH 45214

HF111

Italiano Qr † Qr 12
Phi. Fest. 6570180; /7310180
Symphony No. 8 in b, "Unfinished", D.759
Giulini, Phil. Orch. † Brahms:Haydn Var.
Sera. S-60335

SCHUMANN, ROBERT

Fantasia in C, Op. 17
Rubinstein † Novelettes
RCA ARL1-3427; /ARK1-3427
Novelettes, Op. 21
Rubinstein (Nos. 1 & 2) † Fant.
RCA ARL1-3427; /ARK1-3427

Songs

Fischer-Dieskau, w. Eschenbach (Vol. 3): 3
Gesänge, Op. 83 (ex.); Der Handschuh,
Op. 87; 6 Gesänge, Op. 89 (ex.); 6 Ge-
dichte & Requiem, Op. 90; An den
Mond, Op. 95; Lieder und Gesänge, Op.
96 (ex.); Lieder und Gesänge, Op. 98a
(ex.); Mein Schöner Stern, Op. 101; 6
Gesänge, Op. 107 (ex.); 4 Husarenlieder,
Op. 117; Warnung, Op. 119; 5 heitere
Gesänge, Op. 125 (ex.); 5 Lieder und
Gesänge, Op. 127 (ex.); Spanische Lie-
beslieder, Op. 138 (ex.); Provenzalisches
Lied, Op. 139/4; 4 Gesänge, Op. 142
(ex.); Schön Hedwig, Op. 106; 2 Ballad-
en, Op. 122; 6 frühe Lieder, Op. Posth.
3-DG 2709088

SHOSTAKOVICH, DMITRI

Chamber Symphony for String Orchestra,
Op. 110 (arr. Barshai from Qr No. 8)
Faerber, Württemberg Ch. Orch. † Mou-
ravieff; Tcherepnin Turn. 34545

STRAVINSKY, IGOR

Firebird:Suite
Mata, Dallas Sym. † Sym. in 3
RCA ARC1-3459 (D)
Symphony in Three Movements
Mata, Dallas Sym. † Firebird
RCA ARC1-3459 (D)

TCHAIKOVSKY, PIOTR ILYICH

Symphony No. 6 in b, Op. 74, "Pathétique"
Haitink, Concertgebouw Orch.
Phi. 9500610; /7300739

TCHEREPNIN, ALEXANDER

Bagatelles (10) for Piano & Orchestra, Op.
5
Meyer-Josten, Faerber, Württemberg Ch.
Orch. † Mouravieff; Shostakovich:Ch.
Sym. Turn. 34545

VERDI, GIUSEPPE

Requiem Mass
Scotto, Baltsa, Luchetti, Nesterenko, Muti,
Phil. Orch., Ambrosian Cho. [L]
2-Ang. SZ-3858

VIVALDI, ANTONIO

La Stravaganza, Op. 4)
Ayo, I Musici
2-Phi. Fest. 6770029; /7650029

WAGNER, RICHARD

Der fliegende Holländer
Silja, Uhl, Crass, Greindl, Sawallisch, Bay-
reuth Fest. (1961) [G]
3-Phi. Fest. 6770032; /7650032



WRITE FOR NEW COMPONENT CATALOG

CURRENT SPECIALS!

TECHNICS PRO-CASSETTE RSM-85 \$440.00

TEAC A-430 CASSETTE DECK \$315.00

AKAI GX-M30 CASSETTE DECK \$195.00

TECHNICS SL-Q2 TURNTABLE \$122.00

PIONEER PL-200 \$102.00

MARANTZ RCVR. 2265B \$300.00

MARANTZ RCVR. 2238B \$230.00

MARANTZ SR-1000 WRITE US!!

TECHNICS SB-5000 SPKR. \$65.00

MARANTZ 7 MK II SPKR. \$70.00

SANSUI SC-5100 CASS DECK \$400.00

JENSEN AUTO RCVR. R-430 \$297.00

JENSEN TRI-AX II \$75.00 PAIR

SANYO AUTOMOTIVE - WRITE

TOK SA-C90 \$29.50 for 10 MAXELL - WRITE US FOR LOW \$\$

EVER SEE A BETTER PRICE? LET US KNOW -- WE'LL TRY TO BEAT THE DEAL!

BANK CARDS ACCEPTED NOW !! SEND TODAY !!

* WE HANDLE 60 MAJOR LINES OF STEREO COMPONENTS. WRITE FOR PRICELIST. * PRICES AND AVAILABILITY SUBJECT TO CHANGE WITHOUT NOTICE.

send for free catalog

name _____
address _____
city _____
state _____ zip _____

illinois audio
2 East Delaware Place, Chicago 60611
Phone Now!
(312) 664-0020

limelight. Elisabeth and Carlos, roles for an Aida and a Radamès, are entrusted to a Mimi and a Rodolfo. This is Karajan's way. (Freni and Carreras were, in fact, the Aida and Radamès of his Salzburg *Aida* last summer, and his recording with them is due later this year.) Freni is very beautiful in the final duet, tender, limpid, and true. Karajan never makes her force. All the role is sweetly and purely sung. But she is not the "real thing." She lacks the command that a soprano with bigger reserves of weight and power—a Caniglia, a Tebaldi, a Caballé—brings to the part. Carreras might not have been called on to force, but he does. He sings the strenuous passages with a kind of flat-out quality. The engineers have been careful not to let him be drowned; but even though a phrase like his cry *con disperazione* "Il ciel avaro un giorno sol mi diè" remains audible above the orchestra, it lacks the needed ring of metal in the timbre.

Cappuccilli begins badly. He sounds somewhat tired, even old, in "Carlo ch'è sol," especially in the second verse. The voice needs pressure to gain its colors, richness, and firm focus. Posa's "Inaspettata aurora" (at the close of the duet with Philip) is an aside marked to start *mezza voce* at its first appearance and *p* at its second; Cappuccilli sings it in full voice—and makes a fine sound. He is impressive in the dialogue before the trio "Trema per te"; there is a Stracciari-like force and brightness in the phrases. Karajan holds "Per me giunto" to Verdi's *pp*, at a slow *andante sostenuto* justified by the quarter-note 58 marking, and provides a soft cushion of sound. Cappuccilli keeps to the markings, and essays a *pp*, *très doux* at the climactic F, but the tone loses focus. Again at the "No, ti serba per la Fiandra": It is marked *piano*, but the cut of the phrases and the sense of the words posit a more exciting, incisive kind of soft singing than Cappuccilli provides.

I first heard Ghiaurov nearly twenty years ago, in *Don Carlos*, at La Scala. He was singing the Inquisitor to Boris Christoff's Philip, and he made a tremendous sound. He dominated the duet. In this new set, Raimondi's Inquisitor "outsings" the Philip, but not quite in an appropriate way. Ghiaurov, who succeeded to the royal role at La Scala in 1963-64, is a very experienced Philip, but now there is a hollowness in the timbre. It is a long way from the pure, focused sound of such Philips as Plançon and Marcoux—or, today, Nesterenko. Nevertheless, he gives a big, imposing performance. Surprisingly, Karajan did not insist on precise dotted rhythms in the aria. Raimondi's Inquisitor sounds young, healthy, firm, and formidable—not quite an eighty-year-old tower of strength, but more like a rival bass determined to show who has the

better organ. Van Dam is clean and true as Charles V, but a bigger, more majestic bass is needed. Barbara Hendricks is a sweet Heavenly Voice; the engineers, however, seem to have put her in a distant closet, and the message of comfort sounds as if it were coming over the telephone, rather than floating down from heaven. (In 1975, Anna Tomova-Sintov took the part.)

Some points of detail: The Elisabeth/Philip exchanges of Act IV—a scene that Verdi recomposed in the revision to give Elisabeth a chance to "show her teeth"—are filled with force and character; Freni is splendid here. The Carlos/Posa vow, "Dio che nell'alma," is not the quiet, ardent prayer prescribed by Verdi's marking (*p* for the voices, *pp* for the accompaniment), but neither is it the usual below. The direction "The bells ring out at full clamor" heads the auto-da-fé scene—but I don't think the composer could have wanted them to ring out as they do here, so loudly as to obscure the harmonies. (The opening measures lead from the C major of the preceding scene to the E major chorus, in Verdi's day, scene changes were made without a curtain fall.) The clangor of bells confuses the music and overpowers the soft passages.

I have cited passages in the bad old Italian translation, for that is what is used on this and all other recordings. It still needs stressing that Verdi composed not only the original but also the revised *Don Carlos* in French and published it in French. The Italian translation was made for Italian performances; it blunts the rhythms, coarsens the lines, dislocates the composer's phrasing, and obscures some meanings. It does, in fact, what most operatic translations do—without the compensating factor of (outside Italy) becoming intelligible to a particular audience. It's often said that international singers manage Italian better than they do French, and that's generally true. The same argument suggests that *Faust* and *Carmen* should regularly be recorded in Italian.

What we need now is (1) a recording of the Fontainebleau-plus-1883 *Don Carlos* in the original language, and (2) a recording of the 1867 *Don Carlos*, including the ballet and also the scenes Verdi cut before the premiere (the opening chorus, the Posa arioso, the Elisabeth/Eboli duet, the Carlos/Philip duet, etc.)—a rather different, more expansive, but also splendid opera. It's not a practicable version for the theater, but it would offer on disc a good deal of almost unknown music by the mature (post-*Forza*) Verdi that is well worth hearing. Abbado's 1977 Scala performance was a mish-mash of versions. Before the promised Deutsche Grammophon recording based



THE ONE-STOP
MUSIC SHOP
AT WHOLESALE PRICES

THIS MONTH'S
SUPER SPECIALS!

CAR STEREO

SANYO CASSETTE IN-DASH WITH RADIO		PIONEER CASSETTE IN-DASH WITH RADIO	
FT-1498	\$259.90	KP-4000	\$129.90
FT-2400	224.90	KP-3500	94.90
FT-488	139.90	KP-5005	144.90
FT-646	154.90	KP-8000	154.90
FT-1490 2	164.90	KP-8005	154.90
FT-1495	169.90	KP-8500	179.90
FT-642	94.90	KE-2000	184.90
FT-644	106.90	KE-2002	219.90
CASSETTE UNDERDASH		KE-3000	234.90
FT-1400	\$ 99.90	KP-9000	274.90
FT-1405	114.90	KP-9500	184.90
		KP-9500	209.90

JENSEN

J1001 (6x5 Separates)	\$94.50	KP-272	\$69.90
J1065 (6x9 Trax 50 Watts)	62.50	KP-292	79.90
J1033 (6x9 Trax II 100 Watts)	78.50	KP-373	84.90
J1101 (4x10 Trax 45 Watts)	62.50	KP-250	104.90
J1130 (4x10 Trax II 50 Watts)	78.50	KP-500	129.90
J1174 (5x10 Trax 50 Watts)	78.50	KP-575	99.90
J124 (5x10 Trax II 75 Watts)	62.50	KP-665	89.90
J1069 (6x9 Coax 45 Watts)	39.50	KP-77G	114.90
J1037 (6x9 Coax II 90 Watts)	58.50	KP-88G	109.90
J1077 (5x10 Coax 45 Watts)	39.50	KP-900	129.90
J1041 (5x10 Coax II 75 Watts)	48.50	KP-107G	164.90

We carry the full line of car equipment by such names as Sanyo, Crig, Marantz, Pioneer, Jensen & Audiovox. Write for free catalog.

BLANK TAPES

CASSETTE TAPES		REEL-TO-REEL TAPES	
Ampex Grand Master II C-90	3.11	Scotch 212 1800 FT	4.35
Ampex Pro I C-90	2.79	Scotch 207 1800 FT	5.19
BASF Pro II or III C-90	2.99	TDK L-1600 1800 FT	5.22
Fuji I or II C-90	2.99		
Scotch Lo Noise C-90/3 Ph	4.99/3	VIDEO TAPES	
Scotch Master III C-90	3.29	BETA FORMAT	
Sony LMX C-90	1.54	TDK L-500 (2 Hour)	12.95
Sony HF1 C-90	2.35	Sony L-500 (2 Hour)	12.95
Sony Ferrichrome C-90	3.25	TDK L-500 (2 Hour)	12.50
TDK C-60	1.18	Sony L-750 (3 Hour)	17.50
TDK C-90	2.10	VHS FORMAT	
TDK C-120	2.99	Maxell T-120 (4 Hour)	14.85
TDK AD C-60	1.58	TDK T-120 (4 Hour)	14.85
TDK AD C-90	2.45	JVC T-120 (4 Hour)	13.85
TDK AD C-120	3.48	Fuji T-120 (4 Hour)	14.85
TDK SA C-60	2.18	Scotch VK-250 (4 Hour)	14.85
TDK SA C-90	3.18		

MINIMUM ORDER 12 TAPES-100% GUARANTEED
Call or write for super low prices on Maxell tapes.

CARTRIDGES

audio-technica		HEURE	
AT-20SS	134.95	V15 Type IV	89.90
AT-15SS	89.95	V15 Type III	62.50
AT-12SA	49.95	V15 Type II	34.90
AT-10	2.95	M95D	2.90
STANTON		M91ED	20.50
881S	79.95	M92ED	14.90
681EE S	59.95	M70EJ	9.90
681EE	49.95		
680EE	27.95	PICKERING	
500E	14.95	XSV3000	89.90
EMPIRE		XSV3000	45.90
2000Z	54.50	XV15750	34.90
2000T	29.50	XV15625	24.50
2000E/II	18.50	XV15400	21.50
EDR 9	114.50	PVAC	9.90

ACCESSORIES

DISCWASHER		HEADPHONES	
Complete System	10.95	Kids Pro 4AA	39.90
Diskit	34.95	Kids Pro 4AAA	46.50
Discorganizer	9.95	Koss HV2LC	34.50
16 or 33 Revit	10.95	Koss HV1A	31.50
Zerostat Anti-static Gun	14.95	Sennheiser HD414	42.50
SC-1 Stylus Cleaner	4.95	Sennheiser HD424	64.50
Discsoot	15.95	Sennheiser HD430	72.50
Fuzzbuster II Radar Detector	82.90		
Beam Box FM-8 Antenna	34.50		
Beam Box FM-10 Antenna	64.50		

RECORDS

Pop, Rock, Jazz, R&B	
All 7.98 List	\$4.99
All 8.98 List	\$5.49
All 9.98 List	\$5.99

50¢ additional for cassette or 8 track, please specify.
Minimum order \$25.00

WE STOCK THE COMPLETE SCHWANN CATALOG.
HOW TO ORDER: For immediate shipment, send money order or certified check. Two weeks delay on personal checks. Please add \$3.50 per order for shipping & handling (\$6.50 for orders outside continental U.S.). N.Y.S. residents add tax. Payment must be in U.S. dollars only. No C.O.D.'s. All merchandise 100% guaranteed, brand new & factory fresh.



33 PARK ROW, DEPT. HF, NEW YORK, N.Y. 10038
TO ORDER: CALL MON-SAT 9AM-6PM EASTERN TIME
TOLL FREE (800) 221-8180
ALL OTHER MATTERS: CALL (212) 732-8600
CALL OR WRITE FOR FREE 160 PAGE CATALOG

on it is made, I hope he clarifies his text into (2); otherwise we'll get only some of the hitherto unrecorded music. A.P.

WEBER-LISZT: Polonaise brillante, in E, Op. 72 (*L'Hilarité*)—See Schubert-Liszt: Fantasia for Piano and Orchestra.

WUORINEN: Two-Part Symphony—See Cage: The Seasons.

Recitals and Miscellany

THE GOLDEN AGE OF ENGLAND.

Deller Consort. [David Josefowitz, prod.] QUINTESSENCE PMC 7143, \$3.98.

BYRD: Ave verum Corpus; Lullaby, My Sweet Little Baby. MORLEY: My Bonny Lass She Smileth; Sweet Nymph, Come to Thy Lover; I Go Before, My Darling. PARSONS: Pandolpho. DOWLAND: Mrs. White's Nothinge; Tarleton's Risurrectione. PEERSON: Upon My Lap. WILBYE: Draw on, Sweet Night; Sweet Honey-sucking Bees. DERING: The Cryes of London. WARD: Out from the Vale. WELKES: The Nightingale, the Organ of Delight. TALLIS: Salvator mundi.

TAVERN SONGS: Catches, Gleees, and other Diverse Entertainments of Merrie England.
BR Deller Consort, Alfred Deller, dir. [Seymour Solomon, prod.] BACH GUILD HM 62, \$4.98 [from BACH GUILD 561, 1957].

TO DRIVE THE COLD WINTER AWAY: A Fireside Presentation of Music for Merrymaking Down the Ages.

St. George's Canzona, John Southcott, dir. [Francis Grubb, prod.] VANGUARD VSD 71261, \$7.98.

The death of Alfred Deller has not deprived us of the unique sound of the first great twentieth-century countertenor, for his voice is happily preserved on a multitude of recordings (more widely available, it should be noted, in this country and in France than in England). Always active in the studio, he was making new records until very shortly before his death (a complete version of Purcell's *King Arthur*, released on French Harmonia Mundi, is among the most notable). And reissues continue to appear: The first two records listed here date, respectively, from thirteen and twenty-two years ago.

The final record is an amiable piece of nonsense by a lively English group that treats early music very much as an extension of the folk tradition. These "medievalized" Christmas carols, side by side with Praetorius dances and the odd serious thirteenth-century motet, make a successful but unstylish sequence. Playing is vigorous but not always well tuned, and the singing is feeble indeed. It's all good fun, so long as no one imagines that this is how the music actually sounded. N.K.

two sacred pieces. If you enjoy Deller's intimate, one-to-a-part renderings of the Byrd Masses, then these motets (Byrd's "Ave verum Corpus" and Tallis' "Salvator mundi") will be deeply satisfying—cool, restrained, with no cathedral-like acoustic to soften the edges of the music. We are more accustomed to hearing madrigals performed on this small scale, so there are fewer revelations on the rest of the disc: Wilbye's famous "Sweet Honey-sucking Bees" sounds rushed, but his "Draw on, Sweet Night" is eloquent, with firm, well-focused bass and bright, clear soprano. Several items, including the Byrd lullaby, are performed by soloist and lute—a fact of which the sleeve-note writer was unaware. Alfred and Mark Deller do two Morley canzonets with delicious verve. The sleeve is generally uninformative: Deller's singers are named, but who sings which solo items is not listed, nor are the viol players in Dering's jovial (and here rather precious) "Cryes of London"; nor is the lute player identified, which, considering that he plays two solos by Dowland, is inexcusable. Is he Robert Spencer? No texts are provided.

"Tavern Songs" is one of those compendious collections that span such a wide range of music that one style of performance cannot possibly be appropriate for all the items. Zoom from early seventeenth-century war songs to early nineteenth-century glee club material, through catches by Purcell and drinking songs by Eccles—and there is still the remote beauty of Cornyshe's "Ah Robin" (c. 1500) unaccounted for. To all this music Deller and friends bring a restrained, ever so polite, gently humorous style that contrasts oddly with some of rumbustious sentiments expressed. The Purcell catches are sung in commendably unexpurgated versions, though the smuttiest aspects of these remarkable pieces are represented only by one in which the repeated cries of "So kiss my Ar—" are nicely completed from the final part in the canonic texture by the final consonants of "once, twice, thrice." There really should be a background noise of clanking glasses, uproarious laughter, and giggling serving wenches; perhaps listeners are expected to provide their own.

The final record is an amiable piece of nonsense by a lively English group that treats early music very much as an extension of the folk tradition. These "medievalized" Christmas carols, side by side with Praetorius dances and the odd serious thirteenth-century motet, make a successful but unstylish sequence. Playing is vigorous but not always well tuned, and the singing is feeble indeed. It's all good fun, so long as no one imagines that this is how the music actually sounded. N.K.

For only \$2.95 you can learn all you need to know about the latest tape systems.

Before you spend hundreds of dollars on equipment and hundreds of hours using it, invest a little money and time to make sure you get exactly what you need.

High Fidelity's editors have put it all together in the 1980 Buying Guide to Tape Systems.



Special features include:

- Pay only what you want to for a cassette deck
- Pros evaluate 10 top cassette decks
- Inside secrets of superior tape recording
- No-cost tips for cleaner sound
- 7 simple steps to super car stereo
- Is now the time to invest in home video?
- What owner's manuals don't tell you

Plus

- Special buying guide section covering more than 1000 models

Mail this coupon with \$2.95 and you'll be the expert your friends turn to for advice!

High Fidelity's		DOT11
1980 Buying Guide to Tape Systems		
1 Sound Ave., Marion, Ohio 43302		
Please send me _____ copy(ies) of the Buying Guide to Tape Systems at \$2.95 each.		
I enclose a <input type="checkbox"/> check <input type="checkbox"/> money order for \$ _____		
Name _____		
Address _____		
City _____		
State _____ Zip _____		

Please allow 30 days for shipment.

The Tape Deck

The musicassette Vox Box

So succinct, the descriptive phrase "Vox Box" must have contributed significantly to both recognition and sales of the long-familiar series of budget-priced multiple-disc sets. (Was its inspired inventor intuitively aware of the mnemonic potency of both spondaic meter and the rhetorical principle of *parechesis*—repetition of the same sound in words in close or immediate succession?) Therefore the Moss Music Group does well to crown its expansion of musicassette production by extending the Vox Box idea to tapes: three-cassette packages with booklet, \$15.98 each. The packaging design and dimensions are distinctive, but since the height is identical to that of the DG/Philips Prestige Boxes and the width slightly less than that of the London type, the Vox Boxes present no new storage problems.

I've heard only four of the first twelve releases, but these are undoubtedly representative of the series' generally first-rate Dolby tape processing and varied programmatic appeal. Particularly rewarding is CBX 5133, the extensive Skrowaczewski/Minnesota survey of Ravel's orchestral works produced in 1975. The 1974 Slatkin/St. Louis compendium of Gershwin's orchestral and concerted works, with pianist Jeffrey Siegel (CBX 5132), also has many admirable features—including a fine *Cuban Overture* and *Catfish Row* (Gershwin's own *Porgy and Bess* suite)—but too much else that lacks Gershwin's quintessential jauntiness.

Abbey Simon, expectedly, and Heribert Beissel and the Hamburg Symphony, more surprisingly, are (along with their audio engineers) hard to match for consistent satisfaction in their 1973 recording of Chopin's *oeuvre* for piano and orchestra, now in CBX 5126. But the more recent (1976) first volume of Anthony Newman's Bach preludes and fugues, with chorale preludes interspersed (CBX 5479), I can commend only to Newmanniacs. I like neither the tonal qualities of the Keiser organ nor the indulgently idiosyncratic readings. My copy was defective, with Sides 2 and 3 running backward—probably an isolated first-production aberration, since the copy was immediately replaced by a correct one.

Instruments: Viola, baryton. . .

In addition to its "original" instruments series, greeted in February, Telefunken has launched a Virtuoso Chamber

Music series (\$9.98 each cassette), also with TriTec processing. It leads off with perhaps the best-played viola recital ever recorded, a program of Schumann, Stravinsky, Bach-Kodály, and Vieuxtemps (4.42075) by Atar Arad and pianist Evelyne Brancart. Thus reminded, I will also make room, finally, for an equally warm recommendation of Arad's earlier recording of viola works (Telefunken 4.42007) by Hoffmeister, Paganini, and Carl Stamitz, with the Philharmonia Hungarica under Reinhard Peters.

Even my obsessive fascination with odd sounds is stretched too far by the Munich Baryton Trio's recording of five of Haydn's 125 trios for baryton, viola, and cello (Nos. 44, 52, 61, 96, 101; Archiv 3310 405, \$9.98). For all their musicological earnestness, the performances teeter on the brink of tedium.

. . . Oboe, horn, flute . . .

My personal instrumental biases—as regular readers are surely aware—tilt strongly toward the winds in general, the reeds in particular. And indeed my keenest delights this month are provided by that oboist supreme, Heinz Holliger, who offers the third installment of his Vivaldi concerto series (Philips 7300 726, \$9.98), with I Musici, and two Albinoni releases—four solo and four duo oboe concertos from Op. 7, with Hans Elhorst and the Camerata Bern (Archiv 3310 409, \$9.98), and four solo concertos from Op. 9, with I Musici (Philips 7313 012, \$9.98).

The leading hornist of recent years, Barry Tuckwell, re-records his celebrated Haydn concertos (two by Joseph, one by Michael) in Angel 45Z 37569 (\$8.98). This version is better, except that the English Chamber Orchestra's accompaniments, conducted by Tuckwell, are no match for the Marriner/Academy ones on Argo.

The Irish-leprechaun challenger to Jean-Pierre Rampal's long dominance of the flute discographies, James Galway, expands the concerto repertory with a mildly attractive *Concierto pastoral* commissioned from Joaquín Rodrigo and couples it with his own flute transcription of Rodrigo's *Fantasia para un gentilhomme* for guitar (RCA Red Seal ARK 1-3416, \$8.98). Both are well played and recorded, with Eduardo Mata leading the Philharmonia Orchestra, but everything here pales in comparison with a superb Telemann program (RCA ARK

1-3488, \$8.98), in which Galway doubles as conductor of the Solisti di Zagreb in the popular A minor Suite and the less familiar Concertos in G and C. Though no specialist in baroque style, Galway brings such zest and pellucid tone to this delectable music that he proves quite irresistible.

. . . Harp, lute, guitar

The incomparable Spanish harpist, Nicanor Zabaleta, records far too seldom these days, which further enhances the value of his superbly colored French program (Deutsche Grammophon 3301 051, \$9.98) of mostly novel works by Damase, Roussel, Salzedo, Samuel-Rousseau, Tailleferre, and Tournier, along with transcriptions of Ravel (*Pavane*) and Debussy (*Arabesque No. 1*).

Nonesuch's recent cassette debut list (\$4.96 each) featured two notable lute recitals: one, more than a decade old, with Walter Gerwig playing a program of suites by Bach, Buxtehude, and Pachelbel (N5 1229); the other, an English program (N5 1363) by a talented youngster, Paul O'Dette, making his American debut in a set of eight of Dowland's best pieces coupled with an even more attractive—and historically valuable—batch of seven works by Byrd.

Yet the Old Master lutenist Julian Bream must always be reckoned with, as he demonstrates anew in one of his most impressive, yet immediately delightful, historical documentaries to date: "Music of Spain," Vol. 1 (RCA Red Seal ARK 1-3435, \$8.98). It presents vihuela pavaues and fantasias from Luis Milan's *El Maestro* collection of 1535-36 along with even more rewarding fantasias and *diferencias* from Luis de Narvaez' *Los seys libros del Delphin de música* of 1538.

Then, as always, there is the seemingly inexhaustible flood of guitar recitals and concertos, but only two recent releases fully held my attention. One is Narciso Yepes' latest remake of the perennial favorites, Giuliani's Op. 30 Concerto and Rodrigo's *Fantasia para un gentilhomme*, this time with the English Chamber Orchestra under Garcia Navarro (DG 3300 975, \$9.98). The other is the Romeros' remake of Rodrigo's *Concierto Andaluz* and the *Concierto de Aranjuez* with Pepe Romero as soloist (Philips 7300 705, \$9.98); the accompaniments by Neville Marriner and the Academy of St. Martin-in-the-Fields are far above average. **HF**

Revox B760. One touch tunes it. Perfectly.



Now there's a tuner that works as accurately as a radio transmitter and as easily as a car radio.

You can tune the B760 manually in increments of 25 or 50kHz, or program up to 15 stations in memory for instant selection. Just touch a button for the station you want, and in less than a second the muting light goes off and the digital readouts and tuning meters confirm your station selection.

Both memory and manual tuning are controlled by an advanced digital-frequency-synthesizing circuit with a differential phase-locked loop that compares the output of the master oscillator with a quartz crystal reference frequency. If there's any difference, corrections are made instantaneously, maintaining an accuracy of $\pm 0.005\%$. (That's better than many radio stations can achieve!)

The B760's CMOS memory is so sophisticated that it can automatically direct an antenna rotator toward each memorized station, and even has a battery pack to pro-

tect the memory if you unplug the tuner or lose AC power.

Other features include an optional plug-in Dolby circuit board, oscilloscope outputs to help you minimize multipath distortion, selectable 25, 50 or 75 microsecond FM de-emphasis, adjustable-threshold interstation muting, a headphone jack with level control and a high-blend switch to optimize reception of distant stations.

It's all put together with attention to detail and durability for which the Studer Revox company is so well known. With things like plug-in circuit boards, RF shields plated to resist oxidation and even a coaxial delay line to maintain proper phase, everything is made just a bit better than it has to be. Because we want everything to be perfect.

Studer Revox America, Inc.,
1819 Broadway, Nashville, TN. 37203 (615) 329-9576
Offices: Los Angeles (213) 780-4234
New York (212) 255-4462
In Canada: Studer Revox Canada, Ltd.

STUDER REVOX

fact: five new Shure Cartridges feature the technological breakthroughs of the V15 Type IV

**Plus
Unprecedented
stylus protection**

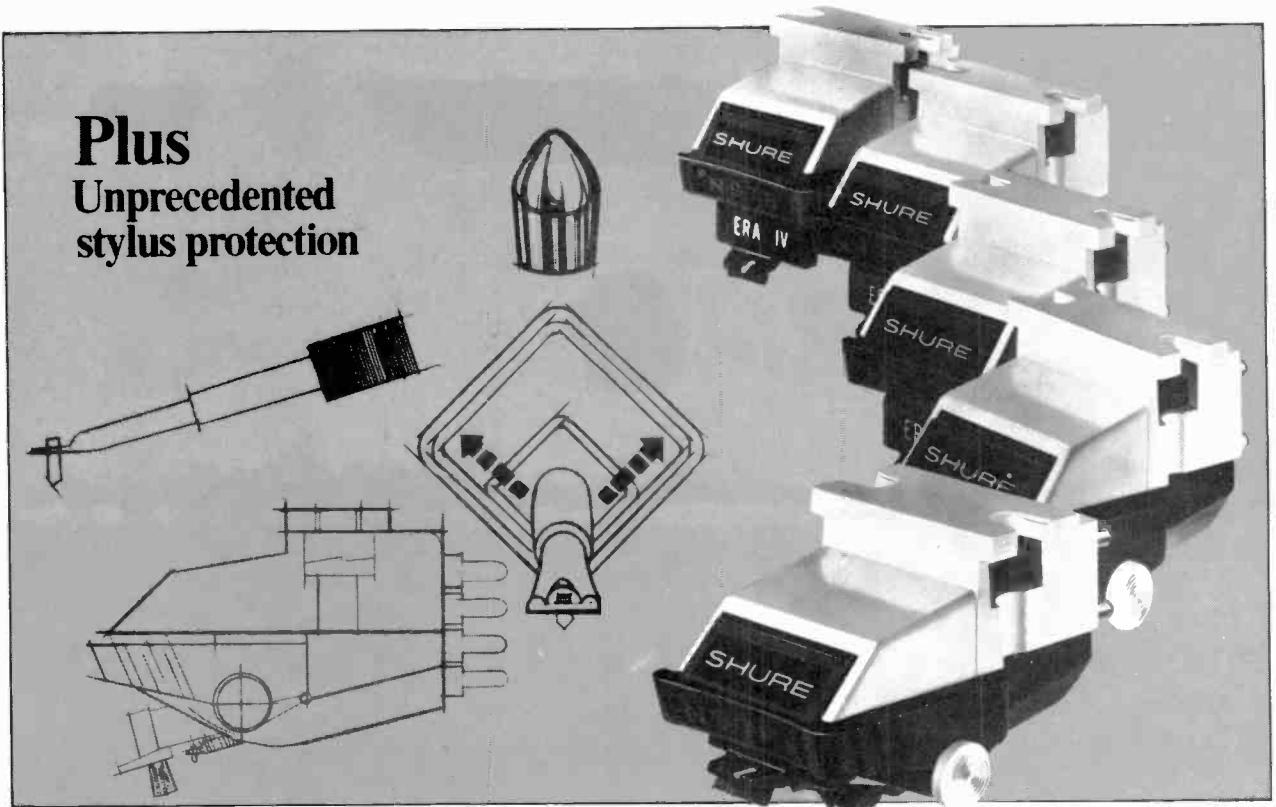

the M97 Era IV Series phono cartridges

Model	Stylus Configuration	Tip Tracking Force	Applications
M97HE	Nude Hyperelliptical	¾ to 1½ grams	Highest fidelity where light tracking forces are essential.
M97ED	Nude Biradial (Elliptical)	¾ to 1½ grams	
M97GD	Nude Spherical	¾ to 1½ grams	
M97EJ	Biradial (Elliptical)	1½ to 3 grams	Where slightly heavier tracking forces are required.
M97B	Spherical	1½ to 3 grams	
78 rpm Stylus for all M97's	Biradial (Elliptical)	1½ to 3 grams	For 78 rpm records.

Shure has written a new chapter in the history of affordable hi-fi by making the space-age technological breakthroughs of the incomparable V15 Type IV available in a *complete line* of high-performance, moderately-priced cartridges: the M97 Era IV Series Phono Cartridges, available with five different interchangeable stylus configurations to fit every system and every budget.

The critically acclaimed V15 Type IV is the cartridge that astonished audiophiles with such vanguard features as the Dynamic Stabilizer—which simultaneously overcomes record-warp caused problems, provides electrostatic neutralization of the record surface, and effectively removes dust and lint from the record—and, the unique telescoped stylus assembly which results in lower effective stylus mass and dramatically improved trackability.

Each of these features... and more... has been incorporated in the five cartridges in the M97 Series—there is even an M97 cartridge that offers the low distortion Hyperelliptical stylus! What's more, every M97 cartridge features a unique lateral deflection assembly, called the SIDE-GUARD, which responds to side thrusts on the stylus by withdrawing the entire stylus shank and tip safely into the stylus housing before it can bend.

NEW! M97 Series Era IV Phono Cartridges...
Five new invitations to the new era in hi-fi.



Shure Brothers Inc., 222 Hartrey Ave., Evanston, IL 60204 In Canada: A. C. Simmonds & Sons Limited
Outside the U.S. or Canada, write to Shure Brothers Inc., Attn: Dept. J6 for information on your local Shure distributor.

Manufacturers of high fidelity components, microphones, sound systems and related circuitry.



BACKBEAT.

The Commodores: "Easy" like \$60 Million

by Steven X. Rea



William King, Tommy McClary, Walter "Clyde" Orange, Lionel Richie, Ronald LaPread, Milan Williams

Tommy McClary, his white Adidas pressed up against the sound-booth glass, sits in an insulated cubicle adjoining the studio control room eliciting a succession of country licks from the acoustic guitar on his lap. He is overdubbing a part for the intro to *Wake Up Children*, a song on the Commodores' newest LP, scheduled for April release. Reclining behind the 24-track console at Motown's Hollywood studio, the group's coproducer James Carmichael—a wry, wizened black man in his middle forties—lights another in a seemingly endless chain of cigarettes, pushes his glasses up along his nose, and

shakes his head ruefully. "Tommy, that sounds like some kind of *slide* guitar or something. What *are* you doin'?"

"I know it does, I know," McClary says, grinning back through the thick sheet of glass that separates the two rooms. Engineers Calvin Harris and Jane Clark and drummer Walter "Clyde" Orange exchange amused glances, as if to say, "Uh oh, here comes another argument."

Carmichael's credits span two decades as an arranger, conductor, and ghost musician for such Motown acts as the Jackson 5 and Diana Ross & the Su-

premes. He has guided the Commodores through six years of hit records, starting in '74 with the disco/funk *Machine Gun* and continuing with numerous pop, r&b, and crossover hits, such as the r&b rocker *Brick House*, the soul ballad *Three Times a Lady*, and the out-and-out country ballads *Easy* and *Sail On*, last year's huge single.

Past country success or no, right now a slide guitar seems to be too much for Carmichael to cope with. McClary enters the control room to hear the playback, after which an amicable but spirited debate between the producer and the tall,



Orange, McClary, Williams (seated), King, and Richie

thirty-year-old Commodore ensues.

"It's like the Eagles do it," McClary says, alluding to his overlay of a country motif on a rock setting. (The Commodores frequently cite such unlikely stylistic influences: others include Elton John, the Beatles, and Bob Dylan.) "Uh huh," Carmichael nods doubtfully.

Pianist, saxist, and lead vocalist Lionel Richie walks in and listens to the track. "Mr. Motown," McClary teases, "doesn't think this intro sounds right." Some quiet discussion leads to a decision to sit with the thing for a while.

Wake Up Children is one of twelve tracks being recorded for the Commodores' tenth Motown album. The material runs the gamut from hard rock to folk to gospel and includes such titles as *Heroes*, *Mind Spirit*, *Jesus Is Love*, and *Sleazy*. *Wake Up Children*, written by Richie and McClary, builds from its slow, resonant ring of acoustic piano and guitars to an amalgam of country blues, hard rock, and gospel. "It's probably the first Commodores song to have political overtones," comments McClary.

Though the vocals have yet to be recorded—they are usually the final stage of the group's recording process—the track is an ambitious piece about which the band is, to say the least, enthusiastic. Thirty-one-year-old William King, who plays keyboards, percussion, and trumpet, comments: "Richie's doing things with his voice that we've never heard before. He sounds like Mick Jagger." "We've

always tried to do something different with each album," says soft-spoken keyboardist Milan Williams. "On our new one, we've gone beyond ourselves."

"We don't usually have a title or a cover concept until maybe a month before the album's due," says Richie. But a concerted effort has been made to concentrate on the album in toto this time, as opposed to the song by song approach they've taken in the past. Even though "Midnight Magic," the Commodores' last LP, garnered three Top 10 singles, won the American Music Award for Favorite Soul Album, and has been nominated for a Grammy, they feel it had some weak spots. This time around they are endeavoring to produce a cohesive album.

The Commodores' ability to move records is unarguable, but because their label only recently became affiliated with the Recording Industry Association of America (which monitors and certifies sales) there's no official tally of the band's sales to date. According to Motown, all nine of their albums have gone gold (500,000 units) and several have reached triple platinum status (3 million). Worldwide record sales are put in the vicinity of \$60 million.

In 1968, McClary, Richie, and King—all business majors at Alabama's Tuskegee Institute—formed a band called the Mighty Mystics, covering tunes such as *Tobacco Road* and James Brown's *Cold Sweat*. Williams, an engineering major,

was playing keyboards in a band called the Jays. Soon after the Mighty Mystics and the Jays heard each other perform at a freshman talent show, they joined forces to form the nucleus of the Commodores. Orange, the only music major in the bunch, replaced the original drummer, Andre Callahan, and Ronald LaPread, another engineering major, replaced bassist Michael Gilbert. Since late 1968 that lineup has remained unchanged. Frat parties, club dates on the "chitlins circuit," and all-white debutante dances followed.

From the beginning the Commodores have placed a strong emphasis on "commercialism" and "versatility," playing hits by pop acts like Three Dog Night as well as Sam Cooke scorers. Those early decisions have paid off: Today their concerts draw an almost equal number of blacks and whites.

This broad-based appeal no doubt comes from their very diverse backgrounds as well. Richie and LaPread are Tuskegee natives, King is from Birmingham, Orange and McClary from Florida, and Williams from Mississippi. Because of their Southern black roots, the Commodores' musical heritage encompasses the '60s Motown sound, r&b, gospel, and rural blues. And Richie, whose grandmother was a classical music teacher, grew up listening to Bach, Beethoven, and Mozart; his uncle, Bertram Richie, was one of Duke Ellington's arrangers. Add to these an impatient finger on the radio dial, and that brings country & western, jazz, and Top 40 to bear on Richie's context.

"People always want to tag us," he says, "by citing James Brown and the Temptations as our main influences. But we also grew up in a pop environment. We listened to the Beatles, Jimi Hendrix, Led Zeppelin, Glen Campbell, and Merle Haggard as much as we listened to Brown. We consider ourselves a pop band playing popular music. We're not just a soul act or a country act or a disco act."

Even the awards they've received have been diverse: They were *Billboard's* Top Soul Album Artists (and Top Box Office Artists) and *Rolling Stone's* Soul Group of the Year in 1978, and *Record World* named them Top Male Group, Top Crossover Group, and Top Album-Selling Group. In that same year, *Three Times a Lady* won ASCAP's Country Songwriter Award and the American Music Award for Best Pop Single.

All of that is a far cry from the rather unspectacular results of their first—and only—LP on Atlantic, which was re-



corded in one day by eccentric r&b artist Swamp Dog (Jerry Williams). "Swamp Dog was our introduction to 'big time' record producers," King recalls laughing. "The first time we met him, he had on a green suit, green shirt, green socks, green shoes, and a green hat." The album's sole single release was a cover of Shorty Long's *Keep on Dancing* (now a collector's item).

Fortunately they had run into entrepreneur Benny Ashburn while performing at Harlem's Smalls Paradise in 1969, and he took control following the Atlantic fiasco. Ashburn, who has been their manager ever since, takes only a one-seventh share of the group's profits, whereas most managers slice off up to one-quarter. Now in his mid-fifties, his first move as "the seventh Commodore" was to book them as the ballroom band on an S.S. *France* cruise to Europe. "We played one show over and one show back," recalls McClary. "It gave us a chance to play for all kinds of people. We did things like *Wichita Line-man*. We even did the *Theme from Love Story!*"

It was when they hit the European stages, though, without an album or any previous familiarity, that they knew they had it. The success of their show, choreographed by King, proved them masters at working an audience. In fact since campus days, their emphasis has been on live performance, and Richie says he writes his songs with a show, not a record, in mind.

The group returned from their modest but triumphant 1970 European tour and were booked as the opening act for the Jackson 5. Since then the Commodores have become top box-office, easily packing 20,000-seat sports arenas. In June they kick off a 100-date, five-month U.S. tour, their most expensive and elaborate to date. But, King cautions, "our theatrics are just icing on the cake. Richie may rise out of a cloud of smoke playing a piano, but if he doesn't have songs like *Sail On* and *Easy* to sing, then it's nothing. The music is the bottom line."

In 1972, Ashburn signed the Commodores to Berry Gordy's Motown label, refusing to accept any advance for the group—an unusual move. "We wanted to get off on the right foot," explains McClary. It took two years before they released their first album because, he continues, "we didn't want to go the traditional Motown route." The label was accustomed to cutting instrumental tracks

and then letting groups go in and sing on top of them. "We didn't want to do that," says McClary. "We wanted to play our own tracks. Motown said, '*Play your own tracks!*'—like we were nuts." "We were self-contained," adds LaPread, "and that didn't jive with Motown's assembly-line system."

Finally, after running the gamut of in-house producers, they met Carmichael. "Stumbled upon him," King jests. They recorded two singles, *Machine Gun* and *The Bump*, both written by Williams. Though the former was a disco smash, it failed to carry the Commodores' name along with it, probably because it was an instrumental. But the hits that followed did: *Young Girls Are My Weakness*, *Brick House*, *Three Times a Lady*, *Zoom*, *Fancy Dancer*, *Slippery When Wet*, *Easy*, *Still*, *Sail On*, and *Wonderland*.

This accumulation of platinum has made the Commodores a multimillion-dollar enterprise. Commodore Entertainment Corporation with its two subsidiaries—Commodore Moving On Transportation (their touring operation) and Commodore Entertainment Publishing—has grossed some \$250 million in sales from albums, publishing royalties, merchandising, concerts, product endorsements (Schlitz beer among them), films, TV specials, etc. Considering their business backgrounds, it's not surprising that they spend as much time thinking about the business side of things as the creative. *Fortune* magazine phraseology—"built-in marketing strategy," "high-yield profit ratio"—abounds in their conversation. Twice annually they hold official business meetings to discuss sales projections and budgets, bookings, and long-range plans. (Film projects and solo albums are imminent for the '80s.) Says Richie: "I think of these guys more as businessmen than musicians. We try to keep costs to a minimum. We're always thinking of the bottom line."

Good business sense is one reason they've lasted so long; impartiality is another. Their publishing company, for instance, is set up so that no one Commodore gets left out in the financial cold. "We have this system called the Where Fair Program," says McClary. "It allows for a rotation of guys sharing the B-side of a single. So everyone has had songs out in the street and on the charts." The group also has a long-standing policy of fining band members when they break the Commodores' disciplinary code, one that for-



Richie with Berry Gordy

bids any drugs and restricts drinking on tour. Their image—"straight, clean-cut, and all-American"—is carefully maintained.

The group is musically ambitious, but they're also acutely aware of the marketplace. For instance, though they listen to a good deal of reggae, they've yet to incorporate any of its elements into their own music. "I don't think the masses are ready for it yet," says Richie. "Maybe in another album or two we might play some reggae."

Carmichael also helps maintain a consistent market profile by keeping their sound within a certain stylistic framework. "He strikes a real balance with us," Richie explains, "because he has a very conservative attitude toward recording, and, of course, we have no attitude at all. We're cut there in left field, believe me."

Watching the Commodores go through rigorous nights of arranging, rehearsing, and finally recording a song like *Wake Up Children* easily belies that off-hand jest. So does the fact that, in a highly volatile industry, they've maintained the same personnel, staff, manager, producer, engineers, and record company throughout their last highly successful decade. The six still reside in relatively modest homes in and around Tuskegee—Richie, Orange, King, and Williams with their wives and children. LaPread is a widower; McClary is the sole bachelor.

One gets the feeling that, naturally, the Commodores are success-oriented, but they're motivated less by a lust for cash than by a healthy sense of competition. Their oft-quoted goal is to be "bigger than the Beatles." Whether they'll achieve that is doubtful. What isn't so doubtful is that having shaken off the r&b stereotype they are a supergroup to be reckoned with. ♪



Back in the Home Studio: The \$2,000 Difference

by Bennett Evans

In the February issue we described how to build a one-room studio for \$2,000. Not the biggest studio, nor the ideal studio, but one that would enable you to make clean, even moderately elaborate demo tapes and perhaps to earn a little money.

In this installment we'll move into slightly greener pastures—\$2,000 greener, to be exact. How you spend your money depends, of course, on where you're starting from. If you followed our advice last time, you already own a mixer, some mikes and stands, and perhaps a quarter-track, but probably a half-track, tape deck. If you're happy with the deck you have, and with the service you get on it, consider buying another of the same make. If you've been doing your own servicing you'll be able to use your hard-won expertise to keep the new deck running right.

THE DECK

Our previous tape deck price range was \$725 to \$1,600. The sixteen decks listed on page 111 cost between \$1,499 and \$2,050, and with more money come more features. For easier editing, virtually all of them provide for cueing (listening) during fast-forward and rewind, and hand-rocking the reels to locate precise splicing points. Several also allow for "dump editing," i.e., winding off unwanted portions of the tape without the takeup reel whizzing around and damaging the end of the tape that you've decided to save.

The Akai Pro-1000, Ampex ATR-700, and Tandberg TD-20A (all two-chan-

nel decks) have mixing facilities for up to four line inputs, which makes mixing down from a quarter-track simpler. Also, the Ampex and Akai have four mike inputs, which can be invaluable if you don't own a mixer or if you frequently do simple remotes and don't want to lug your mixer along. Those inputs (and those of the Otari MX-5050-2SH and Technics RS-1520) accept balanced lines, allowing longer mike-cable runs without noise pickup. Several decks have standard or optional balanced inputs and outputs for line-level signals, even where they don't have balanced mike connections.

Some of the more expensive decks have no mike inputs at all. These are designed for a typical pro studio environment, where all microphones are connected to the mixer or console. Because these machines provide easier access to the bias and recording-EQ controls, you can adjust them to the specific requirements of different types of recording tapes. Some also have switch-selectable NAB (National Association of Broadcasters) equalization (for U.S. use) and CCIR/IEC equalization (Europe), in case you exchange tapes with overseas studios.

Channels & tracks. Most small studios today are pop-oriented, which usually means they make multitrack recordings. The more tracks available, the better, but our budget restricts us to a four-track deck. You'll also need a two-channel machine for mixdown. The question is, should it have half- or quarter-track heads? Half-track (also called two-track) is the studio standard. If you send your tapes out to be disc-mastered, for example, the cutting house will probably expect, and certainly prefer, half-track tapes. The half-track format also provides about a 3-dB better signal-to-noise ratio than quarter-track. Of course, you can't economize on tape—by flipping it over and recording in the other direction—the way you can with quarter-track. (Having done

that, by the way, don't forget that editing tracks going in one direction will wreak havoc on those going in the other.)

Most of the decks listed are available in half- and quarter-track configurations. Many—like the Technics RS-1500US—have additional heads, so that the half-track deck can play quarter-track tapes, and vice versa. The RS-1500US also has interchangeable head assemblies for recording half- and quarter-track tapes. Both of the Pioneer machines carry that versatility one step further: Change the 2022's half-track head assembly for a four-track one, and you have a quarter-track, two-channel machine. Add a second record/play amplifier, and you have a four-channel one.

THE MIXER

The main difference between a \$2,000 and a \$4,000 studio is the capability provided by a second deck. But that's not the only difference. By careful spending, you can get a little more of everything else: more mikes (again I recommend Dick Rosmini's piece in the April 1978 BACKBEAT), more stands, more mixer. Note that I said more mixer, not more mixers. For the most part, one big mixer beats two little ones—unless they can be ganged or stacked together. Some of the mixers covered last time—the 6-in/2-out Sony MX-650 and 670, the Tapco 6201B, and the 6-in/4-out Teac 2A—are stackable. Tapco's expansion unit (8201REB, \$975) isn't just a duplicate mixer; it adds eight more inputs to the 6201B's six, plus reverb and equalization.

Speaking of reverb and EQ, let's look at some of the other features you'll find in mixers costing between \$700 and \$1,500. (February's range was from \$160 for the Heath Kit TM-1626 to \$599 for the Tapco 6201B.) Virtually all of them are stereo boards, with just two output channels. You'll rarely be doing four-channel

If you missed the first article ("A Home Studio for \$2,000? It Can Be Done!") in this series, send a self-addressed stamped envelope to **Backbeat Information Services, High Fidelity, 825 Seventh Avenue, New York, N.Y. 10019.**

Make & Model	Price	Tracks	Chan- nels	Speeds	Heads	Meters	Sync	Pitch Control	S/N*	THD*	Frequency Response*	Mike Inputs*
Akai Pro-1000	\$1,995	2/4	2	15,7½,3¾	4	2 (see remarks)	no	no	60	1%	40-24k ± 3 (50-20k ± 1)	4 b
<i>Remarks:</i> Built-in 4-input mixer; ½-track record & play plus ¼-track play; separate transport and electronics; pan pots on two inputs; independent mixer output for use with other deck; external processor loop; front-panel bias adjust and metering; front-panel equalization adjust; edit cueing; dual-capstan drive; selectable peak/VU metering; cue in fast-wind; optional wireless remote.												
Ampex ATR-700	\$1,795	2(/4)	2	15,7½	3(4)	2 VU	yes	± 5%	60	0.3%	40-15k ± 3 (40-18k ± 3)	4 b
<i>Remarks:</i> Space for optional 4th playback head; memory counter reads in minutes and seconds; manually-defeatable lifters for cueing; motion-sensing logic; remote control; switchable NAB or IEC equalization; VU meter range switchable (0,+3,+6); built-in 4-in, 2-out mixer; master gain control; provision for dump edit; 3-position bias and EQ switches; also available for 3¾ & 7½, and for ¼-track.												
Ferroglyph 7602AH	\$1,950	2	2	15,7½,3¾	3	2 VU	no	no	60	0.2%	30-17k ± 2 (30-20k ± 2)	2 u
<i>Remarks:</i> Adjustable fast-wind speed; master gain control; inter-track transfer for sound-on-sound or echo; mute switch to cut output during fast-wind; optional remote control and indicator units; bass and treble controls; optional Dolby (\$400); motion-sensing logic; ¼-track available.												
Otari MX-5050-2SH	\$1,695	2/4	2	15,7½	4	2 VU	yes	no	68w	1%	50-18k ± 2 (50-22k ± 2)	2 u
<i>Remarks:</i> Optional balanced mike inputs; optional remote control; dump edit provision; built-in splicing block; tape lifter defeat; front-panel bias adjust with test oscillator; adjustable recording EQ and reference levels; motion-sensing logic.												
Otari MX-5050B	\$2,050	2/4	2	15,7½,3¾	4	2 VU	yes	± 7%	66	0.7%	25-20k ± 2 (30-22k ± 2)	2 u
<i>Remarks:</i> All features of 2SH, plus: increased headroom; DC servo capstan motor with pitch control in recording and reproduce; peak-reading LEDs on meters; switch-selectable for 7½ and 3¾ ips; memory counter; switch-selectable NAB/IEC EQ; balanced input available for line only.												
Pioneer RT-2022	\$1,590	2	2	15,7½	3	2 VU	yes	no	57	1%	40-20k ± 3 (30-22k ± 3)	2 u
Pioneer RT-2044	\$2,010	4	4	15,7½	3	4 VU	yes	no	55	1%	as above	4 u
<i>Remarks:</i> Machines identical save for head assembly and second 2-channel record/play amp on 4-channel version; RT-2022 convertible to RT-2044 for \$420; switch-selectable fixed or variable bias; 2 EQ positions each for NAB and IEC; 1 kHz/10 kHz test oscillator with external output; locking cue control; optional remote; wide-range meters calibrated from -40 to +6 VU.												
ReVox A-77	\$1,399	2/4	2	7½,3¾	3	2 VU	Opt.	Opt.	66	3%	30-20k, + 2,-3	3 u
<i>Remarks:</i> 7½/15 two-speed version available (\$1,499)												
ReVox B-77	\$1,499	2	2	15,7½	3	2 VU	Opt.	Opt.	67	0.6%	as above (30-22k, + 2-3)	2 u
<i>Remarks:</i> Dolby optional (71-dB S/N, \$300); LED peak indicators; optional remote; mike, line and "radio" (2.8 mV) inputs; built-in tape cutter/splicer; monitor select includes mono and reverse stereo; sound-on-sound; logic control; ¼-track and other speed pairs available; cueing in fast-wind or pause modes; motion-sensing logic.												
Tandberg TD-20A	\$1,750	2	2	15,7½	3	2 pk	yes	no	69w	2%	20-25k ± 3 (20-30k ± 3)	2 u
<i>Remarks:</i> Actilinear circuitry to increase headroom and provide metal-tape capability (metal tape not yet available); cue and edit; mike/line or line/line mixing; master gain control; bias adjust; meters read equalized recording signal; optional remote; motor (not solenoid) actuation; wireless remote avail.; mike, line and radio (DIN) inputs; ¼-track and 3¾ ips versions avail.												
Teac Tascam 35-2	\$1,900	2/4	2	15,7½	4	2 VU	no	± 10%	63w	1%	40-18k ± 3 (40-22k ± 3)	0
<i>Remarks:</i> Optional DBX; front-panel bias and EQ adjust; LED peak indicators; cue and edit; dump edit; motion-sensing logic; optional remote.												
Teac Tascam 40-4	\$1,700	4	4	15,7½	3	4 VU	yes	Opt.	63w	1%	40-15k ± 3 (40-18k ± 3)	0
<i>Remarks:</i> Optional DBX; LED peak indicators; cue and edit; optional variable-speed adaptor yields ± 20% speed adjust but eliminates 7½ speed.												
Technics RS-1500US	\$1,500	2/4	2	15,7½,3¾	4	2 VU	no	± 6%	68w	2%	20-25k ± 3 (30-30k ± 3)	2 u
<i>Remarks:</i> Isolated-loop drive; quartz-locked direct-drive motor; logic control; optional remote; can operate on 24 VDC; tape counter reads minutes and seconds; 3-position bias and EQ selectors; meter scale selector; timer-start; edit dial; interchangeable 4/2-track head assembly; built-in stroboscope; bias and EQ adjustments on bottom; cue and edit.												
Technics RS-1520	\$2,000	2/4	2	as above	4	2 VU	no	± 6%	60	0.8%	as above	2 b
<i>Remarks:</i> Similar to 1500 but with balanced-line inputs; front-accessible bias/EQ adjust; built-in test oscillator; tape dump.												

Notes:

*Performance at 7½ ips (15 ips in parentheses); w = weighted. Since different manufacturers use different weighting and measurement systems, do not assume that figures are directly comparable. † b = balanced input, u = unbalanced.

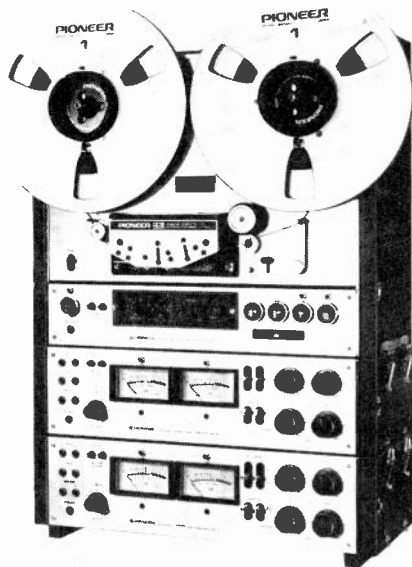
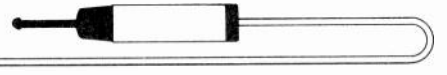
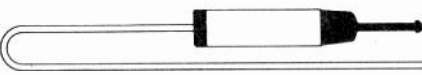

Pioneer RT-2044



Ampex ATR-700

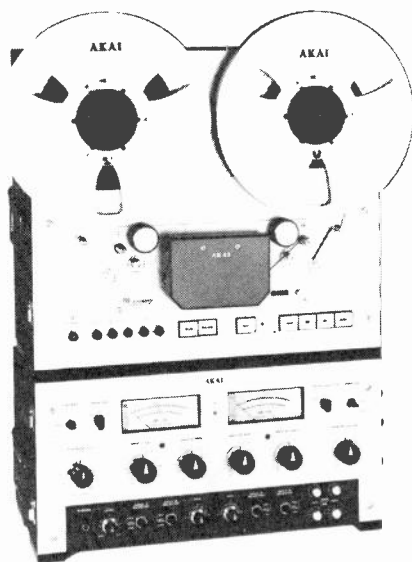

Akai Pro-1000



Technics RS-1520US

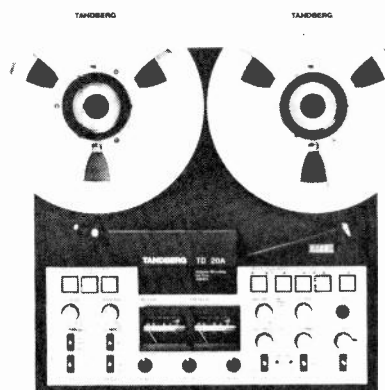

Tanberg TD-20A

recording. Instead, you'll be doing multi-track recordings on your four-channel machine, and mixdowns from multitrack to your two-channel unit. For that, you'll need a slew of microphone inputs, four line inputs, and two output channels. Most of the boards in this range fill the bill, with from six to twelve input channels, switchable to either line or mike.

Unlike the lower-priced mixers, many of these have balanced mike inputs. (Any board designed for serious use should have low-impedance inputs, of course.) Nowadays, most input modules have sliding controls or faders, though some still use rotary pots. There are advantages to both: Faders give you a quick visual indication of what your settings are, and it's easier to move a bunch of them at once. Rotary pots save space on the control panel, and, in some cases, allow for more precise adjustments than the short fader paths found on many of these boards.

Some mixers in this range have equalization for each input, usually in the form of low-, mid-, and high-frequency tone controls. Equalizers with shelving characteristics tend to be more common in still higher-priced boards and have elaborate graphic equalizers or even parametrics.

Panning (electrically positioning a signal anywhere between channels) is probably more useful in mixing down from a multitrack than in a live stereo recording. In the latter, you can move your mikes or performers to place the sounds where you'll want them in the final stereo image. Once they're on separate tracks, though, panning is the only way to get them anywhere but far left, far right, or dead center. (Reverb can help a little too, if your reverb system blends channels.)

The number of patch points—that is, points of access to the circuits—increases as the price goes up, too. Studio mixers in the kilobuck range usually have patch points at the input and output to every circuit stage. That lets you pull all kinds of tricks: ganging equalizers for extreme frequency tailoring, patching around circuit stages that go blooey in the

Glossary of Tape Deck Features

Balanced lines, usually found in pro studio equipment, are heavyweight, two-conductor-plus-shield lines and 3-pin XLR connectors. The ground lead is separate from the two that carry the signal in order to reduce hum pickup. Home gear uses conductor-plus-shield—or unbalanced—lines, with the signal return fed through the grounded shield and terminated at the “cap” of the relatively flimsy pin (“RCA” or “phono”) connectors. Home setups rarely require the long cable runs that studios do, so noise buildup is less critical.

CCIR/IEC is the standard equalization curve used in some foreign countries, as opposed to the NAB equalization curve used in the U.S.

Cue can mean different things to different companies, but it usually means that the tape lifters can be defeated so that the tape remains more or less in contact with the heads in fast modes. This enables you to listen to tape “chatter” in such modes to find a specific section of the tape. Many decks automatically reduce output level during cueing to save wear and tear on tweeters and to avoid magnetizing the heads.

DBX is a noise-reduction system that uses complementary compression and expansion to reduce tape noise. Not all DBX systems are precisely compatible with each other; check before playing back tapes made on a different deck with DBX encoding.

Dolby B is another noise-reduction system and is more widely compatible than DBX. In a *real* pinch, Dolby-encoded tapes can be played on non-Dolby machines, by using tone controls or equalizers (to roll off the highs) to approximate Dolby-decoded response.

Dual capstans in a drive system usually means that there are capstans and pinch rollers both before and after the tape heads. This isolates the tape from outside drag or vibration and maintains optimum tape-to-head contact.

Dump edit enables you to wind unwanted portions of tape off (“dump”)

while listening for the start of the desired portion. When dump edit is engaged, the takeup motor automatically shuts off. To dump edit without this feature, you either must remove the takeup reel or manually hold it fixed throughout the process.

Equalized meters are recording-level meters that read the signal after, rather than before, the recording equalization circuits. Signals that might cause tape saturation because they’ve been boosted by these equalization circuits are more easily detected with such meters.

External processor loop allows the signal to be fed through an external equalizer, noise-reduction unit, reverb device, or other signal processor. It works exactly like the tape-monitor loops on most home preamps.

Four-track / four-channel: In studio use, “four-track” denotes a tape deck with four separate record/playback channels, each using a separate tape track. The term “four-channel” would seem useful to distinguish these decks from quarter-track stereo decks, whose tapes have four identical tracks, though only two can be recorded or played simultaneously. But since the four tracks of four-channel decks are more often used independently (for multitrack recording) than together (for quadriphonic use), the term four-track has stuck and is unavoidable studio parlance.

Isolated loop (closed loop) is a transport system in which the tape is pressed against both sides of a single, very large capstan by pinch rollers and passes over the heads between its first and second contacts with the capstan. As with the dual-capstan drive, this isolates the tape from outside influences where it passes over the heads. The difference is that both pinch rollers press the tape against a single capstan, rather than against two separate ones.

Memory rewind allows you to automatically rewind to a preselected spot on the tape, for easier location of the start of the last take.

NAB is the equalization curve used in the U.S. (See CCIR/IEC.)

Peak indicators, usually flashing LEDs, are used in conjunction with average-level (VU) meters to warn the operator of signal transients that are strong enough to cause distortion, yet too fast for VU meters to respond to. **Peak meters** display peak, rather than average, signal values. They’re sometimes referred to as PPMs (Peak Program Meters).

Pitch control is a variable speed adjustment (usually $\pm 5\%$ to $\pm 10\%$) useful for increasing or decreasing tape time or matching the pitch of instruments recorded at different times.

Quarter-track usually describes a format that records four tracks on a tape, with two tracks (1 and 3) recorded in one direction, and the other two (2 and 4) recorded in the other. (See four-track.)

Transport logic protects the tape from breaking or stretching by automatically stopping it briefly between fast wind or rewind and record or playback. **Motion-sensing logic** can make the stop even more brief since it senses when it’s safe to begin play rather than waiting a fixed period of time.

Two-track is a tape format that records two tracks, each almost half the tape’s width, with a small, unrecorded guard band between them. Also called half-track.

VU meters indicate average, rather than peak, recording levels. Though not all averaging meters meet the true VU standard (which rigidly defines the response to certain specified test signals), most are marked VU nonetheless.

middle of a session (usually just when you've become familiar with which input pot controls which instrument), inserting external signal-processing devices, and so on. With enough patching, you can re-configure your board as easily as you can stack piles of toy blocks—with the advantage that everything goes back to normal the instant you pull out the patch cords.

The \$700 to \$1,500 boards usually provide several operator conveniences that can speed up a session considerably. CUE SEND sends the signal from a given board input to a headphone circuit, so the performers can listen to, for example, the rhythm tracks while overdubbing. Some boards also have a CUE CHANNEL, which picks up any input channel whose fader is pulled all the way down. This enables the engineer to listen to it without feeding it into the mix; it can be used to check signal quality, to tell when a tape track is nearing the point where you want to mix it in, or even to cue up tapes and records that will be fed into the mix later. MONITOR ASSIGNMENT buttons control which signals are fed to control-room speakers, which to speakers in the studio, which to headphones in each location, and so on. TALKBACK systems let the operator talk to the musicians via a mike on the board. His comments or instructions can be fed to their headphones or, between takes, through the studio monitors. All of these features tend to be necessary only when the control

room and studio are separate. But even if you're working in one room (and we assume you are), keep the possibility of a separate control room in mind while you're selecting your equipment.

As studios get larger, even common features like VU meters become more important. In a small setup, you can put your tape deck right behind your mixer and use its recording-level meters directly. But if you have two decks, or if you must peer over the board to see what the musicians in the next room are doing, you'll need a mixer with its own meters. In most studio control rooms, the tape decks are set up behind the operator.

ON THE UPGRADE

Regardless of whether or not you *think* you'll be upgrading your studio, believe me it pays to shop for equipment with expansion in mind. For instance, you'll want to get a board with provision for outboard signal-processing, such as echo. A few mixers have it built in, but you'll need an additional echo unit (or a reverb or delay unit) eventually, so make sure there's a place to patch it in. EFFECTS BUSES (such as echo) can take their signals from before or after the input faders. Most mixers use postfader SEND, since effects then follow the rise and fall of the input signal naturally. But some interesting, if unnatural, effects can be achieved by

feeding the effects buses directly from the input, before the signal is attenuated by the fader, which some consoles also allow. You'll find submaster controls on a few boards in this price class, and quite a few at higher prices. These let you fade several inputs in and out at once—useful, for example, when you've assigned three mikes to the drummer or brass section.

Of course, there's a lot more to a studio than tape decks and mixing boards, even if they are the two largest hardware investments you'll make. There are outboard equalizers and echo, reverb, and delay devices; compressors, limiters, and noise reduction; rhythm devices; vocoders and synthesizers; equipment racks (all that stuff has to go somewhere); patch bays; fuzz boxes, flangers, wah-wahs, etc. Most of these are available at moderate prices—but the cost of fully stocking a studio with them adds up. In our next installment, we'll see how many of these extras, in addition to the basics, a \$10,000 budget will buy.

Saving up to move from the \$2,000 to the \$4,000 level may take a while, and moving from \$4,000 to \$10,000 takes even longer. But the time's not wasted: While you're working, you're learning. For the most important part of your studio isn't what's in your studio. It's what's in your head. 🎧



Teac 35-2

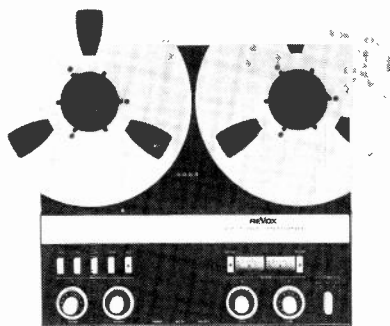

ReVox A-77



Pioneer RT-2022

ESS Heil Wins Again

Comparative tests continue: students at Georgia Tech judge ESS speakers superior to JBL, Bose, Cerwin Vega, Pioneer, AR, Advent, and Infinity.

In the third of a series of blind listening tests, over 650 students at Georgia Institute of Technology judged ESS loudspeakers superior in overall performance to other top speaker brands. In previous tests, hundreds of students at U.C.L.A. and the University of Wisconsin at Madison had also judged ESS best in clarity, accuracy and freedom from distortion.

The controlled direct comparison tests, conducted under the supervision of an independent national testing laboratory, were designed to simulate home listening conditions. Loudness differences were electronically equalized and all speakers were positioned for optimal performance.

The students listened in groups of 30 or less to the same musical material played on each of the speakers in head-on comparisons, without knowledge of speaker brand

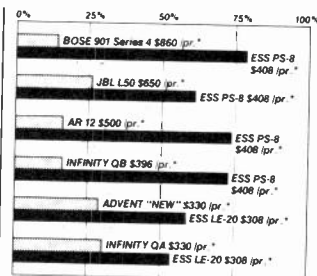

or model. They were then asked to choose the best sounding speaker. At U.C.L.A. and Wisconsin, the students chose ESS in 13 out of 14 comparisons, while at Georgia Tech ESS was chosen amazingly in 24 out of 24 comparison situations.

In all three tests, as the graph shows, ESS speakers were compared to and often chosen over far more expensive name brand models.

ESS technicians are calling the Georgia Tech demonstration "... our most complete victory. We used 19 different sets of speakers in the Georgia Tech comparisons, as compared to 11 at Wisconsin and 10 at U.C.L.A. — yet at Georgia Tech we won every comparison."

ESS's superiority is due to the exceptional performance of the Heil air-motion transformer midrange/tweeter.

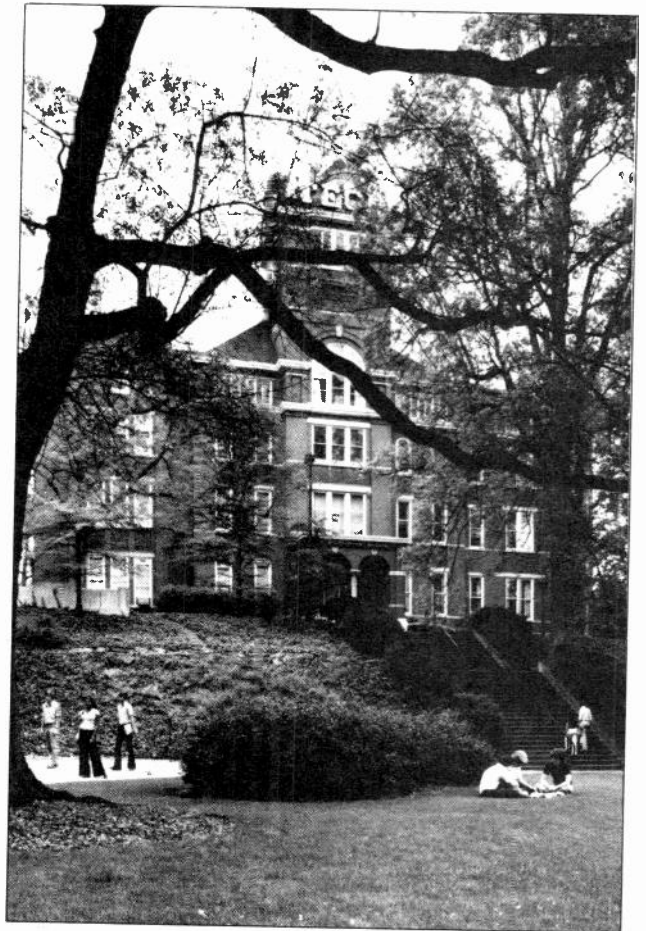

This unconventional driver was invented by Dr. Oskar Heil (creator of the FET) and is licensed exclusively to ESS. It employs a pleat-folded diaphragm that *squeezes* air like a bellows rather than *pushing* it. The squeezing motion increases the air velocity 430% giving the Heil virtually "instant acceleration" for degrees of clarity, accuracy and spaciousness unattainable with conventional drivers.

Complete details of all three tests should be available at your local ESS dealer in the near future. But don't wait for the results, visit your dealer now. Take the ESS Listening Test for yourself. You'll appreciate the difference.

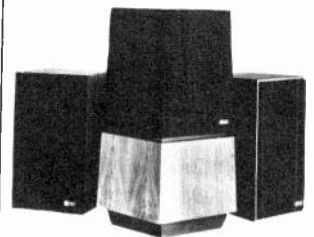

Take the ESS Listening Test yourself!



sound as clear as light

*Suggested Retail Price

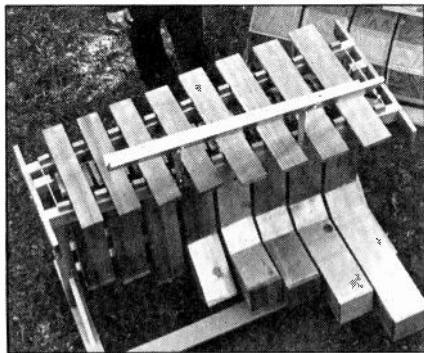
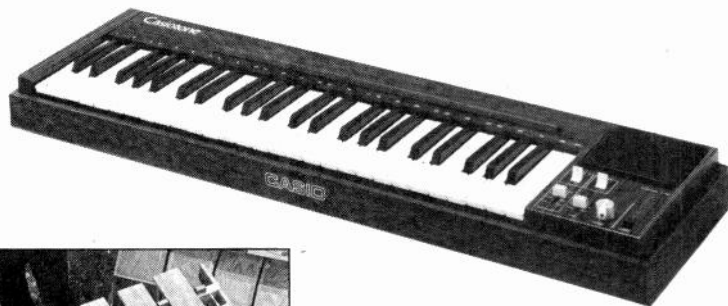

CC Banta's bass marimba, the Casiotone Model 201 four-octave electronic keyboard, and the Roland Rack

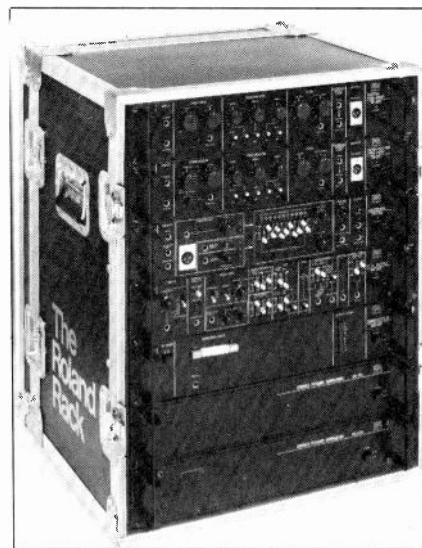

Report from Winter NAMM: Less Hype, More Substance

by Fred Miller

As the "me" decade closes and we embark upon what promises to be a period of technological advancement beyond our wildest dreams, musical instrument and accessory manufacturers appear to be buckling down to no-frills, common-sense marketing and merchandising practices. The NAMM (National Association of Music Merchants) shows of the late '70s were loaded with Madison Avenue hype—buttons, bumper stickers, balloons, and buxom babes wearing costumes of every description. Fortunately little of that was in evidence at last January's convention in Anaheim, California. (Perhaps NOW finally caught up with NAMM.) The emphasis this time seemed to be on the product, not the packaging.

Among the new items on hand was a carrying case/drummer's rug combination from D'Aleo's of California. The rug provides a stable surface for setting up a drum kit and rolls up to hold up to eight heavy-duty stands in a shoulder-strap arrangement. Another innovative goodie, the Ploeger Sound Mirror, clips to the bell of a saxophone and reflects the sound back up to the player without interfering with what the audience hears. (No more playing into the wall to hear yourself!) And

CC Banta displayed a bass marimba with huge wooden keys with tuneable resonators.

Casio, Inc., famous for their pocket calculators and musical timepieces, entered the musical instrument field with a series of good quality, low-cost electronic keyboards. Ranging in size from the 2½-octave Casiotone 10 up to full-sized keyboards, they are quite straightforward in operation and incorporate a wide range of instrument voices. Further down the aisle, Fender displayed its new bite-sized Rhodes Stage Piano with 54 keys. Fender is now making the tops of all its Rhodes (the 73- and 88-key as well) flat, at long last realizing that musicians occasionally need to be able to read music. This should also make it easier to stack the instruments. Con Brio introduced its ADS (Advanced Digital Synthesizer) 100, which comes complete with a programming panel, floppy discs (storage mediums for digital information), and a video screen. It reminded me of an elaborate version of RMI's keyboard computer. Moog's newest synthesizer entry is the Liberation, a portable, 3-octave monophonic unit that looks weird and sounds great. Speaking of looking weird, Zephyr Manufacturing has de-

signed a truly wonderful mike stand that tilts toward the performer from its base and eliminates the need for goosenecks and booms. Another amazingly simple idea for my why-didn't-I-think-of-that file.

There were also many old favorites at the show, devices introduced over the past couple of years that have withstood the test of time. The Roland Rack, for example, has become a very popular item, which isn't surprising since it's such a useful concept: an easily movable unit that incorporates such performance basics as preamp, power amp, flanger, delay line, compressor, etc. And electronic-drum manufacturers Synare and Syndrum are alive and well, refining a concept that just three years ago seemed downright revolutionary.

Although this was said to be the biggest NAMM Western Market show yet, it was clear that some belt-tightening has been going on in the industry. From where I sit, that's a healthy trend. I'm looking forward to a decade that will be shorter on flash and pizzazz than the '70s were but longer on value and substance. ☘



All you feel is the music.

Music should be a sensory delight. But it can't give you the pleasure you deserve if your headphones squeeze your ears and hurt your head.

The **Beyer DT 440** is quite probably the world's most comfortable headphone. At 9 ounces, it's not quite the world's lightest (that record belongs to our Beyer DT 302). But with its sponge-padded ear-cups and low-pressure air-filled headband, it's so beautifully balanced it just about disappears.

When you plug in the DT 440 you'll be part of an almost unbelievably realistic musical experience. The strong bass, high efficiency and

fast transient response have all been acclaimed by sophisticated audiophiles, audio critics and musicians worldwide. And the DT 440's open-air, high-velocity design gives you a perfectly natural balance between recorded and environmentally-present sound.

The overall sound is absolutely clear, yet at the same time, warm and rich. With smooth, undistorted reproduction across the entire audible spectrum.

Stereo imaging approaches the ideal, providing accurate and dramatic locating of each and every sound source.

Please visit your Beyer dealer. He'll make you feel better.

Beyer 
Dynamic

BURNS AUDIOTRONICS, INC.

5-05 Burns Avenue, Hicksville, NY 11801 • (516) 935-8000
In Canada: H. Roy Grav. Ltd.



“Rock & Roll for a Desert Island”

by Stephen Holden

Anyone interested in rock and the literature that has grown up around it must read *Stranded: Rock and Roll for a Desert Island* (Alfred A. Knopf, \$12.95), a collection of essays edited by Berkeley-based writer Greil Marcus, who received a National Book Award nomination several years ago for his *Mystery Train*. For *Stranded* he asked twenty rock critics—fifteen men and five women—to respond to the question, What one rock & roll album would you take to a desert island? Though the essays aren't all first-rate, together they present a powerful case for rock & roll as an art form and for rock criticism as a vital literary genre.

Nurtured in the pages of *Crawdaddy*, *The Village Voice*, and the mid-Sixties magazine *Eye*, rock criticism has developed into a uniquely open-ended personal, political, and cultural forum as stylistically diverse as the music it considers. Unlike his theater and film comrades, the rock critic doesn't have the power to make or break records commercially—radio does, principally. This makes him all but irrelevant in the marketplace, but at the same time it frees him of the temptations of publicity-mongering for his own

Royals, a fictional Fifties rhythm & blues group. This is the book's closer, and sandwiched between it and Tosches' joyride are a dozen or more pieces whose imaginative boldness and sheer zest outstrip most of what you're likely to find in a whole year's worth of *The New York Review of Books*. In reassessing the Rolling Stones' late-Sixties masterpiece “Beggars Banquet,” English critic Simon Frith makes a strong case for the album as “hilarious” and the Stones as “petit bourgeois jesters” and “poets of lonely leisure” whose rebellion has been “an aesthetic style without a core.” Writing about Lou Reed and the Velvet Underground, Ellen Willis celebrates the history of the aesthete-punk stance in rock & roll, then uses Reed's *Street Hassle* as the launching pad for a poetic leap of faith: “I believe that body and spirit are not really separate, though it often seems that way. I believe that redemption is never impossible and always equivocal. But I guess that I just don't know.”

Discussing the aesthete-punk dichotomy more hard-headedly, this time in relation to the New York Dolls, *Village Voice* critic Robert Christgau concludes, “Their music synthesizes folk art's communion and ingenuousness with the exploded forms, historical acuity, and obsessive selfconsciousness of modernism.” In these very well chosen words, Christgau comes closer than anyone has to defining the essence of post-countercultural rock. Jay Cocks uses the career of Huey “Piano” Smith as the springboard for a vivid, stylish musicomythic history of New Orleans. Lester Bangs gets to the heart of Van Morrison's “Astral Weeks” by starting with a reminiscence of his own life at the time of its release (1968). He then literally enters the world of the album to the point where his language and Morrison's run together. The most compassionate and daredevil critic of all, Bangs ends his piece with dazzling side-by-side quotes from Morrison and poet García Lorca. The book's funniest change of pace is from Bangs's piece to Dave Marsh's, which is a compilation of an imaginary album,

“Onan's Greatest Hits,” for the solitary man. “The real truth,” writes Marsh, “is that rock was invented by teenagers with pimples, and acned adolescents are mostly getting it on with their fingers.”

Stranded's two best chapters—Tom Carson on the Ramones' “Rocket to Russia” and John Rockwell on Linda Ronstadt's “Living in the U.S.A.”—couldn't be more dissimilar. Writing about the Ramones, Carson confirms Christgau's aesthetic, but with exciting rhetorical punches: “. . . the appeal of twisting the whole hierarchy of success and defeat around to make it say the opposite of what it seems to mean. It's not graffiti transformed into art so much as it's art redeemed by the spirit of graffiti. . . . You could say that it's all a joke, done just for fun; but in America, simply having a good time is an elusive, tricky ideal, and even jokes have a moral significance. . . . the kind of deadly serious kidding that rock 'n' roll, and America, couldn't live without.”

Rockwell's paean to Linda Ronstadt is the longest chapter and the only one to use standard musicological terminology. Though not many people will share the extent of Rockwell's adulation (he even prefers Ronstadt's version of Warren Zevon's *Mohammed's Radio* to Zevon's own), his essay, gathering together detailed musical analysis, various strands of rock history, biography, and personal reminiscence of his friendship with Ronstadt, is as comprehensive and passionately argued a piece of critical advocacy as I've ever read.

Editor Marcus, who in *Mystery Train* staked his claim to being rock criticism's archtraditionalist, caps *Stranded* with an “essential” discography that's as fascinating as it is partisan. Like all the best essays in the book, his list is informed with a brutal zeal for the authentic, combined with an equally brutal rejection of everything else. It is this zeal—adolescent insight and passion, focused, refined, and turned outward—that characterizes *Stranded*. Never mind that the use of intellectual dialect to exalt an anti-intellectual culture is a fundamental, unresolved paradox; the writing is hot. ☐

“The real truth is that rock was invented by teenagers with pimples.”

benefit. Especially in the last five years, rock critics have used this freedom to take a longer literary/cultural view than theater, movie, and even many book critics, and to develop intellectual and artistic stances sometimes as striking as those of the personalities they write about.

Stranded begins with Nick Tosches' riff on what the Rolling Stones have meant to him over the years. Gonzo journalism in the mode of Hunter Thompson, this funny, druggy reminiscence is a tour de force of intellectualized adolescent macho grossness. Equally iconoclastic is Ed Ward imagining the demise of the Five

Zevon Strikes Again

by Crispin Cioe



Zevon—a grisly presence in pop

Warren Zevon: Bad Luck Streak in Dancing School

Warren Zevon & Greg Ladanyi, producers. Asylum 5E 509

A serious songwriter is one whose tunes have legs of their own. With Warren Zevon's third album (discounting a misguided and recently re-released disc from his very early days), both singer and songs now stand foursquare as substantial, if grisly, presences in pop music. Though his talent and skewed sensibility were clearly established with his first two Asylum LPs, production weaknesses prevented an equally strong musical identity: The first, "Warren Zevon," lacked punch and sounded murky, while "Excitable Boy" had a slick veneer that obscured his rock & roll soul. From all available reports, Zevon either couldn't or wouldn't take a strong artistic hand in those earlier projects. But "Bad Luck Streak," co-produced by engineer Greg Ladanyi, is his own album with his own musical footprints clearly audible on every song. Not surprisingly, those footprints are just as idiosyncratic as his gripping, often oblique tales from beyond.

These are songs of displacement,

of people (and in one case of an animal) who are achingly uncomfortable in a hostile world. To match that, there's often a teeth-gritting, genuinely schizophrenic tension to the military rhythms Zevon uses. Sometimes he generalizes, as on the title track where the singer moans, "I'm down on my knees in pain, swear to God I'll change." The song is like a young boy's nightmare of violent discipline, set in some surrealistic "dancing school." *Wild Age* celebrates the classic American bad boy, à la James Dean, Marlon Brando, et al., with bittersweet backing harmonies from Eagles Glenn Frey and Don Henley. Rick Marotta's muscular, crackling drums figure prominently in the mix on these songs, while David Lindley's weeping guitar solos add a touch of melancholy. *Bed of Coals* deals with the kind of morbid, self-pitying paranoia that is as American as country music. Fittingly, Ben Keith's funereal pedal steel guitar wafts through the song, as Zevon describes a "bed of coals, bed of nails," complaining that "I'm too old to die young, and too young to die now"—without, of course, ever identifying any specific ailment.

Ironically, as his stories become more specific, they become more universal, penetrating deeply into modern life and its discontents. *Play It All Night Long* paints an intensely grim portrait of southern life. While the band plays a dirgelike approximation of Lynyrd Skynyrd, the singer wails: "There ain't much to country living—sweat, piss, tears, and blood." Again, Lindley's atmospheric guitar poignantly underscores the chorus: "Sweet Home Alabama, play that dead man's song, turn those speakers up full blast, play it all night long." On *Jeannie Needs a Shooter*, written with Bruce Springsteen, Joe Walsh's ringing guitar sets up a heavy-metal buckdance figure to accompany a western fable of star-crossed lovers, and a supremely ironic punch line sabotages the song's initial Romeo and Juliet expectations. Only Zevon could write a straight ahead song about mercenary soldiers, and *Jungle Work* lays down the album's fiercest rock & roll. As the singer describes "battle in hell," a darkly ascending string section leads up to the chorus chant: "strength and muscle and jungle work." The verses could have been taken straight from the pages of *Soldier of Fortune* magazine, but the blood-curdling death screams on the fadeout are pure Zevon.

And yet, there's an idealist's moralistic edge to his celebrated flirtation with violence, as if he were as interested in purging evil as portraying it. Sometimes that romanticism emerges full-blown: Played on piano and harmonica alone, *Bill Lee* is a simple and earnest homage to the iconoclastic baseball pitcher, a man Zevon obviously admires for his outspokenness. *Gorilla, You're a Desperado* is a pure delight and one of his best compositions ever. Like Kafka's *Metamorphosis* in reverse, the song is about a "big gorilla at the L.A. zoo, [who] snatched the glasses right off my face, took the keys to my BMW, left me here to take his place." Unfortunately, the gorilla also assumes the singer's problems and ends up "very depressed, [he] went through transactional analysis." The album's sole cover tune is the Allen Toussaint (alias Naomi Neville) chestnut *A Certain Girl*, which the Yardbirds once popularized. The only truly lighthearted song here, it nonetheless fits Zevon's dour profile like a glove.

Three instrumentals, string quartets really, serve as introductions to as many songs. All are tasteful, recalling such composers as Samuel Barber and even Béla Bartók. Such eclectic programming works only because Zevon has literally turned his eccentricity into an integrated, discernible style. The album's one odd-tune-out is a very straight ballad, *Empty-Handed Heart*, which talks about lost love in a "personal" way. When he sings, "Sometimes I wonder if I'll make it without you—I'm determined to," I think of Ross MacDonald, another Southern California writer who freely mixes the gruesome and the sentimental. "It isn't possible to brush people off," wrote MacDonald, "let alone yourself. They wait for you in time, which is also a closed circuit." Only romantics with their eyes wide open could write like this, and Warren Zevon's characters, including himself, know that circuit well.

The Brides of Funkenstein: Never Buy Texas from a Stranger

George Clinton, William Collins, & Ron Dunbar, producers
Atlantic SD 19261

by Crispin Cioe

Funk for George Clinton is like classical Indian music for Ravi Shankar or the blues for Otis Rush: a concrete musical form within which to develop a complete musical world view. Seen this way, all of

FREE!

HI-FI DISCOUNT CATALOG

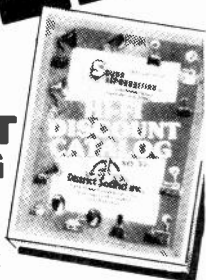

- Lowest prices on audio components!
- Fast service, fully insured, factory sealed cartons!

Sound Reproduction inc.
(201) 227-6720

CLIP & MAIL TODAY!



Sound Reproduction, Inc.
7 Industrial Rd., Fairfield, N.J. 07006

Please rush your free Hi-Fi Discount Catalog

Name _____

Address _____

City _____

State _____ Zip _____

Circle 47 on Page 99

FREE details... A DIFFERENT KIND OF RECORD CLUB

TREMENDOUS SAVINGS
on every record and tape in print—no "agree-to-purchase" obligations of any kind
DISCOUNTS OF 43% TO 73%
off mfg. suggested list...special catalog features hundreds of titles and artists

ALL LABELS AVAILABLE
including most imports through special custom ordering service—guarantees satisfaction

SCHWANN CATALOG
lists thousands of titles; classical, pop, jazz, country, etc

DISCOUNT DIVIDEND CERTIFICATES
Dividend Gifts—certificates redeemable immediately for extra discounts

NEWSLETTERS
informational news and happenings in the world of music... special super-sale listings.

DISCOUNT ACCESSORY GUIDE
Diamond needles, cloths, tape cleaners, etc

QUICK SERVICE
same day shipping on many orders rarely later than the next several days

100% IRON-CLAD GUARANTEES
on all products and services—your total satisfaction is unconditionally guaranteed

Discount Music Club is a no-obligation membership club that guarantees tremendous discounts on all stereo records and tapes and lets you buy what you want...when you want...or not at all if you choose.

These are just a few of the money-saving reasons to write for free details. You can't lose so why not fill out and mail the coupon below for immediate information.

dms DISCOUNT MUSIC CLUB, INC. DEPT. 8-0480
650 Main Street, New Rochelle, N.Y. 10801

Name _____

Address _____

City _____

State _____ Zip _____

Circle 12 on Page 99



Clinton's productions (Parliament, Funkadelic, Parlet, etc.) are more than just commercial outlets—they're variations on a recurring theme. The Brides of Funkenstein—Dawn Silva, Sheila Horn, and Jeanette McGruder—also have been Funkadelic's lead female vocalists for years. On "Never Buy Texas from a Stranger," Clinton casts them in the hard-edged funk landscape that is the Funkadelic trademark (in contrast to Parliament's smoother pop surfaces). The Detroit influence that permeated that band's early-'70s songs, like *Standing on the Verge of Gettin' It On*, dominates here. Rocking guitars from Garry Shider, Mike Hampton, and Eddie Hazel slide between Bootsy Collins' bazooka-like bass and the Brides' multilayered vocals.

On *Smoke Signals* these threads weave a fabric of shifting densities that ranks with Clinton's best work to date. The Brides chant phrases like "I'm sending up smoke signals, baby," in unusually voiced, angular harmonies, against which each singer steps out to solo and shout, space-age gospel style. In less capable hands, this might have come across as either chaotic or boring, but George has learned his formalist lessons well from the classic James Brown and Motown litanies. (In fact, he was a Motown staff songwriter in the mid-'60s.) Even his serio-comic moralizing, like the follow-up to the title track line—"and never buy a bridge when you're in Brooklyn"—makes sense with the Brides wailing away over music this strong.

Burning Spear: Harder than the Best
L. Lindo (Jack Ruby), Winston Rodney, & Karl Pitterson, producers
Mango MLP5 9567
by Crispin Cioe

In Jamaica and the world at large, Winston Rodney of Burning Spear (the other members are Delroy Hines and Rupert Willington) has been a charismatic reggae star for several years, equal to Bob Marley as a musical poet and seer. "Harder than the Best" is a best-of collection, and, since his records pop up only sporadically in America, it serves as a solid introduction to his special gifts.

Where Marley and Toots Hibbert (of Toots & the Maytals) have drawn on American soul music for inspiration, Burning Spear is more African-based, and



The Clash—fulfilling their much-acclaimed potential

Rodney's ethereal voice is reminiscent of both Gold Coast traditional styles and modern singers like Hugh Masekela. His songs are often cinematic, conjuring up vivid scenes from a collective past: "Do you remember the days of slavery, when the work was so hard?..." Yet he uses gently rocking melodies, aiming more for education and enlightenment than rabelousing. (Rodney owns a general store/social center in St. Ann's, Jamaica, and apparently leads the exemplary Rastafarian pastoral life.) *Throw Down Your Arms, Social Living*, and *Black Wa Da Da* are powerful and unique songs, the lyrics at once hypnotic and intellectual, the music's subtle Afro-Jamaican dimensions underscoring the message. This is, as they say on the island, a top-ranking album.

The Clash: London Calling
Guy Stevens, producer
Epic E2 36328 (two discs)
by Sam Sutherland

Until now, the Clash has been lionized as much for its potential as for the quality of its recorded work. To a rock intelligentsia frustrated by the genre's commercialism and subsequent loss of urgency, the awkward angles and rough edges of the band's early singles and albums were proof of its authenticity. The flaws of those records, such as haphazard production and sequencing (due in large part to ongoing squabbles with the record company), were elevated to the status of

Fact:

There are now more than 1000 car stereo products.

Question:

Do you know which ones you need?

Answer:



Why guess—and make expensive mistakes—when you can have the audio industry's top experts show you the way to go?

You'll know exactly what you need to spend for your car stereo system—the components you need, the best place to buy them and who should install them. And much more, like cost-no-object dream installations.

Order now—just \$2.95 for your Buying Guide to Car Stereo Systems—Supply is limited!

DOC11

1980 Buying Guide to Car Stereo Systems
1 Sound Ave., Marion, Ohio 43302

Please send me _____ copy(ies) of the Buying Guide to Car Stereo Systems at \$2.95 each.

I enclose a check money order for \$ _____

Name _____

Address _____

City _____

State _____ Zip _____

Please allow 30 days for shipment



The Ramones—a successful Phil Spector production

scars of uncompromised moralism.

Yet this recklessly honest British quartet has been as limited as it has been liberated by the very passion so central to its critical esteem. It has been the galvanic live show that fleshed out the earnest rapport the band sought with its audience: on record, too often the narrow stylistic range and intensity of performance obscured the humor and humanism that emerged so vividly on stage.

"London Calling" transcends that paradox, achieving a quantum leap in the breadth and clarity of the Clash's music. As such, it marks a triumphant turning point for the band, and possibly for the new rock movement with which it is associated. This is openhanded, openhearted rock modeled on classic sources and requiring little additional explanation beyond the songs themselves.

This time rockabilly, reggae, and various strains of r&b are displayed prominently against the guitar-dominated approach of the first two albums. Augmented by Micky Gallagher's keyboards and the brisk brass charts of the Irish Horns, those revisions as well as Guy Ste-

vens' more lucid production finish amplify rather than obscure the songs' message.

The band's thematic concerns remain as provocative as before, based on the populist ideals it sees threatened by the repressive realities of Ireland, Jamaica, and its native England. If the Clash's targets are the same, its aim is more careful. "London Calling" thus achieves a stirring balance of psychological detail and moral force, similar to Elvis Costello's "Armed Forces" in its indictment of Western decadence.

Such weighty themes still lead Joe Strummer and Mick Jones to chew their lyrics with angry relish, braying as much as singing them: in rheumy, full-throated abandon. But the added shadings here more convincingly convey pathos, humor, and even joy—not just anger. As a result, the Clash's first double album is far more consistent and coherent than either of its single-disc predecessors. The thematic undercurrents begin on the apocalyptic title cut and continue through all eighteen songs in a richly colloquial voice that recalls both the raw rock energy and street-jive color of "Exile on Main Street."

The Ramones: End of the Century

Phil Spector, producer

Sire SRK 6077

by Sam Sutherland

The Ramones playing *ballads*? The Ramones turning down their amps and resorting to lush washes of *acoustic* guitar? Has all reason fled? Is nothing sacred?

That has been the initial reaction of several colleagues and Ramones admirers to the new album, but have no fear. "End of the Century" does add such atypical twists to the breakneck kilowatt rock that has become the group's trademark, but the producer behind these new wide-screen treatments is one of the few who can perform such major surgery without butchering the band's own perspective. Phil Spector is himself a past master of teenage overstatement and exalted pop kitsch.

As a result, the corny string motif that accents the verses on a remake of the Ronettes' *Baby, I Love You* is more than matched by Joey Ramone's wonderfully maudlin lead vocal. Similarly, the flying wedge of wailing saxes that romps through the backdrop of *Rock 'n' Roll Radio* is balanced against a fusillade of driving rhythm guitars. While Spector's penchant for wall-to-wall orchestrations has swamped some of his more recent collaborations in bombast or melodrama, here the union proves felicitous.

Apart from letting several tracks retain the simpler attack of earlier Ramones records, Spector applies his more familiar techniques of sonic hyperbole to a willing subject: the gloriously unsophisticated protagonist that is the hero of every Ramones song. With the common goal of unabashed pop sentiment, rather than "artistic" pretense, "End of the Century" succeeds as a witty expansion of this prototypical punk band's exuberance.

Doug Sahm: Hell of a Spell

Dan Healy, producer

Takoma TAK 7075

by Sam Sutherland

"Hell of a Spell" is the first Doug Sahm record in several years to find a home on a national record label. And it's both significant and heartening that his return to wider visibility comes under the aegis of the revitalized Takoma label.



Bruce Woolley, Musical Frankenstein

by Steven X. Rea



Bruce Woolley & the Camera Club

Mike Hurst, producer
Columbia NJC 36301

Bruce Woolley has seen the future of rock & roll and has embraced it with enthusiasm. The visual realization of that would be Bruce Woolley hugging himself.

The various musical trails blazed into the '80s by the likes of Elvis Costello, Devo, Brian Eno, and Talking Heads have met head on with the pure pop artistry of such hitmakers as the Electric Light Orchestra and 10cc in the '70s, and the Dave Clark Five in the '60s. Their collision is embodied in one young English singer/songwriter—a cynical, intelligent, yet still romantic tunesmith by the name

of Woolley. He has glommed the avant-garde precepts of the art-rockers, learned the misanthropy of the punk-rockers, acquired the frigid precision of the techno-rockers, and borrowed the simple grace and melodic sway of the popsters. He is a musical Frankenstein, his debut LP a summoning of sundry parts into one devastating monster.

Woolley cowrote *Video Killed the Radio Star*, a No. 1 hit in Britain and a charted single in the States as performed by a group called the Buggles. The Buggles' version—like their name—is cutesy teenybopper dross with a syncopated synthesizer sheen. On "Bruce Woolley & the Camera Club," *Video Killed the Radio Star* opens with the singer muttering the first verse in a vacuous whisper: "I heard you on the wireless back in '52, lying awake intently tuning in on you," then stately organ chords burst in and the song takes off. Woolley infuses passion where the Buggles employed mere gimmickry. The result is that the song's theme of machine vs. man, technology vs. the individual, becomes clear.

Though futuristic, sci-fi trappings permeate much of his world. Woolley's main concerns are with human needs and desires. The LP's opener, *English Garden*, is a first-person account of impending senility or loss of sanity in the wake of stardom—all that's left for the protagonist are his flowers: "When the weather is right I do as a gentleman should, In my English garden." Here his vocals owe something to the distraught, twisted inflections of Talking Heads' David Byrne: the sense of reality-as-we-think-we-know-it slipping from the singer's grasp suggests Byrne's own paranoid world view.

Love and romance are dragged coolly and ironically around the field in the form of jealousy (the melodically stunning *Dancing with the Sporting Boys*), rejection (*No Surrender*), manipulation (*Johnny*), adulation (*You Got Class*), and spiteful farewells (*Goodbye to Yesterday*). Woolley is thus a pop craftsman in the classic sense, singing the classic theme—love. But the framework of the songs is starkly modern.

The Camera Club is integral to all of this. Apart from sharing songwriter credits on several tracks, the quartet is adept at shifting rhythms, variably evoking taut, robotlike riffs, fluid, Eno-type electronic reveries (the instrumental *W.W.9*), hard rock, or smooth, lilting pop. Rod Johnson's drums are crisp and terse. Matthew Seligman's bass shores up and propels the whole works. Ex-Vibrator guitarist David Birch keeps things to a palatable minimum but isn't afraid to let loose a shrill guitar line when one is called for. The ultimate shaper of the Camera Club's sound, though, is keyboardist Tom Dolby. The warm, regal tones of Bach, the sloppy effervescence of the Dave Clark Five in *Flying Man* (a totally blatant reworking of *Glad All Over*), and the mechanical rhythms in *Clean/Clean* all appear mercurially at his command.

Bruce Woolley approaches his music with restraint and a sharp, biting wit. His lyrics are eloquent, sometimes surreal evocations of man in the modern world. Amidst the slick, swelling harmonies of "Bruce Woolley & the Camera Club" there's a lot of wry humor. There's something to be taken seriously here too, and that is the very heartening indication of where pop music is heading in the '80s.

New Acts

by Steven X. Rea

D. L. Byron:
This Day and Age
Jimmy Iovine & Shelly
Yakus, producers
Arista AB 4258

"This Day and Age" doesn't let up, its taut, high-powered rock charged along by pulsating guitars and drums. New Yorker D. L. Byron has his band, Protector 4, and producer Jimmy Iovine to thank for the thundering, relentless sound. Tracks such as *Lorryanne*, *Love in Motion*, and *Get with It* roar into high gear. Byron's songs and vocal phrasing are equal parts anthemlike Springsteen and jerky Costello, with just a dash of the other Elvis on some of the late-'50s-tinged cuts (*Listen to the Heartbeat*). What grates here is Byron's affectations: a good songwriter framed in a surging new wave-ish setting, he nonetheless owes too much to the aforementioned artists to be taken seriously.

Richard Fagan
Bob Gaudio, producer
Mercury SRM 1-3811

Richard Fagan gained industry attention via his songwriting credits on several Neil Diamond LPs. The surprise here is that instead of opting for Diamond's postured, soupy, dramatic approach, Fagan rocks straight ahead. He sings with a Dylanesque edge, while tracks like *Don't Bother Coming Up*, *I'm Coming Down* suggest the rough, frayed sound of Bob Seger. Toto's David Hungate and sessioners such as keyboardist Jerry Corbetta flesh out a solid solo outing.



The Last:
L.A. Explosion
John Harrison & the Last, producers
Bomp BLP 4004
(2702 San Fernando Rd., Los Angeles, Ca. 90065)

Sixties influences abound in this low-budget production from L.A.'s independent Bomp label. The Last, an Angeleno quintet, runs the gamut from the Beatles to the Byrds, keeping it simple, short, and snappy. Arrangements are a touch lackluster, and the energy level a little low—a veteran producer would help spark things up a bit.

The Lonely Boys
Andy Arthurs, producer
Harvest ST 12030

Known as Little Bo Bitch in their native England, Lonely Boys is a more apt moniker for this lightweight fivesome. Pop/rock is their game, irradiated by Dermot Moughan's keyboards, with just the slightest nod to the new wave here and there. Lead singer Tony Watson's Cockney twang is the only ragged element in the band's catchy gloss. Weill/Brecht influences appear on the bouncy *The Lover*. Not substantial stuff, but not awful either.

Ian McLagan:
Troublemaker
Geoff Workman, producer
Mercury SRM 1-3786

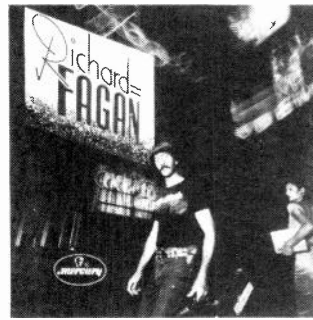

Original Small Face and longtime keyboardist with the Rolling Stones/New Barbarians axis, Ian McLagan steps out on a jaunty, rollicking solo foray with help from Keith Richards, Ron Wood, Stanley Clarke, and Ringo Starr. He is an eloquently plainspoken songwriter who comes straight to the point. His vocals are brash and spirited, making up in rowdy enthusiasm for what's lost in his limited range. A couple of languid reggae numbers veer from the British rocker's true course, providing the only dull moments in this otherwise affable affair.

Off Broadway U.S.A.: On
Tom Werman, producer
Atlantic SD 19263

Off Broadway is another midwestern quintet that travels Cheap Trick turf—the Beatles, the Move, the Who, and, in this case, Badfinger. Producer Tom Werman has framed this spirited aggregation in the same rich, textured setting that has marked his work with Cheap Trick. Lead singer/songwriter Cliff Johnson does a wonderfully nasal McCartney, and his cohorts proffer bountiful harmonies. This is pop with a capital P: Hooks run rampant, and a punchy, gutsy rhythm section underpins the airy melodies. "On" is a lot more consistent than Cheap Trick's "Dream Police."

William Oz
Stewart Levine, producer
Capitol ST 12015

Substandard rock & roll here comes from a far too serious East Coast-based singer/songwriter. William Oz evinces some flair for melody, but inane lyrics and stereotypical macho/rock posturings are a total turnoff. His band's adequate playing is supplemented by synthesizer wiz Larry Fast's dense electronic backdrop. Denser still are the people who handed Oz a record contract.

Pearl Harbor & the Explosions
David Kahne, producer
Warner Bros. BSK 3404

This Bay Area quartet fronted by singer/songstress Pearl E. Gates landed a record deal after a homemade single, *Drivin'*, started taking to the FM airwaves. *Drivin'* is the best cut here: booming, riffy rock that, well, *drives*. The three-piece Explosions' strategy is to burrow into a rhythm hook and stay there; consequently, some of this debut LP is just dull. *You Got It (Release It)* is the other standout. Despite its image, there's nothing new wave about Pearl Harbor & the Explosions.

Sue Saad & the Next
Richard Perry & James Lance, producers. Planet P4

This L.A. "new wave" outfit has about as much to do with the new wave as their hair stylists. The tough, nasty (and screechy) stance by Sue Saad is propelled along by speedy guitars, bass, and drums. Reggae touches and some bluesy balladry on several songs ring a lot truer than the bam-bam-bam rock. Not your standard Richard Perry production, by the way.



Robert Kraft—an original in a genre filled with poseurs

Continued from page 125
 direct, and, when performed correctly, swinging. But because of its wide popularity, it has often fallen into the hands of groups that cannot project it properly. "The Fabulous Bill Holman," originally recorded by Holman in 1957 for Coral records, should serve as an excellent model. Not only has the Canadian-based Sackville reissued it in its original monaural sound and sequencing, but, more importantly, the relaxed performances provide an excellent showcase for Holman's work.

There is no heavy pushing, no shrieking brass, no great burst of excitement. Instead, a steady, pulsing momentum flows like a quiet but fascinating conversation. The virtually infallible rhythm section—Lou Levy on piano, Max Bennett on bass, Mel Lewis on drums—guarantees a swinging setting at any tempo. The soloists are also first-rate, most notably Ray Sims's mellow, slightly burry trombone with its occasional echoes of Bill

Harris, Stu Williamson's steady, crisp trumpet, rollicking alto saxophonists Charlie Mariano and Herb Geller, and Holman himself on tenor.

Holman claims a wide variety of saxophone influences, from Tex Beneke to John Coltrane. The ones most evident here are Lester Young on the solos and Sonny Rollins, whose *Airegin* leads off the set. But on *Come Rain or Come Shine*, very little of either's style shows up. Instead, his warm and thoughtful development of the tune makes it almost a complete Holman showcase.

Robert Kraft and the Ivory Coast: Moodswing
Phil Galdston, producer
 RSO RS 1-3070
 by Crispin Cioe

Everything that usually goes awry with modern vocal jazz worked out just

Order Toll Free!
 Except N.Y. / Alas Hawaii

SCA 800-221-0974

FOR ORDERS ONLY!
 Mon. & Thurs. 9 AM-7 PM, Tues., Wed., Fri., Sat. 9 AM-5 PM
 E.S.T.

STEREO HOT-LINE

ONKYO **Technics**
by Panasonic

CHECK US OUT!

- ✓ Our prices are the lowest.
- ✓ Discounts on over 60 major brands.
- ✓ Reliability: one of the oldest audio mail-order houses in the U.S.A.
- ✓ Rated #1: by a leading trade publication.
- ✓ Large inventory: we buy in volume getting the best deals from the manufacturers, you get the best deal from us.

GIVE US THE OPPORTUNITY TO BEAT THE BEST DEAL YOU'VE BEEN ABLE TO FIND.

— QUOTES AND INFORMATION —
 (212) 253-8888, 9AM-5PM, MON.-SAT., N.Y. TIME

Write or Call us now for the lowest price quotes and a Free price flyer.

STEREO CORPORATION OF AMERICA
 HF-1629 Flatbush Ave.
 Brooklyn, New York 11210

Circle 48 on Page 99

Hi-Fi Buys

<p>SONY STR V55</p> <p>55watts rms at 8 ohms, no more than .02% thd</p>	<p>PIONEER RT 701</p> <p>Open Reel, \$369 Servo Direct-Drive Tape Deck</p>
<p>Technics SL81</p> <p>Servo Motor Belt Drive Turntable \$66</p>	<p>KENWOOD KX 1030</p> <p>Double Dolby 3 Head Cassette Deck With Bias Adjust \$269</p>
<p>TDK SA C90</p> <p>Chrome Bias Cassette Tape \$3.10</p>	<p>SONY EHF C90</p> <p>Extended Range \$2.99 Chrome Bias Cassette Tape</p>

free case with carton purchase of cassettes

CALL TOLL FREE 800-638-0935

Orders shipped within 48 hrs. • Phone and COD orders accepted. • Use Visa, Master Charge, or NAC. • Call or write for quotes. • Catalog available upon request. • All equipment factory sealed with full warranty.

Hi-Fi Buys

1362 HOLTON LANE
 LANGLEY PARK, MD 20783
 (301) 434-5330

Circle 20 on Page 99

MAXELL

WAREHOUSE-DIRECT PRICES
DISCOUNTS OVER 75%!!

UDXL II C90

Sugg List
725 Only **229**

T120

2-4-6 HR VIDEO CASSETTES
Sugg List
2850 Only **1290**

UD35-90

PREMIUM 7" REEL TO REEL
Sugg List
1150 Only **359**

	LIST	A A
UDC 90	5.90	1.89
LNC 90	4.10	1.39
LNC 46	2.46	.99
7 Metal Reel	5.50	1.25
Warm Up Jacket	25.00	10.00
T Shirt	6.00	3.00

ORDERING INFO

CERTIFIED CK DR MONEY ORDER FOR IMMEDIATE DELIVERY FROM STOCKED WHSE ALLOW (4) WKS FOR PERSONAL CHECKS TO CLEAR BANK SORRY NO C.O.D.S OR CREDIT CARDS ACCEPTED U.P.S SHIPPING AND HANDLING CHARGES COLLECTED ON DEL ALL MERCHANDISE BRAND NEW AND CARRIES MFGRS WARRANTY ATTENTION MR RETAILER DISTRIBUTOR CONTACT YOUR LOCAL SALES REPRESENTATIVE ABOUT KEY DEALER PRICING IN YOUR AREA!!

ACTION AUDIO

(DIV. C.W. INC.)

P.O. BOX 3039 PRINCETON, N.J. 08540
(609) 921-9793

FINE PRINT

WE RESERVE THE RIGHT TO LIMIT QUANTITIES. OFFER MAY BE WITHDRAWN WITHOUT NOTICE AT ANY TIME. NO MERCHANDISE OTHER THAN AS ADVERTISED ABOVE IS AVAILABLE.

RECEIVERS
& SPEAKERS
& TUNERS
& AMPLIFIERS
& TAPE DECKSTOP
DISCOUNT
AUDIOCARTRIDGES
& CHANGERS
& AUTOMATIC
& COMPACTS
& HEADPHONES

1150 N. Powis Road, West Chicago, IL 60185

Your National Headquarters for Name Brand Electronics by Mail

- ★ Full Manufacturer Guarantee Applies to All Sales!!
- ★ Orders Shipped in Factory-Sealed Cartons—Most Within 24 Hours
- ★ Multi-Million \$\$\$ Inventory

TOP DISCOUNT AUDIO

1150 N. Powis Rd., West Chicago, IL 60185
800-323-2518MasterCharge and VISA Welcome
Call or Write for the LOWEST PRICES Around!MR _____
MS _____
(First) (Initial) (Last)

(Number and Street)

(City) (State) (Zip Code)

Phone Order Hours: M-W-F 8AM-4:30PM, HF-3
T-Th 8AM-8PM, Sat. 9AM-Noon
WE CARRY THE TECHNICS PRO SERIES—Call for Quotes!

Circle 53 on Page 99

fine on Robert Kraft's refreshingly auspicious debut album. Pianist/singer Kraft emerged from the glitter-prone New York cabaret scene last year with an original pop/jazz sound. His style is rooted in Mose Allison and Thelonius Monk, with light dollops of Latin and rock rhythms flavoring several tunes. This is the mother lode that Ben Sidran, Michael Franks, and, more idiosyncratically, Tom Waits have attempted to mine, with varying success. The danger in this, except for an original like Allison, is that it's easy to sound either mannered or slightly precious—i.e., if it's a pose, it shows.

Luckily, Kraft's persona as a latter-day, jivey Cole Porter fits him as comfortably as Waits's neo-beat posturings. On *Junction Boulevard*—which conjures up Manhattan street sounds with ingenious and purely musical textures—Kraft convincingly tosses off lines like "Handouts, then handshakes, the cons become the pros/Each time a heart breaks some banker's belly grows." Conversely, his smoky voice is softly accurate, à la Mel Torme, on the diaphanously pretty ballad *Bon Voyage*.

Much credit for the overall success of "Moodswing" must go to Kraft's first-rate band, the Ivory Coast. Eclectic violinist Ross Levinson makes a brilliant debut with deeply emotional solos and rich duets with guitarist Stephen "T" Tarshis, all the while avoiding the usual fusion clichés. Bassist Ernie Provencher's tone and phrasing are superb. And producer Phil Galdston and engineer Elliot Scheiner (he of Steely Dan fame) have gotten marvelously resonant sounds from the players and their instruments, even on a couple of scat-swing numbers recorded live at Tramps nightclub in New York. In a tricky genre, these are all good signs for Kraft and his Ivory Coast.

Portrait of Marian McPartland

Carl E. Jefferson, producer
Concord Jazz CJ 101
by John S. Wilson

With so many of Marian McPartland's recordings focused entirely on her piano, it is refreshing to hear her in a more varied and less consistently demanding context. On this disc, she is backed by drummer Jake Hanna, bassist Brian Torff,

and alto saxist/flutist Jerry Dodgion, who plays such a strong role that it is as much a "portrait" of him as it is of McPartland.

Dodgion shows his authority from the start with Herbie Hancock's *Tell Me a Bedtime Story*. His smooth, soaring attack sets the piece floating in air and serves as a striking contrast to McPartland's running, low-register rumble. Despite his creamy tone on *Tell Me*, he avoids any comparisons with Johnny Hodges until he gets to his own tune, *No Trumps*, on which he reflects Hodges' mixture of warmth and firmness. He enlivens the slow, moving *Spring Can Really Hang You Up the Most* by delivering each note with precise, concentrated attention. His flute playing is serviceable on Sara Cassey's lovely *Wind Flower*, and dashing and swirling on McPartland's *Time and Time Again*, particularly in some of the passages with Torff.

But McPartland does not take a secondary role. Her one unaccompanied number is a reflective, beautifully developed treatment of *It Never Entered My Mind*, which she approaches as a vocalist might. (One can almost hear Teddi King's phrasing.) She shares solos with Dodgion throughout, providing a dark and sometimes dissonant contrast to his soaring warmth. Hanna is an excellent, self-effacing drummer, coming to the fore only for a brief bit of brush work on *I Won't Dance*. That tune also gives Torff a chance to show his disciplined facility as a soloist.

Jay McShann: Kansas City Hustle

John Norris & Bill Smith,
producers. *Sackville 3021*
by John S. Wilson

Though its title, "Kansas City Hustle," suggests busy, bustling traditionalism, this record should have been called "The Unexpected Jay McShann." As John Norris writes in his liner notes, McShann has been tabbed "just a blues player." His personal appearances usually do lean heavily on the blues, but they go far beyond the basic idiom, sometimes even revealing—as on this disc—sophistication with non-blues standards.

Playing with a light, clean touch in thoughtful, exploratory lines, McShann lends a fresh view to *Round Midnight* and *Willow Weep for Me*. Both have been

Continued on page 131

MAIL TO: 825 7th Ave., 6th Floor, New York, N.Y. 10019. Phone: 212-265-8360

GENERAL: All copy subject to publisher approval. First line caps. Users of P.O. Box MUST supply permanent address and telephone number before ad can run.

CLOSING DATE: 1st of second month preceding cover date.

CLASSIFIED RATES: Regular type, per word: 1x-\$1.80; 3x-\$1.75; 6x-\$1.65; 12x-\$1.60. **IMPERIAL type, per word: 1x-\$2.40; 3x-\$2.35; 6x-\$2.20; 12x-\$2.15.** Minimum 15 words. Words in caps - 10¢ extra each. Box numbers: \$2.00 additional per insertion to cover cost of handling and postage. Display, per inch: 1x-\$290, 3x-\$280, 6x-\$275; 12x-\$235.

PAYMENT WITH ORDER: Send check, M.O., MASTERCHARGE or VISA No. and expiration date to: Classified Dept., HIGH FIDELITY, 825 7th Ave., 6th Floor, New York, NY 10019.

FOR SALE

AUDIOPHILES WANTED!! Put your knowledge to use, earn an excellent spare time income. We need campus Dealers to sell name brand stereo equipment at substantial discounts in your area. No investment necessary. For information and application please write: ABCO, Dept. CR, 1201 East Main Street, Meriden, Conn. 06450.



LOUD AND CLEAR.
Read all about the K—the amazing speaker that has the power to reproduce even the lowest bass notes—loud and clear. Features the brilliant conehorn design with Speakerlab innovations like Magnar™ domed horn drivers. One of the only kits available for this unique loudspeaker. Read about K's and all the other great Speakerlab speakers and parts in our free catalog.

Speakerlab®
To get yours, write SPEAKERLAB, Dept. 129, 735 N. Northlake Way, Seattle, WA 98103

STEREO REPRESENTATIVES NEEDED!!! LOWEST POSSIBLE PRICES!!! OVER 100 BRANDS!!! KRASCO Rep., 998 Orange Ave., West Haven, Conn. 06516.

SAVE 50% BUILD YOUR OWN SPEAKER SYSTEM. Write McGee Radio Electronics, 1901 McGee Street, Kansas City, Missouri 64108.

ANTI-SKATING FOR AR TURNTABLES!! Proven counterweight design. Install yourself in minutes. \$7.95 postpaid. Audio Innovational Products, P.O. Box 1607, Portsmouth, N.H. 03801.

CERTIFIED AUDIO CONSULTANT HOME STUDY HI-FI Course available. Send \$5.00 for information. Includes AUDIO TECHNICAL YEAR BOOK with 29 sample lessons and application for membership in the Society of Audio Consultants. Write SAC, P.O. Box 552, Dept. HF, Beverly Hills, CA 90213.

KOETSU is here. The legendary handmade moving coil cartridge is now available in the U.S. For the complete story, write: Sumiko, Inc., Box 5046, Berkeley, CA 94705.

SAVE up to 60% BY MAIL on: SCOTCH, TDK, BASF, MAXELL, MEMOREX, CAPITOL MUSIC TAPE, CERTRON (over 180 different reel & cassette tapes to choose from); top brand recorders; America's largest collection of taping accessories, too. Same day service. **FREE catalog.**

America's Recording Tape Specialists

SAXITONE TAPE SALES
1776 Columbia Rd., Washington, D.C. 20009
(202) 462-0800

DBX-124, \$375 NEW, NEVER USED. BEST OFFER. POB 1063, NEW BRUNSWICK, N.J. 08903.

SpeakerGuts.

The absolute latest in advanced speaker technology. Wave Aperture™ Drivers, the Patented Nestrovic Woofer System, raw speaker components selected for their excellence. Horns, crossovers, subwoofers, woofers, midranges, horn and dome tweeters. Over 30 in all. Build your own speaker system and we'll provide top quality speakers and design information. Send for FREE 48 page color catalog from the largest, most experienced speaker kit manufacturer in the world. **DON'T DELAY. Write today!**



Speakerlab®
Dept. 128, 735 N. Northlake Way
Seattle, Washington 98103

HORNS-WOOFERS-MIDS-TWEETERS at tremendous OEM savings Altec, Electro-Voice, Philips, Peerless, Polydax and many others. Dozens of hard to find items used in major manufacturers most expensive systems. Huge selection of crossover network components, automobile systems, and musical instruments loudspeakers. Send \$1.00 for CATALOG. SRC AUDIO Dept. HF 1, 3238 Towerwood Dr., Dallas, Tx. 75234.

TOP-NAME AUDIO AT LOW LOW PRICES!! Aiwa, AR, Bose, ESS, JBL, JVC, KLH, Marantz, Onkyo, Phase Linear, Pioneer, Sansui, Sony, Soundcraftsmen, Teac and many more we can't even mention by name. All factory fresh with full warranty. For prices just call 212-254-3125. Or send \$2.00 for our informative brochure to DIRECT DISCOUNTS LTD., P.O. Box 841, Cooper Station, N.Y. 10003.

HIGH FIDELITY'S TEST REPORTS 1980, 346 fact-filled pages of information on amplifiers, turntables, speakers, tape decks, receivers and other components. \$3.95 plus \$1.00 for postage and handling. Order from: High Fidelity's Test Reports 1980, 1 Sound Avenue, Marion, Ohio 43302.

RECORDS IN REVIEW 1980 EDITION. Available April 1, the 25th annual edition of the record-buyer's "bible." Contains the complete text of all the classical and semi-classical record and tape reviews as they appeared in HIGH FIDELITY magazine in 1979 issues. Durable clothbound edition, yours for \$15.95 plus \$1.25 for postage and handling. Send your order to: Wyeth Press, 1 Wyeth Street, Marion, Ohio 43302

A SINGER'S DREAM!



REMOVES VOCAL FROM MOST STEREO DISCS
The Thompson Vocal Eliminator can actually remove most or virtually all of a solo vocalist from a standard stereo record and yet leave most of the background music untouched! Not an equalizer! We can prove it works over the phone. Write for a brochure and demo record below. **COST: \$249.00**

YOU SHOULD SEE US

For:

- Delay and Ambience
- Studio Echo/Reverb
- Tape Noise Reduction
- Parametric Equalization
- Electronic Crossovers
- Comp/Limiters
- Mic Preamp/Mixers
- Patch Bays



We manufacture a full line of high quality audio and recording equipment. You will probably have to pay twice as much elsewhere to obtain comparable quality. Only Direct Sales make our prices and quality possible. Send \$1 for a 20 page brochure and 20 minute demonstration record.

Write to: **LT Sound, Dept. HF, P.O. Box 729, Decatur, GA 30031. (404) 284-5155**

MULTI-TRACK AND SEMI-PROFESSIONAL AUDIO EQUIPMENT: BEST PRICES! Prompt Delivery! AKG, DBX, TEAC/TASCAM, Sound Workshop, DetaLab, Maxell! Others. Call (919) 467-8113. To order call toll free 1-800-334-2483 WYCO SALES, Dept. HF, Box 887, Cary, N.C. 27511.

ONLY 189 COPIES LEFT! High Fidelity's Silver Anniversary Treasury will soon be out of print. Don't miss this opportunity to get your copy of this 348-page hardcover compilation of the best writing to appear in the magazine over the past three decades. Send \$9.95 to Wyeth Press, 1 Wyeth Street, Marion, Ohio 43302.

PENTAX OWNERS! Send for Keppler's THE PENTAX WAY, the definitive book by one of the world's leading experts on single lens reflexes. Over 350 pages with loads of clear, easy to follow illustrations. \$27.95 plus \$1.25 postage and handling. Send to: Modern Photography's Photographer's Book Service, 1 Wyeth Street, Marion, Ohio 43302.

MORDAUNT-SHORT SPEAKERS, BEYER MICROPHONES, and also some REVOX items at BARGAIN PRICES. Send for full literature: Entertainment Sound Services Inc. P.O. Box 176 Jericho, New York 11753 (516) 921-2249.

MAIL ORDER DIRECT FROM AKIHABARA "TOKYO." All brands Cartridges, Tonearms of JAPAN. Price list offered Free. Hi-Fi Express, P.O. Box 28, Shitaya, Tokyo 110-91.

Audio Video
Professional Quality
CASSETTES
TDK • 3M • AGFA
Call/write for free cassette catalog
Polyline Corp. 312/298-5300
20 1233 RAND RD. • DES PLAINES, IL 60016



DISFARMER: THE HEBER SPRINGS PORTRAITS 1939-1946 by Modern Photography editor Julia Scully and Peter Miller. Richard Avedon lists this book as one of his 12 indispensable books. Sixty-six magnificently reproduced photographs. \$27.50 plus \$1.25 for postage and handling. Send to: Modern Photography's Photographer's Book Service, 1 Wyeth Street, Marion, Ohio 43302.

WHOLESALE TAPES, ACCESSORIES & VIDEO

TDK SA C 90	\$2.85	TDK I 120	\$15.95
TDK SA C 90	2.13	TDK L 500	12.49
TDK AD C 90	2.42	Sony L 750	16.95
TDK D C 90	1.44	TDK L 1800	4.85
MAXELL UDXL I or II C 90	3.33	Maxell UDXL 35-90B 1800	5.38
MAXELL UDXL I or II C 60	2.37	Maxell UDXL 35-90B 1800	6.58
MAXELL UD C 90	2.75	TDK Head Demagnetizer	15.49
BASF Pro II or III C 90	2.52	Shure V 15 Type IV	83.50
BASF PRO I C 90	2.85	Discwasher Complete System	10.25
Ampeg Grandmaster II C 90	2.95	Discwasher Zerostat Gun	14.50
Scotch Master II or III C 90	3.10	Discwasher D-3 16 oz Refill	10.45

ORDER NOW! 100% Guaranteed. Minimum \$3.50 shipping (212) 434 1720
QUALITY TAPES, 864 E. 7th St., Dept. MH, Brooklyn, N.Y. 11230.

LOWEST PRICES, HIGHEST RELIABILITY IN MAIL ORDER- Stereo, Esoteric, Auto, Disco, and Video, Over 150 brands all factory fresh, all guaranteed and insured, shipped fast. 4-5 day delivery in most cases with no deposit on most items. Call or write for free catalog and prices. Order hot line (914) 258-4342 9am-9pm, Mon-Fri. SOUND SHED HI-FI, Box 61A, Merritts Island Road, Pine Island, N.Y. 10969.

GUARANTEED LOW PRICES ON STEREO, VIDEO EQUIPMENT. STELLAR SOUND, 13906 Ventura Blvd., Suite 193, Sherman Oaks, CA 91423 (213) 766-9790.

MISCELLANEOUS

DIAMOND NEEDLES and Stereo Cartridges at Discount prices for Shure, Pickering, Stanton, Empire, Grado, Audio Technica and ADC. Send for free catalog. LYLE CARTRIDGES, Dept. H, Box 69, Kensington Station, Brooklyn, New York 11218. For Fast Service, call TOLL FREE 800-221-0906.

PROTECT YOUR ALBUMS. WHITE CARDBOARD REPLACEMENT JACKETS 35c. PLASTIC LINED INNER SLEEVES 15c. POSTAGE \$1.25. OPERA BOXES, 78 SLEEVES AVAILABLE. FREE CATALOG. CABCO 301-3, BOX 8212, COLUMBUS, OHIO 43201.

COLLEGE STUDENTS! Improve your grades. Send \$1.00 for 356-page, collegiate research papers catalog, 10,250 available. RESEARCH ASSISTANCE, box 25916R, Los Angeles, California 90025. (213) 477-8226.

The Best New Stereo Systems Deserve The Best New Stereo Records (Tapes too) You need the Monthly SCHWANN RECORD CATALOG available from record shops everywhere or, for a sample copy PP, Send \$2.50 to: ABC-SCHWANN. Single Copy Sales, Dept. 2160 Patterson St., Cincinnati, Ohio 45214.

THE PRESERVATION AND RESTORATION OF SOUND RECORDINGS

First book ever written on professional care and maintenance of sound collections—records, tapes and cylinders. Discusses recording media, improved sound reproduction technology, storage, repair and restoration. Lists manufacturers, suppliers, major sound archives. A must for all serious collectors, sound libraries. 150 pages/illus.

Send \$8.95 to:
American Association for State and Local History
1400 Eighth Ave., South, Suite 212
Nashville, Tennessee 37203



SLIPCASES for HIGH FIDELITY Magazine. Simulated blue leather, Holds 6 High Fidelity issues. \$4.95 single case, \$14 for 3 cases, \$24 for 6 cases. USA orders only. Allow 6 weeks for delivery. HIGH FIDELITY Library Cases, Box 5120, Phila-

Free Promotional Albums, Concert Tickets, Stereo, Etc. Information: Barry Publications, 477 82nd Street, Brooklyn, NY 11209.

Camera Collectors! Read Modern Photography's own Jason Schneider on CAMERA COLLECTING, 178-page, fully illustrated book on the great and collectible cameras of the past. Details on the great bargains, odd film sizes and where to find them. Send \$12.95 plus \$1.25 for postage and handling to: Modern Photography's Photographer's Book Service, 1 Wyeth Street, Marion, Ohio 43302.

COMPUTERIZED STEREO COMPARISONS. Computer selects best components for you! Top system for your money. Guaranteed. Name-brands. Complete evaluation—\$5. Free details. Write now! BICOM, Form 10B, 10510 Davison, Cupertino, CA 95014.

Classified Dept., HIGH FIDELITY, 825 7th Ave., 6th Floor, New York, NY 10019 Telephone: 212-265-8360

Name _____
Address _____
City _____ State _____ Zip _____
Telephone _____
Payment enclosed \$ _____ for _____ issues, Check M.O.
 MASTERCHARGE VISA Card # _____ Expiration _____
Bank # _____ Signature _____
Please run following ad copy for _____ issues starting next available issue: _____

NEW EQUIPMENT FOR SALE

BRITISH AND EUROPEAN EQUIPMENT DIRECT TO YOU. Most quality makes of equipment available at advantageous prices. For price list and price quotes send International Reply Coupon. Send \$2 for the brochures you require. Audio T, Dept A, 190 West End Lane, London, NW6 1SQ, England, Phone 01-794 7848. Visitors welcome.

TOP-RATED CARTRIDGES UP TO 70% OFF!! We feature Acutex, ADC, Grado, Nagatron, Ortofon, Sonus, Stanton, et al. Unbelievable prices! Call 212-254-3125 for prices, or write to DIRECT DISCOUNTS LTD., P.O. Box 841, N.Y., N.Y. 10003.

BUY DIRECT and save. British and European Hi-Fi. Attractive prices. Send Reply Coupon for Quote, \$3 bills for brochures. Goodwins, 7 The Broadway, Wood Green, London N22, Phone 888-0077. VISA/Mastercharge. Visitors welcome.

LOWEST PRICES ON STEREO-ESOTERIC COMPONENTS & tapes!! Over 150 brands. Send #10 SASE for quotes. Audio Unlimited, 401 Reynolds Circle #1C, San Jose, CA 95112 (408) 289-8875. 1-6 M-Th.

Buy with confidence

fact: the IV does more!

SHURE VIS Type IV SUPER TRACK IV Stereo Dynetic Phono Cartridge

Consistent record tracking has always been challenged by such ever-present factors as warp, static, lint and dust—especially when these factors combine with today's "hot" recordings.

Send for Quotes & Price List on Shure & Over 100 Other Famous Brands

CARSTON STEREO DISCOUNT CENTER 146 OLD BROOKFIELD RD Danbury, Conn. 06810 (203) 744-6421 (212) 369-6212

MON. TUE WED. FRI 9:00-5:30 THUR. 9:00-8:00 P.M. SAT. 9:00-4:30

QUALITY AUDIO DISCOUNTED! Car/Home. SASE for quotes. Denco Audio, P.O. Box 6104-H, El Monte, CA 91734. (213) 444-9978 evenings, weekends.

TAPES & RECORDS

LIVE OPERA ON REEL/CASSETTE. THOUSANDS OF PERFORMANCES, WORLDWIDE SINCE 1930's. The ONLY service that provides the personal attention demanded by the Vocal Art. Free Gifts, Magnificent Free Catalogue. LIVE OPERA, Box 3141, Steinway Station, L.I.C., N.Y. 11103.

NOTICE: Record Listeners Wanted

(No experience required) Each month you will receive nationally released albums to rate. **There is no extra charge for the LP's you receive** — all you pay is a small membership fee which covers all costs of the LP's including postage and handling. In return for your opinion you will build a substantial album collection - "first come basis." For application write: **EARS SYSTEMS** Box 10245 Dept. HF 5521 Center St., Milwaukee, WI 53210 "Guaranteed" © 1979 EARS SYSTEMS

"SOUNDTRACKS, SHOW, NOSTALGIA & JAZZ—FREE Catalog & Offering List—A-1 Record Finders, P.O. Box 75071-H, LA, CAL. 90075."

SCOTCH RECORDING TAPE, LOWEST PRICES. TAPE CENTER. Box 4305C, Washington, D.C. 20012.

RAREST CLASSICAL, SOUNDTRACKS, SHOWS, PERSONALITY LPs. Huge catalog \$1.00. Grammy's Attic, Box 181, Bluffton, SC 29910.

Free 5.00 T-Shirt

TDK SA-C90	2.89	AMPEX Grandmaster 190	2.59
TDK AD-C90	1.99	AMPEX Grandmaster II-90	2.99
TDK D-C90	1.69	Scotch 212-7R-1800	4.29
TDK SA-C60	2.25	Soundguard Record Pres. Nit.	4.59
BASF Pro II or IIC-90	2.79	TDK L-1800	5.39
BASF Pro II or IIC-90	2.89	TDK LB-1800	6.69
BASF Studio I or IIC-90	2.65	AMPEX Grandmaster 1800 ft. Reel.	5.95
Scotch Master II or IIC-90	3.15	SCOTCH 207-7R-1800	5.09
Scotch Master IC-90	2.69	BASF Ferro 7 ft 1800ft (New)	7.99

Free T-Shirt with every order while supplies last. All tapes can be assorted. No min. Add \$3.00 shipping; or write for free catalog of 250 items plus lowest prices on all Maxell products. 100% guaranteed. 412-283-8621, W. Th 9-5.

TAPE WORLD 220 Spring St. Butler, PA 16001

"LIVE OPERA TAPES. Reels—Cassettes. Unbelievable treasures since 1926. Over 5,000 selections. Free DELUX Catalog: MR. TAPE, Box 138, Murray Hill Station, NYC 10016."

SHOW ALBUMS—Rare, out-of-print ips, 64-page list \$1.00. Bakers Wife or Nefertiti—original cast LP \$9.95. Broadway-Hollywood Recordings, Georgetown, CT. 06829.

1930-1962 RADIO SHOWS, \$1.00 HOUR! Professional 200 page catalog, \$1.25. AM Treasures, Box 192HF, Babylon, N.Y. 11702.

VIENNESE LIGHT MUSIC SOCIETY—Strauss, Lanner, etc. on Dolby Cassettes, KC Company, Box 793, Augusta, Maine 04330.

OPEN REEL TAPES. Top Quality. 100% money-back guarantee. Major labels. Classical, pop, rock, quad—direct disk & video. Bank cards accepted. Catalog/order information, \$1. No other fees, obligations. THE REEL SOCIETY, P.O. Box 55099-H, Valencia, CA 91355.

RARE OPERA, SYMPHONIC MUSIC ON OPEN REEL TAPE. Historic performances. EUROPEAN, DOMESTIC. Free Catalogue. Underhill, Box "U," Bellport, NY 11713.

RECORD HOUND, Box 88H, Eagleville, PA 19408. Fills want lists? Doggone right!!! 3 1/3" specialist. Fast, friendly service.

SCHUBERT/DYER-BENNET. The splendid Tully Hall performance of the Dyer-Bennet translation of "Schone Mullerin" (Characterized by Andrew Porter as "A 'Schone Mullerin' which came to life") now available in a meticulously produced studio recording (stereo—two discs) directly from Dyer-Bennet records, Monterey Stage, Great Barrington, MA 01230. \$17.50 postpaid.

SUPER-FI RECORDS! All types, labels. Catalog \$1; COSMIC CHORDS PO Box 4873 Boulder, Colo 80306.



ON OPEN REEL from master tapes. Argo, Telefunken, Vanguard, Unicorn, MHS. Catalogue \$1.00. Barclay-Crocker, Room 1470-H, 11 Broadway, NYC 10004.

GOLDEN AGE RADIO—your best source for radio tapes. Free catalog. Box 25215-J, Portland, Oregon 97225.

VIENNESE OPERETTA RECORDS, INC. Extensive range, superb vocal performances, on currently available LP's. Free list. P.O. Box 50-B, Dover, Mass. 02030.

Live Performances tapes—opera, conductors, instrumentalists. Superior Sound. Open Reel Only. Catalogues. Good Sound Associates, POB 263 Planetarium Station, New York, NY 10024.

DISCONTINUED RECORDS, Classical, Popular, All Speeds, Free Lists, Fried Steinmetz, One Seaview Avenue, Massapequa, NY 11758.

OPERA VIDEO—Magnificent performances from Europe. Beta, VHS Formats. Free catalog. HRE, Box 12, Kew Gardens, N.Y. 11415.

SCHWANN RECORD AND TAPE GUIDE, now available by subscription. Includes 12 monthly issues of Schwann-1, 2 semi-annual issues of Schwann-2, plus Annual Children's Catalog. Annual subscription \$25.00, add \$10.00 for addresses outside of U.S. Order from: Schwann Record & Tape Guide, P.O. Box 550, Great Barrington, Mass. 01230.

RECORDS FOR COLLECTORS FREE LISTING. RIVERDEAL BOX 52544, HOUSTON, TX 77052.

BRAVO BEETHOVEN (10 CUTS); MOZART MAGIC (14 CUTS) super samplers—LP \$1.98 each, cassette \$2.49 each. Specify. Free Classical/Jazz Catalog. Musical Concepts, Box 53HF, Cedarhurst, N.Y. 11516.

CLASSICAL RECORDINGS FOR COLLECTORS. List, send \$1.00. ARS MUSICA, 29 Knox Road, Brewster, N.Y. 10509.

SOUNDTRACKS—New and out-of-print film music recordings. Free listings and info. CINE MONDE RECORDS, 1488 Valjejo St., San Francisco, CA 94109.

VOCAL TECHNIQUES OF THE GREAT SINGERS ANALYZED. Over 100 from Caruso and Ponselle to Pavarotti and Sills described. 17 items including resonance, registration, Vibrato and support. \$20.00, \$26.00 deluxe, WHC, POB 871, Loma Linda, CA. 92354.

MAIL AUCTION USED RECORDS LIST SASE. DIX, BOX 1771 Philadelphia, Pa. 19105.

LOVE CATS, CLASSICAL MUSIC? Get "An Album of Cats"—numbered limited edition with booklet, \$7.00 postpaid. Enharmonic Records, 1520 West 7th St., Bloomington, IN 47401.

Vox Boxes, Singles 1/2 off. Candide, Turnabout 40% off. Discs, Box 94, Plainview, N.Y. 11803.

FREE DIGITAL RECORDING by Jean-Pierre Rampal with initial purchase of three records from catalogue of over 100 digital classics (including 65 on Denon)! For catalogue, send 50¢ to Classics Only, Box 14186, Columbus, Ohio 43214.

AUDIOPHILE RECORDS: Save 20% to 40%. Free catalog. Foreign customers also invited. Super Sound Record Service; P.O. Box 411237; Chicago, ILL 60641.

FREE SET PRICE SALE CATALOG, classical including opera. 2,360 entries. Reasonable prices. Record Heaven, 1046 North Highland, Atlanta, Ga. 30306.

BUSINESS OPPORTUNITIES

CABLE FM BROADCASTING: Unique no investment/experience business. Home operation possible. Excellent income. "CAFM," Box 130-D-4, Paradise, CA 95969.

MECHANICALLY INCLINED INDIVIDUALS: Assemble electronic devices in your home. Investment, knowledge, or experience not necessary. Start in spare time. Above average profits: \$300-\$600/wk possible. Sales handled by others. Write for free details. Electronic Development Lab, Drawer 1560HF, Pinellas Park, Fla. 33565.

FIELD REPRESENTATIVES WANTED FOR SAVARD SPEAKER SYSTEMS. Various U.S. territories available. Dealer inquiries welcome. (504) 383-0474.

PUBLICATIONS

THE BLIND AND OTHER PHYSICALLY HANDICAPPED can know the joy of reading memorable selections chosen from over 50 outstanding periodicals, completely free of charge. Write CHOICE MAGAZINE LISTENING, Dept. HFC, Box 10, Port Washington, NY 11050 or call 516-883-8280.

SCHWANN'S BASIC RECORD LIBRARY. A 16-page booklet listing 150 of the really basic compositions from the classical repertory to enhance your personal record collection. Only 75¢ per copy postpaid. Order from: ABC Schwann, Single Copy Dept., 2160 Patterson St., Cincinnati, Ohio 45214.

NEW YORK PHILHARMONIC GUIDE TO THE SYMPHONY by Edward Downes. This 1,100-page book is a composer-by-composer, A to Z compendium of program notes from the Philharmonic. Send \$25.00 plus \$1.00 for shipping to: High Fidelity's Music Listener's Book Service, 1 Wyeth Street, Marion, Ohio 43302.

IMPROVE YOUR RECORDINGS! How to: enhance recordings, understand technical information, judge and select equipment. Full, unconditional 30 day guarantee! Send \$3.98 to: CRG Publishers, Box 115, Redondo Beach, California 90277.

Nikon and Nikkormat Owners! Don't be without Keppler's THE NIKON NIKKORMAT WAY, the definitive, most practical reference book for you by the world's leading expert on single lens reflexes. Over 450 fact-filled pages describing and showing you how to get the most out of your picture-taking. \$27.95 plus \$1.25 postage and handling. Send to: Modern Photography's Photographer's Book Service, 1 Wyeth Street, Marion, Ohio 43302.

SERVICES

COLLEGE STUDENTS! Improve your grades. Send \$1.00 for 356-page, collegiate research papers catalog. 10,250 available. RESEARCH ASSISTANCE, Box 25916R, Los Angeles, California 90025. (213) 477-8226.

SAVE POSTAGE! Your mailbox flooded with samples, offers. \$2. SASE. VAL-UCORP., Box 234-HF Mercer, Wis. 54547.

AUDIOPHILES: Precision Real-time (1X1) copies of original master tapes. Brochure, \$1.00 AudioGraph, Inc., Box 7784, Ann Arbor, Mich. 48107.

TAPE COPY SERVICE ALL TYPES BACKGROUND/POPULAR ARTISTS. Mostly Rare. State wants. VMS, Box 77, Hawaii National Park, Hawaii 96718.

ELECTRONICS

ELECTRONIC BARGAINS, CLOSEOUTS, SURPLUS! Parts, equipment, stereo, industrial, educational. Amazing values! Fascinating items unavailable in stores or catalogs anywhere! Unusual FREE catalog. ETCO-017, Box 762, Plattsburgh, N.Y. 12901.

FILMS

VIDEOCASSETTE G-PG-R-X movies only \$6.95 after subscription. Videocassettes exchanged for only \$19.95. National Video Exchange, Box 1012, Warren, Pa. 16365 or 814-723-9124.

Major Motion Pictures, Rock, Classics, Rare Historical Films on video cassettes. Send stamp for free brochure. International Historic Films, P.O. Box 29035, Chicago, IL 60629.

AUDIO-RECORDING

Aspen Music Festival
announces the
AUDIO-RECORDING INSTITUTE
three three-week sessions offering experience in recording live symphony, opera, and chamber music with world-renowned artists.

June 23-August 24, 1980
Aspen, Colorado

For Info: ASPEN MUSIC FESTIVAL
1880 Broadway, New York 10023 • 212/581-2196

Continued from page 128

played by jazz musicians of virtually every school, but he uses his blues as pastel coloring, adding a surprisingly sunny glow to the performances. Ivory Joe Hunter's (*Since I Lost My Baby*) *I Almost Lost My Mind* is gently blue; his own *Blue Turbulence* is not at all turbulent, but slow, relaxed, and very expressively blue. On this last he creates what amounts to a talking piano, the lines spoken with the rhythmic emphasis of a blues singer.

All through "Kansas City Hustle," familiar sources appear for a moment and then evanesce—a running line from Earl Hines, a Basie band riff, a bit of Garner romanticism, a Tatum run. But McShann does not borrow. Rather, he reveals the wealth of his background. Sometimes he is cute about it—wrapping Ellington's *Don't Get Around Much Any More* in echoes of the Duke's *I Let a Song Go out of My Heart*. Not all his efforts are totally inspired. *Baby Won't You Please Come Home* does not rise beyond a bland but swinging lilt, and his *Kansas City Hustle*, a gently rolling boogie, runs on too long. But these are part of the old McShann image. Most of this disc is a new view of this veteran pianist.

Waymon Reed: 46th and 8th
John Snyder, producer
Artists House AH 10 (40 West 37th Street, New York, N.Y. 10018)
by John S. Wilson

This record, made in 1977 but just released, is trumpeter Waymon Reed's first as a leader. Although he got his share of solos playing with Count Basie in the early '70s, at that time the individual players were subordinate to the smooth-rolling Basie machine (with the exception of such saxophonists as Jimmy Forrest and Eric Dixon). He left the band in the mid-'70s and free-lanced around New York, playing in theater pit orchestras or backup groups for singers. Now married to Sarah Vaughan, he is her orchestra leader, and, though this puts him up front where he can be seen, he remains in his wife's shadow.

Reed seems temperamentally suited to the essential but unglamorous role of providing a steady core around which other musicians can generate sparks. His quintet here includes Ella Fitzgerald's old trio—Tommy Flanagan on pi-

ADVERTISING INDEX

For free product literature, use the reader service card on page 99. *For more information, write direct to manufacturer.

Key No.		Page No.
	Action Audio	128
1	ADC Professional Products, a div. of BSR Consumer Products Group	57
	ADS-Analog & Digital Systems	97
2	AIN/A	26
	Akai America	31
3	Altec Lansing	23
5	Apt Corp.	92
56	Audio Pro	96
6	Audio Supermart	123
	Audio Technica U.S. Inc.	4
7	Audiovox Corp.	85
57	Avid Corp.	14
8	Bang & Olufsen	38
	Bose Corp.	Cover III
	Burns Audiotechnology, Inc.	117
	Buying Guide to Car Stereo Systems	121
	Buying Guide to Tape Systems	103
9	Caedmon Records	90
	Classified Ads	129-131
10	DBX, Inc.	12, 13
	Delco Electronics	36
12	Discount Music Club	120
13	Discwasher, Inc.	Cover IV
*	Dual	63
	Electro-Voice, Inc.	37
15	Empire Scientific Corp.	11
16	Empire Scientific Corp.	91
17	ESS, Inc.	115
18	Fisher Corp.	8, 9
	47th Street Photo	123
	Franklin Mint Records	32-35
	Fuji Photo Film U.S.A. Inc., Magnetic Tape Division	89
19	Fujitsu Ten Corp.	93
20	Hi Fi Buys	127
21	Illinois Audio	101
22	Infinity Systems, Inc.	7
23	Institute of Audio Research	38
24	International Hi Fi	123
25	JBL	59
26	Jensen Sound Laboratories	83
27	J & R Music World	102
28	KEF Electronics Ltd.	79
29	Maxell Corp.	15
30	McIntosh Laboratory	62
31	Memorex Corp.	2
32	Mobile Fidelity Records	88
	MXR Innovations	95
	Nakamichi U.S.A. Corp.	65
33	Ohm Acoustics Corp.	66
	Onkyo	16, 17
35	Osawa & Co. (USA) Inc.	69
36	Park Row Electronics	125
37	Penney, J.C.	10
38	Pickering & Co.	6
39	Pioneer High Fidelity	Cover II, 1
40	Pioneer High Fidelity	14
	Radio Shack	21
49	Revox	105
41	Robins Industries	40
42	SAE Inc.	60
43	Sansui Electronic Corp.	25
44	Shure Brothers, Inc.	70
45	Shure Brothers, Inc.	106
46	Sony Corp.	41
47	Sound Reproduction	120
	Speakerlab	125
48	Stereo Corp.	127
	Stereo Discounters	64
49	Studer Revox America, Inc.	105
50	TDK Electronics Corp.	42
51	Teac Corp.	29
52	Technics by Panasonic	5
	3 M Company	81
53	Top Discount Audio	128
*	United Audio Products	63
54	Warehouse Sound	64
16	Watts	91
55	Wisconsin Discount Stereo	40
	Wyeth Press	87
	Yamaha Audio	39



ano, Keter Betts on bass, Bobby Durham on drums—and Basie bandmate Jimmy Forrest on tenor saxophone. The trio's swinging drive and close interaction gives the disc its momentum. Flanagan is the most spirited soloist, ranging from a lively bebop romp on Charlie Parker's *Au Privave* to a blues à la Basie, to a sensitive treatment of the ballad *But Beautiful*.

Even when he is not soloing, Flanagan dominates, filling in the background with fascinating figures. Reed comes into his own most strongly on *But Beautiful* with a lovely flugelhorn development, and Forrest has his best moments in Thelonious Monk's *Blue Monk*. But Flanagan steals the set.

Lew Tabackin / Warne Marsh: Tenor Gladness

Toshiko Akiyoshi, producer
Inner City IC 6048
by Don Heckman

Putting tenor saxophonists Lew Tabackin and Warne Marsh together for a recording is such a fascinating idea that it's hard to understand why *Inner City* waited more than three years to release "Tenor Gladness." (It was recorded in October of 1976.) Tabackin is a brilliant, well-articulated, and carefully controlled vertical player. That is, he builds his solos rhythmically up from the bottom, always in firm, solid connection with the basic pulse. Marsh—one of the great, underrated improvisers of the last three decades—is precisely the opposite, a paragon of the elusive art of floating above the rhythm. He is as horizontal as Tabackin is vertical, his lines teasing in and out of the pulse, sometimes even in and out of the meter.

Working together, they are a study in contrasts, fascinating to us as listeners and, I suspect, fascinating to each other for the challenges that each makes upon the other's abilities. In *Basic #1*, actually a blues, Tabackin revives Don Byas' classic arpeggiated lines in direct contrast to Marsh's slipping, sliding excursions across the bar lines. On the Tristano-ish *March of the Tadpoles*, Tabackin sticks firmly to his stylistic guns. The exchanges at the close of *Basic #2* are brilliant and startling. For a clear picture of each player, Tabackin's unaccompanied discourse on the standard *What's New* (titled *New-ance* here) is a perfect example of his ability to apply a harmonic scheme to almost anything he

plays. And Marsh makes a tightrope journey through the changes of *Easy Livin'* (titled *Easy*), which also contains a lovely, uncredited piano solo, presumably by producer Toshiko Akiyoshi.

Cecil Taylor: 3 Phasis

Sam Parkins, producer
New World Records NW 303
by Don Heckman

Pianist Cecil Taylor, for all his unquestionable genius, has never been a particularly easy performer to listen to. Of all the iconoclastic sounds that emerged from the jazz avant-garde of the Sixties, his were perhaps the most difficult to penetrate.

In the last few years, Taylor has finally begun to receive a few of the accolades his talent deserves—a Guggenheim Fellowship, an honorary doctorate from the New England Conservatory, etc.—but his music has remained, for the most part, as unrepentantly thorny as ever. This new release from New World Records places him in a considerably more visible light. I don't suspect for a moment that "3 Phasis" is going to land on *Billboard's* Top 200 LP chart or, for that matter, that many people will have the courage to listen to it all the way through, though they should. But it is the first performance I've heard from Taylor in which he seems willing to try to provide the listener with a pathway into his music.

The problem in the past has almost always been an absence of sectionalization. The performance tended to follow a kind of bell curve of intensity, without a moment of peace to catch one's breath. One suspected that Taylor had a deep-grained prejudice against those most basic musical devices—repetition and variation.

This time around we hear him playing moments that are pure nineteenth-century rhapsodies; we hear, on Side 2, a lengthy sequence with a walking bass, bluesy piano comping, and a rhythmic 4/4 feeling; and we even hear some passages that are quiet and contemplative. None of this in any way diminishes the intensity of Taylor's vision. On the contrary, it draws one into the richness of the improvisational experience far more than did the nonstop whirlwind of his earlier works. For my money, it's the most fascinating recording he has made yet.

We submit: the Bose® 901®
Direct/Reflecting® Speaker System
provides more value in
concepts, materials and
performance than
any other
speaker system.

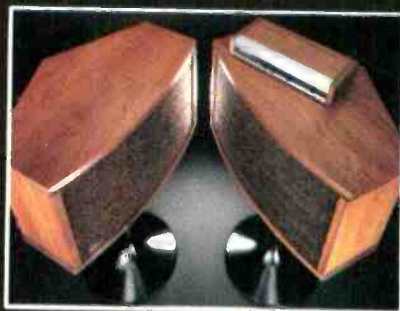

Covered by patent rights issued and/or pending.
© Copyright 1980 by Bose Corporation.
For more information, write Bose Corporation, Dept. HF, 100 Monmouth Road, Framingham, MA 01701

BOSE
Better sound through research.

Better Than Any Pusher

**No matter how fine the fibers or how soft the "plush"
—everything other than the Discwasher system is a pusher.**

**Pushers only line up dirt and microdust into an even line of
contamination. Run your pusher off the record at a tangent—
and you spread these particles into a tangent line. And micro-
dust becomes permanently welded into vinyl by a tracking
stylus.**

**Only the Discwasher system has the patented micro-
tipped fibers which are directional—slanted—to pick
up, hold and thus remove particles from your discs.
These same directional fibers also remove fluid
and solubilized contaminants by capillary
action.**

**The superior record cleaner—
better than any pusher.**

 **discwasher[®], inc.**
1407 N. PROVIDENCE RD.
COLUMBIA, MISSOURI 65201

**Now Available with DC-1
Pad Cleaner at no extra charge.**