

\$1.50 January 1980

IN BACKBEAT: Nine Pop Critics Toast/Roast the Year's Records

HIGH FIDELITY

180007

ICD © 08398

NEW!

Ten Lab/ Listening Reports

- Carver's amazing holographic preamp
- KLH's computer-controlled speaker
- Pioneer's top cassette deck, and seven more!

OLD!

How to Cash In On Your Discs

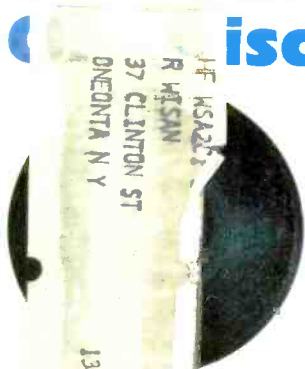

What's record
value 1000?



**IF ALL \$200 TURNTABLES HAVE
THE SAME SPECS, HOW COME THE PL-400
SOUNDS BETTER?**



189307



PIONEER QUARTZ-PLL FULL-AUTOMATIC PL-400

1-30 10-25 REPEAT START/OLT

DYNAPHASE 55



A Great New Sound From Stanton— The Choice of The Professionals

Now the great performance enjoyed by recording professionals worldwide in the Stanton 881S cartridge is also available in a brand new, lightweight headphone... the Stanton Dynaphase 55. Professional quality sound is the result of superior Stanton driver design that includes 1½" dynamic high velocity elements with a specially formulated synthetic film diaphragm and samarium cobalt magnets... allowing for low distortion and exceptionally wide frequency bandwidth.

The tuning of the air cavity behind the diaphragm is a unique design of Dynaphase 55. It keeps the air in phase delivering flattest response and finest acoustical behavior of the driving element. Includes adapter plug. Suggested retail *\$60

Pictured to the right, is the Stanton Dynaphase 35, a headphone offering top performance at its price. With an adapter plug. *\$45

The top-of-the-line Stereo Wafer Model XXI is as fine as they come and featherlight for comfort. *\$70

For further information, contact Stanton Magnetics, 200 Terminal Drive, Plainview, N.Y. 11803



STANTON

THE CHOICE OF THE PROFESSIONALS™

© 1979 STANTON MAGNETICS

Circle 41 on Page 77

HIGH FIDELITY

Leonard Marcus
Editor

Shirley Fleming
Editor, Musical America

James R. Oestreich
Classical Music Editor

Susan Elliott
Editor, Backbeat

Robert Long
Audio-Video Editor

Peter Dobbin
Assistant
Audio-Video Editor

Rebecca Abbott
Associate Editor

Lynda Carlotta
Cynthia Pease
Assistant Editors

Isabel Parker
Editorial Assistant

Edward J. Foster
Consulting Audio Editor

Edward Greenfield
European Editor

Robert S. Clark
Editorial Director

Abram Chipman
John Culshaw

R. D. Darrell
Harris Goldsmith
David Hamilton
Dale Harris

Paul Henry Lang
Irving Lowens

Robert C. Marsh
Fred Miller
Andrew Porter
Susan Thiemann Sommer
Contributing Editors

Sarina Bromberg
Art Director

Wayne Armentrout
Production Director

David Lee
Circulation Director

John D. Kallmann
Circulation Manager

William P. Johnson
Circulation Service Manager

Leonard Levine
Associate Publisher

Warren B. Syer
Publisher

HIGH FIDELITY is published monthly at The Publishing House, Great Barrington, Mass. 01230 by ABC Leisure Magazines, Inc., a subsidiary of American Broadcasting Companies, Inc. Copyright © by 1979 ABC Leisure Magazines, Inc. The design and contents are fully protected by copyright and must not be reproduced in any manner. Second-class postage paid at New York, New York, and at additional mailing offices. Authorized as second-class mail by the Post Office Department, Ottawa, and for payment of postage in cash. Yearly subscription in U.S.A. and Possessions \$11.95; elsewhere \$15.95. Single copies \$1.50. Subscribers: Send subscriptions, inquiries, and address changes to High Fidelity, 1 Sound Ave., Marion, Ohio 43302. Change of address: Give old and new addresses, including ZIP Code. Enclose address label from last issue and allow five weeks for change to become effective. **Postmaster: Send Form 3579 to High Fidelity, 1 Sound Ave., Marion, Ohio 43302. Postal Identification Number 243820.**

Audio/Video

- 6 High Fidelity News**
11 entries in the audio market
- 14 CrossTalk**
- 19 Equipment Reports**
Carver C-4000 preamplifier
KLH Model 3 speaker
Ortofon Concorde 30 phono pickup
SAE Two Model R-6 receiver
Jensen System B speaker
Phase Linear 5100 Series II tuner
Pioneer CT-F1250 cassette deck
Dual CS-731Q turntable
Spatial Coherence preamplifier
Model TVA-1
JVC Zero-5 speaker

Music/Musicians

- 53 How Much Are Your Old Records Worth?**
Part I: Classical Records
by Michael Biel
Part II: Popular Records
by Tim Brooks
- 60 Behind the Scenes**
- 63 Horowitz and Arrau**
Reissues and new releases reinforce the legends of two of the century's great pianists
by Harris Goldsmith
- 65 The Play of Daniel**
Mark Brown's new recording is a worthy successor to Noah Greenberg's
by Susan Thiemann Sommer
- 68 Classical Records**
Bernstein's Missa Solemnis
Kubelik's touchstone Schumann
Shostakovich quartets completed
- 71 Critics' Choice**
- 91 The Tape Deck**
by R. D. Darrell

Backbeat

- 93 The 2nd Annual Critics' Poll**
- 98 Input Output**
Teac's new portable cassette studio
by Fred Miller
- 99 The Three Faces of Fleetwood Mac**
by Sam Graham
- 99 Backbeat Records**
Leonard Cohen
Elton John
Bennie Wallace
- 102 Time/Life's Giants of Jazz**
by Don Heckman

Et Cetera

- 16 HiFi-Croctic**
by William Petersen
- 50 Letters**
- 77 Reader-Service Cards**
- 110 Advertising Index**

The Legend Continues.



Dynaco helped create stereo hi-fi 25 years ago. We built a reputation based on rigorous yet simple designs that produced more sound than the industry had ever seen.

Now we've come back to do it again. With two new speakers that are far and away the best we've ever built. Each of these systems continues the Dynaco legend of simplicity and performance at a

modest cost. Each in its own way will make you part of a listening experience that for 25 years has meant only Dynaco.

To sample that experience, take your favorite record album to your Dynaco dealer. Lean back and listen. You'll hear that Dynaco sounds better than ever. And the legend will continue. We have many new and exciting products coming your way.

dynaco

We build them like we used to.

110 Shawmut Road • Canton, Mass. 02021 • (617) 828-7858

Circle 57 on Page 77

ART CREDITS

Cover photo by Bob Brody, with Barney the cat, Eleanor Greenberg, trainer

- 55-57 Michael Biel
- 59 Jerry Osborne
- 60 Flip album photo from Jerry Osborne; all other photos from Michael Biel
- 61 Michael Biel
- 63 Arrau photo courtesy of National Concert and Artists Management; Horowitz photo by Bender
- 64 Horowitz photo by Bill Ray; Arrau photo courtesy of ICM Artists Ltd.
- 65-66 Bob Long
- 95 Bob Brody

SOLUTION TO HIFI-CROSTIC NO. 49

[Russell Hope] Robbins:
Early English [Christmas] Carols

The true carol is to be distinguished from a hymn or a religious song. It always had set stanzas alternating with a "burden," two lines sung at the beginning and repeated after each stanza—as precise as the art patterns of ballade, triolet, or rondeau

ADVERTISING

Main Office: Robert J. Ur Sr., Director of Advertising Sales, The Publishing House, Great Barrington, Mass. 01230. Telephone: 413-528-1300.

New York: ABC Leisure Magazines, Inc., 825 7th Avenue, 6th Floor, New York, N.Y. 10019. Telephone: 212-265-8360. Seymour Resnick, National Advertising Manager; George Dickey, Record Advertising Manager; Ruth Elliott, Eastern Advertising Manager; Janet Cermak, Administrative Assistant; Yetta Peltzman, Classified Advertising Department.

Midwest: ABC Leisure Magazines, Inc., 190 N. State St., Room 632, Chicago, Ill. 60601. Telephone: 312-782-1173. William P. Gordon, Midwest Advertising Manager; Osbert Bruno, Advertising Representative.

Los Angeles: ABC Leisure Magazines, Inc., 2020 Avenue of the Stars, Suite 245, Century City, Calif. 90067. Telephone: 213-553-2000. Andrew Spanberger, Western Advertising Manager; Janet Endrjonas, Associate Western Advertising Manager.

Tokyo: Japan Advertising Communications, Inc., New Ginza Bldg., 7-3-13 Ginza, Chuo-ku, Tokyo 104, Japan. Telephone: (03) 571-8748. Shigeru Kobayashi, President.

HIGH FIDELITY and **HIGH FIDELITY/MUSICAL AMERICA** are published monthly by ABC Leisure Magazines, Inc., a subsidiary of American Broadcasting Companies, Inc. Warren B. Syer, President; Herbert Keppler, Senior Vice President, Photographic Publishing Division, Leonard Levine, Vice President, Advertising; Warren Tuohy, Vice President, Finance; David Lee, Circulation Director; Cathleen Aloisi, Personnel Director; Wayne Armentrout, Director of Manufacturing. Member Audit Bureau of Circulation. Indexed in Reader's Guide to Periodical Literature. Current and back copies of High Fidelity and High Fidelity/Musical America are available on microfilm from University Microfilms, Ann Arbor, Mich. 48106. Microfiche copies of these magazines (1973 forward) are available through Bell & Howell Micro Photo Division, Old Mansfield Road, Wooster, O. 44691.

Editorial correspondence should be addressed to The Editor, High Fidelity, Great Barrington, Mass. 01230. Editorial contributions will be welcomed, and payment for articles accepted will be arranged prior to publication. Unsolicited manuscripts should be accompanied by return postage.

Circle 1 on Page 77 ▶

You expect to be really impressed by a new cartridge. Otherwise you wouldn't even consider it. What you don't expect is to get the same impressive performance thousands of plays later. But consider this: after 1000 playing hours the new ADC Improved Series cartridges show no audible change in performance! Amazing? You're right. But what's even more

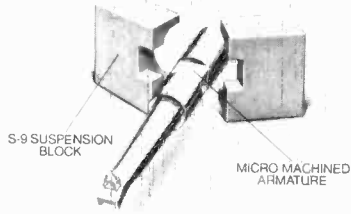

amazing is the new Omni-Pivot System™ that did it. It's a major advance in

micro technology. There are no unpredictable armature governors, wires or adhesives. Instead each armature is micro-machined to perfectly lock into our exclusive new S-9 high definition suspension block. We think it's a real breakthrough. But you should be the judge.

Look at both the frequency response and stereo separation of a new ADC ZLM Improved cartridge. They're incredible. The new ADC ZLM accurately reproduces even the most complex musical passages with absolute neutrality.

Now compare the same cartridge after 1000 playing hours. See any difference? The ADC ZLM Improved cartridge shows less than a 1dB change in performance. That means you won't hear any difference.

Now the good news gets even better. The Omni-Pivot

System™ comes in a wide range of new ADC Improved Series cartridges. The ZLM, XLM MKIII and MKII, and QLM-36 MKIII. All featuring new snap-down stylus protectors.

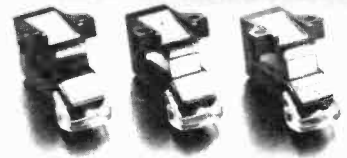

If you already own a fine ADC cartridge, the Omni-Pivot System™ is yours for just the price of a replacement stylus.

Listen to any new ADC Improved cartridge. After you've heard us, we'd like to hear from you. Write Audio Dynamics Corporation, Pickett District Rd., New Milford, Ct., 06776, or call our toll-free number (800) 243-9544.

BEFORE YOU BUY A NEW CARTRIDGE TAKE A LOOK AT A GOOD USED ONE.

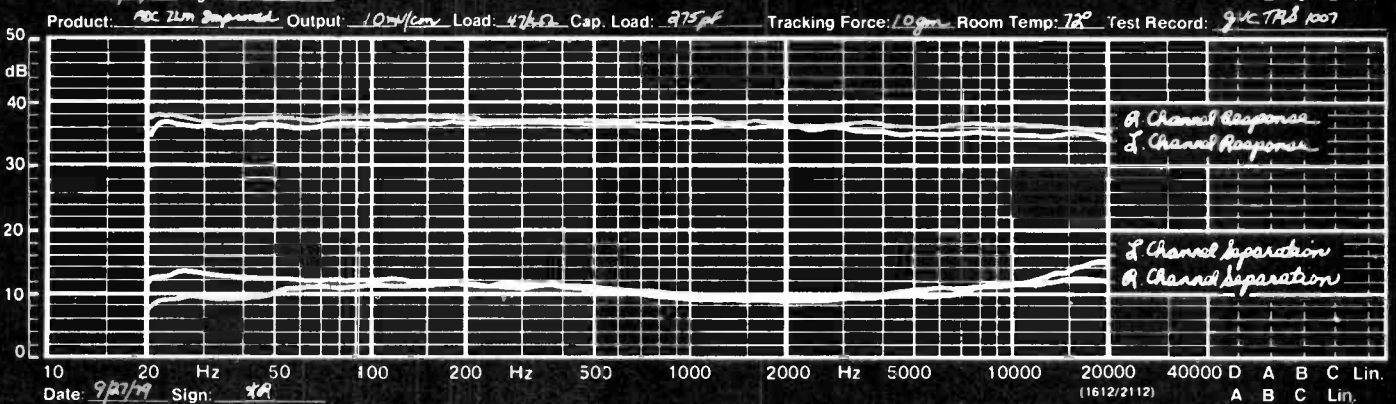
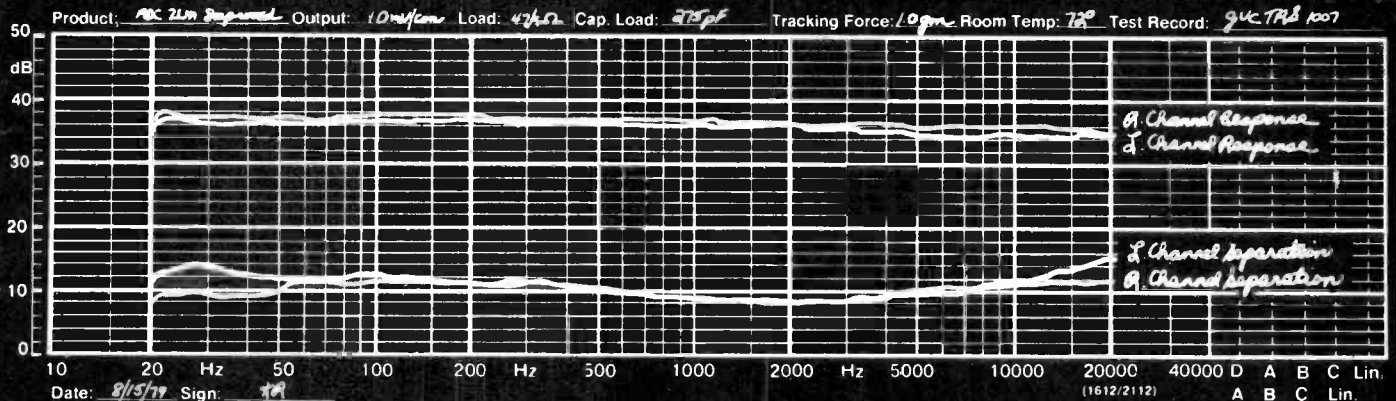

A BSR COMPANY

High Fidelity News

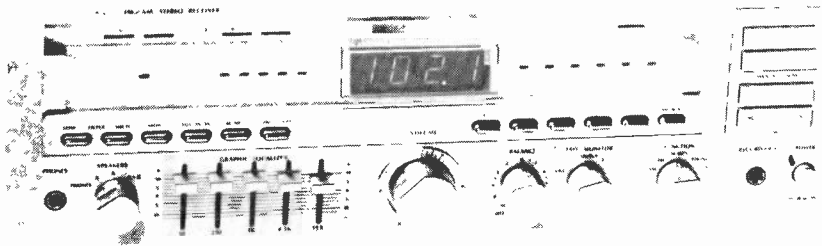
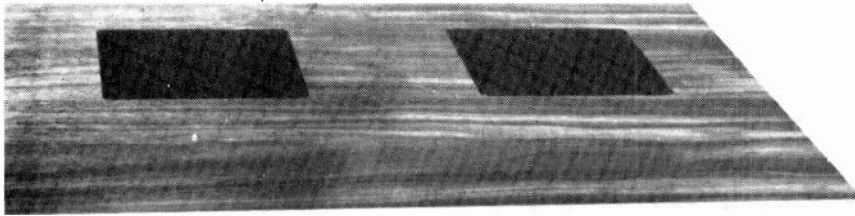

Digital tuning in Sears receiver

The top of the LXI receiver series is a 75-watt (18 $\frac{3}{4}$ -dBW) unit with quartz-locked, frequency-synthesized tuning. Digital LEDs display station frequencies, and a memory function allows presetting of up to five FM and five AM stations. Other features include a five-band graphic equalizer, tape dubbing, high/low filters, and LED signal-strength and center-of-channel meters. Price of Sears' 75-watt receiver is \$399.95.

Circle 148 on Page 77

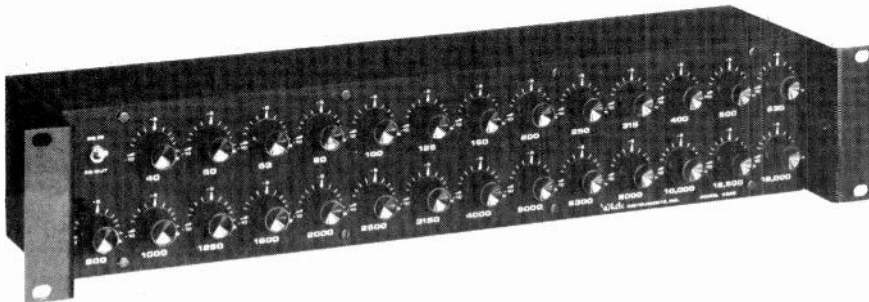

27-band passive equalizer

White Instruments' Model 4320 single-channel passive equalizer features twenty-seven one-third octave filters ranging from 40 Hz to 16 kHz, each of which allows up to 10 dB of cut only. Also provided are an EQ in/out switch on the front panel and two accessory octal sockets on the rear for hookup to biamp or triamp crossovers and for bandpass networks. The equalizer is said to have no insertion loss and is designed to work into low impedances—about 100 ohms or less. The 4320 costs \$550 and comes with a security cover.

Circle 147 on Page 77

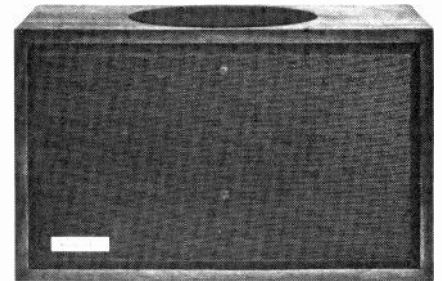

Balanced on a shelf

Like all of Allison Acoustics' speakers, the Allison Five two-way system has been engineered for balanced tonal output in a specific room location—in this case, mounted on a shelf, table, or other surface backed by a wall. An 8-inch long-excursion woofer and a 1-inch tweeter make up the driver complement of this compact acoustic-suspension speaker. Minimum recommended power is 15 watts (11 $\frac{3}{4}$ dBW) for a claimed 97-dB sound pressure level. The Allison Five, rated at an impedance of 4 ohms, sells for \$160.

Circle 146 on Page 77

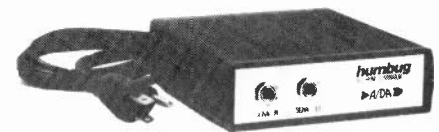

Humbug!

A tracking transversal filter from Analog/Digital Associates is designed to eliminate AC hum from audio signals. The Humbug noise filter/line driver uses phase-locked analog delay line techniques to analyze and remove fundamental and harmonics of power-line frequencies (both 50 and 60 Hz) and is inserted into the signal path before the input of an instrument amp or in the send/receive loop of a mixing board. The Humbug, which can be used as a low-impedance line driver, costs \$150.

Circle 140 on Page 77

(more)

Circle 46 on Page 77 ▶

Technics

From the grandest opera to the Grand Ole Opry. A lot of FM stations play a lot of different music yet still have one thing in common: The need for uncommonly accurate turntables. That's why so many FM stations use Technics direct drive turntables.

That professionals use Technics direct drive turntables is really not surprising. What is, is that now you can get professional performance in Technics quartz-synthesizer MK2 Series: The SL-180C manual, the SL-1700 semi-automatic and the SL-1600 fully automatic.

Wow & Flutter	Rumble	Speed Accuracy	Start-up Time
0.025% WRMS	-78 DIN B	$\pm 0.002\%$	1/4 rotation

As you can see, they all have impressive performance. But with Technics MK2 Series, you also get impressive advances in electronics. Like a quartz-synthesizer pitch control. As you vary the pitch it's instantaneously displayed by 13 LED's in exact 1% increments. That makes life easy.

So does the SL-1600 MK2's infrared disc-size sensor. Just place a disc on the platter, press the start button and immediately an infrared ray activates the micro-computer. Then the Technics precision gimbal-suspension tonearm automatically sets down in the lead-in groove.

And for double protection against acoustic feedback, Technics precision aluminum diecast base has a double-isolated suspension system. One damps out vibration from the base, the other from the tonearm and platter.

The MK2 Series. You don't have to be a radio station to afford performance good enough for a radio station.

Your next turntable should be as accurate as the ones many radio stations use.



MEMOREX HIGH BIAS TEST NO. 2.

WHICH HIGH BIAS TAPE WINS WITH "LUCILLE"?



The legendary "Lucille" is a Gibson ES 355 made specially for B.B. King.

Select any blues solo where B.B. King really lets "Lucille" sing, and record it on your favorite high bias tape.

Now record the same solo on MEMOREX HIGH BIAS tape, and listen to the two tapes back to back.

We're convinced you'll have a new favorite for two important reasons:

1. At standard record levels, no high bias tape has a flatter response across the entire frequency range.
2. The signal/noise ratio of MEMOREX HIGH BIAS is unsurpassed by any other high bias tape at the critical high end.

In short, you can't find a high bias cassette that gives you truer reproduction. And, after all, isn't that what you buy a high bias tape for?

Is it live, or is it

MEMOREX



For unbeatable performance in a normal bias tape, look for Memorex with MRX₃ Oxide in the black package.

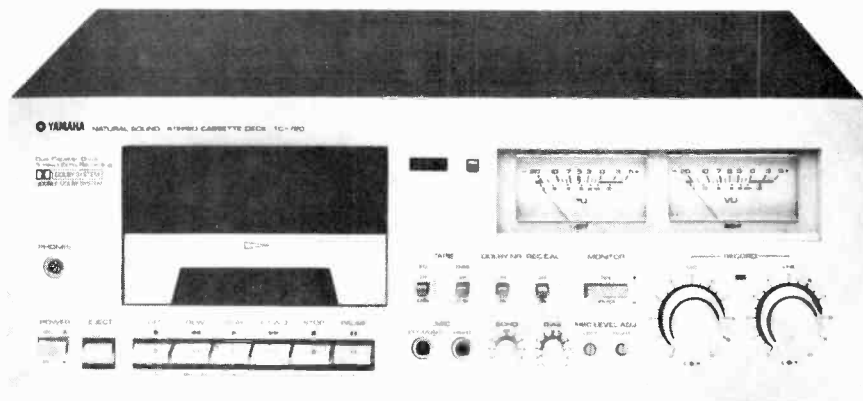

Cassette deck with echo

Yamaha's TC-720 is a three-head cassette deck with built-in variable echo control—the first, to our knowledge, so equipped. Other properties of this deck for the creative home recordist are two independent mike preamps, mike/line mixing, and double Dolby circuits. A pink-noise generator and bias control allow tape matching over a $\pm 15\%$ bias-current range. Dolby tracking can also be fine tuned via two front-panel screwdriver controls. The TC-720, housed in an ebony-veneer wood cabinet, costs \$450.

Circle 149 on Page 77

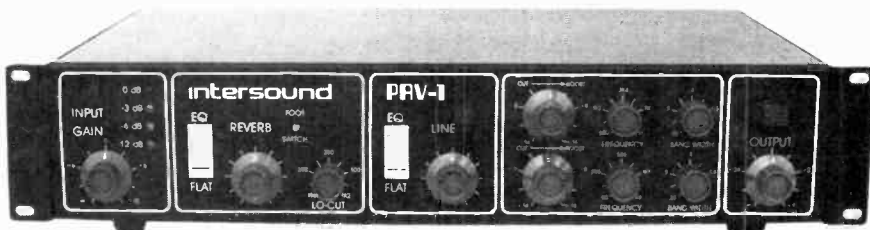

EQ/reverb in one package

Designed for studio and stage applications, Intersound's PRV-1 combines single-channel reverberation with two bands of parametric equalization. Features include independent level and routing controls for reverb and line signals, variable low-cut filter for feedback control, and LED level display. There is provision for an external footswitch with a front-panel status indicator. The PRV-1 comes in a steel rack-mount chassis and costs \$455.

Circle 150 on Page 77

Burhoe adds to speaker line

The Royal Blue is a three-way speaker system with a top-firing tweeter for improved dispersion and three baffle-mounted drivers: a 1-inch biradial tweeter, a 2-inch inverted-dome mid-range, and a 10-inch woofer. Recommended amplifier range is 20 to 150 watts (13 to 21 $\frac{3}{4}$ dBW). The Burhoe Royal Blue speaker comes in a walnut-veneer cabinet and costs \$800 per pair.

Circle 144 on Page 77



Circle 49 on Page 77

McIntosh

"A Technological Masterpiece ..."



McIntosh C 32

"More Than a Preamplifier"

McIntosh has received peerless acclaim from prominent product testing laboratories and outstanding international recognition! You can learn why the "more than a preamplifier" C 32 has been selected for these unique honors.

Send us your name and address and we'll send you the complete product reviews and data on all McIntosh products, copies of the international awards, and a North-American FM directory. You will understand why McIntosh product research and development always has the appearance and technological look to the future.

**Keep up to date.
Send now - - -**

McIntosh Laboratory Inc.
Box 96 East Side Station
Binghamton, NY 13904

Name _____
Address _____
City _____ State _____ Zip _____

If you are in a hurry for your catalog please send the coupon to McIntosh. For non-rush service send the Reader Service Card to the magazine.

Circle 26 on Page 77

Audio-Technica LIFESAVER[™] for the life of your records!

SPRAY AND BUFF EACH RECORD JUST ONCE AND ENJOY...

- No static for 50 plays or more
- No increase in surface noise or distortion even after 100 plays
- More efficient record cleaning with any system, wet or dry
- Protection against environmental attack, loss of vinyl plasticizers
- Improved sound from all records, any age, any speed
- Elimination of many "skips" or "repeats" with worn or damaged records

You can't buy better protection for your records than LIFESAVER with DiscProtect[™] formula. Its unique combination of ionic and non-ionic chemistry creates a microscopic layer of protection, molecularly bonded to last for years.

The ideal antistat and record lubricant, LIFESAVER preserves and improves every record you own. It's everything you would expect from the leader in advanced-technology phono cartridges and state-of-the-art recordings. Available at all Audio-Technica dealers today.



AUDIO-TECHNICA U.S., INC., Dept. 10H, 33 Shawwassee Avenue, Fairlawn Ohio 44313

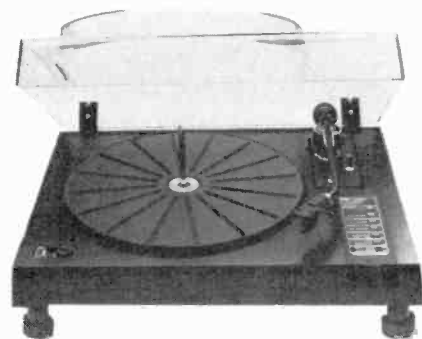

Programmable changer from BSR

Now being shipped from BSR is the Accuglide XR-50, a computerized, belt-driven, multiple-play turntable that lowers and raises records in accordance with user-programmed instructions. Up to twenty-seven commands can be stored in its microprocessor memory. An infrared remote transmitter allows control of all functions, including volume, from a distance of 40 feet. Price of the XR-50 is \$199.95.

Circle 145 on Page 77

CONSTANTLY BETTER

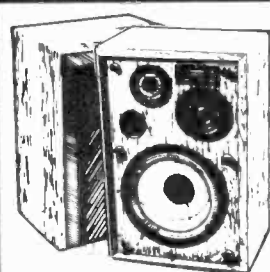

Altec Model 9 II **\$228**



Minolta XD-II f2 Lens **\$323**

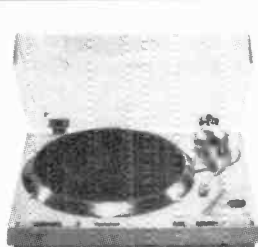

Pioneer PL600 Quartzlocked Direct Drive **\$249**

TOLL FREE 800-356-9514

Weekdays 9-9
Saturdays 9-5

Over 100 Brands like:

- | | | | | |
|----------|----------|------|----------|---------|
| Technics | Maxell | Sony | Cerwin | Nikon |
| Pioneer | Empire | Teac | Vega | Canon |
| Marantz | Altec | Akai | JBL | Minolta |
| Kenwood | Sharp | Dual | Audio | Pentax |
| Sansui | Phillips | Koss | Technica | Vivitar |
| Jensen | Shure | TDK | Clarion | Yashica |

WDS

WISCONSIN DISCOUNT STEREO

2517 Whalen Ln. madison, WI. 53713

Circle 48 on Page 77



Multispeed open reel

The B-77 open-reel deck from Re-Vox comes in four speed configurations and in both half-track and quarter-track formats. The machine's features lend themselves to audio-visual and broadcast applications, in either stereo or mono. Synced voice-overs, sound-on-sound, multiple input switching, multi-mode monitoring, and built-in tape cutter are provided. The decks with 1 7/8 and 3 3/4 ips, 3 3/4 and 7 1/2 ips, or 7 1/2 and 15 ips cost \$1,499; the 15/16 and 1 7/8 ips model costs \$1,649.

Circle 141 on Page 77

(more)

Circle 44 on Page 77 ▶

The standard bearers.



The high bias standard.

In the past few years, these fine deck manufacturers have helped to push the cassette medium ever closer to the ultimate boundaries of high fidelity. Today, their best decks can produce results that are virtually indistinguishable from those of the best reel-to-reel machines.

Through all of their technical breakthroughs, they've had one thing in common. They all use TDK SA as their reference tape for the high bias position. These manufacturers wanted a tape that could extract every last drop of performance from their decks and they chose SA.



And to make sure that kind of performance is duplicated by each and every deck that comes off the assembly line, these manufacturers use SA to align their decks before they leave the factory.

Which makes SA the logical choice for home use; the best way to be sure you get all the sound you've paid for.

But sound isn't the only reason SA is the high bias standard. Its super-precision mechanism is the most advanced and reliable TDK has ever made—and we've been backing our cassettes with a full lifetime warranty* longer than anyone else in hi fi—more than 10 years.

So if you would like to raise your own recording standards, simply switch to the tape that's become a recording legend—TDK SA. TDK Electronics Corp., Garden City, NY 11530.

TDK
The machine for your machine.

*In the unlikely event that any TDK cassette ever fails to perform due to a defect in materials or workmanship, simply return it to your local dealer or to TDK for a free replacement.

Metal tape update

If Fuji holds to its announced intention to have its own brand of metal-particle cassettes on dealers' shelves by early this year, the shortage of the new tape formulation may well ease considerably. Both Maxell and BASF have indicated that they plan to enter the metal-tape market this year, but Fuji has preceded them in publishing prices and lengths.

Claimed performance characteristics of the Fuji formulation do not differ markedly from the claims made for the metal tapes already available from 3M and TDK, namely an increase of 7 to 12 dB in dynamic range over premium ferric formulations and better signal-to-noise ratios. The cassettes will be sold in three lengths: C-46 at \$8.30, C-60 at \$9.10, and C-90 at \$12.

TDK, whose MA-R metal-particle cassette in an aluminum housing has been on the market for several months,

is now shipping C-60s in plastic shells and plans to have a similarly housed C-90 length available soon. They will be called MA; the -R suffix specifies the "reference" metal shell. And 3M, the company that started the whole thing with its introduction last January of Metafine metal tape, is shipping C-90s for \$8.95, the lowest price yet suggested for this length.



Computer-designed Kenwood speaker

The LS-1900 ported three-way speaker system is said to have been designed with the aid of computer analysis and laser holography. The midrange driver and tweeter employ special sus-

pension designs and are isolated by the enclosure to prevent interference from woofer vibrations. Coils in the crossover network are also isolated to inhibit inductive interaction. Rated frequency response of the Kenwood LS-1900 is 30 Hz to 21 kHz, and its price is \$1,165.

Tune up with Morley

The DT-4400 from Morley is a digital frequency counter designed for guitar, bass, and keyboard tuning. It displays frequencies from 1 to 9,999 Hz and activates automatically when an instrument cable is plugged into its front-panel jack. A two-position stand for floor or table is provided, along with instructions and an illustrated chart showing correct frequencies for various instruments. Concert pitch readings for guitar and bass are printed on the case of the DT-4400, which costs \$99.95.

Circle 142 on Page 77

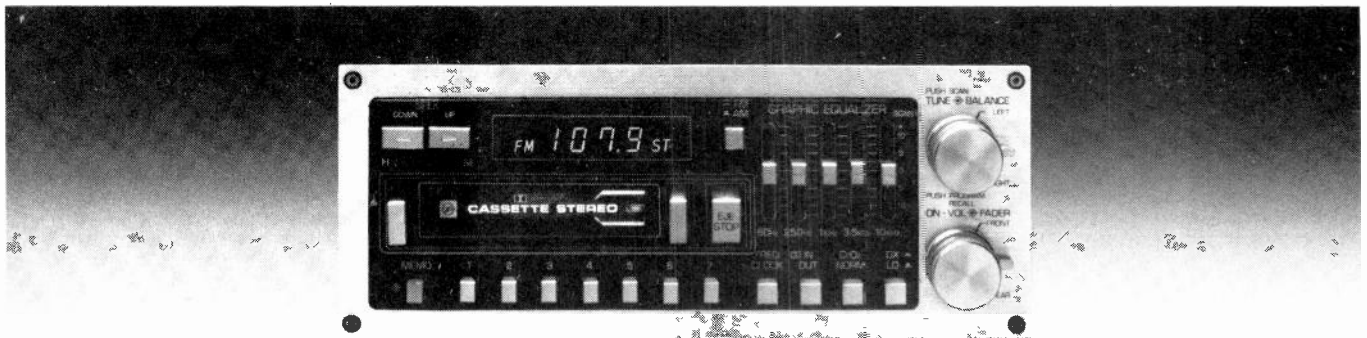

The Dashboard Wizard.™ Before, there was only car stereo.

Put aside everything you've been told about car stereo. The Dashboard Wizard is with us!

He's the latest in-dash audio marvel from Fujitsu Ten. A preamp combination system that will transform your car. The precise digital electronic tuner memorizes your favorite 7 AM and 7 FM stations, with search up, search down and scan tuning, FM muting and local/distance switch. There's even a quartz clock.

Hit the equalization switch and, presto, the auto-reverse cassette deck accommodates chrome and metal tapes.

With a Life Time Metal (LTM) playback head that's built to last well into the future. His five-band graphic equalizer lets you match the music to your car.

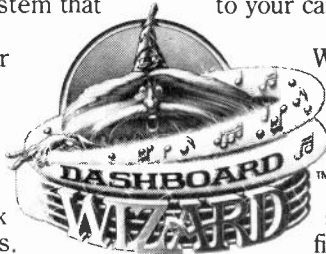

Performance? Miraculous, of course. Wow and flutter is .09% nominal—one of the best specs in car stereo. And with Dolby* on both FM and tape, hiss is a thing of the past.

Hear the Dashboard Wizard at your Fujitsu Ten dealer. Any resemblance to ordinary car stereo is a figment of your imagination.

Fujitsu Ten: The best sound on wheels.

TEN FUJITSU TEN CORP. OF AMERICA

19281 Pacific Gateway Drive, Torrance, CA 90502
In Canada: Noresco Canada Inc., Ontario

*Dolby is the trademark of Dolby Laboratories, Inc.

Now—A Record Club With No Obligation!

Choose Any 3 or 4 Record Set

For Only **\$2⁹⁸**



80. CHOPIN Complete Works For Piano and Orchestra (3 LPs) Claudio Arrau, Elisha Inbal: London Philharmonic Orchestra



81. BACH Mass in B minor (3 LPs) Marshall, Baker, Tear, Ramey, Neville Mariner: Chorus & Academy of St. Martin-in-the-Fields.



82. BRAHMS Four Symphonies (4 LPs) Claudio Abbado: Vienna Philharmonic, Berlin Philharmonic, Dresden State and London Symphony Orchestras

Also Available
On Cassette

No obligation to buy any future offerings.

This remarkable \$2.98 offer is brought to you by The International Preview Society—a highly selective music program that does not oblige you to buy at any time. These multi-record/cassette selections—and many, many more superb choices will continue to be offered in an exclusive Preview magazine approximately every eight weeks. Each issue highlights a Featured Selection... plus an impressive variety of alternate selections (many available on cassettes). And all are well below suggested retail!

You'll save even more through the Society's Half-Price Bonus Plan. For every regular member purchase you make, you may choose a Bonus—album or multi-record set—for only half of the members' already low club price. That amounts to a savings of more than 55% off the suggested retail price!

If you'd like to preview the Featured Selection, you need do nothing. We'll send it automatically. But if you'd prefer an alternate selection or none at all, just mail back the Preview Notification card—enclosed with the magazine—by the specified date. You'll have plenty of advance notice.

Audition Any Selection At Home For Ten Days... Free.

At no cost or obligation, you are invited to audition any one of these multi-record albums... as well as any future offerings... at home for ten days. Only then do you decide whether or not to buy.

As Many As Four Records For Less Than The Price Of One.

You may choose any one of these sets for just \$2.98 plus a small postage/handling charge. (Sales tax added for New York residents.) Remember, each set contains either three or four records (or 2 to 4 cassettes). That's a savings of as much as \$36.94... up to 92% off the suggested list price!

Send no money. We want you to judge for yourself before you decide to buy. If you are not delighted after ten days, return the set.

These are superior, silent-surfaced recordings by Deutsche Grammophon and Philips. They come in a handsome hinged storage case with an informative, illustrated brochure.

Every recording offered by the Society must meet the rigid standards of The Carnegie Hall Selection Committee. Only albums of the most exceptional musical interest, artistic excellence and technical quality are offered.

So do take advantage of this marvelous value and mail in the coupon today. You'll also be reserving the privilege of previewing other great international releases... which you may add to your collection at impressive savings.



83. BEETHOVEN The Piano Concertos (4 LPs) Claudio Arrau, Bernard Haitink: Concertgebouw Orchestra, Amsterdam

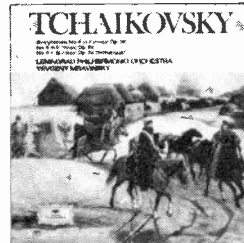

84. TCHAIKOVSKY Symphonies 4, 5 and 6 (4 LPs) Yevgeny Mravinsky: Leningrad Philharmonic Sleeping Beauty & Swan Lake. Herbert von Karajan: Berlin Philharmonic



85. MOZART Don Giovanni (4 LPs) Fischer-Dieskau, Flagello, Nilsson, Schreier, Arroyo, Talvela, Grist, Mariotti, Karl Böhm: Prague National Theatre Orchestra

Free Home Audition Request

The International Preview Society
175 Community Drive, Great Neck, N. Y. 11025

YES! Please send me, for my free audition, the multi-record or cassette set I have indicated by the number below. I may return it after ten days and owe nothing... or keep it and pay only \$2.98 plus a small postage/handling charge (sales tax added for New York residents). This is up to \$36.94 off the suggested retail price. I will also receive, approximately every eight weeks, free preview privileges of the finest classical recordings. I may cancel at any time.

Print album number you have selected here:
Please send all Selections on: LP's Cassettes

Name _____

Address _____

Apt. No. _____

City _____

State _____

Zip _____

Offer limited to the connecting 48 states. Limit one membership per household. Only new members eligible. NOTE: All applications are subject to review, and we reserve the right to reject any application.

29005

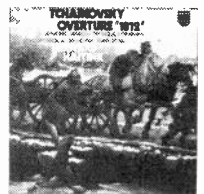

FREE BONUS

Return coupon within 10 days for valuable free gift — TCHAIKOVSKY's 1812 Overture, Bernard Haitink: Concertgebouw Orchestra, Amsterdam.

CrossTalk

Q. The audio industry is shockingly misleading in its specifications and advertisements. Most specs translate into little more than sales hype and are relatively meaningless (though the dBW is a step in the right direction).

For one thing, why can't manufacturers state frequency response figures consistently? One cassette deck maker claims a response of 30–16,000 Hz \pm 3 dB, while another claims 30–19,000 Hz with no dB reference whatever. This is a useless spec, especially considering that the former deck is a fine one costing about \$850, with three heads and three motors, while the latter, which claims better response, retails for about \$400 less! Also, why can't speaker manufacturers include the Q factor in their specifications? This would help greatly in making buying decisions.

There are a few good companies still around—Fried, Allison, Harman Kardon, Thorens, etc.—but most seem more interested in the sexy appearance of their products than in providing true, uncolored sound. Look at all those pretty white woofers, huge S-shaped tonearms, chrome speaker grilles with rings around them, and massive mid-range and tweeter controls that add distortion and drain power.

Well, I have stepped on your toes by putting down your big advertisers, and you surely won't print this letter. It's a shame, because it's meant as a sincere challenge to improve the stereo industry.—Jeffrey S. Albaugh, Baltimore, Md.

A. This letter evidently was written with more than a little passion, yet it is neither unreasonable nor unmerited, in our view. We would remind Mr. Albaugh, however, that audio consumers are a diverse lot whose personal desiderata encompass not only the sterling virtues he extols, but some of the things he decries. If we assume, for example, that he thinks of Pioneer as one of those "big advertisers" and would dismiss as merely "sexy" the Fluroscan metering and memory/repeat features of the Pioneer cassette deck reviewed in this issue, he can simply buy an alternative and leave these features for the many buyers who will find them genuinely useful. We believe there should

be no question of product censorship in the interests of what any buying minority considers of ultimate high fidelity importance. (Mr. Albaugh might find that his preference is not the prevailing one.)

Inconsistent specs cannot be dismissed as a matter of diversity of taste, of course. We would plead that even the \$850 cassette deck is inadequately specified, if the quotation is correct, because no reference level, however vague, is given. Rigorous, independent test reports help mitigate the problem, because the more lax the spec, the greater its departure will be from the bench measurements. And the standards committees of the Institute of High Fidelity are in the process of writing a new rule book to address this matter. Utter unanimity of approach—either among the manufacturers who publish specs or among critics who believe the specs could be better stated—is more than we can expect, however.

Q. Your September issue was depressing. Alas, the new open-reel decks don't have the 1 $\frac{7}{8}$ -ips speed, and the new Integrex Dolby unit will only decode, not encode. We stubborn old folks who want to upgrade our systems have nothing available!—Leslie Reggel, Pittsburgh, Pa.

A. The obvious answer is that you can buy an open-reel deck with the Dolby circuitry built in and/or a cassette deck, which does much better with the 1 $\frac{7}{8}$ -ips speed than any open-reel model (including the Tandbergs that, traditionally, have worked wonders with it) we know of. Open-reel tapes are specifically formulated for higher speeds, cassette tapes for 1 $\frac{7}{8}$; thus the latter have a big edge. But we can sympathize with the bind that tape collectors experience because of advancing technology. One of our editors, for example, has now-unplayable tapes of the entire Shakespeare War of the Roses cycle—a total of eight plays, or twenty-odd hours of drama. His solution was to dub them to another format when he saw that the demise of 1 $\frac{7}{8}$ on open-reel decks was imminent and before his model went into terminal decline.

Q. My Fisher quadriphonic receiver has developed interference between a local radio station and the left channel of the phono mode. It remains even when the turntable is disconnected. I took the receiver to Sears for repair, and it returned it to me without eliminating the problem. Could shielded cable between the receiver and the speakers help?—B. Torres, San Juan, P.R.

A. No. Since the interference exists only in the phono mode, it must be within the receiver's preamp, where we would suspect there's a cold solder joint or similar problem. Possibly the station couldn't be picked up on the Sears repair bench, preventing a positive determination of what was wrong—a discouragingly common difficulty in troubleshooting both interference problems and intermittent ones.

Q. My system—consisting of Bose 301 speakers, Advent 300 receiver, Garrard 990-B turntable, and Shure M-91ED cartridge—has developed what may be warp-tracking problems. When playing records with even the slightest warp, I can hear faintly (especially from the right speaker) a low, rhythmic bumping sound. It is diminished considerably when the records are played in the mono mode, but this seems a giant step backward. Do you have any suggestions as how I can eliminate this annoyance?—David A. Lindsey, Snohomish, Wash.

A. The reduction in bumping when in the mono mode suggests vibration in the vertical plane as the source of the trouble. This could be traceable to a warped or worn idler. First, we'd check the condition of the drive puck in the Garrard. Also, the fact that the noise is louder in the right channel may indicate insufficient antiskating force.

|| We regret that, due to the volume of reader mail we get, we cannot give individual answers to all questions.



Our recording tape is considered by most audiophiles to be the world's finest tape.

Our tape windows are welded in to keep dust out.

Our pressure pad is locked into a special four-sided retainer to maintain perfect tape-to-head contact.

Our slip sheet is made of a substance that's so slippery, even glue can't stick to it.



Our leader not only keeps you from making recording errors, it also keeps your tape heads clean.

Our cassette is held together by steel screws to assure precise alignment and even distribution of pressure on all sides of the cassette.

Our special guide rollers make sure our tape stays perfectly aligned with your tape heads.

Our standard cassette shell is finished to higher tolerances than industry standards.

Our tape is anchored to our hub by a special clamping pin that makes slippage impossible.

There's more to the world's best tape than the world's best tape.

Our reputation for making the world's best tape is due in part to making the world's best cassettes.

In fact, we put more thought

and more work into our cassettes than most manufacturers put into their tape.

We do all this, because at Maxell

we believe in a simple philosophy.

To get great sound out of a cassette takes a lot more than just putting great tape into it.

maxell



Maxell Corporation of America, 60 Oxford Drive, Moonachie, N.J. 07074

DIRECTIONS

To solve these puzzles—and they aren't as tough as they first seem—supply as many of the Output words as you can in the numbered dashes following the Input. Unless otherwise specified in the Input, the Output consists of one English word. "Comp." means compound, or hyphenated, word.

Transfer each letter to the square in the diagram that bears the corresponding number. After only a few correct guesses you should begin to see words and phrases emerging in the diagram, which when filled in will contain a quotation related to music, recordings, or audio.

The words in the quotation are separated by darkened squares and do not necessarily end at the end of a row.

Try to guess at these words and transfer each newly decoded letter back to its appropriate dash in the Output. This will supply you with further clues.

A final clue: The source of the quotation—the author and his work—will be spelled out by the first letters in Output, reading down.

The answer to HIFI-Crostic No. 50 will appear in next month's issue of HIGH FIDELITY.

T 1	E 2		P 3	Q 4	J 5	V 6		O 7	M 8		B 9	A 10	D 11		V 12
M 13	K 14	J 15	C 16	H 17	O 18		F 19	V 20	N 21		V 22	B 23	A 24	R 25	G 26
	K 27	T 28	D 29	N 30	H 31		V 32		M 33	J 34	G 35		I 36	A 37	N 38
L 39		H 40	S 41	V 42	N 43	Q 44	T 45		V 46	J 47	U 48		K 49	E 50	L 51
	D 52	C 53	J 54	O 55		V 56		M 57	O 58	R 59	S 60	D 61		T 62	H 63
J 64	K 65	V 66	N 67	U 68	C 69		E 70	O 71		D 72	T 73	N 74	V 75	A 76	
J 77	F 78	L 79		K 80	D 81	H 82		V 83	G 84	M 85	I 86		N 87		C 88
P 89	R 90	L 91	V 92	K 93		T 94	J 95		V 96		O 97	U 98	N 99	R 100	
D 101	H 102	N 103	K 104		V 105		D 106	A 107	V 108	J 109	L 110	K 111		N 112	F 113
D 114	V 115		Q 116	I 117	O 118	K 119	A 120	N 121	V 122		F 123	G 124	E 125	U 126	
R 127	V 128		B 129	P 130	L 131	V 132		K 133	E 134	D 135	M 136	N 137	T 138	G 139	V 140
Q 141	C 142		N 143	D 144	A 145	T 146	Q 147	E 148		V 149	P 150	N 151	G 152	M 153	
K 154	N 155	H 156	D 157	V 158		C 159	D 160		Q 161	B 162		L 163	V 164	P 165	U 166
D 167	C 168		N 169	G 170		A 171	V 172	K 173	M 174		D 175	C 176		F 177	I 178
V 179		R 180	N 181	K 182	S 183		E 184	V 185		M 186	D 187	C 188	P 189		A 190
I 191	F 192	G 193		K 194	D 195	O 196	V 197		D 198	V 199	Q 200	J 201	N 202	E 203	C 204
T 205	D 206	M 207		Q 208	U 209	H 210	S 211	R 212	Q 213						

INPUT

- A. Jazz pianist Morton (1885–1941) (2 wds.)
- B. Anita _____, pop vocalist, recorded live at 1970 Berlin Jazz Festival
- C. Welsh contralto: Bach cantatas on London (full name)
- D. Gotham orchestra (3 wds.)
- E. Rotation; revolution
- F. Verdi opera
- G. American composer (b. 1926): Sextet on CRI
- H. "Drill, ye _____, drill"
- I. Marry (slang)
- J. English musicologist (1844–1923): wrote reference on complete works of Brahms (full name)
- K. Bohemian composer (1824–84): "My Country" (full name)
- L. "The Poem of _____," Scriabin symphonic work
- M. American pianist/composer (1829–69): "La Nuit des tropiques"
- N. English operetta team (3 wds.)
- O. Anticipates
- P. Percussion instrument
- Q. Swedish tenor (1904–64): "Rheingold" on London (full name)
- R. Opera by Siegfried Matthus, premiered at Weimar in 1976
- S. Also
- T. Carmen's friend
- U. Gradually slackening in speed (lt. abbr.)
- V. British orchestra (7 wds.)

OUTPUT

Solution to last month's HIFI-Crostic appears on page 4.

190	107	171	24	76	145	37	120	10							
23	129	9	162												
53	69	204	16	176	88	188	159	142	168						
206	81	52	61	29	106	114	72	195	175	11	187	144	101	167	160
203	2	50	125	148	70	184	134								
78	177	123	113	192	19										
26	139	193	152	35	124	84	170								
40	102	210	63	156	31	82	17								
86	191	36	117	178											
64	109	77	34	15	201	5	54	47	95						
154	104	14	119	133	49	93	173	182	80	194	27	111	65		
110	163	39	91	131	79	51									
207	136	186	174	8	85	57	13	33	153						
103	202	74	43	121	181	99	151	30	21	38	67	155	112	169	143
118	97	196	7	55	71										
89	165	189	150	3	130										
18	147	213	116	200	58	141	208	4	44	161					
212	127	59	100	180	25	90									
60	211	41	183												
45	138	62	94	1	205	146	28	73							
166	98	126	209	68	48										
140	92	56	158	6	42	128	172	22	83	197	12	46	132	122	105
20	66	164	179	185	32	115	75	108	149						



If you don't clean and preserve your records with Sound Guard™, you're only scratching the surface.

Have you ever considered what it would cost to replace your record collection at today's prices? With that kind of investment at stake, it's no wonder that many music lovers have become more aware of record care. Regular cleaning of your records is important and necessary, but cleaning alone won't prevent them from wearing out. To protect your investment you need more than cleaning. You need both Sound Guard Cleaner and Sound Guard Preservative.

Sound Guard Record Preservative is a revolutionary dry lubricant which virtually eliminates record wear without affecting the fidelity of the record. And when you drag the hardest

substance found in nature—diamond—through the soft, intricate vinyl canyons of a phonograph record at phenomenal rates of acceleration, it doesn't matter how light you're tracking. Something's got to give, and that's the vinyl. But with a Sound Guard-treated record, even after 100 plays, there is no audible degradation of performance.*

Before and after you preserve your records, be sure to use our superior cleaner to remove the dust and oily films that can further mar

performance. (The cleaner will not remove the preservative's protective coating.)

Sound Guard offers the only complete program of record preservation and maintenance. It requires a little more time and effort than just cleaning. But how much did you say it would cost you to replace your record collection?

Sound Guard. Everything else is a lot of noise. 

Sound Guard™

Sound Guard preservative—Sound Guard™ cleaner. Sound Guard™ Total Record Care System. Sound Guard is Ball Corporation's registered trademark. Copyright © Ball Corporation, 1979, Muncie, IN 47302.



*We have the test results to prove it—write us and we'll send them to you

New Equipment Reports

Preparation supervised by Robert Long, Peter Dobbins, and Edward J. Foster. Laboratory data (unless otherwise noted) supplied by CBS Technology Center or Diversified Science Laboratories.

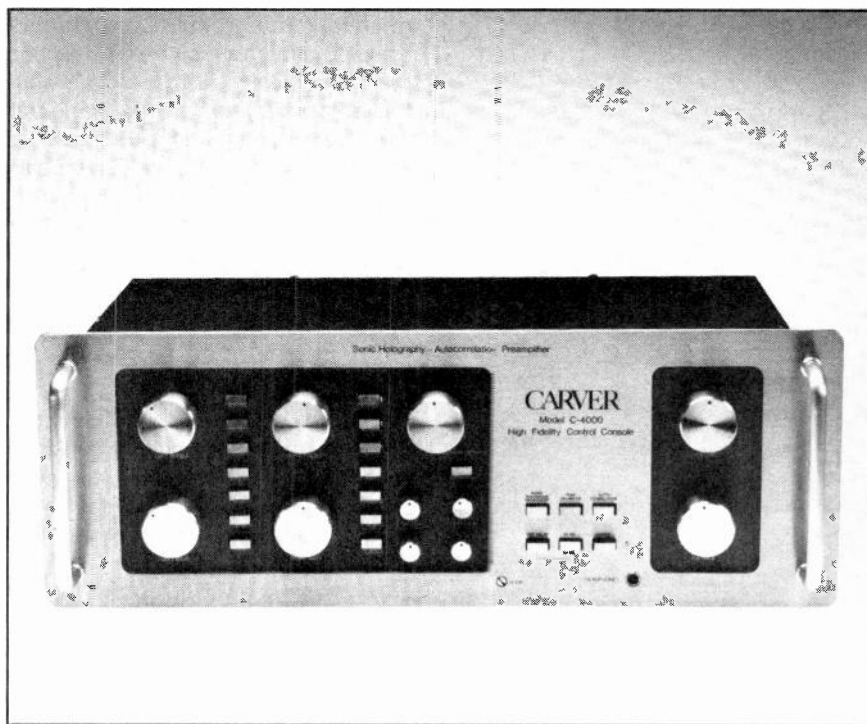

World's First "Holographic" Preamp

New Measurement Standards: In making comparisons between current reports and those published in the past, readers are cautioned to pay particular attention to the reference levels and similar test criteria cited. S/N ratios for electronics, in particular, are measured very differently now that we have adopted salient features of the new IHF amplifier-measurement standard. While we believe that the new technique (which also implies a saner approach to loading of all inputs and outputs) will result in measurements that more perfectly reflect audible, in-use effects, they cannot be compared directly to the numbers resulting from the former, more conventional lab measurements.

Carver Model C-4000 Sonic Holography/Autocorrelation control preamplifier, in metal case. Dimensions: 19 by 6¾ inches (front panel), 8¼ inches deep plus clearance for handles and connections. AC convenience outlets: three switched, three unswitched (1,200 watts max. total). Price: \$867. Warranty: "limited," three years parts and labor. Manufacturer: Carver Corp., P.O. Box 664, Woodinville, Wash. 98072.

It was with a great deal of anticipation that we awaited the first production samples of Carver's original approach to more believable sound reproduction, the C-4000 preamp. We had heard prototypes as far back as the fall of 1978 and had been very much impressed. But how would the manufactured product, the one the public could buy, behave?

The Carver preamp is the sum of more parts than any model within memory. It has all the usual control and preamplification functions (though with a few twists). It includes autocorrelator and peak-unlimiter circuitry similar to that in the Phase Linear Model 2000 preamp (a product of Bob Carver's tenure there, before he founded Carver Corp.) and later offered separately in its Model 1000 (see "The Many Paths to Noise Reduction," HF, March 1976). And there is an ambience simulation system that includes both line outputs for the delayed signals (to be amplified and reproduced on a back speaker pair) and three sets of speaker terminals from a built-in low-power (1 1/2 dBW, or 14 watts, per channel at clipping) back amplifier: the normal left and right pair plus a CENTER set that combines both signals and can be used to redirect the ambience toward the front if, for example, you don't want to use back speakers. But the element that has created all the stir is, of course, what Carver calls the sonic hologram generator.

While he isn't saying exactly what the holographic circuitry does or how it works, it's clear that the fundamental intent is to create acoustic wave fronts at the listener that—at least in some key respects—simulate those that would be present had the recording been made binaurally (not in stereo) and reproduced on headphones (not speakers). In our review of the Sennheiser dummy-head binaural

Carver C-4000 preamplifier

OUTPUT AT CLIPPING	6.4 volts	
HARMONIC DISTORTION (THD; 20 Hz to 20 kHz)		
phono input	≤0.031%	
aux input	≤0.047%	
FREQUENCY RESPONSE	+0, -¼ dB, 13 Hz to 22 kHz	
RIAA EQUALIZATION		
phono 1	±¼ dB, 20 Hz to 20 kHz	
phono 2	± <¼ dB, 20 Hz to 20 kHz	
both	-1¼ dB at 5 Hz	
INPUT CHARACTERISTICS (IHF loading; A-weighting)		
sensitivity	S/N ratio	
phono 1	1.15 mV	70 dB
phono 2	1.15 mV	71¼ dB
aux	64 mV	83½ dB
PHONO OVERLOAD (clipping at 1 kHz)	1 35 mV	
PHONO IMPEDANCE		
phono 1	48k ohms; 40/200/390 pF	
phono 2	48k ohms; <20 pF	
INFRASONIC FILTER	-3 dB at 16 Hz; ca. 18 dB/oct.	

recording setup (January 1975) we exclaimed over the spatial verisimilitude it created: Recorded sounds seemed to come from specific spots within the listening room—or, rather, the simulated aural environment around the headphoned listener—with such palpability that even good stereo imaging seemed blurred and diffuse by comparison. A detailed comparison of stereo and binaural recordings of a given source would turn up not only differences in absolute response, but extremely complex differences in interchannel phase and amplitude relationships. Subjectively, the basic difference is that, with headphone reproduction of the binaural recording, the listener has the feeling of being transported to a specific spot in the recording venue, while the stereo/loudspeaker version transports the recording venue, with less exactitude, into the listening room. The holographic generator is so called as a metaphor based on two similarities to visible holograms: It works with degrees of cancellation and reinforcement due to phase and amplitude differences in two related and “interfering” information channels to create its effect, and it produces a kind of three-dimensional illusion unavailable with more conventional reproduction techniques.

Carver says that at least six hours of tuning the system (including the room) are required for really good holographic imaging. Among basic considerations that may influence the process are the type and placement of the loudspeakers, the size and acoustics of the listening room, and the setting of the preamp controls. The latter include the holographic generator's on/off switch in the separate group of six pushbuttons, the THEORETICAL/NORMAL (essentially, two-mike/multimike-plus-mixdown) switch just below the main selector, a NORMAL/NARROW switch (whose latter position compensates electrically for restricted interspeaker spacing) on the back panel, and compensation for a room-dependent apparent increase in bass that may occur when the holographic generator is turned on. In general, it appears, the smaller the room—and, in particular, the lower its ceiling—the greater the required bass cut. Here three options are available in the left-hand row of pushbuttons. The -2 dB TRIM button introduces a bass shelf that drops (actually by about 4 dB) as frequency descends between 4 kHz and 300 Hz. The bass control itself has two modes seemingly named after their boosting action: The 40-Hz position reaches its maximum boost (up to about 15 dB) only at and below that frequency; LOUDNESS moves the hinge frequency upward by approximately one octave and does, indeed, produce better subjective loudness compensation than the 40-Hz mode. But as the bass controls are rotated counterclockwise past their “flat” positions, their character changes abruptly to shelving controls with higher turnover frequencies and more limited (6 dB maximum) range.

We began with a setup that already met several of Carver's desiderata: a fairly large room with a moderately high ceiling in which the floor-standing speakers are at least four feet from the side walls and from that behind them and are angled inward toward the listeners' seating. We were aided as well by previous experience of the holographic effect. When we followed the manual's explicit instructions for initial setup, we found that the room acoustics already were acceptable for the purpose, without applying the sound-treatment measures it suggests if nasty reflections—which, it says, can hamper holographic imaging—should show up at this stage. Thus, in well under Carver's six-hour time span, we came up with sonic holography that closely approximated what we had heard in his demonstrations and that was little improved by further tweaking.

The ambience system also involves choices and, in a sense, fine tuning. Next to the TIME DELAY on/off is a button that sets the basic delay time: 50 or 80 milliseconds. In the group of four knobs to the left of these pushbuttons are controls for the level of the time-delay output (either to its line-level jacks or to the amplified speaker terminals) and for echo density, or what is termed “regeneration” on some ambience units. As with any ambience device we've worked with, the success of the effect depends in large part on your ability to tune it to the ambience already present in the signal you are seeking to enhance and on keeping the magnitude of the enhancement to no more than bare perceptibility. Turning everything all the way up is patently foolish with any such device and delivers an offensive, springlike reverb sound with the Carver circuit. While it evidently is intended as a further enhancement of the holographic circuitry, it can be used with normal stereo; when we did so, we considered its effect mildly pleasant after careful adjustment.

The peak limiter and autocorrelator can be switched in individually.

Ahh. Decisions, decisions.

Metal, three heads, microcomputer.

Auto reverse, detachable remote, logic.

We don't want to complicate your specs life but Sony gives you inspiring cassette decks. There's one exactly right for you.

Consider our new, three-head, two motor TC-K75 that gives you the higher-fi of metal tape compatibility. That's in addition to regular-fi, chrome and FeCr settings.

And Bias Calibration and Record Level Calibration systems let you optimize the performance of the specific tape you use.

The professional three-head system monitors the recorded signal an instant after it's recorded. And individual heads for each function, record, playback and erase, significantly improve performance.

Sony's new microcomputer in the heart of the TC-K75 adds convenience and dramatically increases reliability.

Digital logic control lets you speed through any sequence of operations by merely pressing the appropriate feather-touch bar.

The Ferrite-and-Ferrite heads last virtually forever. Compared to a conventional permalloy head, Sony's F&F head lasts 200 times longer. Micro-

polished, ultra-hard ferrite both in the magnetic core and guard portions delivers excellent frequency response and a high signal-to-noise ratio.

Another decision: Sony's TC-K96R cassette deck offers the double convenience of auto-reverse ruled by a micro-computer as well

as a detachable remote control unit.

Recording and playback is Sony precise with two newly developed ESL (Brushless & Slotless) motors. Simplified tape transport assures constant tape speed for faithful reproduction.

There's more. A Record Mute, large VU meters with LED peak level indicators, Memory, Timer switch, MIC and LINE input controls and Headphone level control work together to give you impressive value.

The Sony TC-K75 and the Sony TC-K96R. Your decision? Either way you win.



TC-K75

TC-K96R

The control unit snaps off to become a remote control unit for convenient operation at distances up to five meters.



SONY

INVESTMENT LETTER



POSTULATE: YOUR RECORDS ARE VALUABLE AIDS TO PLEASURE AND RELAXATION.

POSTULATE: YOUR RECORD INVESTMENT TOTALS MORE THAN \$1000 (ONE THOUSAND DOLLARS), AND SHOULD BE PROTECTED.

SUPPORTING DATA: REPLACEMENT COSTS ARE ESCALATING; SOME SPECIMENS UNAVAILABLE.

SUPPORTING DATA: DUST IS THE MOST DESTRUCTIVE ELEMENT TO RECORDS. DUST SETTLES ON ALL RECORDS AND MAY BE WELDED IN BY THE TRACKING STYLUS.

PROSPECTUS: THE DISCWASHER D3 RECORD CLEANING SYSTEM, WITH UNIQUE UNIDIRECTIONAL MICRO-FIBERS, LIFTS OFF DUST—RATHER THAN JUST LINING IT UP. RESULTS ARE VISUAL, SONIC AND CLEARLY PROTECTIVE OF INVESTMENT. COST OF SYSTEM IS ONLY \$15 (FIFTEEN DOLLARS). HAS LIFETIME MILLED WALNUT HANDLE AND INCLUDES DC-1 PAD CLEANER.

ADDENDUM: BE GUARDED OF IMITATIONS. SOUND INVESTMENTS SHOULD BE PROTECTED BY THE PROVEN EXPERTISE OF DISCWASHER LABS.



Seek out Discwasher® products at dealers worldwide who are interested in preserving your musical portfolio.

 discwasher, inc.
1407 N. Providence Rd.
Columbia, Missouri 65201

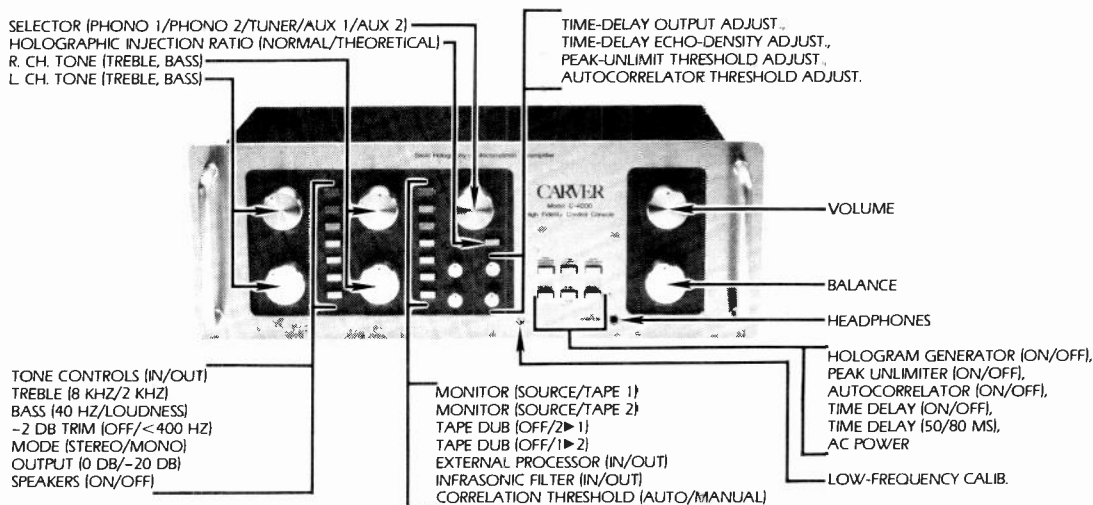

The unlimiter (which, in essence, provides some upward expansion of signal levels above a manually set threshold) is like Phase Linear's: capable of providing a little more "punch" if judiciously used but also of intrusively arbitrary expansion depending on the nature of the incoming signal and the threshold setting. The autocorrelator is said to be more complex and "gentler"—that is, subtler in its action, with less maximum noise filtering and less chance of unwanted side effects—than its already gentle forebear, and direct comparison confirms this. Hiss and rumble fade noticeably when it is turned on and have less tendency to reappear in time to the music and, therefore, to sound like extramusical noises such as overblowing in flute or pedal action in piano. We sometimes preferred our manual settings to the automatic-threshold mode, which is new in this incarnation.

Both on the Diversified Science Laboratories test bench and in our listening room, the basic functions of the preamp are impressive. The design of the two phono preamps (note that each has full circuitry, though they cannot be used simultaneously to dub one record while you listen to another) is not identical, even ignoring the back-panel switch for capacitive loading on PHONO 1. PHONO 2 proved a hair quieter (by up to 2 dB, depending on which functions were switched in during the test) and a split-hair more accurate (within 1/10, rather than 1/4 dB) in RIAA compensation, but some capacitance-sensitive pickups may give PHONO 1 the edge in sound quality. Distortion, while not super-low, was below our threshold of audibility and could not be distinguished even in A/B tests with a model measuring considerably "better."

But the overriding question raised by the unit is how its holographic generator sounds, since this is its unique claim to fame. Our answer: Terrific. With the system set up right and the listener ensconced in the preferred position, the stereo image—even with recordings that, because they are multimiked, depart from Carver's theoretical ideal—generally is crystalline in a way that almost beggars normal stereo reproduction. If that norm can be likened to a curtain of sound extending between the two speakers, the holographic generator seems to open the curtain and reveal a deployment of musical forces extending behind, between, and beyond the speakers, which then appear to be somewhere within the fiddles (left) and cellos (right) of the standard symphonic setup. If the time delay is also turned on, some of the auditorium walls as well as the stage of the presumed concert hall seem to be carried into the listening room, though we find this illusion far less convincing or desirable than that provided by the Carver holography. And, to carry the simile one step further, turning on the autocorrelator is like lifting a thin residual scrim of noise from between the auditor and the stage.

Even peripatetic listeners (like most of us at HF) will find that sonic holography offers imaging advantages; though the effect is admittedly best in axial listening—where, among other things, bass anomalies due to standing waves are minimized in the setup—much of its quality holds up as you move about the room. Those who consider the use of stereo equipment to be essentially a spectator sport may, however, be less inclined to enthusiasm. Not only does sonic holography [at

Report Policy: Equipment reports are based on laboratory measurements and controlled listening tests. Unless otherwise noted, test data and measurements are obtained by CBS Technology Center, a division of Columbia Broadcasting System, Inc., and Diversified Science Laboratories. The choice of equipment to be tested rests with the editors of HIGH FIDELITY. Samples normally are supplied on loan from the manufacturer. Manufacturers are not permitted to read reports in advance of publication, and no report, or portion thereof, may be reproduced for any purpose or in any form without written permission of the publisher. All reports should be construed as applying to the specific samples tested; HIGH FIDELITY, CBS Technology Center, and Diversified Science Laboratories assume no responsibility for product performance or quality.

A "Mighty Midget" Is Smart, Too

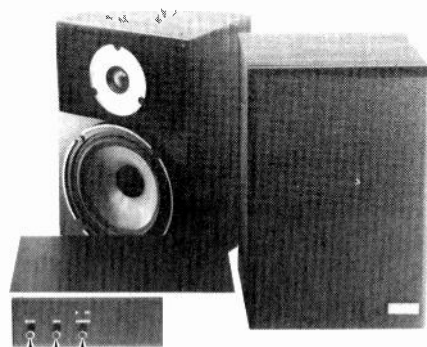

POSITION (WALL/FREE-STANDING)
MONITOR (SOURCE/TAPE)
"COMPUTER" IN/OUT

KLH-3 loudspeaker system

ANECHOIC RESPONSE CHARACTERISTICS (0-dBW input)

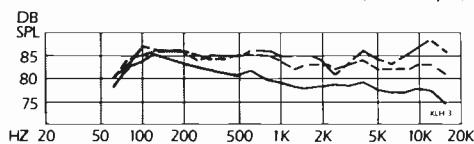

boundary-dependent region
— average omnidirectional response
- - - average front hemispheric response
- · - on-axis response

AVERAGE OMNIDIRECTIONAL OUTPUT
(250 Hz to 6 kHz)
80 dB SPL for 0 dBW (1 watt) input

CONTINUOUS ON-AXIS OUTPUT (at 300 Hz)
102% dB SPL for 17% dBW (59% watts) input

PULSED OUTPUT (at 300 Hz)
114% dB SPL for 29% dBW (89% watts) peak

"NOMINAL" IMPEDANCE 6.3 ohms

least in its initial form) require an activist approach if you are to get it right, but so do the time-delay, autocorrelator, and peak-unlimiter elements of the design. And the formidably complex front panel does not encourage use by the uninformed. Simpler formats may follow; for the time being, sonic holography is a glorious hobbyists' toy with a promising future, and the C-4000 is the most fascinating hands-on preamp we know of.

Circle 137 on Page 77

KLH Model 3 loudspeaker system, in wood veneer cabinet; sold in pairs with Analog Bass Computer unit. Dimensions: 8½ by 12½ inches (front), 6 inches deep; computer, 2½ by 10½ inches (front), 6 inches deep plus clearance for connections. Price: \$450. Warranty: "limited," five years parts and labor. Manufacturer: KLH Research and Development Corp., 145 University Ave., Westwood, Mass. 02090.

A true bookshelf-sized loudspeaker, barely larger than the familiar mini format, the Model 3 is the smallest in KLH's computer-controlled line. A vented, two-way design, it incorporates a 6-inch combination woofer/midrange and a 1-inch soft-dome tweeter surrounded by acoustically absorbent foam to reduce high-frequency diffraction effects. The real story with this speaker, however, lies in the separate Analog Bass Computer that comes with each pair. Although speaker systems equipped with equalizer modules are not new (Electro-Voice and Bose have offered them for years), KLH's approach takes that concept a step further. Aside from its equalization function (completing the speakers' bass alignment, so to speak), the KLH "computer" acts as a sort of electronic motional feedback device, preventing high-level bass signals from driving the woofer's diaphragm beyond its excursion limits, thereby keeping distortion low.

The computer module is inserted either in the tape monitor loop or at the pre-out/main-in connections. (Tape monitor jacks are duplicated on the back of the module, and a TAPE button on the front panel restores monitor switching.) Wires marked LOUDSPEAKER MONITOR on the back must be connected in parallel with the loudspeaker outputs of the receiver or power amp. AC power for the computer is derived via a small transformer that plugs into a jack on the module's back panel. An IN/OUT button on the front panel bypasses the circuitry when speakers other than Model 3s are to be used. (KLH strongly advises against use of the computer with "standard" speakers, warning of possible damage to them. Therefore, running Model 3s simultaneously with a dissimilar pair of rear or remote speakers is ruled out.) There are no controls on the speakers themselves, and connection to the amplifier is accomplished with screw posts.

In operation, the computer accomplishes several things. First, it provides an equalized signal to the amplifier in accordance with the speaker's own performance characteristics. Second, it acts as a sharp high-pass filter, effectively cutting response below 30 Hz. Third, it provides low-frequency compensation for placement either against a wall or free standing. And, fourth, it suppresses signal elements that would represent woofer overdrive. When too great a low-frequency signal is present, the pre-programmed analog circuitry automatically modifies the response of the equalizer so that maximum displacement of the woofer is not exceeded, whatever the unequalized (preamp-out) signal. Awakening of the processor logic can be monitored visually on the module's front panel via two lights above the IN/OUT button.

A primary objective of this scheme is, of course, to wring as much bass as possible from a small enclosure. Judging from the measurements made in the CBS Technology Center anechoic chamber, the Model 3 proves that it has muscle as well as brains. With the POSITION control set for free-standing placement (away from bass-reinforcing walls), low-frequency output is strong and response quite flat and smooth above the characteristic bass hump. The alternate placement setting reduces bass output by around 5 dB below 60 Hz and progressively less as frequency increases. This reasonably efficient speaker handles power to hefty sound pressure levels (above 102 dB on continuous tones and 114 dB on tone bursts) before distortion becomes excessive. While these levels show that the Model 3 can be "played loud," the actual dynamic range does not extend to the superloud peak capability of many contemporary speakers. Second and third harmonic distortion

LUX

TOMORROW'S TECHNOLOGY IN TODAY'S SYSTEMS

THE PERFECT SYSTEM BLENDING TODAY'S TECHNOLOGY AND GOOD MUSIC FOR A PLEASURABLE LISTENING EXPERIENCE.

High fidelity is the sum total of audio experience. It means not only superb styling but ease of operation. It also means the joy of listening, even in the midst of a frenetic work schedule. Just turn on the system, relax and forget your problems and experience an audio happening.

The total audio experience can't be gleaned from specifications. It must be heard... felt. Because many Lux original technical developments enhance the experience, they are not easily specified.

The Lux L-11 Integrated Amplifier uses Realtime Processed DC Amplification. In a conventional amplifier, a capacitor is used in the negative feedback loop to eliminate wave form distortion, but it in turn triggers time lag causing phase distortion in the lower frequency and transient distortion in the higher frequency. Lux's approach to this problem as seen in the Model L-11 was to drop the capacitor from the negative feedback loop; thus erasing the time lag causing phase and transient distortion. DC drift was solved by the use of Lux's exclusive DML-IC (dual monolithic linear integrated circuit).

Lux 5K50 Cassette Deck uses our BRBS System. Building a superb cassette deck needs more technology than standard decks. To make the most of the unit's 3-head design, the BRBS variable bias system is provided. This Bridge Recording by Bias Current and Signal Current avoids transient and phase shift distortion.

Lux R-1120A Tuner/Amplifier and our T-12 Tuner both use the Closed Lock Loop Tuning System. Since it's impossible to enjoy mistuned FM, or to relax when you have to jump up and retune, Lux has perfected frequency control.

While most quartz lock systems operate on the front end only, Lux goes further, with Closed Lock Loop controlling the front end, the IF and detector circuits, with strong, instantaneous corrective feedback to the exact center of the desired frequency range. Another locking circuit, Accu-lock™ physically locks the tuning knob at the desired point. Not only does Lux's system deliver perfect tuning, it retains the last tuned frequency even when the power is turned off and on.

Lux PD-277 offers quality and convenience. Using a Lux designed, servo-controlled brushless, slotless motor, wow and flutter is extraordinarily low at 0.05%, while signal-to-noise ratio is 60dB.

Other outstanding features are a straight low mass tonearm and vertical pivot construction for minimizing resonance and instability.

Quality and convenience are evidenced by electronic controls for all major functions and a separate motor for the tonearm eliminates noisy, friction-producing linkage.

These and other innovations are typical of Lux's outlook. But none of this shows up on spec sheets. Only listening will prove that all of Lux is for your pleasure.

See your nearest Lux dealer for a unique listening experience.



LUX AUDIO OF AMERICA, LTD.

160 Dupont Street, Plainview, NY 11803 (516) 349-7070

11200 Chandler Blvd., North Hollywood, CA 91603 (213) 985-4500

In Canada: Lux Audio of Canada, Ltd., Ontario

Due to the tremendous response from consumers, Lux has decided to extend the Great Rebate Program from December 31, 1979 to January 31, 1980.

figures are low over most of the audible spectrum, averaging out to ½% from 100 Hz to 10 kHz at moderate listening levels (0 dBW). At high listening levels (100 dB), third harmonic distortion remains around the ½% figure, and the "softer" second harmonic rises a bit, to an average of some 2%.

In at-home use, the Model 3 acquitted itself nicely indeed. The sound is remarkably uncolored for such a small speaker. A polypropylene formulation (developed by the BBC) was used in the fabrication of the driver cones, and the sound in the critical midrange reflects KLH's claims that the material has superior anticoloration qualities. Bass is also remarkably extended in these small speakers, and, try as we might, we could not hear the "attack" of the computer as it limited the low-frequency input. If anything, we found the quantity of bass difficult to balance against the upper range. KLH makes much of the necessity of good room placement to extract the best possible sound from the system, but shelf mounting seems mandated by the format. Even with the POSITION button pressed in (for back-to-the-wall placement), we encountered bass-heavy reproduction until we touched up the balance by trimming down the bass at our preamp.

Overall, the Model 3s are impressive performers. Stereo imaging is well defined and stable. The unboxy sound combined with some midrange warmth makes them easy to live with. If you are short of space and seeking a superior small speaker, the KLH certainly should be on your audition list.

Circle 132 on Page 77

A Low-Mass Beauty



Ortofon Concorde 30 phono pickup

FREQUENCY RESPONSE & CHANNEL SEPARATION
(test records: STR-100 to 40 Hz; STR-170 above)

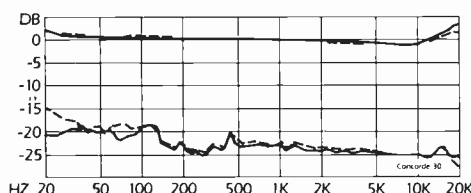

Frequency response

— L ch: +3¼, -1½ dB, 20 Hz to 20 kHz

- - - R ch: +1¾, -1½ dB, 20 Hz to 20 kHz

Channel separation
≥ 20 dB, 130 Hz to 20 kHz
≥ 15 dB, 20 Hz to 20 kHz

SENSITIVITY (at 1 kHz) 1.12 mV/cm/sec

CHANNEL BALANCE (at 1 kHz) ± ¼ dB

VERTICAL TRACKING ANGLE 25½°

LOW-FREQUENCY RESONANCE

(in SME 3009 arm)

vertical 10.5 Hz; 6¼-dB rise

lateral 10 Hz; 7¼-dB rise

MAXIMUM TRACKING LEVEL (re RIAA 0 VU; 1.2 grams)

at 300 Hz +18 dB

at 1 kHz +12 dB

WEIGHT (includes "shell") 6.3 grams

Ortofon Concorde 30 fixed-coil phono pickup in universal headshell, with multiradial diamond stylus. Price: \$165; CL-30 replacement stylus, \$90. Warranty: "limited," one year parts and labor. Manufacturer: Ortofon, Denmark; U.S. distributor: Tannoy-Ortofon, Inc., 122 Dupont St., Plainview, N.Y. 11803.

The integrated pickup headshell, based on the so-called universal headshell-tonearm coupling that recently has grown so rapidly in popularity, is one of those good, practical ideas whose time has finally arrived. An obvious convenience and time-saver (losing tiny mounting screws can be a giant headache), the format also enables manufacturers to engineer a single, low-mass ensemble for arm designs that otherwise tend to be rather massive for today's pickups. Ortofon's Concorde 30—so named because of its resemblance to the supersonic airliner that the down-turned nose—manages to pare total mass to just 6.3 grams, about that of many pickups alone. Also important in the Concorde's design is the use of a fine-line, nude-mounted diamond tip whose multiradial geometry and direct mounting without a "setting" contribute to what Ortofon claims is the lowest effective stylus tip mass available.

As expected from such a cartridge, tracking ability is exceptional. CBS found it capable of navigating the "torture" test with just ¾ gram of vertical tracking force. A VTF of 1.2 grams (the minimum value recommended by Ortofon) was used for the balance of the testing, with the recommended load of 47,000 ohms shunted by 400 picofarads. Channel separation proved very good; frequency response with this load is in line with that of other top-notch pickups. There is a slight dip followed by a moderate peak as the test frequency approaches 20 kHz with the STR-170, but listening tests could not fault the Concorde's high-frequency behavior on music. The output level is ample for typical phono stages, though the channel balance (at 1 kHz) in the bench-test sample was a hair less exact than average among current top models. And both harmonic and intermodulation distortion are acceptably low.

Examining the results of the Concorde's behavior in the low-frequency resonance test discloses the chief virtue of a low-mass design. With the cartridge mounted in our "standard" SME arm, the vertical and lateral resonance are firmly in "ideal" territory—as far removed as practical from the region where warp information may be transmitted to the amplifier circuitry. Since so light a pickup may be beyond the balance adjustment range of some arms, each Concorde comes with a low-mass counterweight with a center-hole diameter of 15 millimeters. Ortofon offers to exchange this one for alternatives with 12- or 18-millimeter openings, should the lighter weight prove necessary and the dimensions of the version provided be inappropriate for your arm. (To save yourself the bother of writing directly to Ortofon, you might check the dimensions with your dealer in advance of

Crystal-clear reasons for receiver-size separates.

If you're trying to choose between a receiver and separate components, we have a suggestion: Settle for both.

Now you can have the compact size of a receiver with the quality of separates.

Sony's new ST-J60 tuner and TA-F40 amplifier are a slim, dynamic duo no larger than a medium-size receiver but with crystalline, powerful separate-component qualities.

The tuner is quartz-crystal locked with a digital synthesizer for drift-free stability and speedy touch tuning. Distortion is virtually non-existent and our slim-line music lover is an FM specialist.

Convenient auto tuning lets you preset eight stations. Simply press the appropriate button and an LED light blinks as the tuner searches for the "memorized" station.



Two other buttons let you manually scan the broadcast scale in either direction. And a Calibrated Tone feature assists you when

recording with a tape deck.

Our new thin-line TA-F40 integrated amplifier snuggles up to its tuner partner for extremely clean, noise-free sound in a beautifully sized package.

Total harmonic distortion (THD) is one of the lowest in this class of amplifiers. Fifty watts per channel surge through a newly developed Pulse Power Supply (PPS). And Sony's exclusive Heat Sink with Heat Pipe ingeniously drains away heat to reduce distortion.

for any stereo mission. And the TA-F40 is so quiet you can even use a high-performance MC cartridge with your turntable.

Sony's new, compact, performance-engineered ST-J60 tuner and TA-F40 amplifier. Two crystal-clear reasons to settle for everything.



ST-J60

TA-F40

LED peak power indicators pinpoint output in six steps for each channel. Light-touch function switches give you smooth control

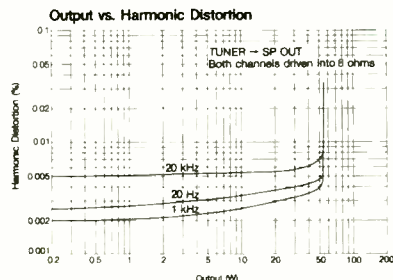
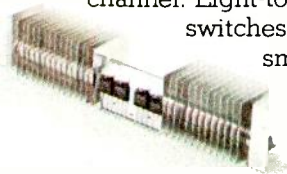

SONY

How Audio History is made.



Mantaray Horn

Has American ingenuity taken a back seat to cheaper foreign labor? Not at Altec Lansing, where we've been inventing and building high-quality speakers for well over 42 years. Like the Model 14. It's so unique, that before we could create it, we first had to invent a whole new family of components.

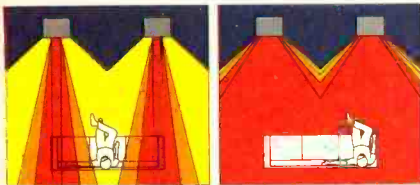

Conventional beaming narrows listening area. Mantaray expands listening sweet spot.

We began with a new type of horn. The Mantaray.^{TM*} It's the first "constant directivity" horn ever created. Conventional horns, cones and domes (including so-called omnidirectional and reflective speakers) tend to "beam," that is, narrow their angle of sound radiation at higher frequencies. This effect causes the stereo image to lose strength off the center axis and to actually wander.

Mantaray, on the other hand, delivers a clearly-defined sound wedge that keeps its strength regardless of the music's changing frequencies.

You get the full spectrum of sound and the most solid three-dimensional stereo image you've ever heard. And since the sound doesn't diminish off center axis, the Model 14 enlarges your listening area, your "stereo sweet spot."

As an extra benefit, Mantaray's precise sound focusing means your music goes in your ears—not in your drapes, walls, and ceilings. Consequently, it's more likely than other speakers to sound the same in your home as it does in your dealer's showroom.



Power Control

Then to give you even higher highs, we developed the first radial phase plug, the Tangerine^{®**}

In contrast to conventional phase plugs with two equidistant circular slots that block some frequencies, the Tangerine's tapered slots permit a free flow of high frequencies to beyond 20 KHz.



Tangerine

Equally important to all this is our new Automatic Power Control System. Unlike fuse-type devices or circuit breakers, the system keeps track of the power pumped into the speaker, lets you know with a blinking light when power exceeds safe limits, and then reduces overloads automatically, but without shutting the speaker off. It's quite a system.

In addition, the Model 14 offers you super-efficiency, highpower handling capacity and exceptional dynamic range, plus a new vented enclosure with a 12-inch bass driver for a tighter, crisper low end. So that's how audio history is made. And it's all yours at a price that means the best sound value available for your home today.

So the next time someone tries to tell you that American workmanship is taking a back seat, play your Altec Lansing speakers for them and prove how wrong they are.

For a free brochure and the name of your local dealer, write:

Altec Lansing International,
1515 South Manchester Avenue,
Anaheim, CA
92803.



The Choice of Professionals



* U.S. and foreign patents pending
** U.S. Patent No. 4050541

TIP DIMENSIONS

tip radii 10.6 by 16.4 micrometers
scanning radii 8.8 micrometers

SQUARE-WAVE RESPONSE

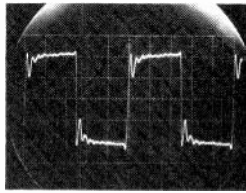

purchase. Ortofon informs us that its dealers should have a varied supply of counterweights in stock.)

In use, the Concorde acquitted itself with good marks all around. It managed to track some of the worst warps we have, and its distinctive downturned nose actually contributes to this by raising the cartridge body over some of the steepest warps, while the narrowness of the nose minimizes the chance of hangup on the edge bead of severely warped discs. We are at a loss to describe its tone since it introduces no characteristic color of its own to the music we heard. Detailing on even the most complex passages emerges with clarity and definition. This, combined with its installation convenience and its sleek physical beauty, make it among the most attractive pickups around.

Circle 136 on Page 77

SAE Two Is No "Me Too"

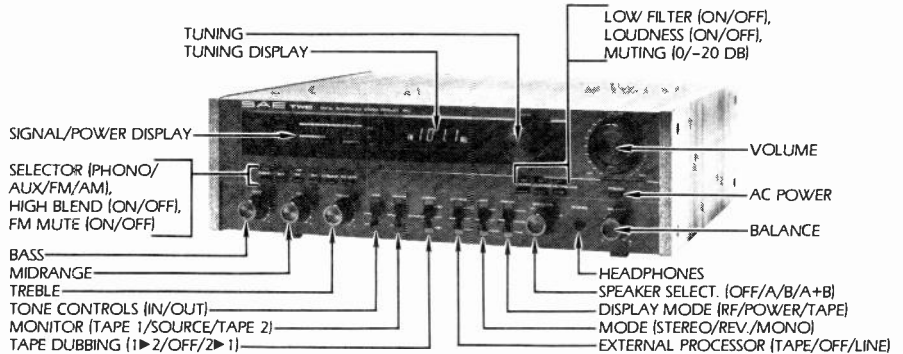

SAE Two Model R-6 tuner section

MONO FM FREQUENCY RESPONSE

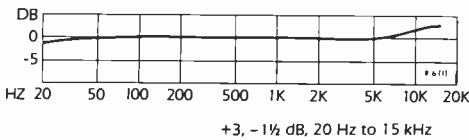

STEREO FM RESPONSE & CHANNEL SEPARATION

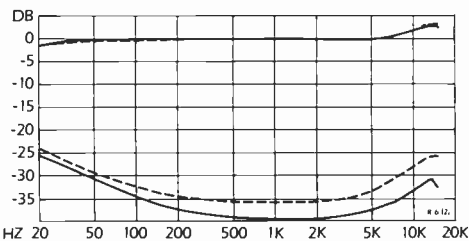

Frequency response

— ch: +3½, -1¼ dB, 20 Hz to 15 kHz
 - - - - ch: +3½, -1½ dB, 20 Hz to 15 kHz
 Channel separation ≥35 dB, 250 Hz to 3.5 kHz
 ≥25 dB, 23 Hz to 15 kHz

SAE Two Model R-6 stereo FM/AM receiver, in metal case with wood ends. Dimensions: 18¼ by 5¼ inches (front panel), 15¼ inches deep plus clearance for controls and connections. AC convenience outlets: two switched (600 watts max.), two unswitched (100 watts max.). Price: \$650. Warranty: "limited," three years parts and labor. Manufacturer: made in Japan for Scientific Audio Electronics, Inc., 701 E. Macy St., Los Angeles, Calif. 90012.

You can count the number of domestically produced stereo receivers on the fingers of one hand and have digits left over. High-quality separates—including those on which SAE's reputation is based—are another matter, of course. But when a company like SAE wants to add receivers (or tape decks) to its line, competitive pricing virtually dictates Oriental manufacture. When SAE decided to build a line in Japan, it distinguished between its separates and the imports by calling the latter the SAE Two series.

The R-6 is the least expensive receiver in that line, but it offers such a slew of novelties and genuinely useful features that it sparks enthusiasm even in the stodgiest reviewers. In addition to familiar niceties like quartz-locked tuning and digital frequency readout, we have such features as switching for an external processor (equalizer, noise-reduction system, or the like) that not only leaves tape-monitor loops unencumbered, but can be switched into the circuit either ahead of the tape-output jacks or into the listening signal path. Thus the processor can be used either to "fix" a signal you are recording or for one you are playing back. The tape recordist used to replugging cables in order to achieve this flexibility will really appreciate the convenience. His needs have been anticipated further by two-way tape-dubbing independent of the main program selector and by a separate three-way monitor switch so that the playback from either deck can be checked in a wink. When you are dubbing between decks with EXT PROC in the TAPE position, the processor is switched into the line between the source deck and the slave. We can't remember a receiver whose tape switching logic is more complete or foolproof.

Frosting the tape recordist's cake are the signal displays; in one mode they function as eleven-segment fluorescent "bar graphs" to supplement the deck's own recording-level meters. In addition, the displays monitor output to the speakers (in 3-dB steps from 0.06 to 60 watts) and act as tuning "aids." In the power mode, Diversified Science Laboratories found all the display elements accurate within ¼ dB, with essentially flat response across the audio band. Although the 3-dB steps are a

FM SENSITIVITY & QUIETING

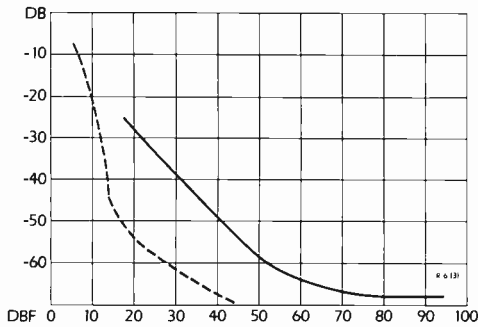

—	stereo quieting (noise)
- - - -	mono quieting (noise)
Stereo sensitivity (for 50-dB noise suppression)	
41 dBf at 98 MHz, with 0.36% THD+N	
(4 1/2 dBf at both 90 and 106 MHz)	
Mono sensitivity (for 50-dB noise suppression)	
16 1/2 dBf at 98 MHz	
Muting threshold	13 dBf
Stereo threshold	16 dBf
Stereo S/N ratio (at 65 dBf)	66% dB
Mono S/N ratio (at 65 dBf)	71% dB

CAPTURE RATIO	1 1/4 dB
ALTERNATE-CHANNEL SELECTIVITY	56 1/2 dB

HARMONIC DISTORTION (THD+N)		
	stereo	mono
at 100 Hz	0.21%	0.16%
at 1 kHz	0.065%	0.046%
at 6 kHz	0.14%	0.072%

STEREO PILOT INTERMODULATION	0.074%
IM DISTORTION (mono)	0.055%
AM SUPPRESSION	65 1/2 dB
PILOT (19 kHz) SUPPRESSION	71 1/2 dB
SUBCARRIER (38 kHz) SUPPRESSION	> 84 dB

SAE Two Model R-6 amplifier section

RATED POWER	17% dBW (60 watts)/ch.
-------------	------------------------

OUTPUT AT CLIPPING (both channels driven)	
8-ohm load	19 dBW (80 watts)/ch.
4-ohm load	20% dBW (115 watts)/ch.
16-ohm load	16 1/2 dBW (45 watts)/ch.

DYNAMIC HEADROOM (8 ohms)	2 1/4 dB
---------------------------	----------

HARMONIC DISTORTION (THD; 20 Hz to 20 kHz)	
at 17% dBW (60 watts)	< 0.01%
at 0 dBW (1 watt)	< 0.01%

FREQUENCY RESPONSE	
+0, -1/4 dB, < 10 Hz to 150 kHz;	
-3 dB at 270 kHz	

RIAA EQUALIZATION	
+1/2, -0 dB, 20 Hz to 20 kHz;	
-5% dB at 5 Hz	

INPUT CHARACTERISTICS (re 0 dBW; A-weighting)		
	sensitivity	S/N ratio
phono	0.34 mV	75 1/2 dB
aux	20 mV	76 1/2 dB

PHONO OVERLOAD (1-kHz clipping)	220 mV
---------------------------------	--------

PHONO IMPEDANCE	35k ohms at 1 kHz (complex)
-----------------	-----------------------------

DAMPING FACTOR (at 50 Hz)	115
---------------------------	-----

LOW FILTER	-3 dB at 30 Hz; 6 dB/octave
------------	-----------------------------

bit crude for setting recording levels, the 30-dB range exceeds that of many recording indicators, and response time is faster than that of the meters in many decks. (Essentially, they respond accurately to any pulse lasting at least 20 milliseconds.)

In its AM/FM mode, the display's upper bar graph indicates signal strength; the lower one serves as an FM-multipath indicator. When you're tuning and orienting your antenna, you should maximize the top reading and minimize the lower bar. In practice, the system works quite well: When we adjust the antenna for a maximum differential between the two bars, the sound is noticeably cleaner than with other readings. As a signal-strength indicator, the upper display distinguishes FM signal levels from 23 1/4 to 54 1/2 dBf (the most important range) in such detail that we find it among the most useful bar graphs we have encountered.

The R-6 requires a little more signal level than average to achieve the magic 50-dB quieting, but its ultimate quieting (with a 65-dB input) is up to snuff, and the audio distortion is low. Sensitivity is essentially constant across the band, and, as is to be expected, the digital display accurately indicates the tuned frequency. All of this is readily apparent when using the R-6. Reception of strong stations in our area is all that we could ask for, though weaker ones are a trifle noisier than usual. The high-blend option is reasonably effective in reducing hiss on stereo signals of marginal strength and actually flattens top-end response by comparison to the curve measured (with the BLEND off) by DSL and shown in our graph. Separation is better than 30 dB across the most important part of the band with the BLEND off and still an adequate 20 dB to about 2 kHz with it on. AM suppression is good and selectivity adequate for most situations.

The R-6 has no channel-center tuning meter, but its presence is not often missed: A TUNE LED lights when you are on your station's target. Releasing the knob at this point activates the station lock, indicated by a separate legend. In order for either indicator to come on, you must tune quite accurately, which takes some care in manipulating the very light tuning mechanism. In some instances—apparently associated with very weak signals or with high multipath—the tuning indicator does not illuminate, and the receiver does not go into lock. Once in lock, however, the R-6 usually maintains a tenacious grip on the signal, even during fading.

The receiver is conservatively rated at 60 watts (17% dBW) per channel. DSL found that it actually pumps out 80 watts per channel continuously into 8-ohm loads before clipping. Dynamically, it delivers the equivalent of 100 watts, for an exceptionally generous headroom of 2 1/4 dB. THD remains below 0.01% throughout the audio band at either the 1-watt or the rated-power level. The high damping factor testifies to the liberal use of feedback. With the tone controls bypassed, basic frequency response is virtually ruler flat to 150 kHz; with the tone controls in the circuit but at the nominal center points, the response is down about 1/2 dB at 20 Hz and 20 kHz. The infrasonic filter slope is mild.

Separate controls are provided for bass, midrange, and treble. The midrange is centered on 1.2 kHz but is effective over much of the band—between about 180 Hz and 7 kHz—and affords a maximum control range of +10 to -11 dB. The shelving bass and treble controls overlap the midrange slightly; the bass picks up at 280 Hz, with +15 to -17 dB maximum (below 40 Hz), and the treble at 2.5 kHz, with +10 to -12 dB above 10 kHz. The loudness contour boosts both ends of the spectrum substantially: by 11 dB or more below 50 Hz and by more than 7 dB above 10 kHz—making the sound somewhat brighter than we like in a loudness contour.

The phono preamp is equalized accurately and has more than sufficient headroom. While its 1-kHz impedance is close to the nominal 47,000 ohms, DSL did not find a suitable value of resistance and capacitance that would model the complex load presented to the cartridge. Perhaps due to the "nonclassic" loading, the disc-reproduction sound of the R-6 struck us as a bit brighter or edgier than average.

Whether from disc or from FM, this is a bright, clean-sounding receiver. Its power reserves belie its modest ratings; indeed, the receiver acts and sounds both more powerful than its 60-watt rating would suggest and more sophisticated than its price tag would imply. The logical switching options almost put the R-6 in a class by itself and are sufficient reason to cast a careful eye on this SAE import.

Circle 131 on Page 77

(more)

YOUR TURNTABLE PROBABLY DESERVES BANG & OLUFSEN.

If you've spent a fair amount of time and money on your audio system, it's likely your turntable is ready for the new MMC 20CL cartridge. You do need a tonearm which can track successfully at one gram, one that has its own resonance well damped, and one which features minimal horizontal and vertical friction. Many of today's higher quality units meet these criteria; more likely than not so does the one you own.

THE MMC 20CL, A REFRESHING PERSPECTIVE IN CARTRIDGE DESIGN.

Critical acclaim has identified the MMC 20CL as an exceptional cartridge. It is. It will not only give you more music from your records, but will insure those records last significantly longer. However, it is not one of those 'astounding breakthroughs' that always seem to be hovering around cartridge design and its promotion. No, while the 20CL does incorporate new thinking, new materials, and new manufacturing methods, it should be reasonably viewed just as it is: simply one step closer to the theoretical ideal. When we introduced the first stereo cartridge to Europe over 20 years ago, we knew that someday we would have the 20CL. Our approach to cartridge engineering tells us that 20 years from now we will have something significantly better.

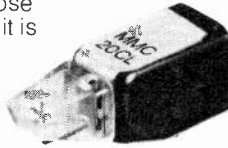

SINGLE CRYSTAL SAPPHIRE, BECAUSE THE CANTILEVER IS CRITICAL.

Unlike aluminum and beryllium, single crystal sapphire transfers the motion of the stylus tip without adding any measurable vibration, and hence distortion, of its own. The absence of this vibration and flexure in the cantilever means the undulations in the record groove are transferred exactly and generate an exceptionally accurate electrical signal. Music is no longer lost between the stylus tip and the armature. Your records open up and music unfolds with new clarity, definition, and spaciousness.



Give your turntable what it deserves. The MMC 20CL with our new universal connector can be mounted directly on most high quality tonearms.

REDUCING EFFECTIVE TIP MASS, BANG & OLUFSEN'S ENGINEERING TRADITION.

As early as 1958, our research demonstrated that effective tip mass (ETM) was the single most determining factor behind record wear and the loss of high frequency sound information. While some manufacturers are now beginning to realize the importance of this specification, only Bang & Olufsen can look back upon a continuous chain of improvements in this critical area. Today, the MMC 20CL with its Contact Line, nude diamond, ultra-rigid sapphire cantilever, and the patented Moving Micro Cross armature features an ETM value of only 0.3mg.

LOW INDUCTANCE, OUTPUT REMAINS CONSTANT REGARDLESS OF LOAD.

As you know, low inductance in a cartridge is related directly to the strength and constancy of the electrical signal fed to your preamplifier input. What you may not know is that the MMC 20CL has an inductance among the lowest of all high quality cartridges available today. This is due to a design which incorporates an exceptionally powerful permanent magnet and coil cores of very low permeability. This design results in very low cartridge induced noise. Subsequently you receive an excellent signal-to-noise ratio without being required to use auxiliary equipment.

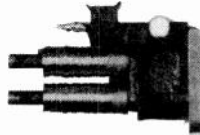

INDIVIDUALLY CALIBRATED.

When you manufacture very high quality cartridges, each unit must be tested—not one out of two, or ten, or twenty, but each one. This is why when you purchase the MMC 20CL, you will receive the test results for your individual cartridge. These results include: output voltage, channel balance, channel separation, tracking ability, and a frequency response graph for each channel.

THIS TIME MAKE THE RIGHT CONNECTION

Bang & Olufsen

For Information Write To: Harold Flemming

Bang & Olufsen of America, Inc., 515 Busse Road, Elk Grove Village, Illinois 60007

Circle 7 on Page 77

Tradition Improved: Jensen's Best Yet

Jensen System B floor-standing loudspeaker system in wood enclosure with variable-tilt base. Dimensions (including base): 16½ by 33¾ inches (front), 11¾ inches deep. Price: \$490. Warranty: "full," five years parts and labor. Manufacturer: Jensen Sound Laboratories, 4136 N. United Parkway, Schiller Park, Ill. 60176.

Jensen's System B combines two elements not always found together in loudspeakers: good sound and attractive styling. Finished in a neutral brown, the enclosure sits in a natural-finish oak-veneer cradle that raises the speaker slightly off the floor and affords the user the option of tilting it slightly upward, should that help dispersion in his listening setup. Thus Jensen has gracefully avoided two extremes: the conventional "big box on end" look and the often outré radical alternatives.

Removal of the grille reveals four drivers mounted flush on the baffle, along with a vertically aligned vent and continuous-acting controls for midrange and treble. Mounted on the back of the speaker is still another driver, a 2-inch tweeter recessed into the cabinet and angled slightly upward, for improved high-frequency dispersion. The baffle-mounted drivers—a 1-inch soft-dome tweeter, a 1¼-inch soft-dome upper midrange, 6-inch lower-midrange driver, and 12-inch woofer—are precisely aligned on a vertical axis to lessen the propagation of interference patterns. The baffle board itself is built out from the cabinet, and the grille molding is recessed behind the front of the baffle to minimize reflection.

The "nominal" impedance rating, as determined by CBS Technology Center, is high enough to preclude problems with any modern amplifier, and impedance remains unusually consistent over most of the speaker's range. The system's high efficiency allows for the use of very low-powered amplifiers, yet it handled both the continuous-tone and tone-burst tests without the least sign of distress. Distortion at both moderate (0 dBW of input) and loud (100 dB of output) levels is very well controlled—quite low, in fact, for a system of this complexity. At 100 dB, the harsh-sounding third harmonic averages less than ½% over much of the band and second harmonic is just a touch higher. With the 0-dBW input (for an output of approximately 85 dB), both second and third harmonic distortion average out to little more than ¼%. The 300-Hz pulses are excellently reproduced, and though the 3-kHz pulse trace shows some evidence of low-level reflections, the effect is not severe enough to warrant concern.

Frequency response was measured in CBS's anechoic chamber with the tone controls set at "0", their flat positions. All three curves are quite flat and unusually smooth. The adjustments—both of which are calibrated at nominal settings of +2, 0, -6, -12, -16, and "low"—do little to improve the sound, in our opinion, and are rather inconsistent in their behavior; if both are set to "low," the results are very poor indeed. But at the "flat" settings, we were pleased by the rich, warm tonal balance of the System B and struck by its deep stereo imaging. Sounds appear to emanate from around and in front of the speakers, rather than from inside the enclosure. As we varied our position in relation to the stereo pair, the image held up well. The dynamic range is equally satisfying and quite exciting; sharp percussive sounds emerge with clarity and strength. The bass is especially noteworthy; the muddy thumping sound of so many vented speakers is here well controlled for crisp articulation.

Considered as a product of a company that for five decades has been turning out speakers, particularly bass reflex systems, the System B represents both a continuation and culmination. It is the top of Jensen's current line and, to our ears, the best speaker the company has ever made. At the same time (and despite many changes in both personnel and location), it is recognizably a Jensen in its warmth and solidity of sound: a tradition brought up to date, if you will.

Circle 135 on Page 77



Jensen System B loudspeaker

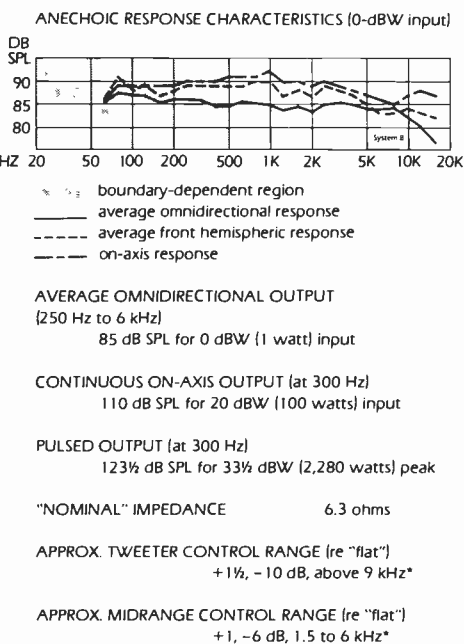

*see text

(more)

The tonearm that isn't.



The traditional tone arm has been replaced. By Linatrack. A revolutionary tracking system developed by Revox.

This sophisticated and highly refined electronic servo-system ensures that your records are played just the way they were cut, with perfect tangential tracking.

We've eliminated the causes of distortion inherent in conventional tone arm design. There's no need for an anti-skating device because there is no skating force. Our unique LED/photo diode array monitors the stylus angle and makes instant corrections to keep the tip absolutely perpendicular.

Pivot friction has also been dramatically reduced by our unique single-point jewelled pivot/magnetic support and suspension system.

With Linatrack, tracking error is reduced to a phenomenal 0.5° or less, virtually eliminating distortion and protecting your records from excessive wear.

The high torque direct drive motor of the Revox B790 uses Hall-Effect magnetic sensors tied to a quartz crystal to constantly read and instantly correct rotational speed. This eliminates the moment-to-moment deviations

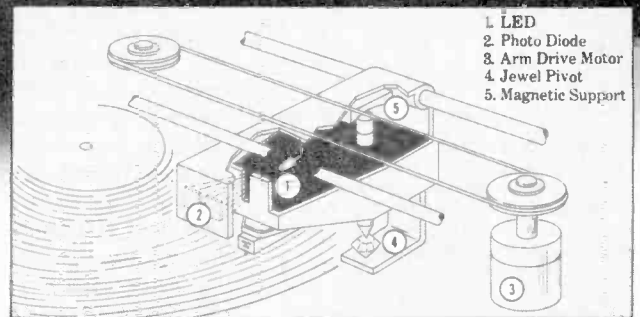

found on even the most expensive conventional direct drive motors. You can verify speed accuracy with the fast responding LED digital readouts. The readouts also provide an accurate log of manual speed adjustments.

Even with its advanced features, the Revox B790 is a pleasure to operate with safe and convenient automation. It works with virtually every cartridge and is ruggedly built to stand up to years of daily operation.

For more good reasons to play your records without a tone arm, experience the B790 at your Revox dealer.

STUDER REVOX America, Inc.
1819 Broadway, Nashville, TN. 37203 (615) 329-9576
Offices: Los Angeles (213) 780-4234 / New York (212) 255-4462
In Canada: Studer Revox Canada, Ltd.

REVOX

A Supertuner for a Medium Price

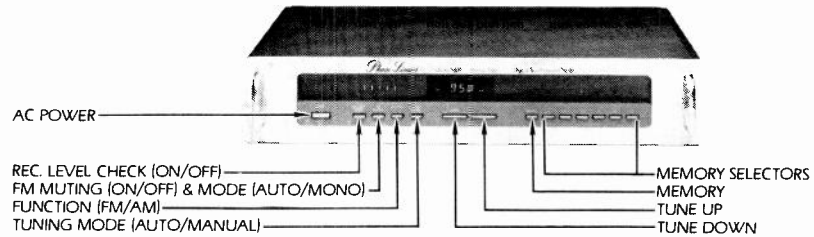

Phase Linear Model 5100 Series II tuner

MONO FM FREQUENCY RESPONSE

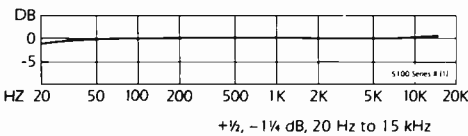

STEREO FM FREQUENCY RESPONSE

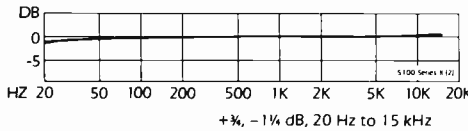

CHANNEL SEPARATION

≥ 45 dB, 60 Hz to 9.5 kHz
 > 40 dB, 20 Hz to 15 kHz

FM SENSITIVITY & QUIETING

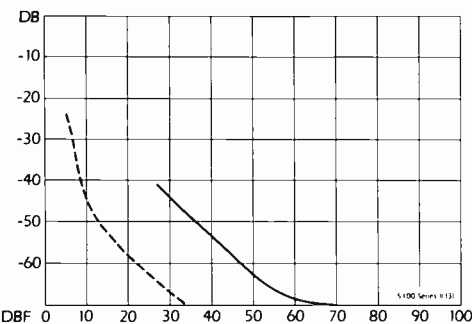

—	stereo noise (quieting)
- - - -	mono noise (quieting)
Stereo sensitivity (for 50-dB noise suppression)	
	36 dBf at 98 MHz, with 0.34% THD+N
	(37¼ dBf at 90 MHz; 36½ dBf at 106 MHz)
Mono sensitivity (for 50-dB noise suppression)	
	12¾ dBf at 98 MHz
Muting threshold	27 dBf
Stereo threshold	27 dBf
Stereo S/N ratio (at 65 dBf)	69¾ dB
Mono S/N ratio (at 65 dBf)	74¾ dB
CAPTURE RATIO	1 dB
ALTERNATE-CHANNEL SELECTIVITY	48½ dB

Phase Linear Model 5100 Series II stereo FM/AM tuner, in metal case. Dimensions: 19 by 3½ inches (front panel), 12 inches deep plus clearance for "handles" and connections. Price: \$449.95; optional SPO (oak) or SPW (walnut) side panels, \$49.95. Warranty: "limited," three years parts and labor. Manufacturer: made in Japan for Phase Linear Corp., 20121 48th Ave. W., Lynnwood, Wash. 98036.

Precision is the *raison d'être* of digitally synthesized tuning. Although such designs made an appearance some years ago, early models had the golden touch: They were more suited to Midas' pocketbook than Everyman's. With the advent of large-scale integrated circuits, this tuning precision has become available to somewhat less affluent audiophiles. One tuner that has taken advantage of these economies is Phase Linear's 5100 Series II, which leapfrogs its forebears by affording digitally synthesized AM as well as FM and a more convenient means of providing station presets.

In the 5100, the allowable FM reception frequencies lie at 100-kHz intervals. Since current U.S. practice requires FM stations to be precisely 200 kHz apart, all possibilities are covered. In the AM band, stations are 10 kHz apart, and the tuner aligns in like manner. There is discussion within the FCC of crowding more AM stations onto the band by tightening the spacing to 9 kHz; should this happen, the 5100 will accommodate the change via a back-panel switch. (Another back-panel switch chooses between standard 75-microsecond FM de-emphasis and the 25-microsecond standard for Dolby broadcasts.) The FCC also has discussed tightening the FM spacing to 150 kHz. This change (which HF strongly opposes, and which seems less likely to come about at this writing) could not be accommodated by this or most other digitally synthesized tuners on the market. So, while the synthesis approach implies virtually perfect tuning, it also entails some gamble that its discrete frequencies will remain those of the broadcast channels.

The 5100 will scan the band automatically, stopping at each relatively strong station—above 40 dBf or so. To get it to move on, you merely press one of the tuning switches (UP or DOWN). At the end of the band, the scan direction reverses automatically. If you put the tuning-mode switch in MANUAL and touch one of these tuning switches, the tuner shifts one increment (100 kHz) for each touch; if you hold the switch down, it steps increment by increment in the appropriate direction. The received frequency appears on the digital readout, which, being unambiguous, requires no channel-center indicator. A five-light signal-strength indicator replaces the traditional meter and covers a range from 19 dBf (first light) to 59 dBf (the threshold of the fifth). Six favorite stations (in both AM and FM) can be preset with a technique that seems to us simpler, more logical, and more foolproof than average for such a feature: You tune the station, press MEMORY, and (within three seconds) press one of the six station-selector buttons. Only during the three-second period can an old memorization be destroyed or replaced; even a power failure will leave the presets intact. And, as with a conventional tuner or receiver, the 5100 comes on at the frequency to which it was tuned when it was switched off.

Diversified Science Laboratories' data show the 5100 to be among the most sensitive tuners to have ever crossed its bench: A mere 12¾ dBf of input in mono or 36 dBf in stereo produces 50 dB of noise suppression at midband, and the sensitivity is reasonably uniform throughout the band. The muting and stereo thresholds are identical, typical of tuners that combine the muting and mono in one switch, as this one does. (The mute is defeated in mono and always active in the auto stereo/mono mode.) A reasonable amount of hysteresis has been built into the threshold to minimize annoying switchovers during fading, and the threshold is

Scott puts out.



Scott's unique gold warranty card.

SCOTT
Warranty Identification Card

Warranty Number: 42631
Model: PRO-100B Speakers (2)
Serial Number: 77650 3/777B24
Expiration Date: September 1994

Individualize with your warranty, model and serial numbers, and expiration date. Scott's fully transferable, five-year parts and labor-limited warranty is your assurance of lasting pleasure.

A Scott exclusive. By carefully controlling the variation of impedance over the entire listening range, Scott speakers give you maximum amplifier power output and minimum speaker distortion.



Because Scott puts more in.

Deeper, richer lows. Crisper, clearer highs. And an accuracy across the entire tonal spectrum that's second to none. That's what you get with Scott Controlled Impedance speakers.

No matter what your listening preference, Scott speakers will make your whole sound system sound better.

At Scott, there's no such thing as an "off-the-shelf" component. Unlike many other makers, Scott custom designs and acoustically tailors every speaker component to give you accurate frequency response, high efficiency, and extra power handling capacity. After all, the sound you get out depends on what we put in.

But listen for yourself. And you'll hear just how much Scott speakers really put out.

For more information on Scott speakers, or on our entire audio line, see your nearest Scott dealer or write H.H. Scott, Inc., Corporate Headquarters, 20 Commerce Way, Dept. 1S, Woburn, Massachusetts 01801. In Canada: Paco Electronics, Ltd., Quebec, Canada.

SCOTT
The Name to listen to.
Makers of high quality high fidelity equipment since 1947.

HARMONIC DISTORTION (THD+N)		
	stereo	mono
at 100 Hz	0.22%	0.19%
at 1 kHz	0.097%	0.13%
at 6 kHz	0.13%	0.27%
STEREO PILOT INTERMODULATION 0.13%		
IM DISTORTION (mono) 0.061%		
AM SUPPRESSION 60%dB		
PILOT (19 kHz) SUPPRESSION 80 dB		
SUBCARRIER (38 kHz) SUPPRESSION 83 dB		

relatively high—equivalent to about 65 dB of quieting in mono, 42 dB in stereo.

The ultimate signal-to-noise ratios are very good in both modes, as are the figures for distortion (especially in stereo), pilot cancellation, AM suppression, and capture ratio (suggesting good ability to handle multipath-contaminated signals). Frequency response is exceptionally uniform, even beyond the 15-kHz maximum of broadcast audio, and the stereo separation is essentially total. A REC LEVEL CHECK replaces the audio with a 370-Hz tone that corresponds to approximately 55% modulation, close to the 50% Dolby-calibration level.

There is one weak point among the superlatives. Especially in view of the 5100's exceptional sensitivity, which tempts us to receive distant weak stations at frequencies close to those of strong local ones, the alternate-channel selectivity seems less than optimum. Under such conditions, the stronger (alternate-channel) station can break through when it is modulated heavily. Of less importance is the fact that the 5100's auto-scan mode occasionally will stop at the sidebands 100 kHz above or below a very strong station. (One tap on the appropriate tuning switch sets the matter right.) And we consider the panel markings very difficult to read.

But this Phase Linear is a pleasure to use. It is extraordinarily sensitive and produces wonderfully clean sound on the majority of stations, perhaps because of its multipath-rejection ability. There's no need to worry about how well it is tuned: You can't make a mistake. The foolproof convenience of the presets extends to the AM band as well as the FM—an exceptional feature in a high-performance tuner. And (perhaps best of all in today's economy) it costs about half the price of the supertuners in which digital synthesis first claimed audiophiles' attention.

Circle 133 on Page 77

Pioneer's Top Deck

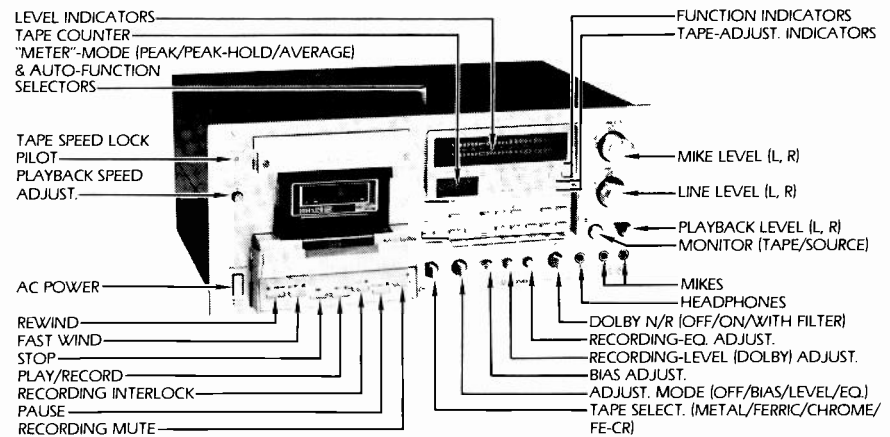

Pioneer CT-F1250 cassette deck

PLAYBACK RESPONSE (TDK test tape; -20 dB DIN)

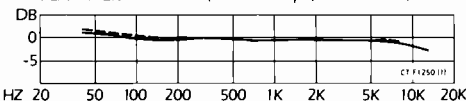

— L ch: +1, -3 1/4 dB, 40 Hz to 12.5 kHz
 - - - R ch: +1 1/2, -3 dB, 40 Hz to 12.5 kHz

RECORD/PLAY RESPONSE, "CHROME" TAPE (-20 dB)

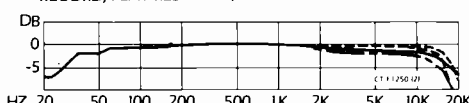

— L ch: +0, -3 dB, 32 Hz to 14 kHz
 - - - R ch: +0, -3 dB, 32 Hz to 16 kHz
 With Dolby noise reduction
 — L ch: +0, -3 dB, 32 Hz to 10.5 kHz
 - - - R ch: +1/4, -3 dB, 32 Hz to 14 kHz

Pioneer Model CT-F1250 cassette deck, in metal case.

Dimensions: 16½ by 7½ inches (front), 13½ inches deep plus clearance for transport superstructure and connections. Price: \$695. Warranty: "limited," one year parts and labor. Manufacturer: Pioneer Electronic Corp., Japan; U.S. distributor: U.S. Pioneer Electronics Corp., 85 Oxford Dr., Moonachie, N.J. 07074.

Though metal-particle tape is still in short supply, the same cannot be said of metal-ready decks. Many manufacturers have rushed to market with decks capable of handling the metal formulation, yet close examination reveals that only a minimum amount of alteration separates these decks from their nonmetal progenitors. Not so the CT-F1250, Pioneer's top-of-the-line model. So much new engineering has gone into it that, aside from a filial resemblance to the CT-F1000 (the company's previous top deck), it must be considered as a separate limb on the family tree.

The two-in-one head (with separate gaps for recording and playback) has been retained, and the monitoring function this affords has been put to use in an extremely accurate bias, equalization, and Dolby-level tuning system. In this setup, three test tones derived from a built-in oscillator are recorded, and the tape output is continuously compared with preset reference levels. Whereas in some

ADC has four Sound Shaper[®] frequency equalizers that will improve your sound system. No matter how good it is. And at a cost that's lots less than trading in your components.

ADC Sound Shapers will improve your speakers. By extending the true bass response, including the critical mid bass.

ADC Sound Shapers will improve the relationship between your cartridge and speakers. From one of partial incompatibility to total compatibility.

They'll also eliminate rumble (low frequency overload), tape hiss and record scratches.

And that only scratches the surface of what ADC Sound Shapers can do. For instance, the walls, carpeting and furniture of your listening room physically bounce sound around so that some spots have less sound than other spots.

Lots less. ADC Sound Shapers will bring these "dead" spots to life.

Perhaps best of all, though, is a Sound Shaper's ability to let you re-equalize what a recording engineer mixed. If a horn section is overwhelming a piccolo, for example, you just slide the appropriate frequency lever. Presto, more piccolo. You can also vanquish a voice. Or boost a tuba.

Sound Shapers segment the entire spectrum of sound. To let you re-shape a sound track to your personal musical preferences. It's all the control you've ever dreamed of but never dreamed possible.

To get into equalizers, start with our Sound Shaper One which operates in five frequency ranges. Or our Sound Shaper One Ten which gives you greater control by operating in ten frequency ranges.

For more professional equalizers, there's our Sound Shaper

Two Mk II which functions in twelve frequency ranges with a two-channel LED meter. And there's our new Sound Shaper Three *Paraphrastic*[™] Equalizer.

It combines all the advantages of a graphic equalizer with all the advantages of a parametric equalizer. Twelve primary frequency controls per channel. Plus twenty-four ancillary control positions per channel. The Sound Shaper Three is the ultimate in controlling and creating with your stereo system.

Take the ultimate step up in sound, without trading in a thing.

ADC Professional Products, a division of BSR Consumer Products Group, Route 303, Blauvelt, NY 10913. Distributed in Canada by BSR (Canada) Ltd., Ontario. *Sound Shaper is a registered trademark of Audio Dynamics Corporation.

HOW TO TRADE UP YOUR RECEIVER, TUNER, AMP, TURNTABLE, CARTRIDGE AND SPEAKERS WITHOUT TRADING IN A THING.

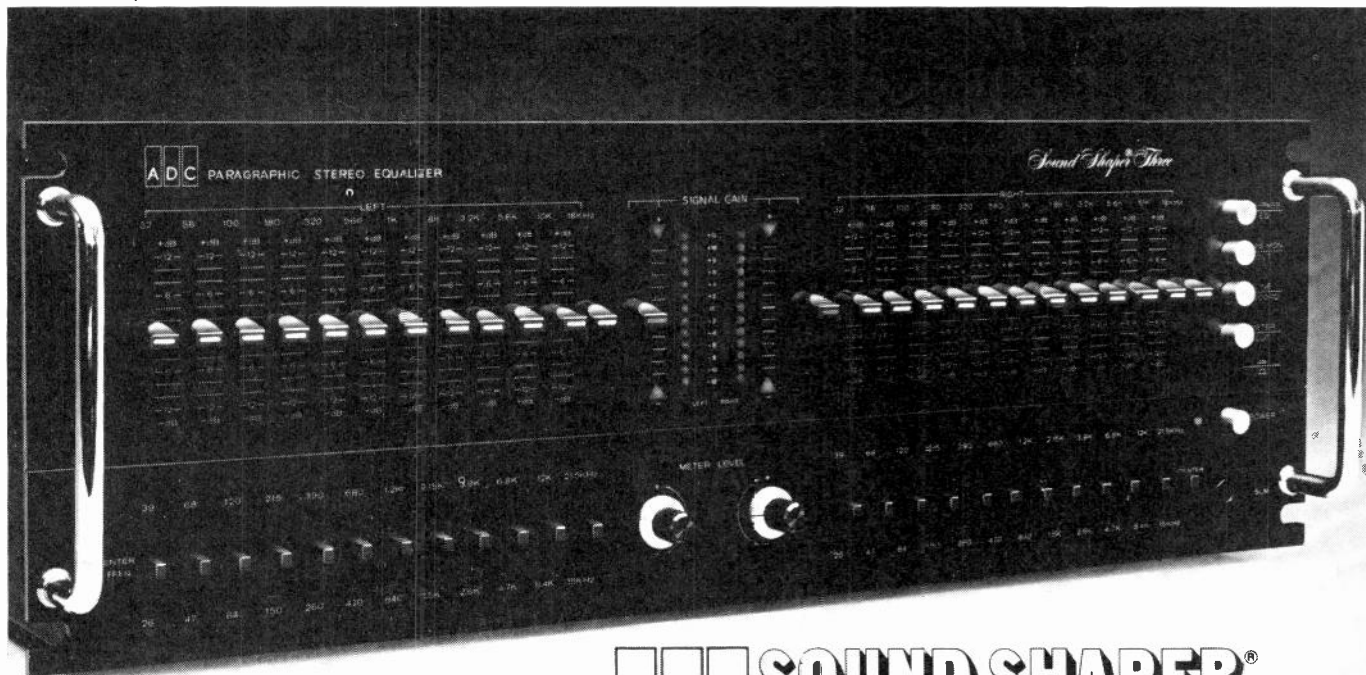

ADC **SOUND SHAPER[®]**
A BSR COMPANY **FREQUENCY EQUALIZERS**

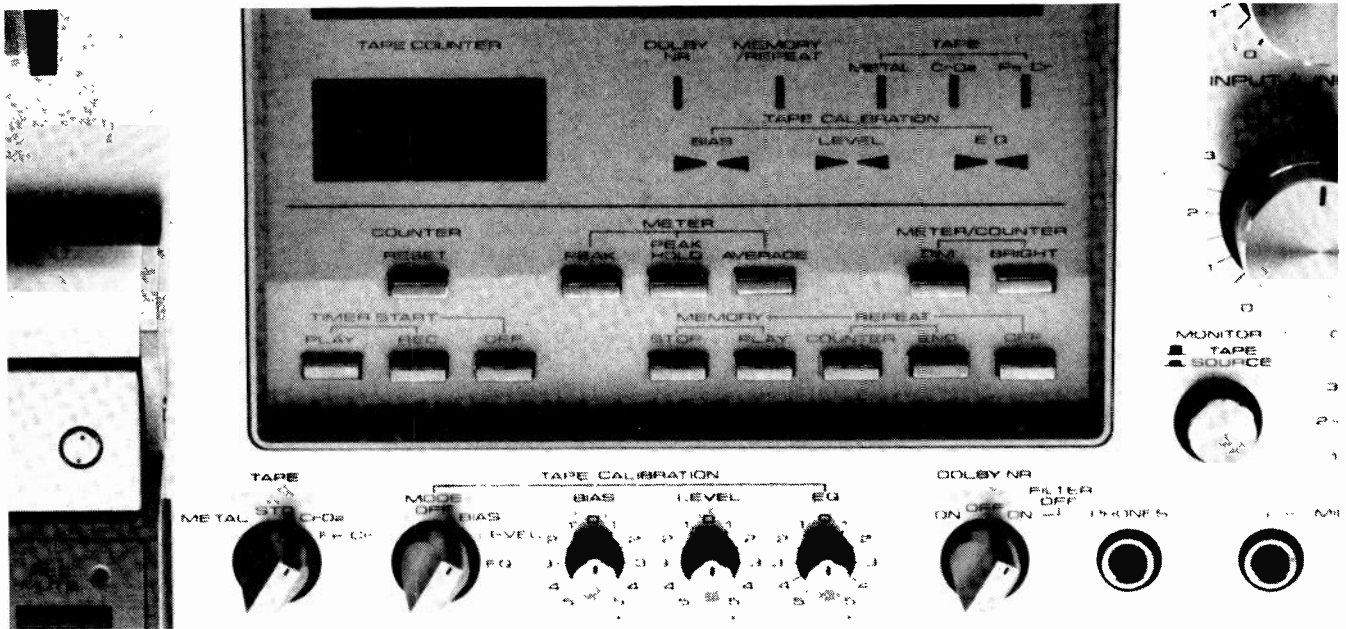

Tape calibration proceeds from left to right (with Dolby off) via TAPE selector and four calibration controls (MODE, BIAS, LEVEL, and EQ). Automatic end-of-tape rewind and playback is available via REPEAT/END or COUNTER REPEAT. Deck can also be programmed to rewind to a specific spot and either stop there or proceed to playback via MEMORY-STOP OR-PLAY.

RECORD/PLAY RESPONSE, METAL TAPE (-20 dB)

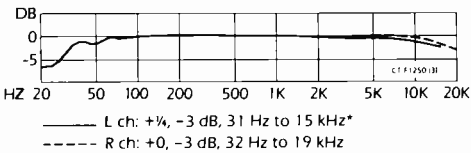

RECORD/PLAY RESPONSE, FERRIC TAPE (-20 dB)

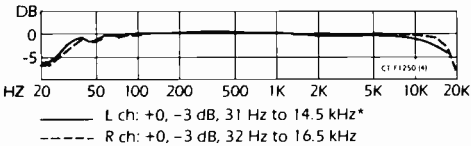

S/N RATIO (re DIN 0 dB; A-weighted)

	metal	ferric
playback (without noise reduction)	59% dB	57 dB
Dolby playback	67% dB	65% dB
record/play (without noise reduction)	56 dB	54 dB
Dolby record/play	64% dB	62% dB

METER READING FOR DIN 0 dB +5 dB

METER READING FOR 3% DISTRIBUTION (at 333 Hz)

"chrome" tape	> +8 dB
metal tape	+5 dB
ferric tape	+5 dB

other decks the whole procedure is automated via microprocessor circuitry, here the user must determine optimum levels by rotating the fine-tuning knobs in sequence until two LEDs (representing high and low values) for each parameter light simultaneously. The tuning procedure is logical and progresses quite quickly. Tests at Diversified Science Laboratories attest to its accuracy: to within 1/2 dB of preset levels for each setting. Considering how narrow these control "windows" are, users should not be disconcerted by a later double-check, in which failure to confirm the settings can be due to inconsequential tape inconsistencies.

The 1250's recording flexibility is hard to top. Mike/line mixing is permitted by the level controls, each of which has separate channel balance elements. A recording mute on the solenoid-controlled transport panel can be used (either in connection with PAUSE or alone) to kill radio announcements without the telltale click that PAUSE causes. It also introduces a perceptible hiatus even when MUTE is not used, preventing seamless "splices" during copying. Dolby noise reduction ("double Dolby" here, to allow for the monitoring function) can be switched in with or without the multiplex filter. Playback pitch control is retained from the 1000, but the recording speed (which cannot be varied) is quartz locked. Tests at DSL indicate pitch variation ranges from almost a whole tone sharp to more than a half tone flat of normal.

The twenty-four-segment Fluroscan "bar-graph" display has three modes—peak, peak-hold, and average—and is calibrated over a wide and useful range of from -35 to +8 dB with 1-dB divisions throughout the important region above -10 dB. In bench tests, the peak metering proves extremely fast, showing no overshoot and responding to pulses of just 0.1 millisecond (100 microseconds), whereas the intentionally damped AVERAGE mode requires pulses of at least 65 milliseconds to come within 3 dB of the mark. In the PEAK mode, the bright blue display shows the peak value for approximately 2 1/2 seconds; in PEAK HOLD, the lab stopped counting at 20 minutes. If ambient conditions necessitate it, the meter's illumination can be dimmed.

As with the 1000, Pioneer does not recommend specific tapes by brand in the owner's manual. In theory, the 1250 can be optimized for any tape you choose to throw at it, making this brand information relatively unimportant unless you want to use the detented "normal" positions on the adjustment knobs. For that use, Pioneer pointed us in the direction of Sony HF as the standard ferric, TDK SA as the chrome equivalent, and TDK MA-R as a metal-particle tape. Pioneer does

Same looks. More guts.

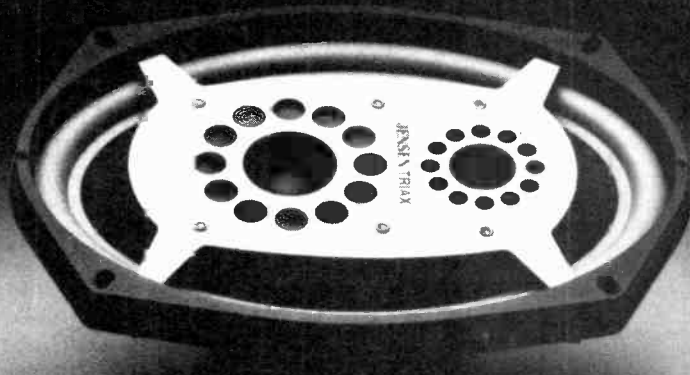
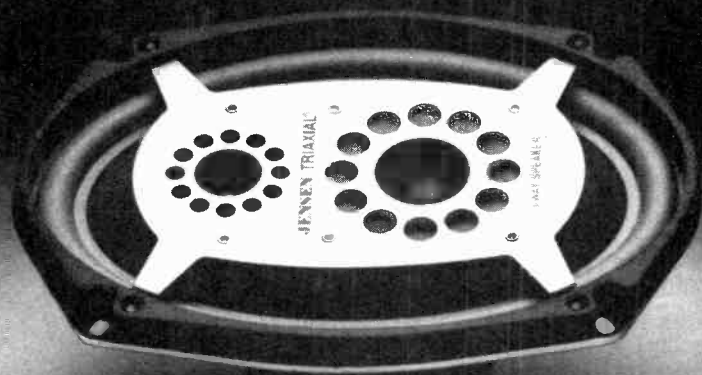

The speaker on the left is the best selling, most popular car stereo speaker ever. The Jensen Triaxial® 3-way speaker system.

The speaker on the right is the one that's replacing it. The new Jensen Series I Triax®. The one with even higher efficiency. More power. More guts.

Sure, they look alike. But the similarity ends there.

Higher power handling.

Believe it. The new 6" x 9" Series I Triax is rated at 50 watts continuous average power, compared to 30 watts for the old Triaxial. Which means it'll take more power—more heat—and more abuse from high power car stereo units, without sacrificing musical accuracy at the expense of high volume levels.

Why can it take more power? Because of its new, larger oven-cured one inch voice coil. It offers 66% greater power handling for superior durability. And because the special piezoelectric solid state tweeter is virtually indestructible, yet sensitive to every musical nuance.

The efficiency expert.

Like all of the new Jensen Series I speakers, the Triax is more efficient than ever, thanks to our special high compliance cones with Flexair® rim suspension, 4 Ohm impedance and new, more efficient motor structures. Which translates to very high efficiency that lets

More improvements.

The Series I Triax features an improved, 20-ounce ceramic magnet structure for deep, well-defined bass. Also a new, rugged gasket for a tight acoustic seal. Black zinc chromate plating insures corrosion resistance.

We also designed it to be easier to install than the old Triaxial with the stud-mounted grille.

Some things don't change.

There are some things we just couldn't improve. Like the idea of an individual woofer, tweeter and midrange balanced for accurate sound reproduction.

We also haven't changed our commitment to quality. And to back it up, we steadfastly support our full line of Jensen Series I speakers with an excellent one year limited warranty.

"But they still look the same..."

You say you still can't see any difference between the old Triaxial on the left and the new Series I Triaxial on the right. Maybe not. But you sure will be able to *hear* the difference. And after all, that's the guts of the matter.

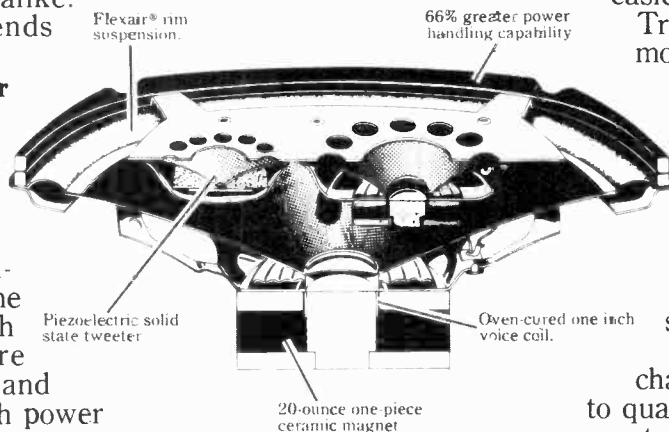

Jensen Series I speakers play louder with less power for smoother, distortion-free music in your car.

JENSEN

The thrill of being there.

4136 N. United Parkway
Schiller Park, Illinois 60176

"Triaxial" and "Triax" are the registered trademarks identifying the patented 3-way speaker systems of Jensen Sound Laboratories. (U.S. Patent No. 4,122,315)

DISTORTION (third harmonic; at -10 dB DIN)

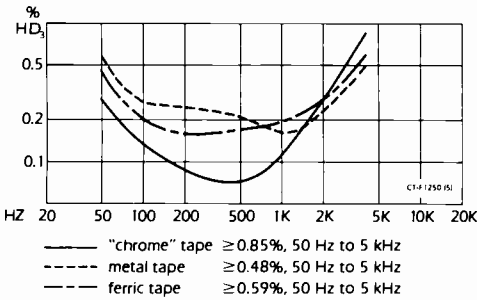

— "chrome" tape $\geq 0.85\%$, 50 Hz to 5 kHz
 - - - metal tape $\geq 0.48\%$, 50 Hz to 5 kHz
 - · - ferric tape $\geq 0.59\%$, 50 Hz to 5 kHz

ERASURE (333 Hz; re DIN 0 dB)

"chrome" tape 74 dB
 metal tape 70 dB

CHANNEL SEPARATION (at 333 Hz) 45 dB

SPEED ACCURACY 0.45% fast at 105, 120,
 & 127 VAC

SPEED ADJUSTMENT RANGE +10.1, -8.2%

WOW & FLUTTER (ANSI/IEEE weighted peak)

	average	maximum
playback	$\pm 0.07\%$	$\pm 0.09\%$
record/play	$\pm 0.09\%$	$\pm 0.12\%$

SENSITIVITY (re DIN 0 dB; 333 Hz)

line input 98 mV
 mike input 0.36 mV

MIKE INPUT OVERLOAD (clipping) 48 mV

OUTPUT (from DIN 0 dB)

playback level at normal (detent) 630 mV
 playback level at maximum 850 mV

*see text

encourage use of the adjustments (so do we), and the lab tuned for each tape before making its measurements, though it did use the suggested formulations.

Response proved excellent over much of the frequency range for each tape, yet the deck did not get as much from the TDK metal-particle tape as other decks we have tested with the Scotch metal tape. Midrange headroom with MA-R is approximately equal to that offered by the Sony ferric, and SA comes out better than both. As expected, MA-R is capable of considerably more headroom than SA, yet at lower frequencies it proves slightly less forgiving than SA. You'll note in the graphs of frequency response that we have cut off left-channel response near 15 kHz for the HF and MA-R tapes. The "missing" portions of the curves actually turn upward again in the lab data—not because response is miraculously restored at higher frequencies, but because of high-level intermodulation "birdies" that disappear as soon as the multiplex filter is switched in. While we could find no aural evidence of these products in the recordings we made without the filter, its use to prevent them might be desirable when there are lots of ultrahighs in the signal you are recording. The distortion curves generally are good, though (again) they don't show the advantage of metal tape that we're used to seeing. Channel output is fairly well balanced. Noise and flutter are very well controlled. The quartz-locked speed, which is unaffected by line voltage, runs a little fast but not seriously so.

Working with the deck, we found the switch markings more helpful than the cumbersome explanations in the owner's manual in sorting out the complexities of the microprocessor counter and memory controls. The OUTPUT level control might better have been called PLAYBACK since it does not alter the source-monitor level. It does influence playback metering, however. A detent at the center position matches playback levels and metering to those of the source input; there is no means of adjusting source feed level to that of the receiver. This quirk aside, we generally admire the control system, which impresses us as well organized for so complex a design. We also give high marks to the tape adjustment system, which delivered sonically admirable results with every tape we tried, and to the metering system. The convenience features (timer operation, auto repeat, and so on) work well and, in a sense, epitomize the 1250 as a sophisticated, multifaceted design addressed unequivocally to the home user who enjoys "bothering" with the complexities that today's technology makes possible.

Circle 138 on Page 77

Dual Redesigns A "Classic"

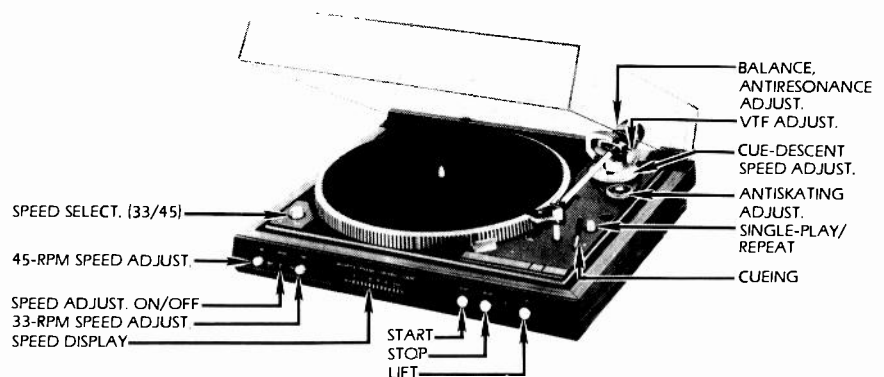

Dual CS-731Q automatic single-play, direct-drive turntable, with integral base and dust cover. Dimensions: 16½ by 14½ inches; 5 inches high with cover closed, 10 inches additional height and 1 inch at back required to open cover. Price: \$559; with optional Ortofon ULM-60E pickup, \$699.95. Warranty: "limited," two years parts and labor; ninety days for cartridge body. Manufacturer: Dual, West Germany; U.S. distributor: United Audio, 120 S. Columbus Ave., Mount Vernon, N.Y. 10553.

The CS-731Q is the latest incarnation of what has come to be a classic Dual: the Model 701 (HF test reports, March and September 1974), its first nonchanger in this country and the first to incorporate a mechanical antiresonance filter in the counterweight assembly. The 731's fully automatic, single-play

If you don't have at least \$1,000 to spend on an Audiovox Hi-Comp autosound system, read no further.

By Robert Harris, Technical Director

There are few things in this world that can take a driver out of the traffic jam or away from a gas line, better than great music, well reproduced.

Audiovox understands this. That's why they engineered the Hi-Comp range of high fidelity stereo components designed to produce exemplary sound in automobiles.

A total range of exotic amplifiers/receivers.

Each model builds on the one before it until you reach the HCM-0010 – the "master system."

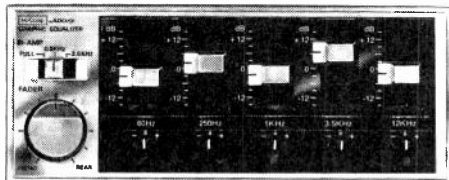

HCE-750 HiComp Semi-parametric graphic equalizer

It's an electronically-tuned AM/FM multiplex receiver with a built-in auto-reverse cassette deck. The HCM-0010 has 12-station memory, LED display,

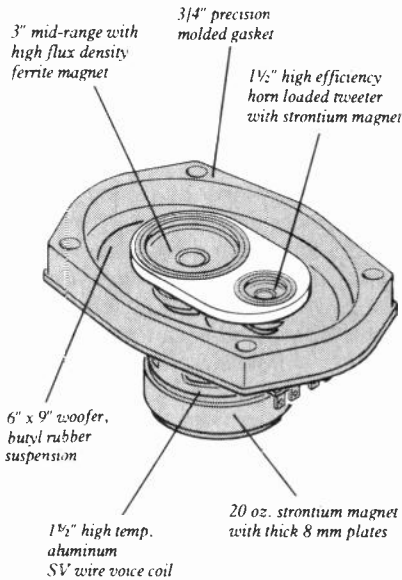

HCS-362 HiComp 6" x 9" 3-way speaker system.

built-in quartz clock and an automatic station seek. It also features a CrO₂ switch, Dolby[®], FM muting, 4-way stereo balance controls, separate bass and treble controls and a Hard Permalloy tape head. Its looks are straight out of a stereo buff's music room.

4 power-matched speaker systems.

The ultimate is the Hi-Comp 362 system: 6" x 9" three way speakers with 1 1/2" Strontium horn tweeters, 3" mid-ranges, 20-ounce Strontium magnet woofers, 1 1/2" heat proof aluminum voice coils, and a 70 to 18,000 Hz response range with crossovers at 2,900 and 9,000 Hz, and a power capacity of 70 watts. Hook these up to the HCM-0010 with the Hi-Comp power amplifier, HCB-830, 120 watts RMS at less than 0.3% distortion, and you've got enough sound to pop a moon roof.

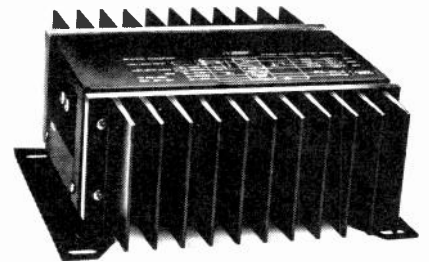

HCB-830 HiComp 120 watt 4-channel power amplifier

Now for the equalizer.

Apart from a heavy-duty fader control or a dual slide-bar pre-amp, the only other Audiovox Hi-Comp component you might buy is the HCE-750 semi-parametric graphic equalizer with 5 slide-bar response controls and bi-amp capability.

You spend \$1,000 and what do you get?

Probably the finest sound you've heard, *anywhere*. It takes money to get it. But it also takes a lot of specialized dedication. Audiovox only knows how to do just one thing: How to engineer the finest automobile sound systems you've ever heard.

For further information, write to: Robert Harris, Technical Director, Dept. HF, Audiovox, 150 Marcus Blvd. Hauppauge, New York 11787.

Dolby[®] is a registered trademark of Dolby Laboratories, Inc.

© 1979 Audiovox Corporation

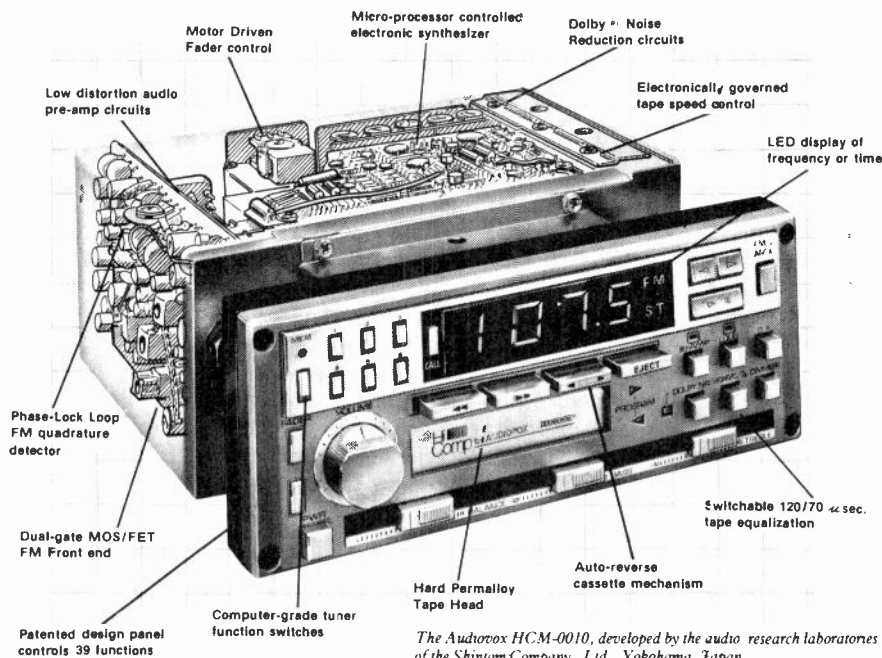

The Audiovox HCM-0010, developed by the audio research laboratories of the Shintom Company, Ltd., Yokohama, Japan.

Dual CS-731Q turntable

SPEED ACCURACY (at 33 or 45 rpm)	
no measurable error at 105, 120, or 127 VAC	
SPEED ADJUSTMENT RANGE	
at 33	-6.6 to +6.0%
at 45	-6.8 to +5.9%
WOW & FLUTTER (ANSI/IEEE weighted peak)	
± 0.04% average; ± 0.07% max. instantaneous	
TOTAL AUDIBLE RUMBLE (ARLL)	-63 dB
TONEARM RESONANCE & DAMPING (set at 8.5; see text)	
with Shure V-15 Type III pickup	
vertical	8.4 Hz; 2-dB rise
lateral	5.2 Hz; 4-dB rise
with Ortofon ULM-60E pickup	
vertical	9.3 Hz; 5¼-dB rise
lateral	8.3 Hz; 6½-dB rise
ARM FRICTION	negligible
MIN. STYLUS FORCE FOR AUTO TRIP	210 mg
TOTAL LEAD CAPACITANCE	208.5 pF

mechanism is virtually foolproof, and the ULM (ultralow mass) tonearm in conjunction with a specially designed Ortofon low-mass pickup is a study in careful, synergistic engineering. Each of the nine turntables, including the changers, in the Dual line incorporates the ULM tonearm and can be ordered with a ULM pickup (2.5 grams). When so mated, the total effective mass of the arm and cartridge is a featherweight 8 grams.

To effect such a dramatic lowering of mass, Dual re-engineered its familiar straight tubular arm, shaving down its diameter, reducing the size and mass of the offset headshell (or, more properly, clip-in mounting platform), and lightening the counterweight. Balancing the arm with cartridges weighing up to 4 grams should be no problem; extra weights are provided for heavier pickups. The company retained the gimbal-suspension principle, but in a strikingly attractive redesign. And it refined the resonance damping of the counterweight so that you can adjust antiresonance behavior to the pickup in use. The "gauge" is marked in increments from 5.5 to 10; you set the filter index after consulting a graph in the owner's manual, showing correct values according to the weight and compliance of a pickup, where known. Data for several popular pickups are included, and such figures for most other cartridges are available from their manufacturers.

Power is provided by a direct-drive motor whose speed is monitored and corrected via a quartz-crystal phase-locked loop circuit. A knurled knob at the left of the platter selects either 33 or 45 rpm, and the speed adjustments (actually for deliberate misadjustments) can be defeated by a switch between the two verniers. There are two speed indicators; strobe markings cast into the platter allow for constant monitoring, and departures from dead-on speed read out on an illuminated front-panel display as positive or negative percentages vs. the quartz reference—up to 5½% fast or slow.

The automatic mechanism seems as jam-proof as any we've encountered. A knob to the right of the platter can be set for single play or for constant replay. The cueing lever on the top deck is duplicated by the LIFT button on the front panel. Both cueing speed and tonearm cueing height are easily adjustable—the latter at a screw next to the platter, behind the "headshell" in our picture. For automatic play, a touch of the START button is enough to set things in gear; for semiautomatic operation, moving the tonearm away from its rest automatically starts the platter rotation, while pressing STOP or returning the arm to its rest will stop the play cycle.

Data from CBS Technology Center show the CS-731Q to be deserving of its flagship status in the Dual line. All its measurements put it firmly in the excellent category. Accuracy for both rotation speeds remains exact and unvarying at each of our line voltages. Speed adjustment range, even greater than the 11% claimed by Dual, allows for a full half-tone pitch change in either direction from normal. Both average and instantaneous flutter values are impressively low, and total audible rumble is in line with that of other top-quality turntables. No measurable error could be found in the settings for vertical tracking force, which is calibrated to 2 grams with 0.1-gram resolution. Antiskating bias, dialed in on a triple scale (for spherical, elliptical, and CD-4 styli), is applied quite linearly and falls within theoretically desirable values. The force needed to trip tonearm return at the leadout groove is well below the normal vertical tracking force range.

The lab measurements for tonearm resonance, including the effectiveness of the tunable antiresonance filter, encompassed both the values obtained with our "standard" Shure V-15 Type III pickup and those for the premounted Ortofon ULM-60E. With the Ortofon pickup and the filter set at its locked (presumably inoperative) position, tonearm resonance falls just a hair short of the "ideal" 10 Hz. Setting the filter to the cartridge's recommended 7.8 index point results in a small (about ¼ dB) diminution of the vertical resonance amplitude plus a 1-dB improvement in the lateral plane—not a very dramatic effect, but since the resonance already occurs in the preferred frequency range, there's no cause for complaint. The more massive Shure's resonance falls, predictably, a little closer to the area where warp information might be transmitted to the amplifier: above 8 Hz in the important vertical plane, but around 5 Hz horizontally. Strangely enough, the lab found that the excellent (2-dB) amplitude of the vertical resonance actually increased to 4¼ dB when the filter was moved from the locked position to the Shure's recommended index point (7.0). The best results with both pickups were

Correction

On page 26 of our November issue the Dimension 5 by Sonic Research is incorrectly described as a moving-coil pickup. It is, in fact, a moving-iron/fixed-coil design.

Why Yamaha speakers sound better than all the others. Even before you hear them.

To make a speaker that produces accurate sound is not simple. It requires painstaking attention to detail, precise craftsmanship, and advanced technology.

And that's where Yamaha comes in. We build all our speakers with the utmost precision in every detail.

As the premier examples of Yamaha loudspeaker craftsmanship, read what goes into the two speakers shown, the NS-690II and the NS-1000M. Then you'll understand why Yamaha loudspeakers sound better. Even before you hear them.

Precision Yamaha crafted cabinetry – (1) The walls on these, and all Yamaha speaker cabinets, are sturdily braced and crossbraced at every possible stress point. (2) The corner seam craftsmanship is so fine that it looks like the cabinet is made from one continuous piece of wood.

The back panels on these speakers are flush-mounted for maximum air volume within the cabinet. (3) Inside, a 3/4" felt lining "decouples" the cabinet from the drivers to achieve acoustic isolation of the woofer from the cabinet. (4) Thick glass-wool also aids in damping the woofer for maximum performance.

Lift one of these Yamaha speakers. It's uncommonly heavy and sturdy. (5) We even glue and screw the woofer cutout from the baffle to the inside rear panel for greater cabinet rigidity.

Now knock on the cabinet. It will sound as solid and substantial as it is.

Precision Yamaha Drivers – (6) The drivers are mounted on computer-cut baffle boards with exacting, critical tolerances to insure precision fit. All Yamaha speakers are acoustic suspension design, and this precise fit is critical for an airtight seal and optimum woofer recovery.

The drivers on these, and all Yamaha speakers, are flush-mounted on the baffle board to avoid unwanted diffraction of the sound waves. (7) This is especially important because all our tweeters and mid-high range drivers are the maximum-

dispersion dome type for the most natural reproduction of voice and instruments.

(8) We use chrome-plated machine screws (rather than wood screws) with two washers (regular and lock) to insure an unyielding mounting.

(9) The speaker frames shown are die cast rather than stamped. That's so they won't twist and alter the voice coil alignment during assembly and use.

Other Precision extras – All terminals are quick connect, screw-mounted assemblies.

(10) The wire leads are carefully soldered, not clipped.

All our speakers use full LRC crossover networks. These crossover networks are among the most advanced available.

Precision that stands alone – There's more. Much more. But, there is another fact of Yamaha loudspeaker construction that simply stands alone in the industry. Each component used in the two Yamaha speakers shown is manufactured by Yamaha. From the hefty die-cast speaker frames to the unique, ultra-low mass beryllium dome diaphragm.

That's a statement no other manufacturer can make. And therein lies Yamaha's story. If we put this much care and craftsmanship into the making of our components and cabinet structures, then imagine the care, precision and craftsmanship that go into the quality of the final sound. A sound built upon Yamaha's unique 98-year heritage as the world's largest and most meticulous manufacturer of musical instruments. From our most economical loudspeaker to our top-of-the-line models shown here, Yamaha retains the same attention to detail and craftsmanship.

Look before you listen. You'll be convinced that Yamaha loudspeakers sound better than the rest. Even before you turn them on. Then ask for a personal demonstration of these and

other Yamaha loudspeakers at your Yamaha Audio Specialty Dealer, listed in the Yellow Pages. Or write us: Yamaha, Audio Div., P.O. Box 6600, Buena Park, CA 90622.



found with the filter moved to about 8.5 and are shown in the data; the filter affects the resonance amplitudes, not their frequencies.

In use, and navigating the worst warps we could find, the Dual/Ortofon combination proved very agile indeed, with nary a mistrack. Even when we investigated the ability of the suspension system to isolate the pickup from shocks to the base and the surface on which it stands—a test in which we judged the results no better than average—the pickup refused to leave the groove. So, while the lab measurements on the antiresonance filter fail to document much advantage in what strikes us as an excellent idea, the actual behavior of the arm with its “matched” cartridge is exemplary. So is that of the automatic cueing and repeat features, which we consider a joy to use.

Circle 17 on Page 77

The Spatial Preamp: How Special?

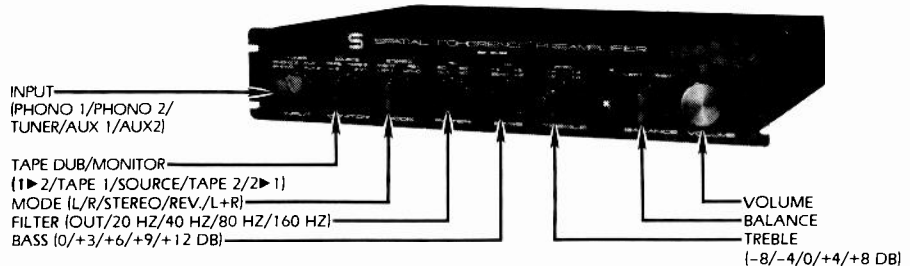

Spatial TVA-1 preamplifier

OUTPUT AT CLIPPING	9.3 volts
HARMONIC DISTORTION (THD; 20 Hz to 20 kHz)	
aux input	≤0.039%
phono input	≤0.043%
FREQUENCY RESPONSE	
+0, -¼ dB, < 10 Hz to 16.7 kHz;	
-½ dB at 40 kHz; -3 dB at 130 kHz	
RIAA EQUALIZATION	+0, -½ dB, 20 Hz to 20 kHz
INPUT CHARACTERISTICS (IHF loading; A-weighting)	
Sensitivity	S/N ratio
aux input	60 mV 87% dB
phono input	0.65 mV 78 dB
PHONO OVERLOAD (1-kHz clipping)	130 mV
PHONO IMPEDANCE	49k ohms (complex)
LOW FILTERS	-3 dB at 19, 40, 80, 180 Hz;
	all 6 dB per octave

Spatial Coherence Preamplifier Model TVA-1, in rack-mountable metal case. Dimensions: 19 by 3½ inches (front panel), 12¼ inches deep plus clearance for controls and connections. AC convenience outlets: two unswitched (100 watts max. total). Price: \$1,395. Warranty: "limited," three years parts and labor. Manufacturer: Spatial, Inc., 3633 Long Beach Blvd., Long Beach, Calif. 90807.

This report must perforce begin with some definitions. The term “spatial coherence” refers to the unique signal integrity, delivering both ultraclear stereo and ultraclean signals, that the company claims for its initial product. To achieve this, Spatial has replaced the usual bipolar transistors, field effect transistors, or tubes—all of which it considers inherently nonlinear—with what it terms Translinear Field Effect Transconductance-Valves. The importance of this move is said to lie in what Spatial calls “noise intermodulation”: noise-correlated distortion products that tend to smear discrete signal components in both frequency and time—and hence, via phase relationships, in space.

As we suggested (“News and Views,” August 1978) on our first encounter with Spatial and its preamp, all this can easily inspire skepticism, particularly when you consider that this is the only company we know of to have discovered noise intermodulation as a fidelity deterrent and that it freely admits the difficulty or even impossibility of isolating the distortion products in either the listening room or the lab because noise intermodulation is so intimately linked to the signal elements that cause it. Adding to the skepticism are some other caveats. 1) The special properties of the preamp do not emerge immediately when it is turned on but, according to the company, require that it be left on for at least one day and preferably one week so that all circuit elements can settle down to their ultimate symbiosis. (Note that there is no on/off switch and therefore no switching for convenience AC outlets.) 2) The listener, too, requires time to glean the full advantages of TFET-Valve circuitry since a major by-product of noise intermodulation is said to be listener fatigue, whose presence or absence cannot be ascertained in short-term listening.

We realized before we opened the carton that this would not be an easy product to test. When we set up the TVA-1, we noticed some maverick elements in the controls. The treble is calibrated from -8 to +8 dB, an unusually restricted range. And, as it turned out on the bench at Diversified Science Laboratories, the actual boost or cut is less than the calibration implies, depending on the knob setting, and refers to a center frequency of about 3.5 kHz with some effect extending down as far as 200 Hz—an atypical characteristic indeed. The more we worked with it, however, the more we liked it. It gently raises or lowers the

JBL'S NEW L150: ITS BOTTOM PUTS IT ON TOP.

JBL's new L150 takes you deeper into the low frequencies of music without taking you deeper into your budget.

This short-tower, floor-standing loudspeaker system produces bass with depth, power and transparency that comes incredibly close to a live performance.



A completely new 12" driver was created for the L150. It has an innovative magnetic assembly the result of years of research at JBL. It

uses a stiff, heavy cone that's been coated with an exclusive damping formulation for optimum mass and density.

And it has an unusually large 3" voice coil, which aids the L150's efficiency and its ability to respond to transients



(peaks, climaxes and sudden spurts) in music.

There's even more to the L150's bottom—a 12" passive radiator. It looks like a driver but it's not. We use it to replace a large volume of air and contribute to the production of true, deep bass. Bass without boom.

If you're impressed with the L150's lows, you'll be equally impressed with its highs and mids. Its powerful 1" high-frequency

dome radiator provides wide dispersion throughout its range. And a 5" midrange transducer handles high volume levels without distorting. The maximum power recommended is 300 watts per channel.

The L150's other attributes include typical JBL accuracy—the kind that recording professionals rely on. Maximum power/flat frequency response. High efficiency. And extraordinary time/phase accuracy.

Before you believe that you can't afford a floor system, listen to an L150. While its bottom is tops, its price isn't.

James B. Lansing Sound, Inc., 8500 Balboa Boulevard, Northridge, CA 91329.

**FIRST
WITH THE
PROS.**



AD-6700

AD-L40

AD-6900MK II

Put metal tape where it will do the most good.

Again AIWA leads the way toward the ultimate in cassette technology—with three of the most sophisticated metal-capacity decks you can buy: the AIWA AD-6900MK II, AD-6700 and AD-L40.

Performance is simply unparalleled.

At -20 dB recording, AIWA's state-of-the-art AD-6900MK II boasts a frequency response of 20~20,000 Hz with metal tape. Even at 0 dB, frequency response is an exceptionally broad 25~12,500 Hz ± 3 dB.

This superb performance is maximized by AIWA's extremely durable Ferrite Combination V-Cut (CVC) play-back/record head. With the best possible gap widths of 5 microns for recording and 1 micron for playback.

The AD-6900MK II's unique 3-head design not only lets you compare source with tape during recording—it also permits the most precise bias adjustment available today for FeCr, CrO₂ and all other LH/Normal tapes: AIWA's exclusive FLAT RESPONSE TUNING SYSTEM.

And only AIWA's AD-6900MK II and AD-6700 offer advanced feather-touch logic controls including Cue & Review—plus exclusive full-function wireless remote con-

trol from across the room. Both decks also feature AIWA's exclusive Double Needle Meters for simultaneous monitoring of Peak and VU.

AIWA's newest AD-6700 and AD-L40 are just as sophisticated.

The AD-6700 offers 2-head design, convenient Auto/Repeat with Memory Switch, full-function wireless remote control and an amazingly accurate 9-point LED peak power display in three dramatic colors.

AIWA's ultra-modern AD-L40 offers the only 20-point LED horizontal peak power bar graph you can buy—for instant three-color warning of distortion.

All three decks were designed with a special Ferrite double-gap erase head and high-power erase circuitry.

So if you're ready for metal tape, put it where it will do the most good. Inside AIWA's incredibly advanced AD-6900MK II, AD-6700 or AD-L40.



Upgrade to **AIWA**[®]

Distributed in the U.S. by AIWA AMERICA INC.
35 Oxford Drive, Moonachie, New Jersey 07074
Distributed in Canada by: SHRIRO (CANADA) LTD.

entire brightness range, so to speak, with little exaggeration or dulling of tinkly or hissy sounds at the extreme high end, and thus is uncommonly effective in addressing overall bass/treble balance. It is relatively ineffective in correcting serious shortcomings that would be better left to a specialized equalizer in any event; it is, for example, utterly useless as a hiss filter.

The bass controls are even more unusual. The main control has boost positions only, calibrated (with fair accuracy) in terms of 20-Hz response, above which frequency the curves slope off gently toward near-flat response above 1 kHz, for considerable overlap with the treble control. The bass-cut function actually is supplied by the independent FILTER, which delivers gentle slopes at all its settings and varies only the turnover frequency; the position markings very accurately reflect the frequency at which each curve is 3 dB down. Since the filter's effect does not extend as high as that of the bass-boost control, both can be used simultaneously to increase midbass response while leaving the deep bass relatively untouched or even cutting it back. And when their many possible combinations are added to the treble options, the tone-control ensemble proves extraordinarily subtle and flexible, though it does require practice to make the most of its potential.

At first, we were unimpressed by the tape control because monitoring and dubbing are combined on a single knob and monitoring options therefore are removed while you are dubbing. Since all the monitoring decks we can think of have a SOURCE/TAPE switch and all the nonmonitoring ones automatically feed the source straight through during recording, an appropriate signal can be monitored via the preamp (which "listens to" the deck on which the copy is being made) with any dubbing scheme we could devise. (Of course, you can't listen to another source while the dubbing is in progress, but we would expect serious audiophiles to monitor most of their dubs carefully anyway.)

DSL's measurements show the TVA-1 to be a fine performer in all conventional respects: Response is very flat, distortion and noise very low. The turn-on transients, however, last more than the few seconds normally allowed by the muting in most amps' protective circuitry. Since the preamp is designed for always-on use (an unusual, though not unique idea), the only material result of this finding would seem to be that, should you suffer a power failure while you're listening, it would be a good idea to shut off your amp until the power is restored and the preamp has had a few minutes to settle down again. Though Spatial insists on at least twenty-four hours' warmup, you can use the unit before that without ill effect and, probably, without being able to hear that it hasn't attained its top form.

We must say "probably" because our efforts to document the presence or absence of the special sonic quality claimed for the preamp proved essentially futile. In A/B comparisons with a preamp of conventional circuitry and almost as good conventional measurements, we simply could not distinguish between the high-level circuitry of the two. The phono stages would not have made an adequate comparison because the Spatial does not present a classic load to the pickup, and capacitance therefore could not be "equalized" to make the cartridge behave the same with both. And, of course, different pickups might well produce different results for the same reason, invalidating the test even if the two preamps could be made to sound the same under a given set of conditions.

We can say that, in every use to which we have put it, the TVA-1 sounds very fine, indeed. In long-term listening, we continued to enjoy it and admired the stereo imaging we were able to achieve with it. The TFET-Valve circuitry may well offer, however subtly, a higher order of listening pleasure and realism, but we could not document it. We suspect that audiophiles will be arguing over this subject—and product—for some time to come.

Circle 139 on Page 77

JVC Updates the Ribbon Tweeter

JVC Zero-5 loudspeaker system in wood-veneer cabinet. Dimensions: 14½ by 26 inches (front), 13½ inches deep. Price: \$400. Warranty: "limited," five years parts and labor. Manufacturer: Victor Co., Japan; U.S. distributor: JVC America, Inc. 58-75 Queens Midtown Expressway, Maspeth, N.Y. 11378.

A body at rest is a formidable obstacle: The heavier it is (the greater its mass), the greater the force needed to overcome its inertia. For that reason, the fight



JVC Zero-5 loudspeaker

ANECHOIC RESPONSE CHARACTERISTICS (0-dBW input)

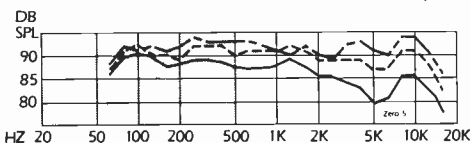

- boundary-dependent region
- average omnidirectional response
- - - average front hemispheric response
- · · on-axis response

AVERAGE OMNIDIRECTIONAL OUTPUT
(250 Hz to 6 kHz)
86½ dB SPL for 0 dBW (1 watt) input

CONTINUOUS ON-AXIS OUTPUT (at 300 Hz)
113 SPL for 20 dBW (100 watts) input

PULSED OUTPUT (at 300 Hz)
126¼ dB SPL for 33¼ dBW (2,120 watts) peak

"NOMINAL" IMPEDANCE 5.3 ohms

APPROX. TWEETER CONTROL RANGE (re "flat")
-6 dB above 8 kHz

APPROX. MIDRANGE CONTROL RANGE (re "flat")
-6 dB, 800 Hz to 5.5 kHz

to trim moving mass in loudspeaker drivers (as well as other physical transducers) has preoccupied audio designers for decades. Part of the appeal of ribbon tweeters has been their inherently low mass, and JVC's contribution is a refinement of that theme.

The classical ribbon tweeter is simply a thin conductor suspended in a strong magnetic field, demanding a transformer to keep the effective tweeter impedance high enough to load audio amplifiers properly. JVC came up with a hybrid in which an 8-ohm "voice coil" is photo-etched on the low-mass (48-milligram) diaphragm, raising the impedance and eliminating the matching transformer. Samarium cobalt magnets generate the required magnetic field. An aluminum horn/phase-equalizer helps improve the directivity of the resulting vibrations. JVC claims improved transient response characteristics, output up to 50 kHz, and high power-handling capability due to effective heat dissipation.

The Zero-5 is a three-way bass-reflex loudspeaker, with a 12-inch woofer and a 4-inch metal-dome midrange driver. Its construction mirrors the care lavished on speaker systems by Japanese manufacturers: A die-cast aluminum frame surrounds the woofer, a perforated aluminum cap protects the midrange driver, and the finish of the enclosure is truly luxurious. Screw posts on the back of the speaker connect it to the amplifier, and continuous-acting level controls for the midrange and tweeter are mounted on the baffle board.

In the tests at CBS Technology Center, the Zero-5 comes off very well in most important respects. The impedance curve, though a little quirky, is relatively well controlled, with the "nominal" rating of 5.3 ohms quite close to JVC's 6-ohm figure. Efficiency is fairly high, even for a vented system, but the speaker still took the full 20 dBW (100 watts) in the continuous-tone test with nary a sign of strain and didn't exceed distortion limits in the pulse test until peak input power had reached more than 33 dBW (2 kilowatts) and the sound pressure level was an ear-threatening 126¼ dB. The distortion measurements are, in fact, extremely low. In the moderate-power test (at 0 dBW, or 1 watt), both the second and the third harmonic remained below 1%—generally well below it—from at least 60 Hz up. At the higher level (100 dB SPL), the second harmonic increased somewhat but still without exceeding 1% over the same range, while the increase in the third harmonic was minuscule. Few loudspeakers we have measured have done as well.

The scope photos of the pulse tests, however, suggest some possible areas of complaint. At 300 Hz, the woofer is notably sluggish in responding to the head end of the pulse, with a slight overhang at the trailing end. At 3 kHz there is evidence of multiple, though very low-level reflections. The response data, too, present curiosities. The midrange and tweeter controls respond with unusual accuracy (vis-à-vis their marked calibration points from 0 to -6 dB with respect to "flat") and consistency, which bespeaks careful crossover design; but a response hole at the upper (5-kHz) crossover in the third-octave measurements shown in the graph disappears in swept-tone measurements, while another in the midrange (between 2 and 3 kHz) that appears with sweeps disappears in the third-octave tests. Since there often are significant differences between these measurements, we didn't pay much attention to them until we had conducted our listening tests, in which midrange coloration—a certain roughness and even honkiness, with a pinched sound on brasses and strings—was our panel's least laudatory but most consistent finding. We also found that stereo imaging was below average in stability and openness. This mediocre imaging, the measurement anomalies, and the perceived midrange roughness are related, we believe. Of less importance, in our opinion, is the response at both frequency extremes, where rolloff can be noted both in the graph and in the listening.

Among the most attractive properties our listeners perceived were unusually clean bass and treble (the respective rolloffs notwithstanding) and the excellent power-handling characteristics, and thus dynamic range, that the lab tests document. They also commented on a certain forwardness to the sound, which can be attractive in pop music particularly. But the Zero-5, attractive as it is in some respects, does not realize the full potential of the ribbon tweeter. Though we cannot confirm that the tweeter is capable of uncommonly flat response extending into the ultrasonic region, we liked what we heard from it and consider the midrange driver—or the integration of midrange with treble—to be the system's limiting factor. We expect good results from ribbon designs to come.

Circle 134 on Page 77

AKAI'S EXCLUSIVE SUPER GX HEADS.

**Improves specs for all types of tape—
including metal.**

In 1969, AKAI introduced one of the most important technological advances in tape recording history — the exclusive Glass and Crystal Ferrite GX Head. The head guaranteed* for over 150,000 hours — the equivalent of over 17 years of continuous, superb play.

But now AKAI makes a great thing even better with two new Super GX Heads. The revolutionary heads designed to improve frequency response by 2,000 Hz, improve S/N ratio 4-6 dB, improve the dynamic range on all tapes and deliver optimum performance with metal tape.

The Super GX Twin Field Head gives you the record/play performance of a three-head deck at two-head prices. With two gaps mounted in a single configuration — an optimum wide gap for recording and an optimum narrow gap for playback — AKAI has eliminated the need for a compromise gap found in traditional record/playback heads.

More impressive is the new Super GX Combo Head, which is actually a separate record and playback head mounted in a single housing. Combined with an erase head, this configuration gives you a three-head deck, with all the same advantages as the Super GX Twin Field Head, plus tape monitoring capabilities.

Both new Super GX Heads offer AKAI's 150,000 hour guarantee, and the kind of state-of-the-art specs you've come to expect from AKAI.

AKAI Super GX Heads. Making a great thing even better.

For more information, write: AKAI, P.O. Box 6010, Compton, CA 90224; in Canada: AKAI AUDIO VIDEO CANADA, Vancouver B.C., Canada.

*limited warranty

AKAI

You never heard it so good.

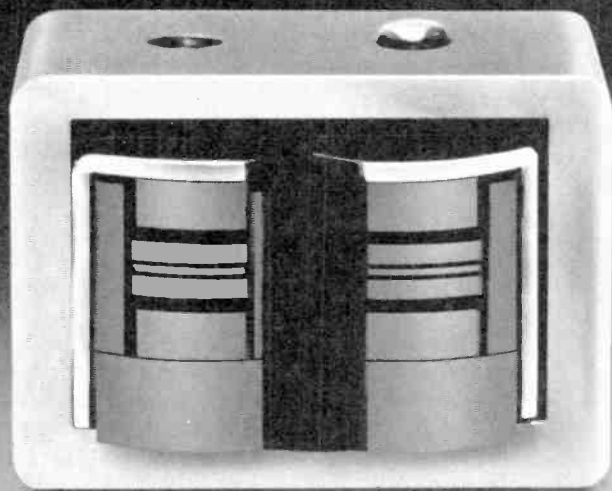

**SUPER
GX**

Interface: C

Series II It sounds like music.

Interface: C Series II is the fulfillment of our six-year association with optimally vented speakers based on the theories of A.N. Thiele—speaker designs first introduced by Electro-Voice in 1973. The Interface: C offers you a unique combination of high efficiency and high power capacity—the only way to accurately reproduce the 120+ dB peak sound pressure levels found in some types of live music.

The SuperDome™ tweeter, an E-V exclusive, and the VMR™ vented midrange driver, the first to apply optimally vented design to mid frequencies, ensure your music is reproduced without the coloration normally found in other high-efficiency drivers. An honest 30 Hz low end totally eliminates the need for expensive subwoofer assemblies.

When you spend \$1,000 for a speaker system, get your money's worth. Audition the Interface: C Series II at your nearest Interface dealer. If you want a speaker that sounds like music, the Interface: C Series II is the one you'll buy.



Electro-Voice®
a gulton company

600 Cecil Street, Buchanan, Michigan 49107

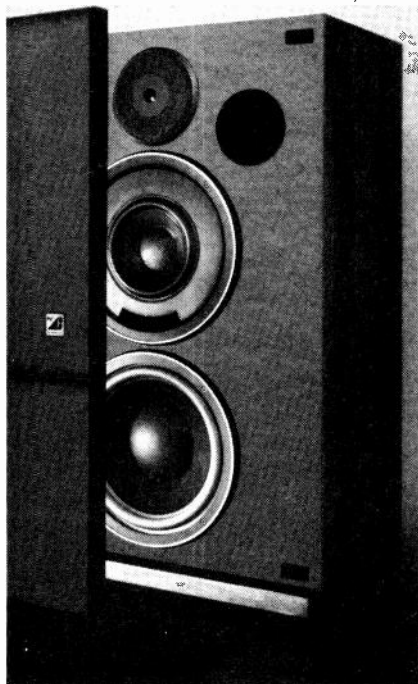

Circle 13 on Page 77

Letters

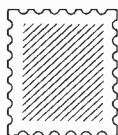

Imported Talent

Joseph Horowitz' article about pianist Bella Davidovich [October 1979] appears to be just an indirect way of writing about Soviet artistic circles and being negative. One might ask why Melodiya issues works by composers whom it is allegedly a crime to perform in the U.S.S.R.

There is no doubt that many musical artists leave Russia for genuine artistic reasons. However, it is also possible that many simply emigrate for the money, a certainly nonartistic motive (presuming they aren't starving); the musical standards in Russia are very high.

Perhaps HF's bias against the U.S.S.R. is political; perhaps it is just a matter of jealousy. A comparison of the musical education systems in the U.S. and the U.S.S.R. and the number of talented individuals produced by each would be very enlightening. That the U.S. imports most of its talent is well known.

Arthur Walling
Hamilton, Ont.

If most of the musical talent in the U.S.—at least of international superstars—is imported, the reason would appear to have little to do with the quality of music education here. Not only most of our imported talent, but a large percentage of the major musicians throughout the world (at least those under sixty years of age) came here for a critical portion of their education. If Mr. Walling is referring to the solid musicians whose names are not household words but who make up our orchestras and other performing groups, the vast majority are both U.S.-born and U.S.-trained—Ed.

Another Composers' Haven

Allan Kozinn's article on Composers Recordings, Inc. [September], brought deserved recognition for the significant accomplishments of this pioneering organization. However, I must point out that CRI has not been the *only* recording alternative to the major labels that has been available to composers. For more than fifteen years, Owl Recording, Inc., has released records of new music, albeit on a much smaller scale, and has fully funded several of them.

We continue to welcome scores and tapes from composers and performers—anyone with a potential recording of "high artistic, educational, or historical value."

Like CRI, Owl finds that the financial picture must be examined at the outset.

One final note: The grant of tax-exempt status to CRI in 1977 followed the precedent established in 1976, when Owl became the first record company in the U.S. to acquire such status.

Thomas Steenland
Program Coordinator
Owl Recording, Inc.
P.O. Box 4536
Boulder, Colo. 80306

DBX for Pop

I welcome the information in Leonard Marcus' editorial [September] that DBX promises to release encoded pop recordings. I own a DBX Model 122 and have found the advantages of increased headroom for tape recording and increased dynamic range in both tapes and discs to be tremendous.

Jimmy Gene Vandegriff
Randolph Air Force Base, Tex.

Labor of Love

I agree with some of David Hamilton's criticism of the new Fritz Reiner discography compiled by Arthur J. Helmbrecht Jr. ["Conductors' Discographies," September]. However, as a member of the Fritz Reiner Society and as one who was in on this "labor of love" from the start, I must take exception to the fact that Mr. Hamilton chose only to criticize. It should be said that, even though this discography might be "incomplete" and "infuriating" because of its manner of organization, its author deserves words of praise for his effort. After all, this is the most complete listing thus far and should serve to lighten enormously the workload of the next person who chooses to undertake this monumental task.

Mohammed Zanjani
Ardsley, N.Y.

Another View of *Má Vlast*

I have to comment on reader Larry Garrison's concern ["Letters," October] over R. D. Darrell's omission of Karel Ančerl's recording of *Má Vlast* in his discussion of the reissue of Václav Talich's performance. Having heard both Talich on the original Parliament recording and Ančerl on the old Crossroads, I must say that the latter is not in the same league. Ančerl has the Czech idiom in hand, but his performance does not flow or breathe. For the quickest comparison, listen to the two versions of Sárka.

John P. Dahlquist
Oakland, Calif.

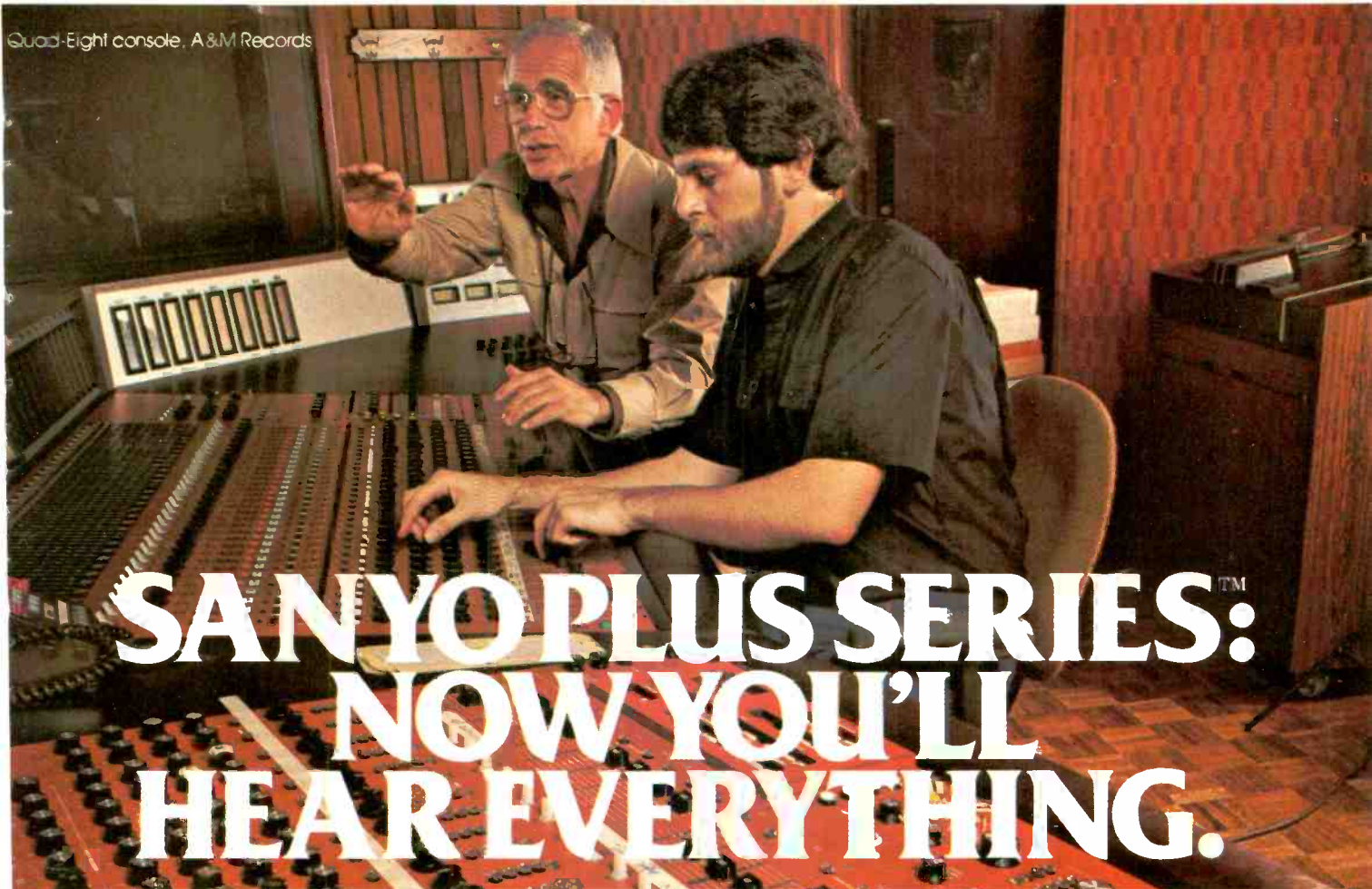

SANYO PLUS SERIES:™ NOW YOU'LL HEAR EVERYTHING.

Today's studio technology is putting sounds on record that most home stereos simply can't cope with.

So instead of hearing everything the way it went down at the recording session, you miss the subtle nuances that make the music come to life.

The refined technology of Sanyo PLUS SERIES components lets you hear every

detail captured in your recordings — without perceptible noise, distortion, or coloration to spoil the sensation of living, breathing music.

Hear the gloriously true-to-life sound of Sanyo soon at better audio dealers.



78s



\$10



\$50



\$20



\$10



\$25

LPs



\$25



\$100



\$25

Are Your Old Records Worth \$\$\$?

How to find out and what to do about it if they are.

Part I: Classical Records

by Michael Biel

Opposite page, top row: Stokowski speaks! Since the single-sided "outline of themes with piano" is often missing from sets of Stokowski's early electrical recording of Beethoven's Symphony No. 7 on Victrola, collectors are constantly looking for it. Columbia's five-disc acoustical set of Felix Weingartner conducting the Brahms First Symphony was short-lived—and thus is rare—because it was issued just before the electrical era and priced high for the mid-1920s: \$8.75 for the set.

Middle row: Ravel's two-disc recording of his *Bolero* on Brunswick, dating from the early 1930s, is not as valuable as the original European Polydor pressings. Cellist Pablo Casals' Columbia record of Bach's *Air for G String* came out of the 1915 recording session documented in the log card displayed on page 64 of last month's issue. On the V-Disc, Mischa speaks! V-Discs were recordings sent to armed forces bases during World War II. The rare ones that turn up in top condition command premium prices, especially when, as in the Mischa Elman disc shown here, they are not dubs of commercial recordings.

Bottom row: Don Gabor's budget label, Remington, produced many now sought-after items like this Albert Spalding recording. The two Camden reissues from 78s are each now worth considerably more than the originals, although none of the artists is named. "The Heart of the Opera," a six-LP set, first appeared on the mail-order World's Greatest Operas label in 1940. Among the anonymous artists are singers Eleanor Steber, Leonard Warren, Norman Cordon, and Vivian Della Chiesa and conductors William Steinberg and Wilfred Pelletier. The poorly dubbed *Nutcracker Suite/Carnival of the Animals* has value because the "Warwick Symphony Orchestra" was the Philadelphia Orchestra led by Stokowski.

The leading attribute of classical music is supposed to be its staying power. It does not become dated, as pop music does. Furthermore, the major characteristic of the phonograph is its ability to preserve sounds permanently. Yet, many owners of classical recordings periodically find it necessary to discard their collections and replace them with new ones. Why? Certainly not because of the subtle changes in performing styles. Rather, the main reason has been revolutions in technology, as when electrical recording began in the mid-1920s, when high fidelity microgrooves replaced electrical shellac 78s in the 1940s, and ten years later when the stereo disc was introduced. Today's noise reduction, direct-to-disc recording, digital taping have thus far been only means back to our familiar stereo LP format. But with the totally incompatible digital disc looming on the horizon, once again it is time to ponder that agonizing question: To save or not to save?

Reviewer Robert C. Marsh shocked many collectors when he asserted in these pages in July 1973: "I am inclined to regard any recording more than five years old as obsolete technically. This doesn't mean that it is not to be played or admired, but it ceases to be competitive with contemporary work. The listener should be told you are talking about the sonic counterpart of a 1968 car." Marsh assumes that all record companies were at the same plateaus in both 1968 and 1973 and that all 1973 recordings were automatically sonically superior to all those from 1968. At the other extreme, some listeners still are inclined toward the Mercury Living Presence

single-microphone discs made a quarter-century ago, and some very rare collectors (mostly British) still prefer *acoustical* recording and reproduction.

Whatever the reason, some of you music lovers are looking for a remunerative way of disposing of your old classical recordings—and perhaps there are collectors frantically seeking just the ones you have. The hard part is finding the person who wants what you have and determining its worth. First, let's divide the collection into four categories: orchestral; solo instrumental, chamber music, and concertos; solo vocal and operatic arias; and complete operas.

The acoustical recording system responded less well to orchestras and the female voice than it did to solo instruments, small instrumental groups, and the male voice. The most famous name from this period is Enrico Caruso, but his discs sold so well—and have been treasured and saved by so many—that few of them are scarce. So those Caruso records you found in your grandmother's attic are probably *not* valuable (unless they are Zonophones with pale blue labels, center-start Pathés, AICC cylinders, or Gramophone and Typewriter labels). The prize acoustical recordings are those that date from before 1910. Scarcity is a large factor here, but the historical importance of early or only recordings by certain artists is not to be overlooked. Almost any pre-1906 disc in mint condition by a name artist is likely to bring in \$10–\$15, and, if you have any of the old Columbias featuring basso Edouard de Reszke, you might get \$375 or more. For discs in only average condition, divide prices in half.

When electrical recording made reproduction of orchestral music more feasible, there was a great effort to build a recorded orchestral repertoire. Some of the early examples are sought after because they are rare, but most of the 78-

Michael Biel, who has conducted research and archival projects in the fields of early recording and radio, is assistant professor in radio-television at Morehead (Kentucky) State University.

rpm sets of standard fare are very common. Besides, collectors of early recordings place great stock in the *individuality* of performances. Orchestral recordings rank very low in this area because the conductor, the predominant force, has to route his interpretation through a hundred other musicians. One recording of a particular symphony is pretty much like the others. Though there can be significant differences in interpretation, you are sure to find one you like from any decade since the microphone, and since the sonic experience is a major ingredient in the enjoyment of orchestral music, this genre is the most likely to suffer from a technically inadequate recording. Thus, there is little call for old orchestral recordings, especially those made before 1950, unless they are interpretively or historically important. Remember, then as now, plenty of duds were recorded.

Complete operas are not much in demand either, despite the individuality of any vocal performance. Again, a conductor guides the proceedings, and, while a lead might be sung by a vocalist of note, the rest of the cast probably is not first-rate. During the era of the 4½-minute 78-rpm side, opera sets often comprised twenty discs, and when an opera is interrupted thirty-nine times, you start to wish that Colline would smother the coughing hag with his overcoat or root for the high priests to hurry up and seal the tomb on Aida and Radames. For these and other reasons, recordings of whole operas were not numerous before the LP, and the notable ones have generally been reissued on LP. Most opera lovers were content to purchase their favorite arias sung by their favorite artists.

Solo instrumental and concerto recordings are in as much demand as solo vocal discs—the skills and interpretive values of the performer are as personal as a fingerprint. Sparked by the interest engendered by the International Piano Archives, there is a worldwide search being undertaken by many collectors for all types of piano recordings. Practically no pianist is overlooked no matter how obscure. Violin discs are a little more abundant, and as yet there is no demand for representation by every

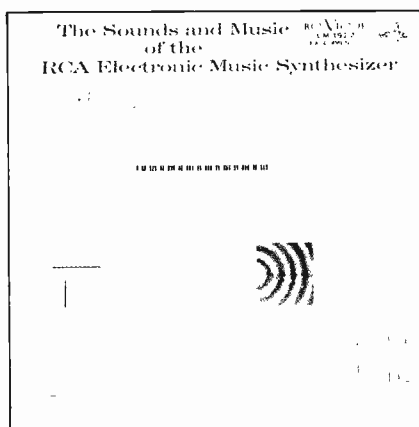

\$75

The 1955 issue on RCA Victor LM 1922 of "The Sounds and Music of the RCA Electronic Music Synthesizer" may not have been a big hit at the time, but collectors now treasure it as the world's first recording featuring a music synthesizer. Composers featured range from Bach to Irving Berlin; the liner notes had to start on the front cover in order to fit.

fiddle player. Sarasate, early Kreisler, and Spalding, yes; Heifetz, later Kreisler, and Zimbalist, generally no. (A complete set of the handful of recordings made by Pablo Sarasate was recently announced at \$2,000.) Pablo Casals' discs are fairly plentiful and not too expensive, but those by other cellists are becoming costly. Other instruments have not attracted such cult attention, so prices have not been driven up. But their scarcity at least preserves their value. This is especially true for most pre-LP chamber music recordings.

Most dealers agree that it is almost impossible to sell many of the 78 orchestral sets, particularly from the 1940s. Conductors like Serge Koussevitzky and Leopold Stokowski who have an avid following sell very well; Arturo Toscanini recordings don't move very fast only because they are so common. A well-produced reissue can kill the value of the original recording, particularly if the original was itself an LP. Occasionally the reissue has *greater* worth than the

original. Some early Camden LPs of anonymous conductors leading such pseudonymous ensembles as the Warwick Symphony, the Centennial Symphony, the Festival Concert, and the Stratford Symphony Orchestras are fetching \$25 even though they are poorly dubbed, because the first is really the Philadelphia under Stokowski, the second the Boston under Koussevitzky, the third the Boston Pops under Arthur Fiedler, and the last the London Philharmonic Orchestra under Koussevitzky and others. And the interest in performers increases dramatically following their death, as happened with Fritz Reiner and George Szell and may be about to happen with Fiedler.

Early LPs can be valuable if the performance was exceptional and never issued in any other form. Sometimes the most unlikely candidates for immortality garner high prices. A record on the old budget label Plymouth (P 12 125) went for \$250 not long ago: Chopin waltzes played by Etelka Freund, a pupil of Brahms's and an intimate of Bartók's. Carl Friedberg's Brahms and Schumann piano works on Zodiac 1001 has sold for \$60, and premium prices may be had for early LPs by Mischa Elman, William Kapell, Albert Spalding (on Remington!), Marguerite Long, and Willem Mengelberg with the Berlin Philharmonic and Concertgebouw Orchestras. The first synthesizer recording, RCA Victor's 1955 "The Sounds and Music of the RCA Electronic Music Synthesizer," has changed hands for \$75.

In some cases the labels themselves are the attraction. There is one valiant collector who is determined to get every RCA Victor LM and LSC record ever released. The early LP period was rich in major labels that dedicated themselves to serious music and then deleted entire series containing hundreds of albums—Capitol, MGM, and Decca come to mind. For the same reason, old 10-inchers are usually sure bets to be collectible. The August 1956 issue of *Schwann* is ample evidence of how suddenly the small record was eliminated from the marketplace. On almost every page there's at least one black diamond for RCA's 10-inch records alone. It

should be remembered, however, that the demand for a mono LP diminishes if it has been reissued and is almost nil if it was released originally in *real* stereo as well as mono.

Up to now, we have studiously avoided mention of anything other than commercially released discs. Test pressings of unissued recordings or alternate takes can be valuable if the artist is significant. One Japanese collector recently paid \$500 for five Toscanini test pressings made by the Arturo Toscanini Society, which was banned from issuing the recordings. Air checks, bootleg concert recordings, instantaneous discs, and tapes are difficult to evaluate. In some instances, the Internal Revenue Service has fixed value of amateur home-recorded tapes and lacquer discs at the cost of the raw, unrecorded item. There is no intrinsic value of a first-generation air check when dubs can be made virtually indistinguishable from the original. Market value can be placed on an item only when it or an identical edition changes hands.

The condition of the discs is vital. Excessive surface noise and scratches will blot out pianissimos, and the first evidence of wear is a fuzzy fortissimo. Most collectors are not looking for an original issue just for the thrill of being the proud possessor of the "first edition." They are looking for the best-sounding pressing. Sometimes the first pressing is the best-sounding, but if postwar shellac will yield less surface noise than the "regrind" garbage used during the war, then the later pressing will be more desirable. Generally, discs of serious music have been treated with greater care and played on better equipment than those containing other kinds of music. And many companies used a better grade of shellac or vinyl for such pressings and exercised stricter quality control. But certain grades of shellac are more prone than others to develop crackle from damp storage conditions. English HMV shellacs are notorious for this problem, although they were highly prized when they were new. Owners of shellac discs are urged to read John Stratton's devastating article "Crackle" in the July 1970 issue of *Recorded Sound*,

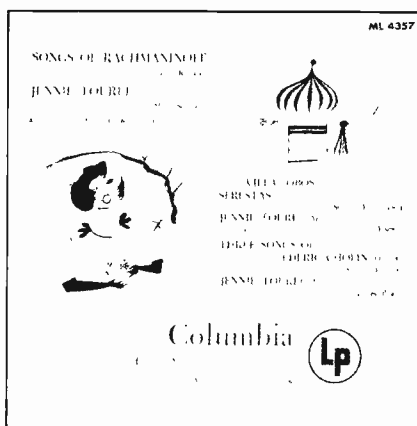

\$25

This Columbia LP (ML 4357) of Jennie Tourel singing songs of Rachmaninoff, Villa-Lobos, and Chopin dates from 1950, just two years after the company introduced the long-playing format to the world of music lovers. The artwork is typical of that provided by Columbia during the early LP era.

No. 39, published by the British Institute of Recorded Sound—and to buy a dehumidifier.

Just as the market for new classical recordings is only about 5% of all record purchases, the market for older ones is comparably small. If you have a modest collection that you would like to sell, you are not likely to easily dispose of it, much less make a profit. Remember, an old record is a used record. You are dealing with a consumable item that depreciates with age and wear. You might not be able to sell most of your classical 78s for more than 25¢ to 50¢, although it will cost you \$2.00 to \$3.00 apiece to buy the same discs from a specialized dealer. You might have a few \$10 or \$25 items in the batch, but the majority would be unsalable or hardly worth listing in a catalog. A small number of collectors looking for the same disc may drive the price up—until everyone finds a copy.

If you have a large collection and are dismayed at the prospect of letting all your "gems" go for a quarter each, you might sell them yourself and let a

dealer take the leftovers. Just don't be surprised if he doesn't want them—your leftovers will probably become his leftovers, and he knows it. The question is, do you need the money and/or the space now?

Or are you willing to take the time to advertise and investigate? An ad in a metropolitan newspaper may turn up enough buyers to clean you out with relatively little bother. More likely, you will need to proceed to other journals with national circulation, including those specifically published for the purpose. [See box on next page.] Putting ads in newspapers of colleges—especially those that have a good music curriculum—might be productive. If the young are sometimes scornful of the past, they are often the most appreciative purchasers of older recordings. The beginning collector is not apt to have a lot of money to spend, but this is a ready market for even the commonplace items.

If you don't mind settling for the joy of giving—or a tax deduction—instead of cash, there are many libraries and music schools that might be good targets for your collection. (Be prepared to demonstrate to the IRS that an old 78 is worth more than a half-dollar.) If they have an archival collection, like Yale, Stanford, and Lincoln Center, they probably already have copies of most of your recordings. Many archives have multiple copies that are circulated among other libraries or are used for fund-raising. Or you might donate your discs to a charity bazaar or thrift shop. There are plenty of collectors who still frequent thrift shops—and many can relate stories of extraordinary finds for a dime or a quarter. Incidentally, for the sake of collectors, if you choose one of these places, check to see how the discs already in stock are handled. If they are thrust into bins that will destroy them, donate your records elsewhere.

After all your research and appraisal, the *potential* worth of a specific disc may not mean a thing. Ultimately, it is worth only what someone is willing to pay for it. And while the potential value of some items might be hundreds of dollars, people who will pay the price are often rarer than the records themselves.

Aids in Selling

Where to Sell

You can find names of dealers in jazz and blues recordings in *Vintage Jazz Mart* (4 Hillcrest Gardens, Dollis Hill, London NW 2 6HZ, England). Though published abroad, this thick magazine is packed with ads for U.S. dealers. And you can find ads for 78s—or advertise some yourself—in U.S. publications such as *Antique Trader* (P.O. Box 1050, Dubuque, Iowa 52001), *Collector's News* (P.O. Box 156, Grundy Center, Iowa 50638), and *Hobbies* (1006 S. Michigan Ave., Chicago, Ill. 60605); for 45s and LPs, *Goldmine* (P.O. Box 187, Fraser, Mich. 48026), *Kastlemusick Monthly Bulletin* (901 Washington St., Wilmington, Del. 19801), and *Record Exchanger* (P.O. Box 6144, Orange, Calif. 92667). Dealers' names can also often be found in the classified ads in this and other record journals.

A selection of those who deal in out-of-print classical records follows:

Figaro's, 1287 Cambridge St., Cambridge, Mass. 02139. LPs only.

Lawrence F. Holdridge, 54 E. Lake Dr., Amityville, L.I., N.Y. 11701. Auction lists of the highest-quality, most rare vocal and instrumental 78s. All bidders, successful or not, receive a listing of prices realized on auctioned records.

Immortal Performances, Jim Cartwright, P.O. Box 8316, Austin, Tex. 78712. Occasional auction and set-price lists covering all types of serious music, 78s, and LPs, plus detailed discographies of selected artists.

Arthur E. Knight Collection (formerly DomArt Collection), 128 Fifth St., Providence, R.I. 02906. Monthly lists of vocals on 78, 45, and LP.

S. A. Langkammerer, 3238 Stoddard Ave., San Bernardino, Calif. 92405.

Nipper, P.O. Box 4, Woodstock,

N.Y. 12498. Will remove you from mailing list if they don't hear from you every four months.

Parnassus Records, Les Gerber, 2188 Stoll Rd., Saugerties, N.Y. 12477. Price lists and search service for micro-groove issues only.

Polyphony, 120 N. Oak Park Ave., Oak Park, Ill. 60301. Free lists of new and used LPs.

The Record Undertaker, Steve Smolian, R.D. 1 Box 152C, Catskill, N.Y. 12414.

Ross Robinson, 40 E. Ninth St., New York, N.Y. 10003. No 78s, and only LPs in top condition.

Spicer, 3283 Lonefeather Crescent, Mississauga, Ont. L4Y 3G6, Canada. Lists of 78s and LPs.

Frederick P. Williams, 8313 Shawnee St., Philadelphia, Pa. 19119. Will compile lists on request.

T.B. and M.B.

Price Guides

To help you estimate the value of individual records, there are several reasonably accurate price guides available. Jerry Osborne and Bruce Hamilton have a series of "Official Prices Guides" covering rock, country and western, and albums, as well as *A Guide to Record Collecting*, basically selected excerpts from the others. They can be found in bookstores or ordered from Jellyroll Productions, Inc., P.O. Box 3017, Scottsdale, Ariz. 85257. Another recent publication is *The Official Price Guide to Collectible Rock Records* by Randal C. Hill (House of Collectibles, Inc., 773 Kirkman Rd. # 120, Orlando, Fla. 32811). The two rock guides are similar in pricing and coverage, though where valuations differ Osborne-Hamilton is usually higher. It also gives more information on the differences in label types and pressings and provides the release date of each record; Hill includes short artist biographies.

For classics, the sole published price guide is limited to U.S. releases of

acoustic 78s recorded by "celebrity" artists: Julian Morton Moses' *Price Guide to Collectors' Records*, \$9.95 for thirty-two pages. Originally published in 1952, its "third edition" in 1976 merely included a chart with which to convert old prices to new (American Record Collectors' Exchange, P.O. Box 2295, New York, N.Y. 10017).

There is even a price guide for the color picture jackets in which some 45s originally came—not the records, just the jackets. It is *The Collector's Price Guide to 45 RPM Picture Sleeves* by Lloyd, Ron, and Marvin Davis (Winema Publications, P.O. Box 172, Medford, Ore. 97501). Unfortunately, no one has yet compiled an even marginally reliable listing for pop 78s. (There is one called *78 RPM Records and Prices*, but it is dreadful.)

Values often are overstated in such publications, presumably because that is what their readers want to see. Osborne-Hamilton, for example, lists nothing at under \$1.00, and Moses' minimum price is \$2.00, although in any box of oldies

there will be many that you can't give away. But the guides may help you to spot the occasional rarity.

This tendency to overvaluation makes price guides quite controversial among collectors, mainly because they leave sellers with unreasonable expectations and thus inhibit transactions. Norm Cohen, writing in the *John Edwards Memorial Foundation Quarterly* at the UCLA Folklore Center, tells the story of a well-known price guide writer of the 1940s, Will Roy Hearne, who was also a mail-order dealer in old records. His listings were generally regarded as high, perhaps being designed to enhance the value of his own stock. On one of his shopping expeditions in the South, Hearne came upon a warehouse full of mint 78s. When he asked the price for the entire lot, the owner whipped out a copy of Hearne's own guide and began quoting \$5-\$10 prices for every disc. "Hell, I know the fellow who wrote that book," Hearne interjected, "and every bit of it is nonsense." But he didn't get the records. T.B. and M.B.

**Part II:
Popular Records**

In December 1898, a magazine called *The Phonoscope* reported to its readers, "Old records are now in great demand by enthusiasts who aim to possess valuable collections." Since commercial recording was less than ten years old at the time, "old" obviously did not mean what it does now. Today there is a large network of collectors specializing in everything from original, individually made wax cylinders of the 1890s to Lesley Gore 45s of the 1960s. The most activity probably centers around rock and rhythm and blues of the past thirty years, followed by classic jazz and blues discs of the 1920s and '30s. Smaller constituencies pursue old country/folk records, big bands, pre-1925 acoustic recordings (disc and cylinder), and early Broadway cast and movie soundtrack LPs.

Collecting old records is not an expensive hobby, which is what makes it attractive to many. Though occasionally prices paid are high, they are in no way comparable to those charged for rare stamps, coins, or books. But that may be changing.

Just a few years ago a 78-rpm disc that once sold for 75¢ brought a cool \$4,000—the highest price ever paid for a single record. If you happen to have an original copy of "Zulus Ball" by King Oliver and His Creole Jazz Band on Genett 5275 (recorded in 1923), you too could be rich. If not, perhaps you could turn up a nice original pressing of "Stormy Weather" by the Five Sharps on Jubilee 5104 (also a 78, from 1952). Only one unbroken copy is known to exist, and that one sold for \$3,866 at auction in 1977.

The current hot item that everyone is looking for is a 1956 radio interview disc, "TV Guide Presents Elvis Presley" (RCA Victor EP G8 MW 8705). It is a one-sided 45 containing the

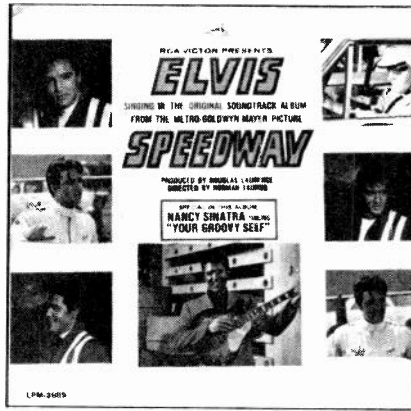

\$1,400

Guidebook author Jerry Osborne has estimated a more than tenfold increase in price for a mint copy of this Presley soundtrack LP since the singer's death. It is only the mono version, LPM (not LSP) 3989, of the twelve-year-old "Speedway" that is so expensive because it was Elvis' last album to be issued simultaneously in both mono and stereo and at the time RCA was pressing few discs in the waning format. Only three copies are known to collectors, although many more are undoubtedly collecting dust on shelves around the world.

singer's answers to four questions, which are supplied on a "continuity sheet" (so the local disc jockey could read them on the air), along with another insert that tells the story behind the interview. It is worth perhaps \$3,000 complete. But be careful, there are counterfeit copies around.

Despite the sought-after rarities, and the visions they conjure up of easy money for what you may find in the closet, most old records are not worth the vinyl or shellac they are pressed on. You can get a quarter apiece for them if you're lucky. But how do you tell what's valuable and what's not, and how do you go about selling those you wish to convert to cash?

Let's take a look at the box of old discs you've found. As with any specialized field, it's impossible to become an expert in one easy lesson, but a few guideposts may help. There are three

by Tim Brooks

factors that may tell which *might* be worth some money:

1. **Condition.** A pop record that is cracked, gouged, or so scratchy that the noise drowns out the music is not going to sell to anybody. Unlike ancient Greek pottery, it isn't worthwhile to piece broken records together.

2. **Type of music.** As a rule, jazz, rhythm and blues, Broadway cast recordings, and the like bring more money than other kinds of pop music. This is true for 45s, 78s, and LPs. If you have a stack of old blues shouters, jazz bands, or 1950s r&b groups, you may be in luck. If all you have is Margaret Whiting—sorry.

3. **Familiarity.** Do you seem to remember that most of the discs you're looking at were big hits way back when? Presley's "Hound Dog," Glenn Miller's "In the Mood," or Gene Austin's "My Blue Heaven" may make good listening (depending on *your* vintage), but they originally sold so many copies that they probably won't bring much today. I once asked a knowledgeable collector friend whether Paul Whiteman's 1920 Victor recording of "Whispering" had really sold a million copies. He replied, "I think I've been offered that many myself."

Of course if you don't recognize the titles and artists as you flip through your collection, that doesn't necessarily mean they're valuable. But familiarity is a bad sign. An exception to the rule is the occasional combination of the familiar and the obscure, such as the rare early release by an artist who later became famous. Don't bring me your standard RCA pressing of "Heartbreak Hotel," but if you have one of the early Sun recordings by Elvis, come right in! Original copies of these legendary Sun 45s and 78s are selling in the \$100-\$300 range, some even higher. But find an expert to tell the difference between the real thing and a bootleg reproduction.

Which pressing you have of a hit record can, in a few cases, be important. One recent price guide lists ten different versions of the Beatles' "Please Please

Tim Brooks is a vice president of the Association for Recorded Sound Collections. He coauthored The Complete Directory to Prime Time Network TV Shows, 1946-Present, recently published by Ballantine Books.

Me," ranging in value from \$1.25 to \$250.

A few widespread misconceptions should be eliminated right now. For one, age is not a factor. Those 12-inch Victor Military Band 78s from before World War I (usually labeled "For Dancing") can't be given away, while some unusual Beach Boys 45s from the 1960s might bring \$100. On the other hand, an LP of John F. Kennedy speeches from the Sixties may be worthless, while a 1912 Edison cylinder recording of Teddy Roosevelt could produce \$40 or \$50.

One-sided records are often thought to be very old and therefore valuable. The fact is that single-sided records were made and widely sold until 1918 (by Sears, Roebuck, under its Oxford and Silvertone labels). Victor's prestigious Red Seal classical discs, which remained one-sided until 1923, bring no special premium.

Some people are convinced that the physical appearance of a 78 is a dead giveaway to its rarity and thus its value. Not usually. The thick Edison discs, for example, have no special worth. Old Man Edison ran his record company as a kind of personal indulgence, with little sense of what was popular or even interesting in music. He turned out hundreds of sedate instrumental solos and duets, nondescript tenors singing "I'll Take You Home Again, Kathleen," and at least a dozen versions of "Nearer My God to Thee"—not likely to excite today's collector. A few jazz bands in the late 52000 series might be worth something, but that is because of their content.

Another odd form frequently found is the cardboard Hit of the Week discs produced from 1930 to '32. They were originally sold on newsstands for 15¢ apiece, a new title being distributed every week in a novel attempt to revive the Depression-ravaged record industry. It worked for awhile but eventually collapsed—even 15¢ was too much to spend on records in 1932. Little jazz was recorded, and no blues. Instead, the emphasis was on dance versions of current hits. There are a lot of them still around.

One format that is prized is the picture disc, which has been produced sporadically for many years. There has been a good deal of collector interest in

Jazz critic Rudi Blesh once called Jimmy Durante the greatest white ragtime piano player before he became a comedian; the 1924 Gennett recording of Jimmy Durante's Jazz Band is perhaps the only example of the Schnozzola's musical career during the early 1920s. (He did make later piano recordings—including one for RCA Victor Red Seal with Wagnerian soprano Helen Traubel!) Don't overlook 45s or children's records either, as the country music "Split Personality" and Superman discs demonstrate. The latter are actually laminated paper 78s that came with a twelve-page illustrated script. The "original radio cast" included Bud Collyer and Jackson Beck. You could probably get considerably more for this 1947 package from the large market of comic-book collectors, especially if the booklet and jacket are in good condition.

The 10-inch Capitol LP at the top of the next page is possibly Jackie Gleason's least-known record. On it he sings songs as six of the comedy characters he portrayed in his early-'50s TV series. At the time "The Dick Powell Song Book" was released in the late '50s, Powell was known in the country mainly as a TV private eye. The LP is still the only reissue of the best of his Decca 78s from the '30s. The final item here is—that's right—Yul's sister. Collectors seek it as a companion to her brother's Vanguard album of Gypsy songs.



\$40

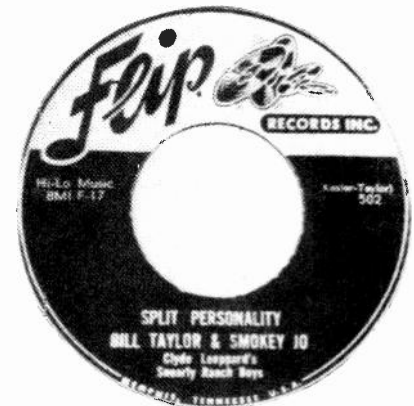

\$125



\$20



\$35

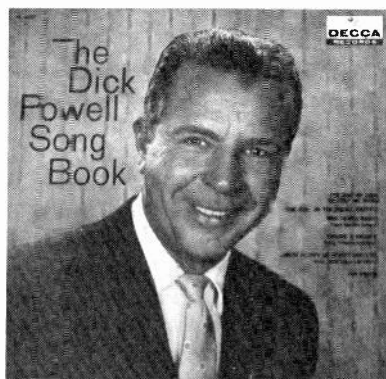

\$20



\$12.50

these lately (quite apart from the industry's recent abortive attempt to rejuvenate them). Probably most famous are the Vogue Picture Records of 1946-47, which have a full color drawing under the surface on each side—rather garish, 1940s "coal company calendar art," one publication called it. Virtually unbreakable and very well recorded for the period, they are going for \$5-\$10 each. Even more valuable are editions made by Victor in the early 1930s, especially "Cowboy's Last Ride" by Jimmie Rodgers (18 6000), with a big picture of the father of country music on one side. About a dozen copies are known to exist. Rumor has it that a bid of \$400 failed to win one offered in a recent auction.

"Little" 78s, usually 7 inches in diameter (same as a 45, but without the large center hole), also tend to earn a premium. Most were made in the early days—in fact, the very first discs sold in the U.S., in 1894, were 7-inchers (and single-sided). Generally these "E. Berliner's Gramophone" records sound dreadful, even by 78-rpm standards, but they will garner \$10 apiece anyway. There are other sizes as well, from 5 inches up, and you can usually sell them for somewhat more than ordinary 10- or 12-inch 78s; those 14 inches or larger, are valuable also but seldom found.

Cylinders sell for at least a dollar or two, and often more, no matter what the content. The later (post-1912) blue celluloid Edison cylinders are virtually indestructible, but the earlier wax ones are fragile: If they don't break, they grow mold. Don't forget those circular containers, with the nice picture of Edison on the side. Even if the cylinder has disappeared, they make dandy pencil holders.

If you think you have something of value, there are several routes you can follow. The best is to sell to, or through, an established dealer. If you are convinced that yours are "money" records, ask for a consignment sale via auction, in which you get an agreed percentage of the selling price. Most dealers will do this only with genuinely valuable records, but it can work very much to your advantage, because you may collect 70% or more of the price. Some dealers use a sliding scale, taking a larger percentage

of the winnings for low-priced discs and a smaller bite from higher-priced ones. Formulas vary widely, so shop around. Or you could sell the collection to him outright. You won't get top dollar per disc, but the total should be respectable. Again, approach more than one dealer. Competition can do wonders, and the experience could give you a better idea of what your records are really worth.

You can sell them yourself, of course, but you should try it only if you have a knowledge of the field—or if you crave adventure. For a onetime sale the time and aggravation will probably not be worth the cash realized, if any. Assuming you're going to sell by mail and through competitive bidding, there are several things you have to do.

First, prepare a detailed list of the records you want to dispose of, including title, artist, label, and manufacturer's number for each. Don't go into lengthy descriptions of how dear to your heart they are.

Next, since the prospective buyer can't see what he is getting, each disc's condition must be fairly and objectively evaluated. Collectors use a detailed grading system, which is outlined in such publications as *Vintage Jazz Mart* and *Goldmine*. It is to your advantage not to overrate your records. If the buyer disagrees with your judgment, you may have to return his money and start all over again.

Advertising is expensive and is useless unless you know where to place the ads. Try a magazine that attracts record collectors, like this one or, with even sharper aim—and cheaper—one of the collectors' publications listed here.

Once you have a buyer, you face the chore of packing and mailing. There is a science to preparing records for shipment, and it's especially important when handling fragile 78s. Records cannot be insured against breakage, and you are the one who will take the loss. The best way to learn about packing is to buy a few discs from established dealers and see how they do it.

Before you go through all this, give those oldies another listen. Maybe you'll decide to keep them. After all, Margaret Whiting did have a nice voice.

HF

Behind the Scenes

More Maazel Puccini. Lorin Maazel, who recently added the Vienna State Opera to his list of music directorships, has added *Le Villi* to his list of recordings of Puccini operas for Columbia. Masterworks' international a&r director Paul Myers went abroad in October to supervise the final mix of the tapes. In the composer's first opera, Plácido Domingo sings Robert and Renata Scotto his betrothed, Anna. Also featured is Tito Gobbi. The album is slated for release this spring.

Is Maazel on the way to conducting all the Puccini operas for Columbia? It has been discussed, although there is nothing official. We certainly wouldn't be at all surprised.

Meanwhile, Maazel has recorded Verdi's *Luisa Miller* for DG, in conjunction with a Covent Garden revival of the opera. The cast includes Domingo, Katia Ricciarelli, Renato Bruson, Gwynne Howell, and Wladimiro Ganzarolli.

RCA in England and Ireland. Although, as reported last month, RCA canceled its projected recording in London of Ponchielli's *La Gioconda*, it went ahead with Leontyne Price's latest recital disc. With Henry Lewis and the Philharmonia Orchestra she recorded a varied collection of arias, from Bellini ("Casta diva" from *Norma*) and Britten (Queen Elizabeth's monolog from *Gloriana*) to Weber ("Ozean, du Ungeheuer" from *Oberon*) and Wagner (the *Liebestod* from *Tristan und Isolde*).

Meanwhile, over in County Kildare, at St. Patrick's Seminary in Maynooth, James Galway, the flutist from Northern Ireland, teamed with the Irish Chamber Orchestra to record for RCA a collection of Stamitz concertos. He also joined violinist Kyung-Wha Chung in recordings of Bach's trio sonatas for the same company, the continuo being handled by harpsichordist Philip Moll and cellist Moray Welsh. Galway's planned concert for Pope John Paul II had to be canceled when the pontiff's visit to Ireland ran behind schedule.

New doings at Moss. While carrying on the Vox tradition of solid performances of a broad repertoire in inexpensive editions, the Moss Music Group is also rapidly developing its own line. The deluxe edition of Thea Musgrave's opera *Mary, Queen of Scots*, reviewed in this issue, signals one new direction. Soon to come is another deluxe four-disc package containing the six Schu-

bert Masses in performances directed by Martin Behrmann. MMG is also entering the audiophile market with digitally recorded performances of the nine completed Mahler symphonies by Harold Farberman and the London Symphony Orchestra. The First and Fourth Symphonies were recorded in November, the Eighth will be recorded in May, and the others will follow apace. George Mendelssohn-Bartholdy, the man who created Vox and Turnabout, has functioned as an a&r consultant since the sale of the labels to Ira Moss, et al.

Leonard Bernstein is suing the owner of a jukebox in a Jackson Heights bar. Frederick Loewe is suing the owner of one in a Santa Monica restaurant.

Pay the \$8.00 already. Leonard Bernstein is suing the owner of a jukebox located in a bar in Jackson Heights. Frederick Loewe is suing the owner of one in a restaurant in Santa Monica. Rod Stewart is suing a fellow who has a jukebox in a pizza parlor in Litchfield, Illinois. And Bruce Springsteen is suing somebody who has one located in a waffle house in Charlotte, North Carolina. What's this all about? Actually, these court actions are among some three dozen lawsuits filed in the names of noted plaintiffs by the American Society of Composers, Authors, and Publishers against jukebox operators who have allegedly not paid the \$8.00 compulsory license fee specified in the new copyright law. ASCAP believes its members are losing perhaps as much as \$3 million a year from unlicensed jukeboxes and has started a crackdown campaign.

Who's afraid of Thomas Wolfe? Apparently intent on disproving Thomas Wolfe's dictum, Peter Munves is going "home" again. One of Simon Schmidt's first steps as the new head of CBS Masterworks was to bring Munves back into the

CBS fold as a special marketing consultant. Munves' reputation as a marketing wizard got its start at Columbia, where he applied the "greatest hits" format to the marketing of classical recordings. His subsequent innovations at RCA and Pickwick (Quintessence) were equally adventuresome. Though it is still too early to foresee all the ramifications of the recent reorganization at CBS, one thing is certain: Peter Munves will again leave his mark. When he promises a "new look" in Masterworks marketing, that is no idle chatter.

PBS Faust. On January 2 PBS will broadcast a Chicago Lyric Opera production of Gounod's *Faust* in celebration of the company's twenty-fifth anniversary season. The performance, taped last September, features Mirella Freni, Nicolai Ghiaurov, and Alfredo Kraus, with Georges Prêtre conducting.

Allelujah II! From both RCA and Columbia comes heartening news for the contemporary-music fancier. RCA is reissuing a recording (ARL 1-1674) of instrumental works of Luciano Berio: the Concerto for Two Pianos, *Nones*, and *Allelujah II*. Its first incarnation was all too brief—it appeared in *Schwann* in January 1977 and disappeared in April 1978—but spectacular. As *HIGH FIDELITY* readers may recall, the concerto won the 1977 Koussevitzky International Recording Award, announced in December of that year. The reappearance of the recording now can only be seen as a victory for intrinsic worth over more conventional commercial considerations. For its part, Columbia is issuing the complete piano music of Aaron Copland in performances by Leo Smit. This is not the sort of project, any more than the Berio, that makes record companies rich; a \$3,000 grant from the Ford Foundation helped make this one possible.

Paul Robeson. Following the nationwide videocast of James Earl Jones's portrayal of the legendary American basso Paul Robeson, we received information from our longtime Berlin correspondent Paul Moor about a Paul Robeson Archive. It's not, we regret to say, in his native country, nor at London or Stratford-on-Avon, where he scored his greatest successes as singer and actor, but rather forms part of the Academy of the Arts in East Germany.

HF

ORIGINAL MASTER RECORDING

A BRAND NEW EXPERIENCE



“TURN ON”
YOUR
STEREO

ORIGINAL MASTER RECORDINGS™ The State Of The Art.

The key high fidelity component guarantee to improve your stereo system. **Super High Fidelity** is achieved by total quality control, using **only Original Stereo Master Tapes!** Our exclusive **Half-Speed Mastering** technique insures natural musical clarity and impact, our high definition **Super Vinyl** disc is custom pressed overseas. Each pressing is protected by a **Static Free Inner Sleeve** and placed in a **Special Heavy Duty Protective Package.** The result is your favorite music by your favorite artists on the highest quality, **Limited Edition** pressings. Your stereo system will **come alive** with the sounds of the original performance!

Available from select audio stores!

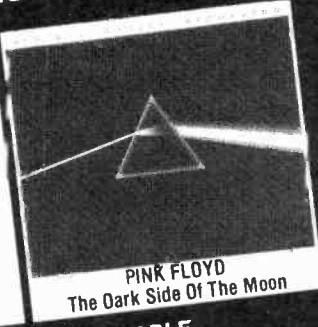

- ALSO AVAILABLE...
- JOE SAMPLE
 - AL STEWART
 - THE MYSTIC MOODS ORCHESTRA
 - JOHN KLEMMER
 - STEELY DAN
 - THE CRUSADERS
 - L.A. PHILHARMONIC ORCHESTRA
 - GEORGE BENSON
 - LITTLE FEAT
 - GRATEFUL DEAD
 - EMMYLOU HARRIS
 - GORDON LIGHTFOOT

P.O. BOX 919 • CHATSWORTH, CA 91311
(213) 993-4945



Introducing Accuglide™. The computerized remote control turntable.

**It provides hours of viewing pleasure.
(You read it right. Viewing pleasure.)**

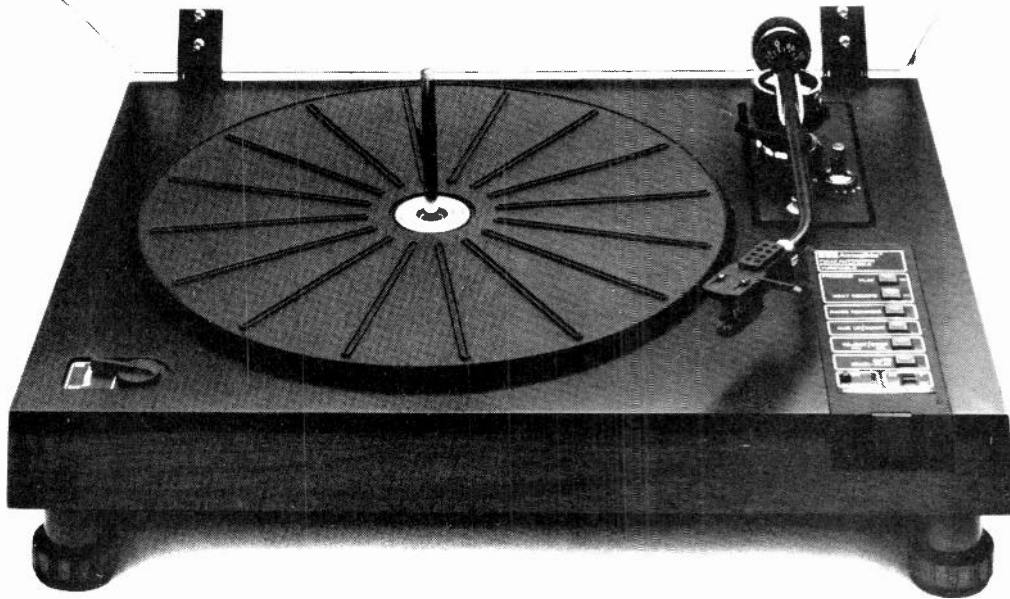

Even before you enjoy listening to Accuglide™, you're going to want to spend time just watching it. Because Accuglide performs like no other turntable you've ever seen.

Watch Accuglide's unique rotary spindle raise and lower your records like an elevator. So your hard rock doesn't drop on "Madame Butterfly."

You'll see Accuglide's spindle rotate its way to the top to pick up your record, carefully lower it, then gently place it onto the platter. Unlike other multiplay turntables, it doesn't drop them.

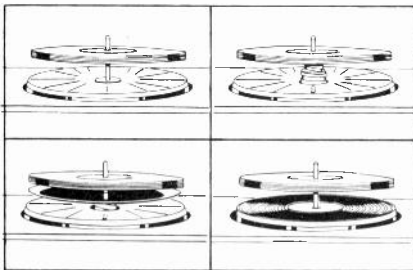

In fact, no other record changing system is as gentle. So your records couldn't be in better hands. Not even your own.

Accuglide's remote control lets you play the "Hallelujah Chorus" from across your living room. Hallelujah!

Now, listening to relaxing music can really be relaxing. Thanks to Accuglide's remote control you can play your favorite music without jumping up and down.

In fact, you can even raise and lower the volume from 40 feet away. So you won't be hassled by your neighbors if you want to play a hustle at 11 PM.

Play it again, Sam, is only one of 27 commands you can give Accuglide.

Simply press the right buttons on the Accuglide turntable or its remote control, and Accuglide's built-in computer stores up to 27 different commands.

So, you can change a record, reject it (you didn't like that one

anyway), raise the tone arm (so you can answer the phone), then resume play without missing a beat, repeat it (because now you want to hear it without any interruptions), then raise your records back to starting position so you can start all over again.

Accuglide's tubular "J" shaped tone arm is superbly balanced for exceptional tracking. And comes with a precision ADC magnetic cartridge with elliptical diamond stylus. Plus, the belt-drive Accuglide has the kind of specs you'd expect to find in the finest turntables. Like Wow and Flutter that's less than .04% WRMS and Rumble that's better than -66dB (DIN 45539B).

And if you think all this sounds good, how does this sound?

You can have all this viewing and listening pleasure for a song.

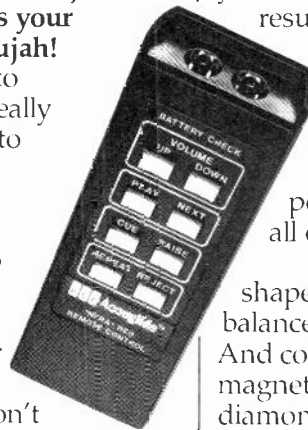

BSR Accuglide™ The computerized remote control turntable.

Feature Reviews



Arrau and Horowitz, then . . .

Horowitz and Arrau—Old and New

Historic reissues and recent recordings combine to replenish the legends of two of the century's great pianists.

by Harris Goldsmith

Claudio Arrau celebrated his seventy-fifth birthday two seasons ago; Vladimir Horowitz marked his last year. Both of these unique artists continue to perform unimpaired. Some sort of retrospective is surely appropriate, and indeed, the juxtaposition of new recordings with valued reissues of earlier performances can only prove beneficial in giving a more balanced and comprehensive impression of what makes each—though admittedly controversial—indisputably great.

RCA has two Horowitz projects—one devoted to reissues of mono and early stereo recordings made before the pianist's twelve-year defection to Columbia, the other culled from concerts given since his return to the fold. The newest item, "The Horowitz Concerts 1978-79," finds the artist in rare form. All the familiar Horowitz characteristics are here in abundance, and the playing has debonair ease and suavity and all the color and spontaneity that were sadly missing from his Liszt sonata and Rachmaninoff Third Concerto released last year.

This is not to say that everyone will approve of all the harmonic changes and editorial emendations (some of them Busoni's, others of Horowitz' own devising) in Liszt's *Mephisto*. And since there is less "tradition" for tampering with phrases and changing notes in Schumann than in Liszt (actually Schumannesque alterations are just as frequent though less advertised), some purists will undoubtedly express outrage at Horowitz' redistribution of lines, near contortion of phrases, and spurts of febrile energy in the *Humoreske*. And yet, the performances have such poetry and communicative style, such magnificent color, and—for all the manipulative rubato and reverse accents—such continuity that those unable to meet Horowitz on his own terms will be missing a great deal. I was utterly disarmed by his playing here.

Although the Schumann and the *Mephisto* are the disc's most substantial offerings, there is as much wizardry in the thrice familiar *Consolation*, here paced with delectable arching line. As for the two Rachmaninoff *morceaux*, even that great

composer/pianist didn't surpass Horowitz' limpid repose in the barcarolle and diabolically nimble passagework in the *Humoresque*.

The sound quality, too, has much more color and depth than in last year's Liszt and Rachmaninoff—I suspect that the microphones were judiciously moved farther back. Only occasionally do the fortissimos verge on tinniness. (Applause has been removed except for the ovation following the final piece on the agenda: a wise solution.)

In every way, then, this collection—which, incidentally, represents Horowitz' first recordings of all five works—will take its place with his finest performances on records.

The reissue is more problematic. Ironically, the Carnegie Hall recital from which this 1951 version of the Haydn sonata was taken also contained a performance of *Pictures at an Exhibition* that was later made into a commercial record (RCA LM 2357). The present *Pictures* is a studio recording, made four years earlier. RCA has done an admirable job of transferring the original 78s, and the 1947 sound as reproduced here almost rivals the later taping for solidity and impact, though not for sheer voltage. (A similar situation held true for Sviatoslav Richter's studio and concert performances of Mussorgsky's original version.)

Which brings me to the heart of the matter: I become infuriated anew by the

late Olin Downes's deliberate misrepresentation of what Horowitz has done to Mussorgsky's competently—in fact, ingeniously—devised piano writing. With all those changed harmonies, garishly rearranged figurations, and the like, it is almost criminal to blithely contend that this arrangement "is a return to the original text

VLADIMIR HOROWITZ: The Horowitz Concerts 1978–79.

Vladimir Horowitz, piano. [John Pfeiffer, prod.] RCA RED SEAL ARL 1-3433, \$8.98. Tape: ARK 1-3433, \$8.98 (cassette).

SCHUMANN: Humoreske, Op. 20. RACHMANINOFF: Barcarolle, Op. 10, No. 3; Humoresque, Op. 10, No. 5. LISZT: Consolation No. 3; Mephisto Waltz No. 1.

HAYDN: Sonata for Piano, No. 52, in E flat*. MUSSORGSKY: Pictures at an Exhibition.

R Vladimir Horowitz, piano. RCA RED SEAL ARM 1-3263, \$8.98 (mono). Tape: ARK 1-3263, \$8.98 (cassette) [recorded in 1947 and 1951*].

COMPARISON—Mussorgsky:
Richter Odys. Y 32223

CLAUDIO ARRAU: The Historic Recordings.

RH Claudio Arrau, piano. DESMAR GHP 4001/2, \$17.96 (mono, two discs) [from various originals, 1927–57].

BALAKIREV: Islamey. BUSONI: Elegie No. 5 (*Die Nächtlichen*). STRAVINSKY: Petrushka: Danse russe. LISZT: Rhapsodie espagnole. Transcendental Etudes After Paganini: No. 1, in G minor; No. 2, in E flat; No. 5, in E (*La Chasse*); No. 6, in A minor. Concert Etude No. 2, in F minor (*La Leggerezza*). *Années de pèlerinage*, First Year: Au bord d'une source; Third Year: Les Jeux d'eaux à la Villa d'Este. CHOPIN: Waltz in F, Op. 34, No. 3. Etudes: in C sharp minor, Op. 10, No. 4; in A flat, Op. 25, No. 1; in F minor, Op. 25, No. 2. Prelude in F, Op. 28, No. 23. Tarantella in A flat, Op. 43. CHOPIN-LISZT: Chant polonais, Op. 74, No. 12: My Joys. DEBUSSY: Preludes, Book II: *La Puerta del vino*, No. 3. SCHUBERT: Fantasy in C, D. 760 (*Wanderer*). SCHUBERT-LISZT: Hark, Hark, the Lark.

ALBÉNIZ: *Iberia*, Books I–II.

BR Claudio Arrau, piano. ODYSSEY Y 35229, \$4.98 (mono) [from COLUMBIA ML 4194, c. 1949].

CHOPIN: Nocturnes (21).

Claudio Arrau, piano. PHILIPS 6747 485, \$19.96 (two discs, manual sequence). Tape: 7699 088, \$19.96 (two cassettes).

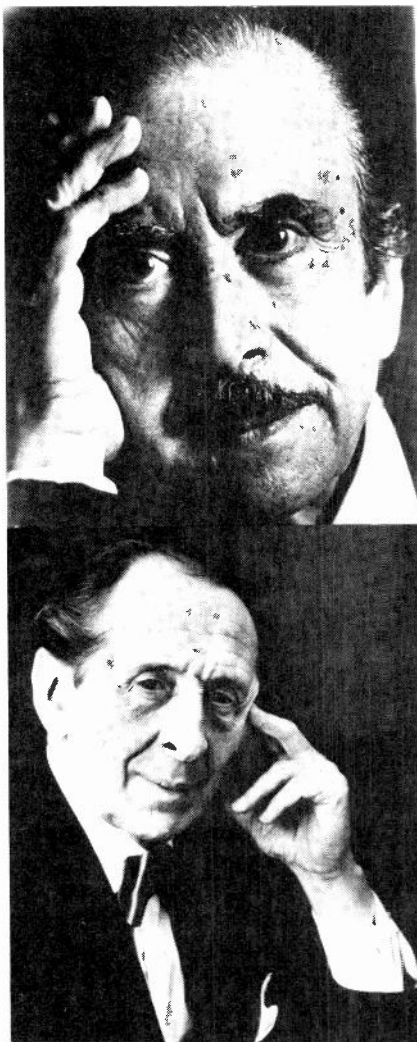

... and now

of the piano pieces as they are published in the Lamm edition . . . following faithfully the original manuscripts" and then, with an evasive admission that "Mr. Horowitz has [after all] done a little 'piano orchestration,'" to categorize such intervention as an "effort . . . solely to realize the intention of the composer and to refrain from gratuitous ornamentation or officious 'correction' of any detail of his text as it stands."

If Horowitz wants to add graffiti to *Pictures*, so be it. But Richter's astounding Sofia concert performance (currently available on *Odyssey*, with George Szell's account of the Ravel orchestration) is at least as exciting and much more exalted; even Horowitz' superior concert reading falls short of it. Somehow, what fits the character of Liszt's *Mephisto* seems more anachronistic in Mussorgsky.

The great Haydn sonata, played with wonderfully bracing élan and piston-stroke fingerwork, is reason enough to acquire

this disc. The performance is fully the equal of the early Horowitz studio recording, and the still admirable reproduction lets one hear much more of the color and articulation than could be discerned from the 1934–35 account (Seraphim 60063).

Horowitz has somehow managed to retain his erstwhile reputation as a keyboard fire-eater, while broadening his image by delving into new repertoire; Arrau, on the other hand, has narrowed his once diversified repertoire but broadened his sonority and interpretive style. Today we think of Arrau as the scholar personified, a sovereign master who favors breadth of vision, leisurely tempos, and a generous helping of rhetorical expansiveness—occasionally carrying elasticity to the point of willful mannerism. The new Philips recording fits this description of him in his latter-most phase, but the reissues shed more valuable light on this still sadly misunderstood artist.

Arrau, admittedly an in-depth interpreter of Beethoven, Brahms, Schumann, and the other German classic/Romantic figures, once had the most catholic of repertoires; the Chilean-born, German-trained virtuoso has probably played and recorded a wider range of music than any other pianist, with the possible exception of Richter. How many interpreters can do such justice to late Beethoven, Albéniz' *Iberia*, and Bach's *Well-Tempered Clavier*? And Arrau's present broad-toned, meditative manner makes one forget his earlier tendency toward fast tempos, utmost delicacy, and a tonal flexibility that favored lean transparency almost to the point of brittleness.

Truly imposing artists have it in them to surprise us, and Arrau has kept that valuable characteristic. His unexpected impetuosity in the recent recording of Chopin's F minor Fantasy, Op. 49 (Philips 9500 393, September 1978), is also in evidence in his 1932 account of Chopin's tarantella, recorded by Parlophone and included in the Desmar anthology. But then, the Desmar collection (beautifully dubbed and impeccably pressed by Teldec in Germany) is full of revelations.

Balakirev's *Islamey* is magnificently controlled rhythmically, the avalanche of notes and rapid chords executed with bristling precision. In some ways, Arrau's reading is even more impressive than Simon Barere's equally virtuosic, somewhat wilder, but less precise performance (recently revived on Varèse Sarabande VC 81045, February 1979). The Liszt performances are, without exception, dazzling—although it must be noted that the *Spanish*

Rhapsody, from a 1936 Telefunken original, is judiciously pruned due to the exigencies of 78 recording.

I was particularly intrigued with the Chopin. Arrau generally has not impressed me as being the most natural exponent of this music, but most of these 1930s readings project a longer line that spins through his pauses and rhetorical rubatos. This, I suspect, is accomplished by way of a more spontaneous address: Arrau appears to be having fun, not taking himself (or the music) quite so seriously as he does today. The Debussy prelude is played with a torrid, insistent rhythm and magnificently solid sonority. In the Schubert fantasy, however, the rhythm is *too* solid, although the sound of that 1957 EMI recording—and the gorgeous instrument used—could still be considered demonstration class.

The Odyssey reissue of the first two books of *Iberia* makes one regret that Arrau never recorded the other half of Albéniz' tour de force. These performances, with every note in place, nevertheless convey wonderful élan, a natural feel for rhythm and texture, and a peculiarly idiomatic sonority. In every respect, this is breathtaking pianism, different from, but certainly the equal of, Alicia de Larrocha's near definitive complete recordings (Turnabout 34750/1 or Musical Heritage Society MHS 1307/8 and London CSA 2235). The Odyssey disc, in a good pressing, presents sound that has dated honorably: The piano still has a modicum of atmosphere and color but becomes a bit constricted in loud passages.

Arrau's traversal of Chopin's nocturnes happily includes the two pieces not ordinarily part of the canonized nineteen. The playing is cognizant of every textual nicety (which the pianist's 1957 *Wanderer* Fantasy isn't, incidentally—he surprisingly keeps the D sharp there throughout the final measure of the second section instead of changing it to D natural). Some sparkle and flow are inevitably missing from these grandly solid renditions, but Arrau manages to convey much of the febrile atmosphere that pervades this music, and Philips' piano reproduction is exceptionally rich. Rubinstein's RCA version of a decade ago had a similarly attractive, bronzen tone but was far more benign and mild-mannered. My favorite accounts remain those of Tamás Vásáry (DG 136 486/7) and Ivan Moravec (Connoisseur Society S 1065, 1165).

Personal preference aside, all of these releases form a major part of the legacy of two of this century's bona fide keyboard stylists.

Bearding the Lions Anew

Though Noah Greenberg's epochal first recording of the medieval *Play of Daniel* was a tough act to follow, Mark Brown's version proves a worthy successor.

by Susan Thiemann Sommer



Processions of singers and instrumentalists are an important element of *Daniel* (here with countertenor Russell Oberlin as the central figure, during a 1960 performance by the New York Pro Musica in Wells Cathedral, Somerset, during a British tour).

Twenty years ago, I was a graduate student sitting in the balcony of New York's Riverside Church, looking down at the spectacular procession that opened the New York Pro Musica Antiqua's production of the medieval *Play of Daniel*. Performances of early music were infrequent in those days, usually pretty staid affairs attended by a rather specialized audience. Noah Greenberg's exuberant ensemble was easily the most exciting and interesting one around, and rumor had it that this play, or pageant, or whatever it was, should definitely not be missed. Of course, *Daniel* had been premiered the previous year at the Cloisters, but no one I knew had been a part of that small, elite audience. I entered the neo-Gothic church with considerable skepticism and left enthralled, overwhelmed, and convinced that, for the first time, I had had a real taste of life in the Middle Ages.

In the years that followed, I worked as a factotum for Greenberg and had a chance to see at close range what had gone into that memorable event. First, there was the brilliant musical transcription of the

Rev. Rembert Weakland, a graduate musician at Columbia University who went on to hold high administrative office in the Benedictine order. Although Father Weakland believed that the ternary patterns of the medieval modes would have governed the rhythm throughout most of the play, he took a daring step—for those times—and applied duple meter to some of the stronger processions, notably to the first entrances of the kings' retinues and to the strange scene where Daniel interprets the handwriting on the wall.

Then there was the makeup of the Pro Musica itself, which determined the casting and, to some extent, the voice parts. An additional role, Belshazzar's Prince, who sang alternate verses in the proces-

THE PLAY OF DANIEL.

Pro Cantione Antiqua, Landini Consort, Mark Brown, dir. [Chris Hazell, prod.] ARGO ZRG 900, \$9.98. Tape: KZRC 900, \$9.98 (cassette).



The prophetic handwriting on the wall, heralded by bells in both Brown and Greenberg versions, is discovered by King Belshazzar, his prince, and a courtier (Brayton Lewis, Oberlin, Marvin Hayes of Pro Musica). Note bells on rack at far right, portable organ next to it.

sions, was created for the exceptional countertenor of Russell Oberlin, and the part of the Queen was allotted to a (female!) soprano, Betty Wilson, who contributed a touch of barbaric splendor with her rich voice and elegant finger cymbals. A narration in verse—by W. H. Auden, no less—was added so that spectators would have some idea of what was going on during the performance. And there were the colorful costumes, the specially made instruments, the dramatic lighting, the extra musicians, the pomp, drama, and pageantry, all under the immediate, energetic supervision of Greenberg, whose vision, enthusiasm, and determination to see his dream realized brought the *Play of Daniel* to life again after seven dormant centuries.

Daniel has had a triumphant career since its revival. The Pro Musica's original Decca recording (still available as MCA 2504) popularized the music, and a performing edition has led to productions in schools and churches throughout the country. But twenty years is a long time. Neither Greenberg nor the Pro Musica is with us today; in their place we have a number of flourishing professional ensembles, many of them in England, which seems to have become the early-music center of the world. (A subsequent recording of *Daniel* appeared on England's Calliope label but has not had wide distribution here.) Fashions in scholarship change as well; all manner of rhythmic interpretations are advanced for the performance of chant these days, and the school which holds that instruments played no part in the medieval church is particularly strong.

So when I learned that a new version of *Daniel* had been recorded by Britain's prestigious Pro Cantione Antiqua, I again approached the work with some trepidation. Would my old friend be totally transformed? Would I have to readjust my musical expectations completely? I was reassured to find that this is not a revisionist production. The music is quite recognizable, and the instruments still add colorful touches to the drama. There are differences of course—some wonderful additions and some disappointments—but the basic sound and shape are much as Greenberg imagined them.

First one notices the rhythmic changes. The Pro Cantione Antiqua uses a lot more duple meter and, on occasion, even a mixture of duple and triple. Director Mark Brown says in his notes that "the piece has been rhythmicized according to simple 'proportionalist' principles. That is to say that the more notes there are in a particular neum grouping, the faster, in proportion, they should be sung." While this lends an element of flexibility to his realizations, at the same time much of the vigor and assurance of the earlier version is lost. Moreover, this comparatively free attitude toward chant rhythm doesn't square historically with the use of rhythmically controlled polyphony, another notable difference between the two performances.

Brown's polyphonic interpolations and additions are very striking and effective. The play is introduced by a beautifully sung motet, *Congaudeant catholici*, which provides a brilliant opening, and for the second miracle—when Daniel has been cast

into the lions' den and an angel suddenly enters to hold off the beasts—everything is suspended and we hear a ravishing and quite celestial performance of the three-voice *E semine rosa*, attributed to Pérotin.

Processions abound in *Daniel*, and while Greenberg's approach was to alternate contrasting sections, Brown prefers a cumulative effect, with the chorus often breaking into two-part organum for the conclusion. This is a sensible decision for a purely recorded performance, where the processions can't be seen to arrive at a physical destination.

The characterizations are for the most part well realized. If one misses the flamboyance of Oberlin's Angel, it could be argued that Kevin Smith's subdued one detracts less from the story line. James Griffett's portrayal of the reluctant prophet is remarkably close to Charles Bressler's; even the plangent timbre of their voices is alike. David Thomas (Belshazzar) and Ian Partridge (Darius) are appropriately regal, but I was disappointed in Smith's lackluster Queen. (I forgave Smith everything, however, when I heard his exquisite solo performance of Pérotin's beautiful *Beata viscera*, an interpolated motet, which divides the two *Daniel* stories and begins the record's second side.) The slimy evil counselors are a stodgy lot. I could imagine them straightening their ties before being cast into the pit. But the quasi-comic Habbakuk, who has to give up his dinner to refresh Daniel in the lions' den, comes off very well as a deep bass (Michael George).

Various instruments are used sparingly but imaginatively to accompany processions, to divide sections by instrumental interludes, and to provide background color for certain dramatic events (for example, the unearthly bells that sound as the ghostly handwriting appears on the wall). The Landini Consort members play nimbly on the recorders, shawms, rebecs, fiddle, psaltery, and harp, but Brown employs less percussion than Greenberg, in line with his de-emphasis on rhythmic regularity.

The performance was recorded in the Church of St. Jude-on-the-Hill, and the sound is spacious and reasonably effective. Processions come and go audibly, and the echo is ecclesiastically resonant but suitably dry. Occasionally a chorus—"Rex in aeiernum vive," for instance—blasts us out of our seats; otherwise everyone maintains an appropriate decorum. All in all, it's a pleasure to welcome this *Daniel*, dressed in new clothes, to be sure, but still looking very familiar. **HF**

Free details on a different kind of record club

offering... BACH, BEETHOVEN, BRAHMS,
FLEETWOOD MAC, LINDA RONSTADT, CHICAGO, KANSAS
BARRY MANILOW, BOSTON, ELTON JOHN, JAMES TAYLOR,
JEAN-LUC PONTY, CROSBY, STILLS & NASH, STEVE MILLER BAND,
PETER FRAMPTON, BARBRA STREISAND, EAGLES, CHUCK MANGIONE
and every other composer and artist in print.

You can now own every record or tape that you may ever want . . . **at tremendous savings** and with **no continuing purchase obligations**. You can get valuable **free dividend certificates**, you can get **quick service** and all the **100% iron-clad guarantees** you want.

Now you can **stop price increases** that leave you with less music for your record and tape budget. You can guarantee yourself **more music for less money** through membership in Discount Music Club.

Look at these benefits:

TREMENDOUS SAVINGS on every record and tape in print—no "agree-to-purchase" obligations of any kind.

DISCOUNTS OF 43% TO 73% off mfg. suggested list . . . special catalog features hundreds of titles and artists.

ALL LABELS AVAILABLE including most imports through special custom ordering service. If we don't stock it we'll get it for you.

SCHWANN CATALOG lists thousands of titles; classical, pop, jazz, ballet, opera, musical shows, folk, rock, vocal, instrumental, country.

DISCOUNT DIVIDEND CERTIFICATES. Dividend Gifts—Every shipment carries a dividend gift or dividend certificate. Certificates redeemable immediately for extra discounts.

NEWSLETTERS. Happenings in the world of music; concerts, critiques, new releases . . . special super-sale discounts of up to 73%.

DISCOUNT ACCESSORY GUIDE. Diamond needles, cloths, tape cleaners, etc. Discount Music Club is your complete one stop music and accessory buying service.

QUICK SERVICE. Same day shipping on many orders . . . rarely later than the next several days. Partial shipments always made in the event of unforeseen delay . . . all at no extra cost to you.

100% IRON-CLAD GUARANTEES on all products and services. Everything is guaranteed factory fresh and free of defects or damages of any sort. Your total satisfaction is unconditionally guaranteed.

Discount Music Club is a no-obligation membership club that guarantees tremendous discounts on all stereo records and tapes and lets you buy what you want...when you want...or not at all if you choose.

These are just a few of the money-saving reasons to write for free details. You can't lose so why not fill out and mail the coupon for immediate information.

	Discount Music Club Department
650 Main St., New Rochelle, N.Y. 10801	
NAME _____	
ADDRESS _____	
CITY _____	
STATE _____	ZIP _____

Classical Reviews

reviewed by	Allan Kozinn
Scott Cantrell	Paul Henry Lang
Abram Chipman	Irving Lowens
R. D. Darrell	Robert C. Marsh
Peter G. Davis	Karen Monson
Robert Fiedel	Robert P. Morgan
Kenneth Furie	Conrad L. Osborne
Harris Goldsmith	Andrew Porter
David Hamilton	Patrick J. Smith
Dale S. Harris	Paul A. Snook
Philip Hart	Susan Thiemann Sommer

ALBÉNIZ: *Iberia*, Books I-II. For a feature review, see page 63.

BACH: *Christmas Oratorio*, S. 248. Hubertus Baumann and Frank Saesch-Pur, boy sopranos; Michael Hoffmann, boy alto; Heiner Hopfner, tenor; Nikolaus Hillebrand, bass; Regensburg Cathedral Choir, St. Emmeram Collegium, Hanns-Martin Schneidt, cond. [Andreas Holschneider, prod.] ARCHIV 2710 024, \$29.94 (three discs, manual sequence). Tape: 3376 012, \$29.94 (three cassettes).

COMPARISONS:

Harnoncourt/Vienna Con. Musicus
Tel. 36.35022
Ledger/St. Martin's Acad.
Ang. SC 3840

Bach's *Christmas Oratorio* is a rather special case in the genre, not so much one large-scale dramatic piece as a grouping of six self-contained cantatas for the different days of the holiday season. It's as heavily "in debt" as anything the Leipzig master wrote, most of its major set numbers having been transplanted from others of his works. But such was the genius of J. S. Bach that it flows for nearly three hours as cohesively as if written in one uninterrupted surge of inspiration. Contrast there is—of keys, of instrumentation, and of mood, ranging from pageantry to pastoral sweetness. But we who learned it from records rather than religious services could hardly experience it as a pragmatically woven chain of episodes.

Archiv's third recording of the ora-

torio shares with the Harnoncourt/Telefunken set an all-out approach to baroque authenticity: use of replica period instruments that play half a tone lower than their modern counterparts; an all-male vocal contingent; scaled-down vocal and instrumental forces; proper treatment of trills, ornaments, and *notes inégales*. But baroque scholarship is not always a monolithic "party line" affair. There's much to choose between these two versions—some of the differences by design, others by the breaks of the game.

Schneidt, who conducts from the podium, maintains a steady, not to say rigorous, beat. Harnoncourt, presumably leading from a position in the ensemble (cello), occasionally lets tempos race ahead in long stretches of animated arias. The new recording will appeal to those who find Harnoncourt's deliberate focusing on rhythmic and dynamic variation too jerky. The Telefunken will remain the preference of those who find Schneidt bland, with his relative inflexibility about agogic accents and homogenization of note values. Among the points in Harnoncourt's favor are the drama and thrust of the opening chorus and the elucidation of the rocking motion of the *Sinfonia* that opens Part II. In Part IV, the two conductors choose widely variant tempos, Schneidt pushing the opening chorus more forwardly and Harnoncourt adopting his most propulsive speed in the great tenor aria. Thus the locus of tension falls differently within the larger span.

In the soprano and bass collaborations of Part IV, the Archiv recording uses several boy sopranos against a solo bass, while Telefunken employs its (unnamed) treble soloist from the Vienna Choir Boys. I can't help thinking that this choice was dictated less by historical or stylistic considerations than by the relative ability of the youngsters available. The uncredited lad in the earlier recording handles his role (including aria material) with impressive aplomb; in the newer release the boys from Regensburg are insecure and faltering, with pitch and breath literally all over the place. Likewise, Archiv's boy alto, Michael Hoffmann, is no match for the mature counter-tenor Paul Esswood, who has graced so much of Telefunken's Bach series, and I turn to Harnoncourt's bass, Sigmund Nimsgern, for the richness and authority

lacking in the lighter-weight voice of Nikolaus Hillebrand. Only the tenor among the soloists in the new set gets my vote, Heinz Hopfner managing the Evangelist and aria assignments with grace, style, and a fresh, ringing sound that eludes the more tired Kurt Equiluz.

It's nip and tuck between the boy choruses, Regensburg's possibly warmer sound likely being a function of more churchly acoustics. For that matter, stereo space is a trifle more imaginatively deployed in the set under review (e.g., in the Part IV "echo" soprano aria). And the instrumentalists here are by and large a more impressive lot. Those natural horns don't burble the way they do in the *Concentus Musicus*, and the trumpet virtuosity of Edward Tarr in the final chorus of Part VI would have been just unbelievable in the earlier days of the antique instrument resurrection.

Whichever of the "super-scholarship" sets you choose, you should own at least one of the conventional (meaning modern instruments and mixed chorus and soloists) albums. I have admired several of these, including Karl Münchinger's (London OSA 1386) and the mid-Fifties Archiv (now deleted) begun under Fritz Lehmann and completed after his untimely death by Günther Arndt. But the recent Angel recording under Philip Ledger, which I think rather better of than does Kenneth Furie (January 1978), is in many respects the most fascinating of all: a provocative mix of baroque conventions (in terms of execution and scaled-down forces) and nineteenth-century expressive mannerisms—intolerable from Robert Tear, at least acceptable from Dietrich Fischer-Dieskau, and with beautifully eloquent work from Elly Ameling and Janet Baker. Modern concert pitch, interestingly enough, doesn't make the work more "brilliant," and I find linear clarity less absolute with contemporary instruments than with the period ones on either of the other versions. A.C.

BARTÓK: *Sonatas for Violin and Piano*, Nos. 1-2.

Gidon Kremer, violin; Yuri Smirnov, piano. [Zenei Rendező, prod.] HUNGAROTON SLPX 11655, \$8.98.

Sandor Végh, violin; Peter Pettinger, piano. TELEFUNKEN 6.42417, \$9.98.

B Budget
H Historical
R Reissue
A Audiophile
(digital, direct-to-disc, etc.)

SANSUI SELECT SYSTEMS

Now it's easy to buy great hi-fi.

Until now, buying a fine audio system hasn't been easy. You had to learn about components. And take time to match them for looks and for sound.

Sansui has changed all that.

Our expert engineers have used advanced Sansui technologies to produce a new series of Select Systems that give you purest high fidelity with minimum fuss.

In our **Select System 70**, great sound starts with the new **R-70 receiver**, as versatile as it's easy to use. You can listen to one music source at the same time as you're taping something else. The bright and precise LED displays help you find your station quickly, and monitor both signal strength and output power. The DC-Servo amplifier section delivers lots of power, virtually without distortion. And radio reception of even the weakest stations is superb.

Sansui's new direct-drive automatic **FR-D3 turntable** tracks your records with unusual precision, and its controls are conveniently outside the dustcover. The Dolbyized **D-90 cassette deck**, a convenient front-loader, has bias and EQ switches to match standard and high performance tapes. And when you connect it to a timer, it'll make recordings while you're away.

To deliver the music, we've provided a pair of our fine 3-way acoustic suspension **SPA-3700 speakers**, with great power and clarity over the entire frequency spectrum and special controls to match the sound to your listening environment.

Everything (except the speakers, of course) is conveniently mounted in a handsome walnut veneer cabinet with smoked glass doors, swivel casters, and plenty of room for your records.

Ask your Sansui authorized dealer to show you the Select System 70 and the other fine Systems, turntables and speakers in the Select line.

When your friends listen to the great sound of your Sansui Select System, they'll wonder how you did it. Tell them it was easy — with a little help from another friend. Sansui.



Sansui

SANSUI ELECTRONICS CORP.
Lyndhurst, New Jersey 07071 • Gardena, Ca. 90247
Sansui Electric Co., Ltd., Tokyo, Japan
Sansui Audio Europe S.A., Antwerp, Belgium
In Canada: Electronic Distributors

SUPERCOMPO
SELECT SYSTEM 70

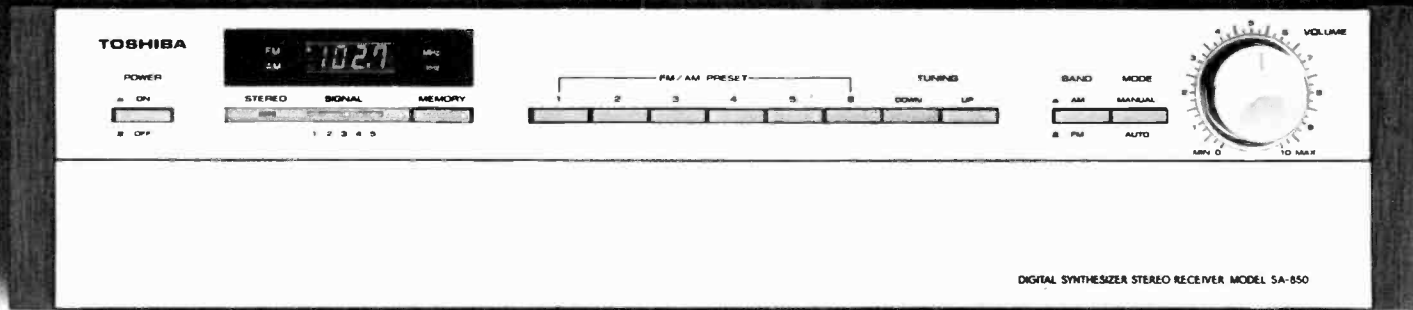

TO BUILD A BETTER RECEIVER, WE LEFT OUT A FEW UNNECESSARY PARTS.

What you see here is a sophistication in high fidelity design that's never been achieved in a stereo receiver. The new Toshiba SA 850.

Look for conventional tuning devices, like a tuning knob, or an FM/AM band, or signal strength and center tuning meters.

You won't find any.

The reason is Toshiba's unique digital-synthesized tuning. The most advanced and precise system of tuning available today.

Toshiba was the first to develop digital synthesizer circuits in a receiver, and now we've utilized them again.

Choose either automatic or manual tuning.

Consider ordinary tuning systems obsolete. The Toshiba SA 850 allows you to tune automatically or manually with the ease of push-button selection.

You get LED digital read-out. And 5 LED signal strength indicators.

In the automatic FM mode, the tuner will scan until it stops at

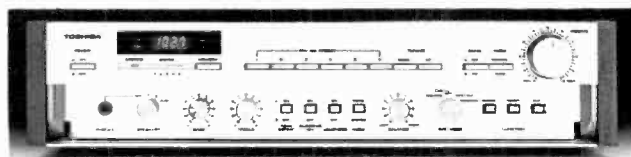

the next listenable station. Also, 6 FM and 6 AM stations can be pre-set for instant recall tuning at the touch of a memory button. The quartz digital synthesizer locks into each station's assigned frequency with absolutely no possibility of drift. You get FM synthesizer accuracy of 0.0025%!

FM stereo S/N ratio is 68 dB. FM selectivity is a high 80 dB. Frequency response is 20 to 15,000 Hz, +0.2 - 0.8 dB.

If power is what you want, then power is what you'll get.

Full complementary direct-coupled power amplifiers provide 50 watts rms per channel into 8 ohms from 20 - 20,000 Hz. And with a THD of only 0.03%. A figure that receivers many times more powerful can't match.

This is achieved by low distortion differential amplifier technology and a triple secondary power trans-

former with twin 10,000 μ F capacitors that virtually eliminate noise and hum.

Precisely what you look for in a preamp section.

We give you provisions for attaching two tape decks. And full monitoring controls, plus duplication switching between the decks.

Our special subsonic filter switch eliminates rumble and other low frequency noise.

A great-looking body and price.

Behind our sleek, slide-away cover is a full range of controls, including tone / defeat switch and a dual speaker selector.

The entire unit has a clean, sophisticated look. So you can indulge your eyes as well as your ears.

But we've saved the best part for last. This digital-synthesized receiver actually costs only \$519.95* less than you'd pay for a digital-synthesized tuner alone.

Now, that's the part we thought you'd like us to leave in.

TOSHIBA
Again, the first.

Toshiba America, Inc. 280 Park Ave., New York, NY 10017

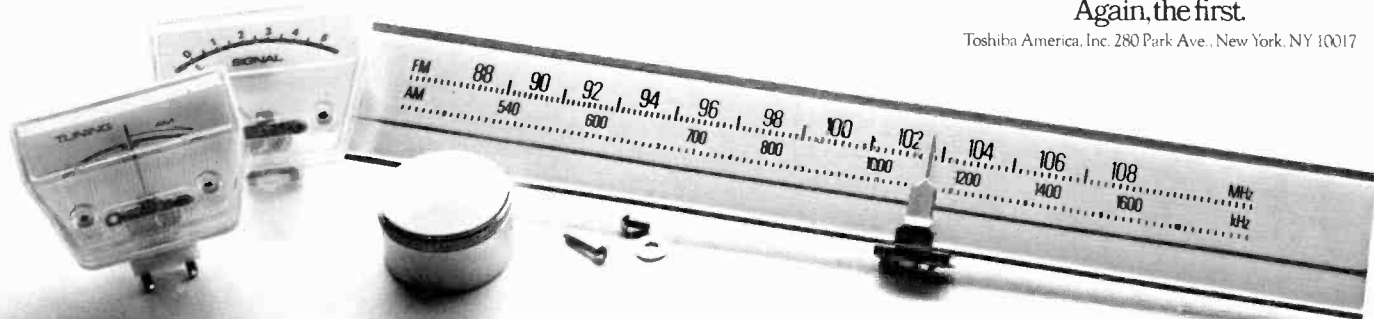

*Suggested Retail Value Solely For Purpose of Information.

COMPARISON—No. 2:

Szigeti/Bartók Van. SRV 304/5

Bartók's mature violin-piano sonatas were composed in 1921 and 1922, and both are dedicated to Jelly d'Aranyi, the grand-niece of the great Joseph Joachim. The early Twenties were a seminal time for violin technique, since Ravel's *Tzigane* (also dedicated to D'Aranyi, incidentally) appeared but two years after the second Bartók sonata. No less than Ravel's fiendishly demanding exercise, Bartók's writing here throws every difficulty known (and a few unimagined ones) at the violinist; unlike the *Tzigane* (where the orchestra, or pianist, remains silent through most of the work), murderous demands are made on the pianist as well. I have always found the First Sonata completely fulfilling and the Second slightly arid emotionally—but this is purely subjective and could easily be reversed. In any event, both compositions represent a major interpretive and technical challenge to performers.

Posterity received a magnificent gift some fifteen years ago when Vanguard unearthed a Library of Congress recital by Joseph Szigeti and Bartók himself and released it on VRS 1130/1 (since reissued in rechanneled stereo). Included was a revelatory reading of the Second Sonata. Over the years, other specialists, such as Yehudi Menuhin and André Gertler, have recorded one or both of the sonatas, sometimes with excellent results. The most serviceable of these recordings, that of Isaac Stern (Columbia M 30944), must now cede honors to both of these newcomers, partly because Alexander Zakin, Stern's pianist, assumes too much of a subsidiary role and partly because Kremer and Végh are more perceptive interpreters than Stern was.

Kremer and Végh are far removed from one another—and from Szigeti in No. 2—but each sounds completely idiomatic and persuasive in his own way. As against the striking, ruminative grandeur of the Szigeti-Bartók performance, Kremer and his excellent Soviet pianist, Yuri Smirnov, revel in a lighter, more whimsical kind of finespun lyricism. This makes the music more immediately accessible without in the least diminishing its primitive energy. Although Kremer eschews conventional, lush violin tone, he is a supreme virtuoso with a haunting coloristic palette at his disposal.

Végh, whose own fiddling is much more formidable than one might expect from a confirmed chamber musician, presents the sonatas in taut classical context: His pianissimo playing is marvelously

apt and controlled, and, although he does not attempt to make the music more palatable to the uninitiated, his beautifully integrated readings glisten with purity of intention (and realization). The English pianist Peter Pettinger offers stylish, slightly sober support in another true collaboration.

The Telefunken disc gets the edge for its superlative processing. The Hungaroton, though perfectly adequate, has slightly flawed surfaces and somewhat tubier sonority. H.G.

BEETHOVEN: *Missa Solemnis*, Op. 123.

Edda Moser, soprano; Hanna Schwarz, alto; René Kollo, tenor; Kurt Moll, bass; Hilversum Radio Chorus, Concertgebouw Orchestra, Leonard Bernstein, cond. [Günther Breest, prod.] DEUTSCHE GRAMMOPHON 2707 110, \$19.96 (two discs, manual sequence). Tape: 3370 029, \$19.96 (two cassettes) [recorded in concert, February and March 1978].

Bernstein's early Columbia recording of the *Missa Solemnis* (M2S 619) had its good points; this sequel nearly twenty years later preserves those assets—fervor, emotional warmth, moments of suitable theatrical excitement—and integrates them into a much more meaningful and cumulative progression. In fact, this may be the finest modern recording of Beethoven's towering masterwork, despite the many imposing aspects of the Klemperer (Angel SB 3679), Giulini (Angel SB 3836), Davis (Philips 6747 484), Solti (London OSA 12111), Böhm (DG 2707 080), and Jochum performances. Bernstein's craftsmanship is less formidable than Klemperer's in terms of sheer planning and precision. And, of course, no conductor could be expected to equal the clarity and rhythmic mastery of Toscanini's achievement with this challenging music. But it is quite remarkable how close Bernstein, with his less ironclad control and more genial conception, has come to the Maestro's incomparable 1940 broadcast performance.

He seems utterly caught up in the work and conducts with a combination of transfixed humanity and muscular simplicity that always directs attention to the music, never to its interpreter. The Kyrie is broadly paced, succinct, and flowing; the Gloria, which follows with very little break—a good idea, in this context, is both exultant and concise (the *meno Allegro* is treated as an integral part of what precedes and follows, not as an inorganic intrusion

Continued on page 73

Critics' Choice

The most noteworthy releases reviewed recently

BACH: Brandenburg Concertos, S. 1046-51. Aston Magna, Fuller. SMITHSONIAN RECORDINGS 3016 (2), Dec.

BACH: Suites for Orchestra, S. 1066-68, et al. English Concert, Pinnock. ARCHIV 2533 410/ (2), Nov.

BEETHOVEN: Works for Cello and Piano. Starker. TELEFUNKEN 36.35450 (3), Oct.

BERLIOZ: Harold in Italy. Suk, Fischer-Dieskau. QUINTESSENCE PMC 7103, Nov.

BOULEZ: Sonata for Piano. WEBERN: Variations for Piano. Pollini. DG 2530 803, Oct.

BRAHMS: Choral Works. Corboz. RCA RED SEAL ARL 1-3350, Nov.

BRAHMS: Piano Concerto No. 2. Tirimo, Levi. MUSICAL HERITAGE SOCIETY MHS 4001, Dec.

DONIZETTI: Lucrezia Borgia. Sutherland, Horne, Bonyngue. LONDON OSA 13129 (3), Oct. FAURÉ: Requiem; Pavane. Popp, Nimsgern, A. Davis. COLUMBIA M 35153, Oct.

GERSHWIN: *Orchestral Works*. Fiedler. LONDON PHASE-4 SPC 21185, Dec.

HAYDN: *Lo Speciale*. Kalmár, Fülöp, Lehel. HUNGAROTON SLPX 11926/7 (2), Nov.

LALO: *Trio No. 1*. SAINT-SAËNS: *Trio No. 1*. Caecilian Trio. TURNABOUT TVC 37002, Nov.

MENDELSSOHN: *Psalms 42, 95*. Corboz. ERATO STU 71101, Nov.

MOZART: *Violin Concertos, K. 211, 219*. Spivakov. ANGEL SZ 37511, Nov.

SCHUBERT: *Quartets Nos. 12, 15*. Gabrieli Qt. LONDON TREASURY STS 15418, Nov.

STRAUSS, J. II: *Waltz Transcriptions*. Boston Symphony Chamber Players. DG 2530 977, Dec.

STRAUSS: *Die schweigsame Frau*. Scovotti, Adam, Janowski. ANGEL SZCX 3867 (3), Oct. VIVALDI: *Motets*. Ameling, Negri. PHILIPS 9500 556, Oct.

CLEVELAND SYMPHONIC WINDS: *Macho Marches*. Fennell. TELARC DG 10043, Nov.

RIVERS OF DELIGHT: *American Folk Hymns*. Word of Mouth Chorus. NONESUCH 71360, Nov.

STRAUSS FAMILY GALA. Georgiadis. DBX GS 2006, Nov.

THE BEST YEARS OF OUR LIVES. Film score by Friedhofer. ENTR'ACTE EDP 8101, Nov.

Dvořák's "Other" Cello Concerto, Smetana's "Other" Quartet

by Abram Chipman

Everyone knows *the* Smetana string quartet and *the* Dvořák cello concerto. Right? And everyone knows that Dvořák wrote four symphonic poems in the last years of his life. Right? Well, everyone is thrice wrong, and Czechoslovakia's official record company sets things straight in two instances while perpetuating misinformation in the third.

Supraphon reminds us—not for the first time—that Smetana's justly renowned E minor Quartet was followed some six years later by a D minor work that continues its autobiographical anguish. But the Second Quartet differs from the First in many ways, mainly in the lack of a slow movement—even a slow epilogue such as the ending of *From My Life*. Instead, it gives us an angry fugue as its third movement and a frenzied and very brief Presto for a finale. Also, ideas are less logically developed in the later work; the composer's deafness was proceeding apace.

I suppose it takes players called the Smetana Quartet to persistently champion their namesake's Cinderella of a work, and they are the only quartet to have made LP recordings of it. Supraphon's stereo catalog lists a previous coupling of these pieces from the same personnel as SUAST 50448; it appeared here briefly in the late Sixties on Crossroads. The remake is better in every way. The sound is darker and richer, and the playing much more in tune. The performance has the extra tensile strength and cohesion required to "sell" the listener on the flawed but fascinating D minor. The familiar warmth and inflection of the Smetana's reading of *From My Life* is even more in evidence here. And the older record began the Second Quartet after the First's finale, on Side 2, whereas the current issue conveniently keeps each work intact on a separate side. A basic chamber music library item.

Dvořák's deservedly immortal B minor Cello Concerto of 1895 was actually preceded by one composed thirty years earlier. That has been largely unknown, because the composer never got it published and seems not to have orchestrated it. A posthumously edited score appeared in 1929, but the arrangers of the text performed in this world-premiere recording regard it as untrue to his manuscript. As heard here, the cello part was revised by Miloš Sádlo, who also plays it, and the or-

chestral part by Jarmil Burghauser, who is to Dvořák what Köchel and Pincherle were to Mozart and Vivaldi.

The A major Concerto certainly shows signs of a developing rather than fully matured creative process. The opening and slow movements merge into one another in the rhapsodic style of concertos by Bruch or Delius. Memorable tunes are limited, though many ideas seem to be anticipations of ones that later flourished in Dvořák's canonical masterpieces. For example, the cellist repeatedly engages in downward chromatic runs that are quite like those in the B minor Concerto's first-movement coda, and the work opens with a tune not unlike the trio section of the G major Symphony. Redundant listening maybe, but also fresh, vital, and sweeping. The finale is dominated by a swaggering triple meter figure that anticipates Dvořák's later fascination with the musical doings of the American Indian. The First Concerto may or may not belong in the forefront of the repertory, but it's certainly deserving of occasional hearings, for reasons of pleasure as well as historical curiosity.

It's hard to find fault with Sádlo and Neumann's strong, idiomatic, and technically secure performances. Some folks might question such a novel debut being mated to a two-disc set of the complete cello works. After all, you may not want yet another copy of the B minor Concerto. Rest assured. Sádlo, who evidently hasn't recorded the piece before, knows it thoroughly and loves it passionately. His musing and dusky baritone contrasts with the lyric soprano of Lynn Harrell (RCA ARL 1-1155), the urgent Heldentenor of Pablo Casals (Seraphim 60240), and the effusive and resonant bass-baritone of Mstislav Rostropovich's repeatedly documented interpretation. There are too many fine recordings of the concerto to pick any one as the all-time best, but Sádlo surely belongs in this exalted company. And he finds a sympathetic collaborator in Neumann, who sounds less square and pompous than he did in Jan Chuchro's version, reviewed by Harris Goldsmith in February 1979 (Supraphon 4 10 2075).

The fillers include a slight but attractive polonaise with piano, otherwise unknown to me, and the orchestrally accompanied versions of the little pieces often appended to the B minor Concerto. *Silent*

Woods has never sounded so heartfelt and simple nor the G minor Rondo so bouncy and earthy as they do in these renditions.

The latest purported integral edition of Dvořák's symphonic poems once again is limited to the four programmatic ones based on the horrendous folk legends of Erben and excludes the immediately ensuing *Hero's Song*, a more abstract but engaging work that has yet to be recorded commercially in stereo. As it happens, Neumann's performances are no more lively or sonically vivid than Zdeněk Chalabala's serviceable cycle, also with the Czech Philharmonic, of the Sixties, which has been reissued by the British Rediffusion/Legend series in a four-disc anthology that includes variously conducted Supraphon recordings of other Dvořák orchestral fare plus a Prague Radio mono tape under Alois Klima of *Hero's Song*. (That's enterprise and dedication for you.) Neumann himself recorded a livelier *Wood Dove* for Telefunken (36.35075).

If you want just a two-disc package of the Erben poems, Rafael Kubelik's is quite exciting, even if the Bavarian Radio Orchestra is no Czech Philharmonic. DG's inclusion of the *Symphonic Variations* is a more generous bonus than the *Husitská Overture* given on Supraphon. **MF**

DVOŘÁK: Cello Works.

Miloš Sádlo, cello; Alfred Holeček, piano*; Czech Philharmonic Orchestra, Václav Neumann, cond.*. [Pavel Kühn, prod.] SUPRAPHON 1 10 2081/2, \$17.96 (two discs, manual sequence).

*Concertos: in A (ed. Burghauser and Sádlo); in B minor, Op. 104. *Silent Woods, Op. 68, No. 5. *Rondo in G minor, Op. 94. *Polonaise in A.

DVOŘÁK: Orchestral Works.

Czech Philharmonic Orchestra, Václav Neumann, cond. [Milan Slavický, prod.] SUPRAPHON 4 10 2591/2, \$17.96 (two SQ-encoded discs).

Symphonic poems: The Water Sprite, Op. 107; The Noonday Witch, Op. 108; The Golden Spinning Wheel, Op. 109; The Wood Dove, Op. 110. *Husitská Overture*, Op. 67.

COMPARISONS—Symphonic poems:

Chalabala/Czech Phil.

Legend LGDD 101

DG 2530 712/3 Kubelik/Bav. Radio Sym.

SMETANA: Quartets for Strings: No. 1, in E minor (*From My Life*); No. 2, in D minor.

Smetana Quartet. [Eduard Herzog, prod.] SUPRAPHON 4 11 2130, \$8.98 (SQ-encoded disc).

that dispels continuity). The Credo is slow but never cumbersome or draggy as in most similarly paced readings; the "Et resurrexit," however, lacks the galvanizing impact it had in Toscanini's 1953 version. Bernstein avoids the temptation to milk the "Benedictus" violin solo in a mawkish manner: He lets the music flow without "interpreting," and the musicians are at one with him (and the music). The Agnus Dei is heartrendingly beautiful, and although the warlike hints lurking behind the pleas for everlasting peace are less sinister than in Toscanini's hands, the basic conflict comes through handsomely.

My only quibbles are the occasional rhetorical broadenings, such as the one in the last bars of the "Dona nobis pacem," the still rarer wobble in some of the soprano's otherwise rich-toned solos, and one or two details that don't emerge quite compellingly enough in this generally well-balanced live concert recording. One textual item: Bernstein has his soloists insert appoggiaturas on their Agnus Dei phrases, as Toscanini did in 1953 (but not in 1940).

In totality, this might well be Bernstein's finest contribution to the phonograph. H.G.

BEETHOVEN: Sonatas for Piano: No. 14, in C sharp minor, Op. 27, No. 2 (Moonlight); No. 18, in E flat, Op. 31, No. 3. Bagatelle "für Elise."

Bella Davidovich, piano. PHILIPS 9500 665, \$9.98. Tape: 7300 763, \$9.98 (cassette).

CHOPIN: Preludes (24), Op. 28.

Bella Davidovich, piano. PHILIPS 9500 666, \$9.98. Tape: 7300 764, \$9.98 (cassette).

Bella Davidovich is the latest in a growing list of émigré musicians from the Soviet Union, and her first Western recordings were released to coincide with a Carnegie Hall recital. Of her ability to play the piano, there can be no doubt; her music-making has a basic solidity, an honorable dependability, and at times even some communicativeness. Yet on the whole, her playing here—and at the aforementioned concert—seems to me rather plodding and unstylish, with a well-regulated routine often taking the place of stimulating sensitivity and genuine insight. At first, I suspected that perhaps Beethoven was not Davidovich's forte and that her true temperament would shine through in the Chopin preludes, but her Chopin interpretation disappoints as well and for the same reasons.

One notices as early as in the A minor Prelude (No. 2) a certain bearish deliberation, and in the G major that follows, the purling left-hand ostinato loses the requisite scintillation because Davidovich produces one basic type of sonority—a tone emanating from shoulder and arm weight rather than from finger articulation. Arrau, very much an arm-and-shoulder player himself, shows in his Philips recording of the preludes (6500 622), how much more power and color can emerge when the plush basic sound is occasionally spiced with cutting brightness and other types of definition.

In some of the quicker pieces, Davidovich plays the patterns faster than the ear can decipher them, producing a slightly smudged sound. Certainly her account of the F sharp minor Prelude (No. 8) lacks the astute linear separation heard in the performances of Arrau, Ashkenazy (London CS 7101), Pollini (DG 2530 550), and Perahia (Columbia M 33507), and at no time does her generalized lyric approach communicate as do those performers and, for all her careless moments, Martha Argerich (DG 2530 721).

In the main, Davidovich is at her most convincing in quiet, lyric preludes, such as the so-called *Raindrop* (No. 15 in D flat) or the massive C minor (No. 20). Others, such as No. 17, that require a more subtle, tensile delicacy verge on squareness and overdeliberation; the perfervid B flat minor (No. 16), the anguished D minor (No. 24), the tumultuous G minor (No. 22), and the suicidal F minor (No. 18) lack the needed degree of vehemence and clarity. Davidovich rightly plays the E flat in the third bar of No. 20, and most of her other textual options show her to be using a reliable edition. This makes her curious—and apparently wholly unauthorized—G sharp near the end of the A major Prelude (No. 7) all the more baffling. (It is also musically unsatisfactory, since it destroys the three-note pattern that recurs throughout the shortest of the preludes.)

Neither is the Beethoven record what one might expect from a pianist whose outlook and training point to the Romantic tradition; the playing isn't Romantic at all, but in fact, rather bland, careful, and rounded off. To be sure, it is pleasingly direct and unaffected, but with so many more insightful readings of these sonatas available, Davidovich's prosaic *Moonlight* and only (to borrow Sullivan's immortal phrase) moderately rapturous Op. 31, No. 3, seem superfluous—a sort of dietetic Rubinstein. Like Ashkenazy in his

INTRODUCING



DIGITAL

THE
EMI
DIGITAL
RECORDING
SYSTEM

Simply stated—*digital recording* is the most revolutionary advancement in the recording art since LP and stereo.

"The new hybrid records bring a full panorama of sound rushing from the speakers. In rock, digital is like scoring a studio seat next to the microphone. In classical, the sound is like a symphonic apotheosis. Floors vibrate; paint could crack; leases may be broken." *Time* (7/9/79). Herein, you're provided the most shockingly clean sound ever to come from disc. Virtually distortion free. And no need for supplemental playback equipment.

DEBUSSY
IMAGES FOR ORCHESTRA
Gigues · Iberia · Rondes de printemps
**PRÉLUDE À L'APRÈS-MIDI
D'UN FAUNE**
London Symphony Orchestra
PREVIN



DS-37674

Via the technical capabilities of the EMI Digital Recording System, Angel Records now enters the world of computerized recording. The repertoire choice is of show-piece quality. Debussy is the ideal medium with which to introduce the form. Colorful orchestration. Wide dynamic range. Challenging contrasts of light and dark. André Previn is the interpretative spokesman; quality perfect Angel discs, the communicative force.



from caedmon

Introducing...

ARABESQUE RECORDINGS

the *new choice*
in classical music

Until now, many of classical music's rarest treasures were so difficult to find or were available only at very expensive prices... at \$6.98 for each record or cassette, your *new choice* is ARABESQUE.

ARABESQUE's debut is celebrated with a spectacular release list... "Bach After Midnight" (AR8044); high-C-above-C soprano, Miliza Korjus (AR8013); the first-ever recording of "The Barber of Seville" (AR8029-3L); Rupert D'Oyly Carte's personal productions of Gilbert & Sullivan's "H.M.S. Pinafore" & "Trial By Jury" (AR 8052-2L); the unobtainable Sibelius' Symphony No. 2 in D Major, conducted by Sir Thomas Beecham (AR8023) and more. For a truly impressive listening experience, your *new choice* is ARABESQUE.

SPOTLIGHT RELEASE



BEETHOVEN's first opera, LEONORE

(Original Version, 1805) Donath, Büchner, Ridderbusch, Moser, Adam; cond. by Herbert Blomstedt

Much of this great music, forerunner of "Fidelio," has not been performed in this century. "Fascinatingly different." — *High Fidelity*. "A valuable recording, a rich study."

— Alan Rich, *N.Y. Magazine*.

Triple record set, Libretto (8043-3L)
Triple cassette set, Libretto (9043-3L)

Each \$21.94

Make your *new choice* now... request catalog from:

ARABESQUE RECORDINGS

caedmon

1995 Broadway • New York 10023 • Dept. HF1

Circle 9 on Page 77

recent recording and Backhaus in his old one, she modifies Beethoven's figurations in the second movement of the latter work to exploit the extended range of our modern keyboard. It is a defensible option, but not one I favor.

Both recordings are up to Philips' usual high standards of sound and processing. H.G.

BERLIOZ: Requiem, Op. 5.

Kenneth Riegel, tenor; Cleveland Orchestra and Chorus, Lorin Maazel, cond. [James Mallinson, prod.] LONDON OSA 12115, \$17.96 (two discs, automatic sequence). Tape: OSA5 12115, \$17.96 (two cassettes).

COMPARISON:

Davis/London Sym. Phi. 6700 019

The way Maazel and his forces sustain and control the quieter passages of Berlioz' Requiem is impressive—as, too, is the smoothness and power of the recorded sound. Kenneth Riegel sings the difficult solo in the Sanctus with sweet and secure tone; not since Léopold Simoneau (in the Munch/Boston recording) has anyone sounded quite as comfortable in this altitudinous writing.

But Maazel's control admits of no exuberance; the biggest moments are stodgy and unexciting, though ample in sound. As before, the villain is rhythmic blandness. Maazel, like Ozawa and Barbenoim, is one of the modern conductors who cannot make Berlioz' syncopations, cross-accents, and irregularities of phrase come bounding to life as once did Harty, Beecham, Toscanini, Kletzki, and even—despite some compensatory bad habits—Munch. Those big string chords on the off-beats in the "Lacrymosa" don't sound like syncopations. The grandly expansive hemiola at the climax of that movement sags badly, and the gross ritard just before its final chord is simply clumsy.

The "Rex tremendae" begins too fast for Berlioz' Andante maestoso; only at the return to Tempo I (at "Qui salvandos salvas gratis") do we get what *should* have been the initial tempo. In the first quiet section of the "Lacrymosa," the bassoons and string basses don't seem to be quite together. In the "Quaerens me" and the Offertorium, Maazel prefers the longer text of the first edition over Berlioz' revised second-edition score; as far as I can tell from my notes, Abrahams' is the only other current recording to make this choice, which the historical evidence certainly disrecommends.

As I've already suggested, the sound is good, a successful blend of clarity and

resonance. The quiet cymbal-and-bass-drum strokes in the Sanctus are registered as events of quiet power, not major detonations. Alas, an undervibrant Requiem is as unsatisfactory as a hyperactive one; the Colin Davis version still makes the most of both of the work's extremes. D.H.

CHOPIN: Nocturnes (21). For a feature review, see page 63.

CHOPIN: Preludes (24), Op. 28— See Beethoven: Sonatas for Piano.

CIMAROSA: Il Maestro di cappella. Il Matrimonio segreto: Overture and Aria. Il Fanatico per gli antichi romani: Sinfonia.

Philippe Huttenlocher, baritone; Lausanne Chamber Orchestra, Armin Jordan, cond. MUSICAL HERITAGE SOCIETY MHS 4040, \$5.20 (\$3.95 to members) plus \$1.25 shipping (Musical Heritage Society, 14 Park Rd., Tinton Falls, N.J. 07724).

Il Maestro di cappella is a capital farce—not a full-fledged opera buffa, but a twenty-minute intermezzo in the form of a long accompanied recitative that uses the idiom and technique of the purest classical buffa. The theme is familiar and indestructible: Everyone, whether fiddler or timpanist, wants to be a conductor.

In this case the aspirant is a singer, boasting to the orchestra that he is no tyro but a disciple of the famous Cavaliere Scarlatti (which the inept translation gives as "Sir Scarlatti!"), and he promises a bonus in the form of a fine aria. The would-be maestro immediately runs into trouble. "What are you doing, my dear oboe? . . . Let's start again from the beginning. . . . Damned double basses, what the devil is going on? . . . Pay attention to the beat!" Then there is apparently a turn for the better: "I am happy. . . . Oh, what a blessed orchestra." Obviously, the orchestra is engaging in the age-old game of testing whether they can throw a new conductor; the basses are grumbling, the horns blasting, the flute misses its cue, and so forth, but when they see that the man knows his business, they come around. There is an excellent little overture, the vocal part could not be more skillfully written, and the bubbling orchestra is full of witty tricks but also of bits of nice melodies. Rossini—and even Mozart—did not miss any of these things.

I could have sworn that the fine baritone who is the entire cast hailed from the foothills of Mount Vesuvius. He has a warm Italian voice, has the style in his

Metal Tape, MC Cartridges, monster amps and digital records have finally met their match.

Your speakers are the most important part of your hi-fi. No matter what you drive them with, they're the only part of a system you actually hear. So, serious hi-fi buffs have usually been more demanding of speakers than any other component.

Now, even more pressure is being applied to speaker technology by a "state-of-the-art" in sound that is racing ahead with innovations in both recording and play-back technique. Yet, improvement in most speakers is limited to "bits and pieces" added on to existing designs.

JVC took a different approach by developing a line of speakers based on the demands of tomorrow's "state-of-the-art" products.

We went back to ground zero by considering two factors.

1) The source: Modern studio engineers cram up to 32 tracks of gutrocking bass, pounding percussion, close-miked vocals and sizzling cymbal and percussion onto a record with more technology and production breakthroughs every day.

2) The signal chain: Digital and direct disc mastering, moving coil cartridges, high-powered low THD amps and metal particle tape can seriously challenge any conventional speaker on the market today.

So we started with a PowerRibbon tweeter that can turn 200 watts of power into crisp, precise, widely dispersed highs using a driver diaphragm nearly twice as light as most conventional dome tweeters. Crank a digital record or metal tape up loud and you get beautiful highs, not a puff of smoke.

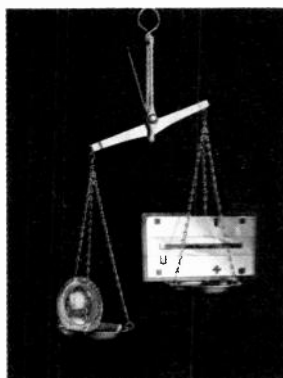

The lighter it is, the faster it moves. A conventional dome tweeter outweighs the JVC PowerRibbon polyimide ribbon element by almost 2:1.

We studied midrange cone flex and then computer designed a phenolic cone aluminum dome mid that achieves multi-octave pistonic motion with wide dispersion and low distortion for realistic instrumentals and intimate vocals.

And finally we determined why a woofer's cone can turn out flabby bass.

It's a cone.

All the exotic materials, coatings and magnet structures in the world just yield a more expensive woofer, not a better cone shape. Our computer designed Alpha woofer is a concave curve for maximum rigidity, driven by a long-throw heat-resistant voice coil and massive

ceramic magnet structure.

The result is tight low bass with depth, not boom.

When you mount these special drivers in a rose-wood veneer enclosure and fine-tune them with our unique Phase-Moire Propagation technique, you have a design whose excellence needn't rest on a single "latest breakthrough." Rather, here is a total speaker design, for the world of sound yet to come.

So before you subject yourself to the cross talk of hundreds of speaker brands, call 800-221-7502 (NY State, 212-476-8300) or write us at 58-75 Queens Midtown Expressway, Maspeth, NY 11378 for your nearest JVC dealer.

One test-listen and you'll be ready for JVC.

Shown: **Zero-5** 3-way, 200W peak input, 35-50,000Hz, 92dB/W (1 M); **Zero-9**, 3-way with additional differential resonance active 12" woofer, 300W peak input, 25-50,000Hz, 92dB/W (1 M). Not shown: **Zero-3**, 3-way with 10" woofer/same tweeter, and dome cone midrange, 150W peak input, 40-50,000Hz.



JVC[®]
US JVC CORP

Now you're ready for JVC.

THE ONKYO TX-MKII RECEIVERS... COMMITTED TO QUALITY



Most manufacturers play "take away" when they design a product line. With every cost reduction, there's a quality loss. Onkyo takes a different approach. Each of the five models in the TX-MKII series of receivers represents an exceptional value for price. And vital performance features such as Onkyo's exclusive distortion-free, quartz or servo-locked FM tuning are built into each of the receivers, as is the sophisticated HTS™ (Human Touch Sensor) control. HTS™ senses your touch on the tuning knob and "unlocks" the station. You rough tune to another station, release the knob and the HTS™ analog comparator circuits automatically find and precisely lock into the most distortion-free station setting.

And aside from the excellent signal-to-noise ratios at all inputs, the Onkyo TX-MKII series provides excellent value-to-

dollar ratios of all power levels, starting with the top-of-the-line digital-readout TX-8500MKII rated at 160 watts per channel, with 0.05% total harmonic distortion, both channels driven into 8 ohms from 20 Hz to 20 kHz, to the modest TX-1500MKII at 17 watts per channel and 0.03% THD under the same conditions.

Don't step down in quality. Step up to Onkyo.

Artistry in Sound

ONKYO

Eastern Office: 42-07 20th Avenue, Long Island City, NY 11105 (212) 728-4639
Midwest Office: 93E Sivert Drive, Wood Dale, IL 60191 (312) 595-2970
West Coast Distribution Center: Damarik Industries, Inc.
20600 Nordhoff Street, Chatsworth, CA 91311 (213) 998-6501
Canada: Sole Distributor, Tri-Tel Associates, Ltd., Ontario, Canada

Free Armchair Shopping Service

On the card opposite, circle the number indicated at the bottom of the ad or at the end of the editorial mention of the product you're interested in. (Key numbers for advertised products also appear in the Advertising Index.)

Type or print your name, address, and zip code on the card. Postage is prepaid.

Mail the card today. You'll soon receive free product literature and specifications from manufacturers.



Three Great Buyer's Guides From HIGH FIDELITY Order Now!

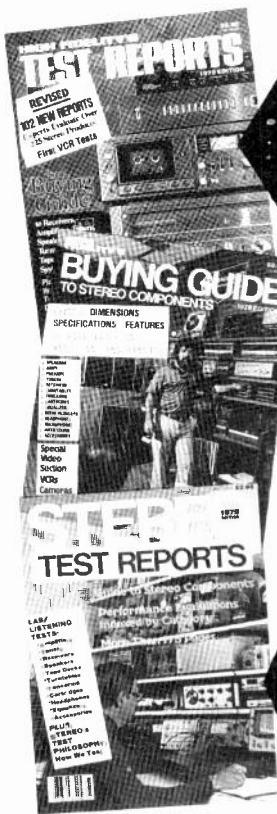

**1979
HIGH
FIDELITY'S
Test
Reports
\$3.95
Circle
161**

**1979
Buying
Guide to
Stereo
Components
\$2.95
Circle
162**

**1979
Stereo
Test
Reports
\$2.95
Circle
164**

To order, circle the number on the attached card that matches the number of the Buyer's Guide you want. Enclose payment plus \$1.00 for postage with your order and mail to:

HIGH FIDELITY
One Sound Avenue
Marion, Ohio 43302

(Enclose payment. No credit orders.)

bones, and displays a hundred hues and nuances that in this genre one expects only from a Baccaloni or Corena (who, incidentally, recorded it twice for London, most recently twenty years ago on a delightful and still available set). But his name, Philippe Huttenlocher, points perhaps to an Alsatian. Whatever the case, he is a real find. The Lausanne orchestra under Armin Jordan functions well, though at times it sounds a little too energetic, which may well be the fault of the sound engineers.

On the other side of the record are the overture and an aria from *Il Matrimonio segreto* and a so-so overture to another opera. Funny how these people operate. They discover and record a gem, then instead of making a memorable recording by digging for something else unknown and attractive (the libraries are full of them) they fall back on whatever is safe and available.

The text of *Il Maestro di cappella* must be fully understood for one to appreciate the amusing goings-on. Musical Heritage furnishes a scurvy page with a hard-to-read text and its translation, as well as some oft-repeated musicology on the sleeve. P.H.L.

DVOŘÁK: Cello Works; Orchestral Works. For a featurette, see page 72.

GOUNOD: Faust.

CAST:

Marguerite	Mirella Freni (s)
Siebel	Michèle Command (s)
Marthe	Jocelyne Taillon (ms)
Faust	Plácido Domingo (t)
Valentin	Thomas Allen (b)
Wagner	Marc Vento (b)
Méphistophélès	Nicolai Ghiaurov (bs)

Paris Opera Chorus and Orchestra, Georges Prêtre, cond. [Christopher Bishop and Gréco Casadesus, prod.] ANGEL SZDX 3868, \$36.98 (four discs, automatic sequence).

COMPARISONS:

Bonyng/London Sym.	Lon. OSA 1433
Lombard/Strasbourg Phil.	
	RCA FRL 4-2493
Cluytens/Paris Opera	Ang. SDL 3622
Clewa/Met. Opera	Odys. Y3 32103

This is a better *Faust* than we have any right to expect, given the present state of the art, and it can be recommended with some confidence over the modern competition, which says as much about the competition as it does about the new version.

Let's get the textual stuff out of the way first. What we have here is the complete published score, which means that

only the London recording contains music not heard here—a few lines here and there, nothing of substance. As in the London and Erato/RCA recordings, the two familiar scenes of Act IV (church and Valentin's death) are preceded by the scene in Marguerite's room that includes her aria "*Il ne revient pas*"; the Erato, however, omits Siebel's answering song, "*Si le bonheur*."

The Walpurgis Night is complete, and that's an important first: At the point in the second tableau where the ballet (which may or may not be by Gounod) was inserted, we hear instead the original recitative and drinking song for Faust ("*Vains records! . . . Doux nectar dans ton ivresse*"). This episode appears in current vocal scores but not in any orchestral score I've seen, and I've never heard it performed before. As I suspected, it is an effective number—the recitative in particular gives the tenor some rousing opportunities—and keeps the scene more manageably proportioned than the ballet (which is performed as an appendix on Side 8).

In theory, then, the new Angel performing edition seems to me the best available to us, but that theoretical advantage is not fully realized in the performance. Plácido Domingo makes a good thing of the "new" number—indeed, the *Nuit de Walpurgis* as a whole goes very nicely—but neither Mirella Freni nor Michèle Command does much to show why the Act IV restorations are a good idea. The competition provides no help in this regard either. At least for "*Si le bonheur*" there's a lovely 1929 Branzell recording (available on Preiser LV 47, which also includes Branzell's "*Faites-lui mes aveux*"); for "*Il ne revient pas*" one must still exercise imagination.

Not that Freni is painful to listen to. Marguerite doesn't force her to puff up the tone as do the heavier roles she has recorded in recent years; all the same, the voice shows the same imbalance Conrad L. Osborne described in connection with her *Bocanegra* Amelia (DG 2709 071, February 1978). The sound curdles under pressure, and the middle octave tends to be breathy and unfocused; the lower-middle area is occasionally reinforced by that same eerie "baby chest"—the A flats of "*Parle, parle encore*" in the love duet sound like a Callas impression.

Elsewhere the somewhat blowsy quality may sound like a Caballé impression, until you check out the real thing in the Erato set. Like Caballé, Sutherland (London) is adroop in cloudland, and the Cluytens/Angel version preserves one of

De los Angeles' more sluggish performances. Does that make Freni the cream of the stereo crop? Maybe so, but if you expect a Marguerite to give us some reason why we should care about her, you'll have to go back to Steber on the old Met recording (now on Odyssey).

Controlled lyric singing is not Domingo's strong suit either, though I'm not about to complain about the sounds he *does* make. This is a vocally well-managed performance, and it has all the external markings of a "sensitive" one. So why does it

leave me cold? It's true that the voice lacks flexibility around and above the break, but this is even more true of Corelli's (London)—a significantly larger-scaled instrument, of course. And yet Corelli almost always seems to me to be trying to create Faust from the inside, whereas Domingo settles for grafted-on gestures.

The happy surprise of the new set is Nicolai Ghiaurov's Méphisto, a dramatic improvement over his contribution to the London recording, made when the voice was in its gorgeous prime. In those days

Ghiaurov was capable of flaunting his voice obnoxiously, and the earlier Méphisto was characterized by an overweighted, gloppy, bully-boy legato. In recent years, as the upper part of the voice has fallen apart, he has shown little inclination to adjust to his diminished capacities, to reassert control over what could still be a significant instrument.

Suddenly we have a new Ghiaurov. He can still manage a firm, rich sound in the lower area—say, from C to G (the voice never had much real bottom); now he's lightening his handling of the upper part of the voice, producing a sound that may lack the former power and brilliance but does complete the voice plausibly, is agreeable to the ear, and is under the singer's control. And that control is exercised to excellent effect—mature, dignified, unhysterical. Oh, there's some heavy going (e.g., "Reines de beauté" in the *Nuit de Walpurgis*), but also much singing that is quite lovely to listen to.

Another pleasant surprise is the Valentin of Thomas Allen. He fills out this difficult role with continuously bright and attractive sound, coupled with some real control of tone color, volume, and attack. What's more, his French is not merely correct, but expressive. For sheer vocal oomph Allen won't be mistaken for Lisitsian (in the old Melodiya recording) or Blanc (in the Cluytens/Angel set), but I had no idea we could muster a Valentin of this quality.

As suggested earlier, Command is a weak Siebel (but again, the competition . . .). Jocelyne Taillon is an above-average Marthe, as she was in the Erato set, although here the competition includes the redoubtable Rita Gorr (Cluytens/Angel). Marc Vento is a fine Wagner.

Georges Prêtre is the only major conductor I know of who really believes in *Faust*, and this shows in his refusal to rush things. His tempos are generally on the broad side (although, as I've pointed out before, Gounod's metronome markings are *extremely* slow); unlike Erato's Alain Lombard, he doesn't let the bottom fall out of the music. I also like the presence of the lower instruments in rich orchestral balance. Prêtre has lots of ideas about the score, but he hasn't entirely succeeded in translating them from conception to performance. More rehearsal might have helped; this is, after all, quite different from the *Faust* the Parisians are used to performing. Part of the problem may be that the Opéra forces, in the process of acquiring a modicum of discipline, seem to have lost some of their native flavor. The choral and orchestral work is reasonably efficient but not especially virtuosic or idiomatic.

Okay, so this isn't the *Faust* to confound naysayers. It's better than what we had and quite adequately recorded. K.F.

Continued on page 82

SUPER DISCS

Quality Music, Quality Pressings, Quality Sound



Nautilus Recordings announces the second of its Half-Speed Master Series. These high quality discs are produced from the original master tapes, mastered at half-speed to insure maximum fidelity and then pressed on 100% virgin vinyl to bring you all the music.

Available now: Dreamboat Annie (Heart). Coming soon: Half-Speed Master Series — America, Pablo Cruise, Joan Baez, Seals & Crofts, Loggins & Messina, Blood Sweat & Tears, Joni Mitchel; Direct Disc LP — John Klemmer; Digital LP — Tim Weisberg.

Expect more from Nautilus Recordings.

Nautilus Recordings
761 Shell Beach Rd.
Pismo Beach, CA 93449
(805) 773-1848
Dealer Inquiries invited



Rare Opportunity! Schwann Record & Tape Guides now available by subscription



Now you can have the latest and best information on over 45,000 recordings at your fingertips. Including artists, labels, and prices. Plus previews of newest releases!

EXTRA! SCHWANN'S "BASIC RECORD LIBRARY" FREE WITH YOUR SUBSCRIPTION!

Since the first Schwann LP Guide appeared in 1949, over 31 million of them have made their way to record stores throughout America. And untold millions of record collectors have made their way to record stores to use Schwann Record & Tape Guides.

Now Schwann Guides will make their way to you—on a subscription basis. Saving you time and effort. Instead of hurriedly thumbing through worn-out, torn-out store copies, you'll receive each monthly issue in mint-fresh condition. To go through at your leisure. And keep handy for reference at all times.

The cornerstone of your subscription is SCHWANN 1, the *monthly* Record & Tape Guide. Each issue contains about 300 pages ... lists approximately 45,000 stereo LP records, 8-track cartridges, and cassettes—on almost 1,000 record, tape, and quad labels. Contents include:

NEW LISTINGS. Hundreds of them each month ... in all categories! With SCHWANN 1's NEW LISTINGS section as your guide, you can be first to hear and judge the new releases ... compare your reactions with those of the critics. And you won't miss out on any new recordings which may sell out quickly at record stores.

COMPOSER SECTION. Contains alphabetical listings, by composer, of every work currently available and the date it was written ... pertinent information about each recording (artists, label, etc.) ... availability of digital, direct-to-disc, stereo or mono, Quad records, 8-track cartridge tapes, Quad-8 tapes, and/or cassette tape versions of each work. Plus those well-known black diamond notations to indicate imminent deletions from the catalog—and from record stores.

PLUS ... COLLECTIONS ... MUSICALS, MOVIES, TV SHOWS ... POPULAR ... JAZZ AND JAZZ ANTHOLOGIES.

BEST SELLING RECORDINGS. The nation's top ten LP's—in classical, jazz and pop.

PRICE LISTS. Latest manufacturers' prices for every label listed, Mono prices, too. This valuable information enables you to compare costs—as well as recording artists—and make the best buying decisions!

Your Schwann Record & Tape Guide subscription includes twelve monthly issues of

SCHWANN 1. In addition, you'll receive two semi-annual editions of SCHWANN 2—with mono and simulated stereo recordings ... spoken word ... international pop and folk ... older jazz mono classics. Plus the annual CHILDREN'S & CHRISTMAS RECORD & TAPE GUIDE, providing listings of more than 1,500 educational and musical recordings for young people, and over 350 Christmas recordings.

Schwann Record & Tape Guides help you list and locate records you're looking for in a matter of seconds.

They enable you to track down musical works you enjoy in concert and on FM ... and that you would like to add to your record and/or tape collection.

They let you know when to snatch up "Collector's Item" recordings before they disappear from dealers' shelves.

They add to your knowledge about music. And about composers—when they lived, what they wrote, and when.

In short, the Schwann Record & Tape Guides are indispensable for all who love music and collect records.

See for yourself by entering your subscrip-

tion now. The cost—for twelve monthly issues of SCHWANN 1, two semi-annual editions of SCHWANN 2, and the CHILDREN'S & CHRISTMAS RECORD & TAPE GUIDE—is only \$25, including postage. That's the lowest price available. Purchased singly by mail, these same fifteen Schwann Guides—at \$2.50 each—would cost \$37.50. You save \$12.50—33%! Act now because this a limited offer and may never be repeated!

Use the coupon below to order. You can't make a wiser investment—for your listening pleasure or your record collection!

EXTRA! FREE WITH YOUR SUBSCRIPTION!

While supply lasts, each new subscriber will receive a free copy of the SCHWANN BASIC RECORD LIBRARY. It's a "classic" in the field, with listings of over 1,100 works—Medieval and Renaissance Music ... The Baroque Era ... Classicism ... Romanticism ... and 20th Century. Helps you build an outstanding collection ... opens up new areas of musical interest for you. A must for every record collector. And it's free with your subscription to Schwann Record & Tape Guides when you order now!

TO: Schwann Record & Tape Guides PO Box 550 Great Barrington, MA 01230 SUBSCRIPTION FORM

YES, send me a FREE copy of the SCHWANN BASIC RECORD LIBRARY and enter my one-year subscription for Schwann Record & Tape Guides—twelve monthly issues of SCHWANN 1; two semi-annual editions of SCHWANN 2; plus the CHILDREN'S & CHRISTMAS RECORD & TAPE GUIDE.

\$25 payment enclosed.

Charge as indicated:

VISA

Master Charge

Interbank # _____

Account # _____

Expiration date _____

Signature _____

NAME _____

ADDRESS _____

CITY _____ STATE _____ ZIP _____

(Above offer good only in U.S. and possessions)

DAH1

fact:
the phono
cartridge is the
heart of hi-fi...



The hi-fi phono cartridge functions as the source of sound (the point at which the recording is linked with the balance of the hi-fi system)—therefore, its role in high fidelity is absolutely critical. Just as the camera can be no better than its lens, not even the finest hi-fi system in the world can transcend the limitations of an inferior cartridge. The cartridge represents a relatively modest investment which can audibly upgrade the sound of your entire record playback system.

Consult with your nearby Shure dealer who will help you select the Shure phono cartridge that is correct for your system and your checkbook. We especially recommend that you audition the Shure V15 Type IV. Discriminating critics throughout the world praise this cartridge as the new standard for faithful sound re-creation. It overcomes such ever-present problems as dust, static electricity, "hot" signals, and record warp that cause "clicks" or "pops" and distorted record reproduction. May we send you our brochure?



Shure Brothers Inc., 222 Hartrey Ave.,
Dept. H1, Evanston, IL 60204
In Canada: A. C. Simmonds & Sons Limited

Manufacturers of high fidelity components,
microphones, sound systems and related
circuitry

Circle 35 on Page 77

HAYDN: Sonata for Piano, No. 52,
in E flat. For a feature review, see page 63.

MOZART: Le Nozze di Figaro.

CAST:

Countess Almaviva	Anna Tomova-Sintov (s)
Susanna	Ileana Cotrubas (s)
Marcellina	Jane Berbié (s)
Barbarina	Christiane Barbaux (s)
Cherubino	Frederica von Stade (ms)
Don Basilio	Heinz Zednik (t)
Don Curzio	Kurt Equiluz (t)
Figaro	José van Dam (b)
Count Almaviva	Tom Krause (b)
Antonio	Zoltan Kélémen (b)
Bartolo	Jules Bastin (bs)

Konrad Leitner, continuo; Vienna State Opera Chorus, Vienna Philharmonic Orchestra, Herbert von Karajan, cond. [Christopher Raeburn, prod.] LONDON OSA 1443, \$35.92 (four discs, automatic sequence).

Herbert von Karajan's prodigious technique is hardly news any longer, but to those still unaware of the sheer mastery of his conducting, this recording will come as a revelation. The smooth blend of instrumental textures, the range of colors at his command, even the varieties of attack he elicits from the Vienna Philharmonic reveal a level of virtuosity (not to mention a degree of willpower) that is almost astonishing. Were technical brilliance the sole criterion of artistic achievement, this *Figaro* would be something to treasure. As it is, it is little more than a curiosity. To see so enormous a talent applied to such dubious artistic aims is cause for wonderment.

In his vocal recordings of the last decade or so, Karajan has created a highly distinctive style, in which spontaneity has been replaced by smoothness, dramatic tension by reflectiveness, the play of character by the exercise of rigid authority. To achieve these ends he will sacrifice the individuality of the singer for a homogeneity of sound that is essentially orchestral in character. The result in recording after recording is a devitalized, dreamlike atmosphere, in which the auditor is made to feel like the witness, not of a drama in progress, but of the conductor's recollections of, and reflections on, that drama.

So it proves once again. In Karajan's hands, what is arguably the most richly human of Mozart's operas becomes frigid, remote, and unengaging. Though matters improve somewhat later on, Act I in particular seems to take place in a world of shadows and ghosts, where characters murmur to one another abstractedly, or breathe their thoughts aloud to themselves in a manner

suggesting moonstruck bemusement. The secco recitative preceding "*Se vuol ballare,*" which, according to the score, is meant to be delivered while Figaro is pacing furiously around the room, is whispered in one's ear almost confidentially; Figaro sounds less defiant of the Count than frightened of him—a situation only aggravated by the aria's lack of all élan and therefore insolence. Cherubino's "*Non so più*" is a protracted murmur, during which the page seems to be swooning away with incommunicable ecstasy.







Susanna and Marcellina try to best one another at a speed so fast and a rhythm so unyielding that all sense of conflict—and therefore of comedy—is put to flight. Much the same is true of the scene in which Cherubino is discovered hiding in Susanna's chair. In Act III, Marcellina's all-important explanation to Susanna of the former's maternal relationship to Figaro is submerged in orchestral sound. In Act IV, the comic misunderstandings that precede the denouement are taken at so fast a clip and treated so airily that the final reconciliation, which seems insufficiently motivated, is robbed of half its effectiveness. In one or two places, Karajan shows himself aware of the powerful forces that confront one another in this opera: in parts of the second-act finale, for example, or in the Count's aria, which has just the right kind of authoritarian weightiness. But on the whole the performance lacks any real sense of dramatic engagement.

Of the singers, only José van Dam, an artist of uncommon intelligence and musicianship, manages both to sing well and to create a sense of autonomous characterization. The others are seriously hobbled by the intransigence of Karajan's leadership, Cotrubas' Susanna sounding vocally undernourished and dramatically wan, and the Count and Countess of Tom Krause and Anna Tomova-Sintov inelegant and monochromatic. Frederica von Stade's Cherubino is livelier but white of tone and affected in the extreme; it would be good to hear from this talented mezzo some extended singing that was both fully sustained and squarely on pitch. Jane Berbié and Jules Bastin are engaging enough but rather too modestly endowed for the demands of Marcellina's and Bartolo's arias. The latter is also true of the less well characterized Basilio of Heinz Zednik. Like the more enjoyable Zoltan Kélémen (Antonio), Zednik needs better Italian coaching. The chorus is good.

The recitatives are closely miked, the rest is recorded more spaciouly. I find the double focus, like so much in this recording, disconcerting. In any case, the over-resonant sound favored by Karajan is hard to get used to. My copy of London's press-

fact: a Genuine Shure upgrade stylus is unquestionably the biggest bargain in hi-fi

We strongly urge you to check your stylus for wear at least once a year to protect your records and maintain the highest standards of listening pleasure. Regardless of when (or where) you purchased your Shure cartridge, there is a Genuine Shure replacement stylus available which will bring your cartridge right back to its original specifications. Even better, you may actually be able to improve its performance significantly over the original with a Genuine Shure upgrade stylus...at surprisingly low cost! For example:

IF YOU OWN:	UPGRADE WITH:
 V15 Type III SERIES	 VN35HE Hyperelliptical stylus
 M95 SERIES	 N95HE* Hyperelliptical stylus
 M70 SERIES	 N72EJ Biradial (Elliptical) stylus  N72B Spherical stylus
ANY M91, M92, M93	N91ED* stylus
ANY M71, M73, M75	N75 TYPE 2* Series styli
ANY M44 Series	N55E stylus
M3D, M7D	N21D* stylus

*Before purchasing any replacement stylus be certain your turntable is compatible with the tracking force of the stylus you select

**Always insist on a
Genuine Shure
replacement stylus.
Look for the name
"Shure" on the stylus
grip.**



Shure Brothers Inc., 222 Hartrey Ave., Evanston, IL 60204
In Canada: A. C. Simmonds & Sons Limited
Outside the U.S. or Canada, write to Shure Brothers Inc., Attn: Dept. J6 for information on your local Shure distributor. Manufacturers of high fidelity components, microphones, sound systems and related circuitry

Circle 36 on Page 77

ings was uncharacteristically noisy. Libretto and translation are furnished. For Mozart lovers the best *Figaros* currently available are, I believe, Colin Davis' (Philips 6707 014) and, though the sound is somewhat dated, Erich Kleiber's (London OSA 1402). D.S.H.

MUSGRAVE: Mary, Queen of Scots.

CAST:

Mary	Ashley Putnam (s)
Mary Seton	Gloria Capone (s)
Mary Beaton	Nancy Boling (s)
Mary Livingstone	Ann Scholten (ms)
Mary Fleming	Pamela Scott (ms)
Henry, Lord Darnley	Jon Garrison (t)
James Hepburn, Earl of Bothwell	Barry Busse (t)
Earl of Ruthven	Pietro Pozzo (t)
James Stuart, Earl of Moray	Jake Gardner (b)
Cardinal Beaton	Carlos Serrano (b)
Earl of Morton	Robert Randolph (b)
David Riccio	Kenneth Bell (bs-b)
Lord Gordon	Francesco Soriano (bs)

Virginia Opera Association Orchestra and Chorus, Peter Mark, cond. [Allen House, prod.] Moss Music Group MMG 301, \$24.95 (three discs, manual sequence).

Very few operas written in the past fifteen or twenty years have received the kind of attention that Thea Musgrave's *Mary, Queen of Scots* received at its world premiere at the Edinburgh Festival in September 1977 and its first American performances in Norfolk, Virginia, in April 1978. But then, very few contemporary operas have the kind of immediate appeal that this one has. Its success goes to show that, even in an age when ascetic psychodramas have made inroads on our musical stages, opera is still a powerful vehicle for good old intrigue, sex, and blood—and if the characters happen to be queens, lords, courtiers, and soldiers, so much the better.

Musgrave's third full-length opera deals with seven years in the life of the ill-fated Queen of Scots, from the time of her return to Scotland after the death of her husband, Francis II of France (in 1561, when she was eighteen), until she retreated to England, deprived of her honor and her crown. Within that period, Mary wed her cousin Darnley, her half-brother James staged the "Chaseabout Raid," Riccio was murdered, the future James I of England was born, Darnley was killed, and plots merged with counterplots. There's obviously plenty of material here for an opera. Or two or three.

Like her predecessor Donizetti, Musgrave chose to take certain liberties

fact: the ultimate ...made more affordable

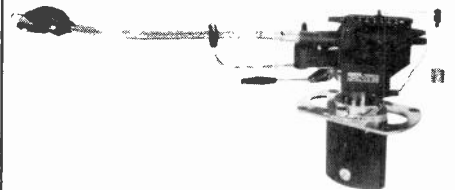

 **SHURE**®

SME

**Series IIS
tone arm**

The designers of the award-winning Series III tone arm took on the challenge of developing a tone arm with essentially *the same* outstanding performance characteristics as the Series III, but at a significant reduction in price.

The Series IIS tone arm is an instrument that is still definitely in the connoisseur class employing state-of-the-art materials and technology for unsurpassed strength-to-weight ratios in critical areas. Perfectionists will achieve the same flawless performance they have come to expect only in the SME Series III.

The tone arm and shell are combined into a one-piece "cartridge carrier," which is removable and interchangeable. Coupling is close to the fulcrum so the carrying arm makes a minimum contribution to the Series IIS total effective mass.

Tracking force and bias adjustments are controlled by a sliding weight adjustment. A fluid damping system is available separately.

 **SHURE**®

Shure Brothers Inc., 222 Hartrey Ave., Evanston, IL 60204
Manufacturers of high fidelity components, microphones, sound systems and related circuitry

Circle 37 on Page 77

Magnetic Tape Warehouse



money & energy
shop by
PHONE



800 526-5383

BLANK CASSETTES

MAXELL UDXL I or II	C60	2.49
	C90	3.35
UD	C60	1.99
	C90	2.85
	C120	3.95
TDK LN	C90	2.39
SA	C60	2.34
	C90	2.89
AD	C60	1.99
	C90	2.49
SONY		
FERRICHROME	C60	2.71
	C90	3.29
HIFIDELITY	C60	1.49
	C90	1.89
LN	C90	1.49
AMPEX		
GRAND MASTER II	C60	2.59
	C90	2.99
BASF PRO I	C90	2.89
PRO II & III	C60	2.10
	C90	2.98

MINIMUM ORDER 10 TAPES

TAPE DECKS

PIONEER CTF 500	129.00
CTF 650	199.00
CTF 900	398.00
AKAI GXC 706D	181.00
GXC 709D	221.00
GXM 30	199.00
JVC KD 10	155.00
KD 65	298.00

TURN TABLES

TECHNICS SL B2	95.00
SL 230	115.00
SL D1	91.00
SL D2	105.00
PIONEER PL 516	109.00
PL 518	152.00
TEAC A 105	169.00
AKAI AP 100	89.00

RECEIVERS

TECHNICS SA 200	169.00
SA 300	209.00
PIONEER SX 580	159.00
SX 680	197.00
SX 780	214.00
JVC JRS 201	267.00
JRS 301	320.00
MARANTZ MR 235	222.00

SPEAKERS

PIONEER PROJECT 60	61. ea
PROJECT 120	79. ea
ALTEC MODEL 3	106. ea
MODEL 9	219. ea
JBL L 19	TO LOW
L 40	TO
L 110	ADVERTISE

ALL MERCHANDISE FACTORY PACKED
MANUFACTURERS GUARANTEE
ADD \$2.50 FOR SHIPPING AND HANDLING
OF 1st CASE, \$1.00 EACH ADDITIONAL CASE.

SEND CHECK OR MONEY ORDER
TO

MAGNETIC TAPE WAREHOUSE

360 S. Maple Ave. • Glen Rock, N. J. 07452

Telephone 201 445-3260

Hours - Mon. thru Sat. 10:00AM to 8:00PM E.S.T.

with history (though while *he* entered the world of fantasy by staging the meeting of Queens Mary and Elizabeth à la Schiller, *she* has made her alterations in the name of dramatic and theatrical coherence). She fashioned her own libretto from an unpublished play by Amalia Elguera, who wrote the libretto for Musgrave's *The Voice of Ariadne*, staged by the New York City Opera in 1977. The grace with which the text and the music dance together demonstrates that the composer made the final decisions about the two simultaneously. Perhaps the most stunning aspect of this opera is its theatricality; Musgrave's sense of timing seems to be all but infallible.

This is particularly important for Americans, who are unlikely to know all the ramifications of English and Scottish history and, thus, may miss the almost mythic implications that the story of Mary holds for British subjects. Even now, it has timely lessons for the Empire. Fortunately, this is not a crucial part of Musgrave's opera; indeed, if there is a lesson to be learned from *Mary*, it seems to me to have to do with the relations of men and women and power, a topic about which the composer apparently felt strongly, even to making the Earl of Bothwell a rapist, ignoring the fact that he would become the queen's third husband.

The scope of the subject matter, and the fact that the three acts revolve around scenes in the ballroom, at court, and at table, might suggest that *Mary, Queen of Scots* is grandiose, not just grand. In fact, the work is easily managed, both by companies of modest size and by first-time listeners. The forty-odd-piece orchestra is used more for its variety of colors than for its concerted impact; Musgrave's scoring is more notable for its delicacy (especially at such moments as when the crown's jewels glitter sonically) than for its force. The instruments' roles vacillate: Sometimes they announce dramatic events, and sometimes they comment, after the fact. It's hard to say whether or not the orchestra was meant to serve this double purpose, but it comes across to excellent effect in performance, not as a liability.

The score is at its best in the passages of relative relaxation, such as the arias and ensembles (yes, old-fashioned arias and ensembles) where the mood is reflective. These include some gorgeous sections using old tunes and dance forms that not only fit into the historical context and give the work an ingenious kind of stability, but meld well with the composer's own clean, lucid style, which avoids trendiness at every point.

The ways in which Musgrave has woven the vocal lines above and around these sixteenth-century melodies are both

revealing and refreshing—revealing of her own musical inclinations, and refreshing in their purity and imaginativeness. The opera is a vehicle for a virtuoso soprano who can handle a high tessitura and take command of the stage while evoking the witness' empathy. Fortunately, the Virginia Opera Association, guided by Musgrave's husband, Peter Mark, has just such a soprano in the young Ashley Putnam. Jake Gardner's portrayal of James is very fine, and Jon Garrison (Darnley), Barry Busse (Bothwell), and Kenneth Bell (Riccio) are all more than adequate, but it is definitely Putnam's show. The soprano's performance is first-rate in every respect; anyone who might have doubted that she is on her way to stardom has only to hear this to have all doubts dispelled.

There are certain aspects of this recording about which one has to have reservations. As good as it is that the Moss Music Group has seen fit to release *Mary, Queen of Scots*, the advisability of using a tape of a live performance is questionable—and if we did have to have a "live from the theater in Norfolk" ambience, did it really have to include the applause? For the purposes of recording, it would have been better to retape some of the ensembles and most of the choruses. The chorus is the performance's weakest link, and there are times when the chain seems to fall apart completely.

Still, the opera's appearance on records is a welcome event. This is a very important work; witness not only the performances that have already taken place, but those that are contemplated by companies such as the New York City Opera. There are many pleasures to be derived here—not least the pleasure of knowing that this kind of work can still be created. K.M.

MUSSORGSKY: Pictures at an Exhibition. For a feature review, see page 63.

PAËR: Leonora.

CAST:

Leonora	Ursula Koszut (s)
Marcellina	Edita Gruberová (s)
Florestano	Siegfried Jerusalem (t)
Pizzarro	Norberth Orth (t)
Fernando	John van Kesteren (t)
Giacchino	Wolfgang Brendel (b)
Rocco	Giorgio Tadeo (bs)

Bavarian Radio Symphony Orchestra, Peter Maag, cond. [Ray Minshall, prod.] LONDON OSA 13133, \$23.94 (three discs, automatic sequence).

For long, Ferdinando Paër (1771-1839) has been known to record collectors—if at all—as the composer of a delightful aria, from his 1821 opéra-comique *Le*

Introducing
the new
Dual 839
cassette deck.

Consider
what it
would be like
to own one.



The new Dual 839 is so different from all other cassette decks that, rather than list its many features, we'll guide you through them as if the 839 were in front of you.

First, the 839 is bi-directional in record and playback. This doubles the length of every cassette.

You'll notice there's no door between you and the cassette compartment. Insert a cassette and it will lock in precise alignment. That's Dual's Direct Load and Lock system. (A subtle but important touch; any slack in the tape is immediately taken up.)

Follow us carefully on this next one. Even when the tape is in motion, you can pull it out and replace it with another . . . and the previous mode resumes automatically. Useful? When the tape nears the end at a crucial moment, you can have a new tape in place without missing a beat.

The 839 is just as innovative in playback. If a tape made on another

deck is too sharp or too flat, no problem. Playback pitch can be varied over an 8 percent range.

And previously recorded tapes with clicks, pops and disc jockey interruptions can be cleaned up electronically—smoothly and permanently. Dual's fade/edit control lets you do that with complete confidence, because it functions in playback.

Back to recording. The peak-level LED indicators react faster than any other metering system. And more accurately, because they're equalized. They read the full processed signal—including the high frequency boost other decks add but only Dual reads. No more risk of overloading a tape into distortion.

There's still more. Much more. Full metal record and playback. 6-way bias/equalization. Two-motor, twin-capstan drive system. Computer logic solenoid-activated controls. Switchable multiplex filter. Switchable limiter. Line/mic mixing. Two-way memory stop with automatic replay. Headphone level controls. And operation by external timer or optional wireless remote control.

What about the 839's audible performance? The specifications can give you a hint. Wow and flutter ± 0.03 percent WRMS. Frequency response from 20 to 20 kHz, ± 3 dB. Signal-to-noise better than 69 dB.

Of course, there's a price for all the 839 offers: \$850. If that seems to be more deck than you really need, there are three other new Dual cassette decks. They start at \$330, and they all feature the Direct Load and Lock system, DC servo motors, twin-belt drive systems, tape-motion sensor/protectors and equalized meters.

For complete details on all four Dual cassette decks, please write to us directly: United Audio, 120 South Columbus Avenue, Mt. Vernon, NY 10553.

Dual[®]

Maître de chapelle, in which the eponymous hero describes an opera he is writing about Cleopatra; complete with instrumental imitations (in the style later and further developed by Peter Ustinov), this was recorded in the late 1920s by the famous French basso Lucien Fugère, then a vivacious eighty years of age. More recently, a "complete" recording (without the spoken dialogue) was issued by Barclay/Inédits ORTF (995.004). This amiable curtain-raiser apparently remained in the active Paris repertory until the Second World War. In truth, Paër's contribution to the pleasure it engendered rested mainly on his thorough knowledge of the period's operatic clichés and a vivid sense of how to send them up [see also PHL's review of Cimarosa's *Il Maestro di cappella*, page 74].

Though he occupied several important positions and wrote quite a number of operas, Paër's place in the history books is not large. From his native Parma, he moved to Vienna in 1798, as Kapellmeister at the Kärntnerthor Theater, and then to Dresden's Hoftheater (in 1802, 3, or 4, depending on which source you consult); when Napoleon marched through, he added Paër to his retinue and took him off to Paris to run the Opéra-Comique and teach music to the imperial family. In 1812, Paër succeeded Spontini as music director of the Théâtre des Italiens, a post he held until 1827. (I'm telling you all this because Decca/London's booklet contains not a jot of biographical information, as if the composer were as familiar as Beethoven or Verdi!)

Most of Paër's posthumous celebrity is based on the historical happenstance here given recorded actuality: At Dresden in October 1804 he presented his setting of the same operatic subject that Beethoven used for *Fidelio*, first performed in Vienna in November 1805. Both Paër's anonymous librettist (presumed to have been one Giacomo Cinti, a singer) and Joseph Sonnleithner, who prepared the text of the first version of *Fidelio*, were translating (into Italian and German, respectively) and adapting the same source material: a French libretto by Bouilly, *Léonore, ou l'amour conjugal*, originally set to music by Pierre Gaveaux and performed in Paris in 1798. The considerable similarities between Cinti's recitatives and Sonnleithner's dialogue ought not to be surprising, nor the close correspondence in the sequence of musical numbers.

Beyond that, however, scholars have noted certain common divergences from the Bouilly libretto shared by *Leonora* and *Fidelio*, suggesting that Beethoven might have known Paër's work. Furthermore, the catalog of the posthumous auction of Beethoven's effects indicates that he owned

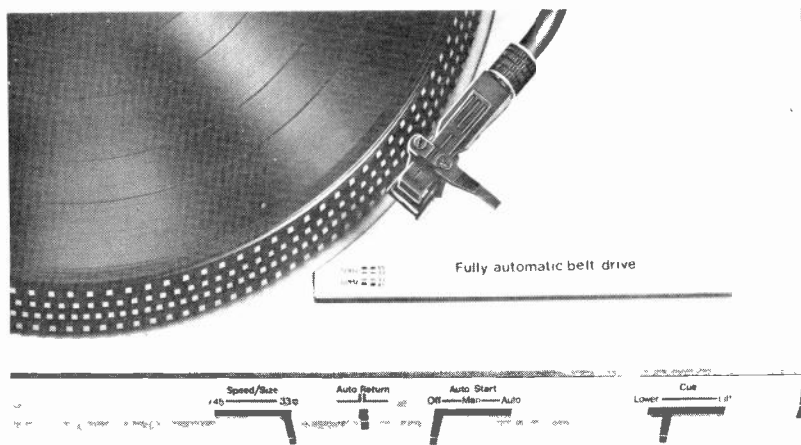

The GT350 is a remarkable turntable. It is a product of Garrard's elite team of designers and engineers we call the Advance Design Group. The belt-driven, front-controlled GT350 integrates an ultra-light carbon fibre headshell with an ultra-light tonearm. An extraordinary 3 year limited warranty underscores the accuracy and reliability of the GT350 drive system.

What makes the GT350 "remarkable" is that it reproduces music with unprecedented gentleness and exquisite accuracy. Write to us, or ask your dealer for a convincing demonstration.

Advance Design Group

Garrard Division of Garrard U.S.A. Dept. B, 100 Commercial Street, Plainview, NY 11803

Circle 53 on Page 77

THE BEST IN SOUND FOR LESS.

LOWEST HI-FI PRICES
IN THE INDUSTRY.

VAST \$6,000,000 INVENTORY
OF TOP NAME BRAND HI-FI
EQUIPMENT & ACCESSORIES.

MAJOR CREDIT CARD
ACCEPTANCE - VISA/MASTER
CHARGE.

TOLL FREE ORDERING
1-800-638-3920



STEREO DISCOUNTERS

6730 Santa Barbara Court, Baltimore, Md., 21227

Circle 30 on Page 77 ▶

a manuscript score of Paër's opera—though we have no idea of when he acquired it (and there is some suspicion, too, that the dealer of that auction sneaked in some things never owned by Beethoven, in the hope of getting higher prices on the basis of association value).

These ears heard nothing of resemblance between the two works to argue any connection beyond the common source and their chronological and geographical propinquity, and I suspect their common divergences from Bouilly are most simply explained by the hypothesis that Sonnleithner had access to Cinti's libretto soon after October 1804. As for Beethoven's copy of the score, that probably came into his hands later, when *Leonora* was privately performed in 1806 at the Lobkowitz Palace or when he heard it in a public performance in 1809 (in German).

Paër uses the *lingua franca* of post-Mozartean Italian-opera-in-Central-Europe very proficiently. In his overture, he summons up a melody in the noble vein of Cherubini and Beethoven, and later brings it back in *Leonora's* big scena (the equivalent of "*Abscheulicher*"), but he is evidently unable to develop it into a structure of Beethovenian substance. Throughout, Paër's aspirations toward nobility of style founder

on his inability to transform his fluent discursiveness into genuine musical-dramatic argument.

The emphasis of this libretto is personal rather than ethical, a trait it shares with Beethoven's first version and not with the more monumental final revision of *Fidelio* that we know best. Marcellina and her tiresome subplot are even more pervasive; she makes a quite disastrous appearance in the dungeon scene, after Pizarro and Rocco have gone off to investigate the trumpet call, simperingly extracting a promise of love from the supposed "Fedele" in return for taking a message to Don Fernando. This tasteless episode trivializes the opera's climax beyond redemption.

Unquestionably, a recording of Paër's opera fills a historical gap; we have precious few recordings of operas written between Mozart's death and Rossini's rise, and it gives us some idea of the kind of thing people were listening to. But its relationship to Beethoven—and to great music—is purely coincidental; whatever Beethoven might possibly have learned from *Leonora*, it was certainly not any of the things that make him Beethoven, that make *Fidelio* a transcendent, galvanizing work—his genius for inventing music of dramatic structural density and unprecedented ex-

pressive gravity, for deriving from harmonic and rhythmic processes a tension that could ignite and illuminate theatrical actions and characters. Paër's amiable note-spinning knows nothing of such possibilities.

In the absence of a score, I am reluctant to vouch for the probity of this recording. Peter Maag's note includes the curious statement that his "task as arranger was . . . limited to completing the viola part, which in many places was merely sketched in, to setting the *secco* recitatives, and to making cuts as carefully and as reverently as possible (i.e. by shortening over-long cadenzas while keeping faith with the idiom of the epoch). The only real liberty I took was in changing some *secco* recitatives into *accompagnato*, particularly at points of high drama. All the rest is authentic." It isn't clear whether some of these editorial intrusions were made necessary by the imperfect condition of the source materials or resulted merely from the conductor's whim. Where the latter was the case (as in changing *secco* into *accompagnato*) it is hard to avoid the feeling that a recording of such a work, of interest primarily to historians and students, ought insofar as possible to reflect the historical facts, avoiding anachronisms and falsifications. At any rate, we certainly

BEFORE YOU THROW OUT A GOOD TURNTABLE OR SPEAKER SYSTEM, CONNECT WITH A GREAT AMPLIFIER. THE PHASE 400 SERIES TWO.

Some speakers sound fine, until you hit a low passage. Then they turn to mud, or rumble at you like a cheap turntable. Chances are, that muddy, distorted sound is in fact, the result of an inadequate amplifier stretched to its limits. Clipping! To improve your sound, you need plenty of reserve power. The Phase 400 Series Two delivers the tremendous power reserve you need for sonic accuracy over the audible frequency spectrum. To accurately reproduce low frequencies without clipping, your speakers require up to 10 times the minimum power requirement of the mid-range frequencies. With the Phase 400 Series Two, when you listen to the 1812 Overture, you hear the blast of the cannon with awesome clarity. Even the deepest notes are clearly distinguishable. **ACCURACY YOU CAN HEAR.** To improve accuracy, the new 400 Series Two utilizes an advanced BI-FET input stage. This integrated circuit keeps the output virtually identical to the input. Distortion and noise are reduced to virtually inaudible levels. Beautiful music in, beautiful music out. **ACCURACY YOU CAN SEE.** You might have some questions about the 400's instantaneous LED output meters. Conventional-style VU meters are slow in comparison because they have to move the mass of the needle. The LED's move at lightning speed, accurately monitoring the output voltage, with scales for 8 and 4-ohm impedances. For accuracy, the meter contains 32 graduations, plus 4 fixed flashers to alert you to clipping. You have a visual safeguard, in addition to the Electronic Energy Limiters to prevent damage from overloads. See your Phase dealer about the Phase 400 Series Two. We think you'll recognize accuracy when you hear it. And when you see it.

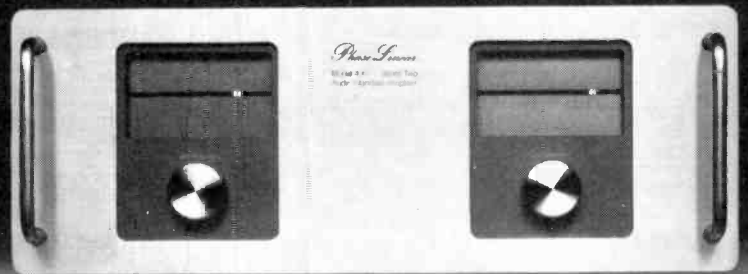

Phase Linear[®]
THE POWERFUL DIFFERENCE

**THIS MONTH'S
SUPER SPECIALS!**

CAR STEREO

SANYO CASSETTE IN-DASH WITH RADIO		PIONEER CASSETTE IN-DASH WITH RADIO	
FT-1498	\$219.90	KP-4000	\$129.90
FT-2400	224.90	KP-3500	144.90
FT-489	139.90	KP-5005	144.90
FT-648	174.90	KP-8000	154.90
FT-1490-2	64.90	KP-8005	154.90
FT-1495	69.90	KP-8500	154.90
FT-642	94.90	KE-2000	184.90
FT-644	106.90	KE-2002	209.90
CASSETTE UNDERDASH		KE-3000	234.90
FT-1400	\$ 95.90	KE-5000	274.90
FT-1405	114.90	KTK-9000	164.90
		KTK-9500	209.90

JENSEN

J1001 (6x9 Separates)	\$94.50	KP-272	\$69.90
J1065 (6x9 Triax-50 Watts)	62.50	KP-292	79.90
J1033 (6x9 Triax II-100 Watts)	78.50	KP-373	84.90
J1101 (4x10 Triax-45 Watts)	62.50	KP-250	104.90
J1130 (4x10 Triax II-50 Watts)	78.50	KP-500	129.90
J1174 (5 1/4 Triax-50 Watts)	62.50	KP-515	99.90
J1124 (5 1/4 Triax II-75 Watts)	78.50	KP-695	89.90
J1069 (6x9 Coax-45 Watts)	39.50	KP-77C	114.90
J1037 (6x9 Coax II-90 Watts)	58.50	KP-865	129.90
J1077 (5 1/4 Coax-45 Watts)	39.50	KP-1000	164.90
J1041 (5 1/4 Coax II-75 Watts)	48.50	KP-707G	164.90

We carry the full line of car equipment by such names as Sanyo, Craig, Marantz, Pioneer, Jensen & Audiovox. Write for free catalog.

BLANK TAPES

CASSETTE TAPES		REEL-TO-REEL TAPES	
Ampex Grand Master II C-90	3.11	Scotch 212 1800 FT	4.35
Ampex Grand Master I C-90	2.79	Scotch 207 1800 FT	4.19
RAAF Pro I C-90	2.88	TDK L 1800 1800 FT	5.22
RAAF Pro II C-90	2.99		
Fujl FX I or II C-90	2.99	VIDEO TAPES	
Scotch Lo Noise C-90/3 Pk	4.99/3	BETA FORMAT	
Scotch Master III C-90	3.29	TDK L 500 (2 Hour)	12.95
Sony LMX C-90	1.19	Sony L 500 (2 Hour)	12.95
Sony HFX C-90	2.35	Fujl L 500 (2 Hour)	12.95
Sony Ferrichrome C-90	3.25	Scotch L 500 (2 Hour)	12.90
TDK C-120	1.68	Sony L 750 (3 Hour)	17.50
TDK C-90	2.10	VHS FORMAT	
TDK C-60	2.99	Maxell T 120 (4 Hour)	17.95
TDK AD C-60	66	TDK T 120 (4 Hour)	16.95
TDK AD C-90	2.45	JVC T 120 (4 Hour)	16.50
TDK AD C-120	3.46	Fujl T 120 (4 Hour)	16.95
TDK SA C-60	1.15	Scotch VK 250 (4 Hour)	16.50
TDK SA C-90	2.88		

MINIMUM ORDER 12 TAPES-100% GUARANTEED
Call or write for super low prices on Maxell tapes

CARTRIDGES

audio-technica		SHURE	
AT-205S	124.90	V5 Type IV	84.90
AT-155S	84.50	V5 Type III	62.50
AT-145A	47.50	M95HE	34.90
AT-125A	32.50	M95HD	29.90
AT-10	12.90	M95E	20.50
STANTON		M95E	14.90
881S	69.50	M70E	9.90
881EE-S	54.90		
881EE	39.90	PICKERING	
880EE	24.90	XSW5000	89.90
500E	12.90	XSW3000	45.90
EMPIRE		XV15750	34.90
2000Z	54.50	XV15925	24.50
2000E/III	18.50	XV15400	21.50
EDR 9	114.50	PIAC	9.90

ACCESSORIES

DISCWASHER		HEADPHONES	
Complete System	10.95	Koss Pro 4AA	39.90
Diskit	34.95	Koss Pro 4AAA	46.50
Discorganizer	11.95	Koss HVVA	34.50
16 oz. 13 Refill	14.95	Koss HVVA	31.50
Zerostat Anti-Static Gun	4.95	Sennheiser HD414	42.50
SC-1 Stylus Cleaner	11.95	Sennheiser HD424	64.50
Discsof	11.95	Sennheiser HD430	49.50
Fuzbuster II Radar Detector	87.90	Sennheiser HD430	72.50
Beam Box FM-8 Antenna	34.50		
Beam Box FM-10 Antenna	64.50		

RECORDS

Pop, Rock, Jazz, R&B	
All 7.98 List	\$4.99
All 8.98 List	\$5.49
All 9.98 List	\$5.99

50c additional for cassette or 8-track, please specify.
Minimum order \$25.00

WE STOCK THE COMPLETE SCHWANN CATALOG.

HOW TO ORDER: For immediate shipment, send money order or certified check. Two weeks delay on personal checks. Please add \$3.50 per order for shipping & handling (\$6.50 for orders outside continental U.S.) N.Y.S. residents add tax. Payment must be in U.S. dollars only. No C.O.D.'s. All merchandise 100% guaranteed, brand new & factory fresh.

JAR MUSIC WORLD

33 PARK ROW, DEPT. HF, NEW YORK, N.Y. 10038
TO ORDER: CALL MON-SAT 9AM-6PM EASTERN TIME
TOLL FREE (800) 221-8180
ALL OTHER MATTERS: CALL (212) 732-8600

CALL OR WRITE FOR FREE 120 PAGE CATALOG

ought to be given a much more precise account of any such and of the reasons for committing them.

By the same token, London's booklet ought to have provided much more historical information than it does, placing Paër and his work in a broad context rather than effusing at length about the "fascinating" (in reality, obvious and mostly inevitable) "parallels between the two works." (For that matter, there is no biographical information about the mostly unfamiliar singers, either.)

Since reviving *Leonora* in Parma in 1974, Maag has conducted it several times, and he knows how to make it move along fluently. What he cannot do anything about is the lack of singers with the flexibility that this music demands. Ursula Koszut, a soprano whose basic timbre shows some of the vibrant edginess we associate with Régine Crespin, is also frequently erratic of intonation, while her provincial Italian diction (from the province of Baviera, that is) results in a less than convincingly fervent delivery of *Leonora*'s lines. Edita Gruberová (Marcellina) makes a better showing with both words and notes, and Giorgio Tadeo (Rocco), though rough of voice, is at least vividly at home in both the verbal and musical languages. I found Siegfried Jerusalem (Florestano) surprisingly Italianate in sound and diction; it cannot be said, however, that he moves his impressive and attractive sound about the florid lines with great facility.

In this version, both Pizzaro and Fernando are tenors; both would benefit from more substantial voices than here provided, and Norberth Orth's Italian is execrable. Conversely, Jaquino is a baritone, acceptably sung by Wolfgang Brendel. There is no chorus. The Bavarian Symphony Orchestra plays well, and the recorded sound is clean and naturally placed. The usual libretto and translation are provided. D.H.

SCHUMANN: Orchestral Works.
Bavarian Radio Symphony Orchestra, Rafael Kubelik, cond. COLUMBIA M3 35199, \$26.98 (three discs, manual sequence).

Symphonies: No. 1, in B flat, Op. 38 (*Spring*); No. 2, in C, Op. 61; No. 3, in E flat, Op. 97 (*Rhenish*); No. 4, in D minor, Op. 120. Manfred Overture, Op. 115.

COMPARISONS—Symphonies:
Barenboim/Chicago Sym. DG 2709 075
Szell/Cleveland O. Odys. Y3 30844
Karajan/Berlin Phil. DG 2709 036

There are three fundamental problems in performing the Schumann sym-

phonies: achieving the right sound, an unbroken line, and a unifying pulse. The problem of sound is rooted in Schumann's difficulties in finding the instrumentation that precisely represented his ideas. His revisions of his scores, like Mahler's, reflect a search for greater precision and clarity in registration, making explicit the colors and textures he had in mind. He was never completely successful, but never so unsuccessful that a conductor with a good ear and stylistic insight cannot secure a strong effect with either textual editing or careful rehearsals—or with (most commonly) a mixture of the two. Szell's clarifications of the orchestration (based on those of Weingartner) made his edition a landmark in the early 1960s.

In these symphonies the rhythm is frequently supported by the harmony, and both are employed to enhance a flowing melodic line that moves with enormous flexibility. The conductor's task is to keep the music moving—even in the slowest phrases there must be a sense of thrust—and to link the many transitions in pulse and thematic material into a seamless fabric of sound. Here Barenboim fails; the line is not always sustained, and many of the transitions are abrupt. Karajan, whose performances are somewhat more militant and assertive than Szell's or Kubelik's, manages these matters well. For those who prefer power to poetry, his set remains the one to acquire.

Kubelik has been playing this music throughout his career, and an earlier recording of the four symphonies (with the Berlin Philharmonic) is available on DG Privilege single discs (2535 116/8). I prefer the newer set: The engineering has improved; Kubelik has matured and melowered; and he is heard with his own orchestra, a group of musicians who in years of close association have learned how best to realize his ideas.

His underlying approach is based on the assumption that Schumann is an unabashed Romantic—that his music is supposed to evoke our feelings and awake our imagination and that this is to be achieved by shaping a melodic phrase with the most intense regard for every detail. This was Szell's approach, and he was so successful that the *Odyssey* discs remain of prime historical importance. Unfortunately they are not all of the same technical quality, but their faults (a tendency to boomy bass, for example) can be remedied with a large equalizer. Kubelik has extremely good, modern recording that exploits the resonance of a fine hall, and although there is significant variation in detail between his performances and Szell's (especially in matters of tempo), one can argue that this album will take the place in the catalog that

the Szell set held for many years.

Kubelik's First Symphony gets off to a wonderful start, with the brass heralding the coming of spring and the introductory phrases leading us into the energetic primary theme of the first movement without any loss of poetic eloquence or musical vitality. Not surprisingly, the entire performance proves to be solidly grounded in the finest elements of the German Romantic tradition.

The Second Symphony must move successfully from a very assertive opening movement to a tricky scherzo. The awkward stops and starts heard in many readings are missing here. The Adagio espressivo is surely Schumann's finest slow movement for orchestra. Most conductors manage the espressivo better than the adagio: They get worried about letting the line go slack and quicken the pace. Kubelik sticks to Schumann's markings with impressive results and then follows with a highly energetic account of the robust finale.

The *Rhenish* is an exceptionally dramatic, extroverted symphony, and the problem is to keep it Schumannesque rather than make it sound like bastardized Brahms. This is accomplished in part by recognizing the distinctive features of the instrumentation, as Kubelik does here. I confess, I would be happier if the middle section of the third movement (*Nicht schnell*) were a trifle quicker, but it works well at his slower tempo. And he succeeds in making the fifth movement a convincing resolution, not the anticlimax it frequently becomes.

The Fourth Symphony is bound together by the cyclical return of thematic material, and here it is important that the form of the work be made explicit. Again Kubelik meets all requirements, and I especially admire the way he keeps the rhythm firm, without exaggerated ostinato-like effects. The result is a very refined statement of a work that is frequently played rather crudely.

This album, which also includes a fine, Byronic account of the *Manfred* Overture, is a touchstone. We will be using it as a standard for many years. R.C.M.

SHOSTAKOVICH: Quartets for Strings: No. 1, in C, Op. 49; No. 2, in A, Op. 68.

Fitzwilliam Quartet. [Peter Wadland and Raymond Ware, prod.] OISEAU-LYRE DSLO 31, \$9.98.

COMPARISON:

Borodin Qt. Sera. S 6034

And so the Fitzwilliam Quartet completes its traversal of the Shostakovich Fifteen. It's a remarkable achievement: re-

markable because the quartet is young, and few such groups are willing to begin their recording careers with a huge and demanding body of contemporary classics; remarkable because it's a financially risky venture for any Western record company, when not even all of Shostakovich's fifteen symphonies can be found in SCHWANN (No. 3 is missing); remarkable because the Fitzwilliam's general level of technical prowess and musical comprehension matches that of the composer's countrymen, as heard on

various Soviet recordings.

The contrast apparent throughout the series between the Fitzwilliam versions and the most widely available rival—the Borodin Quartet's boxed sets—remains in this earliest pair of quartets. The Fitzwilliam's balancing of voices is quite evenhanded. The First Quartet, for example, avoids both the overprominent cello glissandos found in the first movement of the Gabrieli Quartet version (London Treasury STS 15396) and the viola-dominated tex-



Next time you plan a trip to Europe, make sure you visit the unique country.

Where can you find: Europe's blondest blondes?
Europe's highest geysers?
Europe's greatest glaciers?
Europe's largest waterfalls?

And where can you find moonlike craters where the astronauts trained? More volcanos than anywhere else on earth? Historic landmarks of the world's oldest continuous parliament? Celebrations marking Europe's youngest republic?

The answer to all of these questions is—ICELAND. Next time you plan a trip to Europe, make sure you visit Iceland.

The only thing it may cost you is time well spent. Because you'll save enough money on Icelandic's lowest jet fares to Luxembourg to pay for your stopover in Iceland. Or, you can hop over from New York or Chicago for longer tours. See an erupting volcano. Take a cross-country pony trek.

Next time you plan a trip to Europe, ask your travel agent about Icelandic Airlines. Or phone Icelandic Airlines, for folders about Iceland and lowest jet fares to Europe. In New York State, phone (212) 757-8585. Elsewhere in U.S., phone (800) 555-1212 for local toll free number.

Save
money
time
freight
ON NAME
BRANDS



WRITE FOR NEW COMPONENT CATALOG

CURRENT SPECIALS!

TEAC A-430 CASS. DECK
\$315.00PIONEER SX-780 RECEIVER
\$198.00AKAI GXM-30 CASS. DECK
\$195.00KENWOOD KT-413 TUNER
WRITE USTECHNICS SL-Q2 TURNTABLE
\$122.00
 TDK SA-C 90 TAPE
\$30.00 /10
MARANTZ 7Mk II SPEAKER
\$70.00SONY STR-V4 RECEIVER
\$228.00MARANTZ SR-1000 RECEIVER
WRITE USTECHNICS SB-5000A SPEAKER
\$75.00SANSUI SC-5100 CASS. DECK
\$400.00SANSUI SC-3100 CASS. DECK
\$280.00MAXELL XL-C 90 TAPE
\$40.50 /12MARANTZ 2265B RECEIVER
\$317.00MARANTZ 2238B RECEIVER
\$240.00

EVER SEE A BETTER PRICE?
LET US KNOW -- WE'LL TRY
TO BEAT THE DEAL!

BANK CARDS ACCEPTED NOW !! SEND TODAY !!

* WE HANDLE 60 MAJOR LINES OF STEREO
COMPONENTS. WRITE FOR PRICELIST.
* PRICES AND AVAILABILITY SUBJECT TO
CHANGE WITHOUT NOTICE.

send for free catalog

name _____

address _____

city _____

state _____ zip _____

illinois audio

12 East Delaware Place, Chicago 60611

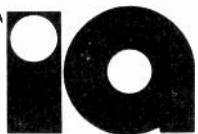

Phone flow!
(312)
664-0020

Circle 19 on Page 77

ture of the Borodin's second movement. The Fitzwilliam's intonation remains rather more secure than the Borodin's through the savage outbursts of the Second Quartet. In that work's giant Passacaglia finale, the new performance may be less breathlessly exciting in the rapid variations, but it more effectively points the climax of the movement toward the final, slow restatement of the theme. On the other hand, the Borodin digs more wickedly into the clucking sarcasm of the First Quartet's opening movement, the spectral atmosphere of its scherzo, and the utter vivacity of its finale. In these movements the Fitzwilliam is relatively earthbound, and in parts of the Second Quartet it is less rapt and intense than the Borodin.

To take the cycle as a whole, the Fitzwilliam stresses formal coherence, classical reserve, and technical finesse, in contrast to the earthiness and color of the Borodin set. Oiseau-Lyre's sonics are considerably cleaner than Melodiya's in the Seraphim pressing, but Seraphim compensates with an attractive price and more extensive notes. Of course, the Borodin had done only the first eleven quartets at the time of its two-volume American release; Nos. 12 and 13 had been added by the time of the British issue in a single box (SLS 879), worth seeking out from import sources. But you'll still have to supplement the Soviet recordings with another coupling of Nos. 14 and 15—either the Taneyev Quartet's (Columbia/Melodiya M 34527) or an import that is in some respects even better, the Beethoven Quartet's (EMI HQS 1362).

Whether you choose a composite Soviet series or the Fitzwilliam set, you should have at least one version of this important body of literature. A.C.

SMETANA: Quartets for Strings.
For a featurette, see page 72.

Recitals and Miscellany

LUCIANO PAVAROTTI: O sole mio: Favorite Neapolitan Songs.

Luciano Pavarotti, tenor; Bologna Teatro Comunale Orchestra, Anton Guadagno, cond.; National Philharmonic Orchestra, Gian Carlo Chiaramello, cond.* [Ray Minshull and James Mallinson, prod.] LONDON OS 26560, \$8.98. Tape: OS5 26560, \$8.98 (cassette).

DI CAPUA: O sole mio*; Maria, Mari'. TOSTI: 'A vucchella*; Marechiaro*. CANNIO: 'O surdato 'nnammurato. GAMBARDELLA: 'O marenariello. DE CURTIS: Torna a Surriento*; Tu, ca nun chiagne!

PENNINO: Pecchè? D'ANNIBALE: 'O paese d'o sole. TAGLIAFERRI: Piscatore é pusilleco. DENZA: Funiculi, funiculà. ANON.: Fenesta vascia.

Luciano Pavarotti's immense popularity derives, there can be little doubt, from the irresistible combination of unusual vocal talent and great personal charm. The former was originally manifested by an individual timbre, a forward placement of tone, a solidly warm middle register, and a remarkable upward extension to at least C sharp. The charm, I am convinced, has its origins in the visual rather than the vocal and has much to do with the kind of vulnerability evinced by certain men of Falstaffian girth, like Jackie Gleason or Fatty Arbuckle. Therefore the effectiveness of Pavarotti's charm is pretty well limited to his personal appearances—whether live or televised—and, except by his most fervent fans, is not easily discernible in his records, where his vocal talents must fend for themselves.

Sad to say, the steady overexploitation of Pavarotti's voice during the past few years—his assumption of such heavy roles as Manrico, Cavaradossi, and Fiesco deserves no other judgment—has impaired its once considerable attractiveness and the ease with which he used to produce his brilliant high notes. The present disc, recorded between 1977 and 1979, only confirms the vocal decline one hears these days in the opera house and in such recordings as his *Tosca* with Mirella Freni.

There is no getting around the fact that in these Neapolitan songs, where a relaxed and ingratiating manner is everything, Pavarotti sounds strained, anxious, and unbeguiling. The long-held, loud high C in "O surdato 'nnammurato," for example, is neither easily produced nor pure in tone. But high notes are by no means his only problem. The *mezza voce* he uses in "A vucchella" is little more than a hoarse croon, and in places (such as in the second verse of "Fenesta vascia") the tone simply flakes.

Perhaps it is because Pavarotti's delivery is so much more strenuous than it used to be that he feels a need to aggrandize these songs, to drag out the middle section of "Marechiaro," for instance, or the opening of "A vucchella." The effect, in any case, is hardly winning. To compare these performances with the records of Schipa, Gigli, or Di Stefano is to see very clearly that Pavarotti is out of his element as well as out of voice.

London's recording is close and resonant. There are notes and texts with translations, as well as an enthusiastic chorus, uncredited on the record liner. D.S.H.

The Tape Deck

by R. D. Darrell

A digitally recorded reel!

Not to be outdone—at least for long—by musicassettes, open-reel revitalizations now feature their first digitally recorded program (Unicorn/Barclay-Crocker M 0500, two reels, \$16.95). It's a musical blockbuster, too: that behemoth of symphonies, Glière's Third, in B minor, Op. 42, the sprawling but often spellbinding *Ilya Murometz*. Harold Farberman's tautly controlled yet grandly expansive Royal Philharmonic performance may not boast the sumptuousness of Eugene Ormandy's 1973 abbreviated version for RCA, but it is truly complete (unlike Nathan Rakhlin's falsely claimed 1976 disc set for Columbia/Melodiya). It has the seeming spontaneity and dramatic grip of a reading in which each of the first three movements has been recorded in a single take, while the sonics thrillingly demonstrate the incomparable lucidity and extended dynamic and frequency ranges of digital technology. Moreover, this is the only taping of this extraordinary work, which—whatever its aesthetic weaknesses—is a unique example of kaleidoscopic scoring and exhaustive (if not exhausting) development of thematic ideas.

Admirers of the Kurt Masur/Leipzig Gewandhaus Mendelssohn symphonies on reel ("Tape Deck," February 1979) won't want to miss their Bruckner Fourth and Fifth (Vanguard/B-C E 71238, \$8.95, and L 71239, double play, \$15.95). Perhaps it's because the dramatic Bernard Haitink/Philips Fourth (no longer available in a reel edition) still dominates my memory, but I find Masur's more restrained version of this well-named *Romantic* Symphony less satisfactory than his also restrained but far more successful solutions to the problems of the enigmatic, mosaic-patterned Fifth.

Among the older programs released for the first time in the open-reel format, three from Barclay-Crocker (11 Broadway, New York, N.Y. 10004) are especially recommended: the 1978 Mozart flute quartets by Paula Robison and Tokyo Quartet members (Vanguard/B-C D 71228, \$7.95); the teenage Mendelssohn's A minor Concerto for Piano and Strings and Two-Piano Concerto in E recorded in 1970, by John Ogdon, Brenda Lucas, and Neville Marriner's Academy of St. Martin-in-the-Fields (Argo/B-C E 605, \$8.95); and Wilhelm Krumbach's 1969 historically invaluable documentations (OP on discs) of the organ

music of members of the Bach family: Johann Christoph, Johann Michael, Johann Bernard, Johann Lorenz, and Johann Ernst, as well as J.S. himself (Telefunken/B-C E 6.41113, \$8.95).

Turnabout: More than fair play

Moss Music Group musicassettes include not only stepped-up production of Vox-label programs, but the debut of a promising Turnabout Chamber Music Series also bargain-priced at \$4.98 each. The performances, by younger as well as established artists, are generally first-rate; the sonic qualities are outstanding, especially on the programs recorded in this country, presumably by Marc Aubort and Johanna Nickrenz. Characteristic is the Haydn *Quinten* and *Emperor* string-quartet coupling (CT 7003). The zest and affection of the young Concord Quartet's readings are a delight in themselves, but even more so are the superbly vibrant, near-ideally balanced and blended sonics captured in a wholly natural ambience. Just about as good are the Brahms clarinet quintet by George Silfies and four St. Louis Symphony colleagues (CT 7000); the rarely heard but charming Lalo and Saint-Saëns first piano trios by the Caecilian Trio (CT 7002); Beethoven's Op. 16 Quintet, starring pianist Abbey Simon, and Op. 25 Serenade, starring flutist Jacob Berg (CT 7004).

The Melos Quartet is more convincing in Wolf's vibrant *Italian* Serenade than in the longueurs of Bruckner's string quintet, with Enrique Santiago as second violist (CT 7005). I don't like either the mannered readings or overresonant recording of the New Hungarian Quartet's Debussy and Ravel string-quartet coupling (CT 7001). And although Ruggiero Ricci fiddles deftly in a batch of Paganini sonatas, cantabiles, and a romanze (CT 7006), guitarist Ernesto Bitetti's accompaniments are unduly subservient, or are made to seem so by the 1977 Hispavox recording. To hear how much better the major work here, the *Sonata concertante* in A, can sound, listen to the György Terebesi/Sonja Prunnbauer version in Telefunken 4.41300 (February 1978) or—better still—in the current Barclay-Crocker reel edition (E 6.41300, \$8.95).

Masked Opera-Ball

The most ambitious Vienna Light Music Society release to date is Richard

Heuberger's *Opernball* in a performance claimed to be complete, and including extensive spoken dialogue, with unnamed soloists and the Biedermeyer Concert Orchestra under Otto Schulz (BDRS 220 and 221, \$18 postpaid from VLMS agents, K. C. Co., P.O. Box 793, Augusta, Maine 04330). It demands duple reviews.

One, for German-speaking listeners, is a lively commendation. This popular 1898 operetta is a Lucullan feast of Viennese *Torten mit Schlagsahne*, sung and acted with authentic grace, sentiment, and vivacity and gleamingly recorded in appropriately lightweight sonics. The other review must include a warning to most Americans that they will be exasperated by the absence not only of printed texts and cast identifications, but even of any song titles, and by the presence of (to them) mysterious dialogue. Nevertheless, the bewitching music just may overcome these handicaps. I hope that VLMS will give it a better chance sometime, in a single cassette of music minus talk.

Grab-bag goodies

Anthologies of reissued recordings usually are too tantalizingly fragmentary to be really satisfactory, but the "International Ballet Box" includes a remarkable variety of music in mostly complete or extended-excerpts form (RCA Red Seal CRK 2-3385, double-play cassette, \$9.98). The composers represented are Britten, Debussy, Falla, Ginastera, Khachaturian, Milhaud, Ravel, and Weber-Berlioz; the conductors include Fiedler, Munch, Ormandy, Ozawa, and Reiner.

If most of the David Munrow/Early Music Consort medieval/renaissance collections seem too costly to risk investigating, there's a representative single music-cassette sampler, "Pleasures of the Royal Courts" (Nonesuch N5 1326, \$4.96), that's delectable and richly nourishing.

Gershwin's own four-hand (one or two pianos) versions of his *Rhapsody in Blue*, *Second Rhapsody*, *I Got Rhythm* Variations, and *Cuban Overture*—plus the three preludes, eighteen songbook arrangements, and other solos—are admirably played and recorded by Frances Veri and Michael Jananis, together and separately, in two deluxe super-chrome musicassettes (Connoisseur Society/In Sync Laboratory C 4015/6, \$10.98 each). **HF**

You know what they say about imitation.

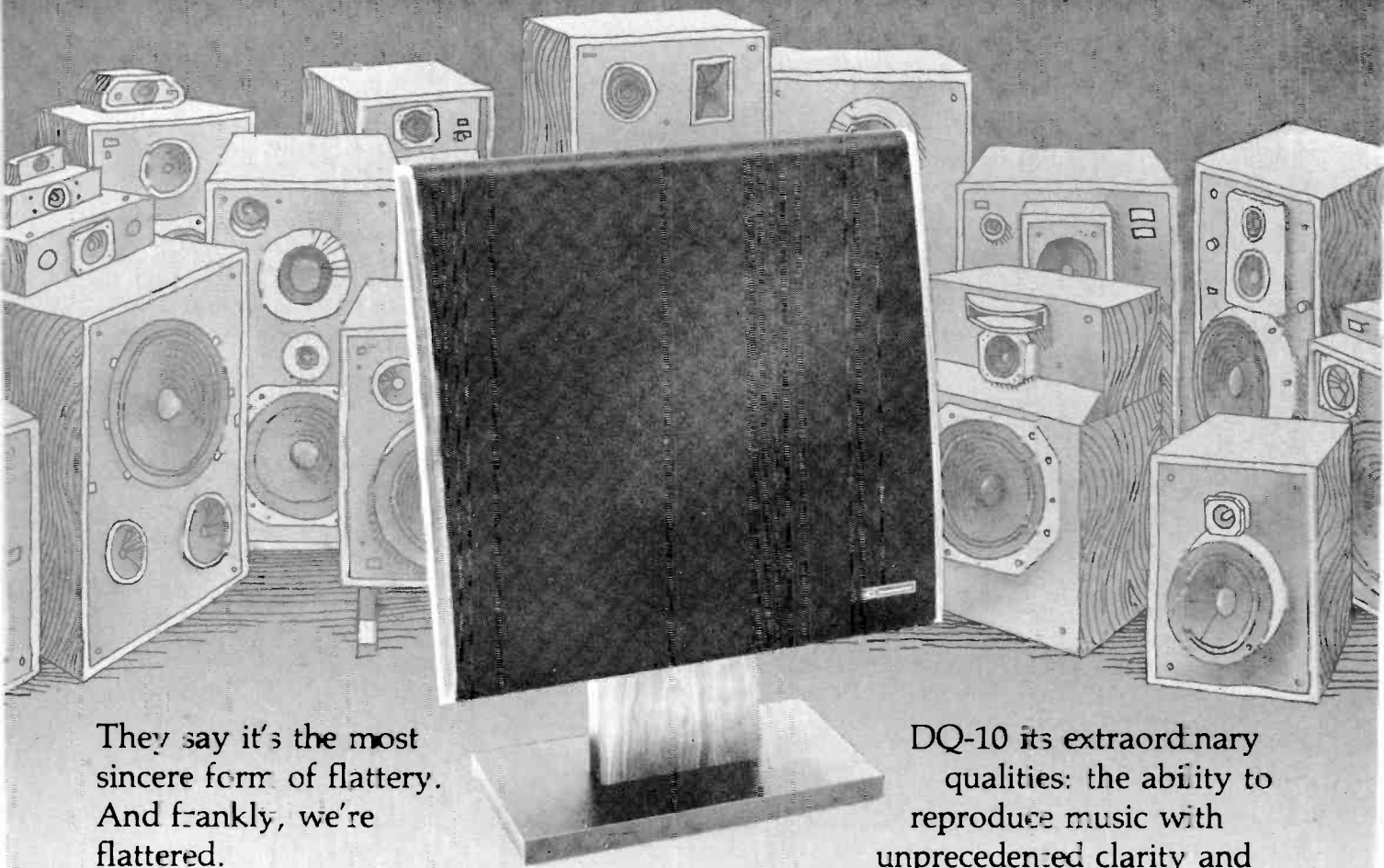

They say it's the most sincere form of flattery. And frankly, we're flattered.

The Dahlquist DQ-10 has become the most imitated speaker system in high fidelity. There's been a cascade of obvious imitations, with prices going up and down the scale.

But the Dahlquist approach is locked into patents embodying the solution to the critical problems of time delay *and* diffraction delay distortion. Thus, the impersonators can offer only the words, not the music of the original.

The Dahlquist Phased Array and Open Air Mounting patents give the

DQ-10 its extraordinary qualities: the ability to reproduce music with unprecedented clarity and spaciousness. It just doesn't make sense to spend hard-earned money for an imitation (at any price), when you can have a pair of the original at surprisingly low cost.

Write to us and we'll send complete information on why the DQ-10 sounds the way it does. Or better still. Ask your dealer for a demonstration. You may find that you don't care *why* it sounds so great. Only that it does.

DAHLQUIST

601 Old Willets Path, Hauppauge, New York 11787



The 2nd Annual Backbeat Critics' Poll

BACKBEAT®



Critics' picks: Neil Young, Talking Heads, Pat Metheny, Willie Nelson and Leon Russell



ALBUMS

Album of the Year

- 1st place **Talking Heads: Fear of Music** (Sire)
- 2nd place **Elvis Costello & the Attractions: Armed Forces** (Columbia)
- Fleetwood Mac: Tusk** (Warner Bros.)
- 3rd place **Graham Parker & the Rumour: Squeezing Out Sparks** (Arista)

Best Pop Album

- 1st **Doobie Bros.: Minute by Minute** (Warner Bros.)
- 2nd **Ian Gomm: Gomm with the Wind** (Stiff/Epic)

Best Jazz Album

- 1st **Helen Humes: Sneakin' Around** (Classic Jazz)
- 2nd **Jackie McLean with the Great Jazz Trio: New Wine in Old Bottles** (Inner City)

Best Rock & Roll Album

- 1st **Graham Parker & the Rumour: Squeezing Out Sparks** (Arista)
- 2nd **Neil Young & Crazy Horse: Rust Never Sleeps** (Warner Bros.)

Best Country Album

- 1st **Willie Nelson & Leon Russell: One for the Road** (Columbia)
- 2nd **Johnny Cash: Silver** (Columbia)

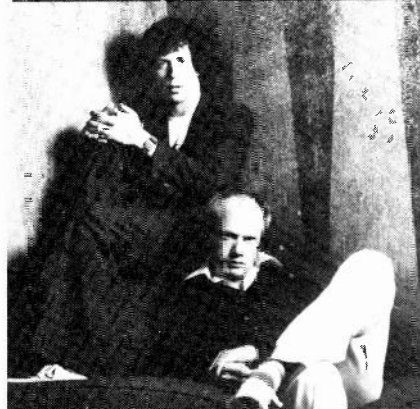
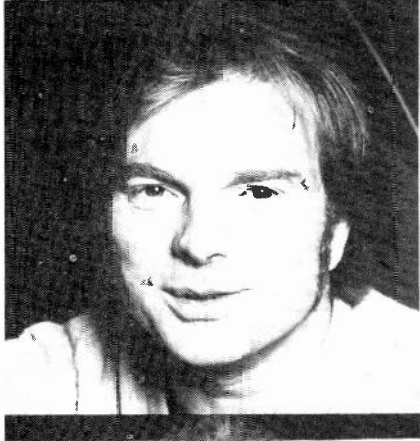

Maggie, Suzzy, and Terre Roche; Van Morrison; Joe Jackson; DuRocs Scott Mathews and Ron Nagle

Best R&B Album

- 1st **Michael Jackson: Off the Wall** (Epic)
- 2nd **The Isley Brothers: Winner Takes All** (T-Neck)

Best Fusion Jazz Album

- 1st **Pat Metheny: New Chautauqua** (Warner Bros.)
- 2nd **Weather Report: 8:30** (Columbia)

Best Serious Contemporary Jazz

- 1st **Bennie Wallace: The Fourteen-Bar Blues** (Inner City)
- 2nd **Art Ensemble of Chicago: Nice Guys** (ECM)

Best Classic Jazz Album

- 1st **Widespread Depression Orchestra: Downtown Uproar** (Stash)
- 2nd **The Marty Grosz-Dick Wellstood Quintet: Take Me to the Land of Jazz** (Aviva)

Best Soundtrack or Original-Cast Recording

- 1st **Stephen Sondheim: Sweeney Todd** (Columbia)
- 2nd **The Who: Quadrophenia** (Polydor)

Sleeper of the Year, Pop

- 1st **Leonard Cohen: Recent Songs** (Columbia)
- 2nd **DuRocs: DuRocs** (Capitol)

Sleeper of the Year, Jazz

- 1st **Ornette Coleman: The Great London Concert** (Arista/Freedom)
- 2nd **Helen Humes: Sneakin' Around** (Classic Jazz)

Best Off the Beaten Path Album

Brian Eno: Music for Airports (PVC)

Best LP on an Independent Label

- Tiny Moore & Jethro Burns: Back to Back** (Kaleidoscope)
- The Persuasions: Comin' at Ya** (Flying Fish)
- The Members at the Chelsea Nightclub** (Virgin International)

Widespread Depression Orchestra:

- Downtown Uproar** (Stash)
- Various Artists: Living Chicago Blues, Vols. I-III** (Alligator)
- Marlene VerPlanck Loves Johnny Mercer** (Audiophile)
- Tete Montoliu: Catalonian Folk Songs** (Timeless/Muse)

Best Sonic Quality

Ry Cooder: Bop 'till You Drop (Warner Bros.) **Lee Herschberg**, engineer

Most Promising New Pop Male Vocalist/Instrumentalist

- 1st **Joe Jackson** for "Look Sharp" (A&M)
- 2nd **Ian Gomm** for "Gomm with the Wind" (Stiff/Epic)
- 3rd **Bram Tchaikovsky** for "Strange Man, Changed Man" (Polydor)

Most Promising New Jazz Instrumentalist

Bennie Wallace for "The Fourteen-Bar Blues" (Inner City)

Most Promising New Pop Female Vocalist

- 1st **Rickie Lee Jones** for "Rickie Lee Jones" (Warner Bros.)
- 2nd **Lene Lovich** for "Stateless" (Stiff/Epic)

Most Promising New Pop Group

- 1st **The Roches** for "The Roches" (Warner Bros.)
- 2nd **The Yachts** for "S.O.S." (Polydor/Radar)

Most Promising New Jazz Group

- 1st **Widespread Depression Orchestra** for "Downtown Uproar" (Stash)
- 2nd **Solar Plexus** for "Solar Plexus" (Inner City)

Most Inspiring Pop Veteran

for an artist who has consistently released quality albums over the past ten years

- 1st **Neil Young** for "Rust Never Sleeps" (Warner Bros.) First solo album, "Neil Young," released in 1968
- 2nd **Van Morrison** for "Into the Music" (Warner Bros.) First solo album, "Blowin' Your Mind," released in 1967



Best Pop Producer

- 1st **Nick Lowe*** for Elvis Costello's "Armed Forces" (Columbia)
- 2nd **Brian Eno** for Talking Heads' "Fear of Music" (Sire)

Best Jazz Producer

- 1st **Manfred Eicher*** for the entire ECM series
- 2nd **Jerry Valburn** for the Marty Grosz-Dick Wellstood Quintet's "Take Me to the Land of Jazz"

Best Songwriter

- 1st **Neil Young** for "Rust Never Sleeps"
- 2nd **Elvis Costello** for "Armed Forces" and for *Girls Talk* (recorded by Dave Edmunds)

Best Live Performance

- 1st **Graham Parker & the Rumour** at the Santa Monica Civic Auditorium (L.A., June)

Honorable Mention:

- Jerry Lee Lewis** at the Club Loreli (New York, August)
- Eartha Kitt** at Les Mouches (New York, March)
- Rickie Lee Jones** at the Village Gate (New York, May)
- Joe Jackson** at the Bottom Line (New York, April)
- Pattie LaBelle** at the Beacon Theater (New York, June)
- Mingus Dynasty Band** at Carnegie Hall (New York, June)

IN MEMORIAM

Sonny Criss, Don Ellis, Lowell George, Donny Hathaway, Stan Kenton, Van McCoy, Charles Mingus, Minnie Riperton, Sid Vicious.
Crawdaddy/Feature, Waxpaper, Capricorn Records.
 Doobie Bros., Gruppo Sportivo, Little Feat, Rezillos, Tom Robinson Band, Television.

The distinguished panel of judges for the 1979 poll: Crispin Cioe, Susan Elliott, Toby Goldstein, Don Heckman, Stephen Holden, Christopher Petkanas, Steven X. Rea, Sam Sutherland, John S. Wilson.

* Second-time winner in this category



(1) The Purple Heart Award; (2) The New, Improved, Previously Unissued Alternate and Outtakes Award; (3) The TS Garp Award for Fear and Procrastination; (4) The Emperor's New Spacesuit Award; (5) The Emperor's New Clothes Award; (6) The Recommended for Instant Cut-Out Bin Awards; (7) The Matching Luggage Awards; (8) The P.T. Barnum Awards; (9) The Old Wine in New Bottles Award

SPECIAL AWARDS

The Emperor's New Clothes Award for the Most Ephemeral Pop Trend of 1979

- 1st prize **Disco** and some of its accouterments, specifically **blatantly sexist album covers, Syndrums,** and the **Village People Singing like Elvis Costello**
- 2nd prize **Singing like Elvis Costello**

The Emperor's New Spacesuit Award for the Most Ephemeral Pop Trend in Prospect for 1980

- 1st **Power Pop, New Rock, or New Wave,** or any band with a one-syllable name, such as the Knack, the Beat, the A's, the Pop, the Shirts, the Sports, the Now
- 2nd **Rollerskates and roller disco**
- 3rd **Skinny ties**

Honorable Mention:

Japanese girls singing English disco songs

The Purple Heart Award for the Record Company That Took the Most Chances, With or Without Success

- 1st ***Warner Bros.** for distributing ECM and for signing and supporting Rickie Lee Jones, the B-52s, and the Roches
- 2nd **All independent jazz labels; Chrysalis** for staying independent; **Tomato Records** for re-leasing—among other high-brow items—*Einstein on the Beach*
- 3rd **CBS** for distributing and supporting Stiff Records, and for investing an alleged \$13 million in Paul McCartney



The Matching Luggage Award

for the Record Company That Took the Least Chances

- 1st** **Capitol** for releasing safe power-pop Knackalikes like the Shirts and the Motels
- 2nd** **Butterfly/MCA** for issuing nothing but camp disco, to wit: The J.T. Connection, Hot City, Dennis McCann, Destination, Tuxedo Junction, Fire & Ice

The P. T. Barnum Award

for the Hype of the Year

- 1st** **The Knack**
- 2nd** **The Record Industry's Financial Crisis**
- 3rd** **The Record Industry's Recovery from the Financial Crisis** (this prize goes to the trade press)

The Recommended for Instant Cut-Out Bin Award

In no particular order:

John Denver and the Muppets:

"A Christmas Together" (RCA)

"Pope John Paul II Sings at the Festival of Sacrosong" (Infinity)

Barbra Streisand: "The Main Event" (CBS)

Cher: "Take Me Home" (Casablanca)

Martha Reeves: *Skating in the Streets*, a single (Fantasy)

Genya Ravan: "And I Mean It!" (20th Century/RCA)

The TS Garp Award for Fear and Procrastination

1st **The Eagles**

"The Long Run" finally showed up in October of 1979. It was due out in June of '77.

2nd **Meatloaf**

His debut, "Bat Out of Hell," was released in July of 1978. We've been waiting for the followup since January of '79. The latest word from Epic is "early in the Eighties." Seeing is believing.

3rd **Fleetwood Mac**

"Rumours" was on the boards for two years, so when they started telling us that "Tusk" was "almost ready" in December of '78, we didn't hold our breath. This one even leaked onto the airwaves before its official release.

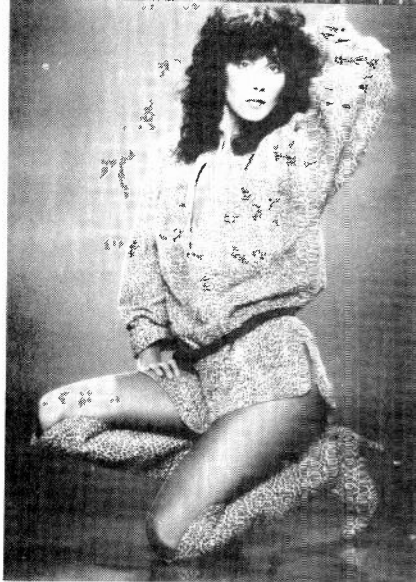

Enroute to the cut-out bin:
Barbra and Cher

4th **Stevie Wonder**

We finally heard a tape of "Journey Through the Secret Life of Plants" at the Bronx Botanical Gardens in October. But "Plants" has been on Motown's release list since summer '78.

Honorable Mention:

The Beatles

Album due since 1971, latest projected release date TBA.

The Old Wine in New Bottles

Award for the Year's Best Repackage or Reissue

Jazz

Giants of Jazz (Time/Life Records)

Commodore Reissue Series

(CBS Special Products)

Charlie Parker:

"The Savoy Studio Sessions" (Arista)

Anita O'Day: "The Big Band Sessions" (Verve)

Pop

Various Artists: "Honkers and Screamers/Roots of Rock & Roll" Vol. VI (Arista)

Waylon Jennings: "Greatest Hits" (RCA)

"Shades of Ian Hunter" (CBS)

The Who: "Quadrophenia" (Polydor)

The New, Improved, Previously Unreissued Alternate and

Outtakes Award for the Least Necessary Repackage or Reissue of the Year

1st **Various Artists:** "A Night at Studio 54" (Casablanca)

2nd **"Barry Manilow's Greatest Hits,"** (Arista)

Honorable Mention:

Elvis Presley: "Our Memories of Elvis, Vol. II" (RCA)

The Backbeat Open

To Mike Curb goes the **Conflict of Interest Award** for being the Lieutenant Governor of California and the President of Mike Curb Records.

To Joni Mitchell goes the **Gee, Isn't the Streetlife Fascinating Award** for "Mingus."

To Bob Dylan goes the **Cancel My Tickets for the Resurrection Award** for "Slow Train Coming."

To Capitol Records goes the **Invasion of the Body Snatchers Award** for coming up with yet another Beatles clone, the Knack (preceded, by, of course, the Raspberries and the *original* Knack, c. 1968).

To ex-Brinsley Schwarzites Nick Lowe, Ian Gomm, Bob Andrews, and Brinsley Schwarz goes the **We'll Show Them One Day Award** for finally making it.

To Stephen Holden goes the **Best Nonmusical Pop Award** for his upright opus, *Triple Platinum*.

JBL. WHEN EXCELLENCE COUNTS.

Whenever and wherever excellence in sound is essential, JBLs are essential.

No other speaker is good enough for top recording professionals, performing musicians on tour and *anyone* who listens for a living.

Because no other speaker is created with JBL's combination of advanced design, high-technology computer and laser research, extensive listening tests and quality of craftsmanship.

And no other speaker has the benefit of JBL's history of over three decades of experience in professional sound.

The JBL heritage of excellence and reliability can be found in a wide variety

of applications.

At outdoor concerts ranging from rock to Beethoven, thousands of listeners can hear the artists clearly... thanks to JBLs.

In recording studios, you'll find more JBLs than any other monitor. In fact, most major albums are mixed or mastered on JBLs, according to a recent Recording Institute of America survey.

Under the lights at discos around the world, more dancers are moving to JBLs... by far the leading disco speakers (Billboard's International Disco source-book).

Night club performers rely on JBL's

new Cabaret Series loudspeakers—the first JBLs made especially for club musicians.

Theater owners who want their audiences to experience today's great new multiple sound tracks are installing JBLs.

And serious musician/songwriters who rely on home recording are following the lead of the big recording studios: They're turning to JBLs, too.

Wherever excellence belongs, you'll find JBL.

James B. Lansing Sound, Inc.,
8500 Balboa Boulevard, Northridge,
CA 91329.

FIRST WITH THE PROS.

JBL

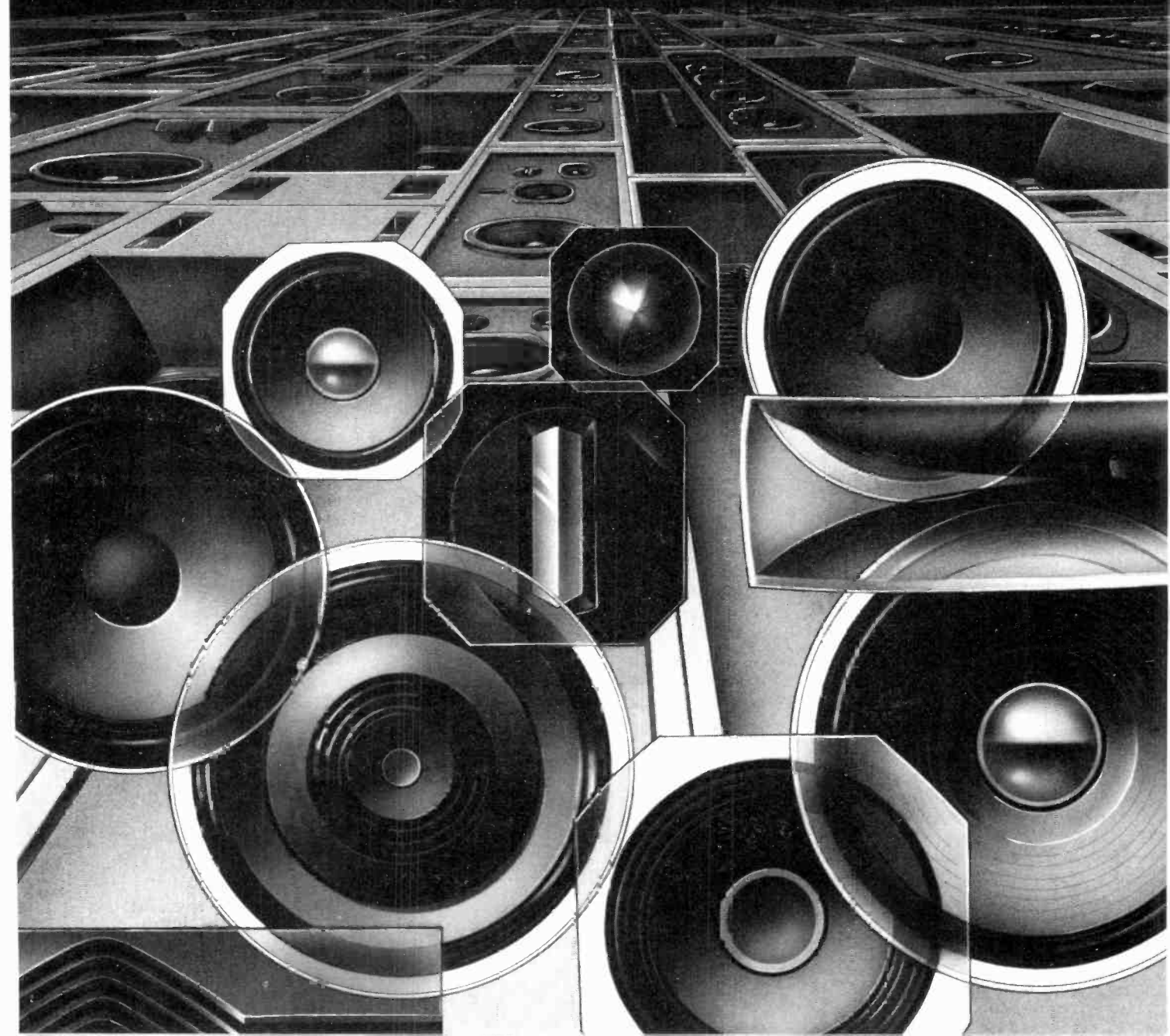



Teac's Multitrack Cassette Studio

by Fred Miller

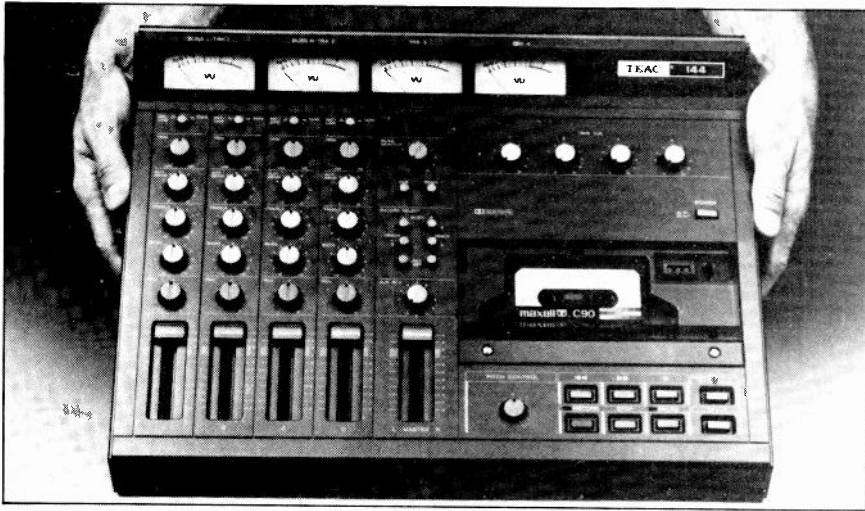

The new **Portastudio Model 144** from Teac is, in a word, sensational. This 20-pound, \$1,100 machine combines a four-input, four-channel mixer with a four-channel cassette deck and can do almost everything that a four-track open-reel deck and an outboard mixer can do. The concept is brilliant but simple: In applying an idea at least twenty years old (overdubbing) to today's cassette technology, Teac has made an important step in bringing amateur songwriters and engineers closer to the professional marketplace. Now they can make high-quality home demonstration tapes easily and with minimal expense.

One thing should be mentioned at the outset: The 144's cassette deck runs at 3 $\frac{3}{4}$ ips—double the speed of a normal cassette—and has a four-channel record/play configuration. Although it can record a maximum of two tracks at once, it can record a cumulative total of four tracks, all with the tape running in the same direction. (Therefore you can't turn the cassette over and use the other side.) This means the recordings you make on it cannot be played back on standard machines and vice versa. But that's okay, because you should mix the multitrack cassette down to a stereo master anyway. (Because of its nonstandard nature, the Porta-

studio is part of Teac's Tascam professional line.)

The basic features are explained fully in the well-written thirty-page owner's reference manual. Each of the four input modules accepts a microphone or line level through a back-panel phone jack and is controllable via a MIC/LINE-TAPE pushbutton on the front panel. TRIM, a rotary pot below MIC/LINE, varies the level of the signal presented to the main fader. This maximizes the potential of the gain structure in matching the input signal to all the various level controls in the Portastudio. Below TRIM is AUX SEND, which splits the incoming signal and routes part of it to the AUX circuits used for external signal processing. That is to say, a "dry" signal may appear at its input fader while simultaneously being altered by echo, phasing, compression, etc., and routed back to the mix via the master AUX RCV pot. (Of course, those special effects must be obtained via outboard devices connected to the Portastudio's AUX circuit.)

Beneath AUX SEND is the equalizer section, which incorporates two bands with the potentials for 10 dB of boost or cut at frequencies of 100 Hz and 10 kHz. Just above the fader is the pan pot, for placing the image somewhere in the 180-degree stereo perspective during a mix

and for buss (channel) assignments during recording. The linear fader is the last stop before the signal proceeds to the grand master fader.

To the right of the input modules are a BUSS MONITOR, which controls the level for monitoring in stereo, and, below it, two pushbuttons marked CUE and REMIX, which determine the point in the circuit at which you are auditioning the program. The cue circuit is conveniently in mono, and the four inputs to it have separate pots in a section marked TAPE CUE. The RECORD SELECT module has an on/off pushbutton for each of the four tracks, that, when depressed, readies the track to record and illuminates its corresponding VU meter. Finally, AUX RCV lies just above the master fader.

The 3 $\frac{3}{4}$ ips cassette deck sits to the right of the mixer controls. Besides the usual play, record, and fast forward functions, MEMORY STOP enables you to rewind the tape to a point set by the counter, which is very useful for punching in. Also, depressing RECORD activates a flashing light that becomes constant during recording. DOOR, which replaces the usual eject button, raises the protective cover above the cassette. One other tremendous asset is the pitch control, which, by means of a variable speed oscillator, allows you to slow down or speed up the tape by about 15%. This is very useful for special effects, dialogue, or getting the high notes that you can't normally make. A power switch completes the front panel. Teac recommends using only high bias ("chrome" position) tapes and scrupulously warns against the use of C-120s.

Adjacent to the four input jacks on the back panel are an 8-ohm headphone jack, pin jacks for AUX SEND, and TAPE CUE outputs (mono) and for AUX IN, LINE OUT, and AUX OUT (stereo).

Don't forget that the Portastudio's deck cannot play back cassettes that are not recorded on it. It is not designed to be an audiophile's dream machine. It includes two Dolby B encoders (for the two busses) and four Dolby B decoders for mixing to "normal" tape. I'd recommend mixing to an open reel for editing, or mixing to another cassette deck with Dolby for a quiet master playable on standard machines.

Having done professional multi-
Continued on page 110

The Three Faces of Fleetwood Mac

by Sam Graham

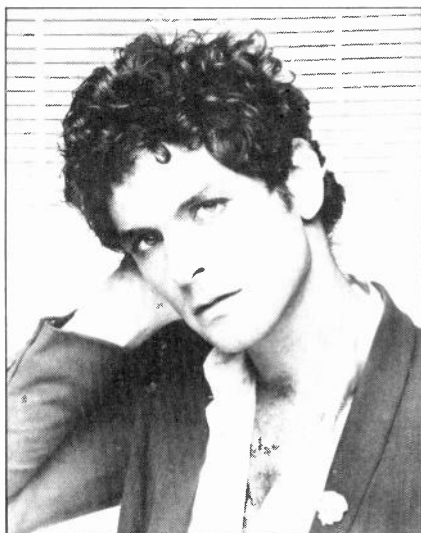

Lindsey Buckingham



Christine McVie



Stevie Nicks

Fleetwood Mac: Tusk

Fleetwood Mac (special thanks to Lindsey Buckingham) with Richard Dashut and Ken Caillat, producers Warner Bros. 2HS 3350

Fleetwood Mac has been many things in the course of its twelve-year career. After all, a dozen albums of original material and as many personnel alterations as the average pro team in training camp would have to have wrought a few changes. One thing it has only rarely been, however, is surprising. This is a solid, reliable band, epitomized by its redoubtable Mick Fleetwood-John McVie rhythm section, the one constant throughout its existence.

Coming nearly three years after the 10-million-selling "Rumours," "Tusk" is one album that deserves to be called long-awaited. And, at perhaps the least likely time, the group has shown itself capable of surprises. Only some of the LP's four sides and twenty songs is the well-oiled, perfect pop of "Rumours"; much of it takes chances and steps outside of the

expected. Not that "Tusk" lacks attractive songs with heavy hit potential—far from it. But every track on "Rumours" sounded like a single. "Tusk" is less obvious, starting with the first song on Side I, a languid ballad called *Over & Over*.

More and more, the band has taken on three separate faces, one each for songwriters/singers Lindsey Buckingham, Stevie Nicks, and Christine McVie. There are no shared bylines, no shared lead vocals; each takes a turn strutting his or her stuff. Still, there are threads that wind through all the sides: that rhythm section, Buckingham's exceptionally versatile guitar playing, Christine's textural keyboards, and the rich, layered backing vocals. For the most part, "Tusk" does sound like the work of a band.

It is when Buckingham steps out front (and with nine songs, that's often) that the album is unusual. Tunes like *The Ledge*, *What Makes You Think You're the One*, *Not That Funny*, and *That's Enough for Me* are typical of his new style, where rowdy vocals compete with very prominent Fleetwood drums (loud and right on the beat) and flatulent electric guitars. Almost radical, that, but not exactly punk Fleetwood Mac. Lyrical melodies and softer acoustic guitars balance the raw

with the refined, putting Lindsey's material in a very different league.

That style doesn't characterize two other stunning Buckingham offerings, *That's All for Everyone* and *Walk a Thin Line*. The lush, echoing vocals and plodding tempos of these two suggest nothing so much as the Beach Boys at their arty best, somewhere between "Pet Sounds" and "Surf's Up." Brian Wilson should be proud, as Lindsey is emerging as a brilliant producer, and he was clearly the prime mover behind the entire double album. If "Tusk" has an overall mood—sometimes sandy and subtle, sometimes raunchy and humorous—he is largely responsible for it.

Christine McVie's songs are less adventurous, but no less successful and sometimes even more so. She has a consistent, universal style, dispensing winning ballads and easy rockers with deceptive ease. And while her six tunes here aren't substantially different from her previous output, the arrangements are on the whole better (particularly the almost-jazzy *Brown Eyes* and the acoustic *Honey Hi*).

What's more, McVie's vocals are simply lovely. *Never Make Me Cry* may be the best she has ever sung: supple, emotional, but utterly without affectation. That

Sam Graham is the author of *Fleetwood Mac: The Authorized History*, published by Warner Books.

and other songs (*Over & Over* among them) will no doubt be of cheer to tobacco conists everywhere, for here is one steady smoker whose singing has in fact gotten better.

It's no small irony that Stevie Nicks, Fleetwood Mac's star performance attraction, is also the weakest musical link. All too often, her songs are musically repetitive and lyrically self-conscious or sophomoric. Repetition building in intensity was vital to past triumphs like *Dreams* and *Rhiannon*, but there is nothing here to match those two—certainly not *Sisters of the Moon* (a good candidate for *Rhiannon '79*), *Angel*, or *Sara*.

Nicks's two other contributions are much stronger. *Beautiful Child* is a genuinely pretty song, while *Storms* is her most successful on all fronts: words ("Never have I been a blue calm sea / I have always been a storm . . ."), music, and performance. (Her voice is oddly constricted here, which fits the song nicely.) Both confirm, as if confirmation was really needed, that Stevie is not without talent. But to these ears, at least, she is neither as consistent as McVie nor as inventive as Buckingham.

"Tusk" is probably not the record that will change the face of popular music. Nor will it necessarily resurrect the sagging record industry: \$15.98 is a lot for vinyl these days, even if the packaging is first-rate and the actual price will be more like nine or ten bucks. But there's a lot of interesting, thoroughly musical activity going on here, and it gets better each time you hear it. "Tusk" is Fleetwood Mac's most ambitious work since original guitarist Peter Green led it from the blues to *Albatross* and *Oh Well*. It also sounds terrific.

Leonard Cohen: Recent Songs.

Leonard Cohen & Henry Lewy, producers. Columbia JC 36264
by Sam Sutherland

With his ambitious but deeply flawed collaborative album with Phil Spector, Leonard Cohen seemed destined for oblivion: His brooding, starkly metaphorical songs and subdued vocal mien were already out of step with the prevailing pop and rock modes of the day, and Spector's stentorian perspective only emphasized Cohen's gloom, rather than providing any new definition or vantage point. Though a cult artist, the Canadian poet, novelist, and occasional songwriter seemed to

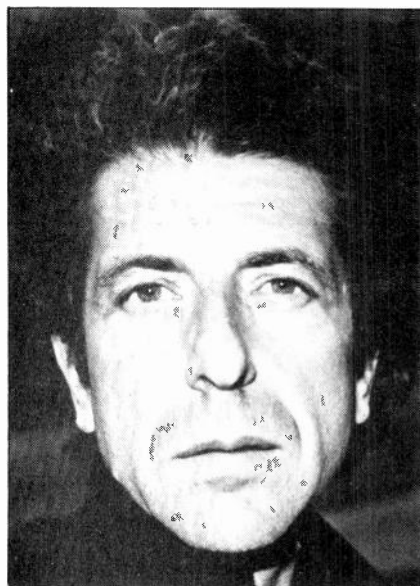

Cohen—his best in years

have chased away even his few admirers.

His return to Columbia and the subsequent release of this new collection thus comes as a twin surprise: That it exists at all contradicts the record industry's usual commercial dictates, but, more important, "Recent Songs" is Cohen's most haunting, coherent work in years. The spiritual malaise so central to his work remains, but it is illuminated by the elegant musical sense largely missing since his classic albums from the late '60s.

One obvious key to the new record's strengths is coproducer Henry Lewy. He has faced a similarly self-absorbed artist in Joni Mitchell and, as with Mitchell, proves particularly astute in translating the songwriter's dark visions into musical settings that are as distinctive as they are cleanly rendered. Cohen and Lewy use an Eastern tinge—provided by violinist Raffi Hakopian and oud player John Bilezikjian—to mirror the poetic sources for *The Guests*, *The Window*, *The Traitor*, and *The Gypsy's Wife*. The addition of that Persian filigree yields a lean, piquant flavor to those songs that is truly timeless. Elsewhere, a mariachi ensemble provides contrasting colors, and even the more conventional instrumentation of the remaining material avoids any overt pop trends that might create a commercial edge at the expense of the music.

Cohen moves from tongue-in-cheek blues (*Humbled in Love*) to deep wells of mysticism (*The Window*) with equally provocative results. And, while "Recent Songs" may numb many pop listeners with its prevailing mood of intro-

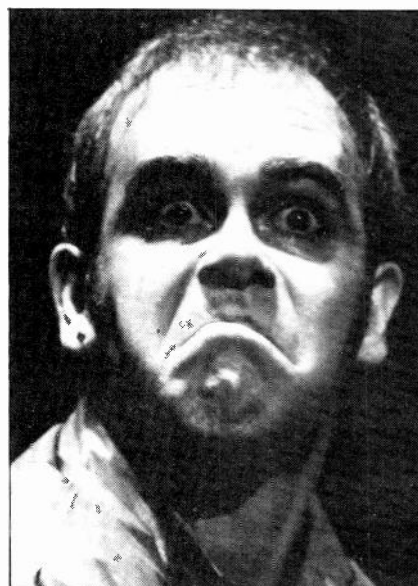

John—nothing personal

spection, for those once charmed by Cohen's eclecticism and gripped by his extraordinary poetry, it commands renewed attention.

Elton John: The Thom Bell Sessions

Thom Bell, producer MCA 13921

Victim of Love

Pete Bellotte, producer MCA 5104

by Crispin Cioe

Since the Beatles, nobody has commanded as much popular acclaim as Elton John did in his prime. His uncanny ability to borrow from rock, soul, and cabaret to fashion a purely pop hybrid propelled him through most of the '70s like a shiny pool of mercury—always fascinating in and of itself, never assuming any definite form. After years on the brutal record-tour-record treadmill so necessary to maintain such stature, John stopped writing with lyricist Bernie Taupin and eased up his pace. The albums since then have varied drastically, and while his last, "A Single Man," may have been too arty for all of his fans to swallow, it still sounded like Elton at work.

"The Thom Bell Sessions" and "Victim of Love" are, at best, testaments to John's versatility. Both lack a sense of personal involvement, and the seamless but slightly quirky synthetic style that has often made his music unique is notably absent. But the Bell sessions—three long songs recorded in 1977 with producer Thom Bell—are superb Philadelphia soul, featuring the Spinners on backups and warmly transcendent production and ar-

Continued on page 104

Launching a new era in the reproduction of music from records

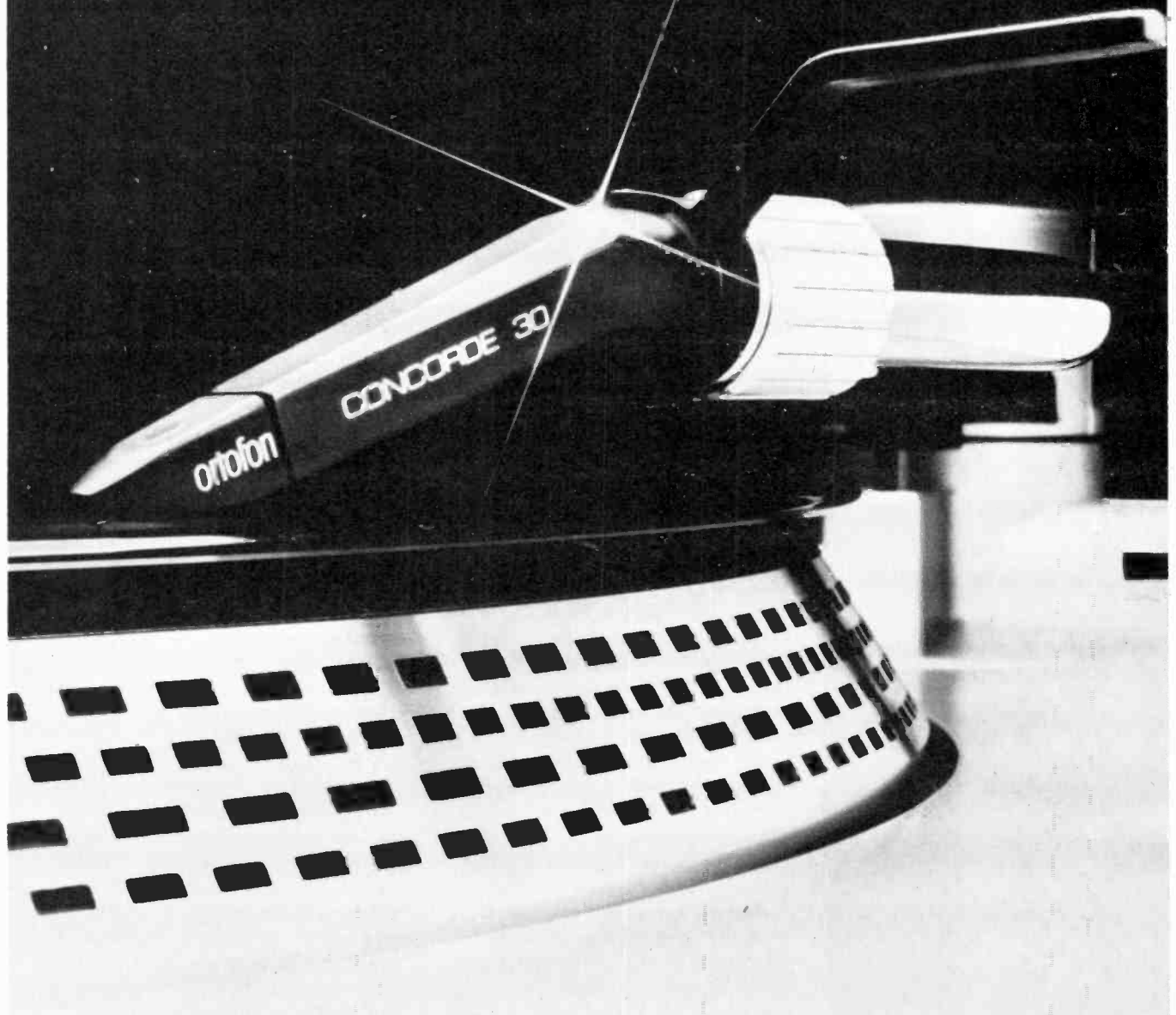

A strong claim, but true. The Concorde combines a cartridge and headshell in a single form, but weighs less than most headshells alone. The reduction in record wear and distortion, and the ability to track accurately despite warpage, pay incalculable dividends to music lovers.

Ortofon dealers are now ready to demonstrate the Concorde. It's worth a visit just to see and hear this remarkable cartridge that stands at the very frontier of music reproduction technology. For complete information write: Ortofon, 122 Dupont Street, Plainview, New York 11803.

ortofon



Time/Life's Giants

by Don Heckman

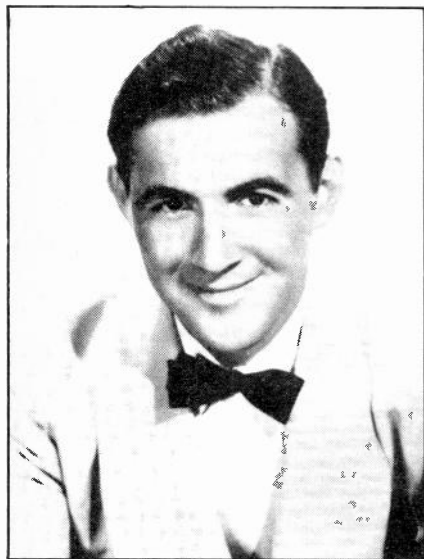

Benny Goodman at age 26



Duke Ellington

Giants of Jazz: Louis Armstrong,

Time/Life Records STL J01

Duke Ellington, *STL J02*

Billie Holiday, *STL J03*

Bix Beiderbecke, *STL J04*

Benny Goodman, *STL J05*

Coleman Hawkins, *STL J06*

Michael Brooks, producer

There was a time, not very long ago, when jazz fans could be happy about almost *any* reissue package. The prevailing mentality at most major record companies was so youth-focused, so dollar-determined, that the task of putting together a respectably packaged and mastered collection from vault material for old-jazz freaks was just too much bother. Times have changed, and many record business accountants have come to the belated conclusion that, if they don't have gold buried in their archives, they at least may have something that can give them a slight edge against the hazards of inflation.

Unfortunately, many of the reissue programs have been more concerned with dollar value than with quality merchandising. Even the better collections—Fantasy's Prestige collection, Arista and Warner Bros.' Charlie Parker sets, Polydor's Verve reissues, and Columbia's Contemporary Masters, to name a few—have sometimes been hampered by program notes (especially important on reissues) that tell us more about the writers than the artists. Historical data, such as matrix numbers, recording dates, personnel, etc., has ranged from excellent to barely adequate.

The Giants of Jazz program from Time/Life makes a heroic effort to overcome most of these shortcomings. Beautifully packaged in sturdy, hardboard boxes, each set includes informative, no-punches-pulled biographical program notes, and the full panoply of modern recording technology has been applied to the old 78 rpm masters in an effort to dig out every whisper of recorded sound. Equally important, Time/Life—unlike most commercial record companies—has not had to limit its selection to what is in its own vaults. Each set draws from a variety of labels.

There does, however, seem to be an arbitrary cut-off point. The Benny Goodman collection, for example, closes with a 1946 selection, thereby excluding the remarkable bebop band he organized

the following year. The Louis Armstrong set closes in 1950, the Coleman Hawkins in 1957, the Duke Ellington in 1956, and the Billie Holiday in 1946. Obviously, each artist produced significant recordings in subsequent years. Does their omission mean they will be documented in future Time/Life collections? One can only hope so. The Ellington catalog—in the '50s and '60s, in particular—is rich and varied, and Holiday's work for Verve in the early and mid-'50s is vintage stuff, as is Armstrong's work with his All-Stars in the same period.

What is here, however, will be more than enough to keep jazz aficionados busy for many, many evenings. Among the highlights on the Goodman album are *Waitin' for Katie*, recorded in 1927, when he was the burgeoning eighteen-year-old clarinet star of the Ben Pollack Orchestra; *Farewell Blues*, a 1931 collaboration with Eddie Lang and Joe Venuti; *King Porter Stomp* and *Stompin' at the Savoy* from his early big bands; *Sing, Sing, Sing*, *Down South Camp Meetin'*, *Bugle Call Rag*, and *Roll 'Em* from the classic 1937–8 band; and *Flyin' Home* and *I'm Confessin'* for the sextet that included the guitar of Charlie Christian.

The Beiderbecke catalog is more limited, and with reason. His recording career spanned less than seven years between 1924 and his death in August, 1931 at the age of twenty-eight. He made approximately 250 records, but on more than two thirds of them he was only a sideman, nearly buried beneath the turgid orchestrations of the Paul Whiteman and the Jean Goldkette orchestras. Perhaps the best testimony to his genius is the fact that his brief solos, sometimes only 16 bars long, shimmered out of those ensembles with sufficient magnitude to build an audience of eager fans. Time/Life has included most of the Beiderbecke classics from his Wolverine recordings in 1924, the Trumbauer collaborations (especially Bix's astonishing solo on the 1927 *Singin' the Blues*), his warm emotional soloing on *Cryin' All Day*, *I'm Coming*, *Virginia*, *Blue River*, and *Jazz Me Blues*, as well as his small gems from the many Whiteman recordings.

Most fans of the jazz saxophone feel that Coleman Hawkins virtually invented the style in the remarkable string of recordings he made between his early work with Fletcher Henderson (*Dicty Blues*) in 1923 and his classic performance of



Body and Soul in 1939. Actually, the discs from that period are not as well known as they should be, perhaps because he spent much of his time living and traveling in Europe. Time/Life provides a good survey of Hawkins' astonishingly fertile work at that time, including two ballad predecessors to *Body: If I Could Be with You One Hour* (1929) and *Someday, Sweetheart* (1933). I was also fascinated by a previously unreleased version of Henderson's *Clarinet Marmalade* (1926) as well as a number of relatively rare recordings made for British release in the early '30s. But, alas, we hear too little of the more modern Hawkins, with only one track (*Stuffy*) documenting his early flirtation with the beboppers in 1945. Too bad his brilliant unaccompanied tenor solo titled *Picasso*, from roughly the same period, wasn't included. Maybe next time.

If Hawkins invented the jazz saxophone, Louis Armstrong just as surely invented the jazz trumpet. His early playing, from the '20s and '30s, can probably be matched for long-term influence only by the work of Charlie Parker. Time/Life has stressed those early years—wisely, I think—in this collection. Included are *Dipper Mouth Blues*, recorded when Armstrong was playing cornet duets with Joe Oliver; a fascinating cornet paraphrase with blues singer Bessie Smith on *Cold in Hand Blues*; *Heebie Jeebies*, *Cornet Chop Suey*, and *Gut Bucket Blues* from Armstrong's Hot Five; *Potato Head Blues* (with Armstrong's amazing stop-time solo) and two other tracks from the Hot Seven; the brilliant 1928 *West End Blues*; another influential solo on *Muggles*; and, from the early '30s, Armstrong's extremely personal method of dealing with pop tunes such as *Sleepy Time Down South*, *Star Dust*, and *Sunny Side of the Street*.

Those who are only familiar with the world-weary voice of the mature Lady Day will be fascinated by Billie Holiday's pure, youthful energy on *I Wished on the Moon*, *What a Little Moonlight Can Do*, and *Miss Brown to You*, all recorded in 1935 with Teddy Wilson's group. Incredibly, her voice darkened and her inflection became more complex in barely a year. For by 1936, she was recording torchers like *No Regrets* and show tunes like *Summertime*, *A Fine Romance*, and *The Way You Look Tonight*. Also provided here is ample documentation of the epic sessions

between Billie and various members of the Count Basie Band, notably tenor saxophonist Lester Young, on *This Year's Kisses*, *Why Was I Born?*, *I Must Have That Man!*, *Mean to Me*, *Easy Living*, and more. Finally, there is the sombre *Strange Fruit*, a song few pop artists would touch even today, recorded by Billie in 1939.

The Ellington collection was, by all odds, the most difficult to put together. It covers the period from the Bubber Miley-influenced *East St. Louis Toodle-Oo* (1926) to an Ellington band appearance at the 1956 Newport Jazz Festival. Thirty years of Ellingtonia is a lot of ground to cover on three discs and there are understandable omissions, most notably the Duke's extended works. What is included, however, is hard to argue with: *Creole Love Call* and *Black and Tan Fantasie*, (still under the spell of the enigmatic cornetist Miley), as well as another *Black and Tan Fantasy*, recorded shortly after Miley left the band in late 1927; early Ellington classics like *The Mooche*, *Mood Indigo*, *Rockin' in Rhythm*, and *It Don't Mean a Thing (If It Ain't Got That Swing)*; nine tracks—including *Sophisticated Lady*, *Jack the Bear* (with the miraculous bass work of Jimmy Blanton), *Ko-Ko*, *Concerto for Cootie*, *Cotton Tail*, *Harlem Air Shaft*, etc.—from the great 1940 band; Ivie Anderson's stunning vocal on *I Got It Bad and That Ain't Good*, as well as Juan Tizol's timeless *Caravan*.

All in all, there is little to carp about in any of these sets. They will, I suspect, be as pleasing to the jazz scholar and collector as they will be to the jazz listener. A good deal of credit for the sheer listenability of the collection must go to engineers Frank Abbey and John Guerriere and the CBS Studios. Many of these tracks undoubtedly sound better in these newly engineered (but not artificially hyped-up) versions than they did in their original form. Waiting in the wings are collections of Jelly Roll Morton and Jack Teagarden, and expected in the next two years are sets from Sidney Bechet, Benny Carter, Lester Young, Guitarists (Reinhardt, Lang, Christian, and others), Red Norvo, Art Tatum, and many, many more. 🎷

Time/Life Records, 541 North Fairbanks Court, Chicago, Ill. 60611. Price per set is \$19.95, not including postage, but *Time/Life* requests that you do not send money. *They will bill you.*

Order Toll Free!
Except N.Y., Alas., Hawaii

SCA 800-221-0974

FOR ORDERS ONLY!
Mon. & Thurs.-9 AM-7 PM, Tues., Wed., Fri., Sat.-9 AM-5 PM E.S.T.

STEREO HOT-LINE

ONKYO Technics Dual

CHECK US OUT!

- ✓ Our prices are the lowest.
- ✓ Discounts on over 60 major brands.
- ✓ Reliability: one of the oldest audio mail-order houses in the U.S.A.
- ✓ Rated #1: by a leading trade publication.
- ✓ Large inventory: we buy in volume getting the best deals from the manufacturers, you get the best deal from us.

GIVE US THE OPPORTUNITY TO BEAT THE BEST DEAL YOU'VE BEEN ABLE TO FIND.

— QUOTES AND INFORMATION —
(212) 253-8888, 9AM-5PM, MON.-SAT., N.Y. TIME

Write or Call us now for the lowest price quotes and a Free price flyer.

STEREO CORPORATION OF AMERICA

HF-1629 Flatbush Ave.
Brooklyn, New York 11210

Circle 42 on Page 77

Park Row Electronics & Camera Corporation

"YOU'VE TRIED THE REST NOW TRY THE BEST"

CALL TOLL FREE

(800) 221-8464 for Master Charge & Visa orders.

BLANK CASSETTES SPECIAL	VIDEO TAPE GIVEAWAYS
In lots of 12 only	BETA
BASF	SONY SL500 12.90
Studio Series C90 2.49	SONY SL750 17.99
PRO III C90 2.79	VHS
MAXELL	JVC T120 14.95
UD C90 2.99	TDK SA T120 18.49
UDXL C60 I or II 2.69	RCA VK 250 17.49
UDXL C90 I or II 3.69	New! Maxell Eptaxial T120 18.49
SONY	VCR
Low Noise C60 1.25	New SONY SL5400 6 hr Recorder 995.00
Low Noise C90 1.49	New JVC HR6700 6 hr. Recorder 995.00
Ferrichrome C90 3.55	VIDEO CAMERAS
MEMOREX	New Bell & Howell Tele Star power zoom thru-the-lens viewing 449.00
New High Bias 60 2.59	JVC 6711US 999.95
New High Bias 90 3.49	PHOTO CARTRIDGES
New MRX 3 C80 1.89	SHURE New 95AG 34.95
New MRX 3 C90 2.49	SHURE V 15 IV 85.95
SCOTCH	STEREO CASSETTE TAPE DECK
Master I or II C90 2.69	JVC KD 8A 499.00
Master III C90 3.15	JVC KD 855 269.95
TDK	JVC 630 297.00
DC 60 1.19	TEAC A300 249.95
DC 90 1.55	SHARP
SA C60 2.15	SHARP RT 225 I 244.95
SA C90 2.99	SHARP RT 3388A 274.95
Head Demagnetizer 15.95	CAR STEREO SANYO
REEL TO REEL SUPER SPECIALS	FT 1490 II 149.95
MAXELL	FT 1490 I 168.50
UD 35-90 5.79	FT 1495 185.00
UD 35-90B 6.99	FT 2400 249.79
UD 35-180B 19.95	PANASONIC
SCOTCH	CJ 8700 299.95
207 1800 ft 5.05	PIIONEER
	KP 4000 124.50

We carry a full line of Car Stereos, Speakers, Calculators, Dictation, Answering Services, Video Equipment & T.V. Games.
Prices Subject to change without notice. Minimum Shipping & handling charge \$3.50

PARK ROW Electronics Corp.

1 Park Row
New York, NY 10038
212-349-0553 (For Information)

Circle 29 on Page 77



Continued from page 100

rangements. It's fairly safe to say that Bell is the producer of this decade, in the sense that his work has consistently been cinematic in scope, so evocative that it virtually defines an era. (The '60s parallel would be the Motown sound.) Even though John sings with real feeling on, for instance, *Are You Ready for Love*, Bell's songwriting and production are what stand out. Ringing brass, fat and precise snare drum hits, and the Spinners pumping along behind the chorus make it a solid Philly soul sander by any measure.

"Victim of Love" is another story. Producer Pete Bellotte is renowned for his arrangements of Donna Summer's musical odysseys, and he has not only produced Elton here, but has also written all the songs save Chuck Berry's *Johnny B. Goode*. The entire album is Munich disco to the hilt (although the young American bassist Marcus Miller adds some distinctive funk to the tracks), but the Chuck Berry opus is gunned along by some rocking guitar fills and a scorching Lenny Pickett sax solo. Again, John's singing is never less than right on the money, and, for what it's worth, I'm sure he can have a career as a disco singer if he wants it. Yet these aren't particularly inspired dance tracks, and since Elton contributes no songs to the disc, there's very little here in the way of musical signature. Elton John doing Donna Summer will never be as exciting as Elton doing himself, and when he does settle on a direction, I'm sure radios around the world will light up like a million pinball machines, because he's still a wizard on his own turf.

The Police: *Reggatta de Blanc*

The Police & Nigel Gray, producers
A&M SP 4792

by Steven X. Rea

The Police snap their rock and reggae regiments back and forth like rubber bands. The Anglo-American trio, whose *Roxanne* single marked one of new wave's first forays into the pop strata of Top 40 radio, are variably taut and precise, loose and limber. The lean, supple bass-drums-guitar sound of "Reggatta de Blanc" is equal parts crisp, crashing rock and "backward" stutter-step reggae pulses. Indeed, the Police are one of the few white groups around that appear at home amidst reggae's fluid, mesmerizingly sensual rhythms.

On *Walking on the Moon*, lead vocalist/bassist Sting sings in his high, nasal,

quirky voice: "Giant steps are what you take walking on the moon." That may be, but the Police take no giant steps on the follow-up to their debut, "Outlandos d'Amour." But while there are no drastic deviations, there are some minor alterations. Sting still delivers most of the lead vocals, but drummer Stewart Copeland's mordantly deadpan singing style is featured on several songs, including his own vision of middle-class suburban despair, *On Any Other Day*. Unlike the first album, which was written almost exclusively by Sting, Copeland and guitarist Andy Summers share songwriting credit on much of "Reggatta de Blanc." Copeland's *Contact*, rampant with puns, and his flip *Does Everyone Stare* ("I never noticed the size of my feet until I kicked you in the shins") both stand out, as does the Who-ish collaborative effort, *It's Alright for You*.

But Sting's *Message in a Bottle*, *Bring on the Night*, and *Walking on the Moon* are the high points. A huge hit in Britain, *Message* should ape that success Stateside. It's an understated, economic song with an infectious "against all odds I shall survive" kind of chorus, the singer hurling his bottle-encased SOS into the sea, fully aware of the futility of his action. *Bring on the Night* is the album's most overtly reggae track. *Walking on the Moon* sports an echoic array of spacy guitar effects free-falling across a dreamy soundscape of bass and drums.

Occasionally, the Police are merely flaccid: The title track is not much more than an aimless instrumental exercise with some "dub" phasing and tribal yelps thrown in. But more often their carefree, self-effacing style is a sign of their good-natured approach. On *Deathwish*, Copeland proffers a bass run, frolicsome and furious, that's straight out of *Not Fade Away*, and on *No Time This Time* the trio brashly bastardize *The Batman Theme*. They can play relaxed, romping music; they can play angry, passionate rock & roll that is tense and electric. But mostly they burrow themselves in a good pop/rock groove and then run around in it with Marx Brothers abandon, all to a loopy, up-tempo rock & reggae beat.

Sly & the Family Stone: *Back on the Right Track*

Mark Davis, producer.
Warner Bros. BSK 3303

Sly Stone: *Ten Years Too Soon*

Sylvester Stewart (Sly Stone), original producer; John Luongo, disco remixer

and editor. Epic JE 35974

by Sam Sutherland

Parliament's George Clinton once remarked that most of the soul records cut since the '60s should have paid royalties to Sly Stone. Clinton should know. His own funk visions continue to tap the same mix of gospel, rock, and pop elements, from chanted vocals and brisk horn choruses to sexy bass lines and hard-edged guitar. With a new rank of similarly inclined and influenced funksters now carrying that approach forward, the provocative Sly has been ubiquitous in his impact on contemporary r&b even as his own presence has receded.

Given the attrition in exposure for the earliest and most ebullient Sly and the Family Stone records, and the nearly half-decade of silence since the last new recording under that aegis, it would be heartening to report that "Back on the Right Track" lives up to its title. But while that same sleepy, swooning voice holds center stage on the opening track (*Remember Who You Are*), offering a familiar blend of playfulness and philosophizing in its rapping message, Sly's new music derails a few minutes into the second side and never really regains its bearings.

Although producer Mark Davis should be commended for avoiding disco cheap shots or updated rock filigree, neither he nor Sly ever achieves the exuberance that the best songs here are clearly trying for. The call-and-response of Sly's vocals with his new backing chorus are deflated by the comparative weakness of the latter, while the rhythmic horn arrangements only intermittently attain the force that drove his earlier records with satisfying consistency. Still, the album might've compared handsomely to its current competition had Sly managed to sustain the respectable level of composition promised by three of Side 1's four songs. Unfortunately Side 2 slides into numbing, unstructured grooves with its first song, the aptly titled *Shine It On*, in which Sly does just—and only—that.

Making the new album's problems even more disturbing is the simultaneous arrival of "Ten Years Too Soon," a disco remix of mostly vintage material, which, in itself, should be punishable by law. Remix master John Luongo has taken the original masters and spliced their tight arrangements with extended rhythm loops and extraneous ensemble passages. He has replaced Larry Graham's visceral



bass-line syncopations with relentless, unimaginative 4/4 accents, obscured the original band's romping horn charts with a constant mutter of overdubbed percussion, and even added cornball Sydnrums that boing away on top of Sly's singing.

Although the liner note pleads that this is an act of reverence, committed lovingly by session musicians that worship the original performances, the grooves argue eloquently to the contrary: This is a bald attempt to wring a few more bucks from Sly's old Epic catalog. In modernizing some truly timeless dance music, Luongo and his confederates evince the sort of aesthetic empathy that might result in tail fins on the classic prewar Bugatti automobile or ice cubes in a glass of Lafite-Rothschild.

It's sad that Sly's first album for Warner Bros. offers so feeble a defense against this sort of cannibalism, but at least he hasn't pandered outright to obvious least common denominators. Luongo and Epic take care of that, offering fans small but reassuring comfort of the knowledge that these vampires have faked themselves out. With disco's fall from commercial grace, what might actually have sold a few copies will now suffer the oblivion this turkey so completely deserves.

Barbra Streisand: Wet
Gary Klein, producer
Columbia FC 36258
by Ira Mayer

"Wet" is Barbra Streisand's first memorable album in some years—memorable not always for the right reasons, perhaps, but certainly for verifying her stature as a song stylist and interpreter. While both "Superman" and "Songbird" provided perfect background music for the passive fan, "Wet" gives pause even before it hits the turntable. It's not so much the cover (Olivia Newton-John affects the wet look far better), but really now, a concept album about water?

No. In fact, the title song is what re-establishes Streisand's credentials immediately. Hers is a belter's voice, but one over which she exercises exceptional control. As with the other ballads on the LP, *Wet* is show-music pop. That idiom in which she excels is here represented by Alan and Marilyn Bergman and Marvin Hamlisch and Carole Bayer Sager. Interestingly, the one old standard included—Johnny Mercer's and Harold Arlen's

47st. photo

VIDEO SPECTACULAR

COMPLETE VIDEO PORTABLE KIT
Recorder, Camera Tripod,
8 Hours of Tapes, maintenance kit,
Cables only \$1595.00

VIDBELT PORTABLE POWER SYSTEM
Includes rechargeable power belt, charger,
portable light & car adapteronly \$239.00

VIDEO TAPE RIOT!!!

VHS UP TO "6" HR.\$14.95
TDK UP "6" HR.\$16.50
BETA UP TO 4 1/2 HR.\$16.75
BETA L-500\$ 9.95

Call or Write us for all your Video Needs

PIONEER

SX-580.....153.50	CTF-500.....137.29
SX-680.....186.50	CTF-700.....248.00
SX-780.....218.00	CTF-800.....287.25
SX-880.....287.25	CTF-900.....335.50
SX-980.....346.25	CTF-1000.....473.00
SX-1080.....455.75	Complete selection of NAME
SX-1280.....553.75	BRAND CAR STEREO'S &
SX-1980.....701.50	SPEAKERS AT HUGE DIS-
	COUNTS

CASSETTE TAPE SPECIALS

TDK SAC-60.....2.15	TDK SA C-90.....2.69
Maxell UDXL 1C-60.....2.50	Maxell UDXL 1 C-90.....3.45
Maxell UDXL 2 C-60.....2.50	Maxell UDXL 2 C-90.....3.45

We're your Sony, Panasonic,
Pioneer, Sanyo, Jensen, Craig
& JVC HQ.



47st. photo inc. 67 West 47th St
New York, N.Y. 10036 212-260-4410 ext. 73
Phone orders only Call Toll Free
800-223-5661 or 800-221-5858 Ext. 73
—Shipping add'l, minimum \$4.50 [limited quantities]—

Circle 15 on Page 77

Hi-Fi Buys

ON PIONEER Technics
SONY Dual
AND OTHER FAMOUS BRANDS

<p>Technics SA-500 AM/FM RECEIVER 55 watts RMS at 8 ohms no more than 0.04% THD</p>	<p>PIONEER CT-F950 STEREO CASSETTE TAPE DECK</p>
<p>Dual CS1246 Fully automatic • Vario belt drive • Single deck multi play</p>	<p>PIONEER HPM-100 SPEAKER</p>
<p>SONY KV-2643R 26 REMOTE CONTROL CONSOLE TELEVISION</p>	

CALL TOLL FREE
800-638-0935
MON.-FRI. 9-8, SAT. 9-4

Orders shipped within 48 hrs. • Phone and COD orders accepted • Use Visa, Master Charge, or NAC • Call or write for quotes • Catalog available upon request • All equipment factory sealed with full warranty.



1362 HOLTON LANE
LANGLEY PARK, MD. 20783
(301) 434-5330

Circle 17 on Page 77

**BIGGEST SAVINGS—
SAME DAY DELIVERY**
CALL 301-488-9600



- We have more of the components and manufacturers you are looking for.
- Our prices are the lowest you'll find anywhere.
- Your phone order is shipped the same day you call.
- In most cases you'll enjoy your equipment within 72 hours.
- We stand behind everything we sell with a "No Lemon" guarantee and a trained customer service department.
- Our Audio Advisors will help you select the right equipment at the best prices for the quickest delivery.

Call (301) 488-9600 for information on equipment, prices and ordering, or send for free brochure, tips on buying hi-fi equipment by mail, test reports and a \$2.00 merchandise certificate.

International Hi-Fi Distributors
Moravia Center
Industrial Park, Dept. 1H
Baltimore, Maryland 21206

Circle 20 on Page 77

It's a musical instrument

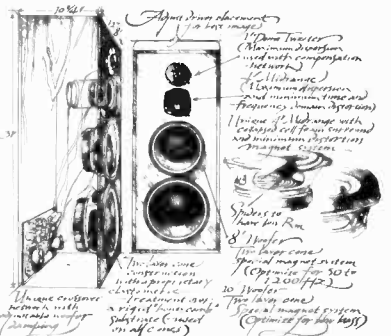

The handcrafted Speakerlab Thirties featuring the patented Nestorovic Woofer System™ are unlike any speakers you've ever heard. Find out about Speakerlab's innovative speakers, kits, and raw speakers. You can save up to 50% when you build them yourself.

Read about all the details in our free catalog. Send for yours today!

133

name _____

address _____

city _____ state _____

zip _____

Speakerlab
Dept. 133, 735 N. Northlake Way
Seattle, Washington 98103

Come Rain or Come Shine—gets a peculiar arrangement that starts out traditionally but escalates to a light bossa-nova beat and then gets a layer of discolike synthesizer.

Another bizarre treatment that doesn't work as well is that of Bobby Darin's *Splish Splash*. The fusion of rock and disco obliterates the crisp, syncopated fun of the original, and the attempt to be frivolous (splashing noises courtesy of Steve Lukather's guitar) sounds forced.

On the more straightforward disco front, the second side duet with Donna Summer, *No More Tears (Enough Is Enough)*, is no doubt a huge hit by now. It is uninspired instrumentally, with drums and bass too much in the foreground for anything but dancing, and with the orchestra all but lost in the mix. The two singers' voices are more complementary than one might have anticipated, though, and Streisand reaches for and sustains notes she hasn't attempted in years. In fact, if nothing more, these disco forays (add *I Ain't Gonna Cry Tonight*) appear to have posed a challenge for the singer. Though they don't require the technique or the emotional input that the ballads do, they do bring an openness to her singing that has been absent for too long.

The Bergmans' *On Rainy Afternoons* and *After the Rain* (cowritten with Lalo Schifrin and Michel Legrand, respectively) and the closing *Kiss Me in the Rain* are of a piece stylistically and in the richness of Streisand's interpretations. They stand well beside her better work of the past and are the three strongest reasons for this disc's memorability.

|||≡ JAZZ ≡|||

Air: Air Lore

Michael Cuscuna, producer
Arista Novus AN 3014
by Don Heckman

The premise behind Air's new album has to go down as one of the—let's be kind—more unusual of recent memory. Very simply, the three-man group has devoted most of "Air Lore" to an exploration of four rag and stomp pieces: Jelly Roll Morton's *Buddy Bolden's Blues* and *King Porter Stomp* and Scott Joplin's *Weeping Willow Rag* and *The Ragtime Dance*.

The first question that comes to mind is "why?," but I'm afraid I can't answer it. The second is "does it work?," and that is related to how close those far-away-in-time pieces come to Air's obviously contemporary point of view. *Buddy Bolden's Blues* (not really a blues), Morton's often-humorous paean to the legendary jazz cornetist, is treated with soulful sensuality. That's not exactly appropriate to the composer's whimsical intention, but it is effective as jazz nonetheless. *The Ragtime Dance*, on the other hand, is peculiarly stilted, with unexplained use of terrace dynamics (loud eight bars contrasted with soft eight bars) and uncertain rhythmic switches. It doesn't shift into high gear until the thematic statement is disposed of and saxophonist Henry Threadgill gets down to some serious "out" improvisation. *King Porter* is much more interesting, perhaps because Air stays closer to the original than to the more familiar Fletcher Henderson reworking. Again, however, the theme statement sounds uncomfortable and real action begins with the improvisation.

Weeping Willow Rag opens with a sensational drum solo by Steve McCall that leads, very uncomfortably, into Threadgill's alto statement of the theme. That business out of the way, Threadgill plays very well, as does bassist Fred Hopkins in his lengthy solo spot. But the theme itself seems irrelevant to the rest of the proceedings. The real problem, I think, lies in the fact that Air has not really found a way to translate these thoroughly pianistic works—with significant parts for both left and right hands—into effective arrangements for the trio instrumentation.

The remaining piece, Threadgill's *Paille Street*, is a moody dialogue between Threadgill's flute and Hopkins' bowed bass, with brushed interjections from McCall's drums. The only original, it is totally out of context with the rest of the album.

Michael Gregory Jackson: Heart & Center

Michael Gregory Jackson, producer
Arista Novus AN 3015
by Crispin Cioe

This is ambitious music. Without being too obvious or forced Michael Gregory Jackson attempts to forge his familiarity with and love of the avant-garde

with his underlying feel for and closeness to popular rhythms and song forms. He has a real gift in this direction and the potential to stand in the line of succession that starts (and, so far, ends) with Duke Ellington.

The guitarist's debut LP, "Gifts," delicately laid out his near-acoustic approach to fusion music. With very sensitive playing from his exceptional band, his songs gracefully and constantly merge extended vamp excursions (sometimes reminiscent of Pharoah Saunders' late-'60s work) with a shifting overlay of melodic/harmonic dissonances that conjure up everything from Stravinsky to Mingus. Color is the element that Jackson seeks to master; my favorite tune on that first album is aptly titled *Vivid Violet*.

On "Heart & Center" he stays with his basic unit (Pheeroan ak Laff on drums, Jerome Harris on electric bass, Marty Ehrlich on reeds and flute) but adds Barry Harwood on keyboards and the wonderful Baikida Carroll on trumpet. These two enrich his palette enormously, and at times the music takes on loose-knit big-band proportions (an arranging skill that Mingus always had). Jackson is singing more, too, often doubling his guitar lines an octave higher. He shares with George Benson the Stevie Wonder vocal influence to a degree, but there are also echoes of Brazilian singer Milton Nascimento, especially Milton's seminal collaboration with Wayne Shorter, "Native Dancer." His lyrics are vaguely spiritual, but in a very friendly and accessible manner, and they perfectly match the tempered optimism of his music.

On guitar, he has an unerring sense of rhythmic displacement and just plain space, whether he's racing off into Hendrix-style permutations or comping airy chords behind Ehrlich's lyrical and beautifully open sax playing. The Laff-Harris rhythm section is dependable and popping, the perfect foil to Jackson's unpredictable compositional turns. And the compositions are what "Heart and Center" are all about. The themes are fresh without being disorientingly angular, and he never quite takes the melodic direction one would expect. This also makes for less predictable solos. On *Falling Rock*, for example, Carroll's trumpet comes tumbling in after the theme like a boulder gathering steam. Another tune, *Of a*
Continued on page 109

MAIL TO: 825 7th Ave., 6th Floor, New York, N.Y. 10019. Phone: 212-265-8360

GENERAL: All copy subject to publisher approval. First line caps. Users of P.O. Box MUST supply permanent address and telephone number before ad can run.

CLOSING DATE: 1st of second month preceding cover date.

CLASSIFIED RATES: Regular type, per word: 1x-\$1.80; 3x-\$1.75; 6x-\$1.65; 12x-\$1.60. **IMPERIAL type, per word: 1x-\$2.40; 3x-\$2.35; 6x-\$2.20; 12x-\$2.15.** Minimum 15 words. Words in caps-10¢ extra each. Box numbers: \$2.00 additional per insertion to cover cost of handling and postage. Display, per inch: 1x-\$290; 3x-\$280; 6x-\$275; 12x-\$235.

PAYMENT WITH ORDER: Send check, M.O., MASTERCHARGE or VISA No. and expiration date to: Classified Dept., HIGH FIDELITY, 825 7th Ave., 6th Floor, New York, NY 10019.

FOR SALE

AUDIOPHILES WANTED!! Put your knowledge to use, earn an excellent spare time income. We need campus Dealers to sell name brand stereo equipment at substantial discounts in your area. No investment necessary. For information and application please write: ABCO, Dept. CR, 1201 East Main Street, Meriden, Conn. 06450.



LOUD AND CLEAR.
Read all about the K—the amazing speaker that has the power to reproduce even the lowest bass notes—loud and clear. Features the brilliant cornhorn design with Speakerlab innovations like Magnor™ damped horn drivers. One of the only kits available for this unique loudspeaker. Read about K's and all the other great Speakerlab speakers and parts in our free catalog.

Speakerlab®
To get yours, write SPEAKERLAB, Dept. 123, 735 N. Northlake Way, Seattle, WA 98103

STEREO REPRESENTATIVES NEEDED!!! LOWEST POSSIBLE PRICES!!! OVER 100 BRANDS!!! KRASCO Rep., 998 Orange Ave., West Haven, Conn. 06516.

SAVE 50% BUILD YOUR OWN SPEAKER SYSTEM. Write McGee Radio Electronics, 1901 McGee Street, Kansas City, Missouri 64108.

ANTI-SKATING FOR AR TURNTABLES!! Proven counterweight design. Install yourself in minutes. \$7.95 postpaid. Audio Innovational Products, P.O. Box 1607, Portsmouth, N.H. 03801.

CERTIFIED AUDIO CONSULTANT HOME STUDY HI-FI Course available. Send \$5.00 for information. Includes **AUDIO TECHNICAL YEAR BOOK** with 29 sample lessons and application for membership in the Society of Audio Consultants. Write SAC, P.O. Box 552, Dept. HF, Beverly Hills, CA 90213.

WE WILL NOT BE BEAT!

1. Super Selection
2. Strong Guarantee
3. Fast Delivery
4. Full Warranty

CALL 203-932-4265
\$1 Rebate for all orders over \$50
MAC VISA COD

★ AUDIO PEOPLE ★
998 Orange Ave., West Haven, CT 06516

SpeakerGuts.



The absolute latest in advanced speaker technology. *Wave Aperture™ Drivers, the Patented Netrovic Woofer System.* raw speaker components selected for their excellence. Horns, crossovers, subwoofers, woofers, midranges, horn and dome tweeters. Over 30 in all. Build your own speaker system and we'll provide top quality speakers and design information. Send for FREE 48 page color catalog from the largest, most experienced speaker kit manufacturer in the world. **DON'T DELAY. Write today!**



MULTI-TRACK AND SEMI-PROFESSIONAL AUDIO EQUIPMENT: BEST PRICES! Prompt Delivery! DBX, TEAC/Tascam, Sound Workshop, AKG, Delta-Lab. Others. Dept. HF, WDI, P.O. Box 340, Cary, NC 27511. Call toll free 1-800-334-2483 in N.C. 919-467-8122.

KOETSU is here. The legendary handmade moving coil cartridge is now available in the U.S. For the complete story, write: Sumiko, Inc., Box 5046, Berkeley, CA 94705.

UNZOO OBFUSCATION OF SALON AUDIO: State-of-the-art and Esoteric Components at Sensible, Affordable Consumer Prices. Newest 36-page fact book/price catalog lists over 4,000 items currently available. Send \$5.00 for prompt mailing [Deductable on first purchase]. Best pricing in North America, SOTA and Esoterica include: SAE, Phase-Linear II, Carver, AEA, Hafler, Lecson, Meridian, Quad, Essence, Grace, Supex, ADC, Satin, JansZen, UltraStat, B & W, Klipsch, Beta, Theta, Win, Specs, BML, RTR, Chapman, Rogers, Burwen, PF, Clarke, Sound Concepts, GAS, SNEER, Soundcraftsman, Beveridge, Audiophile, Signet, Symmetry, Waterloo, Jim Rogers, Denon, Technics Pro Line, Toshiba, Aiwa, Kenwood, Purist, Synergistics, Dyna, Akai, Bose, Sherwood. Bank/Custom references available. Professional Psychoacoustician ready w/no BS Engineering advice. Trade-Ins. VISA/MasterCharge. Personal checks OK. 20% deposit. Orders shipped promptly. Write or phone ASAP for Best Prices. Also, special packaged systems prices. G.E.A.E Golden Ear Audio/Electronics, Drawer #160, Roll-insville, Colorado, 80474, [303] 258-7623 or 258-7524 11 to 9 MST

SAVE up to 60% BY MAIL on: SCOTCH, TDK, BASF, MAXELL, MEMOREX, CAPITOL MUSIC TAPE, CERTRON (over 180 different reel & cassette tapes to choose from); top brand recorders; America's largest collection of taping accessories, too. Same day service. **FREE catalog.**

America's Recording Tape Specialists

SAXITONE TAPE SALES
1776 Columbia Rd., Washington, D.C. 20009
(202) 462-0800

HORNS-WOOFERS-MIDS-TWEETERS at tremendous OEM savings Altec, Electro-Voice, Philips, Peerless, Polydax and many others. Dozens of hard to find items used in major manufacturers most expensive systems. Huge selection of crossover network components, automobile systems, and musical instruments loudspeakers. Send \$1.00 for CATALOG. SRC AUDIO Dept. HF 1, 3238 Towerwood Dr., Dallas, Tx. 75234.

DYNACO OD-1 ambience recovery unit (amazing spacial realism!)-\$19.95 (Kit); \$24.95 (Wired). **DYNACO WALNUT CABINETS**-Single, \$19.95; Double, \$24.95 (specify models). Postpaid. Great gifts! SCC, Box 8014 (1179HF), Canton, OH 44711.

TOP-NAME AUDIO AT LOW LOW PRICES!! Aiwa, AR, Bose, ESS, JBL, JVC, KLH, Marantz, Onkyo, Phase Linear, Pioneer, Sansui, Sony, Soundcraftsman, Teac and many more we can't even mention by name. All factory fresh with full warranty. For prices just call 212-254-3125. Or send \$2.00 for our informative brochure to DIRECT DISCOUNTS LTD., P.O. Box 841, Cooper Station, N.Y. 10003.

DOLBY DECODER NOW ASSEMBLED FOR \$100.00. Also Kit encode/decode. Reviews HFJ Integrex, Box 747, Haverstown, Pa. 19083.

GUARANTEED LOWEST PRICES ON AUDIO, Video Equipment! 160+ brands. Esoteric Pro! Stellar Sound 13906 Ventura Blvd, Suite 193 Sherman Oaks, CA 91423. [213] 766-9790 Monday-Thursday 6-9 PST.

SHURE-V 15 IV-\$83.00; **M 95 HE**-\$27.00; **SME 3009 Series III**-\$190.00. All ppd. DEW. RD 1, Box 658, Halifax, PA 17632, 717-362-3422.

ADDICTED TO DYNAKITS? Phone for quotes/catalog of hard-to-find Dynaco components/accessories. COD's welcomed! [216] 452-6332.

STAN WHITE GLASSCONE SPEAKER for rave European reviews write TACHYON, Box 204, Bloomingdale, IL 61018, 312-529-7590.

A SINGER'S DREAM!



REMOVES VOCAL FROM MOST STEREO DISCS
The Thompson Vocal Eliminator can actually remove most or virtually all of a solo vocalist from a standard stereo record and yet leave most of the background music untouched! Not an equalizer! We can prove it works over the phone. Write for a brochure and demo record below. **COST: \$249.00.**

YOU SHOULD SEE US

For:

- Delay and Ambience
- Studio Echo/Reverb
- Tape Noise Reduction
- Parametric Equalization
- Electronic Crossovers
- Comp/Limiters
- Mic Preamp/Mixers
- Patch Bays

We manufacture a full line of high quality audio and recording equipment. You will probably have to pay twice as much elsewhere to obtain comparable quality. Only Direct Sales make our prices and quality possible. Send \$1 for a 20 page brochure and 20 minute demonstration record.

Write to: LT Sound, Dept. HF, P.O. Box 729, Decatur, GA 30031. (404) 284-5155

MISCELLANEOUS

DIAMOND NEEDLES and Stereo Cartridges at Discount prices for Shure, Pickering, Stanton, Empire, Grado, Audio Technica and ADC. Send for free catalog. LYLE CARTRIDGES, Dept. H, Box 69, Kensington Station, Brooklyn, New York 11218. For Fast Service, call TOLL FREE 800-221-0906.

PROTECT YOUR ALBUMS. WHITE CARDBOARD REPLACEMENT JACKETS 35c. PLASTIC LINED INNER SLEEVES 15c. POSTAGE \$1.25. OPERA BOXES, 78 SLEEVES AVAILABLE. FREE CATALOG. CABCO 301-3, BOX 8212, COLUMBUS, OHIO 43201.

Free Promotional Albums, Concert Tickets, Stereos, Etc. Information: Barry Publications, 477 82nd Street, Brooklyn, N.Y. 11209.

COLLEGE STUDENTS! Improve your grades. Send \$1.00 for 356-page, collegiate research papers catalog. 10,250 available. RESEARCH ASSISTANCE, Box 25916R, Los Angeles, California 90025. [213] 477-8226.

The Best New Stereo Systems Deserve The Best New Stereo Records (Tapes too)! You need the Monthly SCHWANN RECORD CATALOG available from record shops everywhere or, for a sample copy PP, Send \$2.50 to: ABC-SCHWANN. Single Copy Sales, Dept. 2 160 Patterson St., Cincinnati, Ohio 45214.

SLIPCASES for HIGH FIDELITY Magazine. Simulated blue leather, Holds 6 High Fidelity issues. \$4.95 single case, \$14 for 3 cases, \$24 for 6 cases. USA orders only. Allow 6 weeks for delivery. **HIGH FIDELITY Library Cases, Box 5 120, Philadelphia, PA 19141.**

AS CLEAR AND STATIC-FREE AS FM itself—that's SCAL Portable or clock radio modified to pick up special music, talk programs, \$38. FM Atlas, Adolph MN 55701.

NEW EQUIPMENT FOR SALE

BRITISH AND EUROPEAN EQUIPMENT DIRECT TO YOU. Most quality makes of equipment available at advantageous prices. For price list and price quotes send International Reply Coupon. Send \$2 for the brochures you require. Audio T, Dept A, 190 West End Lane, London, NW6 1SQ, England, Phone 01-794 7848. Visitors welcome.

TOP-RATED CARTRIDGES UP TO 70% OFF!! We feature Acutex, ADC, Grado, Nagatron, Ortofon, Sonus, Stanton, et al. Unbelievable prices! Call 212-254-3125 for prices, or write to DIRECT DISCOUNTS LTD., P.O. Box 841, N.Y., N.Y. 10003.

BUY DIRECT and save. British and European Hi-Fi. Attractive prices. Send Reply Coupon for Quote, \$3 bills for brochures. Goodwins, 7 The Broadway, Wood Green, London N22, Phone 888-0077. VISA/Mastercharge. Visitors welcome.

LOWEST PRICES ON STEREO-ESOTERIC COMPONENTS & tapes!! Over 150 brands. Send #10 SASE for quotes. Audio Unlimited, 401 Reynolds Circle #10, San Jose, CA 95112 (408) 289-8875. 1-6 M-Th.

ABSOLUTE LOWEST PRICES on all brands of car and home stereo equipment and musical instruments. Call (707) 963-9653, or write: WFI Distributors, 1148 Main Street, St. Helena, CA 94574.

QUALITY AUDIO DISCOUNTED! Car/Home. SASE for quotes. Denco Audio, P.O. Box 6104-H, El Monte, CA 91734. (213) 444-9978 evenings, weekends.

LOWEST PRICES!! IN MAIL ORDER STEREO, Esoteric, Auto, Disco. Over 150 brands—BGW, Bose, Cerwin Vega, Infinity, JVC, LUX, Marantz, Onkyo, Phase Linear, Pioneer, Tandberg, Technics, Thorens and many others. All factory fresh—shipped fast! Call or write for catalog and prices (914) 258-4342. 9am-9pm, Sound Shed, Box 61A, Merritts Island Road, Pine Island, New York 10969.

TAPES & RECORDS

RARE OPERA, SYMPHONIC MUSIC ON OPEN REEL TAPE. Historic performances. EUROPEAN, DOMESTIC. Free Catalogue. Underhill, Box "U," Belport, NY 11713.

"SOUNDTRACKS, SHOW, NOSTALGIA & JAZZ—FREE Catalog & Offering List—A-1 Record Finders, P.O. Box 75071-H, L.A. CAL. 90075."

SCOTCH RECORDING TAPE, LOWEST PRICES. TAPE CENTER, Box 4305C, Washington, D.C. 20012.

RAREST CLASSICAL, SOUNDTRACKS, SHOWS, PERSONALITY LPs. Huge catalog \$1.00. Grammy's Attic, Box 181, Bluffton, SC 29910.

"LIVE OPERA TAPES. Reels—Cassettes. Unbelievable treasures since 1926. Over 5,000 selections. Free DELUX Catalog: MR. TAPE, Box 138, Murray Hill Station, NYC 10016."

TDK, MAXELL, MEMOREX, CASSETTES, REELS, 8-Track Free Catalog, New Guaranteed. S&S AUDIO, P.O. BOX 94485, Schaumburg, IL 60194.

**NOTICE:
Record Listeners
Wanted**

(No experience required) Each month you will receive nationally released albums to rate. **There is no extra charge for the LP's you receive** — all you pay is a small membership fee which covers all costs of the LP's including postage and handling. In return for your opinion you will build a substantial album collection - "first come basis." For application write:

EARS SYSTEMS
Box 10245 Dept. HF
5521 Center St., Milwaukee, WI 53210
"Guaranteed" © 1979 EARS SYSTEMS

SCHUBERT/DYER-BENNET. The splendid Tully Hall performance of the Dyer-Bennet translation of "Schone Mullerin" (Characterized by Andrew Porter as "A 'Schone Mullerin' which came to life") now available in a meticulously produced studio recording (stereo—two discs) directly from Dyer-Bennet records, Monterey Stage, Great Barrington, MA 01230. \$17.50 postpaid.

FREE CATALOG LP'S. FACTORY SEALED \$2.50 to \$4.00 Modern Designs, 1731 N.E. 51st St., Pompano Beach, Fla. 33064.

CUT-OUT RECORDS, HUGE STOCK. ALL NEW. No catalog, Cohn 2205 Marylane, Broomall, Pa. 19008.

ON OPEN REEL from master tapes. Argo, Telefunken, Vanguard, Unicorn, MHS. Catalogue \$1.00. Barclay-Crocker, Room 1470-H, 11 Broadway, NYC 10004.

SEARCHING? WRITE DISCONTINUED RECORDS, 444 South Victory, Burbank, California 91502.

SHOW ALBUMS—Rare, out-of-print lps, 64-page list \$1.00. Bakers Wife or Nefertiti—original cast LP \$9.95. Broadway-Hollywood Recordings, Georgetown, CT. 06829.

1930-1962 RADIO PROGRAMS, \$1.00 HOUR! Professional 200 page catalog, \$1.25. AM Treasures, Box 192HF, Babylon, N.Y. 11702.

VIENNESE LIGHT MUSIC SOCIETY—Strauss, Lanner, etc. on Dolby Cassettes, KC Company, Box 793, Augusta, Maine 04330.

BASF TAPE: Largest discounts, fastest service. All tapes guaranteed! INTERGALACTIC ENTERPRISES, 1789 Carr, Troy, Michigan 48098.

OPEN REEL TAPES. Top Quality. 100% money-back guarantee. Major labels. Classical, pop, rock, quad—direct disk & video. Bank cards accepted. Catalog/order information, \$1. No other fees, obligations. THE REEL SOCIETY, P.O. Box 55099-H, Valencia, CA 91355.

LIVE OPERA ON REEL/CASSETTE. THOUSANDS OF PERFORMANCES, WORLDWIDE SINCE 1930's. The ONLY service that provides the personal attention demanded by the Vocal Art. Free Gifts, Magnificent Free Catalogue. LIVE OPERA, Box 3141, Steinway Station, L.I.C., N.Y. 11103.

RECORD HOUND, Box 88H, Eagleville, PA 19408. Fills want lists? Doggone right!!! 33 1/3 specialist. Fast, friendly service.

GOLDEN AGE RADIO—your best source for radio tapes. Free catalog. Box 25215-J, Portland, Oregon 97225.

SOUNDTRACKS—New and out-of-print film music recordings. Free listings and info. CINE MONDE RECORDS, 1488 Vallejo St., San Francisco, CA 94109.

SUPER-FI RECORDS! All types, labels. Catalog \$1; COSMIC CHORDS PO Box 4873 Boulder, Colo 80306.

Buy with confidence

fact: the IV does more!

Send for Quotes & Price List on Shure & Over 100 Other Famous Brands

SHURE
VIS Type IV
SUPER TRACK IV
Stereo Dynetic® Phono Cartridge

Consistent record tracking has always been challenged by such ever-present factors as warp, static, lint and dust—especially when these factors combine with today's "hot" recordings.

CARSTON 146 OLD BROOKFIELD RD
Denbury, Conn. 06810
DISCOUNT CENTER (203) 744-6421 (212) 369-6212

MON. - THU. 9:00 - 5:30
THUR. 9:00 - 8:00 P.M. SAT. 9:00 - 4:30

**Classified Dept., HIGH FIDELITY,
825 7th Ave., 6th Floor, New York, NY 10019
Telephone: 212-265-8360**

Name _____

Address _____

City _____ State _____ Zip _____

Telephone _____

Payment enclosed \$ _____ for _____ issues, Check M.O.

MASTERCHARGE VISA Card # _____ Expiration _____

Bank # _____ Signature _____

Please run following ad copy for _____ issues starting next available

issue: _____



Continued from page 106

Highly Questionable Nature, is dedicated to Jimi Hendrix and Albert Ayler. It's a funky meeting of two great deceased musical forces, and the amazing thing is that such influences can live and breathe side by side in Jackson's songs. If he keeps it up, he could very well unify even more musical threads that have traditionally remained separate. And that's what playing with colors is all about.

Bob James and Earl Klugh: One on One

Bob James, producer
Columbia Tappan Zee FC 36241
by J.B. Moore

Since he left CTI and formed his own label under Columbia's aegis, composer/keyboardist Bob James has produced each new LP like a chef working minor variations on a successful, if somewhat unimaginative, restaurant's cuisine. With "One on One" he has added a new entrée in guitarist Earl Klugh, creating a substantial—and welcome—change

in fare.

The ever-present trumpets, trombones, and flugelhorn of previous outings have been replaced by a five-man woodwind section with French horn. Missing too are regular drummers Steve Gadd and Andy Newmark, supplanted here by the lower-key, more progressive Harvey Mason. This is not to say that James has radicalized his framework. The remainder of the rhythm section is familiar, and engineer Joe Jorgensen, an important element in the Tappan Zee sound, is also still on hand.

The result is quite listenable. The strings and woodwinds complement Klugh's subtle, acoustic approach, and James arranges them like the tasteful master of "with strings" jazz, Claus Ogerman. Bassist Ron Carter's appearances on *Mallorca* and *Winding River* add to the richness of the proceedings, particularly his solo on the latter.

If there is a weakness, it is the material. James's three tunes sound like jazz-flavored movie themes (good ones, but movie themes nonetheless), and the bal-

ance—an equal number by Klugh—have a similar "pop-classics" leaning. Still, "One on One" is superior to either's current solo album ("Earl Klugh with Strings" and "Lucky Seven") not to mention a legion of other LPs in this genre. With a song or two from outside sources, a second helping of Klugh-James just might make a truly hearty meal.

Sonny Rollins: Don't Ask Orrin Keepnews, producer Milestone M 9090

It's a good thing composer/saxophonist Sonny Rollins' status as one of the founding fathers of modern jazz was well established more than a few years ago. With what he has been doing lately for Milestone—and "Don't Ask" is a pretty typical example—recently initiated jazz listeners might be wondering what all the fuss is about. Fortunately, his creativity is still very much intact, and even on such silly things as a piece called *Disco Monk* (!) he can startle us with inspired bits and fragments of improvisations.

CAN'T GET ORION RECORDS? Orion's alive and well and easy to get! Send check—order shipped same day. \$6/record, includes postage. \$11 for 2—\$5 each for 3 or more. Orion Master Recordings, Box 4087, Mailbu, CA 90265.

RARE ORIGINAL SOUNDTRACK ALBUMS SEND 25 CENTS FOR LIST. SHOW MUSIC, BOX 12, WOOD RIVER, ILLINOIS 62095.

VIENNESE OPERETTA RECORDS, INC. Extensive range, superb vocal performances, on currently available LP's. Free list. P.O. Box 50-B, Dover, Mass. 02030.

HEAR FAVORITE RECORDS & tapes with startling new clarity. 8800 noise reduction revives noisy sources. Write LOGICAL SYSTEMS 3314a 'H' St. Vancouver WA 98663.

AUDIOPHILE RECORDS: Save 20% to 40% (or more). Fast, personal service. Free catalog. SUPER SOUND RECORD SERVICE: P.O. Box 411237: Chicago, ILL 60641.

ARTHUR FIEDLER, THE KINGSTON TRIO AND Buddy Rich! Invite them all into your living room. Send \$1 for catalog offering these and over 250 different artists on Direct-to-disc, Digital and other specially-cut recordings. Immediate service! Send today. Sound Concepts, PO Box 7063, Eugene, OR 97401.

Live Performances tapes—opera, conductors, instrumentalists. Superior Sound. Open Reel Only. Catalogues. Good Sound Associates, POB 263 Planetarium Station, New York, NY 10024.

DISCONTINUED RECORDS, Classical, Popular, All Speeds, Free Lists, Fred Steinmetz, One Seaview Avenue, Massapequa, NY 11758.

25,000 LP ALBUMS & 1700 78 RPM SETS FOR SALE. Send wants lists. Bernstein, Pine Valley Road, Oyster Bay, N.Y. 11771.

FREE CATALOG... CLASSICAL CASSETTES... PURE NATURAL... SOUND... FOREIGN DEALERS INVITED... EKR CLASSICS, GPO BOX 1977HX, NYC 10001.

MAGIC OF MOZART—14 SELECTIONS LP ONLY \$1.98 CASSETTE \$2.49. FREE JAZZ/CLASSICAL CATALOG MUSICAL CONCEPTS, BOX 53HF, CEDARHURST, N.Y. 11516.

FIRST METAL TAPE recordings: Demo \$19.95, brochure \$2 Direct-to-cassette from original master. Audio Art, Box 9252, Rochester, N.Y. 14625.

UNUSUAL CLASSICAL VOCAL AUCTION. Shellac 78's. Most AGSA/AGSB, VA/VB special issues pressed from masters; many DA/DB's, etc. Also early HMV LP vocal recitals, complete operas, all in excellent condition. List from Addison Foster, c/o Smolian, Box 437, Catskill, N.Y. 12414

Free 4.00 T-Shirt

TDK SA C90	3.05	Ampex Grandmaster I 90	2.69
TDK AD-C90	2.45	Ampex Grandmaster II 90	3.09
TDK D C90	1.59	Scotch 212-7R-1800	3.98
TDK SA C90	2.15	Soundguard Record Pres Kit	4.59
BASF Pro I C 90	2.79	TDK L 1800	5.13
BASF Pro I or IIC 90	2.89	TDK LB 1800	6.31
BASF Studio I or IIC 90	2.59	Ampex Grandmaster 1800 ft Reel	5.95
Scotch Master II or IIC 90	3.15	Scotch 207 7R-1800	5.05
Scotch Master IC 90	2.69	BASF Studio 1800 ft Reel	6.49

Free T-Shirt with every order while supplies last. All tapes can be assorted. No min. Add \$3.00 shipping or write for free catalog of 250 items plus lowest prices on all Masell products. 100% guaranteed. 411-283-8621. M-TH 9-4.

TAPE WORLD 220 Spring St. Butler, PA 16001

SEARCHING? SEND WANT LIST FOR 78's & LP's 5H March. Discontinued Records, PO Box 253, Gwynedd Valley, PA 19437

BUSINESS OPPORTUNITIES

CABLE FM BROADCASTING: Unique no investment/experience business. Home operation possible. Excellent income. "CAF.M," Box 130-D-1, Paradise, CA 95969.

MECHANICALLY INCLINED INDIVIDUALS: Assemble electronic devices in your home. Investment, knowledge, or experience not necessary. Start in spare time. Above average profits: \$300-\$600/wk possible. Sales handled by others. Write for free details. Electronic Development Lab, Drawer 1560HF, Pinellas Park, Fla. 33565.

BUMPER STICKER PRINTING DEVICE. Cheap, Simple, Portable. Free Details. Bumper, POB 22791 (FD), Tampa, FL 33622.

PUBLICATIONS

THE BLIND AND OTHER PHYSICALLY HANDICAPPED can know the joy of reading memorable selections chosen from over 50 outstanding periodicals, completely free of charge. Write CHOICE MAGAZINE LISTENING, Dept. HFC, Box 10, Pert Washington, NY 11050 or call 516-883-8280.

SINGERS—CONVERT YOUR STEREO TO VOCAL ELIMINATOR! No skill or cost. Takes two minutes! EASY! Report S/D. Robert Co., 5578 Burnside Box 6, Rockville, Md. 20853.

SERVICES

COLLEGE STUDENTS! Improve your grades. Send \$1.00 for 36-page, collegiate research papers catalog. 10,250 available. RESEARCH ASSISTANCE, Box 25916R, Los Angeles, California 90025. (213) 477-8226.

SAVE POSTAGE! Your mailbox flooded with samples, offers. \$2, SASE. VAL-U-CORP., Box 234-HF Mercer, Wis. 54547.

ELECTRONICS

ELECTRONIC BARGAINS. CLOSEOUTS. SURPLUS! Parts, equipment, stereo, industrial, educational. Amazing values! Fascinating items unavailable in stores or catalogs anywhere! Unusual FREE catalog. ETCO-017, Box 762, Plattsburgh, N.Y. 12901.

EMPLOYMENT

THE UNIVERSITY OF MICHIGAN SCHOOL of Music announces an opening for soprano on its voice faculty. Applicants should have substantial teaching experience and be currently active in professional performances of oratorio, opera and concert repertoire. Appointment begins September, 1980. Rank and salary negotiable. Inquiries should be directed to: Leslie Guinn, Chairman, Search Committee, The University of Michigan, School of Music, Room 2273 Moore, Ann Arbor, Michigan 48109. A non-discriminatory, affirmative action employer.

ADVERTISING INDEX



For free product literature, use the reader service card on page 77.

Key No.		Page No.
1	ADC Professional Products, a div. of BSR Consumer Products Group	5
2	ADC Professional Products, a div. of BSR Consumer Products Group	37
51	AIWA	46
	Akai America Ltd.	49
3	Altec Lansing	28
4	Angel Records	73
	Audio Technica U.S. Inc.	10
6	Audiovox Corp.	41
7	Bang & Olufsen	31
	Bose Corp.	Cover III
8	BSR (USA) Ltd.	62
9	Caedmon Records	74
	Classified Ads	107-109
52	Dahlquist	92
11	Discount Music Club	67
12	Discwasher, Inc.	22
	Dual	85
57	Dynaco	4
13	Electro-Voice, Inc.	50
14	Empire Scientific Corp.	18
15	47th Street Photo	105
16	Fujitsu Ten Corp.	12
53	Garrard	86
17	Hi Fi Buys	105
18	Icelandic Airlines	89
19	Illinois Audio	90
20	International Hi Fi	105
	International Preview Society	13
50	JBL	45
21	JBL	97
22	Jensen Sound Laboratories	39
23	J & R Music World	88
24	JVC America, Inc.	75
	Kenwood	Cover IV
	Lux Audio of America	25
54	Magnetic Tape Warehouse	84
25	Maxell Corp.	15
26	McIntosh Laboratory	9
49	Memorex Corp.	8
27	Mobile Fidelity Records	61
81	Nautilus Recordings	80
28	Onkyo	76
56	Ortofon	101
29	Park Row Electronics	103
30	Phase Linear	87
31	Pioneer High Fidelity	Cover II, 1
32	Sansui Electronics Corp.	69
33	Sanyo Electric	51
	Schwann Publications	81
34	Scott, H. H., Inc.	35
35	Shure Brothers, Inc.	82
36	Shure Brothers, Inc.	83
37	Shure Brothers, Inc.	83
38	Sony Corp.	21
39	Sony Corp.	27
40	Sound Guard	17
	Speakerlab, Inc.	105
41	Stanton Magnetics	2
42	Stereo Corp.	103
	Stereo Discounters	86
43	Studer Revox America, Inc.	33
44	TDK Electronics Corp.	11
46	Technics by Panasonic	7
55	Toshiba America	70
	United Audio Products	85
48	Wisconsin Discount Stereo	10
	Yamaha Audio	43

Guitarist Larry Coryell has been added to the Rollins group for this outing, but the combination doesn't work as well as it should. Coryell clearly has put the lid on some of his more outrageous rock/jazz licks, but even so, he never seems to get into sync with Rollins' upbeat phrasing. *The File* (by Coryell) and *My Ideal* (an old standard) feature the two in duets that emphasize the peculiar incompatibility of their styles. *The File* is a pure contemporary vamp tune, totally lacking the complex harmonic framework that Rollins needs to play his best. He fumbles through it in, for him, startlingly tentative fashion. *My Ideal* is clearly better for him, but Coryell doesn't seem to know what to do with the tune.

The other pieces—played with quintet backing—pass with little to distinguish them. *Tai-Chi* is interesting primarily as an oddity; Rollins plays lyricaon, using it to produce a floating shakuhachi sound. *Don't Ask* is a good, Rollins-composed line that seems about to spring him loose, but the expected excitement never quite happens. The same is true of *Disco Monk*: Just as the rhythm section's inept effort to produce a disco beat becomes annoying, the tempo lays back behind some vintage, upfront preaching from Rollins' tenor saxophone. One can only wish that "Don't Ask" had a few more such moments. **D.H.**

**Bennie Wallace:
The Fourteen Bar Blues**

*Bennie Wallace & David Baker, producers
Inner City IC 3025
by John S. Wilson*

Bennie Wallace's album debut as a leader has been a long time coming. He has been one of the most interesting saxophonists in New York since the mid-'70s, and until recently he has been heard primarily in loft situations. His trio, with bassist Eddie Gomez and drummer Eddie Moore, had been working together for the better part of a year before they made "The Fourteen Bar Blues" last January.

Wallace is a fascinating amalgamation of the entire spectrum of the jazz saxophone. Although he mentions Parker, Rollins, and Coltrane as early influences and says his current favorite is Johnny Hodges, critics have heard in his playing an impressively wide swath of sources from Webster, Byas, and Hawkins to Sam Rivers, Archie Shepp, Albert Ayler, and Eric Dolphy. On this disc, he frequently brings several of those sources to

mind, but he has absorbed them to such an extent that they have become part of his own style. Rollins is the most apparent, delightfully present even in Wallace's compositions—in the jaunty swing of *Broadside*, in the slightly calypso-ish *Green & Yellow*, and in *Yard 'n Newk*, in which a Rollins line is played by Gomez and joined to a Parker line from Wallace. Rollins' popping phrases also come through in *Chelsea Bridge*, though Wallace's heavily breathy treatment is an interesting derivation of Webster's playing. And on *Trinkle Tinkle*, Bennie shows himself to be closer to Thelonious Monk's piano than was Monk's own saxist of many years, Charlie Rouse.

Gomez' harmonic, tonal, and rhythmic strengths match Wallace's inventive qualities. This is true not only for his solos—a brilliantly articulated bit on *Vicissitudes* and a marvelously melodic exploration of *Flamingo*—but for the power of his presence as a virtual second horn working with and around Wallace's saxophone.

Continued from page 98

track recording for about ten years now, I felt right at home with the procedures outlined in the owner's manual and was truly amazed at how closely the Teac overdub and remix techniques correspond to professional practices. Of course, it is only a two-buss board, and track assignments are made with the help of the pan pots, but the basic configuration is virtually identical to established procedures. In half an hour, I completed three different tests of all the record, overdub, and mix functions. That's pretty fast—an indication of the 144's ease of operation. To mix to a standard cassette, for instance, simply push the MIC/ LINE-TAPE buttons to TAPE, and the four tracks come up in order on the four faders. Set the balance, use the equalizers (if necessary), process the signals through the AUX circuit, hook up the outputs, and away you go. It couldn't be simpler. In fact, the 144 performed without even a hint of difficulty throughout all of my experiments.

I had a hunch something was up when Teac introduced the two-track Syncaset last spring ("Input Output," August 1979). If that was a step forward, the Portastudio is a giant leap in meeting the needs of the consumer recordist.

Circle 121 on Page 77

Introducing the Bose® 550 Receiver.

The new, moderately priced Bose® Model 550 AM/FM Stereo Receiver brings you Bose® technology and research wrapped up in an affordable, innovative package. It includes a direct-coupled amplifier that delivers a solid 40 watts of RMS power per channel—enough to drive almost any loudspeaker. It has an excellent AM/FM tuner section for clear, clean reception. And exclusive Bose® Source and Room Compensation Controls let you adjust for recording characteristics and for room acoustics. These controls make it easy for you to remove mid-range boominess *without* losing your deep bass. Try that with a conventional receiver!

The Bose® 550 Receiver is designed to drive any speakers that suit your taste and budget. And it contains a unique feature you'll really

appreciate when you upgrade your system. More and more customers tell us their first loudspeakers are interim units and that one day they hope to invest in a Bose® 901® Series IV Direct/Reflecting® Loudspeaker System. Ownership of the 550 Receiver brings that day much closer, because the receiver has a built-in 901® Active Equalizer that gives you a significant savings when you purchase 901® speakers.

With or without Bose® speakers, we believe you won't find a receiver that gives you better engineering, better design and better sound for the money. For more information about this fine new Bose® Model 550 AM/FM Stereo Receiver, see your nearest authorized Bose dealer. Or write: Bose Corporation, Dept. HF, 100 The Mountain Road, Framingham, MA 01701.

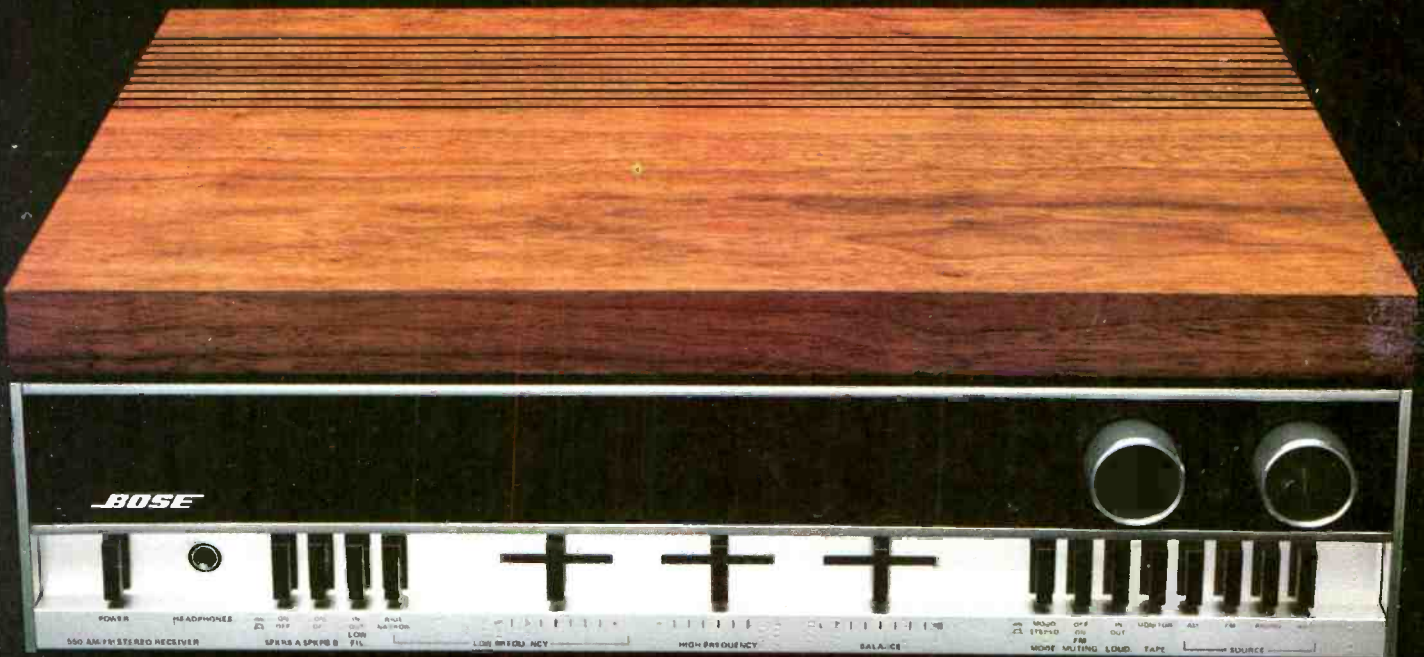

Covered by patent rights issued and/or pending
© Copyright 1979 by Bose Corporation

BOSE
Better sound through research.

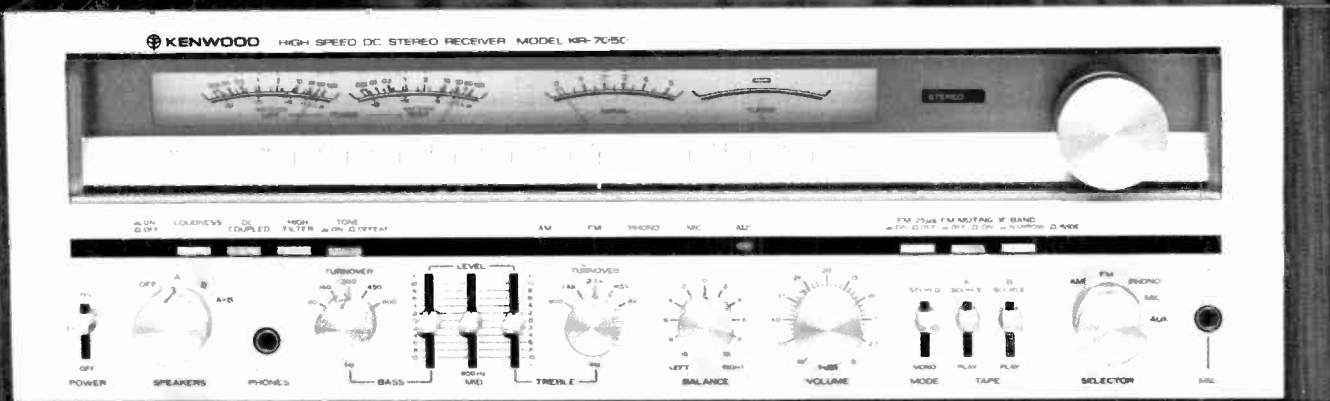
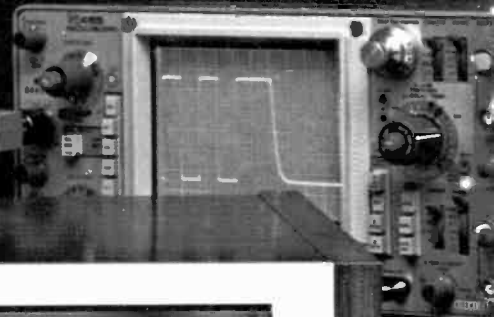
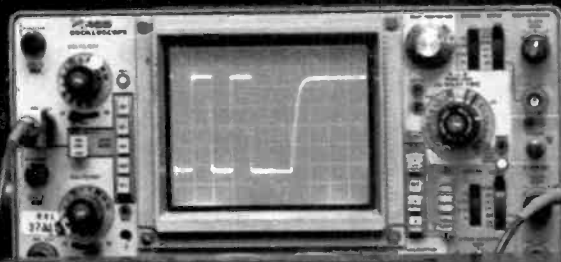

INDEPENDENT TEST REPORT: KENWOOD HAS BETTER TRANSIENT RESPONSE THAN PIONEER, TECHNICS OR YAMAHA.

Recently, we asked an independent testing laboratory to measure Kenwood's new Hi-Speed™ receiver against the competition. Each one "off the shelf" in unbroken factory cartons.

The results were impressive, if not surprising.

The Kenwood receiver outperformed comparable models of other brands in both rise time and slew rate, the same new specifications that are used to

RISE TIME (5 MICROSECOND CLOCK)

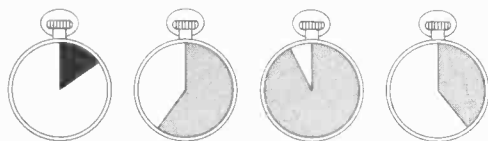

KENWOOD
KR-7050
.85 μs

PIONEER
SX-980
3.0 μs

TECHNICS
SA-700
4.60 μs

YAMAHA
CR-1040
2.00 μs

measure a receiver's ability to handle complex musical signals.

Of course, the Kenwood receiver had one unfair advantage: Kenwood's exclusive Hi-Speed circuitry. Hi-Speed allows an amplifier section to react faster to changes in music to minimize audible transient intermodulation distortion.

In the laboratory, this shows up as superb specs and an almost perfect square wave on an oscilloscope.

In your home, you'll hear superior clarity and definition with excellent imaging. For example, you'll be able to identify an individual singer in a vocal group.

SLEW RATE MEASUREMENT RESULTS

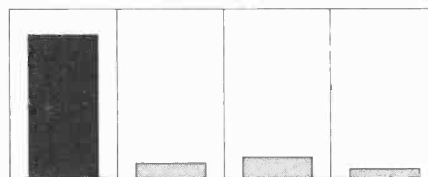

KENWOOD
KR-7050
200 V/μs

PIONEER
SX-980
20 V/μs

TECHNICS
SA-700
29.4 V/μs

YAMAHA
CR-1040
10.7 V/μs

Your Kenwood dealer can show you the entire line of Hi-Speed receivers.

Because if you're going to buy a receiver, why not go with the best performer?

HI-SPEED™

Hear the future of high fidelity

KENWOOD®

For the Kenwood dealer nearest you, see your Yellow Pages, or write Kenwood, P.O. Box 6213, Carson, CA 90749.

In Canada: Magnescnic Canada, Ltd / Test data available upon request.
Rise time and slew rate measured by slope at zero crossing method.