

The 28 Best Records of 1979

HIGH FIDELITY

ICD
© 08398

Six Experts Tell How to Buy a Stereo System for

- \$1,000
- \$3,000
- \$5,000

27 Audio Stocking Savers for Less

beat: uitar - gh's Advice



HF H5A2C1 37R03SALS-60 1 03
 R H5AN
 37 CLINTON ST
 ORENTA N Y
 13820



AND IT'S WHAT GOES
INTO HPM SPEAKERS THAT
MAKES THEM SOUND GREAT ON
EVERY PART OF THE MUSIC.



HPM 60

HPM 100

HPM 150

HPM 40

Most speaker companies try to impress you by describing the "wonderful" sound that comes out of their speakers.

At Pioneer, we think the most believable way to describe how good HPM speakers are is to tell you what went into them.

**THE HPM SUPERTWEETER:
SPEAKER TECHNOLOGY RISES TO NEW HIGHS.**

In many speakers, you'll find that the upper end of the audio spectrum is reproduced by an ordinary tweeter.

In HPM speakers, you'll find that the high frequencies are reproduced by a unique *supertweeter*.

It works by using a single piece of High Polymer Molecular film, (hence the name HPM) that converts electrical impulses into sound waves without a magnet, voice coil, cone, or dome.

And because the HPM supertweeter doesn't need any of these mechanical parts, it can reproduce highs with an accuracy and definition that surpasses even the finest conventional tweeter.

As an added advantage, the HPM film is curved for maximum sound dispersion. So unlike other speakers, you don't have to plant yourself in front of an HPM speaker to enjoy all the sound it can produce.

**MID-RANGE THAT ISN'T
MUDDLED.**

For years, speaker manufacturers have labored over mid-range driver cones that are light enough to give you quick response, yet rigid enough not to distort.

Pioneer solved this problem by creating special cones that handle more power, and combine lower mass with greater rigidity. So our HPM drivers provide you with cleaner, and crisper mid-range. Which means you'll hear music, and not distortion.

WOOFERS THAT TOP EVERY OTHER BOTTOM

Conventional woofers are still made

with the same materials that were being used in 1945.

Every woofer in the HPM series, however, is made with a special carbon fiber blend that's allowed us to decrease the weight of the cone, yet increase the strength needed for clarity. So you'll hear the deepest notes exactly the way the musician recorded them.

And because every HPM woofer also has an oversized magnet and long throw voice coil, they can handle more power without distorting.

**OTHER FEATURES YOU
RARELY HEAR OF**

Every HPM speaker has cast aluminum frames, instead of the usual flimsy stamped out metal kind. So that even when you push our speakers to their limit, you only hear the music and never the frames. In fact, our competitors were so impressed, they started making what look like die cast frames, but aren't.

HPM speaker cabinets are made of specially compressed board that has better acoustic properties than ordinary wood.

Their speakers have level controls that let you adjust the sound of the music to your living room. And these features are not just found in our most expensive HPM speaker, but in every speaker in the HPM series.

All of which begins to explain why, unlike speakers that sound great on only part of the music, HPM speakers sound great on all of it.

At this point, we suggest you take your favorite record into any Pioneer Dealer and audition a pair of HPM speakers in person.

If you think what went into them sounds impressive, wait till you hear what comes out of them.

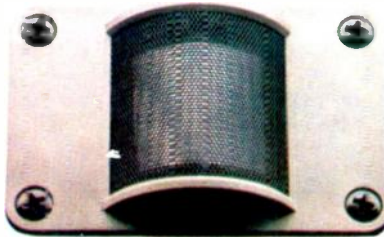

The High Polymer Molecular Supertweeter. So incredible, we named a whole line of speakers after it.

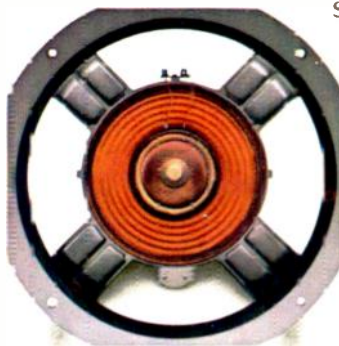

You'll never hear a sound out of these die cast aluminum speaker frames.



Level controls that let you adjust the sound to your listening area.

PIONEER
We bring it back alive.



**WHAT COMES OUT
OF A SPEAKER IS ONLY
AS IMPRESSIVE AS
WHAT GOES INTO IT.**

EXPENSIVE SOUND... INEXPENSIVELY

the new
OA-5A
from
Pickering



© 1979 PICKERING & CO. INC

With the introduction of the OA-5A Pickering adds a new dimension to an already great line of headphones. The OA-5A combines the dynamic performance of low mass, high energy samarium cobalt drivers found in our top-of-the-line stereophones, with the benefits of open-audio design, assuring an acoustically perfect listening environment and the ultimate in listening comfort... without isolating you from your surroundings. And the OA-5A delivers full range frequency response everywhere you go, because Pickering includes a special adapter plug for portables. Suggested retail for the Pickering OA-5A headphone is \$60. For further information write to Pickering and Co., 101 Sunnyside Blvd., Plainview, N.Y. 11803.



OA-3A



OA-7

 **PICKERING**

"for those who can hear the difference"

Above left is the Pickering OA-3A, an advanced headphone that delivers impressive sound quality. With adapter plug. Suggested retail \$45. Our finest example of open-audio design and engineering, the OA-7 has superb listening characteristics and featherlight wearing comfort. Suggested retail \$70.

HIGH FIDELITY

Leonard Marcus
Editor

Shirley Fleming
Editor, Musical America

Robert Long
Audio-Video Editor

Peter Dobbin
Assistant
Audio-Video Editor

Susan Elliott
Editor, Backbeat

Rebecca Abbott
Associate Editor

Lynda Carlotta
Cynthia Pease
Assistant Editors

Isabel Parker
Editorial Assistant

Edward J. Foster
Consulting Audio Editor

Edward Greenfield
European Editor

Robert S. Clark
Editorial Director

Abram Chipman
John Culshaw
R. D. Darrell
Harris Goldsmith
David Hamilton
Dale Harris
Paul Henry Lang
Gene Lees
Irving Lowens
Robert C. Marsh
Fred Miller
Contributing Editors

Sarina Bromberg
Art Director

Wayne Armentrout
Production Director

David Lee
Circulation Director

John D. Kallmann
Circulation Manager

William P. Johnson
Circulation Service Manager

Leonard Levine
Associate Publisher

Warren B. Syer
Publisher

HIGH FIDELITY is published monthly at The Publishing House, Great Barrington, Mass. 01230 by ABC Leisure Magazines, Inc., a subsidiary of American Broadcasting Companies, Inc. Copyright © by 1979 ABC Leisure Magazines, Inc. The design and contents are fully protected by copyright and must not be reproduced in any manner. Second-class postage paid at New York, New York, and at additional mailing offices. Authorized as second-class mail by the Post Office Department, Ottawa, and for payment of postage in cash. Yearly subscription in U.S.A. and Possessions \$11.95; elsewhere \$15.95. Single copies \$1.50. Subscribers: Send subscriptions, inquiries, and address changes to High Fidelity, 1 Sound Ave., Marion, Ohio 43302. Change of address: Give old and new addresses, including ZIP Code. Enclose address label from last issue and allow five weeks for change to become effective. **Postmaster: Send Form 3579 to High Fidelity, 1 Sound Ave., Marion, Ohio 43302. Postal Identification Number 243820.**

Audio/Video

- 10 High Fidelity News**
- 22 CrossTalk**
- 29 Video Topics**
Clubs and catalogs for collectors
- 33 Equipment Reports**
Sansui TU-919 tuner
Yamaha MC-1X phono pickup
JVC KD-A8 cassette deck
Electro-Voice Interface A Series III speaker
RG Pro-20W expander
Rotel RX-504 receiver
- 56 Stereo Systems for \$1,000, \$3,000, or \$5,000**
by Alfred Myers, Michael Riggs, Peter E. Sutheim, William Warriner, Don Heckman, and Ivan Berger
- 71 Christmas Gifts for the Audiophile**
by Peter Dobbin
27 ways to delight for less than \$50

Music/Musicians

- 63 Cracking the Vaults at Columbia and RCA**
by David Rosenthal
You may never hear those unreleased musical treasures
- 67 Best Records of the Year**
by Leonard Marcus
International Record Critics Awards for 1979
- 75 The Plot Against Wagner's Miss Pringle**
by John Culshaw
- 79 Ormandy's Bartók**
by Abram Chipman
Digital RCA or analog Angel?
- 80 The Waltz King Meets Schoenberg and Friends**
by Irving Lowens
DG's disc of Strauss arrangements may be the year's sleeper
- 83 Behind The Scenes**
- 84 Classical Records**
Brandenburgs from Aston Magna
A Vaughan Williams opera

90 Critics' Choice

- 110 The Tape Deck**
by R. D. Darrell

Backbeat

- 121 The Emotions**
by John Storm Roberts
- 125 Buying the Right Electric Guitar**
by Steve Burgh
- 128 Pop-Pourri: Into the '80s—Choose Your Weapons**
by Stephen Holden
- 130 Input Output: MXR's Flanger/Doubler**
by Fred Miller
- 132 The Eagles**
Apocalypse when?
by Ira Mayer
- 132 Backbeat Records**
Joe Jackson/
Cheap Tricks/
Gloria Gaynor
- 136 Takoma's Renaissance**
by Ira Mayer
- 142 Jazz SpinOffs**
by Don Heckman and John S. Wilson
- 146 Music In Print**
by Elise Bretton

Et Cetera

- 30 HiFi-Croctic**
by William Petersen
- 51 Letters**
- 112 General Index to Articles—1979**
- 115 Reader-Service Cards**
- 148 Advertising Index**

dbx 128 tape copies sound better than your records



First, you play your favorite records, tapes or FM broadcasts through the expander section of our Model 128 to restore missing dynamics and reduce noise that's been robbing you of live performance realism.

Then, you preserve the dynamics of this vibrantly enhanced program by copying through the 128 noise reduction section to eliminate tape hiss normally added by copying.

Finally, you play back your taped copy through the decoder of your dbx 128 and hear music with more dynamic range and detail than you've ever heard before off any tape. Sound unbelievable? Well, it was until the dbx 128 came along. But now you can make dynamically enhanced copies that sound better than the originals, with no hiss build-up, on any open-reel, cartridge or cassette recorder.

To learn how, ask the dbxpert at your local dealer for a demonstration of the new dbx 128. For full product information and a list of demonstrating dbx 128 dealers, circle reader service number or contact:

dbx

UNLOCK YOUR EARS

dbx, Incorporated, 71 Chapel Street, Newton, MA 02195 (617) 964-3210

Circle 12 on Page 115

ART CREDITS

Cover photo by Bob Brody

33	Bob Brody
56-62	Lisa Federico
64	Chuck Pulin
65	RCA
69-70	Studio Reto
71	Bob Brody
75	Bayreuth Festival
87	Christian Steiner
90	Misha Donat
126-127	Bob Brody

SOLUTION TO HIFI-CROSTIC NO. 48

Alma Mahler: [Recollections and]
Letters of Gustav [Mahler]

After Beethoven, no modern music lacks an Inner program, but no listener has first to be told what he is expected to feel and see in it. One must have heart and ears and the will to surrender oneself. A mystery always remains, even for the creator himself.

ADVERTISING

Main Office: Robert J. Ur Sr., Director of Advertising Sales, The Publishing House, Great Barrington, Mass. 01230. Telephone: 413-528-1300.

New York: ABC Leisure Magazines, Inc., 825 7th Avenue, 6th Floor, New York, N.Y. 10019. Telephone: 212-265-8360. Seymour Resnick, National Advertising Manager; George Dickey, Record Advertising Manager; Ruth Elliott, Eastern Advertising Manager; Janet Cermak, Administrative Assistant; Yetta Peltzman, Classified Advertising Department.

Midwest: ABC Leisure Magazines, Inc., 190 N. State St., Room 632, Chicago, Ill. 60601. Telephone: 312-782-1173. William P. Gordon, Midwest Advertising Manager; Osbert Bruno, Advertising Representative.

Los Angeles: ABC Leisure Magazines, Inc., 2020 Avenue of the Stars, Suite 245, Century City, Calif. 90067. Telephone: 213-553-2000. Andrew Spanberger, Western Advertising Manager; Janet Endrijonas, Associate Western Advertising Manager.

Tokyo: Japan Advertising Communications, Inc., New Ginza Bldg., 7-3-13 Ginza, Chuo-ku, Tokyo 104, Japan. Telephone: (03) 571-8748. Shigeru Kobayashi, President.

HIGH FIDELITY and **HIGH FIDELITY/MUSICAL AMERICA** are published monthly by ABC Leisure Magazines, Inc., a subsidiary of American Broadcasting Companies, Inc. Warren B. Syer, President; Herbert Keppler, Senior Vice President, Photographic Publishing Division; Leonard Levine, Vice President, Advertising; Warren Tuohy, Vice President, Finance; David Lee, Circulation Director; Cathleen Aloisi, Personnel Director; Wayne Armentrout, Director of Manufacturing. Member Audit Bureau of Circulation. Indexed in Reader's Guide to Periodical Literature. Current and back copies of High Fidelity and High Fidelity/Musical America are available on microfilm from University Microfilms, Ann Arbor, Mich. 48106. Microfiche copies of these magazines (1973 forward) are available through Bell & Howell Micro Photo Division, Old Mansfield Road, Wooster, O. 44691.

Editorial correspondence should be addressed to The Editor, High Fidelity, Great Barrington, Mass. 01230. Editorial contributions will be welcomed, and payment for articles accepted will be arranged prior to publication. Unsolicited manuscripts should be accompanied by return postage.

Circle 66 on Page 115 ▶

The SP-15 has two things our best turntable doesn't have: Quartz-locked pitch control and a lower price.



You know what made the SP-10 MK2 our best turntable, and why so many radio stations use it: Wow and Flutter of 0.025% WRMS. Rumble of -78dB (DIN B). Speed accuracy within an astonishing 0.002%. And amazingly high torque for a start-up time of 0.25 second.

Yet for \$300 less,* the SP-15 has exactly the same high degree of speed accuracy, the same wow and flutter and the same rumble as the SP-10 MK2 while delivering an incredible start-up time of 0.4 second.

Technics quartz-locked pitch control is pretty incredible, too. Unlike the pitch control in many other turntables, it lets you vary the speed with the unvarying accuracy of quartz. In precise 0.1% steps above or below any of the three standard speeds up to a maximum of $\pm 9.9\%$. What's more, the exact speed variation you choose is shown right up front in bright digital display. And with Technics you can lock the pitch at the pitch you choose.

Another reason you'll choose the Technics SP-15 is durability. It has an electronic brake that can stop the platter in 0.4 second, even though a tracking force of

2.2 lbs. (or the weight of 250 tonearms tracking at 2 grams) can't begin to slow the platter down. And to help minimize acoustic feedback, it has a heavy-duty aluminum diecast chassis plus a double-damped platter. And when you add the optional SH-5B2 base (shown with SP-15) you'll get the extra protection needed to cope with high volume levels.

There's also Technics SP-25, a two-speed version. With the same accuracy, quartz-locked pitch control ($\pm 6\%$) and many of the great features of the SP-15.

The SP-15 with quartz-locked pitch control. It has the same phenomenal performance as the Technics turntables many FM stations use and discos abuse: MOTOR: Quartz-locked DC direct drive. SPEED: $33\frac{1}{3}$, 45 and 78 RPM. STARTING TORQUE: 3.0 kg·cm. START-UP TIME: 0.4 sec. (90° rotation at $33\frac{1}{3}$ RPM). WOW AND FLUTTER: 0.025% WRMS. RUMBLE: -78dB (DIN B). PITCH ADJUSTMENT RANGE: $\pm 9.9\%$.

The SP-15. We added quartz-locked pitch control, we subtracted from the price.

*Based on Technics recommended price for SP-10 MK2 and SP-15 (excluding bases).

Technics

Professional Series

Sound has color. All kinds of wild and way-out and wonderful color.

That's why Sony is introducing audio tape with Full Color Sound.

To reproduce every shade, every tone, every tint of color that's in the sound itself.

Sony tape with Full Color Sound has such a full frequency spectrum it can actually record more sound than you can hear.

If your tape recordings don't sound the way this ad looks, switch to Sony audio tape. And be up to your ears in bright brilliant beautiful color.

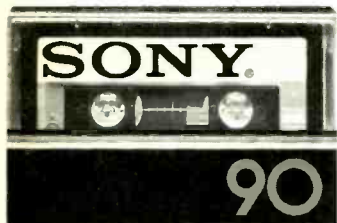



***Sony Tape.
Full Color Sound.***

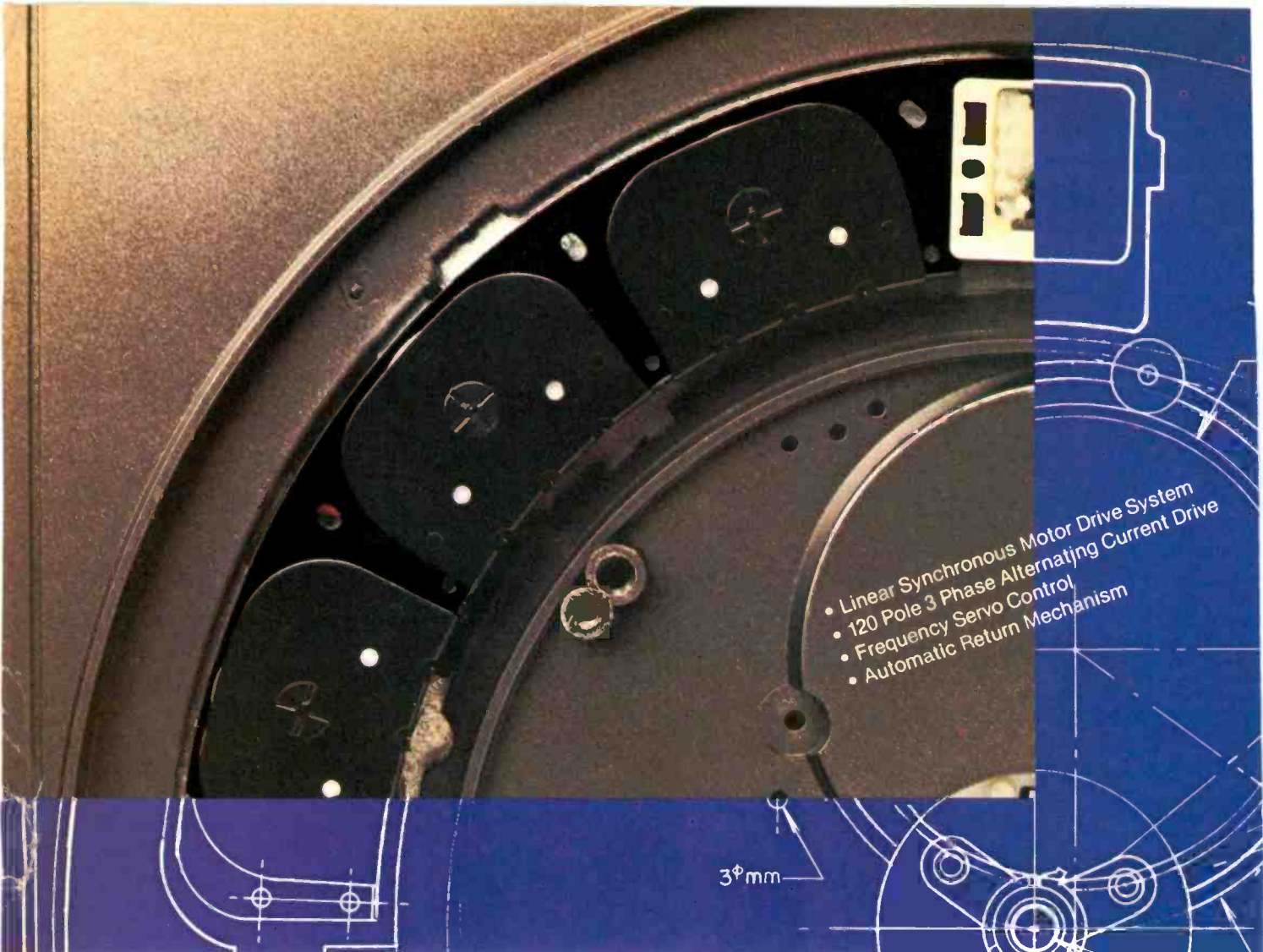

- Linear Synchronous Motor Drive System
- 120 Pole 3 Phase Alternating Current Drive
- Frequency Servo Control
- Automatic Return Mechanism

3 ϕ mm

THE LINEAR DRIVE QUARTZ LOCK MT6335 IS THE KIND OF TURNTABLE YOU'D EXPECT FROM THE NEW FISHER.

Fisher's technological leadership in high fidelity was never more elegantly stated than in the new MT6335 Linear Drive quartz lock turntable. Just as direct drive surpassed belt-driven turntables in terms of performance and reliability, so has Linear Drive from the new Fisher brought turntable performance into a new state-of-the-art.

SIMPLER IS BETTER. Nothing could be simpler or quieter than Linear Drive. The only moving part is the platter itself. There are no complicated motors or rotating electronic components—just a totally silent, dependable drive system with virtually nothing to go wrong, even after thousands of playings. (The MT6335 comes with an unheard-of five-year warranty.) Proof of the incredible stability and performance is seen in the specs: 0.035% wow and flutter. Rumble is an inaudible - 70 dB (DIN B).

QUARTZ LOCK ACCURACY. Total speed accuracy is assured by

the most effective method in use today—a quartz lock phase locked loop servo circuit. Platter speed is continuously monitored and compared to a quartz reference signal for instantaneous speed correction. Deviation from 33 $\frac{1}{3}$ or 45 rpm is virtually zero.

STROBE & SPEED CONTROL.

Other features combine to make the MT6335 a top-performing, easy-to-operate high fidelity turntable. There's a strobe light and fine speed control to alter record pitch and confirm speed accuracy, viscous damped cueing, automatic tonearm return and shut-off—and all controls are front-panel mounted where you can operate them with the dustcover closed. A carefully crafted, fully counterbalanced S-shaped tonearm accommodates most any cartridge and built into the handsome base is a stylus overhang gauge.

LINEAR DRIVE—THE HEART OF THE MT6335 TURNTABLE. The

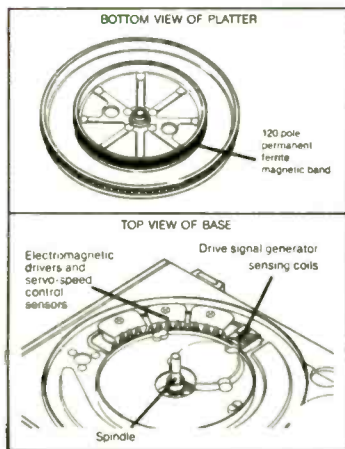
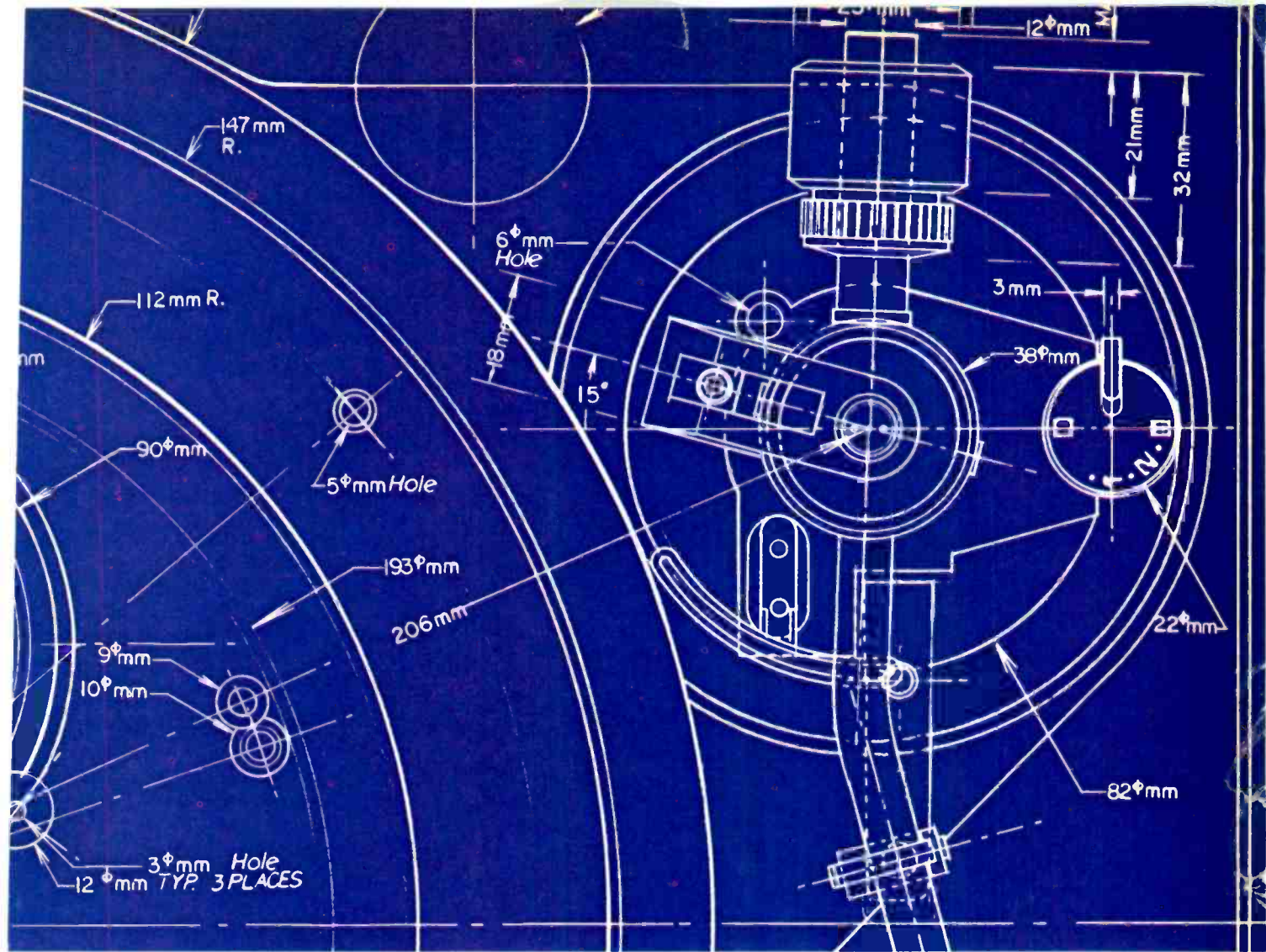

platter on the MT6335 is the only moving part of the turntable drive system. Encircling the platter is a 120-pole magnetic strip. Three drive coils beneath the platter act upon this magnetic strip to propel the platter. Magnetic pulses from the coils "overlap" one another to pro-

vide constant, smooth platter rotation. Conventional 12 or 16 pole direct drive systems can't compare to the MT6335 in terms of low wow and flutter, and freedom from "cogging." The utter simplicity of Fisher Linear Drive means years of trouble-free performance.

IT'S WHAT YOU'D EXPECT FROM THE NEW FISHER. We invented high fidelity over 40 years ago. We've never stopped moving forward. The MT6335 is a good example of that technological leadership. Part of the new Fisher. Where the only thing about us that's old is our tradition for quality and craftsmanship. See the MT6335 at your Fisher dealer. All these features and an under \$250 price.

New guide for buying high fidelity equipment. Send \$2.00 with name and address for Fisher Handbook to: Fisher Corporation, Department H, 21314 Lassen Street, Chatsworth, California 91311.

©Fisher Corp. 1979.



SPECIFICATIONS:

Motor	120 Pole Linear Drive Quartz Phase Locked Loop	Tracking Force Range	0.6 — 3.5 grams
Drive System	Direct	Maximum Tracking Error	± 1.5%
Wow and Flutter (WRMS)	0.035%	Anti-Skate Control	
Rumble (DIN 45539B)	-70 dB		
Speed Variation	0% (Quartz Lock On)	Cueing	Calibrated Adjustable
Speed Control Range	± 6% (Quartz Lock Off)	Weight	Viscous Damped
		Dimensions	17 1/2" x 14 1/2" x 6"
			(WxDxH)

the **FISHER**
New  **FISHER**
The first name in high fidelity®

High Fidelity News

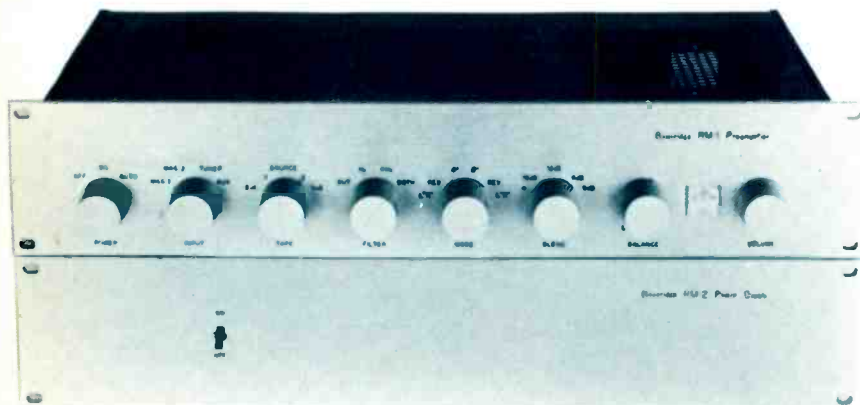

Beveridge's hybrid preamp

The Beveridge RM-1 preamplifier contains vacuum tubes for audio amplification and solid-state circuitry to maintain operating-point stability. Its companion power supply, the RM-2, provides 80,000 microfarads of capacitance to three regulated stages, contributing to a claimed 120 dB of dynamic range. Features of the system include relay protection circuitry, progressively sloped switchable high and low filters, a five-position stereo-to-mono blend switch, and buffered tape outputs. Price of the RM-1/RM-2 is \$2,150.

Circle 137 on Page 115



Accuracy in equalization

The AE-2420R from Soundcraftsmen is a combination frequency equalizer/analyzer said to provide accuracy of 1/10 dB in the equalization of room acoustics and tape recordings. Each of the ten octaves of EQ is provided with ± 12 -dB boost or cut. The analyzer section contains a mike preamp, a digitally synthesized pink-noise generator, and differential comparator circuitry. The AE-2420R costs \$499.

Circle 139 on Page 115



Pick a Pickering

Pickering's phono cartridge lineup includes the XSV/4000, which incorporates the Stereohedron expanded-contact stylus tip. Designed to track at 1 gram or less, the pickup is claimed to have a frequency response of 10 Hz to 36 kHz. A low-mass, powerful samarium-cobalt magnet is said to aid in accurate reproduction of transient peaks. Hinged to the stylus assembly is Pickering's Dustomatic brush. The price of the cartridge is \$140. Accessory styli for mono and 78-rpm discs are also available.

Circle 146 on Page 115



SAE's first road amp

SAE rates the Pro P-300's frequency response at within $\frac{1}{2}$ dB from 20 Hz to 20 kHz, noise at -90 dB (A-weighted), and distortion at 0.05%. The front panel features peak overload indicators and true stepped attenuators for accurate tracking and repeatable settings. All inputs on the standard rack-mount unit are $\frac{1}{4}$ -inch phone jacks, and there is a bridging jack for mono operation. The rated power output is 325 watts (25 dBW) per channel into 8 ohms and a healthy 1,000 watts (30 dBW) mono into 8 ohms. The P-300 costs \$1,300.

Circle 151 on Page 115

Continued on page 14

The standard bearers.



The high bias standard.

In the past few years, these fine deck manufacturers have helped to push the cassette medium ever closer to the ultimate boundaries of high fidelity. Today, their best decks can produce results that are virtually indistinguishable from those of the best reel-to-reel machines.

Through all of their technical breakthroughs, they've had one thing in common. They all use TDK SA as their reference tape for the high bias position. These manufacturers wanted a tape that could extract every last drop of performance from their decks and they chose SA.

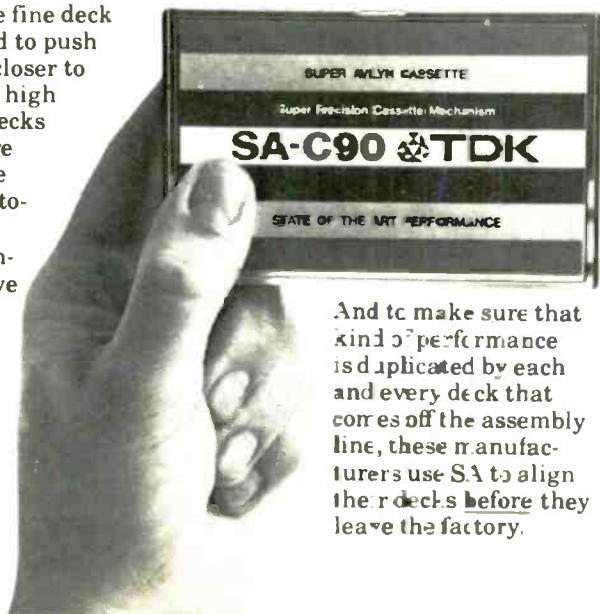

And to make sure that kind of performance is duplicated by each and every deck that comes off the assembly line, these manufacturers use SA to align the decks before they leave the factory.

Which makes SA the logical choice for home use; the best way to be sure you get all the sound you've paid for.

But sound isn't the only reason SA is the high bias standard. Its super-precision mechanism is the most advanced and reliable TDK has ever made—and we've been backing our cassettes with a full lifetime warranty* longer than anyone else in hi fi—more than 10 years.

So if you would like to raise your own recording standards, simply switch to the tape that's become a recording legend—TDK SA. TDK Electronics Corp., Garden City, NY 11530.

TDK
The machine for your machine.

*In the unlikely event that any TDK cassette ever fails to perform due to a defect in materials or workmanship, simply return it to your local dealer or TDK for a free replacement.

TEAC TODAY:

You're looking at four new machines that have more in common with data recorders than audio recorders.

Together they are called the X-Series. And they bring a totally new kind of technology to the open reel format.

Each X-Series transport is an instrumentation mechanism. For 15 years, this TEAC design has stood the grueling test of time in computer installations where dependability is worth millions.

The basic configuration is closed-loop dual capstan. It's extraordinarily quiet, stable and precise. Wow & flutter is very low. Speed accuracy very high.

Three DC motors drive the tape. They're used to keep changes in motor temperature to a minimum under different loads so constant torque is maintained.

Our Magnefloat flywheel assembly, a completely new concept, uses magnetics rather than mechanics to eliminate problem-causing

springs and pressure plates. Axial variations between the tape and capstans are prevented so proper tracking is assured. The result is highly accurate audio reproduction even after years of hard use.

The X-Series transport maintains ideal tape-to-head contact. Audible drop-outs, level and frequency losses are absolutely minimized. Frequency response is wide and flat. And signal articulation is unusually clear.

The brain behind the transport is our LSI control chip. It eliminates the need for mechanical relays so transport control is faster, more positive and reliable. The LSI also lets us provide full motion-sensing in the X-10 and X-10R.

Within the X-Series, machines have been specifically designed for bi-directional record and playback. Perfectly symmetrical head stacks (6 heads in all) assure top performance in

both directions. There's automatic reverse and repeat. And two-way cue monitoring.

New audio electronics accompany this new transport technology. Record and playback amplifiers are quieter and completely free of audible distortion. The sound is cleaner, more faithful to the source. The fidelity is unsurpassed.

An option previously available only on our professional recorders can now be added to any X-Series machine. Called dbx I*, this noise elimination system adds 30dB to the already high S/N and over 10dB of headroom to give you master-quality recordings.

If your audio perception is critical, your listening standards high, audition an X-Series recorder. The performance is flawless. The sound peerless.

TEAC.



*dbx is a trademark of dbx, Inc.

THE X-SERIES.

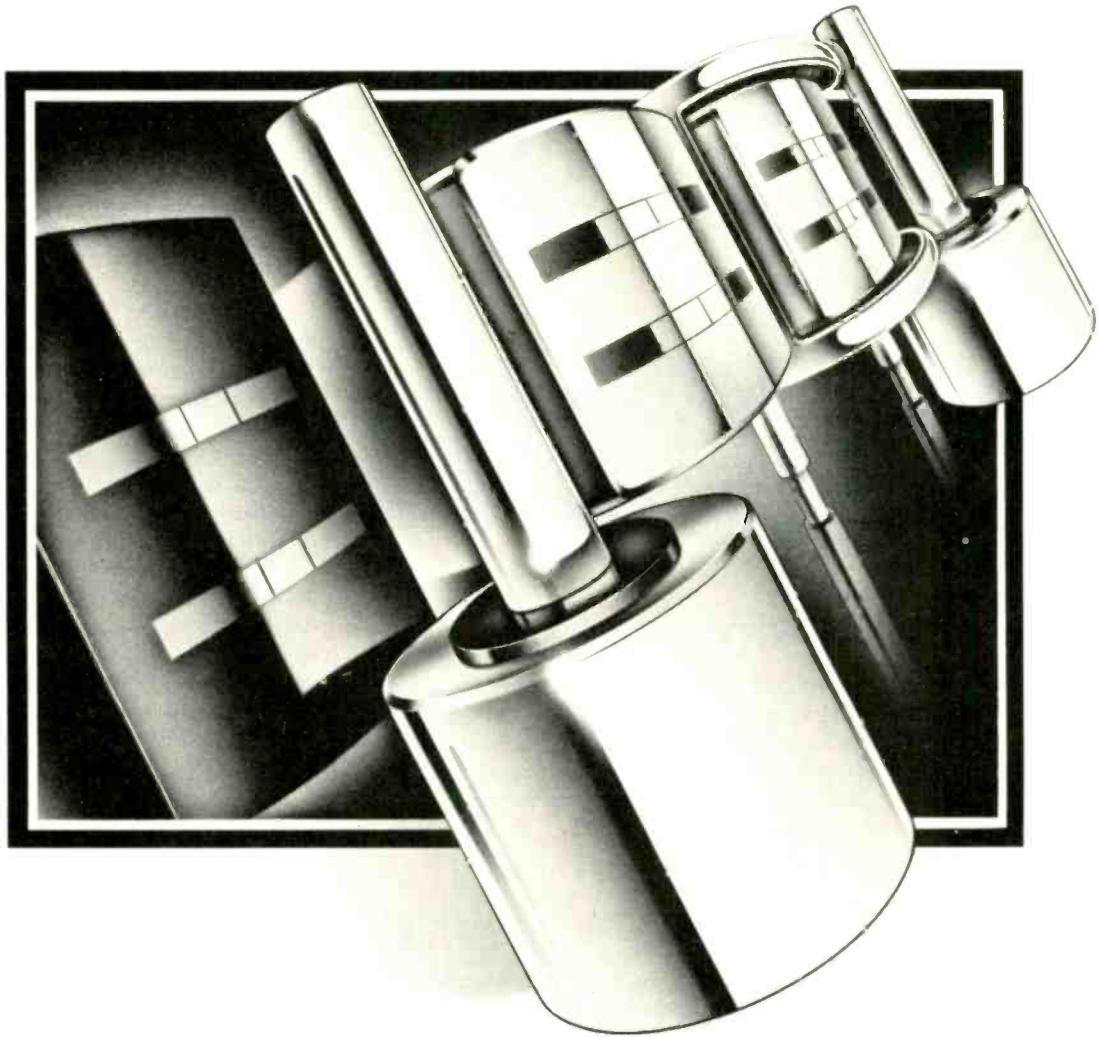



Lock In with Sansui receiver

The tuning system of Sansui's G-7700 receiver is quartz-locked, using a time base, frequency divider, and digital comparator to lock in the FM signal. Capture ratio is rated at 1 dB, and selectivity at 70 dB. The power amp section is rated at 120 watts (20% dBW) into 8 ohms with no more than 0.025% total harmonic distortion. Among features are a 15-segment LED power-level display, loudness compensation, switchable high and subsonic filters, and two-way tape dubbing. The G-7700 costs \$800.

Circle 140 on Page 115



Biamp multipurpose equalizer

Suitable for use in live performances or in the studio, the Biamp EQ/270A one-third-octave equalizer has a ± 12 -dB range in each of its twenty-seven bands from 40 Hz to 16 kHz. The unit also has EQ bypass switching, an LED overload indicator, and oil-damped slide controls with center detent. It can be used to equalize the acoustics of halls and auditoriums, as a feedback controller, or to equalize tape recording. Priced at \$495, the EQ/270A comes in a rack-mount cabinet.

Circle 138 on Page 115



A tuner with recall from ReVox

The B-760 FM tuner from Studer ReVox combines quartz-synthesized tuning, fifteen-station programmable memory with digital readout, and optional Dolby FM plug-in circuit card. Other features of the tuner are variable threshold inter-station muting, headphone amplifier with volume control, high-blend switch, and a choice of 25 or 50 kHz tuning increments. An internal standby battery prevents loss of FM preset memory in the event of a power outage. Cost of the B-760 is \$1,649; the optional user-installable Dolby card is \$130.

Circle 149 on Page 115



Speakerlab's flexible four-piece system

Speakerlab's Subwoofer Drive System 1000 is a four-piece, biamplified setup. The system is made up of two tower speakers that handle the frequency range from 140 Hz to 20 kHz, a subwoofer for the 20-140 kHz range, and a subwoofer drive amplifier rated to provide 130 watts (21% dBW) of power. The amplifier also contains active electronic crossover circuitry with seven selectable crossover points. The complete system, preassembled, costs \$1,190; the kit, SD-1000K, \$990; an assembled subwoofer plus amplifier, SDAS-1000A, \$890; subwoofer kit and amplifier, SDAS-1000K, \$750; the amplifier alone, \$550.

Circle 142 on Page 115



ADC's aluminum tonearm

ADC's ALT-1 tonearm is an aluminum version of the LMF carbon-fiber series. The rear overhang of the ALT-1 has been shortened to move the mass closer to the pivot point. Effective mass is 7 grams, allowing the use of cartridges that track up to 3 grams. Capacitance of the arm wiring is 18 picofarads per channel; the lead wires are rated at 220 picofarads per channel. The ALT-1 is 9 1/2 inches long, comes with a removable carbon-fiber headshell, and costs \$149.95.

Circle 141 on Page 115

Continued on page 16

Put Sound Guard™ on trial.



**Take up to 30 days to try Sound Guard on your records.
Get your money back if not fully satisfied.**

Judge the effectiveness of Sound Guard Record Preservative for yourself. Use it on your records for up to 30 days. See how the ultra-thin lubricant works to reduce static charges, cut down friction, virtually eliminate record wear—and provide your music with long-lasting protection.

Only Sound Guard has the confidence in their record preservative to make this money back trial offer. If you're dissatisfied for any reason, send us the product,* a copy of your

dated sales slip, and we'll refund your money, no questions asked. That's an offer no other record care product seems to be making.

Our confidence also extends to the entire line of Sound Guard record care products; like the Record Cleaning Kit, Stylus Care Kit and Total Record Care System that contains both the preservative and cleaning kits.

You could spend your hard-earned money on all those other record cleaners, preeners, washers and brushes—or you can try Sound Guard at absolutely no risk. We think our offer is the best way to decide which one to try. You've got everything to gain—clean, better-sounding records—and best of all, nothing to lose.



Sound Guard™ preservative — Sound Guard™ cleaner.
Sound Guard™ Total Record Care System.
Sound Guard is Ball Corporation's registered trademark.
Copyright © Ball Corporation, 1979, Muncie, IN 47302



*Return to Sound Guard, P.O. Box 5003, Muncie, IN 47302. Offer expires April 30, 1980.



Electro-Voice stage speaker

The Dominator stage speaker from Electro-Voice, suitable for vocals as well as miked instruments, has a claimed frequency response of 60 Hz to 16 kHz. The three-way system uses a folded-horn-style enclosure for the woofer, limiting circuitry to protect against tweeter burn-out, and a midrange horn to maintain a 100-degree horizontal dispersion at any midrange frequency. The system is bi-ampable at its 600-Hz woofer/midrange crossover point. Handy for traveling musicians, the Dominator has integral handles, is constructed of black vinyl-covered plywood, and costs \$995.

Circle 148 on Page 115



Creative distortion

The Final Phase from Analog/Digital Associates is a versatile phase shifter with a fully adjustable sweep modulation that allows asymmetrical sweep patterns, multiple phaser effects, and syncopated beats. Continuously variable range and intensity controls add to the flexibility of the device. An overdrive foot switch that creates a wide range of distortion effects can be used alone or to enhance phasing. The AC-powered Final Phase is synthesizer-compatible and costs \$189.95. An optional control pedal for wah-phase effects can be obtained for \$49.95.

Circle 147 on Page 115



Speaker kits from KEF

KEF is now making two of its speakers available in kit form. The Cantata kit, an acoustic-suspension design, includes a bass unit, midrange driver, tweeter, and crossover network, along with fuse units and contour controls. The drivers and crossover circuits are pre-mounted and wired on the front baffles. The Cantata kit costs \$395; factory-assembled price is \$625. KEF's two-way Model 104AB speaker, a bass-reflex design, is available for \$250 in kit form or \$425 factory-assembled.

Circle 144 on Page 115

Continued on page 21

Advertisement

The Watts Parastat



In 15 seconds your records are clean, dry and ready to play.

With some systems you pour liquid on your records (and rub it into the grooves), while with others you brush the dirt around (and rub it into the grooves). The Watts Parastat is neither of these.

By placing a plush velvet pad on either side of a soft nylon brush and adding a drop or two of Parastatik® fluid, a

remarkably efficient system is created.

The brush bristles lift the rubbish to the surface. The pads collect and remove it. And the Parastatik® fluid supplies just the right degree of humidity to relax dust collecting static without leaving any kind of film or deposit behind.

No other system does so much for

your records in so little time.

So when you want the best, ask for the original. The Parastat, by Cecil Watts.

Watts products are distributed exclusively in the U.S. by: Empire Scientific Corp., Garden City, NY 11530.

EMPIRE EMPIRE EMPIRE EMPIRE EMPIRE EMPIRE EMPIRE EMPIRE EMPIRE EMPIRE

Circle 18 on Page 115

Cecil & Watts Ltd

The first collection
worthy of the name

Mozart

Introducing
the most complete
Mozart collection
ever assembled
in America!



**TIME
LIFE
RECORDS**

Also available on tape cassettes.

Yale University Collection of Musical Instruments (Belle Skinner Collection)

**\$45 book,
yours free
with purchase**

- 244 pages • 300 illustrations
- 12 color portfolios
- A remarkable key to the "inner Mozart"

Now, in one of the most ambitious recording ventures of the decade, TIME-LIFE RECORDS introduces a record collection that does long-overdue justice to the genius of Mozart. A monumental series encompassing *all* of Mozart's many musical forms.

Own all of Mozart's symphonies, concertos, sonatas, chamber music. Plus his greatest operas, sacred music, dances, divertimentos and concert arias.

A feast for Mozart lovers, from *The Late Piano Concertos* to *The Late Symphonies*, *The Late String Quartets*, *Don Giovanni*, *The Middle Symphonies*—each five-record album captures another facet of Mozart's virtuosity.

Hear Mehta, Bernstein, Sutherland, de Larrocha, Solti, Horne, von Karajan, Ashkenazy and more!

You could never put together a collection like this on your own! These landmark albums feature interpretations by the outstanding performers of our time. Many are new performances—recorded *expressly* for this project.

Listen to *The Late Piano Concertos* for 10 days free.

Start with *The Late Piano Concertos*. Each has its own unforgettable personality. Listen to the album for 10 full days without risk. If you are delighted, you may keep it for only \$24.95 plus shipping and handling, and enjoy free auditions of future albums in the collection. To order, mail card or coupon to TIME-LIFE RECORDS, Time & Life Building, Chicago, IL 60611.

TIME-LIFE RECORDS

Time & Life Building, Chicago, IL 60611

YES, I would like to audition *The Late Piano Concertos* as my introduction to MOZART. Please send this five-record stereo album along with the 244-page book, *Mozart: The Man, The Musician*, for 10 days' free examination and enter my subscription to MOZART. If I decide to keep *The Late Piano Concertos*, I will pay in installments of \$12.47 the first month and \$12.48 the second month, a total of \$24.95 (\$29.95 in Canada) plus shipping and handling, and the accompanying book will be mine at no extra cost. I then will receive future albums (each one containing five stereo records) in the MOZART series, shipped one album at a time approximately every other month. Each album will cost \$24.95 (\$29.95 in Canada) plus shipping and handling (billed to me in two monthly installments) and will come on the same 10-day free-audition basis. There is no minimum number of albums that I must buy, and I may cancel my subscription at any time simply by notifying you. If I do not choose to keep MOZART: *The Late Piano Concertos* and the accompanying book, I will return the complete package within 10 days, my subscription for future albums will be canceled and I will be under no further obligation.

RWACL4

I prefer five Dolby-encoded tape cassettes (\$5.00 extra, also to be billed in two monthly installments). RYACK4

Name _____
 Address _____ Apt. _____
 City _____ State _____ Zip _____
 (or Prov.) (or Code)

THERE ARE FASTER WAYS TO BUILD SEPARATES, BUT THEY WOULDN'T HAVE NIKKO'S ONE-OF-A-KIND EXCELLENCE.



Once is not enough for Nikko.

That's why we go one step beyond the inspection and quality control procedures of most manufacturers. Nikko's "200% Quality Control" program takes more time. But we know that once you buy a Nikko preamp, amp or tuner you're going to enjoy it for a long time. And you can be confident you will because we continuously monitor every unit as it moves along each station of our production line. Then we thoroughly inspect each and every unit a second time before it's shipped to your Nikko dealer. It's Nikko's way to make sure you always get the accuracy, dependability and outstanding performance that we build in. And that's what you get with these new separates.

Alpha III MOS-FET DC Power Amplifier

The Alpha III uses two separate power supplies, each with its own transformer. Its direct-coupled DC amplifier lets nothing come between you and the music since there are no input or output capacitors in the circuit. By combining this design with two pairs of DC power



MOS-FETs, there's rock-solid stability. The Alpha III delivers 80 watts per channel, minimum RMS, at 8 ohms, from 20 to 20,000 Hz, with no more than 0.008% total harmonic distortion. And you can monitor power output with fast, accurate multi-LED indicators.

Beta III Stereo Preamplifier

From its direct-coupled phono input to its high-speed circuitry and top performance specifications, the slim-line Beta III is the perfect control center. Complete versatility is provided to accommodate the impedance characteristics of different phono cartridges. There's also the convenience of two-way tape dubbing and switch-selectable low and subsonic filters. The combination of high sensitivity, flat frequency response and wide dynamic range coupled with low noise and distortion makes the Beta III a professional performer you can enjoy at home.



Gamma V Synthesized FM Stereo Digital Tuner

FM stations a hairline away from each other pose no challenge for the Gamma V

Whether you tune manually or automatically, its digital synthesized tuning circuit pinpoints and locks in the signal. You can even program the unit to memorize and store up to six stations automatically by the push of a button. LED indicators show signal strength and stereo operation. With switching for high blend, IF band (wide or narrow), stereo/mono and adjustable muting, plus exceptional specifications, the Gamma V is everything you'd ever want in an FM tuner.



So if you want to get the best sound from records, tapes and FM broadcasts, you want Nikko separates. We build them as though they're one of a kind; because we refuse to compromise a standard of excellence abandoned by many for the sake of expediency.

Call toll-free 800-423-2994 for your nearest Nikko dealer
Nikko Electric Corp. of America/16270 Raymer St., Van Nuys, Calif. 91406 (213) 988-0105/320 Oser Ave., Hauppauge, N.Y. 11787 (516) 231-8181.

Nikko Audio

© 1979 Nikko Audio





Ibanez' Mini-Flanger

Ibanez has developed a small, battery-run flanger called the FL-301 Mini-Flanger. It has speed, width, and regeneration controls and can be switched on and off by foot. Switching is accomplished electronically with low-noise field-effect transistors. Two 9-volt cells are needed to power the unit, and a built-in LED indicator signals battery status. The Mini-Flanger, housed in a die-cast aluminum case, sells for \$120.

Circle 143 on Page 115



Mach Snell

Snell's Type A loudspeaker, said to minimize room-boundary interference, is a three-way system with individually fused drivers mounted on a curved, segmented baffle to reduce diffraction effects. Crossover frequencies are 275 Hz and 2.5 kHz. Rated frequency response is 36 Hz to 18 kHz, $\pm 1\frac{1}{2}$ dB, measured on axis. Minimum rated impedance of the system is 4 ohms. The Type A costs \$1,680 per pair housed in walnut cabinets or \$1,780 in oak.

Circle 145 on Page 115

Harman redux

When Sidney Harman sold his audio empire—consisting of Harman Kardon, JBL, Tannoy, Ortofon, and Harman International—to Beatrice Foods in 1977, many people in the industry felt a twinge of sadness at seeing this audio pioneer leave a field he helped develop. Well, after serving as undersecretary of commerce for almost two years until last December, he has announced his intention to repurchase two of the companies he

sold, JBL and Harman International, the latter a group of electronics distributors in six foreign countries, for a reported \$55 million.

Though it has been rumored for several months that Beatrice Foods wants to divest itself completely of its audio holdings, an industry analyst informs us that Tannoy and Ortofon will be retained. Beatrice, however, is involved "in the closing stages" of a deal with a Japanese firm, the Shin Shirasuna Electric Company, for the sale of Harman Kardon.

What is it that has the audio industry talking to itself? It is . . .

Phase-R

Phase-R literally brings a recording to life, the only purpose for loudspeakers. Phase-R's incredible ability to provide what the industry has long pursued, a *lifesize, three dimensional staged image* with every instrument and vocalist in their proper place, both front to back and side to side, just as the original performance. Just as unique is Phase-R's ability to deliver real world explosive intensity and incredible dynamic range, from as little as 30 watts RMS. All this is done because of Phase-R's precision components and contemporary loading such as:

- Time Phasing
- Mirror Imaging
- Non Resonant Construction
- Low Diffraction
- Low Baffle Reverberation
- Phase-R's *Compression Line Bass R-3H Filter* (Pat. Pend.)

All in one well conceived design that features:

- High Density Fiberwood Material
- Tongue and Groove Construction
- Multiple Internal Structural Braces
- Matched 2½% Tolerance Crossovers
- Extra Large Inductors Featuring 18 Gauge Wire
- Metalized Polyester Capacitors
- Special High Power Resistors
- And More . . .

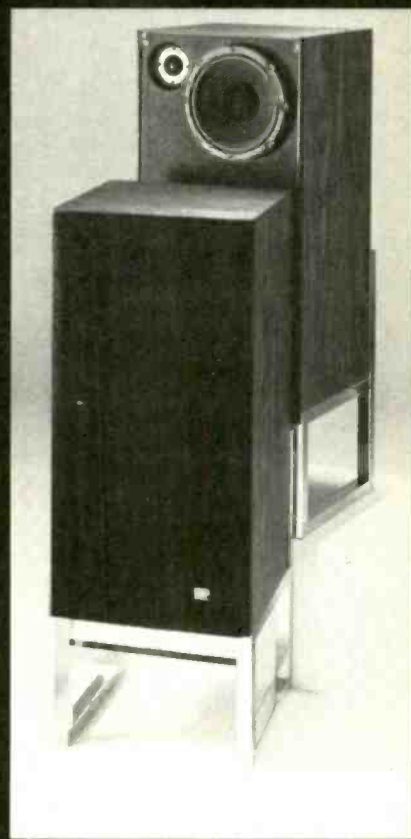

They are unique at an affordable price without peer in their class!

Sold at the best Hi Fi stores nation wide



phase research

3207 Oradell, Dallas, Tx 7522C

(214) 352-2613

Circle 49 on Page 115

McIntosh

"A Technological Masterpiece..."



McIntosh C 32

"More Than a Preamplifier"

McIntosh has received peerless acclaim from prominent product testing laboratories and outstanding international recognition! You can learn why the "more than a preamplifier" C 32 has been selected for these unique honors.

Send us your name and address and we'll send you the complete product reviews and data on all McIntosh products, copies of the international awards, and a North American FM directory. You will understand why McIntosh product research and development always has the appearance and technological look to the future.

Keep up to date.
Send now - - -

McIntosh Laboratory Inc.
Box 96 East Side Station
Binghamton, NY 13904

Name _____

Address _____

City _____ State _____ Zip _____

If you are in a hurry for your catalog please send the coupon to McIntosh. For non-rush service send the Reader Service Card to the magazine.

Circle 40 on Page 115

CrossTalk

Q. My Pioneer SX-828 receiver has a problem: When the set is turned on after being off for a few hours, I lose volume in one or both speakers. By turning it off and on or by tapping it lightly, I can get the volume up again, and the set will play well until it is turned off. The problem exists in all selector modes. A competent serviceman has checked the receiver, but he can find nothing wrong. Do you have any suggestions?—E. S. Dooley, Danville, Va.

A. Since your problem occurs in all modes, it must lie in something common to all—perhaps the power output section or the power supply. It is unlikely that both speakers would fail in the same way, so they probably are not at fault. Most likely the problem is an intermittent contact of some sort—possibly between a component lead and a circuit board or perhaps inside a component—that expands and improves as the receiver warms up with use. Diligent probing with refrigerant sprays (to cool components and see how they react to temperature change) should pinpoint the defect. Failing that, you might try a factory service center.

Q. For several months now 3M and TDK have been advertising metal-particle cassettes as if you could run down to your local store and buy some. To my knowledge, these tapes are showing up only as giveaways with newly purchased decks. I am fast becoming cynical about whether I'll ever see them in audio stores. Perhaps all the problems of metal-tape production haven't yet been worked out; early reports indicated that the pure metal particles had to be sealed inside a chemical substance to prevent them from rapidly deteriorating when exposed to the atmosphere. Will metal-particle tape eventually turn out to be another hype in the tradition of quadriphonics and the Elcaset?—Phil Cohen, Bay Harbor, Fla.

A. The initial shortage of metal-particle tape, according to a spokesman at 3M, came as a result of the company's contractual agreements to supply deck manufacturers with enough of the

cassettes to ship as samples with metal-ready decks, the number of which grew rapidly. Right now both 3M and TDK are producing and shipping the tapes to dealers, attempting to fill the back orders, and there should be enough for everyone early in the coming year. The technology behind the production of metal-alloy tape is not the limiting factor.

Q. I can import several different types of drivers, with really good specifications, from England. But I no longer see catalog listings for speaker cabinets. My favorite driver has a 12-inch woofer rated at 16,000 gauss and a free-air resonance of 25 Hz, with a twin cone in case I don't want a separate tweeter immediately. What U.S. company will sell me a cabinet for it? I also would like to know if anyone supplies passive radiators to do-it-yourselfers.—Louis H. Steinberg, Philadelphia, Pa.

A. Essentially the question is not whether you can find what you want, but why you can't do so. The modern—and, in our view, correct—approach to such questions dictates that the matching of enclosure (and crossovers) to drivers is critical to success in the final ensemble and should not be undertaken by anyone unfamiliar with loud-speaker-system design. Since relatively few music listeners and/or do-it-yourselfers have the necessary technical knowledge (and most, evidently, are aware of their inabilities), the market in preassembled raw enclosures has just about evaporated in favor of plans or kits from companies that also offer the drivers and crossovers to go with them and the engineering expertise to do the matching for you. Scratch design and construction is possible, of course, and only you can decide whether you're equipped to undertake it.

Q. It appears that there is a demand for two audio products that are not yet available. The first is a playback-only Dolby cassette deck with good specs. Most receivers allow dubbing from one deck to another, but who wants to spend the money for the recording facilities in a second deck just to feed the main

Circle 38 on Page 115 ▶

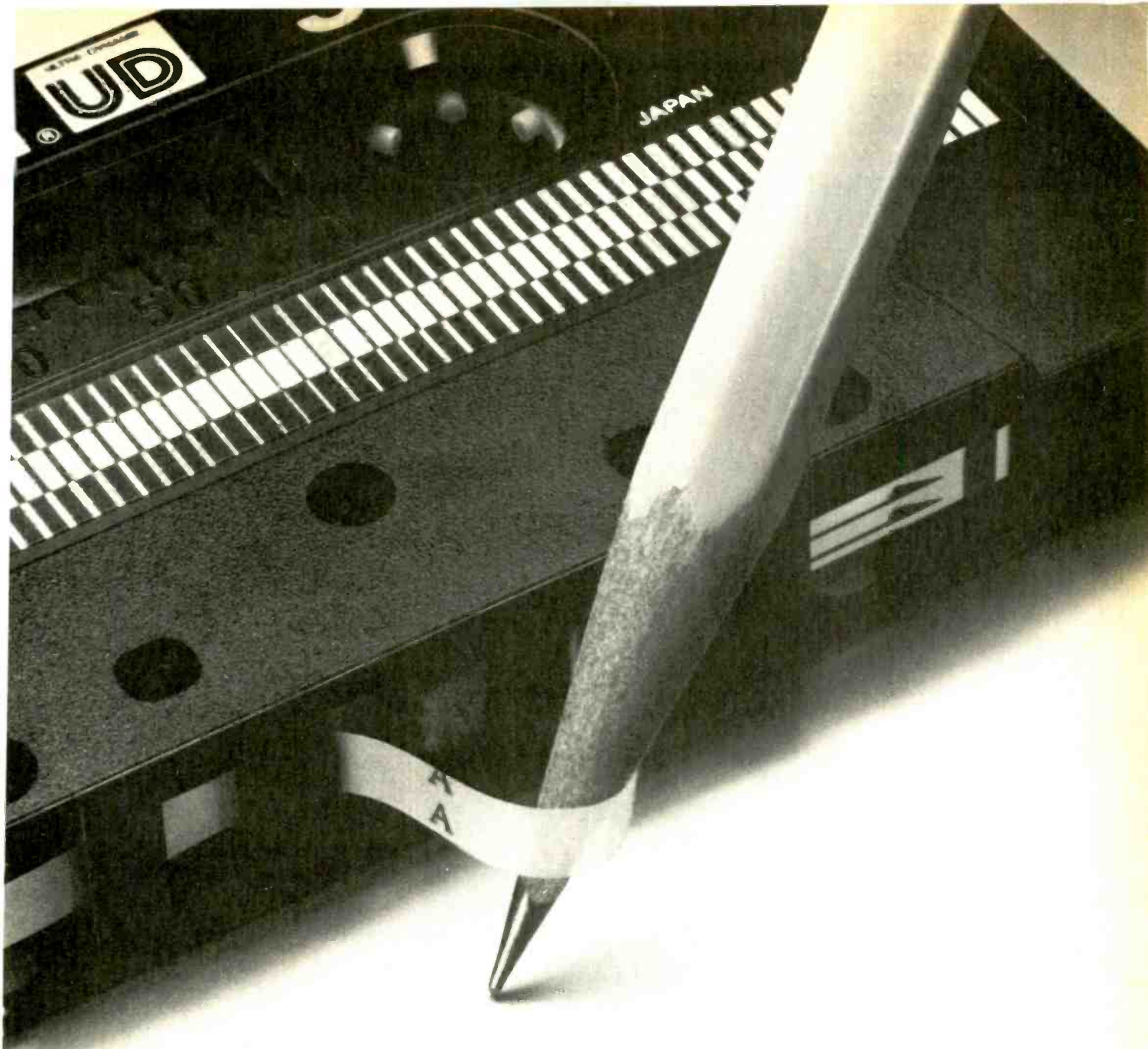

We put more thought into our leader than most manufacturers put into their tape.

One of the reasons Maxell has such a great following is because of our leader.

It has a built-in non-abrasive head cleaner designed to remove the oxide residue other tapes leave behind, without damaging your tape heads.

It also points out what side of the tape you're on (A or B) as well as which direction the tape is traveling. So it's almost impossible to make a mistake.

It even gives you a five second cueing mark, so you can set your recording

levels without wasting tape. Or time.

Obviously, all the thought that went into our leader was designed to help you get more out of our tape.

So if you think our leader sounds impressive, wait till you hear what follows it.

maxell 

Maxell Corporation of America, 90 Oxford Drive, Moonachie, N.J. 07074

Put more sound in your system

with the finest in audio accessories
from Audiotex Laboratories



The Director

stereo tape and input control unit. Adds two auxiliary inputs, two tape monitor circuits, plus equalizer input or third tape monitor to your system. Lets you record directly from one tape recorder to another while listening to a third input source through your system.

The Controller

stereo speaker selector switch. Control up to five pairs of speakers, playing any combination of one to five pairs at the same time. Also includes two head-phone jacks.

Record care products

including the RC-2000, revolutionary new record cleaner and destatizer — a master stroke in record care!

Gold cables and connectors

plated with 23k gold for lowest possible resistance, cleanest possible connection.



PRODUCTS OF GC ELECTRONICS
ROCKFORD, IL. 61101

Audiotex Laboratories

Circle 4 on Page 115

If you can find a receiver that does more.

DC configuration OCL power amplifier Relay protection with LED 18 LED logarithmic power display Logarithmic volume attenuator 2 phono inputs

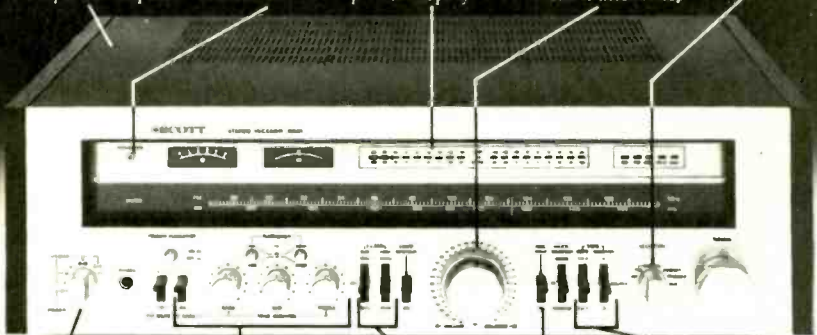

Connections for 3 pair of speakers Bass/midrange/treble tone controls with variable turn-over frequencies and by-pass Twin position active subsonic and high filters Front panel accessory switch 2 tape monitors with full tape copy capability

Scott's new 390R is perhaps the most complete receiver ever made.

A professional control center for your entire sound system, the 390R delivers a full 120 watts per channel min. RMS, at 8 ohms from 20-20,000 Hz with no more than 0.03% THD. And it offers more options, features and flexibility than you'll find on most separates.

Compare the Scott 390R with any other receiver on the market today. If you can find one that does more... buy it.

Buy it.

For specifications on our complete line of audio components, contact your nearest Scott dealer, or write H.H. Scott, Inc., 20 Commerce Way, Dept. 1R, Woburn, MA 01801.

SCOTT
The Name to listen to.
Makers of high quality high fidelity equipment since 1947.

Circle 54 on Page 115

24 HIGH FIDELITY

recording deck? The second item is an outboard Dolby B noise-reduction unit for listening to and recording Dolby FM broadcasts from conventional, non-Dolby receivers and tuners. Six Los Angeles stations broadcast Dolby FM, as well as five in San Francisco and others scattered throughout the country. Why aren't audio manufacturers providing these products?—Ralph G. Abbott, Anaheim, Calif.

A. We agree that playback-only decks make sense, but the public at large doesn't seem so enthusiastic. Such decks have always flopped; witness the Advent Model 202, long since out of production. Outboard Dolby boxes have not fared much better, it seems, though we just reviewed a new one, from Integrex, in our September issue.

Q. Some years ago I purchased an ESL tonearm, but recently an accident damaged the headshell and rendered it useless. When I wrote to the company at an old address, my letter was returned marked "address unknown." I then tried to obtain a replacement from among the many headshells that advertise that they will work on any tonearm, but none works with the ESL. Do you have any information that might help me locate a source for the proper headshell?—H. M. May, Ashland, Ky.

A. The ESL arm has been off the market for so many years that we've had difficulty finding people who even remember it, let alone anyone who knows what happened to the parts and other assets when ESL left the audio scene. The idea behind its plug-in headshell—though not its specific configuration—was later copied in the now-standard "universal" design long used by SME and available from many manufacturers. Of course, a systematic winnowing through parts bins in long-established audio stores or those doing an active business in secondhand equipment might turn up a supply of the ESL headshells. Your only other recourse would appear to be the purchase of a new tonearm.

We regret that, due to the volume of reader mail we get, we cannot give individual answers to all questions.

Circle 57 on Page 115 ▶

Psst. Want a hot tip?

Think for a moment about the single most important element between your record and your ears. The cartridge.

Too often it's the forgotten component even in expensive component stereo systems. That's sad.

A low-fi cartridge not only robs you of your stereo investment, it steals part of every record you buy, usually the "presence" and "definition" of the original recording.

Sony would like to recommend a sure thing. The Sony XL-55 Pro moving coil cartridge.

It's a highly original cartridge proved by exacting studio tests and critical home listening trials. And it passes examination without flying colors.

Sound is colorless, clean and marvelously transparent. Even the highest-frequency pianissimo soars the way it was originally recorded.

The moving coil cartridge, as compared with the moving magnet type of cartridge, uses a direct voltage generating system that obtains superior sound with extremely low distortion. Output voltage is very low and either a head amplifier or step-up transformer must be used. Sony's HA-55 Head

Amplifier offers extremely low-noise amplification for all kinds of MC (Moving Coil) cartridges.



Sony's unique method of generating voltage in our XL-55 Pro is based on a simple figure-8 coil. Output is double that of conventional round coils.

To harness resonance, we adopted an extremely intricate three-layer cantilever mechanism.

Tracking is sure and precise.

The Sony XL-55 Pro MC cartridge.

Remember the component the others forget.

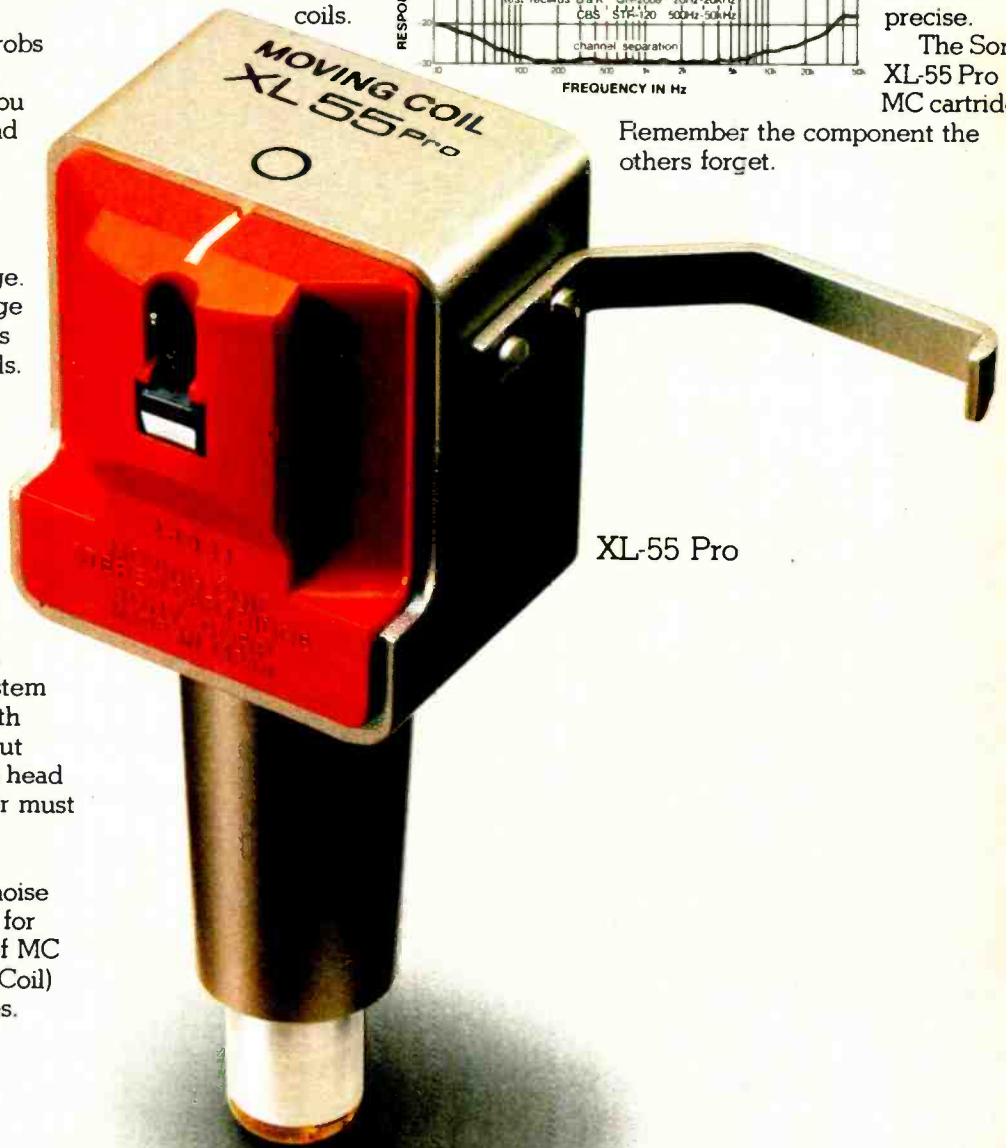
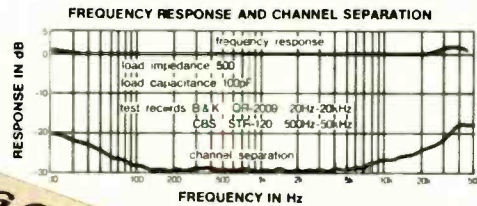

XL-55 Pro

Specifications

Type:	Moving coil
Output voltage:	0.2mV NAB (1kHz, 5cm sec, 45°)
Frequency response:	10-50,000Hz
Channel separation:	More than 30dB (1kHz)
Channel balance:	Less than 1dB (1kHz)
DC resistance:	40Ω
Impedance:	40Ω (1kHz)
Load impedance:	More than 40Ω
Compliance:	15 × 10 ⁻⁹ cm/dyne
Tracking force:	1.5-2.5g (recommended value 2.0g)
Type of stylus:	Elliptical (0.3 × 0.8mm), Nude diamond
Weight:	22g (including the shell)
Installation dimensions:	□A

Design and specifications subject to change without notice.

SONY®

Why JVC's new metal decks knock out your ears and not your wallet.



Free tape.

Even though we knocked out the hi-fi world last year with the world's first true metal-compatible deck, we're not the only company that sells them now. So we've decided to stay one jump ahead by offering you SIX metal compatible models from \$299 to \$749*. Each packed with a free Metafine C-46 metal particle cassette.

One reason we're doing this is because our metal-compatible, KD-Series decks perform so well with conventional tape, you might never get around to buying a metal tape!

But pop the Metafine cassette in and you'll hear the difference. Suddenly you've gained 6dB output level, 10dB signal-to-noise and at least 3000 Hz of high end. Even more with our computerized KD-A8!

Features like Sen-Alloy™ and Super-ANRS even at \$299*.

Our key to metal tape performance is all in our heads. Super-hard, low-distortion Sen-Alloy heads different from any other manufacturer's. When we toss in our unique Super-ANRS noise reduction system that adds 10dB S/N at 5kHz and our

famous Multi-Peak recording indicators, you get a knock-out sound. And all in decks starting at less than \$300.

T-shirts and posters at your JVC dealers.

The arrival of a whole line of decks this good for prices this reasonable is worth celebrating. So we've outfitted participating



dealers with free posters and even some limited edition T-shirts, all with our knock-out Technical Knockout graphic.

Just walk in and ask to hear a comparison of conventional oxide performance

versus metal.

particle tape in a JVC KD-A3, A5, A6, or A8. (The three-head KD-A77 and two-color fluorescent meter A7 will be in the stores by December.)

Where do you go to hear for yourself just how much better metal sounds than oxide?

Call 800-221-7502 and get knocked out.

That's the toll-free number that tells you where you'll find your nearest participating JVC dealer. (In New York, call 212-476-8300.) Drop in to see and hear the technical knock-outs, including the top-of-the-line KD-A8. It features B.E.S.T., the computerized bias/equalization/sensitivity tuning system that fine-tunes the deck to any tape $\pm 1/2$ dB, special "X-cut" heads that add another octave of bass, (flat all the way down to 25Hz!), solenoid operation, Multi-Peak recording indicators, and a host of other audiophilia.

Stop in and take advantage of the free metal tape with each deck, and free posters and T-shirts, while supplies last.

But stunning as JVC's new metal decks are, free offers like these won't last for long.

Now you're ready for JVC.



KD A8 with B.E.S.T., KD A3, KD A5

JVC

US JVC CORP

Shown: KD-A8 with B.E.S.T., KD-A5, KD-A3.
*Suggested Retail Price.

Get
Ready
for a

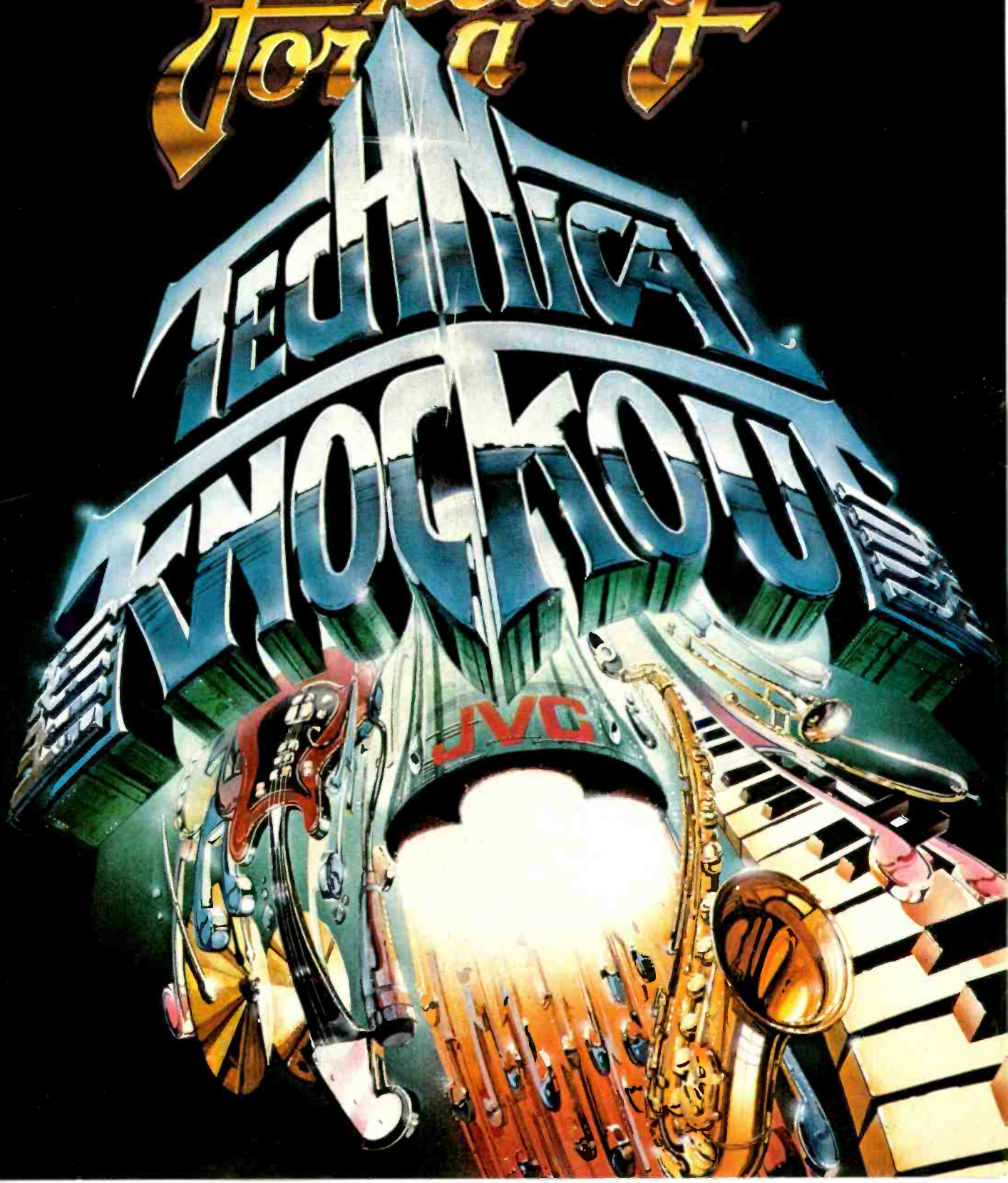

JVC

The facts are stacked for Sony's metalists.

Metal's mellow. Metal sings. Metal soars in frequency response and rockets the dynamic range upwards.

The new metal tapes are a multi-decibel boost to serious ears. But it takes a very special cassette deck to give you this higher-fi.

Two special "metalists" from Sony: The new TC-K65 and the new TC-K55II.

Head Facts

Sony's new Sendust & Ferrite heads in our new decks are uniquely composed of ideal electro-magnetic properties to give you maximum performance with any tape. Regular-fi, chrome, FeCr or metal.

Sendust, Ferrite and a head gap spacer of extremely hard quartz are engineered together for a mirror-like surface, long head life, sharp gap edges and no asymmetrical wear.



Two-Motor Facts

A linear-torque BSL (Brushless & Slotless) motor precisely maintains the all-important capstan speed. And an FG Servo-controlled motor drives the supply and take-up reels.

The BSL motor, in a major design breakthrough, has no slots to cause uneven torque distribution.



Microcomputer Facts

Sony's new microcomputer logic control lets you speed through any operation sequence by merely pressing the appropriate feather-touch bar.

This digital technology in each of our



decks even allows you to record at any moment during playback.

Other Facts

Other distinguished features: The TC-K65 has a Random Music Sensor (RMS) that lets you preprogram any desired selections in any desired order.

A computer-like display signals your selections in bright LED lights. Clearly revolutionary LED Peak

Meters display recording and playback levels with sixteen digits per channel. These new meters "hold" peak levels and respond instantly for truer recording.

The TC-K55II utilizes two large VU meters, and a five-element LED display indicates peak levels for more accurate recording.

The new Sony TC-K65 and the new Sony TC-K55II. The facts are in.



SONY

VIDEO TOPICS

Clubs and Catalogs for Collectors

Remember H. Ross Perot, the Texas tycoon of the computer service market? Well, he has turned his attention to the home video cassette/disc and computer market with an interesting scheme called Inovision (14580 Midway Rd., Dallas, Tex. 75234). Set up as a club, it provides a variety of services for the \$55 membership fee. Every month subscribers receive a copy of "Visionary," a news journal devoted to developments in the consumer electronics field, along with a supplement in which members can advertise to sell, rent, borrow, or exchange programs and equipment. A quarterly catalog offers 22½% discounts on video and computer equipment and blank tape, and lists films available for rental or purchase. And members may, for a small fee, make use of Inovision's equipment for transferring slides and home movies to video cassette.

Tape swapping is the idea behind another new club, the Video Exchange (P.O. Box 486, Marietta, Ga. 30061). A one-year membership (\$60) entitles one to advertise the films he wishes to swap in a monthly newsletter. Members also receive discounts on equipment and tape.

The 1979-80 edition of "Video Tex" is the most complete compilation of entertainment-oriented prerecorded video cassettes we have yet seen. The publisher, Golden Videocassette Library (5415 Butler Rd., Bethesda, Md. 20016), claims that it contains all the entertainment program material on the market, an assertion that seems a bit questionable, considering the number of new releases each week. However, with some 3,000 titles—each accompanied by a synopsis and information on release date, running time, and lead players—"VideoTex" is a useful tool indeed. Its listings are grouped under 27 categories (comedy, drama, musicals, sports, westerns, and so on), along with an alphabetical title index. All of the cassettes can be obtained in either the VHS or the Beta format. Cost of the catalog is \$10, or you can get it free with the purchase of two tapes.

A more diverse collection of material can be found in "The Videolog: Programs for General Interest and Entertainment."

As its title suggests, this catalog goes beyond entertainment programs; its 4,600 listings in more than 115 general interest categories range from accident prevention to world affairs. Movie listings are somewhat limited, with 450 titles grouped under 12 categories. But each is accompanied by complete information on the film's producer/distributor, order number, date produced, color or black and white, length, available video formats, sale/rental/preview prices and policies, special restrictions, foreign-language versions, and a synopsis. A special section titled "Producers/Distributors" lists a name, address, and phone number for more than 100 companies that distribute the programs. "The Videolog," published by Esselte Video (600 Madison Ave., New York, N.Y. 10022), cost is \$20.

It's legal. What we felt was a threat "to the right to home entertainment" ("MCA vs. Sony," April 1977) has been averted in a decision by a Federal district court in Los Angeles, which ruled last October that it is permissible to record TV broadcasts for one's own home use.

Home video recordists have been operating with a suspicion of wrongdoing hanging over their heads since about three years ago, when MCA—or rather its subsidiary Universal Studios—and Walt Disney Productions sued the Sony Corporation on the grounds that the sale of Betamax recorders abetted the infringement of copyrighted material. (Also named in the suit was a William Griffiths, charged with the offense of owning one of the recorders.) Though the decision by Judge Warren J. Ferguson helps clear the way for expanding the video recorder market, reports are that Universal plans to appeal the ruling.

In its response to the suit, Sony argued that noncommercial home video recording was legal, and that the chief reason for Universal's instigation of court proceedings was the planned introduction of a video disc playback system developed by its parent company, a suspicion we voiced in our 1977 editorial.

Judge Ferguson also echoed our sentiments when he ruled that video recorder technology might challenge the "marketing strategy" of program producers, but that otherwise it did them no harm.

The ruling did not extend to the right to record from cable or pay television services, or the right to use off-the-air recordings outside the home. Decisions on these matters remain to be made.

IBM joins MCA. With the recent announcement by IBM that it has formed a joint venture with MCA to develop, manufacture, and market video discs and players, the MCA/Philips optical system has been given a boost in the race to determine which format will emerge as pre-eminent. The two corporations will be equal partners in DiscoVision Associates, with MCA contributing its current video disc business and assets and IBM contributing its own patents and technology as well as cash. MCA, however, retains its copyrights to program material and its consumer video disc distribution business. Some industry pundits are conjecturing that IBM's entry into the field is a signal that it has found a computer application for the optical disc system, but a company spokesman informed us that, since video discs are a playback-only information storage system, applicability to data storage and retrieval is limited.

The first product of the venture will be an industrial player; no plans have been announced for a consumer version. Those lucky few in the Atlanta and Seattle test markets who purchased a video disc player may soon find it easier to buy program material. With this infusion of cash, MCA will doubtless be able to gear up its disc production.

Slow down. A new line of tape designed to provide maximum performance in extended-play (EP) and standard-play video cassette recorders is available from Fuji. Because the slow speeds used by EP machines keep cassette tape in contact with the rapidly moving heads for longer periods of time, Fuji's VHS and Beta-format cassettes incorporate an improved binder system that is said to increase both tape and head life. The binder fuses the magnetic oxide particles securely to the tape, and the tape surface is polished mirror-smooth to prevent shedding due to friction. Fuji claims better signal-to-noise ratio, fewer dropouts, and improved color characteristics. The longest lengths available are the L-500 Beta cassette (500 feet, \$17.50) and the VHS T-120 (814 feet, \$25.50). **HF**

INCREDIBLE CASSETTE OFFER!



a \$5 LCD digital WATCH

Try 10 DAK high energy cassettes risk free for only \$2.19 each and get a beautiful \$69 value LCD digital watch for only \$5.

It's your choice. Think about the kind of music you like. You don't want to think about cassettes jamming, loss of high frequency response or tape hiss.

DAK manufactures a cassette that you can really forget about. Great sound, and no problems. And, for only \$5 we hope you will think a lot about your new LCD digital quartz watch.

YOUR TIME IS PRECIOUS

Imagine yourself just finishing recording the second side of a 90 minute cassette and horrors, the cassette jams. Tape is wound around the capstan, your recorder may be damaged and you've just wasted 90 minutes of your time and perhaps lost a great recording off FM.

Enter DAK. We manufacture over one million units of cassette tape each month in our North Hollywood factory. Many of our tapes are used for high speed duplication where they are recorded at speeds up to 8 times normal. This is the ultimate stress for cassettes and causes more failures than any other use.

MOLYSULFIDE

We developed polyester slip sheets with raised spring loaded ridges to guide each layer of tape as it winds. We coat them with a unique formulation of Graphite and a new chemical, molysulfide.

Molysulfide reduces friction several times better than graphite and allows the tape to move more freely within the cassette. The molysulfide is tougher and makes the liner more resistant to wear. Evidently 3M and TDK were hot on our heels, because they have now also come out with new liners.

Hi frequency protection! Tape is basically plastic, and as it moves within the cassette friction causes the build up of static electricity, much as rubbing a balloon against your hair, or scuffing your shoes on a carpet in dry weather.

Static electricity within the cassette is drastically reduced by the low friction of the molysulfide so that its tendency to erase very high frequencies is drastically reduced. A very important consideration for often played tapes.

MAXELL IS BETTER

Yes, honestly, if you own a \$1000 cassette deck like a Nakamichi, the frequency responses of Maxell UDXL or TDK SA are superior and you just might be able to hear the difference. DAK ML has a frequency response that is flat from 40cps to 14,500cps

±3db Virtually all cassette recorders priced under \$600 are flat ±3db from 40cps to about 12,500cps, so we have over 2000cps to spare, and you'll probably never notice the difference.

No apology. We feel that we have equaled or exceeded the mechanical reliability of virtually all cassettes and offer one of the best frequency responses in the industry. Maxell UDXL is truly the Rolls Royce of the industry, and DAK is comparable to the 100% US made Cadillac or Corvette!

Price DAK manufactures the tape we sell. You avoid paying the wholesaler and retailer profits. While Maxell UDXL 90s may sell for \$3.50 to \$4.50 each at retail, DAK ML90s sell factory direct to you for only \$2.19 each complete with deluxe boxes and index insert cards.

comfort. No cheap imitation, a first rate locking adjustable band.

It's guaranteed. This fine watch comes with a manufacturer's limited warranty for one full year.



a rugged micro-computer

DAK TAKES A RISK

Obviously giving away quality watches is not going to make DAK rich. Even giving away cheap watches wouldn't help. We are betting that you will buy our cassettes again, and we are putting our money where our mouth is!

Customers like you are very valuable in the form of future business. We anticipate receiving over 6000 orders and 4500 repeat customers from this advertisement to add to our list of over 57,000 actives.

TRY DAK ML90 CASSETTES FREE

Try these high energy cassettes on your own recorder without obligation for 30 days. If you aren't 100% satisfied for any reason, simply return the tapes and the watch to DAK for a full refund.

To order your 10 DAK ML 90 minute high energy cassettes at \$2.19 each and the \$69 value watch with your credit card, simply call the toll free number below, or send your check for \$21.90 plus \$5 for the watch and \$3 for postage and handling for each group of 10 cassettes and each watch to DAK. (Calif. residents add 6% sales tax.)

DAK unconditionally guarantees all DAK cassettes for one year against any defects in material or workmanship.

Why not order an extra group of 10 DAK ML90 cassettes for yourself or a friend? We will add one free ML90 cassette to each 10 you buy and of course you can buy one \$69 value watch for \$5 with each group you buy.

© DAK Industries, Inc., 1979



DAK INDUSTRIES INCORPORATED

Call TOLL-FREE (800) 423-2636
In California Call (213) 984-1559
10845 Vanowen St., North Hollywood, CA 91605



A \$5 LCD WATCH?

Of course not! This is an incredible offer. Countless stores throughout the country sell LCD quartz crystal watches like this for up to \$69.

This beautifully styled slim silvertone watch is loaded with features. LCD means that the time in hours and minutes always shows without having to push buttons. Push the button once, and you'll see the date in months and days, and push the button again and the watch shows seconds.

Night light. Usually only found in the most expensive watches. Simply push a button and the entire time section lights up for convenient night viewing.

Quartz crystal accuracy means constant time within 1 minute per month. Crystals use little electricity, so the battery should last up to a year, and may be easily changed by any jeweler.

Stainless steel band for long life and

New Equipment Reports

Preparation supervised by Robert Long, Peter Dobbin, and Edward J. Foster. Laboratory data (unless otherwise noted) supplied by CBS Technology Center or Diversified Science Laboratories.



High Fidelity Tuner—For AM As Well as FM

Sansui TU-919 stereo FM/AM tuner, in metal case with rack-mounting adapters. Dimensions: 17 by 6¼ inches (front panel), 13¼ inches deep plus clearance for controls and connections. AC convenience outlet: one unswitched (100 watts). Price: \$585. Warranty: "limited," two years parts and labor (including two-year international warranty should you take the tuner out of the U.S.). Manufacturer: Sansui Electric Co., Ltd., Japan; U.S. distributor: Sansui Electronics Corp., 1250 Valley Brook Ave., Lyndhurst, N.J. 07071.

AM has been an audio drudge ever since her FM stepsister moved in with all the glamorous garb of static-free, wide-range sound decades ago. A few Prince Charmings (Dynaco and McKay come to mind) have seen the potential quality beneath an exterior characterized by headache cures and record hype, but in most high fidelity tuners and receivers—even the most expensive—the AM section wears hand-me-down circuitry beside the latest FM fashions, like phase-locked loops and switchable IF bandwidth. Perhaps because of its involvement in the gestation of stereo AM, Sansui has become one of the exceptions with the TU-919, in which as much care seems to have been lavished on the AM section as on its sibling.

The back-panel connections are somewhat unusual. There are the standard binding posts for external AM antenna and ground plus a 300-ohm FM downlead and a coaxial 75-ohm input (with mating connector) for FM. In addition to the main audio output jacks, whose signal level can be varied at the front panel, another pair will deliver 25-microsecond FM de-emphasis, ready for decoding, on Dolby FM broadcasts. (The feed, via these outputs and a Dolby B decoder, would be selected at a tape-monitor or external-processor switch on the system's preamp or integrated amplifier.) There also is a pair of jacks that can feed the vertical and horizontal inputs of an oscilloscope for FM multipath analysis; that for the horizontal input comes from the detector and thus could be used for a quadriphonic decoder intended for a discrete broadcast system. Likewise, an IF output from the AM section could be used for a stereo decoder.

New Measurement Standards: In making comparisons between current reports and those published in the past, readers are cautioned to pay particular attention to the reference levels and similar test criteria cited. S/N ratios for electronics, in particular, are measured very differently now that we have adopted salient features of the new IHF amplifier-measurement standard. While we believe that the new technique (which also implies a saner approach to loading of all inputs and outputs) will result in measurements that more perfectly reflect audible, in-use effects, they cannot be compared directly to the numbers resulting from the former, more conventional lab measurements.

Sansui TU-919 FM/AM tuner

MONO FM FREQUENCY RESPONSE

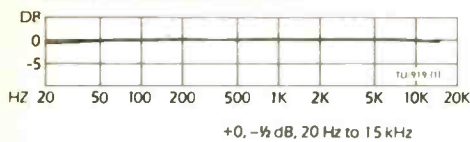

STEREO FM RESPONSE & CHANNEL SEPARATION

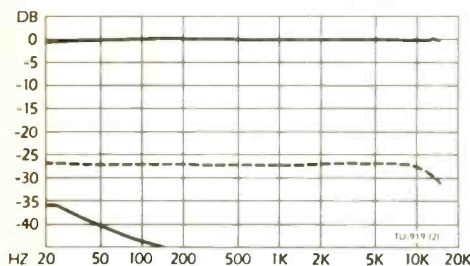

Frequency response +1/4, -1/4 dB, 20 Hz to 15 kHz
 Channel separation
 — wide mode ≥ 45 dB, 150 Hz to 15 kHz,
 > 35 dB, 20 Hz to 15 kHz
 - - - narrow mode ≥ 26 1/2 dB, 20 Hz to 15 kHz

FM SENSITIVITY & QUIETING

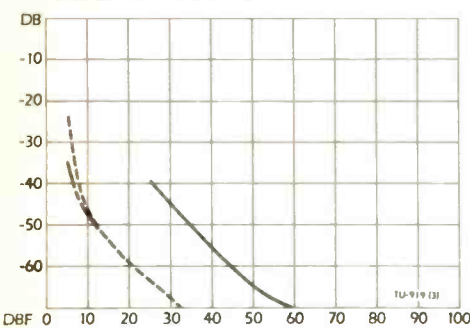

— stereo noise (quieting)
 - - - mono noise (quieting)
 - · - mono noise (quieting) narrow mode
 Stereo sensitivity (for 50-dB noise suppression)
 34 1/2 dBf at 98 MHz, with 0.54% THD+N
 (34 1/2 dBf at 90 MHz; 37 dBf at 106 MHz)
 Mono sensitivity (for 50-dB noise suppression)
 11 1/2 dBf at 98 MHz
 Muting threshold 24 1/2 dBf
 Stereo threshold 22 dBf
 Stereo S/N ratio (at 65 dBf) 72 1/4 dB
 Mono S/N ratio (at 65 dBf) 78 1/2 dB

CAPTURE RATIO wide 1 1/4 dB
 narrow 2 1/4 dB

ALTERNATE-CHANNEL SELECTIVITY
 wide mode 61 dB
 narrow mode 65 1/2 dB

HARMONIC DISTORTION (THD+N)
 Wide mode stereo mono
 at 100 Hz 0.16% 0.14%
 at 1 kHz 0.10% 0.046%
 at 6 kHz 0.10% 0.074%
 Narrow mode
 at 100 Hz 0.55% 0.14%
 at 1 kHz 0.33% 0.12%
 at 6 kHz 0.65% 0.12%

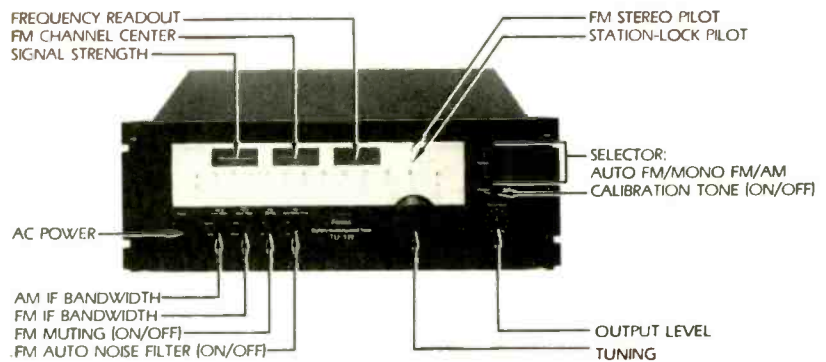

As you can see from the front-panel photograph, the controls include an IF-bandwidth switch for AM (unique in our experience of high fidelity products, though not in quality communications receivers) as well as one for FM (now quite common in the better stereo components). Though we don't normally measure AM frequency response, Diversified Science Laboratories ran curves on each of the AM IF modes so we could examine the differences between them. Both have a gradual rolloff (amounting to about 3 dB per octave) below 100 Hz and are flat in the neighborhood of 500 Hz. The wideband response begins rolling off again at 1 kHz, is down 3 dB at 3.6 kHz, continues its gradual descent until it encounters a very sharp notch filter for the adjacent-channel carrier (10 kHz away, though the trap measured 9.4 kHz in our bench-test sample), then returns to about -20 dB before dropping off at about 27 dB per octave. The narrowband response begins rolling off a little below 1 kHz, is down 3 dB from its flat portion at 2.2 kHz, and gradually assumes a slope of about 36 dB per octave. Thus the narrow mode offers between 6 and 20 dB more suppression of interference products in the range between 5 and 9 kHz, though the wide mode can hardly be called flat by high fidelity standards in this range.

By contrast to typical component AM sections, however, that in the TU-919 is astonishing for its high-frequency content. With a strong AM station broadcasting a clean signal, the results outclass any tuner or tuning section now available to us. Under less ideal conditions, the wisdom of avoiding such a design in standard products and of including the IF switch on this one becomes apparent: The interference "birdies" that are thus awakened remind us of the chirpings at a summer sunrise. The narrow mode effectively silences them—so effectively that precise tuning becomes more difficult in this mode; on weak stations, we learned to tune by ear (using the whistles) in the wide mode and then switch to narrow. The results are, of course, audibly more limited in response—and thus in that respect more like run-of-the-mill tuners—but the extreme sensitivity of this Sansui pulls in stations that are far beyond the capability of most AM tuner sections.

The FM section, too, is very fine, though it naturally has no comparable surprises to offer in this age of stereo tuners approaching the theoretical performance limits. In tuning it, you become aware of one courtesy that was not extended to the AM section: a very legible, well-calibrated tuning dial of better-than-average accuracy. Actually, these qualities are somewhat redundant in the 919 because it also provides a digital frequency readout that tells you exactly which station you're tuned to; the dial is useful to determine at a glance what portion of the band you're tuned to, particularly in quick swings between widely separated stations. The signal-strength meter responds to both AM and FM, of course. The FM-only channel-center meter agrees nicely with the station-lock pilot in pinpointing best tuning at high signal strengths, though at weak ones it remains to the right of center for the Lock indication. Not to worry. The lock actually is on optimum tuning despite the meter reading, and even under these circumstances the meter remains a helpful "rough tuning" indicator as a prelude to the delicate job of finding the locked position.

There are other oddities with weak signals. The muting and stereo thresholds are unstable, and the 919 seems to "oscillate" across them with borderline signals, which can be annoying. (Solution: Turn off the muting or switch to mono-only operation.) And the stereo noise cancellation is unusual in that, below about 45 dBf of

WHICH HIGH BIAS TAPE WINS WITH MAHLER'S FOURTH SYMPHONY?

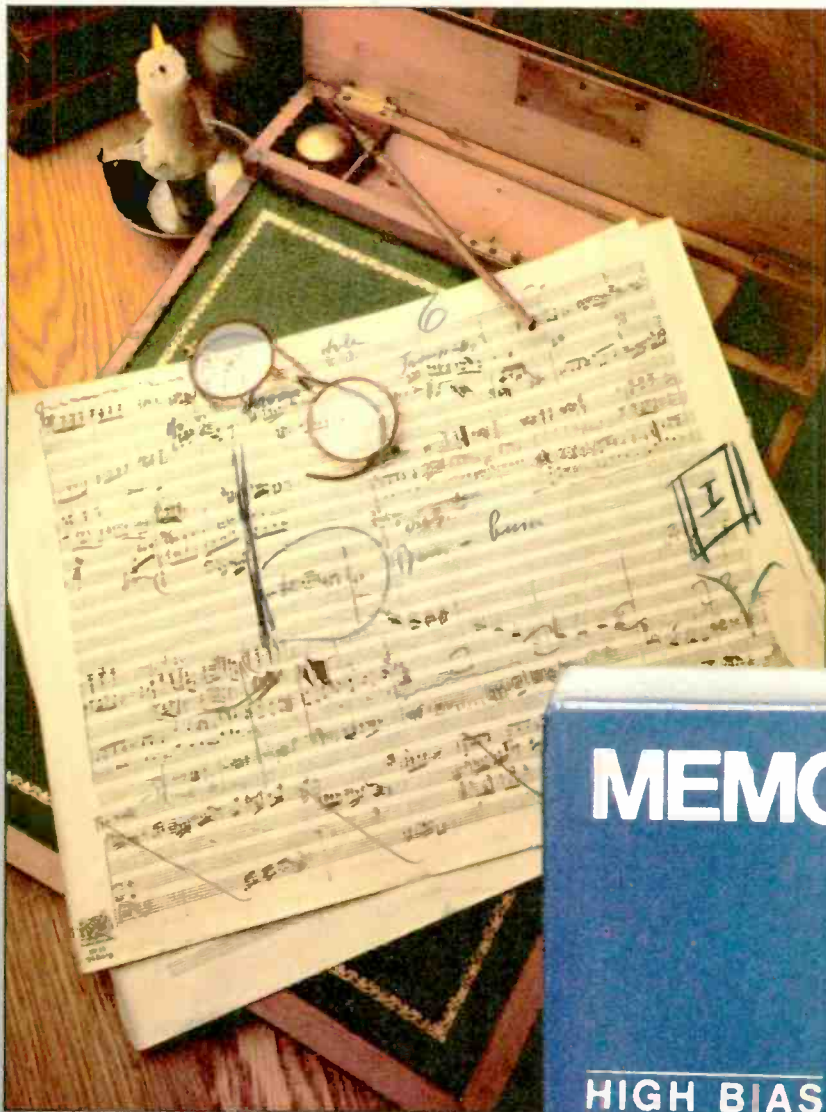

Original manuscript sketch for the first movement of Gustav Mahler's Fourth Symphony. Courtesy of The Hawberry Library, Chicago.

Choose eight measures of Mahler's Fourth that are really rich in the high frequencies. The type of passage that high bias tapes are designed for

Record it on your favorite high bias cassette, using the Chrome/CrO₂ setting. Then again on MEMOREX HIGH BIAS.

Now play back the tapes.

We're convinced you'll have a new favorite.

MEMOREX HIGH BIAS is made with an exclusive ferrite crystal oxide formulation. No high bias tape delivers greater high frequency fidelity with less noise, plus truer response across the entire frequency range.

In short, you can't find a high bias cassette that gives you truer reproduction.

MEMOREX

Recording Tape and Accessories.
Is it live, or is it Memorex?



Technics RS-M95. When price is no object. But performance is.



There are countless cassette decks to choose from when your object is price. But when your only object is performance, look at the RS-M95 with metal tape capability.

The heart of the RS-M95 lies in its quartz-locked direct-drive capstan motor and its computer-controlled tape tension system. Together, they team up to provide constant tape tension, remarkably low wow and flutter and complete immunity from speed inaccuracy. So when you record an A flat, you'll hear an A flat. No more, no less.

But if more is what you want, you'll get it with metal tape. Because, compared to conventional tape, it gives you a frequency response with more dynamic headroom and more high end extension.

You'll also get the advantage of the RS-M95's three-head configuration: Source/tape comparison. What you don't get is azimuth error, because our HPF record and playback heads are not only precisely gapped, they're also precisely enclosed in a single housing.

To add to the RS-M95's three-head configuration, we added double Dolby*. So you can monitor your tapes with the full effects of Dolby noise reduction.

Another glowing feature of the RS-M95 is its two-colored fluorescent (FL) bar-graph meters. They're fast, thanks to a device attack time of just 5 millionths of a second. And accurate, thanks to a Technics high-slew-factor operational amp for absolute wave and peak detection.

Also included are 4-position tape selectors with bias fine adjustments. A built-in 400 Hz/8 kHz test tone oscillator. A separate, coreless DC motor for reel drive. A microprocessor tape counter with triple memory functions and feather-touch controls.

Technics RS-M95. Its performance is its only reason for being.

FREQUENCY RESPONSE (Metal): 20-20,000 Hz (± 3 dB). WOW AND FLUTTER: 0.03% WRMS. S/N RATIO (Dolby in): 70dB. SPEED DEVIATION: $\pm 0.1\%$.

*Dolby is a trademark of Dolby Laboratories.

Technics
Professional Series

STEREO PILOT INTERMODULATION	
wide mode	0.073%
narrow mode	0.31%
INTERMODULATION DISTORTION (mono)	
wide mode	0.031%
narrow mode	0.067%
AM SUPPRESSION	
wide mode	60½ dB
narrow mode	63 dB
PILOT (19 kHz) SUPPRESSION	73¼ dB
SUBCARRIER (38 kHz) SUPPRESSION	>84 dB

input, it automatically and progressively introduces both a filter and an interchannel blend in the high frequencies for some 3 dB of noise reduction below 40 dBf. The idea is clever and sensible and should please many listeners who must cope with weak stereo broadcasts.

The difference between IF bandwidths strikes us as much less noticeable in FM than in AM. But while the narrow mode makes only a modest improvement in alternate-channel selectivity, its influence on interference from the adjacent channel is something else, moving to an exceptional 19¼ dB from a healthy 7½ dB in the wide mode. Narrowband harmonic distortion is (predictably) a little higher and channel separation poorer, but the ear does not perceive these differences nearly as easily as the meter-reading eye does.

We find the calibration-tone oscillator, switched in at the front panel, useful for setting recording levels, though its level appears a little odd. The well-prepared manual says that it is 5 dB below 100% FM modulation; that is, it presumably represents the level of about 56% modulation. Dolby reference level for FM broadcasting is 50% modulation, or -6 dB, so the Sansui level would be almost close enough to use in aligning an outboard Dolby decoder except that the actual level in our bench-test sample measures 63% modulation, or -4 dB. Had the level been set at -6 (which is logical in view of the built-in provision for Dolby de-emphasis), it could have served for both decoding and recorder adjustment.

The unusual byways down which the TU-919 has led us are an index of the fascination that such originality of approach creates. But don't be misled by our pursuit of the exotic: Under its special qualities—and, particularly in the AM section, they are indeed special—lies a very sound fabric. It will not disappoint anyone who might have spent a comparable sum for a conventional FM-only tuner, we're convinced, and it will deliver its extras as a bonus. If you're just looking for good FM reception, you might spend twice as much and be less satisfied; if you're also looking for good AM reception, there simply is no competition.

Circle 133 on Page 115

Yamaha Debuts A Moving-Coil Pickup

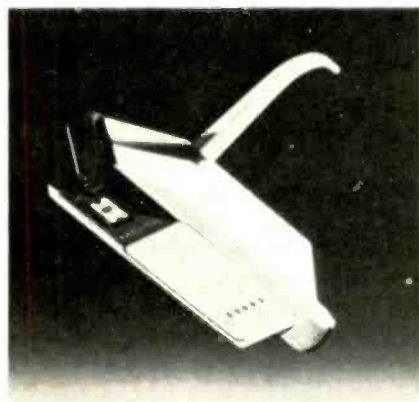

Yamaha MC-1X moving-coil phono pickup with hyperelliptical stylus, in integral "universal" plug-in headshell. Price: \$250; unmounted (MC-1S), \$200. Warranty: "limited," six months parts and labor. Manufacturer: Nippon Gakki Co., Ltd., Japan; U.S. distributor: Yamaha International Corp., P.O. Box 6600, Buena Park, Calif. 90620.

Yamaha has chosen to enter the U.S. cartridge market on its own terms—and fairly esoteric ones at that—with the MC-1X, a refined version of a "classic" moving-coil design. While some other manufacturers have emphasized high output levels appropriate for regular phono-preamp inputs or allowed for user replacement of worn and damaged styli, the new model must be used with a separate head amp or transformer, and its stylus can be changed only by a factory-authorized dealer.

It is an impressive offering, particularly for a company whose name has never been associated with cartridges. Second harmonic distortion is on a par with that of other very fine pickups; intermodulation distortion is held very low indeed. This may well be due to Yamaha's careful mating of coils and a tubular beryllium cantilever, designed to hold spurious movements and resonances to a minimum through a one-point suspension system. The recommended vertical tracking force range is from 1.6 to 2.0 grams, yet the MC-1X traces the CBS Technology Center's "torture test" well at 1.2 grams. Frequency response measures virtually ruler flat up to 10 kHz, and it peaks slowly to a maximum rise of 3 dB at 20 kHz (using the CBS test record), representing smoother, flatter response than average for this region in a moving-coil model.

In its microscopic examination of the stylus, the lab found the hyperelliptical diamond to be of excellent polish and alignment. The vertical tracking angle is low—more in line with cutterhead angles (roughly, 15–20 degrees) than usual, as the sad-but-true figures from the lab's new test have been showing us for some months. In the square-wave response test, the Yamaha's astonishing ultrasonic performance—reaching to something like 60 kHz—mercilessly exposed a resonance of the Westrex III-D cutter used to make the test record. The square-wave photo shown in the data was made through a low-pass filter to reduce the cutterhead's influence;

Yamaha MC-1X phono pickup

FREQUENCY RESPONSE & CHANNEL SEPARATION
(test records: STR-100 to 40 Hz; STR-170 above)

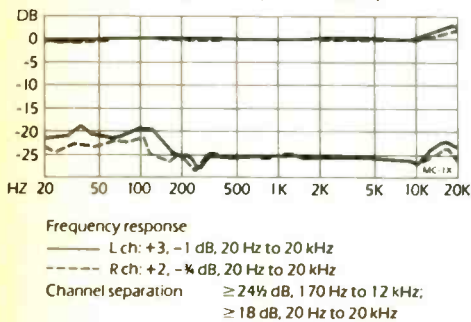

SENSITIVITY (at 1 kHz) 0.06 mV/cm/sec

CHANNEL BALANCE (at 1 kHz) ± < ¼ dB

VERTICAL TRACKING ANGLE 2 1/2°

LOW-FREQUENCY RESONANCE (in SME 3009 arm)
 vertical 8.0 Hz; 2¼-dB rise
 lateral 7.8 Hz; 2½-dB rise

complete removal would have compromised the squareness of the waveform and thus misrepresented the pickup's superb high-frequency behavior.

Mounted in our standard SME arm, the MC-1X displays a low-frequency resonance that falls very close to, but slightly below, the "ideal" 10-Hz point. Since reducing the mass raises the resonance, a somewhat lighter arm (and most recent models—including SME's own, reviewed here in November—are) should still leave the resonance within the desirable range. The very low amplitude of the measurement indicates that the cartridge is unusually insensitive to warps in any event.

It would be difficult to imagine a more pleasant-sounding pickup. Whatever weight you attach to the numbers that emerge from lab testing, a phono cartridge must appeal to the listener's taste in order to satisfy. And the MC-1X is tasty indeed. There is no edge or brittleness to its reproduction of high frequencies. The word "sweet" kept popping up in our evaluations of its ability to handle strings and brass instruments. Stereo imaging is solid and well defined, with no drifting. The \$250 price tag (plus the cost of a head amp or transformer) is rather steep for any but the most dedicated audiophiles, but it would in no way surprise us to find the MC-1X (and its unmounted sibling) establishing an avid following in that company. And perhaps it will prove to be the flagship for a full line of pickups yet to come from Yamaha.

Circle 132 on Page 115

MAXIMUM TRACKING LEVEL (re RIAA 0 VU; 1.0 gram)
 at 300 Hz +18 dB
 at 1 kHz +12 dB

WEIGHT 19.0 grams

TIP DIMENSIONS
 tip radii 5.2 by 10.4 micrometers
 scanning radii 5.4 and 6.3 micrometers



SQUARE-WAVE RESPONSE

A Cassette Deck With a Mind Of Its Own

JVC KD-A8 cassette deck

PLAYBACK RESPONSE (TDK test tape; -20 dB DIN)

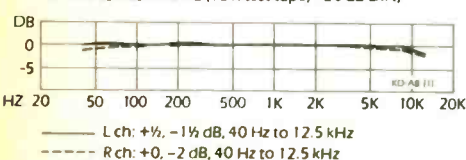

RECORD/PLAY RESPONSE: "CHROME" TAPE (-20 dB)

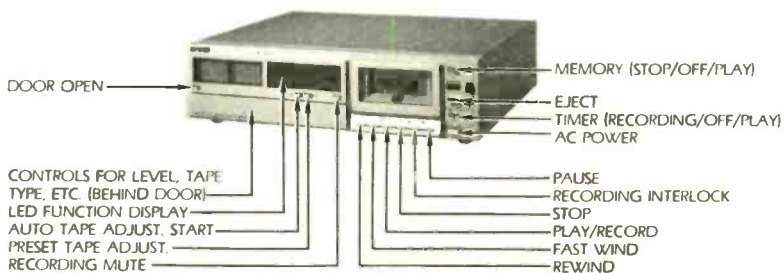
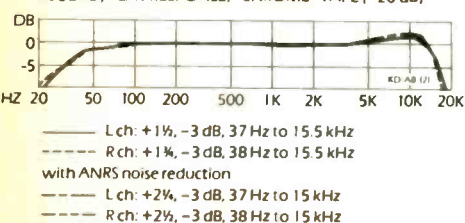

JVC Model KD-A8 cassette deck with BEST automatic recording adjustment, in metal case. Dimensions: 17¼ by 4½ inches (front panel), 14¼ inches deep plus clearance for controls and connections. Price: \$749.95; optional remote control, R-30 (not tested), \$49.95. Warranty: "limited," one year parts and labor. Manufacturer: Victor Co., Japan; U.S. distributor: U.S. JVC Corp., 58-75 Queens Midtown Expressway, Maspeth, N.Y. 11378.

This is an uncanny deck. Though it has many interesting features, one claims pre-emptive attention: the BEST (Bias, Equalization, and Sensitivity of the Tape) recording adjustment. You press a single button, and the machine fast-forwards a little way into the tape (to get beyond the leader), records a series of test tones at different bias levels, rewinds, evaluates the results of the first test and adjusts its bias accordingly, records some more test tones, rewinds and evaluates the second group, adjusts recording equalization and sensitivity on that basis, rewinds to the head of the tape, and signals that it is ready to begin recording. If something goes wrong—say, the tape has been damaged and doesn't make adequate head contact—it will stop the evaluation and notify you that all is not well. So busily does it scurry about doing its adjustment chores that you're tempted to approach it as an organism, rather than as the microprocessor-controlled hardware that it is.

Hidden behind the door at the lower left of our front-panel picture is a

**It takes a computer to get bass this big
into a cabinet this small.**

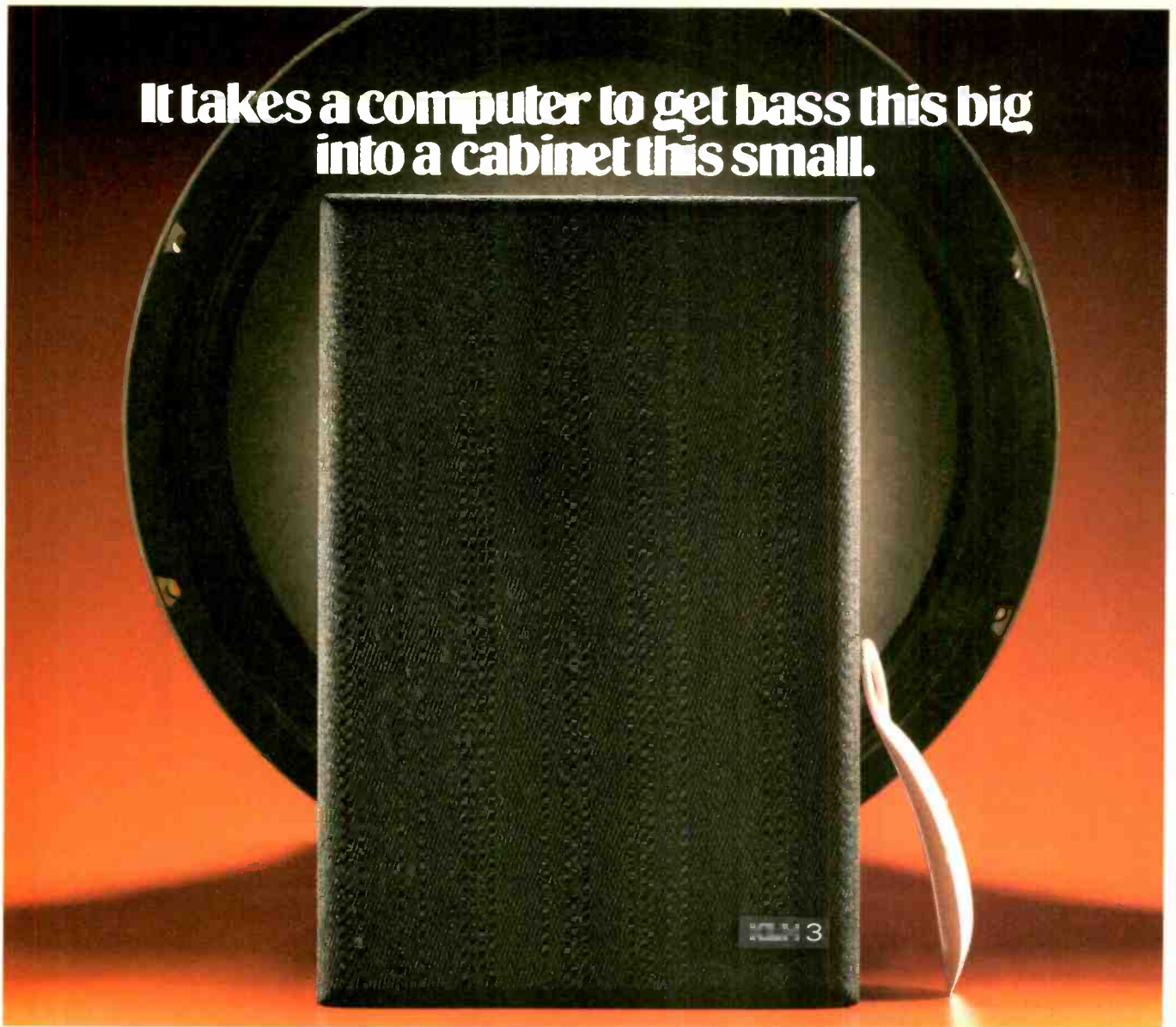

Great bass used to mean great furniture.
But KLH just changed the rules.

The KLH-3 gives you clean bass,
flat down to 40 Hz (-3dB),
in a cabinet just 8" x 12"
x 6". The reason is one of the most sophis-
ticated components ever integrated into a
speaker system:

The KLH Analog Bass Computer.™*

The computer is a separate
module that sits next to
your receiver. It continually
monitors the bass signal
and controls woofer excu-
sion to deliver bass equal to
speakers four times larger.
Bass you feel, as well as hear.

The KLH-3 also makes
use of the latest technology in

*Pat. applied for.

**Manufacturer's suggested retail price.

**Introducing
the Computer Controlled
KLH-3.**



speaker cone material: polypropylene.* For a clear,
uncolored mid-range and high end.

The KLH-3. \$450 the pair, with
Analog Bass Computer.**

Don't think of it as a
great small speaker. Think of it as the
first great speaker that happens to be
small. To find out where you can

hear the full line of KLH Computer
Controlled speakers,™ call
800-225-6042 (in Mass.

800-532-9566). KLH
Research and Develop-
ment Corp., 145 University
Ave., Westwood, MA

02090. In Canada: The
Pringle Group, Ontario.

KLH

The world's most powerful 35 watt receiver.

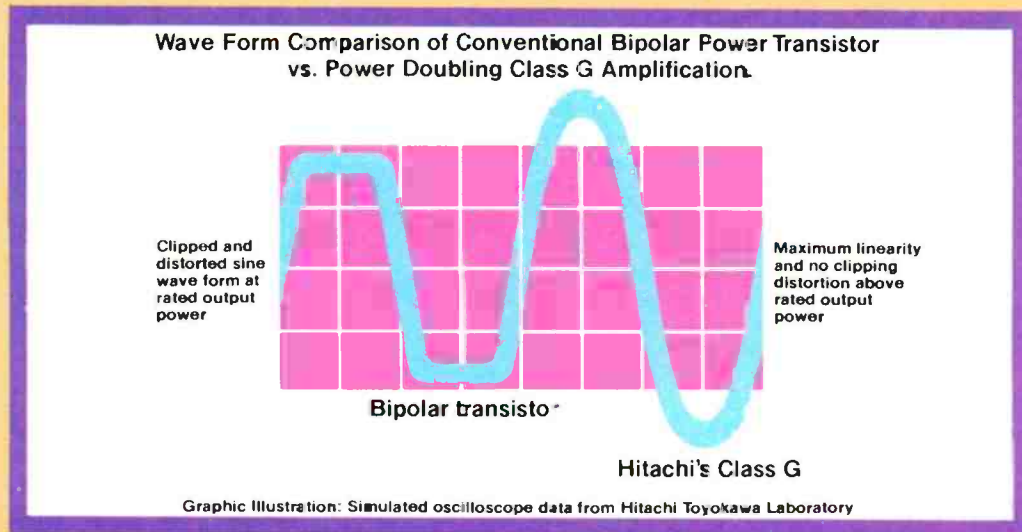

Power Doubling Class G

SR-604

The beauty of the SR-604 stereo receiver:

In normal operation, it delivers 35 watts per channel, both channels driven at 8 ohms, from 20-20,000 Hz, with no more than 0.05% total harmonic distortion. But when it's confronted with a demanding musical peak, it switches over to power doubling Class G amplification, becoming a super power auxiliary amplifier delivering a massive 70 watts per channel.

The result? Clean, unclipped musical peaks and outstanding dynamic range. You'll also like what it does to the tuner section, in critical areas like sensitivity, selectivity and signal-to-noise ratio performance.

The amazing SR-604—super-power, low distortion, all the good things you're looking for in stereo.



HITACHI

The New Leader in Audio Technology

Hitachi Sales Corp. of America 401 West Artesia Blvd. Compton, Calif. 90220

RECORD/PLAY RESPONSE, METAL TAPE (-20 dB)

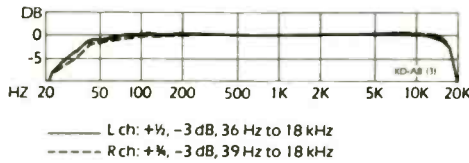

RECORD/PLAY RESPONSE, FERRIC TAPE (-20 dB)

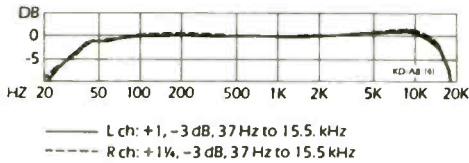

S/N RATIO (re DIN 0 dB; A-weighted)

	"Cr." metal	ferric
playback	61 dB	58 dB
ANRS playback	67% dB	66 dB
record/play	57 dB	53% dB
ANRS record/play	64% dB	62 dB

METER READING FOR DIN 0 dB +5 dB

METER READING FOR 3% DISTORTION (at 333 Hz)
> +5 dB with any tape tested

DISTORTION (third harmonic, at -10 dB DIN)

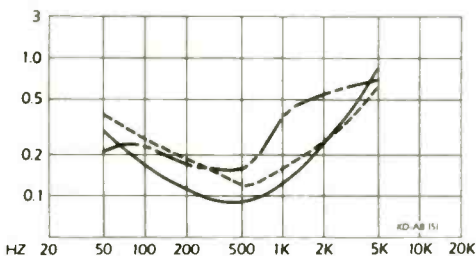

"chrome" tape	≤ 0.85%, 50 Hz to 5 kHz
metal tape	≤ 0.63%, 50 Hz to 5 kHz
ferric tape	≤ 0.68%, 50 Hz to 5 kHz

ERASURE (333 Hz, re DIN 0 dB)

"chrome" tape	> 74 dB
metal tape	71% dB

CHANNEL SEPARATION (at 333 Hz) 52% dB

SPEED ACCURACY 0.5% fast at 105 VAC
0.6% fast at 120 VAC
0.6% fast at 127 VAC

WOW & FLUTTER (ANSI/IEEE weighted peak)

	average	maximum
playback	± 0.05%	± 0.065%
record/play	± 0.045%	± 0.055%

SENSITIVITY (re DIN 0 dB; at 333 Hz)

line input	130 mV
mike input	0.32 mV

MIKE INPUT OVERLOAD (clipping) 110 mV

OUTPUT (from DIN 0 VU) 0.44 V

whole series of features. The output-level knob and jacks for headphones and microphones are standard. The recording-level controls include separate left- and right-channel knobs plus a three-position S&L (search and lock) switch. At MANUAL, it leaves the knobs to do their accustomed job; at the other extreme (SET, which is spring-loaded) recording levels start out at maximum and are progressively "bumped" down by peaks in the signal so that when you release it (to the center position: S&L) each channel will be preset to deliver a +3-dB display on the recording indicators for the highest signal level that passed through the system during the SET cycle. Next is a noise-reduction switch: OFF/ANRS/SUPER ANRS. Then there is a selector for basic tape type with three positions: metal-particle tapes, chrome or normal tapes, and ferrichrome tapes.

Actually, four tape groups are allowed for in these three positions; the deck distinguishes between chrome (or chrome-substitute) and regular ferric ("normal") tapes on the basis of the key well built into the back edge of the shells for the former. (If you have early chrome cassettes without the key well, you can play them with either the METAL OR FERRICHROME setting since both incorporate the 70-microsecond playback EQ, and you can use the BEST system to adjust bias and so on for them.) All of these basic tape options entail preset adjustments of recording parameters; you need not use the BEST system for tapes that match the presets. And here we come to a feature of the deck that we cannot applaud loudly enough—one that we have been pleading for for years. The tape list in the manual indicates (with an asterisk) which specific tape types the preset adjustments were tuned for and (with bold-faced type) which other formulations are sufficiently similar to deliver essentially optimum performance with the presets. The irony of this important set of specifics is that it is provided with a deck that, in theory, doesn't need them, since it will adjust itself to any reasonably standard tape.

Diversified Science Laboratories used the asterisked tapes (Scotch Metafine, TDK SA "chrome," and Maxell UD ferric) to make the measurements shown in this report. Had the custom-adjustment process been more difficult, we would have used the preset adjustments rather than BEST. But the BEST operation is so fascinating that we expect that owners will want to use it, and if they do, they will automatically keep abreast of any changes in formulation. So all the tapes were run through the BEST in advance of measurement. (The lab also used Sony ferrichrome, though we have omitted the data in the interest of simplicity. As in past tests, the headroom and dynamic range proved among the best of the tested tapes, but the high-frequency distortion decidedly the worst and high-frequency response rather rough.)

To investigate the automatic adjustments vs. the preset ones, DSL also ran curves with both options, using two TDK ferrics: the moderately priced D and the "hot," premium AD. BEST, it turns out, is not quite 100% best. Since the reference ferric (UD) is much closer to AD than to D, the preset produced much better results with AD; the upper end of the D response drooped a good deal. With the BEST adjustment, however, D performed very nearly as well as the preset AD and a hair better (!) than the BEST AD, which drooped slightly at the extreme top end by comparison to its excellent preset performance. Of all the curves DSL ran, only those for the preset D (which is listed but not bold-faced in the manual) fall outside what we would call the good-to-excellent class.

The ANRS system (which is Dolby-compatible) and its Super-ANRS option (which is not) do what they are supposed to do. Any high-frequency response irregularities—most noticeable with ferrichrome—are exaggerated to some extent by ANRS as they are with Dolby, and Super ANRS tends to exaggerate them a little more at the normal test level (-20 dB). The point of Super ANRS, however, is to increase high-frequency headroom, and this it does very well indeed, extending the flat portion of the ferric and "chrome" curves recorded at 0 VU almost to 10 kHz, for about the same contour as metal tape without Super ANRS. (Metal tape with Super ANRS goes even further, but this appears to us as overkill since we don't know of any signals that would require a 0-dB level at 10 or 12 kHz.)

The signal-level indicators seem in want of some rethinking. The meters are fairly small, of limited range, and a little sluggish, so we tended to rely on the LEDs during actual use. But there are LEDs only for -10, -5, 0, +3, and +6 dB—not a very fine division, particularly in the important 0-dB range. Further, their 0 (and that of the

meters) is 5 dB below DIN's 0 reference, and the manual tells you to set maxima at the indicators' +3, without reference to tape type and, therefore, actual midrange headroom. It adds up to too many references and too little information for the really serious recordist, but though we find this among the deck's least attractive attributes, it is probably adequate for most users. The S&L system doesn't necessarily help. It works fine if the channel balance of the signals used to set it is good (we'd recommend switching tuners to mono, for example, if that's possible), but since the JVC's two channels adjust themselves independently, imbalance in the adjustment signal produces stereo imbalance in the recording.

Overall, this is a hard deck to be objective about (though the excellent bench-test data speak for themselves) because it is so much an "original" that it tends to focus attention, pro or con, on its individuality rather than on its sterling basic qualities. The BEST system certainly is a triumph: the only simple and accurate way we know to get full adjustment to virtually any tape on a two-head deck. That alone is enough to make this one of the most important pieces of cassette equipment to appear this year.

Circle 135 on Page 115

Star Interface: Small but Bright



Electro-Voice Interface A Series III speaker system in walnut enclosure, sold in pairs with active equalizer unit. Dimensions: 15½ by 24½ inches (front), 8¼ inches deep; equalizer, 2 by 8 inches (front), 7 inches deep plus clearance for controls and connections. AC accessory outlet: one unswitched (200 watts). Price: \$570. Warranty: "limited," five years parts and labor. Manufacturer: Electro-Voice, Inc., 600 Cecil St., Buchanan, Mich. 49107.

Five years ago (February 1974), we reviewed the Electro-Voice Interface A and found it "handsome in sound and appearance." In its present incarnation as the Series III, after major redesign, we still believe it "transcends the commonplace in a number of respects."

All E-V speakers in this family are sold with active equalizers that accomplish three functions: They boost low-frequency response (completing the bass-alignment process, so to speak), provide a sharp infrasonic filter (below 35 Hz in the present model), and permit high-frequency contouring without altering crossover performance. The Interface A Series III is an optimally vented two-way design with an 8-inch midrange/woofer coupled to a mass-loaded 12-inch passive radiator that acts as the "driver" below 49 Hz. (The original model employed a 10-inch midrange/woofer; E-V claims that reduced driver size was chosen for smoother response in the bass and midrange.) Frequencies above 1,500 Hz are handled by a single, baffle-mounted dome tweeter incorporating an acoustic-foam "lens" that, E-V says, becomes acoustically opaque as frequency rises to reduce the effective radiating area, and thus broaden dispersion angle, at the shorter wavelengths. This, together with unusually high rated power handling (25 watts continuous) and efficiency, makes the tweeter superior to the old design—which used two cone drivers, one baffle-mounted and one rear-firing.

Setting up the Series III is quite simple. The equalizer is designed to work at the tape monitor jacks of your receiver or preamp (though it also can be inserted into preamp/amp connections) and actually increases the tape flexibility of your stereo system as a whole. It has outputs for two tape recorders plus monitor input and switching for one. You can play the second tape deck through the aux inputs, giving you a two-deck capacity at the single set of tape connections pre-empted by the equalizer. In addition to the monitor switch, there is one for AC power and tweeter level, marked OFF/0 dB/-3 dB/-6 dB. The OFF cuts AC power to the equalizer's active circuitry and would be used only when you are playing music through another speaker pair. If the Interfaces are your only (or primary) pair, you can plug the equalizer into a switched convenience outlet on your receiver or preamp and forget the OFF. The other three switch positions provide a "flat" setting and progressive high-frequency rolloff.

Since the new Super Dome tweeter is rated for such a high continuous input, E-V feels that its formerly recommended TS-1 tweeter protector isn't necessary;

Electro-Voice Interface A Series III speaker

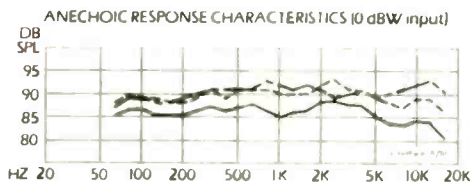

— boundary-dependent region
 — average omnidirectional response
 - - - - average front hemispheric response
 - · - · on-axis response

AVERAGE OMNIDIRECTIONAL OUTPUT
 (250 Hz to 6 kHz)
 86% dB SPL for 0 dBW (1 watt) input

CONTINUOUS ON-AXIS OUTPUT (at 300 Hz)
 111 dB SPL for 20 dBW (100 watts) input

PULSED OUTPUT (at 300 Hz)
 126 dB SPL for 35 dBW (3,200 watts) peak

"NOMINAL" IMPEDANCE 4.5 ohms

APPROX. TWEETER CONTROL RANGE (re "flat")
 -1 & -2½ dB, 5 to 8 kHz;
 -4 & -7 dB above 10 kHz

you won't find an extra pair of binding posts for it on the back of the Series III—just the standard left and right input pair. In the particularly well-written and complete owner's manual, however, the company notes that, if you worry that your own carelessness could result in a blown tweeter, you can wire a one-amp slow-blow fuse into the speaker leads. A diagram is provided to simplify the hookup.

Data from CBS Technology Center show this system to be very efficient. Power handling and dynamic range are exemplary, especially for such a small speaker: It passed the 20-dBW continuous tone test with no sign of strain, and in the pulse test the driving amplifier ran out of steam before the Interface did. The efficiency and the generally low lie of the impedance curve (between 4.5 and about 11 ohms from the midbass up) argue in favor of satisfactory performance even with amps of modest power. Were two pairs to be paralleled, however, the combined impedance of 2.25 ohms, which falls in the musically hyperactive range just below 200 Hz, could result in excessive current drain in many "small" amps.

At the 0-dBW (1-watt) level, both second and third harmonic distortion generally stay below ½% from 70 Hz up—very good, indeed. At high sound pressure levels (100 dB), the second harmonic rises across the audible spectrum, though it rarely exceeds 1%; the more annoying third harmonic stays extremely low over much of that range but rises above 1% both below 100 Hz and in the bottom end of the tweeter's range, around 2–3 kHz. Perhaps by coincidence, the 3-kHz tone-burst test displays evidence of brief but high-amplitude overhang and some minor reflection; the 300-Hz tone burst is well reproduced.

In listening tests, the Series III proved to be accurate and very "unboxy" for a bookshelf speaker. Setting the equalizer's contouring to the "flat" 0-dB mark resulted in a sound that was a bit too brilliant for our room. We finally settled on the -3 position as our favorite, though a very absorbent room might have altered our choice. The stable and well-defined stereo imaging held its own as we changed our relative positions.

Ultra-bass fundamentals below 35 Hz—if they exist in your program source—are, of course, suppressed by the equalizer's infrasonic filter, but low-frequency reproduction as a whole is very well articulated and free of boom. Lower and upper midrange are exceptionally clear and well defined, without the warmth (which often is a matter of midbass emphasis) of many other speakers. The Interface's ability to tackle high frequencies is truly remarkable, though occasionally we detected a slight edge—for example, on higher violin notes—that could be related to the third-harmonic maximum above 2 kHz.

In toto, the Electro-Voice Interface A Series III is a rare speaker. It combines the full-range response and accuracy of some floor-standing models with the convenience of the bookshelf format. Its ability to handle complex orchestral music with nuance and verve puts it in a class with very fine speakers. It should find many admirers.

Circle 131 on Page 115

In Search of Zing Without Zonk

RG PRO-20W Dynamic Processor program expander, in metal case with walnut ends. Dimensions: 17¼ by 3½ inches (front panel), 11 inches deep plus clearance for controls and connections. AC convenience outlet: one unswitched (400 watts). Price: \$395; also available with black front panel as PRO-20BW, \$410, and in black-panel rack-mount case as PRO-20B, \$395. Warranty: "limited," two years parts and labor. Manufacturer: RG Dynamics, Inc., 4448 W. Howard St., Skokie, Ill. 60076.

The RG name (derived from the initials of engineer/designer and, now, company president Robert Grodinsky) first surfaced in Pioneer's RG-1 signal processor ("Many Paths to Noise Reduction," March 1976), which we considered a fairly successful dynamic expander, though no less flawed than competing models. The PRO-20 represents a process of refinement in the intervening years. The two channels no longer are allowed the independent action that we disliked in the original model; the control circuitry (which senses dynamic activity in the music range and ignores, as much as possible, transient noise and so on at the frequency extremes) is subtler and

RG PRO-20W Dynamic Processor

OUTPUT AT CLIPPING (with IHF load)
3.6 V, essentially independent of control settings (6.9 V into high impedances)

HARMONIC DISTORTION (THD, at 1 kHz)

	at 2 volts	at 1 volt
4-dB setting	0.11%	0.057%
20-dB setting	0.10%	0.039%

FREQUENCY RESPONSE

4-dB setting	± 1 dB, 16 Hz to 20 kHz
20-dB setting	down ≤ 2½ dB at 20 kHz; down ≤ 1½ dB at 10 kHz

S/N RATIO (re 0.5 V, A-weighted)

	max. N/R	min. N/R
4-dB setting	89 dB	88 dB
20-dB setting	83½ dB	80 dB

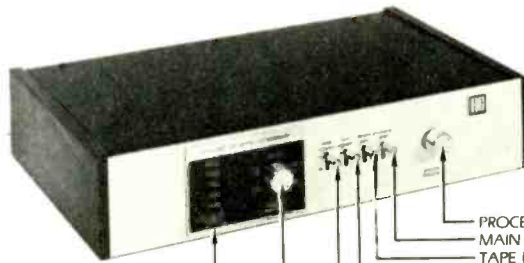

PROCESSOR ACTION DISPLAY
EXPANSION RANGE ADJUST.
PROCESSOR LEVEL ADJUST.
MAIN (PROCESSOR IN/OUT)
TAPE (PROCESSOR IN/OUT)
MONITOR (MAIN/TAPE)
NOISE REDUCTION (MIN/MAX)

more flexibly adjustable; used with a recorder, the PRO-20 will expand either the playback signal or that going to the tape (so you can record the the optimum effect and not have to adjust the expander each time you play the tape); expansion time constants have been honed to minimize either "soaked up" reverb or noise "tails."

Operation is fairly simple. You set up for the program source you want and turn on the processor for either MAIN or TAPE accordingly. You turn the expansion control all the way up to the 20-dB setting and look for a maximum-level passage in the program; when you find it, you adjust the LEVEL PRESET knob until the 20-dB LEDs just light. (Note that this adjusts expansion action relative to signal levels but not output vs. input as such. With the processor out of the circuit, you have essentially unity gain at any level setting.) Now you turn EXPANSION down to whatever setting you want and choose either max. or min. for the NOISE REDUCTION switch. Let's say you've chosen 10 dB of expansion. (The continuous control is calibrated every 4 dB up to 20 dB.) Low-level signals will remain at approximately unity gain. Higher levels will be boosted progressively, with the highest using up most of the selected expansion. A little of the 10-dB expansion will, however, be added at the bottom of the dynamic range, as downward expansion of the background noise—that is, noise reduction; the MAX. position simply extends this downward expansion a little beyond that of the MIN. position.

Now the complicated part begins—the listening. We could get no consensus among our music lovers except on two points: that the success or failure of the PRO-20 is utterly dependent on the tastes and program material of its user, and that when insensitively or carelessly adjusted (particularly in the direction of excessive expansion) it can produce effects that are a travesty of musical fidelity. These statements should startle nobody, since they can apply to almost any signal-processing equipment from tone controls to ambience simulators. Indeed, they constitute the starting point from which such devices should be investigated.

We can, however, offer some majority (and minority) opinions that should help you understand what you're likely to encounter in using the PRO-20. First the majority report. In terms of verisimilitude, this is the most satisfactory expander we've worked with. In classical music, and at moderate settings (no more than 8 dB of expansion), it adds impact and vividness without seeming to do so until you A/B processed and unprocessed signals. Used this way, it produces best results with top quality input signals; noise or distortion, if they are obvious already, are exaggerated by pumping of the expander. But in terms of such side effects, too, the unit is particularly satisfactory.

But in no way can it be considered a compression-undoer, so to speak. For that objective, the exact nature of the compression (and/or limiting) to which the signal had been subjected would have to be known and the "undoer" designed expressly for reciprocal behavior. Thus, as you move from signals of basically good dynamic range through the all-too-typically processed, "loud is better" radio sound to the mush of TV audio, verisimilitude becomes progressively more elusive, and the attempt to compensate for the compression by turning up the expander control entails progressively grosser exaggeration of musical phrase and nuance.

Most of the foregoing, again, presupposes classical music and the search for natural, live-sounding reproduction as such. But when you come to much of rock and, in particular, disco music, these considerations don't necessarily claim the highest priorities. At the extreme of this scale, for example, the impact of a disco beat certainly

Report Policy: Equipment reports are based on laboratory measurements and controlled listening tests. Unless otherwise noted, test data and measurements are obtained by CBS Technology Center, a division of Columbia Broadcasting System, Inc., and Diversified Science Laboratories. The choice of equipment to be tested rests with the editors of HIGH FIDELITY. Samples normally are supplied on loan from the manufacturer. Manufacturers are not permitted to read reports in advance of publication, and no report, or portion thereof, may be reproduced for any purpose or in any form without written permission of the publisher. All reports should be construed as applying to the specific samples tested; HIGH FIDELITY, CBS Technology Center, and Diversified Science Laboratories assume no responsibility for product performance or quality.

THE ONKYO TX-MKII RECEIVERS... COMMITTED TO QUALITY



Most manufacturers play "take away" when they design a product line. With every cost reduction, there's a quality loss. Onkyo takes a different approach. Each of the five models in the TX-MKII series of receivers represents an exceptional value for price. And vital performance features such as Onkyo's exclusive distortion-free, quartz or servo-locked FM tuning are built into each of the receivers, as is the sophisticated HTS™ (Human Touch Sensor) control. HTS™ senses your touch on the tuning knob and "unlocks" the station. You rough tune to another station, release the knob, and the HTS™ analog comparator circuits automatically find and precisely lock into the most distortion-free station setting.

And aside from the excellent signal-to-noise ratios at all inputs, the Onkyo TX-MKII series provides excellent value-to-

dollar ratios at all power levels, starting with the top-of-the-line digital-readout TX-8500MKII rated at 160 watts per channel, with 0.05% total harmonic distortion, both channels driven into 8 ohms from 20 Hz to 20 kHz, to the modest TX-1500MKII at 17 watts per channel and 0.03% THD under the same conditions.

Don't step down in quality. Step up to Onkyo.

Artistry in Sound

ONKYO

Eastern Office: 42-07 20th Avenue, Long Island City, NY 11105 (212) 728-4639
Midwest Office: 935 Sivert Drive, Wood Dale, IL 60191 (312) 595-2970
West Coast Distribution Center: Damaris Industries, Inc.,
20600 Nordcroft Street, Chatsworth, CA 91311 (213) 598-6501
Canada: Sole Distributor, Tri-Tel Associates, Ltd., Ontario, Canada

You expect to be really impressed by a new cartridge. Otherwise you wouldn't even consider it. What you don't expect is to get the same impressive performance thousands of plays later. But consider this: after 1000 playing hours the new ADC Improved Series cartridges show no audible change in performance! Amazing? You're right. But what's even more

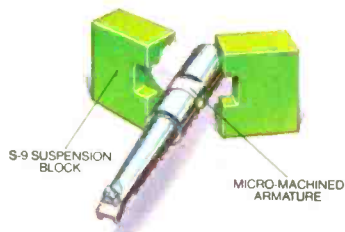

amazing is the new Omni-Pivot System™ that did it. It's a major advance in

micro technology. There are no unpredictable armature governors, wires or adhesives. Instead each armature is micro-machined to perfectly lock into our exclusive new S-9 high definition suspension block. We think it's a real breakthrough. But you should be the judge.

Look at both the frequency response and stereo separation of a new ADC ZLM Improved cartridge. They're incredible. The new ADC ZLM accurately reproduces even the most complex musical passages with absolute neutrality.

Now compare the same cartridge after 1000 playing hours. See any difference? The ADC ZLM Improved cartridge shows less than a 1dB change in performance. That means you won't hear any difference.

Now the good news gets even better. The Omni-Pivot

System™ comes in a wide range of new ADC Improved Series cartridges. The ZLM, XLM MKIII and MKII, and QLM-36 MKIII. All featuring new snap-down stylus protectors.



If you already own a fine ADC cartridge, the Omni-Pivot System™ is yours for just the price of a replacement stylus.

Listen to any new ADC Improved cartridge. After you've heard us, we'd like to hear from you. Write Audio Dynamics Corporation, Pickett District Rd., New Milford, Ct., 06776, or call our toll-free number (800) 243-9544.

BEFORE YOU BUY A NEW CARTRIDGE TAKE A LOOK AT A GOOD USED ONE.

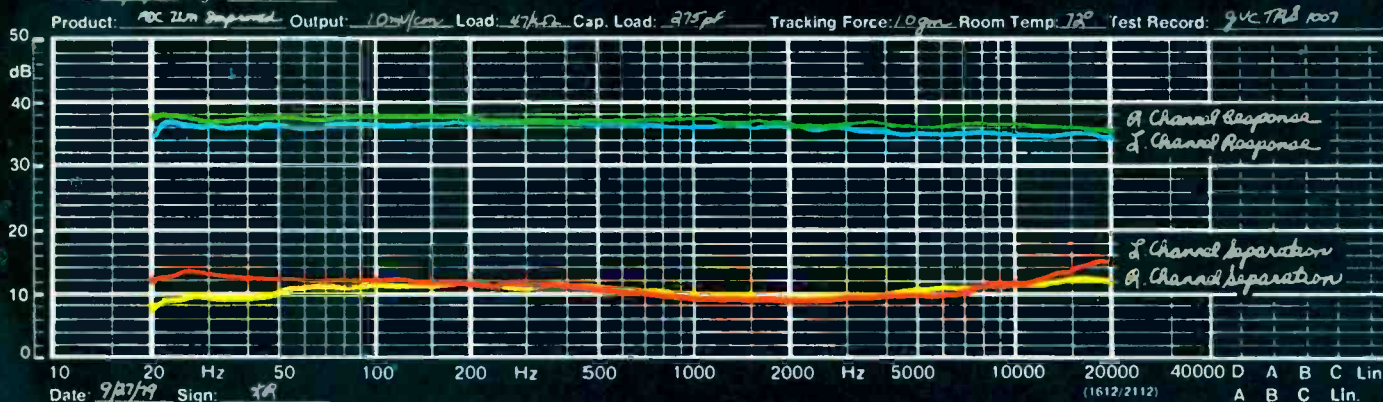
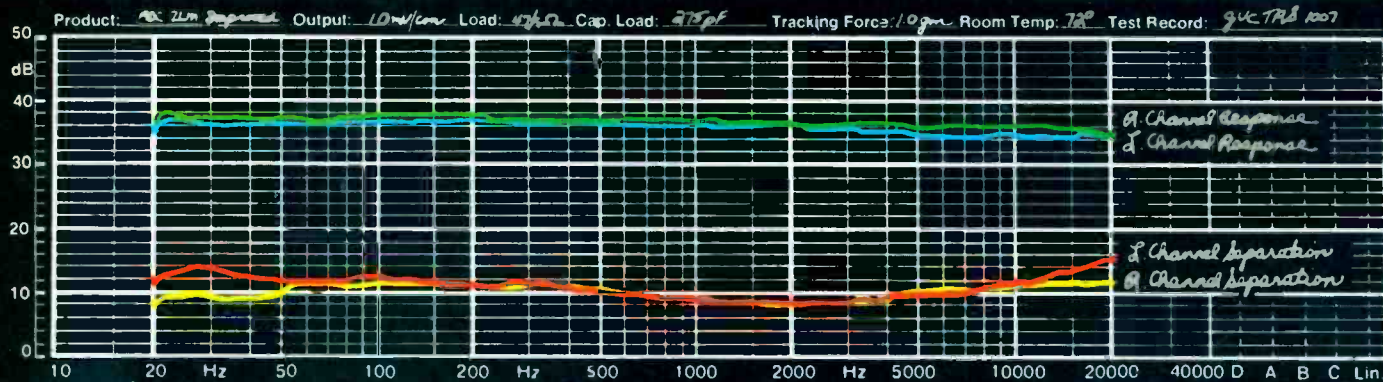

A BSR COMPANY

can be enhanced by expansion. On the other hand, music like that of a jazz combo or most pop vocals, in which the shape of the melodic phrase is important, requires more laid-back application of the expander.

One of our listeners seemed to mistrust the device and basically would prefer to forgo its use rather than suffer any exaggeration or other side effect, however small or rare. Another (the only apartment-dweller in the group) was enthusiastic about expansion as a way of resuscitating music that must be played at relatively low levels and consequently drones on without impact. While expansion under these circumstances all but obliterates the quietest passages, the increased dynamic contrast seems to draw back the listener's interest, which otherwise wanders because there are no real climaxes to rivet it on the music.

In sum, then, we find this possibly the best expander on the market, but—like all such products—one to which listeners will relate in very individual ways, leading to wide diversity in bottom-line value judgments about its usefulness. As the DSL bench-test data show, it is well engineered in basic respects such as response and distortion; the important considerations are all subjective. Among them, the device requires an activist approach to listening if the effect is to be successful. If you are considering adding an expander, it is imperative that you do your own careful listening before making your final decision.

Circle 134 on Page 115

An Inexpensive Receiver for The Urbanite

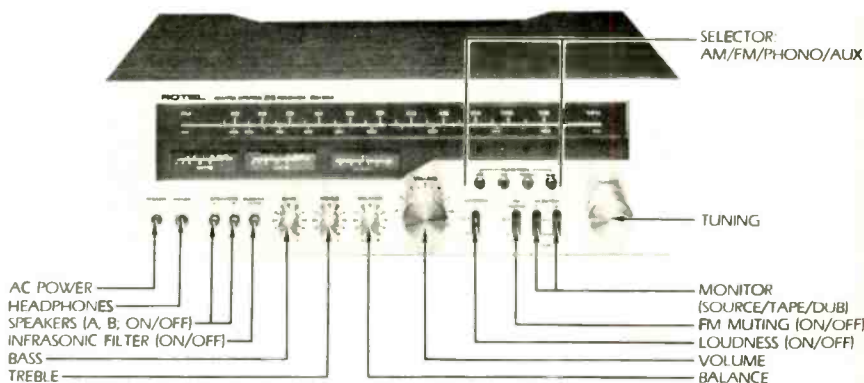

Rotel RX-504 tuner section

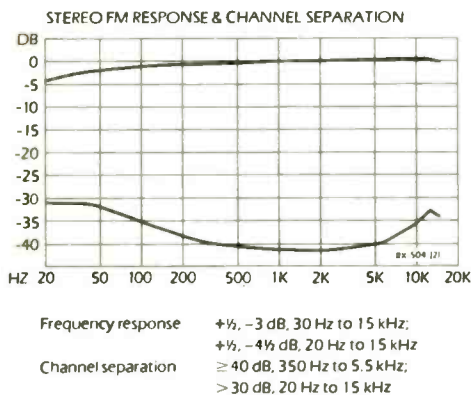
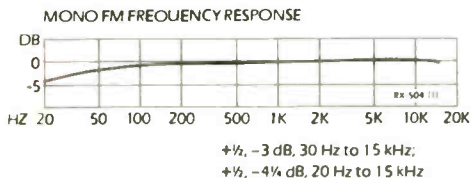

Rotel Model RX-504 stereo FM/AM receiver, in wood case with walnut-grain finish. Dimensions: 17 by 5 1/4 inches (front panel), 12 inches deep plus clearance for controls and connections. AC convenience outlet: 1 switched (200 watts max.). Price: \$350. Warranty: "limited," two years parts and labor. Manufacturer: made in Taiwan for Rotel of America, Inc., 1055 Saw Mill River Rd., Ardsley, N.Y. 10502.

In the past, Rotel has carved its own niche in the audio marketplace: Its products perform well and provide thoughtful features at very competitive price points. Keeping the price down, however, almost always entails some compromise in audio design, and it is to Rotel's credit that it has chosen logical avenues for compromise in the RX-504—a receiver that seems intended specifically for the large class of stereophiles who dwell in urban or suburban areas and are sensitive to the pinch of inflation.

Our first examination of the unit as we unpacked it had us searching the faceplate for a stereo/mono MODE button, but none exists. And this receiver obviously is not intended for rural locations; you cannot switch to mono to save the listenability of weak stereo FM stations. The data, from Diversified Science Laboratories, show the FM section capable of excellent performance, given decent signal strength. FM frequency response and channel separation are quite respectable. The muting threshold, at 12 1/2 dBf, allows stereo reproduction at a signal-to-noise ratio of 19 dB—unlistenable, to our taste, but in urban or suburban areas, with signal levels of at least 38 dBf, stereo sensitivity for 50 dB of quieting is adequate. (A stereo/mono selector would have allowed an extra 26 dB of S/N by sacrificing the stereo, and an in-between

FM SENSITIVITY & QUIETING

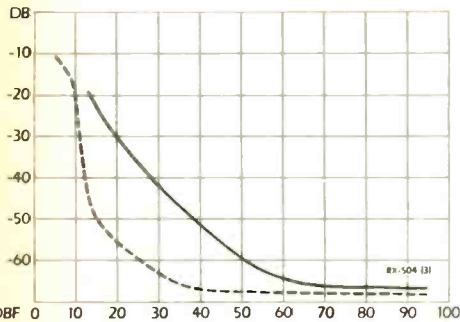

—	stereo noise (quieting)
- - -	mono noise (quieting)
Stereo sensitivity (for 50-dB noise suppression)	
	38 dBf at 98 MHz, with 0.41% THD+N
	(38 dBf at 90 MHz; 38½ dBf at 106 MHz)
Mono sensitivity (for 50-dB noise suppression)	
	15 dBf at 98 MHz
Muting threshold	12½ dBf
Stereo threshold	11½ dBf
Stereo S/N ratio (at 65 dBf)	65½ dB
Mono S/N ratio (at 65 dBf)	68 dB

CAPTURE RATIO	1½ dB
ALTERNATE-CHANNEL SELECTIVITY	60½ dB
HARMONIC DISTORTION (THD+N)	
	stereo mono
at 100 Hz	0.32% 0.42%
at 1 kHz	0.11% 0.22%
at 6 kHz	0.27% 0.18%
STEREO PILOT INTERMODULATION	0.055%
IM DISTORTION (mono)	0.24%
AM SUPPRESSION	51½ dB
PILOT (19 kHz) SUPPRESSION	71½ dB
SUBCARRIER (38 kHz) SUPPRESSION	>84 dB

Rotel RX-504 amplifier section

RATED POWER	16 dBW (40 watts)/ch.
OUTPUT AT CLIPPING (both channels driven)	
8-ohm load	17 dBW (50 watts)/ch.
4-ohm load	18½ dBW (71 watts)/ch.
16-ohm load	15 dBW (31 watts)/ch.
DYNAMIC HEADROOM	+1½ dB
HARMONIC DISTORTION (THD; 20 Hz to 20 kHz)	
at 16 dBW (40 watts)	≤0.043%
at 0 dBW (1 watt)	≤0.027%
FREQUENCY RESPONSE (at 0 dBW)	
	+0, -1 dB, 50 Hz to 39 kHz;
	+0, -3 dB, 5 Hz to 74 kHz
RIAA EQUALIZATION	
	+½, -1¼ dB, 20 Hz to 20 kHz;
	-4 dB at 5 Hz
INPUT CHARACTERISTICS (re 0 dBW; A-weighting)	
	sensitivity S/N ratio
phono	0.38 mV 74½ dB
aux	22 mV 76¼ dB
PHONO OVERLOAD (1-kHz clipping)	190 mV

blend mode, at least, would have helped. The excellent capture ratio likewise suggests an FM section that will perform well in multipath-ridden urban locales.

The amplifier section provides 1 dB of clipping headroom and 1½ dB of dynamic headroom over the rated 16 dBW (40 watts) per channel, which is plenty of power for reasonably efficient speakers and moderately loud listening levels. Frequency response is flat over most of the audio band, though with a slight low-frequency droop (1 dB at 30 Hz). Rated power is delivered with a total harmonic distortion of less than 0.043%; at frequencies up to 10 kHz, the THD remains below the rated 0.03%. The low-frequency damping factor is adequate for good speaker control. Phono equalization, though it produces listenable results, shows slight emphasis in the upper midrange and a gradual rolloff in the bass.

The two tiny output meters react quite slowly and inaccurately—for a 160-millisecond pulse, they register a 10-dB error—but then, we don't put much stock in receiver power meters. The tone controls accomplish their task well enough, but the slight falloff in bass response exhibited by the amp, preamp, and tuner sections might be laid to poor isolation of the bass control, which cannot be bypassed. The LOUDNESS contouring imparts a whopping boost to the bass frequencies at low listening levels; with the volume control set at the 9-o'clock position, depressing the LOUDNESS button results in a 16-dB rise in the extreme low end. When listening through efficient loudspeakers, such a dramatic emphasis of bass response can be jarring—unless you're a disco fan—though the effect diminishes, of course, as the volume is turned up. You can use two decks with the RX-504 and dub in one direction but cannot listen to a source other than tape during the dubbing procedure.

This receiver accomplishes much without costing much. Its amplifier and phono sections are in line with those of many other receivers, and its FM performance is also quite adequate, providing you don't take it with you on a country vacation. For apartment dwellers who want a respectable receiver for most musical purposes, or as a step up from a compact system, we heartily recommend the RX-504.

Circle 136 on Page 115

PHONO IMPEDANCE	51k ohms; 170 pF
DAMPING FACTOR (at 50 Hz)	48
INFRASONIC FILTER	-3 dB at 17 Hz; 12 dB/octave

Manufacturers' Comment

We invite rebuttal from those who produce the equipment we review. The comments printed here are culled from those responses.

Celestion Ditton 662 loud-speaker, September 1979. We have checked the initial production run to locate any other speakers whose midrange drivers suffered from the defect noted in two of HIGH FIDELITY's test samples. Only seven were found, and all have had the component replaced. In addition, the injection-molding procedure used in making the plastic part concerned has since been modified to eliminate the problem.

Robert Shapiro
Vice president, marketing
Celestion Industries, Inc.

AKAI'S EXCLUSIVE SUPER GX HEADS.

**Improves specs for all types of tape—
including metal.**

In 1969, AKAI introduced one of the most important technological advances in tape recording history—the exclusive Glass and Crystal Ferrite GX Head. The head guaranteed* for over 150,000 hours—the equivalent of over 17 years of continuous, superb play.

But now AKAI makes a great thing even better with two new Super GX Heads. The revolutionary heads designed to improve frequency response by 2,000 Hz, improve S/N ratio 4-6 dB, improve the dynamic range on all tapes and deliver optimum performance with metal tape.

The Super GX Twin Field Head gives you the record/play performance of a three-head deck at two-head prices. With two gaps mounted in a single configuration—an optimum wide gap for recording and an optimum narrow gap for playback—AKAI has eliminated the need for a compromise gap found in traditional record/playback heads.

More impressive is the new Super GX Combo Head, which is actually a separate record and playback head mounted in a single housing. Combined with an erase head, this configuration gives you a three-head deck, with all the same advantages as the Super GX Twin Field Head, plus tape monitoring capabilities.

Both new Super GX Heads offer AKAI's 150,000 hour guarantee, and the kind of state-of-the-art specs you've come to expect from AKAI.

AKAI Super GX Heads. Making a great thing even better.

For more information, write: AKAI, P.O. Box 6010, Compton, CA 90224; in Canada: AKAI AUDIO VIDEO CANADA, Vancouver B.C., Canada.

*limited warranty

AKAI

You never heard it so good.

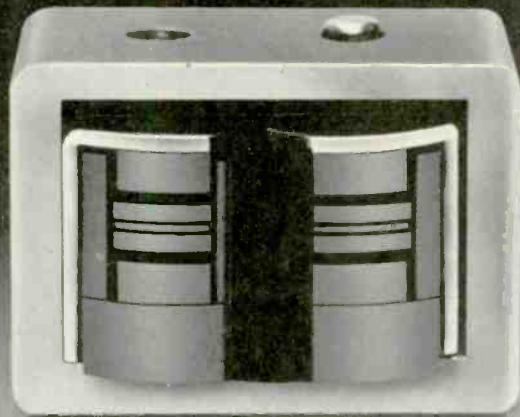

**SUPER
GX**

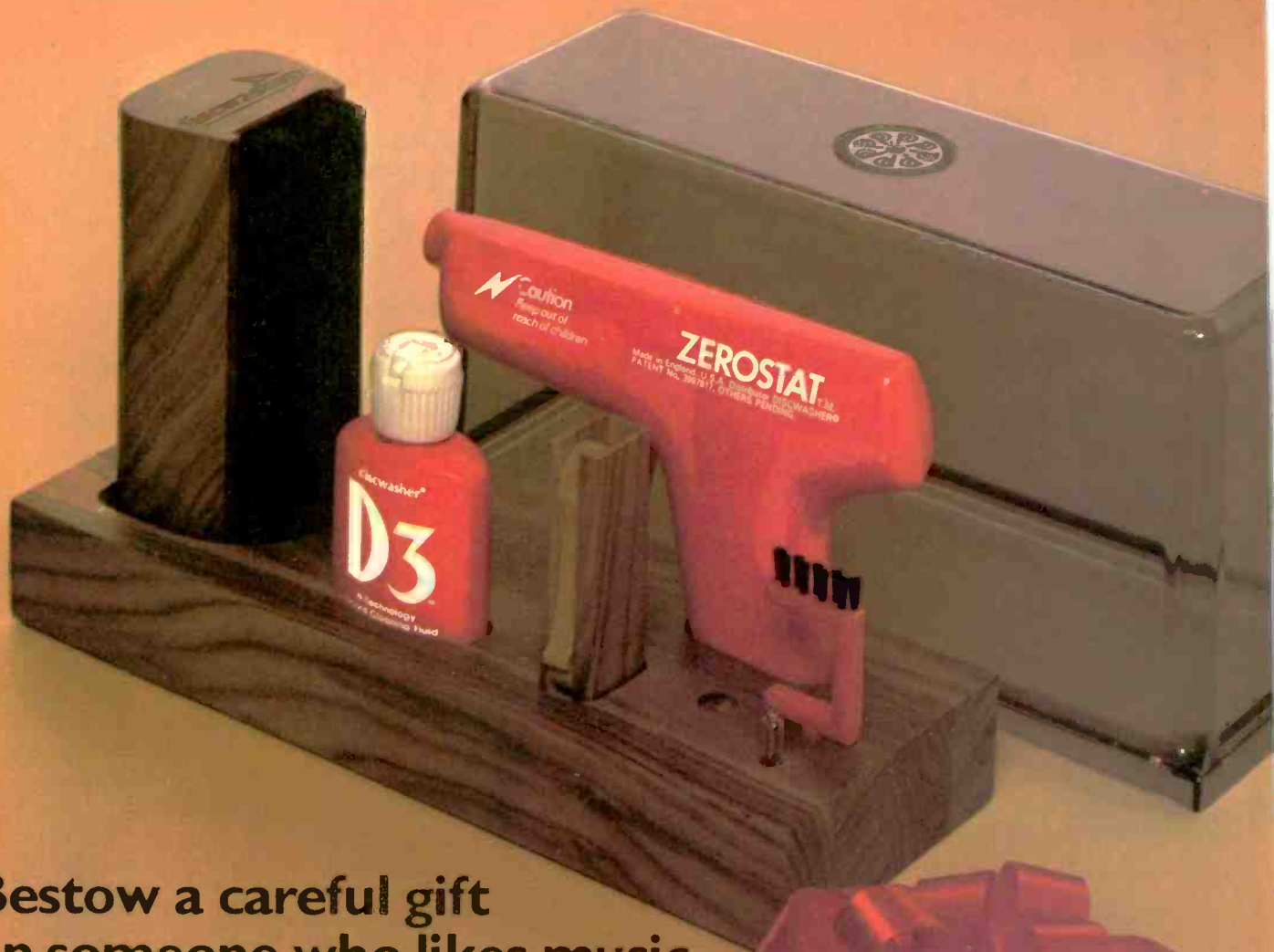

Bestow a careful gift
on someone who likes music.

Record Ecology starts with the DiscKit.™

Record Ecology—total record care—is essential for the quality and longevity of phonograph records. Discwasher products protect valuable record collections worldwide, and these same products are packaged together as the DiscKit.

DiscKit combines, in an elegant package, four of the renowned Discwasher record care products that provide Record Ecology:

- the Discwasher D3 Record Cleaning System
 - the SC-1 Precision Stylus Cleaner for quality phonograph needles
 - the Zerostat Anti-Static Instrument with test bulb
 - the Discorganizer walnut tray and cover for dust-free storage
- (All available separately)

There are no substitutes for Discwasher products. Ask for DiscKit at quality record and audio dealers. When music counts, Discwasher cares.



discwasher®
PRODUCTS TO CARE FOR YOUR MUSIC

1407 N. Providence Rd. Columbia, Missouri 65201

Letters



Born-Again SQ?

Noted in the article "High Fidelity at the Crossroads?" [September] was the re-introduction of the SQ matrix by Fosgate and Audionics of Oregon, both companies using the Tate decoder. Notably lacking was the negative connotation that lately has become attached to the word "quadriphronics."

I've been living with an Audionics Space and Image Composer for a short time, and so far I'm most impressed with its handling of SQ material. Discs and tapes so encoded truly sound better than they ever have before. Where I've been able to compare the discrete tape with the SQ encoding of several Columbia albums, the fact that the results were so amazingly close says a lot for the Tate people and Audionics' care to see that all was right with the Composer before making it available.

Now all we need to do is get the record companies to stop sitting on their encoders and begin producing more SQ recordings. With the Tate system, and the inevitability of lower-cost decoders using this fine enhancement system, the idea may finally catch on the way it should have in the first place. I'm still a firm believer in quad's potential. I hope the advent of the Tate SQ decoder hasn't been in vain.

Jay L. Rudko
Great Falls, Mont.

Quo Vadis?

Your September issue has left me once again with the vague feeling that something is conceptually amiss in the recording industry. Suppose we could actually believe that the industry was constantly striving toward some great day when everything ever written would be available on record. Wouldn't that be exciting? There's a whole world of music out there that seems to be markedly subsidiary in interest to the technology merely designed to reproduce it. It is an exaggeration, but not a radical one, that the works in the standard repertory are run through until they start piling on top of each other, and then the industry achieves a new technological breakthrough so it can start the whole cycle over again. I find myself asking again and again, "Is this trip really necessary?"

Bruce E. Wallis
Victoria, B.C.

Back to Bach

For some nine years I have been enjoying the Op. 3 Sinfonias by J. C. Bach that Paul Henry Lang recently reviewed [September]. I acquired this record as part of an album titled "An Evening with the Academy of St. Martin-in-the-Fields" issued by the International Festival of Great Orchestras. Since this work can hardly be regarded as a repertory "workhorse," it seems unlikely that Marriner would have made a second recording of it in nine years. I wonder why the decision to release now a recording relegated to obscurity originally?

J. G. Klemm Harvey
Muskegon, Mich.

Paul Henry Lang replies: Christian Bach's symphonies have been rescued from oblivion because our rapidly increasing musical literacy is catching up with such fine composers. And since there was a good recording in the freezer, Philips thawed it and reissued it as if it were brand-new.

Star-Rank Orchestras

I must take strong exception to Karen Monson's penultimate paragraph in her review of the Isaac Stern releases of the Penderecki and Rochberg violin concertos [September] in which she states patronizingly that Columbia producer Andrew Kazdin "has made what are essentially less-than-first-rate instrumental ensembles sound fully competent and colorful." For her information, both the Pittsburgh and Minnesota orchestras have been making "fully competent and colorful" discs for quite some time now without undue assistance from the recording wizards—Columbia's or anyone else. Let Ms. Monson examine certain reviews in *The New York Times*, whose music critics have described recent performances by both groups as "first-rate" and "world class."

With the accession of such new musical leadership on the U.S. scene as Marriner in Minnesota, Giulini in Los Angeles, and Previn in Pittsburgh, the symphonic balance of power—according to knowledgeable observers—is expected to change shortly. The so-called Big Five will probably become the Big Eight as more join the "star" ranks of the orchestras of Boston, New York, Philadelphia, Cleveland, and

Interface: C

Series II It sounds like music.

Interface: C Series II is the fulfillment of our six-year association with optimally vented speakers based on the theories of A. N. Thiele—speaker designs first introduced by Electro-Voice in 1973. The Interface: C offers you a unique combination of high efficiency and high power capacity—the only way to accurately reproduce the 120+ dB peak sound pressure levels found in some types of live music.

The SuperDome™ tweeter, an E-V exclusive, and the VMR™ vented midrange driver, the first to apply optimally vented design to mid frequencies, ensure your music is reproduced without the coloration normally found in other high-efficiency drivers. An honest 30 Hz low end totally eliminates the need for expensive subwoofer assemblies.

When you spend \$1,000 for a speaker system, get your money's worth. Audition the Interface: C Series II at your nearest Interface dealer. If you want a speaker that sounds like music, the Interface: C Series II is the one you'll buy.



Electro-Voice
a gulton company

600 Cecil Street, Buchanan, Michigan 49107



Circle 17 on Page 115

Face Reality.

Introducing The DM Factor. Dual Monaural construction. Exclusively Mitsubishi.

It means inside our stereo preamplifier are two perfectly matched mono preamplifiers.

Just like our dual monaural power amplifiers.

Just like your ears.

It means Mitsubishi has achieved more than stereo. But inter-channel separation at more than 80dB at 20kHz. For separation 30dB more than conventional designs.

For THD at less than 0.002% from 20Hz to 20kHz. For effective elimination of leaks, crosstalk, any influence able to distort the stereo image. In both the depth and breadth of the image.

Our new preamplifier was also developed to effectively

handle the moving coil cartridge. For a signal-to-noise ratio of -77dB. Unheard of in any other preamplifier.

Introducing our new frequency synthesizing tuner. With new capabilities, new features, new design.

With THD in stereo at barely 0.08% at 1kHz. Conservative, at that. With switched selectivity for uncompromising reception. With digital read-out. With LED's to determine signal strength and precise tuning. With an uncanny ability to zero in on the quietest signal.

And along with unique electronic engineering, Mitsubishi offers unique mechanical engineering.

Like The Docking System.

It means preamplifier can be linked with amplifier neatly and compactly. Without a myriad of crossed wires.

But no matter what we tell you, the truth is, nothing will

tell you more about our audio equipment than your own audio equipment.

So, use your ears, and by all means compare.

Compare the difference The DM Factor makes. Compare the convenience The Docking System makes. Compare the capabilities of our new tuner.

And you'll know why Mitsubishi made them part of The System.

The only high performance audio system with one name, one look, one warranty, one standard: what comes out must be as real as what went in.

Because reality is what it's all about.

 **MITSUBISHI**
AUDIO SYSTEMS

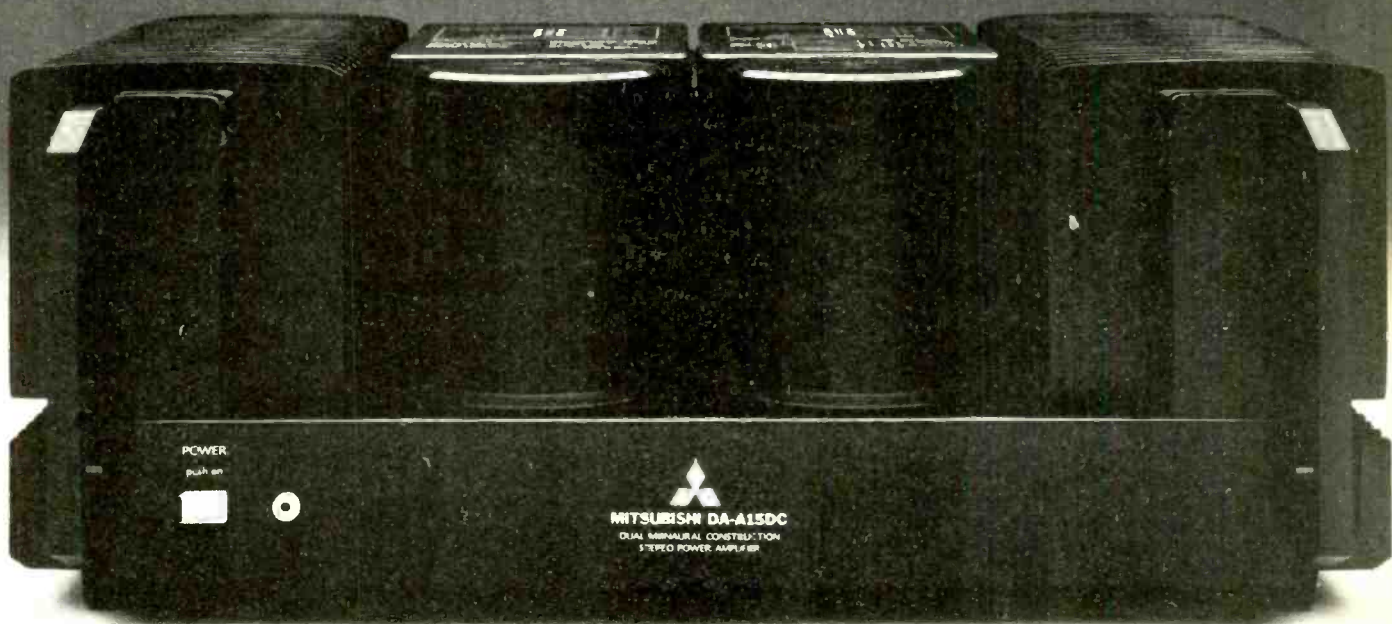
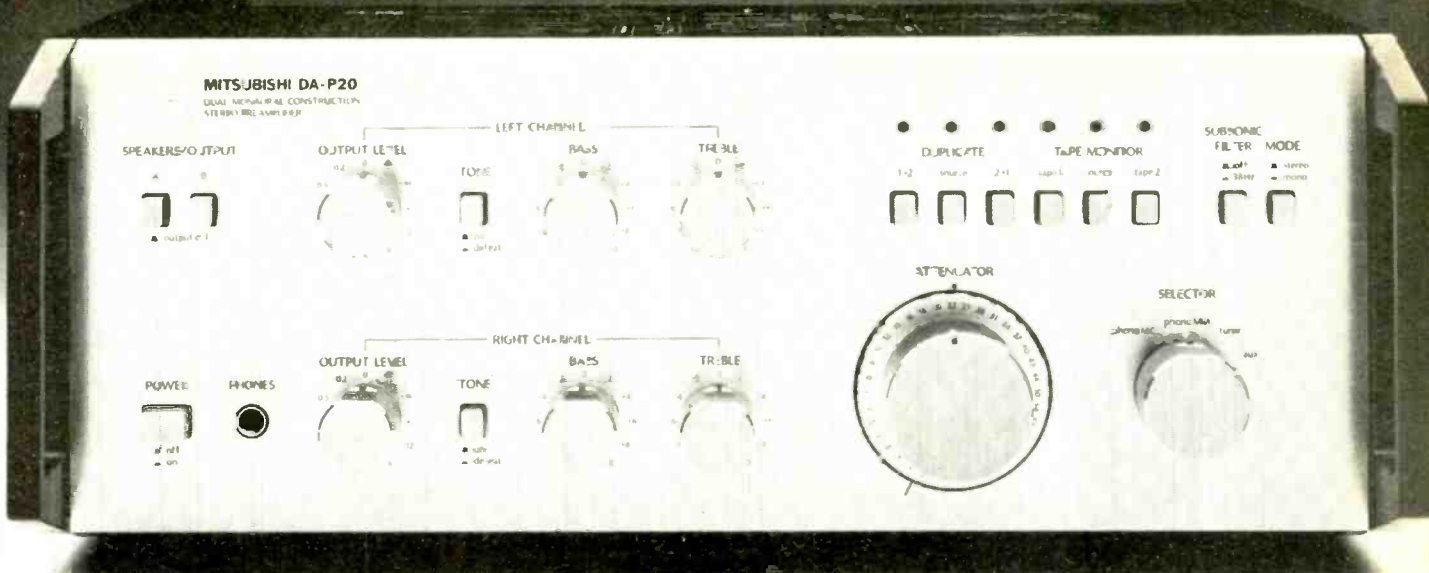

Empire's revolutionary cleaning method peels off every trace of dirt, dust and oil from deep down in your record's grooves.



Write for your free brochure on all fine record care products by Audio Groome. Empire Scientific Corp., Dept AG, Garden City, NY 11530

EMPIRE EMPIRE Audio Groome by EMPIRE

AN APPEAL TO READERS

From time to time we are asked for advice about how to integrate audio equipment into a home (or other) setting, and it strikes us that there is no better source anywhere for such advice than HIGH FIDELITY's readers themselves. So we are soliciting photographs—color or black and white—of your audio installation, together with a detailed description and some information as to why you believe it a particularly successful union of equipment, room, and decor, how solutions to the problems you encountered in assembling, interfacing, and generally meeting your particular needs can be of help to others, or whatever. If the results warrant, HF plans to publish the most interesting responses in our pages or in some other form. We will return your photographs when we finish with them, if you so specify. And don't feel limited to the parlor: We will consider installations in cars, vans, boats, ski lodges, and woodsheds—and basement or garage recording-studio setups particularly—if they are marked by sufficient imagination. Send your material to the Editorial Director, HF, Great Barrington, Mass. 01230.

Chicago—not "less than first-rate," but assembles on the verge of greatness.

Bert F. Cunningham
Minneapolis, Minn.

Available Bartók Recordings

In reviewing a recent London issue of Bartók's Suite for Orchestra, No. 1, and *Two Images*, Op. 10 [September], Abram Chipman refers to a Hungaroton recording (SLPX 1203/4) of the Suite as being part of a two-disc set. This set was discontinued some years ago, though the performances are available separately as part of Hungaroton's Complete Bartók Edition. The Suite (SLPX 11480) is conducted by János Ferencsik, and *Kossuth* (SLPX 11517) by György Lehel. *Images* is on SLPX 1302.

I am a bit puzzled by Mr. Chipman's statement that London's is "again the only readily available recording." Hungaroton records are distributed nationwide under the auspices of Qualiton, Ltd.; as witness, *Billboard* recently asserted that "three of the largest companies that import classical recordings are London, Polygram, and Qualiton."

George Volckening
Qualiton Records, Ltd.
Long Island City, N.Y.

Abram Chipman replies: I apologize for failing to check beyond my own record shelf for the number of this Hungaroton recording. I gave the set number, because its package of "The Young Bartók" is an appealing collection of rarities. I knew of the alternate issuance as singles but hadn't realized the two-disc album was deleted. The wide distribution of Eastern European imports in this country does not extend to all major record outlets in all major metropolitan areas (e.g., the Harvard Coop, largest classical stock in my own area of Boston). London recordings are more "readily available" by most yardsticks people use. I don't like that situation, nor do I downplay the service done by Qualiton Records, but that is the way things are for now.

Szell Discography

The admirers of George Szell that David Hamilton refers to in "Conductors' Discographies" [September] may be interested to know that the Beecham Society edition of the Szell discography by Rabbi Howard J. Hirsch and Jack Saul will soon receive its third printing; we hope it will be done in time for the tenth anniversary of the conductor's death in 1980. It includes recordings Szell made with the Berlin State Opera and Berlin Radio Symphony Orchestras; the Berlin, Czech, London, New York, and Vienna Philharmonic Orchestras; the London Symphony Orchestra; and the Concertgebouw of Amsterdam plus accompaniments for such singers as Carl Martin Oehmann, Richard Tauber, and Michael Bohnen in the 78-rpm era. The discography as originally printed will be supplemented by a list of reissues, private recordings, and a few recently discovered 78-rpm discs, the latter including LP transfers of them.

Thomas E. Patronite
Editor, *Le Grand Baton*
Cleveland, Ohio

HIGH FIDELITY welcomes correspondence from its readers that falls within the scope of our coverage—music, recordings, audio componentry, and aspects of the general cultural milieu that relate to these. Letters may be edited in order to sharpen their sense and style and to pare their length, and we suggest therefore that correspondents confine themselves to 400 words. Please keep 'em comin' to the Editor, High Fidelity Magazine, The Publishing House, Great Barrington, Mass. 01230.

In recent years over 500,000 music lovers chose a Realistic[®] receiver over Kenwood[®], Pioneer[®] and Technics[®] ...



Why?

We make it easy for you. Radio Shack is a retailer as well as a manufacturer. When the store is also the factory, you're apt to get less fiction and more fact. Also, Radio Shack has more company-owned and operated service stations than almost anyone we know of in the audio business (54 to be specific).

We've stood the test of time. Could it be we sell so much Realistic because we've been around since 1921 — long before those other brands were even a twinkle in daddy's eye? Although hi-fi is typically a younger person's product, maybe the kids prefer to bet their hard-earned bucks on the outfit with the grayest hair.

We have the edge on technology. Then there's this to consider: The same company that puts Realistic out front also builds and markets the world's most popular personal computer, the TRS-80[®]. It seems to us that a company smart enough to design

equipment as innovative and complex as a computer is a logical one to choose to build your stereo receiver!

We're close to you. Need another good reason to buy Realistic? Let's take availability. Instead of tens or hundreds of places to find it, we offer over 7,300 — wherever you go in the USA or Canada — and a surprising number of overseas locations as well. Being more available doesn't necessarily make us more lovable. But it goes a long way towards assuring you of being able to get in touch with us when you need advice on adding a tape deck or replacing a lost instruction manual.

We've challenged the rest and won your trust. Incidentally, we're not picking on Kenwood, Pioneer and Technics. The same half-million-plus folks who chose Realistic also probably had a crack at buying Sansui,[®] Marantz[®] and Fisher.[®] The important thing is ... they didn't!

Radio Shack[®]

The Nationwide Supermarket of Sound[®]

A DIVISION OF TANDY CORPORATION
FORT WORTH, TEXAS 76102

A Personal Approach to Choosing Components

Six Experts at Work Within Three Budgets

Selecting a component high fidelity system while sticking to a predetermined budget is no easy task, as each of our six experts can attest. But it's the very problem that all prospective audio buyers face. The purpose of this article is to help readers explore the reasoning that goes into the selection process; it is this process rather than the results that we believe to be of importance. It's of no real value to a reader to know what model a particular expert likes if they do not share the same high fidelity objectives and priorities.

We assigned two writers of diverse interests, backgrounds, and lifestyles to address each of three price points. You will note that, of necessity, they were allowed some flexibility within their budgets. Costs vary greatly from place to place, and the Federal Trade Commission has virtually banned "list prices," making the figures less than precise. But, again, we are little concerned with the specific brands and models chosen. It is the way in which an individual makes his choices according to personal needs and tastes that is instructive. This is how six experts in the field approach the exercise, and we think you'll be intrigued by the diversity of their procedures.

Alfred Myers Chooses a \$1,000 System

Sound reproduction is a highly personal matter; a system that sounds fantastic to one listener may seem barely adequate to another. Likewise, different people have their own opinions about how far they should go with an audio rig. Many purchasers want the act of buying a "stereo set" to be a onetime affair or, at worst, a chore that they will not have to go through again for many years. I'm just the opposite. If I had the chance (and the money), I'd like to try out just about every component that is introduced each year. And there are many other enthusiasts who live with an inescapable gut feeling that some new piece of gear simply must be purchased each year to keep the system "totally up to date"—a laughable and impossible goal. Bearing all of this in mind, I look upon the \$1,000 budget as a starting point: a way to lay the foundation with the barest of essentials.

I'm not including either a tuner or tape deck in this system, because I prefer quality to quantity. It would be possible

to get a receiver, turntable, speakers, and tape deck for about a grand, but you would wind up with budget models. These will prove unsatisfactory both sonically and economically, since they tend to have little or no trade-in value. Mine is a building-block approach—separate components all—and the tape and tuner can be added later. With the poor FM reception in my area, I'd use a tuner just for background music, anyway.

But I require a preamplifier. And, having looked at the variety of very expensive preamps, I have come down to earth and settled on the Hafler DH-101 in kit form (\$200). It's not all that complex or difficult to build (assuming that one understands the basics of kit building), and its sonic qualities will be more than adequate. If you are afraid of even attempting a kit, it is available factory-wired for \$300. Remember that, by using a separate preamp, you can always buy a better one later on without having to buy a new power amp (and tuner, too, if your first inclination is a receiver).

Now I need a power amp. Operating within the budget, yet still wanting good sound, I've decided on the Crown D-75. It's not a super-power amp, capable of driving two pairs of very low-efficiency speakers—it delivers only 35 clean watts per channel—but it can be strapped into a 90-watt mono amp so that, when more money is available, you could just buy another D-75 and use them as a stereo pair. This amp, which sells for about \$350, is built like all of Crown's products: rugged. The alternative—so new that it has not yet shown up in stores—is the Carver magnetic amplifier, which delivers 400 watts per chan-



Alfred Myers, an ardent music lover and audiophile, has written about four-channel sound in HIGH FIDELITY.

nel and is supposed to sell for about \$400. It is worth considering. However, I've used other Crown components and have always been satisfied, so I'll stick with the D-75.

One thing I hate about most bookshelf speakers is that the sound, no matter how accurate, always seems to be coming from a box. I want speakers that are specifically designed to sound a lot larger than they really are—that spread the sound around. My apologies to those readers who swear that the only speakers worth listening to are time-aligned models that cost an arm and a leg. Anyway, for this system I've picked the Bose Model 501s. Granted, they don't sound as impressive as their bigger brothers or as good as dozens of other models on the market, but they don't cost as much, either. A pair will put a \$420 dent in the budget.

You may have noticed that I still have no signal source and have already spent about \$950 at suggested retail prices. Well, who actually pays full price these days? A check with a few local dealers (and of mail-order advertisements) shows that discounts of 25% or 30% are not at all uncommon. Also, if you can get all the components you want from one dealer, you can wangle a sizable discount.

Now for a pickup. I'm choosing the relatively new Shure V-15 Type IV because it sounds good, has the static-elimination feature, and has received excellent reviews. I was favorably impressed when I heard it. I might have preferred a deluxe moving-coil job with a good head amp, but I see no way to include the ultimate in phono cartridges in

this system without going way over budget. The Shure will do just fine at \$150.

Finally, I'll need a turntable, and I'm selecting the BSR Quanta 600 (\$135). This is a belt-drive semiautomatic model made with a special antiresonance, foamed concrete base. While I admit that direct-drive models are nice, a good belt-drive turntable will perform equally well and with no audible difference.

Yes, I have gone about \$250 over budget. But by haggling at buying time, I should be able to get enough of a discount to bring the total system price within the specified range.

Michael Riggs Chooses a \$1,000 System

It's not hard to come up with a very respectable "kilobuck" system, provided you don't ask it to do too much. Though many of us already are dreaming of the death by digitization of the analog LP, it will probably remain the primary music reproduction medium for a few more years. Considering that, I certainly would choose a system that plays records.

Because it's an important and relatively inexpensive part of a disc-playing ensemble, I like to start with the cartridge. We have enough money to buy the best: Let's go with the Shure V-15

Type IV. There are pickups that cost more than the \$150 Shure, but none that beats its combination of superb tracking, flat frequency response, low distortion, and warp-malfunction resistance. It may not have the mystique of the moving coils, but it's an honest reproducer and a fine performer, which is more than can be said for some of the highly touted exotica.

We have \$850 left. I'd love to include tape and an ambience recovery device—a Sound Concepts delay unit, perhaps, or one of the new products from Carver or Audionics—but that would slaughter the budget. The rest of our cash will have to go for a turntable and arm, electronics, and a pair of speakers. Few turntables or tonearms are as good as they should be, and the ones that are tend to be expensive. Why that's true is unclear, but it is. So we'll leave those choices until the end, pacified somewhat by the thought that our cartridge is less arm-sensitive than most, and turn to the question of loudspeakers.

I am budgeting around \$350 for the pair. Of the speakers I know in that price bracket, I like the Cizek 2 and the Allison 5. The Cizek is an unusually successful realization of the standard two-way, front-firing, acoustic-suspension loudspeaker. Because it is designed for flat response in an anechoic chamber, it tends to be a little bright in many rooms, but that is easily corrected. Otherwise, the sound is smooth and clear, with plenty of clean bass from the 8-inch woofer. Best placement for the Cizek 2 is on a low stand away from any walls.

Although similar to the Cizek in many respects, the Allison 5 reflects its



Michael Riggs has been involved with audio for some seven years, the last three as editor of *The BAS Speaker*, the journal of the Boston Audio Society.



Peter Sutheim divides his time between being operations director of KPFK, the Los Angeles listener-sponsored FM station, and free-lance writing, recording, and consulting.

designer's concern with mating the loudspeaker to the room. It is meant to stand with its back against one wall—away from the others, the floor, and the ceiling—with the tweeter facing forward and the woofer facing up. These two speaker designs differ somewhat in balance and imaging, but either is good for the price level; we'd have to spend a lot more to get significantly better performance. My taste runs to the \$149 Cizek over the \$160 Allison, so we'll earmark \$298 for speakers.

For electronics, I prefer separates, but they're not cost-effective in this kind of system. I'd better pick a good integrated amp or receiver. Given the small price difference between the two when their specs are similar, I think we should go for a receiver—especially since the tuner sections you get "for free" usually are pretty good these days, even in inexpensive models.

So which receiver? We want a clean, quiet phono stage with a sharp infrasonic filter below 20 Hz and a classic input impedance. Ideally, its input capacitance should be low, to facilitate matching with the cartridge. Both the Allison and the Cizek are fairly inefficient 4-ohm loudspeakers, so we want a reasonably powerful amp section that works well into low-impedance loads. The NAD Model 7045, which clips at 80 watts per channel into 4 ohms, would be my choice. At \$390, it may be too expensive, but if it turns out we can't find a reasonable turntable and arm for the remaining \$162, we'll make another selection.

Enter the \$180 B.I.C. SP-65. It has a low-mass tonearm, good geometrical ac-

curacy, and a two-speed belt drive (better than direct drive, in my opinion). The arm cable capacitance is 180 picofarads. Hitched to the NAD's phono preamp (50 pF), it presents the cartridge with a 230-picofarad load—just about perfect for our pickup. The weak point of the SP-65's predecessor (the 914) was its suspension. Though better than many, its resonance frequency was higher than it should have been for best acoustic feedback rejection. A set of Discwasher DiscFeet (\$22) would be a good investment if the new model (with which I'm less familiar) proves similar in this respect.

Now we have a \$1,018 system (\$1,040 with the DiscFeet) that I could be happy with. And it's easy to expand. The receiver's amp and preamp are linked by removable external jumpers, making insertion of a delay line or other signal processor easy. There's a headphone jack and two tape monitor loops. If only they'd given me \$3,000—

Peter E. Sutheim Chooses a \$3,000 System

It was only after some reflection that I understood how fiendish this assignment was. Choose a \$3,000 system? Piece of cake, right? Well, it turns out that for \$3,000 you can do *most* things right, but not all. At \$2,000 you're still in the high-end of the mass-market bunch. Go to \$4,000 and above, and you can incorporate some elegantly exotic items that are almost unarguably the best. Let

it be understood that it is quite possible—still this side of madness and without frills or duplication—to spend about \$20,000 on a top-quality record-playing system (no FM or tape). Harrumph!

But that wasn't the assignment. All right, a few starting points. First, the object is to create in my listening room a plausible illusion of a musical performance heard as though through an acoustically transparent window. It is not *primarily* to transport me into the performance space, nor the performance into mine, although that will sometimes be achieved more or less successfully by some recordings.

Second, the best recorded source material available today is on conventional discs. While FM and tape are respectable media, their practical realization for home use in most cases rules them out as primary top-quality sources. (I say this with some regret as a person who makes part of his living working for a high-quality FM station and by making very decent-sounding tape recordings of live music.) So this \$3,000 system includes no FM tuner or tape recorder. The cost of good ones would hopelessly compromise the basic elements of this system.

Third, I believe that someone seriously interested in reproduced music ought to assemble a system that, for a given price level, plays records as well as possible, without gimmicks. The gimmicks may improve the listening experience for some people in some instances, but they absorb money that should be spent on the vital function of extracting as much information as possible from



A producer of industrial audio-visual presentations, William Warriner is known to our readers for his tongue-in-cheek looks at the audio scene.

the record groove. You can add the extras later if you enjoy their effects. Therefore, this outfit does not include quadriphony, ambience devices, or other signal processors.

Fourth, proper installation is crucial for a system capable of this level of reproduction. The alignment of the cartridge in the tonearm, for example, is critical, and manufacturer's instructions that come with tonearms and cartridges often are wrong. The placement of the turntable is likewise very important; if it picks up enough vibration from the speakers through the air and/or the surface it sits on to send a delayed signal back through the system, the resulting "smear" will make that impressive (and expensive) rumble figure meaningless. Speakers must be placed where their inevitable interaction with the acoustics of the room is least harmful; that requires careful listening and a willingness, perhaps, to disrupt conventional room arrangements.

Fifth, take skeptically any advice, including my own, that doesn't square with your own hearing experience. *You* have to live with the system—not I nor the dealer who sells it to you. If you are serious about music and contemplate spending \$3,000 for components, you may well spend several hundred dollars a year on records, so you certainly can afford some concert tickets. Listen to as much live, unamplified music as you can. Every town has musicians and occasional performances—often free—in churches, schools, community centers, and, yes, even homes. The performances will not always win raves for their musicianship, but there is no other way to

judge the accuracy of your reproduction at home. And forget specifications: Almost none of them correlate well with listening quality.

I must add that I don't own the system I have chosen here. I can't afford it. But I have heard and/or studied each of these components in combination with various others, and I believe this system will give you record reproduction that is hard to surpass without spending a lot more money. I am certain that many audiophiles will quarrel with my choices. That will remind you not to take anyone's recommendations as Truth.

Considering all that, here's a run-down of what I have selected for my \$3,000. For speakers, I choose the DCM Time Window (\$690 a pair). To power those speakers, I'd pick Hafler's DH-200 power amp. It costs \$400 wired; if I had to shave the budget, I might get it in kit form for \$100 less. As the primary transducer, I'm satisfied with the quality of Denon's moving-coil Model 103D (\$267); and for a pre-preamplifier the Marcof PPA-1 (\$120) does a good job. To bring the head amp's output up to line level, I'd settle on another Hafler product, the DH-101 preamp (\$300); again, it's available for \$100 less in kit form. For a turntable, I figure you can't go wrong with Thorens' TD-126 IIIB (\$600) with the Denon DA-401 tonearm (\$350).

Enough money is left over to cover the cost of some high-quality accessory items. Litz-wire speaker cable, figured at 25 feet for each speaker and \$1.60 per foot, comes to \$80. Low-capacitance interconnection cables to hook everything together should come to approximately

\$50. And to keep my turntable and records happy, I want the Denon record weight (\$15), the Osawa Diskmat (\$25), Discwasher record cleaner (\$15) and its (or someone else's) antistatic ion pistol (around \$20). The grand total is a hair under budget: \$2,932. How about that?

William Warriner Chooses a \$3,000 System

There is a myth that you can choose components by conducting good old A/B comparisons. You can't. The audio dealers are spread out all over town, with no one carrying every brand of component, so there goes your scientific method. This leads me to a more humanistic test procedure: (1) I put in a lot of hours of listening; (2) I form all audio opinions with my eyes closed, to screen out spurious signals from those fickle organs; and (3) I use five musical "test records" that I know by heart.

I started this hunt by making a best-guess list of attractive components, based on equipment reviews, audio gossip, and personal prejudices. I chose three dealer showrooms plus my house as test sites. Since I believe that all listening rooms create their own acoustical illusions, I auditioned the key items in more than one room.

How to distribute the budget? It has been said that we will hear an order-of-magnitude improvement in program sources over the next few years—a volatile situation. So I settled for just two

sources that should endure: a tuner and an analog phonograph. (I can acquire exotic formats when they are less exotic.) That decision concentrated the budget on the end of the system that is least subject to real obsolescence—the electronics and speakers.

At this price level there is an embarrassment of good electronics, so I made the easy decisions up front. Phase Linear's original 400-watt amp delivers clean, high power year in and year out, if you have enough fuses. Its new version, the Model 400 Series Two, sounds fine and has more protective circuitry. It doesn't weigh a ton, can drive almost anything you want, and sells for \$600 (\$1.50 per watt, just like hamburger-per-pound). A bargain price for a potential family heirloom.

There are fine preamps on the market from Pioneer, Yamaha, Technics, Luxman, Analog Engineering (AEA), and many others: lots of tactile attractions on the front panel, lots of conscientious electronics behind it. But I went for Apt's less sexy Holman preamp, because it should be close to the state of this particular art for years. The phono section is a real gift from a thoughtful engineer. The price (\$493) is a relief.

The integral-shell design of the Ortofon Concorde pickup (\$150) makes such good sense that I have to believe it will become standard. I listened to the Concorde vs. Great American Sound's moving-coil Sleeping Beauty (\$250) and ended up calling it a tie. The Concorde has surprising articulation at low frequencies, and the high end is smooth and analytical. It has none of the prob-

lems (high mass and noise, low durability) associated with moving-coil structures, and you can replace the stylus yourself—an old-fashioned virtue. Picking the Ortofon Concorde was the easiest choice of all.

I am interested only in manual turntables, without being partisan about any one model—except the \$600 (without arm) Project 20, which I can't afford. Both Pioneer and JVC offer good direct-drive, quartz-controlled models at no-frills prices. I'll opt for the JVC QL-5 (\$270). You could ask for a lighter arm to optimize the Concorde, but this one can do the job well enough.

The Technics ST-9030 tuner is not a candidate for the computerized master control award of 1979, but it is a sophisticated, high-performance device at the very decent price of \$460. Like the other electronics on this list, it is rack-mountable. To me, rack mounts make sense. I'd like to see the industry develop an alternative narrow-gauge rack standard.

That brings us to where the problems are: speakers. Based on what was readily available, I listened to six high-performance designs. Most were priced at \$1,200 to \$1,600 a pair—well over a third of my budget. Only two cost less: the AR-90 at \$1,100 a pair and the Bose 901 Series IV at \$850 a pair(!). With both systems at home, fed by the Concorde cartridge, I listened for hours and agonized. Both are bright and clean. The 901s deliver more bass for less input energy, which could help the amplifier budget. They are predictably more spacious, and they do indeed seem to expand the walls of my mediocre listening

room. But to my ears, the upper mid-range (say, at 2–4 kHz) sounds a little strident. With the same music, the AR-90s make me crank up the bass, and it is harder to get the musicians outside those two vertical boxes. But the articulation of musical detail is marvelous, revealing some instruments that had hitherto always been buried in the mix. Using the humanistic method, I closed my eyes and decided—on the AR-90s.

That brings the whole system in at \$3,073. If the folks at HIGH FIDELITY decide to put up a fuss over that extra \$73, I could go back to the 901s and spend \$177 on digitally recorded or direct-cut discs for a total of exactly three grand.

Don Heckman Chooses a \$5,000 System

There are two problems that arise almost immediately when I consider a \$5,000 sound system. The first is obvious: Unless I hear from the Irish Sweepstakes in the immediate future, this is going to be, alas, a dream and nothing more. A somewhat more complex problem is that \$5,000 doesn't go nearly as far as one might expect. We can eliminate, at the very outset, such fascinating exotica as Beveridge's \$7,000 speaker system and Infinity's equally expensive Quantum Reference Standard speakers. Even more moderately priced—Revox's \$1,650 tuner or Crown's superb DL-2 preamp, for example—have to be viewed as part of the overall system. Do I want to spend a third of my



Don Heckman, jazz saxophonist and former music critic for *The New York Times*, has been a regular contributor to our BACKBEAT section since 1977.

budget on a tuner or a preamp? The answer is no.

Ultimately, of course, a sound system, regardless of its cost, should reflect the needs and idiosyncrasies of the owner. The range of my activities—record reviewing and music commentary, composing and performing, writing for television—demands flexibility. I want, first, a high quality system that is as natural sounding as possible. (Actually, each component can be replaced by a more expensive unit, but the increase in quality will be, at best, minimal.) Second, I want a system that will serve the dual purpose of providing monitorlike sound for pure music listening and theaterlike sound for television viewing with an Advent VideoBeam projector and a ¾-inch Sony U-Matic VCR.

Starting from the point of contact, I chose the Shure V-15 Type IV cartridge (\$150) because it is a superb record tracking device. Its sonic performance is at least as good as that of any other cartridge on the market, and its ability to deal with the real-world problems of warped, dirty records is, I think, unmatched.

Like most contemporary turntables, the Denon DP-2500 (\$525) uses a quartz-locked direct-drive system; unlike some of the others, its speed accuracy is astonishing—something on the order of 99.998% at 33½ or 45 rpm. Since inaccurate pitch and wow or flutter of even minuscule proportions drive me up the wall, the Denon's broadcast-quality specs make it an obvious choice.

Next I'd pick Apt's Holman preamp (\$493). It performs all the expected switching functions flawlessly.

More unusual is its use of individual buffer amplifiers on the tape outputs to minimize distortion, as well as its virtual elimination of crosstalk between inputs. And, since I don't plan to include an outboard equalizer, the Holman's tone-control/filter setup is particularly useful.

Back to Denon—my only repeater—for a tuner. The \$450 TU-850 has the specs of models costing twice as much. More important, it does its job quietly and flawlessly.

I've decided on a cassette deck rather than a reel-to-reel unit. (More on this later.) The Nakamichi 581 (\$770) is ready for metal-particle tape and is in the Nakamichi tradition of state-of-the-art cassette equipment.

I've cheated just a bit with my choice of power amplifier: Since the Dynaco Stereo 416 is a kit, its \$650 price is \$300 less than the wired version. If there's a cleaner sounding power amp than the 416, I haven't heard it. In addition, it includes the extremely valuable Dynaguard circuitry to protect speakers from excessive power bursts. For those who need a wired alternative, I suggest the Phase Linear Model 400 Series II. It lacks some of the safeguards of the Dynaco but will get the job done.

Speakers are the most personal items in a sound system. I want neutrality and power because I want to hear music, not sound reproducers. Given a higher budget, I might have chosen AR-9s. The AR-90s (\$1,100 a pair) are only slightly less impressive and are honest enough to deal accurately with the wide range of music I listen to—from rock and jazz to concert music and film scores. I need speakers that will do as

good a job with Webern as with Weather Report, and the AR-90s do.

For noise reduction, I've chosen the DBX 122. At \$275, it is reasonably priced, and it's incredibly effective.

The last group of components is intended primarily for enhancement of projection-screen television viewing. They include, first, a high quality sound television tuner, the \$250 Pioneer TVX-9500: It is fully capable of providing the complete bandwidth of TV sound as it is broadcast today. In addition, I have chosen the \$600 Audio Pulse Model Two time-delay amplifier with two Advent 3 speakers, at \$120 for the pair, to provide ambient sound.

My \$5,000 system actually comes in at \$5,383. I'm counting on the editor's good will to permit the overage. Let me point out, however, that discounts should bring the price well into line. In fact, if one allows for a 20% discount—not excessive, especially in the case of a large system purchase—one could add a Teac A-2300SD open-reel tape deck for \$800 and upgrade the Nakamichi 581 to the Model 582 (at \$120 more it includes independent record and playback electronics for monitoring) and come in at around \$5,026. Now there's a system I'd be happy to take with me to an AC-powered desert island!

Ivan Berger Chooses a \$5,000 System

Five thousand dollars for a system? Devilishly frustrating—in fact, a

Ivan Berger, whose expertise stretches from photography to audio and video technology to home computers, is one of the busiest free-lance writers we know.

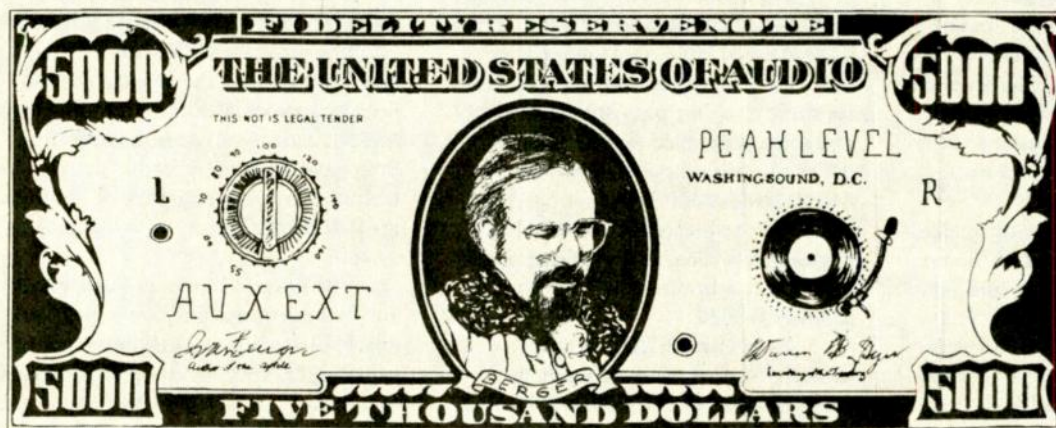

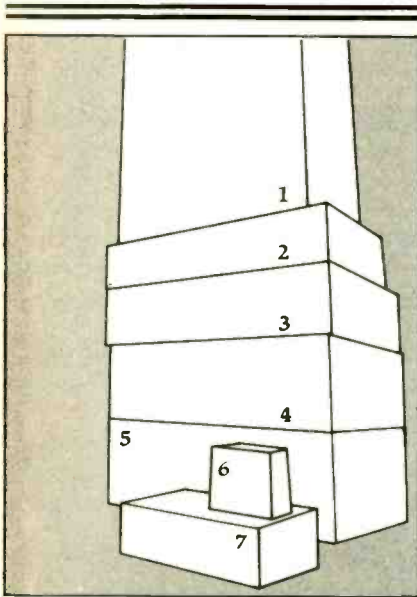

On this month's cover: 1) Electro-Voice Interface A speaker; 2) RG Dynamics Pro-20W dynamic processor; 3) JVC KD-A8 cassette deck; 4) Sansui TU-919 tuner; 5) Rotel RX-504 receiver; 6) Yamaha MC-1X pickup; 7) Electro-Voice Interface A equalizer module.

series of frustrations. Spoken aloud, the sum rolls off the tongue resoundingly enough to set dreams in gear. Yet add up the prices, and it turns out not to be a princely system's ransom, but merely the foundation of a rather fine one. That's frustration No. 1.

Frustration No. 2 is knowing that a \$5,000 system is a myth, or nearly so. People do *own* such setups, but they build up to them gradually, as I have. Such a system's complexion thus is determined by both personal history and personal choice and is a reflection of its owner's idiosyncrasies. (Heaven knows, what follows will be idiosyncratic enough.)

Frustration No. 3 is being unable to select a single set of speakers. In the \$5,000 price range, it's easy to find very good speakers, but very hard to choose among them without weeks of listening comparisons—which, if I were actually spending the money, I would take the time for. I've been impressed in the past

few years by a number of speakers (listed alphabetically here): the DCM Time Windows and Time Bass subwoofers (\$1,430 per pair, total), the Electro-Voice Interface D Series II (\$1,750 a pair), the Magneplanar MG-IIAs (\$825 a pair, but I'd want a subwoofer—the Audio Pro, at \$795, would bring the total to \$1,620), and the Mordaunt-Short Signifier (\$1,480 a pair). They're all good, and they're by no means alike. The only model that eliminates itself is the Magneplanar, since the space where my left speaker must go demands a conventional box enclosure. With three speakers left to choose from, I'll take the average of their prices—\$1,553—as the speaker part of my budget. That leaves about \$3,500 for the rest of the components.

Next comes the other transducer in the system—the phono cartridge. I want three, to change off as the mood and music strike me: an AKG P-8ES (\$135) for its clarity, an Ortofon MC-20 (\$180) for its sweetness, and a Shure V-15 Type IV (\$150) for its trackability. Not that all three don't have plenty of each quality, but each does excel in one. And that's \$465 total—say, \$500 with the spare headshells or slides. I have \$3,000 left.

As an opera fan, I want a changer, even though I know that better performance is available from single-play turntables. (That doesn't have to be the case, but it is.) Dual's Model 1264 (\$275) looks like it could be the best of them; I'd get that, but with the idea of adding a single-play table later. Let's round that off and call it \$250. I now have \$2,750 left.

For a preamp, I am torn between Apt's \$493 Holman and the \$867 Carver C-4000 Sonic Hologram Generator. Since the Carver has unique capabilities for sonic imaging, plus noise reduction and some other nice features, I'll go with it. For a power amp, I pick Hitachi's Model HMA-8300. It pumps out 200 watts per channel (which should be enough), has Class G operation for more dynamic headroom, and is priced reasonably at \$820.

Now I have \$1,100 or so left—enough for a hot tuner and almost enough for the Draco Micro CPU, now that it has come down to \$1,250. But I

don't need a hot tuner. I live in Manhattan, where a shish-kebab skewer is enough antenna to bring in good signal strength, though not necessarily a good signal, Manhattan's multipath being what it is. JVC's Model JT-V77 has exceptional capture ratio, AM rejection, and alternate-channel selectivity, as well as low distortion, all very useful in an urban location. And its sensitivity is far more than adequate here. Of course, it's just \$290, but that's all right: I don't listen to the radio that much, anyway.

And I can use the \$800 I have left to buy a good cassette deck. Here, too, I have several contenders: Aiwa's AD-6700U (\$750), Dual's 839RC (\$850), JVC's KD-A8 (\$750), Nakamichi's 581 (\$770) and 582 (\$890), and Pioneer's CT-F1250 (\$695). They all take metal tape, of course, and they're reasonably comparable in performance. So in the final analysis it comes down to features.

Three brands stand out: Dual, JVC, and Nakamichi. Dual's LED-array meters are peak indicating and follow the recording equalization network. Its optional wireless remote control can also operate Dual's 650 turntable—which, I presume, would take the same headshells as the 1264 changer and hence would make an ideal second turntable to use with that. It has fade editing and auto reverse, both of which are unusual and very useful. Also useful are its mike/line mixing and (especially) its limiter. The JVC is the only one of the three decks that will automatically set bias, equalization, and Dolby recording level, which helps a lazy user like me make the most of every tape formulation. Its semi-automatic recording-level setting is as good as (maybe better than) a limiter for dubbing records. Yet it's the only two-head, single-capstan model in the trio. Both Nakamichi decks have three heads (the 581, however, has no monitoring). Both have a master recording level control, another plus. And they're tied with the JVC for the beauty spot in the system.

So how do I choose? Well, excuse me if I leave you in suspense about my final choice while I toddle down to the stores and get my hands on each of them. Meanwhile, I'll have another listen to my possible speaker choices. **HF**

Cracking the Vaults at Columbia and RCA

Caruso, Ormandy, Bernstein, Casals, Gigli, Melba, Jolson, Sinatra, Novaes, Toscanini, Rubinstein . . . all have made recordings that have never been released. Our intrepid reporter, a senior editor of New York magazine, went to the companies for an explanation—and also learned why you may wait in vain to hear them.

by David Rosenthal

Most people tend to associate Leonard Bernstein's acclaim as a conductor with his series of triumphs leading the New York Philharmonic in the 1950s. And when his career is traced through discographies and learned articles, the transformations of his attitudes and styles are followed from his first youthful recorded efforts at the Philharmonic's helm to his quadriphonic exercises today with the great European ensembles. All very simple and quite pat, except for one thing: There is earlier Bernstein, although unfortunately some of it is unlikely ever to be heard.

In 1945, the young Bernstein found his way into RCA's New York studio to record with a pickup group dubbed the Victor Chamber Orchestra, probably his first commercial recording venture as conductor. The results of these historic sessions are not known, except for the fact that Milhaud's *La Création du monde* was recorded and never pressed. The master—like many thousands of others—remains unreleased, languishing in a cardboard box in a corporate vault, unheard and virtually forgotten.

RCA and Columbia, the two most important U.S. firms by far when it comes to historical recordings, have captured the works of countless artists for posterity over the past eighty years. Yet what you see in record stores or even in the card catalogs of specialized libraries is only a portion of what has actually been produced. In some instances, artists have refused to grant permission for their efforts to be heard by the public. Occasionally, masters have been misplaced, inadvertently melted down, or stolen. Whatever the reason, a vast cornucopia of America's musical heritage is sadly unavailable for distribution.

Tina McCarthy is a gracious, red-haired young woman who heads Columbia Records' Department of Archives and Consumer Relations. As such, it is her task to keep track of the incredible number of recordings Columbia made in the pre-LP era—something that is far from easy when you consider that, until the late Goddard Lieberson made some funds available fifteen years ago, there was no semblance of order whatsoever to Columbia's huge collection. Even today, after years of painstaking detective work, trying to find out whether certain artists made certain discs—released or otherwise—still means that McCarthy must laboriously sift through stacks of index cards, cross-referencing them with yet another sheaf of papers and then calling Columbia's warehouse in Pitman, New Jersey, for an answer.

"There's hardly any artist who doesn't have some unreleased material," says McCarthy, part of whose job involves compiling discographies for major Columbia retrospectives like the E. Power Biggs memorial set issued last spring. "I don't know how many unreleased recordings there are." Hundreds? "Maybe," she replies, with a tentativeness that speaks volumes about the confusion that once reigned in her end of the business. "For years, there was no control over any of this information."

At the Pitman facility is an honest-to-James-Bond guarded vault containing 120,000 metal masters—variously called "parts" or "matrices"—occupying 6,242 square feet. (All are 78s; LP masters are stored in a separate plant in Iron Mountain, New York.) They are kept in well-marked (according to matrix numbers), heavy corrugated cardboard boxes and are cleaned each time they are test-

pressed for office use. It should be noted that unreleased material is rarely made available to anyone outside the Columbia family, even bona fide scholars. McCarthy's terse explanation: "Security reasons."

But any lapses in security seem to stem from Columbia's own past negligence. To this day, it is difficult for McCarthy to be certain about what exists and what doesn't. At times, there are notations in recording log books of masters that don't turn up in the vault or, conversely, "destroyed" masters that miraculously reappear. "From the teens on, there was someone who was supposed to keep files," she says, "and didn't always do so."

The effect of such lackadaisical accounting could easily be seen on a recent afternoon I spent at Columbia going over old recording indexes with McCarthy. A Pablo Casals fan from way back, I was curious to see whether, amid all the sides Columbia had issued of the great cellist over the years, anything had been omitted. Indeed it had. First, on a browning log card, we discovered a *Variations symphonique* made by Casals in 1915. He had rejected it at the time—indicated by a notation on the card that generally means the matrix was destroyed. However, a quick call to the warehouse turned up this very 1915 recording, a master in mint condition. We were not so lucky with a number of other Casals efforts. For example, on January 25, 1922, he recorded MacDowell's *To a Wild Rose* and Rubinstein's *Romance*. Although neither has ever been released, a search of the Pitman vault proved fruitless, both recordings having apparently been lost forever.

If the disappearance of these bonbons detracts little from the memory of a

great artist, there are other bits of history that have a greater importance as examples of both the ridiculous and sublime extremes of various careers. Take for instance Eugene Ormandy, the rather austere leader of the Philadelphia Orchestra for the past quarter-century. Long before he was conducting Shostakovich and Prokofiev in the City of Brotherly Love, the contemporary pieces he was associated with were of quite a different ilk. In 1930, under the name of "Dr. Eugene Ormandy's Salon Orchestra," the maestro committed such hits as "A Kiss to Remember" and "Hymn to the Sun" to disc. Neither has ever been released, and, alas, the metal parts for "A Kiss to Remember" cannot be found. (In Spain, in 1929, Ormandy's band did "She's

Funny that Way," and that classic *does* exist—somewhere).

Though we may only slightly miss those recordings as evidence of another side of Ormandy, mainstream Rudolf Serkin also lies a-moldering in the Columbia vaults. Most early Serkin releases display his work as collaborator with his father-in-law, the violinist Adolph Busch, but many youthful solo performances were never made available. For example, a 1947 Schubert *Wanderer* Fantasy has never been pressed, nor have 1941 recordings of Schumann's *Abegg* Variations and the Mozart C minor Fantasy. The explanation isn't noted on Serkin's "artist card," though one could hazard a guess that at the time they were made, the pianist's commercial

stock had not risen sufficiently to merit a marketing effort.

Representative work by another famed pianist is also unobtainable. Guiomar Novaes, who died earlier this year, recorded the Chopin B flat minor Sonata in 1947 and the B minor in 1941 for Columbia. And although other versions of these works by this great Chopin interpreter are still in the catalog, these were made in her prime. According to McCarthy, Columbia executives recently requested test pressings for a possible memorial album, so these recordings might soon be heard for the first time.

For years, Columbia's strength was its popular music division, and there too a wealth of material remains be-

ARTIST		CASALS, PAELO	
NO.	TITLE	OK	LISTED
37133	VOL. NIDREI PT. 1		Nov 1915
37134	" " " 2		
37131	MELODY IN F	1/27/15	
37132	ADAGIO FROM CONCERTO IN D MINOR	1/27/15	
37129	SALUT D'AMOUR	4/20/15	May 15
37130	LARGO	4/20/15	
37149	SERENADE SPANISH DANCE NO. 2	4/20/15	
37150	LE CYGNE	4/20/15	
37151	ROMANZA	4/20/15	May 15
37209	VARIATIONS SYMPHONIQUES PT. 1	Retired	
37210	APRES UN REVE	5/12/15	Feb 15
37262	DRAM OF LOVE	6/14/15	Feb 15
37263	AIR (BACH)	6/14/15	Feb 15
37256	MAZURKA OP. 11 NO. 3	6/14/15	Feb 15

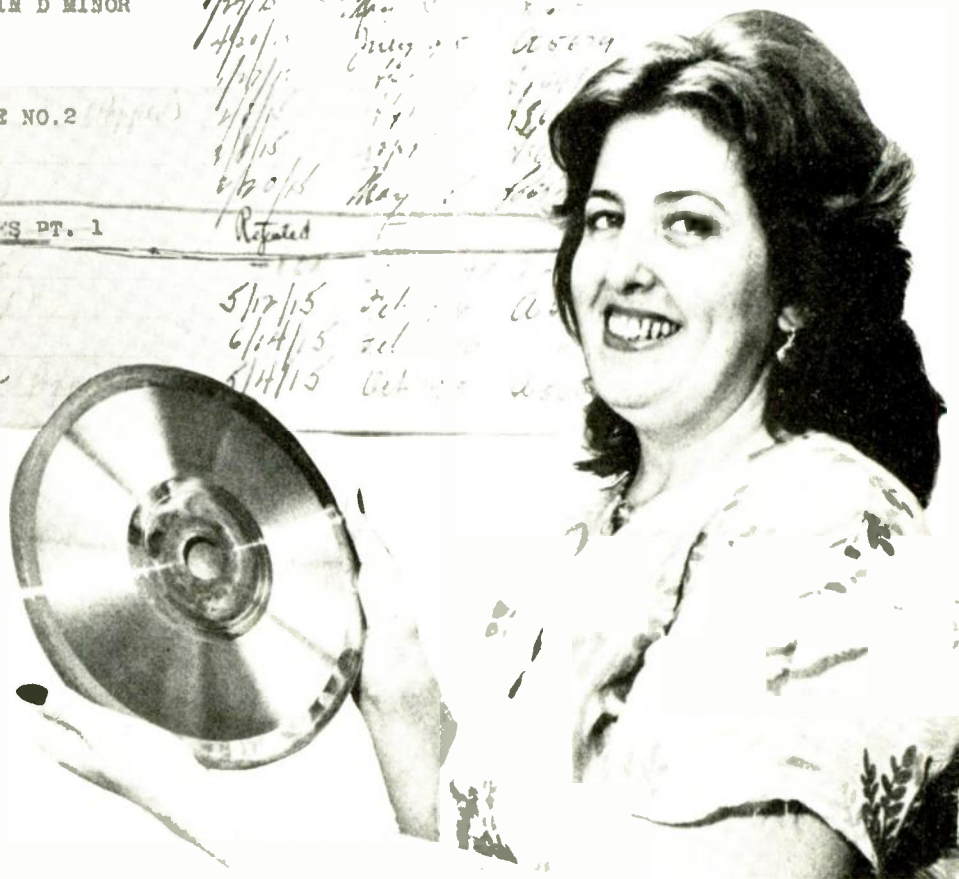

yond the reach of aficionados and experts. On January 14, 1916, Al Jolson recorded "There's a Broken Heart for Every Light on Broadway" and "Eeny Meeny Miney Moe." Both were rejected by Jolson and now cannot be located. On November 11, 1944, a kid from Hoboken named Frank Sinatra cut his version of a song that had done so much for Bing Crosby: "Home on the Range." In the next few years, Sinatra also did such favorites as "Falling in Love with Love," "Meet Me at the Copa," and, with the Skylarks as backup, "There's Something Missing." None of these has ever been commercially pressed. Maybe Columbia is saving them for a future commemorative disc—if the masters can be found then.

Columbia's Tina McCarthy displays a 1929 copper master from the company's vaults. The Pablo Casals log card shown behind her dates from 1915. Composers' names were penciled in only when the disc was approved for pressing. Barely visible here are the faded notations Bruch, Rubinstein, Tartini, Elgar, Handel, Popper, Saint-Saëns, Campagnoli, and then the unattributed and rejected "Part 1" of *Variations symphoniques* that unaccountably turned up in Columbia's warehouse (see text). "Part 2" was apparently never recorded and "Part 1" never received what the final column designates a "double number," or catalog number for the era's newer double-sided discs. (The first two listings, for example—two halves of Max Bruch's *Kol Nidrei*—are coupled on disc A 5722.)

RCA's John Pfeiffer examines a log book indicating recordings Sousa's band made in April 1901. Besides the marches, arranged selections from *Lucia*, *Faust*, *Pagliacci*, and other operas are listed.

Unreleased jazz material appears to be missing too. "There were many auditions in the 1920s," says McCarthy, "where some big-name artists sat in on the sessions. There were Benny Goodman, Eddie Condon, Louis Armstrong, and many others. But how plentiful these recordings are, we just don't know."

At least Columbia is trying. But while CBS has made a budgetary investment in preserving its past, RCA is pinching pennies. Despite the pleas of scholars, archivists, and music lovers, RCA has been unwilling to spend almost anything on unraveling the confusing, never-inventoried products of its golden years. "What's happening at RCA," says

David Hall, curator of the Rodgers and Hammerstein Archives of Recorded Sound at Lincoln Center, "is a crime."

From the early days of the century on, the Victor Talking Machine Company—which became part of RCA in 1928—had the greatest artists entering its Camden, New Jersey, studios for recording sessions. Enrico Caruso, Geraldine Farrar, John McCormack, Nellie Melba, Beniamino Gigli, and other operatic greats were all logged in as having made hundreds of cuts. Unfortunately, many have simply disappeared.

"The trouble began during the war," says John Pfeiffer, executive producer of classical a&r for RCA. "The masters had thick copper backing and it is thought that many were melted down

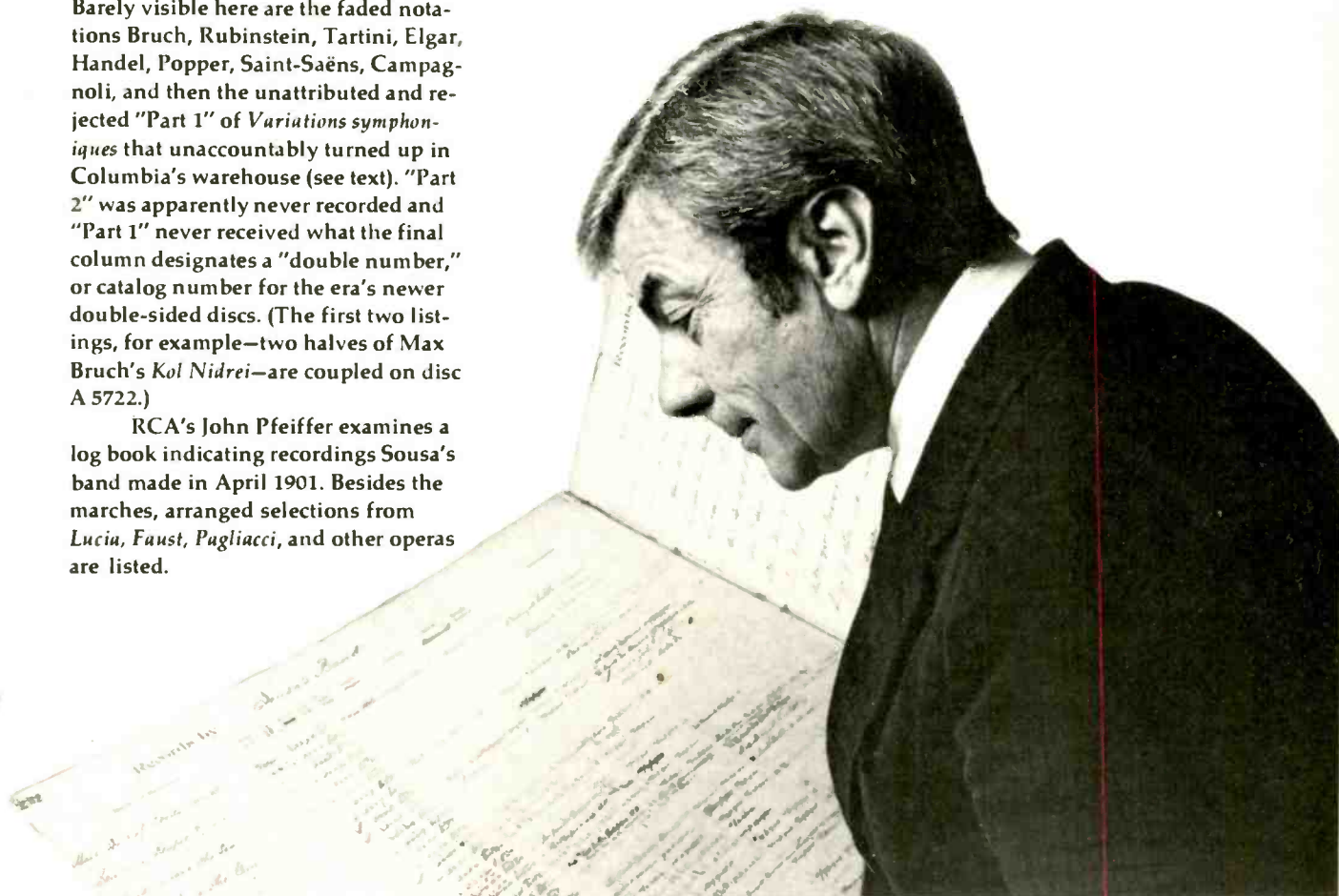

and used in the war effort. Also, when things were moved from Camden to a new vault in Rockaway, New Jersey, about a dozen years ago we don't know how carefully they were refiled. And some things were destroyed. It's sad. This is our heritage."

For years, Pfeiffer has waged a quiet intracorporate struggle over the fate of RCA's historical holdings. He has pushed for computerization of records, restoration of original indexing cards, and a total accounting of just what is squirreled away in the Rockaway vault. According to Pfeiffer, it would cost perhaps \$250,000 to get the job underway. That would ensure that the deterioration of historical documents and the loss of priceless recordings would not continue. "There is a continuing dialogue between RCA and the Library of Congress to microfilm and make available to scholars RCA's record logs, but this has come to a standstill because of changes in RCA's administration."

The disarray was brought home when Pfeiffer was putting together a Caruso set a few years back. He found entries in the Camden logs of numerous sessions for which no master could be found. In some instances, he was forced to make requests from private collectors or from EMI in England to obtain copies of recordings Caruso had made for Victor.

Much of the original paperwork kept on sessions over the past eighty years is literally crumbling. As Pfeiffer was showing me his file on Jascha Heifetz (it was he who put together the magnificent six-volume Heifetz collection for RCA), the old, tattered accounts of the great violinist's studio activities started to fall apart in his hands.

But that was nothing compared to what was nearby. On a bookshelf, lying haphazardly atop one another, were volumes of recording logs dating back to the turn of the century. Some had bindings that seemed on the verge of disintegration, and others were unidentifiable. In fact, while going through these volumes (which contain the dates, disposition, and matrix numbers of everything made in RCA's studios), Pfeiffer—who has become the unofficial custodian and guardian of such treasures at Red Seal—came across one huge handwritten book dated 1900. Inside were recording logs for the Sousa Band, the Georgia Minstrels, the Metropolitan Orchestra, and a

There are notations in Columbia's log books of masters that don't turn up in the vault or, conversely, "destroyed" masters that miraculously reappear.

host of singers long forgotten. Even more amazing was that Pfeiffer had never seen this particular volume before in almost thirty years at RCA.

There is a bright side. Pfeiffer says that the masters remaining at Rockaway are not, as has been rumored, rotting away and that many unreleased treasures and oddities await rediscovery. For example, there are 221 sides by Arturo Toscanini in RCA's in-house catalog. While virtually all were remade by the great maestro, some were not, and others are early versions of great musical and historical importance. How many people know that Toscanini recorded Franck's *Les Eolides* with the NBC Symphony in 1940, for instance—it was never released and never re-recorded. Or that a 1933 version of Beethoven's Fifth with the New York Philharmonic exists? Until Toscanini's family agrees to their distribution, these rarities shall remain just that.

Vladimir Horowitz too has made numerous unissued recordings for RCA. When Horowitz came into the studio, according to Pfeiffer, he would "almost always do a complete work once through and then leave." If the pianist didn't like the playback, he often wouldn't try the piece again for some time. Which is why a couple of Schubert impromptus, an early performance of the Bach-Rachmaninoff D major Preludio and many others are still under lock and key.

Arthur Rubinstein has produced an enormous number of albums for RCA, but many contain remakes of earlier and perhaps quite different versions of some of his bread-and-butter repertory. In 1945, Rubinstein collaborated with Leopold Stokowski and the Hollywood Bowl Orchestra on a Rachmaninoff Second Concerto. Why it has never

come out is unclear: The log card has only the intriguing words, "Rejected from a musical point of view." There is also Chopin's F minor Concerto, recorded that same year in San Francisco with Pierre Monteux. That won't be heard either, since the card carries the injunction "hold indefinitely."

Around the same time as the still-born Rubinstein session, Monteux tried a Chausson *Poème* with Heifetz. It appears that his view of the work differed somewhat from that of his soloist. As Monteux told a friend, "The *Poème* should take twenty-three minutes, and Heifetz does it in thirteen."

Heifetz has not made a recording since 1972 and, at his advanced age, is unlikely to do so again, so it is especially disturbing to discover that some of his material is still unaccounted for. In the vaults there is a Grieg C minor Sonata that he never remade. When Pfeiffer recently visited Heifetz and tried to persuade him to grant permission to make a commercial pressing, the great virtuoso replied: "If I didn't like it in 1936, I'm not going to like it today." And most fascinating, perhaps, is a Sibelius concerto he recorded with Stokowski and the Philadelphia in the early 1930s. The files show that the parts were destroyed sometime after the session.

Of course, that is Heifetz's privilege. Yet the point of all this is more than just whetting the appetites of music lovers and collectors, appetites that may never be satisfied. Artists and record companies have their reasons for not letting certain recordings out of their bins and into the department stores. But to deny scholars and musicologists an opportunity to research this nation's aural history is a cultural crime. Who knows what a team of archivists hunting through the Columbia and RCA vaults could discover? Caruso or Gigli sides? Turn-of-the-century jazz or ragtime? Important popular songs or singers long forgotten?

The solution may rest with the great institutions such as the Library of Congress or the already overburdened Rodgers and Hammerstein collection, with 400,000 recordings and no more space. But although some strides have been made, notably at Columbia, the requisite manpower and money have yet to be fully committed to make these vaults the national resource they must become. **HF**

The Twelfth Annual High Fidelity/ International Record Critics Awards



LUTOSLAWSKI:
Orchestral Works.
Polish National Radio Symphony,
Witold Lutoslawski.
EMI 1C 165 03231/36 (6).
Not released in the U.S.



STRAUSS, R.:
Salome.
Hildegard Behrens,
José van Dam;
Vienna Philharmonic,
Herbert von Karajan.
ANGEL SBLX 3848 (2).



ZELENKA:
Orchestral Works.
Camerata Bern,
Alexander van Wijnkoop.
ARCHIV 2710 026 (3).

Serge and Olga Koussevitzky International Record Award

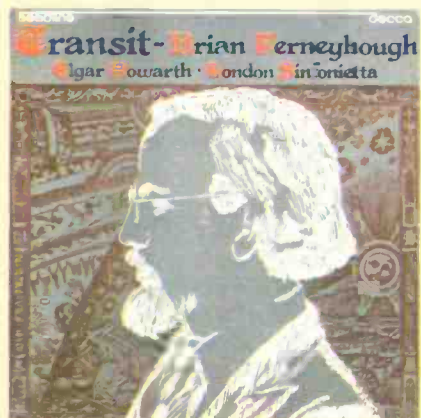

BRIAN FERNEYHOUGH:
Transit.
Elgar Howarth, cond.
DECCA HEADLINE 18.

Judges

José-Luis Perez de Arteaga, *Spain*
Peter Cossé, *Austria*
Edward Greenfield, *England*
Harry Halbreich, *France*
Ingo Harden, *Germany*
Alfred Hoffman, *Romania*
Leonard Marcus, *U.S.A.*
Pierre Michot, *Switzerland*
Bengt Pleijel, *Sweden*

Nominating Committee

John Ardoin, *Dallas Morning News*,
U.S.A.
José-Luis Perez de Arteaga, *Revista Musical Ritmo*, *Spain*.
Luigi Bellingardi, *Nuova Revista Musicale Italiana*, *Italy*.
Martin Bookspan, *ASCAP*, U.S.A.
Karl Breh, *HiFi Stereophonie*, *Germany*
Milton Caine, *American Record Guide*,
U.S.A.
Dominique Chouet, *La Tribune de Genève*,
Switzerland
Peter Cossé, *Salzburger Nachrichten* and
Fono Forum, *Austria*
John Crabbe, *Hi-Fi News & Record Review*,
England
Carl Cunningham, *Houston Post*, U.S.A.
Peter Davis, *New York Times*, U.S.A.
Staff of *Diapason*, *France*
Thor Eckert, *Christian Science Monitor*,
U.S.A.
Edward Greenfield, *Guardian* and
Gramophone, *England*
Harry Halbreich, *Harmonie*, *France*
David Hamilton, *Nation*, U.S.A.
Ingo Harden, *HiFi Stereophonie* and
Frankfurter Allgemeine Zeitung,
Germany
Harry Haskell, *Kansas City Star*, U.S.A.
Staff of *HIGH FIDELITY*, U.S.A.

Antony Hodgson, *Records and Recording*,
England
Alfred Hoffman, *Muzica and Romania*
Literara, *Romania*
Roger Hofmans, *Spectator*, *Belgium*
Shirō Horii, *Stereo Geijutsu*, *Japan*
Richard Kaye, *WCRB*, U.S.A.
Jan de Kruijff, *Disk*, *Netherlands*
Kyoichi Kuroda, *Stereo Sound*, *Japan*
Umberto Masini, *Musica*, *Italy*
Pierre Michot, *Journal de Genève*,
Switzerland
Herbert Müller, *Fono Forum*, *Germany*
Toshio Oka, *Stereo Sound*, *Japan*
Bengt Pleijel, *Musikrevy*, *Sweden*
Wolfgang Seifert, *Westdeutscher*
Rundfunk, *Germany*
Albert de Sutter, *Gazet van Antwerpen*,
Belgium
Ken Terry, *Cashbox*, U.S.A.
Kenji Tsumori, *Asahi Shimibun*, *Japan*
Michael Walsh, *San Francisco Examiner*,
U.S.A.
Daniel Webster, *Philadelphia Inquirer* and
Daily News, U.S.A.
Tilden Wells, *Columbus Dispatch*, U.S.A.
Gerhard Wienke, *Süddeutscher Rundfunk*,
Germany
Dimitar Zenginov, *Bulgarska Musica*,
Bulgaria

Other Nominated Recordings

BERNSTEIN: *Songfest*. Soloists;
National Symphony, Leonard Bernstein.
DEUTSCHE GRAMMOPHON 2531 044.

BIZET: *Carmen*. Teresa Berganza,
Plácido Domingo; London Symphony
Orchestra, Claudio Abbado. DEUTSCHE
GRAMMOPHON 2709 083 (3).

BRITTEN: *Peter Grimes*. Jon Vick-
ers, Heather Harper; Covent Garden,
Colin Davis. PHILIPS 6769 014 (3).

BUSONI: *Sonatinas for Piano* (6).
Paul Jacobs. NONESUCH H 71359.

BUSSOTTI: *Bergkristall*. North
German Radio Symphony, Giuseppe
Sinopoli. DEUTSCHE GRAMMOPHON 2531
011. Not released in the U.S.

DEBUSSY: *Images; et al.* Concert-
gebouw Orchestra, Bernard Haitink.
PHILIPS 9500 509.

DEBUSSY: *Preludes, Book I*. Arturo
Benedetti Michelangeli. DEUTSCHE
GRAMMOPHON 2531 200.

MAHLER: *Symphony No. 4*. Vienna
Philharmonic, Claudio Abbado.
DEUTSCHE GRAMMOPHON 2530 966.

MESSIAEN: *Turangalila Symphony*.
London Symphony, André Previn. AN-
GEL SB 3853 (2).

PROKOFIEV: *Piano Concerto No.*
1. RAVEL: *Concerto in D*. Andrei Gavri-
lov; London Symphony, Simon Rattle.
ANGEL S 37486.

PUCCHINI: *La Fanciulla del West*.
Carol Neblett, Plácido Domingo; Covent
Garden, Zubin Mehta. DEUTSCHE
GRAMMOPHON 2709 078 (3).

PURCELL: *Dido and Aeneas*. Ta-
tiana Troyanos; English Chamber Or-
chestra, Raymond Leppard. RCA RED
SEAL ARL 1-3021.

RZEWSKI: *The People United Will*
Never Be Defeated! Ursula Oppens. VAN-
GUARD VSD 71248.

SCHOENBERG: *A Survivor from*
Warsaw; et al. Günter Reich; BBC Sym-
phony, Pierre Boulez. CBS 76577. Not
yet released in the U.S.

SCHUBERT: *Alfonso und Estrella*.
Edith Mathis, Peter Schreier; Berlin State
Opera, Otmar Suitner. ANGEL SCLX 3878
(3).

SCHUBERT: *Quintet for Strings*.
Melos Quartet, Mstislav Rostropovich.
DEUTSCHE GRAMMOPHON 2530 980.

SCHUBERT: *Schwanengesang*.
Ionel Pantea, Ferdinand Weiss.

ELECTROCORD ST ECE 01507. Not released
in the U.S.

SCHUBERT: *Symphonies Nos. 4, 8*.
Chicago Symphony, Carlo Maria Giu-
lini. DEUTSCHE GRAMMOPHON 2531 047.

SCRIABIN: *Sonatas for Piano, Nos.*
2, 7, 10. Vladimir Ashkenazy. LONDON
CS 7087.

SIBELIUS: *Four Legends*. Phila-
delphia Orchestra, Eugene Ormandy.
ANGEL S 37537.

VERDI: *Otello*. Plácido Domingo,
Renata Scotto, Sherrill Milnes; National
Philharmonic, James Levine. RCA RED
SEAL CRL 3-2951 (3).

WEBERN: *Complete Works, Vol. 1*.
Various performers, Pierre Boulez. CO-
LUMBIA M4 35193 (4).

WEBERN: *Variations for Piano*.
BOULEZ: *Sonata No. 2*. Maurizio Pollini.
DEUTSCHE GRAMMOPHON 2530 803.

ZEMLINSKY: *Quartet for Strings*,
No. 2. LaSalle Quartet. DEUTSCHE
GRAMMOPHON 2530 982. Not yet released
in the U.S.

LE PARNASSE FRANÇAIS. *Mu-*
sica Antiqua, Cologne, Reinhard Goebel.
ARCHIV 2533 408.



With the orchestra in place, violinist Menuhin and editor Marcus open the proceedings.

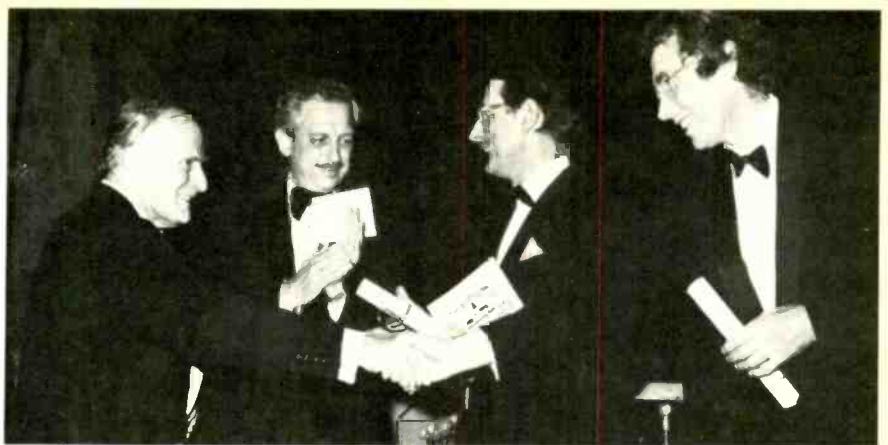

Menuhin congratulates conductor Alexander van Wijnkoop, who recorded the winning album of works by Jan Dismas Zelenka. Also participating are Marcus and Polydor representative Werner Güttinger.

Who Are Zelenka and Zemlinsky and Why Is Everybody Voting for Them?

by Leonard Marcus

GSTAAD, SWITZERLAND—Few attending the final concert of the twenty-third annual Yehudi Menuhin Festival here are likely ever to forget it, and not only for the planned ceremony whereby this year's International Record Critics Awards were integrated into the concert. There was also the unexpected shock Menuhin perpetrated on his audience.

At the conclusion of the concert, which consisted of the still youthful though sixtyish American violinist playing the Bartók (Second) and Beethoven concertos, with Edmond de Stoutz conducting the Zurich Chamber Orchestra, Menuhin stilled the applause with up-raised arms. Then he startled the assemblage by announcing, in German and with characteristic gentleness, that he would not again perform at the festival that bears his name. Not that he was forsaking concertizing, mind you, or his residence in Gstaad; he simply wouldn't play *there* any more. (Actually, although the music world knows of "the Gstaad festival," the concerts themselves take place in a church in the neighboring town of Saanen.) That morning he had met with the festival board, and apparently they could not resolve some administrative and financial differences. The Menuhin Music Academy in Gstaad will presumably continue to thrive, but what will happen to the music festival, by whatever name, is anybody's guess.

Before the Beethoven, when the audience had returned from inter-

mission, Menuhin led the IRCA judges to the stage and opened the ceremonies. It was a curious trio of Grand Prize winners: one album of the complete orchestral works of a Czech baroque composer whom few music lovers had heard of until recently; another of the complete orchestral works of a contemporary Polish composer; and an opera from the standard repertory. But then again, it was a curious and exciting final list the Nominating Committee had blessed us with. You may notice that, eliminating the "antique" collection "*Le Parnasse Français*," all but four composers on the list—Purcell, Zelenka, Schubert, and Bizet—lived into the twentieth century. Whether this demonstrates the uncommon adventuresomeness of the record companies this past year and the growing sophistication of the record-buying public for contemporary music, or only that the century is two-thirds over, I leave to you. One unusual characteristic of the winning recordings: They are all multidisc sets, only the second time in a dozen years this has occurred (the first time was last year).

There was an extraordinarily rich harvest of recordings worthy of a prize this time, and the night before our first ballot the consensus of the judges was that in no way could we pick a winner or winners in time for the ceremonies. Imagine our surprise, then, when three recordings won majorities in the first round. (We each place three votes on the first ballot.)

As usual, the most enlightening part of our meetings was our discussion of the various recordings. Witold Lutoslawski's orchestral works conducted by the composer, one of the winning albums, was considered as major a contribution to today's recorded repertoire as

the Stravinsky and Copland self-conducted projects were in their day. And Lutoslawski turns out to be an excellent conductor—at least of his own works. On the other hand, the judges were radically split over Leonard Bernstein's *Songfest*, some considering it among his best works and a masterpiece, others considering it banal. (I find it wonderful, but then, I find the *original* version of the Third Symphony a masterpiece.) Claudio Abbado's recording of *Carmen* and Colin Davis' of *Peter Grimes* both were highly regarded, but the one was not thought incontrovertibly the best available version and the other was a work not universally beloved by the judges. (*Grimes* did, however, receive more nominations than any other recording.)

Paul Jacobs, as usual, was greatly praised, but the sound on his Nonesuch recording of the Busoni sonatas was not judged superlative, nor was the music. Had there been a prize for sonics, it would probably have gone to Bernard Haitink's Debussy album on Philips, André Previn's recording of Messiaen's *Turangalila* Symphony, or Eugene Ormandy's Sibelius disc, the last two on EMI (Angel). It was primarily the phrasing of the English horn in *The Swan of Tuonela* that kept the Sibelius out of the winners' circle. One wished the swan had been shot a few minutes earlier.

Arturo Benedetti Michangeli, who has been known to play like an angel, was deemed too cold and detached for his Debussy Preludes to be in the running for long. While Abbado's Mahler Fourth was generally lauded, and mezzo soloist Frederica von Stade is always a favorite, that account did not outclass the competition (Szell's on Columbia was preferred by most of the judges). Carol



EMI/Angel representative Arvid Cornelliussen accepts two awards: left, from Spanish judge José Luis Perez de Arteaga for *Salome* and from Swiss judge Pierre Michot for the Orchestral Works of Witold Lutoslawski.

Neblett kept the otherwise excellent *Fanciulla* out of contention. *Dido and Aeneas* was admired, but nobody showed much enthusiasm for it. Andrei Gavrilov's recording of Ravel's Concerto for Left Hand was unanimously acclaimed the best ever of the work, despite some imperfect balances. One judge called Gavrilov the finest Russian pianist after Horowitz and Richter, and nobody was outraged enough to argue. We all wondered when he would defect.

Frederic Rzewski was a name few had heard, but *The People United Will Never Be Defeated!*, his enormous and magnificent set of variations on a Chilean resistance song, won the affection of most of the judges. For fans of the eclectic, which readers of this publication may remember I am, this work for a whistling pianist is superb. Frankly, I had not heard the Ursula Oppens recording of it until forced to by the plethora of nominations it received from American critics. If I had, when Irving Lowens wrote in these pages (April) that "this is one disc that fanciers of contemporary music should not miss," I would have asked him to delete the word "contemporary." Rzewski's own recording is supposed to be coming out soon.

In Pierre Boulez' Schoenberg album, the Op. 31 Variations was judged not up to the quality of Karajan's, Solti's, or Craft's (out of print), and in the Webern album that was recorded under his direction, more knowledgeable ears than mine spotted mistakes. Also, its sound was too often aging and inferior. Important ("suitable for libraries" was how one judge put it), but no cigar. On the other hand, Maurizio Pollini's performance of Boulez' own Second Piano So-

nata coupled with Webern's Variations received an enthusiastic response.

Since we had just come from a Schubert year (1978 was the 150th anniversary of his death), it was no surprise to find multiple Schubert nominees on the list. A good case was made for acclaiming the opera *Alfonso und Estrella* an ideal example of the glory of recordings, since it is a splendid performance of first-rate Schubert that would be unbearable in production yet is perfect for aural enjoyment at home. The gorgeous quintet almost, but not quite, made it, and the sound of Ionel Pantea's *Schwangesang* was thought not up to the highest standards. (For example, the tape hiss is intrusive.) Carlo Maria Guilini's performance of the *Unfinished*, we all agreed, is great and could easily have won a prize. It just didn't work out that way. The Fourth Symphony on the other side was too heavy for most tastes, particularly the awkward tempo of the minuet.

Among the other operas, the fact that both the James Levine and Georg Solti *Ottellos* came out during the year, and that neither completely outshone the other, was an obstacle in voting for the Levine, even though the Solti didn't make the final list. If Carlo Cossutta sometimes seems overtaxed on the latter, reservations were expressed about Plácido Domingo on the former. Even though reservations were also expressed about Herbert von Karajan's *Salome*—neither José van Dam's voice nor the recorded sound was deemed superior (although David Hamilton, reviewing it in HF a year ago this month, thought Van Dam the best thing on the album)—the conductor's erotic interpretation won the day. It is a mad performance, from a mu-

sician who tends to be standoffish, and arguably Karajan's best recording in years. And Hildegard Behrens, making her recording debut in the title role, impressed us all more than she did David.

As for the two Zs, they are both ear-openers. I remember how startled I was when counting the ballots to see the votes for Zelenka and Zemlinsky pile up until both achieved the final list of nominees. HF gave Jan Dismas Zelenka's orchestral works the leadoff review last March, but before that he was just a name I came across once in a very great while. Zelenka was a Bohemian contemporary of Bach, who admired him. While Bach is the one composer I adore to fanaticism, I can do without most other baroque music. Much of Vivaldi and most of Telemann bore me. But Zelenka is a different matter. HF European Editor and fellow judge Ted Greenfield referred to him as Bach with a touch of Charles Ives, and that's about as revealing a description as any. The recording is as striking as the music, with such supreme virtuosos as oboist Heinz Holliger and French horn player Barry Tuckwell participating. Tuckwell's coloratura playing in particular is as breathtaking to the listener as it would have been to any normal performer.

And who is Zemlinsky? Alexander von Zemlinsky could have been a fourth for the Big Three of the Second Viennese School after Schoenberg, Berg, and Webern. Schoenberg, his brother-in-law, always considered Zemlinsky a great composer, and Berg dedicated the *Lyric Suite* to him, but the fame of the three leaders of the School propelled Zemlinsky into oblivion long before he died in Larchmont, New York, during World War II. Certainly the Second String Quartet is a masterwork, and the LaSalle Quartet plays it to the hilt. Stylistically, one might liken it to Reger, except that, to me, Reger sounds the way oatmeal tastes, while Zemlinsky is clear and listenable.

The IRCA selections made, the judges turned their attention to consideration of recordings eligible for the Koussevitzky International Award, which includes \$2,000 to the composer of an orchestral work receiving its premiere recording. The 1979 winner is Brian Ferneyhough, for the Decca Headline recording of his *Transit*. Ferneyhough, a British resident of Germany, has been making a name for himself in Europe. Chicagoans will have an opportunity to hear his music in February, when Abbado conducts his *La Terre est un homme*. **HF**



Christmas Gifts For the Audiophile

*27 Ways to Delight
for Less than \$50—
Plus a Couple More*

by Peter Dobbin

Christmas shopping for the audiophile need not be a very difficult or expensive chore. Despite the fact that an audio system seems complete, some maintenance and accessory items could add much to the enjoyment it affords. To that end, we've come up with a grab bag of audio goodies and gizmos, most costing under \$50. That we have selected one or two out of many competing products does not necessarily mean that we recommend it above the rest, just that it is good and we hadn't the space to list everything.

If your favorite audio buff is hooked on cassette recording and has opted for a deck capable of handling the new metal-particle (sometimes called metal-alloy) tapes, here's your chance to make his life a little easier. Right now blank metal-particle cassettes are difficult to come by; manufacturers such as 3M and TDK are just gearing up production and cannot fill all their dealer orders. With a little digging on your part,

however, you should be able to locate a dealer in your area who has some of these cassettes in stock. Since they are relatively expensive (a gift of just two C-60 TDK metal tapes will cost you around \$25) and somewhat rare, the recipient of such a gift will doubtless give you his undying gratitude. Of course, the avid recordist will welcome even more pedestrian varieties of tape, but before you buy take a peek at his supply and stick to the specific types that you know he likes. If, for example, he does a lot of recording on Maxell UD, the newer and fancier UDXL-I may actually be less desirable with his particular equipment for one reason or another.

Another basic gift for the home recordist, but one that is often overlooked, is an effective head demagnetizer. For example, TDK offers the \$22 Model HD-01. Housed in a clear, cassette-shaped shell, the unit is self-powered and removes noise-causing magnetism from the record/playback head. In use, one simply inserts the HD-01 into the deck's cassette holder and switches to the play mode. A built-in LED lights during the one-second demagnetizing process.

Tape heads also are prone to collect oxide particles from the tape that inhibit performance by reducing output, particularly at high frequencies. Unfortunately, many regular cassette users never get around to cleaning hard-to-reach tape heads. To make inspection of heads easier, Nortronics has come up with the QM-506, a dental-type mirror attached to a small flashlight (\$5.30). In addition, it markets the QM-141 Cassette Life Extender. This \$3.30 package includes a liquid cleaner to remove heavy oxide deposits and a cassette-shaped head cleaner for regular maintenance.

For the tape aficionado who owns several decks and is constantly forced to plug and unplug patch cords from one deck to another, there's Russound's TMS-1 tape recorder selector switchbox. It will accept connections from up to three recorders and interconnect them for any combination of functions. At just \$49.95, it will simplify what can be an onerous task.

For one who prefers the flexibility of reel-to-reel recording and is just trying his hand at various techniques of tape splicing, Joel Tall's *Tape Editing* (\$2.00) may be the perfect gift. This booklet contains twenty-five pages of detailed how-to information for the novice. You can order a copy by writing to EdiTall Corporation (P.O. Box 17435, Dulles International Airport, Washington, D.C. 20041). It naturally favors the use of Tall's EdiTall editing blocks, but we at HF do as well, so we don't see that as a limitation. As a matter of fact, you might want to get your friend the EdiTall KS-3 quarter-inch editing kit (\$17), which contains an aluminum splicing block and thirty editing tabs.

For anyone seeking detailed information on how to make live recordings, chances are he'll find out what he needs to know in the *Handbook of Multichannel Recording* by Alton Everest (Tab Books, 1975). Topics covered include dubbing, special effects, mixing, reverb, echo, and studio acoustics. Cost in paperback is \$7.95.

Perhaps the home recordist on your gift list spends hours searching through stacks of recorded cassettes to find a specific performance. Once a cassette gets separated from its storage box and the paper index insert, it can be difficult to remember the exact program material recorded on it. But buy him a box of Dennison's plain self-adhesive file folder labels for less than \$4.00. The labels fit neatly into the upper portion of the cassette face (above the window) and can be written on—or typed, up to three lines—before they're applied, which helps both neatness and legibility by comparison to writing directly on the cassette.

By far the greatest variety of audio accessories relate to turntables and discs, and a large supplier of such items is Discwasher. Its disc cleaning fluid has been on the market for several years and still is considered by many to be the most effective and least harmful of such moist preparations. For an impressive present, consider the complete DiscKit. Housed in a milled walnut tray with dust cover, it contains a three-ounce bottle of D-3 cleaning fluid, a record brush, the Zero-

stat static-neutralizing ion gun, and a stylus cleaner. Separate apertures in the tray allow for storage of a spare universal headshell and two cartridge-mounting screwdrivers. Price for this all-in-one kit is \$46.

Empire Scientific takes a different approach to record cleaning with its Dry System. It comes in a kit that also includes an ion-gun static eliminator, a dust brush, stylus cleaning fluid and brush, a spare universal headshell, a screwdriver, and cartridge-mounting hardware. Housed in a mahogany base, the complete kit is available for \$79.95.

Another record-cleaning device that is winning admirers is the Pixoff system, distributed by Sonic Research. Similar in design to the familiar clothing lint removers, the Pixoff uses a roller covered with removable layers of thick, pliant adhesive that pulls accumulated dirt and dust from the record grooves. Price is \$17.50, and tape refills are \$3.00 apiece. For those who just want a simple record cleaning brush, Sound Guard offers its Record Buffer. Designed for wet cleaning in conjunction with any record-cleaning fluid or by itself as a dry record brush, its pad is curved to ensure continuous contact with the surface of the disc. To prevent the transfer of dirt and dust from one record to another, the Sound Guard unit comes with a foam grooming pad for cleaning the Buffer prior to each use. Price is an economical \$3.00.

For those who like the convenience of automatic record cleaners, there are various arm-mounted brushes that "track" the disc while it is being played. Bib has one that, it says, solves a record-tracking problem such devices had in the past. Bib's parallel-tracking Groov Kleen uses Teflon bristles that do not inhibit free movement of the brush across the record. Cost is \$13.95.

Several companies (Sound Guard among them, of course) also have products designed to help lengthen the life of vinyl discs by putting down a microscopically thin layer of lubrication. Audio-Technica's entry in this field is called Lifesaver. The substance is applied in aerosol form to the surface of a clean record and then is buffed to distribute the solution evenly. Audio-Technica

claims that treating a record with Lifesaver not only lengthens its life by allowing the stylus to move across it more easily, but reduces static buildup and makes subsequent cleaning easier since dirt and dust do not adhere as tenaciously. The \$13 system includes a two-ounce bottle of fluid, a velvet buffing pad, and thirty small labels on which the date of treatment for each record can be noted.

For the slippery-fingered audiophile who always manages to get fingerprints on disc surfaces, there's the Disc-Cover. This foam mit enables the user to handle albums without ever having to touch the playing surfaces. At just \$3.95, it's inexpensive preventive medicine.

Clean though records may be, static charges that accumulate on their surfaces act as untiring magnets for airborne dust particles. One company that offers an antistatic device is Stanton, whose Permostat is said to ensure against static buildup for the life of the record. The liquid Permostat is applied to a record, which is then buffed. Price for the system, which includes a three-ounce bottle of fluid (enough to treat twenty-five records), a pump sprayer and a buffing pad, is \$19.95.

Antistatic ion guns are also popular and appeal to the Flash Gordon side of the audiophile. While most ion guns must be pumped in order to activate their piezoelectric element, Bib has refined the approach in its Groov Stat 3000; it derives its power from a replaceable battery. A high-pitched signal and neon light indicate that the device is operating, causing a 14,000-volt discharge of positive ions. Bib also sells the Model 94AE tester to check for the presence of residual static charges before and after use of the ion gun. Price for the Groov Stat is \$29.95, and the static tester is \$2.50. Specially treated turntable mats provide another method of controlling static buildup; Statmat from England is a foam mat coated with a conductive compound that allows static charges to be dissipated through the turntable grounding. Price for the Statmat, distributed by IHS Inc., is \$12.95.

Anyone who has ever walked past a turntable while it was operating and heard his footfalls amplified as loud

This Christmas, say good-bye to sizzle, thump, and hiss.

thumps knows what poor turntable isolation sounds like. A turntable is prone to not only this surface-borne type of feedback, but also the air-borne (acoustic) type, such as vibrations transmitted from the speakers. Discwasher has an answer to the isolation problem in the form of its DiscFeet. The four pods that fit over pre-existing turntable feet are said to reduce surface-borne vibrations by as much as 20 dB and acoustic feedback by 25 dB. Price is \$22. Another option for people with wood-grained turntable bases who would like to maintain the wood appearance and still improve isolation is Enid Corporation's Isomate acoustic feedback system. Contained in each Isomate wooden block is a soft rubber damping system. Price is \$13.95.

Record warp is another problem frequently facing the audiophile, and one that can be remedied to a degree with a variety of gadgets. Elpa Marketing distributes something it calls the Audio-Mate Record De-Warper. At first glance it resembles nothing more than a hockey puck, but when slipped over a turntable spindle its weight helps to flatten concave warps. At just \$5.00, who could resist giving it a try? Slightly more expensive (\$15) is the Warp-Out weight, a black zinc ring slightly larger in diameter than a standard 12-inch record. You slip it over the edge bead of a record to help smooth out edge or pinch warp.

Many audiophiles claim that special, antiresonance turntable mats offer extra assurance against vibrations from the rotating platter being picked up by the phono cartridge. An interesting and

somewhat expensive mat, the Spectra Disc Cushion, comes from France. You might ask your dealer for a demonstration before you invest in one (at \$55). Its manufacturer claims that it absorbs all extraneous resonances and results in tighter bass response and sweeter, more natural high frequency reproduction. Another approach to resonance damping is the Eon Disc Clamping Pod. This three-legged plastic device slips over the spindle and clamps the disc tightly to the platter. Its three natural rubber feet absorb spurious vibrations, and the clamping action also helps smooth out record warp. It costs \$12.50 and is distributed by Qysonic.

Another gift for the audio perfectionist is the DBP-10 phono alignment protractor from DB Systems. The aim of this device is to achieve the lowest possible tonearm tracking error by providing a means to calibrate cartridge overhang. At \$20 it's a must for the audiophile who is seeking a reliable way of mounting a cartridge.

Don't forget program material—a really good record always is a welcome gift. Particularly appropriate for the holiday season and a super example of modern digital recording techniques is "New Year's Eve in Vienna" (London LDR 10001/2), recorded live in the city by the Danube and equally memorable for the idiomatic charm of the music and the superclean impact of the sound. Cost is around \$20.

Finally—and we must admit we're prejudiced about this one—if your favorite audiophile wants a way to keep up with everything new in audio equipment and music, you might surprise him with a gift subscription to HIGH FIDELITY or HIGH FIDELITY/MUSICAL AMERICA. You can even keep the cost down by using the special-offer card in this issue. Music lovers are also sure to be pleased by *Records in Review*, an annual compilation of the classical and semiclassical record and tape reviews as they appeared in this magazine. Arranged alphabetically by composer and indexed by performer, the 1979 edition is available for \$16.95 postpaid by writing to Wyeth Press (P.O. Box 550, Great Barrington, Massachusetts 01230). **HF**

If you own even one warped record
you'll appreciate Dual's new
Ultra Low Mass tonearm and cartridge system.

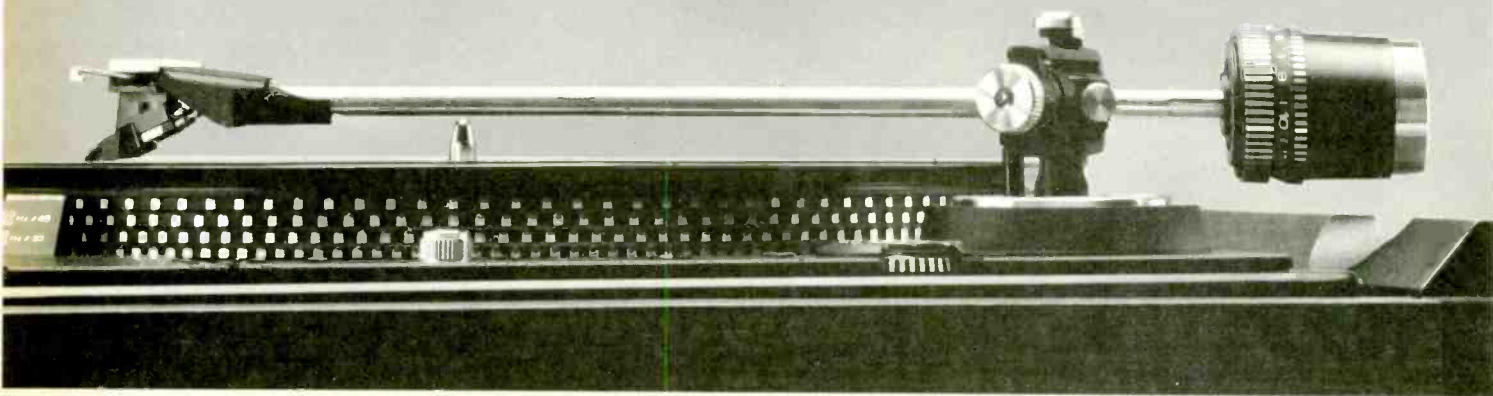

That's not a big "if."

Most records manufactured today are warped. And even when the warps are barely discernible, they interfere with accurate tracking.

The stylus must follow the groove whether it's flat or warped. The heavier the tonearm and cartridge, the more the stylus will tend to dig in when it rides up the warp and to lose contact on the way down.

Conventional tonearms and cartridges have a total effective mass of approximately 18 grams. (Some are even higher.) Dual's new Ultra Low Mass (ULM) tonearm and cartridge system has a total effective mass of 8 grams. The difference this makes in record playback is audible and measurable.

The high inertia of an 18-gram tonearm and cartridge combination can cause tracking force to vary as much as 30 percent. And a warp as small as 1.5 mm (not unusual in new records) can generate harmonic distortion of 2.7 percent. That's audible!

Tracking the same record under the same conditions, the new Dual ULM tonearm and cartridge system reduces

harmonic distortion to only 0.01 percent. That's 270 times less!

ULM not only improves the overall sound quality but significantly extends stylus and record life. What makes ULM possible is the superior design and engineering of Dual's straight-line tubular tonearm with its four-point gyroscopic gimbal suspension—and its ability to accept a cartridge weighing as little as 2 grams. The new ULM cartridges—made by Ortofon to Dual specifications—weigh only 2.5 grams, including mounting bracket and hardware.

To experience the demonstrable advantages of ULM, bring a warped record to your Dual dealer. Listen to it played with the new ULM tonearm and cartridge. (All nine new Dual turntables feature this system.)

You will hear the difference ULM can make on *all* your records, warped or not.

For the complete ULM story, please write to United Audio, 120 So. Columbus Ave., Mt. Vernon, N.Y. 10553.

ULM.

A major breakthrough in record playback technology.



For the life of your records



The only known photograph of Carrie Pringle, taken at the Bayreuth Festival in 1882, gives no clue as to which of the six flower maidens surrounding Hermann Winkelmann (*Parsifal*) she is. Can any reader help?

MUNICH—Take heart if you think that the recent cloudburst of literature about Wagner has confined itself to English-speaking countries. Not at all, for it poureth even more heavily in Germany, where the natives have reached the bottom of all buckets on the question of Wagner's last affair. The matter has been afforded proper academic consideration by Professor Curt von Westernhagen in the *Musical Times* recently, but I feel there is more to it than he or his sources imply. Their response is grave. Mine, I fear, is to roll about on the floor and kick my legs in the air.

It all began about a year ago with an article by Herbert Conrad in the *Nordbayerischer Kurier* about Wagner's encounter in St. Mark's Square, Venice, with a young English soprano called Carrie Pringle. He could only have *seen* her at that stage and had no reason to know that she was a soprano; but, even eighteen months before his death and despite the omnipresence of Cosima, Wagner had not lost his eye for a pretty face. We do not know how they met, but according to an ever-so-slightly-bitchy entry in Cosima's diary for August 5, 1881, she sang Agathe's aria from *Der Freischütz* for him; and the next thing we know is that

she has been engaged to sing in the first group of solo flower maidens in the Bayreuth *Parsifal* of 1882. There were sixteen performances in that season, and Wagner did not hear them all through; he just made sure that he was there for the flower maidens' scene in Act II, at the end of which he always created a disturbance by leaping to his feet and yelling "Bravo!" This did not please the audience, who could not see him in the dark, and must have infuriated Cosima, who suspected that the shout was not so much for the ensemble, but for precisely one-sixth of it, namely Miss Pringle.

Then something very strange happened, which Professor Westernhagen dismisses as chance. (He must be a very tolerant man, for the only fault in his excellent biography of Wagner is his tendency to side with Wagner no matter what the issue.) One night during the *Parsifal* season (nobody can say precisely *which* night) Miss Pringle was about to burst into song and duly took a step forward. A trapdoor opened at her feet, and she disappeared into Klingsor's dungeon or, at the very least, into the trombones, who sit at the back of the under-stage pit at Bayreuth. The other five maidens struggled on by

CULSHAW AT LARGE

The Plot Against Wagner's Miss Pringle

by John Culshaw

themselves, and Miss Pringle, wounded, was taken by cab to her lodgings in Wahnfriedstrasse—the same house, in fact, in which Liszt was later to die. Professor Westernhagen dismisses out of hand the allegation that Cosima had anything to do with the accident, entirely on the grounds that she could not have handled a trapdoor—the *right* trapdoor—without assistance.

Well of course she couldn't, strong as a team of horses though she was; but let us, my dear Watson, look at the motivations. First, having married Cosima (*especially* having married Cosima), Wagner at nearly seventy had no right to be giving the eye to young English ladies whether they could sing or not. Second, he was becoming an embarrassment with those nightly cries of "Bravo," although what he said when Miss Pringle disappeared feet first is not recorded. Third, Liszt is known to have disapproved of Wagner's philandering, not least because the compromised party was his daughter. But suppose Liszt and Cosima contrived the accident between them? Be-gad, the plot thickens!

It is significant that, at a meal after the final rehearsal, Liszt refused to respond

Audio-Technica LIFESAVER™ for the life of your records!

SPRAY AND BUFF EACH RECORD JUST ONCE AND ENJOY...

- No static for 50 plays or more
- No increase in surface noise or distortion even after 100 plays
- More efficient record cleaning with any system, wet or dry
- Protection against environmental attack, loss of vinyl plasticizers
- Improved sound from all records, any age, any speed
- Elimination of many "skips" or "repeats" with worn or damaged records

You can't buy better protection for your records than LIFESAVER with DiscProtect™ formula. Its unique combination of ionic and non-ionic chemistry creates a microscopic layer of protection, molecularly bonded to last for years.

The ideal antistat and record lubricant, LIFESAVER preserves and improves every record you own. It's everything you would expect from the leader in advanced-technology phono cartridges and state-of-the-art recordings. Available at all Audio-Technica dealers today.



 **audio-technica**
INNOVATION □ PRECISION □ INTEGRITY

AUDIO-TECHNICA U.S., INC., Dept. 129H, 33 Shiawassee Avenue, Fairlawn, Ohio 44313

THE CELESTION DITTON 332. ITS RANGE-ABILITY HITS YOU RIGHT BETWEEN THE EARS.

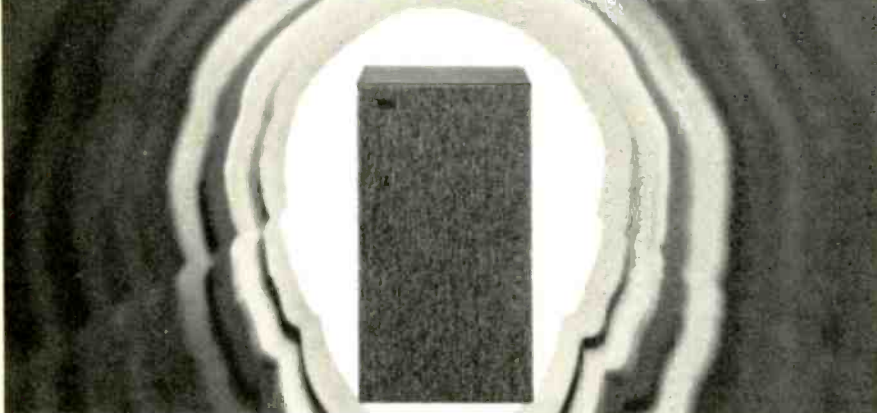

From the incredible bravura of a diva's high C to the seemingly subliminal low E of a string bass. From the explosion of a faraway cannon to the fragile ting of a triangle floating across the room.

That's Range-ability® in the Celestion Ditton 332.

Celestion's Range-ability is also pure pronouncement at any volume—from a level barely perceptible to an overpowering 107dB. Through it all, the Ditton 332 maintains exceptional linearity, imaging, dynamic range and high efficiency.

Celestion manufactures each com-

ponent for its speakers. The result is an integrated acoustic suspension system of superbly efficient elements backed by over 55 years of speaker manufacturing craftsmanship.

Your pair of Ditton 332 cabinets will look as good as they sound. Finishes of oiled American walnut or eim are available.

Range-ability. Finally, listening becomes an experience.

celestion
international 

Circle 10 on Page 115

to a toast and took refuge behind the Master's chair. This of course was a sham, a display of false loyalty to cover the plot that Cosima and he were hatching. Cosima knew the under-stage layout like the back of her hand. She also knew that in 1876 the transformation scenes in the first *Ring* had gone hopelessly wrong because the stagehands were so bored that they had taken to the bottle; if *The Ring* had bored them, what hope was there for *Parsifal*? What's more, they were terrified of her. Her problem was that she did not know the score of *Parsifal* too well. It is therefore my surmise that, on the night when the deed was done, Cosima and Liszt crept backstage, leaving Richard in the box with his eyes glued on Miss Pringle and preparing for his "Bravo!" Cosima roused a couple of somnolent stagehands and placed them under the trap, which they were to open on cue. It was Liszt's job to follow the score and give the cue, which he doubtless did on the final "*Du Thor!*", whereupon Miss Pringle precipitously descended. Since there is not a scrap of evidence to the contrary, it is to be assumed that Wagner did not even notice. The stagehands put Miss Pringle into a cab, and Cosima and Liszt returned to their seats, doubtless mortified that the deed had not been more thoroughly done.

Professor Westernhagen would dismiss all this, if only because his attention is devoted to another aspect of the matter (too late, incidentally, for the American edition of Vol. 2 of his Wagner biography but printed as an appendix to the German edition). It seems that, after the 1882 festival, Miss Pringle went to Milan, and we know that Wagner went again to Venice. Early in the next year Miss Pringle let him know that she was coming to see him, for she doubtless wanted to appear in the festival of 1883. This, according to the Professor, led to an almighty row between Richard and Cosima in the Palazzo Vendramin on the morning of February 13. Their seventeen-year-old daughter Isolde heard it, and so did the servants. And while Cosima was taking lunch with Paul von Joukowski, the designer of the first *Parsifal*, Richard cried out from the next room and died. The implication is that he might not have done so had the row not taken place.

If you study the cast lists, you will find that five of the six principal flower maidens who appeared in 1882 assumed the same parts in 1883 and 1884, after Wagner's death. The Carrie Pringle maiden was sung by someone else. But if she was so young and so pretty and had a voice good enough to gain such attention from Wagner in the last year of his life, the most tantalizing question of all still remains: *Whatever did happen to Carrie Pringle?* **HP**

At 1 $\frac{7}{8}$, it outperforms other cassette decks. At 3 $\frac{3}{4}$, it's in the open-reel class. B·I·C introduces the T-4M. With full metal tape capability, and performance so unprecedented it puts cassette technology on a new plane. Thanks to B·I·C's exclusive Broadband Electronics, at 1 $\frac{7}{8}$ ips the T-4M ranks with the world's finest cassette decks. At 3 $\frac{3}{4}$, it challenges even expensive open-reel machines. The numbers speak for themselves: guaranteed frequency response of 20 Hz to 23 kHz \pm 3dB at 3 $\frac{3}{4}$ on 70 μ Sec tape (20 Hz to 21 kHz at 1 $\frac{7}{8}$!). For complete literature write B·I·C/AVNET, Dept. T, Westbury, N.Y. 11590. **The new T-4M Two-Speed Cassette Deck.**

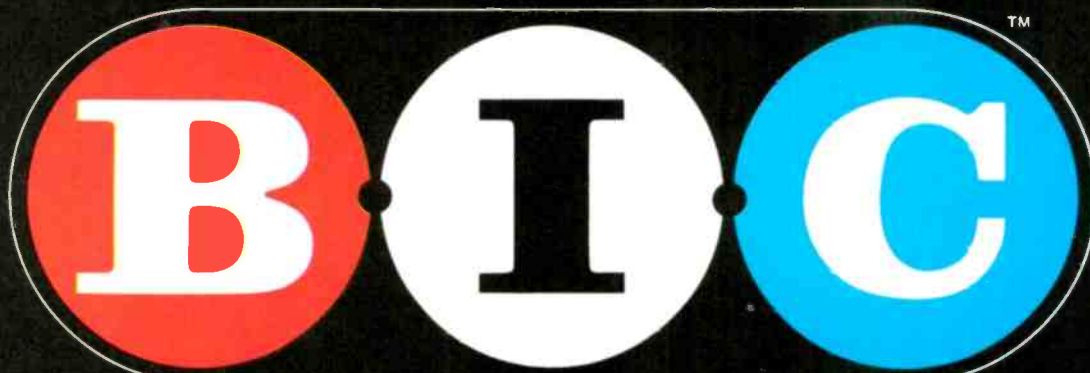

Say "Bee-Eye-Cee". Think "Best-In-Components."

Series Z Changer-Turntables | Cassette Decks | SoundSpanTM Speaker Systems | The Beam Box[®]

Tomorrow is here early.

Now, a line of audio components which is truly ahead of its time. Introducing the SAE TWO R6 and R9 Receivers, matching T7 Tuner and A7 Integrated Amplifier, and C4 Cassette Deck—a collection of engineering masterpieces meticulously blending unique features with impressive specifications.

SAE TWO Receivers and Tuners have a Quartz-Lock reference of the type used by radio stations in bearing their signal. This system actually locks in the station, eliminates drift, lowers distortion and provides performance limited solely by the station's broadcast quality.

The R9 Receiver features a Digitally Synthesized touch tuning section, first developed for the space program, which precisely advances the tuner to every FCC assigned position with pinpoint accuracy.

Additional features include Digital Readout of the exact station frequency taking the guess work out of finding your favorite stations. And, a massless multi-functional Bar Graph Display which responds instantly

and accurately, providing information on signal strength, multipath and power output.

All SAE TWO Receivers and Integrations feature a Single-Strata Voltage Amplifier which utilizes the hybrid technique of selecting active components from the same production batch and mounting them on a uniform thermal base. The result is superior thermal tracking and gain linearity, unobtainable in conventional designs.

The new C4 Cassette Deck has Metal Tape capability, the latest breakthrough in recording technology. It provides greater high end response with lower distortion. And, with the tape deck's adjustable bias feature you can optimize its performance with any brand of tape available now... or in the future.

Unique features? Yes! Impressive specifications? You Bet!

SAE TWO—see tomorrow's line of components today at your SAE dealer.

SAE TWO

For the latest information, fast, write:
SAE TWO, P.O. Box 60271, Terminal
Annex, Los Angeles, CA 90060.
In Canada, The Pringle Group,
30 Scarsdale Rd., Don Mills,
Ontario, Canada M3B 2R7.



Feature Reviews



Ormandy's Bartók: Digital RCA or Analog Angel?

Each has its points,
but Angel stacks up better.

by Abram Chipman

The concurrent appearance of Ormandy conducting Bartók under two auspices raises some questions. Is the best sound RCA's, whose brotherly love for the Philadelphia Orchestra goes back to nearly the dawn of American symphonic recording? Or is it Angel/EMI's, embarked on a brand-new contract with the ensemble? Is it the Scottish Rite Cathedral (formerly Town Hall), oft-preferred as a recording site by both RCA and Columbia over the band's dry-sounding home base, the Academy of Music? Or is it the Old Met (now a church), excitingly rediscovered by Angel? Is it the digital recording method, here bowing in on the Red Seal label (on an all-red disc, in fact)? Or is the analog method still good enough for us?

In reporting what I hear, the assumption is temporarily accepted that the works on these two records make more or less comparable sonic demands. 1) RCA offers more startlingly localized lateral separation, and Angel more front-back sense of depth. 2) Both recordings are very clean, but RCA is decidedly more transparent in its detail. Angel's sonics blend more. 3) Highs are more crystalline on RCA, mid-bass warmer and richer on Angel. In fact, the string tone is sweeter on the EMI analog record. 4) Low-bass energy didn't strike me as superior on the digital record, and the dynamic range began to sound really impressive only in the closing pages of the *Concerto's* last movement. 5) Angel's surfaces are far quieter than one has come to expect. RCA's are noisier: The end of the first side was very swishy—on two different copies (albeit both bearing the same stamper number)—which tends to nullify

the audibly better signal-to-noise ratio of the digital disc. (And while I'm at it, RCA permitted some pre-echo to creep in before the start of the *Intermezzo*.)

The pundits tell us (and the symphonic recordings thus far issued by Telarc bear out) that the digital technology offers superior cleanness, transparency, bass energy, dynamic range, and S/N ratio. RCA's entry into the field decisively excels only in the second of these dimensions. My theory? There's more to audio technology than how sound waves are transferred to a master tape. There are such things as hall acoustics (in case I haven't made it clear, I think Philadelphia's Old Met is the closest thing to the Concertgebouw on this side of the Atlantic). Microphone placement and mixing count for something (where's the sense of space around the orchestra on RCA's release?). So do mastering, pressing, and a thousand and one other factors.

And, you may be sure, the quality of music-making has its effect. There is no doubt that Ormandy has "mellowed" in his view of the *Concerto for Orchestra* since his somewhat glib and glossy Columbia recordings—to a degree that lends some support to the usually rejected notion that Bartók's leukemia affected the vitality and strength of the music he was writing in his final years. I find the new reading utterly dyspeptic. Put on Boulez, and you're in a different world of rhythmic propulsion. Try Kubelik, and there's a modicum of color and refinement. Or Solti, and the tension, humor, and nationalist folk spirit is unmistakable. (The 1965 London recording, incidentally, wears its age with nary a wrinkle.) Going back to another tech-

nology, Koussevitzky's 1944 broadcast premiere of the work cries out for commercial issue, and maybe RCA will oblige someday. It has the original ending and, like Van Beinum's great Concertgebouw recording of a few years, later explores the virtuoso potential of the instrumental writing like nothing since.

Ormandy's *Mandarin* is a fine one. It has a compassion and dignity not found in the more gut-wrenching and lurid Ozawa version, but I like both, as I do Solti's wiry, nervous, and also more lyrical account. All three, of course, omit the ballet's ending (for which you should turn to Boulez on Columbia M 31368), and all three offer the same pairing. In the *Music*, Ozawa is more refined and Solti more impetuously driving. And both earlier (but still sonically impressive) recordings have greater tensile strength and rhythmic flair than Ormandy's somewhat tepid one.

BARTÓK: Concerto for Orchestra.

A Philadelphia Orchestra, Eugene Ormandy, cond. [Jay David Saks, prod.] RCA RED SEAL DIGITAL ARC 1-3421, \$9.98.

COMPARISONS:

Boulez/N.Y. Phil. Col. M 32132
Kubelik/Boston Sym. DG 2530 479
Solti/London Sym. Lon. 6784

BARTÓK: Miraculous Mandarin:
Suite. Music for Strings, Percussion, and Celeste.

Philadelphia Orchestra, Eugene Ormandy, cond. [John Willan, prod.] ANGEL SZ 37608, \$8.98.

COMPARISONS—same coupling:

Ozawa/Boston Sym. DG 2530 887
Solti/London Sym. Lon. 6783

Schoenberg, Berg, and Webern the Ideal Christmas Present?

Yes, if it's really Johann Strauss, says our reviewer of the "sleeper of the year."

by Irving Lowens



Johann Strauss arrangers Arnold Schoenberg, Alban Berg, and Anton Webern

No, the listing here is not a figment of somebody's fevered imagination—we have four famous waltzes by Johann Strauss the Younger arranged by Arnold Schoenberg, Alban Berg, and Anton Webern. And this is an absolutely glorious recording, an absolutely ideal Christmas present. It could be the sleeper of the year.

The story of how these transcriptions came to be is a fascinating one. It has to do with the organization, in November 1918, by Schoenberg of the *Verein für musikalische Privat-Aufführungen* (Society for Private Musical Performances), with the avowed purpose of enabling musicians and music lovers to learn to love modern music by presenting thoroughly rehearsed, private performances of misunderstood contemporary works. During the first nine meetings compositions by Bartók, Berg, Debussy, Hauer, Mahler, Pfitzner, Reger, Schreker, Scriabin, Richard Strauss, Stravinsky, Webern, and Zemlinsky were offered. The name of Johann Strauss II was not included in the first few years—indeed, his music did not seem to be the sort of thing the society would devote its energies to. Just how did the Waltz King get into Schoenberg's act?

Even though the society grew to number some 300 people, it found itself in need of money. In May 1921, at the Schwarzwald School, it held an extraordinary evening event to which guests were in-

vited (contrary to the rule) to hear four Strauss waltzes, all transcribed by "performance instructors" of the group. The pieces were scored by Schoenberg, Berg, and Webern in double-quick time for the customary salon orchestra of the day in Vienna—piano, harmonium, and string quartet. (According to Josef Rufer, that combination of instruments was intended to demonstrate that the thick, muddy orchestration ordinarily heard in salons by no means was due to the ensemble, but stemmed from the musical limitations of the "hacks" who did the arrangements.) At the conclusion of the concert, their manuscripts of the transcriptions were auctioned off, fetching excellent prices.

Writing to his friend Erwin Stein a week after the event, Berg said: "The waltzes all sounded fabulously good, even my *Wein, Weib, und Gesang*. Schoenberg's instrumentation was naturally far superior to mine. I would not have been so venturesome. Steuermann, for example, who smiled when Schoenberg remarked that everyone would have to look at his part at home, received a fantastically difficult piano part, which certainly sounded splendid. After my waltz, frenetic applause broke out, which Schoenberg allowed in order to create a favorable atmosphere. Webern's waltz, the third in the program, had to be repeated, with Webern at the leader's desk and Schoenberg playing the

cello. The performances were splendid; even my harmonium playing went accordingly."

The ensemble that Schoenberg put together for the Strauss evening (how such a sensational happening escaped the eagle eye of Nicolas Slonimsky for inclusion in his cherishable anthology of curiosia, *Music Since 1900*, is a mystery) was stunning. In addition to Edward Steuermann at the piano and Berg at the harmonium, Rudolf Kolisch and Schoenberg shared honors as first violin, Karl Rankl played second violin, the violist was Othmar Steinauer, and the cellist was Webern.

The Boston Symphony Chamber Players may not have haloes around their heads, as did the original performers, but they probably are better artists than the three famous members of the Second Viennese School. Violinists Joseph Silverstein and Max Hobart, violist Burton Fine, cellist Jules Eskin, harmonium player Jerome Rosen, and pianist Gilbert Kalish are simply marvelous as an *alt Wienerisch* salon orchestra.

The only cavil I have with this disc is that only three of its four Strauss waltzes match the 1921 program. The *Emperor Waltz* was arranged by Schoenberg in 1925 for a different ensemble—flute, clarinet, string quartet, and piano. This combination of instruments is only marginally less weird than that used for the others, yet it is magical, evoking that Vienna that is the enchanted city of everyone's dreams. And the addition of flutist Doriot Anthony Dwyer and clarinetist Harold Wright to the assemblage makes me almost willing to forgo—for the moment—the pleasure of hearing a genuine facsimile of Schoenberg's 1921 "*ausserordentlichen Abend*."

There is a note on the jacket that reads: "The low frequency noise heard at certain moments in the recording comes from the bellows of the harmonium and is unavoidable." Except for this barely perceptible technical flaw, the engineering is of the highest standard. Deutsche Grammophon has every right to be proud of this curiosity.

STRAUSS, J. II: Waltzes: Kaiser, Op. 437 (arr. Schoenberg); Rosen aus dem Süden, Op. 388 (arr. Schoenberg); Wein, Weib, und Gesang, Op. 333 (arr. Berg); Schatz, Op. 418 (arr. Webern).

Boston Symphony Chamber Players. [Rainer Brock, prod.] DEUTSCHE GRAMMOPHON 2530 977, \$8.98. Tape: 3300 977, \$8.98 (cassette).

For those who appreciate simple virtuosity

The 480 Series

With the 480 Series, Nakamichi again offers a more affordable cassette recorder—a deck that is simpler to operate, but that sacrifices neither Nakamichi sound nor Nakamichi excellence. The secret is simple. The Asymmetrical, Diffused-Resonance Transport—shared by all three models and closely akin to that of the highly acclaimed 582—is a 3-motor, dual-capstan drive so unique in its simplicity and elegance that it can be manufactured with virtually zero defects. Each 480-Series deck is factory calibrated to yield optimum performance with three types of tape—ferric, chrome-equivalent, and metal. Use products of equivalent quality, and you can experience Nakamichi sound and Nakamichi specifications—response to 20 kHz—in your home.

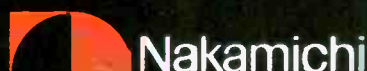

480

The 2-Head Model 480—fully metal-compatible thanks to our special, narrow-gap, Sendust R/P head and exclusive Direct-Flux erase head. Wide-range, peak-responding meters, professional sliding record-level controls, Dolby, and defeatable MPX filter, of course! Even an optional remote control.



481

Step up to the 481, a 3-Head deck utilizing Nakamichi's exclusive "Crystalloy" cores and "Discrete-Head" technology. All the features of the 480 plus the greater dynamic range of a discrete 3-Head format.



482

For those who demand "off-tape monitoring," the 482—a 3-Head deck similar to the 481 but with two complete sets of electronics and Double-Dolby so you can hear exactly what has been recorded as it is being recorded.



The 480-Series starts at under \$500. For more information, write to Nakamichi U.S.A. Corp., 1101 Colorado Avenue, Santa Monica, CA 90401

Many amps can deliver pure sound. The Sansui AU-919 delivers pure music.



Today's audio engineering has reached the point where you can select among a number of affordable high-power amplifiers that have virtually no "total harmonic distortion." That's good. But THD measurements only indicate an amplifier's response to a pure, continuously repeating, steady-state test signal (below, left). They don't tell you how the amp responds to the never-repeating, rapidly-changing transient waveforms of real music (below, right). And only an amplifier designed to reproduce the demanding dynamics of music signals can satisfy the critical audiophile. An amp like the Sansui AU-919.

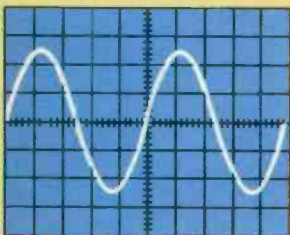

SINE WAVE

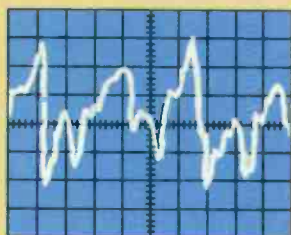

DYNAMIC MUSIC SIGNALS

Because low THD without low TIM is like sound without music, the Sansui AU-919 is designed to respond well to both simple sine-wave test signals and also to handle the jagged, pulsive edges required for realistic reproduction of music—without imparting that harsh, metallic quality known as "transient intermodulation distortion" (TIM).

The Sansui AU-919 sounds better than conventional amps because Sansui developed a unique (patent pending) circuit that is capable of achieving both low THD and low TIM simultaneously.

Our DD/DC (Diamond Differential/DC)* circuitry provides the extremely high drive current necessary to use proper amounts of negative feedback to reduce conventionally-measured THD (no more than 0.008%, 5Hz-20,000Hz into 8 ohms at 110 watts, min. RMS) without compromising our extraordinary 200V/ μ Sec slew rate, ensuring vanishingly-low TIM, as well. The power amplifier frequency response extends from zero Hz to 500,000Hz.

Since ultimate tonal quality depends on more than the power amplifier alone, Sansui also uses its DD/DC* circuitry in the phono equalizer section—where current demands are also particularly high—to prevent TIM. ICL (input capacitorless) FET circuits are used throughout the AU-919, and a "jump switch" is provided that will let you run pure DC from the Aux. input to the output.

Visit your authorized Sansui dealer today, and he'll show you a lot more that the AU-919 has to offer. Like twin-detector protection circuitry and our Penta-Power Supply system. Two-deck monitoring/recording/dubbing facilities. And a high-performance ICL/FET pre-preamp for moving-coil cartridges.

Then listen to the AU-919 with the most demanding music you can find. You'll hear the way the music should sound. Like music. Not just like sound.

*The Diamond Differential/DC, Sansui's (patent pending) totally symmetrical double ended circuitry with eight transistors, is named for its Diamond-shaped schematic representation.

SANSUI ELECTRONICS CORP.

Lyndhurst, New Jersey 07071 • Gardena, Ca. 90247
Sansui Electric Co., Ltd., Tokyo, Japan
Sansui Audio Europe S.A., Antwerp, Belgium
In Canada: Electronic Distributors

Sansui

Recent Record releases

The following listings are excerpts from the "New Listings" section of the October Schwann Record and Tape Guide. Some listings contain a cross-reference (*) to other works on the recording. Letters in brackets refer to language used in vocal music (G, German; E, English, etc.). Cassette editions are indicated by the symbol Δ . Quadriphonic discs are indicated by a Q following the record number.

BACH, JOHANN SEBASTIAN

Brandenburg Concerti (6), S.1046/51

Maksymiuk, Polish Ch. Orch.

2-Ang. SZ-3873

Christmas Oratorio, S.248

Schneidt, Regensburger Domspatzen [G]

3-DG ARC-2710024; /2276012

Duets for Harpsichord, S.802/5

Verlet † Italian: Partita S.831 Phi. 9500588

Italian Concerto in F for Harpsichord, S.971

Verlet † Duets; Partita S.831 Phi. 9500588

Motets (6), S.225/30

Ehmann, Westminster Cho. [G]

2-Peters PLE-124/5

Organ Music

Walcha: Toccata & Fugue in d, S.565;

Prelude & Fugue in Eb, S.552; Toccata &

Fugue in d, "Dorian", S.538; Fantasia in

G, S.572; Fantasia in c, S.562

DG 2535126; /3335126

Partita in b for Harpsichord, S.831

Verlet † Duets; Italian 9500588

Prelude & Fugue in Eb for Organ, "St. Anne", S.552

Walcha (see Organ)

DG 2535126; /3335126

Toccata & Fugue in d for Organ, S.565

Walcha (see Organ)

DG 2535126; /3335126

Toccata & Fugue in d for Organ, "Dorian", S.538

Walcha (see Organ)

DG 2535126; /3335126

BEEHOVEN, LUDWIG VAN

Mass in C, Op. 86

Eda-Pierre, Payne, Tear, Moll, Davis,

London Sym. & Cho. [L]

Phi. 9500636; /7300741

Missa Solemnis in D, Op. 123

Moser, Schwarz, Kollo, Moll, Bernstein,

Concertgebouw Orch., Hilversum Radio

Cho. [L] 2-DG 2707110; /3370029

Sonatas (32) for Piano

No. 14 in c#, Op. 27, No. 2, "Moonlight"

Davidovich (& Für Elise) † Son. 18

Phi. 9500665; /7300763

No. 18 in Eb, Op. 31, No. 3

Davidovich † Son. 14

Phi. 9500665; /7300763

Songs (Scottish, English, Irish, Welsh)

White: When Mortals All to Rest Retire,

Op. 226/15; 'Tis Sunshine At Last, Op.

224/13; The Kiss, Dear Maid, Op.

224/9; Cease Your Funning, Op. 227/5;

The Return to Ulster, Op. 223/1; O

Mary, at Thy Window Be, Op. 108/17;

Sally in Our Alley, Op. 108/25; Cupid's

Kindness, Op. 226/21; The Pulse of an

Irishman, Op. 255/4; On the Massacre of

Glencoe, Op. 223/5; O Harp of Erin, Op.

223/25; Come Draw We Round, Op.

223/8; The Soldier, Op. 228/2; The Bri-

tish Light Dragoons, Op. 224/3; The

Vale of Clwyd, Op. 226/19; Good Night,

Op. 226/26 RCA ARL1-3417

BERG, ALBAN

Lyric Suite for String Quartet

Boulez, NY Phil. † Schoenberg: Verklärte

Col. M-35166; /MT-35166

BERLIOZ, HECTOR

Symphonie funèbre et triomphale, Op. 15

Dondeyne, Gardiens de la Paix

None. 71368

BERWALD, FRANZ

Grand Septet in Bb

Nash Ens. † Hummel

Van. 71260

BIZET, GEORGES

Jeux d'enfants, Op. 22

Haitink, Concertgebouw Orch. † Sym.

Dag 9500443; /7300649

Symphony No. 1 in C

Haitink, Concertgebouw Orch. † Jeux

Phi. 9500443; /7300649

BRAHMS, JOHANNES

Academic Festival Overture, Op. 80

Masur, Leipzig Gewandhaus Orch. †

Sym.; Tragic; Haydn Var.

4-Phi. 6769009; /3-7699110

Concerto No. 1 in d for Piano, Op. 15

Ohlsson, Tennstedt, London Phil.

Ang. SZ-37568

Symphonies (4) (complete)

Masur, Leipzig Gewandhaus Orch. † Aca-

demic; Tragic; Haydn Var.

4-Phi. 6769009; /3-7699110

No. 2 in D, Op. 73

Abbado, Berlin Phil.

DG 2535292; /3335292

Tragic Overture, Op. 81

Masur, Leipzig Gewandhaus Orch. † Aca-

demic; Sym.; Haydn Var.

4-Phi. 6769009; /3-7699110

Variations on a Theme by Haydn, Op. 56a

Masur, Leipzig Gewandhaus Orch. † Aca-

demic; Sym.; Tragic

4-Phi. 6769009; /3-7699110

BRITTEN, BENJAMIN

Ceremony of Carols, Op. 28

Vienna Cho. Boys [E] (& 7 English Carols)

RCA ARL1-3437; /ARK1-3437

CHOPIN, FREDERIC

Preludes (24), Op. 28

Davidovich Phi. 9500666; /7300764

DEBUSSY, CLAUDE

Preludes for Piano, Books 1 & 2

Ciani (Bk 2) DG 2535261; /3335261

DIAMOND, DAVID

Night Music, for Accordion & String Quar-

ter

Davine, Lamont Qr (see Coll.) Crys. S-106

DODGE, CHARLES (1940-

Extensions, for Trumpet & Tape (1973)

Stevens † Henze; Kupferman; Lazarof;

Vega Crys. S-366

DONIZETTI, GAETANO

Concertino in G for English Horn & Or-

chestra

Holliger, Zinman, Concertgebouw Orch. †

Haydn: Oboe Con.; Reicha; Rossini:

Theme Phi. 9500564; /7300713

DUFAY, GUILLAUME

Chansons

Blachly, Pomerium Musices (2): Je me

complains; Navre je suy † Missa Ecce

ancilla; Motets None. 71367

Missa Ecce ancilla Domini

Blachly, Pomerium Musices † Chansons;

Motets None. 71367

Motets

Blachly, Pomerium Musices (4): Anima

mea liquefacta est; Gloria Resurrexit

dominus; Ave regina celorum; Ecclesie

militantis † Chansons; Missa Ecce ancilla

None. 71367

DVOŘÁK, ANTONIN

Concerto in b for Cello, Op. 104

Fournier, Szell, Berlin Phil.

DG 2535106; /3335106

Symphony No. 9 in e, Op. 95, "New World"

Böhm, Vienna Phil.

DG 2531098; /3301098

GIULIANI, MAURO

Le Rossiniane, Op. 119 & Op. 121 for

Guitar

A. Romero † Var. Op. 7, 107 Ang. SZ-37326

Variations (6), Op. 7; Variations on a

Theme of Handel, Op. 107 for Guitar

A. Romero † Rossiniane Ang. SZ-37326

HARBISON, JOHN

The Flower-Fed Buffaloes, for Baritone,

Chorus & 7 Players (1976)

Evitts, Harbison, Speculum Musicae, Em-

manuel Cho. [E] † Rzewski None. 71366

HARRIS, ROY

When Johnny Comes Marching Home, An

American Overture (1934)

Mester, Louisville Orch. † Piston: Sym. 1;

Weinzweig Lou. 766

HAYDN, (FRANZ) JOSEPH

Concerto in C for Oboe & Orchestra [at-

trib.]

Holliger, Zinman, Concertgebouw Orch. †

Donizetti: Con.; Reicha; Rossini: Theme

Phi. 9500564; /7300713

Symphony No. 45 in F#, "Farewell"

Barenboim, English Ch. Orch. † Sym. 48

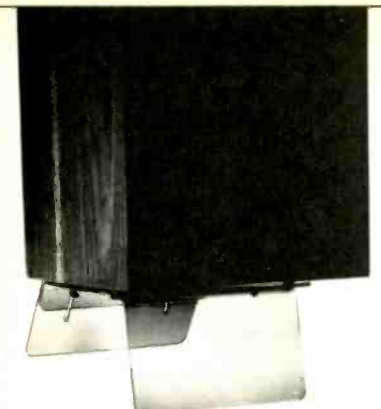

Soundstage Speaker Stands get your sound off the ground for as little as \$39.95.

**It's the least expensive
way to upgrade
your system!**

Soundstage Speaker Stands prevent base booming and sound absorption while promoting flat, tight response and better sound dispersion. Realize the full potential of your speaker system with the Soundstage Adjustable speaker stand, available in clear or bronze. Order today!

**Clear \$39.95 a pair
Bronze \$44.95 a pair**

**Order direct from
the manufacturer!**

Please send me _____ pair(s)

clear @ \$39.95 a pair PPD

bronze \$44.95 a pair. PPD

Check enclosed (Make payable to ABCO, Inc.)

Mastercharge

Visa

Card # _____

Expiration date _____

Name _____

Address _____

City _____

State _____ Zip _____

MANUFACTURED BY
ABCO
SOUNDSTAGE DIVISION

116 Mills St.
Collierville, TN 38017
(901) 853-8030

DG 2531091; /3301091
Symphony No. 48 in C, "Maria Theresia"
Barenboim, English Ch. Orch. † Sym. 45
DG 2531091; /3301091
Symphony No. 82 in C, "L'Ours"
Marriner, St. Martin's Acad. † Sym. 83
Phi. 9500519; /7300675
Symphony No. 83 in g, "Poële"
Marriner, St. Martin's Acad. † Sym. 82
Phi. 9500519; /7300675

HENZE, HANS WERNER
Sonatas for Solo Trumpet (1976)
Stevens † Dodge; Kupferman; Lazarof;
Vega Crys. S-366

HINDEMITH, PAUL
Mathis der Maler (1938)
Koszut, Wagemann, King, Cochran, Fischer-Dieskau, Meven, Kubelik, Bavarian RadioSym. & Cho. [G] 3-Ang. SZX-3869
Quartet No. 3, Op. 22 (1921); Quartet No. 4, Op. 32 (1923)
LA Qr GSC 10
Sonata for Oboe & Piano
Weiss, Carno (& Bourdeau:Premier Solo)
† Messiaen:Merle; Vivaldi:Trio Son.
Crys. S-354

HUMMEL, JOHANN NEPOMUK
Septet in d, Op. 74
Nash Ens. † Berwald Van. 71260

HUMPERDINCK, ENGELBERT
Hansel and Gretel
Cotrubas, Von Stade, Söderström, Ludwig, Nimgern, Pritchard, Gürzenich Orch. [G] 2-Col. M2-35898

KUPFERMAN, MEYER
Three Ideas, for Trumpet & Piano (1967)
Stevens, Swiatkowski † Dodge; Henze; Lazarof; Vega Crys. S-366

LAZAROF, HENRI
Concertazioni, for Trumpet, 6 Instruments & Tape
Stevens, Lazarof, Ens. † Dodge; Henze; Kupferman; Vega Crys. 2-366

MAHLER, GUSTAV
Symphony No. 9 in D
Morris, Symphonica of London
2-Peters PLE-116/7

MASCAGNI, PIETRO
Cavalleria Rusticana
Scotto, Domingo, Elvira, Levine, Nat'l Phil., Ambrosian Op. Cho. [I]
RCA CRL1-3091; /CRK1-3091
(\$11.98)

MESSIAEN, OLIVER
Merle noir, for Flute & Piano
Weiss, Carno † Hindemith:Oboe Son.; Vivaldi:Trio Son. Crys. S-354

MOZART, WOLFGANG AMADEUS
Quartet in g for Piano & Strngs, K.478
Levine, Mann, Ouzounian, Harrell † Qn K.452 RCA ARL1-3376; /ARK1-3376
Quintets (6), K.174, 406, 515, 516, 593, 614
Juilliard Qr, Graham 3-Col. M3-35896
Quintet in Eb for Piano & Winds, K.452
Levine, Still, Brody, Clevenger, Elliot †

Qr. K.478
RCA ARL1-3376; /ARK1-3376
NIELSEN, CARL
Quartet No. 2 in f, Op. 5; Quartet No. 3 in Eb, Op. 14
Nielsen Qr DG 2531125
PISTON, WALTER
Symphony No. 1 (1937)
Mester, Louisville Orch. † Harris; Weinzwieg Lou. 766
PROKOFIEV, SERGEI
Symphony No. 1 in D, Op. 25, "Classical"
Kurtz, Phil. Orch. † Shostakovich:Sym. 1 Sera. S-60330

REICHA, ANTON
Scena for English Horn & Orchestra
Holliger, Zinman, Concertgebouw Orch. † Donizetti:Con.; Haydn:Oboe Con.; Rossini:Theme Phi. 9500564; /7300713
RIMSKY-KORSAKOV, NIKOLAI
Scheherazade, Op. 35
Leinsdorf, Concert Arts Orch. Sera. S-60329
Ormandy, Phila. Orch.
RCA ARL1-0028; /ARK1-0028

ROSSINI, GIOACCHINO
Otello (1816)
Von Stade, Carreras, Ramey, Lopez Cobos, Phil. Orch., Ambrosian Op. Cho. [I] 3-Phi. 6769023; /2-7699110
Theme & Variations for Clarinet & Orchestra
Holliger (oboe), Zinman, Concertgebouw Orch. † Donizetti:Con.; Haydn:Oboe Con.; Reicha Phi. 9500564; /7300713

RZWESKI, FREDERIC
Song and Dance (1977)
Speculum Musicae † Harbison None. 71366

SCHNITTKE, ALFRED (1934-)
Concerto Grosso for 2 Violins, Strings, Cembalo & Prepared Piano (1976-7)
Kremer, Grindenko, Rozhdstvensky, London Sym. † Sibelius:Con. Van. 71255

SCHOENBERG, ARNOLD
Verlärte Nacht, Op. 4
Boulez, NY Phil. † Berg:Lyric Col. M-35166; /MT-35166

SCHUBERT, FRANZ
Der Hirt auf dem Felsen, D.965
Ameling, Deplus, Gage (see Songs)
Peters PLE-123; /PCE-123

Die Schöne Müllerin, D.795
Wunderlich [G] DG 2535133; /3335133
Songs

Ameling, w. Gage [G,I]: Der Hirt auf dem Felsen (w. Deplus, clar.); Auf dem Strom (w. Studebaker, horn); 4 Songs on Italian texts; Gott im Frühlinge; Die Sommernacht; Herbst; Der Winterabend
Peter PLE-123; /PCE-123

SCHUMANN, ROBERT
Arabeske for Piano, Op. 18
Egorov † Fant. Op. 17
Peters PLE-122; /PCE-122

Carnaval, Op. 9
 Barenboim † Faschingsschwank
 DG 2531090; /3301090

Fantasia in C, Op. 17
 Egorov † Arabeske
 Peters PLE-122; /PCE-122

Faschingsschwank aus Wien, Op. 26
 Barenboim † Carnaval
 DG 2531090; /3301090

Intermezzi (6), Op. 4
 Eschenbach † Kinderscenen; Var.; Waldscenen
 DG 2535224; /3335224

Kinderscenen, Op. 15
 Eschenbach † Intermezzi; Var.; Waldscenen
 DG 2535224; /3335224

Manfred Overture, Op. 115
 Kubelik, Bavarian Sym. † Sym.
 3-Col. M3-35199

Symphonies (4) (complete)
 Kubelik, Bavarian Sym. † Manfred
 3-Col. M3-35199

Variations on A-B-E-G-G, Op. 1
 Eschenbach † Intermezzi; Kinderscenen; Waldscenen
 DG 2535224; /3335224

Waldscenen for Piano, Op. 82
 Eschenbach (4) † Intermezzi; Kinderscenen; Var.
 DG 2535224; /3335224

SHOSTAKOVICH, DMITRI
Symphony No. 1 in F, Op. 10
 Kurtz, Phil. Orch. Dag Prokofiev:Sym. 1
 Sera. S-60330

SIBELIUS, JEAN
Concerto in d for Violin, Op. 47
 Kremer, Rozhdestvensky, London Sym. † Schnittke
 Van. 71255

STRAUSS, RICHARD
Sonata in Eb for Violin, Op. 18
 Skowronski, Isaak † Szymanowski
 Eb-Sko 1006

STRAVINSKY, IGOR
Pulcinella (ballet after Pergolesi)
 Berganza, Davies, Shirley-Quirk, Abbado,
 London Sym. DG 2531087; /3301087

SUBOTNICK, MORTON (1933-
Liquid Strata, for Piano & Electronics (1977)
 Grierson † Kraft; Lesemann Town S-24

SZYMANOWSKI, KAROL
Romance for Violin & Piano, Op. 23; 3 Caprices of Paganini, Op. 40
 Skowronski, Isaak † Strauss:Vn Son.
 Eb-Sko 1006

TCHAIKOVSKI, PIOTR ILYICH
Capriccio italien, Op. 45
 Rostropovich, Berlin Phil. † Nutcracker
 DG 2531112; /3301112

Nutcracker Suite, Op. 71A
 Rostropovich, Berlin Phil. (& Andante cantabile, Op. 11) † Capriccio
 DG 2531112; /3301112

Sleeping Beauty (excerpts)
 Rostropovich, Berlin Phil. † Swan
 DG 2531111; /3301111

Swan Lake (excerpts)
 Rostropovich, Berlin Phil. † Sleeping

DG 2531111; /3301111

VEGA, AURELIO DE LA
Para-Tangents, for Trumpet & Tape (1973)
 Stevens † Dodge; Henze; Kupferman; Lazarof
 Crys. S-366

VERDI, GIUSEPPE
Rigoletto
 Sills, Kraus, Milnes, Rudel, Phil. Orch., Ambrosian Op. Cho. [1]
 3-Ang. SZX-3872

WAGNER, RICHARD

Choruses
 Pitz, Bayreuth Fest. [G]; from Fliegende Holländer (w. Schärtel), Tannhäuser, Lohengrin, Meistersinger, Götterdämmerung (w. Greindl), Parsifal
 DG 2535180; /3335180

WEINZWEIG, JOHN (1913-
Symphonic Ode (1958)
 Mester, Louisville Orch. † Harris; Piston:
 Sym. 1 Lou. 766

© 1979 ABC Schwann Publications

SUPER DISCS

Quality Music, Quality Pressings, Quality Sound

Nautilus Half-Speed Mastered Series

SUPER DISCS



Nautilus Recordings premieres The Half-Speed Master Series. These high quality discs are produced from the original master tapes, mastered at half-speed to insure maximum fidelity and then pressed on 100% virgin vinyl to bring you all the music. Coming soon, The Doobie Bros., America, Pablo Cruise, Joan Baez, John Klemmer and Tim Weisberg. Expect more from Nautilus Recordings.

Nautilus Recordings
 761 Shell Beach Rd.
 Pismo Beach, CA 93449
 (805) 773-1848
 Dealer Inquiries invited



Produced by Mike Flicker

MORE THAN 100 EXCLUSIVE TEST REPORTS

STEREO TEST REPORTS

\$2.95 1980 EDITION

From the Editors of STEREO Magazine • A High-Fidelity Group Publication
 Your Buying/Reference Guide to Stereo Components

Component Compatibility
 • What Is It?
 • Why It's A Must

Special:
 Inside Our
 Testing
 Lab

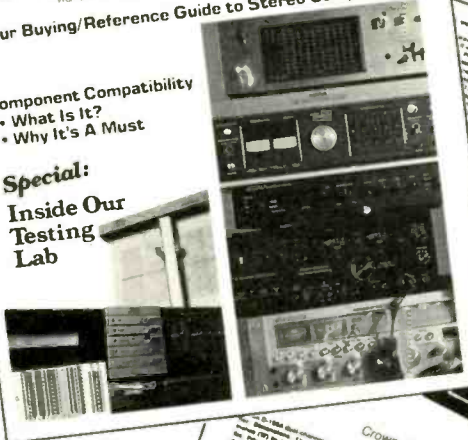

ANNOUNCING STEREO TEST REPORTS 1980



Save time; save money, before you buy, read STEREO TEST REPORTS — more than 100 exclusive test reports from the editors of STEREO magazine

- Tape Equipment
- Speaker Systems
- Phono Cartridges
- Turntables & Tonearms
- Tuners & Receivers
- Amplifiers & Preamplifiers

Plus — System Accessories including Sound Processors & Equalizers, Headphones, Tape & Record Care and More

Plus — Glossary of Stereo Terminology and articles on Saving Money and Buying Compatible Components.

STEREO TEST REPORTS 1980
 1 SOUND AVENUE
 MARION, OHIO 43302

Please send me _____ copy(ies) of STEREO TEST REPORTS 1980 @ \$2.95 each plus \$1.00 for shipping.
 I Enclose \$ _____

Name _____

Address _____

City _____ State _____ Zip _____

Payment must accompany order. Please allow 4 to 6 weeks for your copy to be mailed.

D9LA1

Behind the Scenes

Caedmon goes musical. Until now, the closest that the spoken-word record company Caedmon Records has ever come to acquiring a musical reputation was in releases of *Peter and the Wolf* and *Tubby the Tuba*. All that will change next month, when it will begin its large-scale venture into musical recordings under the Arabesque label. The company will issue them in three somewhat overlapping categories: historical releases (from 78s), standard classics, and operas.

The overlap is obvious almost from the start, with the "historical" release in February of an opera: the first *Barber of Seville* ever recorded. Riccardo Stracciari sang Figaro, Salvatore Baccaloni was Bartolo, and the whole was conducted by Lorenzo Molajoli. Others in this category will include albums by Tiana Lemnitz, Helge Roswaenge, Solomon, and Miliza Korjus (who not only is alive and well and living in Redondo Beach, California, but is currently learning the role of Brünnhilde—not bad for a former light coloratura in her seventies).

In the "standard classics" division, we can look forward to a Sibelius Second from Sir Thomas Beecham and the BBC; a Brahms Requiem with Dietrich Fischer-Dieskau and Elisabeth Grümmer, Rudolf Kempe conducting the Berlin Philharmonic; Charles Munch's last recording: the Brahms First with the Orchestre de Paris; and the Tchaikovsky A minor Piano Trio with Yehudi and Hephzibah Menuhin and cellist Maurice Gendron, among other goodies.

The opera category will include not only such serious works as Mozart's *Idomeneo* (Nicolai Gedda, Anneliese Rothenberger, Edda Moser, with Hans Schmidt-Isserstedt conducting), Beethoven's *Leonore* (the pre-*Fidelio* version previously distributed by Capitol Imports and reviewed in these pages in April 1978), and Carl Orff's *Die Kluge* (with Elisabeth Schwarzkopf and Hermann Prey, once available on Angel), but such lighter fare as Kálmán's *Countess Maritza* and the 1930s D'Oyly Carte recordings of Gilbert & Sullivan. The *Pinafore* album, by the way, will feature a brief message by Sir Arthur Sullivan transcribed on to an 1888 cylinder, probably to let us all know that Caedmon has not forsaken spoken-word recordings at all.

Rach Three. Re-entering the "Rach Three" sweepstakes is pianist Alexis Weissenberg, whose previous go-round with the concerto was with Georges Prêtre and the Chicago Symphony on RCA. This time it is the orchestra that is French and the conductor who is American, as Weissenberg teamed with Leonard Bernstein and the Orchestre National for Angel in September. It is for that company that he has recorded Rachmaninoff's Second Concerto, of course, with Herbert von Karajan leading the Berlin Philharmonic.

TV tribute to Toscanini. Zubin Mehta and the New York Philharmonic will inaugurate a series of prime-time cultural specials over NBC-TV on Wednesday, January 9, from 9:30 to 11 p.m. Eastern Standard Time. NBC's present plans call for the telecasts, which will assume the umbrella title *Live from Studio 8H*, to include ballet, opera, and drama. Studio 8H, of course, was the hall the network created for Arturo Toscanini and the NBC Symphony and the scene of most of the Maestro's latter-day recordings. Mehta is planning the performances as a tribute to Toscanini, who from 1929 to 1936 was also conductor of the Philharmonic.

Mimi again. Barely a month before sessions were due to begin in London on Ponchielli's *La Gioconda* with an all-star cast under James Levine (conducting the National Philharmonic Orchestra—not one of London's permanent orchestras, but a regular gathering of some of the city's distinguished free-lance players), RCA chucked the whole project. The reason given was escalating costs, and the decision has been viewed gloomily as the first indication of a recession in the recording industry. Till now, in London at least, whatever the state of sales, the making of recordings had continued more or less unabated.

RCA's cancellation was Angel's gain. Taking advantage of Levine's and the orchestra's free time, not to mention the booked studio, an unscheduled recording of *La Bohème* was dreamed up by EM's producers. The cast includes Alfredo Kraus as Rodolfo, Renata Scottò as Mimi, Carol Neblett as Musetta, and Sherrill Milnes as Marcello.

Opera galore. Unlike RCA's program of opera recording, Columbia's has been flourishing. This past summer Lorin Maazel completed Puccini's *Le Villi* with Scottò as the heroine, and Raymond Leppard shuttled back and forth between the Glyndebourne Festival and London's Henry Wood Hall, along with the complete Glyndebourne cast, to record Monteverdi's *Il Ritorno d'Ulisse in patria* with members of the London Philharmonic Orchestra. The two principals are Richard Stilwell as Ulysses and Frederica von Stade as Penelope. Leppard used the edition he prepared for the festival.

Columbia's recording of Bellini's *Norma* had more than its share of problems. Like RCA's ill-fated *Gioconda*, it featured Levine conducting the National Philharmonic. The busy Scottò sang the title role, but basso Nicolai Ghiaurov took sick and had to cancel. Paul Plishka was quickly rounded up as a replacement. Tenor casting provided even more complications. Plácido Domingo's schedule finally proved impossible to work out, and Carlo Cossutta was engaged at a fairly late stage of planning. Then, while Scottò was already recording some of her role, Cossutta withdrew. For the second batch of sessions a month later last summer, Giuseppe Giacomini, the tenor who had been singing Verdi's *Don Carlos* at the Met, was brought in.

Boulez in charge. Pierre Boulez has been recording Schoenberg and Varèse in Paris for CBS with his Ensemble Inter-Contemporain. The Schoenberg works include the Chamber Symphony, Op. 9, the posthumous Three Little Pieces for Orchestra, and the chamber arrangement of *Lied der Waldtaube* from *Gurre-Lieder*. He had previously recorded the first two with his Domaine Musical more than a decade ago. The Varèse recordings are of *Déserts*, *Octandre*, and *Intégrales*.

More early Verdi. The latest in Philips' series of early Verdi opera recordings conducted by Lamberto Gardelli is *Stiffelio*. Sessions were held in Vienna with the Austrian Radio Orchestra and a cast including Sylvia Sass, José Carreras, Matteo Manuguerra, Wladinerio Ganzarolli, and Ezio di Cesare. **HF**

Classical Reviews

reviewed by

Scott Cantrell

Abram Chipman

R. D. Darrell

Peter G. Davis

Robert Fiedel

Harris Goldsmith

David Hamilton

Dale S. Harris

Philip Hart

Joseph Horowitz

Allan Kozinn

Paul Henry Lang

Irving Lowens

Robert C. Marsh

Karen Monson

Robert P. Morgan

Conrad L. Osborne

Andrew Porter

Patrick J. Smith

Paul A. Snook

Susun Thiemann Sommer



Rosalyn Tureck: A pianistic conception applied to the harpsichord

BACH: Brandenburg Concertos, S. 1046-51. For a featurette, see page 86.

BACH: Goldberg Variations, S. 988; *Aria and Variations in the Italian Style, in A minor, S. 989.*

Rosalyn Tureck, harpsichord. [Steven Epstein, prod.] COLUMBIA M2 35900, \$17.98 (two discs, manual sequence).

Listening to recordings such as this, I wonder whether the engineers involved (three seem to have been required in this case) weren't on an active campaign to discredit the harpsichord as a musical medium. Why else would one have banished what must have been a reasonably pleasant-sounding instrument (a Dowd) to an antiseptically dead acoustic and subjected it to the cold scrutiny of microphones placed much too close?

For whatever reason, the sound is disagreeably blunt and forced, and I'm

afraid that Rosalyn Tureck's playing style does nothing to improve the impression. Tureck, of course, has established her reputation by playing Bach on the modern piano. This, in itself, is a harmless enough pursuit, but by applying a pianist's conception of the music to the very different sonorities of the harpsichord, she opens a veritable Pandora's box of infelicities.

One senses immediately that she misses the power and nuance of her accustomed instrument, for there is far too much of the 4' stop (made especially unpleasant by the recording technique), and I noted some peculiarly jarring manual changes (as in Variation 6). The slighter sustaining power of the harpsichord gets Tureck into trouble as early as the initial *Aria*: At her ponderous tempo, all sense of line is lost and appoggiaturas are resolved long after the relevant chords have died away. Then, too, she has the annoying habit of "pecking" at bass notes for no apparent reason (as in Variation 4 and the second strain of No. 16), and the hiccups produced in upbeat figurations (as in 13 and 20) constitute a burlesque of baroque articulation. As if to cloak all this in a mantle of scholarly respectability, we are given a lengthy and impossibly pompous sleeve note, well stuffed

with buzz-word panegyric. (Sample: "The very return carries with it, however, a fundamental sense of renewal and reveals yet a new meaning as the result of having undergone the full experience of the *Aria's* potentialities.")

Tureck plays all the repeats, but with all the perversities scattered along the way, one wishes she hadn't. In any case, her rather conservative attitude toward ornamentation—a perplexing question here, to be sure—makes a less compelling case for repeats than do the imaginative (if often fussy) elaborations favored by Igor Kipnis (on Angel S 3796).

In all fairness, Rosalyn Tureck is obviously possessed of formidable technique and control, and I suspect her approach to the *Goldbergs* could make a powerful impression when applied to the piano (from which it is obviously derived). As it is, I very much admire her beautifully expressive rubato in Variations 15 and 21, and there are some exquisite moments in the S. 989 Variations included as a filler. Ultimately, though, the performances are doomed by the mind-over-matter conception of the music and by the refusal to deal with the instrument on its own terms. In this game, there are no winners. S.C.

B Budget
H Historical
R Reissue
A Audiophile
 (digital, direct-to-disc, etc.)

Zenith Audio Components. Specs, specs & more specs.

You know the Zenith name means great television. Now it means great audio, too. Check out some of the specs.

SPECS ON POWER

Zenith's MC7051 receiver delivers 40 watts per channel minimum. With both channels driven into 8 ohms from 20 to 20,000 Hz, there's only 0.05% or less Total Harmonic Distortion.



The pre-amp section provides excellent tone with a minimum of distortion. There are Hi and Lo filters. A loudness switch. Two-way tape monitor. And much more.

The tuner has IC's and ceramic filters to help eliminate noise and station interference. A Phase-Locked Loop MPX-IC gives pinpoint stereo separation by locking onto the stereo signal of the station you select.

SPECS ON SOUND



Allegro 4000 speakers are so efficient that comparable-sized air suspension speakers need twice the amplifier power to match their sound reproduction.

They're accurate, too. As illustrated here, the Allegro 4000 response curve is so flat, it hardly looks like a curve at all.

The Allegro 4000 has a 12-inch cone type woofer with a high excursion phenolic voice coil. A

*Dolby is a registered trademark of Dolby Laboratories, Inc.



midrange with a 5-inch cone in its own subenclosure. And a brilliant 3½-inch horn tweeter.

Allegro 4000's, like all Allegro speakers, also feature a tuned port that uses air pumped by the woofer to extend and reinforce the bass response. And helps reduce distortion.

And for final fine tuning, the treble and midrange controls are right up front.

SPECS ON DIRECT DRIVE

Zenith's MC9050 direct-drive, semi-automatic turntable eliminates "cogging" because torque remains constant. You get no hesitation. And better than -70dB of rumble. At 0.03% WRMS, wow and flutter are virtually eliminated.



The raised platter is heavy die-cast and lathe-cut aluminum weighing nearly three pounds. The tone arm is a highly sensitive, static-balanced S shape made of tubular aluminum for a gentle tracking force. Combined with a high quality magnetic cartridge, you get excellent performance and tracking.

The MC9050 also includes strobe, anti-skate control and bidirectional hydraulically-damped cueing.

SPECS ON TAPE

For fast start ups, Zenith's MC9070 Stereo Cassette Deck depends on a reliable high-torque, frequency-governed DC motor. There are three-position bias and equalization switches that assure you optimum frequency response on any type of tape: 30 to 15,000 Hz on normal, 30 to 15,000 Hz on CrO₂ and 30 to 16,000 Hz on FeCr.

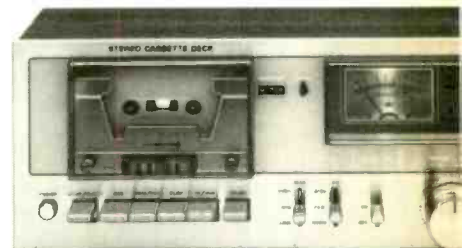

You get twin VU meters. And you can set the level for each channel during record.

To make your recording and playback even better, we included a Dolby* Noise Reduction system.

THERE'S MORE TO ZENITH THAN SPECS, SPECS, SPECS

What really counts is the sound. So stop by your nearby Zenith dealer and listen closely to the full line of components he has to offer. And let your ears be the final judge.

ZENITH
The quality goes in before the name goes on.*

Audio. The Flipside of Zenith.

Scaling a Peak of the Baroque: Bach's *Brandenburgs* with Exemplary Musicianship

by Paul Henry Lang

Bach's *Brandenburg* Concertos, together with Handel's twelve Grand Concertos, Op. 6, of approximately the same time, represent the peak of concerted instrumental music of the baroque era. But while Handel's music draws on Italian ancestry, especially from Corelli, Bach's language is unmistakably German, despite his observance of the general principles and contours of the concerto, that original Italian contribution that influenced in both spirit and technique every form and genre, vocal or instrumental. It was characteristic of Bach to want to penetrate to the core of a genre and exploit all its possibilities, producing what in his time was called a *Kunstbuch*—an anthology and repository of a master's accumulated knowledge and wisdom concerning a particular genre or style of composition. *The Well-Tempered Clavier* and *The Art of Fugue* are well-known examples, but even the B minor Mass, with its conglomeration of vocal styles and forms, is essentially a *Kunstbuch*.

And so are the *Brandenburg* Concertos. No two are alike, their diversity ranging from No. 6, already archaic in Bach's day, to No. 3, which with its lively and utterly imaginative motivic play reaches almost into the symphonic style half a century before Haydn. All of them demand the most accomplished virtuoso playing, and all present great problems of balance and articulation; though Bach follows Italian models, notably Vivaldi, the involved contrapuntal writing is altogether different from the transparency of Italian instrumental polyphony.

Concerto No. 1 is essentially a ripieno concerto *a tre cori*: two horns, three oboes, and strings. All three "choirs" are incessantly on the move, and each is independent, yet constantly exchanging thematic material. Here Albert Fuller, the director of the Aston Magna group, had a

happy idea coming not from historical treatises, but from his own healthy musicianship. In almost all performances the two horns are held down to merge with the rest, a practice that now appears to have been the chief source of the opaqueness of the ensemble, but Fuller makes them the dominant choir, proudly blaring above all the others. The effect is startling; there is an instant focus to the often indistinct contrapuntal meanderings. The texture still refuses to let in enough daylight between the parts despite the use of a very small orchestra, but I suspect that in a live performance, when he need not share executive power with the sound engineers, Fuller has better control over the situation.

With No. 2 the case is the exact opposite: The trumpet usually is dominant at the expense of the other solo instruments (all four are in the treble range). This problem too is nicely solved. As a rule, the solo trumpet is played by a trumpeter, borrowed from the symphony orchestra, who is not used to the florid clarino playing of old and cannot help blasting in the higher ranges, but Friedemann Immer, who plays a natural trumpet with exquisite mastery, makes the instrument a real partner in the quadruple concertino. The single recorder is still lost except in the solos; why not double it in the tutti's?

The Third Concerto is again for three choirs: three violin parts, three violas, and three cellos (plus the continuo, of course). Yet despite the ripieno character of the score, Bach probably had an ensemble of soloists in mind, a sort of accompanied nonet. We must remember that the concerto principle could be applied to any aggregation of instruments and/or voices, hence also to chamber music—indeed, even to music for a single instrument, vide Bach's *Italian* Concerto. No. 4, the most lightly scored of the six, is also the most delightfully transparent. The concertino of violin and two recorders, brimming with ideas that are bandied about with wit and charm, dominates the first movement, a large rondo more than 400 measures long. Later, especially in the third movement, which is an expansive fugue, the ripieno asserts itself. The two recorders play their parts with unerring musicianship and intonation.

No. 5 must have been written for

Bach's own delectation, because it is virtually a concerto for harpsichord, though solo flute and violin are heavily involved. This concerto is all motion, virtuosic in every aspect of music-making. The second movement, unusually entitled *Affettuoso*, is a canonic trio for flute, violin, and the right hand of the harpsichord, the counterpoint flowing with ease and grace, while the last movement, in *da capo* form, returns to the brilliant style. As already mentioned, No. 6 is curiously archaic in its choice of instruments: four viols, cello, and continuo. What immediately attracts the ear is the dark, velvety, and slightly veiled tone of the solo quintet of two arm viols, two knee viols, and a cello. Once more the counterpoint is wondrously liquid, even though canons are strewn about. The second movement is a duet between the two alto (arm) viols, the cello taking the bass part, and the finale is a lusty *gigue* in *da capo* form. Though this is clearly chamber music, the distinction between solo and tutti is always present.

In the notes, Fuller announces with pride that this is the very first performance of the *Brandenburg* concertos with "original" instruments and insists that the difference between modern and original instruments is "central to the composition of these concerti." How do the "fresh new sounds of Bach's instruments" come across? Fuller, himself an excellent harpsichordist, has at his disposal an exceptionally competent group of wind players. The baroque oboes, played by Michel Piguet, James Caldwell, and Stephen Hammer, are fine, and free of the wailing we often hear from "original" oboes, and they sound just like ours, as does the bassoon. The recorders, among the few instruments that have not changed in hundreds of years, must have sounded in Bach's time as they do now, and these two players, Bernard Krainis and Deborah Robin, are peerless. The transverse flute, though mellower than the Boehm flute, does not create a notably different aural picture. Yet John Solum plays it so well that the usual *pfth-pfth* in the weak low register of the old flute is absent. The two horns, Robert Sheldon and Jean Rise, are magnificent, but again their sound is basically the same as what a good horn player produces today. So far I hear none of the "fresh new sounds" Fuller speaks of, only (!) superlative playing. But the trumpet tone is indeed new to twentieth-century ears, less heroic and stentorian than the modern trumpet, and it mixes smoothly with the rest of the ensemble.

Now we come to the main body, the strings. In his notes Fuller says that "violins and violas had no chin rests, calling for a relaxed manner of execution, which in turn affects playing style." Even if these experi-

BACH: *Brandenburg* Concertos (6), S. 1046-51.

Aston Magna Festival Players, Albert Fuller, dir. [Brock Holmes and Bill Bennett, prod.] SMITHSONIAN RECORDINGS 3016, \$17.98 (three discs, manual sequence) plus \$1.49 shipping (Smithsonian Recordings, P.O. Box 10230, Des Moines, Iowa 50336).



Albert Fuller

enced musicians actually did dispense with the chin rest, I am reasonably sure that they hold their instruments under their chins rather than against their shoulders. Nor is the playing "relaxed"; it is gratifyingly vigorous and energetic. I am also convinced that they are using modern bows. Still, the sound they produce from their "re-altered" violins equipped with gut strings, while acceptable in the tuttis, is unattractive, colorless, and cold in exposed solos. The quartet of viols, playing to perfection, does honor to the spirit of the old instruments, though I doubt that they could have sounded so rich in Bach's time. Once more I am willing to bet that the players are using modern bows and doubt that the alto violists rest their instruments on their arms, as absolute historical accuracy would require. The violino piccolo used in No. 1 (pitched a third or fourth higher than the regular violin), an instrument that had a certain vogue in France but was very seldom used elsewhere, is pretty awful, with a strained tone that is almost a caricature of violin playing. It should have been replaced by a normal violin, especially in view of the fact that it did not figure in the original version.

On the whole, this is an admirable performance. Fuller somewhat neglects the dramatic moments, such as the magnificently grating cross relations in the second movement of the First Concerto; they are too tame to be savored. The pace, usually lively and energetic, is at times a little too rigidly unchanging. Fuller commendably shuns old-fashioned asthmatic ritardandos (though he retains the thoroughly unauthentic glee-club trick of inserting a Luftpause before the last chord), but a

modicum of *rallentando* is necessary for the articulation of structural sections, and in general a little more flexibility would have been welcome. Though the rhythm is usually bracing, occasionally—especially in the principal violin part—the syncopations are not sharp enough, and the able solo violin, Jaap Schröder, tends to taper and release the sound too soon, robbing the syncopation of its dynamic force. Fuller is to be congratulated, however, for his thoughtful use of embellishments, the profuse application of which hurts so many good performances of baroque music. He uses them wherever needed, always with taste, and avoids piling them up; as a result the melodic design is never interfered with.

I found Fuller's little essay in the pamphlet that comes with the album rather engaging. In the severe world of performance practice he is as much an effusively romantic hermeneutist as Kretzschmar or Schweitzer and, like Spitta, attributes everything good and new to his hero, Bach, a tendency he shares with Harnoncourt. And as in the case of Harnoncourt, his musicology is a bit affected by this uncritical worship. He says that Bach, "more than any other great composer of his age, studied [and] emulated" the Italian spirit and its art. Well, now, who carried Italian baroque opera to its apogee? And there were others thoroughly immersed in Italian music besides Handel. And what are we to do with this statement: "The intrusion into the Italian concerto of so many French elements (oboes, horns, the violino piccolo, and the gigue) is one of the traits of genius unique to Bach"?

Finally, a little friendly nitpicking about the strained use of Italian terms and their plurals. I mention them solely because I respect the dedication and abilities of the Aston Magna players; they don't need this affectation—or is it part of the authenticity of performance practice? "Concerto," "ritornello" (or ritornel), and other such terms were fully "Englished" by the early eighteenth century (vide Handel's Grand Concertos). There is no more need for Italian plurals and italics in "concerto" than in "soprano," or "adagio," or "cello." Contrariwise, the brochure also lists "violins da gamba," a bastardized term, and "the *Brandenburgs*" is a rather breezy shorthand. In most countries the Italian terms were either translated or naturalized, and the English language is particularly receptive to loan words.

Despite its flaws, I would place this album before all recordings of the *Brandenburg* Concertos with which I am familiar, not because of the original instruments used, but because what reigns here is musicianship, superior instrumental technique, and taste of a high order.

You're In The Company Of Great Conductors

GIULINI TENNSTEDT MUTI PREVIN ROSTROPOVICH KARAJAN

MOZART
REQUIEM
Donath · Ludwig · Tear · Lloyd
Philharmonia Chorus
Philharmonia Orchestra
GIULINI

MAHLER
SYMPHONY No. 5
SYMPHONY No. 10 - ADAGIO
London Philharmonic Orchestra
TENNSTEDT

STRAVINSKY
THE RITE OF SPRING
The Philadelphia Orchestra
MUTI

MEINELSSOHN
Symphony No. 4 in A
"ITALIAN"
Overtures - The Hebrides · Ruy Blas
A Midsummer Night's Dream
London Symphony Orchestra

DVORAK
SYMPHONY NO. 9
"NEW WORLD"
London Philharmonic Orchestra
ROSTROPOVICH

Debussy
**PELLEAS
ET
MÉLISANDE**
Von Stade · Stillwell · Denze
Van Dam · Raimond
Berlin Philharmonic Orchestra
Karajan

SZ-37600 (LP/Cassette) • SZB-3883 (2 LPs/2 Cassettes)
SZ-37646 (LP/Cassette) • SZ-37614 (LP/Cassette)
SZ-37719 (LP/Cassette) • SZCX-3885 (3 LPs)



BARTÓK: *Orchestral Works*. For a feature review, see Page 79.

BEETHOVEN: *Folksong Settings*. Robert White, tenor; Samuel Sanders, piano; Ani Kavafian, violin; Yo-Yo Ma, cello. [Sam Parkins, prod.] RCA RED SEAL ARL1-3417, \$8.98.

Scottish Songs, Op. 108: No. 17, O Mary, at thy window be; No. 25, Sally in our alley. Irish Songs, WoO. 152: No. 1, The return to Ulster; No. 5, On the massacre of Glencoe; No. 8, Come draw we round the cheerful ring; No. 25, O harp of Erin. Irish songs, WoO. 153: No. 3, The British Light Dragoons; No. 9, The kiss, dear maid, thy lip has left; No. 13, 'Tis sunshine at last. Irish Songs, WoO. 154: No. 4, The pulse of an Irishman. Welsh Songs, WoO. 155: No. 15, When mortals all to rest retire; No. 19, The Vale of Clwyd; No. 21, Cupid's kindness; No. 26, Good night. Scottish Songs, WoO. 156: No. 5, Cease your funning. Songs of Various Nationality, WoO. 157: No. 2, The soldier.

Robert White's drawing-room manner is eminently suited to these domestic folksongs; there is art here but no pretension. Perhaps to woo such eminent instrumentalists into participation, the vio-

linist and cellist have here and there been given a crack at the spotlight, as White sits out a stanza—a perfectly reasonable procedure. Also well within the style are the tenor's modest embellishments, and I doubt that Beethoven would have objected to the occasional upward transpositions.

Graceful and gracious music-making, then, in low-pressure music that is nonetheless made with skill. A few of these songs have not been recorded before (we have never had on records a comprehensive survey of this corner of Beethoven's output), and there is but one overlap with the two recent discs by the Accademia Monteverdiana (Nonesuch H 71340 and Vanguard Everyman SRV 356; reviewed in November 1977). Texts are provided, and a sound historical note by Philip L. Miller. The sound is clear and vivid, though my pressing was marred by some patches of grinding noises. D.H.

BERWALD: *Orchestral Works*.

Marian Migdal, piano*; Arve Tellefsen, violin*; Royal Philharmonic Orchestra, Ulf Björlin, cond. [John Willan, prod.] SERAPHIM SID 6113, \$19.92 (four discs, manual sequence).

Concertos: for Piano and Orchestra, in D*; for Violin and Orchestra, in C sharp

minor, Op. 2*. Overtures: The Queen of Golconda; Estrella di Soria. Tone Poems: Festival of the Bayadères; Play of the Elves; Racing; Reminiscences from the Norwegian Mountains; Serious and Joyful Fancies. Symphonies: in G minor (*Sérieuse*); in D (*Capricieuse*); in C (*Singulière*); in E flat.

Apart from Grieg, Sibelius, and—to a lesser extent—Nielsen, Scandinavian composers have not fared well on the American record market. There have been brave attempts in the past to make some of them better known here, but too many of these (like the onetime flurry of releases devoted to Denmark's so-called Waltz King of the North, Hans Christian Lumbye) soon faded from active production. Sweden's outstanding nineteenth-century symphonic composer Franz Berwald (1796-1868) also was given some attention a few years back, and at least a few of his recorded works remain in print. But the present extensive, practically complete, orchestral collection is the major Berwald discographic essay to date, and it stands a better chance than any previous issue of "selling" him and his music to American listeners.

Certainly he is unusual both as a man and a composer. Like Borodin and Ives, he was one of those rare musicians

The Dry System by Audio Groome

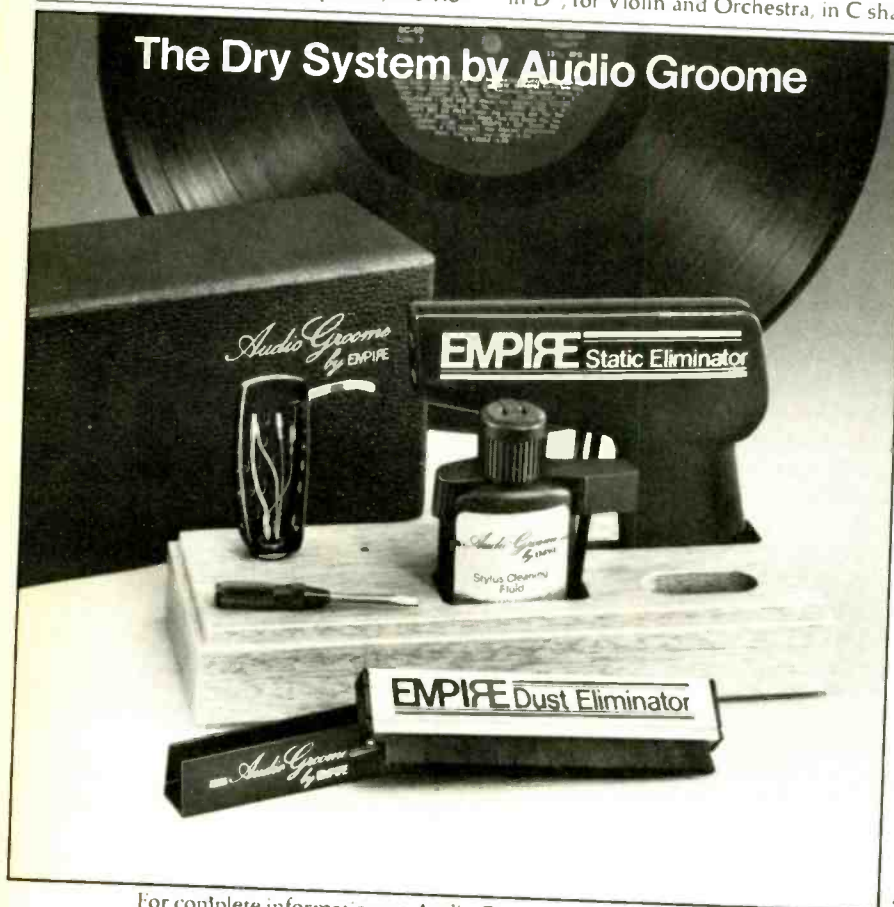

Record care that leaves behind clean sound, not chemicals.

Housed in a solid mahogany base with removable leatherette cover, the Dry System is a combination of Audio Groome products designed to prolong the life of your record collection. The position of each item within the package has been carefully considered so that when placed next to your turntable, the most frequently used are the most accessible.

1. Empire Static Eliminator: Millions of positive and negative ions are released to effectively neutralize the entire surface of the record. It stops dust before it starts.
2. Empire Dust Eliminator: Microbristles reach deep down into record grooves to lift dirt out with thousands of electrically conductive carbon fibres which neutralize the static charges that attract dust.
3. Empire Stylus Cleaning Kit: Built-up dirt on the stylus can disfigure the record grooves and ruin the stylus. Our special formula fluid and brush keeps your stylus free of dirt, helping to prolong record life.
4. Empire Universal Headshell: Many of today's audiophiles use more than one phono cartridge. This additional lightweight aluminum shell allows switching cartridges without constant remounting.
5. Empire Audiophile Screwdriver: The perfect tool for minor adjustments.

For complete information on Audio Groome accessories write to:
Empire Scientific Corp., Dept. AG, Garden City, NY 11530.

EMPIRE EMPIRE EMPIRE EMPIRE EMPIRE EMPIRE EMPIRE EMPIRE EMPIRE EMPIRE EMPIRE EMPIRE EMPIRE

Circle 20 on Page 115

Audio Groome by EMPIRE

ESS Wins... Again

U.C.L.A. experiment repeated: in comparative tests, students attending the University of Wisconsin judge ESS speakers superior to Bose, Pioneer, JBL, Infinity, AR and Cerwin Vega.

Hundreds of students participating in a series of blind listening tests at two separate universities have now judged ESS speakers superior in performance to other top brands by increasingly significant margins.



The controlled direct comparison tests, conducted under the supervision of an independent national testing laboratory, were designed to simulate home listening conditions. Loudness differences were electronically equalized, and all speakers were positioned for optimal performance.

Without knowledge of speaker brands, the students listened in groups of 30 or less to the same musical material on each of the speakers. They were then asked to choose which speaker sounded best in terms of clarity, accuracy and freedom from distortion.

"Of particular significance is the fact that the pairings on the two campuses were not identical," report ESS technicians. "Even though different speaker matchings were made, the participants still chose ESS in 13 out of 14 comparison situations at both universities. And the 14th test at each campus was too close to be statistically valid." In many cases, as the graph reveals, ESS speakers were chosen over far more expensive competing loudspeakers by significant margins.

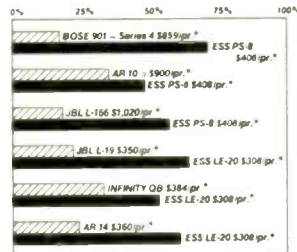

ESS speakers differ from all other conventional speakers because they alone incorporate the ESS Heil air-motion transformer midrange-tweeter (invented by Dr. Oskar Heil, creator of the FET), licensed exclusively to ESS. This unique principle of sound reproduction has been called by one reviewer "the first real breakthrough in loudspeaker design in over 50 years." By squeezing air like a bellows instead of pushing it, the Heil achieves virtually "instant acceleration." This increased velocity permits the Heil to provide a degree of clarity, spaciousness and freedom from distortion unattainable by conventional drivers.

ESS will be conducting similar comparison tests on college campuses across the nation. Watch for the dramatic results from Georgia Tech. Or better yet, visit your local ESS dealer and take the ESS Listening Test yourself. See if you can't appreciate the difference.

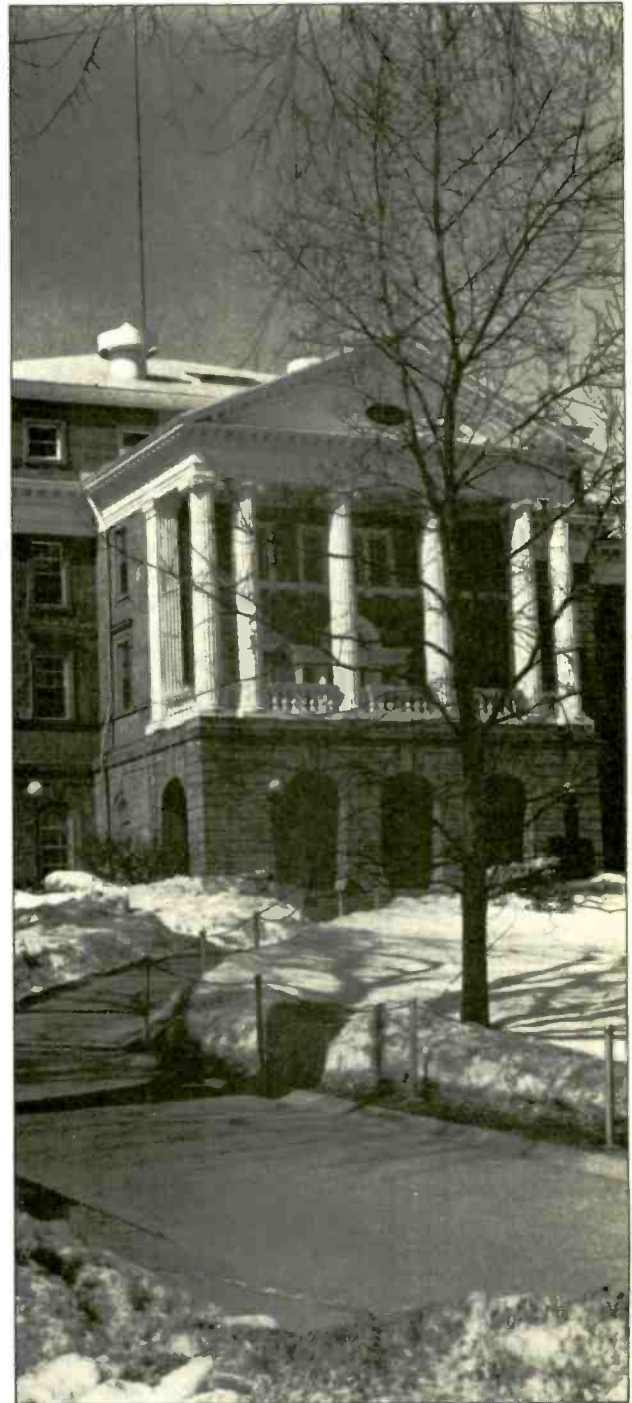
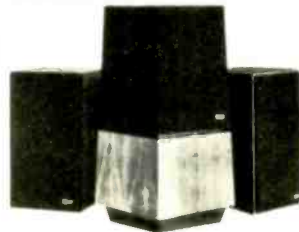

Take the ESS
Listening Test
yourself!

ESS
sound as clear as light

*Suggested Retail Price

9613 Oates Drive, Sacramento, CA 95827

Critics' Choice

The most noteworthy releases reviewed recently

BACH, J.C.: Sinfonias (6). Marriner. PHILIPS 9502 001, Sept.

BACH: Suites for Orchestra, S. 1066-1068, et al. English Concert, Pinnock. ARCHIV 2533 410/1, Nov.

BEETHOVEN: Works for Cello and Piano. Starker. TELEFUNKEN 36.35450 (3), Oct.

BERLIOZ: Harold in Italy. Suk, Fischer-Dieskau. QUINTESSENCE PMC 7103, Nov.

BOULEZ: Sonata for Piano. WEBERN: Variations for Piano. Pollini. DG 2530 803, Oct.

BRAHMS: Choral Works. Corboz. RCA RED SEAL ARL 1-3350, Nov.

BRAHMS: Variations on a Theme by Handel. Arrau. PHILIPS 9500 446, Oct.

DONIZETTI: Lucrezia Borgia. Sutherland, Horne, Bonyngé. LONDON OSA 13129 (3), Oct.

FAURÉ: Requiem; Pavane. Popp, Nimsgrn, A. Davis. COLUMBIA M 35153, Oct.

HAYDN: Lo Speziale. Kalmár, Fülöp, Lehel. HUNGAROTON SLPX 11926/7 (2), Nov.

LALO: Trio No. 1. **SAINT-SAËNS:** Trio No. 1. Caecilian Trio. TURNABOUT TVC 37002, Nov.

MARTIN: Symphony No. 1; Variations for Piano and Orchestra. Lechner, Neumann. SUPRAPHON 4 102166, Sept.

MENDELSSOHN: Psalms 42, 95. Corboz. ERATO STU 71101, Nov.

MOZART: Violin Concertos, K. 211, 219. Spivakov. ANGEL SZ 37511, Nov.

SCHUBERT: Quartets Nos. 12, 15. Gabrieli Qt. LONDON TREASURY STS 15418, Nov.

SHOSTAKOVICH: Lady Macbeth of the Mtzensk District. Vishnevskaya, Rostropovich. ANGEL SCLX 3866 (3), Sept.

STRAUSS: Die schweigsame Frau. Scovotti, Adam, Janowski. ANGEL SZCX 3867 (3), Oct.

VIVALDI: Motets. Ameling, Negri. PHILIPS 9500 556, Oct.

CLEVELAND SYMPHONIC WINDS: Macho Marches. Fennell. TELARC DG 10043, Nov.

RIVERS of DELIGHT: American Folk Hymns. Word of Mouth Chorus. NONESUCH 71360, Nov.

STRAUSS FAMILY GALA. Georgiadis. DBX GS 2006, Nov.

THE BEST YEARS of OUR LIVES. Film score by Friedhofer. ENTR'ACTE EDP 8101, Nov.

FARNON: Captain Horatio Hornblower Suite. CITADEL CT 7009, Oct.

who could make a good living in the world of science or business. During musically unrewarding times, Berwald founded a successful orthopedic (gymnastic) institute in Berlin; later, back in Sweden, he managed a glassworks and a sawmill! Although largely self-educated, he became something of a polymath, pamphleteering on such varied subjects as education, housing, and reforestation. In music he is distinctively an original—writing in a conventional-enough harmonic idiom of his time, to be sure, but with an arresting freedom from clichés. He almost never “sounds like” anyone else: There are occasional very slight suggestions of Mendelssohn, Schubert, or even Berlioz (whom Berwald idolized), but the decisive characteristics are those of freshness, a highly individual imagination and—in the later works at least—assured craftsmanship.

Included in this program is a fine, wide range of works, one needing only a companion chamber music collection to do Berwald full justice. If the very early (1820) Violin Concerto is featherweight, its disarming rhapsodic grace and vivacity are attractively enhanced by the authoritative Norwegian soloist. The contrastingly late (1855) Piano Concerto, while scarcely a major work either, boasts moments of tender delicacy as well as of scintillating bravura that are expertly exploited by the Polish-born soloist (a man, despite the spelling of his first name). Overall this concerto has some special interest for a piano part that flows (after the introductory bars) so continuously that it can be performed without orchestral accompaniment, as suggested in the published score.

The several tone poems are effectively colorful mood or scene evocations, and *Racing* is a breathlessly exciting virtuoso piece that would surely be a bring-the-house-down encore for any Pops concert. But it's mainly in the two fine overtures and all four symphonies—particularly the invigorating open-air *Sinfonie singulière* and the vivacious E flat Symphony—that Berwald is heard at his impressive, truly rewarding best. (Crediting him with six symphonies, as is done in most reference works, is misleading: An early work exists only in fragmentary form; the full score of a later one has been lost.)

Among the set's other attributes are the infectious relish of the readings by the young Swedish conductor Ulf Björilin, who is new to records, at least in the U.S.; extremely effective, ungimmicked EMI recording; enthusiastic notes by the composer's foremost British propagandist, Robert Layton; and the bargain price. The one

not-too-serious weakness here is the choice of a British rather than Swedish orchestra: The Royal Philharmonic plays spiritedly, but it obviously knows the music from only a few rehearsals and lacks both assurance and idiomatic authenticity. R.D.D.

BRAHMS: Concerto for Piano and Orchestra, No. 2, in B flat, Op. 83.

Tirimo, piano; London Philharmonic Orchestra, Yoel Levi, cond. [Brian Culverhouse, prod.] MUSICAL HERITAGE SOCIETY MHS 4001, \$5.20 (\$3.95 to members) plus \$1.25 shipping (Musical Heritage Society, 14 Park Rd., Tinton Falls, N.J. 07724).

Ilana Vered, piano; Philharmonia Orchestra, Anatole Fistoulari, cond. [Tim McDonald, prod.] LONDON PHASE-4 SPC 21179, \$8.98. Tape: SPC5 21179, \$8.98 (cassette).

I was totally unfamiliar with the protagonists on the MHS disc, but the record jacket filled me in quite nicely. Tirimo (who goes by one name, Solomon-style) is a Greek-born resident of London who appears from his photograph to be in his late thirties or early forties. His notable achievements include performing the complete Schubert sonata cycle and editing them as well: His edition, basically an ur-text with annotations, is to be published in 1980 with his own completions of the unfinished movements. And at the age of eleven, he directed seven performances of *La Traviata* with soloists from La Scala. Yoel Levi, conducting assistant for the Cleveland Orchestra, is similarly multitalented. This twenty-eight-year-old Romanian-born Israeli may be the Middle East's answer to James Levine. Levi was the Haifa Symphony's concertmaster for seven years as well as its timpanist, played percussion in the Israel Philharmonic, and is a pianist. In addition to Maazel, his conducting mentors include Kondrashin and Franco Ferrara.

This is an absolutely first-class performance of the Brahms B flat, lucid in texture and flexible in phrase. It has the kind of freedom and intelligence that would seem to grow out of a complete knowledge of the score. Some listeners might prefer a more classical approach, but the rhetorical gestures and tempo modifications here are tasteful and beautifully synchronized. Tirimo's instrument is deep-toned and sonorous, the London Philharmonic is in top form (Alexander Cameron's cello solo in the third movement is eloquently molded), and all of this is heard in spacious, perfectly balanced sonic reproduction. MHS's pressing is uncommonly fine. In sum, this un-

The logic behind the Revox B77.

The logic is the logic which is built-in.

It's an ingenious and highly sophisticated system—much like the human nervous system—which controls the deck's functions.

You can push any button in any order with no chance of damaging your tapes. Our motion sensing system constantly feeds status reports to the logic circuitry which activates your commands in proper sequence.

The logic also permits full-function remote control, and an editing mode that keeps the playback circuitry live, even when the motors are stopped. You can make your splices right on-the-beat, and our built-in splicing block makes it easy.

The design and construction of the Revox B77 further guarantee smooth and accurate operation. To get the

long-life advantage of ferrite without static build-up or head degradation, we use Revox's exclusive Revodur heads, made of metal to dispel heat and static, and vacuum-coated with permalloy for durability.

The B77 has a unique capstan motor that's monitored by a tacho head to precisely control speed and limit wow and flutter to professional studio standards.

Revox offers many options with the B77 including a full range of speed configurations from 15/16 IPS to 15 IPS, variable speed control, ¼ track record/playback and more.

All this professional quality is neatly engineered to fit in a deck you can carry. After all, if you own a machine this good, it's logical to take it with you.

Experience the B77 and the full line of Revox audio components at your franchised Revox dealer today.



STUDER **REVOX** America, Inc.

1819 Broadway, Nashville, TN 37203 615 329-9576/In Canada: Studer Revox Canada, Ltd.

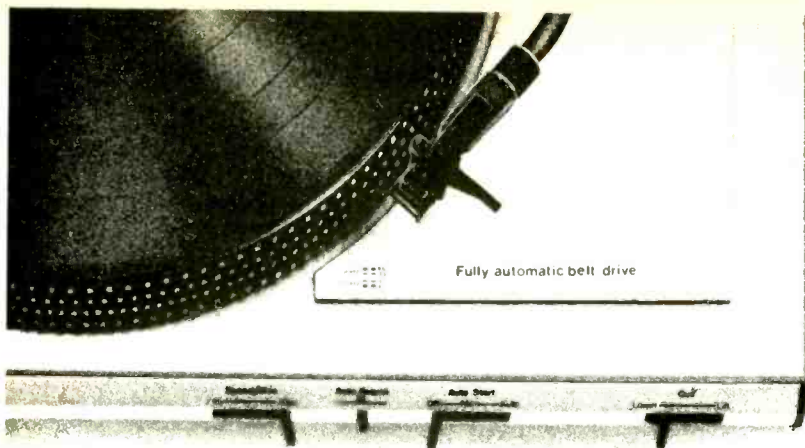

An elite team of designers and engineers – the Advance Design Group – keeps Garrard turntables at the frontier of technology and responsive to the needs of today's music lover. You can choose among belt or direct drive units, single or multiple play models. You can have carbon fibre headshells, super-light tonearms and the extraordinary Delglide® automatic system. Whichever turntable you choose, you're assured of unsurpassed performance and unprecedented reliability underscored by a 3-year limited warranty. Write to us for complete information.

Advance Design Group

Garrard

Division of Plessey Consumer Products, Dept. B, 100 Commercial Street, Plainview, NY 11803

Circle 72 on Page 115

WE COULDN'T SAY SCOTCH® NOW HAS THE WORLD'S TRUEST SOUND IF IT WEREN'T THE ABSOLUTE TRUTH.

Here's the proof... new Scotch® Metafine®. Made with pure metal particles, not just metal oxide, it delivers higher highs, lower lows—double the output of chromium dioxide tapes.

The same dedication to technological perfection that made Metafine possible is a part of every Scotch recording tape we make.



SCOTCH® RECORDING TAPE. THE TRUTH COMES OUT.



heralded release takes its place among the three or four best versions of this much-recorded composition.

There are quite a few felicities in Vered's recording, but her collaboration with Fistoulari and the Philharmonia is patently on a lower level of synchronization. Vered plays with a big, assertive style (which is suitable for the music's basic girth), but her tone, at least as reproduced, is clattery and harsh. Furthermore, the orchestral framework, with its stodgy tempos and occasional loose chording, often saps the reading's energy and forward motion. H.G.

BRAHMS: Six Pieces, Op. 118; Four Pieces, Op. 119; Rhapsody in G minor, Op. 79, No. 2.

Radu Lupu, piano. [Richard Beswick, prod.] LONDON CS 7051, \$8.98.

Lupu's magisterial control of light and shade, his faultless articulation and velvety, colorful tone, make him an elegant and provocative Brahmsian. He manages to bring a fresh point of view to these cameos without sounding the least eccentric.

The A minor Intermezzo, Op. 118, No. 1, is cool, sparing of pedal, and less bombastic than it often is. (The very end, which touches the lowest A on the keyboard, is notably subdued and unthunderous.) Throughout, there are ravishing niceties that catch the attention and hold it: the telling way, for instance, that Lupu characterizes the more lyrical second theme of the G minor Ballade, Op. 118, No. 3, without losing the crisp momentum he has so rightly established, or the way he differentiates the luminosity of the F minor Intermezzo, No. 4, from the brighter luminosity of the F major Romanze, No. 5. His trills in this last piece, incidentally, are magically liquid. It might be an oversimplification, but Lupu seems to build to the dramatic pieces of each set. Thus the E flat minor Intermezzo of Op. 118, with its urgent middle section, and the E flat Rhapsody of Op. 119, with its stalking, deliberate tempo, are presented as capstones.

I expect to return often to this satisfying release. H.G.

CHOPIN: Piano Works.

Peter Serkin, piano. [Peter Serkin and Max Wilcox, prod.] RCA RED SEAL ARL 1-3344, \$8.98. Tape: ARK 1-3344, \$8.98 (cassette).

Barcarolle in F sharp, Op. 60. Berceuse in D flat, Op. 57. Mazurkas: in B flat, Op. 7, No. 1; in D, Op. 33, No. 2; in B, Op. 41, No. 3; in C, Op. 56, No. 2; in F minor,

KEF Model 304
on optional stand ULS II

KEF Model 303
on optional stand ULS I

Elegant, Efficient,
Effective.

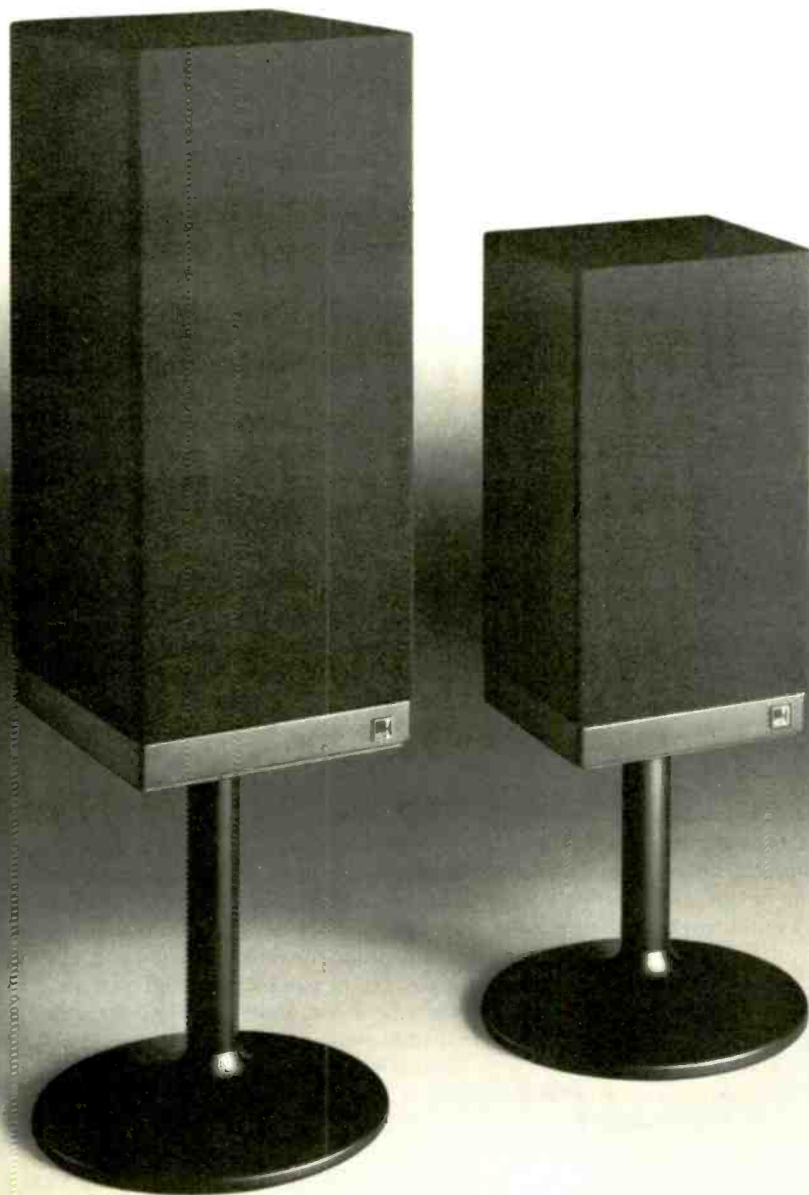

The traditional KEF accuracy in music reproduction now combined with a higher level of efficiency.... Whether for use with amplifiers up to 100 watts or music centers as small as 10 watts, the two new KEF speakers—Model 303 and Model 304—can achieve surprisingly loud volume levels without any sacrifice of the tonal quality for which KEF is world-famous.

Visit your authorized KEF dealer for a thorough demonstration.







For his name and product information write to: KEF Electronics, Ltd., c/o Intratec, P.O. Box 17414, Dulles International Airport, Washington, DC 20041.

In Canada: Smyth Sound Equipment, Ltd., Quebec J4H 3V7.

KEF The
Speaker
Engineers

fact: a Genuine Shure upgrade stylus is unquestionably the biggest bargain in hi-fi

We strongly urge you to check your stylus for wear at least once a year to protect your records and maintain the highest standards of listening pleasure. Regardless of when (or where) you purchased your Shure cartridge, there is a Genuine Shure replacement stylus available which will bring your cartridge right back to its original specifications. Even better, you may actually be able to improve its performance significantly over the original with a Genuine Shure upgrade stylus... at surprisingly low cost! For example:

IF YOU OWN:	UPGRADE WITH:
 V15 Type III SERIES	 VN35HE Hyperelliptical stylus
 M95 SERIES	 N95HE* Hyperelliptical stylus
 M70 SERIES	 N72EJ Biradial (Elliptical) stylus N72B Spherical stylus
ANY M91, M92, M93	N91ED* stylus
ANY M71, M73, M75	N75 TYPE 2* Series styli
ANY M44 Series	N55E stylus
M3D, M7D	N21D* stylus

*Before purchasing any replacement stylus be certain your turntable is compatible with the tracking force of the stylus you select.

**Always insist on a
Genuine Shure
replacement stylus.
Look for the name
"Shure" on the stylus
grip.**

 **SHURE**®

Shure Brothers Inc., 222 Hartrey Ave.,
Evanston, IL 60204
In Canada: A. C. Simmonds & Sons Limited
Outside the U.S. or Canada, write to Shure Brothers
Inc., Attn: Dept. J6 for information on your local Shure
distributor. Manufacturers of high fidelity components,
microphones, sound systems and related circuitry.

Circle 55 on Page 115

Op. 68, No. 4; in A flat, Op. posth. Nocturnes: in F, Op. 15, No. 1; in E, Op. 62, No. 2. Nouvelle etude in A flat. Prelude in A flat, Op. posth. Variations brillantes on a Rondo from Hérold's *Ludovic*, Op. 12. Waltz in A flat, Op. 64, No. 3.

Peter Serkin's Chopin, of which this is the first sample on disc, is nothing if not distinctive. It is poles apart from either the complex display of Horowitz or the heartiness of Rubinstein. Superficially, Serkin's restraint suggests an Apollonian bent. But the general impression is not so much of easy repose as of reined-in or rechanneled intensity.

Pianistically, these are subtle, exquisitely detailed performances. Phrasings, pedalings, and voicings have been worked out with painstaking care. With their half-tints and linear clarity, the textures are lucid and stimulating rather than colorless or cold.

Serkin marshals these resources in a spirit of undemonstrative conviction, even self-denial; one might almost call his approach ascetic. Often he pursues a rapt, trancelike equilibrium. If there is one Chopin piece that invites contemplative rapture, it is the Berceuse, and it is perhaps the finest performance here—a quiescent watercolor, with the filigree flawlessly etched in drypoint. Serkin's chaste, deliberate reading of the autumnal E major Nocturne is also eloquent, particularly the concluding measures, in which he stresses the resigned whole-step fall of the inner right-hand voice. In a comparably intimate vein, and comparably effective, are his versions of the *Nouvelle etude*, the A flat Prelude, and the melancholy F minor Mazurka, Op. 68.

It is harder to know what to make of the more extroverted selections, in which Serkin's constraint can be startling. Taking his cue from the slithery chromatics and dizzy modulations, he makes the A flat Waltz, Op. 64, an involuted moto perpetuo, and this works quite marvelously. But I find his version of the vivacious B flat Mazurka, Op. 7, oddly eviscerated. The tumultuous middle section of the Nocturne in F also seems to need more outward fire and a more voluptuous sound; even in the tranquil opening of the piece, Serkin's tone perhaps lacks sufficient body to sustain the long line.

On the page, the early *Variations brillantes* is a flamboyant display piece. Serkin's reading is gentle, witty, and lean. In place of conventional bravura flourishes, he opts for quiet brilliance, paying precise attention, even at top speed, to every detail of articulation. The cantilena of the Lento variation

is gorgeously spun. There is plenty of virtuosity in this performance, but it is unadvertised.

The Barcarolle seems to me the one performance that plainly fails to cohere. Predictably, Serkin is at his best in the dreamy first page of the D major section. But the brittle, clenched-jaw intensity he brings to the bigger episodes is wrong. And some of the details, including a highly unorthodox pedaling for the opening octave, seem finicky, especially in such fluid music.

In sum, this is a most unusual Chopin recital, with many wonderful features and others that are debatable. Harris Goldsmith's notes far surpass RCA's norm, and the sound, coproduced by Serkin himself, is lifelike and unadulterated. J.H.

DELIUS: *Orchestral Works*.

Academy of St. Martin-in-the-Fields, Neville Marriner, cond. [Chris Hazell, prod.] ARGO ZRG 875, \$8.98. Tape: KZRC 875, \$9.98 (cassette).

A Village Romeo and Juliet: The Walk to the Paradise Garden. Hassan: Intermezzo and Serenade. A Song Before Sunrise. Fennimore and Gerda: Intermezzo. On Hearing the First Cuckoo in Spring. Summer Night on the River. Air and Dance. Koanga: La Calinda.

One couldn't ask for a better-chosen program to introduce the miniaturist Delius. Here are four orchestral excerpts from his operas (a breed recently scuttled from the pages of SCHWANN); an abstract piece for strings, the Air and Dance (newly entering SCHWANN); and three of those nature-inspired seasonal mood paintings that for many are the distilled essence of the rarefied, almost otherworldly, evocativeness and beauty of the Delian muse.

Marriner, it would seem, is one of the precious few conductors with the inclination and ability to keep the palely flickering flame of Delius' reputation alive. He displays a sure sense of the composer's time spans. The gently rocking rhythm of *First Cuckoo* and *Song Before Sunrise*, the leisure and pointedness of *La Calinda*, the sure structural grip of *Walk to the Paradise Garden* in these performances seem hewn from an abiding communion with an authentic tradition, without necessarily sounding like imitations of specific Beecham performances (as if one could possibly imitate Sir Thomas' way with Delius). Texture is always clear—*Summer Night* is a good example. I like less the self-conscious emphasis on portamento violin sound, which in the context of Marriner's approach is ill fit-



fact: professional studio technology comes to home hi-fi!



There is a new phono cartridge line that is the talk of the recording and broadcasting industries: the Shure SC39 Series. It is the first professionally optimized combination of true high fidelity performance, superb trackability, resistance to stylus damage under grueling conditions, and prolonged record life. These unique features make the SC39 ideal for high quality home applications as well.

if you transfer discs to tape

Use the cartridge developed for professional recording studios. The SC39 Series has a special strengthened internal stylus-support wire and elastomer bearing to improve stability when professional backcuing and slip-cuing techniques are employed.

In addition, the SC39 offers a unique stylus tip *not available on any other cartridge*: the MASAR™ tip, designed for playing even delicate lacquer masters, without objectionable noise buildup or "cue-burn" damage. It even helps when playing discs with high surface noise, or 45 rpm records made from reprocessed, substandard vinyl or polystyrene.



if youngsters have access to your hi-fi



This cartridge also comes close to being "butterfinger-proof." Most stylus damage is caused either by dropping the cartridge or by pushing the stylus sideways against the edge of a record. To protect against this, the SC39 is equipped with two remarkable features. The first is the *Lever-Operated Stylus Guard*, which locks the stylus guard in safety position when not in use. With the flip of a thumb, the guard snaps up and the operating lever turns into a handy cueing aid.

In addition, the *SIDE-GUARD Stylus Deflector* protects the stylus shank from damage by withdrawing it safely into the cartridge body in response to sideways impacts.

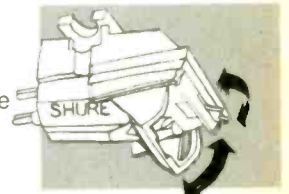

Lever-Operated Stylus Guard

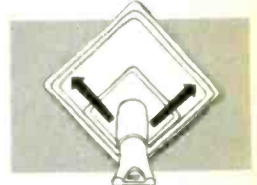

SIDE-GUARD Stylus Deflector

if you prefer professional response

The transparent sound of the SC39 Series is due to its optimized professional response which is virtually flat through the upper mid-range, with a smooth and gentle rolloff at the highest frequencies. It is especially pleasant when used with loudspeakers that tend to exaggerate the high frequencies.

There are three models in the SC39 Series: SC39ED—Biradial (Elliptical) stylus for ¾ to 1½ gram tracking; SC39EJ—Biradial (Elliptical) stylus for 1½ to 3 gram tracking; and SC39B—Spherical stylus for 1½ to 3 gram tracking.

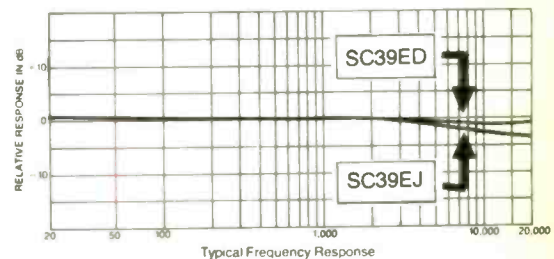

Send for brochure AL620.

SC39 series professional phono cartridges... by



Shure Brothers Inc., 222 Hartrey Ave., Evanston, IL 60204
In Canada: A. C. Simmonds & Sons Limited

Outside the U.S. or Canada, write to Shure Brothers Inc., Attn: Dept. J6 for information on your local Shure distributor.
Manufacturers of high fidelity components, microphones, sound systems and related circuitry.

ting, as is the overly aggressive bass of this recording. Minor quibbles, though.

This record is needed both for what it is and what it promises for the future. Don't miss it. A.C.

GERSHWIN: *Orchestral Works*.

Ralph Votapek, piano*; Boston Pops Orchestra, Arthur Fiedler, cond. LONDON PHASE-4 SPC 21185, \$8.98. Tape: SPC5 21185, \$8.98 (cassette).

Second Rhapsody for Piano and Orchestra* (arr. McBride). Three Preludes (orch. Stone). Overtures (orch. Rose): Funny Face; Let 'Em Eat Cake; Oh, Kay! Girl Crazy: Suite (orch. Anderson). Wintergreen for President (orch. Paul).

This recording, made on June 15 and 17, 1978, in preparation for the 1979 celebration of the Fiedler/Pops Fiftieth Anniversary Season, proved to be the conductor's last. The long, phenomenally prolific,

and successful association of conductor and orchestra could hardly have been more suitably rounded off: Not only was Fiedler still unhampered by the illnesses that were so soon to overtake him, but the program was an inspiration. Gershwin had been featured in the first Fiedler/Pops recording sessions, then for RCA Victor, in 1935: On July 1, *Rhapsody in Blue* was recorded for the first time in its entirety with full symphony orchestra, Jesús María Sanromá at the piano; on July 3, *Strike Up the Band* was recorded.

The major work here, only rarely recorded before and never with as much conviction, is the usually maligned or belittled Second Rhapsody with pianist Ralph Votapek, who seems an ideal choice. I don't pretend to remember just how Gershwin played it in its premiere with Koussevitzky and the Boston Symphony on January 19, 1932, but Votapek is scarcely less steely-fingered and vital than the composer as he remains in my memory; certainly he seems to bring comparable authority to the solo part. Perhaps now there will be some general reconsiderations of the unfavorable or, at best, grudging verdicts that have long been passed on the Rhapsody. Gershwin himself thought highly of it as displaying his matured powers of large-scale musical construction better than anything else he had written.

The minor work is the set of three early preludes, blown up here in elaborate large-orchestra transcriptions by Gregory Stone. The arrangements can't dissuade me from the belief that the preludes are best left in their original form as frankly improvisational little piano-solo pieces.

The rest of the program—and what is most likely to make it a best-seller—is a group of musical-comedy potpourri-overtures; plus the rambunctious "Wintergreen for President" parade from *Of Thee I Sing*. Again the pretentious orchestrations are a far cry in color, weight, and sheer sonic size from what was played by the original theater pit bands. But it's hard to complain, as one is swept away by the sumptuously sonorous settings of some of the finest tunes ever created for the Broadway stage. The overture arrangements by Don Rose (plus two more of his, *Girl Crazy* and *Strike Up the Band*), were first recorded by Michael Tilson Thomas for Columbia (April 1978), but it's no discredit to that talented youngster that neither he nor his Buffalo Philharmonic players can match the magisterial power and authority of Fiedler and the Boston Pops.

These performers, and London's Phase-4 engineers, are all in their glory here. Fiedler somehow reaches back for his

Transform your home into a nightclub, concert hall or cathedral.



Even the finest stereo cannot create the illusion of "being there" in the same acoustic space as the musicians.

Now you can experience the impact of hearing sound in *three dimensions* with the ADS 10 Acoustic Dimension Synthesizer. The ADS 10 uses sophisticated digital time delay techniques to recreate the *ambient* sound field which surrounds the listener in any real acoustic space.

*Stereo Review** on the ADS 10 experience: "... a totally unobtrusive, natural ambience can be achieved — and once you've experienced it, it's very difficult to give up."

*The Complete Buyer's Guide to Stereo/Hi-Fi Equipment** put it this way: "... If you have a good stereo system and ask yourself, 'Is there anything I could do for under \$1200 that would do so much to improve the realism of music reproduction in my home as the ADS 10?', the answer is certain to be 'no'. It's that good."

For more information, write ADS, Dept. HF2, or call 1-800-824-7888 (California 1-800-852-7777) toll free and ask for Operator 483. Or better yet, take your favorite records to your ADS dealer and let him demonstrate how the ADS 10 can recreate the live musical experience in your home.

* Quoted by permission, *Stereo Review*, April 1979, and *The Complete Buyer's Guide to Stereo/Hi-Fi Equipment*, November 1978.



Where technology serves music

Analog & Digital Systems, Inc., One Progress Way, Wilmington, MA 01887 (617) 658-5100

The car stereo buyer's guide to the Audiovox range* of sound systems for 1980:



Model DGC-20
Electronic Tuning AM/FM
Stereo radio with Cassette player
and Quartz Clock



Model DGC-10
Digital Display AM/FM/Stereo
radio with Cassette player and
Quartz Clock/Calendar

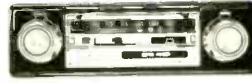

Model CAS-600A
Super Power Stereo Cassette
player with AM/FM/Stereo
radio. Dolby®. 40 Watt output



Model TPB-4000
Super Power 8-Track player with
AM/FM/Stereo pushbutton
radio. 40 Watt output



Model CP-750
Stereo Cassette player with
pushbutton AM/FM/Stereo
radio. 4-Way balance



Model ID-900
Digital Display AM/FM/Stereo
radio with Cassette player and
Quartz Clock



Model ID-800
Digital Display AM/FM/Stereo
radio with 8-Track player and
Quartz Clock



Model ID-675
Super Power Stereo Cassette
player with AM/FM/Stereo
radio. 40 Watt output



Model ID-625
Auto-Reverse Stereo Cassette
player with AM/FM/Stereo
radio. 4-Way balance



Model ID-500E
8-Track Stereo Tape player with
Pushbutton AM/FM/Stereo
radio. 4-Way balance



Model ID-725
Stereo Cassette player with Push-
button AM/FM/Stereo radio.
4-Way balance



Model ID-605
Stereo Cassette player with AM/
FM/Stereo radio. "500" Nose-
piece for Import Cars



Model ID-610
Stereo Cassette player with AM/
FM/Stereo radio. Locking
cassette controls

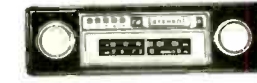

Model C-977A
8-Track Stereo Tape player with
AM/FM/Stereo radio. Special
4½" deep chassis



Model ID-600C
Stereo Cassette with
AM/FM/Stereo radio. Locking
cassette Fast-Fwd. control



Model ID-400C
8-Track Stereo Tape player with
AM/FM/Stereo radio. 105mm
Nosepiece. Track lights



Model ID-300B
AM/FM/Stereo Pushbutton
Tuning radio. Stereo Balance
control. Slide-Bar band selector



Model C-575C
Pushbutton Tuning AM/FM
Stereo radio with "500" nose-
piece designed for Import Cars



Model ID-200B
Pushbutton Tuning AM/FM
radio with Slide-Bar AM-FM
Band selector. 4½" deep chassis



Model C-506B
AM/FM Pushbutton Tuning
radio with "500" nosepiece
designed for Import Cars



Model ID-100B
Pushbutton Tuning AM radio
with illuminated Slide-Rule dial.
4½" deep chassis



Model C-406
AM Pushbutton Tuning radio.
Full-range tone control. "500"
Nosepiece for Import Cars



Model UC-20
Underdash Stereo Cassette player
with FM Stereo radio. F.Fwd/
Rewind/Eject cassette control



Model UT-30
Underdash 8-Track Stereo Tape
player with FM Stereo radio.
Slide-Bar controls. Track lights



Model C-981A
Auto-Reverse Stereo Cassette
player with F.Fwd/Rewind/
Eject. Underdash installation



Model C-988
Underdash Stereo Cassette
player with Slide-Bar controls.
Auto-Manual cassette eject



Model C-911A
8-Track Underdash Stereo Tape
player with Locking Fast-For-
ward control. Track lights



Model C-905
Underdash 8-Track Stereo Tape
player. Super compact size.
Track lights. Slide controls



Model UC-10
Mini Underdash Stereo Cassette
Player with Locking Fast-for-
ward control. Pushbutton eject



Model C-902A
Underdash 8-Track Stereo Tape
player with Slide-Bar controls.
Channel lights. Compact size

Available right now, a unique range of radios and tape players to fit every car.

You just want an AM radio? Audiovox makes it – and it's not a lot of money. You want the works? Cassette, 8-track, sophisticated electronics, speakers that can knock your socks off? Audiovox makes them. Still not a lot of money.

Audiovox is the largest specialist auto sound

company in America. Their high technology specialization results in sensational sound reproduction at a reasonable price.

For further information, write to R. Harris, Dept. HF, Audiovox Corp., 150 Marcus Blvd., Hauppauge, New York 11787.

Audiovox autosound systems are designed and developed by the audio research laboratories of Shintom Co., Ltd., Yokohama, Japan.

* Because of space limitations, we illustrated only 30 models. Audiovox has 109 more plus 77 car speakers and a full line of auto sound accessories.

© 1979 Audiovox Corporation

full youthful ebullience and communicative zest. (Those who have seen the *Sixty Minutes* interview with him will be strongly reminded of the metamorphosis scene where, after seemingly barely managing to totter like a very Ancient Mariner from backstage to the wing, he claps his hands and, miraculously rejuvenated, strides boldly out on the stage with all his characteristic assurance.) If everything seems just a bit larger than life—the performances and

recorded sonics as well as scorings—that always has been one of the secrets of Fiedler's success.

For every Fiedler aficionado, this last recorded program is of course essential. For every Gershwin aficionado, it takes a place of honor as a cornerstone of every Gershwinian library, along with the 1974 RCA "Great Gershwin" reissue collection of c. 1960-62 Fiedler/Pops recordings with pianist Earl Wild. R.D.D.

HAYDN, M.: Concerto for Violin, Strings, and Basso Continuo, in B—See Pisenel: Concerto.

HAYDN: Quartets for Flute and Strings, Op. 5.

RB Jean-Pierre Rampal, flute; Trio à Cordes Français. SERAPHIM S 60327, \$4.98 [from ANGEL S 36336, 1965].

No. 1, in D; No. 2, in G; No. 3, in D; No. 4, in G; No. 5, in D; No. 6, in C.

JEAN-PIERRE RAMPAL: Greatest Hits, Vol. 2.

Jean-Pierre Rampal, flute; various accompanists. [Bobby Finn, prod.] COLUMBIA M 35176, \$8.98. Tape: MT 35176, \$8.98 (cassette).

Both these releases are primarily of interest to Rampal's fans, and only the first can be mildly commended even to them. For while Haydn's miniatures probably are authentic-enough products of his first Esterházy years in the early 1760s (Nos. 4 and 6 also exist in unquestioned c. 1765 divertimento versions for flute, oboe, two violins, and cello), they are surely some of his least consequential *Gebrauchsmusik* chamber compositions. Rampal of course plays with expected deft grace, but the clean recording favors him unduly over the less distinctive—indeed *routinier*—string players.

Rampal and a wide variety of solo and ensemble accompanists are heard to better advantage in the sequel to his first "Greatest Hits" anthology (Columbia M 34561 of 1978). But the present miscellany is one of those dreadful, artistically unconscionable exhibits of surgical excerptomies—mostly movements that have been bloodily excised from the living organisms of which they once were an integral part. On one disc side Bach, Handel, Telemann, Vivaldi, and Mozart are the victims; on the other Bartók, Franck, Ibert, Poulenc, and Prokofiev; on both listeners of any musical sensibility at all. R.D.D.

HOLST: The Planets, Op. 32.

London Philharmonic Orchestra and Women's Chorus, Georg Solti, cond. [James Mallinson, prod.] LONDON CS 7110, \$8.98. Tape: CS5 7110, \$8.95 (cassette).

Since the renewed popularity of Holst's astrological suite has promoted sonic-display versions from most of the currently active virtuoso conductors, it was only a question of time until Sir Georg Solti demonstrated *his* showpiece treatment. And since he has wisely chosen a British rather than an American or other orchestra, and because he has studiously practiced an English accent in his perceptive Elgar inter-

MAXELL MAKES A RECORD OFFER WORTH LISTENING TO.



Get one of these albums free when you buy 3 Maxell UD-XL cassettes.

Anyone who appreciates great music is sure to appreciate these special recordings.

Each contains selected cuts performed by some of the world's greatest jazz, rock and classical musicians. And each has been specially selected under our supervision to bring out the

most in your equipment.

All you have to do to get one free is buy 3 UD-XL I 90 or 3 UD-XL II 90 cassettes.

That way, you'll not only be getting some great tape, you'll also be getting

some great music to listen to. Offer good at participating dealers while supplies last.



maxell 

Maxell Corporation of America, 60 Oxford Drive, Moonachie, N.J. 07074

Introducing Accuglide™. The computerized remote control turntable.

It provides hours of viewing pleasure.
(You read it right. Viewing pleasure.)

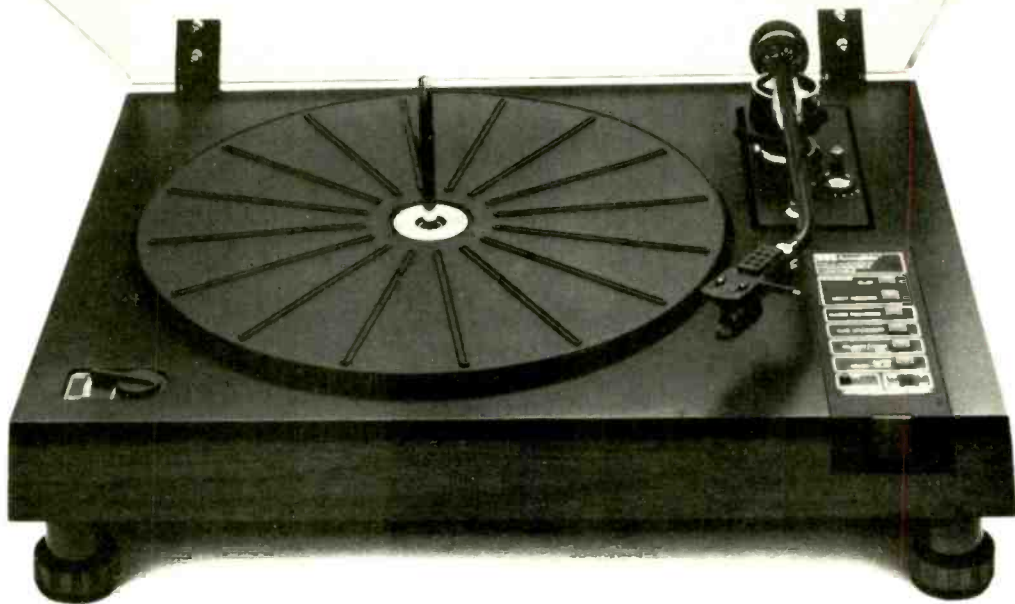

Even before you enjoy listening to Accuglide™, you're going to want to spend time just watching it. Because Accuglide performs like no other turntable you've ever seen.

Watch Accuglide's unique rotary spindle raise and lower your records like an elevator. So your hard rock doesn't drop on "Madame Butterfly."

You'll see Accuglide's spindle rotate its way to the top to pick up your record, carefully lower it, then gently place it onto the platter. Unlike other multiplay turntables, it doesn't drop them.

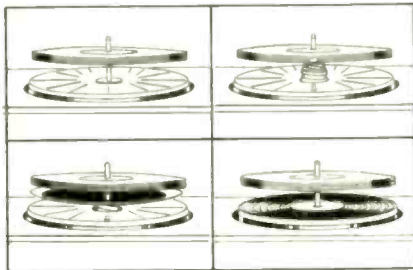

In fact, no other record changing system is as gentle. So your records couldn't be in better hands. Not even your own.

Accuglide's remote control lets you play the "Hallelujah Chorus" from across your living room. Hallelujah!

Now, listening to relaxing music can really be relaxing. Thanks to Accuglide's remote control you can play your favorite music without jumping up and down.

In fact, you can even raise and lower the volume from 40 feet away. So you won't be hassled by your neighbors if you want to play a hustle at 11 PM.

Play it again, Sam, is only one of 27 commands you can give Accuglide.

Simply press the right buttons on the Accuglide turntable or its remote control, and Accuglide's built-in computer stores up to 27 different commands.

So, you can change a record, reject it (you didn't like that one

anyway), raise the tone arm (so you can answer the phone), then resume play without missing a beat, repeat it (because now you want to hear it without any interruptions), then raise your records back to starting position so you can start all over again.

Accuglide's tubular "J" shaped tone arm is superbly balanced for exceptional tracking. And comes with a precision ADC magnetic cartridge with elliptical diamond stylus. Plus, the belt-drive Accuglide has the kind of specs you'd expect to find in the finest turntables. Like Wow and Flutter that's less than .04% WRMS and Rumble that's better than -66dB (DIN 45539B).

And if you think all this sounds good, how does this sound?

You can have all this viewing and listening pleasure for a song.



BSR Accuglide™ The computerized remote control turntable.

J&R THE ONE-STOP MUSIC SHOP AT WHOLESALE PRICES

BLANK TAPES

CASSETTE TAPES	REEL TO REEL
Ampeq Grand Master II C-90 \$3.11	Ampeq Grand Master 1800 n \$6.17
Ampeq Grand Master I C-90 \$2.79	Maxell UD 35-90 1800 n CALL
BSF Studio C-90 \$2.89	Maxell UD 35-160 1800 n CALL
BSF Pro I C-90 \$2.88	Maxell UD 35-160 3600 n CALL
BSF Pro II or III C-60 \$2.70	
BSF Pro II or III C-90 \$2.99	
Fuq Fax I or II C-90 \$3.99	
Maxell UD C-90 CALL	
Maxell UD C-90 CALL	
Maxell UD L or II C-60 CALL	
Maxell UD L or II C-90 CALL	
Scotch Low Noise Dynarange C-90 \$4.93	
Scotch Master I C-90 \$2.84	
Scotch Master II or III C-90 \$3.29	
Scotch Low Noise C-90 \$3.48	
Sony M-F Deedy C-90 \$2.52	
Sony Ferrichrome C-90 \$3.56	
TDK C-60 \$2.56	
TDK C-90 \$1.68	
TDK D C-120 \$2.10	
TDK D C-180 \$2.10	
TDK AD C-60 \$1.74	
TDK AD C-90 \$2.52	
TDK AD C-120 \$3.48	
TDK SA C-60 \$2.22	
TDK SA C-90 \$3.18	

Call or write for super low prices on Maxell tapes.

CARTRIDGES

audio-technica

AT-20SS	\$129.50
AT-15SS	\$89.90
AT-14 SA	\$48.95
AT-12 SA	\$42.90
AT-10	\$12.00

STANTON

881S	\$72.50
681EEES	\$55.00
681EE	\$24.90
680EE	\$12.00
590E	\$12.00

EMPIRE

2000Z	\$59.90
2000T	\$31.50
2000EII	\$19.50
4000DI	\$29.90

PICKERING

XSV3000	\$49.95
XV151200E	\$39.95
XV15150E	\$32.50
XV1525E	\$25.77
XV15400E	\$22.45

CAR STEREO

JENSEN

SANYO

CASSETTE IN-DASH W/RADIO

FT-417	\$113.50
FT-418	\$128.95
FT-1490A	\$127.50
FT-1495	\$148.90
FT-644	\$106.95
FT-642	\$92.50
FT-1490-2	\$169.50

CASSETTE UNDERDASH

FT-1400	\$95.50
FT-1405	\$114.95

PIONEER

CASSETTE IN-DASH WITH RADIO

KP-4000	\$128.70
KP-5005	\$142.95
KP-8000	\$157.30
KP-8005	\$157.30
KP-9000	\$189.95
KE-2000	\$189.95
KE-2002	\$214.50
KE-3000	\$242.90
KE-5000	\$284.90

CASSETTE UNDERDASH

KP-272	\$64.90
KP-292	\$116.95
KP-373	\$82.50
KP-250 w/FM Stereo	\$103.75
KP-500 w/Supertuner	\$134.95
KP-66G	\$92.95
KP-88G	\$114.95
KP-600	\$134.95

8-TRACK IN-DASH W/RADIO

TP-6001	\$99.95
TP-7000	\$114.40
TP-7004 5.5	\$112.90
TP-9004 5.5	\$137.95

We carry the full line of car equipment by such names as Sanyo, Craig, Marantz, Pioneer, Jensen and Audiovox. Write for free catalog.

ACCESSORIES

DISCWASHER Complete System	\$10.95
Dialit	\$34.95
Disorganizer	\$8.95
16 oz. D3 Rejuv	\$10.95
Zerostat Anti-Static Gun	\$14.95
SC-1 Struck Cleaner	\$4.95
FUZZBUSTER II RADAR DETECTOR	\$82.90
BEAM BOX FM 8 ANTENNA	\$36.50

HEADPHONES	PRICE
Koss Pro 4AA	\$39.90
Koss Pro 4AAA	\$48.00
Koss HV11C	\$35.97
HD-120	\$26.95
HD-130	\$24.40
Sennheiser HD-400	\$44.88
Sennheiser HD-414	\$44.88
Sennheiser HD-424	\$65.28

RECORDS

Pop, Rock, Jazz, R & B

All 7.98 List	\$4.99
All 8.98 List	\$5.49
All 9.98 List	\$5.99

50c additional for cassette or 8-track, please specify. Minimum order... \$25.00

WE STOCK THE COMPLETE SCHWANN CATALOG.

HOW TO ORDER: For shipment within 48 hours, send money order or certified check. Two weeks delay on personal checks. Please add \$3.50 per order for shipping & handling (\$5.50 for orders outside U.S.). N.Y.S. residents add tax. No C.O.D.'s. All merchandise 100% guaranteed, brand new & factory fresh.

J&R MUSIC WORLD

33 PARK ROW, DEPT. HF, NEW YORK, N.Y. 10038
ORDER TOLL FREE (800) 221-8180
CALL OR WRITE FOR FREE 120 PAGE CATALOG

pretations, he does better justice to the characteristically English qualities of this music than do most foreign-born conductors. Moreover, he—or producer Mallinson—has had the good sense to commission the jacket notes from the composer's daughter Imogen Holst.

Nevertheless, this is primarily a war-horse presentation: one of the utmost exultant bravura, recorded with arresting—power, and weight. The thunderous lows are so robustly resonant, in fact, that they will require some taming for home playback systems with particularly good low-frequency response.

But if the thunder-and-lightning moments fare very well, the fast movements are taken just a bit more breathlessly fast than by most other conductors, the slow movements are taken considerably slower. The extreme clarity of both color and phrase delineation—to say nothing of Solti's generally fiercely incisive straightforwardness—contribute to a literalness admirable in itself but fatal both to the humor of "Mercury" and "Jupiter" and the Impressionist mystery of "Venus," "Saturn," and "Neptune" with its final *morendo* wordless women's chorus. Listeners who seek mysticism or magic here will be disappointed; not so those who expect genuinely thrilling action-packed sonic drama.

Except for a hasty just-to-check re-playing of the Haitink *Planets* (Philips 6500 072; June 1971) to reassure myself that it securely remains my preferred recorded version, I'm postponing detailed comparisons with other recordings until the latest and most promising one, just out in England, is released here. It is the newest account by the conductor who has been most closely associated with this score for the longest: nonagenarian Sir Adrian Boult, also with the London Philharmonic, for EMI. R.D.D.

MOZART: Quartets for Strings: No. 16, in E flat, K. 428; No. 17, in B flat, K. 458 (Hunt).

Alban Berg Quartet. TELEFUNKEN 6.42348 AW, \$9.98.

These are thoughtful and intelligently prepared interpretations of two of the master's greatest quartets, and yet I find the Alban Berg Quartet less satisfying in Mozart than in its recent Brahms recording (6.35447, April). Both performances seem a mite affected, with slight but unseemly swells superimposed over a tonal characteristic that strikes me as distinctly monochromatic and self-effacing to the point of being inhibited. As a result, Mo-

zart's linearity is less than ideally served, and, paradoxically, so are the music's coloristic and emotional possibilities.

This is admittedly a purely subjective reaction, and if possible collectors should try to hear this faultlessly engineered disc for themselves. The performances are anything but routine. H.G.

PERLE: Thirteen Dickinson Songs*; Two Rilke Songs*.

Bethany Beardslee, soprano; Morey Ritt* and George Perle*, pianos. [Carter Harman, prod.] COMPOSERS RECORDINGS SD 403, \$7.95.

THOMSON: Songs from William Blake (4).* Three Portraits; Three Pictures for Orchestra.*

R Mack Harrell, baritone*; Philadelphia Orchestra, Eugene Ormandy* and Virgil Thomson*, cond. [Carter Harman, prod.] COMPOSERS RECORDINGS SRD 398, \$7.95 [from COLUMBIA ML 2087 (Portraits) and ML 4919, rechanneled].

Though some of the most important works of the twentieth century, including *Pierrot lunaire* and *Marteau sans maître*, can be classified and talked about as art songs, the genre generally remains reflective, if not out-and-out retrospective—a link between nineteenth-century private parlors and our modern public concert halls.

George Perle's *Thirteen Dickinson Songs of 1977-78* vividly illustrate this link. They are delicate songs for an intimate parlor, but also for modern sensibilities. This second element came first, of course, with Perle's choice of texts, which is one of the more fascinating things about this cycle. He stayed away from the best-known poems of Emily Dickinson (and from those used by Copland in the other big Dickinson set) and evidently looked for quietude, remoteness, and even spareness, avoiding overt romanticism. This is not to say there are no familiar poems in this cycle: The first is "Perhaps you'd like to buy a flower/But I could never sell," and the seventh is "These are the days when birds come back—a very few—a bird or two." But Perle wisely shunned the pitfalls of preconceptions and made it easier to frame the words in his own musical style.

That style is at once restrained and evocative. Like Dickinson, he does not give vent to raging emotionalism in these poems, nor does he stoop to even the most obvious (and, presumably, tempting) of clichés. The prevalent mood is slow and reflective, so that "The wind—tapped like a tired man" (No. 6) does not rush by in a torrent. The most welcome product of Perle's treatment of the texts is that no line sounds or seems cloying, not even those that are

"Popped our ears, rattled objects in the room, and were almost as palpable as audible."

THE WORLD'S MOST RESPECTED
LOUDSPEAKER CRITICS TESTED
THE FORMIDABLE RTR PS/1:DAC/1
SATELLITE AND SUBWOOFER
SPEAKER SYSTEM. STEREO REVIEW
SAID IN THE 9/79 ISSUE:

**"Its shape is designed
to minimize internal
resonance modes."**

The satellite's pyramidal
shape yields more trans-
parent woofer sound,
tighter and smoother bass
response and an incredi-
bly open sound quality
rarely found in other
speakers.

**"System easily met
its 16-HZ lower-limit
specification?"**

Compact, efficient and
flat from 16Hz to 150Hz,
the subwoofer reveals
low frequency instru-
ments with a degree of
undistorted realism
never before heard in a
home system. The first
subwoofer to combine
advantages of both
vented and acoustic sus-
pension systems without
their shortcomings.

**"Our initial reaction
to the sound of the
system was influenced
by its absolute non-
boomy bass?"**

Stereo Review confirmed
the goals set by RTR
engineers for their sub-
woofer: Reproduce all
bass exactly as recorded
without emphasis or
artificial change.

**"In respect to sonic
quality, we have not
encountered a better
example of such a
system than the RTR
PS/1:DAC/1?"**

That says it all! If sonic
quality is your goal, audi-
tion this incomparable
system at your RTR
dealer soon. It's priced
well below other state-
of-the-art contenders.

**"Almost in a class
by itself?"**

Compare the RTR sub-
woofer with any other.
Its absolute realism, fast
response, astonishing
delineation and detail are
as taut and powerful as
a live concert.



...When you've heard RTR, you've heard it all.

© RTR 1979

Reprint by permission from September, 1979 issue of Stereo Review magazine, copyright 1979 by Ziff-Davis Publishing Co., all rights reserved. For a complete reprint, write RTR Marketing Dept., 8116 Deering Ave., Canoga Park, CA 91304



magnetic

ape

warehouse

SAVE

money & energy

shop by
PHONE



800 526-5383

BLANK CASSETTES

MAXELL UDXL I or II	C60	2.49
	C90	3.35
UD	C60	1.99
	C90	2.85
	C120	3.95
TDK LN	C90	2.39
SA	C60	2.34
	C90	2.89
AD	C60	1.99
	C90	2.49
SONY		
FERRICHROME	C60	2.71
	C90	3.29
HIFIDELITY	C60	1.49
	C90	1.89
LN	C90	1.49
AMPEX		
GRAND MASTER II	C60	2.59
	C90	2.99
BASF PRO I	C90	2.89
PRO II & III	C60	2.10
	C90	2.98

MINIMUM ORDER 10 TAPES

TAPE DECKS

PIONEER CTF 500	129.00
CTF 650	199.00
CTF 900	398.00
AKAI GXC 706D	181.00
GXC 709D	221.00
GXM 30	199.00
JVC KD 10	155.00
KD 65	298.00

TURN TABLES

TECHNICS SL B2	95.00
SL 230	115.00
SL D1	91.00
SL D2	105.00
PIONEER PL 516	109.00
PL 518	152.00
TEAC A 105	169.00
AKAI AP 100	89.00

RECEIVERS

TECHNICS SA 200	169.00
SA 300	209.00
PIONEER SX 580	159.00
SX 680	197.00
SX 780	214.00
JVC JRS 201	267.00
JRS 301	320.00
MARANTZ MR 235	222.00

SPEAKERS

PIONEER PROJECT 60	61. ea
PROJECT 120	79. ea
ALTEC MODEL 3	106. ea
MODEL 9	219. ea
JBL L 19	TO LOW
L 40	TO
L 110	ADVERTISE

ALL MERCHANDISE FACTORY PACKED
MANUFACTURERS GUARANTEE
ADD \$3.50 FOR SHIPPING AND HANDLING
OF 1st CASE, \$1.00 EACH ADDITIONAL CASE.

SEND CHECK OR MONEY ORDER
TO

MAGNETIC TAPE WAREHOUSE

360 S. Maple Ave. • Glen Rock, N. J. 07452
Telephone 201 445-3260

Hours - Mon. thru Sat. 10:00AM to 8:00PM E.S.T.

awfully sweet to ears that hear the poetry without music.

These songs were written for soprano Bethany Beardslee on a commission from the National Endowment for the Arts; the singer and songs seem perfectly suited. The star of this performance, though, is pianist Morey Ritt, who, despite the fact that the engineers have placed her too far in the background, understands and dispatches the subtle messages of the music surely and sympathetically.

The coupling here is Perle's only other set of songs, those 1941 settings of poems by Rainer Maria Rilke. It's not at all surprising to hear music by America's great authority on Alban Berg mirror the manners of the New Viennese School. The two songs, in German, are early Perle and well-made derivations. They also are very well presented here.

Also notable principally for its songs is CRI's American Historic series re-release of an old Columbia tape of music by Virgil Thomson. Here are four of the five *Songs from William Blake* (1951) that he wrote for baritone Mack Harrell, performed by the dedicatee with Eugene Ormandy and the Philadelphia Orchestra. Unlike Perle, Thomson went for the jugular of the poet's work, with "The Divine Image," "Tiger! Tiger!" "The Land of Dreams," and "And Did Those Feet" ("The Little Black Boy" omitted). Britten's settings are much more suitable to Blake than Thomson's are, but that takes away none of the attractiveness of this relatively modest cycle, which Harrell sings with love and conviction.

The *Three Pictures*, written between 1947 and 1952 for, respectively, the orchestras of his hometown Kansas City, Louisville, and Dallas, and the three miniature *Portraits* are irresistible, like so much of Thomson's music, and they are more than adequately presented by the composer. Most intriguing is "The Seine at Night," the first of the *Pictures*, meant to send to the folks back home, in his words, "a sketch, a souvenir, a postcard of the Seine," by which he studied. Could it be, though, that Thomson didn't expect the listeners in Kansas City to hear the doxology flowing through the music and thus to imagine the connections the young man felt as he sat in New York trying to explain to his childhood friends and neighbors how he felt when he looked downstream to the Louvre? K.M.

PISENDEL: Concerto for Violin, Two Oboes, Strings, and Basso Continuo, in D. TELEMANN: Concerto for Violin, Strings, and Basso Continuo, in B. M.

HAYDN: Concerto for Violin, Strings, and Basso Continuo, in B.

Amsterdam Concerto, Jaap Schröder, violin and cond. [W. Erichson, prod.] QUINTESSENCE PMC 7114, \$3.98.

Here's a welcome bargain-priced release of an arrestingly novel connoisseur program that escaped ABC Records' attention when it was issuing its full-priced Seon series. None of these works seems to be otherwise currently available in this country, and, while they all may seem primarily of historical significance, their lively music appeals surely should not be confined to late-baroque and early-classical specialists.

Georg Johann Pisen del (1687-1755), nowadays one of the most neglected of worthy Bach contemporaries, was famous in his day for his compositions, including eight violin concertos, as well as his own fiddling. Albinoni and Vivaldi both dedicated concertos to him; Bach is thought to have written his unaccompanied sonatas and partitas for him. One of his finest works, the Concerto in D (Dresden MS CX 700) was recorded c. 1966 by Eduard Melkus for Archiv, but that version has long been out of print. This remarkably imaginative, rhapsodic music deserves a better fate than that: It should be known.

So should one of Telemann's relatively few concertos for solo violin, one with particularly poetic slow movements and exhilaratingly vivacious, whizzingly bravura fast ones. I've never come across it before, on or off records, nor the Michael Haydn work, which has been preserved in manuscript in the Budapest National Museum. Dated December 20, 1760, the latter is a sturdy, substantial work that at one time was attributed to Michael's elder brother, although—for all its homespun honesty—it lacks Franz Joseph's original and humorous turns of thought.

Schröder plays here with more enthusiasm and fewer mannerisms than I have ever heard from him. He is given first-rate support. And if at first hearing the 1973 Seon recording gives his violin unpleasantly penetrating tonal qualities, a slight reduction in playback level and a more marked high-frequency cut effectively tame the sonic fierceness, enabling one to enjoy some thoroughly delightful and, for most of us, stimulatingly novel music-making. R.D.D.

SAINT-SAËNS: Concertos for Piano and Orchestra: No. 2, in G minor, Op. 22; No. 4, in C minor, Op. 44.

Philippe Entremont, piano; Orchestra of the Théâtre du Capitole (Toulouse),

Michel Plasson, cond. [Roy Emerson, prod.] COLUMBIA M 35136, \$8.98. Tape: MT 35136, \$7.98 (cassette).

Entremont recorded this same coupling some years ago with Ormandy and the Philadelphia, and that disc is still listed (Columbia MS 6778). The Fourth Concerto is the more successful of these remakes. Entremont has caught a good measure of its élan and style, backed with capable urgency by the bright sound of the French orchestra. There are a few labored passages, however, and the glassy sound he persists in cultivating puts the reading in an echelon below the outstanding modern edition by Michele Campanella and Aldo Ceccato (deleted), not to mention the elderly phonographic classics of Casadesu/Rodzinski (newly pressed by Columbia Special Products, P 14156) and Cortot/Munch.

For all its dash, the reading of the G minor Concerto is made unendurable by overpedaling, rhythmic untidiness, and a karate-chop stereotype of "French" piano tone that defies belief. Arthur Rubinstein (RCA LSC 3165) need not fear. H.G.

STRAUSS, R.: Sonata for Violin

and Piano, in E flat, Op. 18. SZYMANOWSKI: Romance, Op. 23; Three Caprices After Paganini, Op. 40.

Vincent P. Skowronski, violin; Donald Isaak, piano. [Helen-Kay Eberly, prod.] EB-SKO PRODUCTIONS 1006, \$7.98 (Eb-Sko Productions, 1726½ Sherman Ave., Evanston, Ill. 60201).

The Strauss sonata is an impassioned early work—a sort of Don Juan before puberty (just as the even earlier cello/piano sonata, more perky and less sensual, represents Till Eulenspiegel's schoolboy pranks). The Szymanowski compositions are scarcely comparable in merit. The Romance, also a youthful effort, is stolid and derivative, with but a fleeting glimpse of the originality that was to inform this Polish composer's mature writing. And the arrangements of Paganini's Caprices, Nos. 20, 21, and (inevitably) 24, display the same kind of "wrong harmonic shoe on the right (or is it left?) foot" that characterizes the gimmicky parallel work for two pianos by Lutoslawski.

Skowronski writes fervently about this music, and his ardor is unmistakably carried over into his playing. Unfortu-

nately, much of it is accompanied by an inability to quite hit the high notes and by a vibrato that often seems more akin to a wow than a flutter. Strauss can survive such a café approach, but Skowronski and Szymanowski would appear to be Poles apart. The collaboration of pianist Isaak is highly proficient, and the resonant, well-balanced, big-hall sound frames the performances attractively. H.G.

STRAUSS, J. II: Waltz Transcriptions. For a feature review, see Page 80.

SZYMANOWSKI: Works for Violin and Piano—See R. Strauss: Sonata.

TCHAIKOVSKY: The Nutcracker, Op. 71.

Toronto Symphony and Children's Chorus, Andrew Davis, cond. [David Mottley, prod.] COLUMBIA M2 35196, \$15.98 (two discs, manual sequence). Tape: M2T 35196, \$17.98 (two cassettes).

Fast-rising young virtuoso conductor Andrew Davis and his experienced producer David Mottley may have chosen the

BEFORE YOU THROW OUT A GOOD TURNTABLE OR SPEAKER SYSTEM, CONNECT WITH A GREAT AMPLIFIER. THE PHASE 400 SERIES TWO.

Some speakers sound fine, until you hit a low passage. Then they turn to mud, or rumble at you like a cheap turntable. Chances are, that muddy, distorted sound is in fact, the result of an inadequate amplifier stretched to its limits. Clipping! To improve your sound, you need plenty of reserve power. The Phase 400 Series Two delivers the tremendous power reserve you need for sonic accuracy over the audible frequency spectrum. To accurately reproduce low frequencies without clipping, your speakers require up to 10 times the minimum power requirement of the mid-range frequencies. With the Phase 400 Series Two, when you listen to the 1812 Overture, you hear the blast of the cannon with awesome clarity. Even the deepest notes are clearly distinguishable. **ACCURACY YOU CAN HEAR.** To improve accuracy, the new 400 Series Two utilizes an advanced BI-FET input stage. This integrated circuit keeps the output virtually identical to the input. Distortion and noise are reduced to virtually inaudible levels. Beautiful music in, beautiful music out. **ACCURACY YOU CAN SEE.** You might have some questions about the 400's instantaneous LED output meters. Conventional-style VU meters are slow in comparison because they have to move the mass of the needle. The LED's move at lightning speed, accurately monitoring the output voltage, with scales for 8 and 4-ohm impedances. For accuracy, the meter contains 32 graduations, plus 4 fixed flashers to alert you to clipping. You have a visual safeguard, in addition to the Electronic Energy Limiters to prevent damage from overloads. See your Phase dealer about the Phase 400 Series Two. We think you'll recognize accuracy when you hear it. And when you see it.



Phase Linear[®]
THE POWERFUL DIFFERENCE

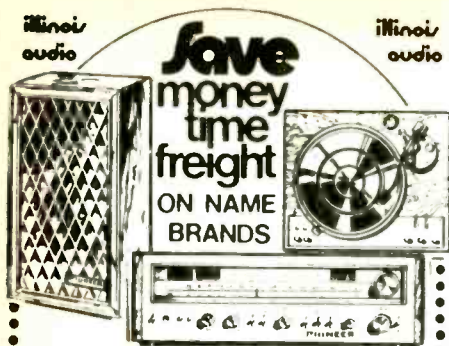

WRITE FOR NEW COMPONENT CATALOG

CURRENT SPECIALS!

- TEAC A-430 CASS. DECK \$315.00
- PIONEER SX-780 RECEIVER \$198.00
- AKAI GXM-30 CASS. DECK \$195.00
- KENWOOD KT-413 TUNER
WRITE US
- TECHNICS SL-Q2 TURNTABLE \$122.00
- TDK SA-C 90 TAPE \$30.00 /10
- MARANTZ 7Mk II SPEAKER \$70.00
- SONY STR-V4 RECEIVER \$228.00
- MARANTZ SR-1000 RECEIVER
WRITE US
- TECHNICS SB-5000A SPEAKER \$75.00
- SANSUI SC-5100 CASS. DECK \$400.00
- SANSUI SC-3100 CASS. DECK \$280.00
- MAXELL XL-C 90 TAPE \$40.50 /12
- MARANTZ 2265B RECEIVER \$317.00
- MARANTZ 2238B RECEIVER \$240.00

EVER SEE A BETTER PRICE?
LET US KNOW -- WE'LL TRY
TO BEAT THE DEAL!

BANK CARDS ACCEPTED NOW !! SEND TODAY !!

- * WE HANDLE 60 MAJOR LINES OF STEREO COMPONENTS. WRITE FOR PRICELIST.
- * PRICES AND AVAILABILITY SUBJECT TO CHANGE WITHOUT NOTICE.

send for free catalog

name _____
address _____
city _____
state _____ zip _____

illinois audio
12 East Delaware Place, Chicago 60611

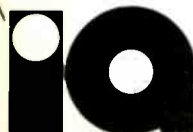

Phone Now!
(312)
664-0020

Circle 29 on Page 115

approach to this hardy annual holiday favorite that is best calculated to sell it to the tough-minded and -eared youngsters of today. Sock it to them! Forget the corny fairytale sentimentalities and go for sensational attention-grabbing showmanship, realistically savage Nutcracker/Mouse-King rumbles, spectacular dance virtuosity, and overwhelming sonic impacts at near-disco dynamic levels.

Old Fogies of any age may find that such highly extraverted treatment does indeed hype-up the familiar music. Certainly the Davis/Toronto performance often is electrifying and the ultra-vivid recording boasts devastating hurricane force. But I doubt that many connoisseur listeners will find any high-voltage shocks adequate compensation for the loss of this music's essential grace, humor, and spellbinding magic. And even the most fanatical audiophile—much as he will relish the superbly captured sock of the bass drum and the crispness of the famous musket-shot transients test—is likely to find the razor-edged highs intolerably fierce. Then, too, the realistic recording, with its considerable woodwind spotlighting, cruelly exposes the Canadian players' limitations in tonal warmth, polish, and subtlety.

If you're not yet ready for so new-fangled a *Nutcracker*, relax: There are plenty of more attractive—artistically and technologically—versions to choose from. The consensus preference probably is Dorati's for Philips (6747 257; reviewed in January 1977). But Previn's for Angel (S 3788; March 1973) also is a good choice, and I have a personal weakness for the first stereo version, away back in 1957—Rodzinski's for Westminster, which remains in print in two bargain-price reissues, Westminster 8147 and Sine Qua Non 155. For the most sumptuous sound of all, though, one must go quadriphonic to the CD-4 disc (or Q-8 cartridge) of excerpts only by Ormandy and the Philadelphians for RCA Red Seal (ARL 1-0027). R.D.D.

TCHAIKOVSKY: Symphony No. 2, in C minor (Little Russian), Op. 17. The Storm Overture, Op. 76.

Concertgebouw Orchestra, Bernard Haitink, cond. PHILIPS 9500 444, \$8.98. Tape: 7300 650, \$8.98 (cassette).

Bernard Haitink has thrown his hat in the ring as a candidate for the Complete Tchaikovsky sweepstakes. With Symphonies Nos. 1 and 3 still to come, this is the most impressive of his campaign appearances yet.

From the outset of the performance, it is clear that Haitink relishes the lift and

point of every phrase. His incomparably alert Dutch musicians do his bidding proud. Few readings have the delicacy and wistfulness in soft passages of this one. The problematical tempo of the second movement ("andantino marziale, quasi-moderato" isn't easy to figure out) is resolved in favor of a solemn but delectably biting slow swagger reminiscent of Beecham's eyebrow-raising version of the Fifties. Many will be relieved to hear that Sir Thomas' even more controversial slow canter in the scherzo is not duplicated here. The finale is splendidly vibrant and witty, while Philips has captured a rich and velvety hall ambience.

Haitink's filler is the 1864 Overture to Ostrovsky's *The Storm*, a piece that shows some inexperience and proneness to ramble. Yet it is colorful and attractive music, fascinating in its melodic foreshadowings not only of the slow movement from Tchaikovsky's First Symphony, but of Martha's Act III aria from Mussorgsky's *Khovanshchina*.

There have been good recordings before of *The Storm*, but this is the first by a world-class orchestra. Competition is, of course, fiercer in the symphony. Abbado, unfortunately, is now deleted, Solti's bargain version (London Treasury STS 15120) outdated sonically, and Previn (RCA AGL 1-1265) marred only by cuts in the finale's coda. Of the recent ones available singly, I found Muti's (Angel S 37472) all too typical of this conductor's sewing-machine approach to romantic music, Rostropovich's (Angel SZ 37394) tonally lovely but wanting in rhythmic backbone. I have nothing but admiration, however, for Markevitch's gutsy, broadly profiled, and humorous reading with the London Symphony, newly reissued on Philips Festivo 6570 161. A.C.

TELEMANN: Concerto for Violin, Strings, and Basso Continuo, in B—See Pisendel: Concerto.

THOMSON: Various Works—See Perle: Thirteen Dickinson Songs.

VAUGHAN WILLIAMS: Hugh the Drover.

Mary	Sheila Armstrong (s)
Aunt Jane	Helen Watts (a)
Hugh the Drover	Robert Tear (t)
Turnkey	John Fryatt (t)
Ballad Seller	David Johnston (t)
John the Butcher	Michael Rippon (b)
Showman	Terence Sharpe (b)
Sergeant	Henry Newman (b)
Constable	Robert Lloyd (bs)

Ambrosian Opera Chorus, Choristers of St. Paul's Cathedral Choir, Royal Philharmonic Orchestra, Sir Charles Groves, cond. [John Willan, prod.] ANGEL SZBX 3879, \$17.96 (two discs).

COMPARISON:

Davies, Lewis, Sargent Pearl GEM 128

"Romantic ballad opera" was Ralph Vaughan Williams' designation for *Hugh the Drover*, his first operatic endeavor, composed between 1910 and 1914—after the Tallis Fantasia and concurrently with *A London Symphony*. It began with the composer's desire "to set a prizefight to music" and was intended to be an English "folk opera" along the lines of Smetana's *The Bartered Bride*; the indigenous tradition stemming from Gay's and Pepusch's *The Beggar's Opera* would be wedded with the then newly discovered tradition of English folksong.

Harold Child, the journalist who made the libretto for Vaughan Williams, didn't hit the right note, though with some touching-up the composer found his work at least usable. The prizefight is set up between Hugh, a poetic wanderer whose trade is catching stray horses for the army, and coarse John the Butcher, to whom Mary, the prettiest girl in town, has been betrothed by

her unsympathetic father, the village Constable. Mary and Hugh have (surprise!) fallen in love at first sight, and when Hugh wins the fight, John and the Constable have him slapped in the stocks on trumped-up charges of spying for the French. Much of the second act is taken up with Mary's unsuccessful efforts to rescue Hugh; when the soldiers come to collect the "spy," they naturally recognize their friend the Drover and at last, after some dithering, Mary goes off with Hugh for life and love on the open road.

These characters, as drawn by Child, are but clichés; especially in the love scenes, they talk in the clichés of middle-class literature, not the language of the peasantry. The lovers, at least, are saved by their music, which is warm, vivid, and passionate in a vein strikingly permeated with the idiom of Puccini's *Madama Butterfly*—its point of contact with English folksong being the frequent use of pentatonic melodies. This sounds odd, but it works; the love duets are effective pieces, and so are several solos: Hugh's "Song of the Road" and Mary's "In the night-time," especially. But the music can't do much for John the Butcher, who is simply a grotesque, a bloodthirsty drunkard with no redeeming

features. And the rest are but lay figures, including Mary's hand-wringing Aunt Jane.

So there's limited drama in the characters. And, after the fight, there's not much drama left in the plot; the stratagems that keep the second act going are not well contrived, and Vaughan Williams expended a good deal of effort trying to remedy this. Like others of his works (including the contemporaneous Tallis Fantasia and *London Symphony*), *Hugh* underwent several revisions, most of the changes involving that second act. The final duet of Hugh and Mary was once much earlier in the act. For a major revival in 1933 conducted by Beecham, Child and Vaughan Williams devised an additional scene to begin the second act, which turned out to be still more padding and dithering that extended the basic situation still further without adding complexity or contributing to revelation of character. Later, the composer virtually disowned this scene, though it was still included in the final 1959 vocal score. It is omitted from this recording. (Though I agree that the scene does not help the opera at all, some of the music looks eloquent on the page; on the principle that everything by a composer of this stature is worth hearing, I'd still like to see it recorded.) Other-

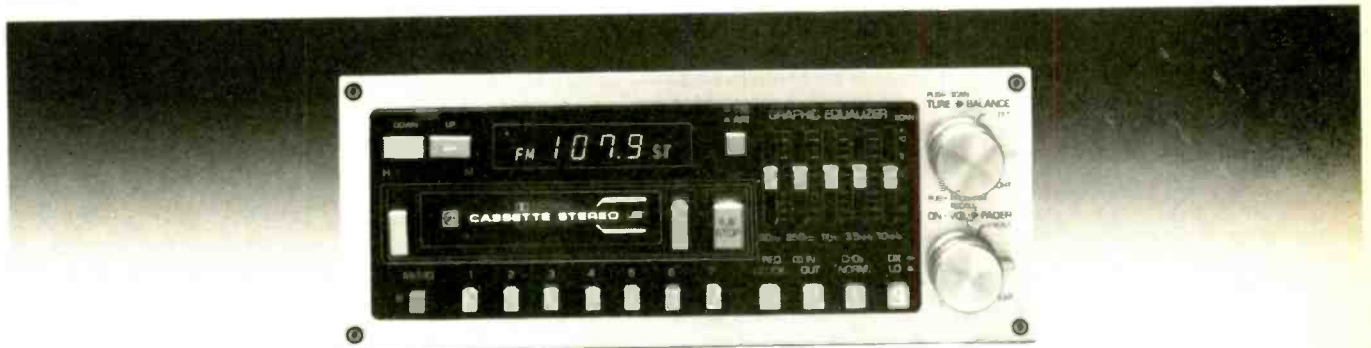

The Dashboard Wizard.™ Before, there was only car stereo.

Put aside everything you've been told about car stereo. The Dashboard Wizard is with us!

He's the latest in-dash audio marvel from Fujitsu Ten. A preamp combination system that will transform your car. The precise digital electronic tuner memorizes your favorite 7 AM and 7 FM stations, with search up, search down and scan tuning. FM muting and local/distance switch. There's even a quartz clock.

Hit the equalization switch and, presto, the auto-reverse cassette deck accommodates chrome and metal tapes.

With a Life Time Metal (LTM) playback head that's built to last well into the future. His five-band graphic equalizer lets you match the music to your car.



Performance? Miraculous, of course. Wow and flutter is .09% nominal—one of the best specs in car stereo. And with Dolby* on both FM and tape, hiss is a thing of the past.

Hear the Dashboard Wizard at your Fujitsu Ten dealer. Any resemblance to ordinary car stereo is a figment of your imagination.

Fujitsu Ten: The best sound on wheels.

FUJITSU TEN CORP. OF AMERICA

19281 Pacific Gateway Drive, Torrance, CA 90502
In Canada: Noresco Canada Inc., Ontario

*Dolby is the trademark of Dolby Laboratories, Inc.

wise, the recording sticks to that final score, which incorporates some changes made as late as 1955.

The opera's basic plot, with all its inequities, is embedded in a setting that allows Vaughan Williams to make fine show of his familiarity with English folksong and his ability to fabricate original examples of the idiom. The country fair of Act I and the May Day festivities of Act II both furnish many solo and choral opportunities: ballads, street cries, a Morris dance, marches, and so on. All of this is vivid and refreshing to hear: Along with the strong music for Hugh and Mary, it carries the piece forward—and in each act there is a well-planned, eloquent ensemble as well. If something less than an involving musical drama, *Hugh the Drover* is full of consistently enjoyable, often stimulating music.

I wish I felt that this recording made the strongest possible case for the piece. The name of Puccini was invoked earlier with respect to the love music, and it is specifically relevant to the vocal writing. This may be a "ballad opera" in name, but it wants full, rich, flexible voices in the leads, not the dry, constricted, short ones that we hear. You can't sing these high-reaching phrases—"Love that has set me free"—in a voice that isn't free; they fall flat. There's more virtue in some of the lesser parts, though of course none of them is really central to the work's musical impact. Helen Watts sounds worn of tone, but brings her characteristic sensitivity to Aunt Jane; Michael Rippon makes a big, slightly woolly

sound as John the Butcher (he's the only one in the cast to offer a country accent); Robert Lloyd is clear if unvaried in his delivery. Henry Newman and Terence Sharpe make good effects with their ballad numbers. The smallest parts (to be sung by "members of the chorus," according to the score) are often very ragged of tone.

Perhaps because of the inability of the two leads to push their roles out front, the performance as a whole doesn't quite jell. Sir Charles Groves could well have moved things along more firmly at times (Mary's "Alone I would be as the wind," in Act I, marked *allegro* and then *animato*, is such a place), and the recorded sound might have more focus—the balance decidedly favors the solo voices, with the chorus and orchestra shortchanged.

In this connection, especially, I was fascinated to compare Angel's set with the "original cast" recordings of *Hugh*, six double-sided 78s recorded acoustically in 1924, shortly after the opera's first performances and recently reissued (from somewhat noisy source material) by Pearl. Though hardly comparable in overall quality, these recordings make certain details—the choral parts in ensembles, the bass line often—more clearly audible than the new set. What is more, the 1924 principals (Tudor Davies and Mary Lewis) are much closer to the vocal ideal for their roles than the modern singers, and Malcolm Sargent (not yet a knight) keeps things moving well. In some respects, this antique is closer to the spirit of the work than the new set.

Angel's package includes a libretto

and a good historical note by Michael Kennedy. D.H.

WAGNER: Operatic Excerpts.

Montserrat Caballé, soprano; Strasbourg Philharmonic Orchestra, Alain Lombard, cond. RCA RED SEAL ARL 1 3351, \$8.98.

Tannhäuser: Overture; Dich, teure Halle; Allmächt'ge Jungfrau. Tristan und Isolde: Prelude and Liebestod.

Rather short measure here for Caballé fans, who would surely prefer more vocal tracks to Lombard's workmanlike performances of the *Tannhäuser* Overture (Dresden version) and the *Tristan* Prelude—the latter on the tepid side, the former less insistent on the principal tempo contrast than Wagner requests. Wagnerians may not find the lady's contribution much more enticing, however: Elisabeth's entrance is stodgy, the prayer hastily and choppyly sung; the initial intimacy of the *Liebestod* is soon abandoned in favor of conventional belting. One is less troubled by the touches of Spanish accent than by the singer's abstraction in dealing with the text (in *Dich, teure Halle*, she trades Wagner's "erschienst" for the present tense, "erscheinst," not augmenting our confidence in her command of the text's meaning). Unlike some excursions into Wagnerian realms from Mediterranean shores, this one proves neither satisfyingly central nor interestingly off-base. Decent, slightly tubby sound; texts and translations on the liner. D.H.

Recitals and Miscellany

ENRICO CARUSO: The Complete Caruso, Vols. 6-7.

H Enrico Caruso, tenor; orchestral accompaniment. RCA RED SEAL ARM 1-3373 and 1-3374, \$7.98 each (mono; Soundstream digital restorations) [from VICTOR originals, 1909-10].

Vol. 6: NUTILE: Mamma mia, che vo' sapé (11/6/09). VERDI: La Forza del destino: Dalla natal sua terra . . . O tu che in seno agli angeli (11/6/09). Aida: La fatal pietra (with Johanna Gadski, soprano; 11/7/09); O terra, addio (with Gadski; 11/6/09). GOLDMARK: Die Königin von Saba: Magiche note (11/7/09). BIZET: Carmen: La fleur que tu m'avais jetée (11/7/09); Il fior che avevi a me dato (11/7/09). MEYERBEER: Les Huguenots: Ah, qual soave vision . . . Bianca al par di neve alpina (11/

NEW from **GOTHIC**

A DIGITAL RECORDING

Catharine Crozier in Recital

Alice Tully Hall
Lincoln Center

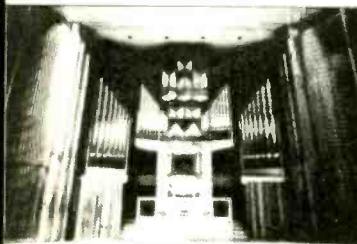

Catharine Crozier in Recital
GORDX

Fantasia and Fugue in G Minor, BWV 542—Bach
Partite diverse, "Sei gegrüßet, Jesu gütig," BWV 768—Bach
Orgelpartita, "Wachet auf, ruft uns die Stimme"—Dilster
Sonate I—Hindemith
Passacaglia Quasi Toccata Na Tema B-A-C-H—Sokola
Six Selections from "A Quaker Reader"—Rorem

About Miss Crozier's recital in Tully Hall, June 1979, Donal Henahan wrote for The New York Times:

"Miss Crozier played an unusually diverse program and played it unusually well. Her selection of registration was invariably shrewd and tasteful. Miss Crozier, in short, gave us a music recital, not an organ demonstration."

2-RECORD ALBUM \$24.95
D-87904

Ask at your local record store or send \$24.95 to:

Gothic Records, PO Box 533, Murray Hill Station, New York, N.Y. 10016

Payment must accompany order. Purchase Orders accepted from schools and libraries. (New York State residents add local sales tax—NYC 8%) (Canadian orders add \$1.00; Foreign orders add \$3.00 for additional postage). Orders filled promptly.

ADC has four Sound Shaper® frequency equalizers that will improve your sound system. No matter how good it is. And at a cost that's lots less than trading in your components.

ADC Sound Shapers will improve your speakers. By extending the true bass response, including the critical mid bass.

ADC Sound Shapers will improve the relationship between your cartridge and speakers. From one of partial incompatibility to total compatibility.

They'll also eliminate rumble (low frequency overload), tape hiss and record scratches.

And that only scratches the surface of what ADC Sound Shapers can do. For instance, the walls, carpeting and furniture of your listening room physically bounce sound around so that some spots have less sound than other spots.

Lots less. ADC Sound Shapers will bring these "dead" spots to life.

Perhaps best of all, though, is a Sound Shaper's ability to let you re-equalize what a recording engineer mixed. If a horn section is overwhelming a piccolo, for example, you just slide the appropriate frequency lever. Presto, more piccolo. You can also vanquish a voice. Or boost a tuba.

Sound Shapers segment the entire spectrum of sound. To let you re-shape a sound track to your personal musical preferences. It's all the control you've ever dreamed of but never dreamed possible.

To get into equalizers, start with our Sound Shaper One which operates in five frequency ranges. Or our Sound Shaper One Ten which gives you greater control by operating in ten frequency ranges.

For more professional equalizers, there's our Sound Shaper

Two Mk II which functions in twelve frequency ranges with a two-channel LED meter. And there's our new Sound Shaper Three *Paraphraphic™* Equalizer.

It combines all the advantages of a graphic equalizer with all the advantages of a parametric equalizer. Twelve primary frequency controls per channel. Plus twenty-four ancillary control positions per channel. The Sound Shaper Three is the ultimate in controlling and creating with your stereo system.

Take the ultimate step up in sound, without trading in a thing.

ADC Professional Products, a division of BSR Consumer Products Group, Route 303, Blauvelt, NY 10913. Distributed in Canada by BSR (Canada) Ltd., Ontario. ®Sound Shaper is a registered trademark of Audio Dynamics Corporation.

HOW TO TRADE UP YOUR RECEIVER, TUNER, AMP, TURNTABLE, CARTRIDGE AND SPEAKERS WITHOUT TRADING IN A THING.



ADC **SOUND SHAPER®**
A BSR COMPANY **FREQUENCY EQUALIZERS**

FREE!

HI-FI DISCOUNT CATALOG

- Lowest prices on audio components!
- Fast service, fully insured, factory sealed cartons from 2 discount leaders!



District Sound inc.
2316 Rhode Island Avenue, N.E.
Washington, D.C. 20018
(202) 832-1900

Sound Reproduction inc.
7 Industrial Road, Fairfield, N.J. 07006
(201) 227-6720

CLIP & MAIL TODAY!

Sound Reproduction, Inc.
7 Industrial Rd., Fairfield, N.J. 07006

Please rush your free Hi-Fi Discount Catalog

Name _____

Address _____

City _____

State _____ Zip _____

Circle 16 on Page 115

FREE details A DIFFERENT KIND OF RECORD CLUB

TREMENDOUS SAVINGS

on every record and tape in print—
no "agree-to-purchase" obligations of any kind
DISCOUNTS OF 43% TO 73%
off mfg. suggested list—special catalog
features hundreds of titles and artists.

ALL LABELS AVAILABLE

including most imports through special custom
ordering service—guarantees satisfaction.

SCHWANN CATALOG

lists thousands of titles:
classical, pop, jazz, country, etc.

DISCOUNT DIVIDEND CERTIFICATES

Dividend Gifts—certificates
redeemable immediately for extra discounts.

NEWSLETTERS

informational news and happenings in the
world of music...special super-sale listings

DISCOUNT ACCESSORY GUIDE

Diamond needles, cloths, tape cleaners, etc.

QUICK SERVICE

same day shipping on many orders,
rarely later than the next several days.

100% IRON-CLAD GUARANTEES

on all products and services—your total
satisfaction is unconditionally guaranteed.

Discount Music Club is a no-obligation membership club
that guarantees tremendous discounts on all stereo
records and tapes and lets you buy what you want...when
you want...or not at all if you choose.

These are just a few of the money-saving reasons to write
for free details. You can't lose so why not fill out and
mail the coupon below for immediate information.

dmc DISCOUNT MUSIC CLUB, INC. DEPT. 8-1279
650 Main Street, New Rochelle, N.Y. 10801

Name _____

Address _____

City _____

State _____ Zip _____

Circle 13 on Page 115

7/09). VERDI: Il Trovatore: Miserere (with Frances Alda, soprano; no chorus; 12/27/09; with Alda and Metropolitan Opera Chorus; 1/6/10). GOUNOD: Faust: Seigneur Dieu, que vois-je!; Eh! quoi! toujours seule? (with Geraldine Farrar, soprano; Gabrielle Gilbert, mezzo-soprano; Marcel Journet, bass; 1/12/10); Il se fait tard... Eternelle! ô nuit d'amour (with Farrar; 1/6/10).

Vol. 7: FLOTOW: Martha: Solo, profugo, reietto! (with Journet; 1/12/10). GOUNOD: Faust: O merveille! (with Journet; 1/16/10); Que voulez-vous, messieurs? (with Antonio Scotti, baritone; Journet; 1/16/10); Mon cœur est pénétré d'épouvante... Attends! Voici la rue (with Farrar; 1/12/10); Alerte! Ou vous êtes perdus (with Farrar, Journet; 1/16/10). FRANCHETTI: Germania: Studenti! Udite; Ah, vieni qui... No, non chiuder gli occhi vaghi (3/14/10). PONCHIELLI: La Gioconda: Cielo e mar! (3/14/10). PUCCINI: Madama Butterfly: Amore o grillo; Non ve l'avevo detto (with Scotti; 3/14/10). GEEHL: For you alone (12/28/10). VERDI: Otello: Nell'ore arcane... Ora e per sempre addio (12/28/10). MASCAGNI: Cavalleria rusticana: Siciliana (12/28/10). LEONCAVALLO: Pagliacci: No! Pagliaccio non son (12/28/10).

The missed opportunities as well as the positive achievements of RCA's digitally restored Caruso series were extensively discussed in these pages at the time of the initial releases (October 1978). One significant improvement may be noted in the latest installments: They really are complete, including the "unpublished" *Trovatore* "Miserere" without chorus as well as the more familiar version made some ten days later. This makes an interesting comparison, for the less "authentic" recording is surely the better sung; note, especially, Caruso's omission, in the remake, of Verdi's indicated upward portamentos to the repeated A flats on "Ah, chi desia..."

Otherwise, I am disturbed to note that some of these dubbings have been made from noisier original materials than earlier RCA releases of the same recordings: e.g., the *Cavalleria Siciliana* is marred by a bad thump that was not to be heard on either ERAT 1 or LM 2639. It is not clear to me why this should have to be so, and again I lament the absence of detailed technical information on how these reissues were accomplished. For some reason, the dividing bands between tracks on Vol. 6 have shrunk to near-invisibility, an affliction to which the earlier releases were not subject.

The liner notes of each disc, it seems, are to be assigned to a different writer, with

concomitant inconsistency and redundancy (Caruso's personal crisis of 1908/9, already discussed in Vol. 5, is recounted afresh on Vol. 6). More unfortunate is the absence of texts and translations for unfamiliar items, such as the *Germania* arias; worse yet, the annotations don't offer the slightest clue to their content.

On the positive side, all tracks are again correctly pitched, and the digital restorations are again remarkably convincing; doubters are referred to the first track of Vol. 7, the *Martha* duet with Journet, for an exceptionally successful example. Strict chronology is violated in the presentation when necessary to preserve musical sense—thus, the two halves of the *Aida* Tomb Scene were actually recorded in reverse order. The extensive *Faust* excerpts are split between these two discs, with the Garden Scene in Vol. 6, the rest in Vol. 7; the controversial excerpt "Elle ouvre sa fenêtre," from the end of the Garden Scene, containing a single word for the tenor that some have believed to be sung by Caruso, is not included. (The annotator's reference to "an almost complete *Faust*" is misleading, for the extant material sung in French comes to no more than half of the opera; still, it would be nice someday to have it all put together in sequence, for the singers are in good form indeed.)

There's a good deal of first-class Caruso here, along with occasional intimations of mortality: The *Cavalleria Siciliana* is now something of an effort, and the imposingly conceived "Cielo e mar" is marred by some audibly strenuous releases. Particularly lovely is the tenor solo in the *Martha* duet; this is the piece known in German as "Ja, seit früher Kindheit Tagen," though Caruso takes it rather more slowly than is usual in the opera's German performing tradition. Only a lunge for an unnecessary final B flat mars this beguiling piece of singing.

Long a subject of controversy has been the aria from Goldmark's *Queen of Sheba*, in which Caruso attains the final high B and C by dint of falsetto; clearly, these notes were troublesome of access to him by this point in his career (note that the *Faust* Trio, recorded two months later, is transposed down a semitone, evading a full-voiced high B). In this, however, Caruso would appear to be stylistically correct—compare the recordings by Leo Slezak and Karl Erb. Since Slezak is remarkably casual with the written notes (even in his second, transposed record) and Caruso is, except for the final phrases, rather more robust than suggested by Goldmark's direction of "sehr zart," a full realization of the aria's potential was not to be found on records until

Nicolai Gedda's modern version (Electrola 1C 063 28993).

In this, or in the comparison of French and Italian recordings of the Flower Song from *Carmen*, or in the aforementioned two "*Misereres*," there is much food for thought and frequent pleasure. Caruso is holding up his end of this project; I wish I felt confident that RCA is doing its part as well. D.H.

MASONIC MUSIC: Works by Giroust, Mozart, Beethoven, Himmel, and Taskin.

S. Hamilton, tenor; R. Terrasson, bass; J. Ver Hasselt, fortepiano; Les Chanteurs de la Tradition; Les Musiciens de Paris. **MUSICAL HERITAGE SOCIETY** MHS 4030, \$5.20 (\$3.95 to members) plus \$1.25 shipping (Musical Heritage Society, 14 Park Rd., Tinton Falls, N.J. 07724).

The Musical Heritage Society must have gone to the flea market for tapes to put together this incredible collection of works, most of which must have been dead when they were born. The title and the name of Mozart lead us to assume that we are going to hear his great orchestral Masonic music, but what we get are a few brief and lugubriously sung songs, the microphone right under the singer's Adam's apple, with the accompanying fortepiano sounding like a guitar with mumps. Then comes Beethoven's *Opferlied*, an insignificant piece.

The lion's share was reserved for three composers totally new to me and whom I had considerable difficulty in running down. However, if the modern lexicons say little about them, there is always that magnificent *Gallery of the Most Famous Composers* (1810), where one can find all the German nonentities, such as Friedrich Himmel and Henri Joseph Taskin. For François Giroust, I had to go to *Larousse de la musique*, which faithfully preserves the memories of the French counterparts of the German worthies, all forgotten for very good reasons.

This is what I would call a blue-plate recording of heterogeneous and indigestible fare. What's the use of offering such a sorry mélange to the public?

In the sloppy ways of the Musical Heritage Society, the conductor is not even mentioned, but a "speaker" who says a dozen words and two "editors" are named. (What is there to be edited in this music?) If these "editors" are the ones responsible for unearthing this stuff, they deserve the Shriners' special leather medal. P.H.L.

JEAN-PIERRE RAMPAL: Greatest Hits, Vol. 2—See Haydn: Quartets.

The Legend Continues.



The New Dynaco A150 & A250 priced from \$150.

Dynaco helped create stereo hi-fi 25 years ago. We built a reputation based on rigorous yet simple designs that produced more sound than the industry had ever seen.

Now we've come back to do it again. With two new speakers that are far and away the best we've ever built. Each of these systems continues the Dynaco legend of simplicity and performance at a

modest cost. Each in its own way will make you part of a listening experience that for 25 years has meant only Dynaco.

To sample that experience, take your favorite record album to your Dynaco dealer. Lean back and listen. You'll hear that Dynaco sounds better than ever. And the legend will continue. We have many new and exciting products coming your way.

dynaco

We build them like we used to.

110 Shawmut Road • Canton, Mass. 02021 • (617) 828-7888

The Tape Deck

by R. D. Darrell

Presentation Bach . . .

What musical gift—at any time of year, for a friend or oneself—can be more immediately yet inexhaustibly rewarding than a handsome boxed taping of one of Bach's supreme choral masterpieces? There are apt exemplars whether you cling to long-traditional readings or relish the more recent attempts to resurrect the putative sounds and styles of the late-baroque era. And if you are as yet undecided about which approach you prefer, some of the current arguments well may be—either positively or negatively—convincing.

For the conservative-minded, Philips has reissued in its new Festivo series Eugen Jochum's 1966 Amsterdam Concertgebouw version of the *St. Matthew Passion* (7650 018, three cassettes, \$20.94). Large-scale choral and orchestral forces and moderately romantic expressiveness are employed—all with admirable restraint, but also with a debilitating lack of dramatic intensity and eloquence.

Neville Marriner's more recent Academy recording of the mighty B minor Mass (Philips 7699 076, two cassettes, \$17.96) aims at a happy medium: modern instruments and women rather than boy soloists and choristers but relatively small forces and baroque idioms. Its prime merits are exhilaratingly brisk tempos and exceptionally deft and precisely balanced choral and orchestral execution, all recorded with an expansiveness and lucidity that at least one reviewer found lacking in the disc edition. Personally, I'm still willing to go whole hog for the controversial ultrapurist account by Nikolaus Harnoncourt for Telefunken (4.35019; "Tape Deck," January 1978), but that is likely to be too much for middle-of-the-road listeners. For them, Marriner is a good choice; for anyone, there are many moments here of memorable exultation.

Parenthetically, to leave the choral works for a moment, the same commendations apply to the new Marriner/Academy set of Bach's four orchestral suites (7699 087, two cassettes, \$17.96). These are more polished performances in more crystalline recording than his idiosyncratic Argo versions of 1971 (KZRC 687-8; "Tape Deck," April 1977), which I'm delighted to recommend anew in their recent Barclay-Crocker open-reel edition (Argo/B-C M 687, \$16.95).

Returning to the choral works, the current Regensburg *St. John Passion* con-

ducted by Hanns-Martin Schneidt for Archiv (3376 015, three cassettes, \$26.94) is characterized by purist extremes, some of which (the use of boy soloists, in particular) strike even me as regrettable. But I do find the beautifully recorded chamber-scaled chorus of men and boys, as well as the extremely small period-instrument orchestra, provocatively fascinating. In any case, there is uncommon historical significance in this first complete recording of the 1724 original *St. John* score plus its 1725 aria-and-choral additions.

For Bachians with less to spend, my only new-release recommendations are instrumental. The mostly early harpsichord Toccatas, S. 910-16, are special favorites of mine, and it's a joy to welcome them back to the active repertory (along with three fantasies, including the mighty *Chromatic Fantasy*, S. 903) in robust performances by the up-and-coming young British clavierist, Trevor Pinnock (Archiv 3310 402/3, \$8.98 each).

If you can run only to a single bargain-priced cassette, you'll find an important Bach first, the recently unearthed fourteen canons, played by duo-harpsichordists Rolf Junghanns and Bradford Tracey on Nonesuch (N5 71357, \$4.96). Overall, however, this release is a Curate's Egg in excelsis: The overresonant bottom-heavy recording demands considerable bass cut to sound right; the players often just plod doggedly along. The other material here ranges from Carl Philipp Emanuel's fine Four Little Duets through Johann Christian's lightweight Sonata in G to a Wilhelm Friedemann Concerto in F (without orchestra) that is—or is made to sound—stolidly dull, even ugly.

. . . and Mozart

Big as the present choral work—Mozart's last masterpiece, the Requiem Mass, K. 626—is in stature, in duration it demands only a single-length tape or disc. The latest one stars Marriner and his Academicians, this time with soloists Ileana Cotrubas, Helen Watts, Robert Tear, and John Shirley-Quirk, in a version that is notably "different" (Argo KZRC5 876, cassette, \$8.98; Argo/Barclay-Crocker E 876, open reel, \$8.95; both with the same notes but no text). What's different is partly Marriner's own characteristically vital reading but mainly the use—for the first time on records—of the new Franz Beyer edition, which corrects a number of details with

which Süssmayr (who completed the score after Mozart's death) went astray. Both editions are excellently processed, but of course it's open reel that best banishes surface noise and captures marginally wider dynamic and frequency extremes of the powerful yet glowingly warm sonics.

The only Mozartean Prestige Box I have at the moment is the Philips Festivo-series reissue of the c. 1967 Beaux Arts Trio's set of six piano trios (7650 017, two cassettes, \$13.96). The performances are disarmingly deft, if rarely inspired; improved mastering brings up to acceptability the original recorded sonics. In any case, this is the only available "complete" (minus the unfinished K. 442) taping.

Finally, there's a "new" Mozart flute concerto, which turns out to be James Galway's transcription of the familiar K. 622 for clarinet. It's startling at first and interesting throughout, but it never persuades one for a moment that Mozart had anything like it in mind. However, both it and the K. 299 Flute-Harp Concerto (with Marisa Robles) are played with exceptional verve and tonal limpidity by Galway with the London Symphony under Eduardo Mata, and the recording is a model of gleamingly crisp vividness (RCA Red Seal ARK 1-3353, \$7.98).

For each, one's own!

The best gift is not necessarily the most costly or most free from flaws, but the one that best suits the recipient's tastes. Example: For those for whom Herbert von Karajan can do no wrong, his sumptuously played, recorded, and packaged four Brahms symphonies plus *Tragic Overture* (Deutsche Grammophon 3371 041, three cassettes, \$35.92) will be a jackpot prize indeed.

For those aficionados of Vladimir Ashkenazy the pianist who may still be dubious about his maturation as a conductor: his Tchaikovsky *Manfred* and Fifth Symphony with the Philharmonia Orchestra (London CS5 7075 and CS5 7107, respectively, \$8.95 each). These are sonically as kaleidoscopic, lambently "Russian," and solidly impactful as any Tchaikovsky recordings to date; I haven't heard as galvanically exciting a Fifth since Koussevitzky's.

There are new slants, too, on a more recent composer, Arthur Honegger, in a Martinon French National Radio Orchestra recording (Connoisseur Society/In Sync C 4011, \$10.98). For in addition to the early successes, *Pacific 231*, *Pastorale d'été*, and *Rugby*, there is the magnificently impressive 1953 *Christmas Cantata* for baritone, chorus, organ, and orchestra—a fit companion to the mighty *King David*. **HF**

Yamaha decks the competition.



TC-720.
The 3-head deck
for the creative
recordingist.

If you like to get involved with your tape recording, this is the deck for you. The bias rotary control and built-in pink noise generator allow you to fine-adjust the deck's high frequency response to best suit the particular tape you are using. The REC LEVEL ADJ controls and REC CAL switch allow you to further adjust the recording sensitivity for proper Dolby® NR tracking, resulting in very high signal-to-noise ratio and exceptionally clean sound. The TC-720 also has a unique built-in "real time" echo facility. You can use this to add new dimensions of studio realism to tapes

recorded for playback in both your car and your home. All these front panel features (and more) are backed by reliable, advanced electronics. The Closed-Loop Dual Capstan Drive keeps the tape at an ideal tension for smooth head contact. An advanced Frequency Generator servomotor transports the tape at a constant, accurate speed with very high torque. High-performance, low-noise amplifying circuits are used for the mic and line inputs. All this superior performance is wrapped in a beautiful simulated ebony cabinet.

*Dolby is a trade mark of Dolby Laboratories.



TC-920B.
Matching the Industry's finest
separates in appearance as well as performance.

For unparalleled performance, the TC-920B starts with the heads. Yamaha's unique Pure Plasma Process results in Sendust heads of unparalleled purity, resulting in high permeability of the core for better sensitivity and playback efficiency, excellent S/N ratio, and greatly reduced tape/head wear.

The 920B has a vast array of audiophile features. Like the unique FOCUS switch. In the "SOFT" position, you will attain a more relaxing, mellow quality to the overall listening effect. In the "SHARP" position, you get a more crisply punctuated high frequency sound quality. There's also a fine bias adjust control to match the deck's characteristics to those of the actual tape in use.

A switchable subsonic filter cuts out subsonic interference due to warped records, line hum, etc., and also safeguards your speakers during playback without altering

sound quality. The bar-graph peak level meters have a fast/slow switch to adjust the recovery time of the meters for maximum control over the material you are recording.

The 920B's sleek black cabinetry enhances the high-performance look of this studio quality deck. For maximum convenience an ingenious hinged panel conceals the less often used controls. Everything was done with striking esthetics and total performance in mind.

The TC-720 and the TC-920B will bring the competition to its knees, and will bring you to your feet, cheering. For the full story, visit your local Yamaha Audio Specialty Dealer listed in the Yellow Pages. Or write us: Yamaha, Audio Division, P.O. Box 6600, Buena Park, CA 90622.

From Yamaha, naturally.

General Index To Articles 1979



Braun L200.

Plenty. If the name is Braun. Worldwide, the name Braun is synonymous with museum quality design and flawless performance.

Therefore, it's hardly surprising that when Braun created the first high performance miniaturized speaker system, it immediately attracted an army of admirers and a host of imitators.

In fact, hardly a week goes by without another "look alike" trying to stake a claim in the market.

However, in spite of or, perhaps, because of the sincerity of these flatterers, Braun has gone on to become the standard of reference for miniature loudspeakers.

And for a very simple reason... they sound better. Nor is this surprising, for Braun literally created, what amounts to, a new speaker technology. And that cannot be imitated.

So, while all the others frantically scramble to catch up, Braun maintains its pre-eminence in the field.

It is this leadership based on superior design, performance and technology that tells you better than anything else, what's in a name.

For specifications and the name of your nearest dealer write: Adcom, 11A Jules Lane, New Brunswick, N.J. 08901. Exclusive distributor in the U.S.A. for authentic Braun Audio Products.

BRAUN

Circle 76 on Page 115

Music and Musicians

- Astaire, Fred: More than Just a Pair of Dancing Feet. Benny Green. April
- Bonoff, Karla: Great Songs Don't Come Easy. Steven Rea. November.
- The Broadway Voice: Just Singin' in the Pain. Conrad L. Osborne. Part I, January; Part II, February.
- The Cars: East Coast Surfin' Music. Toby Goldstein. September.
- Cassidy, Shaun: More than Meets the Eye. Todd Everett. May.
- Conducting French Opera. Julius Rudel. August.
- Corea, Chick: Corea's Musical Macrocosm. Len Lyons. February.
- Culshaw, John (Culshaw at Large)—The Witch of Eighth Avenue (Feb.); Hornet's Nest (Apr.); Richter's Sixteen Silent Minutes (May); The Plot Against Wagner's Miss Pringle (Dec.).
- Davidovich, Bella—Prepares to Conquer America. Joseph Horowitz. October.
- Davidovich: Who's Davidovich? Leonard Marcus. October.
- Dire Straits—Smooth Sailing for. Ken Emerson. June.
- Disco: The Medium Is the Message. Stephen Holden. (Pop-Pourri) August.
- Earth, Wind & Fire—Mystagogic Funk. John Storm Roberts. January.
- The Emotions: "We Don't Want to Be Faddish." John Storm Roberts. December.
- Forbert, Steve—Takes a Bite Out of the Big Apple. Stephen Holden. July.
- French opera (Rudel): See Conducting.
- Functionalist Criticism. Gene Lees. March.
- George, Lowell: Little Feat's Lowell George. Sam Sutherland. August.
- Havana Jam: It Happened in Havana. Eliot Tiegel. June.
- Hornet's Nest (translation of Lieder). John Culshaw. April.
- Into the '80s: Choose Your Weapons. Stephen Holden. (Pop-Pourri) December.
- Lees, Gene (Lees Side)—Music U.S.A.: Part 21: War Songs II: Music Goes AWOL (Jan.); Part 22: Functionalist Criticism (March).
- Mackerras, Charles—on Handel. Bernard Jacobson. March.
- Manchester, Melissa: No Milk-Toast Here. Don Heckman. March.
- The Manhattan Tradition. Stephen Holden. (Pop-Pourri) September.
- Marcus, Leonard (Editorial)—The Leftover Decade (Jan.); Bach Flipped, by Jupiter! (Feb.); High Technology Recordings: The Secret Ingredient (March); The Politics of Audio (Apr.); Listener Fatigue (May); Random Thoughts Provoked by CES (Sept.); Who's Davidovich?/Schwann's Thirtieth (Oct.).

- Metheny, Pat—Finds His Own Voice. Sam Graham. October.
- Music Publishing in the Seventies: The Truth Hurts. Bruce Pollock. April.
- Musician of the Year: See Serkin.
- Musicians as Artists. October.
- Next Big Thing Fever. Sam Sutherland. (Pop-Pourri) November.
- The Oak Ridge Boys Go Secular. Todd Everett. April.
- "Performance-Practice" Muddle—The Great. Paul Henry Lang. July.
- Richter's Sixteen Silent Minutes. John Culshaw. May.
- Rock 'n' Recession. Sam Sutherland. (Pop-Pourri) October.
- Serkin, Rudolf: "Don't Tell Rudi!" May.
- Space Age Pop. Stephen Holden. (Pop-Pourri) July.
- Wagner's Miss Pringle—The Plot Against. John Culshaw. December.
- War Songs II: Music Goes AWOL. Gene Lees. January.
- The Witch of Eighth Avenue. John Culshaw. February.

Records and Recording

- A&R: Dream Job of the Record Biz. Sam Sutherland. November.
- Bach Flipped, by Jupiter! Leonard Marcus. February.
- Best Records. Leonard Marcus. December.
- The Brinsley Schwarz Legacy: Nick Lowe, Ian Gomm, the Rumour. Sam Sutherland. August.
- Cavpag Madman—Diary of a. Conrad L. Osborne. June.
- Commodore Catalog Comes Back to Life. John S. Wilson. October.
- Composers Recordings, Inc.—Surprising Survivor. Allan Kozinn. September.
- Conductor's Discographies: Some Hits, Some Misses. David Hamilton. September.
- Disco, mobile: See Oldest Established Floating Disco.
- Discotech I: How the Big Boys Fix the Mix. Crispin Cioe. July.
- Discotech II: The Producer Is the Star. Crispin Cioe. September.
- Eargle, John—An Interview with. The Making of Superdisc: Miking, Mastering, and Other Matters. Don Heckman. March.
- Forbert: Producing Steve Forbert. Steve Burgh. July.
- High Technology Recordings: The Secret Ingredient. Leonard Marcus. March.
- Home studio: A Bedroom Not for Sleeping. Peter Brown. January.
- Legge, Walter: An Appreciation. John Culshaw. November.
- Mobile Fidelity Takes on the Pop Honor Roll. Sam Sutherland. March.
- Musical Theater Albums: Mining America's

The Universal Expander

Dynamic range limiting during the production of records (and of FM broadcasts) has long been a source of irritation for music lovers. As playback equipment improves, the limitations of most program material become more and more obvious. The vast majority of records are produced with the lowest common denominator in mind—a system that is restricted in its ability to recreate natural dynamic range.

With the introduction of the Dynamic Expander, MXR's Consumer Products Group has achieved its goal of providing a signal expansion technique for all types of music compatible with the finest audiophile equipment available.

Enter the typical dynamic range

expander: While dynamics are restored, a series of disturbing side effects becomes apparent. Because typical expanders cannot distinguish scratches, ticks, pops, and rumble from music, these noises trigger the expansion circuitry. More importantly, because most existing expanders have a fixed value release time, they seem to 'pump' with some music, and hiss or 'breathe' with other kinds of music.

In most cases these drawbacks have outweighed the advantages of expansion for the critical listener.

Enter MXR's Dynamic Expander: a linear signal processor with up to 8 dB upward expansion (restoring musical peaks) and as much as 21 dB downward expansion (reducing noise). MXR has solved the problem of 'breathing and pumping' by providing a variable release-time control that tailors the response characteristics of the expander to the program material.

A sophisticated level detection circuit discriminates between music and unwanted information such as

rumble and scratches. To monitor gain changes, a unique LED display accurately indicates the expander's effect on the signal whether in or out of the circuit. A level control adjusts the detector's sensitivity to optimize the expansion for varying signal levels, and additional controls provide in/out bypass switching and versatile taping facilities.

The MXR Dynamic Expander preserves the bandwidth, stereo image, and spectral balance of the original signal even after processing. Dynamic range expansion that is musically natural will restore the excitement and nuance that makes live music so emotionally satisfying, and will let you rediscover your cherished recordings. Harnessing innovative technology and sophisticated production techniques, MXR continues its commitment to the music lover.

The expanding universe of signal-enhancing equipment from MXR's Consumer Products Group gives demanding music listeners maximum performance from their playback systems regardless of room acoustics or program deficiencies. The MXR Comander allows you to maintain the dynamic range of source material through open reel or cassette tape decks. Environmental equalization is easily achieved with your choice of stereo 10 band (full octave), stereo 15 band (two-third octave) or professional one-third octave equalizers all built to the exacting performance specs for which MXR is famous. See your MXR dealer.

MXR Innovations, Inc., 247 N. Goodman Street,
Rochester, New York 14607, (716) 442-5320

MXR Consumer
Products Group

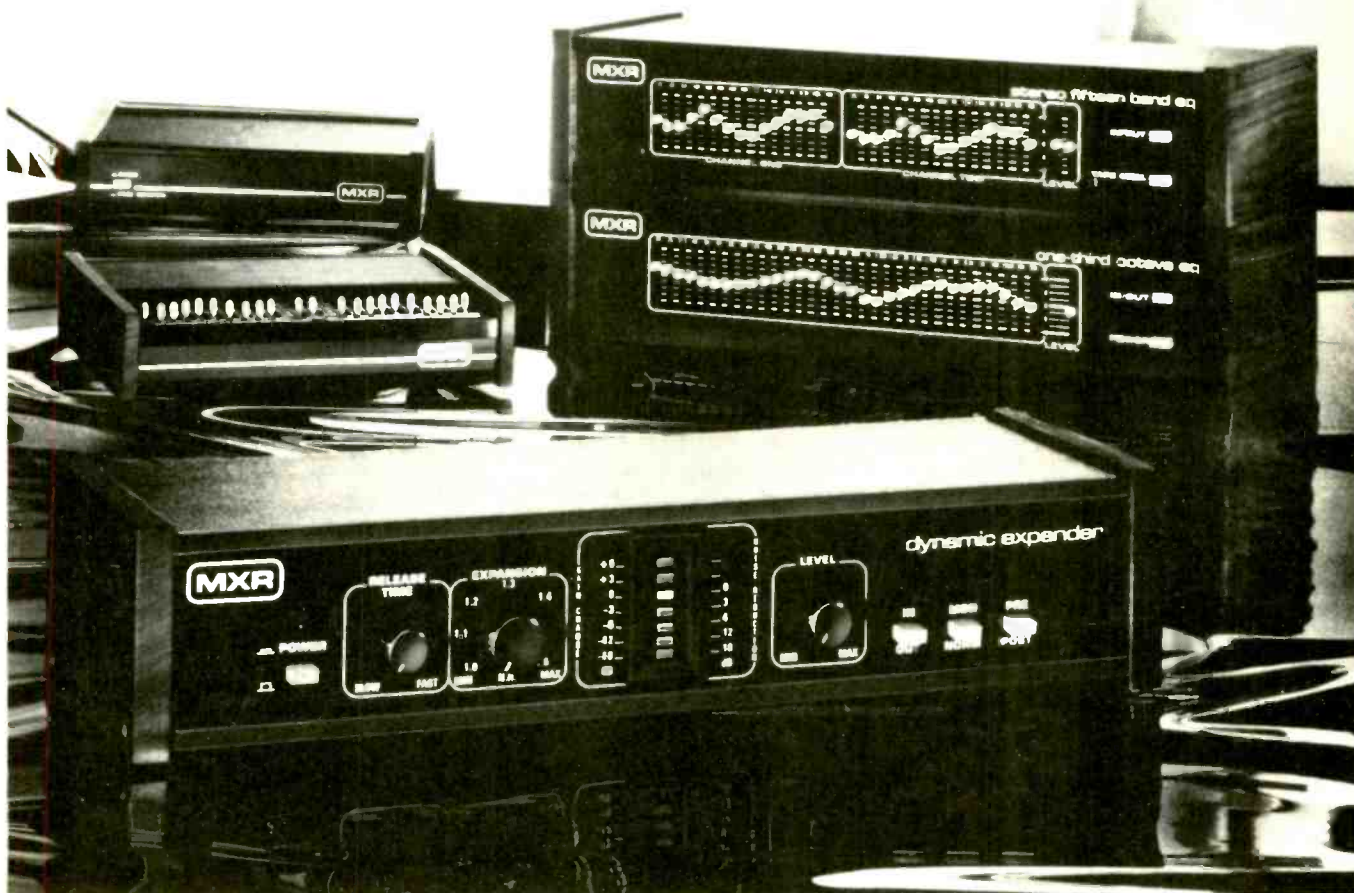

- Gold, Deena Rosenberg. March.
The Oldest Established Permanent Floating Disco in New York. William A. Kanner. February.
Philadelphia Orchestra: The Untamed Philly. Herbert Kupferberg. May.
Pop recordings: Critics' Choice '78. January.
Record Distribution: The Big 6 Take Over. Ira Mayer. October.
Recordings preview—1980. September and October.
Ricker, Stan—An Interview with. The Making of Superdisc: Manufacture—Delivering the Goods. Don Heckman. March.
SCHWANN's Thirtieth. Leonard Marcus. October.
Stiff Issues Tour LPs Without Clive's Help. Toby Goldstein. March.
Superdisc—The Making of. See Eargle; Ricker.
Superdisc—Will It Fly? It's Up and Away Already. Harold A. Rodgers. March.
Superdisc—Will It Fly? Maybe, but Where to? Kenneth Furie. March.
Unreleased recordings: Cracking the Vaults at Columbia and RCA. David Rosenthal. December.

Featured Reviews

- Astaire, Fred: The Astaire Story. April.
Bach: Keyboard Works. Brendel. Kempff. July.
Bach: Organ Works. Leonhardt. March.
Bach: St. John Passion. Soloists; St. Emmeram Collegium, Schneidt. September.
Bach: Suites for Orchestra, 5. 1066-68. English Concert, Pinnock. November.
Bach: Toccatas, Vol. 1. Gould. July.
Bach: Well-Tempered Clavier. Loesser. July.
Bartók: Orchestral Works. Philadelphia, Ormandy. December.
Beethoven: Piano Sonatas. Brendel. Hungferford. Pollini. February.
Berlioz: Harold in Italy. Suk; Czech Philharmonic, Fischer-Dieskau. Vernon; Cleveland, Maazel. Zukerman; Orchestre de Paris, Barenboim. McInnes; Orchestre National de France, Bernstein. November.
Berlioz: Symphonie fantastique. Orchestre de Paris, Barenboim. Orchestre National de France, Bernstein. U.S.S.R. State Symphony, Fried. Leningrad Philharmonic Orchestra, Jansons. Vienna Philharmonic, Monteux. Philadelphia, Ormandy. London Symphony, Previn. London Symphony, Weingartner. Concertgebouw, Van Beinum. November.
Callas, Maria: Various recordings. January.
The Clash: Give 'em Enough Rope. February.
Clementi: Symphonies. Philharmonia, Sci-mone. May.
Cooder, Ry: Bop Till You Drop. October.
Dire Straits. January.
Disney, Walt—The Magical Music of: Fifty Years of Original Motion-Picture Soundtracks. March.
Donizetti: Lucrezia Borgia. Sutherland; Aragall; Wixell; National Philharmonic, Bonyng. October.
Doobie Brothers: Minute by Minute. March.
Dylan, Bob: Slow Train Coming. November.
The Eagles: The Long Run. December.
Franck: Symphony in D minor. NBC Symphony, Cantelli. March.
Gigli, Beniamino: Complete Edition, Vol. 1: Operatic Arias. July.
Gil, Gilberto: Nightingale. May.
Glass, Philip & Robert Wilson: Einstein on the Beach. July.
Irakere. May.
Joel, Billy: 52nd Street. January.
The Knack: Get the Knack. September.
Martinů: Various Works. Czech Philharmonic, Neumann, Košler. September.
Mas, Carolyne. November.
Massenet: Cendrillon. Von Stade; Gedda; Philharmonia, Rudel. August.
McGuinn, Clark & Hillman. April.
Mitchell, Joni: Mingus. September.
Schubert: Die schöne Müllerin. Dyer-Bennet; Garniez. April.
Schumann: Liederspiele. Moser; Schwarz; Gedda; Berry. May.
Schumann: Songs. Fischer-Dieskau; Eschenbach. Schreier; Shetler. May.
Schumann: Spanisches Liederspiel; Minnespiel. French Vocal Quartet. May.
Shostakovich: Lady Macbeth of the Mzensk District. Vishnevskaya; Gedda; London Philharmonic, Rostropovich. September.
Sondheim: Sweeney Todd. Original Broadway cast. August.
Strauss, J. II: Waltz Transcriptions. Boston Symphony Chamber Players. December.
Strauss, R.: Die schweigsame Frau. Scovotti; Burmeister; Adam; Dresden State, Janowski. October.
Superman: Original film soundtrack. London Symphony, Williams. June.
Supertramp: Breakfast in America. June.
Van Beinum, Eduard—Art of. Concertgebouw. April.
Verdi: Otello. Scotto; Domingo; Milnes; National Philharmonic, Levine. M. Price; Cossutta; Bacquier; Vienna Philharmonic, Solti. Martinis; Vinay; Schoeffler; Vienna Philharmonic, Furtwängler. February.
Vista Organ Series. Swann. Grogan. Guenther. May.
Zelenka: Orchestral Works. Camerata Bern, Wijnkoop. March.

Audio and Video

ELECTRONICS

- The Pickup/Preamp Confrontation. Edward J. Foster. June.
RFI and the Nickel Fix. Edward J. Foster. (Soundings) July.
RFI—FCC Probes. (News and Views) April.

(more)

HIGH FIDELITY'S Free Armchair Shopping Service

On the card opposite, circle the number indicated at the bottom of the ad or at the end of the editorial mention of the product you're interested in. (Key numbers for advertised products also appear in the Advertising Index.)

Type or print your name, address, and zip code on the card. Postage is prepaid.

Mail the card today. You'll soon receive free product literature and specifications from manufacturers.

MAIL ORDER BUYER'S SERVICE

Three Great Buyer's Guides From HIGH FIDELITY Order Now!

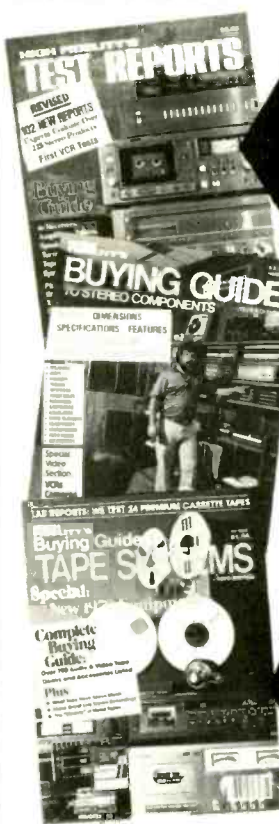

1979
HIGH
FIDELITY'S
Test
Reports
\$3.95
Circle
161

1979
Buying
Guide to
Stereo
Components
\$2.95
Circle
162

1979
Buying
Guide to
Tape
Systems
\$1.95
Circle
163

To order, circle the number on the attached card that matches the number of the Buyer's Guide you want. Enclose payment plus \$1.00 for postage with your order and mail to:

HIGH FIDELITY
One Sound Avenue
Marion, Ohio 43302

(Enclose payment. No credit orders.)

YOU HARDLY NOTICE A HERESY® UNTIL YOU TURN IT ON.



If you're cramped for space, Heresy is a loudspeaker that won't cramp your style. The Klipsch® Heresy will fit anywhere in your apartment and it will just sit there, gentle as a kitten until you turn it on. Then, watch out. Heresy roars like a lion.

Here's a small loudspeaker that has both tremendous

efficiency and wide bandwidth. It uses the same tweeter and mid-range driver as the Klipschorn®, the industry standard for the past 30 years. The rugged 12" woofer is matched to the box for optimum bass performance and bandwidth.

So, just because you can tuck a Heresy in out-of-the-way

places, don't underestimate its power. Your neighbors may well be calling to see how you managed to get an orchestra into your apartment. Heresy is proof positive that big sound can come in small packages.



Klipsch loudspeaker systems are available in a wide variety of carefully selected domestic and exotic hardwood veneers

Please send me your FREE color brochure on the full line of Klipsch loudspeaker systems, along with a list of Klipsch dealers

Name _____ Address _____

City _____ State _____ Zip _____

Clip and mail to Klipsch & Associates, Dept H129, P.O. Box 688, Hope, AR 71801

Signal-processing: Aphex Patent Progresses. (News and Views) February.
Telefunken's High Com. (News and Views) January.

RECORD-PLAYING EQUIPMENT

Magnetic Pickups—The Anatomy of. Kenneth Johnson and William C. Walker. January.
Tracking-Angle Error: A New Slant. James V. White. June.

SPEAKERS

Eight (or So) Records to Judge Speakers By. Norman Eisenberg. October.
Subwoofers. C. Victor Campos. October.

TAPE

BEST—The Beauty of the. (News and Views) March.
Cassette decks: How to Decide Which Features You Really Want. Robert Long. August.

Metal-particle tape: Bits and Particles. Larry Zide. February.
Musicassettes—New High-End. (News and Views) April.
Tape/deck matching: An Open Letter to Joel Tall. (News and Views) January.
Tape/deck matching: Those Misleading Manuals. Robert Long. (Soundings) August.
Taped Programs for Your Car. Harold A. Rodgers. February.
TDK: Chikumagawa and Back. (News and Views) February.
Teac 124: A Cassette Deck with Sync. (Input Output) August.

VIDEO

Prerecorded Video Tapes: Buyer Beware. Robert Angus. November.
Video Recording: State of the Art—For Now. Bennett Evans. November.
Video Topics. February; May; August; October; December.
Videodisc Reaches Market. (News and Views) March.

Miscellaneous

Ambience and Space: Six Experts on the State of the Stereo Art. November.
For the Autophile. Robert Angus. January; March; July; September; November.
Buying the Right Electric Guitar. Steve Burgh. December.
Car Stereo: Dawn of the High Fidelity Era. Robert Angus. May.
CES—Random Thoughts Provoked by. Leonard Marcus. September.
China Chronicles. Leonard Marcus. August.
Christmas Gifts for the Audiophile. Peter Dobbin. December.
Components—A Personal Approach to Choosing. Ivan Berger, Don Heckman, Alfred Myers, Michael Riggs, Peter Suthem, William Warriner. December.
FM and the FCC: The Feds Are Coming! Robert Long. (Soundings) September.
HIGH FIDELITY magazine: Newness and Renewal. Robert S. Clark. (Editorial) July.
High-frequency perception: The Middle-Aged Ear. Robert Long. (Soundings) October.
Listener Fatigue. Leonard Marcus. May.
The Listening Room: The Forgotten Component. Alan Fielding. July.
Measurement data: Reading the Numbers: An Update. June.
Microcomponents: Why—and Whither—Micros? June.
Moog—The Latest from. (Input Output) July.
New products: Audio Heads into the '80s. Robert Long and Harold A. Rodgers. April.
New products: High Fidelity at the Crossroads? Robert Long and Peter Dobbin. September.



Next time you plan a trip to Europe, make sure you visit the unique country.

Where can you find: Europe's largest waterfalls?
Europe's blondest blondes?
Europe's highest geysers?
Europe's greatest glaciers?

And where can you find moonlike craters where the astronauts trained? More volcanos than anywhere else on earth? Historic landmarks of the world's oldest continuous parliament? Celebrations marking Europe's youngest republic?

The answer to all of these questions is—ICELAND. Next time you plan a trip to Europe, make sure you visit Iceland.

The only thing it may cost you is time well spent. Because you'll save enough money on Icelandic's lowest jet fares to Luxembourg to pay for your stopover in Iceland. Or, you can hop over from New York or Chicago for longer tours. See an erupting volcano. Take a cross-country pony trek.

Next time you plan a trip to Europe, ask your travel agent about Icelandic Airlines. Or phone Icelandic Airlines, for folders about Iceland and lowest jet fares to Europe. In New York State, phone (212) 757-8585. Elsewhere in U.S., phone (800) 555-1212 for local toll free number.

Radio: Whither Good Radio? John K. Major. May.
 Radio Programming Consultants: The Power Elite. Donna L. Halper. May.
 The Seventies: The Leftover Decade. Leonard Marcus. January.
 Tandberg: The Case of the Lively "Corpse." (News and Views) April.
 Ursa Major—The First from. (Input Output) July.
 WCES: The Politics of Audio. Leonard Marcus. April.
 Zenith Tries Components. (News and Views) February.

Equipment Reports

AMPLIFIERS (Power and integrated)

Hitachi HMA-7500. March.
 Kenwood KA-801 integrated. November.
 Luxman 5L-15 integrated. April.
 Pioneer SA-9800 integrated. September.
 Rotel RA-2030 integrated. July.
 Scott 480A integrated. May.
 Technics SE-C01. June.
 Uni-Sync 50. May.

CARTRIDGES (Phono)

B&O MMC-20CL. April.
 Empire EDR-.9. October.
 Nagatron HV-9100. January.
 Ortofon MC-10. February.
 Shure M-95HE. September.
 Sonus Gold Blue-Label. August.
 Yamaha MC-1X. December.

HEADSET

Audio-Technica ATH-7. January.

PREAMPLIFIERS

Audio International CM-301. February.
 Crown Straight Line One control & SL-1 PM phono module. November.
 Mitsubishi DA-C20 preamp/tuner. March.
 SAE 2900. January.
 Source Engineering Specialist. March.
 Technics SU-CO1. June.

RECEIVERS

Fisher RS-2007. July.
 McIntosh Mac 4100. February.
 Nakamichi 730. April.
 Nikko NR-819. October.
 Onkyo TX-4500 Mk. II. May.
 J. C. Penney 3275. September.
 Realistic STA-7. August.
 Rotel RX-504. December.
 Sherwood S-7450CP. July.
 Yamaha CR-640. June.

SPEAKERS

Avid M-330. March.
 Bozak LS-300. April.
 Celestion Ditton 662. September.

Dahlquist DQ-1W subwoofer. October.
 Electro-Voice Interface A. December.
 Grafyx SP-Ten. April.
 Infinity Infinitesimal. June.
 JBL L-110. July.
 KEF 105. July.
 Koss CM-530. September.
 Mordaunt-Short Pageant Series 2. November.
 Ohm N subwoofer. October.
 Qysonic Array. August.
 Rogers LS3/5A. July.
 RTR PS/1 Pyramid & DAC/1 Rhombus subwoofer. October.
 Speakerlab 30 kit. July.
 Ultralinear 228. May.
 Visonik Euro 7. July.

TAPE DECKS

Aiwa AD-6900U cassette. March.
 Akai Pro-1000 open-reel. May.
 B.I.C. T-3 cassette. August.
 Harman Kardon HK-3500 cassette. July.
 Hitachi D-7500 cassette. May.
 JVC KD-A8 cassette. December.
 Marantz 5030B cassette. January.
 Mitsubishi M-T01 cassette. June.
 Nakamichi 582 cassette. August.
 Sanyo RD-5370 cassette. August.
 Technics RS-M85 cassette. April.

TUNERS

JVC T-3030. February.
 Mitsubishi DA-C20 tuner/preamp. March.
 Mitsubishi M-F01. June.
 Sansui TU-919. December.
 Series 20 F-26. November.

TURNABLES

ADC 1700DD auto single play. July.
 Denon DP-2500 manual. February.
 Fisher MT-6225 auto single play. January.
 Garrard DD-130 manual. January.
 Kenwood KD-5070 auto single play. January.
 ReVox B-790 auto single play. March.
 Stanton 8005M manual. January.
 Visonik DD-8200 auto single play. January.

MISCELLANEOUS

Advent 500 SoundSpace Control. January.
 Allison Electronic Subwoofer. October.
 Audio Technology AT-510B level display. November.
 Burwen TNE-7000 Transient Noise Eliminator. February.
 Integrex Noise Reducer Dolby B decoder. September.
 RG Dynamics RG PRO-20 dynamic processor. December.
 SME 3009 Series III-S tonearm. November.

A
HOT
 DIGITAL RECORDING
 OF
COOL
 JAZZ

"THE GOOD LIFE"

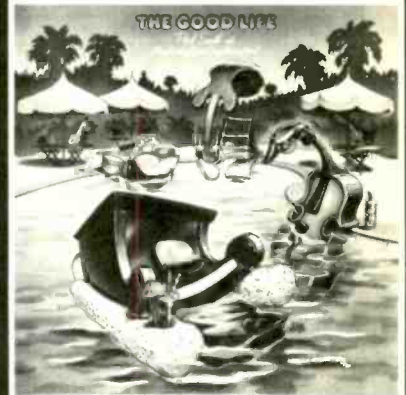

Paul Smith, piano
Barney Kessel, guitar
Monty Budwig, bass
Frank Capp, drums

Produced by Jeffrey Weber.

Brought to you by the Discwasher Record Division, who also distribute audiophile recordings from Denon, Kiras Musical Works and the Discwasher Label.

Look for "The Good Life" and other fine recordings at Discwasher dealers nationwide.

discwasher, inc.
 1407 N. Providence Rd.
 Columbia, Missouri 65201

TAJ MAHAL...DIRECT TO DISC!

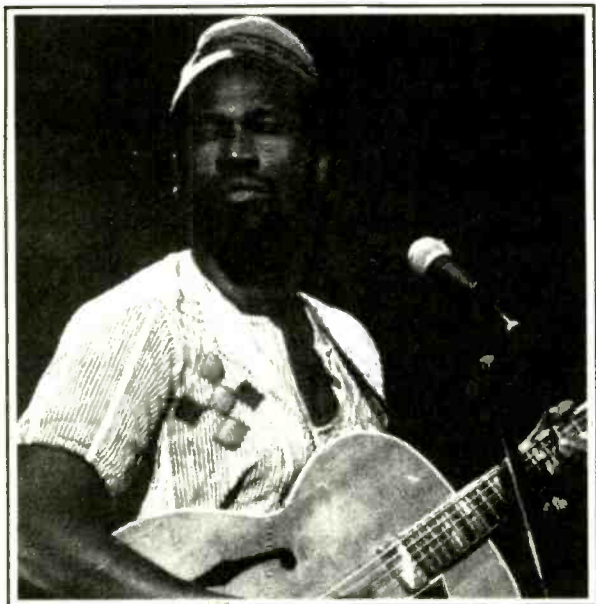

The Music You Asked For... But With Sound Quality You Never Dreamed Of!

Crystal Clear's Got It!

Taj Mahal — Live & Direct — CCX-5011 — Recorded before a live audience, Direct To Disc. Includes "Take a Giant Step", "Little Brown Dog", "Jorge Ben".



The Dillards
CCS-5007 — Bluegrass and Country Rock. Includes "I've Just Seen A Face", "Somebody Touched Me", "Walkin' In Jerusalem", others.



Musselwhite
CCS-5005 — Blues, recorded night club style. Includes "Time's Gettin' Tougher Than Tough", "Big Leg Woman", "Nightclub", others.



Jonas Nordwall
CCS-6003 — Space Themes performed on Theatre Organ. Star Wars, Close Encounters, Superman, Battlestar Galactica.



Merl Saunders
CCS-5006 — R & B tunes including "Shining Star", "Long Train Runnin'", "Another Star", "Do I Move You", more.



Stoneground
CCX-5009 — Straight-ahead rock and roll recorded with a live audience. Includes "Under My Thumb", "Rock 'N' Roll Prophet", "Blackjack City", more.



Direct Disco
CCS-5002 — The hot sound of disco with the clarity and wide dynamics of direct to disc. Includes "Movin'", "Happy Music", "The Hustle", others.

DIRECT TO DISC



**THE SOUND IS
CRYSTAL CLEAR**

Available at leading Stereo and Record Stores, or you may order direct: To order call toll-free: 800-227-4259.

(Visa and Master Charge accepted). Retail price is \$15.98 per record. Orders shipped within two weeks. Fully guaranteed against defects. All records are premium quality pressed in West Germany. California residents add 6% sales tax.

Please send me the following:

— CCS-5011 (Taj) — CCS-6003 (Nordwall)
— CCS-5007 (Dillards) — CCS-5006 (Saunders)
— CCS-5005 (Musselwhite) — CCX-5009 (Stoneground)
— CCS-5002 (Direct Disco)

Mail to:

First Edition Club
Crystal Clear Records
648 Mission Street
San Francisco, CA 94105

Enclosed is check or money order for \$ _____ for _____ records.

Send catalog only.

Name _____
Address _____
City _____ State _____ Zip _____

Direct To Disc Records Make Excellent Christmas Gifts

Circle 11 on Page 115



BACKBEAT.®



The Emotions: Wanda, Jeanette, and Sheila Hutchison

Sometimes we become so obsessed with the evanescence of platinum sellers that we fail to notice how much continuity there really is in popular music. A perfect case in point is the group called the Emotions, whose entirely contemporary sound isn't much different from their entirely contemporary sound of the late 1960s, when they specialized in teen-dream sweet 'n' sexy innocence and represented the quintessence of that era's "girl groups."

Superficially, theirs is a fairly simple sound, but on closer listen to some of the old recordings (specifically "Sunshine," which was re-released on Stax in 1977) that surface simplicity emanates from complex, sophisticated roots. Even in

their first incarnation, their technical variety and subtlety were remarkable. Wanda Hutchison's *I Really Miss You*, for instance, enhanced the midtempo r&b of the time with rich harmony touches and relaxed precision, and their version of Bill Withers' *Ain't No Sunshine*, totally simple in its effect, was remarkably sophisticated in its means.

Over the past four years, the Emotions' Columbia albums—"Flowers," "Rejoice," and "Sunbeam"—have been both financial and musical successes. (Their fourth, "Come Into Our World," is due out presently.) As in the past, a major characteristic of their sound is their very sweet backup vocal harmonies, usually setting off a light, gospel-oriented lead. It's a

The Emotions: "We Don't Want to Be Faddish"

by John Storm Roberts

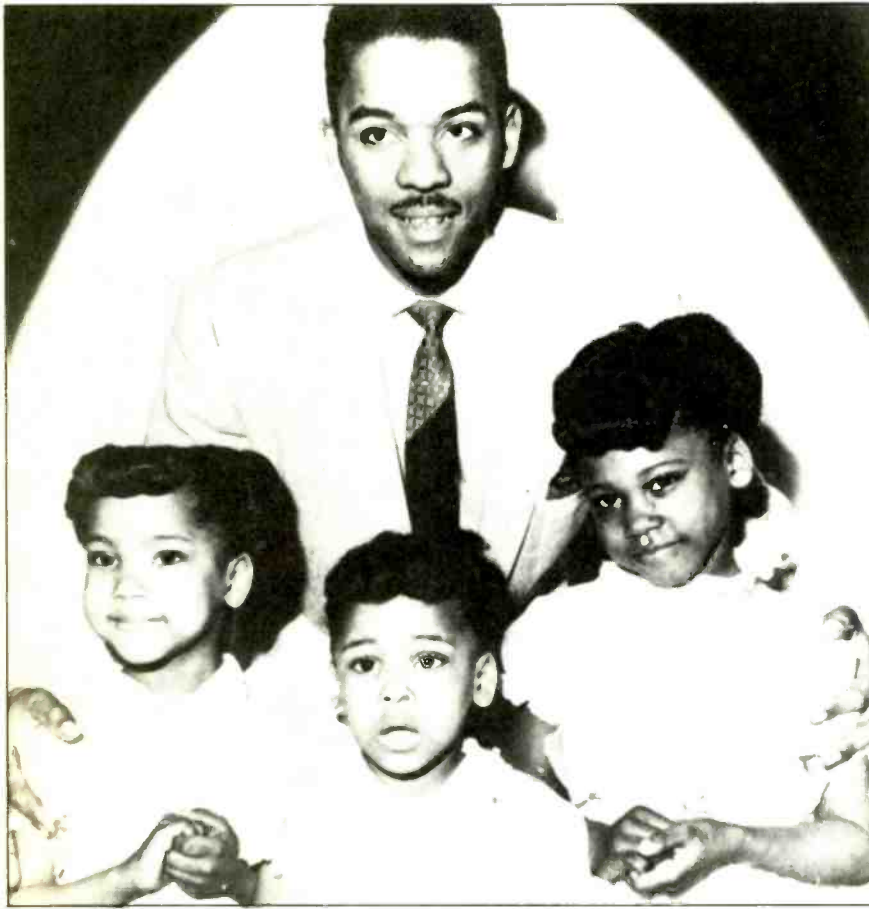

The Heavenly Sunbeams with father Joe in 1956



Wanda, Sheila, Maurice White, and Jeanette

sweetness with various sources. Sometimes, as in *Me for You* (from "Flowers"), or the opening passages of *A Feeling Is* (from "Rejoice"), it comes from those early girl-group stylings. Sometimes it has an almost light-classical quality, like the two remarkable a cappella cuts on "Flowers"—*We Go Through So Many Changes* and *God Will Take Care of You*. Often it mixes several traditions: *Key to My Heart* combines neo-light-classical, pure girl-group, gospel, and '40s mainline pop. But whereas many current (especially disco) groups use snippets of earlier styles in a kind of collage, the Emotions integrate them thoroughly.

Sheila, Wanda, and Jeanette Hutchinson were born in Chicago of a gospel-singing father with a great deal of determination and ambition for his daughters. As children, the three sang locally as the Hutchinson Sunbeams, and the Emotions are still a family affair. Younger sister Pat replaced Jeanette for a while in 1977; brother Joe Jr. has been playing guitar with the backup and writing songs since 1974. Joe Sr. has been manager, mentor, and general shoulder to lean on since the beginning. Only one non-Hutchinson has ever been centrally involved, and even she—Theresa Davis, who replaced Jeanette from 1971–74—is a cousin.

They credit their stylistic diversity to their father. Far from confining them to gospel, he had them singing songs of all sorts—*Blue Danube*, *Ave Maria*, *The Prodigal Son*, *Cool Water*, *Holiday for Strings*—from the start. "It was our father's thinking that this would not only give us a larger audience, but help us learn to appreciate music," Wanda says. "To him, gospel was limiting. He looked at a group like the Lennon Sisters when he saw us—a group for any audience."

The breadth of their repertoire led to appearances with Mahalia Jackson and Red Saunders' *Evolution in Jazz*, and a concert with the Jazz Interpreters, whose drummer was a young man named Maurice White (now of Earth, Wind & Fire fame). It also came to the attention of Pervis Staple, of the Staple Singers, who introduced them to Stax Records in 1968. There, under the production of Isaac



Hayes and David Porter, Sheila, Wanda, and Jeanette cut a series of records as the Emotions. Their first hit was *So I Can Love You*.

In 1973, Stax got involved in a series of lawsuits that eventually led it into bankruptcy, and for a while, it seemed that nobody wanted a girl group caught in the middle of a small label's legal problems. While father Joe hustled around looking for takers, the daughters turned to songwriting, and—in Wanda's case—producing other groups.

Luck, it has been said, is preparation meeting opportunity. In 1975, Maurice White was feeling his way into production with his new company, Kalimba. When he heard the Emotions were hanging loose, he got in touch. They were ready.

The first White-produced Emotions album, "Flowers," was released in June of 1976. While the group went on a sixty-city tour with Earth, Wind & Fire and Ramsey Lewis, "Flowers" went gold. Their 1977 album, "Rejoice," went platinum, and the single, *Best of My Love*, rose to No. 1, scooping up a number of awards along the way. Their third White collaboration, "Sunbeam," also went gold.

White's production technique clearly had a lot to do with the group's second birth. But despite his enormous successes with Earth, Wind & Fire, he never pulled rank. "He is not a know-it-all producer," as Jeanette puts it now. "He uses our ideas and adds his expertise as a producer to make it sound like it needs to in order to be marketable. He's not just saying, 'We'll do it *this* way because I'm Mister So-and-So.' He's drawing out of us what his experience has taught him to look for."

An example was Wanda's *Best of My Love*. "I was used to singing low, even though it'd be an uptempo song," she says. "*Best of My Love* was my first effort in a higher range. I started out in the voice range Maurice had used on the demo tape, and he said, 'No Wanda, I want it an octave higher.'"

"He's not an overproducer," Jeanette adds. "He never overarranges our stuff. And he's not very far from where we

are conceptually. The way he sings, the ways he writes a song and hears it are similar to ours. Our phrasing and even our harmonic concepts seem to be the same." It's an affinity with strong common roots. Not only did both White and the Emotions cut their musical teeth on the Memphis sound, but they both came out of Chicago.

White's production methods are at once democratic and relaxed. Two months or so before rehearsals for a new album begin, the Emotions make a studio demo of their own songs and send it to White, who sends them material of his own and of other writers. "Out of the consensus we'll usually pick six or seven songs," Jeanette says. "The album will revolve around these songs. Then we'll talk about the concept and what the album is going to be called."

The recording process is fairly loose. According to Jeanette, "The only thing that's really planned when we go into the studio is the basic rhythm tracks, where there's not a whole lot of the 'play what you hear' attitude. The spontaneity and creativity come in on the parts over the rhythm. The best albums, I think, come when you have a basic idea where you're going, but you get in there and let your creativity loose."

Once the vocal arrangement has been worked out, it stays pretty much the same. But "the lead's another thing," says Wanda. "I'll put down the first interpretation after reading the story. I try to combine what the writer might want in there with what I feel about it myself. Then we'll put down the vocal background while listening to that lead. We'll change anything we don't like after a while."

The choice of lead singer depends on the song. Each of the women has different strengths. In the Stax era, Sheila did the bulk of the lead work because she is strong on the kinds of ballads that were popular at the time. Wanda got the fast songs, as she does now. "Even when we were singing gospel, I always did the jubilees," she says. "Now, since disco music is uptempo, I do most of the leads. Sheila and I share whatever the hook line is."

The least used is Jeanette: "I've always been in the background. I'm an un-

Self-image is liable to get knocked around by the realities of the marketplace, a phenomenon with which the Emotions have had to come to terms.

"Right now we're going through this disco thing, and I feel disco limits me as a writer."



Jeanette, Sheila, and Wanda with Joe Sr. in 1962

tapped source, because I'm more naturally in a jazz vein. I have the kind of ear that enables me to blend with Sheila or Wanda so it sounds like they doubled themselves."

The Emotions have written a certain amount of their own material from the start, but composition has become a lot more important to them over the last few years, especially for Wanda.

"At first it was on a personal level, not business. I was teaching some of my songs to groups in Chicago during the Stax dilemma. That was the first time I ever worked with a group outside the Emotions. We weren't doing much of anything but writing, so by the time we got with Maurice, we had about twenty originals to show him."

The three sisters' songwriting style pretty much matches their singing. As Wanda puts it, "Sheila writes the ballad type of songs. Out of every five songs I

write, maybe one will be a ballad and the rest moderate or uptempo. And Jeanette's all-around—though to me she really brings out the jazz thing, especially on the 'Sunbeam' album. There were some cats in Chicago that she got to do the demo of *Love Vibes*—jazz players like [bassist] Phil Upchurch."

"I hear the bass line first, and then I'll put the whole structure together," Jeanette says. "Wanda'll come along when I'm singing a bass phrase, and she'll hear the melody to that. So when we come together on a song it's easy. Once I put my melody down—with the musicians, I mean—I'll skeleton it out, give it to the bass man and the drums."

"I hear what the voices should be doing, or the strings," Wanda adds, "and Sheila will hear the sweetening. She'll take these modern chords and just do *everything* to the vocal arrangements!"

In contemporary popular music, once you've made it in one area, you do

what any good business person does. You diversify. For Wanda, that process started during the pre-White lull. "Knowing what I could offer to other groups, I wanted so bad to produce! I knew to get my chops up I'd have to move to either New York or Los Angeles, which was the main reason I left Chicago for L.A.

"The next thing I want to accomplish is making someone else a hit, whether by writing or producing or co-producing, which I figure I'll have to do first anyway." (A definite project with Skip Scarborough is lined up for this year, though details are under wraps until final contracts are signed.)

In singing, in songwriting, or in production, self-image is at least as important as technique or the details of individual skill. But self-image is liable to get knocked around by the realities of the marketplace, a phenomenon with which the Emotions have had to come to terms. "Even before we were known anywhere but Chicago, the image that we had of ourselves and that our father projected to us was 'general appeal,'" says Wanda.

"That's how we see ourselves," adds Jeanette, "and that's why we didn't like becoming categorized as r&b or any one other thing. But that's not the way the business goes! The marketing concept is, you got to have a slot first." And so they've learned to write for the marketplace—and "still keep what is us," Jeanette continues. "That's something that you can't get away from. We're giving the public a small dose at a time. They would be confused if we put it all out at once. Columbia wouldn't know how to handle the album, and it would die!"

How much does this stricture bother them? For Wanda, "It would bother me more if I was limited to singing. As it is, I know I can produce my own thing through someone else."

"Right now we're going through this disco thing," Jeanette says, "and I feel disco limits me as a writer because it only allows me to use parts of the phrases that come to me. I've learned how to take part of a phrase and make a song out of it.

"Meanwhile, we try to keep a continuity with each album. We don't want to jump out there one year looking like one thing and the next year something entirely different. We don't want to be faddish, we want to have a foundation." Few could argue that they don't already have one, and a very sturdy one at that. 

Buying the Right Electric Guitar

by Steve Burgh

I bought my first professional quality electric guitar back in 1964 when I was still in junior high school. Life was so simple in those days. For one thing I had just \$200 to spend. For another there were only about eight or nine major guitar manufacturers—among them Gibson, Fender, Gretsch, and, in the less prestigious leagues, Danelectro, Harmony, and various Japanese models that were very cheaply made. I knew from going to rock & roll shows and talking to friends that Gibsons and Fenders were the best, so I took my accumulated savings down to the biggest music store in town (Trenton, New Jersey) and bought myself a Fender Mustang. Now I was ready to rock & roll.

These days things are not so simple. The National Association of Music Merchants (NAMM) lists over 150 member manufacturers of electric guitars, strings, replacement hardware, amps, etc. Some of the better known ones include Ibanez, Carvin, Univox, Yamaha, Schecter, and Mighty Mite. But, as the saying goes, the more things change, the more they stay the same; Fenders and Gibsons are *still* the best made and most other brands are either Fender-types or Gibson-types. Just taking the other guitars already mentioned, the first four are Gibson-type, the last two Fender.

The latter, such as the Fender Telecaster or Stratocaster or the Schecter and Mighty Mite Strats, is usually a solid-body, flat-faced guitar with a fingerboard scale (the strings' length from the bridge to the top of the neck) of 25½ inches. The fingerboard is made of maple or rosewood and is mounted on a one-piece maple neck, which is attached by three or four screws through a metal plate on the back of the guitar. This makes it easy to remove the neck for repairs or adjustment. Fender types usually have one to three single-coil pickups, a selector switch to engage them,

The author is a producer and session guitarist. He has played on the recordings of John Prine, Billy Joel, Steve Goodman, and Willie Nelson, among others. Producer credits include the debut LPs of Steve Forbert and Carolyn Mas.

very basic wiring, one or two tone controls, and a single master volume pot for all the pickups. Other characteristics such as the type of bridge and tuning machines (or pegs) vary from one model or brand to the next.

Gibson-type electrics come in many more sizes and shapes than Fenders. There is the solid-body carved-top, where the face of the instrument is elevated and contoured (like many of the Les Paul models), the solid-body flat-top (the Gibson S.G., Firebird, or Melody Maker), the hollow "F"-hole (Gibson ES 330, ES 175, L-5 electric, or Byrdland—Ted Nugent's favorite), and the semi-solid "F"-hole, which is basically a hollow-body guitar with a block of wood inside (ES 335, ES 345, ES 355, and the Ibanez George Benson model). All have a shorter fingerboard scale of 24¾ inches; fingerboards are usually rosewood or ebony on a one-piece or multiple-ply (laminated) neck, which is glued to the body. This, of course, means that you can't remove the neck, but Gibson feels that you shouldn't have to in the first place. There are usually two pickups (called "humbuckers"), each with a double coil wired out of phase so as not to pick up extraneous noise, a selector switch, and separate volume and tone controls.

What does all this mean in terms of sound and feel? Fender's longer fingerboard scale gives it a tighter feel than the Gibson's comparatively loose-tensioned short scale. If you were to put the same gauge strings on each you'd find it easier to bend strings on the shorter scale, but strumming is snappier and general response faster on the longer scale. Fender pickups, which are usually single-coil, tend to emphasize the high midrange and give off many clear overtones. This, coupled with the long scale, gives these instruments their plucky, bright sound. By comparison, Gibson-style guitars are rich and smooth sounding, a result of the shorter neck and the humbuckers, which tend not only to pick up less extraneous noise but also to bring out the lower midrange without a lot of overtones. Of course, you can playlead or rhythm on either, though my

preference is the Fender Telecaster or Strat for both styles. Interestingly, most New York session players do prefer Fenders, while their West Coast counterparts all play Gibson ES 335s.

There are several other types of guitars worth mentioning. Fred Gretsch of New York makes some fine solid and semi-solid body electrics, including several models designed and endorsed by Nashville guitarist Chet Atkins. Rickenbacker of California has some unique designs, the best known of which is the semi-solid-body electric 12-string, and Alembic has some fine, handmade solid bodies.

Choosing a guitar is an entirely personal process. The most important thing is feel. When you hold the instrument, is it comfortable? Do the tone and response fit your playing style? My pet peeve is frets, since most of them are lousy. When you run your hand up and down the fingerboard they should feel smooth and even; each one should be the same height and contour. I can't tell you how many potentially great instruments I've seen that were rendered not so great because their frets were either worn (in the case of used models) or roughly finished. Another checkpoint is weight. Heavier guitars are said to have more sustain, but not always. If a guitar is too heavy for you, you may end up with a stiff shoulder or impaired left-hand movement. Also watch out for the lighter models. They might not have enough sustain, and they can be neck heavy, which means you'll have to hold the neck up with your left hand. Again this limits movement, not to mention musicianship. Look for a guitar that feels comfortable both strapped on and sitting on your knee.

Now for the \$64,000 question. Are vintage models better than new ones or than copies? The answer is usually yes. Fender and Gibson are still going strong and are basically following tradition. Many of their new instruments are well made, good sounding guitars. But alas, like everything else, the workmanship and the quality of materials just aren't what they used to be, and the older models have more character than the new ones. Compare, for example, a 1956 Fender Stratocaster with a new one. (CBS bought Fender in 1965; anything made up to 1966 is considered a vintage model and is often referred to as "pre-CBS.") The '56 in good, untampered-with condition is valued between \$1,200 and \$1,500; later or customized models can range from \$250 to \$1,000. A new Strat goes for about



Burgh's 1952 Telecaster

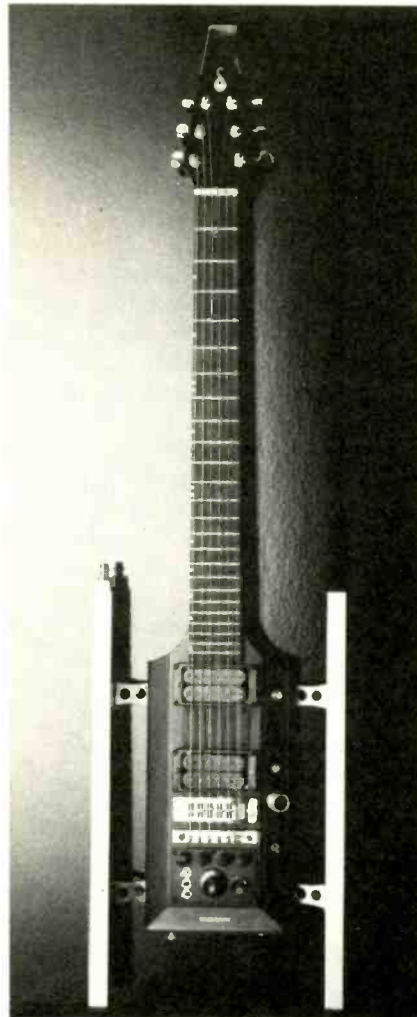

Sardonix Model 800-A2

Most New York session players prefer Fenders, while their West Coast counterparts all play Gibson ES 335s.

My pet peeve is frets, since most of them are lousy.

\$500, depending on where you buy it. It has a few feature refinements, such as a neck-angle adjusting screw, and a five-way switch for various combinations of the three pickups. (With the old, three-way switch you could wedge the toggle between pickups, but it inevitably popped out while you were playing, leaving you with just one.) Fender also has made the truss rod (the metal rod that runs the length of the neck and keeps it rigid) adjustment more accessible by putting it at the top rather than the bottom of the neck. Still, the older Strat sounds, feels, and is made better. It will also increase in value, while its younger brother may depreciate. Including copies such as the Schecter and Mighty Mite, there are an almost infinite number of Fender Strat-type guitars available, both used and new. The same can be said for the Fender Telecaster, which dates back to 1948 when it was called a Broadcaster. (A copyright problem caused a name change in 1950.) Broadcasters and the early Teles are now worth up to \$2,000 in mint condition, but a relatively new used one or a Japanese copy may cost only \$250.

There are at least twenty highly prized old Gibson models. Les Pauls made between 1952 and 1960 are at the top of the list, the 1958-60 Sunburst Les Paul Standard going for over \$3,000 in mint condition. The 1958-60 ES 335s and related models go for between \$1,500 and \$2,000, the early Firebirds for anywhere from \$800 to \$1,500. A limited production model like the Flying "V" can cost up to \$3,000, and the Explorers are, as they say, priceless, since only a few were made. Suffice it to say that a decent copy will cost you up to \$1,500. Unlike Fenders, contemporary Gibsons tend to be either near equivalents of older models or completely new designs. And, of course there are many copies on the market, such as those mentioned earlier. Some of them follow the Gibson style—short scale, humbuckers, and all—but do not look at all like Gibsons. There's one thing to watch for with any new manufacturer—the product has not withstood the test of time that Fenders and Gibsons have.

If you're quite sure of what you want (and if you have the financial resources), there is always the custom-made or customized route. Craftsmen such as Jeff Levin at Sardonix in New York City or Charles LoBue in San Francisco will charge anywhere from \$750 to \$1,500 to make your ideal instrument. John Dalzell

of Mountain Music in Woodstock, New York, will custom-assemble a Schecter Strat to your exact specifications—neck width, type of wood and finish, electronics, etc.

If you don't know what you want, pay a visit to several music stores to see what's available—most will let you try out the instruments. And it doesn't hurt to befriend a few salesmen so you'll be sure to get personal attention when you need it. *Guitar Player* magazine is also a good place to look, since many of the major manufacturers, both foreign and domestic, are apt to advertise there. For used models, check out the ads in the back of the daily papers and the "buy and sell" weeklies, such as *Recycler* in L.A. or *Buy-lines* in N.Y. As with any used merchandise offerings, though, try to read between the lines first. Pawn shops can occasionally yield some decent guitars, but the days of finding a vintage gem for \$100 are gone. Some rules of thumb for any used model: Be on the look-out for neck cracks on Gibsons, and truss rod adjusters on Fenders that have been used a lot to tighter or loosen a warping neck. Refinishing jobs and replacement parts, no matter how good, will always devalue an instrument. In fact, exercise extreme caution with models that are either in need of repair or have been repaired—you may find yourself with a bargain that cost three times as much to fix (or fix again) and will never be quite right. Guitars can be lemons too.

Private collectors, generally found by word of mouth, are usually worth investigating. Sometimes they will have items in original condition at lower prices than retail outlets. Some stores specialize in buying and selling rare oldies. They include Matt Umanov Guitars and Inter-galactic Guitars (both in New York City), Norm's Rare Guitars (Reseda, Calif.), George Gruhn's (Nashville), and the Guitar Trader (Redbank, N.J.). Again, many of them advertise in *Guitar Player*.

Don't ever buy an instrument just because it is old. Although specific oldies may seem more desirable, you might find a newer model or a copy that's better for you. And don't buy the first thing you see, new or used. If possible, take along a friend who has experience in buying guitars. He may see something you miss in the excitement. Above all, buy an instrument that feels just right for you. If you don't find it right away, be patient; there is a great guitar waiting for you.

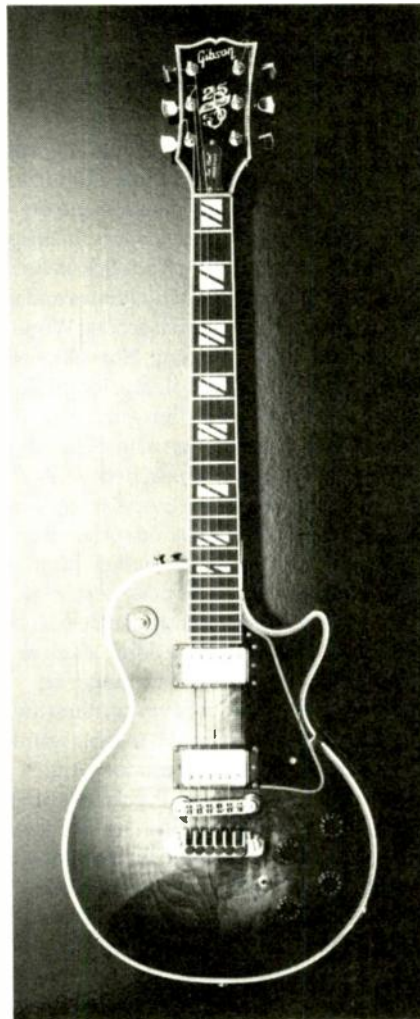

*Gibson Les Paul
25th Anniversary Model*



1956 Fender Stratocaster

Refinishing jobs and replacement parts, no matter how good, will always devalue an instrument.

Don't ever buy an instrument just because it is old.

NATIONAL RECORD PLAN

WINTER DISCOUNT SALE AT UP TO 45% OFF

SAVE TIME, SAVE GAS
SAVE MONEY ORDER NOW
All Records — Classical,
Opera, Pop, Rock, Folk,
Jazz, Shows, Int'l, Country.

List Per LP	Sale Price Per LP
\$3.98	\$2.39
4.98	2.99
6.98	4.29
7.98	5.19
8.98	5.99
9.98	6.69

For multiple sets, multiply sale price per LP by number of LP's in set. All other List Prices, your discount is 33%.

NEED CATALOG? Send \$1.25 for Schwann (plus 50¢ for postage and handling). If you order catalog, we extend sale ending date to give you more time to order.

ALL PRE-RECORDED 8-TRACK CARTRIDGES AND CASSETTES

List Price Per Tape	Sale Price Per Tape
\$7.98	\$5.39
8.98	6.19
9.98	6.89

All other List prices, your discount is 30%.

SPECIALS OF THE MONTH

All Angel \$8.98 List (LP, Tape)	\$5.79
Seraphim (LP, Tape)	2.79
London (LP, Tape)	5.79
London Treasury (LP, Tape)	2.79
Telefunken, Argo (LP, Tape)	5.79

SPECIAL-SPECIAL
AUDIOPHILE RECORDINGS
DIRECT-TO-DISK
DIGITAL, SUPERDISC
10% DISCOUNT

GUARANTEE

Orders shipped within 7-12 days. Cash refund if we can't deliver. Record or tape replaced at no charge after one play if defective.

ORDER NOW SALE ENDS DEC. 31, 1979

List items wanted on separate sheet of paper. State whether LP or Tape. Add 95¢ for first LP or Tape, 25¢ each additional LP or Tape, plus 40¢ for insurance for entire order.

Maximum charge for shipping, handling and insurance is \$3.35.

UPS Shipments if desired, add \$1.25.
VISA, Master Charge, Am. Exp. accepted.

**NATIONAL RECORD PLAN,
DEPT. HF 107, 315 W. 36th St.,
New York, N.Y. 10018**

Into the '80s: Choose Your Weapons

by Stephen Holden

One trend that is certain to stay with us in the coming decade is pop music's continued fragmentation into antagonistic subcultures. It's very unlikely that the current Great Rock & Roll Revival ballyhooed by record companies and rock radio stations will yield a second Woodstock era of good feeling. Nor will it bail the industry out of its slump, for the hardcore rock audience—those in their teens and early twenties—has actually diminished in size over the past decade. At the same time, the larger, over-thirty generation that institutionalized rock is dropping out of the record market. From the disappointing sales of recent albums by Chicago, Wings, the Beach Boys, Carly Simon, and Elton John, it's clear that '70s superacts can no longer be counted on to sell millions on name value alone: most are only as bankable as the quality of their newest product. And though this last makes the climate riper than at any time since the late '60s for the development of new talent, trendiness—in the form of the above-mentioned Revival—is shaping the current policies of most a&r departments.

That trendiness is both a cause and a symptom of pop's fragmentation. I'm suspicious, for instance, of the great Revival's equation of basic two- and three-chord power pop—stylistically indebted to '50s rock & roll—with "purity." One needn't look too closely to see that all of these Knack-alike bands and their audiences are white. Indeed, in twenty-five years, there hasn't been so much racism in the air, symbolized by the slogan "disco sucks"—a particularly popular chant among these new rock "purists."

This is ironic, for several reasons. One is that any serious student of rock & roll knows that without black music, rock would never have been born. Second, disco is a legitimate outgrowth of '60s soul, which can currently be heard among the latest New Wave and power pop records at rock discos, though contemporary black music cannot. (Deejays and audiences have apparently succumbed to the myth, perpetuated by the white rock press, that '60s "soul" music was the high point of r&b, just as the Beatles-Stones-Dylan trinity marked the zenith of rock culture.) What makes the antagonism between rock and disco cultures all the sillier

is the fact that there are far more similarities than differences between their musics. Both power pop and disco are highly mechanized and danceable. With minor alteration, they're practically interchangeable.

For all its dross, disco has left a sizeable legacy, beginning with Gamble & Huff's early '70s productions. The Bee Gees' best records are as certain to be standards as classic Glenn Miller, while Giorgio Moroder, Pete Bellotte, and Summer evolved a pop signature sound that was possibly the most distinctive since Phil Spector. In the hands of producers like Ashford & Simpson, Quincy Jones, and Maurice White, discofied adult pop has reached new heights of high-gloss aural sophistication.

But disco, of course, was over-marketed and overpromoted, last year's sudden glut of all-disco radio stations being a perfect indicator of that. In fact, radio's insistence on strictly formatted programming—black, country, progressive rock, disco, a.o.r. (album-oriented-radio), etc.—geared to specific audiences only underlines the subcultures' differences. Ironically, the only really democratic radio is Top 40, where you can hear a cross-section of American taste from Kenny Rogers to the Knack, from the Marshall Tucker Band to Diana Ross. What does it indicate about the self-limitations of late '70s radio formats that, for instance, the Bee Gees and Barry Manilow, among others, only receive light a.o.r. and disco air-play and still sell three million plus albums? To me, it suggests that the ratings-happy programmers have boxed themselves in by cultivating and then pandering to specialized elite audiences.

While the differences in musical tastes between the white, suburban middle class and the black, urban working class are not about to disappear, I think that industry trendmongers harden these differences. For the notion of one industry-saving musical style, whether it be disco or rock & roll, is divisive and antithetical to pop's traditionally democratic spirit. Turning artistic trends into holy crusades ("disco sucks") encourages greater snobbery and cynicism and politicizes tastes as marketing becomes ever more specialized. In the end, it's bad for everybody's business. ☐

ORIGINAL MASTER RECORDING™

LIMITED SUPER-FI EDITIONS

★ ★ ★ **Flash!** ★ ★ ★

Five Titles Now Out Of Print!!

★ ★ **Last Chance!** ★

Inventory Nearly Depleted!!!

No More Pressings To Be Made!!!

STEELY DAN
"Katy Lied"

**THE MYSTIC MOODS
ORCHESTRA**
"Emotions" & "Cosmic Force"

ZUBIN MEHTA & LAPO
"Star Wars" &
"Close Encounters"

THE CRUSADERS
"Chain Reaction"

Rush to your MFSL Dealer now before it is too late!!!!



or write/phone
Mobile Fidelity Sound Lab
P.O. Box 919
Chatsworth, CA 91311
(213) 993-4945

Imported Super Vinyl Pressings • Half-Speed Mastered • Special Protective Packaging

Input Output: Instruments and Accessories



MXR's Flanger/Doubler

by Fred Miller



The MXR Professional Products Group has added the Flanger/Doubler to its line of effects components. Designed for use by serious musicians for both live performances and the studio, it combines two commonly desired effects in a rack-mountable housing 19 inches wide. Flangers have been around for several years (I've stopped counting how many we've looked at in "Input Output"), and doubling is generally recognized as a good way to "fatten up" a sound. Putting them together in a single package is a great idea.

The flanging effect is achieved via analog delay circuitry—specifically, a bucket-brigade integrated circuit—and works with delays of 0.25 to 5 milliseconds. The doubling requires much longer delays of from 17.5 to 70 milliseconds, and for this MXR uses a charge-coupled device. The F/D is capable of a wide variety of effects, which its operating manual explains thoroughly.

Front panel controls start with power switch and pilot, followed by the FLANGER/DOUBLER selector to engage the appropriate delay circuit. A rotary pot labeled MANUAL regulates the amount of voltage applied to the delay circuitry, thereby controlling the changes in delay time over the stated ranges. Two LEDs above it visually display the position and speed of the "sweep": the left one for low frequency, the right for high. The speed is determined by the combined use of MANUAL, WIDTH, and SPEED. With WIDTH at "0%," sweep is determined completely by MAN-

UAL. With WIDTH "∞" (infinity) it is determined by SPEED, which activates a low-frequency oscillator to affect the delay circuit; the duration of a single sweep at this setting may vary from 50 milliseconds to 30 seconds. At positions between the extremes, the WIDTH takes its instruction from both MANUAL and SPEED for a variety of sounds.

To the right of the sweep section is MIX, a balance control for combining the "dry," or unprocessed, signal and the delayed signal. In the counterclockwise position, only the dry signal is present at the output of the unit, and in the extreme clockwise setting only the delayed signal. Judicious use of MIX permits subtle changes in the sound. Another button, INVERT, interchanges the peaks and dips in the flanged signal and produces yet another effect by canceling the lower frequencies. When opened, REGEN takes a select portion of the processed signal and sends it back to the input for reprocessing. This creates a deeper flanging effect in the FLANGER mode, a long decay in the DOUBLER, and MXR's brand of reverberation. An IN/OUT toggle switch disengages the effect so that only the original signal is heard at the output.

The back panel has a BYPASS jack for external or remote devices, which saves having to run back and forth to the F/D in performance. An additional pair of jacks, marked V.C. (voltage control) IN/OUT can be used to make the F/D dependent on a controlling voltage from a synthesizer or another F/D.

MXR says the Flanger/Doubler can be used with guitar, piano, organ, synthesizer, electric bass, miked vocals, and drums. We tried it on a Clavinet D-6, a Fender Stratocaster, and a Fender Precision bass. All the effects described in the manual were easily achieved, from mild through heavy flanging to doubling to reverberation. The flanged sounds we came up with were quite varied and solid. A mild flange on the Fender bass, for instance, added a new dimension to the instrument. Normal flanging was easy to attain and sounded much as expected. In fact, the Flanger/Doubler can do more than you would need it to do, for most applications.

Doubling was also good and can be useful for thickening a sound or creating the illusion of having more instruments. The reverberation was not up to that level, though it's the simplest effect to obtain. (It doesn't use SPEED or INVERT, just MANUAL and REGEN.) The sound we got was somewhat akin to playing in a large room with stainless steel walls. In fairness though, MXR doesn't place much emphasis on the F/D's reverb capabilities.

The only real drawback on our model was a certain amount of noise at the output from the sweep oscillator: not overbearing, but more than I'm used to hearing from MXR devices. Although several stages of low-pass filtering are employed here, it seems one more filter would have been a good idea.

All things considered, this new device from MXR is worthy of serious consideration for musicians and small—or even large—studios. It will accept a signal from any common source, its flanging effect is noticeably better than that achieved by a widely used, much more costly, unit we've seen, and the doubler is a handy addition for the F/D's relatively low price of \$425. The noise specifications are excellent, according to the literature. The Flanger/Doubler runs on 105–125 volts AC, 50–60 Hz, accepts a high-impedance input, and has a low-impedance output.

Circle 121 on Page 115

Same looks. More guts.



The speaker on the left is the best selling, most popular car stereo speaker ever. The Jensen Triaxial® 3-way speaker system.

The speaker on the right is the one that's replacing it. The new Jensen Series I Triax.® The one with even higher efficiency. More power. More guts.

Sure, they look alike. But the similarity ends there.

Higher power handling.

Believe it. The new 6" x 9" Series I Triax is rated at 50 watts continuous average power, compared to 30 watts for the old Triaxial. Which means it'll take more power—more heat—and more abuse from high power car stereo units, without sacrificing musical accuracy at the expense of high volume levels.

Why can it take more power? Because of its new, larger oven-cured one inch voice coil. It offers 66% greater power handling for superior durability. And because the special piezoelectric solid state tweeter is virtually indestructible, yet sensitive to every musical nuance.

The efficiency expert.

Like all of the new Jensen Series I speakers, the Triax is more efficient than ever, thanks to our special high compliance cones with Flexair® rim suspension, 4 Ohm impedance and new, more efficient motor structures. Which translates to very high efficiency that lets

More improvements.

The Series I Triax features an improved, 20-ounce ceramic magnet structure for deep, well-defined bass. Also a new, rugged gasket for a tight acoustic seal. Black zinc chromate plating insures corrosion resistance.

We also designed it to be easier to install than the old Triaxial with the stud-mounted grille.

Some things don't change.

There are some things we just couldn't improve. Like the idea of an individual woofer, tweeter and midrange balanced for accurate sound reproduction.

We also haven't changed our commitment to quality. And to back it up, we steadfastly support our full line of Jensen Series I speakers with an excellent one year limited warranty.

"But they still look the same..."

You say you still can't see any difference between the old Triaxial on the left and the new Series I Triaxial on the right. Maybe not. But you sure will be able to *hear* the difference. And after all, that's the guts of the matter

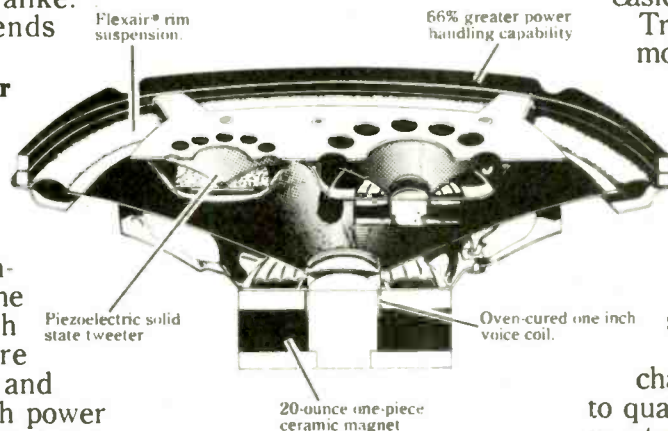

Jensen Series I speakers play louder with less power for smoother, distortion-free music in your car.

JENSEN

The thrill of being there.

4136 N. United Parkway
Schiller Park, Illinois 60176

"Triaxial" and "Triax" are the registered trademarks identifying the patented 3-way speaker systems of Jensen Sound Laboratories. (U.S. Patent No. 4,122,315)

The Eagles: Apocalypse When?

by Ira Mayer



Frey, Henley, Schmit,
Felder, Walsh

Eagles: *The Long Run*

Bill Szymczyk, producer
Asylum 5E 508

Once in a while it would be nice to see these guys shuck their damn peaceful easy feeling and kick ass. Given the nearly three years it took the Eagles to create a follow-up to their hugely successful "Hotel California," I expected "The Long Run" to practically shimmer, even before I put it on turntable. That it does not, though it does get less boring with repeated listenings.

The problems begin with the fact that most of these songs sound as though they would work very well live, but their arrangements fail to yield any sense of ensemble on record. Second, "The Long Run" lacks any sense of adventure or exploration. The California country-rockers' idiom (recorded in Florida these days) is by definition easygoing and restrained. That, however, should not preclude risk-taking. The Eagles plug in too easily to what has been an obviously successful formula. A couple of tracks with a producer other than Bill Szymczyk, for instance, might generate some new interpretive notions or shake up that rotely layered sound.

Virtually each of the ten songs here possesses a promising element—in the playing, in the melody—but the band never delivers. It comes closest on the first single, *Heartache Tonight*, on the meaningless but fun *The Greeks Don't Want No Freaks*, and on Joe Walsh's *In the City*. This last rocks relatively forcefully, but, like *I Can't Tell You Why*, there is no chorus, and the instrumental focus isn't strong enough to compensate for its absence. Of course, not every song needs a chorus, but in the past the Eagles have used them to showcase some pretty, well formulated vocal harmonies. Those are nowhere to be heard this time out, not even on the two songs that do have choruses, *Heartache* and *The Long Run*. Don Henley and Glenn Frey share leads on *King of Hollywood* and *Teenage Jail*, but they sing in unison rather than in harmony.

Those two songs, incidentally, together with *The Disco Strangler* (on which Henley sings with an effective David Crosby-ish rasp), are interesting literal treatments of themes that do step a mite beyond the group's usual turf. In fact, the biggest strength of "The Long Run" may well be its lyrics, which are generally the combined efforts of various members with occasional help from Bob Seger, J. D. Souther, and Barry De Vorzon. This is far from rock & roll poetry, whatever that might be, but the simple unrequited longing of *The Sad Café*, and the knowingly cynical eye of *Those Shoes* are poignantly crafted statements.

The long run indeed. Our great expectations for this supergroup, after waiting only three years, would make Francis Ford Coppola envious. It took him eight years to transfer his vision—like it or not—

to film. The Eagles, however, are hardly visionaries. They are diverting enough, given the instant obsolescence of the pop world. But like the individual songs on it, "The Long Run" continuously builds toward crescendoes that never materialize and one is left wondering, after three years in the making, "Apocalypse when?"

The Beat

Bruce Botnick, producer
Columbia JC 36195

20/20

Earle Mankey, producer
Portrait NJR 36205

by Steven Rea

The Beat and 20/20 are two young L.A. quartets that share many of the same mid-'60s pop penchants collectively being called new wave these days. For folks who file their albums alphabetically, the former's self-titled debut will undoubtedly end up on the shelf next to the Beatles. What the Beat does owe to the early Fab Four—and on grittier rockers like *I Don't Fit In*, *Working Too Hard*, and the slow tempo *You and I* to the early Rolling Stones—is a stripped-down, eagerly executed simplicity. Under the auspices of Bruce Botnick (who recorded such '60s stalwarts as the Doors, the Stones, and Buffalo Springfield), leader/guitarist Paul Collins, lead guitarist Larry Whitman, bassist Steve Huff, and drummer Mike Ruiz completed their LP's twelve tracks in five fleeting days. The result is fast, bare-to-the-bone rock & roll terse with flashing snares (no booming, heavy drums), crisp, clean guitars, and bedrock bass runs. Songwriter Collins sings in a straight-ahead, unstylized manner, taking on such traditional teen-rock topics as sex and romance (*Rock n Roll Girl*, *Look but Don't Touch*, *Different Kind of Girl*), alienation (*I Don't Fit In*), the deadening rigors of nine-to-five jobs (*Work-a-Day World*), and driving fever (*U.S.A.*). He is a first-rate song writer, and collaborated with Eddie Money on *Americathon's Get a Move On* and this album's harmony-laden, hand-clapping crasher, *Let Me Into Your Life*. Collins writes skillfully unpretentious, direct, economical lyrics; they show none of the tired cynicism and calculation that mar the Knack's songwriting.

20/20 takes as its starting-off point the late '60s Beatles, from "Revolver" on through "The White Album." Chris Si-



Cheap Trick: Nielsen, Petersson, Carlos, Zander

lagyi's synthesizer proffers up a bank of Beatle-esque effects: The jet engine drone on *Jet Lag* (an ideal single) recalls the intro to *Back in the U.S.S.R.* But *20/20* isn't merely mimicking; in point of fact it is paying homage. On the fadeout of the spry *Leaving Your World Behind*, over a *Revolution* swell of tape-loop busyness, the band whispers, "Paul is dead." Any group trying to sound like the Beatles, and nothing more, wouldn't dare make such an overt, humorous move.

20/20's songs attempt more than the Beat's, and consequently a few falter in the process. But the bulk of the material—written by guitarist Steve Allen, bassist Ron Flynt, drummer Mike Gallo, and Silagyi—is exceptionally vibrant pop/rock stuff. *Yellow Pills*, *Cheri*, *Remember the Lightning*, *Tell Me Why*, and *Backyard Guys* are the kind of tunes that make listening to the radio fun. Producer Earle Mankey has recorded "20/20" with a great deal of care: Intricate, Beatle-style harmonies abound, guitar and keyboard parts color in spaces that less imaginative bands would've left vacant, and while there's a lot going on, the LP rarely sounds cluttered or jumbled. Gallo's terse drumming and Silagyi's synthesizers supply a modern-sharp syncopation that situates *20/20* firmly in the present.

After all the ponderous plodding of the '70s heavy metal minions and the pompous extravagances of the "serious artist" school of rock, it's gratifying to be knocked back into the bright glare of good ol' rock & roll by the best of the new wave

bands. The Beat and *20/20* are securely among them.

Cheap Trick: Dream Police.
Tom Werman, producer
Epic FE 35773
by Sam Sutherland

Completed well before the release of "Live at Budokan," and delayed for months by that album's unexpected success, "Dream Police" acquired a mystique before ever reaching radio stations or record stores. Whether those heightened expectations help or hinder your opinion of it will probably depend on your familiarity with past Trick studio efforts.

For "Dream Police" is not a breakthrough (nor a failure), simply because principal songwriter Rick Nielsen and producer Tom Werman had already put the finishing touches on Trick's personality by its third album, the excellent "Heaven Tonight." Every instrumental and vocal nuance in the current work was already in place on that earlier record; what these new songs do is perpetuate a style, rather than refine or revise one.

The title track offers the now-familiar mix of power chords and insistent keyboard filigree, all anchored by Tom Petersson's simple but numbingly effective eight-string bass. Topped with Nielsen's and Robin Zander's vocals, the song is a virtual primer of Trick's style.

What older rock fans are likely to criticize is the familiarity of that style's source. Nielsen's admiration for the Move

Park Row Electronics & Camera Corporation

"YOU'VE TRIED THE REST NOW TRY THE BEST"
CALL TOLL FREE

(800) 221-8464 for Master Charge & Visa orders.

BLANK CASSETTES SPECIAL	VIDEO TAPE GIVEAWAYS
BASF	BETA
Studio Series C90 2.49	SONY SL500 12.90
PRO III C90 2.79	SONY SL750 17.99
MAXELL	VHS
UC C90 2.99	JVC T120 14.95
UDXL C60 I or II 2.69	TK SA T120 17.25
UDXL C90 I or II 3.69	RCA VK 250 17.49
	New! Maxell Epitaxial T120 18.49
SONY	VCR
Low Noise C60 1.25	New SONY SL5400 6 hr Recorder 995.00
Low Noise C90 1.49	New JVC HR6700 6 hr Recorder 1050.00
Ferrichrome C90 3.55	
MEMOREX	VIDEO CAMERAS
New High Bias 60 2.59	New B&H & Howell Tele Star power zoom thru-the-lens viewing 449.00
New High Bias 90 3.49	JVC G71US 999.95
New MRX 3 C60 1.69	
New MRX 3 C90 2.49	PHONO CARTRIDGES
	SHURE M95ED 27.95
SCOTCH	SHURE V15 IV 85.95
Master I or II C90 2.69	STEREO CASSETTE TAPE DECK
Master III C90 3.15	JVC KD 8A 499.00
	JVC KD 855 269.95
TDK	TEAC A300 249.95
DC 60 1.19	SHARP
DC 90 1.55	SHARP RT 225 I 244.95
SA C60 2.15	SHARP RT 3388A 274.95
SA C90 2.99	CAR STEREO SANYO
Head Demagnetizer 15.95	FT 1490A 149.95
REEL TO REEL SUPER SPECIALS	FT 1490 II 168.50
MAXELL	FT 1495 185.00
UD 35-90 5.79	FT 2490 249.79
UD 35-90B 6.99	PANASONIC
UD 35-180B 19.95	CQ 8700 299.95
	PIONEER
SCOTCH	KP 4000 124.50
207 1800 ft 5.05	

We carry a full line of Car Stereos, Speakers, Calculators, Dictation, Answering Services, Video Equipment & T.V. Games
Prices Subject to change without notice. Minimum Shipping & handling charge \$3.50

PARK ROW Electronics Corp.
1 Park Row
New York, NY 10038
212-349-0553 (For information)

Circle 47 on Page 115

Hi-Fi Buys

ON **PIONEER** Technics **SONY** Dual
AND OTHER FAMOUS BRANDS

 Technics SA 500 AM/FM RECEIVER 55 watts RMS, at 8 ohms, no more than 0.04% THD	 PIONEER CT-F950 STEREO CASSETTE TAPE DECK
 Dual CS1246 Fully automatic • Vario Beat Drive • Single deck multi deck	 PIONEER HPM-100 Hi-Fi amplifier
 SONY KV-2643R 26 REMOTE CONTROL CONSOLE TELEVISION	

CALL TOLL FREE
800-638-0935
MON. - FRI. 9-8, SAT. 9-4

Orders shipped within 48 hrs. • Phone and COD orders accepted • Use Visa, Master Charge, or NAC • Call or write for quotes • Catalog available upon request • All equipment factory sealed with full warranty.

Hi-Fi Buys

1362 HOLTON LANE
LANGLEY PARK, MD. 20783
(301) 434-5330

Circle 26 on Page 115

isn't a secret, nor could it be after four studio albums that have lovingly resurrected that English band's melodic sense and dynamic arranging ideas. Trick LPs have comfortably outdistanced even the best-selling releases by its underground fore-runner, but that doesn't diminish the newer band's debt, particularly to the Move's guiding lights. Jeff Lynne (now of ELO) and Roy Wood.

On the other hand, "Dream Police"

is more impressive than most of the recent recordings by either of those mentors. Original or not, the title song and rockers like *Way of the World* and *I'll Be with You Tonight* have more of a cutting edge than most of ELO's newer records and anything Wood has done since the early '70s. On *Voices*, the lone ballad here, Nielsen plumbs the same dreamy, Beatle-browed atmosphere that ELO's Lynne has often explored.

Producer Werman opts for his characteristic wall of sound, delighting in the crowded mix and its overlapping effects. If there's a complaint, it's on the question of Petersson's rumbling bass lines, which too often sacrifice melodic shape in the interests of driving home the beat.

Dr. John: Tango Palace

Tommy LiPuma & Hugh McCracken, producers. *Horizon SP 740*

by Crispin McCormick Cioe

Throughout a virtual lifetime in music as a performer, studio pianist, and producer, Mac Rebennack has never strayed too far from his New Orleans roots. For the r&b aficionado, his career as Dr. John has been rewarding, since, along with the Meters and Allen Toussaint, he's virtually the only contemporary pop artist expanding upon the Crescent City's heritage. Unfortunately, the pop mainstream has rarely shared that interest (at least not since the days of Fats Domino and Lee Dorsey), and Rebennack's recent albums have reflected his attempts to come to grips with this. His last, "City Lights," marked a switch to another label and producer, and basically featured big-name studio musicians, mostly from New York, playing New Orleans grooves. The result was an interesting and musically precise evocation, but it never quite caught the ramshackle looseness and behind-the-beat spirit of his earlier albums.

With "Tango Palace," Dr. John is still drawing on studio players (this time mostly from L.A.), but the emphasis is on mixing his traditional second-line rhythms with some straighter funk. At the same time, he has collaborated with several writers and even included one genuine classic, *Something You Got*, done pleasantly uptempo. The result is a more personalized album than he has made in years. On *Fonky Side*, which he wrote with Doc Pomus, the lyrics have an obvious autobiographical ring to them: "Anytime I had a girlfriend or even a wife, and they dippy doodled all on the top of my head, I find I could talk much better in my bed." The theme of disintegration, of the passing of tradition, laces through these songs (especially the Pomus collaborations), and Rebennack handles the subject gracefully, with a beautiful blend of historical perspective and faded imagery. /

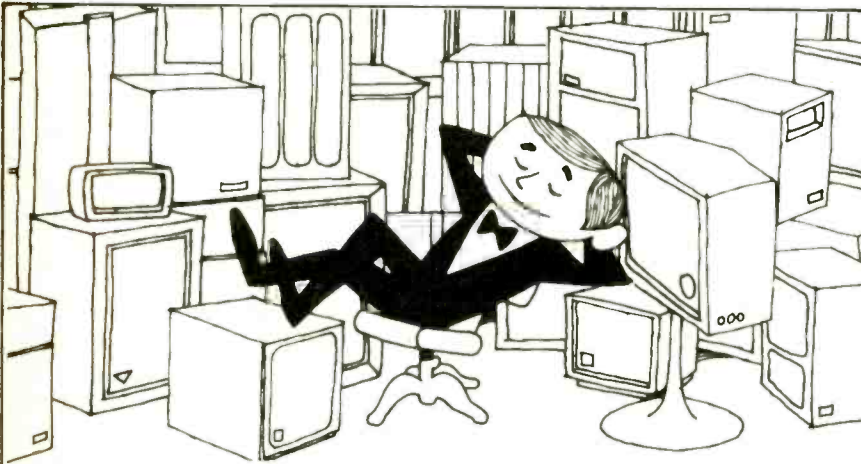

More Than 1200 Speakers!

You will be able to evaluate more than 1200 different speaker models with the brand new 1980 Buying Guide to Speaker Systems. From Acoustic Research to Yamaha, you can compare maximum power handling capability (watts), rated response (in Hz), rated impedance (Z) in ohms, crossover frequency (in Hz), loading principle (acoustic suspension, bass reflex, etc.) and number of drivers and their size. Plus we'll provide you with the speakers' overall dimensions, weight and suggested retail price.

But the 1980 Buying Guide to Speaker Systems is more than just a directory of equipment.

We'll tell you:

- Tips on which speaker design is best
- How to choose your speakers
- How to place your speakers in the room
- Easy steps for upgrading your car stereo speakers.

We even include a glossary that puts speaker terms into a layman's language.

All this for only \$1.95. But order today, copies are limited! Fill out and mail the coupon with \$1.95 per copy plus \$1.00 for postage and handling to: 1980 Buying Guide to Speaker Systems 1 Sound Ave., Marion, Ohio 43302

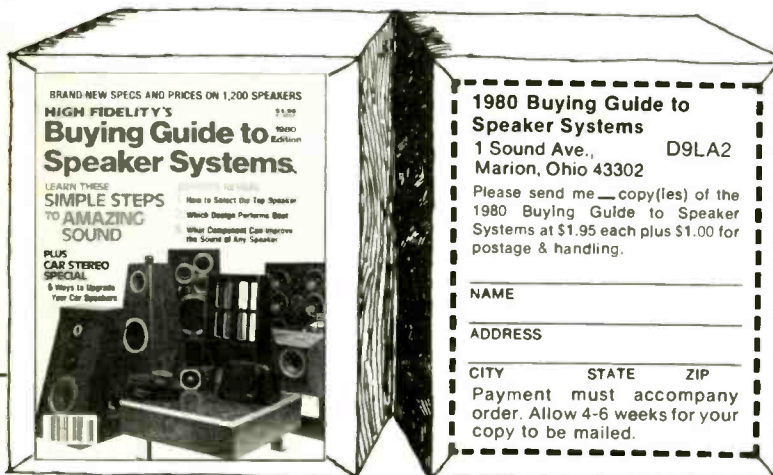

1980 Buying Guide to Speaker Systems
1 Sound Ave., D9LA2
Marion, Ohio 43302

Please send me copy(ies) of the 1980 Buying Guide to Speaker Systems at \$1.95 each plus \$1.00 for postage & handling.

NAME

ADDRESS

CITY STATE ZIP

Payment must accompany order. Allow 4-6 weeks for your copy to be mailed.

Thought I Heard New Orleans Say laments the passing of the Mardi Gras of old, while *Tango Palace* describes a worn-out tango dancer, "pretending Latin ancestry, born somewhere on Main Street, low branch on the family tree, . . . every town's got a tango dancer."

The musicians here are generally sympathetic to his needs, whether they be for late '70s deadpan funk or timeless New Orleans stomps. Bassist Abe Laboriel adds a thread of consistency by playing on all the cuts, and he is outstanding. Dr. John's piano playing is strong throughout, most notably on *Something You Got*, although the LP is certainly no showcase for his prodigious keyboard skills. But that's okay, because his songwriting talent is expanding by leaps and bounds. When he sings, on *Bon Temps Rouler*, "Let's go disco dancin', the latest kind of no-love romancin' " over a strutting New Orleans shuffle, you know he's talking about a timeless kind of Saturday night fever. He puts it another way on *Keep That Music Simple*: "If you really listen at the radio, you'll see it ain't no mystery, the key to a hit record is simplicity. . . . Just stay on the backbeat, son, and hold down the soul." Dr. John is still doing just that.

Gloria Gaynor: I Have a Right

Dino Fekaris & Freddie Perren, producers. Polydor PD 1-6231
by **Christopher Petkanas**

Donna Summer's far-flung eminence has obscured the fact that Gloria Gaynor is the First Lady of Disco via 1975's *Never Can Say Goodbye*. And just as the vibrant singer was slipping away from the collective disco consciousness, last year she re-emerged triumphant with *I Will Survive*, a superior song that provided a metaphor for her opinion of herself as an artist. Her second-time-around success should have surprised no one, for no dance beat has ever disguised her individuality as a full-blooded, wholehearted, skillful soul singer.

The title track on "I Have a Right" is somewhat formulaic in that it returns to the "I'll pull through" theme. But that is pardonable because it is an idea with which Gaynor is quite comfortable. It triggers believable emotions and is delivered directly and without hokum. She sounds achingly desperate as if she is watching



Gloria—disco's real First Lady

the clock for the entire song (8:24) to see if her lover will tell her to go or stay. *The Tonight Show's* Doc Severinsen has a scorching trumpet solo, and the production cooks along evenly throughout. Gaynor has said that she taught herself to sing by listening to records by Frank Sinatra, Nat "King" Cole, Marvin Gaye, and Ella Fitzgerald—a tasteful pool of heavyweight instructors. Martha Reeves's style of hammering out lyrics while managing to glide must have also influenced her. What's more, they share a similar vocal hook.

Producers Dino Fekaris and Freddie Perren, the two ex-Motowners who ended Gaynor's hitless years with *Survive*, have created settings sympathetic to both her limitations and her talents. She is an accessible singer—a tremendous plus—and they do nothing so ambitious as to bury that quality. Their aesthetic combines class and funk, a combination at its sweet, happy, infectious best on *Can't Fight the Feelin'*.

The one glib, mistaken choice of material is *Tonight* from *West Side Story*, an overly long cut (too, too many choruses) that parades around in full disco drag. Linda Clifford succeeded with the notion of sending up a familiar Broadway tune, *If They Could See Me Now*, but that had a narcissistic sentiment compatible with disco culture. *Tonight* doesn't have that in its favor, which is not to say that it couldn't hit: Disco devotees are just maudlin enough to lionize Fifties romance. But just think for a moment what a

thumping rendition of the song would sound like. I'd be interested to hear the opinion of authors Leonard Bernstein and Stephen Sondheim.

"I Have a Right" supplies Gaynor with a sturdier, more viable position in the disco galaxy. The Newark-born singer doesn't have a big identity, and she doesn't need one. Her guileless musicianship is a constant, natural buoy.

Hall and Oates: X-Static

David Foster, producer
RCA AFL 1-3494

by **Crispin McCormick Cioe**

Daryl Hall and John Oates have virtuosic control of several arranging and production styles in American pop music, and their range of skills are rivaled only by fellow Philadelphian Todd Rundgren. "X-Static" offers a broad pastiche of these, sometimes within the same tune. With any other artists, such stylistic pluralism could only be seen as an attempt to cash in. With Hall and Oates, it's more a case of sheer technical ability brimming over the edges. Sometimes their blurred idioms will yield a sharp musical detour with no advance warning; sometimes a song falls flat—usually when its wrappings outweigh its contents.

The duo's most obvious move here is into the land of rock-disco, an amalgam that seems to have been invented for them. *Who Said the World Was Fair* and *Portable Radio* showcase their knack for stringing together smooth lyric-melodic hooks, creating a series of fascinating little journeys within one song. Once these excursions are over, though, it's a little difficult to remember exactly where they went. But drummer Jerry Marotta's rock-steady pulse keeps things convincing, even when the side trips get a little disorienting. And yes, *Portable Radio* is geared for same.

But "X-Static" also explores some new vistas for H&O. Their associations with avant-rock figures like composer/guitarist Robert Fripp emerge clearly on the instrumental *Halofon*, which is a cleverly nightmarish scenario that features pulsing synthesizers straight from an *Alien* outtake. This segues into *Intravino*, a streamlined ode to the joys of wine, which is musically too slick to be called new wave (with all that genre's '60s pretensions), yet is obviously aimed at that audience.

Continued on page 138



Takoma's Renaissance: Tradition Meets Wackiness

by Ira Mayer



The Fabulous Thunderbirds

John Fahey Visits Washington, D.C.

*John Fahey, producer
Takoma TAK 7069*

The Fabulous Thunderbirds

*Denny Bruce, producer
TAK 7068*

Canned Heat: Human Condition

*Canned Heat, producer
TAK 7066*

Michael Bloomfield: Between the Hard Place & the Ground

*Norman Dayron, producer
TAK 7070*

Bernie Krause: Citadels

*Bernie Krause, producer
TAK 7074*

Stevens & Grdnic: Somewhere Over the Radio

*Ron Stevens, producer
TAK 7067*

Takoma. The sound of the name suggests the pacific surroundings that could indeed give rise to a singular blend of classical and folk guitar stylings—let alone to a record label that, at its 1959 inception, was to be devoted to explorations of that instrument and the idioms open to it. Appropriately, founder John Fahey is a highly individualistic and idiosyncratic guitarist who weaves brilliantly impressionistic arrangements of traditional Americana on his instrument. Until now, those invited to join his roster worked in basically similar modes. Though he alone recorded most of the titles in the '60s and early '70s (while also recording for Vanguard and Warner Bros.), Takoma can additionally be credited for introducing us to the talents of his protégé Leo Kottke and of Peter Lang. (The "Leo Kottke/Peter Lang/John Fahey" LP remains in print and, as with most of the label's catalog, continues to sell at a slow but steady pace.)

Earlier this year Fahey sold Takoma to Chrysalis, the independently distributed English-based label founded by Jethro Tull and most successful of late with Blondie. He had reportedly tired of the business machinations necessary to keep a small, highly specialized record company afloat, even as he recognized the need to expand it artistically. Just prior to the sale, for instance, he signed his first rock act—the reconstituted Canned Heat.

Heading Takoma under Chrysalis'

dominion is Denny Bruce, a man who managed Fahey's career in the '60s, and who now hopes to combine the guitarist's determinedly traditionalist leanings with broader artistic and marketing endeavors. "I hope to be able to go back to the point where people would look at Elektra records and want every record they released because it had Jac Holzman's personal stamp on it," he told *Record World*. "Or the days when Atlantic had artists like Ray Charles and people would say, 'I don't know who he is, but he's on Atlantic so he must be good.'"

Only the jazz label ECM has come anywhere near achieving that kind of reputation in recent years, and, in the days Bruce refers to, Elektra was decidedly "folky" and Atlantic &b-oriented. While the initial six album Takoma-via-Chrysalis release is laudable for its generally high level of quality, the span of offerings is such that the fan of one or two LPs will not necessarily be interested in all of them simply because they are Takoma. On the other hand, Chrysalis can give them a depth of market penetration and a potential for exposure that Takoma could hardly effect on its own.

The Fahey album is as much an indicator that at least certain traditions will be carried forward as it is a reassurance that Fahey has not lost interest completely. (Recent live performances have suggested an atypical sloppiness in his attitude and playing.) "John Fahey Visits Washington, D.C." is a deliberate, peaceful, beautifully executed album.

It is also likely to be the least noticed of this half dozen records precisely because it is so quietly characteristic. Each of the other discs overshadows it in forthright exuberance and in general accessibility. Particularly sprightly is the debut of Texas bluesers the Fabulous Thunderbirds. A Tex-Mex strain isn't so much pronounced as it is a leavening agent—i.e., you may not "hear" it, but it's part of the overall flavoring. The group is tighter and more rehearsed than most young, white blues bands, but not at the expense of spontaneity, which comes across in sheer energy, and in a seemingly genuine love of the music.

The Canned Heat set is thankfully much more than the retread this sort of reunion often yields. Remaining of the original 1965 band is lead singer Bob

SHUSUSUSUSUSUSUSUSUSUSUS

Hite, and drummer Fito De La Parra dates back to 1968. The emphasis, as it always was, is blues, but Canned Heat carries the style more toward the rock end of the spectrum than the Thunderbirds or the old-line blues honkers. The cuts are relatively compact if not inspired, and in three cases the Chambers Brothers lend their voices and their credibility to the revitalized line-up.

Mike Bloomfield is another survivor of previous blues-rock eras, a stablemate of Paul Butterfield's and one of the founders of the Electric Flag. He has been an infrequent and inconsistent performer since the early '70s, coasting rather passionately on his technical dexterity rather than pursuing any stylistic development. "Between the Hard Place & the Ground" is by far his most convincing work in some years. At times his guitar actually glistens with the old sense of urgency; his voice, which was never an especially expressive instrument, is richly confident; and the repertory ranges interestingly from Dr. John to Sleepy John Estes to Joe Turner.

Whereas the guitar and blues bases of these four albums give them something of a contextual relationship not at all far removed from Takoma's original oeuvre, "Citadels" and "Somewhere Over the Radio" bear little resemblance to traditional Takoma or to each other. However Bernie Krause's album, like Fahey's, is colorfully impressionistic. It dances rhythmically across continents, and the varying instrumental complexion gives it an aural breadth that is jazzy and often stunning. Krause is the primary composer, synthesizer player, and producer on "Citadels," and while the liner notes bespeak a seriousness that borders on the pretentious, the music is full of heady mood swings, layered textures, and joy.

Stevens & Grdnic's "Somewhere Over the Radio" may well be the sleeper hit of this collection. An extended parody of radio programming, disc jockeys, and commercials, it is the best edited comedy routine I've heard on record. The material is continuously funny and the bent a wacky synthesis of Monty Python's edge-of-hysteria mania. George Carlin's madcap social commentaries, Cheech & Chong's druggie mien, and the Firesign Theater's understanding of how best to mate the medium with the message. 

HEADPHONES THAT PUT THE MOST EXPENSIVE SPEAKER SYSTEMS TO SHAME.

When you listen to Sony headphones, you'll share an intimacy with the music you've probably never experienced before; you'll hear subtleties you've missed with most speakers.

Admittedly, this may sound rather extraordinary. But then, so do our headphones.

SONY

We've never put our name on anything that wasn't the best.

© 1979 Sony Industries, a Div. of Sony Corp. of America, 9 West 57th St., N.Y., N.Y. 10019. Sony is a registered trademark of the Sony Corporation.

Circle 60 on Page 115

WE'VE GOT IT ALL FOR THE HOLIDAYS.

LOWEST HI-FI PRICES
IN THE INDUSTRY.

VAST \$6,000,000 INVENTORY
OF TOP NAME BRAND HI-FI
EQUIPMENT & ACCESSORIES.

MAJOR CREDIT CARD
ACCEPTANCE — VISA/MASTER
CHARGE.

TOLL FREE ORDERING
1-800-638-3920



Call or Write
today for our
FREE all new
80 page catalog.
Plus
Holiday Bargain
Supplement!

STEREO DISCOUNTERS

6730 Santa Barbara Court, Baltimore, Md. 21227

8 IMPORTANT REASONS WHY MORE PEOPLE BUY TOP QUALITY EQUIPMENT FROM INTERNATIONAL HI-FI THAN ANY OTHER MAIL ORDER COMPANY

MORE THAN 80,000 CUSTOMERS NATIONWIDE

1. Guaranteed lowest price . . . you pay same price many dealers pay.
2. No-risk, no-deposit . . . phone orders shipped C.O.D. or Credit Card.
3. Same day shipping when ordered by 1 p.m.
4. Seven audio advisors provide professional help for the inexperienced buyer.
5. Fully insured shipments plus full manufacturers' warranty.
6. Exclusive "no lemon" guarantee.
7. Fully staffed customer service department.
8. Over 70 top name brands . . . equipment most mail order and discount dealers can't supply.



CALL NOW
(301) 488-9600
 Mon.-Fri. 9-9, Sat. 9-4

Write for: • Brochure with prices and lines
 • Tips on buying by mail



International Hi-Fi Distributors

Moravia Center
 Industrial Park, Dept 12H
 Baltimore, Maryland 21206

Circle 30 on Page 115



Continued from page 135
 Which brings us to Hall & Oates' main bag, and, to this listener, their most convincing: so-called blue-eyed soul. *Running from Paradise*, also in the rock-disco vein, underscores their uncanny ability to make soulful pop music out of musical fragments from the past, present, and sometimes even the future. *Running's* harmonic-melodic motif hauntingly and distantly recalls Traffic's *Paper Sun* from the '60s. *Wait for Me*, a lush and wonderfully deliberate ballad, beautifully showcases both singers' emotional ranges, interwoven with Werner Fritzsching's immaculate and gorgeous guitar sound. John Siegler's magisterial bass is completely in keeping with the song's romantic thrust, and of any on the album, this is full-bodied, vintage Hall & Oates.

Their own prowess hampers them occasionally: The music on "X-Static" sometimes sounds too facile, as if craft were being substituted for expression. At a time when the latter is making a strong comeback in rock & roll, this is risky, and it's precisely H&O's brand of souped-up, ultra-moderno rock that tends toward too much glitz. Fortunately, though, there is a

strongly emotional and expressive style that they literally own, and which they've not abandoned. And with these guys, even forays into strange waters are, at the very least, interesting.

Joe Jackson: I'm the Man

David Kershenbaum, producer
 A&M SP 4794

by Toby Goldstein

Joe Jackson has such a complete understanding of the human condition he ought to charge psychiatrist's rates at his gigs. Yet he is as aware of his own frailties as he is good at analyzing other peoples'. Producer David Kershenbaum's juxtaposition of his explicit emotionalism with propulsive rhythms and tightly compressed production makes "I'm the Man" as brilliant as its predecessor and Jackson's debut, "Look Sharp." There's not an overdub or special effect in earshot save for the echo on Jackson's voice, which skillfully replicates the immediacy of his live performances. Even the ballads—*Amateur Hour* and *It's Different for Girls*—are coiled like mainsprings rather than lush and loose.

Jackson has expanded the scope of his writing, creating slightly longer pieces. *Kinda Kute* even encloses a piano solo, exposing one of his lesser-acknowledged talents. He adapts reggae rhythms to suit the up and down romance of *Geraldine & John*, a piercing tale of an adulterous couple. On *The Band Wore Blue Shirts*, he returns to the languorous cabaret melodies he learned on the British working-class club circuit, the music serving as a perfect foil for the song's protagonist—a bored-to-death rote musician. Jackson's explosive tendencies, which result in breathless climactic plateaus, are represented in three cases: the title track, *Don't Wanna Be like That* (a scathing indictment of America), and *Get That Girl*, which blithely recalls Merseymania's classic guitar riffs.

The playing of Jackson's three-piece band, particularly bassist Graham Maby's looping sequences, complements his vocals, which fluidly slide, whisper, cajole, or thunder. In the hands of a less compassionate interpreter, his themes might come across as preachy. But the mirror he holds keeps everybody's imper-

Continued on page 141

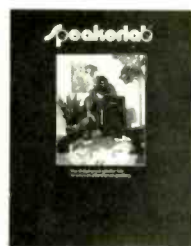

Free SPEAKERLAB CATALOG.

The largest and most experienced speaker kit manufacturer in the world has the world's most exciting catalog. New developments: *Wave Aperture™ Drivers; Powered & Passive Sub-Woofer Systems; The Nestorovic Woofer System (U.S. Pat. #3,984,635)* Huge savings on top quality, "state of the art" speaker systems, raw speakers, and stereo systems. Send for your catalog today or call toll-free **1-800-648-5600** operator #98.

I'm interested. Rush me my FREE Speakerlab Catalog! 12HF

name _____

address _____

city _____

state _____ zip _____

Speakerlab
 Dept. 12HF, 735 N. Northlake Way
 Seattle, Washington 98103

This Christmas Shopping Guide is designed to make your Holiday gift buying easy . . . use it to make your gift selections. You will find something for each and every music listener on your Christmas list. Your favorite high fidelity or record shop is the best place for filling every Christmas stocking.

HIGH FIDELITY

Christmas Shopping Guide

Advertisement



The D3 Record Cleaning System, by Discwasher, has specially designed fabric pad mounted on a hand-finished walnut handle. Handle stores D3 fluid bottle and DC-1 Pad Cleaner. D3 fluid cleans fingerprints and disc contaminants, yet has chemical protection and buffering system that protects vinyl additives necessary for long term record survival.



DiscKit combines essential Discwasher record care products in a beautifully milled walnut tray with dustcover. DiscKit includes: Discwasher D3 Record Cleaning System DC-1 Pad Cleaner, Zerostat Anti-Static Instrument, SC-1 Precision Stylus Cleaner. Walnut tray with smokey dustcover also has spaces for an additional headshell, screwdriver, etc.



The DiscFoot Isolation System is designed to act with existing turntable feet to achieve optimal turntable isolation from airborne speaker feedback and surface-borne vibrations. The structural member and damping foam sections are engineered complexes with chemical inclusions that make them behave differently from other systems. Discwasher, 1407 N. Providence Rd., Columbia, MO 65201



D'Stat II Anti-Static/Resonance Damping Turntable Mat. D'Stat II is a soft felt-like turntable mat which actually eliminates electrostatic charges on the turntable, and buffers the resonance interaction of records and standard mats. Discwasher, 1407 N. Providence Rd., Columbia, MO 65201



The Discwasher SC-1 stylus cleaning system has a precision, large diameter nylon brush and magnifying mirror which reflects into a walnut case. It uses nylon bristles bound together in a specific, calculated density to provide thousands of cleaning tip surfaces and proper stiffness for correct cleaning operations.



The Discwasher DiscKeeper is a storage system with capacity to hold approximately 50 albums. The DiscKeeper's compression sections pull forward so you can "page through" albums. Compression bar holds records flat and upright to eliminate "shelf warp" which can permanently warp your discs. It is made of solid walnut and anodized aluminum in shades of natural wood and matte black.

Advertisement



FRAZIER MARK IV A Super bookshelf loud-speaker system. Compares to many speakers costing twice as much. Made of Hardwood veneers. So efficient it makes a 10 watt receiver sound like 50 watts. 10" woofer, 3x7 Compression horn tweeter. 5 Year warranty. Frazier Inc. 1930 Valley View Lane, Dallas, Texas 75234 Phone 214/241-3441. Write for brochure



Without tolerance defect or compromise. Friction-free, oil-pumped bearing, new construction methods and radical suspension. Highlight the state-of-the-art **DUNLOP SYSTEMDEK**. Strikingly styled, it represents the most easily serviced, stable and accurate turntable yet devised. H & H International, 3047 W. Henrietta Rd., Rochester, NY 14623. 716-424-4827



ROBINS VIDEO CASSETTE ERASER. Get better pictures and sound from your video cassettes with the Robins VCR bulk eraser. Powerful magnetic field sweeps virtually all signals from any video or audio tape in seconds. For U-Matic, VHS and Beta cassettes. Heavy-duty unit is UL listed. #24-001, only \$53. Robins Industries Corp., 75 Austin Blvd., Commack, N.Y. 11725.



ROBINS ROBOLOTE. For music lovers. Ends fumbling for records in the dark. Makes it easy to read labels and place tone arm precisely in groove. Helps prevent stylus and record damage. Attaches to your turntable dust cover. Lights up turntable automatically when cover is raised. UL listed. #40-000, \$20. Robins Industries Corp., 75 Austin Blvd., Commack, NY 11725.



ROBINS WHISTLESTOP CASSETTE HEAD DEMAGNETIZER restores lost fidelity. Erases residual magnetic buildup on heads. You can hear the difference in sound quality and reduced distortion. Easy to use. Insert like any cassette. Complete with batteries. #25-005, \$26.50. Robins Industries Corp., 75 Austin Blvd., Commack, NY 11725.



FRAZIER MARK V Elegance personified. Three Way system that handles the entire audio spectrum at a bookshelf price. Made of hardwood veneers. Super efficient, yet will handle the power. Hand made construction from a fifty year old company. 5 Year Warranty, Frazier Inc., 1930 Valley View Lane, Dallas, Texas 75234. Phone 214/241-3441. Write for Brochure.

AUTHENTIC ORIGINAL FOLK RECORDINGS
By STINSON, oldest and most respected name in folk music

JAZZ
Meade Lux Lewis
Coleman Hawkins

DIXIE
Bob Haggart
Yank Lawson

Spanier and Russell
Art Tatum
James P. Johnson

Norman Granz presents J. A. T. P.

Distributor: inquirers invited

FREE NEW CATALOG lists dozens of treasured originals recorded more than a decade ago by Stinson. Now converted to 12" L.P. - 8 track and cassette form. Burl Ives, Woody Guthrie, Pete Seeger, Leadbelly, Sonny Terry, Josh White, Carlos Montoya, Cisco Houston, Dyer Bennett and many other greats.

STINSON RECORDS, Dept. SW
P.O. Box 3415,
Granada Hills, Calif. 91344

Please send free new illustrated catalog of
 Jazz Folk Dixie L.P.
 8 track cassette



FRAZIER SEVEN Super Floor standing system. Compares to most 1,000 dollar speakers, at less than half that. 12 woofer, three way system. Vertical or horizontal placement. End table height. Don't buy ANY loudspeaker till you've heard the Frazier SEVEN. Hardwood veneers. 5 Year warranty. Frazier Inc. 1930 Valley View Lane, Dallas, Texas 75234 Phone 214/241-3441. Write for brochure.



HIGHEST-FI MOBILE SOUND. Peerless autostereo speakers provide unrivaled fidelity with patented soft-dome construction. Coaxial, separates and customizing kits available. May be bi-amped or used with power amplifiers. Peerless Audio Manufacturing Corp., 40 Jytek Drive, Leominster, MA 01453 (617) 537-6001



Continued from page 138
 fections, including his own, to scale.
 Therein lies Jackson's unique charm.

Bonnie Raitt: The Glow
Peter Asher, producer
Warner Bros. HS 3369
by Steven Rea

Bonnie Raitt has left the sticks for the big city. The country blues of Robert Johnson, Sippie Wallace, and Mississippi John Hurt that earmarked the raspy-voiced singer's early albums have been supplanted on "The Glow" by the cityfied r&b of Mary Wells, Little Richard, and Sam & Dave. Raitt hasn't been known for her risk taking; her gradual move "up-town" is about the only major change one can chronicle through her decade-long career. It's hard to level criticism at someone for sticking to what she does best: Transposing the occasionally overwrought sentiments of L.A.'s school of sensitive singer/songwriters (J.D. Souther, Eric Kaz, Karla Bonoff, Marc Jordan) into moody, melancholy jazz blues; confidently putting forth a brash, boozy tough mama persona; summoning twangy metallic tones from her National Steel Slide Guitar and its electric counterpart.

Producer Peter Asher brings to "The Glow" the same Aphex Aurally Excited sound—in all its uncluttered clarity—that has distinguished his work with Linda Ronstadt and James Taylor. His perfectionist's reputation won't diminish with this LP; he has elicited top-notch performances from L.A.'s session elite: guitarists Waddy Wachtel and Danny Kortchmar, bassist Bob Glaub (Raitt's longtime bass playing companion, Freebo, appears only on one track), drummer Rick Marotta, and Little Feat keyboardist Bill Payne. But there's a taut, funky spontaneity to "The Glow" altogether unlike the sleek pop precision of Ronstadt's and Taylor's recent LPs. While the recording and the playing are technically perfect, it goes beyond that: The songs sound live, and *alive*.

A pair of Sam & Dave hits open the set: the upbeat *I Thank You and Your Good Thing (Is About to End)*, which is a slow-paced soul number sweltered up by the horns of Trevor Lawrence, Larry Williams, Steve Madaio, and an ardent sax solo from David Sanborn. Raitt also tackles Little Richard's *The Girl Can't Help It*,

Continued on page 145



The OA-5A Headphone from Pickering has high energy samarium cobalt drivers that deliver superb sound quality. Lightweight nylon tricot covered foam ear cushions make the OA-5A perfect for long range listening comfort. Suggested retail \$60.00. Pickering and Co., Sunnyside Blvd., Plainview, N.Y. 11803.



The MXR dynamic expander is a linear signal processor which can restore musical peaks and reduce unwanted noise in today's records, tapes, and FM broadcasts. An LED display indicates the Expander's effect on the signal, and additional controls provide in-out bypass switching and taping facilities.



DA5 ANTENNA. A top quality indoor shielded ferrite loop AM antenna. Solid state preamp. Tuning and sensitivity controls. Directional and nulling capabilities. Receives AM stations up to 1500 miles. Assembled \$185.00, kit \$135.00. McKay Dymek Co., 111 S. College Ave., P.O. Box 5000, Claremont, CA 91711. Call Toll Free 800/854-7769 (Calif. 800/972-1783).



Beyer DT 302 is the world's lightest, most comfortable headphone, weighing just 2.5 ounces. Open-air design with foam ear cushions. Frequency response 20-20kHz. High efficiency: 97dB with 1mW. Maximum output 120dB SPL. Compatible with low and medium impedance outputs. Burns Audiotechnics, Inc., 5-05 Burns Ave., Hicksville, NY 11801.

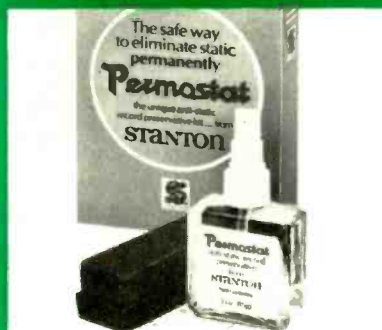

Permostat is the revolutionary record care breakthrough from Stanton because it really works. Permostat eliminates record static permanently with a single application. Kit contains enough Permostat to treat 25 records, pump sprayer, buffing pad and record identification tabs. Permostat Kit \$19.95. Refill, \$15.95. Stanton Magnetics, Inc., Terminal Drive, Plainview, N.Y. 11803.



POLK AUDIO MONITOR SERIES LOUDSPEAKERS have been rated by audio critics and listeners alike as the best sound for the money available today. The Polk compare with the world's finest and most expensive loudspeakers; the biggest difference you'll hear are the affordable prices. Polk Audio, Inc., 1205 South Carey Street, Baltimore, Maryland 21230, Dept. B-14.

Jazz

by Don Heckman
& John S. Wilson

Joanne Brackeen:

Keyed In

Bob James &

Joe Jorgensen, producers

Columbia/Tappan Zee

JC 36075

Pianist Joanne Brackeen is a far better player than composer. She approaches her seven originals with a strong, muscular inventiveness that takes her all over the keyboard, but the dark tonalities and humorless introspections of the pieces themselves work against her. Bassist Eddie Gomez and drummer Jack DeJohnette provide sympathetic accompaniment. **D.H.**

Egberto Gismonti: Solo

Manfred Eicher, producer
ECM 1-1136

Gismonti's proficiency on piano and eight-string guitar is astonishing. The music is pure Brazilian romantic, with his piano pieces filtered through a healthy seasoning of Chopin (especially on *Ano Zero*). It's mood music, to be sure, but it stands up well to repeated hearing, if only because of Gismonti's constant ability to surprise us. **D.H.**

Rune Gustafsson &

Zoot Sims:

The Sweetest Sound

Rune Ofverman, producer

Pablo Today 2312 106

The dark, mellow sound of Rune Gustafsson's guitar is a lovely parallel to Zoot Sims's tenor saxophone. They complement each other in their



solos and engage in some delightful interplay. But the rhythm section—Bucky Pizzarelli on guitar, George Mraz on bass, Peter Donald on drums—could have used the clarity of a piano to dispel some of its thumping. **J.S.W.**

Richie Kamuca: Charlie

Richie Kamuca, producer
Concord Jazz CJ 96

"Charlie" is a program of tunes associated with Charlie Parker—*Hot House*, *Confirmation*, *Dizzy Atmosphere*. Richie Kamuca, playing alto, reflects Parker's lines, though his tone is broader and warmer. Blue Mitchell on trumpet lends a subdued Gillespie flavor, while pianist Jimmy Rowles is impressionistic in his own way. **J.S.W.**

Carmen Leggio Quintet:

The Gem

Leggio Records CL 1
(P.O. Box 64, Tarrytown, N.Y. 10591)

Given the presumed carte blanche that goes with making your own record for your own company, Carmen Leggio—a loose, swinging tenor saxophonist out of the Maynard Ferguson and Woody Herman bands—has put together a rather strange album. He has teamed up with a woman named (here) Flossy



Tall, who plays the unlikely combination of trumpet and flute adequately but with no jazz feeling. Still, though he admits in his liner notes that "the album can be used for Muzak," Leggio gets off some good solos, sings the blues persuasively, and drummer Frankie Dunlop offers some lively scat singing. **J.S.W.**

Shelly Manne Quartet

featuring Lee Konitz:

French Concert

Ed Michel, producer
Galaxy GXY 5124

This 1977 concert at Saint-Quentin-en-Yvelines, France was a particularly felicitous setting to showcase Lee Konitz's beautifully matured alto saxophone improvisations. Drummer Shelly Manne, pianist Mike Wofford, and bassist Chuck Domanico don't sound at all—thank heavens—like the west coast musicians they are. Be sure to check out Konitz's solo on *What's New?*. It's a classic. **D.H.**

Paul McCandless:

All the Mornings Bring

Paul McCandless, George Schutz & David Greene, producers. Elektra 6E 196

Why does Paul McCandless' music keep reminding me of the brainy music-school types who were always

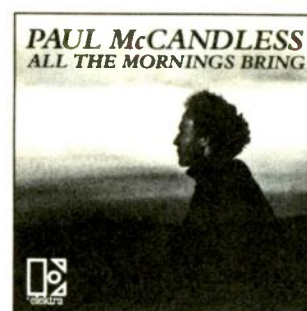

two steps ahead of the instructors? Perhaps it's because he sounds as uninvolved emotionally as they did. When he plays his woodwinds with Oregon, McCandless is not exactly a warm performer; on his own, he's positively chilly. Hyperactive piano playing from Art Lande doesn't do much to break through the ice. **D.H.**

Tradition Hall Jazz Band:

A Tribute to "Papa"

Sandcastle SCR 1039
(Sandcastle Records, 157 W. 57th St., New York, N.Y. 10019)

"A Tribute to Papa" continues a tradition that dates back to the Original Tuxedo Jazz Band of New Orleans, which later was known as Papa Celestin's band. After Celestin's death, Papa French took over, who in turn was succeeded by his son and the band's current leader, Bob. The main line of continuity is pianist Jeanette Kimball, who played with Papa Celestin. But tradition hangs heavy in the hands of the current lineup. The tunes on this disc—*Sleepy Time Down South*, *Basin Street Blues*—are too traditional, and there is an inordinate amount of routine singing. But there are some enlivening moments by Kimball and by Don Suhor on clarinet. **J.S.W.**

HIGH FIDELITY CLASSIFIED

MAIL TO: 825 7th Ave., 6th Floor, New York, N.Y. 10019. Phone: 212-265-8360

GENERAL: All copy subject to publisher approval. First line caps. Users of P.O. Box MUST supply permanent address and telephone number before ad can run.

CLOSING DATE: 1st of second month preceding cover date.

CLASSIFIED RATES: Per word: 1x-\$1.60; 3x-\$1.55; 6x-\$1.50; 12x-\$1.40. MINIMUM 15 words. Words in caps-10¢ extra each. Box numbers: \$2.00 additional per insertion to cover cost of handling and postage. Display: 1 inch-\$275; 2 inch-\$550; 3 inch-\$825. Also 6 and 12 consecutive issue discount rate.

PAYMENT WITH ORDER: Send check, M.O., MASTERCHARGE or VISA No. and expiration date to: Classified Dept., HIGH FIDELITY, 825 7th Ave., 6th Floor, New York, NY 10019.

FOR SALE

AUDIOPHILES WANTED! Put your knowledge to use, earn an excellent spare time income. We need campus Dealers to sell name brand stereo equipment at substantial discounts in your area. No investment necessary. For information and application please write: ABCO, Dept. CR, 1201 East Main Street, Meriden, Conn. 06450.



LOUD AND CLEAR.
Read all about the K—the amazing speaker that has the power to reproduce even the lowest bass notes—loud and clear. Features the brilliant cornhorn design with Speakerlab innovations like the Magnar™ damped horn drivers. One of the only kits available for this unique loudspeaker. Read about K's and all the other great Speakerlab speakers and parts in our free catalog.

Speakerlab®
To get yours write
SPEAKERLAB, Dept. 121
735 N. Northlake Way
Seattle, WA
98103

STEREO REPRESENTATIVES NEEDED! LOWEST POSSIBLE PRICES!!! OVER 100 BRANDS!!! KRASCO Rep., 998 Orange Ave., West Haven, Conn. 06516.

SAVE 50% BUILD YOUR OWN SPEAKER SYSTEM. Write McGee Radio Electronics, 1901 McGee Street, Kansas City, Missouri 64108.

Audio Video
Professional Quality



CASSETTES
TDK • 3M • AGFA
Call/write for free cassette catalog
Polyline 312/297-0955
20 Corp. 1233 RAND RD. • DES PLAINES, IL 60018

KOETSU is here. The legendary handmade moving coil cartridge is now available in the U.S. For the complete story, write: Sumiko, Inc., Box 5046, Berkeley, CA 94705.

ADDED TO DYNAKITS? Phone for quotes/catalog of hard-to-find Dynaco components/accessories. COD's welcomed! (216) 452-6332.

CERTIFIED AUDIO CONSULTANT HOME STUDY HI-FI Course available. Send \$5.00 for information. Includes AUDIO TECHNICAL YEAR BOOK with 29 sample lessons and application for membership in the Society of Audio Consultants. Write SAC, P.O. Box 552, Dept. HF, Beverly Hills, CA 90213.

MULTI-TRACK AND SEMI-PROFESSIONAL AUDIO EQUIPMENT: BEST PRICES! Prompt Delivery! DBX, TEAC/Tascam, Sound Workshop, AKG, Delta-Lab Others Dept. HF, W/DI, P.O. Box 340, Cary, NC 27511 Call toll free 1-800-334-2483 in N.C. 919-467-8122

Cartridges At Wholesale—Other Stereo Bargains Free Price List. Audio Component Systems, 1329 Union Mill Road, Olympia, WA 98503.

SAVE up to 80% BY MAIL on: SCOTCH, TDK, BASF, MAXELL, MEMOREX, CAPITOL MUSIC TAPE, CERTRON (over 180 different reel & cassette tapes to choose from), top brand recorders; America's largest collection of taping accessories, too. Same day service. **FREE catalog.**

America's Recording Tape Specialists

SAXITONE TAPE SALES

1776 Columbia Rd., Washington, D.C. 20009
(202) 462-0800

ANTI-SKATING FOR AR TURNTABLES! Proven counterweight design. Install yourself in minutes. \$7.95 postpaid. Audio Innovational Products, P.O. Box 1607, Portsmouth, N.H. 03801

UNZOO OBFUSCATION OF SALON AUDIO! State-of-the-art and Esoteric Components at Sensible, Affordable Consumer Prices. Newest 36-page fact book/price catalog lists over 4,000 items currently available. Send \$5.00 for prompt mailing (Deductable on first purchase). Best pricing in North America. SOTA and Esoterica include: SAE, Phase-Linear II, Carver, AEA, Hafler, Lecson, Meridian, Quad, Essence, Grace, Supex, ADC, Satin, JansZen, UltraStat, B & W, Klipsch, Beta, Theta, Win, Specs, BML, RTR, Cnapman, Rogers, Burwen, PF, Clarke, Sound Concepts, GAS, SNEER, Soundcraftsman, Beveridge, Audiopulse, Signet, Symmetry, Waterloo, Jim Rogers, Denon, Technics Pro Line, Toshiba, Aiwa, Kenwood, Purist, Synergistics, Dyna, Akai, Bose, Sherwood. Bank/Customer references available. Professional Psychoacoustician ready w/no BS Engineering advice. Trade-Ins. VISA/MasterCharge. Personal checks OK 20% deposit. Orders shipped promptly. Write or phone ASAP for Best Prices. Also, special packaged systems prices. G.E.A.E. Golden Ear Audio/Electronics, Drawer # 160, Rollinsville, Colorado, 80474, (303) 258-7623 or 258-7524 11 to 9 MST.

A SINGER'S DREAM!



REMOVES VOCAL FROM MOST STEREO DISCS
The Thompson Vocal Eliminator can actually remove most or virtually all of a solo vocalist from a standard stereo record and yet leave most of the background music untouched! Not an equalizer! We can prove it works over the phone. Write for a brochure and demo record below. **COST: \$249.00**

YOU SHOULD SEE US

For:

- Delay and Ambience
- Studio Echo/Reverb
- Tape Noise Reduction
- Parametric Equalization
- Electronic Crossovers
- Comp/Limiters
- Mic Preamp/Mixers
- Patch Bays

We manufacture a full line of high quality audio and recording equipment. You will probably have to pay twice as much elsewhere to obtain comparable quality. Only Direct Sales make our prices and quality possible. Send \$1 for a 20 page brochure and 20 minute demonstration record.

Write to: **LT Sound, Dept. HF, P.O. Box 729, Decatur, GA 30031. (404) 284-5155**

ACTION SALE! TDK AUDIO TAPE (Lots of 10 only) DC-60 \$1.19 each, DC-90 \$1.49 each, SAC-60 \$2.10 each, SAC-90 \$2.90 each. TDK Video Tape (No minimum order) T120 4 hr. VHS \$16.95, L500 Beta \$13.95. Add \$3.00 shipping per order. N.Y.S. residents add 8% sales tax. Empire Action Audio/Visual, P.O. Box 248, Dept. HF, Howard Beach, New York, 11414

HORNS—WOOFERS—MIDS—TWEETERS at tremendous OEM savings! Altec, Electro-Voice, Philips, Peerless, Polydax and many others. Dozens of hard to find items used in major manufacturers most expensive systems. Huge selection of crossover network components, automobile systems, and musical instruments loudspeakers. Send \$1.00 for CATALOG SRC AUDIO Dept. HF 12, 3238 Towerwood Dr., Dallas, Tx. 75234.

DYNACO OD-1 ambience recovery unit (amazing special realism!)—\$19.95 (Kit); \$24.95 (Wired). DYNACO WALNUT CABINETS—Single, \$19.95; Double, \$24.95 (specify models). Postpaid Great gifts! SCC, Box 8014 (1179HF), Canton, OH 44711

DYNACO MARK III KITS, LAST FACTORY SEALED NEW units. \$200.00 each, two for \$375.00 plus COD freight. C. Raible, 1726 Bentley #5, Los Angeles, CA 90025.

DYNAVECTOR 3000 PREAMP NEW—SACRIFICE \$1500. Dick Wagner, 5930 Penfield Ave., Woodland Hills, CA 91367 (213) 992-6266.

FREE GUIDE TO MOVIES available on video tapes. Send name, address, make & model of recorder. HOME VIDEO, 237 W 54th, New York 10019, Dept. IH3.

HOW TO ARRANGE & CLASSIFY YOUR RECORD LIBRARY. Send \$1.00 and #10 S.A.S.E. to Paul Samuel, 12 Manorhouse Dr., Dobbs Ferry, NY 10522.

ALL AUDIO RETAILERS should own the **SOUNDER "PHASE CHECKER"** for easily determining the Phase Polarity of ALL speaker systems and components. The Model 250 is reliable, durable, and designed for convenience in use in audio stores. Built-in mic and hi-gain preamp included. Only \$295. Avoid being "Phased Out" Send for free info or call **SOUNDER ELECTRONICS, 211 Madrona St., Mill Valley, CA 94941 (415) 383-5811.**

TOP-NAME AUDIO AT LOW LOW PRICES! Aiwa, AR, Bose, ES, JBL, JVC, KLH, Marantz, Onkyo, Phase Linear, Pioneer, Sansui, Sony, Soundcraftsman, Teac and many more we can't even mention by name. All factory fresh with full warranty. For prices just call 212-254-3125. Or send \$2.00 for our informative brochure to **DIRECT DISCOUNTS LTD, P.O. Box 841, Cooper Station, N.Y. 10003.**

"DIAMOND LIL" has **DIAMOND NEEDLES** and **STEREO CARTRIDGES** at lowest prices. Factory boxed for Shure, Pickering, and all others. Free catalog. **DIAMOND LIL, 4530-A N.W. 4th St., Delray Beach, FL 33445.**

MISCELLANEOUS

DIAMOND NEEDLES and Stereo Cartridges at Discount prices for Shure, Pickering, Stanton, Empire, Grado, Audio Technica and ADC. Send for free catalog. **LYLE CARTRIDGES, Dept. H, Box 69, Kensington Station, Brooklyn, New York 11218. For Fast Service, call TOLL FREE 800-221-0906**

PROTECT YOUR ALBUMS WHITE CARDBOARD REPLACEMENT JACKETS 35c. PLASTIC LINED INNER SLEEVES 15c. POSTAGE \$1.25. OPERA BOXES, 78 SLEEVES AVAILABLE. FREE CATALOG. CABCO 301-3, BOX 8212, COLUMBUS, OHIO 43201

Free Promotional Albums, Concert Tickets, Stereos, Etc. Information: Barry Publications, 477 82nd Street, Brooklyn, NY 11209

The Best New Stereo Systems Deserve The Best New Stereo Records (Tapes too)! You need the Monthly **SCHWANN RECORD CATALOG** available from record shops everywhere or, for a sample copy PP, Send \$2.50 to: **ABC-SCHWANN Single Copy Sales, Dept. 2160 Patterson St., Cincinnati, Ohio 45214.**

COLLEGE STUDENTS! Improve your grades. Send \$1.00 for 356-page, collegiate research papers catalog. 10,250 available. RESEARCH ASSISTANCE, Box 25916R, Los Angeles, California 90025. (213) 477-8226.

SLIPCASES for HIGH FIDELITY Magazine. Simulated blue leather. Holds 6 High Fidelity issues. \$4.95 single case, \$14 for 3 cases. \$24 for 6 cases. USA orders only. Allow 6 weeks for delivery. HIGH FIDELITY Library Cases, Box 5120, Philadelphia, PA 19141.

COMPARE THE DIFFERENT POPULAR ORGANS AND STYLES CASSETTE—8 TRACK \$5 CHRISTIE, 1792 UNION AVE. SE, MINERVA, OHIO 44657.

SARDONYX GUITARS for Information write to Sardonyx, P.O. Box 1272, L.I.C., N.Y. 11101.

NEW EQUIPMENT FOR SALE

BRITISH AND EUROPEAN EQUIPMENT DIRECT TO YOU. Most quality makes of equipment available at advantageous prices. For price list and price quotes send International Reply Coupon. Send \$2 for the brochures you require. Audio T, Dept A, 190 West End Lane, London, NW6 1SO, England, Phone 01-794 7848. Visitors welcome.

TOP-RATED CARTRIDGES UP TO 70% OFF!! We feature Acutex, ADC, Grado, Nagatron, Ortofon, Sonus, Stanton, et al. Unbelievable prices!! Call 212-254-3125 for prices, or write to DIRECT DISCOUNTS LTD., P.O. Box 841, N.Y., N.Y. 10003

BUY DIRECT and save. British and European Hi-Fi. Attractive prices. Send Reply Coupon for Quote, \$3 bills for brochures. Goodwins, 7 The Broadway, Wood Green, London N22, Phone 888-0077. VISA/Mastercharge. Visitors welcome.

LOWEST PRICES ON STEREO-ESOTERIC COMPONENTS & TAPES!! Over 150 brands. Send \$10 SASE for quotes. Audio Unlimited, 401 Reynolds Circle #10, San Jose, CA 95112 (408) 289-8875 1-6-M-Th.

Buy with confidence

AKAI AA-1125 Send for Quotes & Price List on AKAI & Over 60 Other Famous Brands

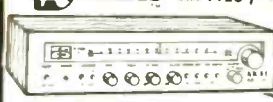

AM/FM STEREO RECEIVER
Continuous Power Output of 25 Watts/Channel Min. RMS at 8 ohms from 20 to 20,000Hz with no more than 0.3% Total Harmonic Distortion, 2 Tape Inputs, 1 Phono Input, Phase Lock Loop Multiplex Section, Tape Dubbing.

ARSTONS Mon.-Fri. 9:00-5:30 Sat. 9:00-3:00
146 Old Brookfield Road, Danbury Conn. 06810 (203) 744-6421 (212) 369-6212

ABSOLUTE LOWEST PRICES on all brands of car and home stereo equipment and musical instruments. Call (707) 963-9653, or write: WFI Distributors, 1148 Main Street, St. Helena, CA 94574.

QUALITY AUDIO DISCOUNT! Car/Home. SASE for quotes. Denco Audio, P.O. Box 6104-H, El Monte, CA 91734. (213) 444-9978 evenings, weekends.

******* BUILD YOUR OWN BIG SCREEN T.V. ******* Are you into watching sports?? 777 Have You Seen the Big Screen T.V. in Taverns?? 777 Now You Can Watch That Big Game in Your Home on a Screen Size of Your Choice, Using Your Own 12"-19" Portable. I have put together a simple instruction and Plan Book, listing major lens and screen suppliers, which make it possible. Satisfaction Guaranteed. Send \$9.95 To: Self Images, Box 775-D, Hayden Lake, Idaho 83835.

LOWEST PRICES! STEREO, ESOTERIC, AUTO, DISCO. Over 100 brands. ALL guaranteed. Call for prices 914/258-4342 4-9pm. Sound Shed, Box 61A, Merritts Island Road, Pine Island, New York 10969.

TAPES & RECORDS

RARE OPERA, SYMPHONIC MUSIC ON OPEN REEL TAPE. Historic performances. EUROPEAN, DOMESTIC. Free Catalogue. Underhill, Box "U," Bellport, NY 11713.

"SOUNDTRACKS, SHOW, NOSTALGIA & JAZZ—FREE Catalog & Offering List—A-1 Record Finders, P.O. Box 75071-H, L.A. CAL 90075."

SCOTCH RECORDING TAPE, LOWEST PRICES. TAPE CENTER, Box 4305C, Washington, D.C. 20012

RAREST CLASSICAL, SOUNDTRACKS, SHOWS, PERSONALITY LPs. Huge catalog \$1.00. Grammy's Attic, Box 181, Bluffton, SC 29910.

"LIVE OPERA TAPES, Reels—Cassettes. Unbelievable treasures since 1926. Over 5,000 selections. Free DELUX Catalog: MR TAPE, Box 138, Murray Hill Station, NYC 10016."

TDK, MAXELL, MEMOREX, CASSETTES, REELS, 8-Track Free Catalog, New Guaranteed. S&S AUDIO, P.O. BOX 94485, Schaumburg, IL 60194.

SEARCHING? WRITE DISCONTINUED RECORDS, 444 South Victory, Burbank, California 91502.

SHOW ALBUMS—Rare, out-of-print lps, 64-page list \$1.00. Bakers Wife or Nefertiti-original cast LP \$9.95. Broadway-Hollywood Recordings, Georgetown, CT 06829.

OPEN REEL TAPES. Top Quality. 100% money-back guarantee. Major labels. Classical, pop, rock, quad—direct disk & video. Bank cards accepted. Catalog/order information, \$1. No other fees, obligations. THE REEL SOCIETY, P.O. Box 55099-H, Valencia, CA 91355.

LIVE OPERA ON REEL/CASSETTE. THOUSANDS OF PERFORMANCES, WORLDWIDE SINCE 1930's. The ONLY service that provides the personal attention demanded by the Vocal Art. Free Gifts, Magnificent Free Catalogue. LIVE OPERA, Box 3141, Steinway Station, L.I.C., N.Y. 11103.

THE REAL TDK SA CASSETTE STANDS ON ITS WARRANTY

TDK's super precision mechanism and unique Super Avilyn magnetic tape coating are two reasons why no one has been able to copy our SA cassette. However, since they can't match TDK SA's performance, they've settled for the package. And that has fooled some

people. Especially those who did not buy from an authorized TDK dealer.

TDK has a simple way to wipe the fakes out of existence.

Be sure your dealer displays the authorized TDK dealer sticker and ask whether he backs TDK's full lifetime warranty. If he does it's real. If he doesn't, it's probably fake. It's that simple.

Besides that very important difference—and TDK SA's superior performance—look for a) poor printing quality on the wrapper, b) a smudged "C-90"

on the liner card, c) lack of code number on top of shell. At \$5.69* per cassette, you'll want to be sure you're getting a genuine TDK SA.

Still, your best guarantee is our warranty. And that is only available at authorized TDK dealers. The real TDK will stand by that.

TDK®
The machine for your machine.



TDK FULL LIFETIME WARRANTY
For Audio Cassette & 8-Track Cartridge Products

In the event that this product should become defective, you may return it to your dealer for a replacement or a new one. TDK will replace it free of charge. Simply return it to your local dealer or to TDK Electronics Corp., 225 East 10th Street, Garden City, New York 11530.

TDK® will not be held liable for any damage or loss of data caused by the use of this product. The product is sold as is. No warranty is made by TDK.

BASF TAPE: Largest discounts, fastest service. All tapes guaranteed! INTERGALACTIC ENTERPRISES, 1789 Carr, Troy, Michigan 48098

RECORD HOUND, Box BBH, Eagleville, PA 19408. Fills want lists? Doggone right!!! 33 1/3 specialist. Fast, friendly service.

SCHUBERT/DYER-BENNET. The splendid Tully Hall performance of the Dyer-Bennet translation of "Schone Mullerin" (Characterized by Andrew Porter as "A Schone Mullerin" which came to life!) now available in a meticulously produced studio recording (stereo—two discs) directly from Dyer-Bennet records, Monterey Stage, Great Barrington, MA 01230 \$17.50 postpaid.

FREE CATALOG LPs, FACTORY SEALED \$2.50 to \$4.00. Modern Designs, 1731 N.E. 51st St., Pompano Beach, Fla. 33064.

SUPER-FI RECORDS! All types, labels. Catalog \$1; COSMIC CHORDS PO Box 4873 Boulder, Colo 80306.

CUT-OUT RECORDS, HUGE STOCK ALL NEW. No catalog. Cohn 2205 Marylande, Broomall, Pa. 19008.

ON OPEN REEL from master tapes. Argo, Telefunken, Vanguard, Unicorn, MHS. Catalogue \$1.00. Barclay-Crocker, Room 1470-H, 11 Broadway, NYC 10004.

GOLDEN AGE RADIO—your best source for radio tapes. Free catalog. Box 25215-J, Portland, Oregon 97225

SOUNDTRACKS—New and out-of-print film music recordings. Free listings and info. CINE MONDE RECORDS, 1488 Vallejo St., San Francisco, CA 94109.

CAN'T GET ORION RECORDS? Orion's alive and well and easy to get! Send check—order shipped same day. \$6/record, includes postage \$11 for 2-55 each for 3 or more Orion Master Recordings, Box 4087, Malibu, CA 90265

RARE ORIGINAL SOUNDTRACK ALBUMS SEND 25 CENTS FOR LIST SHOW MUSIC, BOX 12, WOOD RIVER, ILLINOIS 62095

VIENNESE OPERETTA RECORDS, INC. Extensive range, superb vocal performances, on currently available LP's. Free list P.O. Box 50-B, Dover, Mass. 02030

HEAR FAVORITE RECORDS & tapes with startling new clarity. 8800 noise reduction revives noisy sources. Write LOGICAL SYSTEMS 3314a H St. Vancouver WA 98663.

SOUNDTRACK, ORIGINAL CAST, PERSONALITY LP's. Large free catalog includes out of print and imports at discount prices. STAR 279, Box 7, Quarryville, PA 17566.

BLANK TAPE SALE

TDK SA C90	3.05	Ampex Grandmaster I 90	2.69
TDK AD C90	2.45	Ampex Grandmaster II 90	3.09
TDK D C90	1.59	Scotch 212 7R 1800	3.99
TDK SA C60	2.15	Soundguard Record Pres Kit	4.59
BASF Pro I C 90	2.79	TDK L 1800	5.13
BASF Pro II or IIC 90	2.89	TDK LB 1800	6.31
BASF Studio I or IIC 90	2.59	Ampex Grandmaster 1800 ft Reel	5.95
Scotch Master I or IIC 90	3.15	Scotch 207 7R 1800	5.09
Scotch Master IC 90	2.69	BASF Studio 1800 ft Reel	6.49

AR tapes can be inserted. No minimum order. Shipping 3.00 per order. Or write for free catalog of over 250 products, including lowest prices on all Maxell products. All tapes 100% guaranteed. Free gift with every order. 412-283-8621 M-Th 9-4.

TAPE WORLD 220 Spring St. Butler, PA 16001

AUDIOPHILE RECORDS: Save 20% to 40% (or more) Fast, personal service. Free catalog SUPER SOUND RECORD SERVICE: P.O. Box 411237 Chicago, ILL 60641

ARTHUR FIEDLER, THE KINGSTON TRIO AND Buddy Rich! Invite them all into your living room. Send \$1 for catalog offering these and over 250 different artists on Direct-to-disc, Digital and other specially-cut recordings. Immediate service! Send today. Sound Concepts, PO Box 7063, Eugene, OR 97401.

RECORDSAVERS, POLY-LINED INNER SLEEVES TEN CENTS EACH, POSTPAID, MINIMUM 100 DEES, INC BOX 452B GLENVIEW, IL 60025

CHRISTMAS CAROLS CASSETTE 60 MINUTES \$2.95 PLUS \$0.50 POSTAGE . ALSO FREE CATALOG CLASSICAL MUSIC CASSETTES . GUARANTEED EKR CLASSICS, GPO BOX 1977HP, NEW YORK, NEW YORK 10001

Melodia Label Classics Large Selection Direct Importers-Znane, 5237 Geary Blvd San Francisco, Ca 94118

NOTICE: Record Listeners Wanted

(No experience required) Each month you will receive nationally released albums to rate. **There is no extra charge for the LP's you receive** — all you pay is a small membership fee which covers all costs of the LP's including postage and handling. In return for your opinion you will build a substantial album collection — "first come basis". For application write

EARS SYSTEMS
Box 10245 Dept. HF
5521 Center St., Milwaukee, WI 53210
"Guaranteed" © 1979 EARS SYSTEMS

Live Performances tapes—opera, conductors, instrumentalists. Superior Sound. Open Reel Only. Catalogues Good Sound Associates, POB 263 Planetarium Station, New York, NY 10024

SOUNDTRACKS, Shows, Personalities Auction. LPs, EPs, 78s. FREE LIST. Bothy Press, Music Dept., 320 East New St., Lancaster, PA 17602.

DISCONTINUED RECORDS, Classical, Popular, All Speeds, Free Lists, Fred Steinmetz, One Seaview Avenue, Massapequa, NY 11758

25,000 LP ALBUMS & 1700 RPM SETS FOR SALE. Send wants lists. Bernstein, Pine Valley Road, Oyster Bay, N.Y. 11771

1930-1962 RADIO PROGRAMS, \$1.00 HOUR! Professional 200 page catalog, \$1.25. AM Treasures, Box 192HF, Babylon, NY 11702

VIENNESE LIGHT MUSIC SOCIETY—Strauss, Lanner, etc. on Dolby Cassettes, KC Company, Box 793, Augusta, Maine 04330

BUSINESS OPPORTUNITIES

CABLE FM BROADCASTING: Unique no investment/experience business. Home operation possible. Excellent income. "CAFAM," Box 130-D-12, Paradise, CA 95969

MECHANICALLY INCLINED INDIVIDUALS: Assemble electronic devices in your home. Investment, knowledge, or experience not necessary. Start in spare time. Above average profits. \$300-\$600/wk possible. Sales handled by others. Write for free details. Electronic Development Lab, Drawer 1560HF, Pinellas Park, Fla 33565

PUBLICATIONS

THE BLIND AND OTHER PHYSICALLY HANDICAPPED can know the joy of reading memorable selections chosen from over 50 outstanding periodicals, completely free of charge. Write CHOICE MAGAZINE LISTENING, Dept. HFC, Box 10, Port Washington, NY 11050 or call 516-883-8280

AM-FM cassette recorder with built-in SCA. Now tune in those elusive subcarriers, and tape them, too! Ready to play, guaranteed \$60. FM Atlas, Adolph, MN 55701.

DIVA, INSIDERS WEEKLY OPERA NEWSLETTER, SUBSCRIBE today! \$10.00 per year. DIVA, 37A Bedford Street, Box 63, NYC 10014. A unique gift!

SERVICES

COLLEGE STUDENTS! Improve your grades. Send \$1.00 for 356-page, collegiate research papers catalog. 10,250 available. RESEARCH ASSISTANCE, Box 25916R, Los Angeles, California 90025 (213) 477-8226

ELECTRONICS

ELECTRONIC BARGAINS, CLOSEOUTS, SURPLUS! Parts, equipment, stereo, industrial, educational. Amazing values! Fascinating items unavailable in stores or catalogs anywhere! Unusual FREE catalog. ETCO-017 Box 762, Plattsburgh, NY 12901

FILMS

VIDEOCASSETTES! Major motion pictures, classics, animated films, science fiction & horror, rock, and more! Send \$0.4 for catalogue. Video Ventures, Box 167-HF, Durham, North Carolina, 27702



Continued from page 141

only she's made it *The Boy Can't Help It*, and her sly, aggressive sexiness regenerates the song easily. (Unlike, for instance, Ronstadt's stiff, illogical rendition of Elvis Costello's *Alison*).

Raitt's steadfast allegiance to Jackson Browne's gloomily romantic worldview is represented by his *Sleep's Dark and Silent Gate*. She also hands in her first original since the "Give It Up" LP, *Standin' by the Same Old Love*, a lively salutation to everlasting love. The title track, by Veyler Hildebrand, is a torchy Billie Holiday-like ballad backed by a simple bass-drums-piano jazz trio. While "Give It Up" still stands as the definitive Bonnie Raitt album, "The Glow" radiates cogent authority and is assuredly among the best of her seven LPs.

JAZZ

Helen Humes: Sneakin' Around
Disques Black and Blue, producer
Classic Jazz CJ 110
by John S. Wilson

Until recently, Helen Humes was primarily known for her work in the late '30s and early '40s with Count Basie's band. But although she is mostly a blues artist, she rarely got to sing the blues in that setting because Jimmy Rushing had the territory staked out. Even on the ballads that were usually assigned to her, she had to sing at a lively dance tempo.

"Sneakin' Around" brings Humes into more accurate focus. It gives her a chance to sing not only the blues, but also some rhythm tunes and a pair of slow ballads. One of the high points is a nine-minute tribute to Rushing in which her high-pitched, shouting style summarizes his most typical blues verses and occasionally even recalls Big Joe Turner. Her creativity in the generally hidebound world of blues is demonstrated on *St. Louis Blues*: She starts at an unusually slow tempo, enabling her to breathe an amazing amount of expressive fresh air into this worn and overdone song. Her performances of *Every Now and Then*, a slow ballad (with a banal lyric), displays her lovely lyrical qualities and the sensitivity with which she handles shading and nuances.

But the set is not all Humes's. Her

Continued on page 148

by Elise Bretton

Ambrosia: Life Beyond L.A.
Warner Bros., 10 songs, \$6.95

The three-man cabal calling itself Ambrosia opens this collection with the standard set of riffs about the loneliness of life on the road. And you think you've got troubles? We learn that guitarist David Pack has decided "the only time . . . I'll ever be happy in my own mind is dyin'"; bassist Joe Puerta's problem is "there is no easy way to heal the soul that's been abused"; and that for percussionist Burleigh Drummond, "watching each day pass so slowly gets to me more than I can bear." Gentlemen, spare me; no one forced you to go into the music business.

Average White Band: Feel No Fret
Big 3 Music, 9 Songs, \$5.95

The AWB, long absent from the folio lists, abandons its usual up-and-at-'em approach and here endeavors to combine soupy love lyrics with hard rock rhythms. But as transcribed, the heavy, complex bass patterns are far too sophisticated for the expediently-rhymed hook phrases of Alan Gorrie, Hamish Stuart, et al. I believe I've heard lyrics like these before: "Unless you're truly certain . . . you know you're gonna be hurtin'" and "too late to cry, wond'rin' just what passed you by." Ironically, the only above-average piece of material is the new piano-vocal setting of a fifteen-year old Bacharach-David standard, *Walk on By*.

Eubie!
Warner Bros., 15 songs, \$5.95

Eubie Blake, the son of two slaves, wrote some sparkling music for various Broadway shows in the 1920s, an era when black performers were still obliged to present themselves as shuffling, shouting, eye-rolling stereotypes. This folio—all of whose tunes appeared in the recent Broadway hit *Eubie!*—contains a sampling of his prodigious melodic output, including *I'm Just Wild About Harry* and the classic *Memories of You*. The lyrics (by Noble Sissle and Andy Razaf) are jaunty, sassy, and, above all, good humored; and Danny Holgate's piano-vocal transcrip-



Walsh—a mere boondoggle

tions are evocative of the period without being ricky-tick. No, these songs do not "get down" and they do not "bring the message to the people"; but without Eubie Blake, there would have been no Wes Montgomery, no Funkadelic, and no Donna Summer. We are all enriched by his compositions.

Steve Gibb: Let My Song
Cherry Lane, 10 songs, \$5.95

Sharing a surname with the rich and famous is no guarantee of Class-A treatment. Relegated to a grainy black-and-white cover image created by a vindictive photographer, Steve Gibb enters the highly competitive print market armed only with the pen of talent—usually no match for the sword of glitz. His sensitive and powerful ballads are in the tradition of Barry Manilow/cum Bobby Goldsboro and have been recorded by Kenny Rogers, Helen Reddy, and Dottie West. Gibb merits discovery by a wider audience; singers, this one's for you.

Heart: Dog and Butterfly
Warner Bros., 8 songs, \$6.95

The singing/writing Wilson sisters have created another musical butterfly net



FOR ORDERS ONLY!

Mon. & Thurs.-9 AM-7 PM, Tues., Wed., Fri., Sat.-9 AM-5 PM
E.S.T.

STEREO
HOT-LINE



CHECK US OUT!

- ✓ Our prices are the lowest.
 - ✓ Discounts on over 60 major brands.
 - ✓ Reliability: one of the oldest audio mail-order houses in the U.S.A.
 - ✓ Rated #1: by a leading trade publication.
 - ✓ Large inventory: we buy in volume getting the best deals from the manufacturers, you get the best deal from us.
- GIVE US THE OPPORTUNITY TO BEAT THE BEST DEAL YOU'VE BEEN ABLE TO FIND.

— QUOTES AND INFORMATION —
(212) 253-8888. 9AM-5PM, MON.-SAT., N.Y. TIME

Write or Call us now for the lowest price quotes and a Free price flyer.

STEREO CORPORATION OF AMERICA

HF-1629 Flatbush Ave.
Brooklyn, New York 11210

Circle 62 on Page 115



Your National Headquarters for Name Brand Electronics by Mail

- ★ Full Manufacturer Guarantee Applies to All Sales!!
- ★ Orders Shipped in Factory-Sealed Cartons—Most Within 24 Hours
- ★ Multi-Million \$\$\$ Inventory

TOP DISCOUNT AUDIO

1150 N. Powls Rd., West Chicago, IL 60185
800-323-2518

MasterCharge and VISA Welcome
Call or Write for the LOWEST PRICES Around!

MR _____
MS _____
(First) (Initial) (Last)

(Number and Street)

(City) (State) (Zip Code)

Phone Order Hours: M-W-F 8AM-4:30PM,
T-Th 8AM-8PM, Sat. 9AM-Noon

WE CARRY THE TECHNICS PRO SERIES—Call for Quotes!

Circle 68 on Page 115



of "sus 2s," "F (add Bs)," and "N.C.s." A cowriter named Susan Ennis has joined the elliptical sorority and the result is high-energy obfuscation. These are not songs so much as mantras, and when I am confronted with Ferlinghetti-like phrases such as "It showed me the way to the deepest mountain," "We're balanced together ocean upon the sky," and "buzzing through the mayhem," I wonder whatever happened to telling it like it is.

Steely Dan: Greatest Hits
Columbia Pictures, 17 songs, \$6.95

Steely Dan (Walter Becker and Donald Fagen) are represented by some chart items of eight-plus years ago in this compendium designed to lure the golden-oldies impulse buyer. Although we remember *Rikki Don't Lose That Number*, *Do It Again*, *Reelin' in the Years*, and *Pretzel Logic* with fondness, not all of these hits were their greatest and the editing/proofreading is scandalously sloppy.

Joe Walsh: But Seriously, Folks. . . .
Warner Bros., 8 songs, \$6.95

I hope Eagle Joe Walsh grows out of his Jerry Lewis period before we all lose patience with him. If he would concentrate on his craftsmanship and leave the diving to Jacques Cousteau, I would not be telling you that this is a slender offering for the money, and that devoting three pages to the notation of a 2-chord guitar-strum song entitled *Theme from Boat Weirdos* affects me with a bad case of the early morning simples and is, as Grandma used to say, a mere boondoggle.

The Best of Don Williams, Volume II
Big 3 Music, 16 songs, \$5.95

This lachrymose collection of Nashville is so understated that the artist himself is almost invisible. Certainly this is a bizarre reversal of sales psychology. Don Williams is given proper credit as the writer of *I'll Forgive but I'll Never Forget* and *I Don't Want the Money*, and as cowriter with Wayland Holyfield of *Till the Rivers All Run Dry*. But publishing a top-flight recording artist's song folio without photos, biography, or cover portrait is more characteristic of the KBG than the Big 3. I never did see the first volume; perhaps it was completely invisible.

It's Like **MAGIC!**

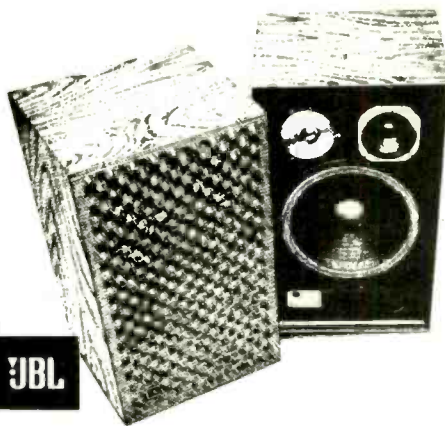

\$238 ea.

JBL 166

Accurate reproduction for the audio enthusiast

TOLL FREE 800-356-9514

Weekdays 9-9
Saturdays 9-5

Over 100 Brands Discounted

- Technics
- Pioneer
- Marantz
- Kenwood
- Sansui
- Jensen
- Maxell
- Empire
- Altec
- Sharp
- Phillips
- Shure
- Sony
- Teac
- Akai
- Dual
- Koss
- TDK
- Cerwin
- Vega
- JBL
- Audio
- Technica
- Clarion
- Nikon
- Canon
- Minolta
- Pentax
- Vivitar
- Yashica



WISCONSIN DISCOUNT STEREO
2517 Whalen Ln. madison, wi. 53713

Circle 69 on Page 115

STATEMENT OF OWNERSHIP, MANAGEMENT, AND CIRCULATION (Act of August 12, 1970: Section 3685, Title 39, United States Code)

1. Title of Publication: High Fidelity
2. Date of Filing: September 17, 1979
3. Frequency of Issue: Monthly
- 3A. No. of Issues Published Annually: 12
- 3B. Annual Subscription Price: \$11.95
4. Location of Known Office of Publication: 825 Seventh Ave., New York, New York County, N.Y. 10019
5. Location of the Headquarters or General Business Offices of the Publishers: State Road, Great Barrington, Berkshire County, Mass. 01230
6. Names and Addresses of Publisher, Editor, and Managing Editor:
 Publisher: Warren B. Syer, The Publishing House, State Road, Great Barrington, Mass. 01230
 Editor: Leonard Marcus, The Publishing House, State Road, Great Barrington, Mass. 01230
 Managing Editor: Wayne Armentrout, The Publishing House, State Road, Great Barrington, Mass. 01230
7. Owner: ABC Leisure Magazines, Inc., The Publishing House, State Road, Great Barrington, Mass. 01230. (Sole stockholder: American Broadcasting Companies, Inc., 1330 Avenue of the Americas, New York, N.Y. 10019)
8. Known Bondholders, Mortgagees, and Other Security Holders Owning or Holding 1 Per Cent or More of Total Amount of Bonds, Mortgages, or Other Securities: None
9. For Completion by Nonprofit Organizations Authorized to Mail at Special Rates: Not Applicable

10. Extent and Nature of Circulation	Average No. Copies Each Issue During Preceding 12 Months	Actual No. of Copies of Single Issue Published Nearest to Filing Date
A. Total No. Copies Printed (Net Press Run)	402,483	428,778
B. Paid Circulation:		
1. Sales through Dealers and Carriers, Street Vendors and Counter Sales	34,833	43,257
2. Mail Subscriptions	310,012	308,125
C. Total Paid Circulation	344,844	351,382
D. Free Distribution by Mail, Carrier or Other Means:		
1. Samples, Complimentary, and Other Free Copies	3,066	2,070
E. Total Distribution (Sum of C and D)	347,910	353,452
F. Copies Not Distributed:		
1. Office use, Left-over, Unaccounted, Spoiled After Printing	6,195	2,855
2. Returns from News Agents	48,378	72,471
G. TOTAL (Sum of E, F 1 and 2—Should equal net press run shown in A)	402,483	428,788

11. I certify that the statements made by me above are correct and complete. (Signed) Warren B. Syer, Publisher

12. For Completion by Publishers Mailing at the Regular Rates: (Section 112.121, Postal Service Manual)
 39 U.S.C. 3626 provides in pertinent part: "No person who would have been entitled to mail matter under former section 4359 of this title shall mail such matter at the rates provided under this subsection unless he files annually with the Postal Service a written request for permission to mail matter at such rates."
 In accordance with the provisions of this statute, I hereby request permission to mail the publication named in Item 1 at the phased postage rates presently authorized by 39 U.S.C. 3626.
 (Signature and title of publisher)
 (Signed) Warren B. Syer, Publisher

DON'T CALL

unless you want the best professional advice on your next home, car and boat stereo purchase.

- Wide variety of brands available, representatives of finest components.
- Factory sealed cartons with full manufacturers warranty.
- Fast shipments, fully insured.
- Expert advice on all stereo purchases.
- AND our prices are most competitive.

Our trained staff will help you select the right stereo products for your needs and budget. It's worth the call.

CALL 1-800-TOLL FREE 638-5260

AUDIO SUPERMART
A Division of Stereo Super Sound

(301) 267-9001
304 Legion Avenue
Annapolis, Maryland 21401

Circle 75 on Page 115

47st. photo VIDEO SPECTACULAR

COMPLETE PANASONIC VIDEO PORTABLE KIT
Recorder, Camera Tripod,
8 Hours of Tapes, maintenance kit,
Cables only \$1895.00

VIDBELT PORTABLE POWER SYSTEM
Includes rechargeable power belt, charger,
portable light & car adapteronly \$239.00

VIDEO TAPE RIOT!!!
VHS UP TO "6" HR.\$14.95
TDK UP "6" HR.\$16.50
BETA UP TO 4 1/2 HR.\$16.75
Call or Write us for all your Video Needs

PIONEER		
SX-580	153.50	CTF-500 137.29
SX-680	186.50	CTF-700 248.00
SX-780	218.00	CTF-800 287.25
SX-880	287.25	CTF-900 333.50
SX-980	346.25	CTF-1000 473.00
SX-1080	455.75	Complete selection of NAME BRAND CAR STEREO'S & SPEAKERS AT HUGE DISCOUNTS.
SX-1280	553.75	
SX-1980	701.50	

CASSETTE TAPE SPECIALS
TDK SAC-60 2.15
TDK SA C-90 2.69
Maxell UDXL 1C-60 2.50
Maxell UDXL1 C-90 3.45
Maxell UDXL2 C-60 2.50
Maxell UDXL2 C-90 3.45

47st. photo inc. 67 West 47th St
New York, N.Y. 10036 212-260-4410 ext. 73
Phone orders only Call Toll Free
800-223-5661 or 800-221-5858 Ext. 73
Shipping add'l, minimum \$4.50 [limited quantities]

Circle 23 on Page 115

148 BACKBEAT



Continued from page 145

accompanists—Gerald Wiggins on piano, Major Holley on bass, Ed Thigpen on drums—are supplemented by Gerard Badini, a French tenor saxophonist who might have come out of the halcyon days of Kansas City.

The Widespread Depression Orchestra: Downtown Uproar
Bernard Brightman & Frank Driggs, producers
Stash ST 203 (Stash Records, P.O. Box 390, Brooklyn, N.Y. 11215)

There have been, over the past twenty years, innumerable groups that have played the arrangements of the Glenn Miller, Tommy Dorsey, and Benny Goodman bands. And from the official representative of the Miller estate to semi-professional bands such as the Sentimental Seventeen (which borrowed from the Swing era), their purpose has been to reproduce the original charts as accurately as possible. But the Widespread Depression Orchestra's approach to the Big Band era is different.

Founded in 1972 as a seven-piece rhythm and blues group, WDO has grown to a nine-member ensemble that concentrates on the work of the black big bands—Ellington, Basie, Lunceford, Hines, Calloway—as well as such parallel small groups as Louis Jordan's Tympany Five and Coleman Hawkins' combos. But the musicians do not simply copy their models. Rather, they have enough individuality to create within the playing styles and material of their sources. When WDO plays *Downtown Uproar*—a piece originally recorded by a small Ellington group led by Cootie Williams—it catches the ensemble drive and excitement that made Cootie's version memorable. But Jordan Sandke's trumpet expands on Cootie's role and doesn't try to sound like him, and alto saxist Michael Hashim brilliantly leads some ensemble passages with a full-throated gutsy quality that is his very own.

Because of sidemen such as Sandke and Hashim, the performances are alive and immediate, filled with colors that come as much from the contemporary musicians as from the original sources. In vibes player/singer Jon Holtzman, too, WDO has a strong, distinctive personality who can sing Calloway (*Topsy*) or Jordan (*Choo Choo Boogie*) on his own terms while generating some suggestion of his models. This disc is the most vital revival of the Big Band era that has come along yet. J.S.W.

ADVERTISING INDEX

For free product literature, use the reader service card on page 115.

Key No.		Page No.
1	ADC Professional Products, a div. of BSR Consumer Products Group	46
2	ADC Professional Products, a div. of BSR Consumer Products Group	107
	ADS, Analog & Digital Systems, Inc.	96
	Akai America Ltd.	49
3	Angel Records	87
75	Audio Supermarket	148
	Audio Technica U.S. Inc.	76
4	Audiotex	24
5	Audiovox Corp.	97
8	BIC/Avnet	77
	Bose Corp.	Cover III
76	Braun	112
9	BSR (USA) Ltd.	99
	Buying Guide to Speaker Systems	134
10	Celestion International	76
	Christmas Shopping Guide	139-141
	Classified Ads.	143-145
11	Crystal Clear Records	120
71	Dak Enterprises	31
12	DBX, Inc.	4
13	Discount Music Club	108
14	Discwasher, Inc.	50
15	Discwasher, Inc.	119
16	District Sound	108
	Dual	74
74	Dynaco, Inc.	109
17	Electro-Voice, Inc.	51
18	Empire Scientific Corp.	16
19	Empire Scientific Corp.	32
20	Empire Scientific Corp.	88
21	Empire Scientific Corp.	54
22	ESS, Inc.	89
	Fisher Corp.	8, 9
23	47th Street Photo	148
24	Fujitsu Ten Corp.	105
72	Garrard	92
4	G C Electronics	24
25	Gothic Records	106
26	Hi-Fi Buys	133
27	Hitachi Sales Corp.	40
28	Icelandic Airlines	118
29	Illinois Audio	104
30	International Hi-Fi	138
31	Jensen Sound Laboratories	131
32	J & R Music World	100
33	JVC America, Inc.	26, 27
34	KEF Electronics	93
	Kenwood	Cover IV
35	KLH Research & Development	39
36	Klipsch & Associates	117
37	Magnetic Tape Warehouse	102
38	Maxell Corp.	23
39	Maxell Corp.	98
40	McIntosh Laboratory	22
41	Memorex Corp.	35
42	Mitsubishi Audio Systems	52, 53
43	Mobile Fidelity Records	129
44	MXR Innovations	113
	Nakamichi U.S.A. Corp.	81
77	National Record Plan	128
	Nikko Audio	20
46	Onkyo	45
47	Park Row Electronics	133
48	Phase Linear	103
49	Phase Research	21
50	Pickering & Co.	2
51	Pioneer High Fidelity	Cover II, 1
	Radio Shack	55
73	RTR Industries Inc.	101
52	SAE Inc.	78
53	Sansui Electronics Corp.	82
54	Scott, H.H., Inc.	24
55	Shure Brothers, Inc.	94
56	Shure Brothers, Inc.	95
57	Sony Corp.	25
58	Sony Corp.	28
59	Sony Industries	6, 7
60	Sony Industries	137
61	Sound Guard	15
16	Sound Reproduction	108
	Speakerlab	138
62	Stereo Corp.	146
	Stereo Discounters	137
63	Studer Revox America Inc.	91
64	TDK Electronics	11
65	Teac Corp.	12, 13
66	Technics by Panasonic	5
67	Technics by Panasonic	36
	3M Co.	92
	Time Life Records	17-19
68	Top Discount Audio	146
	United Audio Products	74
18	Watts	16
69	Wisconsin Discount Stereo	147
	Yamaha Audio	111
70	Zenith Radio Corp.	85

The Bose® 901® – past, present, future.

Past The first Bose 901 Direct/Reflecting® speaker was introduced in 1968. It was the result of research started twelve years before at M.I.T. under the direction of Dr. Bose. This speaker introduced the fundamental advances of a balance of reflected and direct sound, nine matched, full-range speakers, active equalization and uniform power response — all very controversial concepts at the time. But the performance produced by this new technology soon earned for the 901 speaker its international reputation as the most highly reviewed loudspeaker regardless of size or price.

Present The founders of Bose, all from the field of science, decided that Bose would reinvest 100% of its profits back into the company to maintain the research that was responsible for the birth of the 901 loudspeaker. The unprecedented success of the Bose® 901® in world markets, coupled with this 100% reinvestment policy, has created what we believe is by far the best research team in the industry. This team has made over 300 design improvements in the 901 speaker since its introduction — including such basic developments as the Acoustic Matrix™ Enclosure (illustrated), the helical, low impedance voice coil and the advanced full-range precision drivers. And the new concept of controlling the spatial properties of the 901 speaker has just been introduced via the unique Bose Spatial Control™ Receiver.

Future At Bose we have decided that "901" will continue to be the designation of the product that represents the state-of-the-art of our technology — whatever size, shape or form that product may take. In our research we continue to look at any and all technologies and product concepts that might hold possibilities for better sound reproduction. Consistent with the past, we will introduce new technology into the 901 speaker as it is developed — often without announcement. This is our dedication to the goal that whenever you invest in the Bose® 901® system you will receive the latest technology and the best in music reproduction.

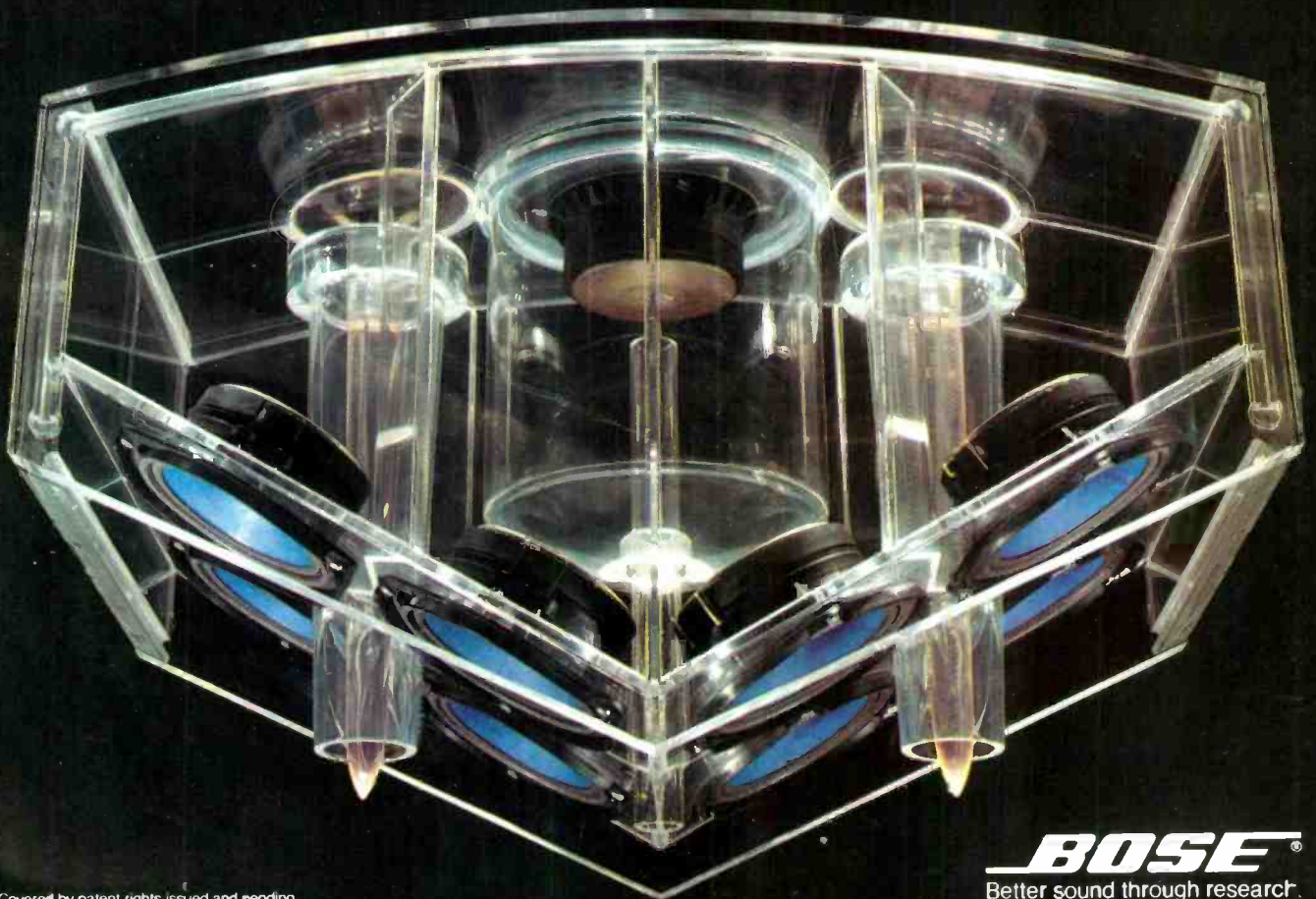

Covered by patent rights issued and pending.

BOSE®
Better sound through research.

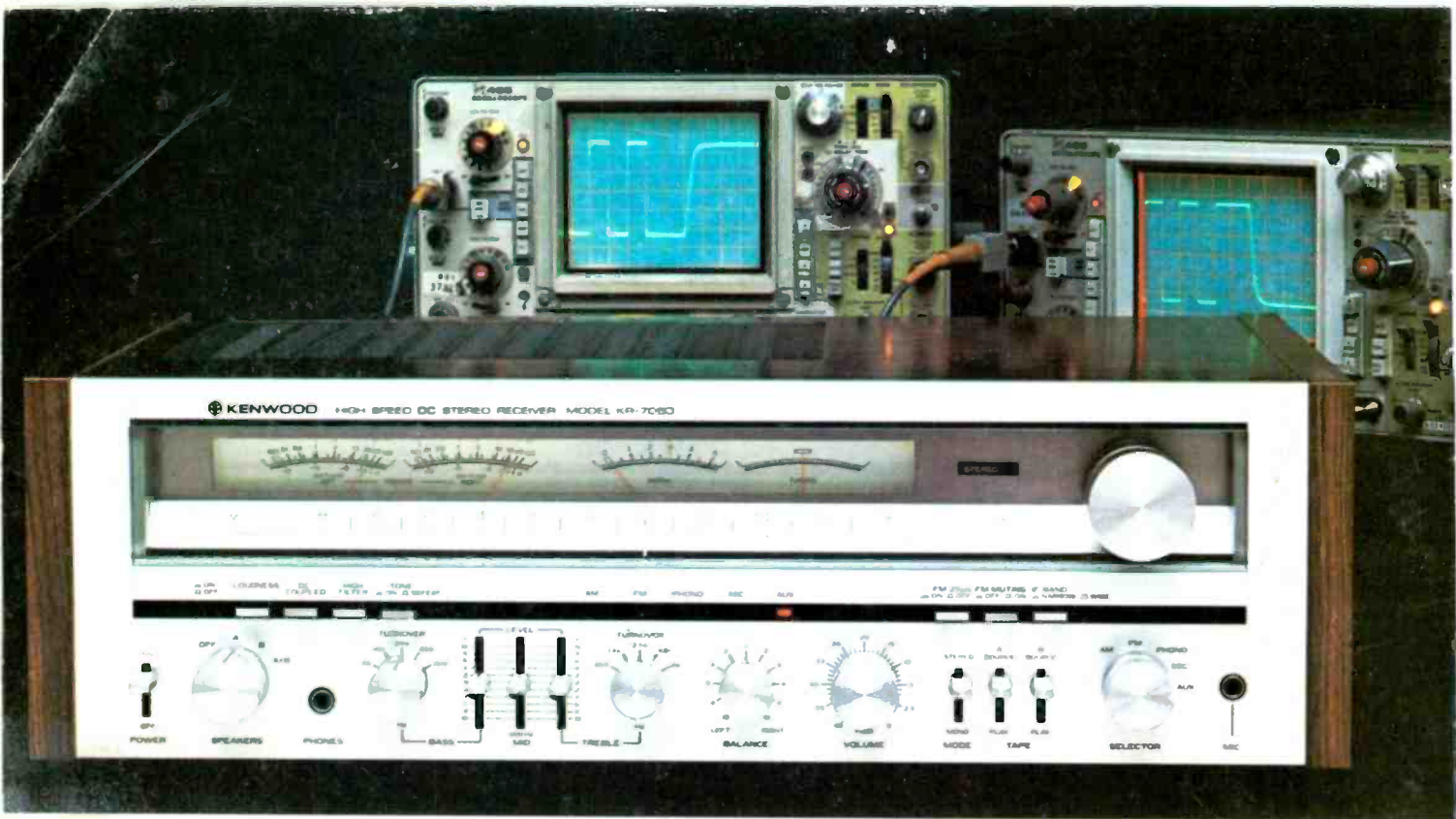

INDEPENDENT TEST REPORT: KENWOOD HAS BETTER TRANSIENT RESPONSE THAN PIONEER, TECHNICS OR YAMAHA.

Recently, we asked an independent testing laboratory to measure Kenwood's new Hi-Speed™ receiver against the competition. Each one "off the shelf" in unbroken factory cartons.

The results were impressive, if not surprising.

The Kenwood receiver outperformed comparable models of other brands in both rise time and slew rate, the same new specifications that are used to

RISE TIME (5 MICROSECOND CLOCK)

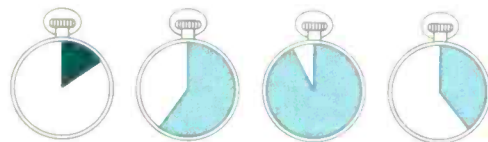

KENWOOD
KR-7050
.85 μ S

PIONEER
SX-980
3.0 μ S

TECHNICS
SA-700
4.60 μ S

YAMAHA
CR-1040
2.00 μ S

measure a receiver's ability to handle complex musical signals.

Of course, the Kenwood receiver had one unfair advantage: Kenwood's exclusive Hi-Speed circuitry. Hi-Speed allows an amplifier section to react faster to changes in music to minimize audible transient intermodulation distortion.

In the laboratory, this shows up as superb specs and an almost perfect square wave on an oscilloscope.

In your home, you'll hear superior clarity and definition with excellent imaging. For example, you'll be able to identify an individual singer in a vocal group.

SLEW RATE MEASUREMENT RESULTS

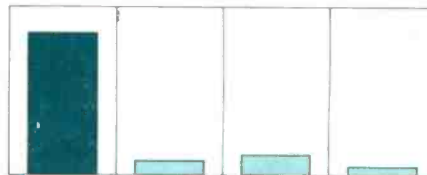

KENWOOD
KR-7050
200 V/ μ S

PIONEER
SX-980
20 V/ μ S

TECHNICS
SA-700
29.4 V/ μ S

YAMAHA
CR-1040
10.7 V/ μ S

Your Kenwood dealer can show you the entire line of Hi-Speed receivers.

Because if you're going to buy a receiver, why not go with the best performer?

HI-SPEED™

Hear the future of high fidelity

KENWOOD®

For the Kenwood dealer nearest you, see your Yellow Pages, or write Kenwood, P.O. Box 6213, Carson, CA 90749.

In Canada: Magnasonic Canada, Ltd. / Test data available upon request. Rise time and slew rate measured by slope at zero crossing method.