

IN **Backbeat**

- WILD CHERRY • CBS'S MARKETING MUSCLE

HIGH FIDELITY

MARCH 1977 \$1.00

ICD ® 08396

Ten Lab/Listening Reports

- Advent 300 Receiver
- Dual CS-704 Turntable
- Stax SR-44 Earspeaker System
- Dynaco Stereo 300/A Power Amplifier
- Micro Seiki DDX-1000 Turntable
- Paradox TA-12 Time Align Speaker
- Realistic STA-2000 Receiver
- Yamaha C-2 Preamplifier
- Beomaster 1900 Receiver
- Stereopillow

**Boston:
America's Audio
Capital?**

HF BCH5 D079 OCT 77 1 03
MR DAVID S BUCHANAN
HAZEL GREEN ACAD
HAZEL GREEN KY

41332



Pioneer HPM-200
5-way 5-driver system

Pioneer HPM-100
4-way 4-driver system

Pioneer HPM-60
4-way 4-driver system

Pioneer HPM-40
3-way 3-driver system

 **PIONEER**
Anyone can hear the difference.

CIRCLE 29 ON READER-SERVICE CARD

The HPM series.

Four radically new speaker systems specifically designed to beat the best.

You can't beat JBL, Advent, Bose and AR with me-too ideas. They're really good speakers.

So, instead of just trying to make better conventional speakers, we knew we had to come up with a totally different and superior design concept.

After years of research and development, our engineers found the answer. They created a whole new technology based on the electrical properties of High Polymer Molecular film. The result is a sound that's louder, clearer, more natural, lower in distortion than you ever expected to hear out of a speaker system.

HPM film technology requires no magnet, no coil, no cone or dome, no moving parts at all. The amplified signal is converted into sound waves directly at the surface of a thin, light membrane. And the entire structure housing the membrane can be curved for the best possible sound dispersion.

Pioneer's new HPM drivers combine high efficiency with amazingly accurate transient response. Distortion is virtually nonexistent even at very high sound-pressure levels. The principle was evolved mainly for tweeters, although a giant HPM woofer is at least a theoretical possibility.

In each of the new Pioneer models shown here, regardless

of price, the top end of the audio spectrum is reproduced by an HPM driver. In the big HPM-200 system, so is the upper midrange.

The woofers used in the HPM series are almost as unconventional, even though they still have cones. But what cones! They combine low mass and high rigidity to an unprecedented degree, thanks to an exclusive method of reinforcement with carbon fibers. As a result, they move as true pistons, without any of the smearing of bass frequencies experienced with ordinary cones.

Of course, the proof of a new speaker technology isn't in the telling but in the listening.

If the new HPM speakers didn't have audibly more impact, more detail, more transparency than the best previous speakers at comparable prices, our engineering effort would have been a meaningless exercise. There are certainly enough speakers on the market today.

So we invite you to listen and compare very carefully. Match the HPM in the price range of your choice against the corresponding speaker on the far right, or anything else in your dealer's showroom.

We think you'll end up agreeing that a good new idea beats a good old idea every time.

U.S. Pioneer Electronics Corp.,
75 Oxford Drive, Moonachie,
New Jersey 07074.

**It would be foolish to create
a new line of speakers
and not overcome these obstacles...**

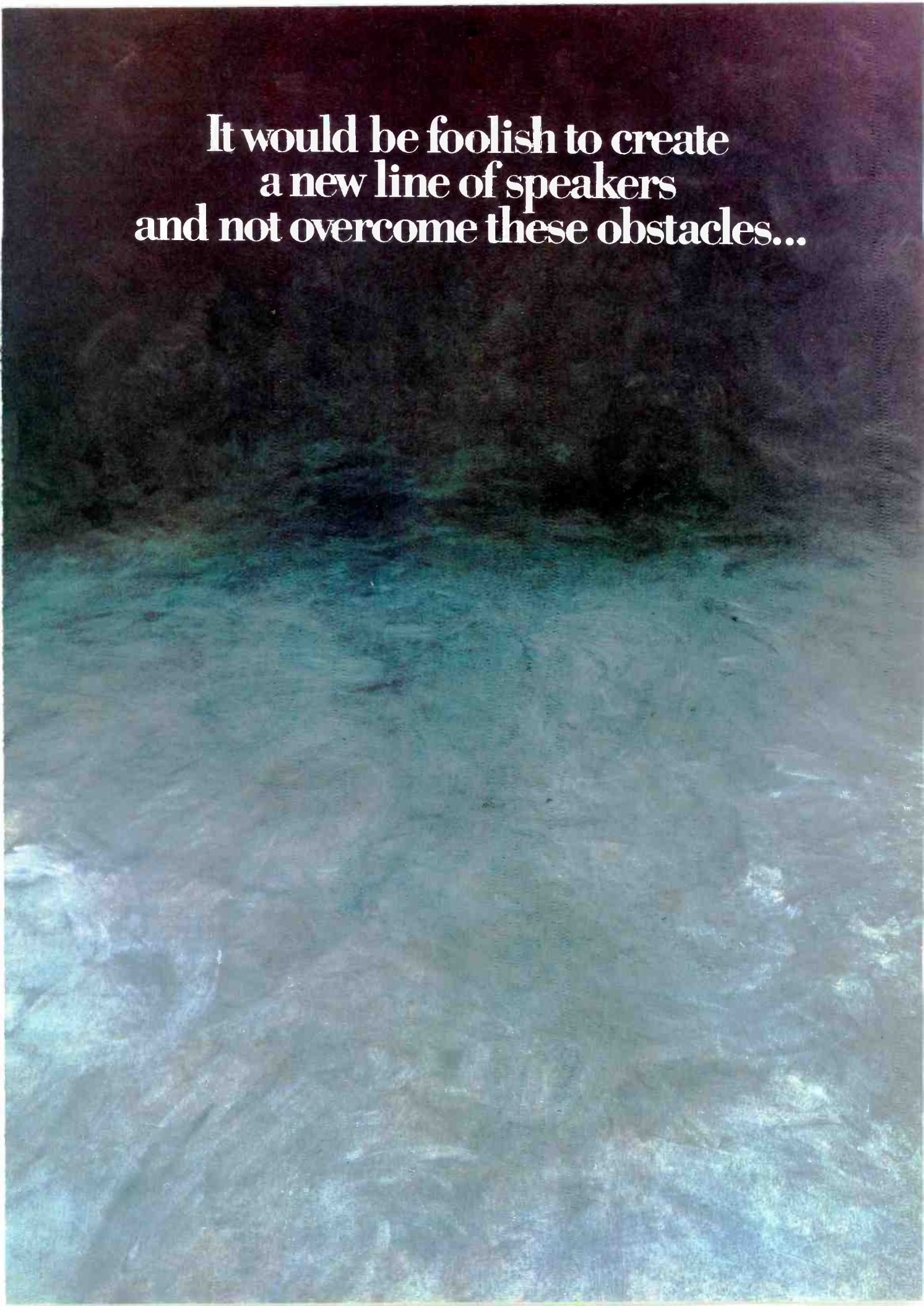

JBL Horizon LI66

Acoustic Research AR-1ST

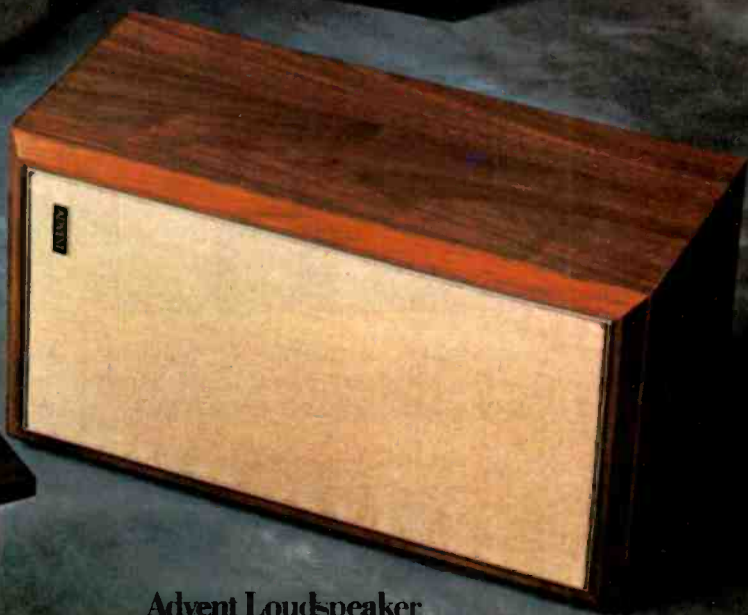

Advent Loudspeaker



Bose 901 Series II

WKLS, Atlanta, broadcasts 100% disc-to-air. That's why it uses Stanton's 681 series... exclusively.



Bob Helbush, Chief Engineer, making a quality control check using a 681 cartridge.

Top notch broadcasters who capture a large share of the listening audience, are critically aware of the necessity to achieve a superior quality of sound. Station WKLS is just such a station.

As Bob Helbush, chief engineer, states: "We broadcast 100% disc-to-air except for some commercials. So, for maximum quality sound and phase stability, we use the Stanton 681 SE for on-the-air use. We consider it the ideal answer for that application. And our program director uses Stanton's 681 Triple-E for auditioning new releases before we air them".

And Don Waterman, General Manager, added: "Today, every station in the SJR Communications group . . . all eight of them, all in Major Markets . . . use Stanton 681 cartridges on every turntable".

There are good reasons for this vast acceptance. Stanton's 681 Calibration Series cartridges offer improved track-

ing at *all* frequencies. They achieve perfectly flat frequency response to beyond 20 Kc. And the top-of-the-line, superb 681 Triple-E has an ultra miniaturized stylus assembly with substantially less mass than previously, yet it possesses even greater durability than had been thought possible to achieve.

Each 681 Series cartridge is guaranteed to meet its specifications within exacting limits and each one boasts the most meaningful warranty. An individually calibrated test result is packed with each unit.

Whether your usage involves recording, broadcasting or home entertainment, your choice should be the choice of the professionals . . . the STANTON 681.

Write today for further information to Stanton Magnetics, Terminal Drive, Plainview, N.Y. 11803.



CIRCLE 42 ON READER-SERVICE CARD

HIGH FIDELITY

MARCH 1977 VOLUME 27, NUMBER 3

MUSIC AND MUSICIANS

- 4 High Fidelity Weds Schwann *Leonard Marcus*
- 17 Lump in the Throat *John Culshaw*
- 22 Music U.S.A.: 2. At a Nation's Heart *Gene Lees*
- 72 The Great Mozart-Beethoven Caper *Paul Moor*
- 84 Behind the Scenes
- 87 Reopening the Meyerbeer Case *Patrick J. Smith*
- 89 Of Fiddles and Fiddlers *Irving Lowens/Shirley Fleming*
- 91 Wagner's Roman Colossus *David Hamilton*
- 125 The Black & White of Wild Cherry *Bruno Bornino*

EQUIPMENT AND INSTRUMENTS

- 30 Too Hot to Handle
- 33 News and Views
- 36 Equipment in the News
- 51 Equipment Reports
 - Micro Seiki DDX-1000 turntable
 - Advent 300 receiver
 - Stax SR-44 Earspeaker System
 - Yamaha C-2 preamp/control center
 - Paradox TA-12 loudspeaker system
 - Realistic STA-2000 receiver
 - Dual CS-704 turntable
 - Dynaco Stereo 300/A amplifier
 - Stereopillow
 - Beomaster 1900 receiver

- 79 Boston: Audio Hub City? *Michael Riggs*
- 127 Studio Circuit: Star Tracks *Fred Miller*
- 131 CBS's Marketplace Muscle *Bob Ford Jr.*
- 135 Instruments and Accessories

REVIEWS

- 87 Essays
 - Le Prophète* Fiddles and fiddlers *Rienzi*
- 95 Classical Records
 - Seon's U.S. debut Levine's Mahler Third
- 96 Critics' Choice
- 123 The Tape Deck *R. D. Darrell*
- 138 Backbeat Records
 - Joni Mitchell George Harrison Cliff Smalls
- 148 Books
 - Rolling Stone's* rock history *Jazz Encyclopedia*

ET CETERA

- 6 Letters
- 70 HiFi-Croctic *William Petersen*
- 118 Advertising Index
- 119 Reader-Service Cards

BACKBEAT begins on page 125



High Fidelity is published monthly by ABC Leisure Magazines, Inc., The Publishing House, Great Barrington, Mass. 01230, a subsidiary of American Broadcasting Companies, Inc. Copyright © 1977 by ABC Leisure Magazines, Inc. The design and contents are fully protected by copyright and must not be reproduced in any manner. Second-class postage paid at New York, New York, and at additional mailing offices. Authorized as second-class mail by the Post Office Department, Ottawa, and for payment of postage in cash. Yearly subscription in U.S.A., Possessions, and Canada \$7.95; in Pan-American Union \$8.95; elsewhere \$9.95. Single copies \$1.00. Subscribers: Send subscriptions, inquiries, and address changes to High Fidelity, 1 Sound Ave., Marion, Ohio 43302. Change of address: Give old and new addresses, including ZIP code. Enclose address label from last issue and allow five weeks for change to become effective. Postmaster: Send Form 3579 to High Fidelity, 1 Sound Ave., Marion, Ohio 43302.

**HIGH
FIDELITY**

Weds

Schwann

There are no children yet, of course, but it gives me great pleasure to announce the marriage of the SCHWANN RECORD & TAPE GUIDES to HIGH FIDELITY, the consummation of which is here signaled by our first use of caps and small caps instead of italics to print their titles. Just before Christmas our parent corporation, American Broadcasting Companies, Inc., bought the company founded by William Schwann to publish his record catalogs—and for propriety's sake I think I should drop the metaphor right now. Bill will continue to head up the SCHWANNs under a long-playing contract, and his offices will remain in Boston.

The two publishing ventures—ours a critical review of records, SCHWANN's a catalog of them—make a most natural and happy combination, and we are all pleased that from the dozen and a half offers that Bill Schwann received over the past few years to purchase his organization he chose us as the "most compatible." The recent discussions we have had with him and his staff indicate that the pooling of knowledge and ideas will result in benefits to us both. For instance, SCHWANN lists new releases that may not be reviewed in HIGH FIDELITY; we review recordings that they may not list. But if the statement of fact is simple, the solutions are not.

There are several SCHWANNs, although SCHWANN-1 is the best known and most widely used. It lists the new releases each month, classical recordings available in stereo, and pop recordings up to two years old. On most occasions it is the record-buyer's bible.

SCHWANN-2, which comes out twice a year, takes over the listing of any pop records that are still available after two years. It is also the repository for mono recordings whether "electronically processed for stereo" or not, international pop and folk, spoken word, gospel, and a miscellany of everything from birdcalls to frequency test records. SCHWANN'S CHILDREN'S CATALOG and BASIC RECORD LIBRARY describe themselves by their titles.

Finally there is the SCHWANN ARTIST ISSUE, about which I wrote last June. In that editorial I carped that this invaluable record guide, listed by performer, had to wait six years for its most recent publication. From now on, I suppose, any carping will be via interoffice memo—at least before a public editorial—although I may as well tell you that we do not plan to wait that long in the future.

Carping may come from the other direction too, as in any family—and in fact already has. Orthographists may note that we are spelling "catalog" two letters shorter than previously. (It turns out that the Merriam-Webster folk have switched their preference to SCHWANN's spelling too.)

Okay. Bill? Now about Odeon—

Leonard Marcus

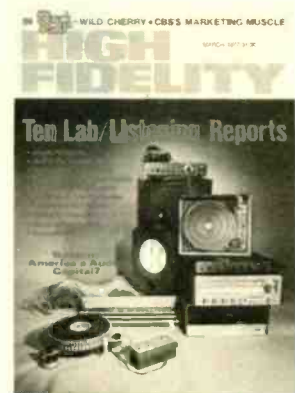

Cover photo:
Roy Lindstrom

LEONARD MARCUS
Editor

ROBERT S. CLARK
Executive Editor

KENNETH FURIE
Music Editor

ROBERT LONG
Audio-Video Editor

HAROLD A. RODGERS
Associate Audio-Video Editor

SHIRLEY FLEMING
Editor, Musical America

SUSAN ELLIOTT
Editor, Backbeat

WAYNE ARMENTROUT
Director of Production

REBECCA ABBOTT
Copy Editor

LYNDA CARLOTTA
CYNTHIA PEASE
Assistant Editors

GAIL KOOKOOLIS
Editorial Assistant

ROY LINDSTROM
Graphics Director

EDWARD GREENFIELD
European Editor

ROYAL S. BROWN
JOHN CULSHAW
R. D. DARRELL
NORMAN EISENBERG
ALFRED FRANKENSTEIN
HARRIS GOLDSMITH
DAVID HAMILTON
DALE HARRIS
PAUL HENRY LANG
GENE LEES
IRVING LOWENS
ROBERT C. MARSH
H. C. ROBBINS LONDON
Contributing Editors

MILTON GORBULEW
Senior Circulation Director

DAVID LEE
Circulation Manager

WARREN B. SYER
Publisher

**People who've
bought them
love them.
People who
sell them
love them.
Critics love them.
You could be next.**



There's a lot to love here. Five turntables with low speed (300 rpm) motor, program system, superior tone arm. Performance that ranks with the best single play units. Yet multiple-play capability when and if you need same. For details pick up our "bee eye cee" 5 Turntables folder at high-fidelity dealers or write to British Industries Co., Dept. PE, Westbury, N.Y. 11590.

5 Turntables B I C™

Model 920 about \$79 - 940 about \$109 - 960 about \$159 - 980 about \$199 - 1000 about \$279. ©1976 British Industries Co. A Division of Avnet Inc.

CIRCLE 5 ON READER-SERVICE CARD

COMING NEXT MONTH

In April, Edward J. Foster offers the nontechnical reader the background for **Interpreting Record-Playing Equipment Tests**. The article is accompanied by a **Buyer's Guide to Turntables, Cartridges, and Tone Arms** listing more than 200 models. Roy McMullen takes us inside **Pierre Boulez' IRCAM**, the institute for contemporary musical research and pedagogy opening in Paris this year, and **Rosa Ponselle Reminisces** on her singing career with author James A. Drake. "100 Years of Recording," Jim Jonson's series of four color acrylic paintings depicting the history of recording will continue with **The Acoustic Era**. Plus test reports, columns, record reviews, **BACKBEAT**.

SOLUTION TO HIFI-CROSTIC NO. 21

NORMAN DEL MAR:

Richard Strauss: A Critical Commentary on His Life and Works, Vol. 2

With two undoubted and three near masterpieces to its credit, it seems petty to disparage the relationship Strauss maintained with Hofmannsthal. Nevertheless the collaboration did harm to Strauss, who lost his pre-eminence in the avant-garde of contemporary composition.

ADVERTISING

Main Office: Ramon Rustia, Director of Advertising Sales, Leonard Levine, Advertising Promotion Manager, The Publishing House, Great Barrington, Mass. 01230. Telephone: 413-528-1300.

New York: ABC Leisure Magazines, Inc., 130 E. 59th St., 15th floor, New York, N.Y. 10022. Telephone: 212-826-8381. Seymour Resnick, National Advertising Manager.

New England: The Publishing House, Great Barrington, Mass. 01230. Telephone: 413-528-1300. G. F. Jerry Harris.

Midwest: ABC Leisure Magazines, Inc., The Publishing House, Great Barrington, Mass. 01230. Telephone: 413-528-1300. Leonard Levine, Midwest Advertising Manager.

Los Angeles: ABC Leisure Magazines, Inc., ABC Entertainment Center, 2040 Avenue of the Stars, Suite 270, Century City, Calif. 90067. Telephone: 213-553-5648. Andrew Spanberger, Western Advertising Manager.

Tokyo: Japan Advertising Communications, Inc., New Ginza Bldg., 7-3-13 Ginza, Chuo-ku, Tokyo 104, Japan. Telephone: (03) 571-8748, Shigeru Kobayashi, President.

High Fidelity and **High Fidelity/Musical America** are published monthly by ABC Leisure Magazines, Inc., a subsidiary of American Broadcasting Companies, Inc., Warren B. Syer, President, Herbert Keppeler, Vice President, Photographic Publishing Division, Warren Tuohy, Vice President, Finance, Cathleen Altosi, Assistant to the President, Member Audit Bureau of Circulation. Indexed in Reader's Guide to Periodical Literature. Current and back copies of **High Fidelity** and **High Fidelity/Musical America** are available on microfilm from University Microfilms, Ann Arbor, Mich. 48106. Microfiche copies of these magazines (1973 forward) are available through Bell & Howell Micro Photo Division, Old Mansfield Road, Wooster, O. 44691.

Editorial correspondence should be addressed to The Editor, **High Fidelity**, Great Barrington, Mass. 01230. Editorial contributions will be welcomed, and payment for articles accepted will be arranged prior to publication. Unsolicited manuscripts should be accompanied by return postage.



Letters

Record Piracy

I read Robert Angus' article on record pirates [December], with great interest, primarily because he managed to shed a little light on how and where Eli Oberstein made at least some of the records he was issuing on his Hit label during the Petrillo ban. Discographers had advanced all kinds of theories to explain this; chief among them were that he had recorded outside the country—in Canada or Mexico—or that he used talented nonunion amateurs.

The company apparently never issued any catalogs; at least, I've never heard of any. Several discographers (myself included) have tried to assemble such a catalog, but now that we've listed our own holdings, we are at a dead end. If any reader of this publication has large holdings of Varsity, Royale, Elite, or Hit records, I'd appreciate his getting in touch with me to advance the cause of discographic research.

George A. Blacker
48 Foote St.
Cheshire, Conn. 06410

I have just read the saucy and amusing article on record pirates, and how charming and lighthearted it is. What I miss from this informative and well-written entertainment is any recognition of the fact that record pirates are ruthlessly ripping off the men and women who write and publish music. At the risk of shocking a man as charming and sophisticated as Mr. Angus, there is an old-fashioned word for this: stealing. I disapprove of stealing from anyone, and I particularly disapprove of stealing from creators, no matter how great the desire for unavailable recordings of their creations.

I wonder how the author would feel if he had a painting on his wall and I went in and took it simply because no prints of this painting were available—or just because I wanted to take it to resell for a profit. I cannot accept stealing from a bookstore, a grocery, the collection plate of a church, Tiffany's, or the pocket of a composer. What are composers and lyricists supposed to pay their rent with?

By the way, I may want to go up to visit the Berkshires, where your offices are located, and since I do not have a car I am considering stealing one. After all, it would be more convenient than buying a bus ticket.

Walter Wager
Director of Public Relations, ASCAP
New York, N.Y.

Mr. Angus replies: As a member of ASCAP, I am very happy to have Mr. Wager and his associates looking out for my interests, and I can understand his point of view.

I did not mean to suggest in my article on music piracy that I necessarily approve of the practice. I did mean to suggest that there is more than one side to this argument and that, as a record collector, I have much to be grateful to the pirates for. There is a big difference, both morally and legally, between stealing an object like an automobile or a painting or money from a collection plate and reproducing or copying a work of art. When the work of art is readily available through normal channels to anyone who wishes to buy and a pirate makes copies for sale (as in the case of bootleg pop music tapes), the loss to the creator is real in dollars and cents. But when the work of art is not readily available (or may never have been available) commercially, the loss to the creator would seem much more difficult to demonstrate. This kind of piracy does not involve the removal of property from one person or place and its transfer to another. Nor in any of the cases I cited, I believe, was there an out-of-pocket loss to the composer.

In the case of out-of-print recordings, isn't it the owner of the rights who feels that it's not commercially worthwhile to reissue them who is affecting the earnings of the creator rather than the pirate who attempts an end run around the system? Until the pirate comes along, the former's decision is final, no matter how many collectors might want to purchase copies. The collector who supports all of this does so because, unlike Mr. Wager in the case of a trip to the Berkshires, he has no alternative. There is no bus available. Most collectors, I believe, would much rather deal with the legitimate authorities than with pirates. But when it comes to many collectors' items, the bus has long since ceased to run.

Choosing Components

"How I Choose a Component System" [December] has to be the worst and most misinforming drivel to appear in any audio magazine. I have no ill feeling toward **HIGH FIDELITY** magazine. What irks me is the pure garbage chosen as audio systems.

Mr. Berger seems to have some sense, generally, but opts for a PAT-4 rather than a modified PAS-3X, which will blow away a PAT-4 any day. Mr. Radford-Bennett has the most sense of all the experts except for his choice of the Genesis II speakers. Really!

Anyone who is still fooling around with four-channel systems is an utter idiot! Messrs. Myers and Marsh have piddled away vast amounts for equipment that is slurred (Bose 901 and Marantz 240), highly colored in the midrange (KR-9940 and SQD 2020), and total junk when compared to systems available in the \$3,000 price range.

Mr. Zwicker has been suckered into including an ambience simulator and an el-

You've got to be serious.

If you're interested in Phase Linear, you've got to be serious. Serious about music. Serious about enjoying the most realistic sound possible from a home stereo system. Serious about acquiring quality state-of-the-art components built to deliver a lifetime of top performance.

The three components featured here represent the very finest technical achievements of the Phase Linear Corporation:

The Phase Linear 5000 FM Tuner: An advanced tuner with a Dynamic Range Expander that restores FM broadcast signals to rival your records and tapes.

The Phase Linear 4000 Preamplifier: An incredibly sophisticated preamp and control center that actually compensates for limitations inherent in the recording and playback process through noise reduction and dynamic range expansion.

The Phase Linear 700B Power Amplifier: The most powerful, most dependable stereo amplifier you can buy, at any price.

Phase Linear manufactures a complete line of amplifiers and preamplifiers, a noise reduction unit, and a speaker system. Ask your dealer for an audition. If you're serious.

Phase Linear
The Powerful Difference

Manufactured in the USA Distributed in Canada by H. Roy Gray, LTD.

The feel of excellence.

UNTIL YOU'VE LISTENED TO ESS'S NEW HEIL AIR-MOTION TRANSFORMER SPEAKER SYSTEMS, YOU WON'T REALIZE HOW OBSOLETE YOUR CONVENTIONAL LOUDSPEAKER MAY BE.

YESTERDAY'S TECHNOLOGY

Your current loudspeaker, even a fine one, may be obsolete. Using yesterday's technology, technology developed over 50 years ago, it cannot hope to compete with today's developments. No one expects yesterday's electronics to compete with today's solid state electronics. Yet it is common to find well made speakers of 20 years ago that are just as good — sometimes better — than many loudspeakers on the market today. The reason is simple. High fidelity electronics have made tremendous advances; while loudspeaker technology has remained virtually unchanged in the last fifty years . . . Until Oskar Heil perfected, and ESS introduced, the revolutionary Heil Air-Motion Transformer.

THERE IS A BETTER WAY — THE HEIL AIR-MOTION TRANSFORMER

The Heil Air-Motion Transformer is not a mere improvement on *old* ways of reproducing sound; it is the discovery of a *better* way. As such, it bears the mark of genius. The result of four years research by Oskar Heil, the gifted molecular physicist and musician who invented the FET or field-effect transistor in 1934, long before it could be used; and the



Klystron tube widely used in color TV transmitters. It was his vision into the fundamental laws of physics that resulted in a speaker design free of the deficiencies and performance limitations of conventional drivers.

THE SECRET? TRANSFORMATION

The Heil Air-Motion Transformer, the first significant breakthrough in

speaker technology in 50 years, is equivalent in its impact on loudspeakers to the introduction of the jet engine in aviation. For the same reason. In conventional loudspeakers, in conventional airplanes, a heavy solid object had to be moved first — in the loudspeaker a cone, in the airplane a propeller. The jet and the Heil Air-Motion Transformer disregard these inefficient methods of moving air. *Air is moved directly.* The inherent advantage of this simplification was augmented by the fact that this revolutionary driver is a "transformer" as well as a "transducer." It not only *converts*

electrical energy into acoustic energy as do all transducers, it *increases or transforms* the energy five fold.

Unlike conventional speakers which *push* air only as fast as they move, on a one to one basis, the Heil Air-Motion Transformer *squeezes* air out 5 times faster than it itself moves to achieve *instant acceleration*. This fast "rise time" results in the crisp transients, remarkable clarity, high definition, astonishing dispersion and superb dynamic range achievable only by a Heil Air-Motion Transformer loudspeaker system.

LIGHT YEARS AHEAD OF THE INDUSTRY

Dr. Heil's efforts were realized in the Spring of 1973 when ESS introduced the amt 1, the first loudspeaker to incorporate the revolutionary Heil Air-Motion Transformer. The demand was unprecedented. More than 2,000 units were sold in the first ten days of its introduction. The first amt loudspeaker was not inexpensive. The suggested retail price was \$298.00 each, or about \$375.00 at 1977 prices. Nevertheless, 20,000 amt 1's were sold

in only 10 months, more loudspeakers at this price point than had ever been sold in the history of the high fidelity industry.

You have only to experience the airiness, dynamic range, low distortion, clarity and definition — in a word, the unparalleled performance of the Heil Air-Motion Transformer speaker system — to understand why.

SECOND GENERATION HEILS

As excellent as ESS's first generation speakers were, the second generation Heil Air-Motion Transformer speaker systems are even better. Not because of radical changes in the air-motion transformer (you can't make something that fine much better), but because we refined the transformer and vastly improved everything else. The systems boast superb woofers and crossovers, and the cabinets are themselves fine furniture. Finally, we made the cost of owning audio excellence affordable by introducing lower priced Air-Motion Transformer systems with such high efficiency that they can be driven by low-priced, modest powered electronics. Or if you want to let the chips fall where they may, they will handle tremendous power.

Is your present system obsolete? Audition the new ESS line at one of your neighboring quality audio centers and find out.

YOUR EARS WILL APPRECIATE THE DIFFERENCE.

(800) 447-4700

(In Illinois call 800-322-4400)

The logo for ESS, consisting of the letters 'ESS' in a bold, stylized, sans-serif font. The 'E' and 'S' are connected, and the 'S' has a distinctive shape with a curved bottom.

products are available in Canada through ESS CANADA.

9613 Oates Drive,
Sacramento, CA 95827



sound as clear as light

Performance. Scott Stacks Up.

Every serious listener knows that separate tuners and amplifiers offer greater system versatility and flexibility than the all-in-one receiver. But Scott separates stack up where it really counts—performance.

Every one of Scott's complete line of tuners and amplifiers is engineered and designed to give you all the performance features you expect, at a price no higher than many receivers currently on the market.

Scott's T 526 AM/FM Stereo Tuner and A 436 Integrated Power Amplifier provide such important performance features as front panel Dolby de-emphasis switching, a phase locked loop multiplex section and linear motion calibrated controls.

And that's only part of the story. Compare these important performance features with any other medium-priced tuner and amplifier on the market today.

The Scott T 526 Tuner

IHF sensitivity rated at $1.9 \mu\text{V}$, S/N ratio 68 dB and a capture ratio of 1.5 dB.

Signal strength and center channel tuning meters.

Four gang tuning capacitor for better image rejection.

AM section designed around a tuned RF amplifier using J-FET for improved signal-to-noise ratio.

AM noise suppression circuitry.

The Scott A 436 Amplifier

42 watts RMS per channel, driven into 8 ohms from 20 Hz to 20 kHz with no more than 0.3% THD.

True logarithmic meter amplifier obviates the need for range switching.

Individual channel power level meters calibrated in % of full power output capability eliminates confusing dB and VU readings.

Two completely independent tape monitors allow two tape recorders to be used simultaneously for direct tape-to-tape copying.

Instantaneous electronic protection circuit in the output stage.

IM distortion lower than 0.15% for a cleaner sound without listening fatigue.

High and Low filters, two auxiliary outlets and mic inputs.

And the Scott T 526 and A 436 come complete with professional rack-mount handles, and are backed by a three-year, parts and labor limited warranty.

For specifications on Scott's complete line of audio components, write or call H.H. Scott, Inc., 20 Commerce Way, Woburn, Mass. 01801. (617) 933-8800. In Canada: Paco Electronics, Ltd., Quebec, Canada. In Europe: Syma International S.A., 419 Avenue Louise, Brussels, Belgium.



 **SCOTT**
The Name to listen to.

Receivers/Tuners/Amplifiers/Turntables/Speakers

CIRCLE 34 ON READER-SERVICE CARD

cheapo Sony TC-377 reel deck. If all the funds spent on ho-hum equipment and frivolities were applied to a few carefully chosen pieces, the sound attainable at \$5,000 would be absolutely staggering.

Mr. Zide mentioned some very fine equipment—Mark Levinson, GAS, Revox, Lux—but has chosen in an asinine way. If you can't hear the difference between a DC-300A and Ampzilla, you're deafier than a doorknob! Also, the difference between "top-of-the-line models from any of the established manufacturers" is more than slight!

It appears that the so-called audio experts are choosing units that are more flexible, have lower distortion, or have snob appeal, rather than selecting equipment that most closely reproduces a live musical experience.

Thom Jakowczyk
Thom Jakowczyk Audio Systems
Alta Loma, Calif.

It was with great interest that I read the report on six experts' choices within three budgets. Having searched for some time for an ideal component system, I would like to suggest that there is a better system available at less cost than that of the systems suggested by your experts.

I have come to the conclusion that the best of today's highly developed receivers are on a par with separate components (preamp, amp, and tuner). Consequently, I purchased a Yamaha receiver, and I could not be more pleased.

I have heard most of the speakers your

experts named, but the best ones I have heard were not even mentioned. They were the large McIntosh and Yamaha 1000 speakers, either of which was easily superior, personal taste aside, to the Bose 901 Series II, the Allison One, and AR-11 systems. I purchased the Yamahas because the enclosure was, for me, better designed and better suited my needs.

I have a Dual 1229Q turntable with a Shure V-15 Type III cartridge and a Sony TC-377 open-reel deck, and for \$2,950 I have truly superb—nay, incredible—sound. It is difficult for me to believe that your experts' \$5,000 systems are audibly \$2,000 better, just as it is to believe that their \$3,000 systems are as good as this one.

David P. Robinson
New York, N.Y.

Obviously, some people have missed the main point of the article. The idea was to let you look over our experts' shoulders and see how they chose, not so much what they chose. Clearly some equipment had to be picked, but we considered that a secondary matter and still do.

Mr. Robinson's conclusions are undoubtedly based on some experience and probably work fine for him, but in audio equipment—and especially in loudspeakers—there is no such thing as "personal taste aside." Whatever the merits of Mr. Jakowczyk's arguments, as a dealer in audio equipment he can hardly claim to be nonpartisan. From where we sit, the basic difference is that our experts are being subjective and will admit it; Messrs. Robinson

and Jakowczyk are being equally subjective and will not admit it.

I must offer my congratulations on Harry Zwicker's decision to use an audio digital delay unit in his \$5,000 system. Since it is an amazing piece of digital technology, I was surprised that none of the other highly esteemed audiophiles who contributed to the article even considered such a device. I hope that audiophiles will recognize that an audio delay unit will soon become a necessity in any well-designed system.

Keith Warner
Cranston, R.I.

Flattery will get you nowhere, Mr. Warner; you missed the point of the article. The letter from Mr. Kranenburg that follows provides a useful corrective.

I read with interest "How I Choose a Component System." I am certain each one of us has at one time stood back, viewed and listened to our system, and wondered what other serious listeners would think of the setup.

As we know, it is impossible to logically conclude that there is but one ultimate high fidelity system that would appeal to every one of us. Nevertheless, it is personally rewarding to learn that there are others who tend to think and reason as we do where choosing a system is concerned.

John N. Kranenburg
Fair Lawn, N.J.

Hi-fi editors don't endorse anybody's speaker system.



But the Technical Editor of a leading hi-fi magazine recently wrote:

"What is the ideal or best speaker system? I really can't say. If someone presented me with a product that sounded as good as the best, and was half the size, and had twice the efficiency, and sold for, say \$400 a pair, I would be inclined to judge it as 'best'—but you may not."

Amazing. These are the very same design goals we set for a new E-V speaker system and achieved in the vented, equalized Interface: A.



In fact, compare these comments with the Interface specs:

Our vented, equalized design gives you a cabinet half the size of sealed systems. Our efficiency is up 2-3 dB, around twice that of other speakers. Low frequency response (3 dB down at 32 Hz) is unprecedented. And our suggested retail price, including equalizer, is \$450 a pair.

Only you can decide if you agree with this Editor's high standards. Or if Interface: A performance is best. Listen to Interface at your E-V dealer. Send us your vote.

Interface Vented, Equalized Speaker System

Electro-Voice, Inc., a Gulton company
619 Cecil Street, Dept. 374H, Buchanan, Michigan
49107

Just to set the record straight, Harry Zwicker is the treasurer—not the president—of the Boston Audio Society. Jim Brinton [who also has written for HF] is the president. Readers who are interested may obtain membership information on the BAS by writing to the Boston Audio Society, P.O. Box 7, Kenmore Square Station, Boston, Mass. 02215.

Michael Riggs
Cambridge, Mass.

Mr. Riggs addresses the Boston audio scene in detail in his feature article in this issue.

I would like to point out a serious error in Mr. Zide's article. The price listed for the

Magnepan MG-II is the price per pair. The cost per speaker, which is the way the other models were listed, is \$312.50, which makes it the least expensive by quite a margin. Mr. Zide chose his speakers because they were the least expensive, not realizing that the MG-IIs were actually \$375 less per pair.

M. S. Sanders
Magnepan, Inc.
White Bear Lake, Minn.

Mr. Zide did not select the Duntech speakers only because they were the least expensive, but also because they most nearly suited his taste.

We would like your readers to know that the price given for our DR-1 speakers in

"Larry Zide Chooses a \$5,000 System" was incorrect. The price of the DR-1 is \$1,185 per speaker, not \$895 as printed.

Joseph Alinsky
RTR Industries
Canoga Park, Calif.

Four-Channel Sound

Congratulations on your excellent article on quad ["Four-Channel Sound Today," by Alfred Myers, November]. I have had four-channel sound since SQ came out and have been a quadrimaniac ever since. As a salesman in a stereo store, I can tell you from experience why quad has not taken off as fast as I and others had hoped it would: salesman! Many customers have told me that other salesmen have said that four-channel is too complicated or too expensive. That's rubbish!

To check for myself, I went to most audio stores in my area and asked some simple questions about it. The results? Nearly all the salespeople I asked tried to change the subject or told me to forget it and stick with stereo.

Maybe someday we will have one quad record system, but until then there are a lot of people who could afford this exciting new medium but are turned off by salespeople who don't know their CD-4 from a hole in the matrix! Meanwhile, I for one will just keep turning on people to the sound of the Seventies.

Pat Shea
Waukegan, Ill.

I am sure I am as enthusiastic a booster of quadriphonic sound reproduction as Alfred Myers, at least judging from the tone of his article. But he seems to be letting his enthusiasm interfere with his perception of reality. He mentions that no record company that has moved to quadriphonics has since ceased issuing four-channel discs. Yet ABC Impulse, which at one time seemed committed to producing its entire catalog in the QS matrix system, has now returned to two-channel stereo engineering. The Warner/Elektra/Asylum/Nonesuch/Atlantic/Reprise group and A&M, both of which chose the CD-4 system, have released no four-channel discs for months. And RCA's CD-4 productions have recently become annoyingly sparse.

To boot, a check of the SCHWANN catalog over the past year reveals that quadriphonic albums have been discontinued at two to three times the rate that new ones have been released. Other than Vox and Angel (and perhaps Columbia, if it actually institutes its single-inventory promise), the situation looks pretty dismal. Now that the hardware is finally being perfected, another software crisis seems to be upon us.

Larry Clifton
Capron, Va.

CB Blues

I am afraid that I consider your answer to G. P. Gennaro concerning CB interference ["Letters," December] inadequate. It is, indeed, a sad state of affairs when all of us who love our music in the privacy of our own homes are forced to surrender this right to a "ten-four, good buddy" neighbor.

Children Of The klipschorn® Loudspeaker

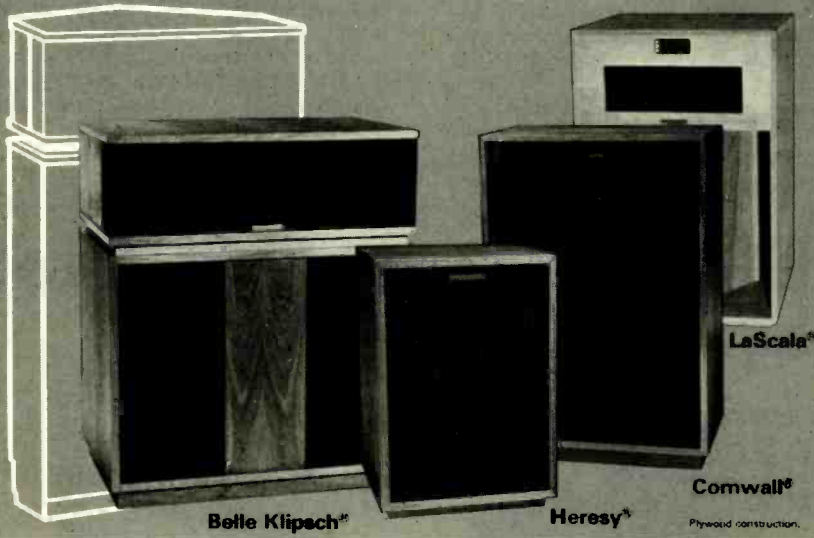

So your listening room won't accommodate a KLIPSCHORN®. Then Klipsch gives you a choice. Large, small, horn-loaded bass, direct radiator bass. All non-corner speakers. Yet all except the HERESY® have the same drive components. Even with it the only difference is a 12" instead of a 15" bass driver. And each Klipsch speaker is individually tested to meet Klipsch standards. Ask your dealer to show you how closely the children approach the father in true sound reproduction. Mail this coupon for information on the complete Klipsch line.

klipsch

P.O. Box 688H-3, Hope, Arkansas 71801

Please send me your latest brochure and list of dealers.

Name _____

Address _____

City _____ State _____ Zip _____

In Canada: Superior Electronics, Inc.



CIRCLE 21 ON READER-SERVICE CARD

OUR SECOND BEST IS BETTER THAN MOST OTHERS' FIRST BEST.

AUDUA is one of the world's finest cassette tapes. But it's not the best cassette tape made by TDK.

Our SUPER AVILYN (TDK SA) has the edge. And that's only if you're using the special bias/equalization setting on your tape deck.

However, if you're using the normal or standard setting, you'll have to settle for AUDUA—second best.

Chances are you won't find anything better, or with more consistent sound quality, for decks with normal tape selector settings. In other words, even if you don't own extravagant equipment, with AUDUA you can still hear extravagant sound reproduction.

You see, because of AUDUA's superior dynamic range at the critical high-end, you'll hear any music that features exciting "highs" with an amazing brilliance and clarity you won't get with any other tape. (And when it comes to open-reel tape, you'll probably find nothing comes close to AUDUA open-reel for reproducing highs.)

Whatever AUDUA you use—cassette or open-reel—you'll hear your system like you've never heard it before.

But there is something else you should hear before you try AUDUA. The price.

Unlike other so-called "super premium" cassettes, AUDUA's price is down to earth. (That should make AUDUA sound even better.)

Compared to what others consider their best, there's just no comparison.

So try the second-best cassette we've ever made.

You won't find much better.

TDK Electronics Corp.,
755 Eastgate Boulevard,
Garden City, New York 11530.
Also available in Canada.

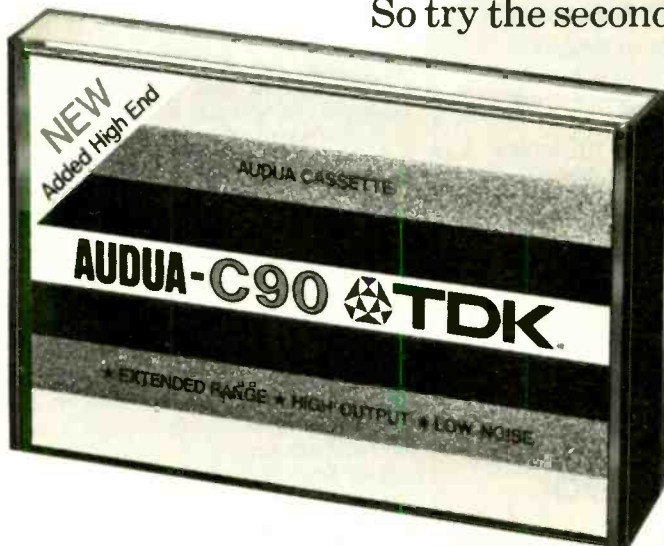

TDK[®]

Wait till you hear
what you've been missing.

CIRCLE 44 ON READER-SERVICE CARD

Are you looking for speakers to torture your dog, or for a better deal in the sound you can hear?



Relax. We're not accusing you of cruelty to animals. But we do think it's

high time to get up-front on speaker specs. Separating the ones that make a difference to the human ear, from the ones that soak you just to drive poor Rover mad.

Years ago we realized what most of you really want: great sound reproduction, more reasonably priced. And being an up-front, coast-to-coast loud-speaker company, we could take it from there.

By cutting out the gimmicks, the inaudible esoterics, we could concentrate all our resources on perfecting the sound values your own hearing could appreciate.

Building in enough power-handling for top-line electronics, without running up the tab on specs that serve no practical purpose.

And what this approach saves is passed on to you. In such terrific sound systems, so terrifically packaged, we're not afraid to encourage one-on-one auditions against any comparably-priced speakers.

In side-by-side comparisons of our total price/performance/

packaging, it's *that* apparent that Ultralinear gives you more bang for the buck. Dollar for dollar. Sound for sound.

And since no two ears are alike (or bank accounts either), we put a broad selection of Ultralinear speakers up-front. In bookshelf, floor-standing or tower systems—



pick your own price and configuration. With a choice of sleek cabinet finishes and grilles. With plenty of technical goodies, like blowout-proof circuit breakers—built in.

No wonder audio sales personnel are quick to recommend our up-front concept in loudspeaker development. They know value... and their experience confirms what you've always suspected: too many expensive speaker specs are for the dogs.

For the full-color line brochure from the up-front, coast-to-coast loudspeaker company, write to

Ultralinear, 3228 East 50th Street, Los Angeles, California 90058. A list of your local Ultralinear dealers will be included.

Ultralinear

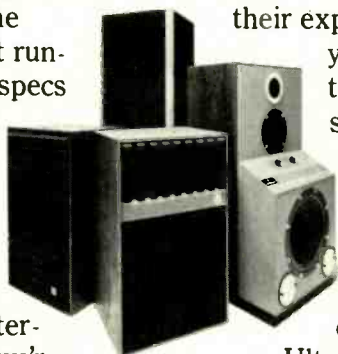

If Mr. Gennaro has neighbors suffering from this same invasion of privacy, I suggest that it quickly becomes the rights of one vs. the rights of many and that something needs to be done about it.

A minimum of ten families on my street are being plagued with just this situation, and we are going to take a stand. I have a petition going to our city council with sixteen names from my street alone! I feel that your magazine should stand with us on this issue and not tell us that it is the CBER's right to virtually destroy our expensive stereo systems.

Stephen P. Kirkton
Columbus, Ohio

We didn't say we liked CB interference. We simply reported that, according to current federal law, a CB user is within his rights as long as he obeys all applicable regulations while operating his equipment. Obviously, laws are subject to change—although one must remember that CBERs vote too. Petitioning your city council, which has no jurisdictional power in this area, is a waste of time. Your senators and representative are the ones to contact. If you want to know what to do while waiting for the law to change, our March 1976 issue contained an article by William Warriner on ways to eliminate broadcast interference.

May I refer Mr. Gennaro to the *Radio Amateurs Handbook*, p. 484 et seq. (especially p. 502) in the 1976 edition? This book should be available in most electronic stores. It has some excellent suggestions as to how to keep the signal out of the set, and anyone should be able to correct the problem with its guidance.

James B. Holder
West Monroe, La.

Dett on Disc

In his review of Philips' "American Piano Works" [December], Irving Lowens says that the music of Nathaniel Dett, whose *In the Bottoms* was under discussion, has not been recorded before. Not so! Percy Grainger—who, as your reviewer pointed out, championed Dett's music—long ago recorded some of the same music appearing on the Philips disc, in particular the infamous "Juba Dance" [the finale of *In the Bottoms*—Ed.]. Mr. Lowens has reservations about the playing of pianist Clive Lythgoe, but he need have none about Grainger, who was one of the great pianists of the early part of the century.

Your readers might be interested to know that tape transfers of most of Grainger's recordings are available at cost from the Gustafson Piano Library, Department of Music, Bishop's University, Lennoxville, Quebec, Canada.

Derek C. Oppen
Stanford, Calif.

Mr. Lowens didn't say that there were no previous recordings of Dett's music, only that he didn't recall any. Actually, *In the Bottoms* was favorably commented on by Alfred Frankenstein in his February 1971 review of Natalie Hindersas' recording of "Music by Black Composers," *Desto DC* 7102/3.

Waveform fidelity. If you don't understand it, you could be making a \$350 mistake.

Today a good amp and tuner can easily cost you \$350, \$500, \$700 or even more. But no matter how much a component costs, if it doesn't have waveform fidelity, the music that's put into it won't be the music that comes out. And that's an expensive mistake to make.

It's also a mistake Technics won't let you make. Because Technics' two new integrated amps, the SU-7600 and the SU-8600, as well as our two new tuners, the ST-7600 and the ST-8600, have superb waveform fidelity.

With both tuners, the waveform being broadcast will be the waveform you'll receive, with virtually no distortion or cross modulation. Because both have flat group delay filters in the IF sections. So the time delay is constant for all frequencies.

There's also a Phase Locked Loop IC in the MPX sections. That's why, for example, with the top of our line, the ST-8600, you'll get stereo separation of 45dB

at 1kHz and 35dB at 10kHz. And a frequency response that's as flat as it is wide, 20Hz to 18kHz (+0.2dB - 0.8dB).

And with an 8-ganged tuning capacitor (5 for FM and 3 for AM) and a Technics developed 4-pole MOS FET, broadcasts with the ST-8600 will sound more like master tapes than FM.

You'll also find waveform fidelity in both amps. Including our most powerful one, the SU-8600. With 73 watts per channel, minimum RMS, both channels driven into 8 ohms from 20Hz to 20kHz, with no more than 0.08% total harmonic distortion.

And the SU-8600 will stay 73 watts regardless of the power-hungry transient bursts found in many musical waveforms. The reasons: Sixfold independent power supplies for the control voltage and power amplifiers. The results: Virtually no transient cross-talk distortion. And optimum waveform fidelity.

So before you make a \$350 mistake, or an even more expensive one, listen to our new amps and tuners. Your Technics dealer has them. Along with Technics waveform fidelity.

Cabinetry is simulated wood.

Technics by Panasonic



look up to Realistic®!

You'll be surprised. Everything about the new Realistic Optimus® T-100 was designed with the discriminating music lover in mind. Tower design puts the speakers at perfect height, without special mounting or stands. Two active 8" acoustic suspension woofers and a 3" tweeter deliver sound so natural you can feel as well as hear its richness. Unlike many large high-performance speaker systems, the T-100 is efficient enough to be driven by almost any hi-fi equipment without pushing the amplifier, yet has the capacity to take 75-watt program peaks. The 3-ft. high, walnut veneer enclosure is finished on all sides to simplify placement and add fine furniture elegance. Sold only by Radio Shack. Ask for 40-2025 and find out what "towering sound" sounds like — today!

139⁹⁵*
each

*Retail price may vary at individual stores and dealers.

Smart styling that's practical, too



Grille removes for easy
speaker balance adjustment



Bottom-mounted terminals —
speaker cable remains out of sight

SOLD ONLY WHERE YOU SEE THIS SIGN:

Radio Shack®

A TANDY CORPORATION COMPANY • FORT WORTH, TEXAS 76107



Use your credit card
at most stores

Radio Shack operates as Tandy International Electronics in Australia, England, Belgium, Holland, Germany, France; and as Tandy Radio Shack In Japan.



Noye's Fludde as staged at the fourteenth Aldeburgh Festival

Lump in the Throat

by John Culshaw

I AM CONCERNED with a solitary and unpredictable experience common to all of us, which is that moment when the emotional response to music brings about that curious physical phenomenon known as a lump in the throat. Operatic death scenes can bring it on easily, according to your taste and the quality of the performance: Think of the deaths of Violetta, or Otello, or Mimi, or Butterfly. Certain arrivals can have the same effect, like Isolde's in Act III of *Tristan*, although there, of course, it is the orchestral explosion that triggers the response. Departures can also do it, as witness that incredible moment in the last act of *Otello* when Emilia is virtually through the door before Desdemona cries out the farewell that she knows will be her last. Yet what has led me to this subject is not operatic at all, at least in the usual sense of the word.

In the course of sorting my records, which I dwelt on some time ago [June 1976], I came across and played the old but still excellent Argo recording

of the late Benjamin Britten's *Noye's Fludde*, and it suddenly struck me that the biggest lump-raiser of all is a hymn or chorale within the context of a larger work. To see what I mean you have only to think of the *St. Matthew Passion*, or the curtain-rise on Act I of *Die Meistersinger*, or the prayer in *Hänsel und Gretel* (neither a hymn nor a chorale, actually, but close enough to have the same effect), or the closing passage of Bernstein's *Mass*.

The Britten piece is the most consistently "lumpy" so far as I am concerned, although this may be because most of the performers are children and because the audience is invited at certain points to join in the hymns. You must have a heart of granite not to be moved by the gradual emergence of the hymn "Eternal Father" during the storm scene, and especially by its final verse, when everyone in the building should be in full voice because the harmonies have reverted all of a sudden to those we remember from childhood. Yet even that splendid Victorian hymn is all but eclipsed

by the one at the very end, based on a famous tune by Thomas Tallis. For me that is the ultimate lump in the throat, no matter how often I hear it.

A few years ago I produced a BBC television broadcast of *Noye's Fludde* from the Maltings at Snape, near Britten's home, which happened to be the last of a series of public performances that the television crew had also attended to become familiar with the production. Television field crews are not necessarily specialists in, or even lovers of, music; most of their time is spent on football or at the racetrack or at political conventions, and to do the job at all requires a special kind of toughness rather than sensitivity. I know my way about the Maltings very well indeed, and such was my state at the end of the first performance that I was determined not to leave through any of the usual exit doors, where I would have inevitably met someone I knew. So I made for the lighting box at the back that provided a secret method of escape, and there I collided with the television sound engineer, who was as tough as they come. I looked at him, and he looked at me, and each of us knew why the other was there. "What did you think of it?" I managed to blurt out. He said, "It always makes me cry!"—and dashed out the door.

It is, of course, much easier to succumb when you have all the visual ceremony before you and when you are a member of an audience than when you are simply listening to a record. Yet in *Noye's Fludde* and the other examples I have mentioned, I do not find the experience much diminished by recording: The lump is still there at the right moments. Can it be that there is something basically reassuring or comforting about a hymn or a chorale? Or is it that they kindle some unconscious nostalgia for childhood, since for many of us in the Western world they were probably the first music we ever heard? Or is it simply that, in a world of seemingly endless violence and cruelty and ugliness, they represent some kind of vague haven of calm and stability, symbolized by a community of voices?

It is certainly not for nothing that, when Tallis' great tune has brought *Noye's Fludde* to an end, the Voice of God is heard speaking to Noah:

For vengeance shall noe more
appear,
And nowe fare well, my darlinge deare. ●

EIGHT ALL-NEW MARANTZ UNITS.

Probably the largest — and certainly the finest — line of stereo receivers ever unveiled. And it all starts with the **world's greatest receiver**, the Marantz 2385, with output rated at an astonishing **185 Watts per channel** (minimum RMS at 8 Ohms, 20-20,000 Hz, with no more than 0.05% Total Harmonic Distortion). And at the other end of the line-up is the most incredible receiver **value** Marantz has ever offered: the 2216, with 16 Watts per channel, minimum RMS at 8 Ohms, 20-20,000 Hz, with no more than 0.5% Total Harmonic Distortion.

And there are 6 other new and outstanding Marantz receivers — with prices to match any budget, with all-new higher power output, and with range of features to match any degree of involvement with audio.

Never before has the incomparably thrilling sound of Marantz been available over such a broad spectrum of power and performance. Never before has a receiver line packed so much muscle, either, and with such low distortion. Never before have you had more compelling reasons to buy your first receiver or to upgrade your present one. At last "component

quality" acquires true meaning in describing receivers. The Marantz 2385 Receiver, for instance, **exceeds** — in power, features and specifications — most separates on the market today, while still being packaged into a remarkably manageable size for such walloping power and vast array of features.

THE MOST IMPRESSIVE COMBINATION OF QUALITY PERFORMANCE FEATURES EVER ENGINEERED INTO A RECEIVER LINE.

Every possible technological advance that can improve performance has been designed into this new generation of Marantz receivers. For example, the 2385 includes: Plug-in optional **Dolby* FM Noise Reduction Adapter** for the lowest noise possible with FM reception. **18 dB per octave Bessel-derived high filter** — an advanced linear phase design that reduces unwanted high frequency noise — and does the job with a more natural, less colored sound be-

2385



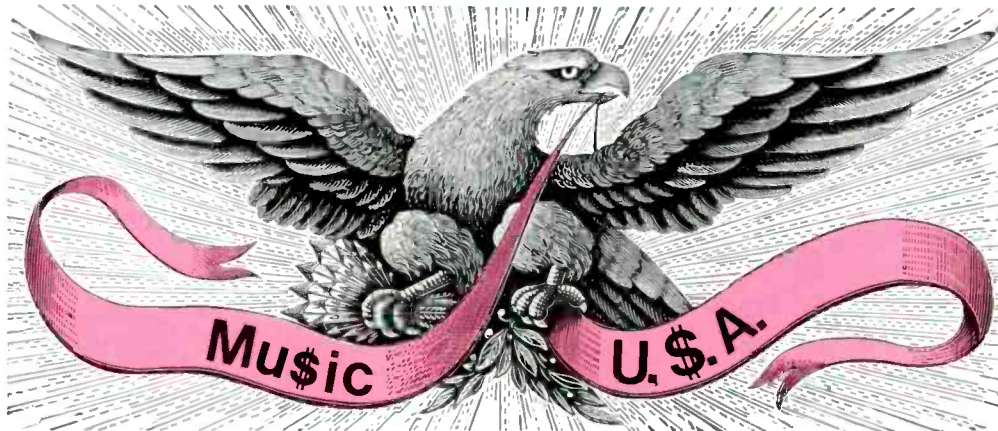

THE BEST WAY to see into the heart of a nation is to learn its music. The wonderful logic of Bach is inherently German in character, as is the disciplined use of harmonic progression by the nineteenth-century German Romantic composers. When the Germans later stretched progression to the limit, it was always logically, and when at last Arnold Schoenberg assaulted the citadel of tonality, he did so systematically and arithmetically. The French personality is revealed in the music of Rameau, Couperin, Debussy, Ravel, and, I would be inclined to say, Edgar Varèse. And, of course, could anything be more Italian than the melodies of Verdi and Puccini?

The Chilean composer Juan Orrego-Salas told me once that he thought the reason his music was angular might be that he grew up within view of the jagged Andes, which vision early became part of his consciousness. This led me to a curious speculation. Sibelius has always enjoyed greater respect and popularity in Canada than in the U.S. Could this be because the forested topography of much of Canada, particularly the more populous eastern third of the country, resembles that of Finland?

Taste, a French composer observed, is the product of a thousand distastes. (The observation is even better in French—"Le goût est le résultat de mille dégoûts"—since *dégoût* carries the additional connotation of disgust and revulsion.) The aphorism precisely describes the process by which art is both made and appreciated. The selective processes of the artist are the result of his entire cultural experience: national, regional, local, and even familial. And he not only reflects but contributes to the national characteristics of music.

2. At a Nation's Heart

by Gene Lees

It has passed almost unnoticed by jazz critics that national musical characteristics survived the crossing of the Atlantic to turn up in jazz. It should be noted at once that there are conspicuously few Anglo-Saxon Protestants in jazz. This is not intended as a deprecation of the talent of the WASPs who do play jazz—guitarist Herb Ellis and pianist/composer Roger Kellaway are among the very best practitioners of the art. But generally the English are not as impassioned about music as, for example, the Welsh, the Irish, or the Italians. No doubt for that reason, the English have shown less talent for music than most other Europeans, just as surely as they have shown more for literature. The distrust of pleasure is inherent in the various forms of English Protestantism.

Whatever the reasons, most white jazz musicians are Jewish, Irish, or Italian, with a smattering of America's other ethnic minorities, including Mexican (bassist Ralph Peña) and American Indian (bassist Joe Mondragon). And usually the musical characteristics of a man's ethnic group turn up in his playing.

The Italian-Americans tend to be very lyrical players—for example, trombonists Frank Rosolino and Carl Fontana, guitarist Gene Bertoncini,

pianists Gene DiNovi and Michael Renzi, drummer Ronnie Zito and his brother, pianist and arranger Torrie Zito, violinist Joe Venuti, and tenor saxophonist Flip Phillips. And film composers Dominic Frontiere and Henry Mancini possess an Italianate lyricism.

There is even a distinctively Italian vocal sound—not universal, to be sure, but common. Some would call it a gravelly sound, like that comedians affect when attempting to capture the speech of the archetypal Italian gangster, but it is perhaps better described as a woody texture, somewhat like that of a viola. It can be heard in many singers of Italian origin, including Tony Bennett, Frank Sinatra, Frankie Laine, and Perry Como. It is heard in the speech of celebrities like Anne Bancroft, Brenda Vaccaro, Congressman Peter Rodino, and late Richard Conte. Further, there is a tendency of New York-New Jersey area Italians to dentalize *d*'s and *t*'s and to liquefy the letter *r* when it follows either of these. The *r* is almost lisped, softening one of the harsher sounds in American English; at the same time, the woody or gravelly sound tends to desentimentalize even the most sentimental songs. The combined effect, as in Sinatra's work, is extraordinarily lovely.

When I mentioned this sound to an Italian friend who himself has it, he quipped: "It probably comes from all the screaming and yelling at home when you're a kid." I am inclined to think, however, that it is the result of a physical characteristic in the vocal cords of many (but not all) Italians, just as blond hair is a characteristic of many (but not all) Swedes.

There is also a distinguishable
Continued on Page 29

cause it eliminates the overshoot and "ringing" common to other filters. **18 dB per octave 15 Hz sub-sonic Butterworth low filter** cuts sub-sonic transients and rumble that effectively rob you of vital amplifier power. Never before has such advanced filter technology been applied to audio components or receivers.

The Marantz 2385 also offers: **2 LED peak power indicators** to continuously monitor amplifier output to instantly let you know when transients are driving the amplifier to full output. An amplifier section utilizing **full complementary symmetry direct-coupled output** in a massive **triple-paralleled** transistor array—an advanced design never before used in a receiver. The result is the highest day-in, day-out operating reliability and lowest Total Harmonic Distortion. **5-gang FM tuning capacitor**, in conjunction with **dual-gate MOS FET FM front end** ensures virtually complete rejection of spurious signals, with an IHF usable sensitivity of **1.6 microvolts**, and a 50 dB quieting sensitivity figure in stereo of **25 microvolts**—virtually the finest such specification ever obtained in a receiver—even a separate tuner.

And the 2385 includes: **Three tone controls for each channel**—bass, treble and mid-range—for maximum tonal flexibility. **Selectable frequency turnover points** to adjust range of influence of each tone control. **Independent tape copy facility**, which permits dubbing from one tape deck to another while listening to yet a third signal source, such as records or FM. **Linear phase IF filters** for lowest distortion. **LED function indicators**.

But look at the exciting array of features included in virtually every receiver: **phase-locked loop**, a sophisticated circuit that maximizes stereo separation while minimizing distortion. **Dual-gate MOS FET FM front end. Full complementary symmetry amplifier section plus direct-coupling. 25 micro-second de-emphasis switch** for properly receiving Dolby FM, the new generation in stereo broadcasting. **Gyro-touch tuning** for smoothest, most accurate station selection.

See the new 1977 Marantz receiver line at your Marantz dealer now. Fantastic!



2330

2285

2265

CHOOSE THE MARANTZ THAT'S RIGHT FOR YOU.

MODEL NUMBER	2216	2226	2238	2252	2265	2285	2330	2385
RATED CONTINUOUS POWER, MINIMUM RMS AT 8 OHMS, 20-20,000 HZ	16 Watts per channel	26 Watts per channel	38 Watts per channel	52 Watts per channel	65 Watts per channel	85 Watts per channel	130 Watts per channel	185 Watts per channel
TOTAL HARMONIC DISTORTION	0.5%	0.3%	0.1%	0.1%	0.08%	0.08%	0.07%	0.05%
FM SENSITIVITY (1-KF USABLE)	13.2 dBf (2.5 μ V)	10.8 dBf (1.9 μ V)	10.8 dBf (1.9 μ V)	10.8 dBf (1.9 μ V)	10.3 dBf (1.8 μ V)	10.3 dBf (1.8 μ V)	10.3 dBf (1.8 μ V)	9.3 dBf (1.6 μ V)
50 dB QUIETING SENSITIVITY (STEREO)	39.2 dBf (50 μ V)	37.2 dBf (40 μ V)	37.2 dBf (40 μ V)	37.2 dBf (40 μ V)	33 dBf (35 μ V)	36 dBf (35 μ V)	36 dBf (35 μ V)	33.2 dBf (25 μ V)
FM DISTORTION (1 KHZ)	MONO 0.4% STEREO 0.7%	0.15% 0.3%	0.15% 0.3%	0.15% 0.3%	0.15% 0.3%	0.15% 0.3%	0.15% 0.3%	0.15% 0.2%
CAPTURE RATIO	3.0 dB	1.0 dB	1.0 dB	1.0 dB	1.0 dB	1.0 dB	1.0 dB	1.0 dB
FILTERS	High filter	High filter	High filter	High filter	High and low filters	18 dB per octave Bessel-derived high filter and Butterworth low filter		
FM DOLBY CAPABILITY	—	25 μ S FM de-emphasis	25 μ S FM de-emphasis	25 μ S FM de-emphasis	25 μ S FM de-emphasis	25 μ S FM de-emphasis	Built-in FM Dolby system	Optional plug in Dolby FM adapter—25 μ S FM de-emphasis
SUGGESTED LIST PRICES**	Under \$240	Under \$300	Under \$360	Under \$460	Under \$570	Under \$670	Under \$790	Under \$1100

*TM Do by Labs, Inc. © 1977 Marantz Co., Inc., a subsidiary of Superscope, Inc., 20525 Nordhoff St., Chatsworth, CA 91311. Prices and models subject to change without notice.
 **Suggested list prices are for value reference only. Actual selling prices are at dealer's option.

marantz®
 We sound better.



**THE 1977
MARANTZ
RECEIVER LINE
OFFERS THE
GREATEST CHOICE
OF POWER
AND LOWEST
DISTORTION...
RIGHT ON UP
TO THE FINEST
RECEIVER
EVER BUILT.**

Still Number

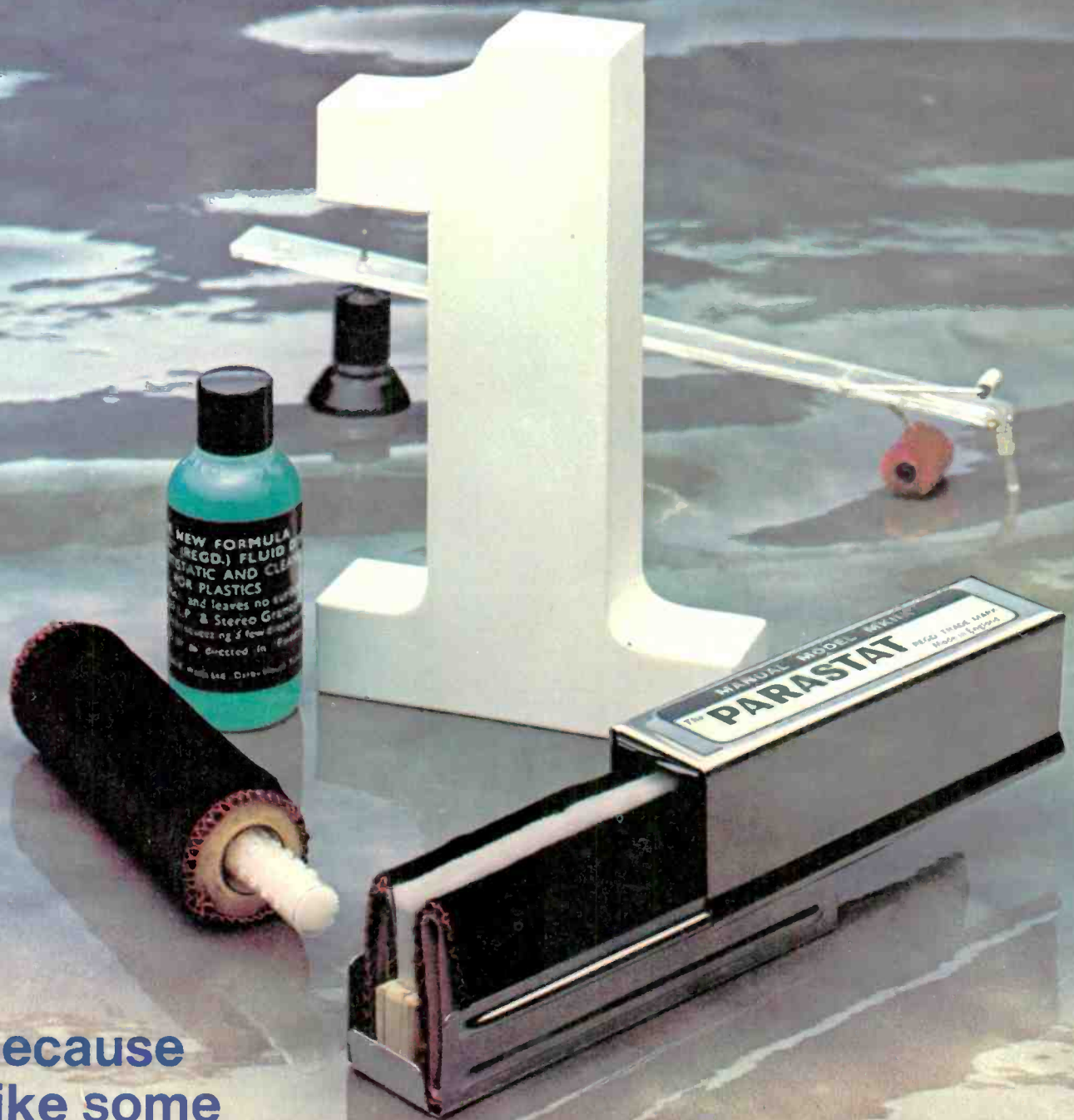

...because
unlike some
record "care" products **Watts really works!**

Watts Disc Preener. World's most popular record cleaning tool. Simply add a few drops of Watts "Anti-Static" solution to its moistened core and *without* transferring any liquids to the record's surface, Preener cleans and preserves the grooves of your new records. Watts Preener leaves no residue to clog the stylus, which can degrade the sound quality of your favorite record.

Watts Parastat. 2 Cleaners in One. Parastat's special brush penetrates record grooves to loosen and remove dust and dirt. Ideal for records which have been mistreated with anti-static sprays. Parastat also provides cleaning action for the maintenance of new records. With a *drop or two* (we're not in the fluid business) of Watts "Anti-Static" solution, to the Parastat's lower pad, the proper degree of humidity is applied to relax dust-attracting static.

Watts Dust Bug. Elegantly simple in design and function, the famous Dust Bug keeps a new record clean by removing dirt and dust which may settle on the record while in use. When the red plush pad of the Bug is slightly dampened with Watts "Anti-Static" solution which is supplied, Dust Bug provides just the proper degree of humidity to prevent the generation of static electricity. While imitated, the ultra-lightweight Watts Dust Bug has never been *equalled* in performance and effectiveness.



Record Care Products are distributed by:

ELPA MARKETING INDUSTRIES, INC. EAST: New Hyde Park, New York 11040 WEST: 7301 E. Evans Rd., Scottsdale, Arizona 85260

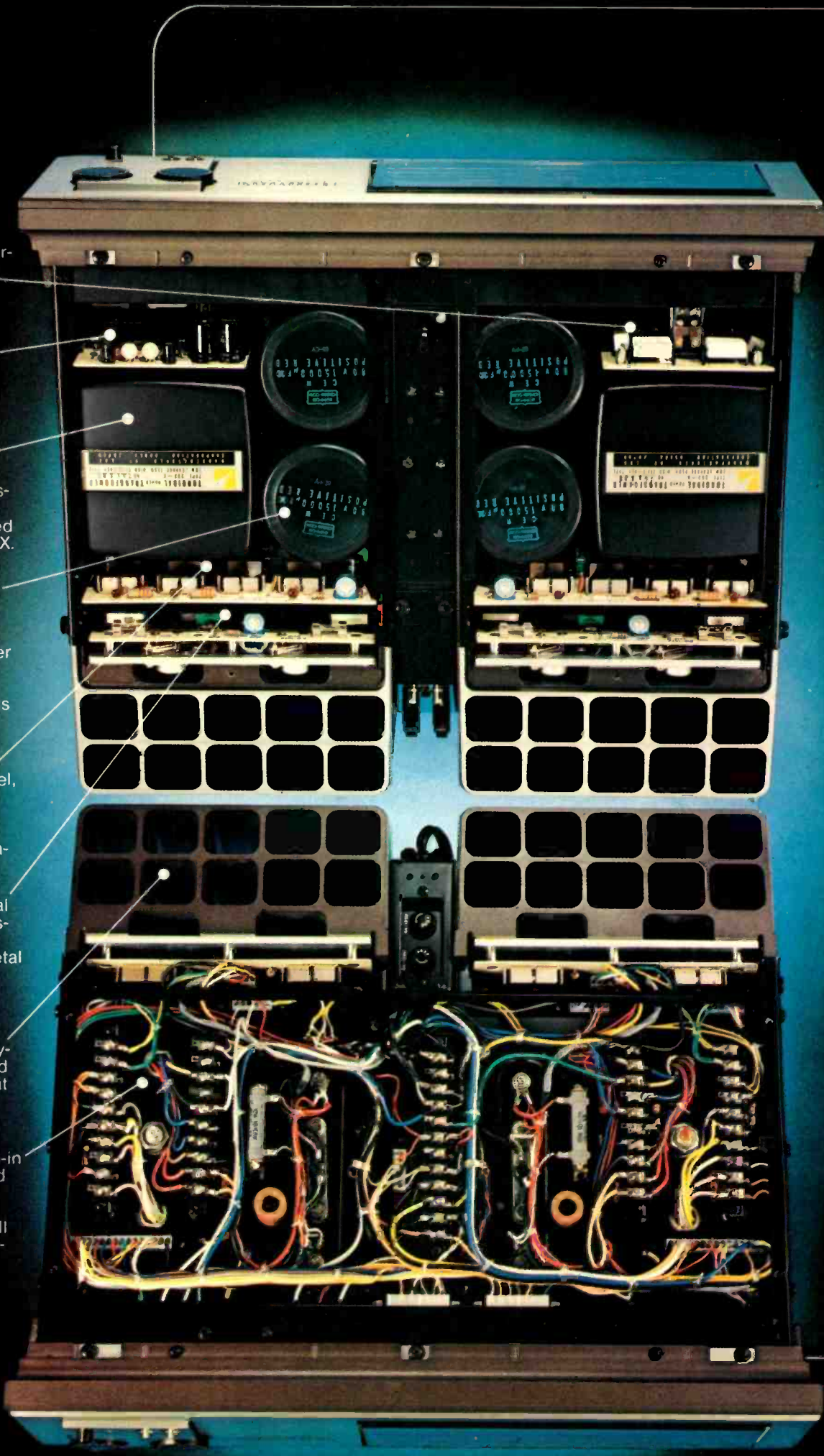

Plug-in circuit board incorporating turn-on/turn-off muting and speaker-protection components.

Plug-in printed circuit board controlling front-panel power readouts.

Each channel's hermetically-sealed toroidal power transformer is designed for maximum efficiency and lowest possible hum leakage. The transformers are designed and manufactured by LUX.

The four filter capacitors have a specified capacitance of 15,000 microfarads each, double the value found in many other high-power amplifiers. This assures high-power stability under continuous large-signal conditions.

Plug-in drive stages, separate for each channel, built onto high-reliability circuit boards. Mirror-image construction optimizes lead-length to adjacent inputs and outputs.

Output transistor terminal board. The output transistors themselves are mounted on a 1/4-inch metal plate, integral with the heatsinks for maximum thermal conduction.

Massive sand-cast honeycomb heatsinks designed to provide maximum heat dissipation.

Cabled harness wiring with terminal strips, plug-in circuit board sockets and direct point-to-point wiring, each used as appropriate to the overall design. This flexible construction approach optimizes layout and facilitates servicing.

LUX power amplifiers are designed to provide more than merely x watts per channel.

If your interest in a power amplifier is based primarily on its dollar cost per watt, you're not likely to give much initial thought to a LUX. We don't compete in that simplistic power game. Our concerns are with every aspect of amplifier design and construction—to assure your continuing satisfaction throughout what you can expect to be a very long period of ownership. If you share these concerns, you may then find the LUX approach to have special significance and value well beyond purchase price. Especially when it comes to sonic excellence.

As *Radio-Electronics* neatly put: "There is much we still don't know about what makes one amplifier sound better than another—but LUX seems to have found some of the answers, at least."

These solutions now exist because the research that LUX audiophile/engineers conducted went far beyond the obvious questions about amplifier design to those subtle but sonically significant aspects of high-power circuit design usually bypassed or ignored by conventional thinking, test techniques, and instrumentation.

For example, ordinary protection circuits can introduce audible and unpredictable distortions when activated by certain types of loudspeaker loads. These are not disclosed, let alone cured, by the usual test procedures. LUX's solution: four separate sensing circuits sophisticated enough to distinguish the electronically subtle differences that can occur between

normal high-level output signals and abnormal voltage/current conditions

Models M-4000 and M-6000 have fully independent power supplies employing separate toroidal power transformers for each channel. These allow the full wattage potential and signal-handling stability to be individually realized by each channel even under continuous large-signal drive conditions. Massive honeycomb heatsinks provide the thermal dissipation necessary for overall reliability and long-term performance stability.

The LUX difference goes beyond this. Every power amplifier undergoes an extensive series of tests at our New York facilities. This assures that each unit will match or exceed fourteen different published specifications. A Performance Verification Certificate attesting to the specific measurements obtained is packed with each unit. (Your dealer also has a copy and another stays with LUX as a permanent record.)

With all this in mind, plus the features and specifications listed below and the revealing internal views at left, your selection of a power amplifier can best be made only at one of our carefully selected audio dealers where LUX and other fine components can be compared and evaluated. Assuming that you have the ability to distinguish the sometimes subtle—sometimes obvious—differences among high-power amplifiers, we'll be pleased to await your considered judgment.

Luxman M-4000 Power Amplifier: 180 watts per channel minimum continuous power, both channels driven simultaneously into 8 ohms. Total harmonic and intermodulation distortion no more than 0.05%. Frequency response: 5-50,000 Hz, ± 1 dB. Signal to noise ratio: 108 dB. Features include separate power supplies for each channel, including output and drive stages. Two meter power output display in combination with LED peak output indicators reveal dynamic range of program material. Output level set by precision potentiometer with 1-dB click stops. \$1,495.00

Luxman M-6000 Power Amplifier: Similar features and specifications, except 300 watts per channel. \$2,995.00



LUX Audio of America, Ltd.

200 Aerial Way, Syosset, New York 11791 • In Canada: White Electronics Development Corp., Ontario

Results of extensive comparative tests yours for the asking.

What is perhaps the most exhaustive test of power amplifiers and preamplifiers ever made was recently conducted by Stereo Sound, Japan's leading audio publication. Among the many Japanese and American-made products tested were the Luxman M-4000 power amplifier and the C-1000 preamplifier. With permission of the publisher, we have translated and reprinted the complete report. We shall be pleased to send you a copy upon written request.

**Take a spin on our new
fully automatic turntable.
And leave the
direct driving to us.**



With Sony's new PS-4300, you just sit back and enjoy the ride. Wherever the record takes you.

That's the blissful simplicity of a fully automatic turntable.

But the PS-4300 is more than purely practical. We like to think of it as a model union: combining the convenient and the complex.

It is a profoundly engineered machine, with intelligent design slashing through down to the smallest detail.

We gave brushes the brush.

The motor that powers the PS-4300 is brushless and slotless. Direct drive, if you will.



This deceptively simple construction makes for a smooth-running motor with less friction and noise than traditional DC motors. And it eliminates cogging.

What's more, this smooth-running motor is monitored by a

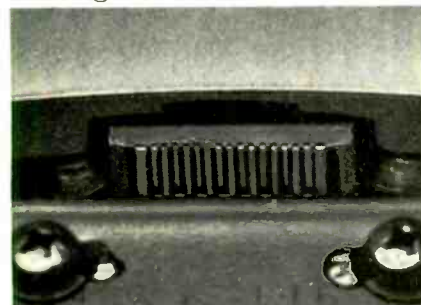

smoothly-engineered 8-pole magnetic pick-up head. And our magnetic speed sensor works through an intricate electronic feedback system; driving the platter directly—without a jumble of belts and pulleys getting in the way.

So our torque is not a turkey, and we've got low wow and flutter and high speed stability to boot.

An electric eye. For your ear.

Hands off the PS-4300!



Our optical sensing system automatically returns the arm when your record is over.

Optical sensing is light years ahead of the conventional mechanical linkage. Eliminating the pressure and distortion you'd ordinarily get at the end of a record.

A tone-arm that's a strong arm.

Now we're not calling anyone clumsy. But there is the chance you might make a mistake and grab hold of the tone-arm while it's in motion.



That's why the PS-4300 has a tone-arm that's more than just statically balanced. It comes with a protective clutch device. (The only clutch you'll find on our fully automatic turntable.)

This latching set-up protects your arm against too much strain.

Moving from arms to feet, ours are designed to cut feedback. They're rubber-soled: suspended by cup-shaped rubber shock absorbers.

And they're adjustable, letting you level the turntable. So you might say our feet come with elevator shoes.

Our vibration-reducers are great shakes.

Sometimes the cabinet itself

can vibrate—distorting what comes out of it.

Not so with the PS-4300.

Our cabinet is built out of a material with a low Q. Low Q materials hardly vibrate, and nobody watches their P's and Q's like Sony.

Even our platter has been undercoated with a damping material.

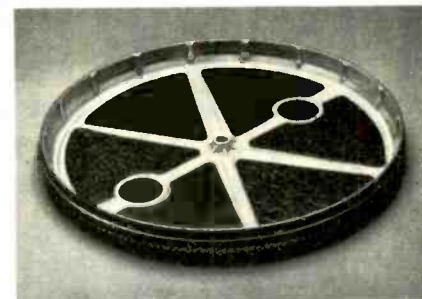

And what looks like a bad case of acne on our record mat is a series of bumps that provide an air cushion and absorb vibration.

An exercise in self-control.

You can see that we've covered just about everything when we created the PS-4300.

Even the cover.

Our dust cover is ingeniously simple. When closed, it leaves the controls accessible.



And what controls they are! One-touch, LED-indicated switches for start/stop and repeat.

One light tap starts everything going, while your record, under the dust cover, is in splendid isolation.

So if what you're looking for is an unmatched fully automatic direct drive turntable, drive on over to Sony.

SONY®

THE ADC CARTRIDGE CAUSES NO PERCEIVABLE WEAR OVER THE LIFE OF YOUR RECORDS.

MKII is different, because our engineers found a way to detach the magnet and reposition it above the stylus, so the stylus applies less pressure against the groove.

Less pressure means less wear.

The fact is, of all the leading brands, ADC cartridges have the lowest mass moving system you can buy. That means better sound and superior performance.

The XLM frequency response is exceptionally flat, from 15Hz to 24KHz ± 1.5 dB. And for the ultimate in stereo reproduction, it has a minimum of 23dB of channel separation.

Think about it. In the long run you'll probably spend more on your record collection than you will on your whole stereo system. So it makes sense to buy a cartridge with proof that it makes your records sound better and live longer.

THE ADC LOW MASS CARTRIDGE.

IT HELPS YOUR RECORDS LIVE LONGER.

Unbelievable? Believe it. A series of tests conducted by a leading independent audio-testing laboratory prove it. The tests show that the ADC XLM-MKII cartridge causes no perceivable wear until after 60 plays. Industry sources estimate the "life of a record" (the average number of times a record is played) to be 40 to 50 plays.

Other cartridge manufacturers may talk about less record wear, but ADC has proven *no wear over the life of your record.*

The reason for this is our unique patented design. It's patent #3294495.

We call it the "induced magnet" cartridge.

Most cartridges are designed so that a heavy magnet is part of the moving system.

The ADC XLM-

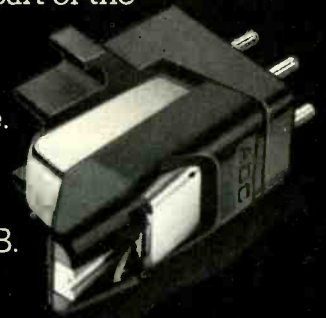

The ADC low mass cartridge. Unbelievable.



A BSR COMPANY

ADC Phono Cartridges

A Division of

BSR Consumer Products Group
Rte. 303, Blauvelt, N.Y. 10913

THE PROOF:

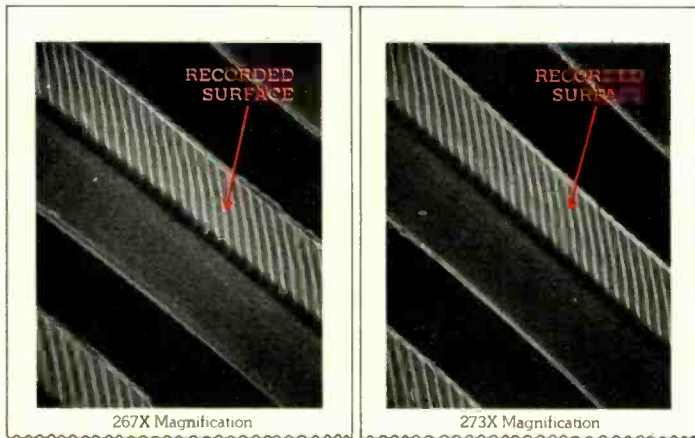

This is a photomicrograph of a 20kHz record groove that has never been played before.

This is a photomicrograph of a similar 20kHz record groove played 75 times with an ADC XLM-MKII cartridge. As you can see there is no difference.

THE DIFFERENCE:

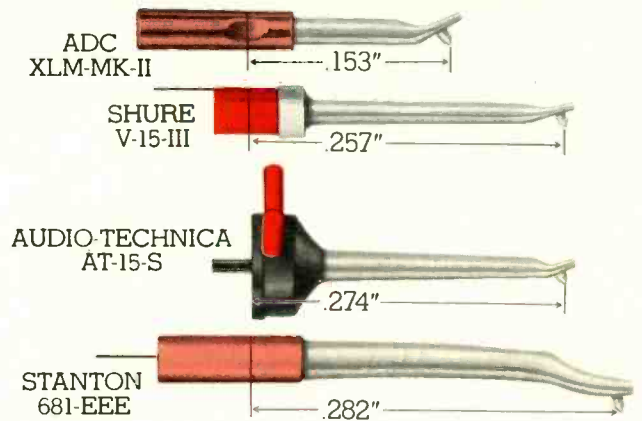

The way to get the most accurate reproduction of sound is to lower the total effective mass of the moving parts of the stylus. And that's exactly what

our engineers did. In fact, of all the leading brands, ADC cartridges have the lowest mass moving system you can buy.

INDUCED MAGNET

MAGNET

If you'd like your own personal copy of the test result, write to ADC at address shown above.

CIRCLE 50 ON READER-SERVICE CARD

black sound—a kind of soft, whispery airiness. It has nothing to do with regional accents; it is a quality of sound. One perceives it in the singing of Oscar Peterson, Carmen McRae, Sarah Vaughan, and particularly the late Nat Cole, whose piano playing was as soft, bouncing, and lyrical as his voice.

In fact, there is usually a relationship between the way a musician sings or speaks and the way he plays his instrument. That whispery black sound is apparent in the work of such trumpet players as Miles Davis, Freddie Hubbard, and Clark Terry. Jack Teagarden had a lazy, careless enunciation, similar to the way he played trombone; Bob Brookmeyer's trombone has the same kind of mumbled laconic eloquence as his speech.

Jewish jazz musicians, such as Al Cohn and Ziggy Elman, sometimes sound Jewish, as if memories of cantorial singing and of Mediterranean modes are lodged in some secret chamber of the subconscious. And the Irish musicians, such as pianist Dave McKenna, trumpeter Bobby Hackett, composer Pat Williams, tenor saxophonist Zoot Sims, and baritone saxophonist and composer Gerry Mulligan, sound Irish—lyrical and humorous. I once asked Mulligan if he felt Catholic. After a moment's reflection, he said, "No, but I do feel Irish."

"I would imagine so," I said, "because sometimes your playing makes me think of songs like 'Kerry Dancers.'" With which Mulligan told me that the late Judy Holliday, who had a remarkable gift for the apt phrase, used to say, when Zoot Sims began a solo, "There he goes, playing that Barry Fitzgerald tenor again." It is a startling description, for the bubbling, bouncing, joyous solos of Sims do indeed sound like the peal of Irish laughter.

It must be emphasized that these observations are generalities, not absolutes. Barney Kessel's guitar work does not sound Jewish, and Sal Nistico's tenor saxophone sounds less Italian than black. What a man admires is clearly a major factor in the formation of his taste and therefore his work, and sometimes the admiration overcomes whatever ethnic characteristics his music might otherwise have. But in general, national characteristics hold true, and many of those of Europe are among the most important forces in the shaping of American music.

And one of the factors that in turn shapes national characteristics in music is the language of the country, which subject I will consider in the next column. ●

← CIRCLE 50 ON READER-SERVICE CARD

You can study the glowing consumer reports in your favorite hi-fi magazine. Objective, informative, helpful.

You can talk with knowledgeable owners who often talk of little else. Subjective, enthusiastic, convincing.

But it isn't until you actually listen to an Avid speaker system for yourself that you learn why they have won such unprecedented critical acclaim.

Only then can you sense the superb



design, engineering, and craftsmanship that have made Avid the most accurate speakers in their price range.

Only then, in light of your own listening pleasure, can you understand why Avid speakers can be your best buy.

That's why we invite you to audition one or more of the fine selection of Avid speaker systems at your Avid dealer. Be an Avid listener.

Avid.

The most widely acclaimed new line of hi-fidelity speakers.

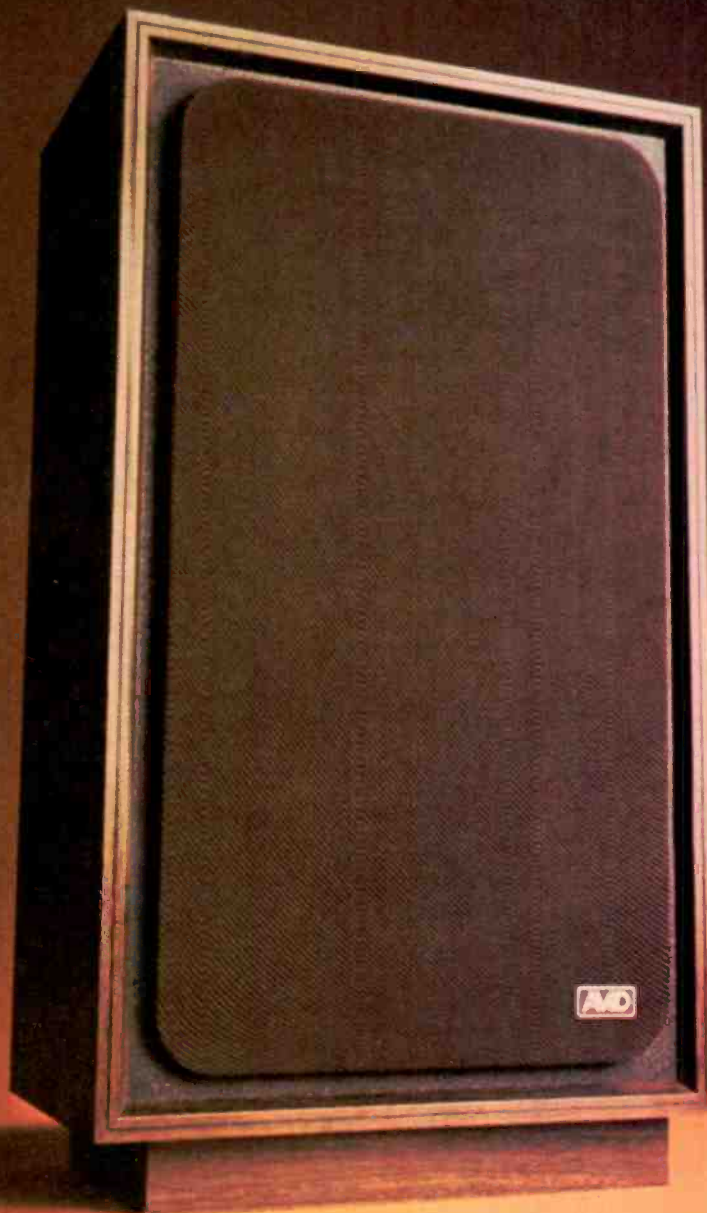

CIRCLE 7 ON READER-SERVICE CARD

AVID.

Avid Corp., 10 Tripps Lane, E. Prov., R.I. 02914. Distributed in Canada by: Kairon Electronics, Montreal, Quebec.



Too Hot to Handle

I have a Kenwood 6340 quad receiver with a plug-in CD-4 demodulator. I recently purchased a four-channel Teac open-reel recorder in order to tape all my CD-4 records. As yet I have been unable to make acceptable recordings due to excessive distortion and the presence of a high-frequency tone in the recording. If the same disc is copied in stereo, the recording comes out beautifully.

I have been able to eliminate the problem in two ways, both of which produce unacceptable recordings: 1) by adjusting the carrier signal level to a point where all separation between front and rear channels is lost; 2) by recording at such low volume on the Teac that playback is plagued with lots of noise. Can you help me out?—John Steigleder, Tarzana, Calif.

We would guess that the carrier frequency from the disc is leaking into the quad output and intermodulating both with the recorder's AC bias and with the audio. If so, the four quad outputs could each go through a high-cut filter before being fed to the tape recorder. If you have access to four channels of Dolby-B noise reduction with FM filtering (which cuts out everything above about 17 kHz to prevent interference between the 19-kHz pilot or the 38-kHz subcarrier and the Dolby circuit), that should eliminate unwanted by-products created by the interaction of the demodulator and the recorder; if these by-products remain, it probably indicates malfunction in the demodulator.

I am very critical of sound quality from a disc. Some discs are so warped that the finest tone arm couldn't possibly track them, and some have pits and mountains on their surfaces. My audio equipment totals \$3,000 but what good does all this do when discs that should never have made it past the quality inspectors (if any) are put on my turntable? I use some of the top quality disc cleaning equipment (Discwasher record cleaner d-II and the Zero-stat), but it has been a big disappointment. I have been thinking of installing some noise-reduction equipment, but I wonder if this would be just a waste of money also.—R. A. O'Briant, F.P.O., Seattle, Wash.

Take heart, help is on the way—a little, at least. We know of some new noise-reduction products in the works and plan to report on them as soon as possible. Generally the record companies insist that they are not receiving many complaints about their products. If you and all other dissatisfied record buyers direct complaints to the offending companies, that might help. And you can't

expect products like Discwasher and Zero-stat to cure manufacturing defects in records. They are intended for cleaning and static reduction, respectively.

I own a Marantz 4300 four-channel receiver. According to specs, it delivers 100 watts [20 dBW] per channel with two, or 40 watts [15 dBW] with four, into 8-ohm loads. Eventually I would like to install a larger power amp in the pre-out section of the Marantz, retaining its preamp section. The rated preamp output is only 1 volt. Is this voltage enough to drive, say, a power amp rated at 100 to 150 watts [20 to 21½ dBW] to full output? I plan to use one power amp for the front channels and one for the back.—Tom Fiore, Brooklyn, N.Y. It depends on the amp. Quite a few in that range can be driven to rated output power by 1 volt, and you really don't need to be too fussy about this since the difference between 1 volt and, say, 1.2 volts at the input is less than 1.6 dB at the output. Most people are hard-pressed to hear a difference that small under normal listening conditions.

I have been using a Citation 12 amp (and Citation 11 preamp) to drive JBL 100s. I have now upgraded my speakers to Ohm Fs. I feel the amp is inadequate and want to buy a higher-powered one.

I play mostly chamber music, solo piano, or small jazz groups, in a room of about 2,000 cubic feet. Although some of the music has a wide dynamic range, I don't play loud rock or loud symphonies very often. Will a Phase Linear 400 function well at such a low level? Will an Ampzilla or a BGW? I have heard that some of the superamps have to work at a certain level before they "wake up."

Which amp would you buy to play such music in such a room with Ohm Fs? Assume an \$800 or \$900 limit.—Dick Wellstood, Sea Girt, N.J.

Any "superamp" that needs an alarm clock to "wake up" is not worth buying. Certainly the Phase Linear, Ampzilla, and BGW work perfectly well at low levels. Why in the world do you want a more powerful amplifier anyway, if you listen at low levels? The principal difference between your Citation 12 and the superamps you are considering is that the latter can drive your speakers about 5 dB louder. The differences at low levels will be even less apparent with the highly inefficient Ohm Fs than with most other speakers.

I have a Pioneer SX-737 receiver and a good outdoor FM antenna with 75-ohm lead-in. My

problem is that multipath distortion occurs when the television set in my living room is on NBC and my receiver is tuned to 101.1 FM. This television is in no way hooked up to my FM antenna, since it has its own antenna. The strange thing is I have a portable set in the same room with my stereo, also hooked up to the TV antenna, and I get no interference from it whatsoever! How do I get rid of this frustrating problem?—Terry Westbrook, Texas City, Tex.

What you have is probably not multipath—though the effect may be similar—but parasitic radiation from the TV set. (The portable set doesn't radiate.) There are several possible remedies: 1) If the FM antenna is directional and has a rotator and if the station comes from a direction that allows it, point the FM antenna away from the TV antenna. 2) Install an FM trap in the TV antenna lead. 3) Enjoy another channel. 4) Keep the TV turned off. 5) Get the TV checked for excessive radiation. 6) Get a new TV set.

A section of a recent JBL ad focused exactly on what interests me the most about loudspeakers: "Take the volume to the edge of silence, then come back a little. Can you hear every part of the music? Are all the textures and detail and harmonics of the music still there, or is only the melody lingering on?"

As an apartment dweller on the verge of component buying, I can't think of a more important aspect of speaker performance. Yet all loudspeaker test reports I've read focus almost exclusively on how well speakers perform loud and super loud. Why don't you include low-volume listening evaluation as well?—Martin Abraham, New York, N.Y.

We do include low-level evaluation in our loudspeaker reviews, although perhaps not in an obvious way. We are concerned with the dynamic range of the speaker, the difference between the loudest and the softest sounds it can reproduce. A range of 65 dB or so will take care of just about anything that can be recorded on disc, but an orchestral performance on a DBX-encoded tape, for example, could demand 80 dB or more range from the speaker. The limiting factor is usually how loud the speaker can play without excessive distortion. The low end is normally not a problem; in fact many speakers do an excellent job of reproducing the residual noise from the power amps driving them. Another probability is that the ambient noise in the room will overwhelm the speaker output while it is still clear as a bell. In any case, it is difficult to see how a loudspeaker could suffer from a disabling low-level aberration without betraying itself at higher levels as well. Therefore, in our opinion, program material of wide dynamic range—from pianissimo to fortissimo—is necessary for evaluation of all aspects of loudspeaker performance. We would suggest, incidentally, that you switch on the loudness (or contour) control if you perform the test outlined in the JBL ad; otherwise the strange frequency response that results may be blamed on the speaker rather than on the nonlinear response of the ear.

The new Dual CS721 is the ultimate expression of the principles that determine the performance of tonearms and drive systems. Its straight-line tubular tonearm pivots horizontally and vertically within a true, four-point gimbal, thus maintaining dynamic balance in all planes.

Another Dual innovation—Vertical Tonearm Control—contributes in yet another way to fine tracking performance. A vernier height adjustment over

The new Dual CS721 represents everything Dual has learned about turntables.

an 8mm range parallels the tonearm to the record with any cartridge. This eliminates the added mass of cartridge spacers otherwise needed to achieve precise vertical tracking angle. In all there are seven tonearm settings and adjustments — from stylus overhang to cueing height and descent speed — all serving to optimize tracking performance with any cartridge.

The direct-drive system of the CS721 is of comparable precision. The electronically-controlled, DC, brushless motor is the smoothest and quietest ever made. A major contribution to this end result is an exclusive Dual feature: two stacked coil layers, each consisting of eight coreless bifilar-wound coils, that overlap to achieve a gapless rotating magnetic field. This eliminates the successive magnetic pulses typical of all other motor designs.

Although the CS721 is Dual's most expensive model, it's hardly the most expensive turntable available today. When you make comparisons, as we believe you should, you may well consider the CS721 considerably underpriced.

Dual

United Audio Products

120 So. Columbus Ave., Mt. Vernon, N.Y. 10553

Exclusive U.S. Distribution Agency for Dual

Straight-line tubular tonearm provides maximum torsional rigidity and lowest effective mass. With the same effective tonearm length and tangential tracking error, any other shape must either sacrifice rigidity or increase mass.

The Dual CS721. Single-play direct-drive turntable with fully automatic start and stop, plus continuous repeat. Features include: 10% electronic pitch control, illuminated strobe, dynamically-balanced 12" platter anti-skating separately calibrated for conical, elliptical and "long-contact" styli. Dual CS704. Similar, except semi-automatic. Mechanical sensor locates lead-in groove of 12" and 7" records; tonearm lifts and motor shuts off at end of play.

Counterbalance contains two mechanical filters, tuned to absorb energy in resonance frequency ranges of tonearm/cartridge system and chassis to avoid feedback.



The Simple Answer is A Complex Solution.

New D3 Fluid

- unmatched function
- unequaled vinyl safety

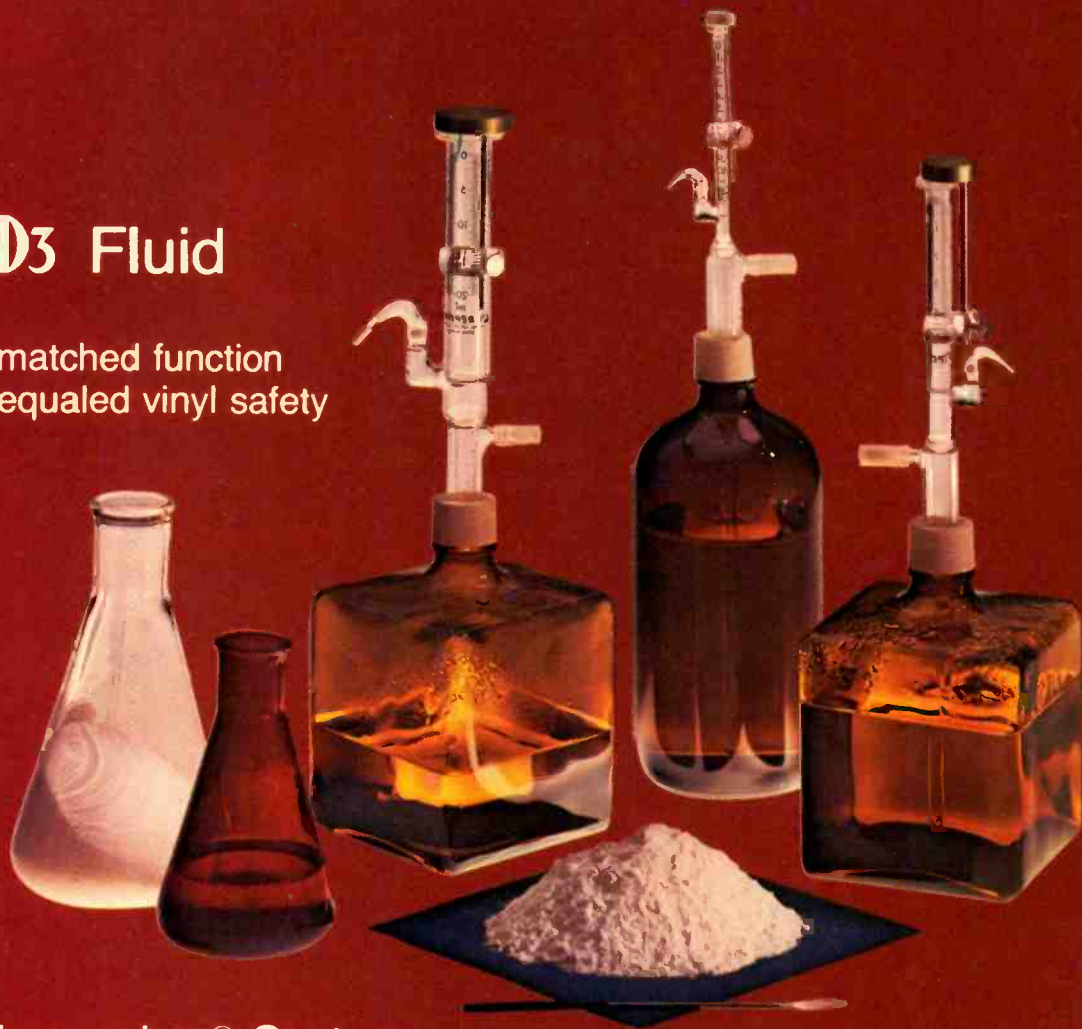

The Discwasher® System:

the best record care
system in the world.



Discwasher Group
Columbia, Missouri

Speaking of Techniques

To talk of a "bravura production line" sounds a little odd, but that's just what we encountered on a recent trip to Japan as one of the guests of Technics.

The full brand name, as most readers must surely know, is Technics by Panasonic; and Panasonic, in turn, is the brand name used in North America by Matsushita Electric. (In most of the rest of the world National or National Panasonic is used.) Matsushita is one of the world's largest corporations, and therein lies the paradox of Technics. While innovation, particularly in this country, often comes from the smaller "specialist" companies devoted exclusively to quality components, Technics is both giant and specialist.

In its plants we were regaled with the performance achievements in forthcoming products and with the astonishingly automated production lines. Matsushita's corporate philosophy, it appears, is to increase both the quantity and the quality of its products, wherever possible, without new personnel (and hence added costs) by designing machinery to accomplish mechanical tasks and moving the liberated operators on to new—and, one hopes, more challenging—tasks. Because its vast resources include in-house design and construction of such automated fabrication and checkout equipment, Matsushita can do things on its production lines that, presumably, small companies could not; because its resources also include heavy investments in research, new-product development can take a very different course from that at the smaller specialty companies.

We were bemused by the difference when, shortly after our return, a spokesman for one of the most respected small American component houses talked to us of his "mad-scientist president"—an epithet applied with some affection. The genus, far from facing extinction in the high

fidelity industry, often is conceived of as a necessity for the industry's survival. At Technics we encountered no mad-scientist syndrome; what we did encounter was enthusiasm, industry, ingenuity, and the evident determination to become leaders in every aspect of stereo reproduction—not just in such specifics as direct-drive turntables, where Technics already occupies a unique niche.

One cannot walk along the Technics production lines—watching machines pop resistors and capacitors into place on circuit boards or, lights flashing, check out a whole series of parameters on a completed board or stack those that pass the tests neatly to one side while it sets those that don't at the other for human investigation—without being impressed. Far from the conventional cookie-cutter, all of whose defects are perforce imposed on all product, this approach presumes a higher degree of quality control, step by step during the manufacturing process, than any high fidelity production line we can recall.

But, curiously, even this automation was not what impressed us most. We had arrived in Osaka, Matsushita's home city, on Sunday evening. Just after lunch on Monday we went to the first of several technical briefings. The program began with a multiprojector slide film designed to define Technics' image of itself as background for all that we were to see and hear in the next few days. Suddenly, as part of the presentation, there we were, on slides, emerging from the Osaka airport. Between Sunday night and Monday noon they had taken the pictures, had them rush-processed, and integrated them into an elaborate slide film. That's class. Aside from the ego trip involved, it displayed—perhaps more clearly than anything else we saw in Japan—that Technics has the resources to accomplish just about anything it has a mind to do.

Tape Ripoffs, Continued

Copycatting of established brands of tape has turned out to be more widespread than we had supposed. Maxell has an imitator based somewhere in the Far East that styles itself Maxwell (with a w) in order to prey on the unwary. The similarity of the two names is sufficient to confuse the hasty shopper, who then owns a poor-quality cassette and is totally without recourse, a Maxell spokesman warns—so it pays to watch spelling as well as package style.

In the meantime, another predator (besides KDK, on which we reported in January) has come to light in TDK clothing, this one calling itself Skymaster. Indications are that there are other bogus names and that Maxell and TDK are not the only brands being imitated. We will try to keep you posted. We can only hope that our readers will protect themselves by using their eyes and their heads and making sure that they are buying what they think they are.

NOW.
GREAT F
PRICE O

FOR THE FEGOOD

There are a lot of good loudspeakers around these days. Especially if you're going to pay \$100 or \$150. Some are pretty good. Some are really good.

But good isn't great.

Introducing Bolivar Speaker Works. We make two loudspeakers. Both are 3-way bookshelf systems. One is \$150; the other \$114. Both are really efficient. (Twice as efficient as the current leader in that price range.) You won't need a big receiver to get a big sound.

The enclosures are the same kind used for expensive loudspeakers, but we finished them in a warm-toned vinyl. No fancy wood veneers. We put the money in the sound.

Come listen to Bolivar. Then listen to any other speaker that costs about the same. You'll buy Bolivar.



Bolivar Speaker Works

Your nearest Bolivar dealer? That's easy. Call (800) 243-6100. In Connecticut, 1-800-882-6500.
Bolivar Speaker Works, Bolivar, Tennessee 38008

Victor Brociner Dies

Victor Brociner, one of the pioneers and guiding spirits of the high fidelity industry—and our “High Fidelity Pathfinder” last September—suffered a fatal heart attack November 24. He was sixty-six years old. Of late vice president for engineering and stereo products of Avid Corpora-

tion, Providence, Rhode Island, Brociner had a long and distinguished career as a uniquely creative engineer. With Avery Fisher and a third partner, he founded Philharmonic Radio. He later headed his own company and subsequently was associated with University Loudspeakers and H. H. Scott. A high fidelity innovator for forty years, he will be sorely missed.

Equipment in the News



Audio Research's new technology in SP-4

Audio Research, known for its adherence to vacuum-tube technology, has developed the Analog Module, a solid-state amplification stage said to act as a super-tube in that it offers the best qualities of the vacuum tube but is even more linear, thus allowing less negative feedback and decreased transient intermodulation distortion. The SP-4 preamp—one of the new units incorporating the Analog Module—is a control center with a phono section that includes an optional low-level head amp for moving-coil cartridges. Other features include tape dubbing as well as monitor switching and a subsonic filter. The SP-4 costs \$695.

CIRCLE 139 ON READER-SERVICE CARD

Ampex' NAB-reel home/pro deck

The ATR-700 from Ampex is an open-reel recorder with variable speed, 10½-inch reel capability, full remote controls, and a built-in 4-in/2-out mixer. It has a three-motor drive system and offers three record/playback formats: full-track, half-track, and quarter-track. The ATR-700 is wired for two-channel operation. Synchronous playback allows the user to record a second channel in sync with the sound on the first channel. Other features are provision for editing, separate switches for bias and equalization, and a pause button for cueing flexibility. The ATR-700 costs \$1,695.

CIRCLE 140 ON READER-SERVICE CARD



Shure equalization analyzer system

The compact Model M-615AS routes pink noise from a built-in generator through your speakers, measures it with a special microphone, and reads the results on a ten-band frequency-spectrum display panel. This information allows adjustment of an accessory room equalizer (such as Shure's own SR-107) so that the energy is balanced in all ten frequency bands. LEDs show whether the energy in a given band is greater or less than desired. There are controls for pink-noise amplitude and input level, a 3-dB-per-octave rolloff switch (typical of most “house curves”), and a HI/LO ENVELOPE control that adjusts the threshold of the HI LEDs relative to the LO LEDs. With all the LEDs off and the envelope control at minimum, frequency response of the measured sound system is claimed to be flat within 2 dB. The system comes complete with analyzer, microphone, cables, and carrying case and costs \$429.

CIRCLE 146 ON READER-SERVICE CARD



Straight talk about direct drive

The DD75 is our first direct drive turntable. It reflects a lot of what we've learned in half a century of building quality turntables.

The heart of any direct drive turntable is the motor. Since it is in direct contact with the platter, it must be as steady—and as free from vibration—as a pacemaker. The performance of the motor is measured by these specifications: rumble, wow and flutter.

But without a lightweight tonearm, unrestrained by friction, the best motor can't deliver high quality, high fidelity sound. After all, the only thing that moves the tonearm is the minuscule stylus tracing the record groove. If the tonearm is heavy, or drags, the sound will be distorted. The specifications which determine tonearm performance—mass and friction—are as important as rumble, wow and flutter.

Direct drive turntables can be manual or automatic. The difference has a direct bearing on record safety. With a manual turntable, you risk scarring your records or damaging your stylus, particularly when lifting the arm off the record. That's because the human hand can't *always* be steady and accurate. The risk is minimized with a system that lifts the arm precisely, automatically.

Motor. Tonearm. Record protection. Convenience. These essentials directed the design of the new direct drive DD75.



The Garrard DD75 delivers rock-steady speed with a DC motor, governed by an electronic servo system. It is totally immune to fluctuations in household current. The specifications are impressive: rumble -70dB (Din B), wow and flutter 0.03%. The same electronic system provides variable speed control, $\pm 3\%$, monitored by an easily-read, illuminated strobe.



Unlike the tonearm in most direct drive turntables, the slender arm of the DD75 is extremely low in mass—just 16 grams. It rides effortlessly on jewel bearings, with friction so low that it will track the finest cartridges at their minimum rated stylus pressure.



In addition to fully damped cueing, the DD75 automatically lifts its tonearm and shuts off the motor at the end of play. This is done *non-mechanically* by a reliable photo-electric circuit. You never have to leap across the room to stop playing the lead-out groove. You can even use this system in mid-record, by lightly touching the *Stop* button. Play can be resumed at the precise point where it was interrupted.



The appearance of the Garrard DD75 fully complements its performance. It is mounted in a base of genuine teak veneer, with shock-absorbent feet to insulate the turntable from external vibration. The tinted dust cover has special friction hinges: it stays where you raise it.

Garrard's first direct drive turntable yields some very direct benefits. Not the least of which is the price: a straight and sensible figure—under \$230.

For an illustrated, detailed folder on the DD75, please write: Garrard Division, Plessey Consumer Products, 100 Commercial Street, Plainview, N.Y. 11803.

Garrard
Turntable specialist for 50 years.



FISHER INTRODUCES THE WORLD'S FINEST RECEIVER.

This headline from any other manufacturer might sound like just so many words. But, it's by Fisher, the company that started the high fidelity industry back in 1937. And the company who introduced the very first AM/FM stereo receiver 18 years ago.

In a sense, we've been building the RS1080 for 40 years . . . researching, engineering, inventing, and refining our technology to finally develop what is surely the world's finest receiver at any price.

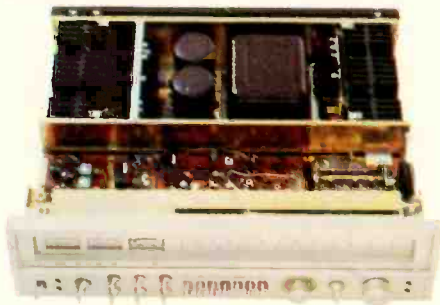

Our RS1080 is rated at an enormous 170 watts per channel, minimum RMS into 8 ohms, from 20 to 20,000Hz with no more than 0.1% total harmonic distortion. There is lots of pure, clean power to give you lots of pure, clean sound at any listening level. But power is only part of why the RS1080 is the world's finest.

Tuning. Precise, accurate tuning is a *must* for FM listening. And the RS1080 includes 3 separate tuning meters: signal strength, center-of-channel, and most



important, a multipath meter with phase-locked-loop circuitry.

FM Dolby. For the ultimate FM listening experience, the RS1080 has built-in, factory calibrated FM Dolby decoder circuitry. This feature lets you hear the full dynamic range of Dolby broadcasted music. Another *must* if a receiver is designed to be the world's finest.

Other state-of-the-art features and specifications include 8-gang tuning, 1.7 μ V FM sensitivity, plus all the front panel controls and rear panel input/output jacks you'll ever need.

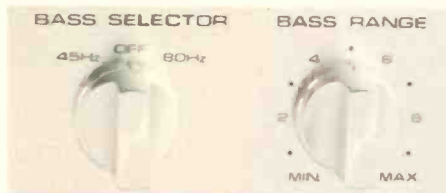

Bass Extender. A major exclusive feature of the RS1080 not found in any other receiver is our bass extender and bass range level control. At a flip of a control you can boost bass response up to 12dB at either 45 or 80Hz. Electrically tuned circuits assure sharp roll-off characteristics, and a tremendously

noticeable improvement in bass response without muddying-up the mid range or increasing hum or rumble. The result is a truly sensational improvement in sound quality in your listening room with any speaker system.

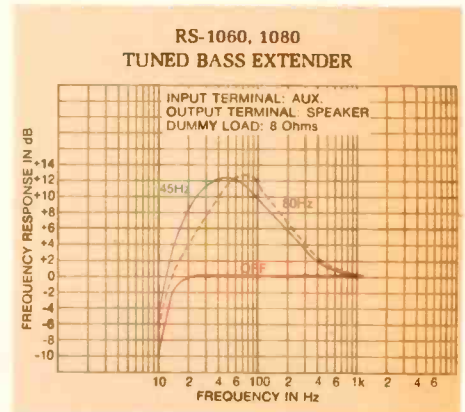

Sure, maybe some late-comer audio manufacturers have good receivers on the market, but at Fisher, we are convinced that our RS1080, priced at \$900*, is the world's finest. Look at and listen to the Fisher 1080. Available at fine audio stores or department store audio departments.

©1977 Fisher Corporation, 21314 Lassen Street
Chatsworth, California 91311

FISHER

The first name in high fidelity.

The New Sansui

A receiver is a many-splendored thing. It is not simply a combination of a tuner, preamplifier and amplifier. It is the skillful matching of all the right elements in the most effective and satisfying proportion, which can only be achieved by the teamwork of highly experienced electronics and acoustical engineers.

That's why only a leader like Sansui can consistently offer you the finest receiver available in each category today. Look at the features and the specifications on these pages and you will agree. And, if you haven't listened to a Sansui recently, do. Put yourself at the controls of a Sansui. You'll know what it is like to be in complete command of your musical destiny.

Take Sansui's new top-of-the-line 9090DB, with power and then some. It offers the convenience of a complete built-in Dolby® system to decode Dolby-FM broadcasts

and to add full noise-reduction facilities to any recorder that lacks them. Twin power meters permit instantaneous power monitoring, and convert at a button's touch to Dolby level indicators. Sansui's unique triple tone controls, with switch-selectable turnover frequencies, give you full control over both the ends of the audible spectrum and over the vital "presence" midrange as well. Truly one of the world's finest receivers.

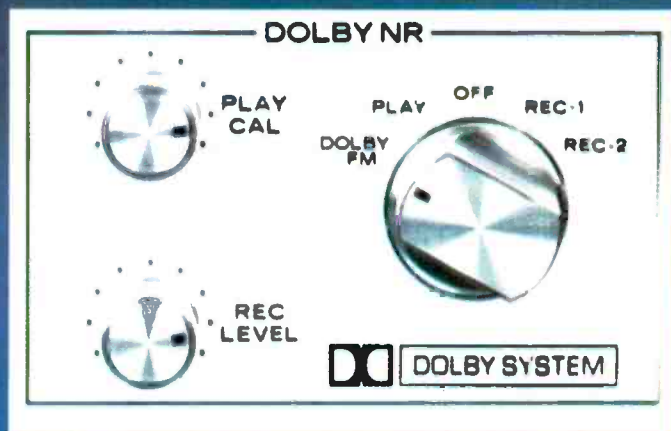

Sansui. The

MODEL 9090DB. (on front page)

AUDIC SECTION

Power Output: 125 watts per channel, min. RMS, both channels driven into 8 ohms from 20Hz to 20kHz with no more than 0.1% Total Harmonic Distortion.

Phono 1, 2: 2.5 mV for full output, RIAA accuracy: ± 0.3 dB, 30Hz to 15kHz. Input Impedance: 50k Ω .

Hum and Noise: better than 80 dB (Aux, Tape); better than 70 dB (Phono).

FM SECTION

IHF Sensitivity: 9.8 dBf (1.7 μ V)

Alternate Channel Selectivity: >85 dB

Signal to Noise Ratio: >70 dB

Stereo Separation: >40 dB

Freq. Resp.: 30Hz to 15kHz, +0.5dB, -2.0 dB

MODEL 9090

Twin power meters

Triple tone controls with turnover selector

Separate tuning and signal-strength meters

7-position source/dubbing switch

Pre/main jacks

20 dB muting switch

3-system speaker selector

25 μ sec FM output for Dolby* adaptor

MODEL 8080DB

Complete built-in Dolby* Noise Reduction

Twin power/Dolby-level meters

Triple tone controls

Separate tuning and signal-strength meters

Pre/main jacks with additional preamp

2 phono inputs

20 dB muting switch

3-system speaker selector



9090

the world's most

SPECIFICATIONS	9090 DB	8080 DB	9090	7070	6060	5050
Power Output Min RMS per channel, both channels driven into 8 ohms at rated Total Harmonic Distortion.	125 watts @0.1% THD	85 watts @0.1% THD	110 watts @0.2% THD	60 watts @0.3% THD	40 watts @0.4% THD	30 watts @0.5% THD
FM Sensitivity	9.8 dBf	9.8 dBf	9.8 dBf	10.3 dBf	10.8 dBf	11.2 dBf
Dolby* Circuitry	Yes	Yes	No	No	No	No
Twin Power Meters	Yes	Yes	Yes	Yes	No	No
9090 and 9090 DB, walnut veneer. All other cabinets simulated walnut grain.						

*Trademark of Dolby Laboratories, Inc.



8080DB

SANSUI ELECTRONICS CORP.

Woodside, New York 11377 • Gardena, California 90247

SANSUI ELECTRIC CO., LTD., Tokyo, Japan • SANSUI AUDIO EUROPE S.A., Antwerp, Belgium • In Canada: Electronic Distributors

Kenwood's latest Dolby deck

The KX-720 is a stereo cassette deck from Kenwood with Dolby noise reduction. The deck uses a 90-millimeter (3.6-inch) flywheel that is said to smooth out speed variations in the drive system for less wow and flutter. Kenwood also uses a new high-density ferrite in the head core for better reproduction of high frequencies. Features include separate two-position bias and equalization controls, de-emphasis switch for recording Dolby FM broadcasts, and cue and review. Frequency response is rated at 30 Hz to 16 kHz with chrome tape. The price of the KX-720 is \$259.95.

CIRCLE 147 ON READER-SERVICE CARD

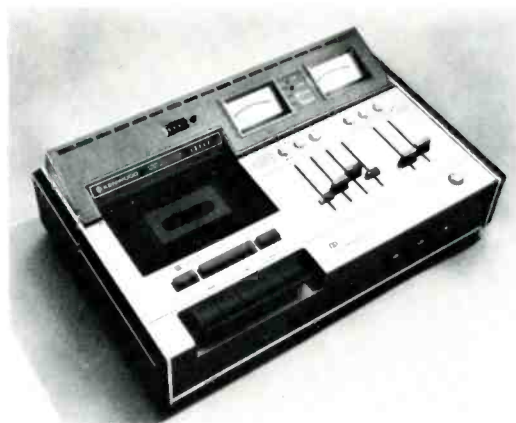

Electronic changer from BIC

British Industries Company has introduced a new belt-drive changer, the Model 1000. It employs two motors: A 24-pole synchronous motor drives the platter, and a second motor controls the cue and change cycle. The platter stops when the tone arm is cued or in cycle. All functions have electronic touch controls and LED indicators. The unit includes a built-in strobe and has a CD-4 position in its antiskating mechanism. The Model 1000 has an optional remote control and a low-mass skeletal cartridge head shell. The plug-in record-support post can be removed for manual operation. The cost is \$279.95.

CIRCLE 148 ON READER-SERVICE CARD

MXR's digital delay system

The Professional Products Group of MXR has announced a digital delay system for stage and studio applications. Basic delay times, selected by pushbutton, run from 0.31 to 480 milliseconds and a regeneration control creates multiple echoes. The front panel has an LED overload indicator, standard 1/4-inch phone jacks for input and output, plus controls for level, sweep, and mix (to blend the delayed and direct signals). A continuous control allows adjustment of delay time from half to twice the selected basic value. The unit comes equipped for rack mounting and bears a suggested list price of \$995; an optional road case costs \$39.50.

CIRCLE 149 ON READER-SERVICE CARD



Heathkit's AR-1515 receiver

Heath Company's newest receiver kit, the AR-1515, displays AM and FM broadcast frequencies with a digital readout rather than a tuning dial. Two meters aid in tuning. The meters, mode indicators, and digital readout are located in a front-panel window for easy viewing. Only five other controls are visible: power on/off, tuning, mode, selector, and volume. The secondary controls, including FM muting, tape-dubbing inputs and outputs, and speaker switches, are behind a hinged panel. Rated power is 70 watts (18½ dBW) per channel from 20 Hz to 20 kHz into 8 ohms with less than 0.08% total harmonic distortion. FM sensitivity is rated 1.8 microvolts (10½ dBf) and selectivity at 100 dB. The price of the AR-1515 is \$549.95. Also available are kits for the AA-1515 amplifier section (\$299.95) and the AJ-1515 tuner section (\$379.95).

CIRCLE 150 ON READER-SERVICE CARD



Model 9090DB



receivers.

5050



6060



music.

distinguished

MODEL 7070

Twin power meters
Triple tone controls
Separate tuning and signal-strength meters
7-position source/dubbing switch
2 phono inputs
20 dB muting switch
25 μ sec. FM output for Dolby* adaptor
Mic mixing input with level control

MODEL 5050

Separate tuning and signal-strength meters
25 μ sec. FM output for Dolby* adaptor
Mic mixing input with level control
2-system speaker selector
Pushbutton high filter
Mode and loudness switches

MODEL 6060

Separate tuning and signal-strength meters
25 μ sec. FM output for Dolby* adaptor
Mic mixing input with level control
2-system speaker selector
Pushbutton high/low filters
Mode and loudness switches



7070



A whole new world of beautiful



Bohsei deck offers bidirectional playback

The IT-1000, an open-reel tape deck from Bohsei Enterprise Company, U.S.A., has 10½-inch reel capacity, three motors, full-logic solenoid-actuated tape motion, and mike and line inputs. Auto reverse, using a second playback head (for a total of four) provides up to 8½ hours of uninterrupted playback. The transport operates at 7½ or 3¾ ips. At 7½ ips, wow and flutter is rated at 0.06%, signal-to-noise ratio at better than 55 dB, and frequency response at 30 Hz to 20 kHz, ± 3 dB. The IT-1000 costs \$1,075.

CIRCLE 151 ON READER-SERVICE CARD

New power-display system in 2400L

SAE's power amplifier, the 2400L, has a new power-display system that reads output in 3-dB steps from 40 milliwatts (-14 dBW) to 200 watts (23 dBW) per channel plus overload. Response imbalances and imaging are indicated immediately by the amp's fast-response circuitry. Power indication is said to be accurate even at the lowest levels. The amplifier is basically the SAE 2400, rated at 200 watts (23 dBW) per channel with less than 0.05% distortion. Signal-to-noise ratio is rated at better than 100 dB. The 2400L, which is designed for stability even with the most reactive loads and includes a feedback level control that does not affect noise level, frequency response, or input impedance, sells for \$800.

CIRCLE 141 ON READER-SERVICE CARD



Monitor-head cassette deck from Technics

The RS-9900US from Technics is a cassette system divided into two separate stackable units. One houses the tape transport, the other the electronics. The transport has a three-motor, dual-capstan, closed-loop drive. Separate recording and playback heads permit maximum playback performance and tape monitoring. The transport has Dolby noise reduction, peak-reading meters, and a calibration oscillator for Dolby-level and head azimuth adjustments. A tape-timer meter indicates in minutes how much program time is left on the cassette. Pitch control allows adjustments in tape speed over a range of ± 5%. Frequency response is rated at 20 Hz to 20 kHz with chrome tape, wow and flutter at 0.04%. The price of the RS-9900US is \$1,500.

CIRCLE 142 ON READER-SERVICE CARD

Sansui's newest receiver

The 9090DB is the top model in Sansui's current receiver line. Dolby decoding for FM is provided, as well as encoding and decoding for use with non-Dolby tape decks. The front panel features triple tone controls, two headphone jacks, high and low filters, and a -20-dB muting switch. Inputs are provided for two tape decks, two turntables, and aux, and the receiver can handle up to three pairs of speakers. Rated power is 125 watts (21 dBW) per channel from 20 Hz to 20 kHz into 8 ohms with no more than 0.1% total harmonic distortion. The 9090DB costs \$750.

CIRCLE 143 ON READER-SERVICE CARD

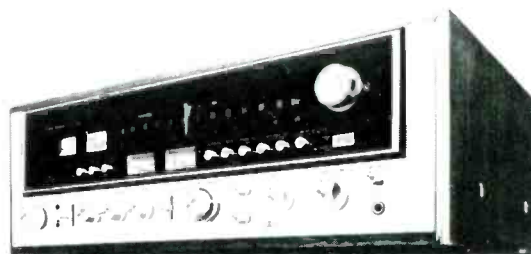

CIRCLE 48 ON READER-SERVICE CARD →

The Sensuous Speaker.

Yamaha's new two-way beryllium dome NS-500.

A very responsive speaker with a rich, luscious sound. Highly defined, finely detailed. A deeply involving sound.

In a word, sensuous.

With the NS-500, you get all of beryllium's advantages (transparency, detail, and lack of distortion that go beyond the best electrostatic speakers), but at a price roughly half that of the NS-1000. Only \$500 the pair, suggested retail price.

The joy of beryllium.

The ideal dome material for a high frequency driver must respond instantly to changes in amplitude and frequency of the input signal. So the ideal dome material must be virtually weightless as well as extremely rigid.

Beryllium is the lightest and most rigid metal known. Its density is less than two-thirds that of commonly used aluminum, and its rigidity is almost four times as great — thus preventing dome deformation and consequent distortion. What's more, beryllium's sound propagation velocity is twice that of aluminum.

The beryllium dome found on the NS-500's high frequency driver is the world's lightest — about half the weight of one petal of a small sweet-heart rose. Which is one of the reasons for this speaker's exceptional sensitivity and response. And for its sensuous sound.

A closer look.

To be able to offer the sophistication of beryllium at a more affordable price, without sacrificing quality of performance, Yamaha designed the NS-500 as a two-way bass reflex system.

This gives the NS-500 a trace more emotion at the low end than the resolutely objective NS-1000. But it also gives the NS-500 more efficiency (91dB SPL at one meter with one

watt RMS input). Which means you don't have to invest in the highest powered amplifiers or receivers in order to drive the NS-500 to its full rated output.

For an optimum match with the beryllium tweeter, Yamaha developed a very light, very rigid "shell" woofer. And a special hermetically-sealed air core LC crossover with a carefully selected 1.8kHz crossover point.

As a result of these design parameters, the NS-500 boasts an insignificant 0.03% THD below 50dB SPL, from 40Hz to 20kHz, making it the perfect complement to Yamaha's state-of-the-art low distortion electronics.

Underneath the sleek monolithic styling of its solidly crafted enclosures, the NS-500 is full of many exclusive Yamaha features and distinctive Yamaha touches of craftsmanship.

But to fully appreciate the beauty of the NS-500, you really should visit your Yamaha Audio Specialty Dealer.

And if you're not familiar with the name of your local Yamaha Audio Specialty Dealer, drop us a line. In turn, we'll also send you a free preprint of the Audio Engineering Society paper on Yamaha beryllium technology mentioned above.



 **YAMAHA**

P.O. Box 6600, Buena Park, CA 90622

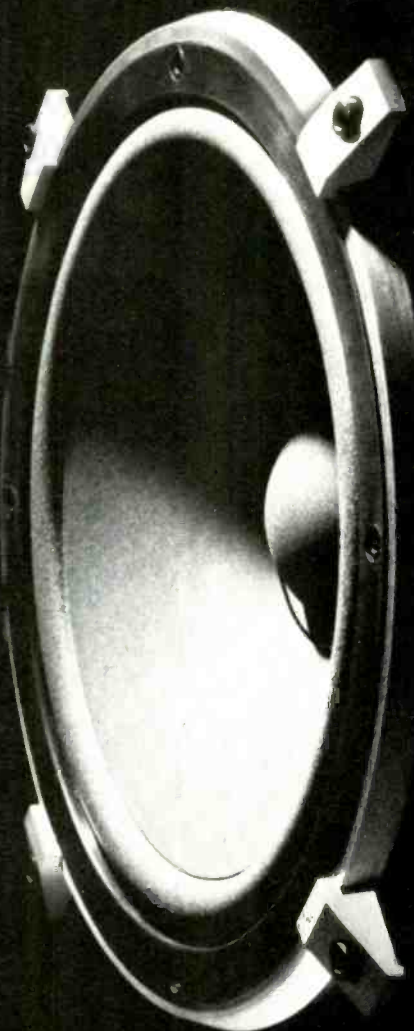

THE GAP BETWEEN OTHER TAPES HAS

INTRODUCING UD-XL I AND UD-XL II.

Maxell tapes have always been considered by many people to be the highest quality tapes in the world.

But instead of sitting back and resting on our laurels, we've spent the last few years looking for ways to move even further ahead.

The results of our efforts are Maxell UD-XL I and UD-XL II. Two tapes which are not only better than anything we've ever made, they're better than anything anyone's ever made.

To begin with, UD-XL I is an improved version of our own UD-XL.

More specifically, it's a ferric oxide tape designed for use with the tape selector switch in the normal position (120 microsecond equalization and standard bias).

Its performance characteristics include the lowest harmonic distortion level of any premium cassette on the market today.

An extremely flat frequency

Saturation Comparison at 8 kHz

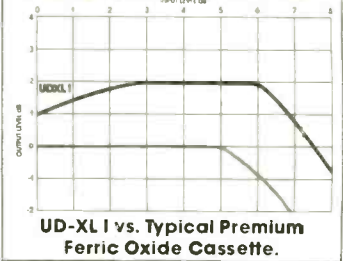

UD-XL I vs. Typical Premium Ferric Oxide Cassette.



MAXELL AND ALL JUST WIDENED.

Signal-to-Noise Ratio Comparison

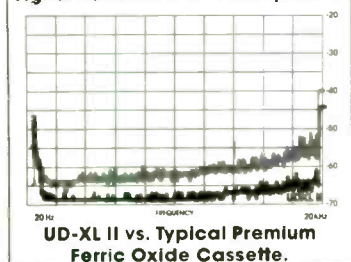

response from the lowest to the highest frequencies.

And an exceptionally high resistance to saturation even

at the highest recording levels.

UD-XL II, on the other hand, is a ferric oxide tape specially formulated for use with the tape selector switch in the chrome position (70 microsecond equalization and high-level bias). It offers the low noise advantage of "chrome"

without the disadvantages. Its performance characteristics include extremely low modulation noise and a 5 dB signal-to-noise ratio improvement over ordinary premium tapes.

If you'd like to know more about UD-XL I and UD-XL II, stop into your local dealer and ask some questions. Not just about our tapes, but about our competitors' as well.

We think you'll soon discover something that we've always known.

The best just keeps getting better.

MAXELL. THE TAPE THAT'S TOO GOOD FOR MOST EQUIPMENT.

Maxell Corporation of America, 130 West Commercial Ave., Moonachie, N.J. 07074.

CIRCLE 22 ON READER-SERVICE CARD



Empire's Blueprint for Better Listening...

No matter what system you own, a new Empire phono cartridge is certain to improve its performance. The advantages of Empire are threefold. One, your records will last longer. Unlike other magnetic cartridges, Empire's moving iron design allows our diamond stylus to float free of its magnets and coils. This imposes much less weight on the record surface and insures longer record life.

Two, you get better separation. The small, hollow iron armature we use allows for a tighter fit in its positioning among the poles. So, even the most minute movement is accurately reproduced. Give you the space and depth of the original recording. Three, Empire uses 4 poles, 4 coils, and 3 magnets (more than any other cartridge) for better balance and hum rejection. The end result is great listening. Audition one for yourself or write for our free brochure, "How To Get The Most Out Of Your Records." After you compare our performance specifications we think you'll agree that, for the money, you can't do better than Empire.

Empire Scientific Corp., Garden City, New York 11530

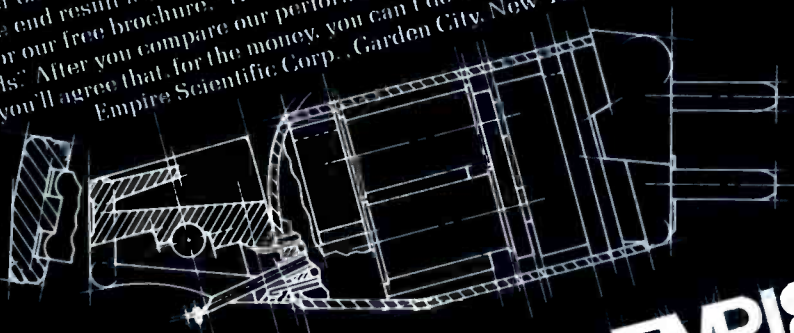

EMPIRE
Already your system sounds better.

MODEL	4000 D/III	4000 D/II	4000 D/I	2000Z	2000 E/III	2000 E/II	2000 E/I	2000 E	2000
FREQUENCY RESPONSE	10Hz-50KHz ± 3 db	15Hz-50KHz ± 3 db	15Hz-45KHz ± 3 db	20Hz-20KHz ± 1 db	20Hz-20KHz ± 2 db	20Hz-20KHz ± 2 db	20Hz-20KHz ± 3 db	20Hz-20KHz ± 3 db	20Hz-20KHz ± 3 db
TRACKING FORCE RANGE	¾-1¼ gm	¾-1½ gm	1-1¾ gm	¾-1¼ gm	¾-1½ gm	¾-1½ gm	1-2 gm	1¼-2½ gm	1½-3 gm
SEPARATION: 15Hz to 1KHz 1KHz to 20KHz 20KHz to 50KHz 20 Hz to 500Hz 500Hz to 15KHz 15KHz to 20KHz	28 db 23 db 15 db	26 db 21 db 15 db	24 db 20 db 15 db	20 db 30 db 25 db	20 db 28 db 20 db	20 db 25 db 18 db	18 db 23 db 15 db	18 db 23 db 15 db	16 db 21 db 13 db
I. M. DISTORTION @ 3.54 cm/sec	2% 2KHz-20KHz	2% 2KHz-20KHz	2% 2KHz-20KHz	08% 2KHz-20KHz	1% 2KHz-20KHz	15% 2KHz-20KHz	2% 2KHz-20KHz	2% 2KHz-20KHz	2% 2KHz-20KHz
STYLUS	.2 mil bi-radial	.2 mil bi-radial	.2 mil bi-radial	2 x .7 mil elliptical	2 x .7 mil elliptical	2 x .7 mil elliptical	2 x .7 mil elliptical	3 x .7 mil elliptical	.7 mil radius spherical
EFFECTIVE TIP MASS	4 milligram	4 milligram	4 milligram	2 milligram	6 milligram	6 milligram	6 milligram	9 milligram	1 milligram
COMPLIANCE	30x10 ⁻⁶ cm/dyne	30x10 ⁻⁶ cm/dyne	30x10 ⁻⁶ cm/dyne	30x10 ⁻⁶ cm/dyne	20x10 ⁻⁶ cm/dyne	18x10 ⁻⁶ cm/dyne	17x10 ⁻⁶ cm/dyne	16x10 ⁻⁶ cm/dyne	14x10 ⁻⁶ cm/dyne
TRACKING ABILITY	32 cm/sec @ 1KHz @ 1 gm	32 cm/sec @ 1KHz @ 1¼ gm	30 cm/sec @ 1KHz @ 1½ gm	38 cm/sec @ 1KHz @ .9 gm	32 cm/sec @ 1KHz @ 1 gm	28 cm/sec @ 1KHz @ 1¼ gm	28 cm/sec @ 1 KHz @ 1½ gm	28 cm/sec @ 1KHz @ 1¾ gm	32 cm/sec @ 1KHz @ 2 gm
CHANNEL BALANCE	within 1 db @ 1KHz	within 1 db @ 1KHz	within 1½ db @ 1KHz	within ¾ db @ 1KHz	within 1 db @ 1KHz	within 1¼ db @ 1KHz	within 1½ db @ 1KHz	within 1½ db @ 1KHz	within 1½ db @ 1KHz
INPUT LOAD	100K ohms/ channel	100K ohms/ channel	100K ohms/ channel	47K ohms/ channel	47K ohms/ channel	47K ohms/ channel	47K ohms/ channel	47K ohms/ channel	47K ohms/ channel
TOTAL CAPACITANCE	under 100 pf/channel	under 100 pf/channel	under 100 pf/channel	300 pf/channel	400-500 pf/channel	400-500 pf/channel	400-500 pf/channel	400-500 pf/channel	400-500 pf/channel
OUTPUT @ 3.54 cm/sec	3 mv/channel	3 mv/channel	3 mv/channel	3 mv/channel	4.5 mv/channel	4.5 mv/channel	7 mv/channel	7 mv/channel	7 mv/channel

Preparation supervised by
Robert Long and Harold A. Rodgers
Laboratory data (unless otherwise noted)
supplied by CBS Technology Center

New A CONSUMER'S GUIDE Equipment Reports

Micro Seiki DDX-1000— Lean and Classic

The Equipment: Micro Seiki DDX-1000 turntable system, a two-speed (33, 45 rpm) single-play, manual turntable plus control unit in metal case. Dimensions: 17½ by 17½ inches (top), 5 inches high plus clearance for arm adjustment accessibility; control unit, 6¾ by 3¾ inches (top), 3¼ inches high plus clearance for controls; approx. 3-foot interconnect cable. Price: \$600. Warranty: "limited," two years parts and labor. Manufacturer: Micro Seiki Co. Ltd., Japan; U.S. distributor: Teac Corporation of America, 7733 Telegraph Rd., Montebello, Calif. 90640.

Comment: If a turntable were distilled to its irreducible minimum, what would be left? Presumably there would have to be a platter on which the disc rides, plus some means for guiding and supporting the cartridge as the stylus performs the exacting task of tracing out the grooves. When you look at the Micro Seiki DDX-1000, that's all you see: a platter and an arm. Of course, there has to be more to the product, but its appearance tells a lot of its story. The emphasis is on elegantly refined basics.

An astute observer would notice that the vertical stripes that decorate the outer rim of the platter constitute a strobe pattern. Illumination for it comes from a neon lamp enclosed in a small outboard pod and driven by its own oscillator—which the manufacturer claims is almost ten times as accurate as an AC-power-line reference. Control of the unit is by means of an external module connected to the main section by an umbilical cord. The mounts for tone arms (you can use as many as three) are integral with the adjustable feet that support the turntable and isolate it from external vibrations.

Accuracy of speed as measured by CBS labs is excellent.

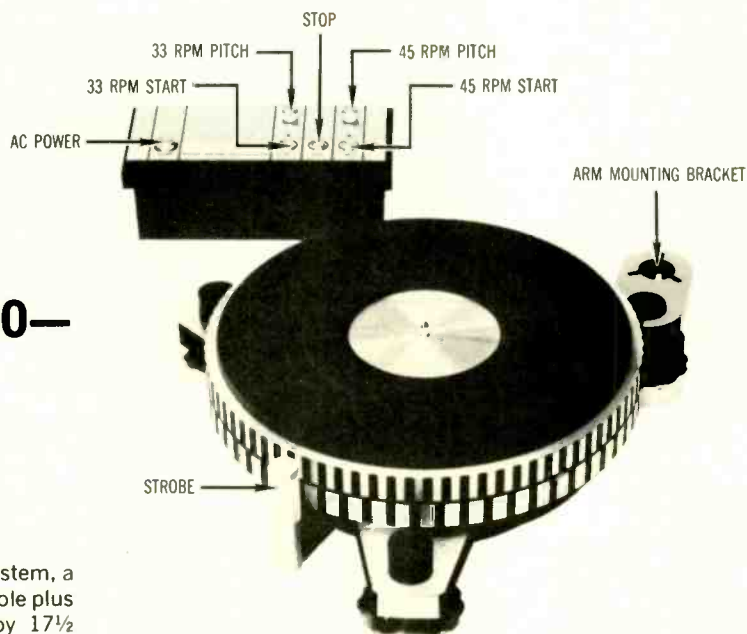

Set to either 33 or 45 rpm with an initial supply voltage of 120 VAC, the turntable shows no measurable deviation at 105 or 127 VAC. The range through which the speed can be varied exceeds the $\pm 6\%$ (equivalent to about a semi-tone sharp or flat) specified by the manufacturer at both 33 and 45 rpm. Stability of movement is on a par with speed accuracy, with the lab data substantially confirming the 0.025% claimed for wow and flutter. Similarly, rumble is suppressed by slightly more than 63 dB as measured using the CBS ARLL weighting. The motor torque and servo action of the DDX-1000 combine to provide locked speed in less than two seconds (one revolution at 33) after turnon.

No tone arm is supplied, and the AX-1 mount accepts thirty-five of the more popular arms, with the notable exception of the SME-3009, for which a special mount (AX-2)

REPORT POLICY Equipment reports are based on laboratory measurements and controlled listening tests. Unless otherwise noted, test data and measurements are obtained by CBS Technology Center, Stamford, Connecticut, a division of Columbia Broadcasting System, Inc., one of the nation's leading research organizations. The choice of equipment to be tested rests with the editors of HIGH FIDELITY. Manufacturers are not permitted to read reports in advance of publication, and no report, or portion thereof, may be reproduced for any purpose or in any form without written permission of the publisher. All reports should be construed as applying to the specific samples tested; neither HIGH FIDELITY nor CBS Technology Center assumes responsibility for product performance or quality.

can be ordered. Micro's own MA-505 tone arm, which costs an additional \$150, is adjustable for height, vertical tracking force, and antiskating force while a disc is being played; overhang is adjustable as well.

A turntable that is doing its job properly makes for an anticlimactic listening test, and so it was with the Micro Seiki. We soon found ourselves taking the performance of the unit completely for granted. The multiple-tone-arm feature is a big plus, as it allows easy A/B testing of phono cartridges and tone arms. It even allows those who are superfluous to reserve certain arm/cartridge combinations

for particular types of music. One minor point troubles us a little: There is no dust protection supplied with the turntable—although there are not many surfaces where dust can collect.

Obviously, a turntable at this price is not Everyman's bargain, but the engineering and construction that one has a right to expect for this much money are there without a doubt. The DDX-1000 has features that are unique in our experience, and its striking appearance is a direct result of the engineering thought that has gone into it.

CIRCLE 131 ON READER-SERVICE CARD

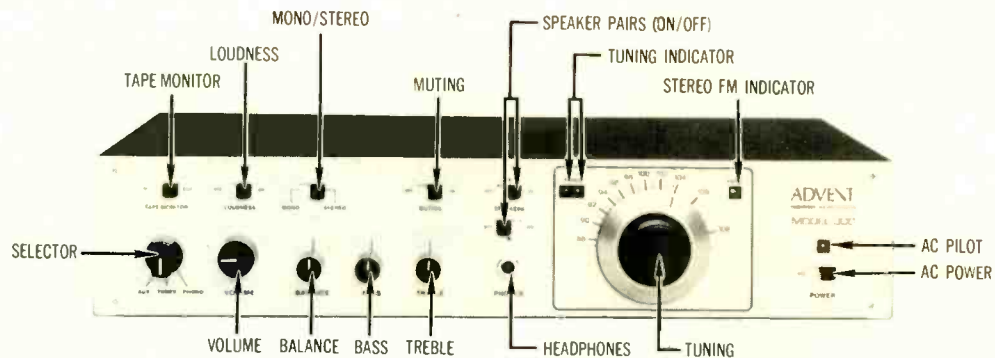

Advent's 300 Receiver: Simple Is Beautiful

The Equipment: Advent 300 stereo FM receiver in metal case. Dimensions: 15 $\frac{3}{8}$ by 3 $\frac{1}{2}$ inches (front panel), 9 $\frac{1}{8}$ inches deep plus clearance for controls and connections. Price: \$259.95. Warranty: "limited," three years parts and labor. Manufacturer: Advent Corporation, 195 Albany St., Cambridge, Mass. 02139.

Comment: If it were possible to devise a performance-to-appearance ratio for audio products, those of Advent Corporation would, in all likelihood, be strong contenders for top honors. It's not that they don't look good, but that there has been no attempt to make them into sculptures. The value (and thus the cost) has been put inside the box and is directed at the consumer's ears, not his eyes. And, typically, the resulting sound has been very good. This is the tradition that the 300 springs from and is meant to advance—and as far as we are concerned the advance has been made.

The FM section is spartan in its simplicity and has nary a meter in sight. Channel-center tuning is accomplished—and very effectively—by setting a pair of light-emitting diodes (one indicates "too high," the other "too low") for equal brightness. Antenna rotation for minimum multipath is done by ear—even the scope outputs are missing. But, as the CBS data show, the goodies are there. The 1 $\frac{1}{4}$ -dB capture ratio, comparable to that of far more expensive equipment, will help a lot in getting rid of that multipath, and the alternate-channel selectivity (74 dB) falls in the good-to-excellent class. Suppression of stereo noise by 50 dB is accomplished with an RF input of just over 39 dBf, a signal level easily come by in urban and near-urban environments. Total harmonic distortion (which includes miscellaneous spurious products as well as distortion) is kept

well in check, even at 10 kHz, where it can often be troublesome. Separation could almost be mistaken for that of a supertuner. In fact, when reasonably strong signals are available, it is amazing how closely the FM sound of the Advent resembles that of tuners—without a preamp and power amp—whose prices are close to twice as much.

Perhaps the most striking feature of the 300 is its new phono preamp circuit. Its measurements are respectable enough (signal-to-noise ratio of 65 $\frac{1}{2}$ dB re full output, equivalent to 76 $\frac{1}{2}$ dB noise suppression re the conventional 10 millivolts; 100-millivolt overload; RIAA equalization accurate to within ± 1 dB, 20 Hz to 20 kHz despite a nondefeatable rumble filter), but conventional measurements don't tell the whole story. The key question is: What will it sound like with a cartridge rather than a test generator connected, when it has to operate with a complex source impedance? Advent's engineers have studied this matter in depth and have designed the circuit for minimal impedance interaction. We found that an otherwise fine pickup that seemed somewhat shrill was much smoother than we had thought possible—when it was connected to the Advent preamp. This tends to support the company's boast that the 300 will audibly surpass many far more expensive units.

Of all the features of a receiver, power is probably the most costly, and by today's standards the output of this model appears modest. But realistically the 11 $\frac{3}{4}$ dBW (15 watts) per channel—40 Hz to 20 kHz at 0.5% distortion—offered is perfectly adequate for most listening. With moderately efficient speakers, we were able to generate substantial sound pressure levels before clipping set in. And the recovery from clipping, an important consideration in a small amp, is instantaneous and graceful. Had Advent

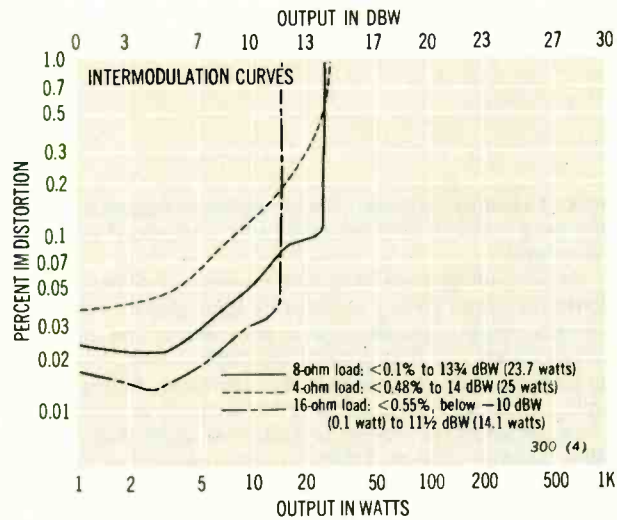
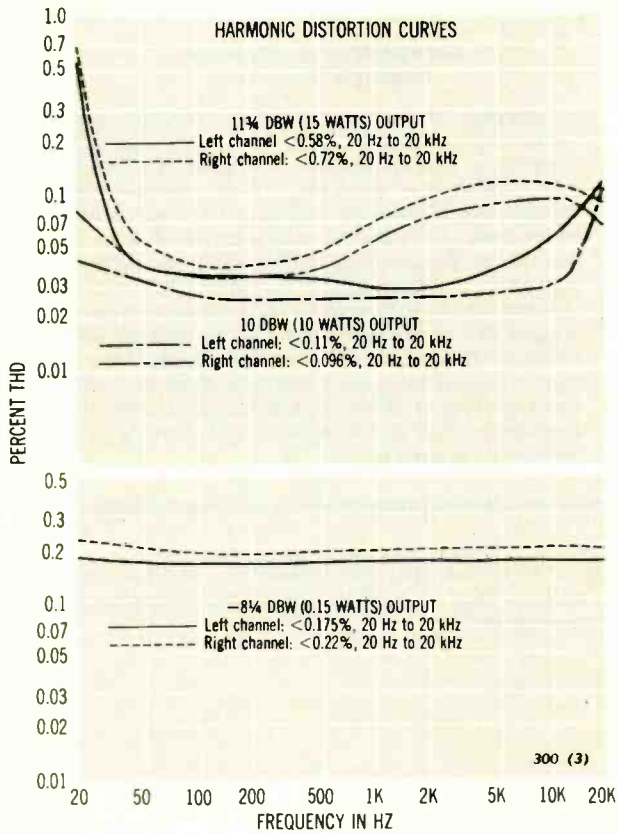

Square-wave response

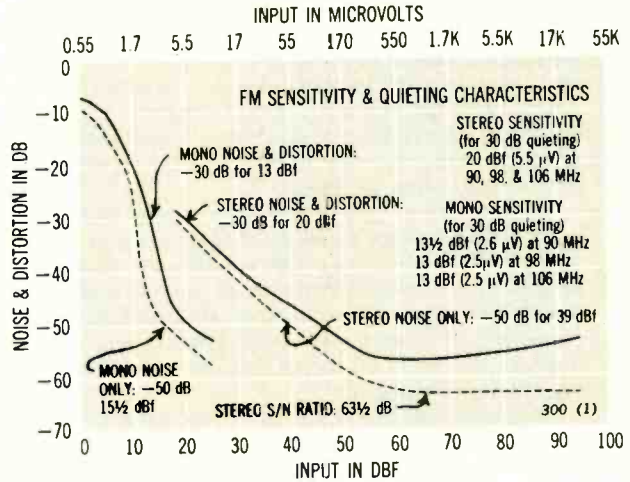

Advent 300 Receiver Additional Data

Tuner Section			
Capture ratio	1½ dB		
Alternate-channel selectivity	74 dB		
S/N ratio (mono, 65 dBf)	66 dB		
THD	Mono	L ch	R ch
80 Hz	0.11%	0.18%	0.16%
1 kHz	0.12%	0.15%	0.14%
10 kHz	0.25%	1.05%	1.15%
IM distortion	0.18%		
19-kHz pilot	-69 dB		
38-kHz subcarrier	-58 dB		
Frequency response	mono + ½, -1½ dB, 20 Hz to 15 kHz		
L ch	+¾, -2 dB, 20 Hz to 15 kHz		
R ch	+1, -2½ dB, 20 Hz to 15 kHz		
Channel separation	>40 dB, 190 Hz to 4.2 kHz		
	>30 dB, 20 Hz to 13 kHz		
Amplifier Section			
Power output at clipping (channels driven simultaneously)	L ch 12¼ dBW (17 watts) for 0.10% THD		
	R ch 12½ dBW (18 watts) for 0.09% THD		
Frequency response	+0, -½ dB, 20 Hz to 10 kHz		
	+0, -1 dB, 15 Hz to 30 kHz		
RIAA equalization	±1½ dB, 20 Hz to 20 kHz		
	+1½, -0 dB, 40 Hz to 20 kHz		
Input characteristics (for rated output at full gain)	Sensitivity	Noise	S/N ratio
phono	2.75 mV	-53¾ dBW	65½ dB
tape	110 mV	-63¾ dBW	75½ dB
aux	110 mV	-63¾ dBW	75½ dB
Phono overload (clipping point)	100 mV at 1 kHz		
Damping factor at 1 kHz	48		

chosen to rate the power section a tiny 1¼ dB lower, at 10 dBW (10 watts) per channel, the power bandwidth (FTC style) would extend 20 Hz to 20 kHz and distortion diminish to less than half the rated amount. Thus the 300 has substantially half the sonic output capability of a good-quality 20-dBW (100-watt) per channel power amp. If you must have more than this, removal of two jumpers makes the preamp output accessible.

These jumpers, connecting PRE-OUT and MAIN-IN pin jacks, are on the back panel, which is generally as spartan as the front. There is only a 300-ohm FM antenna input for example (if you use 75-ohm lead-in, you can couple it to the 300 via a balun transformer), and there is a single (switched) AC convenience outlet. There is one "extra," however; an 18-volt DC output that can be used to power the Advent mike preamp.

The basic simplicity of the control section is consistent with the principal features of the unit. Tone-control and LOUDNESS responses seem well judged, as are the FM muting and automatic stereo switching.

The design is, over-all, economical and without frills. Advent's announced intention with the 300 is to make a receiver that, within its power capability, sounds as good as anything available at any price. While we cannot substantiate that claim—it is, after all, a partially subjective one—



The Equipment: Stax SR-44 Earspeaker, an electrostatic stereo headphone system with adapter for connection to loudspeaker terminals. Dimensions: (adapter box) 3½ by 2½ inches (front panel), 6¼ inches deep plus clearance for controls and connections; weight: (headset) 7 ounces, excluding cord. Price: \$85. Warranty: "limited," one year parts and labor. Manufacturer: Stax Industries, Ltd., Japan; U.S. distributor: American Audioport, Inc., 1407 North Providence Rd., Columbia, Mo. 65201.

Comment: The Stax SR-44 headset is similar to the SRX MK. 3 (HF, March 1976) in principle and operation except that an electret is used to provide the internal electrostatic field for the drivers. This allows a considerable simplification in the adapter unit—which now needs only to step up the driving signal to the requisite high voltage and provide protection against overload—and allows a dramatic reduction in price. The SR-44 is of fairly high efficiency and, while it must be connected to a loudspeaker output rather than a headphone jack, works very well with a modest

Cartridge-Preamp Interaction: Tracking Down a Glitch

In our review of the Sonus Blue Label cartridge (September 1976), we complained of an edginess that creeps in at high frequencies. At the time we investigated the matter carefully, playing the cartridge through several preamps—including the phono section of the Crown IC-150A—that had been giving us excellent results. We were delighted to find, therefore, that connecting the Sonus Blue to the Advent 300 receiver virtually banished the edginess. Comments from users suggest that the Advent is not the only preamp with which the Sonus can produce similar results. Accordingly, we would revise our conclusions about the Sonus and say that the excellent performance at lower frequencies extends to the highs as well—as long as a compatible preamp is used.

we cannot dismiss it as untenable either. And that, considering the price of the product, constitutes a remarkable accomplishment.

Stax SR-44 Sounds like a Dream

amount of amplifier power. Rated maximum output is 110 dB sound pressure level, enough to fry your ears if you're not careful.

The ear pads of these fairly light phones are exceedingly comfortable and form a sufficiently tight seal to the ear without undue pressure. The drivers are of the open-backed variety and thus provide little attenuation of external sounds. They do, however, very effectively relieve the feeling of partial deafness that one often experiences with a headset when the level in one channel drops markedly below the other. The cord that connects the adapter to the headset is a bit more than 8 feet long and provides ample freedom of movement. The color-coded cable that connects to the amplifier is about 3 feet long—a trifle skimpy, in our opinion, since extending it would require splicing. We would have preferred a set of input terminals that allow the user to connect the length of cable he needs. The loudspeaker terminals pre-empted by the SR-44 are duplicated on the back of the adapter; they and the cable seem adequate for anything short of extremely inefficient speakers driven by a monstrosously powerful amp.

According to data provided to us by American Audioport, the frequency response of this headset lies, with two exceptions, well within the range that would be interpreted by the average ear as flat—that is to say, without unnatural coloration. We did not seek to prove or disprove this except

by listening, and what we heard was superb. Music was reproduced with a clarity and immediacy that was astonishing and that led us to prolong the testing session simply for pleasure. One of the exceptions alluded to above is a slight rolloff that begins at about 80 Hz and reaches a mere 2 dB down at 20 Hz. If it bothers you—we hardly noticed it except on test signals—it is easy to equalize out, for the SR-44 is as free of audible bass distortion as any headset we have ever heard.

The other exception is a dip a little more than an octave wide centered just above 3 kHz. As the importer indicates, this dip, far from being troublesome, has the effect of suppressing a good deal of the noise and scratchiness that contaminates just about all program material to some degree and that becomes particularly noticeable in headphones. We found that we prefer the sound of the SR-44 over that of some other headsets that may be technically more accurate but that tend to be merciless in exposing the peccadillos of the program. This is a headset that will not make you hate your record collection—in fact, quite the contrary.

One of the perennial problems of headphone listening is that unless the program material is specially prepared—binaurally recorded—the spatial presentation is not really natural. This applies to the Stax phones too, but there is a difference. The music seems to come from inside your head, but so vividly that it is like a dream. The effect is close to hypnotic. We can't guarantee that the SR-44 headset will sound that way to you, but if headphones are your thing, we do suggest that you try it. You may be in for quite a treat.

CIRCLE 133 ON READER-SERVICE CARD

A Note on Headphone Response

Flat frequency response is one of the basic shibboleths of high fidelity—justifiably so in the case of electronics, in which it is possible to measure from the input to output terminals and verify that the signal that comes out is substantially the same as what went in except for desired changes, in amplitude, for instance. For loudspeakers and headphones, however, this criterion simply does not apply. As one expert has pointed out, the phrase "output terminals" does not have any distinct meaning for a loudspeaker. The output of a headphone is clearly defined, but since the manner in which the drivers couple to the ear effectively bypasses the natural "signal processing" performed by the outer ear—which has anything but a flat frequency response—the measurement conundrum is about as bad as it is for loudspeakers. Complicating matters still further is the fact that no two ears are the same—not even the left and right ears of the same person.

Some research has been addressed to this point, and a set of limiting curves, between which the response of a properly made headphone should lie, has been determined. This is helpful to the designer, but it does not tell how any particular headset will sound to you. As with loudspeakers, the only way to tell how well a headphone reproduces music is to listen. Test reports are useful guidelines, but the final decision must be yours. All we are using as test equipment is our ears.

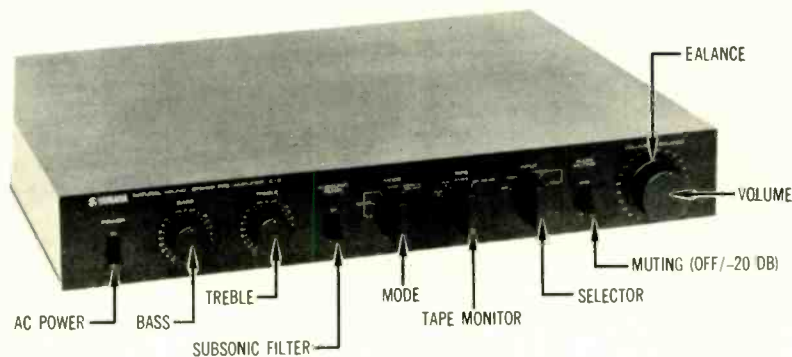

Yamaha's C-2, a Preamp for Purists

The Equipment: Yamaha C-2, a stereo preamp/control center, in metal case. Dimensions: 17½ by 2½ inches (front panel); 12½ inches deep plus clearance for controls and connections. Price: \$650. Warranty: "limited," three years parts and labor. Manufacturer: Nippon Gakki Co., Ltd., Japan; U.S. distributor: Yamaha International Corp., P.O. Box 6600, Buena Park, Calif. 90620.

Comment: In many areas of art and design there seems to be a polar conflict between generative principles: classical vs. romantic, strict form vs. free form, Apollonian vs. Dionysian. If this dichotomy were to be applied to audio equipment, and to preamps in particular, a complex, fea-

ture-laden control panel might be thought romantic, and a spare set of controls—each impeccable in its operation—called classic. Yamaha's C-1 would fall into the first class, and the C-2 into the second. Each is a tour de force, the latter the more difficult to succeed with, in our opinion, since the romantic approach is more immediately appealing. Yet as the C-2 demonstrates, the in-depth probing required for the appreciation of classicism may have even richer rewards.

In much equipment that is generally conceded to have excellent signal-to-noise ratios, the distortion of the Yamaha would be unmeasurable. The noise would mask it. And the residual noise is at the vanishing point. According to

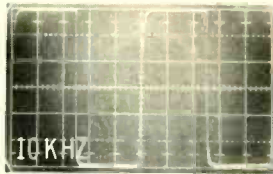

Square-wave response

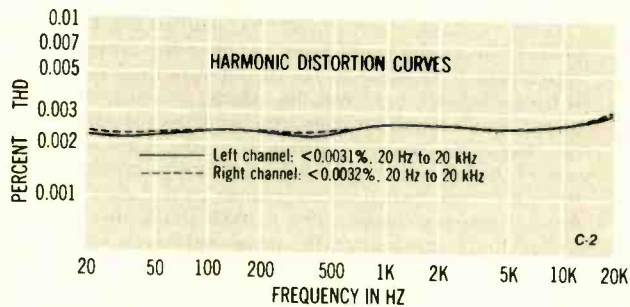

the CBS lab data, the clipping point of the preamp is at 11.75 volts, a level sufficient to drive any power amp that we know of to produce neatly flat-topped waveforms. Total harmonic distortion at clipping is 0.005%, equivalent to -86 dB with respect to the desired signal. When the output level is held to a more reasonable 2 volts, THD averages 0.0025% (-92 dB) across the audio band, with a worst-case figure of 0.0032% (-90 dB). This substantially confirms the manufacturer's specification (which presupposes slightly different conditions of measurement). The specification for IM distortion could not be confirmed, however; whatever IM there is lies below the limits of the test equipment. Less than 0.01% is all the lab could report.

Noise levels in the C-2 are, again, superlatively low. Despite the fact that the gain of PHONO 1 and 2 are a bit higher than usual (at 51 dB), the S/N ratios for those inputs measure 82 dB re a 2-volt output. Referenced to the conventional 10-millivolt input, this is equivalent to 87 dB. Clipping at 1 kHz occurs with a 330-millivolt input. PHONO 3, a pre-preamp (or "head amp") for moving-coil car-

Yamaha C-2 Preamp Additional Data

Output at clipping (channels driven simultaneously)
 L ch 11.75 volts for 0.005% THD
 R ch 11.75 volts for 0.005% THD

Frequency response $\pm \frac{1}{2}$ dB, 10 Hz to 70 kHz

RIAA equalization $\pm \frac{1}{4}$ dB, 20 Hz to 20 kHz

Input characteristics (for 2 volts output)

	Sensitivity	S/N ratio
phono 1, 2	5.6 mV	82 dB
phono 3	0.13 mV	67 dB
aux, tuner	310 mV	96 dB
tape 1, 2	310 mV	96 dB

Phono overload (clipping point, 1 kHz)

phono 1, 2	330 mV
phono 3	9.1 mV

Subsonic filter -3 dB at 15 Hz; 12 dB/oct.

tridges, has a total gain of 84 dB and an S/N ratio of 67 dB, equivalent to a staggering 105 dB re a 10-millivolt input. Obviously so high a reference input is somewhat unrealistic for the intended application—though the overload point at 1 kHz is 9.1 millivolts—but it does show how extremely quiet the pre-preamp is. The high-level inputs all have S/N ratios of 96 dB. (Lest the eagle-eyed seize on the apparent discrepancy between our measurements and Yamaha's claims, we note that our noise data, unlike those of the manufacturer, are unweighted.)

The equalization stages of the C-2 are on a par with the gain stages. The RIAA curve is virtually perfect from 20 Hz to 20 kHz, and the tone controls are within $\frac{1}{2}$ dB of their intended responses. The subsonic filter, a useful tool in warding off the effects of recorded rumble and warped discs, is 3 dB down at 15 Hz and rolls off at 12 dB per octave, just as claimed. Its effect in the audible bandpass amounts to $-1\frac{1}{4}$ dB at 20 Hz—which, of course, proved undetectable on program material.

Insofar as the C-2 projects its personality, it generates a

About the dBW . . .

We express output power and noise in terms of dBW—meaning power in dB with a reference (0 dBW) of 1 watt. We repeat herewith the conversion table so that you can use the advantages of dBW in comparing current products with those we have reported on in the past. You can, of course, use the figures in watts that accompany the new dBW figures for these comparisons, but then you lose the ability to compare noise levels for outputs other than rated power and the ability to figure easily the levels to which specific amplifiers will drive specific speakers—as explained in the June 1976 issue. If you do not have that issue and would like a reprint of the full exposition, send 25¢ (U.S.) to: dBW, c/o High Fidelity Magazine, The Publishing House, Great Barrington, Mass. 01230.

WATTS	dBW	WATTS	dBW	WATTS	dBW
1.00	0	10.0	10	100	20
1.25	1	12.5	11	125	21
1.6	2	16	12	160	22
2.0	3	20	13	200	23
2.5	4	25	14	250	24
3.2	5	32	15	320	25
4.0	6	40	16	400	26
5.0	7	50	17	500	27
6.3	8	63	18	630	28
8.0	9	80	19	800	29

sense of restrained purism. It does not overwhelm one with its controls, which are in fact quite basic. The design of the controls encourages the user to consider their effects carefully: Who can twist away thoughtlessly at a tone control calibrated near its center in ½ dB increments? We suspect that the C-2 will help a listener to learn how good his hearing is and become still more discriminating.

If anything about the unit leaves us less than totally ecstatic, it is the design of the levers. It is difficult to tell at a glance, against the black front panel, whether they are up or down. This led us in one instance to engage the 20-dB attenuator and wonder later why the volume control had to be advanced so far before a reasonable listening level was obtained.

There is no position for dubbing between the two tape decks the C-2 is capable of handling, but the tape switching does include one refinement we have never seen before: a REC-OUT-OFF position that kills the feed to the

recorders and thus prevents any noise or other adverse interaction between them and the preamp when you are not actually recording. Should extension loudspeakers be desired, the C-2 is equipped to drive two power amps.

But what is almost eerie about the Yamaha is that, as far as hearing is concerned, it simply is not there. If you hear a hiss when you turn the volume up high, it is coming from the input source, not from the preamp. If the tonal balance seems strange, the C-2 will help you straighten matters out, but the blame will have to fall on some other part of your system. And you can forget clicks and pops, except from program material—the preamp barely makes those, even when the SELECTOR is switched. To within a fraction of a decibel the C-2 does only what it is ordered to, and with its smooth-acting controls it accepts directions readily. A more elegant and convincing argument for refined basics would be difficult to imagine.

CIRCLE 137 ON READER-SERVICE CARD

Paradox TA-12: Leviathan So Sweetly Sings

The Equipment: Paradox TA-12, a floor-standing loudspeaker system in wood enclosure. Dimensions: 18 by 34 inches (front), 16 inches deep. Price: \$330. Warranty: "limited," five years parts and labor. Manufacturer: Sonic Energy Systems, 6914 Harwin Dr., Houston, Tex. 77036.

Comment: Remember Willie the Whale, who surged up mightily from the deep and opened his cavernous mouth, not—as we might have feared—to overwhelm, but rather to charm with his refined operatic voices? Well, the Paradox TA-12 is a little like that. After wrestling two of these 75-pound monsters out of their shipping containers and hooking them up, we expected that their sound would fairly bowl us over and were at first a little disappointed when it didn't. A little more listening left us convinced that we were hearing music with uncommon clarity. That's not an unusual turn of events; colorless speakers may seem bland at first, but often prove the most pleasing.

One thing that makes the Paradox seem subdued initially is its rather low efficiency—unusually low for a ported design. According to CBS labs, a 0-dBW (1-watt) input of pink noise, 250 to 6,000 Hz, results in an acoustic output of close to 87 dB sound pressure level at 1 meter on axis in the anechoic chamber. The dynamic range extends to quasi-discotheque level, however, if you have the amplifier power. At the onset of serious distortion, the speaker produces a continuous SPL of 105 dB from an input of 20 dBW (100 watts). Under transient conditions, measured with a pulsed input signal, the maximum usable output is 111½ dB SPL from a drive power of 26½ dBW (450 watts) peak. Second- and third-harmonic distortion remain quite low until continuous levels of 100 dB or so are surpassed.

Nominally the TA-12 is an 8-ohm speaker, and its impedance curve remains at or above this value everywhere



except for a small region around 1 kHz, where it falls to 7 ohms. Accordingly, two of these units connected in parallel represent an acceptable load for typical solid-state amps. Almost coincident with the bass rise in the impedance curve, as one might expect, is a rise in the omnidirectional power response of about 4 dB, measured anechoically. Though this indicates slightly underdamped behavior of the woofer, it is not obtrusive in normal listening. Actual bass response is a function of the listening room as well as the loudspeaker. Low-end output, in our opinion, is sufficient to allow the reinforcement that might be gained from corner placement to be sacrificed in favor of the smoothness that can result from placing the speaker clear of the corner in a spot where the distances from the woofer to the three nearest room boundaries (floor and two walls) are irregular.

From 100 Hz upward the power response is about as flat as any we have seen, tailing off by about 5 dB from 3 kHz to about 18 kHz. Interestingly, the omnidirectional, front-hemisphere, and on-axis response curves are close to parallel, indicating excellent dispersion. While this could indicate very little change in coloration as one moves off axis, such is in fact not the case. For other reasons, the Paradox TA-12 sounds best when heard from within a frontal sector about 60 degrees wide.

The Paradox, as the unusual geometry behind its

stretch-knit grille might suggest to those in the know, is designed to compensate for propagation delays between the drivers. (The manufacturer calls this Time-Alignment.) This characteristic, together with a specially designed crossover network, allows it to reproduce recognizably square wave-shapes, according to data from the manufacturer. While this ability may seem related to transient response (which is abundantly quick in any case), the most audible effect we could find seems to be the TA-12's ability to distinguish clearly between direct and reverberant sound in a recording. We could find no test that would attribute this unequivocally to phase coherence alone (or at all), but this model is able to "dry up" an overly reverberant recording and glean from it a clarity and openness that we would not have suspected possible. A good deal of

this pleasant effect is lost at listening positions far off axis, although a reasonable frequency balance is maintained.

The midrange and tweeter are provided with controls that are meant to be used within a range of ± 3 dB (they go from about +3 dB to completely off), which should be sufficient to match the speakers to most rooms.

If it is not clear by now that the TA-12 impresses us very favorably, let us remove any doubt: It does. Its sound fairly sparkles (some might find it just a trifle forward) without being cold or clinical. Stereo imaging is outstanding, and the sense of transparency is such that one tends to forget the speakers are there. Some listeners judge that their sound outperforms their price. That doesn't surprise us—not at all.

CIRCLE 136 ON READER-SERVICE CARD

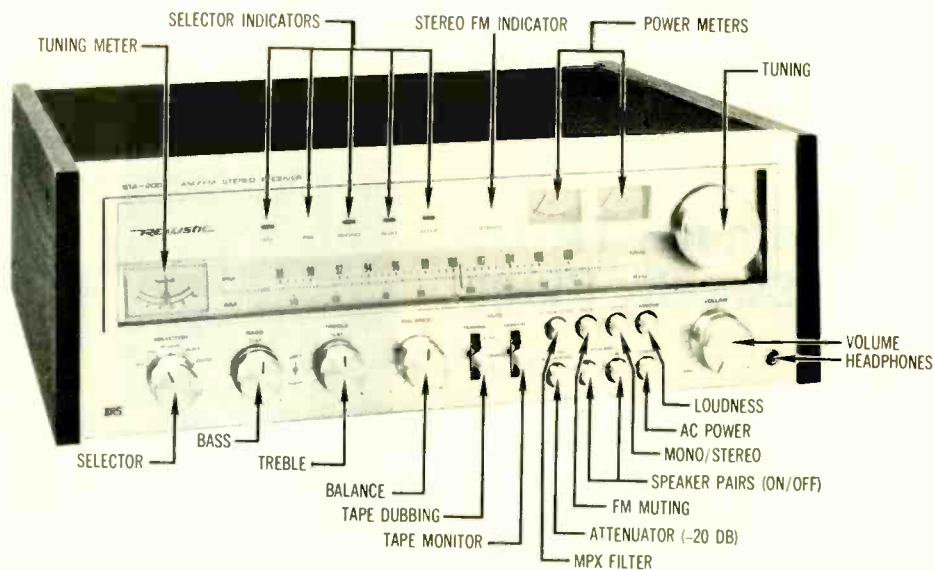

Realistic New Look—Clean and Powerful

The Equipment: Realistic STA-2000, an FM/AM stereo receiver, in metal case with wood trim. Dimensions: 19¼ by 6⅞ inches (front panel); 13⅞ inches deep plus clearance for controls and connections. Price: \$499.95. Warranty: "limited," two years parts and labor. Sole distributor: Radio Shack Division, Tandy Corp., 2617 W. Seventh St., Fort Worth, Tex. 76107.

Comment: Even at first glance, the Realistic STA-2000 announces itself as a receiver to be reckoned with. It sports the current "clean look" and yet retains its own distinction and individuality. When you try to pick it up, it tests your muscle and hints at its own. And indeed the amplifier section, with its rated 18¾-dBW (75-watt) per-channel output capability, is a solid contender in the light-heavyweight class. Add to this a well-chosen array of highly functional controls and very competent FM and preamp sections, and the result is quite an attractive package.

The designers of the STA-2000 are to be complimented on their solutions to some of the human-engineering problems associated with styling of this type. Pushbuttons are large enough that there is no doubt whether they are in or

out, and the generous throws provided in the levers make their disposition abundantly clear as well. Moreover, the buttons one is likely to push least often (POWER and SPEAKERS A and B) are provided with heavier spring loads than the others, giving the user the chance to reconsider before the deed is done. The dial is large and legible (thanks, in part, to its upward angling), the knobs have a good solid feel, and the power-output meters (an unusual feature in a receiver of any price) keep one aware of what is being demanded of the loudspeakers.

But the essence of the STA-2000 is not its convenience and styling; its heart, rather, lies squarely in its circuitry. Putting the tuner section through its paces in the lab, CBS determined that the 50-dB quieting point for stereo FM reception is reached with an RF input of well under 38 dBf, a very low level. Distortion is held to suitably minute levels, even THD at 10 kHz, where many a receiver (or tuner) has been known to run into trouble. And the other cardinal specifications of the FM section—including alternate-channel selectivity, ultimate signal-to-noise ratio, capture ratio, and separation—place it solidly in the performance range to be expected in its price class. The sole exception is fre-



Nikko's dedication and your patience are now rewarded.

The people at Nikko have a very unique philosophy about the way they produce and market audio products.

It starts with producing only state-of-the-art components, the testing of every unit before you buy it, a three-year parts and labor warranty* and conservatively rating every specification. Only in this way do you reap the benefits of true performance. Nikko now presents its finest discrete matched components: the Alpha-1 dual channel power amplifier has a three-stage Darlington direct-coupled OCL pure comple-

mentary circuit, large electrolytic capacitors (33,000 mF), and a rack mount design with optional side panels.

A matching Beta-1 "FET" preamplifier features high-voltage FET circuitry, three-stage direct coupled with two-stage differential amplifier, and a number of useful features, including a phono impedance selector and tape monitor (play 1, play 2, dubbing 1 to 2, dubbing 2 to 1). Beta-1 is also provided in a rack mount design (shown stacked atop Alpha-1).

Alpha-1 specifications

Continuous power output of 220 watts per channel, both channels driven from 20 to 20kHz into 8 ohms with no more than 0.08% total harmonic distortion.

Intermodulation distortion: no more than 0.08% (at rated output)
 Frequency response: 10 Hz-100kHz \pm 0dB 1dB
 Input sensitivity/impedance: 1V/50Kohms
 Signal-to-noise ratio (I.H.F.): 100 dB
 Dimensions: 7" high, 11 1/2" deep, 19" wide
 Price: \$599.95

Specifications subject to change without notice.

Beta-1 specifications

Input Sensitivity:	Phono 1 & 2 Tuner	2mV 100mV
	Aux	100mV
Input Impedance:	Phono 1 & 2	22K/47K/100Kohm
	Aux Tuner	50Kohm
Total Harmonic Distortion:	no more than	0.015% (at rated output)
Signal-to-noise ratio (I.H.F.):	Phono 1 & 2	72dB
	Aux	100dB
Frequency Response:	Phono 1 & 2 (RIAA equalization)	30-15kHz \pm 0.2dB
	Aux Tuner	20-20kHz \pm 0.1dB
Phono Overload Level:	400mV RMS @ 1kHz	
Output:	1V rated, 10V max.	
Power Consumption:	120V 25VA 50/60 Hz	
Dimensions:	2 1/2" high, 11 1/2" deep, 19" wide	
Price:		\$299.95



Nikko Electric Corp. of America
 16270 Raymer St., Van Nuys, Calif. 91406
 In Canada:
 Superior Electronics, Inc., Montreal

** See the warranty card with the product for full details.*

The above prices are shown for informational purposes only. Actual retail price will be set by the individual Nikko dealer at his option.

CIRCLE 25 ON READER-SERVICE CARD

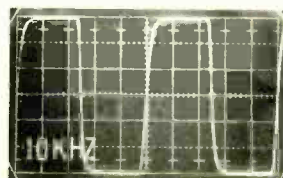
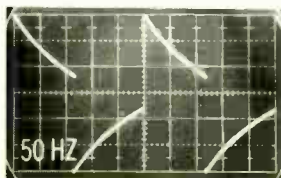
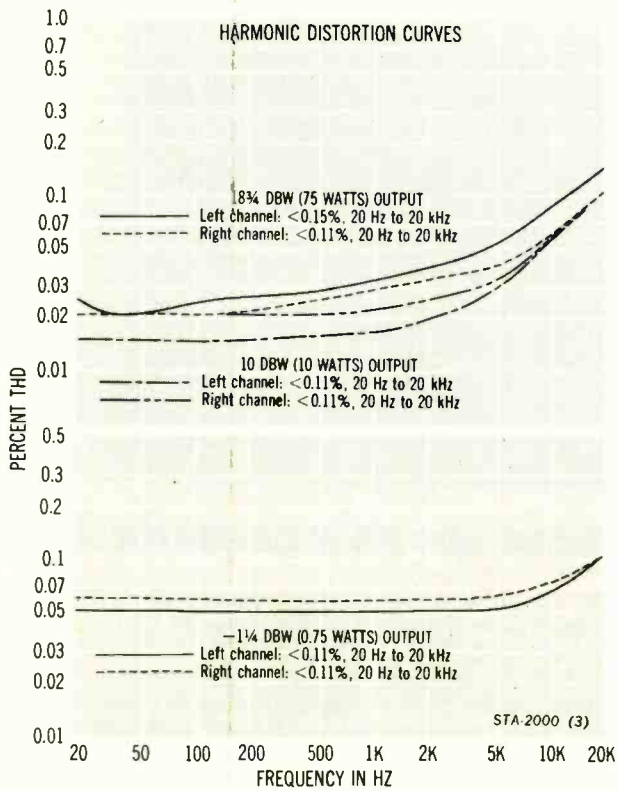
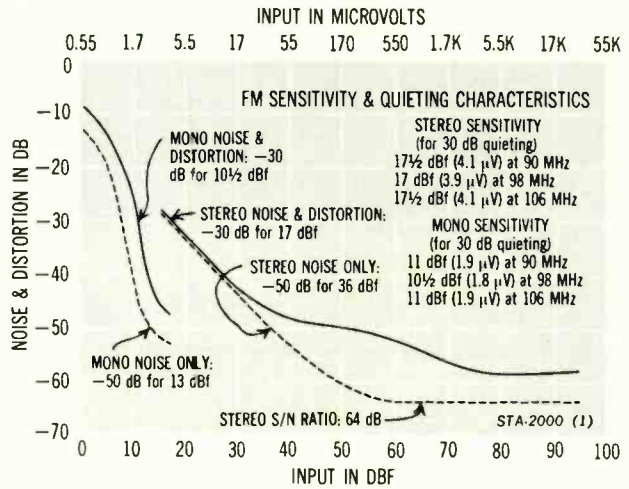
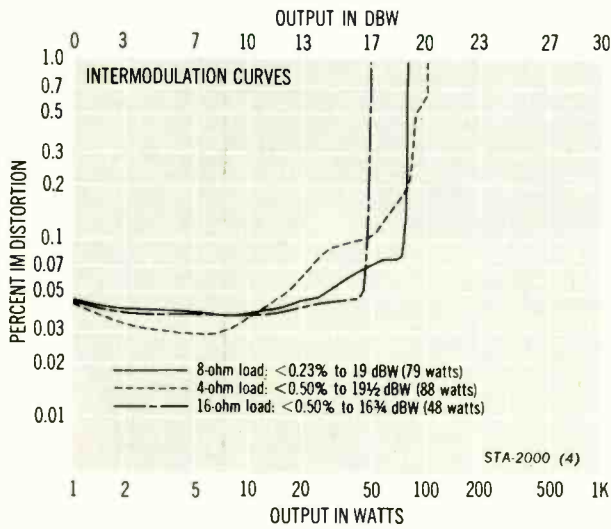

Square-wave response

Realistic STA-2000 Additional Data

Tuner Section			
Capture ratio	1½ dB		
Alternate-channel selectivity	85 dB		
S/N ratio (mono)	68 dB		
THD	Mono	L ch	R ch
80 Hz	0.26%	0.31%	0.40%
1 kHz	0.13%	0.22%	0.20%
10 kHz	0.23%	0.78%	0.76%
IM distortion	0.02%		
19-kHz pilot	-63½ dB		
38-kHz subcarrier	-68 dB		
Frequency response	mono + ¾, -3 dB, 20 Hz to 15 kHz		
	L ch + ¾, -3 dB, 20 Hz to 15 kHz		
	R ch + 1, -3 dB, 20 Hz to 14 kHz		
Channel separation	> 40 dB, 65 Hz to 8 kHz		
	> 30 dB, 20 Hz to 12.5 kHz		
Amplifier Section			
Power output at clipping (channels driven simultaneously)	L ch 19 dBW (78 watts) for 0.053% THD		
	R ch 19 dBW (78 watts) for 0.047% THD		
Frequency response	+ 0, -¾ dB, 20 Hz to 27 kHz		
	+ 0, -3 dB, 10 Hz to 62 kHz		
RIAA equalization	± ½ dB, 40 Hz to 20 kHz		
	+ ½, -3 dB, 20 Hz to 20 kHz		
Input characteristics (for rated output at full gain)	Sensitivity	Noise	S/N ratio
phono	2.2 mV	-47½ dBW	66½ dB
aux 1, 2	140 mV	-65¾ dBW	84½ dB
tape 1, 2	140 mV	-65¾ dBW	84½ dB
Phono overload (clipping point)	210 mV at 1 kHz		
Damping factor at 1 kHz	74		

quency response: Careful listening reveals some slight departures from impressive behavior both in stereo and mono. The multiplex blend control is effective in reducing noise from weak stereo stations, but the muting control does allow an occasional blip of interstation noise to slip through as the unit is tuned rapidly across the dial.

With noise figures rivaling those of many a separate component, the preamp section too shows its capability. The phono stage is especially good in that its signal-to-noise ratio, referenced to the conventional 10-millivolt level, is equivalent to nearly 80 dB. The overload point of this stage also is somewhat better than average. A low-end rolloff amounting to 3 dB at 20 Hz is apparent in the RIAA curve. This is not necessarily disadvantageous as it does offer protection against rumble and subsonic noise, but if it is intentional, we believe a defeat switch should have been provided.

The controls are unusually flexible: Bass and treble equalization for the two channels can be adjusted separately, and monitor and dubbing facilities are provided for two tape decks. The 20-dB attenuator button (useful while answering the telephone, say, without having to reset the

volume) and the fact that switching transients from the SELECTOR are very well suppressed (there is a slight delay before the audio comes on) represent nice touches.

If any part of the STA-2000 approaches overachiever status, it is the power amplifier. It meets its specifications for power and distortion (0.25%) with a good deal to spare and offers sonic performance preferable to that of at least one 20-dBW (100-watt) per-channel separate that we know of—and at a far more attractive price. It retains its low distortion down to levels below 0 dBW (1 watt), where most listening is done, and draws attention to itself only by the ample power held in reserve for reproducing peaks. Its damping factor is more than sufficient to keep the loudspeakers in check at low frequencies.

The conclusion, then, is inescapable: The Realistic STA-2000 must be taken seriously, both in performance and appearance. It has eschewed seductive frills in favor of solid performance and acquits itself creditably. Its standing relative to other members of its price class is fully competitive. This is a receiver that neither the competition nor the value-conscious buyer should ignore.

CIRCLE 138 ON READER-SERVICE CARD

Dual CS-704, a Very Together Turntable

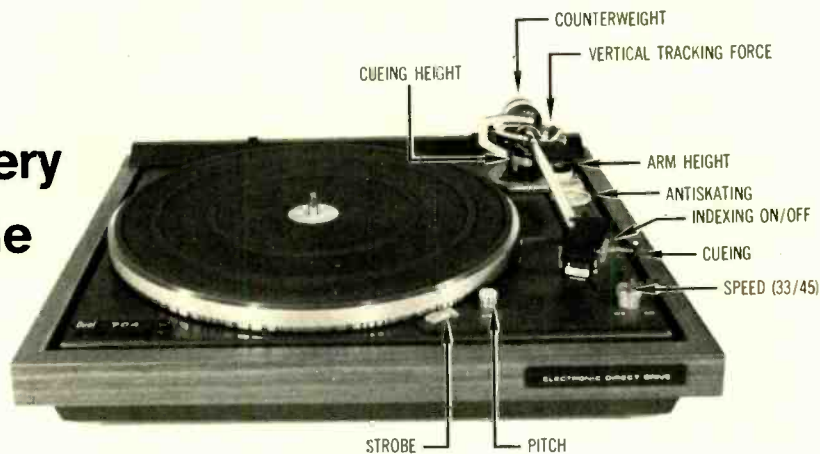

The Equipment: Dual CS-704, a two-speed (33, 45 rpm) direct-drive turntable with integral tone arm, wood base, and dust cover. Dimensions: 16¼ by 14½ inches (top); 6 inches high with dust cover closed, 15½ inches clearance required with cover fully open. Price: \$310. Warranty: "limited," one year parts and labor. Manufacturer: Dual, W. Germany; U.S. distributor: United Audio Products, Inc., 120 S. Columbus Ave., Mount Vernon, N.Y. 10553.

Comment: The word "together" in the headline of this report is, clearly enough, meant to be taken in a figurative sense. It can, however, be applied in a literal sense as well: The CS-704, in contrast to some of the turntables that we have seen, which could almost be called kits, arrives almost completely assembled. Remove the packing material, loosen three screws, drop the platter into place, secure the dust cover. Very refreshing. There is the inevitable nuisance of mounting a cartridge—something we regard as the price of freedom of choice—but even here the Dual offers as much convenience as any unit we can think of, partly because its tone arm is adjustable in height.

The CS-704 is utter simplicity to operate. Lift the tone arm, move it to the left, and the system turns itself on. Continue the leftward movement until a slight resistance

is felt, and you're cued for a 12-inch disc; push on to the next point of resistance, and a 7-inch is cued. This indexing feature can be defeated if you want. Release the cueing lever at any point (the arm must be over the platter or the lever just springs back harmlessly), and the disc starts to play. At the end of a side, the platter stops and the arm is raised. There is almost no way to make an error that will damage either record or stylus.

Lab testing, too, is taken right in stride by the CS-704. CBS found that either speed, once it is set with power line voltage at 120 VAC, remains exact (within the limits of measurement) when the voltage is 105 or 127. The PITCH control offers a little more than a quarter tone of adjustment both ways at both speeds. Excellent short-term rotational stability is documented by an average peak flutter (ANSI/IEEE weighting) of 0.03%, with an instantaneous peak value of 0.07%. Rumble, suppressed by 62 dB using the CBS ARLL weighting, falls in the good-to-excellent class and is virtually inaudible.

Besides its adjustable height (which allows a cartridge to be mounted for optimum vertical tracking angle without the use of shims), the tone arm incorporates some interesting features. A mechanical filter decouples the counterweight so as to damp the tone-arm/cartridge resonance.

The resonant frequency measures $7\frac{1}{2}$ Hz (using the Shure V-15 Type III pickup), a figure that we would ordinarily consider dangerously close to the warp region. But in the Dual the resonance is damped to a mere 1-dB rise, which makes the point very nearly moot. And in practice, the CS-704 handles warped records like a champ.

Friction in the tone-arm bearings is negligible for both horizontal and vertical movement, and the stylus-force mechanism is as accurate as the lab test equipment at any setting from 1 to 3 grams. (Above or below that, who cares anyway?) The antiskating system increases force linearly with setting on all scales; Dual's calibration for Shibata and similar styli (the scale labeled CD-4) is virtually identical to that for ellipticals, with values about 13% lower delivered by the calibration for spherical styli.

Our listening test of the CS-704 led to an interesting observation: The excellent damping provided by the antireso-

nance filter results in less recorded rumble and low-frequency chaff being transferred through the stylus and pickup to the preamp. This translates into a small but perceptible increase in the over-all clarity of sound. The overhang adjustment is slightly limited in range, yet the worst discrepancy in fit we found seemed without audible effect. And the instructions don't show how to adjust cueing height (our callout photo does, and, we are told, the manual's oversight will soon be fixed).

From its basic performance to its human engineering, the Dual CS-704 strikes us as a product well conceived and well realized. We would not hesitate to trust it with our most beloved records and find, in fact, that it makes our fumble-fingeredness much less of a hazard. Beyond that, it has let us hear that many of our discs are just a bit better than we had thought. It is a fine job all around.

CIRCLE 17 ON READER-SERVICE CARD

Dynaco's Stereo 300 Amplifier— Muscle and Lots of Moves

The Equipment: Dynaco Stereo 300/A, a power amplifier with optional conversion for four-channel operation or low-impedance loads, in metal case with wood end blocks. Dimensions: $18\frac{3}{8}$ by $7\frac{3}{8}$ inches (front panel), $14\frac{1}{2}$ inches deep. Price: wired (Stereo 300/A), \$599. Options: Stereo 300 kit, \$399; QSA-300 quad/stereo kit, \$399; MC-3 illuminated-meter kit for QSA-300, \$125; QSA-300M/A wired quad/stereo amp with meters, \$699. Warranty: Stereo 300/A, "limited," one year parts and labor; Stereo 300, "limited," one year parts. Manufacturer: Dynaco, Coles Rd., Box 88, Blackwood, N.J. 08012.

Comment: The Stereo 300 is really two stereo amplifiers—four channels of amplification and two power supplies—mounted on a single massive chassis. Operated singly, each of the four channels is rated at 19 dBW (75 watts); they can be combined to form two channels rated at 22 dBW (150 watts). Distortion in all cases is rated at less than 0.25% total harmonic or IM, 20 Hz to 20 kHz, a level that CBS could not force the amp to approach, even by driving it to clipping. Reasoning that stereo operation uses all four amps and that at least as many users will opt for two-channel operation as for four, we decided to test in the former mode.

The Dynaco strikes us as conservatively yet economically designed. Rated power is exceeded by a modest margin that amounts to less than 1 dB and thus constitutes a production safety margin rather than significant headroom. This seems entirely proper and realistic, since an additional 3 dB would require a doubling of output power. The moral: If you need a bigger amp than this, you had better look for something *really* big if you expect to hear the difference. The true conservatism is in the exceedingly small distortion (less than 0.1% worst case) alluded to earlier. This is one of the cleanest power amplifiers we can recall—both in its lab performance and its sound.



Part of the job of a power amp is to control the loudspeakers, and this the Stereo 300 does exceedingly well despite the fact that the damping factor does not seem astronomical. Actually, if the DC resistance of loudspeaker voice coils is taken into account, a damping factor greater than the 31 measured for this unit is of negligible benefit. More to the point, this figure suggests that the amp is reasonably clean under open-loop conditions and that negative feedback has been kept modest. This, together with the high slew rate claimed by the manufacturer, suggests that there is little likelihood of any transient distortion.

A driving signal of just under 1.5 volts into 35,000 ohms, which is easily supplied by most preamps, produces rated output power, and signal-to-noise ratio is excellent at 104 dB, equivalent to less than -82 dBW of noise. Thus, there should be no problem using this amplifier even with efficient speakers. Frequency response is within $\frac{1}{2}$ dB of flat from 20 Hz to 40 kHz.

To our way of thinking, the Stereo 300 is truly elegantly designed. There is performance aplenty, and all of it is where it counts; nothing has been wasted on frills or window dressing. Beyond that the unit is incredibly flexible. It can be used for quad, for bi-amping, for paralleled speakers (the low-impedance connection is fine with loads down to 2 ohms), for speakers stacked two per channel—you name it. (The internal wiring alterations are simple

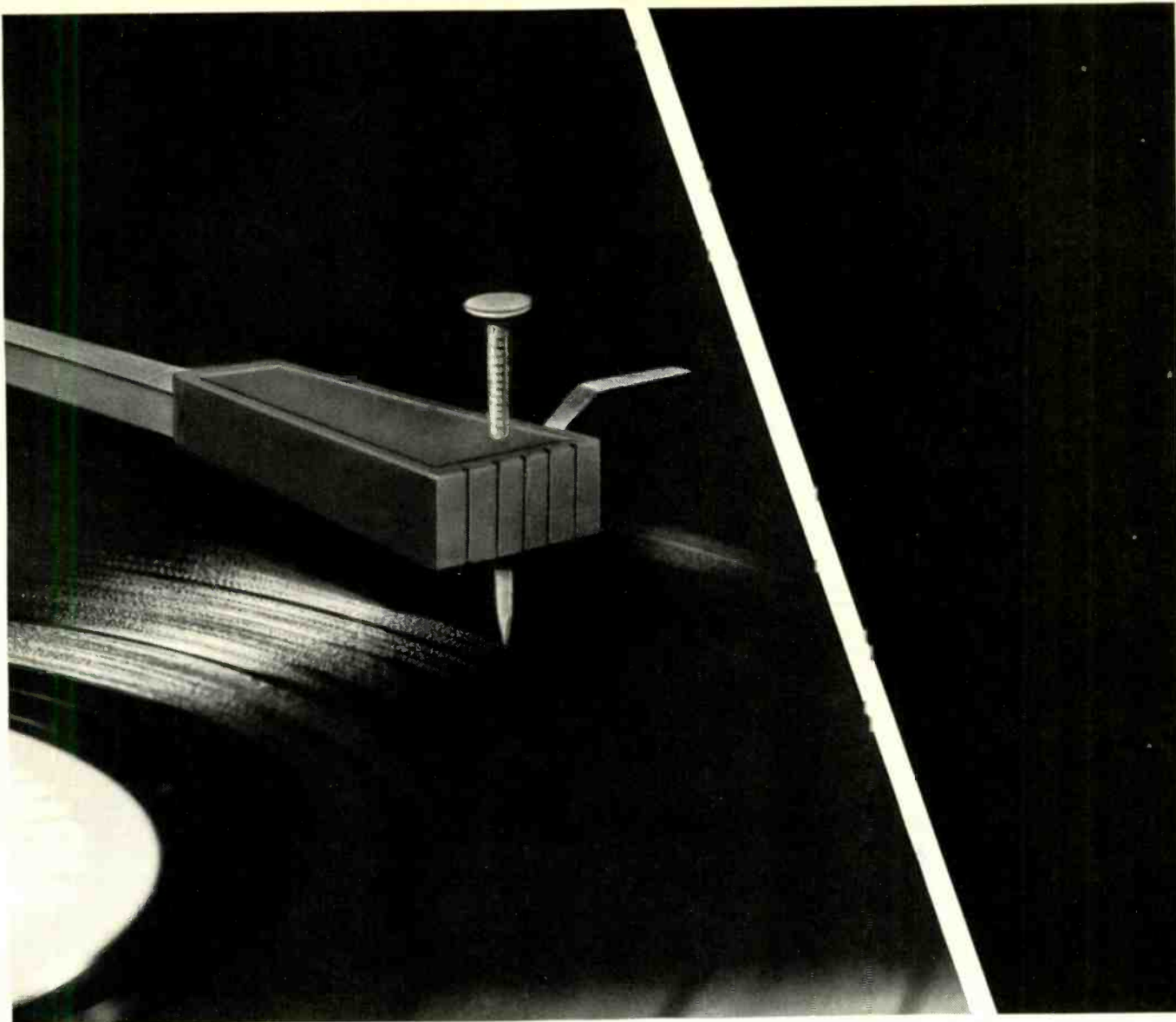

This is no way to nail down a hi-fi bargain.

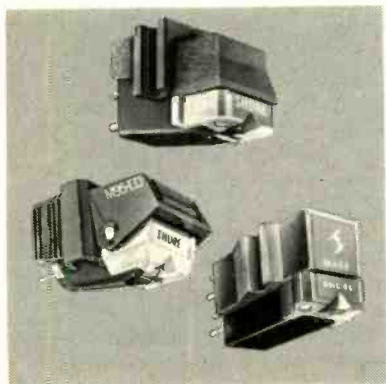

Some stores think that one of their cost-cutters in assembling a "bargain" stereo system is to install a run-of-the-mill, inexpensive cartridge. After all, who's going to notice a tiny cartridge when it's surrounded by powerful speakers and a dynamite turntable? Unfortunately, some shoppers are reluctant to insist on a better cartridge when buying one of these package specials. But you are made of sterner stuff! And if you insist on a Shure cartridge, "better" doesn't have to mean more expensive. Time and time again, consumer magazines have rated Shure cartridges the best in their price category. As the source of sound for the entire system, that tiny Shure cartridge and its critical stylus determine what you'll ultimately hear. And as bargains go, that's the best tip you'll hear today—or any day!

Shure Brothers Inc.
222 Hartrey Ave., Evanston, IL 60204
In Canada: A. C. Simmonds & Sons Limited



Manufacturers of high fidelity components, microphones, sound systems and related circuitry.

CIRCLE 39 ON READER-SERVICE CARD

enough.) This looks like a lot of amplifier for a lot less money—particularly if you decide to build the kit—than you normally would expect to pay.

CIRCLE 132 ON READER-SERVICE CARD

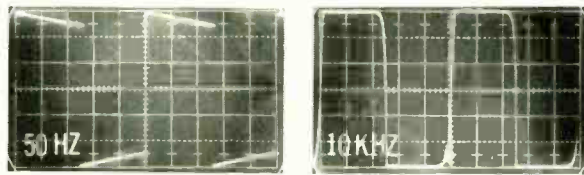
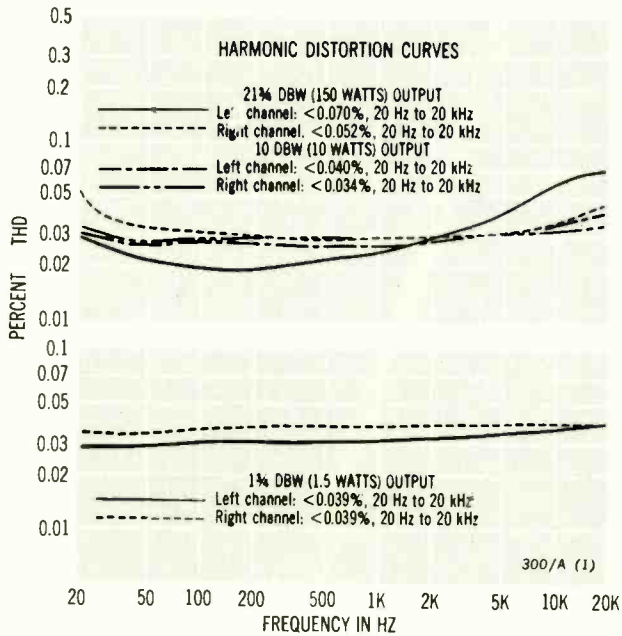

Square-wave response

Dynaco Stereo 300 Additional Data

Power output at clipping (channels driven simultaneously)
 L ch 22 dBW (160 watts) for 0.060% THD
 R ch 22 dBW (158 watts) for 0.072% THD

Frequency response
 +0, -½ dB, 20 Hz to 40 kHz
 +0, -3 dB, below 10 Hz to beyond 100 kHz

Input characteristics (for rated output at full gain)
 Sensitivity 1.42 V Noise -82¼ dBW S/N ratio 104 dB

Damping factor at 1 kHz 31

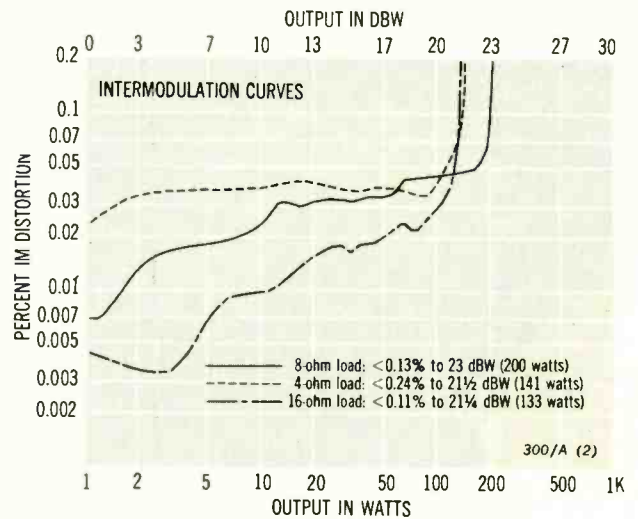

Stereopillow, a Novel Way to Listen—and Relax

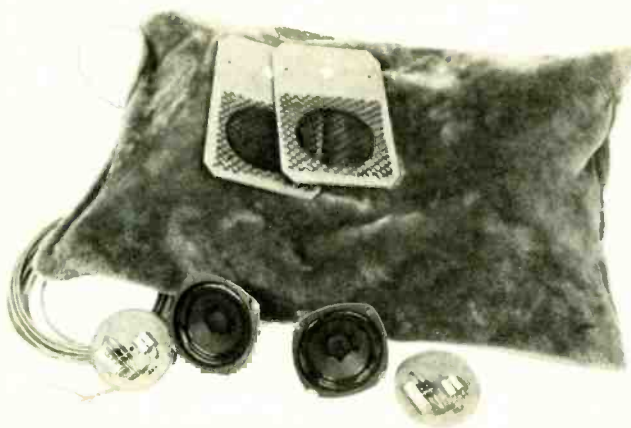

The Equipment: Stereopillow, a personal listening system disguised as a full-size polyurethane foam pillow with replaceable gold velour cover. Dimensions: 27 by 17 inches, fairly plump. Price: \$79.95. Warranty: "limited," one year parts and labor. Manufacturer: Yeaple Corp., 12255 University Ave., Rochester, N.Y. 14607.

Comment: J. S. Bach wrote the *Goldberg Variations* for a harpsichordist (named Goldberg) whose patron reportedly suffered from terrible insomnia and whose job was to soothe his patron's nerves into somnolence. Modern technology being what it is, you now can relax on a very comfortable pillow and have the sounds of Bach's music (or anyone else's) bathe your ears in truly sybaritic fashion—and it costs a lot less than keeping a harpsichordist on your staff.

The device that makes this possible by bridging the gap between loudspeakers and headphones is the Stereopillow. While headphones are clamped to the listener's ears and create a virtual sound field that follows every movement of the head, however slight, the Stereopillow

positions its drivers about two inches away. Thus the sound field is independent of the position of the user's head; also the ear is close enough to the driver—in the "near field"—that extended bass response is possible. Furthermore, room effects cannot color the perceived sound.

These advantages do not come quite free—the listener is required to keep his head in the right spot. But this is where the pillow part comes into play. It soothes, caresses, even seduces you into keeping your head where it should be, without insisting that you be careful or attentive. Should you roll too far to one side, the increased volume on that side becomes the gentlest of reminders to turn back, and without spoiling the sense of stereo.

For at least some people, the stereo image does have its peculiarities, however. We—and those who assisted us in the testing—generally find that the music seemed to come from behind. The designers suggest (and we agree) that the degree to which this effect is noticed depends on the shape of the outer ear and will vary from one person to another. It is, in any case, not at all disturbing.

Trotting out some of our test records, we investigated the frequency response curve of the Stereopillow and found it smooth and impressively extended, especially into the bass regions. (The low end outperforms some very creditable loudspeakers we have heard—probably, in part,

because of the freedom from room effects.) Generally, the response falls off with increasing frequency, dips a bit in the upper midrange, and develops a couple of minor peaks at high frequencies before the end of useful response, at 15 to 16 kHz. This agrees essentially with the manufacturer's claim. We find that the sound becomes a bit brighter and airier with a moderate treble boost—which the unit takes in perfect stride—at the electronics to which the Stereopillow is connected.

One thing that we particularly like about the Stereopillow is its low distortion. You can listen at levels loud enough to mask external sounds completely without muddying the sound. And clarity is maintained at low levels too; the dynamic range is just fine. Some of the sound, minus extreme highs and lows, projects into the room. At a distance of a few feet, however, the sound pressure level falls to 20 to 25 dB below that perceived by the user.

How good is the Stereopillow? The interaction with a listening device such as this is highly personal. We like the sound and the experience of hearing it via the Stereopillow, but it may not be for everyone. It certainly is worth a try if you are turned on to private listening in comfort. For more information contact the manufacturer, not us. We'll be busy checking out the possibilities of Stereopillows—for two.

CIRCLE 134 ON READER-SERVICE CARD

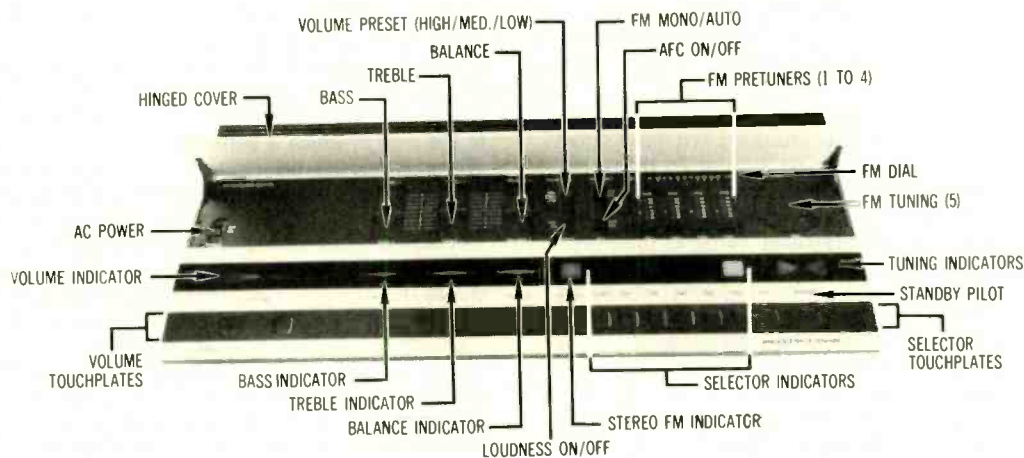

B&O's Iconoclastic Receiver

The Equipment: Beomaster 1900, a stereo FM receiver in metal case with wood trim. Dimensions: 21¼ inches wide; 2½ inches high plus 5½ inches clearance for top cover opening; 10¼ inches deep. Price: \$495. Warranty: "limited," three years parts and labor, shipping partially paid. Manufacturer: Bang & Olufsen, Denmark; U.S. distributor: Bang & Olufsen of America, 515 Busse Rd., Elk Grove Village, Ill. 60007.

Comment: If you didn't know the Beomaster 1900 was a receiver, you probably wouldn't guess. As it sits there with

its elegant low profile awaiting your touch, not a single control or indicator seems to be in sight, save perhaps a small light to tell you that the unit is in the STANDBY mode—if that's how you left it. Your touch is literally all that is needed to put it into operation, for the controls are a set of appropriately labeled wells that react to the contact of your finger. The touch controls allow a choice of PHONO, TAPE, or any one of five FM presets. Volume, which is preset to a desired level—low, medium, or high, via a three-position switch—at turn-on, is adjusted by means of two touch controls, one to raise it, one to lower it. A system of lights gives

With the cover closed over the more esoteric controls—the normal operating mode—the Beomaster 1900 makes a striking ensemble with the Beogram 1900 turntable.

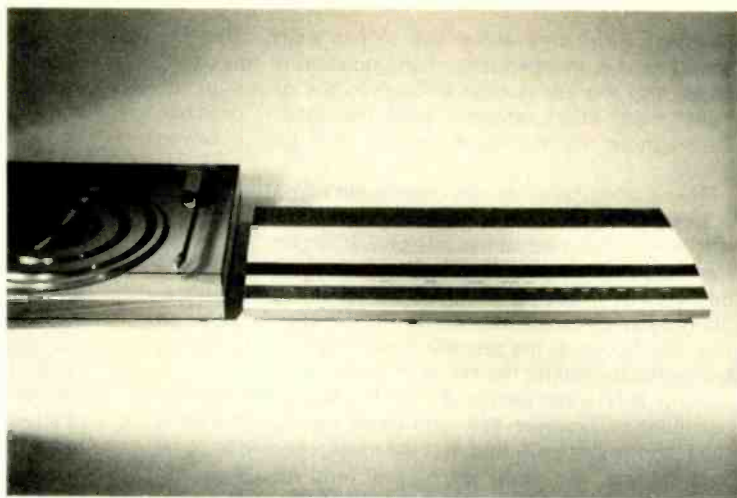

a visual indication of the volume setting. The less often used functions are controlled by an array of switches, sliders, thumbwheels, and the like, all of which are hidden behind a hinged panel on top of the receiver.

The power amp section of the Beomaster is rated at 14¾ dBW (30 watts) per channel, into an 8-ohm load, 20 Hz to 20 kHz, with total harmonic distortion of no more than 0.2% and IM distortion of less than 0.15%. The tests performed by the CBS labs confirm that these specifications are met, with something to spare. Damping factor measures 76 at 1 kHz and, judging from the fairly tight bass response elicited from the speakers, remains high at low frequencies. Frequency response at 0-dBW output is essentially flat from 1 to 10 kHz. At the low end there is a gentle rolloff that begins in the region of 200 Hz and reaches -1¼ dB at 20 Hz and -4½ dB at 10 Hz.

The preamp section is very good with respect to noise performance: The tape input has an equivalent input noise of -61¼ dBW, for a signal-to-noise ratio of 76 dB re full output; the phono section is 10 dB noisier, which is usual, and when its S/N ratio is referenced to the conventional 10-millivolt input, a very respectable 74 dB is obtained. Phono overload level at 1 kHz is 54 millivolts, a lower-than-average figure. Equalization for RIAA response (measured by CBS as total departure from "flat" and hence including the amp's slight bass rolloff) shows a 1-dB rise at 20 kHz, a broad 1-dB dip centered at about 300 Hz, and a rolloff that begins at 50 Hz and reaches -2⅔ dB at 20 Hz. This last characteristic may offer some protection against feedback and rumble from warped records and the like, but its slope is not steep enough to make it optimal for this purpose. Tone control responses are normal, and the loudness contour seems reasonable.

The FM section has good sensitivity and noise performance and reaches the all-important 50-dB S/N ratio in stereo with a modest RF input of just under 38 dBf. The ultimate stereo S/N ratio measures an excellent 67 dB. Distortion is well suppressed, although the familiar rise in THD at 10 kHz is apparent. Intermodulation is low, and the capture ratio is adequate. Automatic frequency control is available for all five of the tuner presets, and its use would seem advantageous, for there is some perceptible drift when it is switched off for any extended period.

Presets 1 through 4, which presumably will not be retuned often, are adjusted by means of thumbwheels and have dials that are a bit tricky to read. The fifth preset functions as the "main" FM control section and has a slightly larger, more legible dial and a more convenient tuning mechanism—a flat, rotating disc with a recess for one's fingertip.

Channel-center tuning is accomplished by setting a pair of lights for equal brightness. In our listening tests (for which we used B&O's own Beogram 1900 turntable and MMC-4000 cartridge), we found that the FM audio level was sufficiently higher than the phono level to give quite a jolt to the user who switches from phono to FM without reducing the volume—or engaging STANDBY for 10 seconds or so to let the volume readjust automatically to its preset level. The MMC-4000 is not a particularly insensitive cartridge, so this effect will be noticed with other models as well. The highly efficient protection circuit, which returns the unit to STANDBY when power drain becomes excessive, will protect the output stage and any speakers of reasonable power capacity against actual damage, however.

The touch controls of the Beomaster are convenient and pleasant to operate and give a distinct aura of luxury. The volume control requires that the user become accustomed to the rate at which it shifts up or down when activated. The preset switch referred to earlier is concealed under the hinged panel. Speakers and other outboard equipment are attached via DIN connectors, for which all the necessary adapters are provided. One stated purpose for using these connectors is to keep wires, plugs, and the like discreetly out of sight; another is to save space. In our opinion, the move succeeds in both respects.

Clearly the Beomaster 1900 is not your basic, everyday receiver. Its cosmetics are unusual (and the matching Beogram 1900 turntable makes for a visually stunning ensemble). Once one becomes accustomed to the innovative style of the model, operation is straightforward, and the sonic performance is certainly adequate for a receiver of this price class. Whether or not this is the receiver for you is a matter of taste—not only in sound and conveniences, but, to an unusual degree, in styling. The Beomaster has thrust its foot boldly forward; we doubt that your response to it will be neutral.

CIRCLE 135 ON READER-SERVICE CARD

(Additional data on page 68)

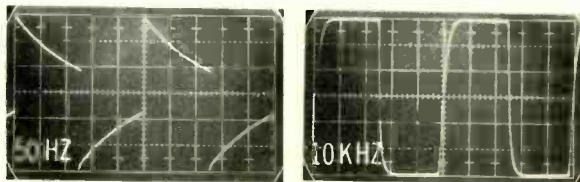

Square-wave response

THE OPTIMUM.



The first cassette deck that can find selections automatically.

Now there's a cassette deck that plays it your way.

The Optonica RT-3535. It's the world's only cassette deck with APLD, the Automatic Program Locating Device that lets you select the songs you want to hear automatically, instead of manually searching for each cut.

But that's not all.

This Optonica cassette deck also has the kind of specifications that will impress the most dedicated audiophile.

The high quality tape transport features a 2-motor drive system, and a precision polished capstan shaft. Which results in a wow and flut-

ter of an amazingly low 0.04%. Compare that figure with other top of the line cassette decks and you'll see why Optonica can honestly call the RT-3535, The Optimum.

A built-in Dolby System means you won't have to worry about hiss and noise ruining the performance of your tapes. And the ultra-hard Permalloy head means you'll have greatly improved frequency response, especially in the high range.

We invite you to test the Optimum cassette deck at one of the select audio dealers now carrying the full line of Optonica stereo components. Call toll-free, 800-243-6000 day or

night (In Connecticut dial 1-800-882-6500), for the name and address of your nearest Optonica showroom, where you can see the complete Optonica line and pick up your free copy of our catalog. Or for further information, write Optonica, Dept. C3C, 10 Keystone Place, Paramus, New Jersey 07652.

From our cassette deck that finds selections automatically to our unique turntable built on granite, find out why throughout Europe and Japan, Optonica is one of the fastest selling lines of stereo components on the market today.

OPTONICA THE OPTIMUM.

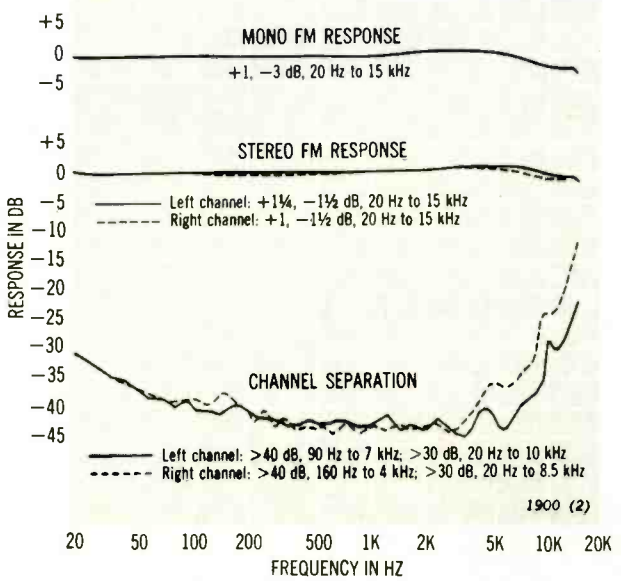
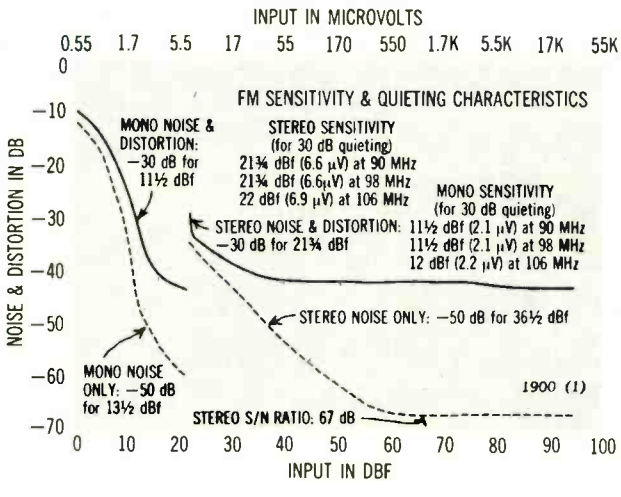
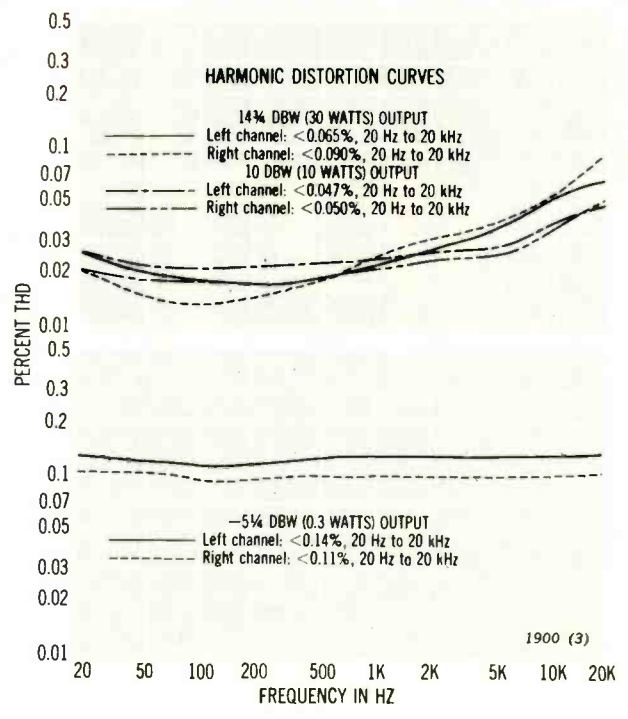
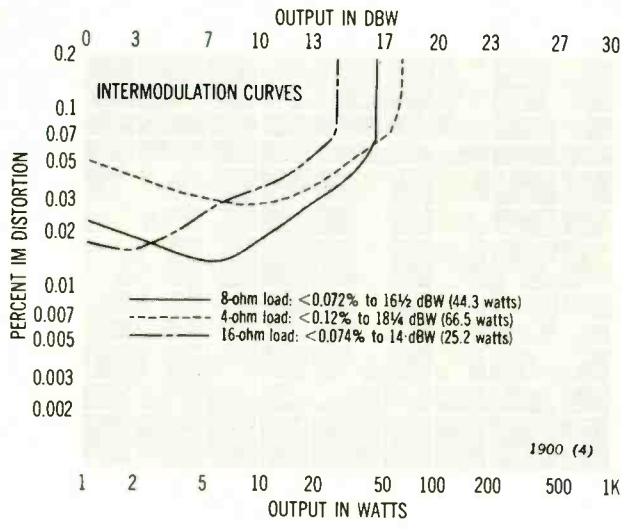

Beomaster 1900 Additional Data

Tuner Section			
Capture ratio	2½ dB		
Alternate-channel selectivity	70 dB		
S/N ratio (mono, 65 dBf)	70 dB		
THD	Mono	L ch	R ch
80 Hz	0.50%	0.85%	0.76%
1 kHz	0.38%	0.42%	0.35%
10 kHz	0.32%	2.2%	2.1%
IM distortion	0.8%		
19-kHz pilot	-63½ dB		
38-kHz subcarrier	-64½ dB		
Amplifier Section			
Power output at clipping (channels driven simultaneously)			
L ch	15 dBW (31 watts) for 0.024% THD		
R ch	15 dBW (32 watts) for 0.031% THD		
Frequency response	+¼, -1 dB, 30 Hz to 40 kHz +¼, -3 dB, 14 Hz to 70 kHz		
RIAA equalization	±1 dB, 35 Hz to 20 kHz +1, -2¼ dB, 20 Hz to 20 kHz		
Input characteristics (for rated output at full gain)			
phono	3.9 mV	-51¼ dBW	66 dB
tape	270 mV	-61¼ dBW	76 dB
Phono overload (clipping point)	54 mV (at 1 kHz)		
Damping factor at 1 kHz	76		

THE OPTIMUM.

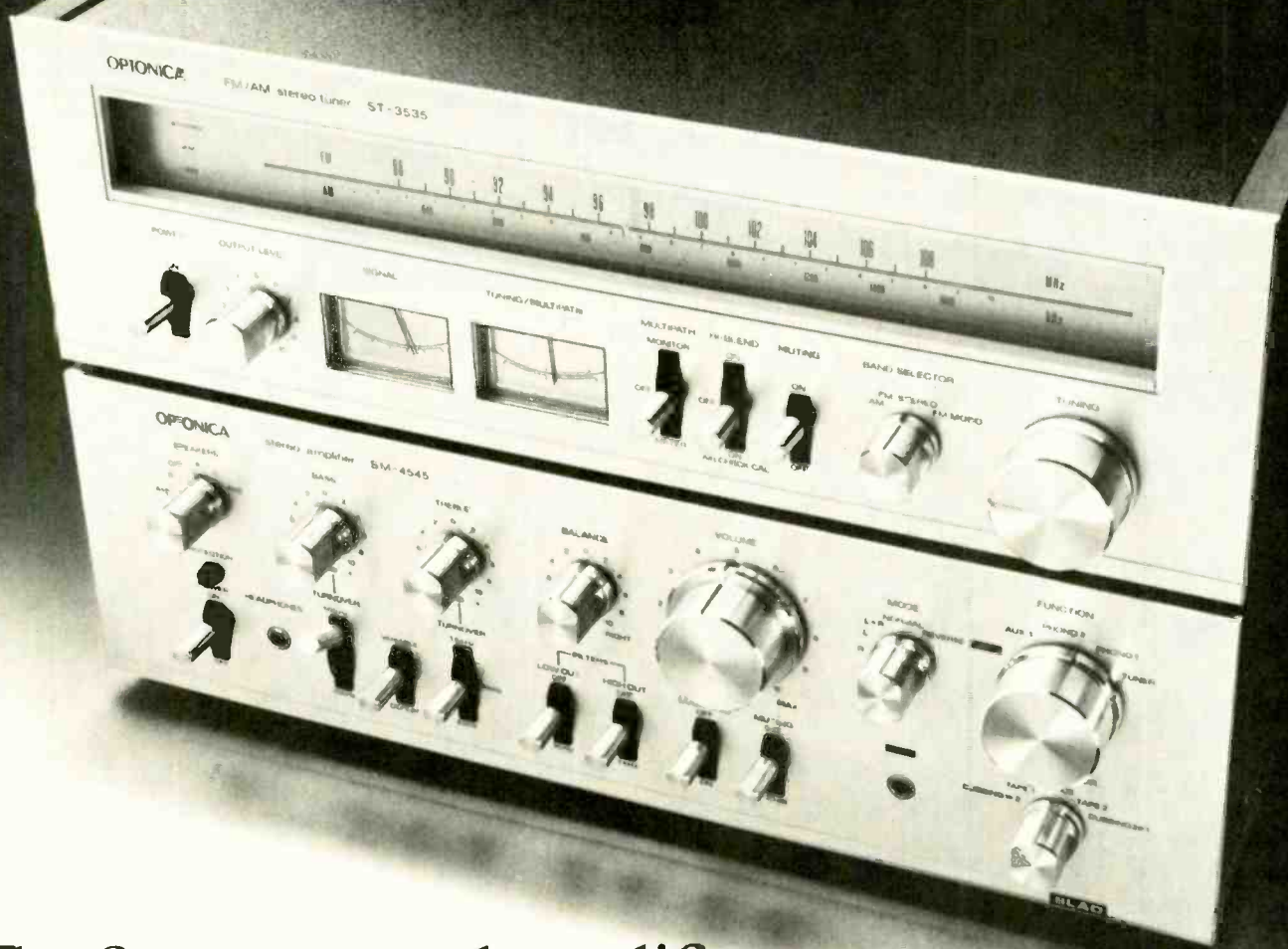

The first tuner and amplifier that won't scare you into buying a receiver.

Most people buy a receiver instead of a separate tuner and amplifier because they think it's easier to handle, less complicated, not as frightening, even less expensive.

Nothing could be further from the truth. Which is amply proven by the Optonica ST-3535 tuner and the SM-4545 amplifier... a pair so easy to get along with, and so easily affordable, you'll be glad you didn't settle for a receiver.

The Optonica ST-3535 tuner is designed for clear reception and high sensitivity and has a built-in meter that detects multipath distortion.

And here's a feature we bet you won't find on a receiver: an air check calibrator to give you an accurate FM Air Check. Just flip on the switch and a level signal equivalent to that of

the FM signal is generated. Then all you have to do is set the recording level to 0 VU on the tape deck.

Why does Optonica call its amplifier the Optimum? Just try to find a receiver or amplifier that can match our newly developed SLAD (Spikeless Amplifier Design) circuitry, designed to prolong the life of your amplifier by eliminating notching distortion at high power output. This also results in excellent low distortion characteristics with 0.1% total harmonic distortion at 65 watts per channel, minimum RMS at 8 ohms, from 20 Hz to 20 kHz.

We invite you to test the Optimum tuner and amplifier at one of the select audio dealers now carrying the full line of Optonica stereo components. Call toll-free, 800-243-6000 day

or night (In Connecticut dial 1-800-882-6500), for the name and address of your nearest Optonica showroom, where you can see the complete Optonica line and pick up your free copy of our catalog. Or for further information, write Optonica, Dept. A3C, 10 Keystone Place, Paramus, New Jersey 07652.

From the first tuner and amplifier that won't scare you into buying a receiver to our unique turntable built as steady as a rock, find out why throughout Europe and Japan, Optonica is one of the fastest selling lines of stereo components on the market today.

OPTONICA THE OPTIMUM.

E	1	N	2	H	3	P	4	I	5	T	6	Z	7	L	8	A	9	M	10	H	11	B	12	J	13		
N	14	P	15	Z	16	A	17	F	18	L	19	B	20	ZZ	21	U	22	W	23	H	24	S	25	Y	26	L	27
M	28	Z	29	N	30	A	31	G	32	H	33	T	34	V	35	R	36	C	37	E	38	K	39	N	40		
X	41	B	42	H	43	P	44	Z	45	ZZ	46	L	47	O	48	D	49	V	50	K	51	B	52	F	53	N	54
T	55	ZZ	56	I	57	P	58	H	59	A	60	N	61	L	62	N	63	Y	64	D	65	F	66	M	67		
P	68	H	69	B	70	I	71	L	72	Z	73	G	74	N	75	W	76	Y	77	O	78	H	79				
E	80	I	81	S	82	T	83	N	84	P	85	K	86	Y	87	C	88	M	89	L	90	W	91	R	92	ZZ	93
E	94	T	95	D	96	G	97	H	98	N	99	P	100	O	101	B	102	F	103	A	104	Y	105	M	106	I	107
T	108	N	109	E	110	C	111	P	112	Z	113	O	114	D	115	Y	116	U	117	B	118	J	119				
I	120	R	121	F	122	S	123	B	124	V	125	E	126	H	127	W	128	J	129	O	130	L	131	G	132	X	133
M	134	O	135	E	136	P	137	L	138	H	139	T	140	T	141	A	142	N	143	I	144	D	145	S	146		
B	147	O	148	E	149	I	150	N	151	J	152	O	153	U	154	V	155	G	156	F	157	Z	158	T	159	E	160
B	161	Z	162	N	163	A	164	N	165	ZZ	166	Y	167	O	168	G	169	H	170	B	171	ZZ	172	N	173		
I	174	J	175	H	176	P	177	B	178	C	179	F	180	S	181	T	182	H	183	K	184	W	185	M	186	ZZ	187
D	188	E	189	B	190	H	191																				

DIRECTIONS

To solve these puzzles—and they aren't as tough as they first seem—supply as many of the Output words as you can in the numbered dashes following the Input. Unless otherwise specified in the Input, the Output consists of one English word. "Comp." means compound, or hyphenated, word.

Transfer each letter to the square in the diagram that bears the corresponding number. After only a few correct guesses you should begin to see words and phrases emerging in the diagram, which when filled in will contain a quotation related to music, recordings, or audio.

The words in the quotation are separated by darkened squares and do not necessarily end at the end of a row.

Try to guess at these words and transfer each newly decoded letter back to its appropriate dash in the Output. This will supply you with further clues.

A final clue: The source of the quotation—the author and his work—will be spelled out by the first letters in the Output, reading down.

The answer to HiFi-Croctic No. 22 will appear in next month's issue of *High Fidelity*.

INPUT	OUTPUT	INPUT	OUTPUT
A. Irish-American cellist and composer (1859-1924): <i>Natoma, Madeline</i>	31 142 17 60 104 9 164	N. Following <i>The</i> , title of Nielsen's Second Symphony; also ballet with music by Hindemith (2 wds.)	173 75 165 109 30 143 40 151 61 84 54 14 2 99 163 63
B. Musical ornamentation	124 102 52 70 147 161 118 42 12 20 178 190 171	O. Ecclesiastical garb	135 148 168
C. Opera by Isidore de Lara	179 111 37 88	P. Jazz pianist, band leader, and composer (b. 1906; full professional name)	44 85 177 112 100 15 137 68 4 58
D. Bohemian dance similar to the mazurka	115 96 188 65 145 49	O. Wagner's Irish princess	130 48 78 153 114 101
E. Russian tenor (1867-1943) noted for Wagnerian roles (first and last names)	126 38 94 136 110 1 149 160 189 80	R. Swiss musicologist (1873-1935): <i>Introduction to Music History</i>	121 92 36
F. Popular dance in vogue during the 1920s (comp.)	66 157 53 18 180 122 103	S. Two-part polyphony based on thirds, sixths, and tenths	82 25 123 146 181
G. French-Canadian soprano (c. 1885-1948) long at Covent Garden	132 156 97 32 74 169	T. Ragtime dance popular in World War I era (2 wds.)	159 108 55 141 6 182 95 140 83 34
H. Collage of sound produced by recording on tape and editing noises, voices, percussion, etc. (2 Fr. wds.)	59 183 170 43 176 127 139 3 79 24 11 33 98 69 191	U. Knowledgeable, as about jazz (slang)	22 154 117
I. For instance, Chopin's Op. 29	81 71 144 174 120 57 5 107 150	V. American movie star who made his New York debut as the Drum Major in Berg's <i>Wozzeck</i>	155 50 125 35
J. Site of annual U.S. music festival	13 129 152 175 119	W. Important form of early polyphonic music	128 23 185 91 76
K. Of the human figure, undraped	184 86 51 39	X. Arabic lute	41 133
L. Borodin opera completed after his death by Rimsky-Korsakov and Glazunov (2 Rus. wds.)	90 47 19 27 131 72 138 8 62	Y. In a fugue, a close succession with the answer beginning before the subject is completed (It.)	87 64 105 167 26 77 116
M. Stokowski's successor as music director of the American Symphony	106 28 186 89 10 134 67	Z. Repeated subject throughout Berlioz' <i>Symphonie fantastique</i> , a forerunner of Wagner's leitmotiv (2 Fr. wds.)	158 113 29 162 7 45 73 16
		ZZ. Applauded	166 187 46 93 21 172 56

Solution to last month's HiFi-Croctic appears on page 6.

THE OPTIMUM.



The first turntable that's as steady as a rock.

Turntables shouldn't cause howling and screeching through the night. But that's exactly what happens, thanks to mechanical and acoustic feedback caused by loudspeakers vibrating an insecure turntable.

Since most turntable bases have been made of laminated plywood, beech, die-casting or plastic, howling has been a problem that just wouldn't go away.

Until today, that is.

Announcing the Optonica RP-3636 Direct Drive Turntable. We built the ideal turntable, literally as solid as a rock because it's built on 15.8 pounds of Mikage granite stone. Which means that vibrations from the speakers are absorbed, reducing acoustical feedback and

maintaining maximum signal to noise ratio.

The Optonica RP-3636 also features a highly sensitive S-shaped tonearm. Which means that the stylus will pick up subtle sound signals as accurately as the cutter stylus that recorded them. And an oil-damped cueing control that gently lifts and lowers the tonearm so your records will be protected from damage.

We invite you to test the Optimum turntable at one of the select audio dealers now carrying the full line of Optonica stereo compo-

nents. Call toll-free 800-243-0000 day or night (In Connecticut dial 1-800-882-6500), for the name and address of your nearest Optonica showroom, where you can see the complete Optonica line and pick up your free copy of our catalog. Or for further information, write Optonica, Dept. T3C, 10 Keystone Place, Paramus, New Jersey 07652.

From our unique turntable built as steady as a rock to our cassette deck that automatically finds your selections, find out why throughout Europe and Japan. Optonica is one of the fastest selling lines of stereo components on the market today.

OPTONICA THE OPTIMUM.

A High-Class Musicological Cops-&Robbers Tragicomedy

in Three Acts

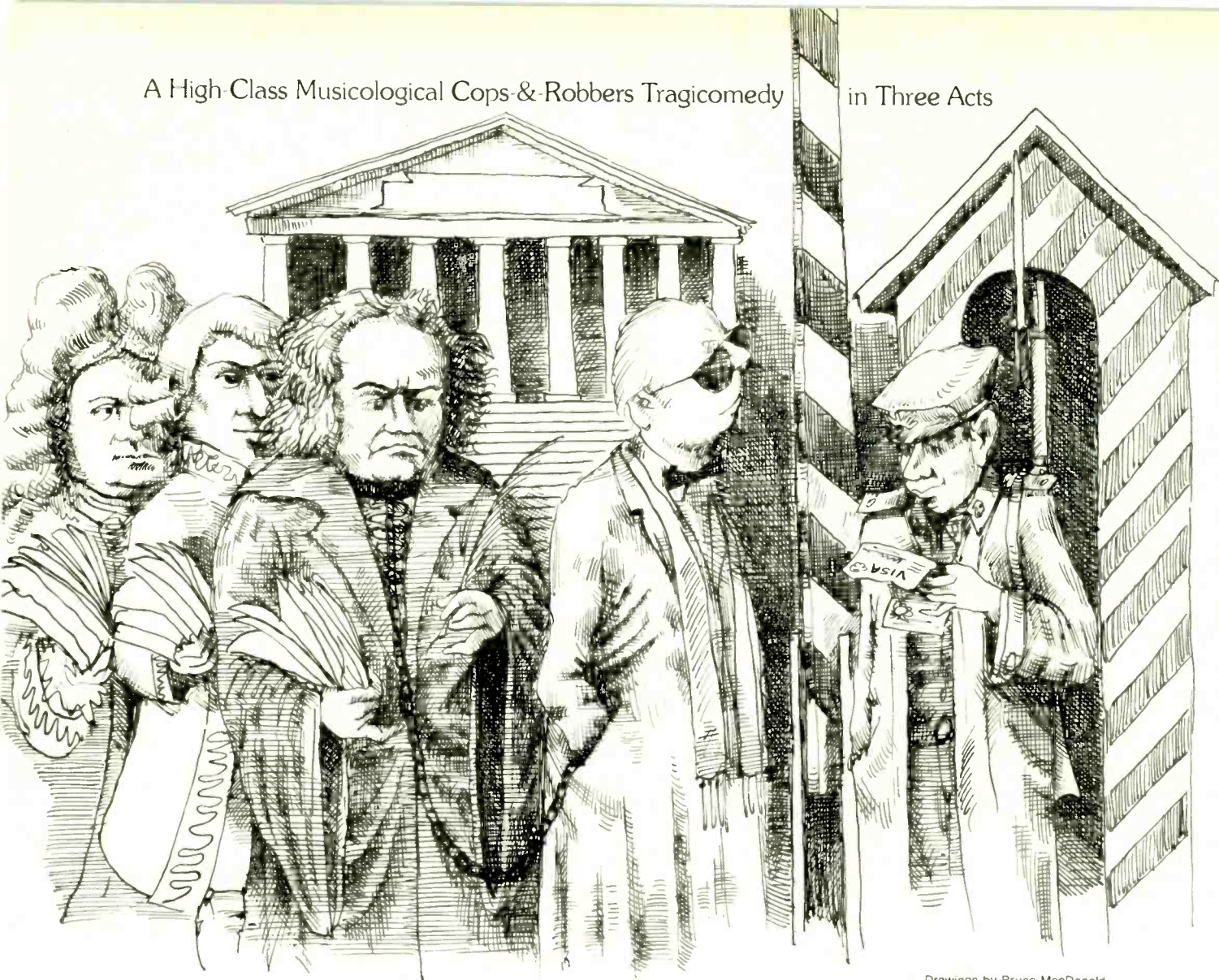

Drawings by Bruce MacDonald

by Paul Moor

The Great Mozart-Beethoven Caper

Or, Does the Pierpont Morgan Library House Stolen Goods?

Act I

OUR STORY OPENS in East Berlin on the first of May, 1951. As on May Day in all Socialist countries, a carnival atmosphere prevails; schools and offices have closed, enabling the enormous political demonstration to attract as many citizens of the Ger-

Paul Moor, writer, musician, CBS broadcaster, and long-time correspondent for HIGH FIDELITY and MUSICAL AMERICA, has lived in Germany for the past twenty-five years.

man Democratic Republic as possible to the Marx-Engels-Platz, either as marchers or as spectators.

Around the corner, in the spacious old boulevard Unter den Linden, the imposing buildings stand quiet and empty as the crowds swarm past, in the balmy spring air, on their way eastward to the big square. Cater-cornered from the State Opera and next door to the university stands the German State Library, Berlin's equivalent of Washington's Library of Congress. Like the others, it is empty—or, at least, almost. One man there this morning has urgent business. His colleagues, had they not the day off, would recognize and defer to

him as Dr. Joachim Krüger-Riebow, director of the library's music section and its literally priceless autograph manuscript collection. As usual, he carries one of only two existing keys to the safe that contains the legendary collection of musical manuscripts.

His colleagues know the forty-one-year-old librarian as a passionate lover of music, as a bibliophile—indeed, his passion justifies the term “bibliomania”—and as a creditable performer on three instruments. He has acquired a reputation as a staunch and loyal member of the governing Socialist Unity (Communist) Party and as the heart-and-soul secretary of the Society for German-Polish Friendship; he figured actively and importantly in the return to Poland of Chopin manuscripts stolen during the Nazi occupation. (He speaks Polish well, not to mention modern Greek.) It did him no harm when, eight months ago, a government minister—a party comrade, naturally—recommended his promotion from a lowlier position at the library to his present post, one of the most important and distinguished of its kind in the world.

The May Day crowds, on pleasure bent, pay no heed when a truck backs up to a sidestreet entrance of the German State Library. Wasting no time but attracting no attention by undue haste or furtiveness, the driver and the music librarian load three or four packing cases. Minutes later, with the librarian as passenger, the truck crosses the sector boundary into West Berlin. (The Berlin Wall will not go up for another decade.)

Our scene shifts now to Cologne airport four days later, as Dr. Krüger-Riebow arrives from Berlin. His baggage includes one of the packing cases. When a lubberly attendant drops it, it bursts and, before the suspicious regard of a uniformed customs inspector, a cascade of obviously old manuscripts pours out onto the floor. The inspector asks pointed questions. The librarian, however, has the necessary official identity papers to confirm his claim to the exalted scholarly nature of his office. He tells the staring inspector he intends to deliver the manuscripts to the Beethoven House in nearby Bonn, the master's birthplace. The inspector retains some mistrust, but the obviously official documents have exerted their customary magical effect upon the German bureaucratic mind. He allows his suspect, with his patched-up baggage, to pass, addressing him, with reflexive deference, as *Herr Doktor*.

At the Beethoven House, its director Dr. Joseph Schmidt-Görg receives his East Berlin colleague politely. When he learns what he has brought with him as a get-acquainted present, politeness gives way to the nearest thing to utter, lyric rapture a proper musicologist can experience. Dr. Krüger-Riebow says that *at the risk of his life* he has just barely, in time's nick, snatched these priceless

treasures out of the sweaty, uncouth clutches of the Russians, who, he says, were planning to remove them to Moscow in the imminent future. Dr. Schmidt-Görg, touched—nay, moved—by his visitor's selfless, musicological heroism, promises the absolute discretion his visitor demands. Dr. Schmidt-Görg gladly prepares and hands over an itemized receipt for this overwhelming, totally unexpected windfall.

As the refugee bibliophile returns to the airport, he muses poignantly, perhaps, about all of the other treasures that, for one reason or another, he has left behind in the Soviet sector of Berlin: by Bach alone, the *St. Matthew Passion*, the six *Brandenburg Concertos*, the first half of *The Well-Tempered Clavier*, and the *Orgelbüchlein*; two acts of Mozart's *The Marriage of Figaro*; the Brahms D minor Piano Concerto; Beethoven's Piano Sonata, Op. 111; Schubert's Goethe songs; Schumann songs, by the volume—to mention merely a tiny selection of the gems to which he had had exclusive and unrestricted access.

Even so, he has not done too shabbily by the Beethoven House. With quiet, decorous, musicological satisfaction, Dr. Krüger-Riebow, who has courageously turned his back on prestige and position, shows the still slightly suspicious customs inspector his receipt from Dr. Schmidt-Görg. Among the items listed are dozens of letters written by Buxtehude, Czerny, Mahler, Mendelssohn, Meyerbeer, Richard Strauss, and Cosima Wagner; two musical manuscripts each of Glinka and Debussy; Handel's *Salve Regina*; twenty-seven Beethoven manuscripts, including sketches for the *Pastoral Sonata*, Op. 28, *Missa Solemnis*, String Quartets Nos. 12 and 16, Opp. 127 and 135, respectively; and the Eighth and Ninth Symphonies; and, most staggering of all, 137 of the extant 139 “conversation

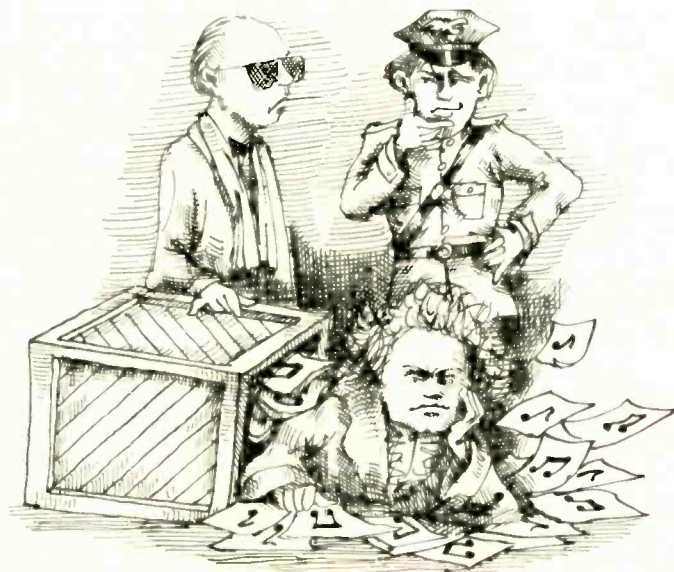

notebooks" to which the deaf Beethoven, during the last decade of his life—a decade that saw the creation of his supreme masterpieces—had to resort in order to communicate.

Now we cut to New York, where in September 1951 *The New York Times* publishes a story datelined Berlin: "The priceless 'conversation books' recording Beethoven's talks with his friends during his final years of deafness have disappeared from the former Prussian State Library on the Unter den Linden in the Soviet sector of Berlin. Rumor of this loss was confirmed when Carleton Smith, director of the National Arts Foundation, was told he could not see them when he visited the collection yesterday. . . ."

"One of the library's senior curators, Dr. Joachim Krüger-Riebow, disappeared late this spring at about the same time that the absence of the precious five-foot shelf of notebooks was first noted. Dr. Krüger-Riebow, who had the reputation of being a loyal Socialist Unity Party member until he absconded, is presumed to be working his passage home with these treasures of Germany's musical heritage."

Irony of fate! The story breaks in distant America before it does in Germany—and how many musicological scholars working in Germany read *The New York Times*?

Act II

Eight years have passed. Our anti-Communist librarian has settled down to unmarried life in West Berlin with a lady friend named Reichwein, who helps him run a rare-books business. Eccentricity, not unknown in this profession, here runs rampant. The business bears the name Bayreuther Musik-Antiquariat, although it operates out of Berlin and has only a post-office box in Bayreuth. It publishes an annual catalog, about a hundred pages thick, which makes bibliophilic mouths water. Prices on individual items range up to about \$5,000. Orders come in from as far away as Japan.

One such order, in September 1959, is placed by the Shiseido company in Kyoto, which pays almost \$6,000 down. This necessitates a business trip for our hero. On September 16, in Hannover's Municipal Library, Dr. Krüger-Riebow turns up Ludwig Erk's three-volume *Deutscher Liederhort*. Next morning, in the Duke August Library in Wolfenbüttel, he finds an early volume of Frescobaldi, another rare book of late sixteenth-century Italian music, and a 1514 Buchardus volume, with a combined worth of \$4,000 to \$5,000. He proceeds to Göttingen, where he goes to the university library's catalog room. A young woman doing re-

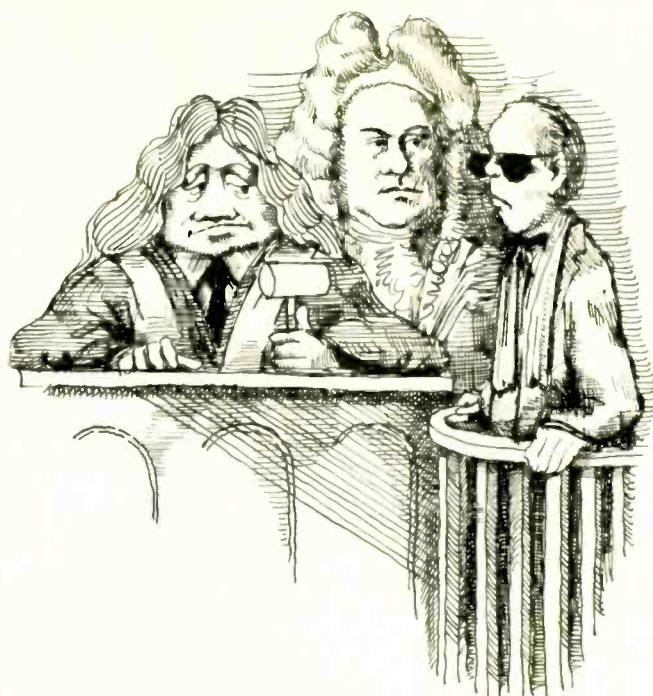

search there seems to regard him with interest but presently leaves. On the open shelves he finds the 1956-57 and 1957-58 editions of *American Book Prices Current*. After he has passed the barrier, but before he has left the building, a policeman detains him. Inside his coat, under his arms, he has the two books, worth only about seventeen dollars each. The policeman listens impassively to his stammered explanation that he had had to go to the toilet but had not wanted to interrupt his scholarly research.

As a matter of routine, the police check his room at the Gebhards Hotel. There they discover not only the swag from Hannover and Wolfenbüttel, but also a portable chemical workshop for the eradication of library stamps and other identifying markings. The Göttingen police alert their Berlin counterparts, who find in Dr. Krüger-Riebow's digs, among many other interesting articles, literally thousands of slips of paper, each one bearing the title of a rare book and the name of the library where one might consult it. The Göttingen police fling "Dr. Joachim Krüger-Riebow" into the local slammer. A guard, noticing that whenever he enters the scholarly guest snaps smartly to attention underneath the cell window, remarks his evident familiarity with German jailhouse procedure.

About six months later, on March 24, 1960, "the music dealer Joachim Krüger, born on February 10, 1910, in Wust, county of Jerichow," as the court record baldly identifies him, stands accused before a Göttingen judge. The prosecutor charges him with theft in the three cities in as many days, with fraud against Shiseido, with use of falsified identity papers, and (Germany takes such things

seriously) with unauthorized use of the academic title *Doktor*.

The trial strips Joachim Krüger to his authentic identity. He never, it now transpires, even attended a university. In fact, he lacked two years of finishing even the *Gymnasium* in Stendal. Returning to civilian life in 1945 from a Waffen-S.S. sabotage batallion, he joined—at least so he says—the Gehlen Organization, originally Hitler's espionage apparatus against the Soviet Union that the Americans took over almost intact when the war ended. As Krüger tells it, the postwar spooks gave him his phony identity papers, including the *Doktor* fillip and the less commonplace surname Riebow, to camouflage his problematical military past before assigning him to spy in and against East Berlin.

Implacably the court confronts him with the record of his previous iniquities, undreamed of by those who originally hired him to work in the state library. His record in Magdeburg shows he had been sentenced on April 23, 1936, to two and a half years, on March 3, 1938, to six months, and on December 9, 1938, to three months; rather mysteriously, on an unspecified date in 1938, a court in distant Königsberg (now Kaliningrad, U.S.S.R.) hit him with an unspecified prison sentence. These cases involved such human failings as forgery, fraud, embezzlement, and theft. The Göttingen court, taking into account the full recovery, undamaged, of the loot involved in this trial, lets Krüger off with a mere eighteen-month sentence.

Act III

The trial arouses curiosity and ambient interest in many of the other state library knickknacks that Krüger thoughtfully chose that day nine years earlier when he chose freedom. Dr. Karl-Heinz Köhler, a distinguished *real* musicologist who replaced Krüger in the state library, had begun in 1956 to advertise for the stolen boodle—the Beethoven notebooks, Mozart's Piano Sonata in A minor, K. 310, etc.—in such professional journals as *Die Musikforschung*, published in the West German city of Kassel. Bit by bit, manuscript by manuscript, it gradually becomes clear that the two or three original packing crates that Krüger did *not* deposit in Bonn in fact served him as the original capital with which he established his flourishing worldwide book business.

A number of honest music librarians in various countries, innocent purchasers from middlemen of items Krüger had purloined and then sold with a forged accompanying letter of authentication on stolen state library stationery, voluntarily and

without any to-do return them to Dr. Köhler. Among them is Harold Spivacke, director of the Library of Congress' music division, who returns a Haydn autograph letter that had originally stuck to Krüger's fingers.

German-speaking musicologists and librarians customarily study such journals as *Die Musikforschung* as assiduously as fundamentalist ministers study the Bible. In Bonn, however, Dr. Schmidt-Görg remains mum. Some word of the Beethoven House's unsolicited acquisitions has trickled out, but at least to one inquiry—the year before the Göttingen trial brought everything into the open—from Hildegard Weigel, a West Berlin research musicologist, the director replies: "Of Beethoven conversation notebooks in Bonn nothing is known to us."

Acting upon press reports of Krüger's trial, Dr. Köhler writes to Dr. Schmidt-Görg. In reply he gets an orderly four-page typewritten list confirming the whereabouts for the past nine years of Krüger's one packing case full of loot. On July 6, 1960, the state library's *Generaldirektor* himself writes to Schmidt-Görg, formally requesting him to return the booty.

Silence.

On August 26 he tries again and on September 13 receives a reply. Dr. Schmidt-Görg defends his position based on the fact that the Prussian State Library, the original owner of the treasures he holds, ceased to exist in 1945 along with the German state of Prussia; the library changed its name first to the Public Scientific Library, then to the German State Library. Schmidt-Görg, on his unique and priceless windfall, sits tight.

Dr. Köhler, ordinarily a mild and mannerly scholar, reaches the end of his tether and of his patience, and goes onto the offensive. In the East Berlin popular weekly *Sonntag* on February 26, 1961, he publishes a thorough, aggressive documentation of the entire Mozart-Beethoven caper, including the full text of Schmidt-Görg's letter, which he calls "insulting"; at two other points he also employs the term "insult," the scholarly equivalent of a glove slapped with deliberation across the adversary's chops.

Conscientious West Germans, notable among them the composer Wolfgang Fortner, respond to Dr. Köhler's broadside. They proclaim, in essence, that Cold War anticommunism must not blind honest, respectable Germans' eyes to common thievery. A face-saving musicological bucket line goes into action: The Beethoven House passes the boodle along to West Berlin's Academy of the Arts, which passes it along to the Academy of the Arts of the German Democratic Republic, which on May 14, 1961, after ten years and thirteen days, returns it to its rightful owner, the German State Library.



This is the opening manuscript page of Mozart's ever-popular A minor Piano Sonata, K. 310, which currently reposes in New York's Morgan Library on loan from the Robert O. Lehman Collection. Scholars will note that Mozart wrote the beginning of the left-hand part in the tenor clef. Criminologists will note that the manuscript was part of Joachim Krüger's swag.



Dr. Köhler with the recovered Beethoven notebooks



Dr. Schmidt-Görg—he sat tight



Meanwhile, back at the Göttingen courthouse, poor Krüger's troubles, far from over, seem scarcely to have begun. He stands totally exposed—at least, a number of anxious musicologists and librarians hope so. On July 6, 1961, a month before the end of his eighteen-month sentence, Göttingen's public prosecutor finally gets around to charging him with all the peccadillos that he had committed before the three for which he was busted. During this one-day second trial, Krüger testifies freely about ripping off the Beethoven notebooks, the Mozart K. 310 Sonata, and so on, still desperately clutching his by now thoroughly waterlogged lifesaver that he did it all to save such German cultural treasures from Russian Communist barbarism. The Göttingen *Kriminalpolizei* says its investigations show that, aside from the Bonn deposit, Krüger realized "enormous income" from his swag.

For theft, West German law foresees a maximum sentence of five years' imprisonment. The statute of limitations on theft, however, comes into force five years after the deed. And 1961 minus 1951 equals 10. On these charges, for offenses of infinitely greater gravity than those on which the first Göttingen trial convicted him, Krüger goes scot-free.

On August 18, 1961, Joachim Krüger walks out of prison. Five days earlier, the German Democratic Republic had built that darling wall across Berlin, an architectural accomplishment that did not remain without effect upon such little spirit of give-and-take as existed between the two Germanys up to that time. Had that event come but a few months earlier, prior to the bucket-line operation, who would have possession of the stolen property today?

Krüger settles down in Göttingen, and on Febru-

ary 9, 1962, the court has him up again for petty shoplifting but a month later drops the charges. On March 25, 1963, comes another such accusation.

Epilogue

If you wonder what became of that Mozart piano sonata, I have a modest scoop to report. You can find it, as of this writing, in the Morgan Library in New York. The Morgan has it on indefinite loan from the opulent collection of Robert O. Lehman, a producer of musical films and scion of the banking Lehman family. He bought the sonata in 1963, allegedly unknowing, from Rudolf Kallir, vice president of the American Mannex Corporation ("I'm in the steel business—s-t-e-e-l") and father and father-in-law, respectively, of noted pianists Lilian Kallir and her husband, Claude Frank. Kallir thus far prefers not to say where he got it. On January 28, 1960—three years before he unloaded it onto Lehman—*The New York Times* reported Kallir as saying "that he had acquired it from a 'well-known dealer here' in 1955. He said he had received a purported authorization of sale . . . [and that] he had made his purchase of the Mozart item 'in good faith.'"

Now, Lehman may sue Kallir, Kallir may sue God knows whom, but as for Krüger, fateful circumstance militates against anybody's suing him. That day in 1963, when the Göttingen police went to fetch him, he seemed to have disappeared into thin air.

Should you chance to read these lines, Joachim, no matter where, stay in bed with your hat on.



Dedicated to Robert O. Lehman, with compassion and with the consoling hope that he, as a film producer, will recognize a hell of a story. ■

Dolby FM and Conventional FM

Symmetry is the Difference

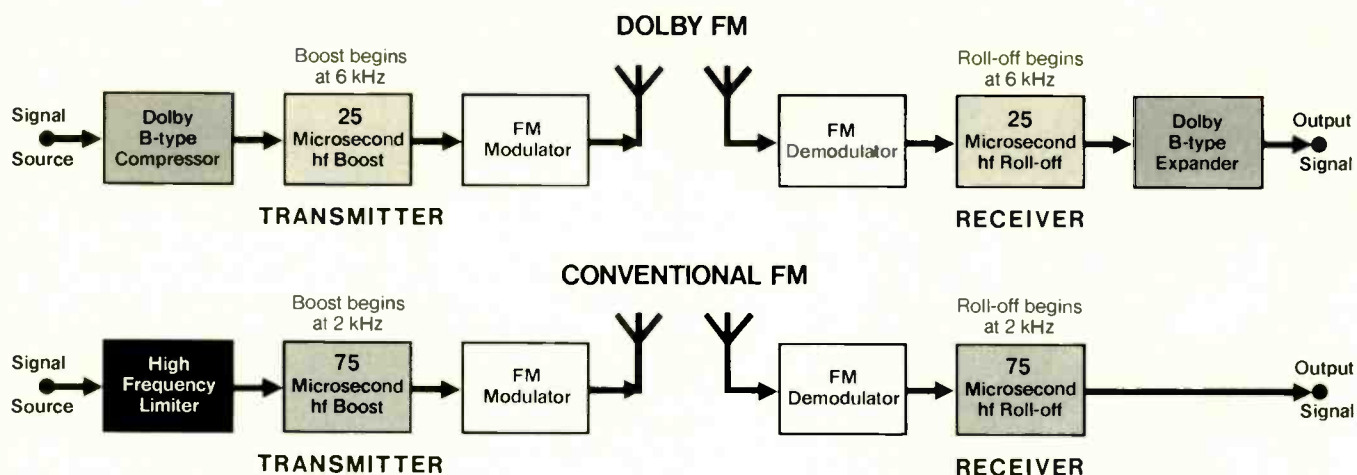

These block diagrams show the difference between Dolby FM and conventional 75 microsecond FM. The difference is symmetry. With Dolby FM, the circuits at the transmitter are matched by complementary circuits in the receiver. Such symmetry of signal handling has long been valued in disc and tape recording – and indeed in noise reduction systems. Unfortunately, in conventional FM broadcasting the standards were set so long ago (back in the 40's) that modern wide-range program material causes problems; high frequency limiting has to be used, and thus there is an extra process at the transmitter which is not matched by any complementary treatment in the receiver.

The Dolby B compression and ex-

pansion system is well known for its mathematically exact mirror-image operation; this is a key element in permitting FM stations and receivers to function in a symmetrical way. Here's how. First the conventional 75 microsecond high frequency boost and roll-off are reduced to the point where high frequency limiting is no longer required at the transmitter (this happens with a reduction to 25 microseconds, which gives a boost and cut beginning at about 6 kHz instead of 2 kHz). Unfortunately, this step is inherently accompanied by about a 5 dB increase in receiver noise. In the second step, however, the addition of the Dolby B system not only takes care of the additional noise but results in a noise level some 5 dB lower than conventional FM.

Thus, the overall effect is that about half of the 10 dB Dolby noise reduction capability is traded off for symmetrical signal handling. But, considering the two extremes of the dynamic range, there is still a genuine *total* increase of 10 dB in available dynamic range above about 3 kHz.

If you like the idea of a symmetrical FM system with reduced noise, then we invite you to write to us for further information. The following information is available:

1. Technical details and explanations of Dolby FM.
2. A list of stations with Dolby FM encoder units.
3. A list of receivers with built-in Dolby FM circuits.

Listening to Dolby FM

Basically, listening to the improvement brought about by Dolby FM is like listening to any audio equipment improvement – such as those made to turntables, pickups, amplifiers, and speakers. A particular improvement in a component may well be there all the time, but its noticeability will depend on various factors, such as the listening environment or the type and quality of the program material.

In the same way, the overall Dolby FM listening improvement is subtle most of the time; occasionally, however, it will be quite obvious. It should be remembered that in FM the 10 dB action of the Dolby system is distributed nearly equally between the low-level noise and the high-level signals. The audibility of any change is therefore less obvious, and depends more on program material and other conditions, than the effect of the Dolby system on cassettes.

Relative to the hiss level of conventional broadcasting and reception, a somewhat (but not startlingly) reduced hiss will be

noticed by listeners with weak-signal reception conditions; listeners with a strong signal will note no change (as with conventional FM, the noise will be determined by the station's source material). Listeners in any reception area, though, will notice a full recovery of source material high-frequency dynamics, regardless of signal strength. On most stations, cymbal crashes and other program material containing high-level high-frequency components will sound distinctly brighter and cleaner. Otherwise, for those rare stations which conventionally hold down modulation in order to preserve high-frequency signal integrity, the introduction of Dolby encoding allows an increase in overall level by several dB. Of course, this increase will be apparent to all listeners, regardless of location and whether or not they have receivers equipped with Dolby FM circuits.

We think that critical listeners can hear and enjoy the various improvements described above often enough to make the extra cost of Dolby FM well worthwhile.



Dolby Laboratories Inc

'Dolby,' and the double-D symbol are trade marks of Dolby Laboratories Inc.

731 Sansome Street
 San Francisco, CA 94111
 Telephone (415) 392-0300
 Telex 34409
 Cable Dolbylabs

346 Clapham Road
 London SW9
 Telephone 01-720 1111
 Telex 919109
 Cable Dolbylabs London



Hub City of American Audio

The home of the bean and the cod has also been the home of an inordinate amount of high fidelity innovation.

by Michael Riggs

SEVERAL YEARS AGO, when I moved from the heartland of America (St. Louis, to be precise) to Boston, I was a budding audiophile with no very clear notion of what the city would be like. I knew, of course, that there was a Boston Symphony Orchestra, that Harvard and MIT were here, that some good loudspeakers called it home, and that something called the Boston Audio Society was just beginning to make itself known to the world. Once settled in, my first move was to join the Audio Society, which proceeded to educate me about high fidelity and about the remarkable city in which I live. Boston, it turns out, is a hotbed of audio activity. For the audiophile, there is no place more exciting.

Two sources converge to make audio in The Hub City the adventure it is. The first is the deep

well of talent and technical expertise in the metropolitan area. Boston, Cambridge (her sister city across the Charles River), and the suburbs are home to some thirty colleges and universities and to an impressive number of high-technology industries. Twenty-odd audio manufacturers of one stripe or another—probably a higher per-capita concentration than any other metropolitan area in the world can claim—are native to the Boston area, including such old-timers as Acoustic Research, KLH, and H. H. Scott. Whatever the need, if it's within the reach of current technology, it either could be or is being produced here.

But hardware can only reproduce music, and the love of reproduced music can come only from the love of music itself. Boston and environs overflow with music of every kind. The core of this activity is the Boston Symphony Orchestra, flanked by the astonishing Sarah Caldwell and her Boston Opera Company and by the New England Conservatory. A relatively large number of clubs fea-

Michael Riggs is by profession an investment counselor and by avocation the editor-in-chief of the Boston Audio Society's monthly journal, The BAS Speaker.

ture jazz groups, many of them home-grown, and FM stations WBUR, WGBH, and WHRB program jazz on a regular basis. The Berklee School of Music is probably the country's major institution devoted solely to the teaching of jazz and popular music. Cambridge, in particular, has maintained a strong folk and blues scene. On a clear day, you can hear bagpipes in Harvard Square. It takes a large, musically aware population to nourish such variety. It is not by accident that the SCHWANN CATALOG has been prepared in Boston during the nearly three decades it has been published [for more on SCHWANN, see the editorial on page 4.—Ed.] nor that Bolt, Beranek, & Newman, the Boston firm of acousticians, has dominated its field for much of that period.

That diversity is a source of special delight to the audiophile, however, because he has a way of keeping in touch with it that others do not fully appreciate. FM in Boston is exceptional in the scope and quality of its live broadcasting. Four stations—WBCN, WBUR, WCRB, and WGBH—do significant amounts of live broadcasting, with WCRB and WGBH regularly transmitting Boston Symphony concerts to thousands. WCRB is the producer and distributor of the BSO tapes, and has recently assumed the same role for the New York Philharmonic, whose concerts it also broadcasts. This musically active station also duplicates and distributes the tapes of the Chicago Symphony produced by WFMT.

The outstanding sonics of the BSO broadcasts are no accident, and the fact that they really are top notch (often better than the Symphony's recordings) is not as surprising as it would be in most places. Bostonians have been involved in the development and refinement of stereo FM broadcast and reception from the beginning. Daniel von Recklinghausen (then of H. H. Scott, now of KLH) worked closely with the FCC when the stereo multiplexing system now in use was chosen, designed one of the first stereo generators, helped stations all over the country set up and align their generators, and supervised the design of the first stereo tuners that really worked. Later KLH built the first high-quality solid-state tuner. More recently the interesting work has been at the other end of the chain. Some WGBH broadcasts probably represent the highest FM fidelity in the nation today.

The moving force behind these broadcasts is AR's Victor Campos. Early in his *Adventures in Sound* series he demonstrated that FM could be an extraordinarily high fidelity medium if all automatic limiters and compressors are removed from the signal path. This makes necessary a small amount of manual gain riding to prevent over-modulation, but it results in a cleaner signal with much improved dynamic range. The program material for *Adventures in Sound* consists of Dolby-A encoded dubs from master tapes. Decoding



Victor Campos, originator of "Victorization"

doesn't occur until the signal reaches the transmitter, thus minimizing noise from the phone lines between the studio and the transmitter. The resulting sound through a good tuner is stunning. WGBH also uses this process—affectionately called "Victorization" (after Campos) by Bostonians—on many of its BSO broadcasts, with similar results. Boston may be the only city in the country where it makes sense to spend the money for a state-of-the-art tuner.

The technical aspects of high fidelity are covered by radio as well. Saturday mornings on WBUR, Peter Mitchell and Dick Goldwater are hosts of *Shop Talk*. They frequently have guests and always have interesting discussions. The program is one of the things that give the local audiophile community its definition.

The other shaping force is the Boston Audio Society, probably the largest and the most active audiophile organization in the world. Founded four years ago by Alvin Foster and a handful of devotees, it has doubled in size every year until it now has about eight hundred members, some as far away as Japan and Australia. Of course people don't (usually) come from the ends of the earth to attend monthly meetings. In a sense, the meetings go to them. The vehicle is *The BAS Speaker*, the house organ. More than any other audiophile publication, it is a collective effort, a forum for the membership. Hundreds of people of every conceivable background, from astrophysicists and audio manufacturers to housewives and students, even when separated by continents or oceans, participate in lively, informed discussion.

The society's meetings most often feature a lecturer from the industry, sometimes a member with an idea or demonstration to present, and occasion-

ally both. (Sometimes it's the same person.) Unlike many organizations, the BAS is not monolithic in outlook or philosophy. The tie that binds is concern.

The upshot is that members develop uncommonly good sense about equipment. They also arrive at some unconventional conclusions and some remarkably effective ways to make things better. The lately renewed interest in damped tone arms stems largely from investigations and experiments by members. Phono preamps, which long have eluded the engineers' quest for measurements that correlate with sonic quality, may be yielding to the efforts of a number of members. Others have reported on the audible (or inaudible) effects of phase shift and on the desirability of infrasonic filtering. No one denies that new knowledge and techniques are emerging from the continuing debates.

This same spirit of skeptical inquiry extends into the local audio industry, as was evident during a recent BAS tour of Acoustic Research's Norwood facility. AR's position in the history of high fidelity is well established. Edgar Villchur's acoustic-suspension principle was, perhaps, crucial in making stereo commercially viable. The suspension system he developed for the AR turntable has been widely imitated, and when AR got around to introducing a line of electronics, they were among the best available. (A BAS clinic revealed that the AR tuner performs very well even in comparison with today's high-performance phase-locked-loop tuners.)

And AR hasn't stopped its extensive research and development activities. The BAS was shown the anechoic and reverberant chambers that AR uses in loudspeaker development. Rising interest in car stereo has prompted the use of real-time

analyzers to investigate the acoustics of automobile interiors, with an eye to developing a small speaker for installation in cars. Another project involves computer analysis of the impulse responses of loudspeakers. AR hopes that information will help to determine the significance (if any) of a speaker's impulse response characteristics. AR's new line of loudspeakers is the outgrowth of research on crossover design and driver development, which includes ongoing work in plastic-cone units.

AR is also actively pursuing psychoacoustic research, on the one hand to determine the lower limit of distortion audibility with various kinds of signals and on the other to find ways to simulate the acoustics of concert halls. This has led to a sixteen-channel, computerized, digital audio-delay line for use as a research tool. There has been a persistent rumor (which AR persistently denies) that it is planning to market a home delay system.

AR's offspring—KLH, Advent, and Allison among them—continue to be innovative as well. KLH has introduced a line of loudspeakers, some of which incorporate a newly developed tweeter. Despite appearances (it resembles an electrostatic element), it's an electromagnetic device. The designer was Von Recklinghausen, who claims excellent transient response, extraordinarily smooth frequency response out to 30 kHz, and far greater power-handling capacity than any other tweeter.

A problem most designers have ignored, or at least treated as an imponderable fact of life, is that room acoustics seriously affect a loudspeaker's output, especially in the bass region, where room resonances play a prominent role. Roy Allison did much quantitative research, first at AR and later with his own company, into the interaction of speakers with room boundaries. This led him to design speakers that use room effects in a positive way. Allison Acoustics' loudspeakers, when placed properly, have much flatter bass response in typical rooms than most other models. This is the sort of audio work that Boston prides itself on: an effective and practical solution to a problem everyone—not just "golden ears"—can hear.

Advent Corporation (Henry Kloss, Advent's founder, was a central figure in both AR and KLH) has a reputation for taking a pragmatic approach to audio. It is best known for its loudspeakers, but Kloss actually founded the company to develop his idea for a large-screen, "high fidelity" television receiver, now dubbed the VideoBeam. Advent also did more than any other single manufacturer to make the cassette a high fidelity medium and to promote the Dolby-B noise-reduction system. It was the first company to distribute chromium-dioxide cassettes, the first to manufacture a high quality cassette deck with both Dolby noise-reduction circuitry and provisions for chromium dioxide, and the first to market a separate Dolby-B



Peter Mitchell and Dick Goldwater



Three associated with offspring of Acoustic Research: left, Henry Kloss, founder of Advent; above, Daniel von Recklinghausen of KLH and Roy Allison, founder of Allison Acoustics

unit. Its latest product, the Model 300 receiver (among our test reports this month), is the result of much investigation into the behavior of tuner, amp, and preamp electronics under normal conditions. Among its most exciting features is a state-of-the-art phono preamplifier (in a \$250 receiver!) said to sound as good as any separate unit available. Advent's published reports on its work have done much to remove the mystery from preamp design.

Recently a new speaker manufacturer has been making itself heard: Cizek Audio Systems, founded by Roy Cizek, longtime BAS member. Cizek's looks similar to many other acoustic-suspension loudspeakers, but it has exceptionally flat response and incorporates several innovations, among them unusually flexible response-shaping controls and a crossover network that presents an almost flat impedance curve to the driving amplifier.

Other influential Boston-area loudspeaker designers include Arthur Janszen, one of the fathers of modern electrostatic speakers and the designer of the classic KLH 9, and the late Victor Brociner, who had a long, distinguished career in audio and was the creator of the Avid line. The people responsible for the Genesis speakers got their start with Boston manufacturers. Winslow Burhoe, formerly of KLH and later founder of Epicure, has gone on to start the Little Speaker Company. Meanwhile, the Epicure group, having designed and marketed a diverse line of loudspeakers, has entered the electronics field with a top quality amplifier and a matching preamp.

Another innovative company, headed by MIT professor Amar Bose, has extended its speaker line

down to the little 301. In the other direction, its latest version of the Bose 901 system, on which the company's fame was founded, has taken it into materials and, particularly, technologies far beyond the purview of most speaker companies. Critical considerations of aerodynamics and ultra-high-precision plastics molding and coil windings had to be mastered before the Series III could reach production. Bose also has entered the amplifier market with the Model 1801, whose design parameters were selected according to the results of psychoacoustic research.

Dunlap-Clarke, for several years a manufacturer of state-of-the-art power amplifiers devised with particular attention to the problems of driving difficult loudspeaker loads, has introduced a preamplifier incorporating the latest advances in phono-preamp circuitry. The recently formed Davis-Brinton makes a phono-preamp module designed to produce the very highest sound quality possible; its preamp plugs into the high-level inputs of an amplifier or receiver. Mark Davis and James Brinton have used new test procedures and design principles, highest quality parts, and a specially structured bandpass filter to insure consistent state-of-the-art performance.

Another field in which Boston companies have led the way is noise reduction. Kloss, when he was president of KLH, encouraged Ray Dolby to develop the Dolby-B system and was the first to use it. Most of Dolby's competition comes from DBX—another Boston company. Its first consumer products were sophisticated companders, intended mainly to restore dynamics lost through compression and only secondarily to provide moderate noise reduction for recordists. Later it introduced

noise-reduction devices that, while delivering an even greater dynamic range than Dolby's, are easier to use. Recently DBX began selling circuit boards that are plug-in replacements for Dolby-A boards, making the DBX system conveniently available to Dolby-equipped professional recordists and studios at minimum cost. The company continues to promote DBX-encoded discs. At the same time, Burwen Labs (now a part of KLH) has developed a variable bandpass filter—the Model 1201—that works on a principle originating with H. H. Scott in the early Fifties. The 1201 achieves about the same degree of noise reduction as the Dolby-B system, but without the need for specially encoded program material.

Arguably the most exciting new idea in audio is ambience simulation. Here again, Boston is the unchallenged leader. The only two companies making a serious effort in this direction, Sound Concepts and Audio Pulse, are located in this area. Their audio delay lines have, without quadriphony (and without need of special program material), produced at least as good an illusion of acoustic space. The Sound Concepts SD-50 and the Audio Pulse Model One, and the ideas behind them, promise to leave a deep imprint in the history of high fidelity.



Joel Cohen,
founder of
Sound Concepts, Inc.

A complete list of Boston-area audio-related companies runs the gamut from the U.S. headquarters of BASF (a sprawling international structure with interests far beyond the recording tape with which we associate its name) to Source Engineering (a modest company that is just beginning to produce yet another type of noise-reduction equipment and the only current consumer preamp designed specifically to solve the problems of the antique-record collector). The audiophile community also has been witness to and participant in the rise of true high fidelity in car stereo, as led by ADS.

Boston isn't just another big city with a clot of high fidelity manufacturers. The companies and the people who make them what they are care enough to take chances, to run with an idea, and to sacrifice cosmetics and marketing frills for good sense and solid design—no expensive, impractical exotica here. The keynote is innovation and genuine advancement of the art of music reproduction. If that's a surprise—well, maybe you should come and see for yourself. ■

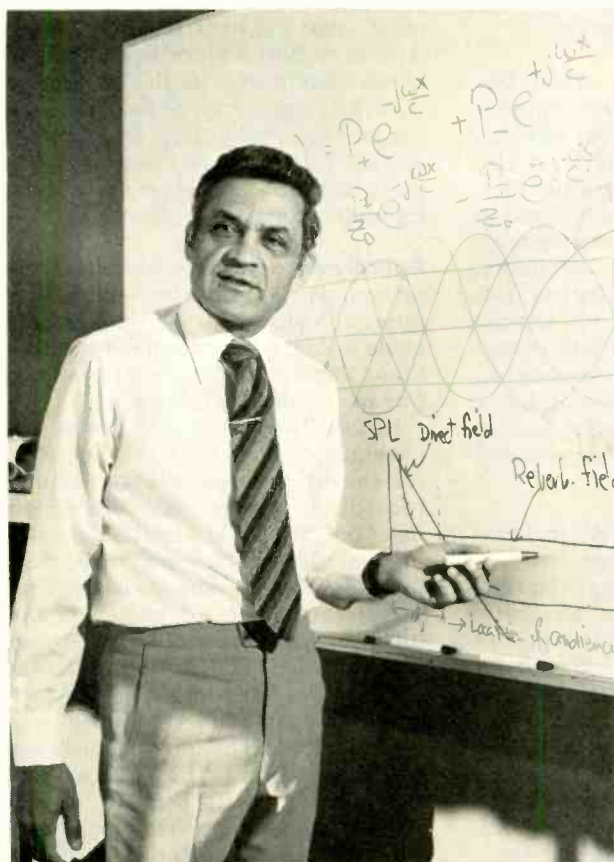

Dr. Amar Bose



Roy Cizek

Behind The Scenes

Lenny at large. Leonard Bernstein's longtime exclusive association with Columbia Records has come to an end. Though it is expected that he will continue to record for CBS, he already has entered into extended arrangements with both Deutsche Grammophon and EMI. (CBS had previously released him for the DG *Carmen*, in an informal arrangement that resulted in the Boston Symphony Orchestra's participation in the Columbia recording of Stravinsky's *Oedipus Rex* led by Bernstein.)

The DG association began last summer with Liszt's *Faust* Symphony, taped after the Tanglewood performance with the Boston Symphony. Composers mentioned for future projects include Beethoven, Mendelssohn, Schumann, Stravinsky, and Bernstein himself. The first EMI sessions were held in November, a blitz with the Orchestre National de France scheduled to produce four discs: Berlioz' *Symphonie fantastique* and *Harold in Italy* (with Donald McIntnes); the Schumann cello concerto and Bloch's *Schelomo* with Mstislav Rostropovich; and a Milhaud collection including *La Création du monde*.

And Montserrat Caballé has told a French interviewer that she will be recording *Salome* with Bernstein—for Philips!

CBS at Covent Garden. By the time this appears, CBS should have completed its recording of Donizetti's *L'Elisir d'amore*, made in conjunction with the December 1976-January 1977 revival of the year-old Covent Garden production. With one exception, the cast was to follow that of the stage performances: Ileana Cotrubas as Adina, Lillian Watson as Gianetta, Ingvar Wixell as Belcore, and Geraint Evans as Dulcamara. The exception: CBS's Plácido Domingo, engaged for Nemorino before the Covent Garden cast was completed with José Carreras. The conductor: John Pritchard. (The chorus and orchestra, of course, are those of the Royal Opera House.)

After *L'Elisir*, CBS plans to complete Puccini's *Trittico* with *Il Tabarro*. As with *Gianni Schicchi* and *Suor Angelica*, Lorin Maazel will conduct; Renata Scotto and Domingo will sing Giorgetta and Luigi. Now in the talking stages are Thomas' *Mignon*, Massenet's *Cendrillon*, and Meyerbeer's *L'Africaine*.

Philips' fiddlers. Somebody at Philips must be partial to fiddlers. With such distinguished performers as Arthur Grumiaux, Henryk Szeryng, and Herman Krebbers recording actively, the label has signed Salvatore Accardo to

an exclusive contract. Accardo had already recorded a number of Vivaldi and Tartini concertos for Philips with *I Musici*; now he has completed the Bach solo sonatas and partitas, the two Mendelssohn concertos (with Charles Dutoit and the London Philharmonic, his collaborators in the 1975 Deutsche Grammophon set of the Paganini concertos), and the Tchaikovsky concerto, *Sérénade mélancolique*, and *Valse-Scherzo* (with Colin Davis and the BBC Symphony).

Meanwhile, Grumiaux is finishing his stereo remake of the Beethoven violin sonatas, with Claudio Arrau. (Both participated in distinguished mono cycles: Grumiaux with Clara Haskil, Arrau with Joseph Szigeti.)

Shostakovich's symphonies. Decca/London has a sizable Shostakovich cycle planned: the fifteen symphonies, to be recorded by Bernard Haitink and the London Philharmonic.

Dorati's not-just-Haydn. Antal Dorati's first large-scale project as principal conductor of the Royal Philharmonic has been a cycle of the Beethoven symphonies, of which Nos. 5, 8, and 9 have so far been released in England on Deutsche Grammophon's midprice Privilege label. Inevitably, however, his attention turned (returned?) to Haydn, and for Decca/London he and the RPO will record the three big oratorios. Already on tape is *The Creation* featuring Lucia Popp, René Kollo, Benjamin Luxon, and Kurt Moll, with *The Seasons* and *Il Ritorno di Tobia* to come.

Verdi from Strasbourg. Alain Lombard and the Strasbourg Philharmonic have been pursuing their ambitious recording program for Erato, with major projects including the Verdi Requiem and Offenbach's *La Périchole*. The Verdi soloists are Joyce Barker, Mignon Dunn, Ermanno Mauro, and Paul Plishka, with the Slovak Philharmonic Chorus. (Plishka, incidentally, replaced Pierre Thau as Méphistophélès in the announced cast of Erato's *Faust*; the cast otherwise remains as reported in October 1976: Montserrat Caballé as Marguerite, Giacomo Aragall as

Faust, Philippe Huttenlocher as Valentin, Anita Terzian as Siebel, Jocelyne Taillon as Marthe.) The Offenbach cast is headed by Régine Crespin, Alain Vanzo, and Jules Bastin, with Opéra du Rhin forces and a narration by Alain Decaux.

French connection. Connoisseur Society has more on the way from many of the artists it has been promoting through its licensing arrangement with France's Pathé Marconi. The young pianists Michel Béroff and Jean-Philippe Collard have been active in the studio: Béroff with Bartók (two discs of excerpts from *Mikrokosmos*), Collard with Schumann (*Carnaval*, *Abegg Variations*, Op. 28 *Romances*) and Debussy (complete *Images*, *L'Isle joyeuse*, *Suite bergamasque*, *Masques*); together they have recorded the four-hand-piano original of Dvořák's *Slavonic Dances*, a sequel to their disc of Brahms's *Hungarian Dances*. Alexis Weissenberg has recorded the Bach *Goldberg Variations* (with all repeats, on two discs), György Cziffra the complete Liszt *Années de pèlerinage*. New to Connoisseur Society is the fine Hungarian pianist Georges Solchany, who will be heard in the complete Bartók *Mikrokosmos*. From the late Jean Martinon will come an all-Dukas disc (the symphony and excerpts from the opera *Ariane et Barbe-Bleue*, with the Orchestre National) and the Schumann Fourth Symphony (with the Orchestre des Jeunesses Musicales); from Leonid Kogan, the Beethoven violin concerto (with the Paris Conservatory Orchestra under Constantin Silvestri).

Apocalyptic quad. The Austrian Preiser company, familiar for its extensive series of historical vocal reissues, has made its first quadriphonic recording: Franz Schmidt's apocalypse oratorio, *Das Buch mit sieben Siegeln*.

In our November 1976 issue, reviewing Musical Heritage Society's reissue of the oratorio's previous recording, Abram Chipman noted that "nobody could possibly take the place of Julius Patzak in the role of St. John." Preiser has done its best to find a replacement, in the person of the (then) sixty-five-year-old tenor Anton Dermota. (Patzak, by comparison, was a mere stripling of sixty-two when the Amadeo recording was made in 1960.) The other soloists are bass Robert Holl as the Voice of God, soprano Margarita Kyriaki, mezzo Hertha Töpper, tenor Thomas Moser, bass Arthur Korn, and organist Rudolf Scholz. Alois Hochstrasser conducts the Graz Concert Choir and the Lower Austrian Tonkünstler Orchestra. ●

Inventions make McIntosh the LEADER in

- Long Trouble-Free Equipment LIFE
- Listening Quality
- Performance

Inventions are engineering leadership recognized by the granting of a United States patent. The New McIntosh amplifiers are an inventive product of continuing research at McIntosh. The new inventions have provided NEW circuit design that permits NEW product performance which gives NEW long life predictions and NEW pleasure and enjoyment in Music Listening.

The McIntosh MC 2205 Power Amplifier always "Sounds Clean". . . .

. . . Because of inventive "POWER GUARD"

Amplifiers when driven to clipping are capable of delivering up to twice their rated power with more than 40% harmonic distortion. The extra energy content of the clipped signal will damage most speakers. McIntosh leadership in engineering has developed a new circuit that . . .

- (1) dynamically prevents power amplifiers from being overdriven into hard clipping . . .
- (2) which protects speakers by preventing clipping . . . (3) assures that the amplifier will produce its maximum output without increased distortion. That new circuit is "POWER GUARD".

. . . Because of Inventive Output Circuit Design

To achieve long trouble free life in an amplifier it is essential to have cool operation. Cool operation results from the careful design of the output circuit, proper matching of the output circuit to the loudspeakers with an autotransformer and a mechanical design that permits the use of generous sized heat sinks with adequate ventilation without the use of fans. The MC 2205 has 110 square inches (7.64 square feet) of radiating heat sink surface. In addition, the chassis has been designed to permit the maximum amount of air to flow over the heat sinks to conduct away the life limiting heat.

Bipolar epitaxial output transistors and the McIntosh output circuit allows the amplifier to operate as cool as possible. When there is limited program demand of the amplifier only the optimum number of output devices operate. Conservative McIntosh engineering keeps operating temperatures low assuring long life.

. . . Because of Inventive Speaker Matching

The interleaved multiterminal wound McIntosh designed autotransformer transfers all the power you paid for to all impedance taps. The McIntosh autotransformer does its outstanding job without adding phase shift, (common in other designs) limiting frequency response or power output. In short, the McIntosh autotransformer is the inventive answer to a difficult problem.



Shown in optional walnut veneer cabinet.

Delivers 200 watts average power output minimum, per channel continuous across 1, 2, 4, or 8 ohms with no more than 0.1% harmonic distortion.

. . . Because of an Inventive 5-way Protection Plan for you

1. The patented McIntosh Sentry Monitoring circuit constantly monitors the output signal. At signal levels up to rated output this circuit has high impedance and has no effect upon the output. If the power output exceeds design maximum, the Sentry Monitoring circuit operates to limit the signal to the output transistors.
2. Should the temperature of the heat sinks rise above normal through restricted ventilation or other causes, the AC is disconnected from the amplifier by an automatic heat sensing relay. The AC will be restored when the temperature returns to normal.
3. Any DC component in the output circuit from whatever cause is shunted to ground through the McIntosh autotransformer. You and your speakers are protected completely from this kind of amplifier failure.
4. McIntosh gives you a money back guarantee of performance. Your McIntosh instrument must be capable of meeting its published performance limits or you get your money back.

5. The famous McIntosh 3 Year Service Contract protects you from any cost of repair for three full years because McIntosh will provide all parts, materials and labor needed to return the measured performance to the original performance limits free of any charge. The SERVICE CONTRACT does not cover any shipping costs to and from the authorized service agency or the factory.

For more complete information, send today:

McIntosh Laboratory, Inc.
East Side Station P.O. Box 96
Binghamton, N.Y. 13904
Dept. HF

NAME _____
ADDRESS _____
CITY _____ STATE _____ ZIP _____

If you are in a hurry for your catalog please send the coupon to McIntosh. For nonrush service send the Reader Service Card to the magazine.

The Onkyo Challenge...

The TX-4500 stereo receiver with Quartz Locked Tuning succeeds where others fail.

Hirsch-Houch, world famous audio test lab, said of the TX-4500... "literally impossible to have the slightest mistuning." They added... "Tuner always matched the best measured performance we were able to obtain by manual tuning."*

Onkyo's secret weapon in the war against high-priced low-fi is the exclusive Quartz Locked Tuning, a system that maintains pinpoint reception, maximum channel separation and minimum distortion.

In almost every case, Hirsch-Houch's results from their tests were better than we stated on our specs. Perhaps we're too modest.

They further added... "Both its FM Tuner and Audio Amplifier performance are in almost every respect far above the norm for receivers, especially in this price range, and

in some areas the performance rivals that of the most highly regarded separate components."

Conclusion, again quoting from Hirsch-Houch... "Over the years we have found that most competitively priced receivers are fairly equal in their overall performance characteristics. It appears to us that the Onkyo TX-4500 may be just a little more equal than its peers, so as to speak."

Ask your Onkyo dealer for a copy of the Hirsch-Houch Test Report or write to us. Your dealer also has Onkyo's TX-2500, a modest priced version featuring Servo Locked Tuning, which is the next closest thing to Quartz Locked Tuning.

Try the Onkyo Challenge. There's no way you can lose. You'll find out what makes us quietly superior.

* Stereo Review October, 1976



TX-4500 Quartz Locked AM/FM Receiver 55 Watts per channel, min. RMS, at 8 ohms from 20 Hz to 20 kHz with no more than 0.1% Total Harmonic Distortion.

ONKYO.

Onkyo U.S.A. Corporation

Eastern Office: 42-07 20th Avenue, Long Island City, New York 11105, 212-728-4639.

Midwest Office: 935 Sweet Drive, Wood Dale, Ill. 60191, 312-595-2970.

Canada: Sole Distributor, TriTel Associates Ltd. Willowdale, Ontario, Canada M2H2S5.

Bringing *Prophète* to life:
Henry Lewis and
Renata Scottò



Columbia Records/Clive Baraka

The
New
Releases

Columbia Reopens the Meyerbeer Case

The vitality of Henry Lewis' conducting and the conviction of Renata Scottò's singing help bring Le Prophète to life.

by Patrick J. Smith

THE GRAND OPERAS of Giacomo Meyerbeer are one of the last major outposts of unrecorded nineteenth-century opera. We have had only a good, if equivocal, performance of the most famous of them, *Les Huguenots*, from Richard Bonyngé (London OSA 1437, January 1971, still in the catalog). *Le Prophète* (1849) stands between *Huguenots* and *L'Africaine*: despite a lot of listenable music, it is the weakest of the three. Columbia's new recording, however, should win the composer some converts, for it is a generally strong, and definitely recommendable, rendition.

Scribe's libretto tells of the Anabaptist uprising in the 1530s in Germany, centering on the false prophet, Jean. The plot, however, has little to do with the historical facts, and is history tailored to the nineteenth-century grand-opera sensibility. Thus Jean is a simple, God-fearing innkeeper, who loves his mother and his fiancée (in that order), and who is used as a pawn by a trio of bogus "monks." Jean is one of Scribe's best-drawn characters (although his mother love stifles the libretto), shown as an honest bourgeois inflamed into action by the injustice and

cruelty of the nobility and manipulated by opportunistic powermongers. He continually has doubts as to his actions and the rightness of his cause, but his coronation brings him to the point that he believes that he is *really* the son of God—at which precise moment, in the theatrical masterstroke of the opera, his mother recognizes him. He then realizes the sins of his pride and his lust for fame, and destroys himself and his enemies in a final conflagration.

Scribe fills out this portrait of Jean (a forerunner of Mussorgsky's subtler false Dmitri) with his usual flair for the grandiose in terms of scenic splendor and theatricality, building his work through a series of "numbers"—arias, duets, and ensembles—to its dramatic high point in the fourth act, as in *Huguenots*. In addition to Jean, there are three other characters: the Anabaptist trio (a three-headed exemplar of sleazy evil), his fiancée Berthe, and his mother Fidès. Fidès, rewritten and expanded for Pauline Viardot-Garcia, is one of the major mother figures in all opera, and her sentimental aspects are constantly to the fore. Indeed, this feature of the libretto is today the most dated, for what was of considerable power in the

nineteenth century is now not only sentimental but lachrymose, threatening to turn Jean into a mama's boy and his mother into an annoying *kvetch*.

Which brings us to the music. There is no question that Meyerbeer is of prime historical importance as a composer. To listen to any one of his later works is to realize the extent of his influence: His ideas were stolen by almost every subsequent opera composer of the century. The range of his musical effects is extraordinary—time and again his response to the musical or dramatic demands is arresting.

Why, then, have his operas never moved into the repertory? Not, I submit, because there are no singers today to do him justice, although that is a factor. Operas of other composers—Verdi and, pre-eminently, Wagner, to cite two—can be put across without top-notch singers. But Meyerbeer lacked that final ounce of talent—that final ounce that a lesser musical mind like Donizetti had.

Meyerbeer's music is essentially short-winded, in the span of his musical ideas and in the span of his imagination. Many of his individual "numbers" are good, and some are outstanding, but the underlying feel is of a craftsman carefully shoring up his talents rather than a genius profligately spreading his around. Also, his ideas (as Wagner noted) do not have the breadth and depth that the form of grand opera required. Quite often the tunes seem rooted in *opéra comique*, and if they have more character and muscle than, say, the tunes of Auber, they do not—except in certain instances, such as the classic fourth act of *Huguenots*—assume an overriding importance of a kind that even Donizetti could command. As with Liszt, the intellectual reach was greater than the musical grasp—and, as with Liszt, there was added an element of pandering to a public.

Le Prophète, no less than any of his grand operas, is a fascinating documentation of Meyerbeer's strengths and weaknesses. Take the *trio bouffe* in the third act—a drinking song out of *opéra comique* whose verse text exults in the slaughter the Anabaptists will wreak when they capture Münster. Yet the circumstances of the scene and the hypocrisy of the Anabaptists (portrayed in the vocal line) combine with the insouciance of the music to make a highly ironic statement (one that did not escape Verdi when he wrote *Ballo in maschera*). On the other hand, the "big tune" of the fourth-act ensemble of recognition and rejection—the high point of the opera—while sticking in the mind is a tune of utter triviality. It destroys the moment: Something far stronger is needed, and Meyerbeer's superior craftsmanship will not suffice. Further, the fifth act is a distinct letdown—too long and musically undistinguished to follow the fourth.

What keeps Meyerbeer's operas moving is the constant rhythmic vitality (rather than any melodic sweep) of the numbers. Meyerbeer loves to use accents, short motifs, notes separated by rests and such musical devices as a kind of Scotch snap to give the music a verve and sparkle. The justly famous *Pati-neurs* ballet scene contains an unbroken stretch of Meyerbeer at his best. And here Henry Lewis contributes to bringing Meyerbeer's music to life, for his steel-sprung reading propels the music forward. It is a rather fast performance (a bit heavy-handed in the

ballet music), but one that does justice to the score. I liked certain of his ideas, such as performing the familiar Coronation March not as an expansive pre-*Aida* processional, but as a clanging, circusy event (enhanced by close-miking), perfect in its tinsel superficiality for the entrance of the false prophet.

The best singing comes from Renata Scotto as Berthe, which may be paradoxical in that Berthe has always been thought the weakest drawn role. But Scotto sings with an ease and familiarity with the music that is amazing, given its infrequency of performance. She shapes the phrases with an unerring rightness and controls her sometimes hard-edged soprano so that it becomes a French-sounding instrument of lovely focused tone, yet with plenty of vocal reserve for the climaxes. Her duets with Marilyn Horne are the vocal high spots, and her fiery "cabaletta" in the Act IV duet (which strongly reminds me of the *Rigoletto* "Si, vendetta" duet) is electrifying. Her one weakness is a habit of gliding over words in order to phrase, although when she does, for dramatic purposes, choose to enunciate, her French is exemplary. I hope she can be persuaded to sing more of the French repertory.

Horne sings *Fidès* with a clarity of tone and an accuracy of pitch that mercifully mitigate the pathos of the role. The voice, however, no longer has that richness it once did, and it must be said that, although she sings her big set pieces very well, they lack an urgency of communication. Next to Scotto, Horne seems a little distant.

James McCracken's tenor has always been a problematic instrument, and it is here in rather parlous condition. His singing is throughout effortful, of little beauty, as if pushing the notes past an unwilling throat. McCracken's tremolo now borders on a trembling, and the voice is incapable of legato (as the demands of the Act II *pastorale* attest) or of singing under a forte. Because of this latter fault, he resorts to a type of head-tone falsetto for some passages. Since the sounds produced are never integrated with the rest of the voice, this singing results in some very weird and unworldly effects. The best that can be said is that McCracken does project a forcefulness, even though it is one that calls attention to McCracken's difficulties rather than elucidating the role of Jean.

Of the three Anabaptists Jerome Hines, who has the most to sing, displays a spread tone and a gruffness that work pretty well in his big aria (a rerun of Marcel's "Paff, poff" in *Huguenots*); I wish he could have recorded the part a decade or so ago. Jean Dupouy should be singled out as a first-rate character tenor, and the chorus is fine.

The opera is presented substantially complete, the major cuts being of the second verse of the *pastorale* and in the shortening of the chorus in the final scene. The sound on the review acetates is very reverberant, with some pre-echo.

MEYERBEER: Le Prophète.

Berthe	Renata Scotto (s)	Jonas	Jean Dupouy (t)
Fidès	Marilyn Horne (ms)	Zacharie	Jerome Hines (bs)
Jean de Leyden	James McCracken (t)	Mathisen	Christian du Plessis (bs)
		Count Oberthal	Jules Bastin (bs)

Ambrosian Opera Chorus, Royal Philharmonic Orchestra, Henry Lewis, cond. [David Harvey, prod.] COLUMBIA M4 34340, \$27.98 (four discs, automatic sequence).

Of Fiddles and Fiddlers (and Friends)

I. William Sidney Mount's "Cradle of Harmony": Is this any way to build a fiddle?

by Irving Lowens

FEW MUSIC-LOVERS are familiar with the name of William Sidney Mount (1807-68), but it is very familiar to connoisseurs of American art, who cherish his scenes of antebellum American life and consider him one of the finest of our early painters. Except for frequent visits to New York City, Mount spent his entire life in or about the village of Stony Brook, Long Island, and about three-fourths of his known work may be found in and about museums in his home town.

Almost matching his passion for the paintbrush was his passion for the violin and for fiddle music, a fact known to the public not at all, but very well known to a few multidiscipline specialists. Among the latter is music and art critic Alfred Frankenstein, who has spent many years of his life investigating Mount's and who provides the illuminating brochure included with Folkways' recording of fiddle music.

Throughout Mount's adult life, he delighted in playing the violin for country dance parties and for home entertainment. He also assembled an enormous collection of fiddle music, most of it in manuscript. But of even greater interest is the novel, extraordinarily sonorous new type of violin that Mount designed, an instrument he poetically named "The Cradle of Harmony." His own description of his creation, as set down in his patent application of June 1, 1852, cannot be improved upon:

"The nature of my improvement consists in the peculiar form in which I construct the back of the instrument, or that part which receives the strain of the strings when they are tightened in the process of tuning the instrument. In the construction of all stringed

instruments heretofore made, the form of the back has either been convex or flat, and hence in the process of tuning the instrument by tightening the strings the effect has been to strain or bend the back, and also, as an inevitable consequence, so to compress the fibers of the wood composing the sounding board in front as to alter, interfere with, or impair its sonorous and vibrating qualities.

"To overcome this difficulty, I constructed the back of the instrument, or that part which is strained by the tightening of the strings, in a concave form, so that a convex surface is presented in front toward the strings. By this form of construction when the strings are strained in the process of tuning, the effect is to lengthen instead of shorten the lower line, and thus, while the back of the instrument is relieved from the strain to which it would otherwise be subjected, the compression of the wood composing the sounding board is entirely avoided.

"Constructed in this manner, the back and sides of the violin, by reason of the concavity, receives the strain of the strings when tightened, and the greater shortness of the sound post increases the vibration of the sound board, making the tone of the instrument more sonorous, rich and powerful."

Just so. And increased power was very important to Mount, since a lone fiddler, playing for country dances in an atmosphere of stamping feet and shouting merrymaking, needed all the volume he could get.

Mount's Cradle of Harmony remains extant in only three exemplars: the Patent Office model manufactured by James H. Ward, a New York City carpenter, now on display in the Renwick Gallery in Wash-



William Sidney Mount's oil painting *Catching the Tune* (also known as *Possum up a Gum Tree*, after the folk tune) shows the fiddler holding an instrument designed and made by Mount himself.

Museums at Stony Brook, L. I.

ington, D.C.; another made by James A. Whitehorne, who was (like Mount) a painter by trade; and a third fabricated by Mount's nephew Thomas Shepard Seabury, who worked in a carriage factory. No Cradle of Harmony was ever built by a professional instrument-maker.

The Seabury instrument, dated 1857, is the one used by Gilbert Ross in this recording of thirty-five fiddle tunes selected from among the thousands Mount copied and collected from printed and oral sources. He developed the habit of exchanging tunes with another nephew, Robert Nelson Mount, who later became a professional fiddle-player, but, oddly enough, Mount does not seem to have composed many tunes himself. The collection includes only a single Mount original, "In the Cars, on the Long Island Railroad." On the manuscript, he wrote: "Stony Brook, Dec. 4th & 5th, 1850, by Wm. S. Mount."

What is the correct way to play these tunes? Mount describes his method in a letter written on February 4, 1841, to his nephew Nelson:

"Take out your old box and go at it, pell-mell. Some parts of the strains you must play softer than the others, particularly the Minores, they are beautiful. Play some of the strains in octaves above and below, at leisure. In shifting, slide your fingers up and down. You know what I mean. Let your two first fingers work up in playing the whole set. You can make var[ia]tions as you play it."

That's almost exactly what Ross does. Ross, by the

way, is much better known as a concert violinist than as a country fiddler. A pupil of Leopold Auer, he was the founder and for more than twenty years the first violinist of the University of Michigan's Stanley Quartet. "The classical violinist does not forget his Bach and Mozart, his classical indoctrination," Ross says. "[He] only lays them aside for the moment and succumbs unabashedly to the spirit of Stony Brook's Thursday night parties. He 'hauls a tune now and then in the old-fashioned way,' as Mount wrote, and tries to heed (though not too literally) Nelson Mount's advice to his brother: 'Until then you may saw away.'"

Altogether, this is a fascinating exploration of a little known byway in the history of American music, beautifully performed, intelligently chosen, and succinctly described. And I might mention that Frankenstein's *William Sidney Mount: A Documentary Biography* should be in print (from Abrams) by the time you read this. I've been waiting for it to appear for about fifteen years, and "The Cradle of Harmony" has sharpened my appetite considerably. This is surely one of the most delightful curiosities spawned by the Bicentennial.

THE CRADLE OF HARMONY: William Sidney Mount's Violin and Fiddle Music. Gilbert Ross, violin. FOLKWAYS FTS 32379, \$6.98.

Willet's Hornpipe; 'Tis the Last Rose of Summer; Waltz; Merry Girls of New York; Yellow Hair'd Laddie; Stony Brook Moonshine; Yankee Hornpipe; Birks of Inverny; Brown Polka; In the Cars, on the Long Island Railroad; twenty-five more.

II. Bach's violin-and-harpsichord sonatas: What exactly do you play them on?

by Shirley Fleming

LAST SEPTEMBER in these pages I discussed the Eduard Melkus/Huguette Dreyfus Archiv release of the Bach sonatas for violin and harpsichord and deemed it a respectable, uncolored presentation and just a bit dull. My vote at that time went to Menuhin, partly because of his personal persuasiveness in the music, partly because he assigned a viola da gamba to reinforce the bass line, as Bach directed.

Now the plot thickens, in the form of three new versions that are, in a sense, mutually exclusive: None really lends itself to comparison with the others because each uses different tools for the task. On Columbia, Glenn Gould—accompanying Jaime Laredo—employs a piano and dismisses the need for the gamba (a "superfluous" requirement in any case, the Columbia annotator assures us). On Orion, Andre Granat and Edith Kilbuck stick to the harpsichord but also reject the services of a gamba. On Telefunken (a set issued as Vol. 1 of Bach's chamber music), Alice and Nikolaus Harnoncourt and Herbert Tachezi include a gamba and also announce that they are using "original instruments"—which, since their harpsichord was built in 1973, must mean that in addition to seventeenth-century violin and gamba, the violin bow as well as the gamba bow is a curved

one. That, at any rate, is the way it sounds, though no indication is given in the album notes.

Let me say at the outset that I would throw out of court any version of these works that does not include the gamba—an essential component not merely in terms of color, which is important enough, but also in terms of line: There is too much of significance going on at the bottom of Bach's three-part writing to risk losing it when the texture gets thick overhead. With that proviso, let us step "out of court" for a moment and consider the two no-gamba versions.

Laredo and Gould provide a very strange experience indeed, one that at times seems so far removed from Bach that one literally squints at the score to see if the ears deceive. Gould seems to be pristinely bent on making the piano sound like the harpsichord it ought to be, and his solution is a jabbing staccato in all those left-hand even-sixteenth-note figurations that punctures the fabric of the music like so many bullet holes. In the fast movements this is less noticeable, but in the adagios it is bizarre. Laredo's sweet violin sings its song benignly, but he sounds almost like a stranger who has wandered into the wrong room.

Gould's dominant presence also expresses itself in great freedom in embellishment, in which he indulges more liberally than any of the other keyboard players under consideration. At times this seems acceptable but not necessary, as in the opening measures of the first movement of Sonata No. 2, where he fills in elaborately around a dotted half note (the harpsichordists on other discs simply sustain it undorned); at times it is incredibly distorting, as in the opening movement of Sonata No. 3, where a lavish series of upward-sweeping arpeggios dispels any semblance of the basic sixteenth-note pacing and creates a kind of rumba rhythm that must have the Kapellmeister spinning in his grave. These chords are arpeggiated by other performers but in a much tighter formation.

Well, there is no need to belabor the point. A musician of Gould's caliber does not fall into things of this kind idly, and one can only conclude that he must have something in mind that one fails to understand. When he is unencumbered by the necessity of creating a unified ensemble sound and is free to go it alone, as in the Adagio for solo keyboard in Sonata No. 6, he is firm and clear in delineation of line and succeeds in turning the piano into a reasonably Bachian instrument.

The Granat/Kilbuck set falls into the general category to which I assigned the Melkus/Dreyfus album—straightforward, competent, not exceptional. In violinistic terms Granat's playing is less polished and less nuanced than Laredo's, and he sometimes fails to hold a melodic line together so cohesively. In short, the tendency here is toward the dry side, in concept and execution. (It should be noted that the Orion set includes, in addition to the standard S. 1014–19 Sonatas, four alternate movements for those works and two more sonatas, S. 1021 and 1023, for violin and continuo.)

The Harnoncourt/Tachezi version, complete with viola da gamba, is something else again—an unusual exposition of these sonatas that takes a little getting used to but yields bright rewards in liveliness, in a sense of unflinching forward flow, and in rhythmic zest. The effect of the curved bow, which lacks bite on the downstroke attack of a note and lets the full sound swell in the middle, gives a quite different color to the proceedings, one which grows more attractive as the ear adjusts to it. Harnoncourt/Tachezi are also believers in the baroque practice of playing some patterns of equal notes as if they were unequal—as in the first and third movements of Sonata No. 1. I have some reservations about the stylistic appropriateness with which Alice Harnoncourt conceives of certain note-groups, pressing ahead to the climactic note in a somewhat rhapsodic manner and underemphasizing the notes along the way; Menuhin, for one, pays more deliberate attention to each note in the pattern. But the Harnoncourt way, undeniably, creates momentum and vitality and, to my ear, produces one of the most interesting versions of these works on the market.

BACH: Sonatas for Violin and Harpsichord (6), S. 1014–19. Jaime Laredo, violin; Glenn Gould, piano. [Andrew Kazdin, prod.] COLUMBIA M2 34226, \$13.98 (two discs, manual sequence).

Sonatas: No. 1, in B minor; No. 2, in A; No. 3, in E; No. 4, in C minor; No. 5, in F minor; No. 6, in G.

B **BACH:** Works for Violin and Harpsichord. Endre Granat, violin; Edith Kilbuck, harpsichord. [Gideon Cornfield, prod.] ORION ORS 76213/5, \$13.96 (three discs). Sonatas for Violin and Harpsichord (6), S. 1014–19 (plus four alternate movements). Sonatas for Violin and Continuo: in G, S. 1021; in E minor, S. 1023.

BACH: Chamber Music, Vol. 1: Sonatas for Violin and Harpsichord (6), S. 1014–19. Alice Harnoncourt, violin; Herbert Tachezi, harpsichord; Nikolaus Harnoncourt, viola da gamba. TELEFUNKEN 26.35310, \$15.96 (two discs, manual sequence).

Wagner's Roman Colossus

Rienzi enters the catalog in a performance that suggests the potential of Wagner's foray into Paris-style Grand Opera.

by David Hamilton

Rienzi was Wagner's first big success. By the time it was staged, in Dresden on October 20, 1842, he had already moved on to other things: *Der fliegende Holländer* was completed, and the foundations of the *Tannhäuser* libretto laid out. But *Rienzi*'s acclaim led directly to the presentation of *Holländer* in Dresden the following January, and to Wagner's appointment a month later as Kapellmeister to the Royal Saxon Court. For a short while, everything seemed possible; it was a turning point in the composer's career—one that stubbornly refused, however, to turn

the way he wanted it to, for the Dresden audience didn't take to *Holländer*, nor later to *Tannhäuser*, and the frustrations of the job eventually led to Wagner's participation in the abortive 1848 rebellion and his subsequent long exile from Germany.

Even *Rienzi* only made its way slowly beyond Dresden—a fact that is no reflection on its original success; censorship (revolution was a touchy subject in those days, as was the political role of the papacy), length, requirements of stage spectacle, and the demands of the title role all conspired against it. Even-

An old line cut shows the last scene of the fourth act of *Rienzi* in progress during the work's premiere at the Königliches Hoftheater in Dresden.

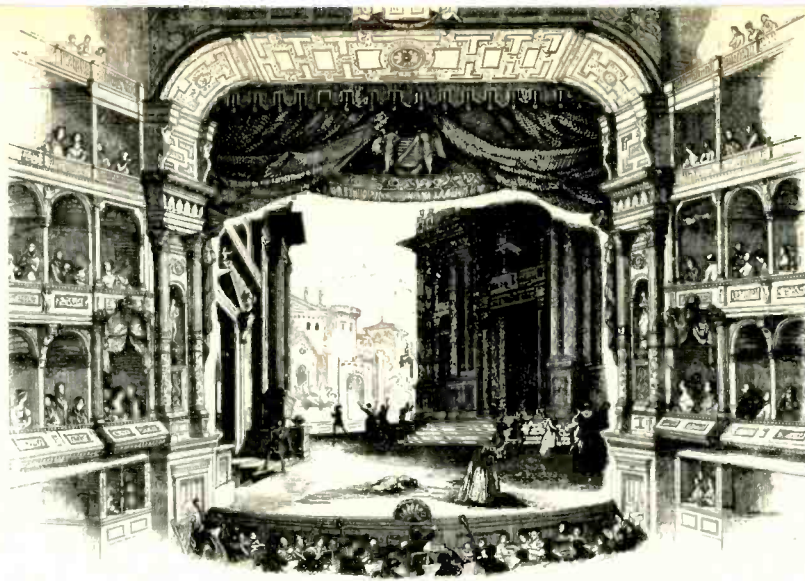

Bettmann Archive

tually, of course, Wagner's later works stole the limelight, and *Rienzi*, along with most of the essentially Parisian tradition to which it belongs, passed into theatrical limbo, despite occasional revivals in Germany and Italy. By the time this review appears, a production will have taken place in San Antonio—but prior to that *Rienzi* hadn't been heard in America since 1923, when a touring German company put it on in New York.

Now *Rienzi* joins such fabled works as Rossini's *Guillaume Tell* and Meyerbeer's *Le Prophète* [subject of a review on page 87—Ed.] and *Les Huguenots* in the phonograph's repertory of Grand Opera. The reasons for its early favor are not hard to discern. The music fairly bursts with energy, and it never lets up. Much of it is four-square, in the manner that Wagner didn't really begin to shake until after *Lohengrin*. Much of it is conventional, leaning heavily on diminished-seventh chords, string tremolos, and other stock devices of Romantic opera's *lingua franca*. Much of it is derivative, not only of the Parisian models, but also occasionally of Beethoven's *Fidelio*, of Mendelssohn and Schumann (the solo Messenger of Peace), of Bellini (*Adriano* and *Irene* frequently course in thirds and sixths). Some of it is inevitably tedious on records, without the visual spectacles that the repetitive music was intended to accompany.

The substance of *Rienzi* is rhetoric and show, grand effects deployed on a grand scale. The libretto is laid out, not to present a character study of a fourteenth-century Roman visionary who sought to restore the city's great past, but to "wow" the audience with unexpected thrills, dazzling stage spectacles, and heroic vocal displays. Bulwer-Lytton's novel (not to mention historical fact) is drastically simplified, and even the principal characters are but stock figures: *Rienzi* the heroic champion of the people, *Irene* his faithful sister, *Adriano Colonna* the young man torn between duty to his father and love for *Irene*.

Through the five acts, they march in and out, responding predictably to the seesawing turns of the plot, hardly ever revealing any inner life. The subsidiary figures are totally indistinguishable, mere step-outs from the chorus. The whole thing is basically a machine to generate situations: marches and battles, proclamations and celebrations, interruptions and confrontations, benedictions and maledictions, an

enormous and tedious ballet, and just about anything else you can think of, up to the burning of the capitol with *Rienzi* and *Irene* inside it.

And yet it works, it moves along with drive and exuberance. For all that *Rienzi* isn't an opera I'd want to hear often, a really slap-up performance in the theater ought to be one hell of a show. Our chances of seeing such a performance are slim enough: It would be hard to cast (how about Janet Baker as *Adriano*, for starters?), a real challenge to keep rhythmically vital (James Levine could do it), and almost prohibitively expensive to produce in proper grand style—strictly a festival proposition. Which is perhaps a roundabout way of coming to this point: Don't let what you hear of *Rienzi* in this recording lead you to underestimate its potential impact or its role in Wagner's development. (He never wrote another such work, but the Grand-Opera techniques are an essential element in later works, from *Tannhäuser* to *Parsifal*.)

The first of my reservations about the new recording concerns completeness; although the historical essay in Angel's booklet mentions the cutting that Wagner undertook before and after the premiere, it makes no statement about the version recorded. *Rienzi* is a long opera, and Wagner enthusiastically acceded to abridgements for practical reasons; a copy made under his supervision and sent to Hamburg for consideration omits somewhere between 15% and 20% of the original, and the first printed score of 1844 is still shorter. (These revisions entail not only cuts, but also rewriting and reorchestration.)

Logically, either of these versions is a candidate for recording; both of them can claim to come from the hand of the composer at a time when he was still involved in the work. Equally authentic, of course, would be Wagner's original full-length score—except that it hasn't been seen since 1945 (when it was the property of Adolf Hitler), and there is no other surviving source for the orchestration of certain passages. A new edition of the full score, now being published by Schott, will present all the relevant material, including the surviving vocal score of these passages. (By orchestrating them, Edward Downes and Ernest Warburton prepared the text for a BBC broadcast last summer that was probably even more complete than the Dresden premiere.)

But EMI didn't have access to all this material when its recording was made, so it settled for a simpler alternative: This recording corresponds (barring a few minor vocal variants and the omission of indicated literal repeats) to the Fürstner edition of 1899 (published in miniature score by Eulenburg). Prepared, it seems, by Cosima Wagner and the Bayreuth chorus master Julius Kniese (although no editorial credit appears on the title page), this edition is, at the very least, controversial—and in any case does not stem from Wagner himself. There isn't space here to explore this matter in any detail (and, until the new edition and its critical report are completely available, we won't know enough of the facts), but among its numerous omissions is one that is greatly to be deplored: a somber ensemble of lamentation in the third-act finale. True, Wagner himself cut this in later Dresden performances (much to the distress of Tichatschek, the original *Rienzi*, who admired it greatly)—but only for reasons of time, which should not have kept it out of the recording. There is nothing sacred (or "authentic") about the cuts Cosima and Kniese made long after Wagner's death, and it defies common sense to devote an entire side to some of history's more perfunctory ballet music (though not even all of *that*, in fact) while omitting this superb piece of concerted writing.

Not that this version of *Rienzi* is brief. It runs to 1,184 pages of miniature score, including passages probably not performed in many decades (recent stage productions have tended to omit nearly half the score); some of them are not even in the singular pirate set circulated a few years back, which spliced together material from six live-performance tapes in its search for completeness (including material not in the Angel set, notably the aforementioned third-act ensemble). Two recent European sets are put out of the running altogether: Top Classic's issue of a 1942 Berlin broadcast (H 657/8) and Eurodisc's publication of a 1974 Berlin concert performance of limited distinction (88 619 XDR). Two discs each, these could hardly be described as comprising more than "high-lights."

Not only is Angel's performance more complete than those, it is more listenable. Its besetting sin, to my ears, is that it sounds like a studio job, a reading rather than a "real performance." Heinrich Hollreiser is a perfunctory conductor, rarely investing Wagner's striding and soaring tunes with much lift (try the figure in the orchestra that enters with Cecco in the first-act finale, or the melody that opens the second act—they're just played, not characterized). It's all decent and orderly—the orchestra copes fairly well and the chorus bears up impressively under Wagner's extensive demands—but the vitality and variety of the score are muted.

Similar comments apply to the singing; even when technically satisfactory, much of it is on the neutral side. Despite his pronounced beat on sustained notes (and not only on high ones), René Kollo is a bearable *Rienzi*—and that's saying quite a lot, for the writing is murderous, rising constantly to high A flats and A's, much of it very exposed, declamatory stuff. With experience, I'm sure Kollo would find more variety in the part, rather than bulling his way through it at full tilt, which is wearing for us as well as for him. Only the circumstances of modern studio recording allow him to do it this way; for a stage performance he

would have to learn how to save his strength, and that might force him to vary his approach—or risk instant suicide for a voice that even now shows signs of ill use and faulty technique.

The young Adriano is a travesty part; Wagner realized that next to *Rienzi* a second tenor would be impossible. Janis Martin is the most committed and intense member of this cast, but her pitching is often unreliable. She's an elevated mezzo, and I've heard her sing soprano parts rather satisfactorily, so the inference I draw is that she didn't have time to work out all the problems in this elaborate, high-lying role (most mezzos take Adriano's aria down a tone or more, but she sings it as written). Siv Wennberg makes a potentially exciting sound, but the bulk of her work is marred by alarmingly poor intonation, perhaps for the same reasons. When these three principals join in a triple cadenza in the second-act finale, the effect is simply excruciating.

Except for Günther Leib (Cecco), the various lower voices are passable, and Peter Schreier's Baroncelli is the most distinguished, distinctive piece of work in the whole set.

The sound is respectable enough, although the off-stage material tends to sound boxy. Aside from a few patches of crowd noise, there's little effort at "production," and the sword-on-shield banging that Wagner scores into the coda of the Battle Hymn has simply been omitted. The ballet music, given a side to itself, is brought to a full close, spoiling the effect of the interrupting dissonance, which here lamely begins the subsequent side. Another clumsy break comes on the brink of Adriano's aria.

Finally, on my copy of Side 8 (from a G3 stamper), the fourth act's final pages are chopped off in mid-phrase, twelve measures before the end. Presumably this will be corrected in due course; in the meantime, caveat emptor—i.e., check Side 8 before purchasing.

WAGNER: *Rienzi*.

Irene	Siv Wennberg (s)	Cecco del Vecchio	Günther Leib (b)
Adriano	Janis Martin (s)	Paolo Orsini	Theo Adam (bs-b)
Messenger		Steffano Colonna	
of Peace	Ingeborg Springer (s)		Nikolaus Hillebrand (bs)
<i>Rienzi</i>	René Kollo (t)	Raimondo	Siegfried Vogel (bs)
Baroncelli	Peter Schreier (t)		

Leipzig Radio Chorus, Dresden State Opera Chorus, Dresden State Orchestra, Heinrich Hollreiser, cond. [David Mottley, prod.] ANGEL SELX 3818, \$35.98 (five SQ-encoded discs, automatic sequence).

The Corrected *Rienzi*

The Side 8 editing error noted by Mr. Hamilton has indeed been corrected, but not before first-production copies were shipped to dealers. (The review set was in fact store-bought.)

For those who find that they have bought uncorrected copies, Angel promises to replace the disc containing Side 8. Write (a postcard will do) to the Consumer Relations Dept., Angel Records, 1750 N. Vine St., Los Angeles, Calif. 90028.

Some \$5 blank cassettes have the nerve to tinker with Beethoven. We think it's outrageous.

Beethoven, even when he was deaf, knew exactly how a piccolo sounded in relation to the rest of the orchestra. Some cassette manufacturers would just as soon forget. Their cassettes give the piccolo and other high frequency sounds a distorted prominence. They appear to do this deliberately, regarding absolutely natural sound as raw material to be improved upon.

At BASF, we think this is an abomination. We're purists; we stake everything on total accuracy of sound reproduction. You will never encounter artificially enhanced high frequencies in our cassettes. We believe that if you care enough to buy an expensive audio system, the last thing you need is a cassette that imposes its own dubious tastes upon your sensitive ears.

Faithful reproduction entails more than miracle ingredients and fanciful initials on a cassette label. At BASF, we begin with the best quality ferric oxide. We mill it by a patented process to

achieve maximum packing density and uniformity of coating. We use an exclusive chemically cross-linked polymer binding which will never deteriorate and cause head-related frictional noise or wow and flutter.

We use a unique multi-stage polishing process, and our slitting technique results in an edge that's clean even when viewed under a microscope. Even our cassette case is different, incorporating our patented Special Mechanism, designed to assure smooth tape feed for years of dependable performance.

Is completely natural sound worth that kind of effort? To people who know the difference, it is.

At BASF, we're purists. We've been obsessed with total accuracy since we invented magnetic tape back in 1932. There are no shortcuts to perfection. But you knew that when you planned your own audio system. We'll give you no reason to compromise when you buy our cassettes.



 **BASF The Purist**

Our Promise: the purest, most accurate sound that tape can reproduce.

reviewed by ROYAL S. BROWN

ABRAM CHIPMAN
 R. D. DARRELL
 PETER G. DAVIS
 SHIRLEY FLEMING
 ALFRED FRANKENSTEIN
 KENNETH FURIE
 HARRIS GOLDSMITH
 DAVID HAMILTON
 DALE S. HARRIS
 PHILIP HART
 PAUL HENRY LANG
 ROBERT LONG
 IRVING LOWENS
 ROBERT C. MARSH
 ROBERT P. MORGAN
 JEREMY NOBLE
 CONRAD L. OSBORNE
 ANDREW PORTER
 H. C. ROBBINS LONDON
 HAROLD A. RODGERS
 PATRICK J. SMITH
 SUSAN THIEMANN SOMMER

Classical

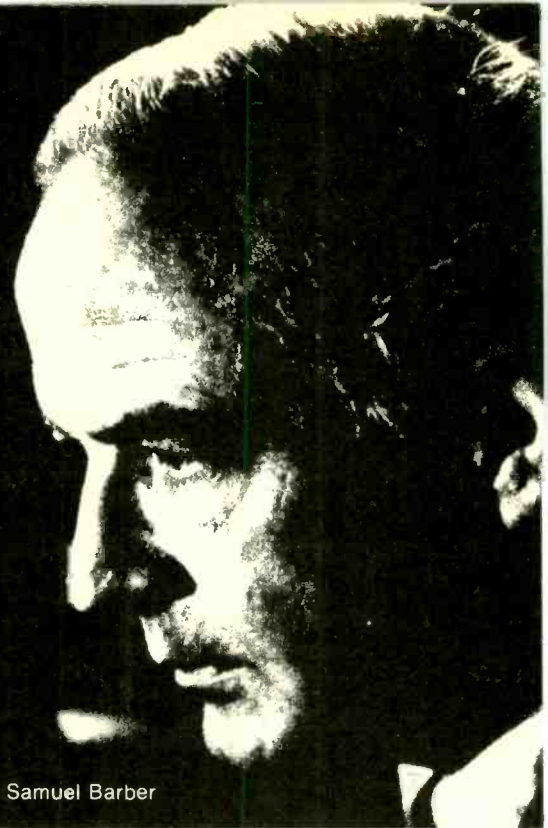

Samuel Barber

BACH: Flute Works. Paula Robison, flute; Kenneth Cooper, harpsichord; Timothy Eddy, cello. [Seymour Solomon, prod.] VANGUARD VSD 71215/6, \$13.96 (two discs).

Sonatas: for Solo Flute, S. 1013; for Flute and Harpsichord (4), S. 1020, 1030-32; for Flute and Continuo (3), S. 1033-35.

Comparison: Rampal, Veyron-Lacroix, Savall RCA CRL 3-5820

One of the fastest-rising young musical stars in this country, Paula Robison boasts distinctive solo-virtuoso and chamber-ensemble talents that have been demanding better discographic representation for some time—a demand now admirably met by Vanguard's set of the eight basic Bach solo-flute works. And here, in full measure, is eloquent proof, not only of Robison's technical expertise, but also—and more uniquely—of her markedly individual interpretative personality. Her sensitively varicolored tonal qualities are vividly captured in gleamingly pure recording, which favors the flute over the deft but more modest harpsichord (or harpsichord/cello continuo) parts, but not at the cost of any textural clarity.

A must for every Robison fan, this set faces for others the strongest possible competition from the July 1975 Rampal/RCA three-disc album. For the latter includes not only the present eight works, but three additional ones for practically the same cost. And it is no less well recorded, in a slightly more open acoustical ambience and with generally less reticent collaboration, that of the tonally softer-focused gambist in particular. But if even Robison can't quite match the well-nigh flawless bravura of Rampal (who can?), she succeeds just where the superhuman Frenchman is weakest: in projecting a sense of personal involvement and relish. Objectively, Rampal must be the preferred choice, but in music, or any other art, objectivity isn't always the determining factor. R.D.D.

BACH: Works for Violin and Harpsichord. For an essay review, see page 90.

BAKER: *Le Chat qui pêche*. * **GOULD:** Symphonette No. 2. Linda Anderson, soprano*; Jamey Aebersold, alto and tenor saxophones*; Dan Haerle, piano and electric piano*; John Clayton, bass and electric bass*; Charlie Craig, drums*; Louisville Orchestra, Jorge Mester, cond. [Andrew Kazdin, prod.] LOUISVILLE LS 751, \$6.95 (Louisville First Edition Recordings, 333 W. Broadway, Louisville, Ky. 40202).

The opening few minutes of David Baker's *Le Chat qui pêche* (*The Fishing Cat*), named after a tiny Parisian street, should bowl over just about any listener who turns on to a big jazz sound, particularly since producer Andrew Kazdin and his crew obviously went overboard to get whopping sonics. Indeed, the decibel count for most of this work might best be read on the Richter scale, because of both the music and the high recording levels. But this relentless loudness takes its toll pretty quickly, as Baker does not seem to be working, in this five-movement piece, on much more than a catalog of the various jazz idioms that he

knows so well as a scholar on the subject. Rather than third-stream jazz, as he calls this 1975 composition, *Le Chat qui pêche* struck me as little more than big (too big) sound jazz. The vocalizing soprano adds a nice, rather cinematic effect here and there.

It is most rewarding, on the other hand, finally to have a complete recording of Morton Gould's 1939 Symphonette No. 2. I have always liked the rather caustic irony that lurks behind even the jauntiest Gould melody or instrumental effect, and nothing exemplifies this tendency better than the deceptive wispiness of the famous "Pavane" second movement. (Note also the acid string punctuation that pops up in the first.) The Louisville Orchestra's performance of the work lacks a certain bite, but it is good enough; and, again, the sound is brilliant. The Gould alone makes this disc worthwhile, and the Baker has a definite demonstration-disc value. R.S.B.

BARBER: Symphony No. 1, Op. 9. Essays for Orchestra: No. 1, Op. 12; No. 2, Op. 17. Night Flight, Op. 19a. London Symphony Orchestra, David Measham, cond. [Robert Angles, prod.] UNICORN RHS 342, \$7.98 (distributed by HNH Distributors).

B **BARBER:** Symphony No. 1, Op. 9. **MAYER:** Octagon.* William Masselos, piano*; Milwaukee Symphony Orchestra, Kenneth Schermerhorn, cond. [Marc J. Aurbort and Joanna Nickrenz, prod.] TURNABOUT TV-S 34564, \$3.98 (QS-encoded disc).

B **BARBER:** Sonata for Cello and Piano, in C minor, Op. 6. **DIAMOND:** Sonata for Cello and Piano. Harry Clark, cello; Sanda Schuldmann, piano. [Daniel Nimetz, prod.] MUSICAL HERITAGE MHS 3378, \$3.50 plus 95¢ postage (Musical Heritage Society, MHS Building, Oakhurst, N.J. 07755).

Barber's First Symphony (1935-37, revised

Explanation of symbols

Classical:

- B** Budget
- H** Historical
- R** Reissue

Recorded tape:

- Open Reel
- ◐ 8-Track Cartridge
- ◑ Cassette

1942) is a beautifully unified, four-movement-in-one work with an almost Shakespearean dramatic pacing. Both here and in the shorter *First Essay for Orchestra* (1938), his sense of affective timing is perfect—in the latter a short, gloomy motive (recalling the mood of the famous *Adagio for Strings*) is stated and eventually replaced by a sharp, typically steely Barber scherzo, only to be brought back in a final, climactic surge whose effect is chilling.

I am surprised that these two works have not received more attention on disc; the intense but much more extroverted *Second Essay* (1942) has proven more popular, perhaps because it is less depressing than the *First*. Unfortunately, neither performance of the symphony fills the need for a good modern version—the Hanson rendition (Mercury SRI 75012), by far the best, is in rechanneled stereo, although the sound is decent enough. The Measham/London Symphony performance is slack, eliciting little feeling of continuity or dramatic coherency. Measham fares better in the *Second Essay*, but *Night Flight*, the reworked slow movement of the composer's repudiated (but not unrecorded) *Second Symphony* (1944), all but falls apart at the seams, and I am not especially impressed by the playing of the *First Essay*, one of my favorite contemporary works. Schermerhorn and the Milwaukee Symphony are much more successful in maintaining the symphony's tensions, but the playing is not all that good, and the recorded sound, particularly in the strings, is considerably duller than Unicorn's clean but rather depthless reproduction.

The early (1932) cello sonata shows Barber's more mellowly lyrical side, with a remarkable theme in rising minor sixths opening the work and a number of haunting melodies and intriguing figures as it progresses. In strong contrast, David Diamond's 1938 sonata, which here receives its first (and most welcome) recording, is a knottier piece, with immense rhythmic vitality but little melodic or harmonic drive. Both works are technically well played by the Clark-Schuldmann duo, though I am not partial to Harry Clark's reedy cello tone. The Diamond gets a vigorous, well-paced interpretation, but the Barber is on the ponderous side. Musical Heritage's very present sound reproduction is a strong plus.

Finally, William Mayer's 1971 *Octagon*, the filler for Schermerhorn's Barber symphony, is an eight-movement (naturally) piece for piano and orchestra, a modernistic, rather brittle showpiece stressing sonority (both chordal and instrumental) and allowing the listener to feast on bravura antics from both soloist and orchestra. Nothing reaches very deeply, either intellectually or emotionally, but it is exciting music brilliantly performed by William Masselos and Schermerhorn, with much better engineering than in the Barber. R.S.B.

BEETHOVEN: Sonatas for Piano: No. 18, in E flat, Op. 31, No. 3; No. 23, in F minor, Op. 57 (*Appassionata*). Lazar Berman, piano. [Steven Epstein, prod.] COLUMBIA M 34218, \$6.98. Tape: ●● MT 34218, \$7.98; ● MA 34218, \$7.98.

BEETHOVEN: Sonata for Piano, No. 23, in F

minor, Op. 57 (*Appassionata*). **LISZT:** Sonata for Piano, in B minor. Lazar Berman, piano. SAGA 5430, \$6.98 [originally released in England as SAGA XIX 5019, 1958] (distributed by CMS Records).

The Columbia disc was taped last spring while Berman was making his first U.S. tour; the Saga was taped in 1958 following an obscure recital (sponsored by Saga) in the little room of London's Royal Festival Hall. Berman, of course, remade the Liszt sonata too—a 1974 Melodiya product released domestically as Columbia M 33927.

If you want the Liszt, the newer version is the one you should get. It is more strongly integrated than the refined but rather small-scaled and episodic Saga (and more suitably coupled with more Liszt). If it is Beethoven you are seeking, you may do well to bypass both discs.

The two *Appassionata* performances are quite different, and—as with the Liszt—almost every advantage is with the later one. In the finale, Berman now observes the important direction to play “the second part twice,” and he is always respectful of accents and other markings, though he never convinces me that he really understands all their implications. Dry and methodical

though his playing may be, it is leagues ahead of the provincial early effort, which reduces the sonata to a haphazardly assembled series of salon vignettes.

Columbia's overside Op. 31, No. 3, falls midway between the almost studentish account that Berman gave (on a horrible “house” piano) at the Ninety-second Street YMHA and the extroverted, quite exciting one from his debut at Miami University in Oxford, Ohio. The pianism is tastefully fleet (but not really notable for finely graded control), while the interpretation sounds oddly constrained and not particularly, or characteristically, Beethovenian. And in this sonata Berman bypasses the first-movement repeat, thereby upsetting the structural symmetry.

Black marks for Columbia's engineering and pressing. In many ways, the admittedly too plummy, recessive British sound of nineteen years ago is more agreeable than the tight, brittle, colorless “modern” reproduction. The sound on the Melodiya Liszt sonata—to say nothing of Berman's Deutsche Grammophon records—is strikingly superior. H.G.

BEETHOVEN: Symphony No. 6, in F, Op. 68

Critics' Choice

The best classical records reviewed in recent months

- BACH:** Concerto Reconstructions (ed. Hogwood). Marriner. ARGO ZRG 820/1, Dec.
BACH: Harpsichord(s)/String Concertos. Leppard. PHILIPS 6747 194 (3), Dec.
BACH: Italian Concerto; B minor Partita. Kipnis. ANGEL S 36096, Jan.
BARTÓK: Bluebeard's Castle. Troyanos, Nimsgern; Boulez. COLUMBIA M 34217, Feb.
GLUCK: Operatic Arias. Baker; Leppard. PHILIPS 9500 023, Jan.
HANDEL: Organ Concertos (16). Rogg, Armand. CONNOISSEUR SOCIETY CSQ2 2115 (2) and 2116 (2), Jan.
HAYDN: Piano Works. McCabe. LONDON STEREO TREASURY STS 15343/5 (3), Jan.
HAYDN: Symphonies Nos. 99, 100. Bernstein. COLUMBIA M 34126, Feb.
HAYDN: Trios H. XV:14/15. Beaux Arts Trio. PHILIPS 9500 034, Jan.
JANÁČEK: Choral Works. Veselka. SUPRAPHON 1 12 1486, Dec.
LISZT: Concerto No. 1. **TCHAIKOVSKY:** Concerto No. 1. Gutiérrez, Previn. ANGEL S 37177, Feb.
LISZT: Concerto No. 1; Totentanz. Kiss, Ferencsik. HUNGAROTON SLPX 11792, Feb.
LISZT: Concertos Nos. 1, 2. Berman, Giuliani. DEUTSCHE GRAMMOPHON 2530 770, Feb.
MAHLER: Das Lied von der Erde. Baker, King; Haitink. PHILIPS 6500 831, Jan.
MOZART: Quartets Nos. 20–23. Juilliard Qt. COLUMBIA MG 33976 (2), Feb.
MUSSORGSKY: Pictures at an Exhibition, B flat Scherzo; Turkish March. Béroff. ANGEL S 37223, Dec.
ORFF: Carmina Burana. Kegel. PHILIPS 9500 040, Dec.
RACHMANINOFF: Isle of the Dead; Symphonic Dances. Previn. ANGEL S 37158, Jan.
ROSSINI: Elisabetta, regina d'Inghilterra. Caballé, Masterson, Carreras; Masini. PHILIPS 6703 067 (3), Feb.
SCHUMANN: Sonata (Concerto Without Orchestra). **SCRIABIN:** Sonata No. 5. Horowitz. RCA RED SEAL ARL 1-1766, Jan.
SHOSTAKOVICH: Quartets Nos. 8, 15. Fitzwilliam Qt. OISEAU-LYRE DSLO 11, Feb.
STAMITZ, J.: Clarinet Concerto; Symphonies (3). Hacker, Hogwood. OISEAU-LYRE DSLO 505, Feb.
STRAVINSKY: Le Sacre du printemps. Monteux. LONDON STEREO TREASURY STS 15318, Feb.
STRAVINSKY: Le Sacre du printemps. Abbado. DEUTSCHE GRAMMOPHON 2530 635, Feb.
WAGNER: Die Meistersinger von Nürnberg. Fischer-Dieskau, Ligendza, Domingo; Jochum. DEUTSCHE GRAMMOPHON 2713 011 (5), Feb.
DAVID MUNROW: Art of Courtly Love. SERAPHIM SIC 6092 (3), Feb.
DAVID MUNROW: Instruments of the Middle Ages and Renaissance. ANGEL SBZ 3810 (2), Feb.
ARTURO TOSCANINI: And the Philadelphia Orchestra. RCA RED SEAL CRM 5-1900 (5), Jan.



Karl Böhm—his first integral cycle of Brahms symphonies

(*Pastoral*). Hungarian State Orchestra, János Ferencsik, cond. [István Juhász, prod.] HUNGAROTON SLPX 11790, \$6.98.

This *Pastoral* is excellent in every way—fully the equal of the recent distinguished Seventh from these forces (SLPX 11791, December 1976).

Ferencsik belongs to the sadly dwindling band of conductors who interpret Beethoven with a maximum of understanding and a minimum of fuss. There is nothing either eccentric or meretriciously "traditional" about this performance. The basic rhythmic pulse is rock-solid in each movement, neither too fast nor too slow; there are no coy little tempo adjustments like the all too familiar ritardandos on the bassoon figurations at bar 236 of the first movement or the bothersome underlining of the climax at bar 146 of the finale. And the Hungarian State Orchestra compensates for a slight lack of polish with the most responsive, mellow, expressive playing.

In sum, then, a thoroughly bucolic interpretation that is certain to stand up to time. The recording is splendid too. Ferencsik takes the scherzo repeat, but not the one in the first movement. H.G.

BRAMMS: Sonatas for Violin and Piano: No. 1, in G, Op. 78; No. 3, in D minor, Op. 108. Miklós Szenthelyi, violin; András Schiff, piano. [János Mátyás, prod.] HUNGAROTON SLPX 11731, \$6.98.

These admirably musical young Hungarians fare better in the more extroverted D minor Sonata, in which fervor and introspection are more easily balanced. Sometimes the playing is understated to the point of matter-of-factness, but the general sensitivity and purity of intent are quite touching.

In the G major Sonata, more elegance and supple mobility are needed to keep the arching line aloft, and the severe problems of balance and projection have not been

satisfactorily solved. At the beginning of the first Allegro *ma non troppo*, for instance, Szenthelyi seems to be employing the long *urtext* bowing, but he simply cannot command enough sonority to project the opening phrases intact. At other points pianist Schiff covers his colleague instead of merely surrounding him. And I suspect that the recorded balance accurately reproduces what was presented to the microphones. H.G.

BRAMMS: Symphonies (4). Vienna Philharmonic Orchestra, Karl Böhm, cond. [Werner Mayer, prod.] DEUTSCHE GRAMMOPHON 2711 017, \$31.92 (four discs, manual sequence). Symphonies: No. 1, in C minor, Op. 68; No. 2, in D, Op. 73; No. 3, in F, Op. 90; No. 4, in E minor, Op. 98.

Böhm has recorded all the Brahms symphonies before, but this is his first integral cycle. His approach is an individual one, not calculated to appeal to all tastes: broad and deliberate, but free of extraneous gestures. Rather the inner security of his rhythmic sense and the natural musicality of his phrases "lock in" the hearer's attention. These performances have a chamber music texture at least partly traceable to DG's bright, almost weightless recording, in which the winds (including the amiable, slightly quavery Vienna oboe) shine effortlessly through the strings.

The new First is broader in the first movement, less steady elsewhere than Böhm's 1960 Berlin recording for DG. The outstanding feature is the third-movement trio, which has a serene, almost clucking, contentment. The finale is a little finicky, and this is the one place the Vienna strings turn almost whiny.

I recall Böhm's mono Berlin Second for DG (once issued here on Decca) as a dull and stodgy affair. Here, although he takes all the time in the world (especially in the slow movement), the entire score glows with a radiant tragic intensity and massive metrical solidity. If told that the conductor was Pablo Casals, I wouldn't doubt it!

I've always been fond of Böhm's earlier Vienna Third for Decca/London (available as Vox STPL 513 300, rechanneled)—a firm, generous-hearted, and sweeping rendition. The remake is a bit casual in its resolute simplicity, and the individual profile of the movements is underplayed. The high strings sound more acerbic here than in the rest of the set.

The Fourth hasn't been in Böhm's discography since a prewar Dresden set for HMV, which I remember as modestly and firmly authoritative. Here too is a reading of exemplary cumulative strength. In both the first and second movements there are exceptionally gentle pianissimos, yet the carefully scaled climaxes, when they come, go full throttle. Pacing is conservative, with a welcome funereal dignity in the slow movement. A wryly puckish scherzo leads to a finale neither rigidly monolithic nor indulgently sectionalized. Instead, each variation of the glorious passacaglia receives just the right contouring in a spontaneous and smooth way. A Fourth of such integrity and dignity joins the top group of all the recordings we have had. A.C.

BRUCKNER: Symphony No. 8, in C minor (ed. Haas). Berlin Philharmonic Orchestra, Herbert von Karajan, cond. [Michel Glotz, Hans Hirsch, and Magdalene Padberg, prod.] DEUTSCHE GRAMMOPHON 2707 085, \$15.96 (two discs, manual sequence).

Comparisons:
Karajan/Berlin Phil.
Haitink/Concertgebouw

EMISXDW 3024
Phi. 6700 020

Karajan's 1958 Angel Bruckner Eighth (SB-3576, deleted, but recently reissued in the British HMV Concert Classics series) was turgidly conducted and soggy recorded, and he has not altered the basic grand scale of his conception. I am a bit more swayed now by the portentous weight of his opening Allegro moderato, in which every grandiloquent gesture is wrung out. And the measured pace of the scherzo is no intrinsic impediment, as Szell demonstrated in his tensile recording of the Nowak edition of the symphony (Columbia M2 30070). But the sticky legato with which Karajan's violas and cellos phrase the main tune vitiates any positive effect. Though the Adagio is rushed in spots (most cruelly in the ineffably tender closing pages), the finale becomes more and more ponderous as it progresses, till the music seems to be undergoing a mudpack treatment.

The new recording does improve on its predecessor in some welcome respects. The bite and intensity of the playing often turns into demonic surge and thrust what was formerly effete, and Karajan's control over dynamics, when he chooses to exercise it, is consummate. He does so in most of the symphony's first half (as in the pizzicato crescendo at bars 128-33 of the scherzo); later, however, he becomes less attentive—the passage at bars 50-60 of the scherzo, for example, is loud and crude.

The engineering has much to do with the difference between the Karajan recordings. In place of EMI's homogeneous weight and cavernous blending, DG provides a sharply focused perspective, crisp and clear and of seemingly limitless power. The strings bounce, the brasses bite. But Philips' engi-

The Hit List
of Light
Popular Classics

Karajan Conducts

Volume 1.



S-37231

Volume 2.



S-37232

Volume 3.



S-37250

20 favorite orchestral showpieces in all. And played as only Karajan can conduct them. Available as three individual Angel LPs, handsomely engineered and invitingly sequenced.

Liszt: Hungarian Rhapsody No. 2
Suppé: Light Cavalry Overture
Liszt: Les Préludes
Strauss Jr.: Thunder and Lightning Polka
Rossini: William Tell—Overture
Berlioz: Hungarian March S-37231

Tchaikovsky: 1812 Overture
Sibelius: Finlandia
Strauss Sr.: Radetzky March
Smetana: The Moldau
Borodin: Polovtsian Dances 8 & 17—
Prince Igor S-37232

Chabrier: Joyeuse Marche
Waldteufel: The Skaters—Waltz
Bizet: Farandole
Weber-Berlioz: Invitation to the Dance
Chabrier: España
Tchaikovsky: Sleeping Beauty—Waltz
Verdi: Aida—Ballet Music
Weinberger: Schwanda—Polka
Ponchielli: Dance of the Hours S-37250



CIRCLE 3 ON READER-SERVICE CARD

neering for Haitink—the only other conductor on current recordings who uses the Haas edition of the Eighth—is at least as well balanced internally, albeit somewhat more reticent and damped over-all, and the Concertgebouw's playing is fully as impressive as the Berlin Philharmonic's. Moreover, Haitink avoids Karajan's mannerisms in the finale, which is given with real force and meaningful integration. He is also more tender and flowing in the Adagio, and many will prefer his lithe and bubbling account of the scherzo.

Although the Nowak edition of the Eighth, which follows Bruckner's revised score of 1890, seems to be the current favorite, I remain loyal to Haas, who incorporated the basic 1890 revisions but restored several brief passages from the original score of 1887 that he felt Bruckner had cut against his own better judgment. Incredibly, DG bills this recording as the "version of 1887." (The latter has been published—in 1973 by the Bruckner Society—but not recorded.) A.C.

DELIUS: Fennimore and Gerda.

Fennimore: Gerda Elisabeth Söderström (s)
Erik Retstrup Robert Tear (t)
Niels Lynne Brian Rayner Cook (b)
(plus numerous smaller roles)

Danish Radio Chorus and Symphony Orchestra, Meredith Davies, cond. [David Mottley, prod.] ANGEL SBLX 3835, \$14.98 (two SQ-encoded discs, automatic sequence).

It is fitting that the long-awaited disc debut of Delius' final opera, though recorded by a British conductor and principal singers under the auspices of the Delius Trust, should have taken place in Scandinavia. The composer's libretto is based on Niels Lynne, a Danish novel by Jens Peter Jacobsen, and the ambience and scenery of the Northland pervade the tragic story. Indeed, Delius' imagination seems more in tune with the backdrop of fiord, farmland, river, and the warm hearth on a bleak winter's night than with the human relationships of the characters.

The psychodynamics of the libretto are ambiguous. Fennimore is a woman who has apparently loved both the writer Niels and his longtime friend, the painter Erik. Both men become creatively blocked once they are involved with her, for reasons that are taken for granted rather than explored in depth. Following Erik's drunken, accidental (?) death and Fennimore's bitter dismissal of Niels, with whom she had recently cuckolded Erik, Niels retreats to a pastoral life to happily wed the teeny-bopper Gerda.

Sir Thomas Beecham never forgave Delius for thus watering down the novel's tragic ending, where even Gerda is eventually destroyed; indeed, his biography of the composer portrays the years culminating in the 1910 completion of *Fennimore and Gerda* as ones stifled by petty bureaucratic details attendant upon his growing commercial successes. And the music explores the relationships between the women and the men with a disturbing lack of enduring passion and depth. In terms of the most effective focus of both libretto and music, the work could well have been called *Niels and Erik*. But that would have forced Delius to face unflinchingly what the

words only hint at in double entendres. One waits in vain for illumination of the characters' sexual conflicts, or for any sense of grief, heartbreak, or loss when Niels and Fennimore part. Delius the escapist turns, as so often, to the passive absorption of nature.

The orchestral fabric of this ninety-minute work moves in a stream of atmospheric painting that is Delian sorcery at its fullest. There is little evident motivic development but gleaming wisps of color and harmony that evoke the grotesquerie, childlike bliss, and constant longing for far-off nature that are so much a part of the composer's special world. For me, the outstanding moments are Fennimore's serenade to the joys of unfettered freedom (in the first of the opera's eleven scenes), the wordless tenor voice (Anthony Rolfe Johnson in this recording) coming across the water in the second, the autumnal interlude between the fifth and sixth, the icy and mocking orchestral accompaniment (with fragments of Eventyr) to Fennimore's discovery of Erik's death, and of course the music flanking the tenth scene (Niels's contented discovery of the farmer's life), which for concert purposes has been consolidated into "the" Fennimore and Gerda Intermezzo. (Even Beecham softened his disapproval of the score for those five minutes of it.)

The performance is consistently clean, sensitive, and atmospheric. The Danish Radio Symphony has the idiom superbly ingrained—non-English orchestras can play Delius. Conductor Meredith Davies is more successful here than in his rather choppy reading of *A Village Romeo and Juliet* (Angel SBLX 3784, May 1973). Elisabeth Söderström handles both title roles splendidly (granting the premise of one performer doubling such different characters), and Brian Rayner Cook is a thoughtful and warmly articulate Niels. Robert Tear's Erik, though, is less ardent and tormented than Max Worthley's in a BBC production that has circulated in the underground. The supporting cast (of mostly walk-on parts) does its work conscientiously.

Angel's pressings are quiet enough but somewhat lacking in brightness. The album includes a succinct but thorough assessment of the work by Eric Fenby, the complete text, and a splendid Edvard Munch drawing evidently done for the cover of the original vocal score. A.C.

DIAMOND: Sonata for Cello and Piano—See Barber: Symphony No. 1.

DVOŘÁK: Symphony No. 9, in E minor, Op. 95 (*From the New World*). New Philharmonia Orchestra, Riccardo Muti, cond. [John Mordler, prod.] ANGEL S 37230, \$6.98 (SQ-encoded disc). Tape: ●● 4XS 37230, \$7.98; ●● 8X 37230, \$7.98.

MENDELSSOHN: Symphony No. 3, in A minor, Op. 56 (*Scotch*); Calm Sea and Prosperous Voyage Overture, Op. 27. New Philharmonia Orchestra, Riccardo Muti, cond. [John Mordler, prod.] ANGEL S 37168, \$6.98 (SQ-encoded disc).

TCHAIKOVSKY: Symphony No. 1, in G minor, Op. 13 (*Winter Dreams*). New Philharmonia

THE METROPOLITAN OPERA'S NEXT PERFORMANCE COULD BE ITS SWAN SONG. UNLESS YOU GIVE A QUARTER.

The Metropolitan Opera is one of America's most important cultural institutions.

It's running out of money, but you can help.

Through matching grants, Pioneer High Fidelity and the National Endowment for the Arts will quadruple the value of your donation.

Even a quarter can make a difference.

You don't have to be a millionaire to be a patron of the arts.

When you give a quarter, the Met gets a buck.

I have enclosed a donation of \$ _____ for the Metropolitan Opera. (Checks should be made payable to The Metropolitan Opera/Pioneer Fund.)

Name _____

Address _____

City _____ State _____ Zip _____

Mail the coupon with your donation to:

U.S. Pioneer Electronics Corp., Dept. M.E.T., 75 Oxford Drive, Moonachie, N.J. 07074

 **PIONEER** We all owe a lot to music.
HIGH FIDELITY



RTR sound is a singular creation

Like the human voice and all things striving for perfection, RTR sound systems have only one maker. Each critical component is designed and manufactured by RTR. From hand-wound voice coils to hand-rubbed cabinetry, everything fits and operates as one. Thus RTR systems approach the perfection of realistic sound.

Few others are so dedicated. They create systems from the components of many manufacturers—often including transducers built by RTR. Though they build fine speakers, they build only finite systems. That is the law of group creation.

If you strive for realistic sound at a sound price, seek your nearest franchised RTR dealer. He will show you a singular solution.



For dealer list, write
RTR, Dept. HF, 8116 Deering Avenue,
Canoga Park, CA 91304.

CIRCLE 32 ON READER-SERVICE CARD

Orchestra, Riccardo Muti, cond. [John Mordler, prod.] ANGEL S 37114, \$6.98 (SQ-encoded disc).

Riccardo Muti's first symphonic records do not satisfy the high anticipation aroused by his vault to international celebrity and by his appreciable contribution to a fine recorded *Aida* (Angel SCLX 3815, February 1975). Moreover, I find it difficult properly to apportion blame among conductor, orchestra, and engineering.

Muti's approach to the orchestra bears a resemblance to that of Eugene Ormandy, with whose blessing he has been named principal guest conductor of the Philadelphia Orchestra: Attacks and releases, though together in good ensemble, are smooth and gentle; much of the time the strings use a wide vibrato, sounding quite lush in slower and more expressive passages. (This might have been more impressive still were the string complement more numerous. It sounds rather anemic to me, especially when pitted against an aggressive wind band in tutti climaxes. Again, though, the fault may be less the orchestra's than the engineering's, about which more below.)

Interpretively, Muti is rather bland in all three of these composers. He makes the best impression in the Tchaikovsky First Symphony, but even here the excellent and quite different readings of Michael Tilson Thomas (DG 2530 078) and Leonard Bernstein (Columbia M 30482) demonstrate how effectively a strong interpretive profile can improve this weak score. Similarly, a number of recordings of the Mendelssohn Scotch Symphony—for example Peter Maag's (Stereo Treasury STS 15091), Otto Klemperer's (Angel S 35880), and Herbert von Karajan's (DG 2530 126)—enliven and enlighten this superbly Romantic score much more effectively. Both here and in the Dvořák *New World*, Muti fails to impart real energy and impulse to the music; in both symphonies, his best work comes in the slow movements.

I do not mean to imply that Muti lacks rhythmic security; within the parameters of his inclination to languor, he has full control of the music. Yet he seems to rely for over-all effect on the sensuous aspect of the orchestra, and here both the orchestra and the recording let him down. Although the sound is well balanced in frequency range and as free of actual distortion as any record I know, there is an acoustic distortion that I find hard to describe. With two different cartridges, through headphones as well as speakers, the quality I hear might best be termed "furry"—slightly blurred, lacking in clarity and immediacy. Even with headphones, the stereo effect is weak, the over-all sound peculiarly centered, with a great deal of right-channel information in the left and vice versa. There is enough evidence of European EMI issues—in the form of foreign reviews and firsthand reports of direct comparisons—to suggest that some of the problem arises on this side of the Atlantic, and there is also increasing reason to believe that SQ encoding contributes to this lack of definition in two-channel playback.

The failure to reproduce Muti's first symphonic recordings with anything like state-of-the-art technology is all the more frus-



James Levine
Relishing Mahler's challenge

trating because it makes it impossible to judge fairly a young conductor who may have a great future. For that matter, is blurred reproduction of a seemingly anemic orchestra the ideal way to promote a career? P.H.

GOTTSCHALK: Four-Hand Piano Works. Eugene List with Cary Lewis^o and Joseph Werner^r, piano. [Joanna Nickrenz, prod.] VANGUARD VSD 71218, \$6.98.

Souvenirs d'Andalousie, Op. 22ⁱ; *La Gallina*, Op. 53ⁱ; *Orfa*, Op. 71^o; *Marche de Nuit*, Op. 17ⁱ; *Printemps d'amour*, Op. 40^o; *The Union*, Op. 48^o (arr. List); *Radiouse*, Op. 72ⁱ; *Réponds-moi*, Op. 50^o; *Tremolo*, Op. 58^o; *L'Étincelle*, Op. 80ⁱ; *Ses yeux*, Op. 66ⁱ; *La Jota aragonesa*, Op. 14^o (arr. Savant).

It was back in 1956 when Eugene List recorded the first major Gottschalk piano program, one that many Gottschalk connoisseurs, myself included, still consider unsurpassed in intoxicating verve by the many later—some of them more virtuosic—recorded performances. (That original program is currently available as Vanguard SRV 485; also, re-edited but still in mono, as part of a Gottschalk miscellany on Vanguard SRV 723/4.) Since then, however, List has returned to the fabulous pioneer of a truly American music only once, in the uneven 1972 "Gottschalk Festival" collection (Turnabout TV-S 34440/2), in which the best things for piano were four pieces in their original four-hand editions.

Now, at last, to the delight of both Gottschalk and List aficionados, the pianist is back with one of his 1972 partners (Cary Lewis) and one new one (Joseph Werner) in the same four originals (*La Gallina*, *Radiouse*, *Réponds-moi*, and *Ses yeux*), augmented by seven more four-hand arrangements (several by the composer himself) and List's two-piano arrangement of *The Union*. Most of these, whatever their present format, are more or less familiar either from their original solo versions or from solo arrangements of the four-hand originals. But *Orfa*, *Printemps d'amour*, and *Tremolo* are surely firsts. (*L'Étincelle* is a new title to discs, but it proves to be the

same as *La Scintella*, recorded earlier by both Mandel and Rigai.)

As usual with Gottschalk's music, the big showpieces (*The Union*, *Jota aragonesa*, *Souvenirs d'Andalousie*, *Tremolo*) are dazzlingly effective for all their rodomontade; the salon mazurkas, valse, polka, and programmatic *Marche de Nuit* are amusing lavender-and-old-lace antiques; while the examples of authentic Latin American-style pioneering (*La Gallina* and *Réponds-moi*) are incomparably delectable. List and his alternating partners wisely eschew camping-up even the most old-fashioned pieces (except, perhaps, in *The Union*), playing with contagious high spirits and considerable grace—but never with quite the same magic of the List of some twenty years ago.

Despite the glittering brilliance of the close-up recording, the over-all sonics seem somewhat lightweight. Or is this an intentional attempt to simulate the lighter tonal qualities of the pianos Gottschalk must have played himself? In any case, I would have welcomed throughout the more substantial sonority and impact of the two-piano *Union* performance. These are only minor flaws, though, in a release indispensable to everyone who treasures the pioneering List/Vanguard recital. Both programs radiate unique appeals and promise unique rewards to everyone interested in genuinely American music. R.D.D.

GOULD: *Symphonette No. 2*—See Baker: *Le Chat qui pêche*.

LISZT: *Sonata for Piano, in B minor*—See Beethoven: *Sonata for Piano, No. 23*.

MAHLER: *Symphony No. 3, in D minor*. Marilyn Horne, mezzo-soprano; Glen Ellyn Children's Chorus, Chicago Symphony Chorus and Orchestra, James Levine, cond. [Thomas Z. Shepard and Jay David Saks, prod.] RCA RED SEAL ARL 2-1757, \$15.98 (two discs, automatic sequence). Tape: ●● ARK 2-1757, \$15.95; ●● ARS 2-1757, \$15.95.

Comparisons:
Forrester, Haitink/Concertgebouw Phi. 802 711/2
Lipton, Bernstein/N.Y. Phil. Col. M2S 675
Procter, Horenstein/London Sym. None. HB 73023

"A symphony should be the whole world," one of Mahler's most enduring aphorisms, applies nowhere more forcefully than to this hour-and-a-half behemoth, ranging among metaphysical demonology, human spirituality, and bucolic nature worship. Small wonder that no single recording has encompassed the score.

James Levine obviously responds to the challenge of the immense (half-hour-plus), surrealist first movement. He relishes sudden expansions and contractions of volume with astoundingly perceptive accuracy and effectiveness (e.g., the gruff octave drops passed between low brass and string basses at fig. 42 of the *Universal* score), and, despite occasional inconsistencies, the over-all transparency of detail in this recording is second to none. Certainly the all-important uprush of cellos and basses first occurring at fig. 3, so feeble in Horen-

If your cartridge is more than three years old, don't replace your stylus!

Don't get us wrong. There is nothing worse than playing your records with a worn stylus. And no better way to restore your old unit to its original glory than a new cartridge.

But frankly, there have been significant strides made recently in the phono cartridge field. And the new cartridges of today stand head and shoulders above even the finest of a few short years ago.

Here's the choice: Get fresh—but outdated—performance with a replacement stylus, or enjoy all the benefits of modern cartridge research and development for just a few dollars more. You'll find that you can update your system for far less than you might imagine. It's probably the most dramatic single improvement you can make.

For instance, Audio-Technica offers Universal™ cartridges equipped with a genuine Shibata stylus and our uniquely effective Dual Magnet™ system beginning at just \$75.00 list. Or you can replace your present cartridge with a fresh new Audio-Technica cartridge with highly-polished elliptical tip for as little as \$25.00 list.



AT11E \$45.00 AT12Sa \$75.00 AT13Ea \$25.00 AT-5Sa \$125.00

Are these new models worth the difference? Absolutely. You'll be amazed at what you hear from today's generation of phono cartridges. Improved frequency response. Lower distortion. Better separation. Less record wear. Truly better sound.

A new Audio-Technica cartridge.
Your best value in hi-fi.



audio-technica
INNOVATION □ PRECISION □ INTEGRITY

AUDIO-TECHNICA U.S., INC., Dept. 37H, 33 Shiloh Avenue, Fairlawn, Ohio 44313

Learn the naked truth about your phono cartridge.

If you're the kind of music lover who wants to get the very most from your stereo system, you can't afford to be without the Micro-Acoustics Transient and Tracking Ability Demonstration Test Record. Because it does what no test record ever did before.

Until now, test records concentrated on tracking ability—how well a stylus keeps contact with record grooves on louder, harder-to-follow passages, at low stylus pressures.

But cartridges need good transient ability, as well. To accurately reproduce the sudden start-and-stop bursts of sound at all frequencies that differentiate one instrument from another... and localize instruments in space.

Micro-Acoustics' new TT-2002 test record is the only record specifically designed to test both abilities. On side 1 of this easy-to-use disc is a series of electronic and musical tests incorporating technology we've developed as the world's leading manufacturer of recording styli. Side 2 is a dramatic demonstration of quality music, played by the top names in the business.

One small catch: Our record has humbled many a proud stereo cartridge, and may well make you unhappy with what you're using. Unhappy enough to listen to our 2002-e direct-coupled cartridge—which isn't intimidated by any record. Even ours.



Micro-Acoustics Corp.
8 Westchester Plaza, Elmsford,
N.Y. 10523

Enclosed is \$3.95. Send me the record. I'm curious and unafraid.

I'm just curious. Send free literature.

Name _____

Address _____

City _____

State _____

Zip _____

ma
Micro-Acoustics

HF-377

stein's recording, is imperiously forceful here as it has never been before.

Levine's attention to larger contourings is impressive too. He is uncommonly skillful, for example, at gauging his tempo modifications to allow for Mahler's frequent successive slowdowns or accelerations (cf. the rit., *pesante*, and *wieder zurückhaltend* at fig. 17). He also glides marvelously from the wild climax of the development into the percussion section's march bringing back the opening horn calls—a phenomenally well-calculated *diminuendo* and *ritard*. In certain expressive details, however, Levine seems almost embarrassed to "let go." The trombonist eight bars after fig. 60 does not observe the *portamento* in his lamenting solo, and in the carnival-like outburst at fig. 44 the winds make a straitlaced sound compared with the uproarious, but always virtuosic, noises produced by the New York Philharmonic under Bernstein or the Concertgebouw under Haitink.

Levine stalks somewhat intrepidly, unbendingly, through the brilliant, Van Gogh-like miniature second movement, a stark contrast to Bernstein's overexpressive Viennese ripeness—but one extreme doesn't justify another. Horenstein shapes the movement with enormous grace and flair, despite an unpleasant-toned first oboe. Haitink too maintains a sensible pace, with proper weight and flexibility and playing that is all agility, refinement, and poetry.

In the third movement, Levine takes Mahler's "without haste" marking more literally than any other conductor on records, which makes it difficult to impart much of a "lustig" ("merry") quality to the woodwind passage at fig. 19, although the brass antiphons in the coda are very neatly articulated at this deliberate tempo. Bernstein starts out ponderously but quickens after each of the triolike posthorn solos. Haitink is moderate, and I like his performance for the golden fullness of the horns after fig. 15 and the startling brazenness of the trumpet fanfare after fig. 17. Over-all, however, I prefer a faster basic tempo, as taken by Leinsdorf (RCA, deleted) and Kondrashin (Melodiya S 0383/6).

The third movement poses another problem: What instrument do you use for the posthorn solos? In the RCA notes, Jack Diether argues that a Mozart-type posthorn can't play the notes and that Mahler didn't have access to one anyhow. I am impressed by the sound of the instrument played by William Lang on the two London Symphony recordings—called a posthorn on Solti's (London CSA 2223), where it is too closely miked, and a flugelhorn on Horenstein's, where it sounds fine and is probably correctly identified. The Abravanel recording (Vanguard Cardinal VCS 10072/3) claims to use a posthorn, but to my ears it sounds like a trumpet. Levine—like Haitink and Bernstein, among others—does use a trumpet, and it's certainly effective enough.

In the fourth-movement Nietzsche song, RCA's Marilyn Horne surpasses the harsh and wobbly singing of Martha Lipton (with Bernstein), but I would turn to Norma Procter (with Horenstein) for the song's immobilized anguish, to Maureen Forrester (with Haitink) and Valentina Levko (with Kondrashin, in Russian) for its warm passion. Levine sustains enormous breadth and intensity, with superbly shaded playing,

marred by a sudden level change a bar before fig. 8.

I am always bothered by the near-universal side break between the two vocal movements: the fifth-movement alto-and-chorus song should burst in joyously on the dying cadence of the gloomy song that precedes it. (Only the Kubelik performance, DG 2707 036, and the anonymous one in the Everest Mahler box, both of which fit the whole first movement on one side, avoid this break.) Levine's performance is as joyous as one could want, and I particularly like the crispness and bite of Margaret Hillis' Chicago Symphony Chorus.

Levine's finale, the slowest on records, is tender, passionate, and noteworthy for its distinguishing of the three basic pulses. My only complaint is that he seems so intent on maintaining his audaciously broad pace that he doesn't simultaneously shape a spontaneously flowing lyric phrase. Still, only Bernstein's finale is as noble, and it lacks Levine's control. Haitink is a bit casual, though not so ridiculously rushed as Solti. Horenstein is ardent, warm, and flowing, but some will insist on greater weight.

In sum, I would rank Levine's Third with those of Haitink, Bernstein, and Horenstein, each boasting unduplicated qualities. RCA's engineering lacks something in sheer panache, and, at the low recording level, my copy had some rather pronounced surface swish. Diether's liner notes are, as always, most substantial. **A.C.**

MASSENET: Le Cid (abridged).

Chimene	Grace Bumbry (s)
L'Infante	Eleanor Bergquist (s)
Rodrigue	Placido Domingo (t)
Don Arias	Clinton Ingram (t)
The King	Jake Gardner (b)
St. Jacques	John Adams (b)
Don Diegue	Paul Plishka (bs)
Comte de Gormas	Arnold Voketaitis (bs)
Don Alonzo	Theodore Hodges (bs)
L'Envoyé Maure	Peter Lightfoot (bs)

Byrne Camp Chorale, Opera Orchestra of New York, Eve Queler, cond. [Thomas Frost and Steven Epstein, prod.] COLUMBIA M3 34211, \$20.98 (three discs, automatic sequence; based on the concert performance of March 8, 1976).

In recent years Eve Queler and the Opera Orchestra of New York have enabled New Yorkers to hear numerous works they are unlikely to encounter in local theaters, but the compromises that seem reasonable for such concert performances do not suffice for a recording.

Take the question of cuts. Obviously it is unreasonable to impose upon a concert audience the whole of *Le Cid*, whose enormous length is largely occasioned by the demands of nineteenth-century theatrical spectacle. But a recording is, among other things, a musical document. In addition, far from improving what, for all its fascination and skill, is hardly a masterpiece, cutting damages the work's proportions. In this abridgment, the final three scenes are simply too frenetic to serve as the climax and resolution of the courtly drama. According to the Heugel vocal score, only Act I is absolutely complete. In Act II the cuts are: 25 bars of Rodrigue's role (pp. 107-8), 32 bars of duet between Rodrigue and Gormas (115-18), 65 bars of chorus (135-41), 31 bars of ensemble

the SAE Revolution

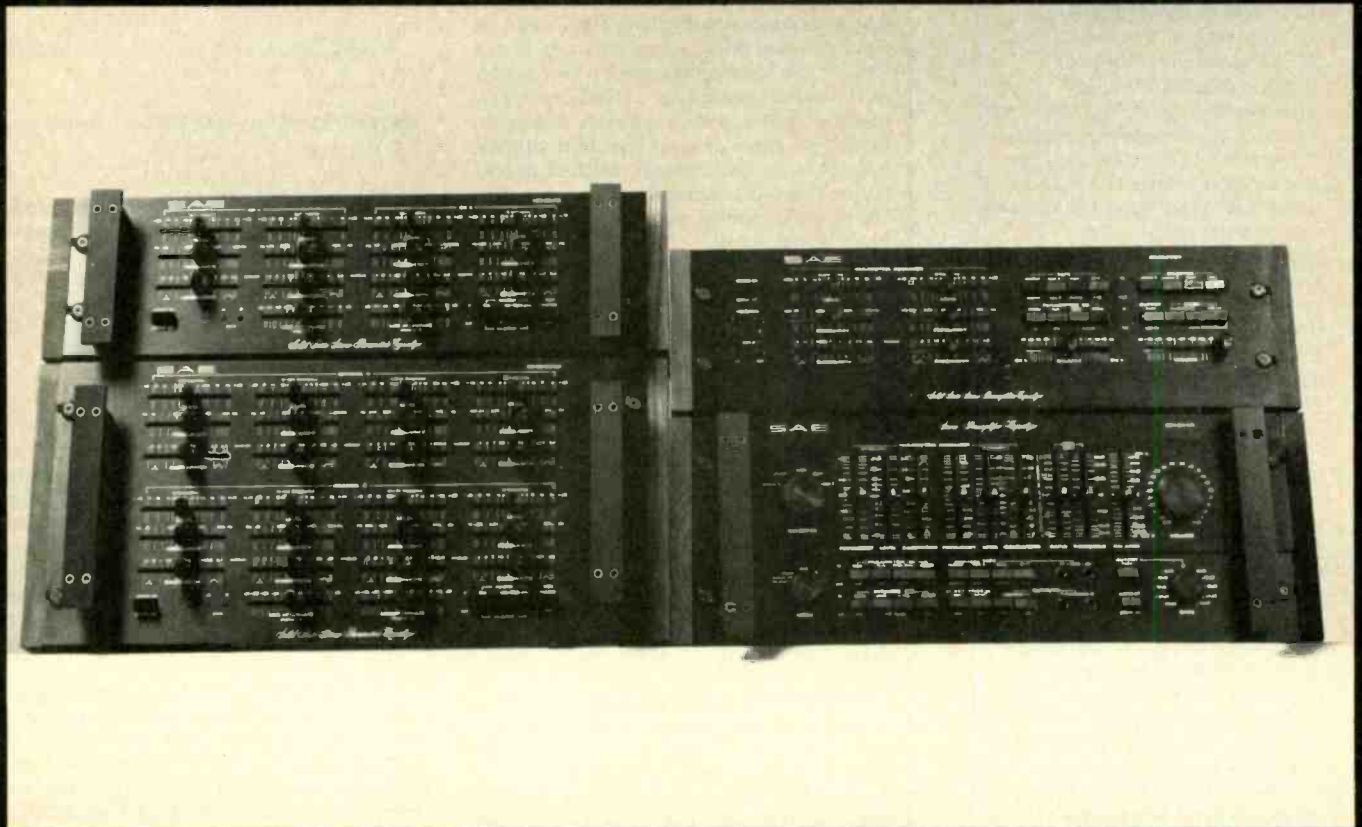

Suggested Price: 1800 — \$300.00 (Top Left), 2800 — \$550.00 (Bottom Left), 2900 — \$450.00 (Top Right), 2100 — \$900.00 (Bottom Right).
Cabinets shown optional at additional cost.

SAE has long been involved in the field of tone equalization. From our pioneering efforts in variable turnover tone controls to our more recent advancements in graphic equalizers, we have continually searched for and developed more flexible and responsive tone networks. From these efforts comes a revolution in tone equalization — the Parametric Equalizer.

Parametric Equalization, long a mainstay in the recording industry, is now available in SAE pre-amplifiers (2100, 2900) and as separate components (2800, 1800).

With the parametric, you can control not only cut and boost, as in the graphic, but also bandwidth and center-frequency. With this extra control flexibility, you can control precisely any problem or create any sonic effect you wish. Whether you need a .3 octave

notch filter because of room resonance, or a tailored bandwidth boost to bring out a hidden vocalist, the control flexibility of the parametric can fit these needs and many more. All of the products shown here offer the sonic performance and quality of construction that is typically SAE.

SAE

HF-377

SCIENTIFIC AUDIO ELECTRONICS, INC.
P. O. Box 60271, Terminal Annex
Los Angeles, Cal. 90060

Please send more information on the SAE Revolution

Name

Address

City State Zip

THEY'RE EVERY MICROPHONE YOU EVER WANTED.

We've taken the latest advances in electret technology one step further. By combining them with advanced acoustic technology to make professional condenser microphones more portable, more practical and less costly. A lot less.

The secret is our "family" concept.

One common powering module (K2U) serves three different compact heads: omnidirectional (ME20), cardioid (ME40) and shotgun (ME80). Thus, for most studio and location situations, it's no longer necessary to carry three different complete units. Each head contains its own microphone capsule and "front-end" electronics, all exactly matched to its own precisely-controlled acoustical environment. Resulting in the first electrets with response and directionality to rival our famous RF condenser models in all but the most critical applications.

The Powering Module, runs on a single 5.6V battery, or phantom-powered directly from your recorder, preamp or other auxiliary equipment. A miniature LED monitors power and indicates proper voltage. Connection to preamps, mixers, etc. is balanced* low-impedance via a 3-pole Cannon XLR connector. Best of all, of course, is the great versatility. In a matter of seconds, you screw on whichever head you need and go!

If all this sounds good to you, call or write us. We have a lot more good things for you to hear.

Powering module and heads available separately. Prices subject to change without notice.

*Unbalanced version also available

CARDIOID HEAD.
\$78.00 list.

OMNIDIRECTIONAL HEAD.
\$55.00 list.

POWERING MODULE.
\$79.00 list.

SHOTGUN HEAD.
\$108.00 list.

SENNHEISER

ELECTRONIC CORPORATION

10 West 37th Street, New York 10018 (212) 239-0190
Manufacturing Plant: Bissendorf/Hannover, West Germany

(181-83), 6 further bars of chorus (191-93). In Act III: the 3 bars of orchestral postlude to Chimène's aria, "Pleurez, mes yeux" (236), 52 bars of chorus (264-69), the *Rapsodie Mauresque* for orchestra (271-79), 25 bars of ensemble (286-90). In Act IV: 139 bars of ensemble (311-12, 316-25), 55 bars of orchestral music (330-34), 34 bars of ensemble (342-44).

Sometime I should like to hear the score Massenet composed. Sometime, too, I should like to hear it sung in the language of the libretto: by and large, the French heard here is execrable. Grace Bumbry and Eleanor Bergquist manage well enough, but Plácido Domingo is somewhat careless and the rest are simply insufficient. The Comte de Gormas says "aime" where he ought to say "âme"; the king pronounces "ces appels" as if it were "cessappels"; Don Diègue gets many critical vowels hopelessly wrong. In the latter case, it is clear that Paul Plishka has not been well enough coached in textual matters—he makes hash of a line like "Il ne l'eût jamais fait, si je l'eusse pu faire!" from Act II.

Even so, Plishka is a good singer. Most of those heard here are not. Apart from Bumbry, Domingo, and Plishka (and possibly Bergquist and Arnold Voketaitis), they sound plainly inadequate, even amateurish. Bergquist is better than that, but even so she is pallid and thin-voiced. And Voketaitis, in a role created by Pol Plançon, one of the greatest *basses chantants* of the nineteenth century, is rough in sound and ungainly in technique. Plishka, in the role created by Edouard de Reszke, produces some noble tone but as yet lacks elegance and the kind of vocal finish that would enable him to deal with the technical difficulties the role abounds in, like the sudden drop of a tenth in Act II on "deshonneur" (p. 197).

Bumbry is an unwinning Chimène, harsh in timbre, monochromatic, lacking in grace and femininity as well as in tonal steadiness at anything below *mf*. At her best in declamatory passages, she seems, even in those, unidiomatic and at odds with the music. At the end of Act II she unwisely interpolates what might have been intended as a C sharp but sounds more like a scream. She, Plishka, and Domingo all take unwritten high notes, the latter most damagingly at the end of "O Souverain, O Juge, O Père" in Act III—an artistic outrage, a rewriting and misrepresentation of the music: Instead of the gradual diminuendo Massenet specified for a heavenly choir and St. James (of whom the hero is avouched a comforting vision on the eve of battle), somebody has cobbled into the score a fortissimo climax sung by the choir and, above them, Domingo letting fly with a mighty high B—after which he reverts to the original hushed conclusion: "La vision s'efface!"

Otherwise Domingo, in this recording of a role he has had no stage experience in, is generalized, as one might expect. Vocally he is thrilling in the higher, louder passages and less assured in the others. The chorus sounds as if it could have used more rehearsal time and more personnel. The orchestra does well. There is some beautiful solo playing, especially the long clarinet obbligato before Chimène's Act III aria.

As for the largely unfamiliar score, one can see that the heroic world of Corneille

(the seventeenth-century playwright on whose tragedy the libretto was based), with its ritualized conflict between love and duty, made little appeal to the composer's deepest feelings. There are some fine pages here—the Infante's invocation to the spring; Chimène's aria; a great deal of Rodrigue's music: the entire vision scene—but too much that is merely utilitarian.

The recording is variable—no doubt because of the need for retakes—but at no point is it good enough by today's standards. There is a libretto, abridged in accordance with what is actually heard, but nothing about the music or the edition proffered under the guise of a complete recording.

A misbegotten venture. D.S.H.

MAYER: Octagon—See Barber: Symphony No. 1.

MENDELSSOHN: Sonata for Cello and Piano, No. 2, in D, Op. 58. **SCHUBERT:** Sonata for Arpeggione and Piano, in A minor, D. 821. Lynn Harrell, cello; James Levine, piano. [Peter Dellheim, prod.] RCA RED SEAL ARL 1-1568, \$7.98. Tape: ●● ARK 1-1568, \$7.95; ● ARS 1-1568, \$7.95.

Neither work is from its composer's top drawer, but the Mendelssohn sonata, requiring a more extroverted kind of bravura, fares better here. The intermezzo is quite crisp, and the chorale-influenced third movement is, thank heavens, purged of its saccharine excesses. But the first movement lacks energy: The tempo is a shade slow, the piano's ostinato chords are inflexibly hammered out, and the cello line never soars. No match for Feuermann and Rupp on Victrola VIC 1476.

The Schubert is even more problematic. On the arpeggione, the hybrid instrument—fretted like a guitar but bowed like a gamba—for which it was written (and so recorded on Archiv 2533 175), the sonata is a mere *pièce d'occasion*. Recast as a cello piece, it becomes a horribly difficult virtuosic vehicle that has eluded such luminaries as Feuermann (Seraphim 60117—technically brilliant but musically joyless) and Rostropovich (London CS 6649—disfigured by an attempt to give this gracious material an emotional weight it doesn't possess).

The Harrell/Levine performance is reasonably paced, technically able, and yet, on the whole, disappointing. Harrell's sound has an equalized consistency without much textural or coloristic differentiation, and he always seems to insert a slithery shift just where it will detract from the shape of a phrase or the impetus of a line. Levine plays with clean efficiency, showing a bit more temperament than his partner.

The sound is clear, resonant, and well balanced. H.G.

MENDELSSOHN: Symphony No. 3; Calm Sea and Prosperous Voyage Overture—See Dvorák: Symphony No. 9.

MEYERBEER: Le Prophète. For an essay review, see page 87.



There has never been anything quite like the new Nakamichi 600 Cassette Console, either in appearance or performance. Elegant functional styling, coupled with world-famous Nakamichi engineering, establishes standards that are unlikely to be equalled for years to come.

By design, the 600 is a study in human engineering. All of the operating controls, as well as all adjustment and calibration controls, are engineered into the graceful front panel, assuring ease of operation and maintenance.

The shape of the future

But the real news is in the increased dynamic range of the 600. The Nakamichi Focused-Field Crystal Permalloy head not only assures a remarkable frequency response of 40 to 18,000 Hz; it achieves superior penetration of the tape coating, producing a higher, undistorted signal level. Special IM Suppressor circuitry reduces saturation nonlinearities and increases dynamic range to an incredible 68dB at the standard 3% distortion figure with Dolby* on. Program material may be recorded at levels 3 to 4dB higher than previously possible.

To take full advantage of this available headroom, the Nakamichi 600 employs precise peak reading meters with an unheard of 47dB range. Full meter deflection is an unprecedented +7dB.



That's a big plus any way you look at it!

Naturally, this superior dynamic range yields a vastly improved signal to noise ratio and impressive openness of sound. The tape transport, designed especially for the 600, is light and positive in action, and employs a pulse controlled DC Servomotor, which cuts wow and flutter to a minimum and guarantees constant tape speed, unaffected by fluctuation in line voltage or frequency.

Additional features include built-in Dolby* Noise Reduction, 400 Hz calibration tone, MPX filter for FM recording, memory rewind, and individual record level controls plus master level control and independent bias and equalization switches. The 600 is the first in an innovative group of special components, The Recording Directors' Series, designed to provide unequalled performance and exceptional flexibility.

So visit your Nakamichi dealer soon, and get a glimpse of the future, or for additional information write Nakamichi Research (U.S.A.), Inc., 220 Westbury Ave., Carle Place, New York 11514.

NAKAMICHI 600



*Dolby is a Trade Mark of Dolby Laboratories, Inc.

A World Standard:

CBS LABS Test Records

For years, the unique, high-precision CBS Laboratories Technical Series Professional Test Records set an industry standard. Now the new series is even better—revised, recut, and expanded.

Each record contains a complete series of easy-to-use tests to help rapidly and accurately evaluate components and systems.

Seven Steps to Better Listening (STR 101)—Only \$6.98. Helps you make sure your equipment functions properly . . . helps tune your system to your ears and your room acoustics. Included is a 16-page booklet by Edward Tatnall Canby explaining how to use the record's "ears-alone" tests for left-right identification, phasing, speaker balance, tone control setting, buzz and rattle elimination, lateral tracking, and vertical tracking.



STR-100—Stereophonic Frequency Test Record—A general purpose record for pickup and system evaluation. Recorded with a constant velocity characteristic below 500 Hz and a constant velocity characteristic above 500 Hz. **\$10.00**

STR-130—RIAA Frequency Response Test Record—Provides spot and sweep frequency measurements for response testing and calibration of professional and consumer record reproduction equipment. **\$15.00**

STR-140—RIAA Pink Noise Acoustical Test Record—By use of bands of noise rather than pure tones, standing waves are minimized, permitting the testing and adjustment of loudspeakers in the room in which they will be used. **\$15.00**

SQT-1100—Quadraphonic Test Record—For the calibration, verification and adjustment of SQ™ decoding equipment. **\$15.00**

Quantities are limited—order now!

HIGH FIDELITY

Music Listener's Record Service
Dept. HW

2160 Patterson Street, Cincinnati, Ohio 45214

Here's my check for \$_____. Please send me, postpaid, the records I've circled below.

STR-100 STR-101 STR-130
STR-140 SQT-1100

NAME _____

ADDRESS _____

CITY _____ STATE _____ ZIP _____

Check or money order must accompany your order.
Allow 60 days for delivery.

ORNSTEIN: Piano Works. Michael Sellers, piano. [Giveon Cornfield, prod.] ORION ORS 75194, \$6.98.

Wild Men's Dance; Three Moods; Melancholy Landscape; Chant of the Hindou Priests; A la chinoise; Ten Poems.

This record helps fix that musical maverick, Leo Ornstein, only now emerging from some forty years of obscurity. From his piano quintet (Composers Recordings SD 339, May 1976) and the orchestral *Nocturne and Dance of the Fates* (Louisville LS 754, December 1976), one might place him as a watered-down Rachmaninoff or Bloch or a Scriabin-like hocus-pocus artist. But these piano works, composed during the second decade of the century, reveal a dominant, innovative, unruly personality, capable of drawing incredibly angry and volcanic sounds from the piano.

The brief *Wild Men's Dance* is an effectively brusque and insistent example of the musical primitivisms then in vogue. The *Three Moods* ("Anger," "Grief," and "Joy") are almost repertory pieces, having been previously recorded by William Westney (on the same disc as the piano quintet). Michael Sellers blasts away at "Anger" even more recklessly than Westney, though it could be argued that the latter's more firmly accented interpretation makes more sense. *Melancholy Landscape* and *Dance of the Hindou Priests* are bleak and mysterious miniatures, effective and evocative, which I find less true of *A la chinoise*.

The entire second side is taken up by *Ten Poems*, pieces whose brute force and hypnotic menace can well bring on the heebie-jeebies when heard late at night in a dark room. Unfortunately the jacket blurb tells us nothing about these pieces except that Martha Graham choreographed them and Waldo Frank wrote about them.

Sellers plays in a dry, propulsive style, seemingly uncowed by the ferocious technical demands. (Ornstein was known as a phenomenal keyboard virtuoso himself.) If your taste in piano reproduction runs to the velvety, best forget this one—it's for hardened ears. **A.C.**

PUCCINI: Mass in A. Kari Lövaas, soprano; Werner Hollweg, tenor; Barry McDaniel, baritone; West German Radio Chorus, Frankfurt Radio Symphony Orchestra, Eliahu Inbal, cond. PHILIPS 9500 009, \$7.98.

Comparison:
Corboz/Gulbenkian Foundation RCA FRL 1-5890

Hard on the heels of the Erato/RCA recording (March 1976) of Puccini's youthful Mass comes another and better performance. First performed in 1880, when the composer was twenty-two, the Mass is an attractive, tuneful, uninspiring piece of work, essentially a graduation exercise. There is hardly a passage that, with other words, would not pass with ease in a secular context: in the tenor solo "*Gratias agimus tibi*" of the Gloria, for example, one hears unmistakably adumbrated the passionate accents of Puccini's forthcoming sensual heroes.

Werner Hollweg would not, perhaps, be one's choice for an ideal Des Grieux or Rodolfo, but apart from some momentary unsteadiness he sings out with conviction and the right kind of forthrightness; he is better, certainly, than the fairly bloodless William

Johns on RCA. Kari Lövaas is satisfactory in "*Qui tollis peccata*," and Barry McDaniel is solid and reliable throughout, though his tone is not exactly ingratiating. The orchestra and chorus are very capable, and Eliahu Inbal gives the right kind of operatic impetus to the proceedings.

No text. Excellent recording, flawless pressing. **D.S.H.**

PURCELL: Theater Music, Vol. 1. Academy of Ancient Music, Christopher Hogwood, harpsichord and cond. [Peter Wadland and Raymond Ware, prod.] OISEAU-LYRE DSLO 504, \$7.98.

Abdelazer (with Joy Roberts, soprano); *Distressed Innocence; The Married Beau; The Gordian Knot Untied.*

The English did not take to opera, that "popish importation," with the alacrity of the rest of Europe, but they liked to enliven their plays with incidental music. This recording offers a little anthology of primarily instrumental numbers composed by Purcell for four plays. Each suite begins with a French overture in Lully's style (the French influence is felt everywhere), followed by minuets, airs, hornpipes, and other dance forms. All of it is pleasant—and on Side 2 better than that—yet it does not take long before a certain similarity makes one's attention wander.

There was once an Academy of Ancient Music in London dedicated to the performance of "old" music, presided over by Christopher Pepusch (of *Beggar's Opera* fame), a learned man who today would be called a musicologist. The new Academy of Ancient Music is also directed by an able and learned man, Christopher Hogwood, and its members perform skillfully, even virtuosically, on "authentic" instruments. There is, however, a degree of dullness in the playing, for the moods are unchanged and the pace is too steady, lacking those barely imperceptible tempo changes that lend life to a performance. (To their credit, however, our Academicians eschew the exaggerated final allargandos that have been regarded as *de rigueur* for old music since the nineteenth century.) The sound is wanting in color; the dynamic scheme is overly restrained.

Most enjoyable are the opening sections of the French overtures, whose broad pathos comes across. For the rest, even Purcell's lesser compositions surely have more sensuousness and élan than we hear here.

P.H.L.

RACHMANINOFF: Concerto for Piano and Orchestra, No. 3, in D minor, Op. 30. Alicia de Larrocha, piano; London Symphony Orchestra, André Previn, cond. [Michael Woolcock, prod.] LONDON CS 6977, \$6.98. Tape: ●● CS 6977, \$7.95.

Comparisons:
Ashkenazy, Ormandy/Philadelphia RCA ARL 1-1324
Mogilevsky, Kondrashin/Moscow Phil. Ang. SR 40226

De Larrocha is a bit overmatched by this monster concerto. In many places she is simply unable to cut through the thunderous tuttis as do Ashkenazy and Mogilevsky. In addition, strangely, there is a problem of digital incisiveness; in whirlwind passages the fingerwork doesn't sparkle, and without knife-edged articulation such writing fails to make its impact.

A Totally New Kind of Audio Component

The Audio/Pulse Model One Digital Time-Delay System



There is also a questionable habit of slowing down for lyrical episodes, which puts even greater strain on the coherence of this structurally diffuse work.

Otherwise, De Larrocha's reading is very lyrical and musical, somewhat reminiscent of Moura Lympany's ancient London recording. Unlike Lympany, however, De Larrocha plays the score uncut, and I also welcome her uncommon choice of the more modest of Rachmaninoff's two cadenzas for the first movement. Previn's leadership is sympathetic to the idiom in its sweet, low-key way, and he gets much better recorded sound this time than he did with Ashkenazy in their 1972 set of the Rachmaninoff concertos.

The choice remains between Ashkenazy/Ormandy and Mogilevsky/Kondrashin, with the versions of Horowitz and the composer retaining their interest. H.G.

B REINAGLE: Sonatas for Piano: No. 1, in D; No. 2, in E; No. 3, in C. Jack Winerock, piano. [James Rich, prod.] MUSICAL HERITAGE MHS 3359, \$3.50 plus 95¢ postage (Musical Heritage Society, Musical Heritage Society Building, Oakhurst, N.J. 07755).

One of the big guns of American music in the eighteenth century was English-born Alexander Reinagle (1756-1809). Although he was born in Portsmouth, he received his musical education in Scotland under the guidance of Raynor Taylor (1747-1825), who also later emigrated to the States. Reinagle arrived in New York in 1786, calling himself a "member of the Society of Musicians in London," but he achieved small success and shortly moved to Philadelphia, where his talents were more keenly appreciated and where he soon became a leading figure in the musical life of the town.

He was a composer of some small talent. In 1904, thanks in great measure to the perspicacity and enthusiasm of Oscar G. Sonneck, pioneer historian of American music and first chief of the Library of Congress music division, the Library received as a gift two volumes of manuscript music containing four piano sonatas and two sets of variations, all composed by Reinagle and previously unknown. The donor was Louis Johnson Davis, whose grandmother was Reinagle's second wife; there was no question of the authenticity of the music.

For technical and musicological reasons, the sonatas are not very well known even to specialists in early American music. It is therefore a pleasure to report that pianist Jack Winerock of the University of Kansas has made available here the sound of Reinagle's first three sonatas as recorded on a grand piano made around 1827 by John Broadwood & Sons of London, a well-preserved instrument in the collection of the department of musical instruments of New York's Metropolitan Museum of Art. Furthermore, the piano has been left in essentially unrestored shape, so that the listener can get a pretty accurate idea of just how the sonatas sounded on a superior instrument built just a few decades after they were composed.

This is not to say, however, that the use

Continued on page 110

The Audio/Pulse Model One re-creates the feeling of *being there*. It can make a living room sound like a concert hall or cathedral or theater or night club.

It is the first of an entirely new breed of audio equipment, and its sophistication goes beyond any other product we know of. It uses the equivalent of 150,000 transistors (in 90 integrated circuits) for highly advanced fully digital processing of audio signals. With conventional solid-state techniques of a few years ago, it would have to be as big as the kitchen in an average home, and if made with tubes it would be as big as the concert hall itself. Yet, despite its advanced technology, the Model One is simple and enjoyable to use -- and *it requires no special program material*.

When you hear what it does, we think you will agree it is the long-awaited major step toward totally realistic sound reproduction.

Why Time-Delay?

A live concert, whether by John Denver or the Boston Symphony, is a much more involving experience than listening to a stereo system. One reason is that at a live concert you are actually enveloped in the ambient sound

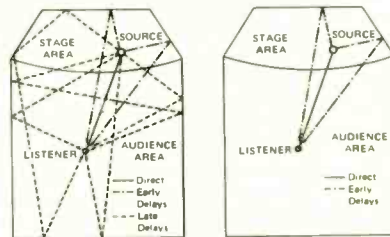

field -- completely surrounded by reflected, delayed, reverberant sounds (above left), while even the finest stereo system is limited to reproducing the front-arrival sounds coming from the concert stage (above right).

The Audio/Pulse Model One Digital Time-Delay System restores this missing dimension by electronically duplicating the way in which delayed, reflected, ambient sounds produce the

richness and depth of a live listening experience. Like a concert hall, the Model One produces a high-density pattern of delayed reflections and reverberant decay.

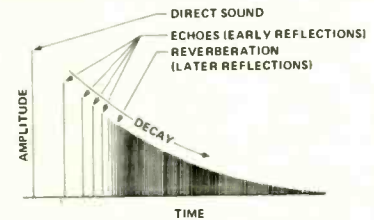

When the Model One is added to a stereo system, the front-arrival direct sounds continue to be reproduced by your existing stereo speakers; the Model One's delayed, reverberant signals are fed to a separate amplifier and heard over a second set of speakers (which don't have to be big or ultra-wide-range), located to the sides or rear of your listening area.

The flexible controls of the Model One let you make anything from a single guitar or singer to a rock band to a full-size symphony orchestra sound as if you are hearing it in its natural setting. It is designed to work with any conventional stereo program source -- record, tape, or broadcast -- and also will come surprisingly close to its full effect with *mono* recordings and broadcasts.

What it really is and does has to be heard.

Audio Pulse, Inc.
Bedford Research Park, Crosby Drive
Bedford, Mass. 01730 (617) 275-1595

Audio Pulse

To: AUDIO PULSE INC.,
Crosby Drive, Bedford, MA 01730

Please send me full information on the Audio/Pulse Model One Digital Time-Delay System and a list of your demonstrating dealers.

Enclosed is \$5. Please send me a copy of the 50-page Owner's Manual for the Model One.

Name _____

Address _____

City _____

State _____ Zip _____

CIRCLE 51 ON READER-SERVICE CARD

FLEXIBLE

STRAIGHTLINE

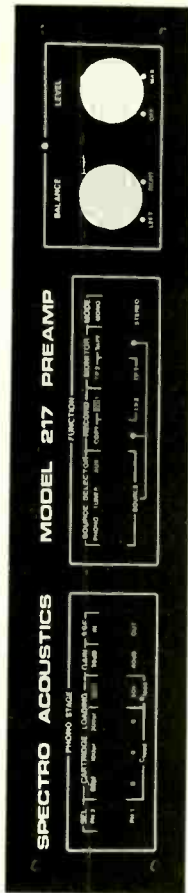

Model 217 Suggested Retail \$250.00

PREAMPLIFIER

The Spectro Acoustics Model 217 is the first preamplifier to provide complete facility to accurately "load" any standard phono cartridge to the manufacturer's specifications. With these idealized conditions, true ultra-accurate "flat" response is possible. A gain selector optimizes noise and overload conditions depending on the output of the individual cartridge and a third order Butterworth subsonic filter eliminates sub-audible turntable rumble and potentially destructive low frequency acoustic feedback from high power amplifiers. Switching includes two phono inputs for A/B cartridge comparisons and bi-directional bypass copying for two tape decks.

Distortion:

THD 0.05% 20Hz-20kHz
IMD 0.0075% SMPTE

Noise:

Phono: S/N 82 db "A" weighted
High Level: S/N 110 db "A" weighted

Frequency Response:

10Hz-100kHz ± 1 db
(Flat within 1 db to the limits of a calibrated Sound Technology 1700A analyzer)

The straight-line design has no tone controls or equalization to alter the linear response in any way. However, full flexibility is maintained for the audiophile who wishes to patch in an equalizer or any other outboard signal processor.

SPECTRO ACOUSTICS INC.

1309 E. Spokane Pasco, Washington
(509) 545-1829 99301

CIRCLE 41 ON READER-SERVICE CARD



Frans Brügggen (left) and Gustav Leonhardt

Seon: Old Friends on a New Label

by R. D. Darrell

FOUNDED IN 1971, the Hamburg, Germany, Seon catalog of musical "documents and masterworks" has been unknown to most American discophiles. But there are many old friends among its largely Dutch artists, led by the internationally famous twin stars of combined musicology and virtuosity: Gustav Leonhardt and Frans Brügggen. Previously associated with Telefunken's *Das alte Werk* series, they have been led to the new label by Seon's guiding genius, Wolf Erickson, the former director of *Das alte Werk*.

It is the brand-new ABC Classics label of ABC Records that does American connoisseurs an invaluable service by bringing us the productions of this challenger to the DG Archiv and Telefunken *Das alte Werk* domination of the inexhaustible realms of fifteenth- to eighteenth-century music performed in the authentic traditions and on actual or replica period instruments. And the arresting first ABC Classics/Seon release list—four album sets, six singles, all with scholarly trilingual notes and texts (priced at \$6.98 per disc)—effectively testifies to the new series' adherence to the older ones' high artistic and technological standards and adventuresome repertory.

Witness the first major representations of two hitherto "unknown" masters, Antoine Forqueray and Thomas Stoltzer. Forqueray (1671-1745) was a child prodigy gambist/composer in the court of Louis XIV whose vivid musical portraits of contemporaries were posthumously rescored by his harpsichordist son. On ABCL 67009, Leonhardt plays a dozen of these (*La Rameau, La Leclair, La Sylva*, etc.) with bold power and panache on a magnificently sonorous Rubio replica of a pertinent-period Pascal Taskin instrument.

Stoltzer (c. 1480-1526) proves to be one of those Janus-like giants who face both the past and the future. Historically noted for his large-scale German-psalm settings of Biblical translations by Luther himself, Stoltzer impresses me even more by his earlier *Missa duplex per totum annum* and several shorter a cappella works on ABCL 67003/2 (two discs). And there are exceptionally fascinating, pungent medieval timbres and pioneering variation-form experiments in four of his instrumental-only *Tonorum melodiae*. The Munich Capella Antiqua sings and plays magisterially under the direction of Konrad Ruhland, in the expansive ambience of a baroque-era Bavarian church.

Of course not all historically significant music is of immediate interest to nonspecialist home listeners. And even the finest musicologists may miscalculate at times—as in three programs that, for me, promise more than they deliver.

John Blow's *Ode on the Death of Henry Purcell*, a musical eulogy for his pupil and friend, has needed stereo recording, while his big collection of secular solo and part songs never has been as well represented on discs as his anthems and organ works. But either British historians have overrated Blow (1649-1708) or I'm insensitive enough to be unutterably bored despite all the earnestly persuasive efforts made on his behalf by a distinguished group of singers and the Leonhardt Consort on ABCL 67004.

It makes excellent sense to combine Mozart's first two, relatively neglected, violin concertos with the mini-concertos encapsulated in his early serenades (ABCL 67010/2, two discs). But the probable fact that Mozart learned to fiddle on a baroque violin doesn't necessarily make it

aesthetically "right" now. I object still more to both soloist Jaap Schröder's and conductor Brügger's lapsing into such wholly inappropriate mannerisms as romantically surging "expressiveness" and accentual overitalizations.

No admirer of Leonhardt's protean gifts, and of his many admirable Bach recordings in particular, will want to miss his authoritative *Musical Offering* (ABCL 67007). It well may be a lapse from my own purist ideals that for once he leaves me more respectful than deeply moved. For while I accept in theory the correctness of playing the *Offering's* six-part *ricercare* as a harpsichord solo, this perhaps greatest of all Bach fugues always demands (for me) the lucidity and breadth of the Edwin Fischer string-orchestra arrangement in which I first encountered it. This bias aside, however, the present over-all performance, skillfully played as it is, lacks the infectious zest and sense of personal involvement of the less vividly recorded 1964 Bilgram/Richter version (Archiv 198 320), one that also presents both three- and six-part *ricercars* as harpsichord solos.

It's when musicological purism is fired by infectious interpretative fervor that the presumed dead past comes gloriously alive again—as it does so variously and excitingly in the remaining five ABC Classics/Seon programs.

Leonhardt's less severe, more animated and engaging alter ego reappears in "Baroque Organs of the Alpine Countries" (ABCL 67008/2, two discs), a fascinating musical travelogue through the Alpine Italian, Swiss, and Austrian regions to hear the restored Renaissance- and baroque-era organs of Churburg Castle, churches in Compatsch and Muri, and abbeys in Wilton, Wilhering, and Stams. The delectably provocative tonal qualities of these fabulous (mostly unrecorded) instruments are an audiophile's treasure house. Leonhardt's selections as well as his registrations are musically rewarding too: Besides Eberlin, Froberger, Krebs, Pachelbel, and Pasquini, there are more obscure names, such as Von Kerll, Muffat, Storace, and Zachau. And nothing—least of all the acoustical ambiances—is lost in the fine on-location recording.

Schröder also returns, now as first violinist of the Quartetto Esterházy, to prove that baroque strings are far better suited to Haydn's *Sun* quartets than to Mozart concertos of about the same time. Unlike the same quartets played on Strads, etc., which have been revamped, these sound darker, reedier, but entrancingly more endearing.

Other lutenists before Eugen Dombois have recorded Bach's S. 998 Prelude, Fugue, and Allegro and some Weiss suites, if not the present *L'Infedele*. But the improvisatory fantasias of David Kellner (c. 1670–1748) are unfamiliar. And I've never heard more virile lute performances. If you've deemed the lute a weak-voiced or even effete-voiced instrument, "The Baroque Lute, Vol. 1" (ABCL 67006) should jolt you out of your error!

If Christmas music for you means only the romanticized mawkishness of "Silent Night" and similar nineteenth-century favorites—to say nothing of the still more decadent pop favorites of our own commercialized day—don't fail to cleanse your ears and mind with the gloriously fresh and honest "Christmas Music of the 15th and 16th Centuries" (ABCL 67002), again featuring the Munich Capella Antiqua. Ruhland resurrects a wide variety of precious tonal jewels for both unaccompanied and accompanied (by contemporary instruments) small chorus. And if the Munich ensemble performs more soberly than some similar American ones, it sings, plays, and is recorded with magnificently eloquent authority.

Finally, there's my personal Delectable Mountain of the series, the three-disc set of Handel woodwind sonatas (ABCL 67005/3): from Op. 11, four for recorder, two for flute, and one for oboe; two of the "Halle" flute sonatas; one oboe and two recorder sonatas from manuscript collections; plus isolated movements. Some have been recorded before, but usually on modern instruments and seldom if ever as zestfully and vividly as they are by Brügger, oboist Bruce Haynes, and harpsichordist/organist Bob van Asperen (with bassoon or cello reinforcement). And these performances are unique in that *all* the woodwinds used were made by the Stanesby father and son who flourished in Handel's time and were much esteemed by him. What could be a more quintessentially Handelian experience than to hear his sonatas just as they must have sounded to the composer himself?

Anyone who is skeptical about the personal appeal and rewards of old music and old instruments, or about the quality of this series, will do well to try out a convenient, ultra-low-priced sampler: "ABC Classics/Seon: The First Release" (ABCL 67001), which includes one or two selections or movements from each of the regular programs. It also provides a fair index to the over-all recording and processing standards of the series.

"I've got a 60-minute recording studio in my pocket."

It's called the MICROCASSETTE® PearlCorder-S®.



A MICROCASSETTE recorder that's so unique, it's like having your own mini-studio in your pocket with remarkably good fidelity for music as well as voice. It's smaller than a checkbook (5¼" from top to bottom, slightly thicker than a pack of cards), and lightweight (12 ounces with batteries), but it's packed with studio precision and professional features:

- 60 minutes recording time.
- Capstan drive for constant tape speed, built-in electret condenser microphone, AC bias, record-warning light.
- All metal construction for years of dependable service.
- One-hand operation; instant loading.
- Fast forward and rapid rewind.
- Automatic level control.
- Connects to your stereo or full-size recorder with a Compacord, for both recording and playback.

The PearlCorder-S performs beautifully in an office, in your car, even on airplanes; and it's backed by the reputation of the Olympus Optical Co., Ltd., a company famous for fine cameras, medical and other precision scientific instruments.

The PearlCorder-S. Carry one. And have a studio with you.

Available at fine photographic, audio, and A-V dealers everywhere. Or write for our brochure, "Pocket Full of Miracles."

OLYMPUS CORPORATION OF AMERICA
TWO NEVADA DRIVE / NEW HYDE PARK, NEW YORK 11040

60 minutes of sound in this actual-size MICROCASSETTE®



In Canada: W. Carson Co., Ltd., Ont.
CIRCLE 26 ON READER-SERVICE CARD

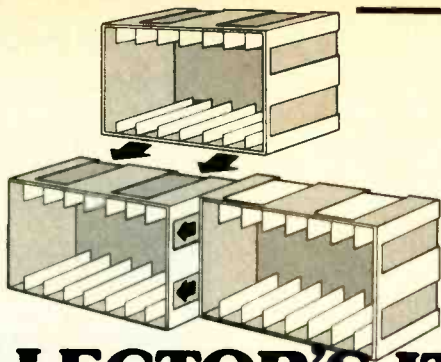

COLLECTOR'S ITEM

It's Add 'N Stac[®], the world's only *expandable* cassette and 8-track storage system. Expandable because it provides as much tape storage as your collection calls for. Add 'N Stac[®] is a module, so you can buy only one or a few at a time. Each module has a patented interlocking device on all four sides. As your collection grows you simply lock one module into the next and—Presto!—expansion space.

Add 'N Stac[®] is available in either

cassette or 8-track size. Both come in a selection of colors to help you match your decor or color-code your collection by category. Pre-drilled mounting holes let you create a striking wall unit, or if you prefer, stack an arrangement on a table or shelf.

Store, organize and protect your expanding tape collection with the world's only *expandable* system. At under \$2.00 a module, it's definitely a collector's item.

"... all in all this is the best storage system we know of for the serious collector."
—HIGH FIDELITY

Add 'n Stac[®]

a product of



Royal Sound Company, Inc.

For information ask your dealer or write:

Royal Sound Co., Inc., 248 Buffalo Ave., Freeport, N.Y. 11520 USA

Registered U.S. Patent Office, U.S. and Foreign Patents

CIRCLE 31 ON READER-SERVICE CARD

of the Broadwood is a totally positive factor in this recording, especially since the instrument leaves quite a bit to be desired by way of pitch stability and mechanical reliability. Its many imperfections (called "trivial" in the jacket notes, but sounding anything but trivial) interfere considerably with even the most sympathetic listener's appreciation of these slight sonatas, so clearly influenced by the music of Carl Philipp Emanuel Bach.

Nevertheless, Winerock's playing is musical, and there are no other recordings of any of Reinagle's music available, to the best of my knowledge. I'd recommend it for its documentary value until something better comes along. I.L.

ROSSINI: Ballet Music. Monte Carlo Opera Orchestra, Antonio de Almeida, cond. PHILIPS 6780 027, \$15.96 (two discs).

Le Siège de Corinthe; Moïse; Guillaume Tell; Otello.

The record jacket calls this "the" ballet music of Rossini; the insufficiently informative liner notes speak only of "highlights." Just how much more Rossini may have composed, for one operatic production or another, I'm afraid I don't know, and I shall be delighted if some reader better versed in the labyrinthine complexities of Rossini-for-schung will write and tell me.

What we have here, at any rate, is the obligatory ballet music he provided for the Paris productions of four of his operas. Of these only *Tell*, of course, was actually conceived for the Opéra from the start, and perhaps this explains why its ballet music—or at least the *pas de six* and the *pas de trois*—seems to be of an altogether higher order than the rest. Unfortunately it also receives the least affectionate performance on this record, or perhaps it is just that the music itself shows up the deficiencies of Almeida and his orchestra the more clearly. It was here that I found myself longing for the wit and insouciance of a Beecham, a Constant Lambert, or a Désormière to spring those simple rhythms just enough to bring out the supple elegance of the melodies they support and propel.

In a way, though, the *Tell* ballet music is the least important item in the set, since it is covered by Angel's magnificent complete recording. This is not the case with the ballet music Rossini provided for *Le Siège de Corinthe*, as his *Maometto II* became in its final (1826) Paris version. The composite Italian version used by Schippers for his recording omits the dances, so this new version of them can usefully serve as an appendix to it—always provided that you can find a French vocal score to show you where to insert them. Paris productions of *Mosè in Egitto* (1827) and *Otello* (1844) were also provided with the obligatory dance music, more appropriately in the latter case than in the former. (I cannot imagine how the little hunting number that concludes the *Moïse* ballet was supposed to take place beside the Red Sea!)

Perhaps it is unfair to wish that this music were performed here with greater finesse, since Rossini himself could hardly have expected anything better of the orchestra at the Opéra in his day. All the same, music as insubstantial as this de-



Handbook of Multichannel Recording

Here is very possibly the single most important book on sound recording for

the layman or professional who wants to make quality recordings of musical groups. For the first time, here's a book that covers it all—dubbing, special effects, mixing, reverb, echo, synthesis—for both stereo and four-channel recording. Simply circle No. 781 on the coupon below.

"Handbook of Multichannel Recording" is only one of a wide selection of carefully chosen audio books made available to HIGH FIDELITY readers through Music Listeners' Book Service (Many of the selections are not readily available in bookstores.) Choose your books today from the list below, circle the numbers on the coupon, and enclose your check or money order. That's all there is to it.

No. 781 HANDBOOK OF MULTICHANNEL RECORDING. F. Alton Everest.

A comprehensive volume of 322 pages, with 201 illustrations, covering all aspects of live recording in both stereo and four-channel formats. Paperbound: \$7.95. Hardbound: \$10.95.

No. 598 OFFICIAL GUIDE TO HIGH FIDELITY. Compiled by the Institute of High Fidelity.

An informative introduction to the various components that make up a modern high fidelity system, covering everything from phono cartridges to quad systems. Paperbound: \$2.00.

No. 756 FOUR-CHANNEL STEREO... FROM SOURCE TO SOUND, 2nd Edition (1974). Ken W. Sessions, Jr.

Complete technical and nontechnical information on all approaches to four-channel sound, both discrete and matrix. Paperbound: \$4.95. Hardbound: \$7.95.

Check or money order must accompany your order. No cash or C.O.D.'s, please. Allow 60 Days for Delivery.

HIGH FIDELITY
MUSIC LISTENERS' BOOK SERVICE

Dept. HW
2160 Patterson Street, Cincinnati, Ohio 45214

Here's my check for \$ _____ Please send me, postpaid, the books I've circled below.

781 598 756

Name _____

Address _____

City, State & Zip _____

mands playing of the utmost stylishness if it is to survive without its visual accompaniment, and Almeida takes an altogether too square and unnuanced line with it for my taste. Not quite as valuable an issue, then, as his previous album of Verdi's ballet music, but worth having for anyone interested in getting a more complete picture of Rossini's operas than the usual run of scores or performances will provide. J.N.

SCHUBERT: Sonata for Arpeggione and Piano—See Mendelssohn: Sonata for Cello and Piano, No. 2.

SCHUMANN: Quintet for Piano and Strings, in E flat, Op. 44*; Quartet for Piano and Strings, in E flat, Op. 47. Beaux Arts Trio; Dolf Bettelheim, violin*; Samuel Rhodes, viola. PHILIPS 9500 065, \$7.98.

SCHUMANN: Quintet for Piano and Strings, in E flat, Op. 44; Quartet for Piano and Strings, in E flat, Op. 47. Thomas Rajna, piano; Alberni Quartet. [Simon Lawman, prod.] CRD 1024, \$7.98 (distributed by HNH Distributors).

Schumann's Op. 44 Piano Quintet has never had difficulty attracting an audience (not to mention "star" soloists), but at least with the general public its frequent disc companion, the Op. 47 Piano Quartet, while equally impassioned and large in scale, full of virtuosic opportunities, has fared less well.

Both these new couplings feature a low-keyed "team" spirit that keeps the scale on the smallish side, emotionally civilized rather than torrential. Given this approach, I prefer the Philips disc from virtually every standpoint. The performances by the augmented Beaux Arts Trio are more elegantly nuanced, more subtly organized, more imaginative. Though CRD's instrumental balance is sound and considerate enough, the Philips performers give evidence of far greater analytical preparation, putting their efforts on a higher plane of perception. Note, for instance, the way the subordinate figurations in the piano part are made a structural component at the beginning of the quintet, or how the swirling string parts lilt with beguiling grace in the third movement of the quartet when the lovely cello theme returns. Again at the end of the quartet the Philips team prepares the harmonic climax with greater commitment and stress.

For all that, I find the Beaux Arts performances disappointingly genteel alongside more fully energized, heroic recordings: for the quintet, the Gabilowitsch/Flonzaley (reissued in 1973 in RCA VCM 7103, now unfortunately deleted) and Serkin/Budapest (Columbia MS 7266 or M2S 734); for the quartet, the lovely Horowitz/Schneider/Katims/Miller version for Columbia (long overdue for reissue).

H.G.

SHOSTAKOVICH: Symphonies: No. 7, in C, Op. 60 (*Leningrad*); No. 9, in E flat, Op. 70. Czech Philharmonic Orchestra, Václav Neumann, cond. [Jan Vrána and Pavel Kühn,

prod.] SUPRAPHON 1 10 1771/2, \$13.96 (two discs, manual sequence).

This album contains the first and last of Shostakovich's three wartime symphonies. The Seventh, composed mostly in the second half of 1941 following the German invasion of Russia, is basically an affirmation of Soviet heroism, with two fairly bombastic outer movements surrounding two inner movements of surprising mellowness and subtlety (the third contains one of the composer's longest and most beautiful melodic inventions). The 1945 Ninth, originally intended to follow the unrelentingly tragic Eighth with a reaffirmation of spirit complete with chorus and soloists, turned out to be a short piece of musical theater of the absurd in which even the most serious passages have a rather grotesque flavor.

Both performances by Václav Neumann and the excellent Czech Philharmonic are marked by a slightly cold precision (along with some rhythmic unsteadiness) and excellent instrumental balance and definition. Neumann does not indulge in any interpretive excesses, thus coming up with renditions that are about as neutrally straightforward and inoffensive as any on disc. He does show indifference to certain musical niceties, however. In the Seventh Symphony's finale, for instance, he is apparently so concerned with not pulling out all the stops until the end (an admirable ambition) that he sloughs over such sequences as the 7/4 episode, in which the dramatic pizzicato slaps are avoided.

The recorded sound, featuring excellent stereo separation and producing some gorgeous brass sonorities, is quite impressive, but my copy is marred by poor surfaces. All in all, this album has an appeal to Shostakovich enthusiasts, but my first recommendations remain Bernstein for the Seventh (Columbia M2S 722) and Weller for the Ninth (London CS 6787). R.S.B.

STRAUSS, J. II: "Ewig junger Walzerkönig." Various performers. EMI ODEON 1C 147 30226/7, \$15.96 (two discs, mono) [recorded 1906-50] (distributed by Peters International).

Electrola's sesquicentennial package for the "eternally young Waltz King" includes enough celebrated items not recently (or not ever) on LP that a mere listing of contents will define its attractiveness for devotees of this genre. Not everything turns out to sound as well as it reads on the labels, but let's break it down by categories.

Waltzes: *Blue Danube* (VPO, Karajan, 1946). *Vienna Woods* (German Opera House, Schönherr, 1940). *Voices of Spring* (LPO, Beecham, 1939). *Artist's Life* (VPO, Kleiber, 1929). *Emperor* (VPO, Furtwängler, 1950). All save the Beecham were variously abridged to fit the 78 discs, though none so much as the set's one outright curio, an antediluvian (1906) traversal of *Wine, Women, and Song* by the "Kapelle des 'Hofball-Musikdirektors' Johann Strauss 3., Wien," under—we are assured—the personal direction of this nephew of the Master. The playing is pretty scruffy, and the scratchy original disc skips at one point, but there is a certain *Schwung*. Among the

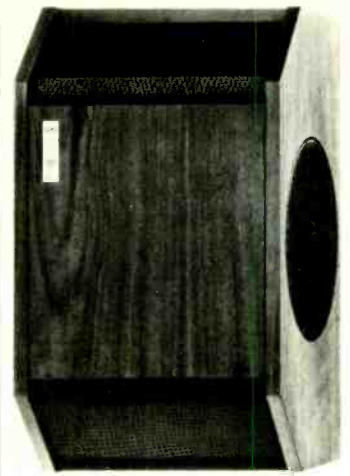

ALLISON: FOUR

ALLISON ACOUSTICS 7 Tech Circle, Natick, Massachusetts 01760

Allison dealers are now demonstrating the Allison-Four, the first "bookshelf" loudspeaker system with Stabilized Radiation Loading*. This unique design minimizes the large variations in middle-bass power output produced in conventional systems by reflected impedance from room boundaries. In uniformity of bass power delivered to a real listening room, the new model FOUR's only peers are the larger and more expensive Allison three-way systems. The FOUR is a two-way system with a crossover frequency of 2,000 Hz. But its extreme low-frequency response is the same as that of the Allison-Two, and it is

*Patents pending
**Higher in the South and West because of freight cost.

fully equivalent to other Allison systems in high-frequency range, smoothness, and omni-directional dispersion in the forward hemisphere.

These factors give the Allison-Four great flexibility in room placement without performance compromise. It can be placed on a table or shelf, or hung on a wall using the wall-mounting hardware supplied with it. A stereo pair can be located on the same wall, on adjacent walls, or even on opposite walls away from the main listening area. There is no requirement that the systems face toward the area. The Allison-Four's price is \$175.00**. Descriptive literature, complete specifications, a statement of Full Warranty, and a list of dealers are available on request.

CIRCLE 2 ON READER-SERVICE CARD

NEW!

Two Major Wagner Books!



Richard Wagner in Bayreuth
by Hans Mayer
Reflections on Wagner's Ring
by John Culshaw

Richard Wagner in Bayreuth is the intimate story of the amoral, hedonistic, arrogant megalomaniac who attained international recognition as a musical genius—and of Bayreuth, the quiet Bavarian town he made famous.

Reflections on Wagner's Ring is a compilation of John Culshaw's acclaimed Saturday Metropolitan Opera broadcast intermission talks—a masterpiece that no opera lover (and certainly no student of Wagner) can afford to miss.

These are only two of the wide selection of carefully chosen books made available to HIGH FIDELITY readers through Music Listeners' Book Service. Others are listed below.

No. 602 RICHARD WAGNER IN BAYREUTH. Hans Mayer.
An enthralling history of Wagner, his family, and the little Bavarian town he made famous. **\$18.50**

No. 601 REFLECTIONS ON WAGNER'S RING. John Culshaw.
An invaluable compilation of information based on Culshaw's Saturday Metropolitan Opera broadcast intermission talks. **\$6.95**

No. 512 SEASON WITH SOLTI. William Barry Furlong.
A sustained close-up view of Georg Solti and his Chicago Symphony. Human and readable. **\$12.50**

No. 600 OUR TWO LIVES. Halina Rodzinski.
The story of Artur Rodzinski's turbulent career in the world of music, told by the woman who shared it with him. **\$10.95**

No. 341 THE GLORY OF THE VIOLIN. Joseph Wechsberg. Illustrated.
A fiddle fancier's delight from the pen of the famed New Yorker author, who delves into all aspects of the violin, including the fascinating business of buying, selling, and cheating. **\$8.95**

Check or money order must accompany your order.
No cash or C.O.D.'s please.
Allow 60 Days for Delivery.

HIGH FIDELITY MUSIC LISTENERS' BOOK SERVICE
Dept. HW
2160 Patterson Street, Cincinnati, Ohio 45214

Here's my check for \$ _____ Please send me, postpaid, the books I've circled below.

602 601 512 600 341

Name _____

Address _____

City, State & Zip _____

others, I much admire the Furtwängler, the style (but not the execution) of the Kleiber, and the execution (if not the style) of the Beecham.

Polkas, etc.: Tritsch-Tratsch (VPO, Karajan, 1946), Perpetuum mobile (VPO, Krauss, 1929), Leichtes Blut (VPO, Knappertsbusch, 1940), Neue Pizzicato Polka (VPO, Böhm, 1949), and a pastiche "Intermezzo" concocted for 1001 Nights by one E. Reiterer (Saxon State, Böhm, 1938). Surprisingly, the Knappertsbusch is quite lively, the 1949 Böhm rather logy.

Fledermaus: Overture (Berlin State, Walter, 1929), Alfred's opening song (Herbert Ernst Groh, 1935), Adele's Laughing Song (Schumann, 1927), Rosalinde's Czardas (Ivogün, 1932), and an abridged Act II finale (Tauber, Lehmann, Branzell, et al., 1928). I don't know what Groh is doing in this company, but the rest of these are deservedly famous. It's particularly good to have Tauber's voicing of the "Brüderlein" solo back again.

Zigeunerbaron: Barinkay's entrance (Schmidt, 1932), Zsupan's couplets (Kunz, 1949), Saffi's Gypsy Song (Cebotari, 1948), and the Nightingale Duet (Berger and Kullmann, 1933). This is a less distinguished selection, with Schmidt landing on a perilous high C and Cebotari sounding rather strained near the tragic end of her life.

Nacht in Venedig: half of the Annina/Caramello duet from Act II (Schöne and Wittrisch, 1930), the Lagunenwalzer (Kunz, 1949), and the Duke's "Treu sein." The last of these is conducted by Korngold, whose version is used, but the singing is sluggish and self-indulgent. The others are ingratiating enough.

From other vocal works, there's a characterful soliloquy from Wiener Blut (Wittrisch, 1932), a lengthy duet from the same posthumous mélange (Vera Schwarz and Groh, 1932—he's stiff, she's blowsy), the inevitable and still beguiling Nun's Chorus from Benatzky's Casanova pastiche (Frind, 1928), and—inexplicably—Groh once again, singing "Nur für Natur" from Der lustige Krieg. It beats me why he should get three tracks.

Of course, as with all such collections, each of us knows he could have done this better. I miss Lehmann's "Mein Herr, was dächten sie von mir" and Berger's "Spiel ich die Unschuld" from Fledermaus, not to mention the Zigeunerbaron finales from the Tauber/Lehmann/Branzell session. I'm sure you can think of some others. Still, for study of the style as practiced between 1925 and 1950, there's plenty of material here, pretty well dubbed (though the Ivogün track has been dedicked in a noticeable way).

The rather supine notes by Max Schönherr are offered in an execrable, sometimes incoherent translation. The sources of the material are well documented, however, and there is a generous portfolio of photos, including minor luminaries such as Clemens Schmalstisch and Frieder Weissmann, in case you've ever wondered what they look like. D.H.

TCHAIKOVSKY: Swan Lake, Op. 20. London Symphony Orchestra, André Previn, cond. [Christopher Bishop, prod.] ANGEL SCLX 3834, \$21.98 (three SQ-encoded discs, au-

Buy with confidence

THERE IS A DIFFERENCE IN MAIL ORDER. IT'S CALLED EXPERIENCE! WE HAVE 28 YEARS!

PIONEER

KENWOOD

TEAC

BIC

SEND FOR QUOTES AND PRICE LISTS

BUY FROM NEW ENGLAND'S LARGEST STEREO HOUSE

ARSTON Studios

146 Old Brookfield Road, Danbury, Conn. 06810
(203) 744-6421 ((212) 369-6212
Mon.-Fri. 9:00-5:30 Sat. 9:00-3:00

Add'l postage: \$3 per year outside U.S., its poss.

If you have no label handy, print OLD address here

name _____ please print

address _____

city _____

state _____ zip-code _____

New Address

name _____

address _____ please print

city _____

state _____ zip-code _____

Moving?

Be sure and send us your new address 8 weeks before you move so you won't miss any copies of HIGH FIDELITY.

And please include an old mailing label from our magazine when writing us about your subscription.

Write to:
HIGH FIDELITY,
1 Sound Avenue, Marion, Ohio 43302

Change of address.
 Enter new subscription 1 year \$8.95
 Payment enclosed bill me

omatic sequence) Tape: ●● 4X3S 3834, \$23.98.

Comparisons:

Rozhdestvensky/Moscow Radio Sym.

Met./Ang. SRC 4106

Fistoulari/Netherlands Radio Phil.

Lon. SPC 21101/3

This version of *Swan Lake* is textually the same as that first heard on Angel's still available Soviet set featuring the Moscow Radio Symphony under Rozhdestvensky. With the 1974 Fistoulari/London Phase-4 recording, these are the only current ones that contain all the music heard at the work's original Moscow presentation in 1877. (In April 1970, when the Rozhdestvensky set was issued here, R. D. Darrell set forth with admirable clarity the contents of what then passed for "complete" versions, concluding that only Rozhdestvensky's and an earlier Soviet recording, conducted by Yuri Fayer, deserved the designation.)

There will always be something problematical about this often played score, since it has come down to us, not from the original production, but from the production given in St. Petersburg in 1895, two years after the composer's death. For this latter version, the conductor Riccardo Drigo, himself a ballet composer (e.g., *Les Millions d'Arlequin*, St. Petersburg, 1900), made certain changes in Tchaikovsky's score at the behest of Marius Petipa, who supervised the entire production and also choreographed Acts I and III, while leaving Acts II and IV, the lakeside sequences, to his assistant, Lev Ivanov. Briefly, the changes are: those of sequence and omission (e.g., the *Grand pas de deux* from Act III was eliminated from the score completely; in its place was heard the *pas de deux*, formerly in Act I, now popularly known as the *Black Swan pas de deux*); and those of addition (a polka, probably composed by Drigo, was inserted into Act III, together with one of Tchaikovsky's piano pieces from Op. 72, orchestrated by Drigo, and two more of his arrangements from Op. 72 were also added to Act IV).

All of the "complete" recorded versions of *Swan Lake* follow the sequence of the original production (more or less; Tchaikovsky himself made changes up to at least the fifth performance), restore what was eliminated in 1895 (this includes, not only the missing *pas de deux*, but a very attractive "Danse russe," which begins with a long, unaccompanied violin solo), and omit the numbers added by Drigo (though—nothing being simple in connection with *Swan Lake*—Fistoulari includes one of them, in Act III).

Of these three versions I have no hesitation in recommending the Previn. With Darrell I agree that Fistoulari is "crotchety," though I find Rozhdestvensky far less agreeable, much coarser and pushier, than he did. Previn, who has at his command a first-rate orchestra (with excellent soloists like violinist Ida Haendel and cellist Douglas Cummings), is closer to the essential sensibility of this music: graceful, lyrical, and elegiac. Though here and there Previn's tempos do not accord with what the stage action might ideally require, I find him on the whole very convincing, and much of what he does, especially in Act III, is brilliant.

The recording is excellent, the pressings

What you don't know about effective tip mass won't hurt you, just your records.



You can find out what you don't know by contacting us for our comprehensive cartridge brochure.

Bang & Olufsen

Bang & Olufsen of America, Inc., Dept. 11G
515 Busse Road, Elk Grove Village 60007

CIRCLE 4 ON READER-SERVICE CARD

Could the ultimate system be all Crown?



It depends on how you define "ultimate." But Crown may be the only top-quality, state-of-the-art manufacturer whose components could build a complete, ultimate hi-fi system.

For instance: A CX-824 tape deck, world-renowned for reliable performance. Connected to an IC-150A pre-amp. With the signal amplified by a DC-300A power amp, proved in many thousands of hours of professional use. Output controlled, monitored and switched by an OC-150. Possibly a VFX-2 for personal control of crossover points. And sound faithfully reproduced by ES-212 electrostatic speakers.

All Crown. We think that system would be somebody's ultimate. Certainly ours. Maybe yours.

Write us today for the name of your nearest Crown dealer. He'll talk to you — ultimately.

When listening becomes an art,



Crown

Box 1000, Elkhart IN 46514

CIRCLE 8 ON READER-SERVICE CARD

FREE details. A DIFFERENT KIND OF RECORD CLUB

TREMENDOUS SAVINGS

on every record and tape in print—
no "agree-to-purchase" obligations of any kind
DISCOUNTS OF 43% TO 73%
off mfg. suggested list—special catalog
features hundreds of titles and artists

ALL LABELS AVAILABLE

including most imports through special custom
ordering service—guarantees satisfaction.

SCHWANN CATALOG

lists thousands of titles,
classical, pop, jazz, country, etc.

DISCOUNT DIVIDEND CERTIFICATES

Dividend Gifts—certificates
redeemable immediately for extra discounts.

NEWSLETTERS

informational news and happenings in the
world of music—special super sale listings.

DISCOUNT ACCESSORY GUIDE

Diamond needles, cloths, tape cleaners, etc.

QUICK SERVICE

same day shipping on many orders,
rarely later than the next several days.

100% IRON-CLAD GUARANTEES

on all products and services—your total
satisfaction is unconditionally guaranteed.

Discount Music Club is a no-obligation membership club
that guarantees tremendous discounts on all stereo
records and tapes and lets you buy what you want...when
you want...or not at all if you choose.

These are just a few of the money-saving reasons to write
for free details. You can't lose so why not fill out and
mail the coupon below for immediate information.

DMC DISCOUNT MUSIC CLUB, INC. DEPT. 8-377
650 Main Street, New Rochelle, N.Y. 10801

Name _____
Address _____
City _____
State _____ Zip _____

CIRCLE 9 ON READER-SERVICE CARD

HEAR-IT-YOURSELF KIT



This is a Speakerlab 7, a 4-
element acoustic suspension
speaker kit you can assemble your-
self in an hour with simple tools.

It saves you up to 50% over
comparable ready made systems.
Read about the S7 and other sys-
tems and raw speakers we sell in a
new 40 page catalog. It's a fact-
packed manual with chapters on
acoustic theory, enclosures, choos-
ing drivers and design principles.

And it's free. Just write us and
ask for the most complete
catalog/manual ever written on
speaker building.

Speakerlab
Dept. HF9 5500 35th NE Seattle WA 98105

less so. The notes by the usually first-rate
Noel Godwin are not as clear as they might
be and certainly contain nothing as valu-
able as those by James Lyons in the
Rozhdestvensky set. Moreover, Godwin's
synopsis, "based on the published score
and the original production," does not
agree with the (correct) listing of the musi-
cal numbers as given elsewhere in the
booklet. And beware of misprints. The
photo captions are a festival of misspellings
(Birgit Heil for Birgit Keil, Noelle Pontoise
for Noella Pontois and so forth). D.S.H.

TCHAIKOVSKY: Symphony No. 1—See Dvo-
řák: Symphony No. 9.

VIVALDI: Gloria; Credo; Beatus vir; Laudate
Jerusalem. Mária Zempléni, Melinda Lugosi,
and Katalin Szökefalvi Nagy, sopranos; Klára
Takács, mezzo; Budapest Madrigal Chorus,
Ferenc Liszt Chamber Orchestra, Ferenc
Szekeres, cond. [István Juhász, prod.] HUN-
GAROTON SLPX 11695, \$6.98.

The Gloria and Credo (independent works,
not parts of a Mass) are now relatively fa-
miliar, but the two psalm settings—of Nos.
111 (*Beatus vir*) and 147 (*Laudate Jerusa-
lem*)—are less known.

The ritornel construction of *Beatus vir* is
that of the concerto, but the alternation
among ritornels of mezzo-soprano solo,
duet, and polyphonic chorus creates an at-
tractive variety. Though this is an inter-
esting and well-composed work—how mod-
ern Vivaldi's broad unison passages sound—
it does not reach the propulsive
splendor of the Gloria. But *Laudate Jerusa-
lem* is a sparkling baroque jewel, full of ex-
citement, drama, and virtuosity, the color-
aturas of the soloists contrasted by the
crisp syllabic chorus, while the orchestra
races about them. There are two choruses
and two orchestras in the old Venetian
polychoral tradition, and though the spatial
division is not clearly discernible on
recordings, the tossing of the musical sub-
stance from here to there is in evidence.
This is preferable to the antiphonal tricks
employed by recording engineers that usu-
ally exaggerate the situation.

The performances are superb. Ferenc
Szekeres maintains an ideal balance be-
tween voices and instruments, carefully
husbanding the full weight of the orchestra
for Vivaldi's typically explosive tutti. His
tempos are excellent, and the dynamic vari-
ety tastefully convincing. About the only
complaint I have concerns a minor but an-
noying habit of hesitating for a split second
between the penultimate and the final
chord. Sopranos Katalin Szökefalvi Nagy,
Melinda Lugosi, and Mária Zempléni and
the rich-voiced alto Klára Takács are all
first-class artists—secure, true of pitch, re-
markable in articulation and breath con-
trol, even in the fastest coloratura passages.
The little orchestra too is first-rate, but the
glory of the recording is the chorus, its ster-
ling qualities supported by a flawless
recording of the choral sound. The record-
ing engineer, Endre Radányi, proves that
true choral sound, that rarity in phono-
graph recordings, can be achieved.

I regret to add that the vocal texts are
once more missing. P.H.L.

TOP Discount AUDIO

Your NATIONAL HEADQUARTERS

For Famous Brand Electronics By Mail

1150 N. Powis Rd., West Chicago, Ill. 60185 • (312) 293-1825

*All Orders Shipped In
Factory-Sealed Cartons*

**Write Or Call For
The Lowest Prices
Anywhere!**

MILLION \$\$\$ INVENTORY

LOWEST PRICES ON

RECEIVERS	TURNTABLES	TUNERS
SPEAKERS	CHANGERS	CARTRIDGES
TAPE DECKS	AMPLIFIERS	HEADPHONES
CALCULATORS	COMPACTS	CAR AUDIO

Top Discount Audio 1150 N. Powis Rd.
West Chicago, Ill. 60185
(312) 293-1825

HF-3 _____ Date _____

Please send me a quote on _____

MR _____
MS _____

CIRCLE 47 ON READER-SERVICE CARD

SAVE!

MONEY • TIME • FREIGHT

- 🎵 QUALITY STEREO EQUIPMENT AT LOWEST PRICES.
- 🎵 YOUR REQUEST FOR QUOTATION RETURNED SAME DAY.
- 🎵 FACTORY SEALED CARTONS—GUARANTEED AND INSURED.
- 🎵 SAVE ON NAME BRANDS LIKE:
A.D.C. KLH
A.R. SHURE
DYNACO KOSS
FISHER SONY

PIONEER
AND MORE THAN 50 OTHERS
BUY THE MODERN WAY
BY MAIL—FROM

ia

illinois audio

Department 217H
12 E. Delaware Place
Chicago, Illinois 60611
312-664-0020

CIRCLE 18 ON READER-SERVICE CARD

WAGNER: Rienzi. For an essay review, see page 91.

WEBERN: Works for String Quartet—See Recitals and Miscellany: Alban Berg Quartet.

Recitals and Miscellany

LEON BATES: American Piano Works. Leon Bates, piano. [Giveon and Marion Cornfield, prod.] ORION ORS 76237, \$6.98.

MACDOWELL: Sonata No. 4, Op. 59. (*Keltic*). **BARBER:** Excursions, Op. 20. **WALKER:** Sonata No. 3.

The debut recording of the youthful black pianist Leon Bates (made possible in part by a grant from the Philadelphia Foundation) turns out to be more interesting than usual.

The real surprise is the pianist's performance of Edward MacDowell's last piano sonata, a work that virtually never appears on concert programs these days. The so-called *Keltic* Sonata, dedicated to Edvard Grieg (who was decidedly flattered by the gesture), is anything but easy to project intelligently. It sprawls; it rambles; but occasionally it is genuinely eloquent. Perhaps its formidable Romanticism explains why nobody plays it in recital, especially when compositions of considerably slighter stature receive much attention. But nobody except Marjorie Mitchell has even attempted to record it, and she is absolutely no match for Bates, either technically or interpretively. The *Keltic* Sonata is a much better piece than its reputation, and so far the Bates recording stands as the definitive one.

Also included on the disc are a neatly shaped performance of Samuel Barber's *Excursions* and a strong performance of George Walker's Sonata No. 3, written on commission for Bates and first performed by him in a recital at the Kennedy Center in Washington in January 1976. Walker is without question a very gifted composer, but I do not find this sonata as challenging or as imaginative in conception as his two earlier ones. But the record is worth acquiring for the MacDowell alone, as well as to make Bates's acquaintance. I.L.

ALBAN BERG QUARTET: Works for String Quartet. Alban Berg Quartet. TELEFUNKEN 6.41994, \$7.98.

WEBER: Five Movements, Op. 5; Six Bagatelles, Op. 9; Quartet, Op. 28. **HAUBENSTOCK-RAMATI:** Quartet No. 1 (*Mobile*). **URBANNER:** Quartet No. 3.

Comparisons—Webern:
LaSalle Qt in DG 2720 299
Otto Italiano Phi. 6500 105

There's no question but that this young quartet can execute the Webern pieces just as expertly as its older colleagues. For a novelty, the group seems inclined to push the dynamics closer to the loud end of the range than is usually heard in this music, and I don't believe this is just a function of closer miking—the quality of the sounds

produced is actually more violent. At times, this is exciting: The leader really digs into the high D (three octaves above middle C) near the end of Op. 28's first movement that Webern has marked fortissimo—weight where weight is really needed.

But much of the time I am less persuaded, especially in the Op. 9 pieces, which develop more energy than their brevity can comfortably contain. The second of the Op. 5 pieces, for example, is imbalanced because the last section doesn't come down to the triple piano indicated—a serious matter when only two phrases in the entire piece are marked as loud as piano. These are fine distinctions indeed—but then the music itself is based entirely on fine distinctions.

In general, I still find the LaSalle Quartet to give the most scrupulous—and therefore the most clarifying—accounts of this music, although there are some striking details in the Quartetto Italiano's less consistent versions as well. Since DG has not yet issued a single-disc version of the LaSalle's Webern in this country (it still comes only as part of its admirable Schoenberg-Berg-Webern omnibus), couplings may well influence your choice: LaSalle includes Webern's 1905 quartet as well as the three canonical works, while the Italians add to that the Slow Movement of the same year.

And the Alban Berg Quartet offers works written especially for it by the Israeli composer Roman Haubenstock-Ramati (b. 1919) and the Austrian Erich Urbanner (b. 1936). The "mobile" aspect of Haubenstock-Ramati's First Quartet is not, as one might expect from plastic-art analogies, the sequence of movements, but rather the choice among possible realizations of each movement within a fixed sequence ABCDCBA—thus involving multiple versions of three of the movements within a particular performance. Except for the quiet central movement, these are not very distinctive—a fairly standard repertory of contemporary string sounds in violent juxtapositions. Although Urbanner's Third Quartet, an eight-minute single movement, has some indeterminate details, it is composed along almost classical lines: although the "new sounds" he uses do not always mesh with some surprisingly traditional material, the course of the musical thought is clear and sometimes striking. The performances are brilliant and convincing.

D.H.

JOSÉ CARRERAS: Operatic Recital. José Carreras, tenor; Royal Philharmonic Orchestra, Roberto Benzi, cond. PHILIPS 9500 203, \$7.98.

BELLINI: Adelson e Salvini: Ecco, signor, la sposa. **DONIZETTI:** Maria di Rohan: Nel fragor della festa ... Alma soave e cara. **DONIZETTI-SALVI:** Il Duca d'Alba: Inosservato ... Angelo casto e bel. **MERCADANTE:** Il Giuramento: La dea di tutti i cor ... Bella adorata incognita: Compiuta è omai ... Fu celeste. **PONCHIELLI:** Il Figliuolo prodigo: Il padre! ... Tenda natal. **VERDI:** I Lombardi alla prima crociata: La mia letizia infondere. Jerusalem: L'infame ... O, mes amis, mes frères. Luisa Miller: Oh! fede negar potessi ... Quando le sere al placido. Un Ballo in maschera: Forse la soglia attinse ... Ma se m'è forza perdetti. La Forza del destino: La vita è Inferno ... O tu che in seno

José Carreras' first solo record gives hope of wonderful things. The sheer sound of the voice, firm, full, elastic, and sensuous, is frankly irresistible. The evenness of his scale over a span of about an octave and a half—that is, from the bottom of the staff to

Brand New! 1977 Edition High Fidelity's Test Reports

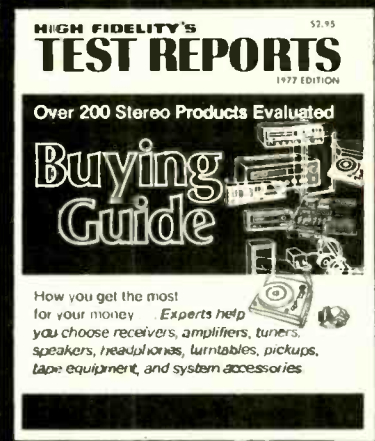

The new 1977 edition of High Fidelity's Test Reports is packed with more than 200 test reports of currently available stereo and four-channel equipment and accessories, including:

**Receivers
Headphones
Amplifiers
Tape Equipment
Turntables & Pickups
Speakers
Tuners . . . and more!**

This new book is bigger and better than ever before! 300 pages of in-depth analyses with charts, tables, pictures and prices, plus a guide to technical audio terms. Order now. Indicate the number of copies you want and return your check or money order with this form.

High Fidelity's Test Reports
1977 Edition
1 Sound Avenue, Marion, Ohio 43302

Please send me _____ copies of the 1977 High Fidelity's Test Reports at \$2.95 each, plus \$.50 postage and handling, total \$3.45.

NAME _____
ADDRESS _____
CITY _____ STATE _____
ZIP _____

high B (he seems to have no C)—is a pleasure in itself. So are his vowels and his easy negotiation of consonants. A technically tricky passage like the opening phrases of the *Forza* aria, with its wide upward and wider downward intervals, gives him no problems nor, since his management of the breath is so accomplished, does the long, broad phrasing required in the passage "come se fosse l'ultima ora del nostro amor," toward the end of the *Ballo* aria.

Here, however, reservations obtrude. The *Ballo* passage, marked *con slancio*, requires a lengthy crescendo to a high B flat and a lengthy diminuendo leading to a phrase marked *leggiere* and a shorter crescendo-diminuendo, ending *pianissimo*. None of this is very evident in Carreras' performance. The kind of shading and mu-

sical subtlety, the attention to dynamic variations, all the niceties that bring music to dramatic life, are at present beyond him. Whether they will ever be within his grasp is questionable, given the pressures of worldwide success such as he already enjoys. Without those refinements, however, he will never be able to realize his promise. Technically he is well equipped, though he relies a great deal on the intrusive aspirate to get him from one note to another, and there is a general want of elegance, which is particularly noticeable in such music as "Fu celeste" from Mercadante's *Il Giuramento* and the *Luisa Miller* aria.

Still, there is a lot of sheer sound to enjoy here, and in the choice of music encouraging evidence of an adventurous musical taste. In this particular Philips has regret-

tably failed Carreras by providing no texts. Satisfactory accompaniments. Excellent recording and the usual flawless pressing.

D.S.H.

THE CRADLE OF HARMONY: William Sidney Mount's Violin and Fiddle Music. For an essay review, see page 89.

EDUARD MELKUS ENSEMBLE: Rococo Dance Music. [Andreas Holschneider, prod.] ARCHIV 2533 303, \$7.98.

Few releases as highly specialized as this one, featuring rare miniatures drawn from unpublished manuscript sources, can match its appeals. For openers, it will be wanted by every owner of Melkus' samplings of Biedemeier and Viennese classical period dance repertoires (Archiv 2533 134 and 2533 182). And it should prove to be invaluable both to musicologists and historically minded balletomanes for its illuminating representations of French, Austrian, and German dances dating from around the third quarter of the eighteenth century, played here on actual or replica instruments of the time and in tempos based on rehearsals with dancers expert in the steps of the time. (This attempt at historical authenticity enlists the aid of Eva Campianu, who also contributes detailed notes on eighteenth-century dances to augment Melkus' own musical annotations and the usual Archiv data on sources, personnel, and the instruments used.)

Of course C. P. E. Bach and Rameau aficionados will welcome these expertly played and cleanly recorded (appropriately, in Vienna's Palais Schönburg) versions of the former's Wq. 190 polonaises and Wq. 189 minuets, and seven dances from the latter's lyric tragedy *Zoroastre* of 1749. I doubt that there exists any nonscholar fan of Josef Starzer (1726-87); I have come across his name before only as the actual composer of some of the pieces in the *Divertimento* No. 5, K. 187, usually credited to Mozart. But the onetime fame of this Viennese violinist and ballet composer is sure to be resuscitated for everyone who hears the ten dances drawn from his *Diane et Endimione*, *Roger et Bradamante*, and *Gli Orazi e gli curiazi*, all of which date from the early 1770s. Small-scaled as these little pieces may be (only one runs as long as three minutes), they bear the distinctive hallmark of a highly original and imaginative musical personality. Starzer's rediscovery is likely to delight layman-listeners even more keenly than musicologists.

R.D.D.

CLAUDIA MUZIO: Edison Diamond Discs, Vol. 2. Claudia Muzio, soprano; orchestral accompaniment except where noted. [James Gladstone, reissue prod.] ODYSSEY Y 33793, \$3.98 (mono) [recorded 1920-21].

CATALANI: *La Wally*; *Ebben? Ne andro lontana*. **GIORDANO:** *Andrea Chénier*; *La mamma morta*. **GOMES:** *Salvator Rosa*; *Mia picciarella*. **LEONCAVALLO:** *I Pagliacci*; *Ballatella*. **PUCCINI:** *La Bohème*; *Sì, mi chiamano Mimì*. **TCHAIKOVSKY:** *Yevgeny Onegin*; *Letter Scene* (excerpt; in Italian). **VERDI:** *Il Trovatore*; *Tacea la notte*; *D'amor sull'ali rose*. **BACHELET:** *Chère nuit*. **CHOPIN:** *The Maiden's Wish*, Op. 74, No. 1 (in French). **MASCHERONI:** *Eternamente* (with Albert Spalding, violin; Robert Gayler, piano). **SOERO:** *Crisantemi*.



Next time you plan a trip to Europe, make sure you visit the unique country.

Where can you find: Europe's blondest blondes?
Europe's highest geysers?
Europe's greatest glaciers?
Europe's largest waterfalls?

And where can you find moonlike craters where the astronauts trained? More volcanos than anywhere else on earth? Historic landmarks of the world's oldest continuous parliament? Celebrations marking Europe's youngest republic?

The answer to all of these questions is—ICELAND. Next time you plan a trip to Europe, make sure you visit Iceland.

The only thing it may cost you is time well spent. Because you'll save enough money on Icelandic's lowest jet fares to Luxembourg to pay for your stopover in Iceland. Or, you can hop over from New York or Chicago for longer tours. See an erupting volcano. Take a cross-country pony trek.

Next time you plan a trip to Europe, ask your travel agent about Icelandic Airlines. Or phone Icelandic Airlines, for folders about Iceland and lowest jet fares to Europe. In New York State, phone (212) 757-8585. Elsewhere in U.S., phone (800) 555-1212 for local toll free number.

CIRCLE 16 ON READER-SERVICE CARD

THE PERFECT GIFT BOOK FOR ANY MUSIC LOVER

... INCLUDING
YOURSELF!

Share with your friends this fascinating anthology drawn from America's leading journal of music and sound . . . and don't forget to order a copy for your own library.

To celebrate the 25th anniversary of HIGH FIDELITY, its editors have selected fifty of the best articles from the magazine's quarter century. More than 300 pages of authoritative, brilliant, often controversial, always intriguing insight — featuring such outstanding writers as:

- Aaron Copland on Mozart • Ashley Montagu on women composers
- Roland Gelatt on Verdi's Italy • Gunther Schuller on Duke Ellington
- Wieland Wagner on Richard Wagner • Gene Lees on Johnny Mercer
- Milton Babbitt on the credo of avant-garde composition
- Colin Davis on Berlioz • Leonard Marcus on Bach • Conrad Osborne and John Culshaw locking horns over Culshaw's stereo recording techniques . . . and much, much more!

Clearly it's one of the outstanding books about music and recording published in this century. Use the coupon to get copies for you and your friends promptly.

Sorry — we cannot invoice. Payment must accompany order. Allow 60 days for shipping.

Wyeth Press
Great Barrington, MA 01230

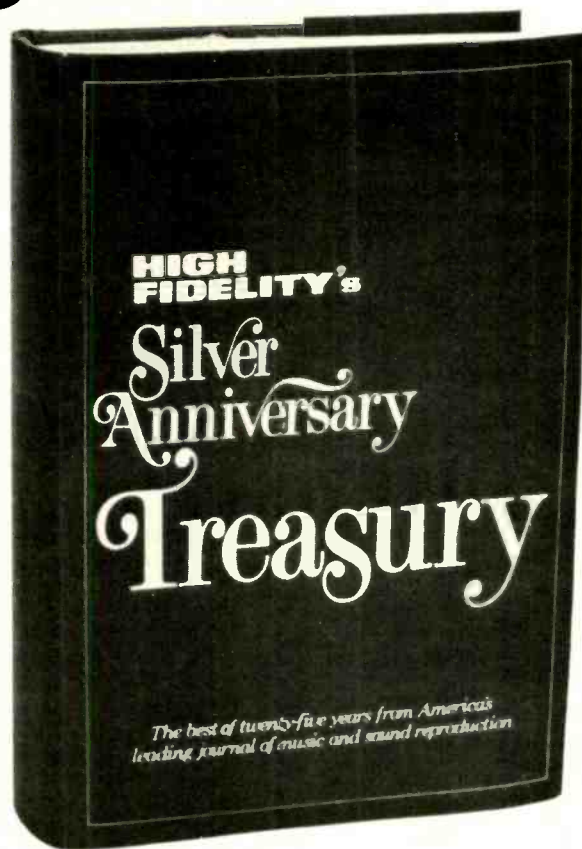

To: **WYETH PRESS** Great Barrington, MA 01230

I enclose \$_____ for _____ copies (@ \$9.95 each) of
High Fidelity's SILVER ANNIVERSARY TREASURY.
Send my books (postage prepaid by publisher) to:

Name _____

Address _____

_____ Zip _____

HF-177



ADVERTISING INDEX

Key No.	Page No.
50	ADC Professional Products Group, A division of BSR (USA) Ltd. 28
1	ADR Audio 146
2	Allison Acoustics 111
3	Angel Records 98
51	Audiopulse 107
	Audio Technica U.S., Inc. 101
7	Avid Corp. 29
4	Bang & Olufsen of America 113
	BASF 94
	Bolivar Speaker Works 34, 35
	Bose Corp. 143
5	British Industries 5
6	Carston Studios 112
	Classified Ads 149-151
	Component Discounters 146
8	Crown International 113
9	Discount Music Club 114
	Discwasher, Inc. 32, 148
10	District Sound 147
	Dixie Hi-Fi 146
	Dolby Laboratories, Inc. 78
17	Dual 31
11	Dynaco, Inc. 134
12	Electro-Voice, Inc. 11
	Elpa Marketing Industries 23
13	Empire Scientific Corp. 50
	ESS, Inc. 8, 9
14	Fisher Corp. 38
15	Garrard 37
	High Fidelity's Test Reports 115
16	Icelandic Airlines 116
18	Illinois Audio 114
19	JVC America, Inc. 124
30	Kenwood Cover IV
20	King Karol Records 118
21	Klipsch & Assoc. 12
	Lux Audio of America Ltd. 24, 25
	Marantz Co., Inc. 18-21
22	Maxell Corp. 48, 49
52	Maxell Corp. 141
23	McIntosh Laboratory 85
	Micro-Acoustics Corp. 102
	Music Listener's Book Service 110, 112
	Music Listener's Record Service 106
49	MXR Innovations 137
24	Nakamichi Research (USA), Inc. 105
25	Nikko Electric Corp. of America 59
26	Olympus Corp. of America 109
27	Onkyo 86
35	Optonica Electronics 67
36	Optonica Electronics 69
37	Optonica Electronics 71
28	Phase Linear Corp. 7
29	Pioneer High Fidelity Cover II, 1
	Pioneer High Fidelity 99
	Radio Shack 16
	Record Mart 118
31	Royal Sound 110
32	RTR Industries 100
33	SAE, Inc. 103
38	Sansui Electronics Corp. 40-45
34	Scott, H.H., Inc. 10
	Sennheiser Electronic Corp. 104
39	Shure Brothers 63
40	Sony Corp. of America 26, 27
	Speakerlab, Inc. 114
41	Spectro Acoustics Inc. 108
42	Stanton Magentics 2
43	Stereo Corp. of America 146
	Superscope, Inc. 152, Cover III
44	TDK Electronics 13
	Teac Corp. of America 122
45	Technical Sound Industries 121
46	Technics by Panasonic 15
47	Top Discount Audio 114
	Ultralinear 14
17	United Audio Products, Inc. 31
	Watts 23
	Wyeth Press 117
48	Yamaha International 47

This, like Odyssey's previous Muzio collection (Y 32676), is required listening for anyone interested in the expressive possibilities of the human voice.

From the start of her career Muzio knew how to move as well as delight the listener. In these 78s, made when she was just over thirty, her very timbre—full of half-lights, delicate shadings, nuances of coloration—bespeaks pathos and vulnerability. She sounds like someone who has felt the brunt of experience. Her piano singing, especially when the music does not take her too high, is at one and the same time exquisite and powerful: Through it we seem to be privileged sharers of intensely private feelings. (Her attempts at lightheartedness are not usually very successful. Here "Mia piccirella" from Gomes' *Salvator Rosa* sounds heavy and unsmiling.) By the time of Muzio's final 78s (the Columbias, made in 1934-35) her voice had darkened and become less volatile, but the unique characteristics of this great singer were no less in evidence and the vividness and sincerity were even more pronounced.

Edison caught her midway in her career, when voice and expressivity were in a state of equilibrium. (So, actually, do her Pathés, forty-one in all, made in New York a couple of years earlier. The records she made for HMV in Milan in 1911 are appealing but immature.) With this LP, Odyssey has now issued twenty-three of her thirty-three published Edison sides. Most are wonderful, all are characteristic. The *Trovatore* excerpts, for example, reveal that Muzio had no trill and lacked security at the top. But the molding of "Tacea la notte," the sense of an unbroken, sensitively articulated musical line, is unforgettable, and so in "D'amor sull'ali rosee" is the wonderful dark and tragic coloration of the tone. "La mamma morta" is another revelatory performance. Just to hear Muzio enunciate "Vivi ancora! Io son la vita!" is worth the price of this record. Some of the material here (in particular the songs) is weak; all the operatic material, except for the *Pagliacci* Ballatella and "Mia piccirella," is endlessly fascinating, especially the excerpts from *Bohème*

and *Wally*, not least for her way with the text. (In the Bachelet and Chopin songs, incidentally, her French is excellent.)

The sound is naturally primitive, but perfectly acceptable. There are texts—not always the same as Muzio's—and translations. For Muzio lovers, I might point out that a selection of her late Columbias is available on Seraphim 60111 and among the material on OASI's six Muzio LPs are songs by Refice and excerpts from his opera *Cecilia* (OASI 576), a large number of her Pathés (566, 568, 564), and her first two Milan recordings (526). D.S.H.

FREDERICA VON STADE: Mozart and Rossini Arias. Frederica von Stade, mezzo-soprano; Rotterdam Philharmonic Orchestra, Edo de Waart, cond. PHILIPS 9500 098, \$7.98.

MOZART: Le Nozze di Figaro: Non so più; Voi che sapete. Don Giovanni: Vedrai, carino. La Clemenza di Tito: Parto, parto; Ecco il punto. . . Non più di fiori. **ROSSINI:** Il Barbiere di Siviglia: Una voce poco fa. Otello: Assisa a piè d'un salice. La Cenerentola: Nacqui all'affanno.

After the promise evinced by Von Stade's first solo recital ("French Operatic Arias," Columbia M 34206, February 1977), this one comes as a great disappointment. None of these performances is really satisfactory; all sound, at least to my ears, dreadfully precious. Every character—the ebullient Cenerentola and the despairing Vitellia (*La Clemenza di Tito*), the ingratiating Zerlina and the plaintive Desdemona—js realized in the same fashion: by a vocal delivery that wants firmness and line, by phrasing that is excessively arch and mannered, and by enunciation that lacks accuracy (especially in the matter of doubled consonants), vividness, or even meaning.

As an example of several of Von Stade's faults I would point to "Vedrai, carino," where Zerlina, talking of the remedy she has for Masetto's ailment (he has been beaten up by Don Giovanni), calls it a natural cure. "è naturale"—a phrase that, ironically enough, Von Stade sings as artificially as possible, half of it being distorted, half swallowed. Actually, she does a lot of phrase-swallowing in this recital, another particularly inappropriate example being, of all things, "salice" (willow), the key word at the opening of Desdemona's Willow Song.

Of course, a good deal of the vocalism here is technically accomplished (a certain amount of the *fioriture*, for instance) and, except momentarily in "Non so più," there is none of that singing above pitch she tends to be guilty of in the opera house. But, even so, she does not manage her breath as well as she might, and at the ends of phrases the voice often runs out. A more important deficiency is appropriateness of style and manner or, put another way, musical understanding. Von Stade sounds on this occasion as if she needs good, firm coaching. In the opera house her physical attractiveness and the warmth of her personality add a great deal that is clearly untranslatable to records alone. And what on earth is she singing Zerlina's music for? "Vedrai, carino" is much too high for her (and "Non più di fiori" is too low).

Not recommended—even though the accompaniments are good, the recording is excellent, and the pressing superb, and there are texts and translations. D.S.H.

RECORD MART Advertisement

KING KAROL'S NEW EVERYDAY LOW PRICE POLICY!

ON EVERYTHING . . . ALL LABELS!
SUPER-FAST MAIL ORDER SERVICE

MFG. SUGG. LIST	OUR PRICE
3.98	2.79
4.98	3.79
5.98	4.19
6.98	4.49
7.98	5.69

TAPES

6.98	4.99
7.98	5.99
8.98	6.99

Mail Orders to
KING KAROL RECORDS
P.O. Box 629,
Times Sq. Station,
New York 10036
Add 50¢ for 1st item & 25¢
for each additional item.
New York State Residents
add applicable sales tax.
Send \$1 for complete catalog



CIRCLE 20 ON READER-SERVICE CARD

Here's your FREE "at home" shopping service!



It's easy! All you do is use the Reader Service card at right.

- 1 Just circle the number on the card that matches the number below the ad or editorial mention that interests you. You'll also find the key numbers for advertised products in the Advertiser's Index.
- 2 Then type or print your name and address. Don't forget your zip code.

- 3 Drop the postage-paid card into the mail. You'll receive literature, colorful brochures and specifications about the products that interest you . . . free and without obligation! Use HIGH FIDELITY's "at home" shopping service today!

MAIL ORDER BUYER'S SERVICE

Now you can enjoy the best in both musical worlds—in one colorful magazine: **HIGH FIDELITY/ MUSICAL AMERICA**



For the full story of music and musicians, include MUSICAL AMERICA as part of your High Fidelity subscription.

MUSICAL AMERICA covers the live musical scene completely. You'll get news, reviews and reports of important musical events all over the world—written by critics who know the score and how to write about it. You'll meet today's outstanding composers, conductors and performers . . . learn how they work and live . . . what they think and say about music.

MUSICAL AMERICA adds a new dimension to High Fidelity—and to your enjoyment of music. Use the postage-free card to start copies coming your way regularly.

(MUSICAL AMERICA is available only by subscription . . . and only with High Fidelity. It is not sold on newsstands. Another important reason to order your subscription now!)

1 2 3 4 5 6 7 8 9 10 11 12 13 14 15
 16 17 18 19 20 21 22 23 24 25 26 27 28 29 30
 31 32 33 34 35 36 37 38 39 40 41 42 43 44 45
 46 47 48 49 50 51 52 53 54 55 56 57 58 59 60
 61 62 63 64 65 66 67 68 69 70 71 72 73 74 75
 76 77 78 79 80 81 82 83 84 85 86 87 88 89 90
 91 92 93 94 95 96 97 98 99 100 101 102 103 104 105
 106 107 108 109 110 111 112 113 114 115 116 117 118 119 120
 121 122 123 124 125 126 127 128 129 130 131 132 133 134 135
 136 137 138 139 140 141 142 143 144 145 146 147 148 149 150
 151 152 153 154 155 156 157 158 159 160 161 162 163 164 165

1 2 3 4 5 6 7 8 9 10 11 12 13 14 15
 16 17 18 19 20 21 22 23 24 25 26 27 28 29 30
 31 32 33 34 35 36 37 38 39 40 41 42 43 44 45
 46 47 48 49 50 51 52 53 54 55 56 57 58 59 60
 61 62 63 64 65 66 67 68 69 70 71 72 73 74 75
 76 77 78 79 80 81 82 83 84 85 86 87 88 89 90
 91 92 93 94 95 96 97 98 99 100 101 102 103 104 105
 106 107 108 109 110 111 112 113 114 115 116 117 118 119 120
 121 122 123 124 125 126 127 128 129 130 131 132 133 134 135
 136 137 138 139 140 141 142 143 144 145 146 147 148 149 150
 151 152 153 154 155 156 157 158 159 160 161 162 163 164 165

NAME _____
 ADDRESS _____
 CITY _____ STATE _____ ZIP _____
 I am a subscriber I am not a subscriber

NAME _____
 ADDRESS _____
 CITY _____ STATE _____ ZIP _____
 I am a subscriber I am not a subscriber

FIRST CLASS PERMIT NO. 570 MARION, OHIO

BUSINESS REPLY MAIL

No Postage Necessary if Mailed in the United States

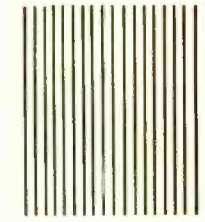

Postage will be paid by:

HIGH FIDELITY

1 Sound Avenue
 Marion, Ohio 43302

NAME _____
 ADDRESS _____
 CITY _____ STATE _____ ZIP _____
 I am a subscriber I am not a subscriber

Here's your **FREE** "at home" shopping service!



It's easy! All you do is use the Reader Service card at right.

- 1** Just circle the number on the card that matches the number below the ad or editorial mention that interests you.
You'll also find the key numbers for advertised products in the Advertiser's Index.
- 2** Then type or print your name and address. Don't forget your zip code.

- 3** Drop the postage-paid card into the mail.
You'll receive literature, colorful brochures and specifications about the products that interest you . . . free and without obligation!
Use HIGH FIDELITY's "at home" shopping service today!

MAIL ORDER BUYER'S SERVICE

Three Great Buyer's Guides from HIGH FIDELITY— Order Now!

HIGH FIDELITY'S TEST REPORTS



1977
Test
Reports
\$2.95
circle
161

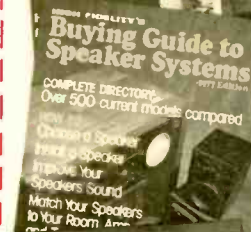

1977
Buyer's
Guide to
Speaker
Systems
\$1.50
circle
162

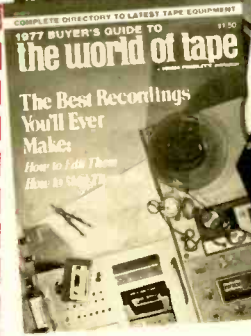

1977
Buyer's
Guide to
the World
of Tape
\$1.50
circle
163

To order, circle the number on the attached card that matches the number of the Buyer's Guide you want, enclose payment with your order and mail to:

Reader Service
P.O. Box 14306, Annex Station
Cincinnati, Ohio 45214
(Enclose payment. No credit orders.)

BUSINESS REPLY MAIL

No postage stamp necessary if mailed in the United States.

Postage will be paid by—
HIGH FIDELITY

Reader Service 77
P.O. Box 14306
Annex Station
Cincinnati, Ohio 45214

First Class
Permit No. 111
Cincinnati, Ohio



BUSINESS REPLY MAIL

No postage stamp necessary if mailed in the United States.

Postage will be paid by—
HIGH FIDELITY

Reader Service 77
P.O. Box 14306
Annex Station
Cincinnati, Ohio 45214

First Class
Permit No. 111
Cincinnati, Ohio



Please enter my subscription to HIGH FIDELITY magazine at the special rate of:

- 15 issues for only \$9.47 22 issues for only \$13.88
 33 issues for only \$18.87

I prefer a full year of High Fidelity/MUSICAL AMERICA. I'll receive all of High Fidelity plus 40 pages each month of news and reviews of important musical happenings throughout the world—concerts, opera, etc.—for only \$18.00

E7CR

Name _____

Address _____

City _____ State _____ Zip _____

payment enclosed bill me

High Fidelity—15 issues add \$2.00; 22 issues add \$4.00; 33 issues add \$6.00.
High Fidelity/MUSICAL AMERICA—for one year add \$2.00.

BUSINESS REPLY MAIL

No postage stamp necessary if mailed in the United States.

Postage will be paid by—
HIGH FIDELITY

Reader Service 77
P.O. Box 14306
Annex Station
Cincinnati, Ohio 45214

First Class
Permit No. 111
Cincinnati, Ohio

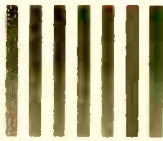



introducing our speaker the TSI/120

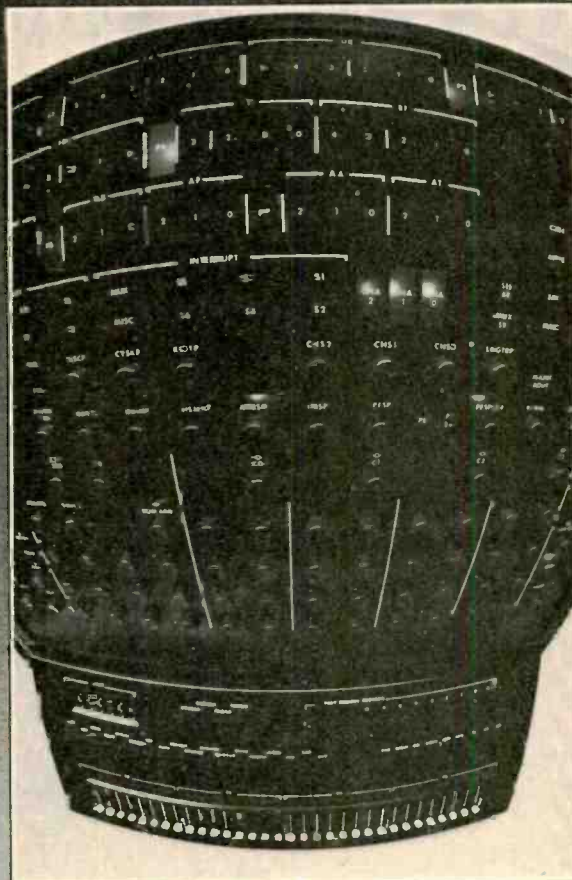

introducing our Guru the Univac 707

At Technical Sound Industries we don't give you great loudspeaker Gurus, just great loudspeakers

Most speaker companies today offer the world the designs of their "Great Guru of Loudspeakers." He's usually someone who's recently re-invented the speaker principles of his particular design (and who's been modest enough to put his name on the grille cloth).

At Technical Sound Industries we haven't re-invented the speaker or their physics principles, but we have taken a long look at what the customer wants. Not East Coast sound. Not West Coast sound. But accurate sound. Efficient sound. And clear sound. With the lowest distortion.

At Technical Sound Industries we believe that two heads are better than one, and three are better than that when it comes to speaker design; so we've assembled the designs and opinions of many good engineers in our speakers. We've co-ordinated this effort with high-speed computer design techniques. And we've come up with a full line of the most listenable speakers you've ever heard. A line of speaker products based on some pretty heavy engineering that's yielded our Bass Linear Motion Transformer™ and our Sila-Sealed Power Dome Tweeter™ with hi-temp epoxy voice coil. The beautiful parts are the prices and the hot lacquered walnut veneered cabinets. TSI® Loudspeakers . . . optimized accuracy in transducers.

For more information write: Technical Sound Industries, Inc., 1435 Jacqueline Drive, Columbus, Georgia 31906. Call our dealer hotline for where to buy: 1-800/241-0914 or 404-563-8403.

Technical Sound Industries, Inc
 "we're bridging the gap between
 good sound and technology"

It's all in your hands now.

These essential music-making tools let you get in, around, and behind your music. One part, one track at a time. Then when all the elements are the best they can be, you blend them together and generate the finished product. A process that involves your innermost sensitivities and perceptions. A personal statement.

The 3340 has undoubtedly helped more people make more demos and masters than any other tape recorder. Our new model, A-3340S, has extended high end frequency response in the sync mode, plus manual cueing. The Model 2 is about the best value going in small mixers—6-in, 4-out with full panning and multiple patch points. Plug in a few high quality TEAC ME-Series electret condenser mics, and you could be quite literally in business.

When you have
the right tools,
the work is
more productive.

TEAC®

The leader. Always has been.

TEAC Corporation of America
7733 Telegraph Road, Montebello, Calif. 90640
©TEAC 1975

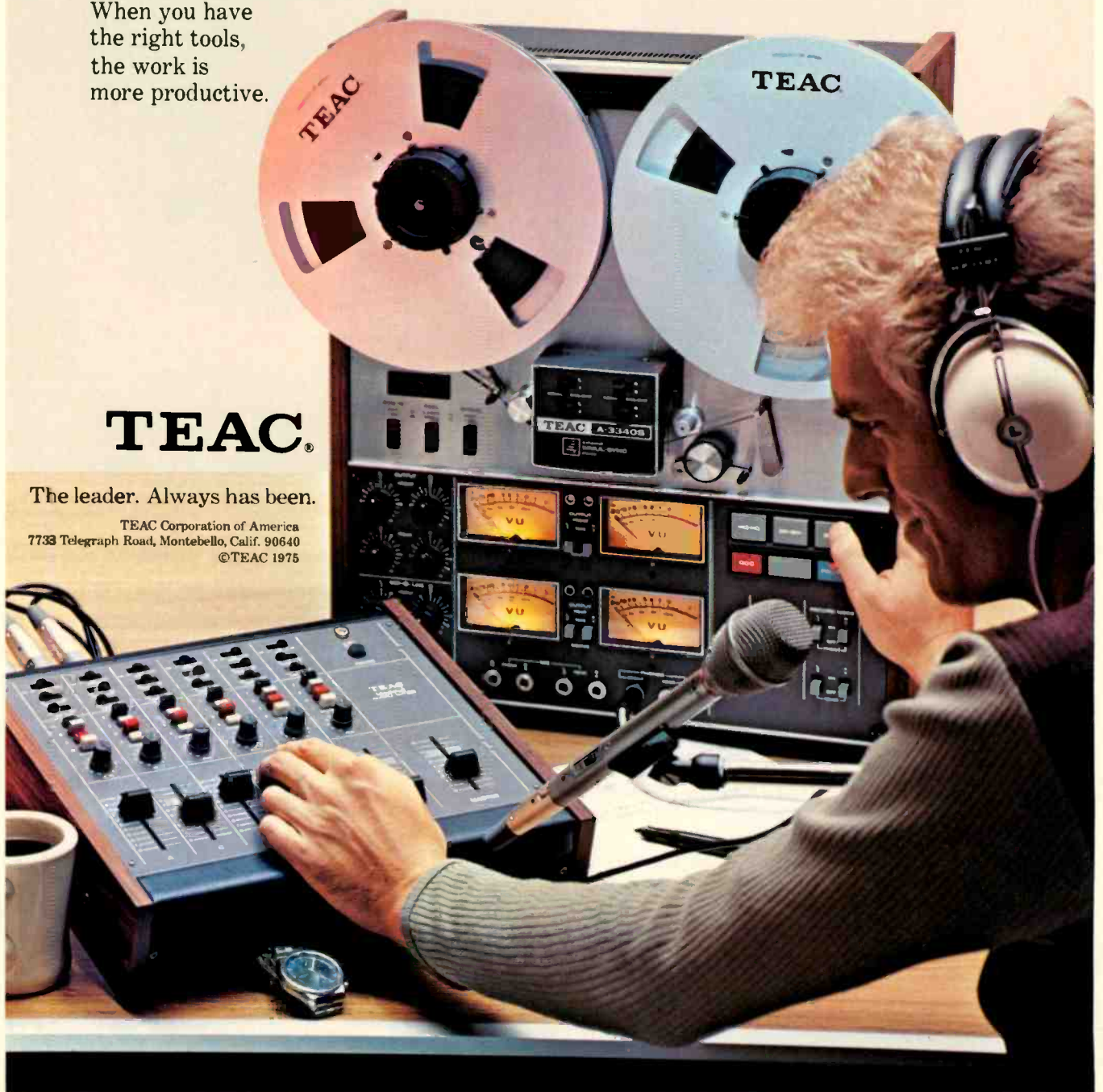

Resplendently re-resounding Ring. What's newest isn't always the most newsworthy—as when all twelve of London's brand-new releases of imported musicassettes are brazenly upstaged by three revitalizations of pioneering stereo-recording triumphs. One of these is the all-time milestone of combined artistic and technological achievement: the first (1958-65) complete Wagner *Ring* tetralogy, conducted by Sir Georg Solti. That nineteen-disc set was first taped on eleven open reels, later in domestically processed cassettes. But both Ampex editions are out of print, and in any case the earlier cassettes were no match for the new ones, completely re-edited and reprocessed (in Dolby B, of course) and sumptuously packaged in four "prestige" boxes (2, 3, 3, and 4 cassettes, respectively).

Each opera has its own notes-and-texts booklet, while the over-all box- ing includes the hard-cover book, *Ring Resounding*, in which producer John Culshaw relates the whole fascinating story of the mighty work's planning and execution. The complete package, London Ring S 5-1, lists at \$135; individual volumes: *Rheingold*, OSA5 1309, \$23.95; *Walkure*, OSA5 1509, and *Siegfried*, OSA5 1508, \$39.95 each; *Götterdämmerung*, OSA5 1604, \$47.95; the Culshaw book, \$7.50.

Today, nearly eighteen years after the Solti *Rheingold* first electrified the audio world, no connoisseur needs to be reminded of this *Ring*'s greatness. But some may need assurance that musicassettes nowadays are capable of doing full justice to that greatness. In direct comparisons with my treasured reels, the only apparent difference is the new tapes' somewhat lower modulation level—no handicap, since the cleanliness of the re-editing and the minimization of surface noise (surprisingly good considering that the original recording was done before the advent of Dolby A mastering) permit the playback level to be compensatingly raised without risk of distortion.

Youngsters approaching this *Ring* for the first time may not be as overwhelmed as we oldsters were by sound and staging effects that no longer seem as sensationally spectacular for their own sake. But both they and we can better realize the dramatic rightness of not only these effects, but the over-all performance. And if not all the singers match the excellence of Nilsson, Flagstad, Neidlinger, and Fischer-Dieskau, the cast as a whole transcends any weakness of some of its parts, while the playing of the Vienna Philharmonic and Solti's magisterial direction remain

by R. D. Darrell

The Tape Deck

incomparable. For either Wagnerian or cassette skeptics, this incredible work must indeed be heard—of course via truly adequate playback equipment—to be believed.

Tebaldi's Aida and Desdemona redivivus too. For Verdians, London re-suscitates the still invaluable usable past with musicassette editions of its first complete-in-stereo *Aida* (1959-60) and its 1961 *Otello*, both starring Renata Tebaldi at or not far past her vocal prime, with the Vienna Philharmonic under Karajan: respectively OSA5 1313 and OSA5 1324, two Dolby-B cassettes each, boxed with notes and texts, \$23.95 each. Both recorded performances (but for me, that of *Otello* in particular) still rank among the best currently available: the earlier open-reel editions are out of print, the present cassette processings first-rate. And if neither work technologically defies its age as potently as the Solti *Ring*, the recordings' original tonal warmth and richness are still persuasively evident.

Martinon's Debussy in (tempered) XDR. Angel's new cassette series also turns back, if only a couple of years, to one of the late Jean Martinon's distinctive legacies—his Debussy orchestral works. It has issued the first four volumes (Angel 4XS 37064/7, Dolby-B XDR cassettes, \$7.98 each), with the remaining two to come. Not all the French National Radio orchestral playing can match the best in the Debussy discography, but none of the Martinon readings lacks acute sensibility and the best are paradigms of quintessential Gallic plasticity. Surely not to be missed are the *Petite Suite*, *Danse*, and *Plus que lente* (Album 1); *Danses sacrée et profane* (Album 2); the three *Images* and *Jeux* (Album 3); and the three *Nocturnes* (Album 4).

The lucid yet solid Pathé-Marconi EMI recording is highly effective, the processing first-rate except for a momentary channel dropout (perhaps only in some copies) just before the end of the Album 2 saxophone rhapsody. But it's worth notice that the modulation level of these latest releases, while relatively high, seems a couple of dB lower than the excep-

tionally high levels of the first Angel XDRs ("Tape Deck," October 1976). I, or rather my two Advent players, had no trouble with them, but I've learned that some readers have had overload-distortion problems. I might guess that the considerable delay in the appearance of newer XDR cassette releases may have been for reconsiderations—and for at least some reduction in modulation levels more likely to be within the limitations of mass-public cassette-playback systems.

At the RCA Fluters' Ball. One of the few younger flute virtuosos to challenge superstar Jean-Pierre Rampal (b. 1922) is the Irishman James Galway (b. 1939). His fine Franck sonata of June 1976 now is followed by a recital, "The Man with the Golden Flute," of encore, salon, and display pieces of markedly less aesthetic value but undeniable amateur-player and popular appeal: RCA LRK/LRS 1-5094, cassette/cartridge, \$7.95 each. There's dazzling bravura in his Dinicu *Hora staccato*, Paganini *Moto perpetuo*, and Rimsky *Flight of the Bumblebee*; genuine novelty in Michio Miyagi's *Huro No Umi* and Franz Doppler's *Fantaisie pastorale hongroise*, Op. 26. But the rest is mostly either schmaltz to begin with or made to seem so by the transcribers and by Charles Gerhardt's nondescript National Philharmonic orchestral accompaniments.

The great Rampal himself is represented prodigally by three Erato programs in RCA cassette/cartridge editions, \$7.95 each. The first comprises probably the best all-around versions of the Mozart K. 313 and 314 Concertos and K. 315 Andante, with the Vienna Symphony under Guschlbauer (FRK/FRS 1-5330). The second (also available earlier via the Musical Heritage Society) proffers dazzling flute/reticent harpsichord versions of Vivaldi's six *Pastor fido* sonatas, Op. 13. It originally (1737) was scored permissively for hurdy-gurdy, bagpipes, recorder, oboe, or violin with continuo, so why not even a not particularly baroque-sounding flute for such surprisingly elegant and courtly music?

The Bach program combines the familiar B minor Suite (but not the Musical Heritage one with the same Pail-lard Orchestra) with the Cantata No. 209 *sinfonia*, plus a delectable novelty: a (Rampal?) flute version of Radeke's reconstitution of the S. 1059 Harpsichord Concerto based on the two *sinfonias* and an alto aria from Cantata No. 35. No Rampal—or Bach-aficionado can afford to miss this treasure (FRK/FRS 1-5693). ●

JVC Professionals. The only receivers that adjust sound to the acoustics in your room.

S400

S300

S600

Listening to a demonstration of music systems at a dealer is an excellent way to make a buying decision. But it can be misleading. Because what you hear in the dealer's acoustically designed sound room may not be what you hear at home.

The reason is simple. Sound quality is determined by various factors, including the size of a room and its acoustic elements. Drapes. Carpet. Furniture. Windows. Ceiling height. Walls. They all play a role in the sound you hear.

To help you get the best sound from your music system—wherever you listen to it—JVC has built into its top three receivers (S600, S400, S300) their exclusive SEA graphic equalizer system. This unique 5-zone control lets you create 371,293 different tone adjustments. As a result, you can custom tailor the sound to compensate for any room size and acoustic surfaces. The graphic equalizer also enables you to overcome deficiencies in old or poor recordings and the placement of speakers. Nobody else has this built-in feature. Nobody. And the only

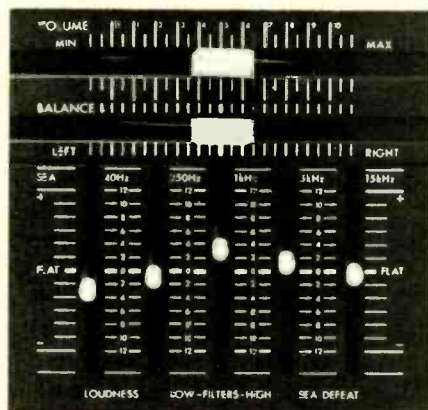

Exclusive 5-zone SEA graphic equalizer system for better performance from components and listening room.

way any other make of receiver can match the sonic versatility of these three JVC models is by your adding to it (at an additional cost of \$100 or more) a separate, outboard graphic equalizer.

When you consider that you get the built-in graphic equalizer plus JVC's

many other outstanding features for the price of a conventional receiver in their price ranges, you can understand why the JVC professionals are rapidly becoming the #1 receiver to own.

JVC also offers the less sophisticated, moderately priced S200 and S100 receivers with precision, linear slide controls for bass, treble and volume. Regardless what you plan to spend for a receiver—think like a professional and get the best. Think JVC.

Visit your local JVC dealer, or call toll-free (outside N.Y.) 800-221-7502 for his name.

JVC America, Inc., 58-75 Queens Midtown Expressway, Maspeth, N.Y. 11378 (212) 476-8300. Canada: JVC Electronics of Canada, Ltd., Scarborough, Ont.

JVC

Backbeat

The Black & White of Wild Cherry

by Bruno Bornino

We were talking about Wild Cherry's identity problem, and Bob Parissi—the group's lead guitarist, vocalist, and composer—accidentally underlined it. "There are still a lot of people who don't know we're black yet, or don't know we're white, excuse me," he corrected himself to general laughter. "Anyway," he continued, "on our second album, we felt we had to explain we were white in one of our tunes."

Such is the price of success. The group's first single, *Play That Funky Music*, and follow-up first album, "Wild Cherry," both went platinum. It's an unusual first-time-out feat, made more unusual by the fact that Wild Cherry is a white group that does black

funk better than most black bands and any white band in recent memory.

Having hit the top, the group now sees its problem as staying up there without sacrificing individuality. "If we take the right steps we can develop a new thing, something a little fresh in rock & roll," says Parissi. "I think it's going to be up to us to keep our eyes on things to see that every base is covered." "Us" means Bryan Bassett, guitar; Ron Beitle, drums; Allen Wentz, bass and synthesizer; Mark Avsec, keyboards; and Mike Belkin and Carl Maduri who head up the production/management team of Cleveland-based Sweet City Records, an Epic subsidiary.

The band members credit Belkin and Maduri, founders of Sweet City, with giving them creative freedom with their product. Maduri explained: "It was to our advantage to let these guys do their own thing. It was pretty obvious from the start that they knew what direction they wanted to take, and we happened to be in total agreement with them. It was also the way we work with Epic. We had offers from other major recording companies, but chose Epic because they gave us absolute control and freedom over product.

"Our primary goal was to create a Cleveland sound, something along the lines of Motown or Philly International. And the only way you can do that is with absolute control," Maduri describes the Cleveland sound as "electrified funk" (also the title of Wild Cherry's new album)—black-influenced rhythm and blues accented by characteristically white guitar riffs, rather than the standard r&b brass emphasis. It's a disco sound, spiced with soul.

Parissi insists that Wild Cherry will maintain the

Bruno Bornino covers the rock scene for The Cleveland Press.



Platinum Cherries: Ron Beitle, Bob Parissi, Bryan Bassett (seated), Allen Wentz, Mark Avsec

Cleveland sound, even though their new album was cut in New York. "We established ourselves in Cleveland, and we will always keep that association. The reason for going to studios in other cities is to try to make the sound closer to what's in our heads. And the only way to do that is get more power out of the tracks."

Maduri and Belkin happened upon the group in a Cleveland recording studio a year ago when the then-unknown band (Parissi, Bassett, Beitle, and Wentz) was making a demo of *Play That Funky Music*. "We hit it off right from the start," said Maduri.

Before the formation of Wild Cherry—which was named after a box of Smith Brothers cough drops (and may also have other implications)—in 1974, Parissi had played professionally for ten years. After the usual succession of high school rock bands, he received a recording contract that gave MGM first refusal rights. But after a national tour with Bobby Vinton, numerous television and club dates, and work with such luminaries as Rick Derringer and the McCoys and Terry Knight (former manager of Grand Funk Railroad), Parissi decided to quit the music business. "It just wasn't fun anymore. I was really down. Even though I enjoyed some success, I felt that I had wasted a lot of time and was on the road to nowhere. I sold all my musical equipment except for one guitar, and took a job managing a steak house in Pittsburgh. Then, fortunately, I met Bryan."

Bassett picked up the story at this point. "I was between bands at the time, working as a groundskeeper in Pittsburgh's Three Rivers Stadium. I had hopes of making music my career, but I just didn't know how to do it."

"The most gratifying touring experience for them has been their acceptance by black audiences."

"We all had dreams of making it in the business," said Beitle, whose first drum kit was an improvised model fashioned by his father from cardboard boxes and tinfoil. "I played in a number of club bands, but more and more clubs were going disco so I took a job with a coal company in Pittsburgh."

Bassist Wentz started as a sax player and then switched to synthesizer, figuring that a facility with electronic instruments would eventually look better on the bottom line. Avsec had been playing flute, sax, guitar, and synthesizer with the now-defunct Sweet City Band, a group of studio musicians who provided backup on Wild Cherry's first album. Maduri suggested he become a permanent member of Wild Cherry.

Parissi feels that as long as the "team" stays together, Wild Cherry will enjoy longevity. "Most of our success on the first album came from word of mouth. Outside of the single, very few tracks were ever played on the AM or FM stations."

"Our new album—'Electrified Funk'—is just the opposite," said Bassett. "It's something that we believe will get a lot of airplay."

Maduri played the new album's single, *Baby*

Don't You Know. Parissi's voice exploded from the over-sized speakers: "Baby don't you know that the honkies got soul . . ." "We realize that it sounds very much like our first hit," he explained. "But it was something we felt we had to do. It's the best shot we could come up with because it's the perfect answer to *Play That Funky Music*. What we hope this will do is resolve the whole black-white confusion."

Judging from the new ten-song LP, listeners will probably continue to be confused as to whether the band members are black or white, especially on two soul ballads, *Closest Thing to My Heart* and *Hold On*. Other cuts include some heavy rockers and a disco tune, *Dancin' Music Band*. The title song and *It's All Up to You* are expected to get the most airplay. The latter is the only one that Parissi didn't write.

The band seems proud of their first album, but feels, inevitably, that the second is much better. "We were better prepared this time," said Parissi. "We rehearsed for two weeks and then cut the album in five days. We made sure that we didn't over-rehearse and that we went into the studio with fresh ideas. I wrote the songs while we were on tour with the Average White Band and the Isley Brothers. Each one took about three hours to write."

Despite its initial success, Wild Cherry has remained an opening act. "We don't care whether we open headline," said Wentz. "We'll do whatever helps the most."

They will be playing a lot of college dates, because student response has been the strongest of any audience. After spring performances in Australia, they plan to play the entire AWB tour. Negotiations are also under way for several TV appearances, due to the success of last year's guest shots on the *Dinah Shore Show*, *Midnight Special*, and *Rock Concert*. "We noticed increased record sales immediately following each appearance," said Maduri.

Parissi says that the band has "no hours and rules on the road. We're adults, and try to act accordingly. We do our entertaining on stage, not off. It took a lot of hard work and trust to get where we're at. We're not going to blow it by playing childish games."

The most gratifying touring experience for them has been their acceptance by black audiences. "When we first started touring, about 90% of the audiences were black," said Beitle. "They seemed startled at first to see that we were white, but immediately warmed up to us and made us feel real comfortable while we were performing."

Maduri feels the only thing that could hurt Wild Cherry at this point is that some are "expecting too much from the band because of last year's success. We knew no matter what single we released or how good the new album was, it just wouldn't be good enough for a lot of people. They think that unless we go platinum again, or at least gold, we're a one-shot group. The critics and skeptics just aren't aware. There are only a few acts that get gold or platinum records with every release.

"I'd love to see them do it again, but it's too much to even hope for, let alone expect. And it won't be the end of the world if they don't. Wild Cherry is going to be around for a long time." ●

by Fred Miller

Studio Circuit

Making Star Tracks: Record Plant, Electric Lady, Mediasound

Chances are that a healthy segment of your record collection was recorded at the Record Plant, Electric Lady, or Mediasound. These studios, among a select few in the country, are responsible for the work of Carly Simon, the Rolling Stones, Peter Frampton, Stevie Wonder, Janis Ian, Eric Clapton, and countless other musical superstars. What exactly is it that sets them apart from the thousands of other fully equipped facilities across the country? Why do the big-name artists and producers keep coming back? In an effort to penetrate the mystique, I spent a few days casing the three studios. The Record Plant, which has perhaps the most extensive facilities, has four studios used for recording. All have a MCI 24-track recorder, a full complement of Dolbys, a Hammond organ with a Leslie speaker, custom-built consoles and Westlake monitor systems, limiters, compressors, expanders, flangers, phasers, noise gates, and microphones sufficient to cover about any situation. Maintenance engineer Penn Stevens' unique staff stays pretty busy keeping all of this in top operating condition, in addition to appraising and modifying new equipment as it arrives. Occasionally these modifications have even been adopted by the manufacturers for use in subsequent models.

I asked Shelly Yakus, the Plant's chief engineer, about noise reduction (engineers' preferences differ widely on this subject). He feels that for rock, the studio's mainstay, the signal level on the tape should be hot enough to eliminate the need for accessory noise-reduction systems such as Dolby and DBX. Shelly worked with Phil Ramone at A&R Studios in the late Sixties when four-track was still the standard multi-track configuration(!). Since coming to the Record Plant, he has worked with "a lot of groups you've never heard of," plus some more familiar acts: John Lennon, Bruce Springsteen, the J. Geils Band, Chick Corea, Cheap Tricks, and Kiss.

The Record Plant's owner, Roy Cicala, is also an engineer of high repute. His credits include Big Pink, Van Morrison, Gordon Lightfoot, Frank Sinatra,

Frankie Valli, Jimi Hendrix, Frank Zappa, and The Animals. Roy showed me into his new mixing room, which is very clearly his baby. The room was designed according to his specifications—not only equipment, but decor and lighting as well (a crystal chandelier



*Studio A at Mediasound, a converted church (top),
and Studio A at Electric Lady*

The ultimate in separation—Record Plant's "piano box" in Studio C



hangs from the vaulted ceiling). He was in the process of mixing a new record for the J. Geils Band, and it was obvious that despite all the pressures of running the business he was having a hell of a good time in his new room working on music he digs.

None of the four studios has a sealed drum booth; all use baffles for isolation. One of the rooms on the tenth floor has a grand piano with a plywood box built around it (similar to Elton John's recording setup) for complete separation from other instruments. We discussed recording tape: Record Plant uses the new Grand Master tape from Ampex which Roy feels has lower harmonic distortion and more headroom than other low-noise tapes.

The Plant not only masters lacquers made from its own tapes but does some outside work as well. The relatively large staff (thirty) exudes an aura of relaxed professionalism and seems very friendly, which no doubt accounts in part for the frequent return of their clientele. No jingles, industrials, or spoken word here: Well into the Seventies the Record Plant continues to be a *record* studio.

The Electric Lady is smaller than the Record Plant—and kinkier—but no less state of the art. Founded in 1969 by guitarist Jimi Hendrix and his manager Michael Jeffries, the Lady was conceived as a new kind of creative workspace for musicians. The majority of professional recording studios at that time were located in midtown Manhattan. By building a studio in a Greenwich Village basement, Hendrix and friends could get away from the shirt-and-tie atmosphere of "uptown," the pressure of the studio clock, and the frequently jaded approach of the more commercial engineers. While the decor was to be strictly Sixties Psychedelic Outrageous (including a pop culture collage in the bathroom), Hendrix and chief engineer Shimon Ron wanted only the best in equipment. The result was a debt of over a million dollars and a continually postponed opening date.

Once the Electric Lady did get off the ground, however, waiting to afford the finest proved worth it. Ron had installed Ampex MM1000 multitrack machines, Altec monitors, the then-new Dolby noise-re-



*Left and above:
Roy Cicala's baby, The Mix Room at Record Plant*



duction system, and a full complement of high quality microphones. And the Studio A recording console was designed with 32 output busses at a time when 16-channel recording was just beginning to become popular. So when Electric Lady went 24-track not too long ago, little modification to the original equipment was necessary. At present, both rooms are equipped with MCI 24-track recorders, with interchangeable 16-track heads. Altec monitors are still used, and the consoles, which are updated periodically, have Automated Processes equalizers and faders at this writing. A round-the-clock maintenance staff uses some of the finest testing gear available to diagnose, prescribe for, and cure just about any ailing item in the studio's vast inventory.

Studio A utilizes a live end/dead end approach, with one side of the room constructed of hardwood surfaces to provide a concert hall ambience for wind and string instruments. The other side is carpeted (walls, floor, and ceiling) to reduce reflected sound and leakage. A large number of gobos, or baffles, in varying sizes, can be moved around the room to create small isolation areas.

Shimon Ron, who also worked with Phil Ramone at one time, attributes the Electric Lady's success to "good sound and good feelings." Without a doubt, the Hendrix name helped the studio in its early years, but



Starting top, from left to right: The Lounge, Mediasound; The Mix Room, Record Plant; Studio A, Mediasound; Studio A, Electric Lady; Studio C, Record Plant





From the top: Studio C at the Record Plant, Electric Lady's kinky walls, Studio A at Mediasound

it has stayed as busy as it is today because of the quality of the product.

Mediasound, as its name implies, earned its early reputation by recording for "the media." Current activity includes the music for *Sesame Street* and *The Electric Company*, television and radio commercials, and movie soundtracks—setting it apart from the Record Plant or Electric Lady. In recent years, however, the studio has become a favorite of many pop mainstream and disco recording artists. The reputation gained from some work for Stevie Wonder, Martha Reeves, and Kool and the Gang eventually brought the likes of Barry Manilow, Van McCoy,

Melba Moore, Melanie, the Stylistics, Hubert Laws, and the Maynard Ferguson Band to its door.

I spoke with Susan Planer, who with owners Joel Rosenman and John Roberts (they were behind the Woodstock Festival) is responsible for the growth of the facility. Susan joined the staff before the doors opened in July of 1969, having worked at National Recording and Fine Recording in New York. She recalls that the original concept was to provide a full service studio, where a client could cut his master tape, have it made into a lacquer, order cassette and/or open-reel duplication, or have transfers made to film. And, by choosing a location on Manhattan's West 57th Street, Media would be within five minutes of the greater part of New York's music industry. It seems to have been a good idea. Seven years ago Media opened for business with two engineers and a 12-track recorder; it now boasts four recording studios, a disc cutting room, new 24-track Neve consoles and MCI recorders, a studio staff of fifteen, and a maintenance staff of seven. The monitors are Big Reds with Mastering Lab crossover networks, all recently installed.

Engineer Fred Porter gave me the grand tour of all the studios. Media occupies what used to be a church, and Studio A is the converted sanctuary. The incredibly high ceilings and stone walls give the room a beautifully huge sound, and it is large enough to accommodate a full orchestra. Movable gobos can be positioned to create isolation areas. Their unusual height—some are ten feet tall—lends flexibility to a room that might otherwise be too reverberant for modern multitrack recording. A total isolation booth adjacent to the control room can be used for live vocals, an announcer, or a quiet resting place between takes. Studios B and C, downstairs from the church proper, are smaller but work well for their purposes. I did my first 16-track recording in Studio B back in 1971, and over the years it has become known as the "hit room"—nothing to do with my being there, unfortunately. Studio C is used for overdubs and mixing; the fourth facility, the Lounge—so-called because it used to be the engineers' lounge—is on the second floor and is the favorite of several pop producers. An unusual aspect of Media's operation is a strict policy of promoting from within the company. Everyone on the staff starts out in the shipping department and works up through tape duplicating, setting up sessions, "gofering" for engineers, and many hard hours of on-the-job training. (Trainees are also allowed to record during off hours for practice.) Only then are they given the opportunity to sit down at the board to do a paid recording. Susan finds that this system works extremely well. Several of Media's engineers and producers with gold albums to their credit came to the studio as untrained teenagers. Not the kind of place to rest on past achievements, the studio plans to use the talent on its staff for expansion. This includes a possible production organization that will offer arranging, new talent development, and sale of finished masters to record companies.

The formula behind the mystique seems to be a simple one: a combination of the finest recording equipment and total professionalism. Maybe that's all there is to it—but it's a formula that eludes all but the best. ●

by Bob Ford Jr.



CBS Records: Muscle in the Marketplace

Success for the recording artist today no longer hinges on individual talents alone. More often than not, a label's willingness to invest large sums in studio costs and advances and its ability to move hundreds of thousands of discs quickly and efficiently into the marketplace are the key ingredients in making or breaking a career. It is understandable, then, that competition among record companies is fierce. Those that are smaller and/or privately owned are pitted against recording conglomerates, but both sides are equally pressured by the public's changing musical tastes and in-house need to turn a profit. And the ability of a label to perform as a marketing/a&r/sales force takes on an added importance when you consider that the rewards for performer and label alike can reach into the millions of dollars.

At CBS Records, where the emphasis on marketing expertise has grown steadily in the past decade, the track record is impressive, though subject to criticism. Claims that CBS is one of the better labels—if not the best—when it comes to producing and selling records are often countered by charges that the company uses its financial muscle to sign and promote acts in an overly aggressive way, sometimes unfair to the competition. Label executives scoff at the latter notion, citing that market demands require an aggressive stance on the part of all record companies. They add that commitments to their artists preclude anything short of an all-out effort.

Called home by a number of top-name recording acts (Bob Dylan, Earth, Wind & Fire, Andy Williams, Paul Simon, Barbra Streisand, Aerosmith, Charlie Rich, Chicago, and Neil Diamond among them), CBS has grown from its founding as the Columbia Phonograph Company in 1889 to a point where today its shaping of musical tastes is felt virtually around the world. Internationally, more than twenty-three subsidiary and/or joint-venture operations and seventeen licensees offer CBS product, while at home the listening public is given its choice of music and artists on Columbia, Epic, several custom labels (smaller recording operations that pact with CBS for marketing, promotion, and sale of their product via CBS branch outlets around the country), and the Los Angeles-based Portrait label. Portrait, unveiled last summer, is the first in-house pop label created at CBS since Epic's founding in 1955.

Roster checks and balances

While corporate rationale behind Portrait was to "fully establish CBS as a two-coast record company," some ob-

servers have opined that the label's main function is to lift weight off what they see as overcrowded artist rosters on both Columbia and Epic, especially in light of CBS's having signed more than one hundred new acts in the last year and a half. CBS execs strongly deny the theory. They say that Portrait is designed to strengthen West Coast presence and that the label will operate with only a small, select roster. (Debut signings to Portrait were ex-Guess Who leader Burton Cummings and Joan Baez, whose final album on A&M was released this past fall.)

Bruce Lundvall, president of the domestic CBS Records Division, explains that while the company has inked a host of new talent—most of whom already have established market identity—the actual size of its artist roster has not grown appreciably in the past year. Constant review and trimming of those acts that do not sell is the balancing point. Lundvall also notes that CBS's closest competitor, the WEA Group (Warner Bros., Elektra/Asylum/Nonesuch, and Atlantic), signed approximately the same number of acts during the period.

Making the million-seller

This move to sign acts with consumer recognition from previous label affiliations is based on a CBS belief (and confidence) that its marketing setup can generate substantial sales gains over those the artist may have produced in the past. In the words of Walter Yetnikoff, CBS Records Group president, "Record for record, given equal artistic input, we will outsell by far any other company." Competitors may wince at the statement, and the skeptical may question it, but to the artist, personal manager, and record store owner, Yetnikoff's words bear the ring of truth, backed by the ring of the cash register. In 1975 CBS produced approximately fifty gold records, and last year's tally runs a close second with a total of forty. Sales at CBS for each of the years were in the hundreds of millions of dollars.

Yetnikoff's viewpoint is that CBS is not interested in artists in the pop/contemporary field who in the end would be selling no more than 100,000 units per album. He stresses the words "in the end." The goal is to work with acts who have the upside potential of going gold. When not signing totally new acts, the company goes after established artists with a base audience who can initially sell anywhere from 100,000 to 300,000 units per album. The idea is to then turn the act into a million-seller.

More often than not, this doesn't happen overnight. But CBS's policy, says Lundvall, is to "stick with our artists if we

CBS RECORDS GROUP

Walter Yetnikoff, President

CBS INTERNATIONAL

Dick Asher, President

INTERNATIONAL PUBLISHING

Lou Raguso, Director

CBS RECORDS DIVISION

(Domestic)

Bruce Lundvall, President

COLUMBIA SPECIAL PRODUCTS

Al Shulman, VP

Collectors' Series

EPIC/CBS ASSOC. LABELS

Ron Alexenburg, Senior VP

PORTRAIT RECORDS

Larry Harris, VP & Gen. Mgr.

CBS MANUFACTURING

(Record pressing)

Albert Earl, VP

PRODUCTION DEAL

(Company sells finished master to Epic; logo does not appear on product.)

TREE INTERNATIONAL RECORDS

Jack Stapp & Buddy Killen

Joe Tex

CUSTOM DISTRIBUTED LABELS

(Label maintains own identity on product.)

KIRSHNER RECORDS

Don Kirshner

Kansas
Elliott Randall

T-NECK RECORDS

Isley Brothers

Isley Brothers

CARIBOU RECORDS

James Guercio

L.A. Express
Dennis Wilson

VIRGIN RECORDS

Richard Branson, U.K.
Charles Levison, U.S.

Boxer / U-Roy

JOINT LOGO DEAL

(Company shares label credit with Epic on all product.)

SWEET CITY RECORDS

Herb & Mike Belkin

Wild Cherry

FULL MOON RECORDS

Irv Azoff

Dan Fogelberg

believe in them." He cites Boz Scaggs, with the label for six years (three albums) before "Silk Degrees" took off and became his first million-seller.

Yetnikoff backs Lundvall's viewpoint on artist development: "You can't bend artists to the marketplace. You have to let them mature into the type of performer you are looking for."

Occasionally, the artist without any market identity is signed by CBS, proving that the one-in-a-million shot *can* happen. An unsolicited demo tape came into the office from the group Boston and what resulted was a contract with Epic and a true success story. Boston sold more than 300,000 units of its debut album in three and a half weeks. "We're basically all armchair a&r people at CBS," says Lundvall, "from people in the promotion department, the accounting department, to the salesmen and the actual a&r staffers."

He feels it is important to constantly be on the lookout for something new, good, and nonderivative.

"We do listen to everything sent in, and we are looking for new artists," he says, "but it is rare when something like what happened with Boston occurs." In all but a few cases, label deals are worked out through personal managers and/or lawyers.

Notably, CBS backs its a&r decisions (and artists) with considerable marketing research and execution. Very few weeks go by when label staffers aren't in the field reviewing buying trends, musical tastes, reactions to pricing, radio station programming, etc. From store displays to press parties to radio, television, and print advertising, the dollar commitment is indeed enormous—enough so that every release has a detailed marketing plan in writing before it is shipped.

The marketing of records and tapes has become "very sophisticated" in recent years, Yetnikoff says, adding that one area to watch will be the increased use of television as an advertising medium by CBS.

The apparatus is there: the CBS branch offices, the diversified musical approach, the custom label operation affording broader scope, the marketing punch, and the individual label rosters, each with its share of talent gone gold. With good cause, many artists would give a great deal to have the CBS marketing commitment backing their musical message.

[Next month, BACKBEAT will take an inside look at the successful operation of a smaller, independent record company.]

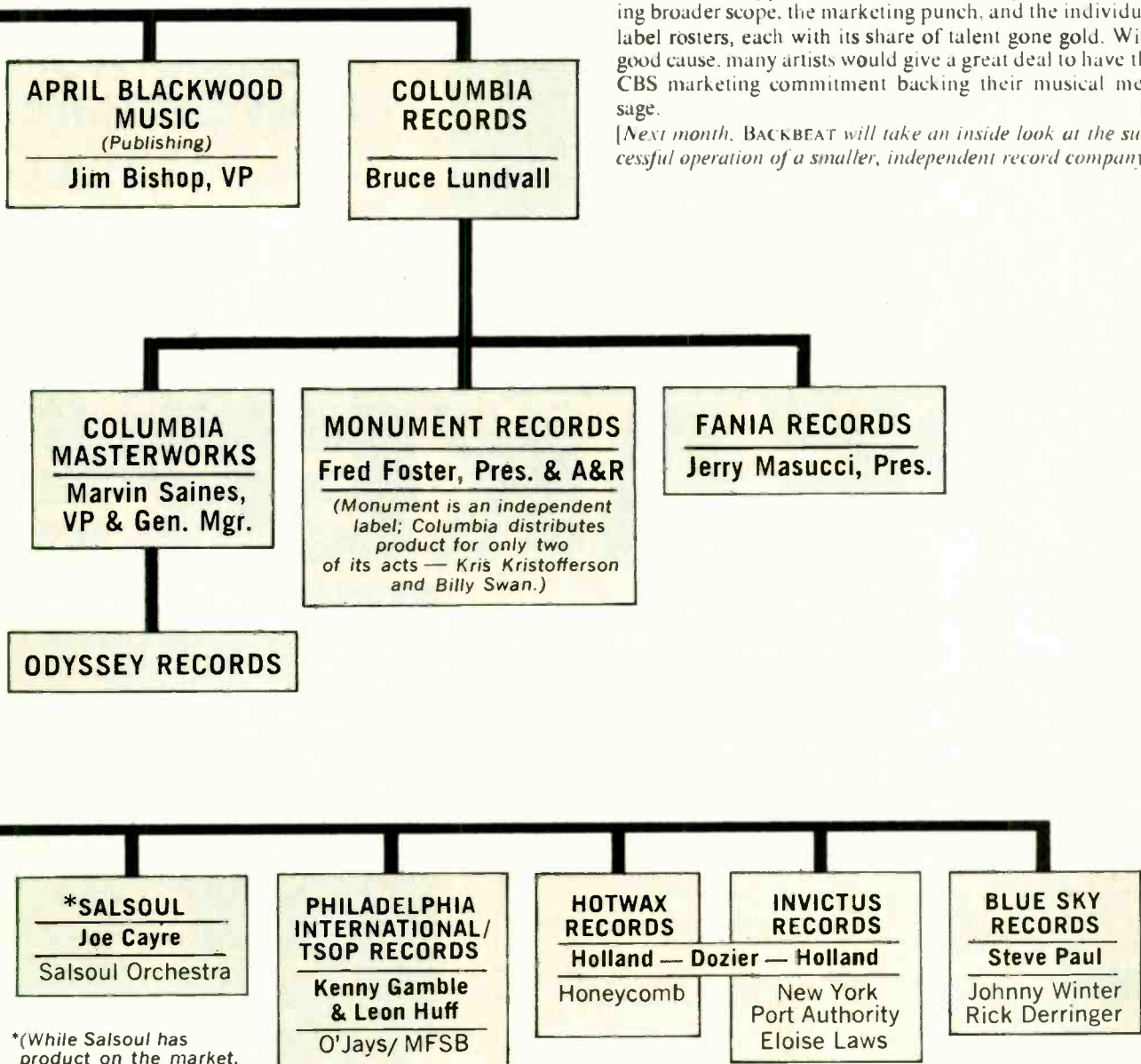

*(While Salsoul has product on the market, the label is currently inactive within CBS. Epic has first refusal rights on Salsoul masters and as yet has not activated its option to distribute.)

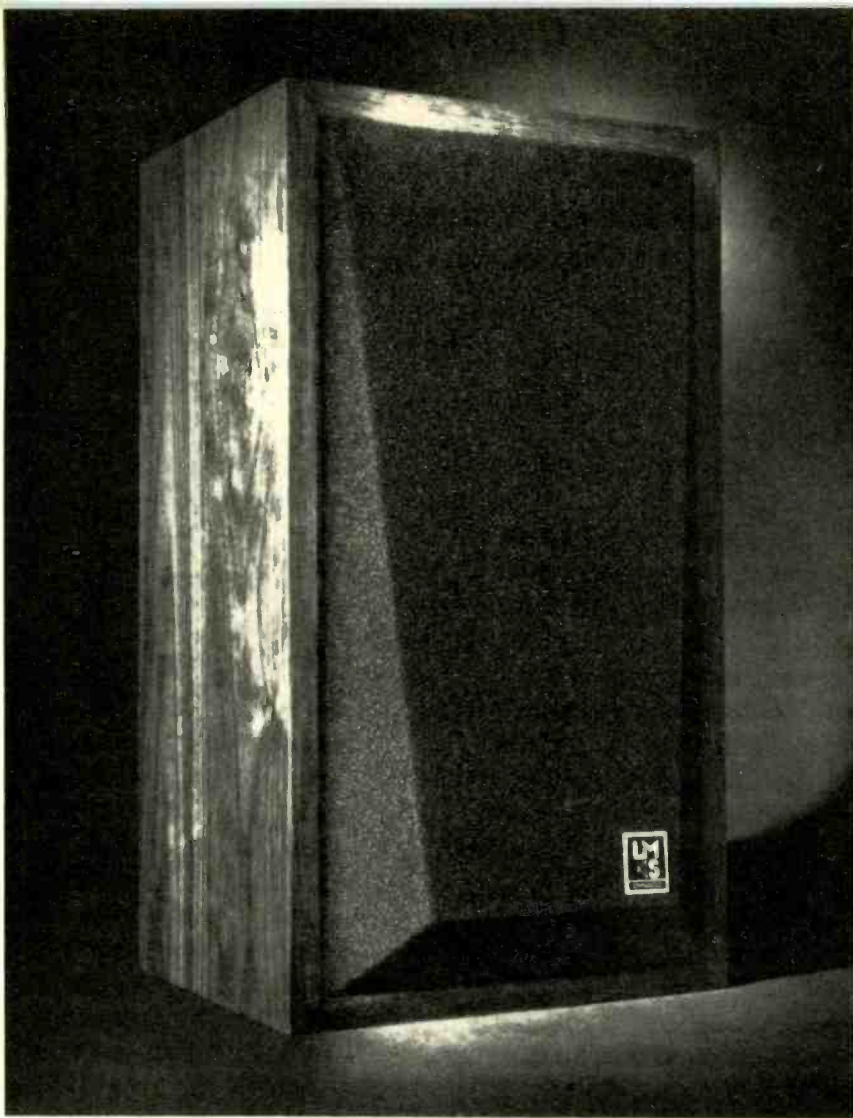

The sound the
audio world
now demands.
Dynaco's

LMS SPEAKERS

LMS: The new Dynaco hallmark of its **Laboratory Monitor Series**—speakers with lasting musical satisfaction. The rock-solid beauty of one inch thick genuine walnut veneer cabinets (33% thicker than the others) enhance the sound as well as the decor. They complement the output of high compliance linear suspension woofers with massive magnet structures and oversize 4 layer voice coils for highly efficient transfer of maximum energy levels. Rigidly isolated 5 inch midrange drivers add maximum definition in the three larger models. The same aluminum voice coil ultra-dispersion dome tweeter used throughout is paired in the top two models for maximum energy capability.



*Only at selected dealers—write for one nearest you.
Priced from \$169—approximate retail value.*

For descriptive literature write
LABORATORY MONITOR SERIES by DYNACO, INC.
Coles Road—Box 88, Blackwood, N.J. 08012 · 609/228-3200

CIRCLE 11 ON READER-SERVICE CARD



Input Output

Instruments and Accessories



Flanging, a sound effect that has been described as “playing through a jet engine” or “turning the sound inside out,” has become increasingly popular with rock musicians over the last few years. Early in the Sixties it was achieved by feeding the same signal through two tape recorders to a combined output. The speed of one deck was varied by gently thumbing the flange (hence the term “flanging”) of its supply reel. The flanged output signal was delayed by a few milliseconds, and as it was combined with the other machine’s output it created some unusual, and often pleasant, sonic effects.

The recent availability of digital and analogue time-delay circuitry has enabled manufacturers to create this effect without the use of tape decks. Flangers, phasers, and time-delay systems range in price from \$50 to \$50,000, and the quality range is as wide.

The Electric Mistress. This device from Electro-Harmonix, advertised as a flanger, produces additional sounds not available from true flanging as described above. Adjustable by means of three knobs (rate, range, and color), the Electric Mistress can enhance or change the sound of your instrument dramatically. I played a Fender Rhodes electric piano through our review sample and, although somewhat noisy, it produced a nice-sounding chime effect. With the

rate and range controls wide open, the speed and depth of the effect almost completely masked the Fender’s original sound.

We did some further testing on a rock recording session with guitarists John Tropea and Jeff Miranov. Unfortunately the Mistress was excessively noisy when inserted into the line between the guitar and either of the two different Fender Twin Reverb amps. Most annoying was the leakage from a swept oscillator, which could be varied in rate but not silenced. When we finally did cut the record, we had to substitute a quieter flanger.

The housing is less than impressive—a light-gauge metal case with a plastic slide switch. The circuit board inside is sloppily constructed, using enough sol-

vent approach, feeling that speaker-cabinet vibrations will sooner or later take their toll on any electronics contained in the same enclosure.

With the new Control Unit 1520, Barcus-Berry seems to be following a middle-of-the-road course. It is a preamplifier system, designed for use with the company’s 1600 Series of power speaker modules. Because each module contains its own power amplifier, the 1520, with its wide range of tone controls and special effects, is designed as a separate component and may be placed some distance from the speaker module. Thus the musician does not have to sit on top of his own speaker to reach the controls.

The Control Unit has a lot going for it. The instrument input section has a sensitivity control before the volume control

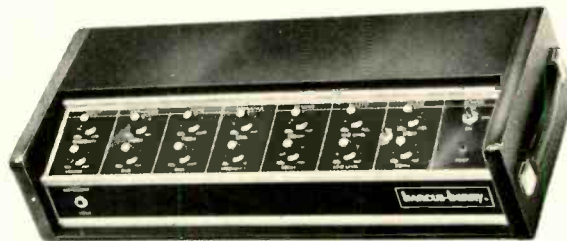

Barcus Berry Control Unit 1520

der for two units, and the battery “compartment” is just a piece of styrofoam. This construction doesn’t inspire confidence or suggest durability under heavy use.

The Electric Mistress may be powered by two standard 9-volt batteries or an AC adapter (available from the manufacturer). It weighs 1 pound, 10 ounces and retails for \$199.95.

CIRCLE 121 ON READER-SERVICE CARD

Barcus-Berry Control Unit 1520. There’s still some disagreement among technicians and musicians as to the makeup of the ideal instrument amplifier system. Some favor an integrated system, with all the electronics built into (or on top of) the speaker cabinet. Despite the obvious operational simplicity of such a setup, others prefer the separate compo-

to compensate for differing output levels from other instruments. With the help of Phil Kapp and Hector Centeno of Terminal Music in Manhattan, we tried a Fender Stratocaster guitar and a Gibson Howard Roberts model through the 1520 and its companion Model 1601 power speaker module. The tone controls were excellent. In addition to the usual bass and treble, there is a midrange equalizer that is adjustable in frequency from 300 to 500 Hz. The reverb circuit has the usual volume pot and an additional control for decay time. (The latter seems to vary only from long to very long, so its usefulness is somewhat limited.) The 1520 has a built-in phase shifter that sounds good and eliminates the need for another pedal and attendant cords. There is also an “expander” that extends the range of the bass and treble

controls. Other features include an accessory mixer input, a tape input with its own volume control (for mixing prerecorded sounds with the live ones you're making), a separate echo send/receive patch for inserting delay devices, another footswitch patch for various pedal-operated devices, and four separate output jacks for tape recorder, headphones, microphone line, and power amplifier. A convenience AC outlet is also provided on the back panel.

When used with the 1601 speaker module, the system worked beautifully at lower playing levels, yielding a clean sound with even response over a wide range. At louder levels, the sound was marred by some distortion, despite our efforts to eliminate it by varying the ratios of guitar signal, sensitivity, and input volume. This unit has a built-in phaser but lacks some common rock & roll features like a "bright" switch and multiple instrument inputs, so it seems to have been designed for use by lighter players. With the sound so clean at low volumes, the 1520 should make a nice amp for the jazz or studio musician, or for small clubs and background musings. Manufacturer's specifications are as follows: Frequency response, ± 1 dB, 100 Hz to 20 kHz; total harmonic distortion, 0.25%, 100 Hz to 20 kHz; input sensitivity control, 20-dB range. The suggested list price of the 1520 is \$247.50; it weighs 13 pounds.

CIRCLE 122 ON READER-SERVICE CARD

Novaline Concert 88. The 88 is a full keyboard electric piano, topping a line of smaller keyboards from this company. It is simple to operate, with only an on/off switch and volume control on the front panel. The underside provides an accessory input jack and an output jack that allows the use of an external amplifier, more powerful than the one built into the Concert 88. The keyboard action is smooth and even; it has a pleasant sound, and the tuning remains stable. It does sound like an electronic instrument, which makes the company's claim of "truest piano sound" seem somewhat overenthusiastic. As with most of the more popular electric pianos of the day, the Novaline 88 has a sound of its own, and it may be used where a Fender

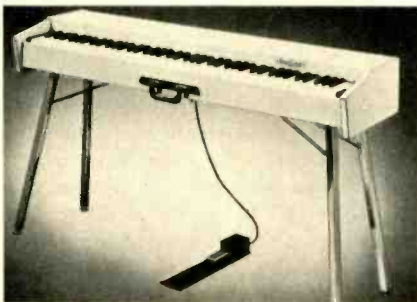

Novaline Concert 88

Rhodes, for instance, might not be desirable due to its limited color possibilities. As a bonus, the sound does not distort when the keys are hit hard—a common fault with electric keyboards.

Novaline Concert 88 comes self-contained with a sustain pedal, carrying case, and rather spindly collapsible legs. It weighs 58 pounds and, with the internal amplifier, costs \$1,250. The 88-S, without amplifier, costs \$1,150.

CIRCLE 123 ON READER-SERVICE CARD

Omec Digital Amplifier. Last month I discussed recent advances in integrated circuitry and the coming availability of instant information retrieval for the everyday consumer. Well, it's coming faster than I thought. Orange Musical and Electronic Corp. of England has announced the Omec Digital Amplifier, scheduled for spring delivery in the U.S. (No samples were available to us at presstime.)

The Omec is the first of its kind. No more volume controls, tone controls, potentiometers, or mechanical switches. The amp uses digital memory circuits that the player programs through a front-panel control keyboard. The memory circuits allow any one of four preset programs to be recalled instantly at the touch of a selector—and the choice of program is displayed on the front panel. Alterations to the volume/equalization setting can be made while playing, and these are automatically incorporated into the memory circuits when the channel is changed. Tone controls are said to have a 36-dB range for bass, mid-range, and treble, and the spring reverb is equalized. Three types of distortion are available from the unit, which contains a limiter-compressor that should deliver a distortion-free sustain, if desired. Omec claims that each of the four channels can be programmed to yield 806,737 sound combinations—which ought to be enough to keep anyone busy—and any of these can be duplicated at a later time by noting the settings that were needed to create them. The Omec Digital Amplifier (which, by the way, does not come with a speaker cabinet) will be distributed in this country by International Musical Instruments. Suggested list price is \$995.

CIRCLE 124 ON READER-SERVICE CARD

Maestro Sound Products has introduced a new concept in foot-pedal sound-processing devices. Unlike other pedals, these allow the musician to control all functions with his foot, eliminating the need to give up the use of one hand to adjust the effects. Each of the four new pedals is housed in extruded aluminum and solid die-cast zinc, affording durability and sufficient weight so as not to creep across the stage. Rotary pots at the housing sides are large

enough to be manipulated by the foot, and the lettering is easily visible to the standing musician.

Maestro Stage Phaser (MPP-1). This is a six-stage phaser with variable speed and depth control operated by the foot. A center switch makes it possible to select either of two preset phasing speeds. A status light indicates whether or not the phasing effect is in circuit. The control wheels at the side light up when the accessory battery eliminator is used. Output noise is -82 dBm, insertion loss, 0 dB. Suggested retail price: \$149.95.

CIRCLE 125 ON READER-SERVICE CARD



Maestro Stage Phaser

Maestro Phaser (MP-1). A trimmed-down version of the Stage Phaser, this model does not have the two presets, status lights, or the illuminated control wheel. Like the more expensive model, it does have six stages with variable speed and depth control. Manufacturers' specs are identical to the Stage Phaser; list price is \$79.95.

CIRCLE 126 ON READER-SERVICE CARD

Maestro Fuzz (MFZ-1). This distortion device has been designed to provide a wide range of control over a full complement of fuzz voicings. One drive foot-control knob adjusts the intensity of the fuzz effect produced by low-order harmonic distortion. The second knob is for volume adjustment. Maximum output level is $+5$ dBm; input noise, -100 dBm. Suggested retail price is \$49.95.

CIRCLE 127 ON READER-SERVICE CARD

Maestro Fuzztain (MFZT-1). In this device Maestro has added a sustainer (compressor) to the basic fuzz pedal. In addition, a foot selector switch gives pure sustain, soft fuzz, or hard fuzz. When used with battery eliminator the foot controls light up and a status light indicates whether the unit is on or off. Maximum sustain (compression) is 45 dB. Compression threshold is listed at -55 dBm, compressor attack time at 10 milliseconds, and compressor release time at 500 milliseconds. Suggested retail price is \$79.95.

CIRCLE 128 ON READER-SERVICE CARD

FRED MILLER

Creative Technology!

The MXR Compaander and Stereo Graphic Equalizer provide you with the ultimate in creative sounds.

The MXR Compaander is a noise reduction device capable of doubling the dynamic range of most open reel and cassette tape decks, allowing professional results in home recording. In operation the Compaander compresses the dynamic range of the signal going onto the tape and expands the dynamic range upon playback. With the MXR Compaander noise is reduced enabling the softest sounds to be heard, while musical peaks can be reproduced without distortion.

The MXR Stereo Graphic Equalizer, a natural companion, is a two channel frequency equalizer that offers ten bands of discrete adjustment on each channel. The primary function of the MXR Equalizer is to provide precise compensation for aural tone quality discrepancies that may be caused by room acoustics, speaker inadequacies, or program sound quality. With a touch of the slide control the MXR Equalizer will tailor your playback to suit any number of variables and develop the mood you want to hear.

Both the Compaander and Equalizer are compact, stylish and handsomely packaged in black anodized aluminum with walnut side panels. Their design and circuitry will complement any modern Hi-Fi system.

The MXR Compaander is attractively priced at \$129.95 and its companion the MXF Stereo Graphic Equalizer at \$199.95.

MXR products have become the standard for signal processing in professional recording and live musical performances. This combination of engineering excellence and creativity provides you with superior MXR products.

For more information on MXR products, see your nearest MXR dealer or direct inquiries to MXR Innovations Inc., 277 N. Goodman Street, Rochester, New York 14607 (716) 442-5322.

MXR Consumer Products Group



CIRCLE 49 ON READER-SERVICE CARD

DON HECKMAN
 STEPHEN HOLDEN
 JOHN STORM ROBERTS
 FRANK ROSE
 SAM SUTHERLAND
 JOHN S. WILSON

Joni Mitchell's "Hejira"

Having dramatically extended the scope and scale of her self-produced recording style since 1973, Joni Mitchell now executes an equally radical retraction of that context on "Hejira" to again explore the small ensemble setting. If that sounds like one step forward, one step back, it's not. Melodically and instrumentally, the new songs revise her earlier, more intimate studio approach, but through impressionistic arrangements and Mitchell's subtle but pervasive production coloring (achieved with engineer and longtime coproducer Henry Lewy), the resulting mood and perspective achieve a distinctive unity.

For those admirers gained during her commercial crest ("Court and Spark"), the move may prove jarring. Yet Mitchell's return to a more modest framework was anticipated in last year's experimental "The Hissing of Summer Lawns." In "Court and Spark," a lavish and richly detailed orchestral emphasis, complemented by more aggressive rhythm playing and expansive vocal harmonies, charged her songs with cinematic intensity, underscoring the ongoing conflict between romantic mythology and the darker lessons of experience central to much of Mitchell's work. The evolution of that thematic issue influenced the more restrained, yet intricate jazz settings of "Hissing," which cooled its predecessor's passionate pop dynamics to comply with a looser, less structured melodic style dictated by the artist's increasingly convoluted narrative stance.

On "Hejira," that cooling process continues, coupled with a revived melodic definition that shares the evocative modal harmonic sense visible in her writing. The session crew has been minimized to a basic handful of elements, all texturally conceived: Rhythm sections are reined to a nearly subliminal yet elastic pulse, solos are submerged into the fluid, massed rhythm guitars played by Mitchell (who makes judicious use of electronics to achieve a rounded, thicker tone), and wind instruments and percussion are similarly overlaid to emphasize a total harmonic shape rather than melodic detail.



The balance between a modal compositional focus and the abstracted instrumental filigree provided by her support (with guitarist Larry Carlton, acoustic bassist Jaco Pastorius, and percussionists Bobbye Hall and Victor Feldman standing out) remains coherent throughout, making the LP's most immediate impact a cumulative one.

The songs treat familiar Mitchell motifs—brief lovers encountered as demonic agents for spiritual release,

friends reunited across cultural distances, self-reliant heroines still grappling with the chains of sexual and romantic convention—both symbolically and in direct narratives. While Mitchell's perspective is closer to "Blue" and "For

Joni Mitchell: Hejira. Henry Lewy, producer; musical direction by Joni Mitchell. *Asylum 7E 1087, \$6.98.*

Tape: ●● TC5 1087,
 ● TC8 1087, \$7.97.

the Roses" in its confessional intimacy, there are glimpses of the more journalistic sense of detail and characterization explored on "Hissing," and the combination makes the songs more emotionally engaging than the last album's elaborately visualized scenes. The elegiac *Amelia* and *Refuge of the Roads* echo the artist's often vehement rejection of mundane social convention and white-collar materialism—the skyscraper wasteland that has become a prominent feature in her emotional landscape—but the current vignettes reflect a greater compassion than the often embittered tableaux of "Hissing."

"Hejira" is a risk for Joni Mitchell, even in the afterglow of international acceptance at the broadest level, for the subdued intensity of these new performances demands far more from her audience than the heady romantic bloom that made "Court and Spark" so attractive to radio programmers as well as confirmed fans. Yet the risk is well taken. This album reaffirms Mitchell's commitment to a more intimately conveyed and humanly scaled approach to her psychic and emotional odysseys, an approach that here yields poetic and lyrical depth worth the risky commercial odds.

SAM SUTHERLAND

50 Years of Jazz Guitar. Michael Bennett, producer. *Columbia CG 33566*. \$9.98.

A fifty-year survey of jazz guitar on records that goes back to 1921, as this set does, has to be stretching things a bit. And Michael Bennett, who produced this adventurous and revealing collection, seems to admit as much by opening with a 1921 recording of an octocorda (a rarely used eight-string guitar) and immediately jumping to 1927 and '28 to consider the first significant jazz guitarists, Lonnie Johnson and Eddie Lang. From here to the set's terminal point, 1971, Bennett manages to include most of the major guitarists, although there are some notable absences in the '50s and '60s, such as Wes Montgomery, Tal Farlow, Jim Hall, Barney Kessel, none of whose records were available to him. But the earlier history is documented appropriately with pieces by Dick McDonough and Carl Kress, Django Reinhardt, Teddy Bunn, George Van Eps, and Charlie Christian (including a sampling by the pioneer electric guitarist, Eddie Durham, who inspired Christian to switch from piano to guitar).

Along with these obvious milestones, Bennett has turned up a fascinating array of guitarists who labored in virtual anonymity. Joe Sodja, for example, was a striking, Reinhardt-influenced guitarist of the mid-'30s; Coco Heimal, of Candy and Coco, swings lightly through a piece on which Gene Austin (the *My Blue*

Heaven crooner) plays some rugged piano; Leon McAllister, another early electric guitarist, blazes through the Jimmie Lunceford hit *White Heat* with Bob Wills's Texas Playboys; and, of a later vintage, Hank Garland, a country guitarist of the '50s, shows that he also had a strong jazz style. The great merit of this set, aside from the values of the individual performances, is that it reveals a much broader and deeper scope for the jazz guitar than even reasonably interested fans might be aware of. J.S.W.

Grupo Folclórico y Experimental Nuevayorquino: Lo Dice Todo. Rene Lopez & Andy Kaufman, producers. *Salsoul SAL 4110*, \$5.98. *Tape: S8T 4110*, \$6.98.

The Cuban-based hot Latin style called salsa has become so integrated that the New York Folk and Experimental Group is aptly named. Although the group is composed of some of the hippest musicians in the field, the extraordinary variety of its second album derives partly from the very wealth and cohesion of the Latin tradition itself. One number—*Cinco en Uno Callejero*—fuses rhythms and melodies from Cuba, Brazil, Puerto Rico, and the Dominican Republic. Another is a Brazilian street-samba, more punchy by far than the glancing, oblique bossa nova. But the Cuban-based numbers dominate the album and are richness enough, spanning classic Cuban country picking on the guitar-like *tres*, high Hispanic singing—macho-romantic without sentimentality—and the quite different but equally classic voices and drums of the Afro-Cuban *guaguancó*, a form whose melodies are as African as its percussion.

And the performances! Masterly vocal improvisation from Henry Alvarez and Virgilio Marti; ravishing trumpet from "Chocolate" Armenteros in the lyrical Cuban solo style that blends Roy Eldridge and the bullring; Don Gonzalo's flute weaving in and out of stormy ensemble brass like golden lightning; Bobby Paunetto's avant-garde jazz arrangement in *Corta el Bonche*; Alfredo Delafe's violin showing the bluegrass players what Cuba knows about down-home fiddle. Armenteros and Don Gonzalo come from the Cuban era that fueled U.S. Latin music's 1940s and 1950s Golden Age; Delafe and Paunetto are New York Latinos with avant-garde instincts. All four are as easy in jazz as in salsa. Their music—and that of everyone on the album—can only be characterized as avant-garde traditionalism. This very fusion makes "Lo Dice Todo" one of those rare recordings that necessitates no less than a rave review. J.S.R.

Emmylou Harris: Luxury Liner. Brian Ahern, producer. *Warner Bros.*

BS 2998 \$6.98. *Tape: M5 2998*, *M8 2998*, \$7.97.

With her third album Emmylou Harris may have finally laid to rest her audience's hopes for a crossover into pop. Harris sings country songs, but her earlier work as a folk interpreter and subsequent rebirth as the late Gram Parsons' protégée/singing partner impelled her earliest rock and progressive country fans to expect an ongoing stylistic revision over her faithful, immaculate country interpretations.

That view would render "Luxury Liner" a holding action, and in that respect the new album follows the patterns of its predecessors in theme, musical setting, and choice of material. The Louvin Brothers, Parsons himself, and Rodney Crowell are again chief sources; Harris' superb Hot Band and Brian Ahern's crisp yet naturalistic production dovetail seamlessly with her earlier recordings.

Yet these ten new performances prove as fresh and engaging as the last set, and as a former charter member of the Harris-For-Popdom contingent I find myself defecting at last to the country side. One decisive element is a subtle but pervasive new strength to an already potent vocal technique. Instead of gratuitous concessions to pop fashion, Harris offers less obvious but more significant revisions of her recorded personality: The purity and true pitch that have always given her voice a sweet lyricism are here balanced with emotional effects new to her style. The faster, rockabilly-tinged songs—Parsons' title tune and Chuck Berry's (*You Never Can Tell*) *C'est La Vie*—display a toughness and power only hinted at before.

Harris is letting her style respond more sensitively to the emotional force of each song, rather than the dictates of melody and phrasing. On the title cut she executes the urgent chorus with both precision and passion; on the Parsons/Ethridge *She*, purity of tone is sacrificed for an affecting huskiness that cancels earlier reservations about her girlish timbre.

"You're Supposed to Be Feeling Good" summarizes this new breadth in its smooth shift from delicate verse to dynamic chorus. The song is the album's one exception to fairly straightforward country rhythms and melodies, and moves with supple, syncopated momentum. Yet Harris and Ahern reinforce their carefully developed sense of style by including a couple of pure country classics, notably the Louvin's *When I Stop Dreaming* and A. P. Carter's *Hello Stranger*.

Unifying the work is Harris' underlying thematic intelligence, and a vivid song sense shared with producer Ahern. She breaks with cowboy-song tradition

in the dark, nearly mystical narrative power of Townes Van Zandt's *Poncho & Lefty*. And the LP's representative honkytonk cut, *I'll Be Your San Antone Rose*, rings with a bittersweet ironic sting that transcends its source points in the more bathetic country standards. When Harris sings, "If tonight you'll be my tall dark stranger, I'll be your San Antone Rose," she instills a weariness and quiet sorrow that transcend mere pity. If Jeanne Moreau sang country songs, I suspect they'd sound like this one. S.S.

George Harrison: Thirty-Three & 1/3. George Harrison, producer. *Dark Horse* DH 3005, \$6.98. Tape: ●● M5 3005, ●● M8 3005, \$7.97.

"Thirty-Three & 1/3" is being billed as George Harrison's idea of a fun record. It does have a couple of fun songs: *This Song* and *Crackerbox Palace*, the former a catchy piece of fluff, the latter a zany delight. But it also has a lot of semi-listenable dreck—some of it pallid, some of it self-righteous and stupid.

There may be a religious movement somewhere that inspires songs of beauty and light, but Harrison has not found it for all of his flirtation with Eastern mysticism. There may be accompanists somewhere who inspire music of strength and purpose, but Harrison hasn't found them either. Instead he is back with Gary Wright, Billy Preston, and Tom Scott, mediocrities every one. He has locked himself into an environment in which sloppy music and sophomoric lyrics become good enough. Like every Harrison album since "Concert for Bangladesh," this record couples the kind of juvenile self-discoveries that used to characterize Moody Blues songs ("It's easier to tell a lie than it is to tell the truth...") with the kind of crooning that follows extended bouts of psychic self-flagellation.

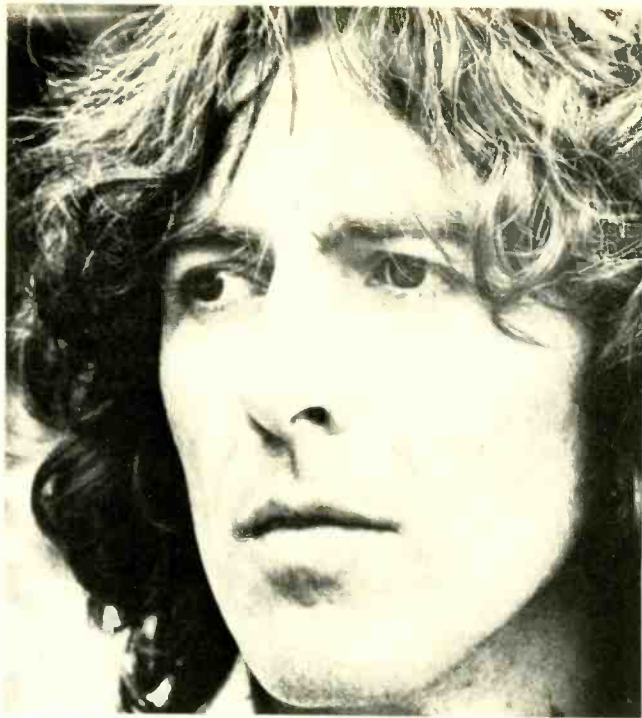

George Harrison—trying hard to have a good time

Crackerbox Palace proves that Harrison is still capable of giving a good time, but the rest of the album suggests he's seldom capable of having one. F.R.

Murray McLauchlan: Boulevard. Murray McLauchlan & Bernie Finklestein, producers. *True North* ILTN 9423, \$6.98. Tape: ●● ZCT 9423, ●● Y8T 9423, \$7.98.

"Boulevard" is the sixth album by this distinguished Canadian singer-songwriter, who has yet to receive due recognition in the U.S. Like his fellow countryman, Gordon Lightfoot, Murray McLauchlan writes and sings a folk-oriented style of pop. But where Lightfoot is content to evoke the troubadour's peripatetic existence with a glib bittersweetness, McLauchlan is much rougher-edged and finally a more compelling artist.

"Boulevard" presents a mercilessly unsentimental pageant of Canadian working-class life peopled with character types evoked by McLauchlan in very terse, emotionally charged language. To the psychotic killer in *Met You at the Bottom* McLauchlan says: "Everybody loves a loser/ They want to see him pay his dues/ Everybody loves a loser/ But they don't want to stand in his shoes." In *As Lonely as You*, he rejects a lonesome prostitute: "I can't stand to see you/ I can't look when you cry/ I can't help you no how/ I'm too selfish to try." *Gettin' Harder to Get Along*, *Train Song*, and *On the Boulevard* are driven by similar feelings of rage and futility. They present a morbidly realistic view of life in which everything appears to be in a state of spiritual and physical deterioration.

This is powerful stuff because McLauchlan avoids the trap of self-pity even as he explores the limits of compassion and emotional charity. His bluntness bars any impulse toward sentimentality. His strained but not unattractive voice, which resembles a world-weary Arlo Guthrie, complements the bleakness of the material. "Boulevard" is also McLauchlan's first "rock" album in that it is electronically, not acoustically, based. It recruits a respected Canadian session band, The Silver Tractors, whose music sounds uncomfortably crude on first listening, but subsequently translates into rough and muscular. Together, the singer, material, and band forge an album that comes close to the summit of neorealism in modern folkrock. S.H.

Phil Ochs: Chords of Fame. Michael Ochs, compiler. *A&M SP 4599*, \$6.98. Tape: ●● CS 4599, ●● 8T 4599, \$7.98.

"Chords of Fame" is a two-record career retrospective of the late folksinger Phil Ochs, and contains an affectionate reminiscence by poet Ed Sanders, numerous photographs, and twenty-four sides—some of them released for the first time. Though the portrait they fix is of a large talent perpetually frustrated by unattainable artistic ambitions, it also reaffirms that Ochs was the best political-topical songwriter of the early '60s and an important influence on Don McLean and John Denver. Ochs's most famous offerings like *I Ain't Marchin' Anymore*, have a simple formal integrity and passionate wit that made them the most persuasive protest songs of the period.

Continued on page 146



McLauchlan—the summit of neorealism

IF OUR TAPE SOUNDS BAD ON YOUR HI FI SYSTEM YOU NEED A BETTER HI FI SYSTEM.

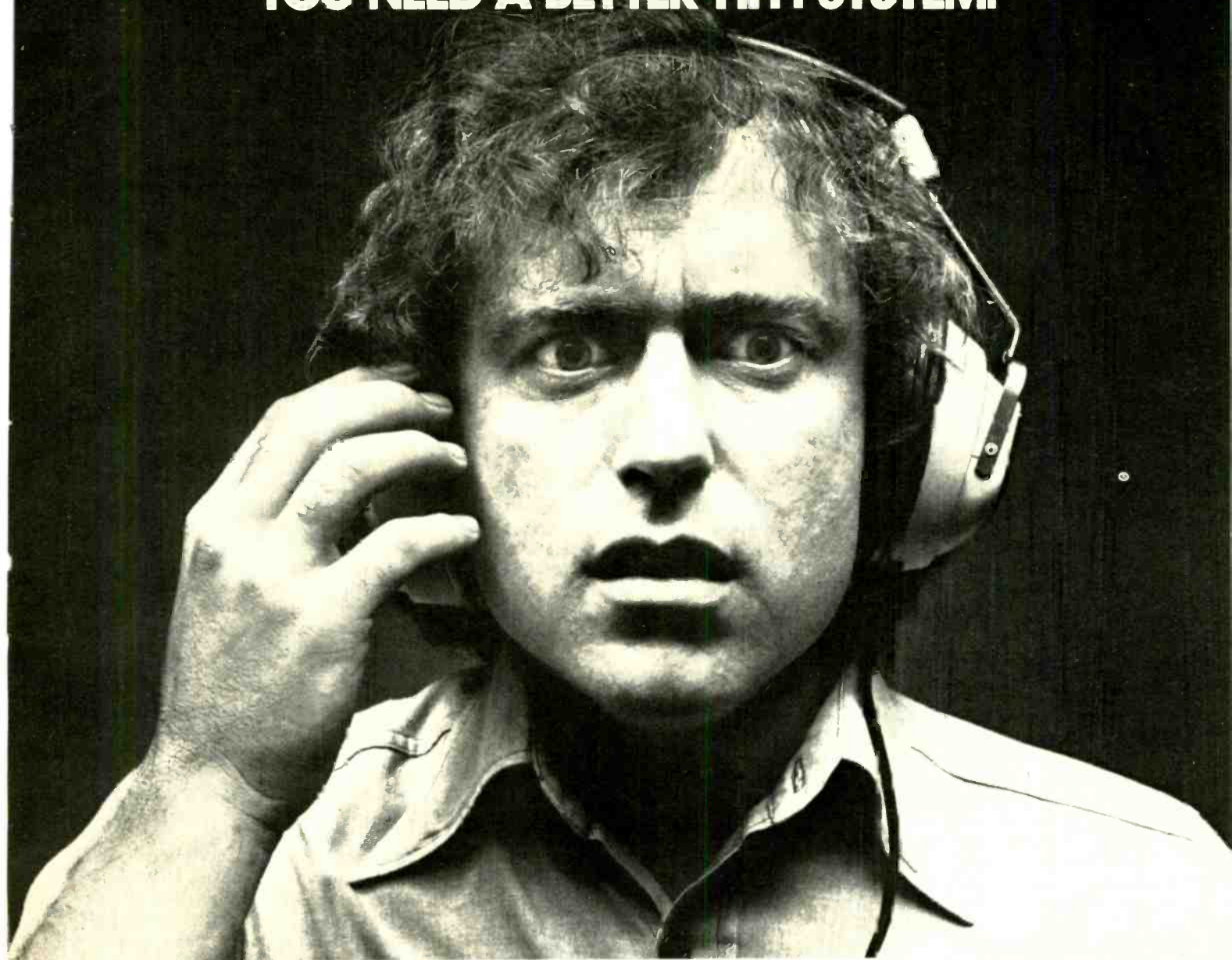

Maxell tapes are the best way to see just how good or bad your hi fi system is. Because Maxell tapes are made to stricter standards than many hi fi systems.

To begin with, only the highest quality materials go into Maxell tapes. The finest polyester, screws, hubs and pressure pads.

Every batch of magnetic oxide we use gets run through an electron microscope. If every particle isn't perfect, the sound you hear won't be either.

Since even a little speck of dust can make a difference in

Maxell. The tape that's too good for most equipment.

what you hear, no one gets into our plant until they've been washed, dressed in a special dust-free uniform, even vacuumed.

The fact that we're such fanatics about making Maxell tapes pays off for you in the enjoyment of superior sound. And in the Maxell guarantee.

Which says if you ever have a problem with any Maxell tape, send it back and we'll send you a new one. No questions asked.

Naturally, a product this good doesn't come cheap. In fact, a single reel of our best tape costs

more than many inexpensive tape recorders.

So if you don't have a good hi fi system, save yourself some money and buy cheaper tapes.



Break
Away

Michael Franks Is No Three-Chord Composer

It's been a long time since it was fashionable in pop music to sing softly, especially if you don't carry a big shtick. Because of our affection (affliction, some would say) for high energy and larger-than-life statements, a lot of fine performers—Bobby Dorough, Mose Allison, and (sometimes) Lani Hall come to mind—have been pretty much relegated to the backwaters.

About six months ago I began to hear a couple of laid-back songs on the radio that captured my attention. One was about a girl who cooked terrific eggplant and had a "Gioconda kind of dirty look"; the other described the problems the singer had with his lady's "always froze . . . Popsicle Toes." The songwriter, I soon discovered, was named Michael Franks, and the songs were from a not very well known album called "The Art of Tea" (Reprise MS 2230).

Okay. In the context of social upheaval in China, oil embargoes in the Middle East, and the expectation of an imminent 8.5 - on - the - Richter - Scale earthquake in the San Fernando Valley, songs about eggplant and cold feet may not seem terribly significant. Even so I'll bet a lot of us can relate at least as comfortably to a song about a lady who's "got the nicest North America/This sailor ever saw" as we can to the purging of Chou Chen or the latest gossip from the sidewalks of Asbury Park.

Franks has a new album out now, comfortably, if a bit ambiguously, titled "Sleeping Gypsy." Like "The Art of Tea," it probably has its greatest appeal to the specialized tastes of those listeners who are willing to meet a performer half way. Franks doesn't knock you out,

doesn't overwhelm you, doesn't grab you with cheap sentimentality, doesn't even seem to be reaching out. He simply sings his songs with the cool directness one associates with Dorough or Joao Gilberto, telling us, in essence, "Here they are, folks, take what you can from them." In and around his vocals the space is airy



and open, allowing ample room for windswept, soaring jazz improvisations from such stellar players as alto saxophonist Dave Sanborn, tenor saxophonist Mike Brecker, pianists Joe Sample and Joao Donato, and guitarist Larry Carlton.

The material is what makes the album special. Without his songs, Franks would be a delightful performer, to be sure, but with them, he is as ready to happen as Phoebe Snow was when she recorded *Poetry Man*. Like Snow, Franks moves easily across the line that once separated jazz from pop (and now seems increasingly easily breached) and his sensibilities embrace both music and lyrics.

He is no more a three-chord composer than he is a rhymers of simple couplets. Yet he has the unique gift of epigrammatic simplicity—a gift that all fine songwriters must have. It is a deceptive simplicity. In *Chain Reaction* he sings, "What good is your song if it ain't in my key/Loneliness makes you strong, only love makes you free." Here he is at least as axiomatic as Kris Kristofferson's statement "Freedom's just another word for nothing left to lose," but in both cases the undercurrent of meaning is deeper than the surface indicates.

And Franks rarely allows himself to become sappily romantic. Every time the precipice of sentimentality draws too near, he deftly spins away from it with a totally unpredictable rush of whimsy: "I hear from my ex, on the back of my checks/It just ain't like Cole Porter/It's just all too short order." Right to the point—no phony humility there.

A few of the pieces on "Sleeping Gypsy" were recorded in Brazil. One is aptly titled *Down in Brazil*; others are *Bwana He No Home* (with a super piano solo by Donato) and *Antonio*. Curiously, these are the songs that—despite their light, bossa-nova qualities—suffer from ponderous rhythm tracks. (One of the problems, I suspect, is that a conga drum is used to accent, rather than augment, the already strong bass lines.)

Fortunately there are no such hazards on any of the others. *Don't Be Blue*, with its straight-ahead, keep-it-moving, blues-style march tempo, features a fine, double-time alto solo from Dave Sanborn (and another epigrammatic line: "Everyone is lost until they're found"). *Lady Wants to Know*, a wistful tune about Daddy (who "plays the ashtray") and Baby (who's "just like Miles") and Lady (who's "just like Helen when she smiles") is energized by Mike Brecker's typically strong tenor saxophone. I

Continued on page 147

Michael Franks: Sleeping Gypsy.

Tommy LiPuma, producer.

Reprise BS 3004, \$6.98. Tape: ●●

M5 3004, ● M8 3004, \$7.97.

A speaker unlike any other.

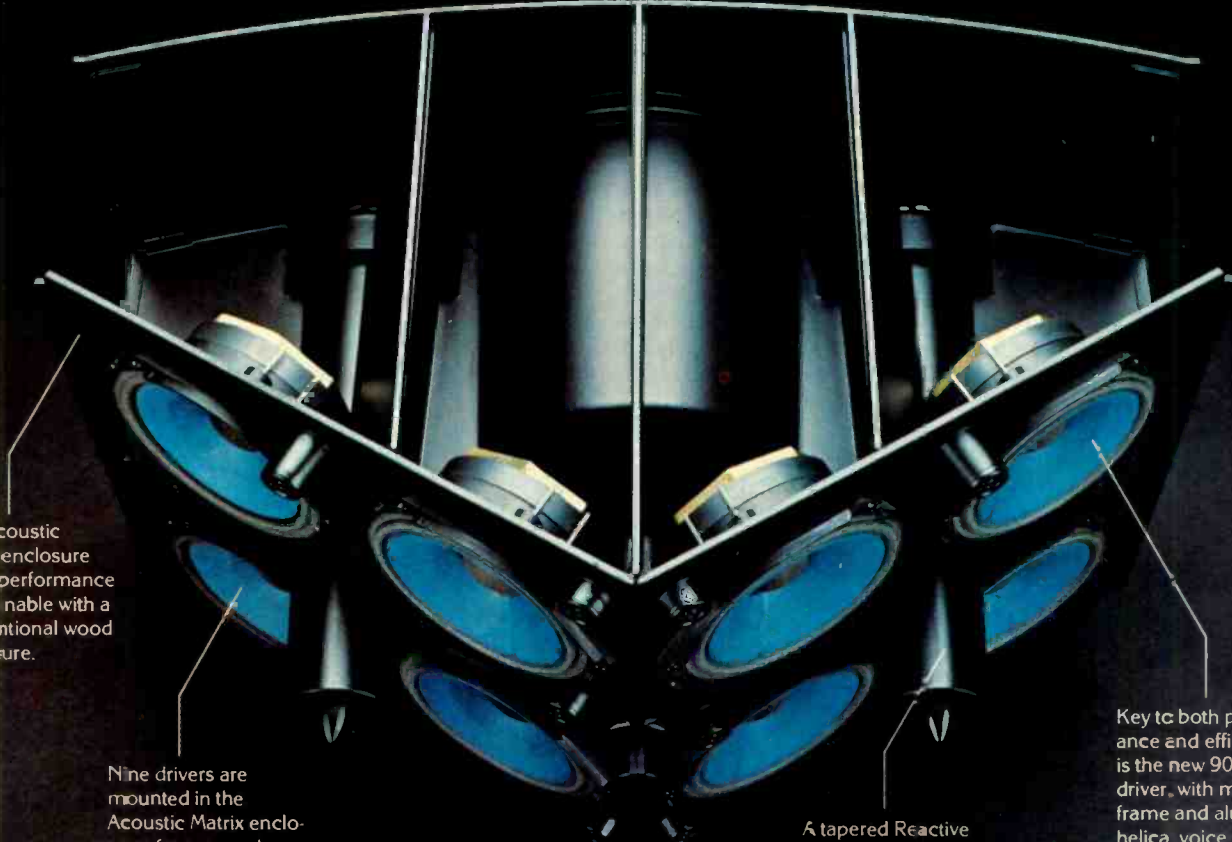

The Acoustic Matrix enclosure yields performance unattainable with a conventional wood enclosure.

Nine drivers are mounted in the Acoustic Matrix enclosure, four on each rear panel and one facing forward.

A tapered Reactive Air Column radiates the lowest bass from the four drivers on each rear panel.

Key to both performance and efficiency is the new 901 III driver, with molded frame and aluminum helical voice coil.

Introducing the Bose 901[®] Series III.

In 1968, Bose introduced an unconventional loud-speaker system: the legendary Bose 901. Now, we are introducing a new speaker of revolutionary concept, design, materials, and performance: the Bose 901 Series III.

What you will hear.

You will be struck by a sense of immediacy and presence, spaciousness of sound, and accurate stereo image almost anywhere in the room. Equally startling are the realism and accuracy of the timbre of each instrument, the clarity and dynamic range of the deepest bass

notes, and the precise definition of individual instruments.

Efficiency

Most dramatic, however, is the remarkable efficiency with which this level of performance is achieved: the new 901 Series III can produce the same volume of sound with a 15 watt amplifier as the original 901 with a 50 watt amplifier.

This dramatic breakthrough in the basic economics of high-fidelity makes it possible to put together a high performance component system at a lower price than was previously possible, even though the 901 Series III is a more expensive speaker than its predecessor.

Technology

Spectacular performance and efficiency are the results of proven Bose design concepts and technological innovations that include the unique, injection-molded Acoustic Matrix[™] enclosure and a new, ultra-high-efficiency driver.

At the same time, the 901 Series III is (as is the original 901), a Direct/Reflecting[®] speaker with a separate electronic equalizer.

To appreciate the spectacular performance of the Bose 901 Series III, simply ask a Bose dealer to play the 901 III in comparison to any other speaker, regardless of size or price.

For a full color 901 III

brochure, write Bose, Box HF 12, The Mountain, Framingham, Mass. 01701. For the nearest Bose dealer, call (800) 447-4700. In Illinois call (800) 322-4400.



BOSE[®]

The Mountain, Framingham, Mass. 01701.

DON HECKMAN & JOHN S. WILSON

Sidney Bechet and Mezz Mezzrow. Irv Kratka & Eric Kriss, producers. *Classic Jazz 28*, \$11.96 (two discs).

The incredible power and impact of Sidney Bechet's soprano saxophone bursts out of these 1945 and 1947 sessions for Mezz Mezzrow's King Jazz label, overwhelming almost everyone around him. Fortunately he all but wipes out Mezzrow's piping clarinet, but Sammy Price's piano, a positive and joyful force, deservedly shares space. Hot Lips Page is present for a few cuts but his trumpet is largely obscured by Pleasant Joe's singing or Mezzrow's audacious attempts to play lead. J.S.W.

Betty Carter: What a Little Moonlight Can Do. Esmond Edwards, producer. *ABC-Impulse 9321*, \$7.98 (two discs). Tape: ● 8027 9321, \$8.95.

Two of her earliest sessions (1958 and 1960) show Carter as far more accessible in the Sarah Vaughan/Billie Holiday genre than in the spiky, prickly manner she has developed since. Wynton Kelly's superb piano and Benny Golson's strong tenor saxophone provide a loose, easy accompaniment on the 1958 recordings, but those from 1960 have a big studio band and arrangements that often lock Carter into banality. The voice is consistently impressive—full, rich, and flexible, with a gorgeous texture in the bottom notes. J.S.W.

Herb Ellis-Ray Brown Sextet: Hot Tracks. Carl E. Jefferson, producer. *Concord CJ 12*, \$6.98.

This is unpretentious, orderly jamming by a sextet that swings as a whole and is spurred by Sweets Edison's biting solos and Plas Johnson's arrogant tenor sax. Most of the material is original and of more than average substance, but the high point is the standard *But Beautiful*, where Ray Brown's plucked bass solo is so richly sonorous that it almost sounds as if it were bowed. J.S.W.

Gil Scott-Heron and Brian Jackson: It's Your World. Gil Scott-Heron and Brian Jackson, producers, *Arista AL 5001*, \$9.98 (two discs).

Gil Scott-Heron is such a dynamic performer that one tends to overlook the way his powerful lyric messages usually overpower the music that should support them. This collection of new and old Scott-Heron pieces (there is a fine version of his now-classic *The Bottle* and a hilariously witty rap in which he deals with the Bicentennial) was gathered from both concert and studio performances. The location doesn't seem to matter. Scott-Heron's effervescent energies persist in breaking through, with or without an audience. But the horn solos, which get too much space, are never more than adequate, and the hard cooking rhythm section never gets to play anything other than the most rudimentary harmonic vamps. Still, if you're not concerned about having a particularly interesting jazz experience, Scott-Heron has much to say worth hearing. D.H.

Hubert Laws: Romeo & Juliet. Bob James, producer.

Columbia 34330, \$6.98. Tape: ●● PCT 34330, ● PCA 34330, \$7.98.

It was inevitable. Beethoven's Fifth made the charts as a disco hit, so why not Tchaikovsky—and especially *Romeo and Juliet*, with its familiar, soaring melody. So here it is, with all the polished slickness that can be mustered up by professionals like Laws and producer/arranger Bob James. Is it well done? You bet. Is it musical? Ah, well that's not exactly what they had in mind, folks, but it will keep your feet moving. And so will three of the other four tracks—all of them too long for listening, but just right for wallpaper disco jazz. Only on Ravel's *Forlane* do we get a chance—mild though it may be—to hear Laws grapple with a piece of music that places a few mild demands on his considerable talents. D.H.

Chuck Mangione: Main Squeeze. Chuck Mangione, producer. *A&M SP 4612*, \$6.98. Tape: ●● CS 4612, ●● 8T 4612, \$7.98.

Mangione sounds a lot better here than he has on past recordings. His great strength, for this listener, is as an inventive jazz improviser. For once he has allowed himself to be a bit more of just that, with a merciful reduction (but still not enough) in the orchestral bombast that usually dominates his work. Given the space to play, he knows what to do with it. He is aided enormously by a really super rhythm team that includes such gifted New York musicians as Bob Mann, John Tropea, Don Grolnick, Tony Levin, Ralph McDonald, and Steve Gadd. D.H.

Michael Mantler: The Hapless Child and Other Inscrutable Stories. Carla Bley, producer. *Watt 4*, \$5.50 (New Music Distribution Service, 6 West 95th St., New York, N.Y. 10025).

Michael Mantler, long associated with New York's jazz avant-garde, has set a formidable task for himself with these vocal/instrumental settings of six poems by Edward Gorey, sung by Robert Wyatt. Unfortunately, Mantler seems to have missed the point in Gorey's Lewis Carroll-esque fantasies. Most are set—wrongly, I would say—in ponderously serious musical frames, completely at odds with the spooky mixture of scatterbrained hilarity and *fin-de-siècle* disillusion which courses through the stories. The presence of such fine musicians as Steve Swallow and Jack DeJohnette in the accompanying group is virtually unnoticeable. Nor are matters helped by a tape mixdown that maintains a persistent, dense grayness. D.H.

Teddy Wilson: Teddy Wilson and His All Stars. Hank O'Neal, producer. *Chiaroscuro 150*, \$6.98.

Teddy Wilson has been isolated in solo and trio situations for so long that one forgets what a marvelous ensemble pianist he is. With a sparkling sextet—Harry Edison's crisp trumpet, Vic Dickenson's sensuous trombone, arrangements and smooth soprano saxophone by Bob Wilber—Wilson plays in the groove that produced the superb Billie Holiday records of the 1930s. No vocals here; the instrumental solos carry it all the way. J.S.W.

JOHN STORM ROBERTS



James Brown: Bodyheat.

James Brown, producer. *Polydor PD 1-6093, \$6.98. Tape: ●● CTPD 1-6093, ●● 8TPD 1-6093, \$7.98.*

The heart of soul is the gospel-based human voice. The powerhouse of funk is the rhythm section—more precisely, the bass guitar. Its repetitions are

dance-oriented and a basic trend in modern Afro-American music. James Brown, a prime creator of funk, is also solidly rooted in the gospel sound. But both aspects get only a routine workout: “Bodyheat” is no “Cold Sweat.”

Con-Funk-Shun. Ron Capone & Con-Funk-Shun, producers. *Mercury SRM 1-1120, \$6.98. Tape: ●● MCR4 1-1120, ●● MC8 1-1120, \$7.98.*

This skilled assemblage of contemporary r&b and disco clichés gradually induces an itchy tedium. All of it is efficient, but none of it is individual. In a word, a con-kok-shun.

The Blackbyrds: Unfinished Business. Donald Byrd, producer. *Fantasy F 9518, \$6.98. Tape: ●● 5 9518, ●● 8 9518, \$7.98.*

This is tight, punchy, professional funk from Donald Byrd's protégés. Good keyboard playing, blah singing, and a calculated air about the whole thing.



Aretha Franklin: Aretha: Ten Years of Gold. *Atlantic SD 18204, \$6.98. Tape: ●● TC 18204, ●● TP 18204, \$7.97.*

Here we have a decade of church-based soul pinnacles from one of our greatest glories before we lost her to Vegas. Cuts like *Respect*, *Think*, and *Rocksteady* make this record

among the season's indispensables.



The Impressions: It's About Time. McKinley Jackson, producer. *Corillion SD 9912, \$6.98. Tape: ●● TC 9912, ●● TP 9912, \$7.97.*

The Impressions' new lead singer Nate Evans has power but there are just too many similar male r&b groups out there. Standard backings and themes. Pleasant, professional, and, alas, ho hum.

Funkadelic: Hardcore Jollies. George Clinton, producer. *Warner Bros. BS 2973, \$6.98. Tape: ●● M5 2973, ●● M8 2973, \$7.97.*

Like its blood brother Parliament, Funkadelic's sci-fi humor fails to hide more authentic funk per stereo inch than ten rhythm & blues hyped heavies: tight guitar, real swing, brilliantly loony arrangements that draw from just about everywhere, some sharp musical satire, and a memorable ripoff of *Für Elise* in the cut called *Smokey*. One song is titled *If You Got Funk, You Got Style*. Funkadelic got both.



Millie Jackson: Lovingly Yours. Brad Shapiro & Millie Jackson, producers. *Spring SP 1-6712, \$6.98. Tape: ●● CTSP 1-6712, ●● 8TSP 1-6712, \$7.98.*

Millie Jackson has one of the finest voices around—deep, powerful, vibrant, and passionate beyond mere sexiness. She treats fairly standard material

with the gully-low drive-'em-down that remains the guts of black popular music.

Parliament: The Clones of Dr. Funkenstein. George Clinton, producer. *Casablanca NBLP 7034, \$6.98. Tape: ●● NBLP5 7034, ●● NBLP8 7034, \$7.98.*

The other half of Funkadelic, this group is a little more jazz-oriented, equally swinging, equally sinister, and equally funny from its church-organ-voluntary opening to endless touches of parody and pastiche that never detract from the main thrust. I think they're brilliant.



Sly and the Family Stone: Heard Ya Missed Me, Well I'm Back. Sly Stone & Sylvester Stewart, producers. *Epic PE 34348, \$6.98. Tape: ●● PET 34348, ●● PEA 34348, \$7.98.*

And welcome. This is plain fun: a quirky blend of r&b, salsa, a general party-party spirit, and even some parody

that includes a delicious Shirley-and-Lee '50s-style duet in *Nothing Less than Happiness*. Nothing's perfect, but at his best Sly achieves a combination of funk and stylishness that spells joy.

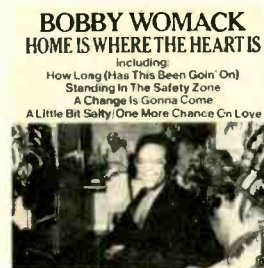

Bobby Womack: Home Is Where the Heart Is. Bobby Womack, producer. *Columbia PC 34384, \$6.98. Tape: ●● PCA 34384, ●● PCT 34384, \$7.98.*

Womack is a blazing singer, out of the churches like most such and with more power than any two of his current rivals put

together. His Muscle Shoals backup has real bite along with the studio pop-funk clichés. No real surprises here but plenty of meat.

SAVE

TOP QUALITY GEAR
LOWEST PRICES
PROMPT DELIVERY
SAVE ON FREIGHT
SELECTION

GARRARD BSR
KENWOOD DYNACO
B.I.C. SANSUI
DUAL PIONEER
and more than 50 others

PLEASE REQUEST PRICE QUOTATIONS ON YOUR CHOICE OF QUALITY STEREO GEAR

Component Discounters

Dept. 3HF
17565 Meadowood
Lathrup Village, Michigan 48076
313-559-1270

PRICE WAR

AMERICA'S #1 VALUE LEADER
STEREO CORPORATION OF AMERICA



AUDIO DISCOUNTING STARTED IN NEW YORK & NOW WITH THE END OF FAIR-TRADE WE ARE SURE THAT NO ONE CAN BEAT OUR PRICES:

- WE DISCOUNT OVER 60 MAJOR BRANDS
- OVER 10 YEARS OF RELIABLE SERVICE IN THE MAIL ORDER FIELD.
- LARGEST INVENTORY/LOWEST PRICES!

WE GET THE BEST DEALS FROM THE MANUFACTURERS; YOU GET THE BEST DEAL FROM US. DON'T DELAY!!!

WRITE US NOW FOR LOWEST PRICE QUOTE

WRITE OR CALL FREE STEREO PRICE CATALOG

SHOP BY PHONE!
(212) 253-8888
N.Y. TIME
9-5 MON. THRU SAT.
Mastercharge/BankAmericard

STEREO CORPORATION OF AMERICA

H-F 1629 Flatbush Ave.
Brooklyn, New York 11210

CIRCLE 43 ON READER-SERVICE CARD

ONE MARK AHEAD OF THE REST....



ADR Audio, one mark ahead of its competitors with the lowest prices of Famous Brand audio components, has now added complete CB & Video depts. All orders promptly shipped from the ADR warehouse in factory sealed cartons, fully warranteed, fully insured. Send for our special price quote & newest money saving catalogue. Its your move...

FOR IMMEDIATE QUOTE
CALL (202) 723-6060

A.D.R. AUDIO
6200 CHILLUM PLACE N.W.
WASHINGTON, D.C. 20011

Continued from page 140

Ochs, who flourished in the shadow of Bob Dylan, wanted always to be a respected poet and musician, as well as a journalist/singer/writer/rhetorician. But artistic expression was painfully difficult for him. The sense of occasion that elevated his cautionary American anthem, *Power and the Glory*, forbade that he approach metaphor intuitively. If passionate wit came easily to Ochs, compassionate humor seldom came at all.

Still, this anthology shows that the expressive artist sometimes succeeded in spite of himself. *There but for Fortune* was set to a tune whose relaxed lyricism outshone its rhetoric. The reflective, nearly apolitical *Changes* anticipated the dreamy singer-songwriter genre of the early '70s. *Pleasures of the Harbor, Crucifixion, and Flower Lady*, among others, also had their share of beautiful images. *Outside a Small Circle of Friends* holds up as one of the most scorching political self-examinations ever written. And in *Chords of Fame*, written and performed in a country/rock style, Ochs ironically recognized the disparity between the folkie he had been and the rock star he longed to become by evoking his own fate (alcoholism and suicide) in someone else's biography.

It is doubly ironic that, from the standpoint of production, *Chords of Fame* is the album's only decent track. Elsewhere, Ochs whines a half note to a whole note flat against the worst arrangements and sound settings imaginable. It is a shame that his legacy had to be preserved this way. S.H.

Hermeto Pascoal: Slaves Mass. Airtro Moreira, Flora Purim, & Dick Cutler, producers. Warner Bros. BS 2980, \$6.98. Tape: ●● M5 2980, ● M8 2980, \$7.98.

Ah, now this is what jazz is all about. Hermeto Pascoal, with the kind of vision that too often has to come from an outsider (in this case, a Brazilian), has come up with a record that touches all the bases that jazz *should* touch—a veritable synergism of contemporary sounds and rhythms. He has done it without pomposness (the frequent use of unusual meters like 7/4 and 5/4 is done with naturalness, never headlined) and with a persistent sense of humor—bits and snatches of avant-garde techniques are generally presented in appropriately skeptical settings.

What does all this have to do with the exuberant, gutsy, shouting, laughing, and crying music that is literally spilling out of the album? A lot. Hermeto obviously knows and feels the importance of passion in his music, but he's no dummy and doesn't depend upon numbing effects of repetition and volume to make his points. This is music that makes you feel, yes indeed, but it's music with

DIXIE HI-FI **SAVE ON**
Brand Name Audio Components **BY MAIL**

Write Today for Our FREE Audio Catalog

DIXIE is one of the oldest and largest stereo mail order houses in the country. Our lower prices on brand name components can save you real money. Call us today for a price quote, toll free (800)446-7925, in Virginia call (804) 257-4241. Everything shipped in factory sealed cartons with manufacturer's warranty.

DIXIE HI-FI HF-3
2040 Thalbro Street
Richmond, Va. 23230

Please rush me your FREE Audio Catalog and complete information. I understand there is no obligation.

Name _____
Address _____
City _____
State _____ Zip _____



substance, too.

Cherry Jam is just that—a fiery jam session—but it is also a primer in how to structure and build in what is usually an extremely unstable, episodic format. *Just Listen* can be just marveled at: Hermeto's virtuosity as a pianist easily puts him in a class with some of Keith Jarrett's finest outings. And there are others: the extremely theatrical mix of voices and instruments on *Slaves Mass*; the bright (and extremely difficult), etude-like *Little Cry for Him*; the melodic *Mixing Pot* and *That Waltz*. Good stuff, all of it. Welcome to jazz, Hermeto, it's nice to hear you in action. D.H.

Kenny Rogers. Larry Butler, producer. *United Artist UA LA689G*, \$6.98. *Tape: UA CA689H*, • *UA EA689H*, \$7.98.

Kenny Rogers is an interpretive singer in country music's modern mainstream whose effortlessly loping voice—masculine without machismo—finely matches the genre's conversational understatement. This album covers much of the commercial country range and includes some of the best current songwriting, as well as some of the worst. Rogers can't transcend the cliché-ridden lyrics of *I Wasn't Man Enough* or *Green Grass of Home*. But his laconic pain works effectively in *Laura* (a masterly song about the bewilderment of a "good provider" who doesn't know why what he provides isn't enough) and in *Lucille*, a jukebox ballad as taut and full of undercurrents as a classic short story.

Country music's often ignored subversive side comes across in a couple of songs, *Puttin' in Overtime at Home*, a pleasant paean to taking a day off work for dalliance, and *The Son of Hickory Holler's Tramp*.

And the genre's strong yet subtle sense of its own tradition puts much of the clout behind *While I Play the Fiddle*, a three-beers-down-poor-me piece distinguished by sawing hoedown fiddle, a melody flavored with Mexican touches, and classic high-lonesome two-part vocal harmonies. Similarly, *Lay Down Beside Me* is a waltz of no great memorability until Rogers lifts his voice and cuts through the melody with a series of sour mountain variations. *Mother Country Music* is also a superb song, with strong echoes of the high Appalachian sound that fueled bluegrass. J.S.R.

The Cliff Smalls Septet: Swing and Things. Bill Weilbacher, producer. *Master Jazz MJR 8131*, \$6.98.

There are indications in this collection that Cliff Smalls has the potential for the best mainstream jazz group to come along in years. The combination of tight ensemble writing, a crisp, slightly stylized attack, and Small's light-fingered,

trickling piano is reminiscent of Eddie Heywood's group of thirty years ago. Not surprisingly, Smalls's keyboard style derives more from Earl Hines than from Heywood, since he played piano and trombone with Hines's big band in the '40s. As an arranger, Smalls's sense of tonal color derives from Ellington. The septet includes two genuine Ellingtonians in sax player Norris Turney (who has absorbed Johnny Hodges' alto style) and trumpeter Money Johnson, so the Duke's influence is felt more strongly here than it otherwise might be. In addition, trombonist Candy Ross has a broad, brash style that could have been at home in the Ellington band.

The showpiece of this set is *On Green Dolphin Street*. Over the past twenty years this tune has been run through the jazz mills so often that it's practically threadbare. But Smalls dresses it in an imaginative arrangement: He opens exotically with rising and falling ensemble breaks surrounding his piano, then goes into a piano solo which develops in Hinesian fashion over a powerful bass figure, and ends with the horns singing softly in an Ellington mood. *Cliffo*, an original blues, shows off his stylish (but scarcely stylized) piano in a laid-back mood while on *Just One of Those Things* he cuts loose over ensemble riffs. It's an uneven set because some of the pieces boil down to a round of solos. Fats Waller's gleeful *Stealin' Apples* is pumped out in stiff and starchy fashion, and an arrangement of *Star Dust* that opens with a brilliant verse and chorus, goes downhill through uninspired solos, ending with a dismal thud in a pretentious concerto-like keyboard flurry. But *Dolphin Street* alone allows a view of Smalls's imaginative approach and gives this recording special distinction, and other material is provocative enough to take this group beyond a mere studio session. J.S.W.

Continued from page 142

Really Hope It's You and *Chain Reaction* (as well as *Lady*) sound to me like strong candidates for success as singles.

I don't suppose it makes much difference that Franks has a master's degree in contemporary culture and wrote a doctoral dissertation on "Contemporary Songwriting and How It Relates to Society" (!). He seems to have survived the whole experience rather well. It does matter that he is widely experienced, having run the gamut from teaching to providing music for such films as *Count Your Bullets* and *Zandy's Bride* and songs for a Sonny Terry/Brownie McGhee album. And it also matters that he has paid as much attention to Thelonious Monk and Cole Porter as he has to Bob Dylan. Why does it matter? Listen to his music and find out.

DON HECKMAN

LOW PRICES & RELIABILITY

DISCOUNT HI-FI STEREO COMPONENTS

• RECEIVERS • SPEAKERS • TURNTABLES • CARTRIDGES • TAPE RECORDERS

The stereo system you have long admired but just couldn't afford, may well be within your price range. DISTRICT SOUND sells to you at DISCOUNT PRICES. We have at DISTRICT SOUND most of the leading brands, and can provide one of the best selections at the best prices.

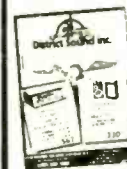

These and hundreds of other items are listed at our low discount prices in our FREE catalog. Send for catalog today.

District Sound Inc.
2316 RHODE ISLAND AVENUE, N.E.
Washington, D.C. 20018
(202)832-1900

CIRCLE 10 ON READER-SERVICE CARD

Protect valuable back issues



The perfect way to save your valuable issues of HIGH FIDELITY, and to keep them well protected and handy for easy reference. Each custom designed case holds 12 issues. \$4.95 each/3 for \$14/6 for \$24. Send your check or money order today!

HIGH FIDELITY LIBRARY CASES

Box 5120

Philadelphia, Pa. 19141

Please send me _____ High Fidelity library case(s) at \$4.95 each/3 for \$14/6 for \$24. USA orders only. Allow 4-5 weeks for delivery.

Total payment enclosed _____
(Check or money order payable to High Fidelity)

Name _____

Street _____

City _____ State _____ Zip _____

You Can't Do Better For Twice The Price

STAX SR-44—Incomparable frequency response, efficiency and transient rise time for \$85.

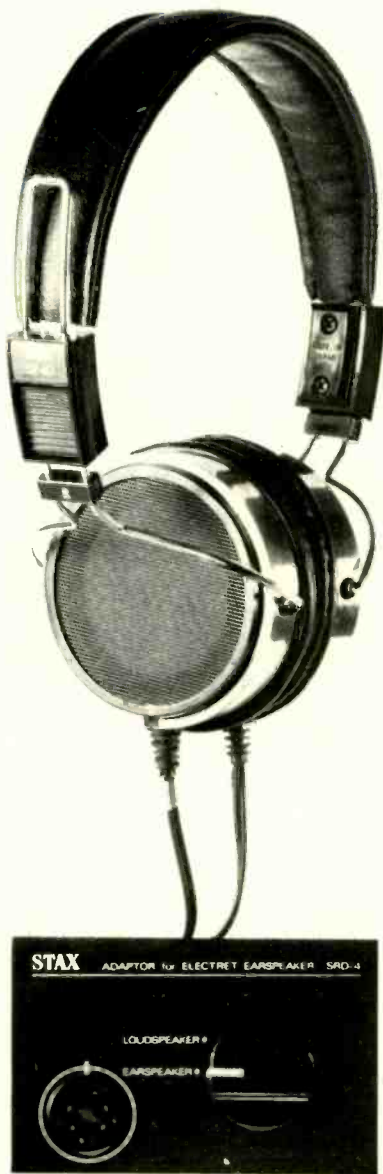

American Audioport
Columbia, Mo. 65201

Books

THE ENCYCLOPEDIA OF JAZZ IN THE SEVENTIES. Compiled by Leonard Feather & Ira Gitler. *Horizon Press.* 393 pages. \$20.

This third volume of the *Encyclopedia of Jazz*, like its two predecessors, calls to mind the post office—one depends upon it, admires the collective effort that makes it possible, yet remains convinced that the job could be done better.

For all the surrounding essays, listings, and photographs (there are two-hundred of the latter), the book's *raison d'être* is the 1,400 capsule biographies that cover over 300 pages. Most are in standard format—date and place of birth; formal studies; lists of important jobs and associations by year; influences; poll victories and other awards; music festival, television, and film appearances; compositions and album appearances as leader or featured sideman. The length of each entry is more often determined by the amount of available information than the importance of the individual. Some of the detail is of questionable value—poll victories are good indicators of public taste, but participation in jazz festivals tells us more about George Wein than the artists—though the list of recordings, often chosen by the subjects themselves, should offer the greatest aid to inquisitive new listeners.

Qualitative judgment is apparently not the intent of the *Encyclopedia* and a variety of short-cut methods are used to convey a musician's essence, including quotes from other authorities, one-sentence capsules (e.g.: "Though underrated by the public [Al Cohn's] playing is much admired by fellow musicians"), or the artist's own statement of purpose. Authors Feather and Gitler, who generally disdain the musics commonly labeled "avant-garde" and "jazz-rock," suggest their true feelings about performers from these genres by either leaving the praise to others or offering their own opinions. But the most bothersome cases are those in which no position is taken. (The excellent Tommy Flanagan and Hank Jones, to cite two men the authors admire, appear in their listings to be just two busy pianists.) Perhaps the current lack of consensus in the jazz world would inevitably doom a more judgment-oriented approach: after all, in the "Recommended Records of 1966-75" poll at the back of the book, where nine critics were given ten choices each, only seven artists (and five specific LPs) were named three or more times.

Omissions and lack of continuity are the book's real shortcomings. Many im-

portant new music players are missing (Donald Garrett, Steve McCall, Kalaparusha Maurice McIntyre, Pat Patrick, John Tchicai, etc.), but since the authors relate that "certain artists, protesting that they did not wish to be classified as jazz musicians, asked to be excluded," it is impossible to tell which cases are actual oversights. Even worse, to get the full history of those who are included and have been around for more than a decade, one must consult the original *Encyclopedia of Jazz* (revised edition published in 1960), the *Encyclopedia of Jazz in the '60s* (from 1966) and the present volume. A single volume would clearly be too cumbersome, but since it took ten years for an update and we're now faced with three books, the time would have been better spent consolidating the entries into two volumes.

There are additional problems: Certain biographies are already out of date (no mention of George Benson Superstar), some contain errors of fact (how could Leroy Jenkins play with Albert Ayler in 1971 when Ayler died in 1970?), and the appendices are of varying value (do we really need another long treatise on jazz education?). But I can't deny that I will consult the *Encyclopedia* regularly, or that there is a wealth of information here for listeners of varying interest.

BOB BLUMENTHAL

THE ROLLING STONE ILLUSTRATED HISTORY OF ROCK & ROLL. Edited by Jim Miller.

Rolling Stone Press/Random House. 382 pages, \$19.95 cloth; \$9.95 paper.

For those who are tired of fanzine-flavored "who's who in pop music" books, this compilation of seventy-plus articles should prove a welcome change. *The Rolling Stone Illustrated History of Rock & Roll* takes a broad-brush-stroke look at rock's quarter-century history by way of contributions from some twenty-six working rock press colorists.

The ground covered ranges from perceptions of the genre's roots to glimpses of the Presley years, the heyday Sixties of the Beatles, and the eclecticism of the Seventies. Additional stops along the way include Top 40 radio, payola scandals, rock and motion pictures, the cross fertilization between British and U.S. artists, the emergence of black music as a commercial power to be reckoned with, musical regionalism, and rock festivals. The task is monumental. And considering the number of artists who span the life of rock & roll, the fact that due credit is given to most is admirable. Among

Continued on page 151

HIGH FIDELITY CLASSIFIED

130 East 59th St., New York, N.Y. 10022
Phone: (212) 826-8393/94

CLASSIFIED RATES: 1-time \$1.20 per word per issue, minimum \$12. 6 consecutive issues—\$1.10 per word per issue. 12 consecutive issues—\$1.00 per word per issue. Words in caps—10¢ extra each.

Box Numbers: \$1.00 additional per insertion to cover cost of handling and forwarding mail. Count 10 extra words for box number and address.

DISPLAY CLASSIFIED AND DISCOUNTS: 1 inch by 1 column—\$230. 2 inch by 1 column—\$460. 3 inch by 1 column—\$690. Also 6 and 12 consecutive issue discount rates. Deadline is two months prior to publication date. Full payment must accompany all copy for classified ads.

for sale

ULTIMATE—"LIVE!"—Operatic, Symphonic—Reel! Cassettes! Bargains! BOX 1101, WOODHAVEN, N.Y. 11421.

STEREO CARTRIDGES AND STYLUS REPLACEMENTS FOR: ADC, Audio Technica, B&O, Grado, Empire, Micro/Acoustics, Pickering, Ortofon, Shure, Stanton, Supex. Write for free catalog: **NEEDLE IN A HAYSTACK**, Dept. H, P.O. Box 17435, Washington, D.C. 20041.

BUILD YOUR OWN SPEAKERS AND SAVE UP TO 50%.

Send for our free, fact packed 40 page catalog manual and learn how to assemble your own multi-element stereo speakers from scratch or from kits. Our jobbing-retailer's chapters on design, construction, wiring, enclosures, diaphragms, woofers, tweeters and horns. Write us today!



SPEAKERLAB
Dept. HF A, 5500 35th St
Seattle, Washington 98105

3600' FRESH LOW NOISE HIGH OUTPUT AMPEX TAPE, 10 1/2" metal reel, 6 for \$35 plus UPS \$3.50. Other tape also on special. Write for Catalog, S.I.C., POB 338, Dunwoody, GA. 30338.

HI-FI ENTHUSIASTS WANTED!! Earn more than just spare money in your spare time. We need campus representatives to sell name brand stereo components at discount prices in your area. High commission, no investment required. Serious inquiries only, please Contact: Alan Weisberg, K&L Sound Services Co., 75 No. Beacon St., Watertown, Mass. 02172. (617) 787-4073.

AUDIOGRAM REVIEWS THAT ARE CLEAR, CONCISE AND Comprehensive. The Audiogram will not leave you in doubt as to what a component sounds like. Rate \$10.00 12 issues. Write The Audio Advisor, P.O. Box 17202, Washington, D.C. 20041.

STEREO REPRESENTATIVES NEEDED!! LOWEST POSSIBLE PRICES!!! OVER 100 BRANDS!! KRASCO, 623 Campbell Ave., West Haven, Conn. 06516.

RARE ROMANTIC PIANO SCORES—Moscheles, Henselt, Herz, Litolf, Scharwenka, Scriabin, etc. Free catalog. **MUSIC TREASURE PUBLICATIONS**, 620 Ft. Washington Ave., 1-F, New York, N.Y. 10040.

PERFECTIONISTS PREFER "DYNAKITS BEFORE Purchase You Owe Yourself Our Quote MAINLINE III, 971 Fronheiser, Johnstown, Pa. 15902.

PROTECT YOUR RECORDS POLY SLEEVES for jackets 8¢ Roundbottom record sleeves 7¢ Poly lined paper sleeves 15¢ White jackets 35¢ Postage \$1.50. Record Supply House, Hillburn, New York 10931.

MXR's 10 band Equalizer Maxell recording tape. All widths. Lowest prices. N.A.B. Audio, Dept. H., P.O. Box 7, Ottawa, IL 61350.

DYNAKITS, SHURE, SME—lowest prices. **FRIED LOUDSPEAKERS** (not discounted). Perfectionist modifications. Underground HiFi Sales, 324b Broadwater Road, Arnold, Md. 21012. (301) 647-0919.

ACCURATE SOUND NOW OFFERS SEVEN HIGH accuracy speaker kits, including an exceptional car or van speaker and ultimate transmission line with ribbon tweeter top end. Prices range from 115.00/pair to 785.00/pair. Kits include drivers (KEF, Coles, & Decca), crossovers using film capacitors, air core inductors, and high quality L-pads, back plate with binding posts and fuse holder, and cabinet plans. Drivers and crossovers available separately. Domestic and exotic wood veneers available. For more information: **Accurate Sound**, 1213 "M" Street, Lincoln, Nebraska 68508 (402) 489-1218.

AUDIOPHILES WANTED!! Put your knowledge to use, earn an excellent spare time income. We need campus Dealers to sell name brand stereo equipment at substantial discounts in your area. No investment necessary. For information and application please write: **ABCO**, Dept. CR, 1201 East Main Street, Meriden, Conn. 06450. Call (203) 238-7979.

THE WAREHOUSE—LOWEST PRICES ON TYPEWRITERS, MANUAL AND ELECTRIC. All brand new, factory sealed, and fully warranted. Free catalog and prices. **YOU CAN'T BUY IT ANYWHERE FOR LESS!** Fast service. **THE WAREHOUSE**, Dept 8, 187 North Main Street, Milltown, New Jersey 08850.

AUDIO STEREO COMPONENTS and SONY TV's at rock bottom prices. Why pay up to 40% more? **Arkay Audio**, 68-B Watertown Street, (Route 16), Watertown, Mass. 02172.

PROFESSIONAL HI-FI HOME STUDY COURSE—Instructors include Len Feldman, Julian Hirsch, Larry Klein, and Larry Zide. Send \$2.00 for full color Audio Primer and full information on joining Society Audio Consultants (SAC), 49 E. 34th Street, Dept HF, NY, NY 10016.

"HOW TO GET INTO BROADCASTING," learn all about the profession. \$4.95. **EGW Publications**, Box 5516-DC, Walnut Creek, CA 94596.

ELLIPTICALS? New process replaces old diamond tips with SHIBATA tip. Extend record-stylus life. \$15.99. Replaced with original type—45% of list. Send any stylus. **Diafix**, Box 762, E Windsor, N.J. 08520.

YELLOW PAGES OF AUDIO—\$3.95 Reference To Over 5,000 audio products and 1,000 publications. Box 94-H, Colmar, PA 18915.

SAVE ON SACRED COWS—BOSE, SAE, REVOX, Sansui, Kenwood, Marantz, BIC, Dokorder, Sony, JVC, Philips. Over 50 top brands. Write for quotes: **SOUTHBOUND SOUND**, P.O. Box 52508, Atlanta, Georgia 30355.

Garland Audio, Inc. cordially invites you to audition the **SONEX TWO TIME ALIGNED** speaker designed by E.M. Long. Openness, depth, detail, imaging, and musical transparency best describe the **SONEX TWO**. **Garland Audio, Inc.**, 2960 Stevens Creek Blvd., San Jose, Calif. 95128, (415) 244-6724.

THE ABSOLUTE SOUND, in Issue 9, will review: The Audio Research SP-4 and Dual 100 (the company's first transistorized units); the long-awaited Ampzilla II; Infinity's FET pre-amp and Black Widow amp; the Phase Linear III speaker system; the Grado Signature cartridge; (more about) the Acoustat-X full-range electrostatic; the Fulton J. speaker; the AGI pre-amp; the AKG cartridge; the Goldring 900 SE cartridge; the Elac 555-E cartridge; the Stax tone arm; Dahlquist's electronic crossover and sub-woofer, and much, much more. You might as well give in and subscribe: \$12 for four issues (USA), \$13 in Canada (add \$2 for first-class mail); outside North America, \$16 (air). **The Absolute Sound**, Attn: Manager, Box 5, Northport, New York 11768.

SAVE 50% build your own speaker system. Write **McGee Radio Electronics**, 1901 McGee Street, Kansas City, Missouri 64108.

If music reproduction is what you are after, the **SONEX TWO** speaker system deserves your attention. For the name of your dealer, write: **Sonex**, Box 5046, Berkeley, Calif. 94705.

IMPROVE YOUR SOUND SYSTEM AMTECH LOUDSPEAKER ATTENUATOR—new, unique loudspeaker volume control can dramatically improve quality of your sound system. Controls remote speakers. Equalizes levels of two pairs of speakers in same listening area with differing efficiencies. Improves headphone listening. Write for free brochure. **AMTECH**, 2505 East 7th Avenue, North St. Paul, Minnesota 55109.

miscellaneous

DIAMOND NEEDLES and Stereo Cartridges at Discount prices for Shure, Pickering, Stanton, Empire, Grado and ADC. Send for free catalog. All merchandise brand new and factory sealed. **LYLE CARTRIDGES**, Dept. H, Box 69, Kensington Station, Brooklyn, New York 11214.

SLEEP-LEARNING—HYPNOTISM! Strange catalog free. **Autosuggestion**, Box 24-F, Olympia, Washington 98501.

CONGRATULATIONS! YOU ARE NOW READING ONE OF HIGH FIDELITY'S best read pages! Use it yourself when you want to sell equipment, or a service, or want to let the avid music listener know about anything. **High Fidelity Classified**, 130 East 59th St., N.Y. 10022.

SEARCHING? WRITE DisContinued RECORDS, 216 NORTH ROSE, BURBANK, California 91505.

FOR MUSIC ENTHUSIASTS—FREE CATALOG of specially designed gifts. **GIFTS MUSICA**, Box 16099, D-upt. H4, Seattle, Washington 98136.

new equipment for sale

DON'T PAY THE HIGH MAIL ORDER PRICES. THIEVES WAREHOUSE OF TAMPA, 1531 SOUTH DALE MABRY, TAMPA, FLORIDA 33609.

DON'T PAY THE HIGH MAIL ORDER PRICES. THIEVES WAREHOUSE OF SARASOTA, 6564 GATEWAY AVENUE, SARASOTA, FLORIDA 33581.

DON'T PAY THE HIGH MAIL ORDER PRICES. THIEVES WAREHOUSE OF FT. WALTON BEACH, 652-D BEAL PARKWAY, N.W., FT. WALTON BEACH, FLORIDA 32548.

DON'T PAY THE HIGH MAIL ORDER PRICES. THIEVES WAREHOUSE OF MOBILE, 1770 BELTLINE HIGHWAY, MOBILE, ALABAMA 36609.

DON'T PAY THE HIGH MAIL ORDER PRICES. THIEVES WAREHOUSE OF PENSACOLA, 3731 NAVY BOULEVARD, PENSACOLA, FLORIDA 32507.

DON'T PAY THE HIGH MAIL ORDER PRICES. THIEVES WAREHOUSE OF MONTGOMERY, 3386 NORMAN BRIDGE ROAD, MONTGOMERY, ALABAMA 36105.

DON'T PAY THE HIGH MAIL ORDER PRICES. THIEVES WAREHOUSE OF ATLANTA, 3164 PEACHTREE ROAD, N.E., ATLANTA, GEORGIA 30303.

DON'T PAY THE HIGH MAIL ORDER PRICES. THIEVES WAREHOUSE OF ATLANTA, 4166 BUFORD HIGHWAY, N.E., ATLANTA, GEORGIA 30345.

DON'T PAY THE HIGH MAIL ORDER PRICES. THIEVES WAREHOUSE OF ATLANTA, 1030-3 CHEROKEE ROAD, SMYRNA, GEORGIA 30080.

DON'T PAY THE HIGH MAIL ORDER PRICES. THIEVES WAREHOUSE OF NORTH TAMPA, 1441 EAST FLETCHER AVENUE, TAMPA, FLORIDA 33612.

BIC Turntables & Speakers
at Wholesale Prices

DIRECT TO PUBLIC!
Factory Sealed — Full Manufacturer's Warranty

TURNABLES LIST YOUR COST			SPEAKERS LIST YOUR COST		
1000	\$280	\$166	FORMULA 1	\$ 75	\$ 47
980	\$200	\$119	FORMULA 2	\$120	\$ 75
960	\$160	\$ 95	FORMULA 4	\$160	\$100
940	\$110	\$ 65	FORMULA 5	\$220	\$138
920	\$ 80	\$ 48	FORMULA 6	\$300	\$185
(Std. Base & Cover add \$15)			FORMULA 7	\$445	\$280
(* add base add \$20)					

Send check or money order. No C.O.D.'s
N.J. Residents add 5% ST

FREE CATALOG Of Our Equally Amazing Money Saving Stereo Equipment

the Warehouse
187 N. Main St., Milltown, N.J. 08850

DON'T PAY THE HIGH MAIL ORDER PRICES. THIEVES WAREHOUSE OF TALLAHASSEE, 1119 APACHE LECHEE PARKWAY, PARKWAY SHOPPING CENTER, TALLAHASSEE, FLORIDA 32301.

DON'T PAY THE HIGH MAIL ORDER PRICES. THIEVES WAREHOUSE OF ATLANTA, 4162 JONESBORO ROAD, ZAYRE CENTER, FOREST PARK, GEORGIA 30050.

DON'T PAY THE HIGH MAIL ORDER PRICES. THIEVES WAREHOUSE OF ST. PETERSBURG, 9151 PARK BOULEVARD, NORTH LARGO, FLORIDA.

DON'T PAY THE HIGH MAIL ORDER PRICES. THIEVES WAREHOUSE OF PANAMA CITY, 5220 WEST HIGHWAY 98, SUITE D, PANAMA CITY, FLORIDA 32401.

DON'T PAY THE HIGH MAIL ORDER PRICES. THIEVES WAREHOUSE OF BIRMINGHAM, 123 ROEBUCK PLAZA DRIVE, BIRMINGHAM, ALABAMA 35206.

DON'T PAY THE HIGH MAIL ORDER PRICES. THIEVES WAREHOUSE OF ORLANDO, 1915 EAST COLONIAL DRIVE, ORLANDO, FLORIDA 32803.

DON'T PAY THE HIGH MAIL ORDER PRICES. THIEVES WAREHOUSE OF ATLANTA #6, BELVEDERE PLAZA SHOPPING CENTER, 1203 COLUMBIA DRIVE, DECATUR, GEORGIA 30032.

DON'T PAY THE HIGH MAIL ORDER PRICES. THIEVES WAREHOUSE OF KNOXVILLE, 5710 KINGSTON PIKE, KNOXVILLE, TENNESSEE 37919.

BUY HI-FI COMPONENTS THE MODERN WAY:

PHONE & MAIL

Call TOLL FREE or write for LOW PRICES

Nationwide **800/854-7769**

California **800/472-1783**

Approved by Phone

MCK SALES

250 N THOMAS, PO BOX 2100
POMONA CA 91766

AR · HY · GAIN · CB
DYNACO · DUAL
KOSS · SHURE
MANY OTHERS

DON'T PAY THE HIGH MAIL ORDER PRICES. THIEVES WAREHOUSE OF JACKSONVILLE 1239 ARLINGTON ROAD & LONE STAR JACKSONVILLE, FLORIDA 32211.

DON'T PAY THE HIGH MAIL ORDER PRICES. THIEVES WAREHOUSE OF JACKSONVILLE, 6078 OLD ST. AUGUSTINE ROAD, JACKSONVILLE, FLORIDA 32217.

DON'T PAY THE HIGH MAIL ORDER PRICES. THIEVES WAREHOUSE OF MIAMI, 1756 S. W. 8th STREET, # 201 MIAMI, FLORIDA 33135.

SAVE UP TO 69% ON OVER 100 TOP BRAND AUDIO components from Carston Studios. New England's audio supermarket, one of the oldest mail order firms (est. 1962) and certainly one of the most reliable. All orders shipped from stocked warehouse. Send for price quote and price list. Carston Studios, Old Brookfield Road, Danbury, Connecticut 06810.

DON'T PAY THE HIGH MAIL ORDER PRICES. THIEVES WAREHOUSE OF MOBILE/VILLAGE SQUARE, 301 SOUTH CRAFT HIGHWAY, MOBILE, ALABAMA.

DON'T PAY THE HIGH MAIL ORDER PRICES. THIEVES WAREHOUSE OF BIRMINGHAM, 103 SOUTH 18th STREET, BIRMINGHAM, ALABAMA.

DON'T PAY THE HIGH MAIL ORDER PRICES. THIEVES WAREHOUSE OF CLEARWATER, 1502 A GULF TOBAY BOULEVARD, CLEARWATER, FLORIDA.

DON'T PAY THE HIGH MAIL ORDER PRICES. THIEVES WAREHOUSE OF PENSACOLA #2, 3820 NORTH 9th AVENUE, PENSACOLA, FLORIDA 32503.

DON'T PAY THE HIGH MAIL ORDER PRICES. THIEVES WAREHOUSE OF PLANTATION, 231 SOUTH STATE ROAD 7, PLANTATION, FLORIDA 33317.

DON'T PAY THE HIGH MAIL ORDER PRICES. THIEVES WAREHOUSE OF NORTH MIAMI BEACH, 1807 N.E. 164th STREET, MIAMI, FLORIDA 33162.

DON'T PAY THE HIGH MAIL ORDER PRICES. THIEVES WAREHOUSE OF ATLANTA, 2769 LAKEWOOD AVENUE, S.W., ATLANTA, GEORGIA 30315.

DON'T PAY THE HIGH MAIL ORDER PRICES. THIEVES WAREHOUSE OF HIALEAH, 6741 WEST 4th AVENUE, HIALEAH, FLORIDA 33012.

DON'T PAY THE HIGH MAIL ORDER PRICES. THIEVES WAREHOUSE OF FT. LAUDERDALE, 3347 NORTH FEDERAL HIGHWAY, FT. LAUDERDALE, FLORIDA 33306.

DON'T PAY THE HIGH MAIL ORDER PRICES. THIEVES WAREHOUSE OF DUMONT, 78 WASHINGTON AVENUE, DUMONT, NEW JERSEY 07628.

DON'T PAY THE HIGH MAIL ORDER PRICES. THIEVES WAREHOUSE OF FAIR LAWN, 34-09 BROADWAY, FAIR LAWN, NEW JERSEY 07410.

DON'T PAY THE HIGH MAIL ORDER PRICES. THIEVES WAREHOUSE OF RIDGEWOOD, 25 GODWIN AVENUE, RIDGEWOOD, NEW JERSEY 07450.

DON'T PAY THE HIGH MAIL ORDER PRICES. THIEVES WAREHOUSE OF BOCA RATON, 499 N.E. 20th STREET BOCA RATON, FLORIDA 33431.

DON'T PAY THE HIGH MAIL ORDER PRICES. THIEVES WAREHOUSE OF ATLANTA #7, 215 COPELAND ROAD, ATLANTA, GEORGIA 30342.

DON'T PAY THE HIGH MAIL ORDER PRICES. THIEVES WAREHOUSE OF GAINESVILLE, 434 N.W. 13th STREET, GAINESVILLE, FLORIDA 32601.

DON'T PAY THE HIGH MAIL ORDER PRICES. THIEVES WAREHOUSE OF HOLLYWOOD, 5719 HOLLYWOOD BOULEVARD, HOLLYWOOD, FLORIDA 33021.

DON'T PAY THE HIGH MAIL ORDER PRICES. THIEVES WAREHOUSE OF JACKSONVILLE #3, CEDAR HILLS SHOPPING CENTER, 3716 BLANDING BLVD., JACKSONVILLE, FLORIDA 32210.

FORMULA 4 PLS4/D THE BEST SOUNDING UNIVERSAL TONE ARM AVAILABLE. U.S. AUDIO DEALERS LITERATURE ONE DOLLAR BILL. MAYWARE, LTD., 15 HEATHER WALK, EDGWARE, MIDDLESEX, ENGLAND.

BRITISH AND EUROPEAN EQUIPMENT direct to you. Ariston, Armstrong, Celef, Celestion, Connoisseur, Chartwell, Decca, Fons, Formula 4, Goldring, Nakamichi, KMAL, Lecson, Monitor Audio, Ortofon, Radford, Revox, Rogers, SME, Spondor, Sugden, Tannoy, Transcriptor, Other makes available. Price quotes free, for brochures send 2.00 mentioning makes required. Audio T-Dept. A, 190 West End Lane, London NW6. Phone 01-794-7848 Visitors welcome.

DON'T PAY THE HIGH MAIL ORDER PRICES. THIEVES WAREHOUSE OF BIRMINGHAM #3, 2134 A&B WARRIOR ROAD, BIRMINGHAM, ALABAMA 35208.

DON'T PAY THE HIGH MAIL ORDER PRICES. THIEVES WAREHOUSE OF DAYTONA, 1769 SOUTH RIDGEWOOD, SOUTH DAYTONA, FLORIDA 32019.

DON'T PAY THE HIGH MAIL ORDER PRICES. THIEVES WAREHOUSE OF BILOXI, 441 PORTER AVENUE, BILOXI, MISSISSIPPI 39530.

DON'T PAY THE HIGH MAIL ORDER PRICES. THIEVES WAREHOUSE OF FT. MYERS, 3081 CLEVELAND AVENUE, FT. MYERS, FLORIDA 33901.

DON'T PAY THE HIGH MAIL ORDER PRICES. THIEVES WAREHOUSE OF PENSACOLA #3, TOWN & COUNTRY PLAZA, PENSACOLA, FLORIDA 32505.

DON'T PAY THE HIGH MAIL ORDER PRICES. THIEVES WAREHOUSE OF AURORA, 10218 EAST COLEFAX, AURORA, COLORADO 80010.

DON'T PAY THE HIGH MAIL ORDER PRICES. THIEVES WAREHOUSE OF WESTMINSTER, 2969 WEST 72ND AVENUE, WESTMINSTER, COLORADO 80030.

DON'T PAY THE HIGH MAIL ORDER PRICES. THIEVES WAREHOUSE OF MACON, 1564 EISENHOWER PARKWAY, MACON, GEORGIA 31206.

STOP LOOKING for a good deal on hi-fi equipment—you've found it here—at your hi-fi headquarters in the heart of the Midwest. We are factory authorized dealers for most major brands. Write or call today for our low quote and become one of our many happy and satisfied

customers. HOOSIER ELECTRONICS, P.O. Box 2001, Terre Haute, Indiana 47802, (812) 238-1456.

SANSUI and PICKERING! BELOW mail order prices! Send to: GSH Super Savings, P. O. Box 86, Eden, N.C. 27288.

tapes & records

OPERA TAPES—DISCS OPEN REEL AND CASSETTES—historical performances of last 40 years—Unbelievable treasure and rarities—ALSO LP RECORDS. Ed Rosen, 66-33 Saunders St., Rego Park, N.Y. 11374.

FILM-STAGE SOUNDTRACKS Large free list. A. Lutsky, P.O. Box 557342, Miami, Fla. 33155.

TAPES. CLASSICAL SINGERS, CONDUCTORS, instrumentalists in live performance. Emphasis on Superior Sound. Catalogues. Good Sound Associates, PO Box 489, Planetarium Station, New York, N.Y. 10024.

RARE OPERA, SYMPHONIC MUSIC ON OPEN REEL TAPE. Historic performances. EUROPEAN, DOMESTIC. Free Catalogue. Underhill, Bellport, NY 11713.

TDK, BASF, Memorex, Maxell, cassettes, reels, 8-tracks. Lowest prices, guaranteed, new. S&S Audio, P.O. Box 56039, Harwood Heights, IL 60656.

SHOW ALBUMS—Rare, out-of-print LPs, 52-page list 50¢. Broadway/Hollywood Recordings, Georgetown, CT 06829.

QUADRAPHONIC RECORDS AND TAPES—WORLD'S LARGEST SELECTION—ALL LABELS, OVER 1000 TITLES—at discount prices! For your free illustrated quad catalog, write: SOUND CONCEPTS, Box 654-B, Peoria, Illinois 61601.

SONAR'S OPEN REEL TAPES. Duped one-to-one from the master. Quad and stereo; ¼, ½ track, 7½, 15 ips; 7", 10½" reels. Highest quality anywhere! Sonar Records Corp., P.O. Box 455H, Kingsbridge, Bronx, NY 10463.

GOLDEN AGE RADIO—YOUR BEST SOURCE for radio tapes. Box 25215-J, Portland, Oregon 97225.

SOUNDTRACKS/OC, PERSONALITIES!—FREE NEWSLETTER! RTSH, 3700 Plaza, F-211, Santa Ana, California 92704.

"SOUNDTRACKS, SHOW, NOSTALGIA & JAZZ—FREE Catalog & Auction List—A-1 Record Finders, P.O. Box 75071-H, L.A. CAL. 90075."

SCOTCH RECORDING TAPE, LOWEST PRICES. TAPE CENTER, Box 4305C, Washington, D.C. 20012.

PROTECT YOUR ALBUMS. WHITE CARDBOARD REPLACEMENT JACKETS 35¢. PLASTIC LINED INNER SLEEVES 15¢. POSTAGE \$1.25. RECORD BOXES AND 78 SLEEVES AVAILABLE. CABCO 301-2, BOX 8212, COLUMBUS, OHIO 43201.

EVERYTHING ON OPEN REEL! Classical, Popular, Dolby. Quadraphonic. Latest releases. For "Reel News," send \$1.00. Barclay-Crocker, Room 857 H, 11 Broadway, New York 10004.

IMPORTED + DOMESTIC HARD-TO-FIND SOUNDTRACKS, Shows, Nostalgic Personalities. Catalog \$1.00 (Refundable). List Communications, Box 916-T, NYC 10023.

OLDIES ON OPEN REEL TAPE—Free Brochure Rock n' Reel Rental, Dept. A, 4 Prescott Ave., Dix Hills, NY 11746.

QUASI-RATIONAL PRODUCTS now carries everything in record protection—Paper-vinyl liners, preeners, fluids, etc. ALSO the finest in blank tapes & accessories. Royce C.B.'s—Jensen car speakers—Pioneer auto stereos. Marvelous prices and service. FREE CATALOG. QUASI-RATIONAL PRODUCTS, P.O. Box 171, Prospect Heights, Ill. 60070.

LIVE OPERA TAPES, UNBELIEVABLE VARIETY, SATISFACTION, GUARANTEED. FREE CATALOGUE LIVE OPERA P.O. BOX 3141, STEINWAY STATION, L.I.C., N.Y. 11103.

CLASSICAL CLOSE-OUTS & OVERSTOCKS IMPORTED & domestic \$1.99-\$3.99 per disc write Berkshire Record Outlet, Inc., 910 South St., Pittsfield, MA 01201 for lists.

those spotlighted are Little Richard, Buddy Holly, Ray Charles, Aretha Franklin, the Who, Janis Joplin, Stevie Wonder, Chuck Berry, and Elton John.

Selective discographies follow each article and each disc carries the highest position it attained during its life on the *Billboard* charts. There are hundreds of pictures, most of the press agent/publicity variety, some in performance. The latter work exceptionally well, especially those of early rock & rollers.

The one major flaw of the publication is the lack of attention to rock & roll's overall impact on the very culture it grew out of. But there are sure to be arguments as to whether a definitive history is even possible, considering the nature of the music, and to date this effort has a leg up on the competition. **JIM MELANSON**

ALL YOU NEED IS LOVE—THE STORY OF POPULAR MUSIC by Tony Palmer. *Grossman Publishers, 323 pages, \$15.*

While this particular saga of American pop music does have its rewarding moments, the pervading tone of less-than-objective negativism eventually tries patience. Possibly the reason is that *All You Need Is Love* is the basis for a future BBC documentary television project (Palmer is a British film director and journalist), and a consequent premium has been placed on spice for the home viewer.

At the very outset we are told, "Popular music is a paradigm of American culture. No one knows a song is good until the public says so—whereupon it can be stolen, reproduced, manufactured, and marketed for profit." The author's priorities and the summary fashion in which he tosses the blanket of mass appeal over aesthetic sensibilities warns that what's to come is primarily surface treatment, subject to interpretive scratching.

Most musical genres are covered (ragtime, blues, jazz, vaudeville, swing, r&b, country, the Broadway musical, rock, etc.), and at times the historical anecdotes are both amusing and interesting, especially those provided by the all-star cast Palmer turned to for research: Benny Goodman, Eubie Blake, Leonard Feather, Stephen Sondheim, and Dave Brubeck to name a few.

But generally, Palmer moves cursorily from artist to artist, period to period, seldom pausing for a connecting influence or deeper look into musical individuality. Too often he emphasizes ripoffs, career disintegration, booze, drugs, and racism.

One of the few redeeming qualities is the fine pictorial layout; this should at least keep the coffee-table reader happy.

J.M.

CLASSICAL LP's CURRENT/OOP. LIST. ETC. A.R.S., 13 Dante Street, Larchmont, N.Y. 10538.

OLD RADIO SHOWS on tape. Most have original commercials. Low as \$1.87 per hour. Catalog \$1.00. Phantom Empire, 2500 Pennington, Houston, Texas 77093.

CUT-OUT RECORDS. HUGE STOCK ALL NEW. No catalog, Cohn, 2205 Marylane, Broomall, Pa. 19008.

OLD RADIO PROGRAMS, 50c!! AM TREASURES, BOX 192, NC, Babylon, N.Y. 11702.

"RARE OUT OF PRINT JAZZ & POPULAR Vocal LP's Sold by Auction. Free Lists. Leon Leavitt, 824 1/2 North Las Palmas, Los Angeles, CA. 90038."

WE WILL BEAT ANY PRICE SHEET IN America. Featuring TDK, Maxell, BASF, and Ampex. Tape World International, 220 Spring Street, Butler, PA 16001.

RECORDING TAPE SPECIALISTS OFFERS LOW PRICES, FAST SERVICE, WIDE VARIETY OF BRANDS, UNUSUAL CATALOG. SAXITONE TAPE SHOP, 1776 COLUMBIA ROAD, N.W., WASHINGTON, D.C. 20009.

Rarest classical, soundtracks, shows, personality LPs. Huge catalog 50c. Grammy's Attic, Box 181, Bluffton, SC 29910.

CASH FOR USED RECORDS! Will Pay: \$1.00 to \$2.00 for quality LPs . . . 8-track and Cassette Tapes. (Rock, Jazz and Classical etc.) SEND list of your used albums or 25c for our complete Buying Guide! Rasputin Records, 2340 Telegraph Ave., Berkeley, Ca. 94704.

SERIOUS COLLECTORS NEED KASTLEMUSICK! Buy, Sell, Trade in our Monthly Bulletin. Also, new 1977 Directory for Collectors of Recordings hot off press. Send 3 stamps for FREE SAMPLE and Information. Kastlemusick, 170 Broadway, Suite 201, NYC 10038.

BACH 16 KEYBOARD CONCERTOS, complete, Svinsky, piano. 3-LP set \$11.94 list only \$8.98 postpaid. Free catalog. Musical Concepts, Dept. HF3, P.O. Box 53, Cedarhurst, NY 11516.

78 RPM RECORD LISTS. (1) Popular & Jazz, (2) Americana, (3) Classical, (4) Country-Western. State Category. AUCTION ONLY. Write, S.A. Langkammerer RECORD LISTS, 3238 Stoddard, San Bernardino, Ca. 92405.

RADIO PROGRAMS FREE CATALOGUE. STONEGROUND. DEPT. A, BOX 335, COUNCIL BLUFFS, IA 51501.

BASF TAPE: Fresh Stock. All widths 40%—55% OFF. Guaranteed! INTERGALACTIC, 1043 Kirts, Troy, Michigan 48084.

"VIENNESE NIGHTS"—Rare series of the repertoires of the great Waltz Kings in utterly complete, authoritative performances. Available to members on Dolby cassettes. Extensive catalogue of world's largest archives. Apply: VLMS, "Pickwick Papers," Stickford, Boston, Lincs. England."

COLLECTORS RECORDS: JAZZ, BLUES, COUNTRY, ROCKABILLY, ETC. SHELLAC SHACK, BOX 13685, SAN ANTONIO, TEXAS 78213.

personals

DATES GALORE! Meet singles—anywhere. CALL DATELINE, toll-free (800) 451-3245.

WARTS. Vergo* Cream is painless, safe, easy, gentle. Buy Vergo* at better pharmacies.

PENFRIENDS worldwide, send age, interests. Free reply. HARMONY, Box-I-HF1 Gravesend Station, Brooklyn, N.Y. 11223.

business opportunities

CAMPUS REPRESENTATIVES—Double your profits! Contact TOKYO AUDIO LTD., Box 3241, Los Angeles, California 90028.

For Sale by Owner, no comm. to pay. Best equipped, busy shop west of Chicago. In University town, excellent growth potential. Capital Search, Inc., Box 1517, Pendleton, OR 97801.

periodicals & magazines

BACK ISSUE MAGAZINES. Over 200 titles, 1890 to 1976. Send Stamped Envelope. Free List. Everybody's Bookshop Dept. HF, 317 West 6th, Los Angeles, Calif. 90014.

HIGH FIDELITY

Classified Advertising Department
130 East 59th St., New York, N.Y. 10022 212-826-8393/94
Michael Littleford, Classified Advertising Manager

Please run the following classified advertisement in the next available issue.

Name _____

Address _____

City _____ State _____ Zip _____

Telephone _____

RATE: For Regular and Display, see schedule above. *CASH MUST ACCOMPANY ORDER. Closing two months prior to issue.

The Revolutionary

Wow & flutter: .04%*. Signal/noise ratio: 62 dB.**

Introducing the incredible Elcaset system. Developed by Sony to bring you unsurpassed cassette sound.

1. The Elcaset tape is as wide as reel-to-reel tape: $\frac{1}{4}$ "

2. Tape moves twice as fast: $3\frac{3}{4}$ ips. Result: the widest dynamic range, the widest frequency response, the cleanest sound ever offered in a cassette format. Unlike the standard cassette, the Sony Elcaset sound is not compressed, constrained. It's expansive and full. It "breathes." It's true high fidelity.

3. The tape is lifted out from the cassette and guided across the heads by a stabilizing pin in the deck

itself — just as in reel-to-reel.

Result: lowest wow and flutter, superior tape/head alignment, even better frequency response. (See diagram).

4. All-new tape formulation with thicker oxide coating and thicker polyester for highest quality sound.

5. Automatic tape formulation adjustment. Small holes encoded on the cassette case "tell" the Elcaset deck what type of tape is being used (SLH, FeCr). The Elcaset then automatically adjusts both bias and EQ for optimum performance.

Tape (Actual Size)

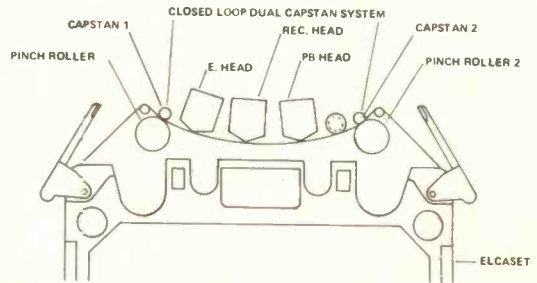

Sony Elcaset System

Frequency response: 25 Hz-22 kHz, ± 3 dB***

An engineering triumph, the Sony EL-7 Stereo Elcaset Deck was designed exclusively for the new Elcaset tape.

1. Closed-loop dual capstan tape drive. One of the most advanced tape drive systems now available, it assures constant tape-to-head contact pressure, low wow and flutter and virtually nonexistent modulation noise.

2. The 3-motor system starts with a DC servo motor for utmost reliability. A sophisticated feedback circuit corrects for line voltage fluctuations, and other speed-altering factors. This is the finest tape recorder motor system money can buy. Proof? Wow and flutter of only .04%.

3. Sony's 3-head system offers the most precise tape/head alignment possible. All three heads are made of ferrite and ferrite — a super-strong formulation that lasts up to 200 times longer than standard perm-alloy. Head surfaces are mirror-smooth for friction-free tape travel and optimum tape/head contact. Incredibly close tolerances in the head gap assure widest frequency response.

4. Direct coupling of playback head with the FET first-stage reproduction amplifier significantly reduces distortion, improves signal/noise ratio and frequency response linearity.

Also available: The Sony EL-5 Stereo Elcaset Deck. Includes many of the same high performance features of the Sony EL-7 at a lower price.

Deck

Brought to you by

SUPERSCOPE



Memory tape counter provides automatic sequential rewind and playback immediately after recording from a specific spot on the tape.

Timer activating capability, in conjunction with an external timer, turns on/off playback or record mode unattended.

Illuminated "feather-touch" solenoid operation. Log-c-controlled system allows instantaneous mode change, bypassing stop.

Air-cushion eject slowly, softly opens tape compartment door, thus minimizing wear on eject system.

Dolby Noise Reduction System includes 25 μ S de-emphasis circuit for Dolby FM, as well as controls for standard Dolby applications.



**BEETHOVEN, SCHUBERT AND MOZART
WOULD BE PLEASED TO HEAR THE NEWS.
INTRODUCING THE FIRST INTEGRATED DC AMPLIFIER.**

The DC amplifier is a rather amazing instrument. It reproduces music without phase distortion or time delay distortion. Down to 0 Hz (direct current) the response is flat. French horns sound French. A string bass sounds like a string bass. And Mozart sounds like Mozart.

Needless to say, it's sensational.

And now it comes in an *integrated* amplifier. The Kenwood 600. The first integrated DC amplifier.

With dual power supplies. At 130 watts per channel, minimum RMS at 8 ohms from 20 to 20,000 Hz with no more than 0.08% total harmonic distortion.

The perfect companion to our new 600T, the finest tuner we've ever made (and we're famous for our tuners).

For full information and specs, write Kenwood Electronics, 15777 South Broadway, Gardena, Ca. 90248; or 72-02 Fifty-First Ave., Woodside, NY 11377.

