

ICD

HIGH FIDELITY®

NOVEMBER 1974 \$1.00
08398

LAB TEST REPORTS
Ferrograph Model 75 tape deck
Technics Model T-400 speaker
Sony TC-177SD cassette deck
Philips GA209 turntable
Infinity Monitor 1A revisited

Are Your Cartridge And Tone-Arm Compatible?

Recommended combinations for best results with over 80 stereo cartridges . . .



MF LTH3GAA24C009 OCT 76 1 03
HR C LATHAM
7424 GRANBURY CIR
ST LOUIS MO 63123

SPECIAL
gton
raised
plus . . .
Duke on
SCS

4/2 CHAN

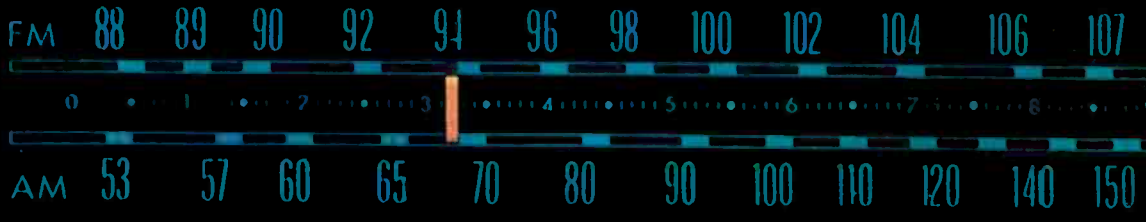

REMOTE

◆ OUTPUT ◆

4-CH

SELECTOR

SQ CD-4
4-CH REMOTE
VOL/BAL

SQ LOGIC HIGH FILTER LOW FILTER

BASS
REAR FRONT

3 0 3

MIN. MAX.

MIDRANGE
RIGHT LEFT

3 0 3

MIN. MAX.

TREBLE
REAR FRONT

3 0 3

MIN. MAX.

4 is the best receiver you can own.

decoder gives you dramatic channel separation.

Lots more good stuff.

If you need more convincing... the 634 has four individual level meters and a "joystick" balance control, plus optional remote control for volume and balance. There are Baxandall bass and treble controls and a midrange presence control, and tape outputs on the front and rear panels. And 4-channel headphone jacks, illuminated

function readouts, and much, much more.

It's all put together incredibly well with over-size parts that should last for years and years. And common-sense design with things like plug-in circuit boards to make servicing a snap in the unlikely event that something ever goes wrong.

If this sounds like the receiver you've been waiting for, stop waiting. You can try it out at your nearby Fisher Studio

Standard dealer. Or send for our informative and interesting book about all the new Studio Standard receivers. Write Fisher Radio, Dept. HF-11, 11-40 45th Road, Long Island City, N.Y. 11101.

Fisher
Studio-Standard

Actual size.



The new Fisher 634

Here's why:

The Fisher 634 has so much power, performance, versatility, and overall quality, that whether you use it as the heart of a blockbuster stereo system or an exotic 4-channel system it will do more for you than any other receiver you can buy.

Plenty of pure power.

The 634 puts out 45 watts RMS per channel in the 4-channel mode. And a

special power-boosting "strapping" technique gives you 100 watts RMS per channel in stereo, more than some of the most highly-touted stereo-only receivers and enough to handle even very inefficient speakers in very large rooms.

Full Logic SQ and CD-4.

So you can listen to as much 4-channel music as possible, the 634 has state-of-the-art IC decoder circuits for both CD-4 and SQ.

The SQ has "full logic" for increased separation and clarity, plus Fisher's exclusive "Phase Logic" for even more separation across the rear.

Exceptional FM reception.

A dual-gate MOS/FET FM front end gives you terrific sensitivity to haul in many more stations with brilliant clarity than any other receiver. A ceramic ladder filter rejects interference. A Phase Lock Loop multiplex

FISHER

CD-4/4-CH

LEFT FRONT RIGHT



Studio-Standard

PROGRAM
SELECTOR

MODE SEL

LEFT

FRONT

PHONO 1
CD-4
PHONO 2
FM
AM
AUX

TAPE
MONITOR

MONO

2-CH

CD-4
SEPARATION

RCDR
OUT



RIGHT

REAR

METER
ATTEN

MUTING
OFF

PHASE
LOGIC

CHANNEL RECEIVER

8 MHz
10
0 KHz

MICROBALANCE



TUNING



LEFT



RIGHT



FRONT



REAR



SPEAKERS

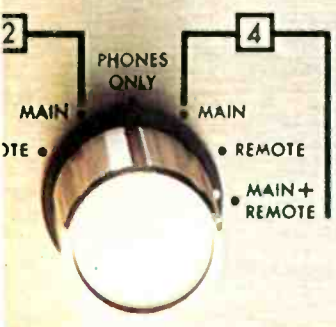

LOUDNESS CONTOUR



MASTER VOLUME

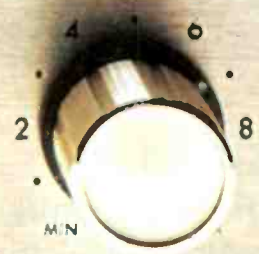

POWER



FRONT

PHONES



REAR

Even when you use just part of it.



WTFM, known for its high quality signal, is first to convert to the new Calibration Standard... STANTON'S 681 TRIPLE-E.

Good music stations need the best broadcast cartridges for auditioning original recordings and taking transfers as well as for on-the-air use.

Larry Strasser, Chief Engineer of WTFM New York, states:

"I have been impressed for years with the quality and dependability of Stanton's broadcast cartridges. Naturally I wanted the improved version for our station just as soon as it became available."

Stanton's 681 Triple-E offers improved tracking at all frequencies. It achieves perfectly flat frequency response to beyond 20 Kc. It features a stylus assembly that possesses even greater durability than had been previously thought possible to achieve.

This came about because Stanton's engineers, who were deeply involved in the development of Stanton's superb discrete 4-channel cartridge, 780/4DQ, achieved certain intricate refinements and sophisticated new techniques that were equally applicable to stereo cartridge design and construction.

Each 681 Triple-E is guaranteed to meet its specifications within exacting limits, and each one boasts the most meaningful warranty possible: an individual calibration test result is packed with each unit.

You can enjoy the professional audio quality of Stanton products whether your purpose involves Broadcasting or Home Entertainment.

CIRCLE 60 ON READER-SERVICE CARD



Shown during the middle of a busy day's operation are: Larry Strasser... Dean Anthony... Nell Bassett... Gerald Janes... Michael Marion... Walter Mason... Sharon Ritterband... Sandy Rosen.



Write today for further information to Stanton Magnetics Inc., Terminal Drive, Plainview, N.Y. 11803.

music and musicians

| | | |
|--|------------------------------------|----|
| Edward Greenfield | METAMORPHOSIS | 23 |
| In Britain, André Previn is a national institution | | |
| Gene Lees | ELLINGTON REMEMBERED | 28 |
| Was he that great? A minority report | | |
| Gunther Schuller | ELLINGTON IN THE PANTHEON | 63 |
| John S. Wilson | THE DUKE IN THE RECORDING STUDIO | 65 |
| His fifteen hundred records are an integral part of Ellington's creativity | | |
| | THE DUKE ON DISCS | 79 |
| A key to all currently available recordings | | |
| Gunther Schuller | WILL THE DUKE'S MUSIC SURVIVE HIM? | 87 |

audio and video

| | | |
|--|---------------------------------|----|
| | TOO HOT TO HANDLE | 38 |
| | NEWS AND VIEWS | 40 |
| Explosive tape recorders . . . DBX damps down noise | | |
| | EQUIPMENT IN THE NEWS | 42 |
| | EQUIPMENT REPORTS | 53 |
| Ferrograph Model 7504HDAW open-reel tape deck | | |
| Technics Model T-400 speaker system | | |
| Philips GA-209 turntable | | |
| Sony Model TC-177SD stereo cassette deck | | |
| Infinity Monitor 1A remonitored | | |
| Larry Zide | PICKING A PICKUP | 46 |
| Why are some makers reluctant to recommend an arm and cartridge match? | | |
| | WHICH CARTRIDGE WITH WHICH ARM? | 48 |
| 17 manufacturers state their recommendations | | |

record reviews

| | | |
|--|--------------------------------------|-----|
| R. D. Darrell | THE HYPHENATED STOKOWSKI | 91 |
| Odyssey and Phase-4 give us a new look at those controversial adaptations | | |
| John McDonough | BIRD REDISCOVERED | 95 |
| A six-disc set from Spotlite restores Charlie Parker's vital Dial recordings | | |
| Royal S. Brown | AN ESSENTIAL AMERICAN-MUSIC DOCUMENT | 97 |
| England's Argo offers absorbing works by Riegger and Sessions | | |
| | CLASSICAL | 99 |
| Robert Long | FOUR-CHANNEL DISCS AND TAPES | 133 |
| Bouncing Bach . . . Tall toll . . . Pops up to date | | |
| | LIGHTER SIDE | 134 |
| Bill Amesbury . . . Douglas Flint Dillard . . . Dianne Steinberg | | |
| | JAZZ | 140 |
| Anita O'Day . . . Dick Wellstood . . . Mary Lou Williams | | |
| R. D. Darrell | THE TAPE DECK | 146 |
| The advent of Advent . . . Rags by Joplin and others | | |

etc.

| | | |
|--|---------------------|-----|
| | LETTERS | 6 |
| Which little maids? . . . Off-center pressings . . . Gershwin requests | | |
| | PRODUCT INFORMATION | 18 |
| An "at-home" shopping service | | |
| | ADVERTISING INDEX | 130 |

Ellington appraised. See page 63.



Bird's back. See page 95.



This month's equipment. See page 53.



High Fidelity is published monthly by ABC Leisure Magazines, Inc., a subsidiary of American Broadcasting Companies, Inc., 1330 Avenue of the Americas, New York, N.Y. 10019. Copyright © 1974 by ABC Leisure Magazines, Inc., a subsidiary of American Broadcasting Companies, Inc. The design and contents are fully protected by copyright and must not be reproduced in any manner. Second-class postage paid at New York, New York and at additional mailing offices. Authorized as second-class mail by the Post Office Department, Ottawa, and for payment of postage in cash. Yearly subscription in U.S.A., Possessions, and Canada \$7.95; in Pan-American Union \$8.95; elsewhere \$9.95. Single copies \$1.00. Indexed in Reader's Guide to Periodical Literature.

Current and back copies of High Fidelity and High Fidelity and Musical America are available on microfilm from University Microfilms, Ann Arbor, Michigan 48106. Microfiche companions of these magazines (1973 forward) are available through Bell & Howell Micro Photo Division, Old Mansfield Road, Wooster, Ohio 44691.

Change of address notices and undelivered copies (form 3579) should be sent to High Fidelity, Subscription Department, 1 Sound Avenue, Marion, O. 43302. Please state both old and new addresses when requesting change. Editorial correspondence should be addressed to the Editor, High Fidelity, Great Barrington, Mass. 01230.

Sound so clear you can hear a pin drop, or a piccolo player catch his breath.

Listening to the Pep 79E is like being suspended from the concert hall ceiling with the microphones. Nothing comes between you and the music. Because we built a perfect membrane driver. An electrostatic element that produces the most transparent, distortion-free sound you've ever heard. And now electrostatic stereophones aren't bulky or isolating. The Pep 79E weighs a mere 8½ ounces, and our trans-air concept blends outside sounds with inside sounds without sacrificing performance. Frequency response: 10 Hz to 22,000 Hz. It's black, with Chroma trim, has comfortable ear cushions, a fully adjustable headband, and 15 foot coil cord. Comes with a trouble-free, self-energized console. The system is guaranteed for 1 year. The only alternative is huge, costly speakers that will wake up your neighbors.



Pep 79E Electrostatic System
Sugg. Retail Price \$90.00



Superex Stereophones. Feel what you hear.

For free literature write: Superex Electronics Corp., Dept. 19, 151 Ludlow Street, Yonkers, N.Y. 10705.
In Canada, Paco Electronics Ltd., Quebec

LEONARD MARCUS
Editor

NORMAN EISENBERG
Executive Editor

WAYNE ARMENTROUT
Managing Editor

KENNETH FURIE
Music Editor

ROBERT LONG
Audio-Video Editor

SHIRLEY FLEMING
Editor, Musical America Section

REBECCA ABBOTT
Copy Editor

VIOLA MATSON
Assistant Editor

WILLIAM TYNAN
Special Projects Editor

ROY LINDSTROM
Art Director

ROBERT MADDOCKS
Associate Art Director

MORGAN AMES
ROYAL S. BROWN
R. D. DARRELL
PETER G. DAVIS
HENRY EDWARDS
ALFRED FRANKENSTEIN
HARRIS GOLDSMITH
DAVID HAMILTON
DALE HARRIS
MIKE JAHN
PAUL HENRY LANG
GENE LEES
ROBERT C. MARSH
H. C. ROBBINS LONDON
Contributing Editors

MILTON GORBULEW
Senior Circulation Director

STANLEY BINDER
Circulation Director

CLAIRE N. EDDINGS
Associate Publisher and
Director of Advertising Sales

WARREN B. SYER
Publisher

Cover Photo: Roy Lindstrom

ADVERTISING

Main Office: Claire N. Eddings, The Publishing House, Great Barrington, Mass. 01230. Telephone: 413-528-1300.

New York: ABC Leisure Magazines, Inc., 130 E. 59th St., 15th floor, New York, N.Y. 10022. Telephone: 212-581-7777. Seymour Resnick, Eastern Adv. Mgr.

New England: The Publishing House, Great Barrington, Mass. 01230. Telephone: 413-528-1300. Ross Turner.

Los Angeles: ABC Leisure Magazines, Inc., ABC Entertainment Center, 2040 Avenue of the Stars, Suite 270, Century City, Calif. 90067. Telephone: 213-553-5648. Andrew Spanberger.

Chicago: ABC Leisure Magazines, Inc., 2011 Spring Road, Oak Brook, Ill. 60521. Telephone: 312-323-3800. Leonard Levine.

Tokyo: Japan Advertising Communications, Inc., New Ginza Bldg., 7-3-13 Ginza, Chuo-ku, Tokyo 104, Japan. Telephone: (03) 571-8748. Shigeru Kobayashi, president.



Choose one of these four world-famous orchestras to enjoy in your home for 10 free concert evenings!

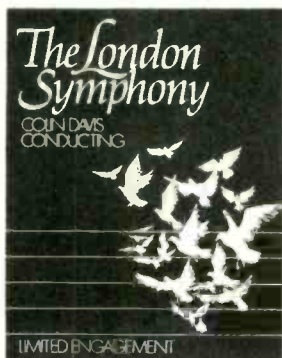

Featuring Beethoven's majestic *Emperor Concerto*, Berlioz' popular *Symphonie Fantastique* and more!



Hear a moving interpretation of Ravel's hypnotic *Bolero*, Mussorgsky's *Pictures At An Exhibition* and others.

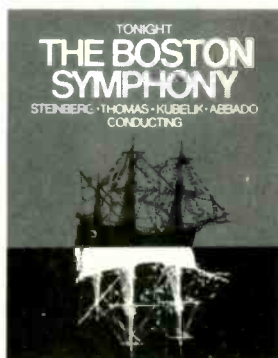

Magnificently performed, delight in Tchaikovsky's *Winter Dreams*, Holst's *The Planets* plus many others.



Enjoy Mendelssohn's unforgettable *A Midsummer Night's Dream* and Brahms' *Second Piano Concerto* as just some of the highlights.

Audition superb stereo recordings with no obligation to buy!

The International Festival of Great Orchestras brings you the best of critically-acclaimed performances by top-ranking orchestras... without your ever having to leave your living room!

To begin, you choose the world-renowned orchestra you want to audition—the London Symphony, Berlin Philharmonic, Boston Symphony or Amsterdam's Concertgebouw Orchestra. Then mail the coupon below and we'll send you a superb four-record stereo concert program by the orchestra you choose—along with an exclusive concert guidebook—all in a handsome, hinged storage case. Listen to... read about... and enjoy your concert program for 10 days free!

Keep all 4 records for less than the price of 1—pay just \$6.98!

If you decide to keep the set, you pay an incredibly low \$6.98* (plus a small postage and handling charge). This special introductory price saves you almost \$25 off the suggested list price of comparable records in retail stores!

Enjoy exclusive concert programs throughout the year!

As a member, every two months you'll receive another exclusive concert program by a world-famous orchestra to audition for 10 days free. These handsomely-boxed, silent-surfaced European pressings—each



Choose the concert program you want to audition for 10 days free!

including four records for each concert plus an *exclusive* concert guidebook—cannot be bought in any store. They're available only through the mail—only from the International Festival of Great Orchestras! And you keep *only* the concert programs you want—*only* when you want them. *There is absolutely no obligation to buy every month!*

Of course, each album is yours to enjoy for 10 full days before you decide whether you want to add it to your permanent record library... and for each one you do decide to keep, you pay only our regular low members' price of \$16.95* (plus a small postage and handling charge)... a savings of more than 45% over comparable retail prices!

Send no money now—just indicate on the coupon below the concert you'd most like to hear and mail the coupon today!

The International Festival of Great Orchestras Q77
175 Community Drive, Great Neck, N.Y. 11025

Please check *one* box only:

1. London Symphony 3. Boston Symphony
 2. Berlin Philharmonic 4. Concertgebouw Orchestra

Yes! Please send, for my free audition, the handsomely-boxed concert program I have indicated above, including four superb stereo records and my concert guidebook. I may return the complete set after 10 days and owe nothing, or keep it and pay only \$6.98* (less than half the regular low members' price) plus a small postage and handling charge. I will then receive, at two-month intervals, additional concert programs by world-renowned orchestras for my free 10-day audition—each a four-record set plus an exclusive concert guidebook. I may return any set or keep it at the regular low price of only \$16.95* (plus postage and handling). *As a member, there are no minimum number of records I must buy—and I may cancel my membership at any time.*

Name _____ (please print)

Address _____

City _____

State _____ Zip 19307/Q77

Offer limited to U.S. and its possessions. Offer expires 1/31/75. Limit: One membership per household—only new members eligible. *Sales tax added for New York residents.

Taping TV

Robert Long's article on do-it-yourself recording of "TV's Golden Moments" [August] was most enjoyable, partly because I have experienced some of the frustrations and many of the joys he describes. He is certainly on-target in his references to the uneven quality of so many musical programs. Even so, there are many gems to be taped from TV, as I've been doing for more than a decade.

Among the collectors' items I've been able to get: Betty Grable doing the title number from *Hello Dolly* (which she was then performing on Broadway but never recorded commercially), Bette Davis' 1963 foray into folk singing with the New Christy Minstrels, Carol Burnett's early-'60s spoofs of "Mimi Pizarria" and "I Don't Want to Play Nelson and Jeanette Anymore," Helen Gallagher and Bobby Van doing a 1962 takeoff on Ruby Keeler/Dick Powell musicals (many years before they were teamed in the Broadway revival of *No, No, Nanette*), Danny Kaye and Lucille Ball's "Glory Hallelujah Twist," Kaye and Gwen Verdon's "The Tapioca," Angela Lansbury's "A Chance to Sing and Dance," plus any number of songs by such commercially underrecorded performers as Diahann Carroll, Kaye Ballard, Georgia Brown, and Larry Kert.

But best of all are the duets by people who never (or hardly ever) record together—such as Ella Fitzgerald with Frank Sinatra and Bing Crosby, Lena Horne with Tony Bennett, Julie Andrews with Harry Belafonte, Bob Dylan with Johnny Cash, Peggy Lee with Petula Clark, Dinah Shore with Duke Ellington, Ann Miller with Tiny Tim, and Judy Garland with Barbra Streisand.

Speaking of such combinations, isn't Mr. Long in error in referring to a performance of "Three little maids from school are we" as a collaboration of Joan Sutherland, Dinah Shore, and Carol Burnett on a Burnett show? My tape has Sutherland and Shore doing the song with Ella Fitzgerald on a 1963 Dinah Shore show, as well as collaborating (on the same program) on a version-to-end-all-versions of "Lover Come Back to Me." The Carol Burnett show has indeed produced some equally classic moments—for example, its 1971 version of "You Can Drive a Person Crazy" from *Company* with the unforgettably unlikely trio of Eileen Farrell, Marilyn Horne, and Miss Burnett.

When you can capture something like that, well, all the mediocre stuff you may tape from TV and then promptly erase doesn't matter!

Roy Hemming
New Haven, Conn.

Mr. Long replies: Mr. Hemming's tape confirms my memory—and the original draft of the article—on the "Three little maids" casting. The data was checked by our diligent research staff, however, and the only concrete information it could obtain was as printed. More recently Music Masters (a New York record dealer specializing in esoterica) positively confirmed the existence of the version on Mr. Hemming's tape, but not that specified in the final article. Could there be two?

This is a brief note of appreciation—and responsive-chord-striking—for Mr. Long's excellent article. There must be thousands of us tape nuts scattered around the country.



Ella Fitzgerald—One of the little maids?

Talk about carrying things to extremes (not to mention, as Mr. Long did, getting up in the middle of the night—sometimes to record three super Warner Bros. films from 1:00 to 7:00 a.m.), I have a small TV in my office and have captured on C-120 cassettes a lot of films that for some obscure reason never seem to be shown during the evening hours. It's great fun to listen to them later, even without the picture; I guess I'm aurally oriented.

I have hundreds and hundreds of complete and excerpted soundtracks. Many thanks for vindicating my long-stood-by thesis that many of these one-of-a-kind items are irretrievable, will never be shown again, and represent a (albeit minor) legacy that will give satisfaction and pleasant hours not only to myself, but to others who may inherit my collection.

William H. Smith
San Francisco, Calif.

Mr. Long replies: Don't sell your collection short. Just think of the profits now being made from the "(albeit minor) legacy" of past radio shows, and hang onto your tapes. Just as commercial record companies often must buy or borrow copies of their own recordings in order to prepare LP reissues, so the TV networks may someday turn to amateurs like yourself to fill archival gaps for commercial issue.

Mr. Long did his readers a real disservice in casually dismissing the GE P-4930 portable TV-audio receiver, which sells for under \$40. It is the best available device for getting good TV sound. Simply connect it to your outdoor antenna or cable feed via a clip lead attached to your TV set's antenna terminals and plug a cable into the GE's headphone jack to feed the signal into your stereo system, and you'll get better sound than the Heathkit TVs provide and much better sound than usually is achieved by hiring a technician to wire a takeoff jack into a conventional TV set. If there is any complaint about the P-4930, it is that it is too good; it reveals all too clearly the wretched engineering common in both network and local TV broadcasting.

I fully share Mr. Long's enthusiasm for taping TV audio. I would not part with my tapes of Laurence Olivier, Orson Welles, Kate Hepburn, and Robert Morley (all chatting with Dick Cavett); Peter Ustinov swapping concert anecdotes with Leopold Stokowski and vocal-

izing a bassoon solo for the maestro; or Kenneth Clark's "Civilisation" series (his grand generalizations have even more thought-provoking power without the distractingly beautiful visuals). On long automobile drives out of range of decent FM, I play cassettes of old late-show film soundtracks; after you've seen *Casablanca* or *The Maltese Falcon* a couple of times you can relive the entire film by hearing the audio track, supplying the video mentally. Paul Henreid is even more noble than usual, and Sydney Greenstreet even more smooth and villainously clever, when heard in a darkened car speeding down an interstate highway late at night.

Peter W. Mitchell
Charlestown, Mass.

Mr. Long comments: I defer to Mr. Mitchell, who reviewed the GE unit for the Boston Audio Society. In one respect, however, his report shows it to have a common failure for the recordist: nonlinearity in its response, requiring equalization if its full sonic potential is to be realized. Since few amplifiers have tone controls ahead of the tape-recording jack, that may mean either an onboard equalizer of some sort or tone-control adjustment each time you play a tape. But the GE also appears to have one signal advantage: low levels of extraneous noise, which can be a big pain in the recording head with conventional TV receivers.

You should have carried a strong note of warning about hooking up to a TV set. There is a shock hazard present in many sets connected to and grounded through a stereo amplifier. In many cases a qualified technician's best suggestion might be to forget about connecting the two.

Donald R. Hoyer
Hyde Park, N.Y.

The article stated plainly that this is a job for "a competent service technician," but the warning is worth repeating.

A Pressing Problem

I wish to comment on remarks concerning the quality of our pressings, made in some recent reviews appearing in your magazine.

A fact little known outside record-manufac-

BELT DRIVE ISN'T NEW. MULTIPLE PLAY ISN'T NEW. A TURNTABLE THAT COMBINES BOTH IS NEW. READ ALL ABOUT IT.



Back in monophonic times, turntable motors drove platters through a series of wheels called "idlers".

Many automatics and changers still use this system. In those days, records and playback systems were still relatively unsophisticated, so the distortions an idler drive system created didn't matter much.

Today, however, distortion is a critical problem. With recordings of increased dynamic range, wow, flutter and rumble must be reduced to inconsequential levels.

A belt-drive system is light years ahead of idler drive in that department.

And here the belt is driven by a unique motor found only in B-I-C turntables. It is a 300 RPM, 24-pole motor and it is inherently freer from noise and vibration than the 1800 RPM units with from 2 to 16 poles, which are standard in even the best of the conventional automatics.

The advantage of Programmed Multiple Play

The 980 and 960 are not record changers.

They are belt-drive Programmed Turntables which are engineered to play as many as 6 records at a time.

They have a 2-point record support system which is far less complicated and far more reliable than any umbrella spindle we've ever seen.

But an even more important advantage is this.

An automatic record handling system like the one on a B-I-C turntable can handle a single record, or 6 at a time, perfectly. No false drops. No bouncing and skating a diamond stylus across the grooves. It eliminates human error, and human error is what damages the sidewalls of your record grooves forever.

The simplicity factor

The 980 and 960 have the visibly lower profile of single-play manual instruments. They've been engineered to be simple machines, so they have fewer parts and fewer potential problems.

They abound in innovations. In the tone arm, the cartridge shell, the program panel, the entire system.

We can send you more detailed information if you write to Dept. 11B, British Industries Co., Westbury, L.I. 11590; or better yet, see them at your local audio specialist.



Copyright 1974 B-I-C is a trademark of British Industries Co., Westbury, New York 11590. A division of Avnet Inc.

This is the 980 with
solid state speed control and strobe.
About \$200. The 960 is identical
except for these two features. About \$150.

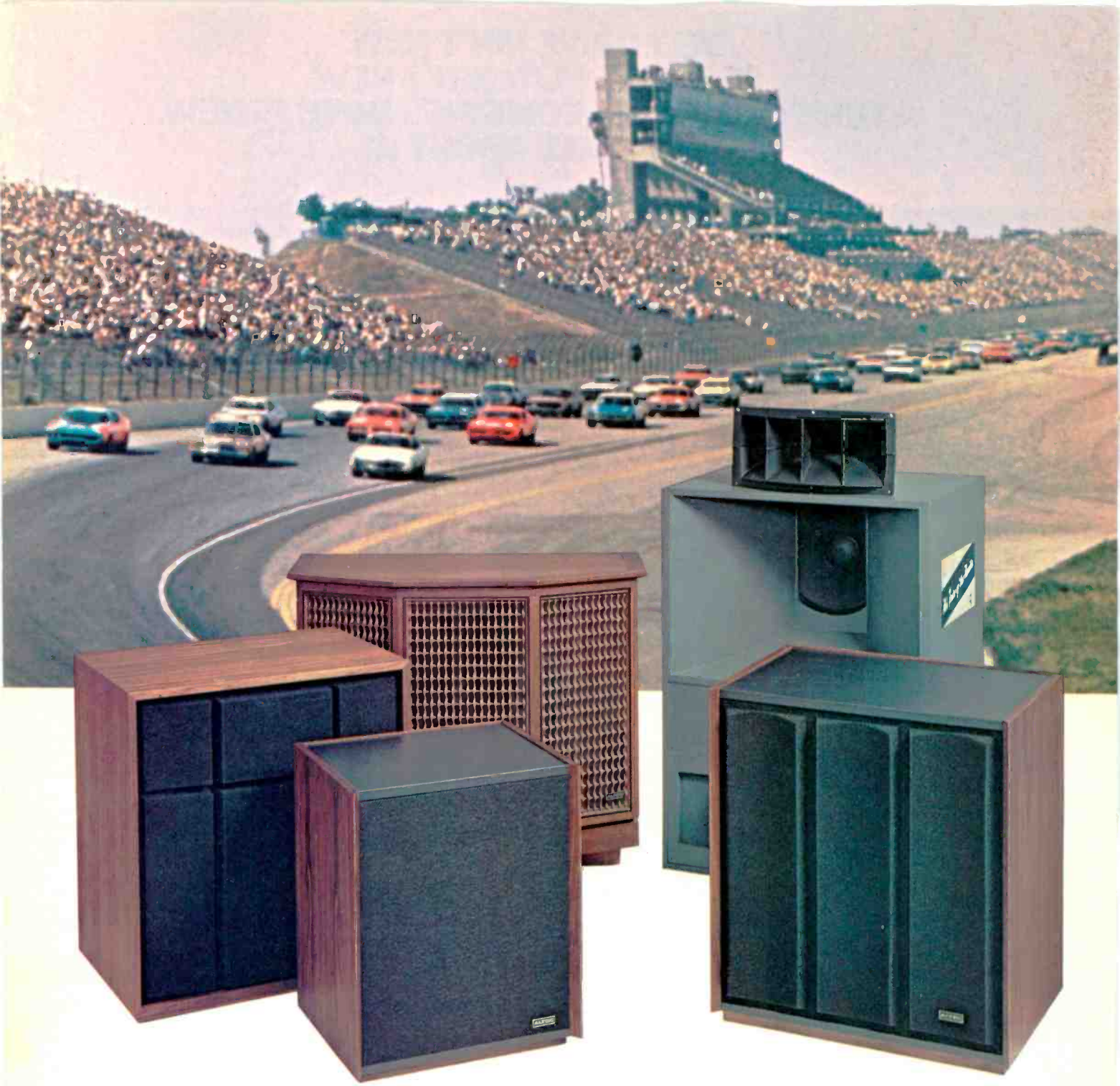

*"The world's most powerful sound system is installed at the Ontario Motor Speedway, California."
Guinness Book of World Records, 1974 Edition.*

Gentlemen, start your ears.

30,800 watts of pure power through 355 precision speaker assemblies. Enough sound energy to spread the word cleanly, clearly and truthfully to more than 230,000 screaming fans. Year after year. All above the ear-rending din of 50 roaring race cars.

It took more than ordinary experience to design and produce that spectacular sound system. It took the kind of knowledge and craftsmanship only 37 years of building high quality sound systems can teach.

It took Altec.



The same Altec you'll hear in our super-line of high fidelity loudspeaker systems. The same experience. The same knowledge. The same craftsmanship. The only differences are that we've dressed them up for your use. Some are small. Some large. Some are powerful. Some are very powerful.

And they're all made to satisfy the ears of just one very important listener. You.

Before you buy your next speaker system, stop by your local dealer and listen to Altec. Championship performance for more than three decades.

©copyright 1974 Altec Corporation

1515 S. Manchester Ave., Anaheim, Calif. 92803

CIRCLE 2 ON READER-SERVICE CARD

ALTEC

the sound of experience.

Hardheaded. The new Sansui SC-737.



Sansui's Exclusive
Magni-Crystal Ferrite
Record/Play Head

For years Sansui has produced hard-headed and solid stereo components. Our latest hard-headed development is the SC-737 cassette deck with new Magni-Crystal Ferrite heads. These super-hard heads are virtually impervious to wear, one of the major causes of tape deck quality erosion. Along with new heads, the SC-737 gives you Dolby™ circuits for quiet record and playback, bias equalization for standard or chromium based tapes, peak reading VU meters and a "radarscope" tape travel indicator.

The SC-737's motor is something special, too. A 4-pole hysteresis synchronous type keeps speed constant regardless of voltage changes. Photoelectric shutoff and microphone mixing, including center channel input make the SC-737 the cassette deck for even the most hardheaded audiophile. Hear it at your nearest franchised Sansui dealer.

*Dolby is a trademark of Dolby Laboratories Inc.

Sansui

SANSUI ELECTRONICS CORP.

Woodside, New York 11377 • Gardena, California 90247 • SANSUI ELECTRIC CO., LTD., Tokyo, Japan
SANSUI AUDIO EUROPE S.A., Antwerp, Belgium • ELECTRONIC DISTRIBUTORS (Canada) Vancouver 9, B.C.

turing circles is that the supply of vinyl for record pressing is a monopoly controlled, I am told, by two suppliers for the entire U.S.!

As is customary, we scheduled a large (fifteen-album) fall release last year. Unfortunately this coincided with the peak of the vinyl "shortage," when we were told we were lucky to get any pressings at all, at whatever price.

Here is a true irony: A composer will pour his heart and soul into a piece of music; an artist will spend half a lifetime perfecting his art so as to give his best for the performance; the record company will spare no effort to achieve an outstanding recording, zealously guarding every step of the operation, taping, editing, mastering (production is never authorized before a test pressing is approved; sometimes it takes as many as six tests before we are happy); and then what? It is a sad reflection on the state of commercial record pressing in the U.S. that with the finest of materials and equipment (and prices certainly among the finest and growing finer all the time!), the average U.S.-made pressing is no match for its European counterpart.

The nub of the problem is that the entire U.S. record industry is pop-oriented. The sound levels of most popular-music records are such that surface quality matters hardly at all. With classical pressings accounting, we are told, for less than 5% of the total, it is hardly surprising that pressing plants are indifferent to the plight of the classical-record manufacturer.

Importing pressings is obviously not the answer. Any suggestions?

Giveon Cornfield

President, Orion Master Recordings
Malibu, Calif.

In recent years your editorial, letters, and review columns have been full of well-warranted complaints about poor pressing quality. I have seen no comment, however, on what I consider the most pernicious kind of record defect: off-center pressing. I would estimate that at least two-thirds of the records I buy, on a wide variety of full-price and budget classical labels, are pressed visibly off-center on at least one side, by which I mean that the tone arm can be seen wavering in and out as the record rotates. This problem seems to afflict even the most prestigious imported labels, acclaimed for their high pressing quality.

The various kinds of surface blemishes to which we are perpetually subjected at least leave the music undistorted, while requiring the listener to hear it through a screen of extraneous noise. But off-center pressing deforms the music itself. A record that is markedly off-center is likely to display a pronounced pitch wobble, especially toward the end of the side. A lesser degree of deviation will produce sub-

tle degradations in the sound, often audible as a slightly sour quality or as a sound that is not quite so clear and well-focused as it ought to be. Needless to say, any degree of off-center effect renders worthless the wow and flutter characteristics of high-quality turntables.

Having failed in fifteen years to learn how to produce a decent stereo pressing with any degree of consistency, the industry is now trying to entice us into the realm of four-channel, where pressing quality is even more critical. I have no plans to convert to four-channel now or in the foreseeable future, but I do demand higher quality in the stereo discs I buy. If some of the energy and expertise going into devising four-channel gimmickry were applied to improving quality control, it might be possible to make stereo-disc reproduction live up to its all

too seldom fulfilled promise.

Daniel Morrison
Albany, N.Y.

Record Sequencing (concluded)

Although I am one of the "purists" referred to by Mr. Kile Baker ["Letters," July] and shudder at the thought of stacking records, I must confess that when they are played manually the order doesn't really make much difference. So why not surrender gracefully to those who obviously don't bother with Dust Bugs or who like to remain immobile for several hours?

My main concern is with the quality of the recording and the performance itself. Furthermore, with the current vinyl shortage added to

You could clean your records with just about anything- including tears.

It's a crying shame that the devices many people mistakenly use to clean their records, actually can damage them. Using sprays, cleaning cloths, lint-loaded tissues, even penknives, to eliminate dust, dirt and grit from record grooves can add pops, clicks, distortion and loss of high frequencies. The only positive way to restore the brilliant sound of your records is to clean, maintain and protect them with the Watts Record Care Kit. In addition to the now classic guide, "Professional Methods for Record Care & Use," it includes everything you need to remove dust, dirt, grit and static charge from record grooves safely and professionally. Without tears. Only \$24.95. Watts record care equipment and kits are available at hi-fi dealers and record counters everywhere. Elpa Marketing Industries, Inc., New Hyde Park, N.Y. 11040 / Scottsdale, Ariz. 85260



Record Care Kit

for the life of your records

AVAILABLE IN CANADA THROUGH SMYTH SOUND EQUIPMENT LTD.

Correction

In R. D. Darrell's review of the Juilliard Quartet's "Miniatures for Strings" album (August HF), the Schubert *Quartettssatz* included on the recording is the D. 103 of 1814 rather than the D. 703 as listed. Our apologies to Mr. Darrell.

the ever-existent problem of a small market for classical discs, we'd better stop quibbling over minor matters such as the sequence or resign ourselves to having no new releases.

Julie Renouf
Bradford, Mass.

We'll buy that. And there, dear reader, the question rests (for this time around).

Review the Performances

A weary word to your classical-record critics: Please endeavor to spare us the amateur sociology—just review the performances. Pretentiousness does have its limits! Robert C. Marsh's August Elgar review, intending to be

august indeed, would have been greatly improved by invisible ink.

One arrives in high expectations, of course. After all, three columns [actually barely one and a half.—Ed.] on *Falstaff*, the *Cockaigne Overture*, and the First Symphony will surely yield an in-depth comparison of all listed performances with special attention to tempos, phrasing, dynamics, recorded sound, and filler couplings. Sadly it is not to be. We find instead a trite and stereotyped analysis of the British upper classes, Elgar's difficulties with social insecurity, and a total inability to separate music from its cultural sources and literary allusions.

It is one thing to be a poor historian. (I don't think "stately ceremony" and "smug self-

love" would do justice as summaries of any era.) It is quite another to praise *Falstaff* because it has "a real character to depict" and condemn the symphony for its "sinful pride." That is to be an uncomprehending musician as well.

Mr. Marsh seems to be under the illusion that music is "about" things. I had hoped that critics since Hanslick knew better. I defy Mr. Marsh to play the *Cockaigne Overture* to a novice. Will the apt pupil pipe up, "Aha, Hyde Park, there go the lovers"? Drive! It's not a movie. I only look forward to the next review of the Beethoven Third: I haven't had a good lecture on Napoleon in some time.

As I said, just review the performances!

Steven W. Kruger
New York, N.Y.

Gesualdo Texts

I was interested to read Susan Thiemann Sommer's August review of Telefunken's box of Gesualdo madrigals. In her review, she criticizes Telefunken for not supplying either texts or translations and opines that one would have to have access to a research library to remedy this omission. But—madrigal bulls take note—this isn't necessary, at least not for the first three books. These have been released by the Musical Heritage Society (MHS 917/9) with the same performers (apparently the same recording as the Telefunken) in a package containing the Italian text, an English translation, and an introduction to each madrigal.

I should add that, despite the title "Five-Voice Madrigals," Book I is for six voices. The Quintetto Vocale Italiano is joined for this book by the sonorous bass Dimitri Nabokov.

Gladys Rudolph
Toledo, Ohio

Gershwin's Gershwin

David Hamilton was right—the latest Gershwin reissues certainly don't exhaust the topic ["Will We Be Ready for the Gershwin Centenary?" July]. Some of his most interesting works remain hard to get.

I have the acoustically recorded *Rhapsody in Blue* on 78s, as well as the later electrical recording. There is a marked difference between the two. The acoustic recording is of the jazz-orchestra version originally played at Aeolian Hall in 1924. It is the rescoring for "symphonic orchestra" that we hear in the 1927 electrical recording. Since then the *Rhapsody* has been rescored several more times, until most modern versions sound very different indeed from the original!

In the jazz-orchestra arrangement one senses a certain period charm partly lost in the 1927 recording, and I have yet to hear an LP *Rhapsody* that had any of this feeling. RCA, please dig through your vaults and find the masters for Victor Blue Label 55225 and reissue it.

The Hamilton article also made no mention of the greatest injustice of all to us Gershwin fans. Everyone knows of the numerous symphonic arrangements from *Porgy and Bess*, but not many people know that they don't have to be content with imitations. In 1936 Gershwin himself wrote *Catfish Row* (also known as *Suite from "Porgy and Bess"*) for Alexander Smallens and the Philadelphia Orchestra. It contained a lot of music cut from

the fact that we sell **more** Lafayette Criterion Speaker Systems than any other speaker manufacturer is no accident.

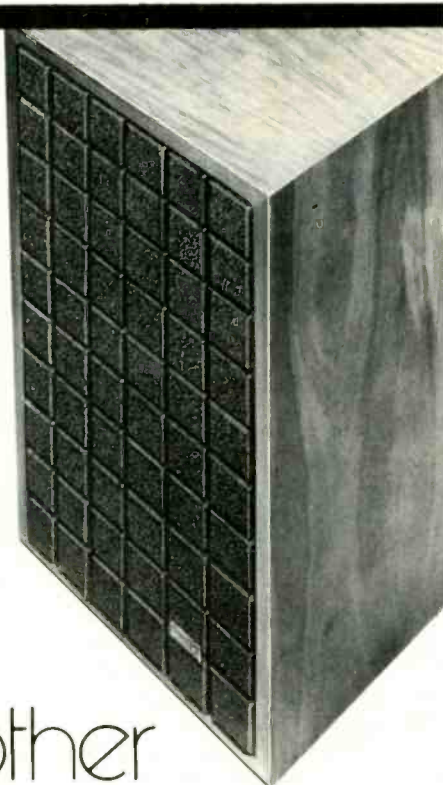

They're BETTER!
Compare Criterion

speakers with others in their price range—in virtually every instance you'll find: larger magnets, larger diameter voice coils, heavier-gauge wire in crossovers, specially manufactured cone materials and quality control that's the most rigid in the industry. Also speaker to speaker uniformity—an illusive but VERY necessary quality in ANY speaker line. The sound is clean, peak-free, natural—listen to Lafayette Criterion speakers—you can't go wrong!

Lafayette RADIO ELECTRONICS
Listen to us, you can't go wrong.

111 Jericho Turnpike, Syosset, L.I., N.Y. 11791

54 Years of Leadership and Integrity in Electronics • Write for FREE Catalog • Stores Coast-to-Coast

CIRCLE 37 ON READER-SERVICE CARD

Hi-Fi Ho-Hum

Competing with the giants in a giant industry is no small task. Which should explain why we at Sherwood feel a sense of accomplishment.

After all, we can't invest as much in advertising as the larger manufacturers. Nor produce as many different types of equipment. So we certainly can't come close to matching their total sales volume.

Yet, we've steadily gained leadership status in the field of high fidelity electronics. For one simple reason:

Dollar-for-dollar, Sherwood provides more power and greater performance in its products than anyone else.

You can prove this by comparing our products with others in the same price categories. The S-7210 is a case in point.

It has minimum RMS 26 X 2

(8 ohms 20-20,000 Hz), with maximum harmonic distortion of only 0.6%. FM Sensitivity (IHF) of 1.9 uv. Alternate channel selectivity of 65 db. Front panel switching of 4-channel decoder (which doubles as second tape monitor). FM muting switch. And a Tape Dubbing feature.

What's more, the S-7210 is built with the most advanced componentry. Integrated circuits, FET circuitry, solid-state ceramic FM IF filters.

All for under \$300.

So although it's easy to be impressed by the sheer size of a company or the weight of its advertising, when you get right down to it performance-per-dollar makes it all hi-fi ho-hum.



Sherwood Electronic Laboratories
4300 North California Avenue
Chicago, Illinois 60618.

Sherwood.

The word is getting around.



The 800+.

It's six of the best receivers you can buy.

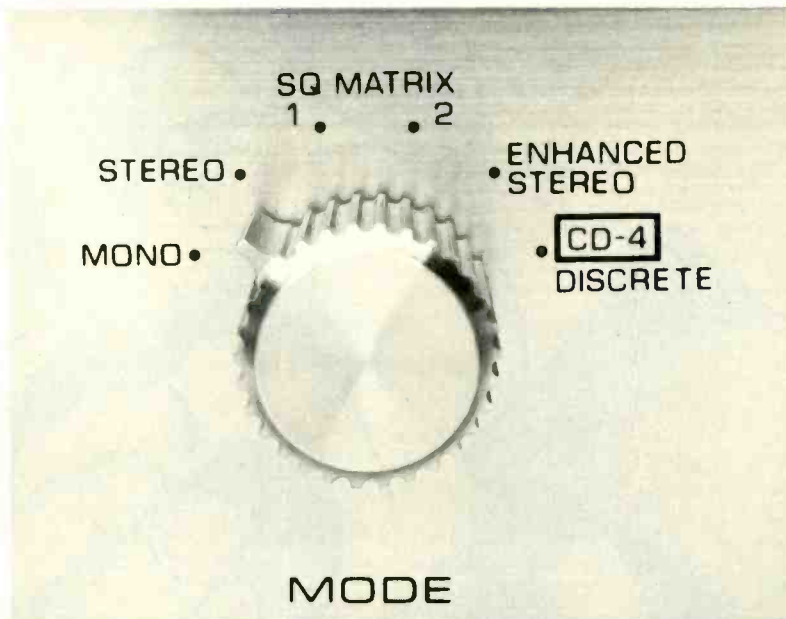

If you'd stop reading this and and go listen, we'd both be ahead of the game. If words could do it you'd be into poetry, not music.

The harman/kardon 800+ gives you both kinds of four channel now. Built-in CD4 now. Built-in SQ now. No waiting. (Anyone who tells you to wait for four channel has a hole in his receiver.) The 800+ will play any four channel record you can buy now. With four separate amplifiers delivering a glorious 22 watts continuous power. Each.

Mono and stereo, of course. Pure stereo. Some four channel systems play stereo like they only half mean it. (They turn off two of their four channels and call it "stereo.") If you're playing stereo on the 800+ you get the whole sound. A simple switch blends the power of four channels into two – more than doubling their quad output. 50 watts continuous power per channel!

Then, two kinds of stereo you've never seen before:

Stereo/Stereoc. Listen to your tape deck in the living room. Listen to FM in the bedroom. At the same time.

Enhanced Stereo. An incredible bit of electronic magic that makes your entire stereo library think it's quad. (We know an unnerving number of music buffs who say that enhanced stereo is better than quad. You listen. You decide.)

Six receivers: mono, stereo, stereo/stereo, enhanced stereo, CD4 and SQ.

Words, words, too many words. Go hear the 800+. Listen to it do what it does.

One last word: \$500. The six receivers are yours for \$500. Which figures out to \$83.33 a receiver.

That's music.

The harman/kardon 800+.

Power output: 4 x 22 watts continuous per channel. all channels driven into 8 ohms from 20Hz to 20,000 Hz. (Stereo mode 2 x 50 watts RMS)

Harmonic Distortion: Less than 0.5% THD

Frequency Response (AMP): 4Hz to 70,000Hz ±1.0 dB
Hum & Noise: Better than 85 dB (unweighted)
FM Sensitivity: 2.0 microvolts (IHF)
FM Selectivity: 40 dB
FM Capture Ratio: 2.5 dB
Ultimate S/N Ratio: 70 dB (1000µV)



harman/kardon

High fidelity component systems from \$200 to \$1300.

55 Ames Court, Plainview, New York 11803 A subsidiary of Harman International.

CIRCLE 28 ON READER-SERVICE CARD

Seven Speakers, One Message:

"Lifetime Guaranteed" By Radio Shack!

Lifetime Guarantee

Radio Shack guarantees to the original owner without time limitation the proper electro-mechanical function of all Optimus® and Nova® speaker systems in original, unopened enclosures, providing that the system has not been abused (our determination is final) and that the owner provide transportation to and from the repair site. Your system must function properly or Radio Shack will repair it **FREE OF PARTS AND LABOR CHARGES** — today, tomorrow, forever! This guarantee is honored at all Radio Shack stores from coast-to-coast. Your receipt is all you need to obtain lifetime free service.

Realistic Optimus and Nova Speakers — America's Best Buy!

Radio Shack puts more into its famous Optimus and Nova speakers by leaving a few things out. Things like middleman profits. Because we design our own speakers, you get better quality control, unique engineering features, elegant walnut wood veneer cabinets.

FREE New 1975 Radio Shack Catalog

OVER 2000 PRODUCTS
EXCLUSIVES ON EVERY PAGE
BEAUTIFUL FULL COLOR

Stereo • Quadraphonic • Phonographs
TV Antennas • Radios • Citizens Band
Kits • Recorders • Tape • Tools
Auto Tune-Up • Electronic Parts
Test Instruments • More!



164 pages of the finest in home and hobby electronics. Respected brand names like Realistic, Micronta, Archer, Science Fair — and they're available only at Radio Shack stores and dealers nationwide! See what's *really* new in electronics by getting this catalog now.

SEND FOR YOURS TODAY!
FILL OUT COUPON BELOW

1975 Mail to Radio Shack, P. O. Box 1052,
Catalog Ft. Worth, Texas 76101. (Please print.)

451

Name _____ Apt. No. _____

Street _____

City _____

State _____ ZIP _____



Optimus-9
179⁵⁰

Nova-8
139⁵⁰

Optimus-5
114⁵⁰

Nova-7B
119⁵⁰

Optimus-2B
69⁹⁵

Optimus-1B
89⁹⁵

Optimus-2BF
59⁹⁵

Nova-8. Firm bass even at 20 Hz. 12" woofer. 3 other speakers handle the midrange and one doubles as a tweeter, too. 20-20,000 Hz. 25x14x11½". #40-4020.

Optimus-5. Top rated by a leading testing organization. 12" woofer, 3 midrange/tweeter units. 20-20,000 Hz. 25x14x11½". #40-2002.

Optimus-1B. Uncolored audio — at an affordable price. 10" woofer, 2 midrange/tweeter units. 20-20,000 Hz. 23x12x11". #40-2005.

Optimus-9. Our best — radiates from front and rear for enhanced midrange. Five speakers including 12" woofer. 20-20,000 Hz. 28x19x9". #40-4023.

Nova-7B. Superb sound, style to match. 10" woofer, two 8" midrange/tweeter units. 20-20,000 Hz. 22x12½x11". #40-4025.

Optimus-2B. First low-cost system good enough to win the Optimus name. 8" woofer, tweeter. 30-20,000 Hz. 20x11x10". #40-2023.

Optimus 2BF. Same as 2B, but you can custom finish its white vinyl enclosure. #40-2024.



Master Charge or
Bank Americard at
participating stores

Radio Shack®

A TANDY CORPORATION COMPANY

3000 STORES • 50 STATES • 8 COUNTRIES

Retail prices may vary at individual stores.

CIRCLE 49 ON READER-SERVICE CARD

the original 1935 production, as well as some of the more popular songs from the opera. (I believe the transition from the Jasbo Brown music to "Summertime," which Hamilton states has never been recorded except by Gershwin himself, is found in this suite.)

After about a dozen performances of this suite (his last orchestral work), Gershwin died and it was forgotten. It surfaced briefly around 1959, when Maurice Abravanel and the Utah Symphony brought forth a first (and, it now appears, last) recording of it (Westminster WST 14063). Reviewers were very enthusiastic, hoping that this would put an end to efforts to "improve" on Gershwin, that this suite would supersede Robert Russell Bennett's *Porgy* "symphonic picture" on record shelves.

Well, here it is 1974 and Gershwin's suite is nowhere to be found. ABC/Westminster would do us all a great favor by reissuing the Abravanel recording on Westminster Gold, and other orchestras would do us a great favor if they were to record it. Until then, we'll just have to struggle along with our "improved" Gershwin. (If Gershwin were alive today, would everyone still be trying to improve and rearrange his music? I doubt it.)

Steve Lenius
St. Paul, Minn.

Follow the Bouncing Syntax

Jordan Ramin ["How to Launch a Hit Song," August] has it backwards. The famous "Music to Watch Girls By" Diet Pepsi TV commercial did *not* show "beautiful girls strolling by people drinking Diet Pepsi." Rather it showed beautiful girls drinking Diet Pepsi strolling by people.

Dave Barry
South San Francisco, Calif.

Even Diet Pepsi needs exercise?

Electrostatic Omission

In his June speaker article ["How Do Speakers Work?"], Robin Lanier shows one particularly lamentable piece of ignorance in regard to electrostatic speakers: He evidently has not heard of, let alone heard, the Dayton-Wright speaker, made here in Ontario. This full-range electrostatic does not have "twenty square feet or more" of area, and it produces bass—lots of it—and all perfectly real. Mr. Dayton-Wright does it by enclosing the electrostatic elements in a sort of bag of inert gas, which enables him to use far higher voltages than in most designs. His discovery is unquestionably a giant step forward in electrostatic design, and it seems a pity that there is no mention of it in an article that purports to give us the latest. No realistic slate of candidates for The Best Speaker There Is could fail to include this unit.

Jan Narveson
Waterloo, Ont.

The Dayton-Wright electrostatic was described a year earlier [HF, June 1973] by Irving M. Fried in an article on new loudspeaker designs. We had asked Mr. Lanier to survey the loudspeaker types available on the U.S. market to help our readers understand the various classifications into which they fall. Since the Dayton-Wright is available here only in extremely limited areas and quantities, he did not include it—though we agree it is an exceptionally interesting design.

DUAL PERSONALITY

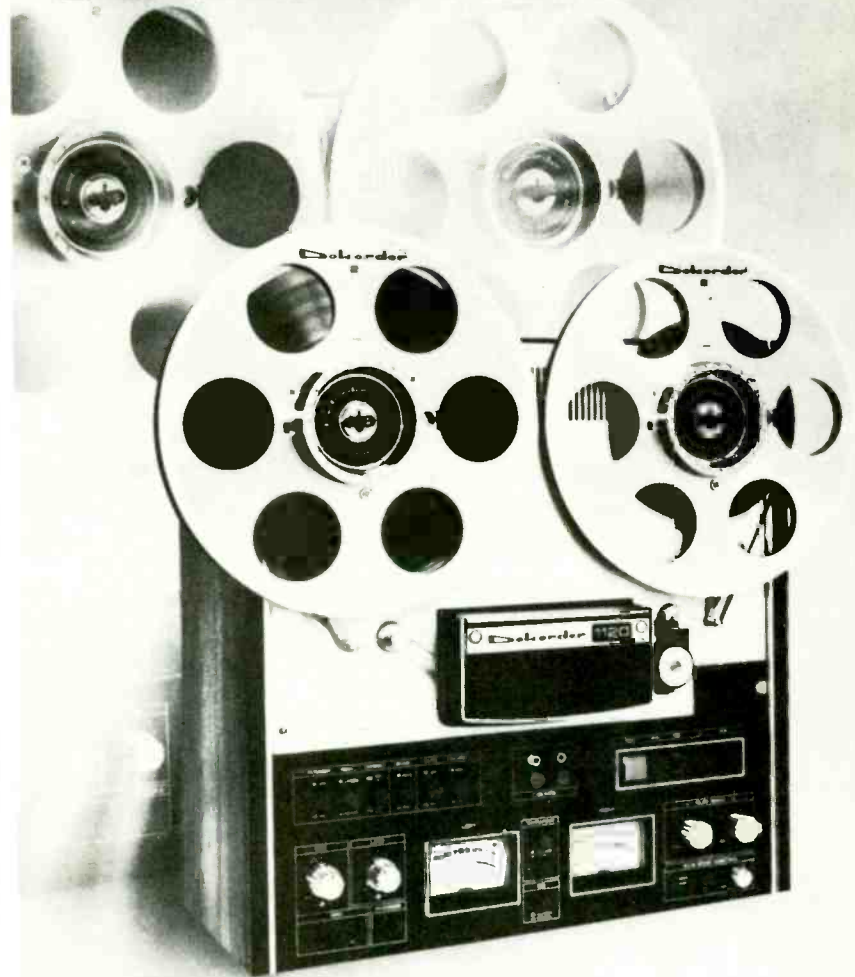

Available as a 4-track or 2-track stereo tape deck, the DOKORDER 1120 has all the professional features you could ever want!

10½ inch reels • 15/7½ IPS • 3-motor transport
• 3 heads • bias control • tape/source monitoring
• Either 4-track or 2-track configuration convertible to alternate version as optional modification.

Suggested retail price: \$649.95

Dokorder Inc.® 5430 Rosecrans Avenue, Lawncal, California 90260

CIRCLE 23 ON READER-SERVICE CARD

Maxell offers another amazing achievement of modern cassette technology.

Round screws in square holes.



We wanted to make some really big improvements to our Ultra Dynamic cassette. But there just weren't any big improvements left to make. So we made a lot of little improvements.

Our screws aren't loose.

Our square holes are better because plastic shavings from the threads drop into the corners of the holes and create a much tighter grip. And since the shavings are in the holes, they can't cause trouble jumping around in the works.

Little pad finally gets grip on self.

Instead of glue, a little metal frame holds the pressure pad. In a grip of steel. With the result that you don't need to worry about signal fluctuations or loss of response any more.

An improvement you can see but can't hear.

The first five seconds of our new UD cassette is a timing leader. And we've marked the place where it starts so you'll always know exactly where you are.

But the leader's also a head-cleaner and what's amazing about it is that it doesn't rub as it scrubs as it cleans. Because it's nonabrasive. So it keeps your

tape heads clean without wearing them down.

More hertz.

We've also improved our tape. We've increased the Hz to 22,000 Hz so you get even higher highs. The signal-to-noise ratio's now 8dB more than ordinary cassettes—which means you get less noise and cleaner sound. And the dynamic range is wider so distortion is lower.

Our new long-playing cassette is shorter.

Our new UDC-46 is 23 minutes per side. Which very conveniently just happens to be the approximate playing time of your average long-playing record. (Our other cassettes are 60, 90 and 120.)

Altogether we've made five new improvements. As you can see—our business is improving.



maxell.

The answer to all your tape needs.

Maxell Corporation of America, 130 West Commercial Avenue, Moonachie, N.J. 07074

CIRCLE 40 ON READER-SERVICE CARD

Academic

I'm getting fed-up-to-here (and my hand is not pointing to my gullet) with the careless and cryptic type of review given to the Desto disc of Ned Rorem's *Ariel* and *Gloria* ["In Brief," July]. Such phrases as "safely angular settings" and "really no worse than a lot of academic new music" strike me as cowardly and noncommittal. The review implies two things, essentially: 1) that the composer sought refuge and approval, artificially, via the "angularity" of his writing, and 2) that "academic new music" (whatever that is) is something to be ashamed of—if not scorned.

Isn't it time we got off the exasperating High Horse and returned to a discussion of music as music? On the basis of this review one is left in the dark because the reader is at the mercy of a reviewer concerned more with the how instead of the what. To judge a work solely on the basis of its "newness" or "originality," rather than its artistic merit, is the reason, I suspect, that we are now in the midst of "rediscovering" Joplin, Janáček, Delius, Nielsen, and many other composers who wrote "academic new music" for their time.

Harry Atwood
Tucson, Ariz.

Tchaikovsky Echoes

In his July review of Shchedrin's ballet *Anna Karenina*, Dale Harris states (as does the record jacket itself) that the work contains "echoes" or "reminiscences" of the Tchaikovsky Fourth and Sixth Symphonies, *Nutcracker*, *Swan Lake*, and *Eugene Onegin*. Since, after repeated hearings, I can find no trace of actual quotations from these works in the ballet, I find it odd that no mention is made of those Tchaikovsky works that have been clearly utilized.

Considerable use has been made by Shchedrin of the Andante from the third movement of the Second String Quartet, much as a recurrent theme throughout the work. Also the mazurka from the Theme and Variations for Piano, Op. 19, No. 6, has been orchestrated and is used for Anna's solo. Finally, three fragments from the opening and closing movements of the Third Symphony are quite distinctly heard.

The score is wonderfully evocative of the Tolstoy novel, and I look forward to seeing the ballet.

Charles Marootian
Paterson, N.J.

High Fidelity, November 1974, Vol. 24, No. 11. Published monthly by ABC Leisure Magazines, Inc., a subsidiary of American Broadcasting Companies, Inc.

High Fidelity/Musical America. Edition published monthly. Member Audit Bureau of Circulations.

Editorial correspondence should be addressed to The Editor, High Fidelity, Great Barrington, Mass. 01230. Editorial contributions will be welcomed. Payment for articles accepted will be arranged prior to publication. Unsolicited manuscripts should be accompanied by return postage.

Subscriptions should be addressed to High Fidelity, 1 Sound Ave., Marion, Ohio 43302. Subscription rates: High Fidelity/Musical America: In the U.S.A. and its Possessions, 1 year \$16, elsewhere, 1 year \$17. National and other editions published monthly: In the U.S.A. and its Possessions, 1 year \$7.95. Subscription rates for all other countries available on request.

Change of address notices and undelivered copies (Form 3579) should be addressed to High Fidelity, Subscription Fulfillment Dept., 1 Sound Ave., Marion, Ohio 43302.

CIRCLE 15 ON READER-SERVICE CARD →



ONE OF THE FINEST RECEIVERS YOU CAN FIND. IF YOU CAN FIND IT.

The Concord CR-260 is damn hard to find, because we're just as particular about the stores who sell it as we are about the quality of workmanship that goes into it.

And for under \$250*, it's damn hard to beat. You simply can't find features like ours in such a beautifully designed receiver for such a reasonable price.

While other receivers may have some of our features, none have all of them! There's simply no competition for the CR-260 at this price.

Here's what makes the CR-260 worth finding:

We've taken the care to make tuning more precise, even under the most difficult conditions.

While other receivers have one FM tuning knob, that's not good enough for the CR-260. We went to the trouble of engineering an additional second control for ultra-fine FM tuning.

And when it's receiving a stereo station the dial pointer changes from amber to red.

It even has two FM meters, one for signal strength,

and another for center of channel tuning. Other deluxe touches are the detents on the bass and treble controls that help you reset any combination exactly.

And here are some of the vital statistics: 50 watts rms total power output at 1% total harmonic distortion. FM capture ratio an incredibly low 1.5 db. And for just pure aesthetics, a beautiful blackout dial.

You'll want the full story on all the CR-260's features before you begin your search; just drop a line to: Concord Products, Benjamin Electronic Sound Co., 40 Smith Street, Farmingdale, N.Y. 11735.

We hope it's easier for you to find than it was for us to make.



THE CONCORD CR-260.
Damn hard to find. Damn hard to beat.

*Manufacturer's suggested retail; slightly higher in the west.

The lowest-priced Dual may well be all the turntable you're ever likely to need.



Dual 1225, \$129.95

The least you should require of a turntable is the assurance that its tonearm can track flawlessly with the most sensitive cartridges available, and that its drive system will introduce no audible rumble, wow, or flutter. To accept less means risking damage to your precious record collection and producing sounds from your system which were never recorded.

Happily, the lowest-priced Dual, the 1225, provides this assurance and much more at just \$129.95. For it is the perfect example of Dual's basic design concept: to build every Dual turntable with more precision than you are ever likely to need.

In the case of the 1225, this means a vernier-adjust, counter-balanced tonearm capable of flawless tracking at as low as one gram. Stylus pressure is applied exactly as in costlier Duals: around the vertical pivot,

Dual 1228, \$189.95



Dual 1226,
\$159.95

Dual 1229Q, \$259.95

maintaining perfect balance in all planes. Anti-skating force is also applied exactly as in the highest-priced Dual: with separate calibrations for conical, elliptical and CD-4 styli.

Other features the 1225 shares with the more costly Duals include pitch control, viscous-damped cueing and a precision drive system. The 1225's hi-torque motor maintains speed within 0.1%, even when line voltage varies as much as 20%, and its hefty 3-3/4 lb. platter provides effective flywheel action that minimizes the audible effect of any possible speed variations.

All of this explains why even Dual's lowest-priced models have been so well accepted by audio experts. (Many tell us their original Duals which were bought early in their careers are still in service.)

Considering all this, why do so many serious music lovers spend as much as \$259.95 for the 1229Q? (Readers of the leading music/audio magazines own more Duals—at

every price level—than any other quality turntable.)

Although the 1225 has all the precision your records need, the 1229Q has refinements that you may well want. For example, the 1229Q is a full-sized turntable with a 12" dynamically-balanced platter, driven by the powerful Continuous-Pole/synchronous motor. Its gimbal-mounted 8-3/4" long tonearm can track at as low as 0.25 gram, and has provision for adjusting its vertical tracking angle. It also has an illuminated strobe, and cueing is damped in both directions to prevent bounce.

Dual's other two multi-play turntables, the 1226 at \$159.95 and the 1228 at \$189.95, offer one or more of these refinements. Which may bring you to this question: having decided that you and your records deserve a Dual, which one should you buy?

For the answer, we suggest you visit your franchised United Audio dealer where the new generation of Dual

turntables is now on display.



United Audio Products
120 So. Columbus Ave.,
Mt. Vernon, N.Y. 10553
Exclusive U.S. Distribution Agency for Dual

by Edward Greenfield

The Metamorphosis of André Previn

In Britain, Previn is more than a great conductor—he's a national institution.

ASK ANY BRITISH passerby to name a conductor, and the first answer will almost certainly be André Previn. That is the sort of impact he has had on an audience far wider than those who normally buy records or go to concerts. On BBC Television, Previn's "Music Nights" attract audiences of many millions, several times as many as those for potential rivals, and that is so not only for Beethoven or Tchaikovsky, but for a centennial tribute to Vaughan Williams or a program of French music as well.

A couple of Christmases ago it seemed only natural when the peak comedy program of the day, the "Morecambe and Wise Show," featured Previn in a knockabout takeoff on a concerto rehearsal. In finely tailored insults he gave as good as he got. The following Christmas he returned, along with other Morecambe and Wise guests, for a series of "Whatever happened to . . .?" clips. Previn was shown with a peaked cap over his Beatle cut, holding a ticket machine on the platform of a London bus—a different sort of conductor.

When Previn was given his own chat show as well as a new music series this past summer, he had Morecambe and Wise as his first interviewees. His second choice was equally significant: the Rt. Hon. Edward Heath, M.P., now leader of the opposition and an honorary member of the London Symphony Orchestra, of which Previn has been principal conductor since 1968. John Culshaw, once Decca/London's pioneering producer and now head of music on BBC Television, was shaken rigid to see Previn actually wearing a collar and tie. Previn explained that the tie, chosen by his wife (Mia Farrow, also present), was the only one in his wardrobe and that he felt he

owed it to the occasion to wear it. But then who should come around the corner but the former prime minister wearing a chunky sweater and no tie.

From all this—and remembering Previn's spotlight career from his teens onward, through Oscars for film music in Hollywood, jazz piano records, Broadway musicals, and headline marriages—it would be easy to conclude that he is a master of publicity rather than a major musician, a pop figure impossible to take seriously in Beethoven's Ninth.

What the British public knows—something the American public has perhaps been slower to appreciate, the pop image being more firmly established—is that everything he does is genuine. When he clowns with Morecambe and Wise, he does it not patronizingly to feed his image, but because he enjoys it. He talks to Edward Heath in the same straight-from-the-shoulder terms he will use with a star-struck kid who asks for an autograph or, for that matter, a television audience of millions. Everyone who sees a Previn program knows exactly what he is like to talk to.

From the journalistic point of view, almost anything he says is naturally and spontaneously "good copy." He is incapable of being boring, and that goes not only for television programs before millions and for conventional press conferences, but for orchestral rehearsals too. If his work in the MGM studios taught him anything (and he would say it was vital in his development), it was how to work with first-rate musicians, to challenge them, not to bore them, to keep ahead of them but to remain a controlling equal.

His first day as a conductor, when as a teenager he scored his first feature film, the musicians tested him by tuning to A flat instead of A. Only as he raised his baton did he say brightly, "Right, everybody, transpose a half-tone up." After that it was reasonably plain sailing. "As

soon as I had conducted for two days I realized that it was all I ever wanted to do. It was an instant and complete revelation."

Previn stories are legion. In rehearsal he suddenly asks blankly, "What's that?" Told that it is a triangle, he comments sourly, "Sounds more like cuff links." Or, rehearsing the Leicestershire Schools Orchestra on a particularly illuminating television program, "The Other LSO," he doesn't even stop during a wild run-through of Glinka's *Ruslan and Ludmila* Overture. At one point the violins come to grief on a rushing phrase, and Previn happily snaps: "Better luck next time!"

His comments are tough but constructively so. Professional players, he tells the young musicians, have a way of looking at the conductor without seeming to. "Now you seem to look, but don't!" He adds with a grin: "Do take an occasional look—you'd be surprised." He goes on to say that he really would rather have a horrendous mistake in playing that was really meant than a perfectly correct "Oh God, I hope I'm right."

Not once does he patronize the youngsters. He never patronizes any audience—on television, in the concert hall—and that plainly is the secret of his success. He has his share of showmanship, but it is the actual communication that matters to him, not the means. With all the publicity, he could no doubt have commanded an audience on any terms in the beginning, but the way audiences return, whether for television, concerts, or records (in Britain he sells more records than Karajan), confirms that the promise is kept. After a concert I have seen him drained to the dregs, only to perk up within minutes to a fresh challenge—a story to tell, a sharp comment to make. He drives himself mercilessly all day every day.

The ever-present parallel is Leonard Bernstein, and there Previn with a def-

Mr. Greenfield, HIGH FIDELITY/MUSICAL AMERICA'S London correspondent, is music critic of The Guardian. His book on André Previn is published in England by Ian Allan Ltd.

VERSATILE IS enjoyable



IC150

This IC150 . . . is the finest and most versatile control unit I have ever used. For the first time I can hook all my equipment together at once. I find many semi-pro operations possible with it that I have never before been able to pull off, including a first-class equalization of old tapes via the smooth and distortionless tone controls. I have rescued some of my earliest broadcast tapes by this means, recopying them to sound better than they ever did before.

-- Ed Canby, AUDIO

Among the things you can do with an IC150:

Produce your own taped programs! Record from any of seven inputs: 2 phono, 2 tape, 1 tuner, 2 auxiliary (tape player, cassette deck, guitar, microphone, etc.)

Clean up record scratch, tape hiss and turntable rumble with filters which scarcely alter program material.

Improve frequency response with bass and treble controls for each channel.

Enhance stereo image with the IC150's exclusive panorama control.

Record two copies of a program at once, and monitor source and tape for each.

Correct ping-pong effect for more enjoyable headphone listening.

The IC150 performs all these functions and more with lower distortion and noise than any other preamplifier.

This combination of clean sound and versatility cannot be bought anywhere else for less than \$600. But you can buy it for only \$349 at your **Crown** dealer. See him today to make your own comparison. (For independent lab test reports on the IC150, write CROWN, Box 1000, Elkhart, Indiana, 46514.)



CROWN

Made Only in America

CIRCLE 16 ON READER-SERVICE CARD

erential shrug does not dissent. Bernstein was indeed a formative influence at several stages. A conscript U.S. Army sergeant at the time of the Korean War ("Well, I could *read!*", he says, explaining his promotion that far), he first heard Bernstein conduct in San Francisco and was swept away by what struck him as a maelstrom. Two days later, at his next conducting lesson with Pierre Monteux (he was then one of two Monteux pupils), he was asked to conduct the opening of the Brahms Fourth Symphony. After a few bars Monteux beckoned. "You went to see Mr. Bernstein? Go back and do it again." After the rehearsal he took Previn aside: "Dear boy, before you try to impress the ladies in the mezzanine, make sure the horns come in!"

If Bernstein was communicating an intense experience, Previn came to understand, the showmanship was incidental. And professionalism, not good salesmanship, has won Previn his place in the music world today. From his earliest years in Berlin he was given an intensive classical training at the insistence of his father, who to the end of his days shrugged at any of André's Hollywood successes: "Well, it isn't the *Eroica*." When the LSO made its surprise choice of Previn (a long shot was made at Bernstein, a closer-aimed one at Solti), it was largely because of his efficiency in rehearsal, his ability to get first-rate results with the minimum of pain, the maximum of enjoyment and excitement.

Previn represents the second generation of conductors determined, like Bernstein, to turn their backs on the old mandarin image. "He is everybody's kid brother," says his own big brother (six years older), also a British resident and a successful man in film production. It is not an image that Previn, now in his mid-forties, can perpetuate forever, but he still shows no inclination toward musical high priesthood.

He is always ready to deflate himself, but only so long as it helps his ultimate authority. "Who Needs a Conductor?" was the title of one of his most successful television programs, and with tongue in cheek he demonstrated that the LSO can give a perfectly acceptable performance of a Mozart symphony without anyone wagging a stick. He also showed a rival's trick for coordinating the difficult opening of Strauss's *Don Juan*: starting before the applause stops.

If Previn is not apt to discuss his own technique in depth, it is not for want of self-analysis. Watching his first rehearsal in Salzburg's Grosses Festspielhaus, I saw clearly the technical acuteness: casing the acoustic, adjusting the LSO's sections to the decay time, very different from the Royal Festival Hall's.

It was significant too that his main of-

fering at that important Salzburg concert—the first ever by a visiting British orchestra—was the first Austrian performance of Shostakovich's Eighth Symphony (which he had recorded a few months earlier). His concentration over the enormous spans of the opening slow movement and of the last three linked movements deeply impressed the notoriously conservative audience. Formerly counted a brilliant exponent of colorful extrovert music (notably the Russians), Previn now makes his deepest mark in music with a spiritual content too. Hence the Shostakovich Eighth, the most spiritual of that composer's fifteen symphonies. Similarly on overseas tours he has programmed the two most restrained of Vaughan Williams' symphonies, the Third (*Pastoral*) and Fifth. Those, he knew, would demonstrate better than anything the special qualities the LSO has acquired in his tenure.

You will still occasionally hear that the LSO has been "Americanized," but that is not even a half-truth. In an important sense it was more American-sounding when Previn took over. Nowadays a smoother, silkier string tone is encouraged (still searingly brilliant when necessary); long-held diminuendos at the ends of movements have you catching your breath. The LSO horn section is the most smoothly coordinated of any in London, not at all brash, while significantly Previn encouraged the appointment of Jack Brymer, Beecham's clarinetist for years in the RPO, as the LSO principal. Manifestly the orchestra is less abrasive than it was, which I fear is what British commentators, however misleadingly, mean by "American-sounding."

Previn himself may do almost any musical job you could name with seeming ease, but that ease is deceptive: He knows what the struggle is like. As a conductor, he is unusually perceptive working with concerto soloists, which reflects not only his clear head and professionalism (helped by his own experience as a virtuoso pianist, with Bernstein among others), but also his uncanny ability to understand the problems of others.

The most difficult struggle has been disentangling himself from his pop success. At thirty he decided that if he stayed in Hollywood much longer he would never escape and so chose to stomp the less-than-glamorous (and drastically less remunerative) symphonic circuit. (Even now, as a topflight conductor based in Britain, his earnings cannot compare with his latter-day Hollywood income.) The Houston Symphony named him to succeed Barbirolli as principal conductor, but that was only a temporary stop on the way to the LSO post, which he had already confessed publicly meant more to him than any other.

Keep on trackin'

© 1974 Empire Scientific Corp.

Empire's new wide response 4000D* series phono cartridge features our exclusive "4 Dimensional"TM diamond stylus tip.

ing prevents any discernible record wear. Every Empire long-playing cartridge is fully shielded with 4 poles, 4 coils and 3 magnets (more than any other brand).



This phenomenal cartridge will track any record below 1 gram and trace all the way to 50,000 Hz.

For a free Guide to Sound Design write to:
EMPIRE SCIENTIFIC CORP.
 Garden City,
 N.Y. 11530.

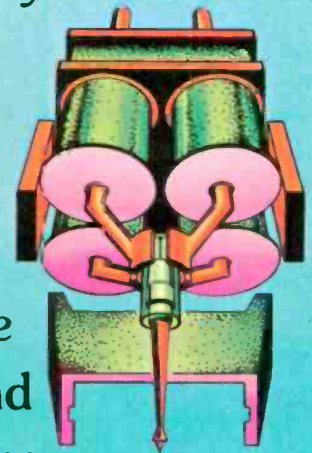

Empire's "4 Dimensional"TM diamond has a 0.1 mil radius of engagement yet the very low force required for track-

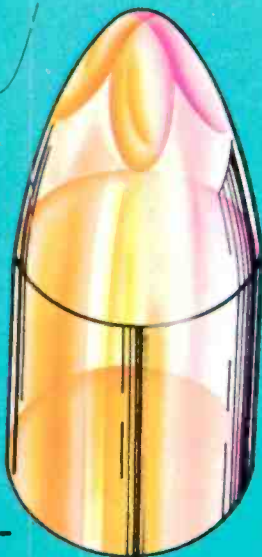

Mfd. U.S.A.



EMPIRE

* Plays any 4 channel system perfectly. Plays stereo even better than before.

CIRCLE NO. 21 ON READER SERVICE CARD

The Specification Guarantee.* Perhaps someday everyone will have it.

You're looking at the new Technics 600 Series, two of the finest cassette decks we've ever made. But equally important, they're also our first examples of "the Specification Guarantee."

The only kind of a specification we feel is worth serious consideration.

That's because "the Specification Guarantee" isn't merely a collection of overly impressive numbers achieved under ideal conditions. It's five meaningful performance specifications that every Technics RS-676US and RS-610US cassette deck, including yours, is guaranteed to meet or surpass*. And if by some unlikely chance it doesn't, we will make sure it does. After all, that's what we feel a guarantee is all about.

But the guarantee isn't the only impressive thing about these specs. The numbers are equally impressive. Even when you compare

them with the "unguaranteed" performance figures you usually see. Yet our figures are conservative, understated. Figures that your

unit is likely to surpass rather than just meet. And that makes them even more impressive.

The RS-676US. The RS-610US. And "the Specification Guarantee."

The concept is simple. The execution is precise. The performance is outstanding. The name is Technics.

| | RS-676US | RS-610US |
|---|-------------------------------------|------------------------|
| Wow & Flutter (JIS WRMS) | 0.08% or better | 0.15% or better |
| Frequency Response: Normal Tape Position | 40Hz - 12kHz (-2/-4dB) (+2/-3dB) | 50Hz - 10kHz \pm 3dB |
| CR _O , Tape Position | 40Hz - 13kHz (+2/-4dB) (+2/-3dB) | 50Hz - 12Hz \pm 3dB |
| S/N Ratio (Weighted, Signal level 250 pWb/mm): Without Dolby ¹ | 50dB or better | 49dB or better |
| With Dolby (Above 5 kHz) | 58dB or better | 57dB or better |
| THD @ VU at 1 kHz, Normal Tape Position | 2.0% or better | 2.3% or better |
| Speed Accuracy | Within \pm 1.5% | Within \pm 2.0% |

¹Dolby is a trademark of Dolby Laboratories Inc.

*Specification Guarantee will be honored for a period of ninety days from the date of original purchase. Void if the product is damaged, altered, or abused following original sale, or if repaired by other than authorized Panasonic personnel, or if the product is not purchased and retained within the U.S.A. or Puerto Rico. Test procedures are available in detailed description on request from Technics by Panasonic, 200 Park Avenue, New York, N.Y. 10017. Specification Guarantee is in addition to the usual parts and labor warranty.

200 PARK AVE., NEW YORK, N.Y. 10017. FOR YOUR NEAREST AUTHORIZED TECHNICS DEALER, CALL TOLL FREE 800 447-4700. IN ILLINOIS, 800 322-4400.

Technics

by Panasonic

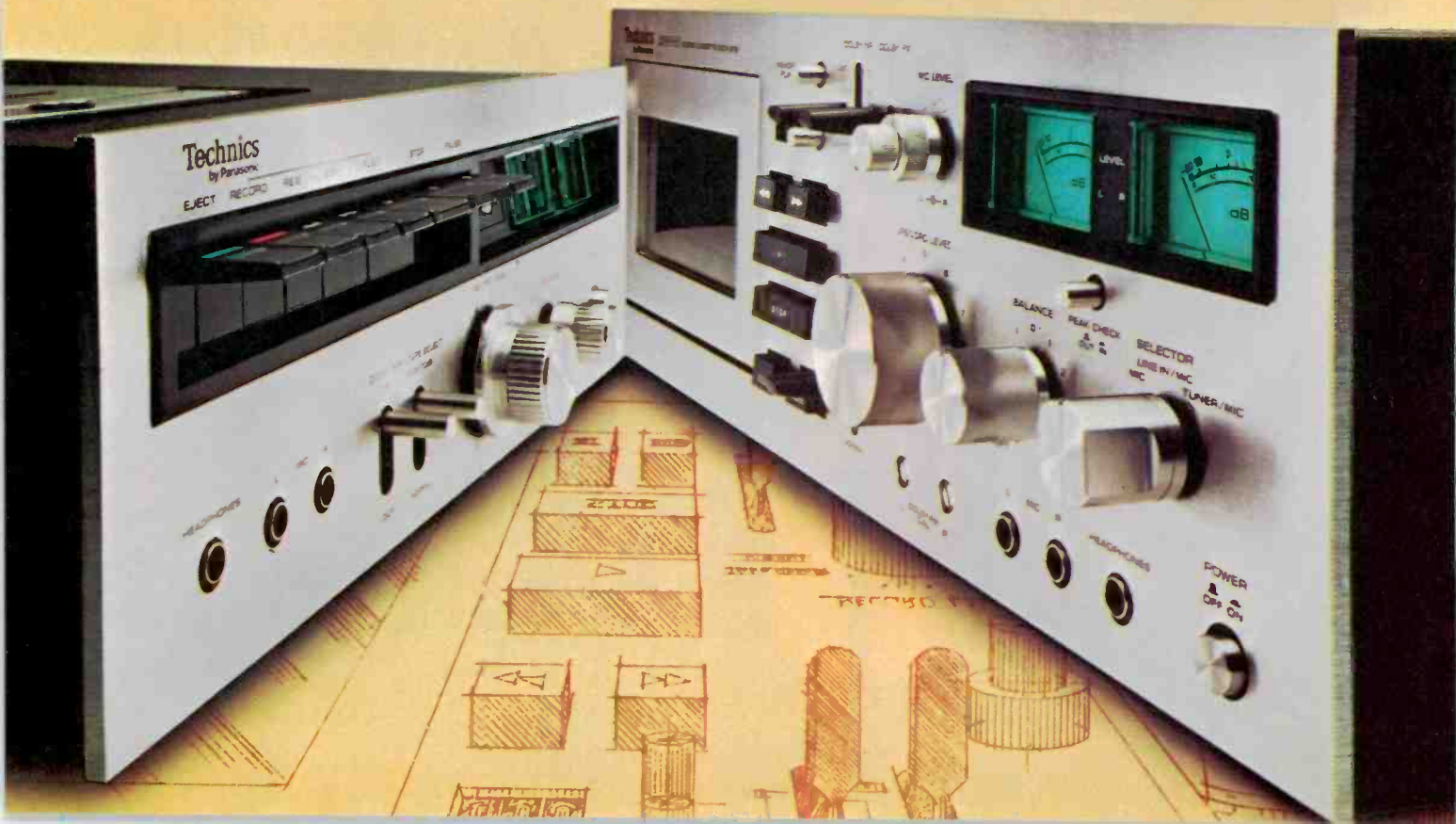

It still does. He still insists that his television programs and recordings be done with his own orchestra, and though dissenting voices in the orchestra murmur from time to time (hankering no doubt after the mandarin figures of old) no one doubts that Previn is a decisive force in the LSO's success in the concert hall and on record. He may not be the most thorough of orchestral trainers—he is too quick for that, hates to weary his players—and sometimes the string section would welcome a good spell in the classroom, but the LSO remains the most consistently inspired of London's orchestras, and for that Previn must take much of the credit.

However Anglicized his life has become (he loves the Surrey countryside where he and Mia have a delightful early-eighteenth-century home), he keeps, in every sense, his American accent. I teased him recently when his narration for Britten's *Young Person's Guide to the Orchestra* had him saying "brahss" with an English "a" sound, but that is very much an exception. If he is happier in England, it may be partly that he has effectively escaped the unwelcome side effects of his pop success. He can write the occasional musical (his latest, on J. B. Priestley's *The Good Companions* with lyrics by Johnny Mercer, has recently opened in London), indulge his catholic musical taste, appear on television, and still emerge as above all a great conductor.

As yet, even in Britain it is color rather than classicism that dominates. But those who remember his Beethoven Ninth at the Festival Hall or his playing of Mozart concertos (whether conducting from the keyboard or with Sir Adrian Boult) and those who relish his annual feast of family chamber music in the Queen Elizabeth Hall during South Bank Summer Music know how wide-ranging his talent is.

In Europe at least the movie-based reputation has long receded behind his hard-won new status. "For heaven's sake," he answered when, at the music editor's request, I asked how he feels about the lingering image problem at home, "there ought to be a statute of limitations. I haven't done a Hollywood film since 1962, and I only see movies on aircraft."

The training and experience of his Hollywood years (which, it should be remembered, came in addition to, not instead of, a normal classical training) have been of lasting value in his "serious" work. Looking at his incredibly varied career, one is apt to conclude that even the most unlikely corners of it have led almost inevitably to the end result: a complete musician in an age of soul-destroying specialization, one driven to communicate at every level. ●



The world of **KARAJAN**
is a world of **MUSIC.**

And Deutsche Grammophon is privileged to add to it constantly. This Fall's releases include:

SCHUMANN: Symphony No. 1, "Spring"; Symphony No. 4, Berlin Philharmonic. 2530 169

STRAUSS: Death and Transfiguration; Four Last Songs, with Janowitz, Berlin Philharmonic. 2530 368

SCHUMANN: Symphony No. 3, "Rhenish," Berlin Philharmonic. 2530 447

ORFF: De Temporum Fine Comoedia, with Ludwig Schreier, the 1973 Salzburg Festival cast, Cologne Radio Symphony. A WORLD PREMIERE RECORDING. 2530 432

BACH: Mass in B Minor, with Janowitz, Ludwig Schreier, Kerns, Ridderbusch, Vienna Singverein, Berlin Philharmonic. 2709 049

Incomparable recordings of incomparable performances.



CIRCLE 47 ON READER-SERVICE CARD

the
lees side

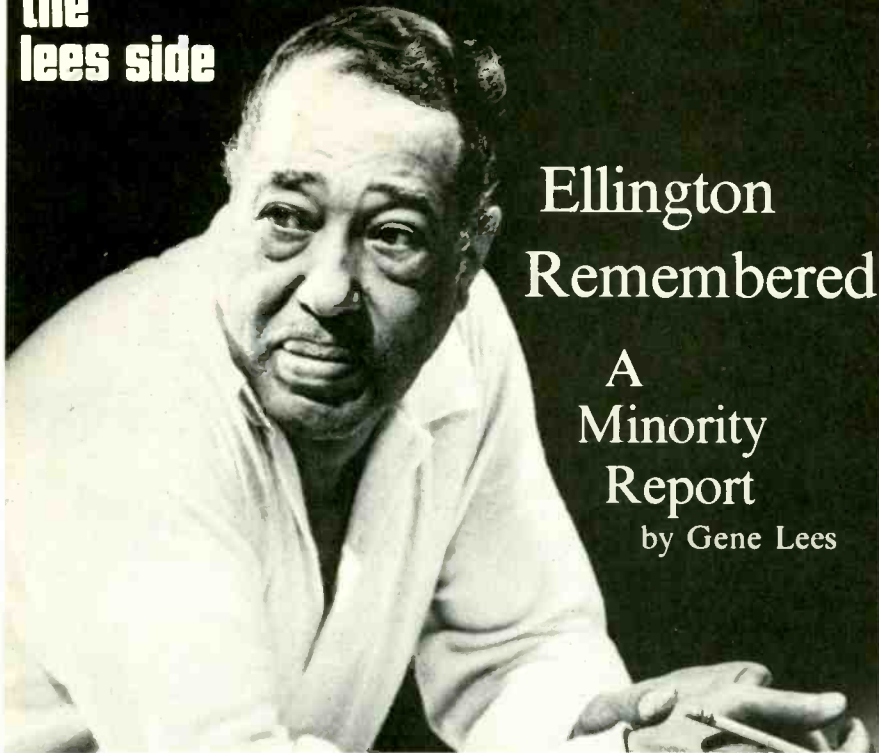

Ellington Remembered

A Minority Report

by Gene Lees

I DIDN'T KNOW Duke Ellington well. I'm not sure anyone did, but in my case the omission was deliberate. I have never been able to be comfortable with anyone whose work I do not unconditionally admire. I am incapable of standing there, drink in hand, at the après-concert reception, participating in the chorus of predictable praise or, on the other hand, maintaining that silence which—such are the sensitivities in these matters—becomes to the object of this attention so thunderously eloquent.

I think Duke knew I felt that way about him too. He used to put me on about it, without ever embarrassing us both by bringing it to words: It was all in that Buddha smile of his and the penetrating, amused light in his eye.

I once had to present him with one of the innumerable awards he accumulated during his life, and as I stood there on the stage he said something droll—I forget what—that told me he *knew* where I was at in regard to him and his music. He was an incredibly shrewd and observant man, and he perhaps should have disliked me, but as far as I know he didn't.

A substantial amount of nonsense was written about Ellington in the days after his death at seventy-five last May. Someday history will have to make its evaluation of his work. I hardly think it will go along with the disc jockey who said, "He was the most important composer of the twentieth century—more important than Shostakovich or Stravinsky." So much for you, Igor—and you too, Béla, Maurice, Claude, Charles, and the rest of you cats.

In the obituaries, they kept pointing

out that Duke had written nine hundred songs. (Some said a thousand.) As a matter of fact, that's not a lot, considering the length of his life and the intensity of his activity. And "songs" must be taken to mean, by and large, thirty-two bars of melody with chord changes; and a lot of his charts, probably most of them, were "head" arrangements, meaning they evolved in playing rather than manuscript writing. Duke's *oeuvre*, then, doesn't begin to compare with the seven-hundred-odd opuses, fully notated and in many cases orchestrated, of Bach. Or Stravinsky.

All that is nonsensical comparison, of course. It's comparing apples to oranges, Jeeps to amphibious tanks, Piper Cubs to 707s.

But one composer I deeply respect, and one of the demurrers in the cult of Ellington, said a few years ago, "Instead of moving on into the larger forms and mastering them, Duke merely hired Billy Strayhorn." In the sudden posthumous newspaper and TV accolades to Duke, I did not encounter one mention of Strayhorn, the gentle and gifted arranger and composer who died a few years ago—of cancer, like Duke. Theirs was an unusual arrangement. Strayhorn was more than Duke's arranger and amanuensis, and their work was as close, probably, as we'll ever get to joint composition. No one will ever know how much of that music Strayhorn was actually responsible for.

The Ellington band was usually sloppy, sometimes to the point of sounding actually seedy. In my early years, I used to say it sounded as if one of the

saxophonists had gotten drunk and not shown up; later I learned that this not infrequently was literally the case. Duke would, once in a while, begin a performance with perhaps seven men on the bandstand, and the others would come drifting in as they felt like it until a full complement, more or less, was reached. There were a lot of sons of bitches in the band, and one of the trombonists told me that when he went with Duke it was about eight months before anybody spoke to him.

They were a weird sort of traveling circus that Duke somehow knew how to handle, men who in some cases couldn't fit into the rest of musical society but whose idiosyncrasies of sound Duke could use as colors in his own strange and highly personal tapestries. He said he kept traveling with a band because it gave him the privilege of hearing his own music every night, but I suspect that at least part of the reason he kept on was to provide employment for his men. He didn't need the money, certainly: His ASCAP earnings for his songs alone must be enormous, even now.

His band was a sort of secret society; the players did as they damn pleased, and Duke let them get away with it. "But when it really matters," he once told Freddie Williamson, his booking agent with the Joe Glaser office, "they come through for me."

I heard them do it once. It was at the Newport Jazz Festival, eight or ten years ago. Ellington and his weird ragtag, go-to-hell, we-could-care-less crew went on-stage and started to play. Their power grew by the passing minute, and they became the very meaning and embodiment of "swing." My, how they swung. It was like encountering some strange new form of energy. The power, the surging strength of it! The audience went wild. I saw Nat Hentoff standing near me, actually grinning and nodding his head to the time, and I heard a familiar voice cheering and screaming and realized suddenly that it was my own. It was a musical experience I will remember as long as I live.

And yet, if you want to try a trick, someday when you are among a lot of hip people, or those who presume to be, try saying, "I never really cared for the Ellington band." You will be astounded how many will say, "What, you too?" It is like the secret club of nonfans of Ella Fitzgerald.

Such is the conformism of hippitude that to question Ellington's supremacy is to get yourself drummed out of the Ins after an appropriate ceremony of condescending pity. So Duke has been granted a sort of diplomatic immunity to objective evaluation. Yet I know a number of musicians, including arrangers

New Zenith Allegro® brings deeper, richer sound to 4-channel.

Here's how:

You're looking at the Zenith Allegro tuned port.* It's part of a sound system with a difference.

You see, a lot of speakers (even air-suspension types) trap deep, rich bass inside the speaker cabinet, so you never hear it. But this tuned port channels out more of that sound, so you can hear it. (In fact, if you put your hand over the port you can even feel it.)

With a specially-designed woofer for solid bass and mid-range tones, plus a horn-type tweeter for crystal-clear high notes, Allegro delivers virtually the full range of sound of the original performance. And does it so efficiently that other systems with comparable-size air-suspension speakers need amplifiers with twice the power to match Allegro's overall sound performance.



But that's not all. Because behind this remarkable speaker system is some equally remarkable componentry.

A solid-state tuner/amplifier designed specifically for use with Allegro speakers, and featuring AM, FM, and even 4-channel matrix FM reception, where available. A 4-channel discrete 8-track tape player. A precision record changer for 4-channel matrix records.

And you can even play (and greatly improve the sound from) stereo broadcasts, tapes, and records.

Zenith Allegro 4-channel. Once you hear it, you'll know how 4-channel sound should sound.

patent pending

The surprising sound of Zenith.

ZENITH Allegro

The quality goes in before the name goes on™



**AUTOMATIC
PROGRAM
FINDING...**

**AT
LAST
A TAPE
DECK
THAT
ELIMINATES
THE
BIG
PROBLEM
WITH
TAPE
DECKS.**

With other cassette decks, finding your tape selection is hit or miss. You press fast forward... stop... rewind... stop... fast forward—over and over in a mad search for each selection. But not with Sharp's RT-480. Just press fast forward or rewind. Our Automatic Program Finder finds the precise beginning of your selection. And does it automatically. No fumbling,

bumbling, or mumbling.

We eliminate the hiss as well as the hiss. With a built-in Dolby "B" type noise reduction system.

The RT-480 is professional all the way. With Micro Crystal Ferrite heads for CrO₂ tapes. A selector switch for normal, low-noise, and CrO₂ tapes. Pause control for editing. Automatic shutoff in every

mode. Lighted, expanded scale VU meters. Advanced hysteresis synchronous motor for inaudible wow and flutter: 0.15%, weighted, rms. S/N ratio: 58 dB. And the frequency response is from 25-17,000Hz with CrO₂ tape.

All this, plus great styling, 2 microphones and dust cover. And under \$250. For the name of your

nearest Sharp hi-fi dealer, contact "Audio," Sharp Electronics Corp., 10 Keystone Pl., Paramus, N.J. 07652.

MAKES OTHER CASSETTE DECKS OBSOLETE. THE RT-480. ONLY FROM

SHARP

*Dolby is a Trade Mark of Dolby Laboratories, Inc.

CIRCLE 56 ON READER-SERVICE CARD

and composers of real stature, who secretly, as if they are coping with a shameful ailment which can in fact be discussed only with a fellow sufferer, have some genuine reservations about his band and his music.

But such is the paradox of this protean phenomenon that many of the musicians whose music I respect—Gil Evans, for one; Robert Farnon, for another—have themselves been deeply influenced by and deeply admire Ellington. Oscar Peterson is always threatening to take me down into his basement with a stack of Ellington records and go through it all, chapter and verse.

One might speak of Basie and Ellington as the two mainstreams of big jazz orchestra style. A lot of men contributed to the development of what we think of as the Basie style of orchestration and playing, particularly Don Redman and Fletcher Henderson. They organized the sections in the way that is common to most big bands—rhythm section, trumpets-trombones, and saxes—and voiced them, by and large, together. Saxes would play with saxes, trumpets with trumpets and sometimes with trombones, but the different choirs didn't mix it up much. They led distinct and separate lives, except insofar as they would accompany each other or sometimes come together tutti.

Duke didn't do it that way. He put his colors together up through the sections, mixing and matching colors in all sorts of odd ways. He was the first man—in jazz, that is—to use a wordless female voice as an instrumental color. "Mood Indigo," if memory serves, features a bass clarinet voiced with muted trombone and trumpet. That's what gives that strange, haunted, and haunting, sound to the record. Gil Evans, Charles Mingus, Gerry Mulligan, Ralph Burns, Oliver Nelson, Clare Fischer, and any number of composers and arrangers I like, learned in Duke's school. And their influence has permeated much of the rest of American music, including motion-picture scoring.

Duke did all sorts of things before anybody else did, including use of the brass section as a sort of rhythm instrument. He was incorporating Latin American touches years ago. When he would discover something odd, like the exotic sound of Cuban valve trombonist Juan Tizol, he would incorporate it into his band and use its color in a recording like "Caravan." That is, instead of saying to a man, "Do it this way because that's how I want it," he would say (and only to himself), "That's what this oddball sounds like, and I'm going to use it just the way it is."

His band music was, in a sense, like a brilliantly strange assemblage of *objets trouvés*. Juan Tizol and Lawrence Brown in the same trombone section? In Elling-

ton's world of color, the answer was a firm, "Why not?" And these strange, distinctive musicians, interestingly, almost always sounded better in the Ellington band than out of it. Some really couldn't work anywhere else. Where else could you fit the odd slushy drumming of Sonny Greer? In the Ellington band, it worked.

Only two men I can think of—Clark Terry and the late Ben Webster—were fully as effective out of the Ellington band as they had been in it. Some of his musicians left for a while and then, like lost sheep, came back, and there is speculation about what some of them will do

now that he is gone.

For all these things, and more, Ellington is a major figure in American musical history, if not quite what the wire service rewrite men said he was.

Among the other inaccurate observations at the time of his death was a remark by John Chancellor, the NBC newscaster and well-known music freak. He said Duke didn't look a day over forty. It was a kind, gracious thing to say, but it wasn't true. In recent years, the suave handsomeness—he rather strongly resembled an uncle of mine, also a musician and also dead now—had given way to a lined and weary puffiness. Duke

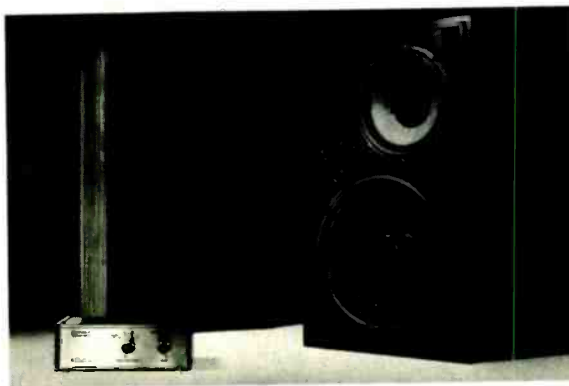

We have this different new speaker system...

Its woofer isn't really a woofer

but it gets down flat to below forty Hertz (3 dB down at 32 Hz)

It has a tweeter on the back

(plus one on the front)
so you hear uniform, well-dispersed acoustic output to beyond 18,000 Hertz.

It's not an acoustic suspension system

but it's 2 to 3 dB more efficient than almost all sealed systems

It's too small to be really good

but STEREO REVIEW says, "...the Interface:A can deliver a level of undistorted bass far superior to that of any other speaker of its size that we have heard!" (March, 1974)

So it must be really expensive

it costs \$450 per pair, complete! (Suggested retail price)

And right now we have 320 dealers standing by to show and demonstrate this different new speaker system.

Just call

800-447-4700 (Toll Free) In Illinois only 800-322-4400

for the name and location of those nearest you.

Interface: A™

BY ELECTRO-VOICE

a gulton company

Dept. 1144H, 619 Cecil Street, Buchanan, Michigan 49107

CIRCLE 26 ON READER-SERVICE CARD



Stereo Shelving with a Twist!

As versatile as it is beautiful—Kirsch® Freestanding Shelving. With just a twist to its exclusive Ring-lock™ design, add or remove units as you need them. Features new flush top design. Solid support. Resistance to stains. Best yet, it's reasonably priced. At fine stores that carry Kirsch. Or write: Kirsch Co., Dept. M-1174, Sturgis, Mich. 49091.

Kirsch

where quality still means something.

CIRCLE 35 ON READER-SERVICE CARD

didn't like growing old. Who the hell does? But I think he hated it more than most men. He dyed his hair in latter times, and it had a henna tint that people pretended (sometimes even to themselves) not to notice.

For you see, as everyone in the music business knew, Duke dug chicks. Married and divorced in his young years, he later traveled in the more elevated circles of society, that world of suave and sensual amorality inhabited by the likes of Tallulah Bankhead, Cole Porter, and Noël Coward—all gone now, alas. He was not, shall we say, averse to the pleasures of the boudoir.

In the obituaries, much was made of the polished, ironic, and modest disclaimers he would make when honors were accorded him. As a matter of fact, Duke was very vain, and the ravages that time took of that wonderfully handsome and aristocratic face really, I think, saddened him. I suppose the only consolation for growing old is the thought of *not* growing old.

Because of his position, and perhaps because he had learned from his father, a middle-class butler, how to keep his cool and smile and be very polite, and partly too because people like politicians and business tycoons secretly think entertainers are stupid and therefore say more in front of them than they realize they are saying, Duke knew plenty. Dizzy Gillespie once said to me, laughing shrewdly, "I know more than they think I know," which he most assuredly does. Translated into Latin, that would have made a perfect motto for the Ellington escutcheon.

Duke once told someone I know, during a discussion of politics, "Trust nobody. *Nobody*." (His father, I have read, sometimes butted at the White House.) On another occasion, someone else was speculating about possible Communist involvement in the drug traffic for the calculated purpose of undermining America. Duke said, "The Communists were always in it, even back in the Thirties." But for the most part, he kept his cool and his own counsel and was content to know more than anybody knew he knew.

He took the world as he found it, both in life and in music, tolerating impossible discrepancies and contradictions in men and circumstance. That is how he was able to make a functioning unit of men with utterly distinctive instrumental sounds. Therein lies the essential difference between classical and jazz composition. Classical composition assumes, with a certain narrow variability, a "correct" trumpet sound or a "correct" trombone or violin sound. Jazz tolerates all sorts of oddity and individuality, and Duke went beyond toleration.

He turned idiosyncrasies to his advan-

FREE

McIntosh CATALOG and FM DIRECTORY

Get all the newest and latest information on the new McIntosh Solid State equipment in the McIntosh catalog. In addition you will receive an FM station directory that covers all of North America.



MX 113

FM/FM STEREO - AM TUNER AND PREAMPLIFIER

SEND TODAY!

McIntosh Laboratory, Inc.
East Side Station P.O. Box 96
Binghamton, N.Y. 13904

NAME _____
ADDRESS _____
CITY _____ STATE _____ ZIP _____

If you are in a hurry for your catalog please send the coupon to McIntosh. For non rush service send the Reader Service Card to the magazine.

CIRCLE 41 ON READER-SERVICE CARD

Empire Speakers named "Best buy of the year"



Empire Speakers were named "1974 Best Buy of the Year" by Consumers Digest Stereo •

Quadraphonic buyers guide. Consumers Digest was enthusiastic about our moderate priced, wide ranging well balanced sound with its rich lush bass and exemplary high frequency dispersion. With their optional imported marble tops they felt "that Empire Speakers were handsome pieces of furniture that don't look like just speakers."

Designed for super stereo or exciting 4 channel, Empire's unique cylinder speaker produces the kind of sound no ordinary box can deliver. The all-around sound is simply

phenomenal... it radiates in all directions: front rear, left and right. These perfect 3-way systems use a heavy down-facing woofer for bass you can feel as well as hear. A powerful mid-range for crisp, clear alto and voice tones and an ultra-sonic tweeter with 180 degree dispersion. The power handling capacity of Empire Speakers is awesome. They can take all the power your receiver can give them without overload, burnout or strain.

Thousands of satisfied Empire owners agree. Here are comments from just a few of them: "Superior sound over anything near it in price"

J.A. Hyattsville, Md. "This speaker is truly a work of art!"
J.F., Vancouver, B.C. "Full sound even at low levels,"
W.G., Alexandria, Va. "Can handle large amounts of power,"
D.M., Huntsville, Ala. "Fantastic bass,"
A.H., Burke, Va. "No ugly grill cloth,"
B.M., Newark, N.J. "Incredible fidelity,"
K.K., Dallas, Texas.

Ask your favorite dealer to let you hear Empire's great speakers and write for our free full color "Guide to Sound Design."

EMPIRE SCIENTIFIC CORP.,
Garden City, N.Y. 11530.

EMPIRE 

Mfd. U.S.A.



Model 9500 M II

Model 7500 M II

Model 6000 M II

CIRCLE NO. 99 ON READER SERVICE CARD

NOW! Walco PRESENTS

THE NEW PT-TYPE

(SHIBATA DESIGN)

PARABOLIC TIP STYLUS



**GREAT FOR REGULAR STEREO RECORDS!
A "MUST" FOR 4-CHANNEL DISCS!**

There's also a Walco Diamond Stylus For Most
Phonograph Cartridges in Use Today!

Walco has been producing top quality phonograph needles since 1939. They are Precision Made, Economically Priced, and Fully Guaranteed. Millions of satisfied users have made Walco a Leading Name in the Audio Industry.

3 DIAMOND TIP TYPES AVAILABLE FOR WALCO STYLII

SPHERICAL



Ball-shaped tip, highly polished, plays all LP records. The standard tip in use today.

ELLIPTICAL



Longer side to side radius makes tip fit record groove better, for more perfect tracking and compliance.

PARABOLIC* (Shibata Design)



Parabolic shape of tip makes best contact with record groove critically needed for proper tracking of CO-4 (Discrete) & Matrix 4-channel grooves and regular 2-channel stereo.

The PT-type stylus produces less pressure on the record surface, for less record wear, longer stylus life.



The effect of a 2-gram tracking force is shown on a record groove PT-Type stylus (left) and an Elliptical stylus (right).

*11 popular models now available.

Sold Nationally at
Fine Audio and Record Stores
Write for Free Brochure on new
PT-Type (Shibata Design) Stylus

ALL WALCO NEEDLES GUARANTEED
AS PER WARRANTY ENCLOSED
WITH EACH NEEDLE

Walco

WALCO ELECTRONICS
Div. Walco-Linck Corp. Jct. Rts. 3 & 46, Clifton, N.J. 07013

CIRCLE 70 ON READER-SERVICE CARD

The ADC-XLM. A significant difference.

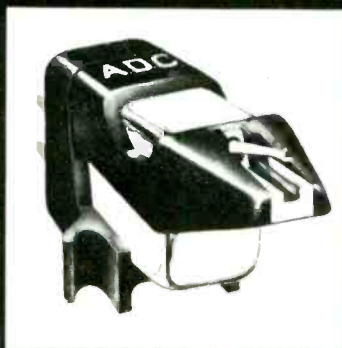

The phono cartridge, the smallest and perhaps the most critical element in a home music system, can make a significant difference in your perception of recorded music.

If it does its job well, it can convey a startlingly real sense of the original musical experience. If it doesn't, you end up with a pale, distorted imitation. Or worse, a permanently damaged record.

For only the cartridge comes into direct contact with the fragile record groove and translates its microscopic undulations into intelligible musical sounds.

For years, the experts, audio professionals, have relied upon ADC cartridges to provide faithful record reproduction and protect their valuable collections.

Today, more than ever, the choice of the experts is the new ADC-XLM, a cartridge of unmatched performance and reliability.

At a modest \$50, it can make a significant difference in your own music system.

For complete information and reprints of independent test lab evaluations write: Audio Dynamics Corporation, Pickett District Road, New Milford, Conn. 06776.



Audio Dynamics Corporation

tage and accommodated such disparities as Ray Nance's violin; Cat Anderson's paper-thin high-note trumpet; the swooping golden-sad alto saxophone of Johnny Hodges, who was a sort of concertmaster of the band and often used his authority over the other musicians with imperious disdain; the big, virile, throaty baritone saxophone of Harry Carney, ever since the 1920s the solid cement foundation of that band, a kind and good man who himself lay in a hospital with double pneumonia even as Duke's cancer was producing its own final pneumonia; and the smoky autumnal trombone of Lawrence Brown.

Duke knew how to handle them, produce order out of their chaos; he knew how to handle *the world*. And he could do it all at the same time and find his distant mocking laughter in the very act of it. He was putting us all on, and that very put-on was perhaps his most brilliant performance.

Here is an instance: One of his saxophonists was a flagrant and notorious junkie who, as it turns out, died a few weeks ahead of Duke, which was a mercy—he couldn't have functioned in the world without Duke. A few years ago, this man was picked up by two federal narcs in Las Vegas. They booked him and then spoke to Duke. How, Mr. Ellington, they asked, can a man of your international stature, a man who has received every imaginable honor, keep a man like this in your band?

"Gentlemen," Duke said in a way that anyone who knew him can instantly hear in the mind's ear, "he has two of the most beautiful little girls."

The two narcs went to court and testified for the saxophonist. And *got him off*!

That's how Duke did it. He functioned and made his music and managed not to let the world's madness drive him mad and still got some laughs and some life out of life. And the girls. Always the girls.

I loved his tunes, although his band often bugged me. I will miss him, perhaps far more than those whose praise for him was so fulsomely uncritical. And certainly I found the real Duke Ellington much more interesting than the paper hero presented by "the media" on the day he died. He was a complex, highly intelligent, articulate, cunning, restless, ironic, sophisticated, superior, tolerant, amused, hurt, and, in the last analysis, intensely private man. I know a lot of people who saw him frequently and a few who thought they knew him well. But I don't think anybody really did.

Now that I have organized my thoughts on paper, I realize that I admired him more than I knew. Perhaps he knew that. He was that perceptive.

Duke Ellington had his secrets, and he took them with him. G'by, Duke. ●

If you want a better receiver... build it yourself.

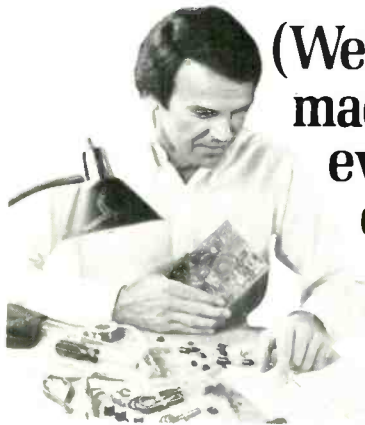

(We've made it even easier, in the Heathkit AR-1500A)

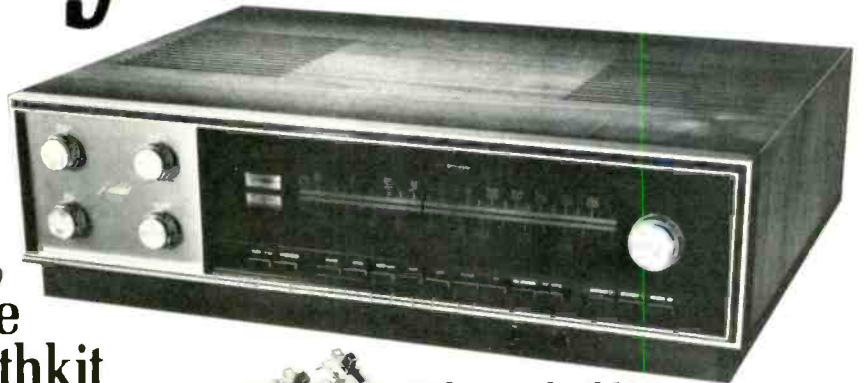

How to improve a classic

The Heathkit AR-1500 set new standards for stereo performance when it was introduced in 1971. So, in designing the AR-1500A, we set out with two goals in mind: first, to make our best receiver even better and second, to make it even easier to build than before.

The "inside" story

To start with, the FM tuner ranks as one of the finest in the industry, with its 4-ganged FET front-end; sensitivity under 1.8 μV ; two computer-designed 5-pole LC filters delivering over 90 dB selectivity; a 1.5 dB capture ratio. It all means you'll hear more FM stations, less noise and practically no interference.

Our new phase lock loop multiplex demodulator maintains excellent separation at all frequencies, not just 1000 Hz so FM stereo will sound even better. And the new multiplex section requires only one simple adjustment.

Even the AM rates hi-fi status — with two dual-gate MOSFETS, one J-FET and a 12-pole LC filter. And we improved the Automatic Gain Control to keep AM signals rock steady.

The amplifier is so good we had a hard time improving it — 60 watts per channel at 8 ohms, less than 0.25% total harmonic distortion, 0.1% or less intermodulation distortion. So we refined it by adding an impedance-sensing device to the protective circuitry. It prevents false triggering at low frequencies, which means deep, solid bass with less noise.

HEATHKIT ELECTRONIC CENTERS —
Units of Schlumberger Products Corporation.
Retail prices slightly higher.

ARIZ.: Phoenix; CALIF.: Anaheim, El Cerrito, Los Angeles, Pomona, Redwood City, San Diego (La Mesa), Woodland Hills; COLO.: Denver; CONN.: Hartford (Avon); FLA.: Miami (Hialeah), Tampa; GA.: Atlanta; ILL.: Chicago, Downers Grove; IND.: Indianapolis; KANSAS: Kansas City (Mission); KY.: Louisville; LA.: New Orleans (Kenner); MD.: Baltimore, Rockville; MASS.: Boston (Wellesley); MICH.: Detroit; MINN.: Minneapolis (Hopkins); MO.: St. Louis (Bridgeton); NEB.: Omaha; N.J.: Fair Lawn; N.Y.: Buffalo (Amherst), New York City, Jericho, L.I., Rochester, White Plains; OHIO: Cincinnati (Woodlawn), Cleveland, Columbus; PA.: Philadelphia, Pittsburgh; R.I.: Providence (Warwick); TEXAS: Dallas, Houston; WASH.: Seattle; WIS.: Milwaukee.

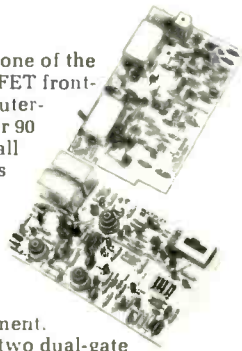

Who can build it? Anyone!

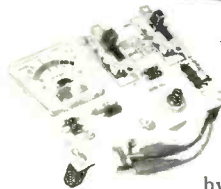

You can build the AR-1500A even if you've never built a kit before. The illustrated assembly manual guides you step by step and a separate check-out meter tests the work as you go. The parts for each subassembly are packed separately and a wiring harness eliminates most point-to-point wiring.

And since you built it, you can service it. The meter and swing-out circuit boards make it easy to keep your AR-1500A in peak operating condition year after year.

Without a doubt the AR-1500A is one of the world's finest stereo receivers. It ought to be — it's been painstakingly designed to be handcrafted by you. It just goes to prove what people have always said, "if you want it done right, do it yourself."

Kit AR-1500A, less cabinet, 53 lbs., mailable \$399.95*
ARA-1500-1, walnut veneer case (as shown), 8 lbs., mailable... \$24.95*

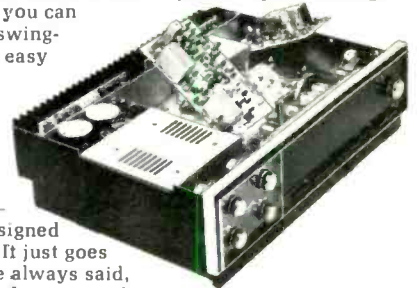

AR-1500A SPECIFICATIONS — AMPLIFIER — Power Output at 8 ohms, 60 watts per channel with less than 0.25% total harmonic distortion from 20-20,000 Hz, both channels driven. Frequency response (1 watt level) — 1 dB, 9 Hz to 80 kHz; Harmonic Distortion: Less than 0.25% from 20 Hz to 20 kHz at 60 watts output. Intermodulation Distortion: Less than 0.1% with 60 watts output. Damping Factor: Greater than 60. Channel Separation: Mono, 55 dB. Output Impedance: 4-16 ohms, optimized for 8 ohms. FM SECTION (Monophonic) Sensitivity: 1.8 μV . Selectivity: 90 dB. Image Rejection: 100 dB. IF Rejection: 100 dB. Capture Ratio: 1.5 dB. Harmonic Distortion: 0.5% or less. Intermodulation Distortion: 0.1% or less. (Stereophonic) Channel Separation: 40 dB or greater at midfrequencies: 35 dB at 50 Hz, 25 dB at 10 kHz, 20 dB at 15 kHz. AM SECTION: Sensitivity: 50 μV with external input; 300 μV per meter with modulated input. Selectivity: 20 dB at 10 kHz, 60 dB at 20 kHz. Image Rejection: 70 dB at 600 kHz, 50 dB at 1400 kHz. IF Rejection: 70 dB at 100 kHz. Dimensions: Overall 18 1/2" W x 5 1/2" H x 13 1/2" D. *Rated IIF (Institute of High Fidelity) Standard.

Send for your free Heathkit Catalog

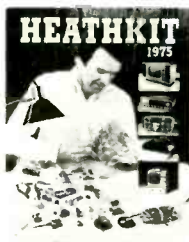

HEATH COMPANY, Dept. 8-11
Benton Harbor, Michigan 49022

HEATH
Schlumberger

Please send FREE Heathkit Catalog.
 Enclosed is \$_____, plus shipping.

Please send model(s) _____
Name _____
Address _____
City _____ State _____ Zip _____

*Mail order prices; F.O.B. factory
Prices & specifications subject to change without notice

HF-290

CIRCLE 29 ON READER-SERVICE CARD

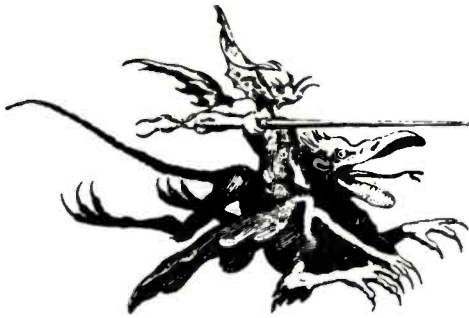

too hot to handle

Your report on the Pioneer RT-1020L [open-reel deck, July 1974] didn't seem to rate it as high as your reports on the Teac 3300 and the Tandberg 9000X. I must admit to a bias for Pioneer products; I've never needed a repair on any of my Pioneer units, and though I use my T-8800 [an earlier open-reel deck] almost every day it performs faultlessly. Now I'd like to buy another deck to go with it. In your opinion, is the quality of construction in the new Pioneer close to that of Teac and Tandberg?—John Monzella, Belleville, N.J.

All three brands have consistently impressed us: Teac for its ruggedness of construction and sanity of design; Tandberg for its often brilliant innovativeness, particularly where the fine points of performance are concerned; and Pioneer for its good value and the excellent flexibility of its features. All of the models you mention could be cited as examples of these strengths; none, to our way of thinking, incorporate design weaknesses significant enough to offset their strengths. That isn't to say they all are equally "good"—it's just that the evaluation of their relative quality is subject to individual interpretation and that we don't think you could go seriously wrong with any of them.

Are speaker equalizers worth it? Should I use one with my AR-2ax's?—Andrew Hinds, Fort Collins, Colo.

A speaker equalizer is "good" only in inverse proportion to how "bad" you think the speaker is without equalization—and then only if the equalizer is designed to "correct" what you conceive of as bad. The multiple-band equalizers (like the Altec AcoustaVoicette) will correct almost any imbalance or nonlinearity in response, of course; within reason they can make the speaker's response measurably flat or at least closer to flat than most speakers are in most rooms without equalization. Simpler equalizers (which typically have one control for boosting the deep bass, often another for boosting the extreme treble, and perhaps a third for adjusting relative midrange—or "presence" range—emphasis) may do a similar job at far lower cost. The AR-2ax, for example, has a response characteristic that gently rolls off above 1 kHz (as measured at CBS Labs) and stays about 6 dB below the 1-kHz level from 5 kHz up. To some ears this will translate to fine performance that needs no equalization; to others it will suggest some over-prominence of the midrange; to still others it will sound a little weak at the high end. An

equalizer would be useless for the first group; the second group would want the midrange control; the third group might be satisfied with a treble touchup, perhaps using amplifier controls rather than an equalizer. Similarly, if you want more output from 32-Hz organ pedal tones—a frequency at which loudspeaker bass always is rolling off—you would need an equalizer specifically designed to boost output below about 50 Hz. But the more boost that is applied, the higher the distortion rates will run, so the degree of "improvement" possible involves a complex value judgment on the part of the listener.

If I get a cassette deck with automatic reverse, will it affect the deck's performance or cause any other problems?—Willard Ryland, Columbia, Tenn.

At least, automatic reverse adds complexity (that is, more elements that potentially could malfunction) to the deck; at the most, it threatens unstable head alignment and compromise elsewhere in the design to prevent seemingly exorbitant selling prices. The same might have been said, at one time, about auto-reverse open-reel equipment, which today has achieved a high degree of reliability and performance very close to that of comparable nonreversing equipment. But the problems of doing likewise in cassette equipment are obvious when you consider that if it costs, say, \$100 (at retail) to add a really rugged automatic-reverse system, that would be 20 per cent added to the price of a \$500 open-reel deck but 50 per cent added to the price of a \$200 cassette deck. Faced with numbers like that (obviously we're picking these specifics out of the air), manufacturers are hesitant to commit auto-reverse designs to the production lines for fear that they may find themselves with a model that won't work or won't sell or both. But the demand seems to be growing, and where there's a market there's a way.

I don't understand your efficiency ratings for speakers. According to your review [May 1971], the Dynaco A-50 "will produce a level of 94 dB (at one meter on axis) when powered by as few as 3.5 watts." How efficient is this, and how much power do I need in the amplifier? The manufacturer recommends 25 watts. I ask because your review of the JBL L-100 [August 1971] says it'll produce the reference level with 2.8 watts. This doesn't seem very different from the 3.5 watts for the Dynaco, yet JBL says all you need for the L-100 is 2 watts

minimum to produce good volume in a medium-sized room.—John A. Pacetti, Manhattan, Kan.

The question can be summarized by another: How loud is loud? The 94 dB of our test is pretty loud; louder, we suspect, than many component owners drive their systems to in normal use. Yet a live rock band may deliver levels up to as much as 120 dB in the auditorium, and some home listeners try to get as close to "live" levels as they can. Starting at our base of 94 dB, theory dictates that you must double the power to achieve 97 dB (or 3 dB higher), quadruple it to achieve 100 dB (another 3 dB), octuple it for 103 dB, and so on. So for an average level of 100 dB at 1 meter on axis you would need almost 15 watts minimum into the Dynaco, 11 watts or more into the JBL; for 103 dB you would need 28 and 22 watts respectively. In other words, the required power can be altered drastically by what appear to be small changes in the desired acoustic output. (They're not that small; it's just that the dB scale is exponential, while the power scale is not.) Dyna's recommendation of 25 watts seems sane on the basis of allowing for unusually high playback levels and offering some headroom so that peaks aren't clipped. But it's far more than most users ever will actually want or need. Your 2-watt rating for the L-100 presumably is based on JBL's own efficiency-rating system (which involves measuring output at 15 feet for a 1-watt input and taking 75 to 80 dB as "a comfortable listening level"). Working either from their rating (76 dB) or ours, the L-100 normally will draw no more than about 2 watts in average rooms. But that's not the same thing as a minimum power recommendation, which should allow for higher levels when (and if) they are needed.

I recently purchased the Kenwood KR-9340 quad receiver, largely on the basis of your test report in the March issue. The performance figures you published and the specs on a sheet I got with the receiver are two different animals. The discrepancies that I am most concerned with are the capture ratio of 1.5 dB (Kenwood says 3.0 dB) and the FM-section signal-to-noise ratio of 71 dB (Kenwood says 65 dB). I simply do not understand why the measurements are so much better than Kenwood claims.—Carleton Golden, Astoria, N.Y.

These two discrepancies are quite striking (though others are not) and appear to illustrate one reason why we always are rather circumspect about spec sheets on new products. The data usually must be prepared from prototypes or from initial production samples if the information is to be printed up and available by the time the product is announced. In regular production, however, the manufacturer may find it impossible to hold some performance parameters as closely as he had predicted on the basis of the handmade prototypes; conversely he may find improved production methods with a "sticky" circuit and be able to do considerably better in the regular output than he did in the initial run. It appears that Kenwood has affected such an improvement in these two respects.

RTR breaks through the wall of speaker distortion with "The Transparent Enclosure"

Throughout the history of high fidelity, the acoustic engineer and the audiophile have been plagued by the distorting influence of the never perfect speaker enclosure. The RTR 280DR represents the first major breakthrough in eliminating this adverse effect.

This breakthrough was not easy. It required a complex design incorporating four custom designed woofers ... one front mounted, two side mounted with balancing networks, and one planar slot loaded driven through a reverse phase bridge network. Proof of performance is shown by the complete lack of fundamental resonance exhibited by the broad, smooth curve shown in Figure 1.

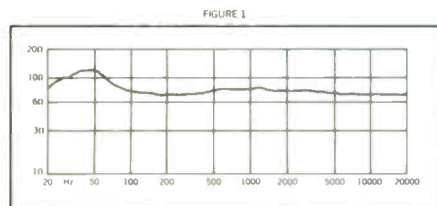

280DR Impedance, Midrange control at "5," Tweeter control any setting

This unique design earned the following comments from Dr. R. C. Heyser in *Audio* magazine (Nov. 1973): "The harmonic distortion on the 280DR is extremely low. A flute tone E₁ (41.2 Hz) at 20 watts input produced 1 percent E₂ (second harmonic) and 1 percent A₂ (third harmonic). The critical mid bass remained below 0.4 percent at this same level.—The lack of sonic distortion lulled us into testing at high power.—Investigation of the impedance plot showed that we were in fact delivering close to 200 watts of heating power to the 280DR at maximum test level."

Total Dispersion

Many music lovers, relating to the concert hall experience, have maintained that the ideal speaker should radiate uniformly hemispherically. (This is not to be confused with the "reflecting concept.") The 280DR was engineered for "Total Dispersion."

To achieve this "Total Dispersion," six high frequency drivers were joined

with the four woofers to produce an incredibly uniform polar energy response which is shown in Figure 2.

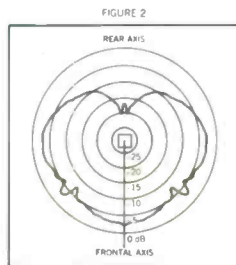

280DR Polar Energy Plot

Total Bandwidth

Total bandwidth is dependent on the proper in-system functioning of all transducers. The four woofers are designed and manufactured by RTR. They are special ten-inch transducers with butyl surrounds and two-inch epoxy impregnated voice coils. Five magnetic high frequency drivers are utilized to properly simulate concert hall ambience. A newly developed super tweeter, operating on the piezoelectric ceramic disc bender principle, extends overall response of the 280DR to 25,000 Hz. Figure 3 shows the uniformity of the frequency response of this super tweeter.

In an average listening room, the midrange and tweeter controls can be adjusted to yield the typical overall frequency response of the 280DR as shown in Figure 4 within ± 3 dB of the illustrated curve *without equalization*.

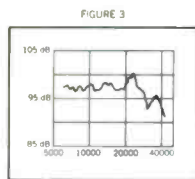

280DR Super Tweeter Frequency Response

280DR Response Characteristics

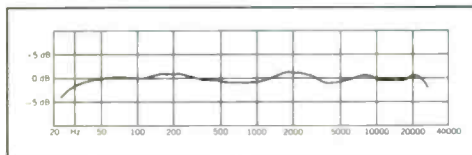

Creating Music

The 280DR does not create music. But it does reproduce music with great accuracy. Prove it to yourself by auditioning an RTR 280DR at your RTR franchised dealer and experience RTR "Total Capability."

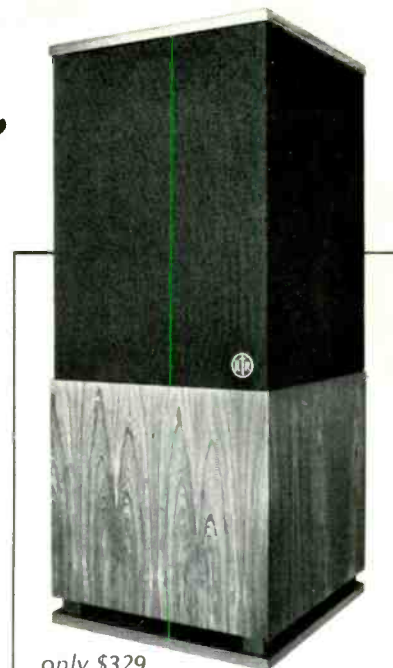

only \$329

280DR Specifications

- Enclosure:**
Genuine hand-rubbed walnut veneers
- Size:**
16 1/2" x 39" x 16 1/2" deep
- Shipping Weight:**
95 lbs.
- Frequency Response:**
22 to 25,000 Hz
- Speaker Complement:**
Four 10" woofers, five 2 1/2" mid-range/tweeters, one piezoelectric super tweeter
- Crossover Frequencies:**
2500 Hz and 7500 Hz
- Impedance:**
8 ohms nominal
- Recommended Amp. Power:**
25w to 100w RMS per channel
- Controls:**
Midrange and tweeter level, speaker protect circuit breaker with push button reset, dual 5-way input jack.



For more information circle the number below or write RTR INDUSTRIES Dept. HF, 8116 Deering Ave. Canoga Park, CA 91304

CIRCLE 52 ON READER-SERVICE CARD

A Dangerous Charge

A major consumer organization says some portable tape recorders with built-in battery chargers—especially some inexpensive models—can be unsafe. Certain types of batteries may cause these models to explode, the group contends.

For the past year the Educational Products Information Exchange Institute (a New York City group funded by the Ford Foundation and associated closely with the Consumers Union) has attempted to force the manufacturers of these allegedly dangerous tape recorders to remove them from the market. It filed charges of hazardous practice against these companies with both the Federal Trade Commission and the Consumer Products Safety Commission. In dispute are certain inexpensive (under \$25) models from Craig, Norelco, Sharp, VM, and Wollensak, though presumably many others might also be cited. The CPSC is currently investigating and will report its findings to the FTC.

The EPIE charges specifically that so-called "long-life" alkaline cells, used in portable cassette machines whose battery terminals are live when the unit is line powered, may cause dangerous corrosive leakage or even explode. These cells carry a written warning that they may explode if recharged, but the EPIE questions how many people ever read the fine print. So any battery-powered equipment that has an automatic-recharge feature when connected to AC might be suspect unless it provided some means of switching off the charging voltage.

Cassette machines used around children in schools were the initial subject of the investigation, which was begun with nothing more specific in mind than checking the recorders for possible shock hazards. It was noted

that extensive corrosion had occurred in the battery compartment of many AC/battery-powered recorders where the battery terminals were always live.

Further investigation revealed that all alkaline cells are not alike and that, while some may be recharged, this must be done with care. (For example, very limited current should be used in all cases. And if several cells are being recharged at a time they should not be connected in series; one cell could become fully charged before the others and would be subjected to further current in a fully charged state.) The key difference between alkaline cells is in the size of their gas-venting hole. Rechargeable cells have a large vent for the gas to escape; the "long-life" types have a small vent, which may cause pressure to build up inside the cell during charging.

The EPIE admits that during its own lab tests, under normal operating conditions, it has never been able to explode a battery. But it does report chronic corrosive leaks. Cooperation among recorder manufacturers has been mixed, the EPIE says. It singles out 3M (Wollensak) as highly responsive; 3M has stopped production and distribution of the model in dispute pending results of its own safety tests.

What is probably of lasting importance here is the admonition to use the correct type of cells in portable equipment. If the terminals are live during use on line current, and if the battery cannot be recharged safely, remove the cells from the equipment before using it on line voltage. If you want the ease of switching between battery and line power, nickel-cadmium ("nicad") cells, which are specifically made to be recharged, are a wise investment.

DBX Disc-Noise System Unveiled

It's official. The DBX system for noise reduction in disc recordings, which you read about in this column in April 1974, has been unveiled to the public.

Our report said that we found the dynamic range—about 100 dB—startling, that two records encoded for playback through the system were available, and that the DBX-120 decoder would cost about \$200. Since then, Klavier Records, producer of one of the original two, is said to have several more recordings in the can. (The initial disc is available either with or without the DBX encoding; we presume this pattern will continue.) And Stan Kenton has recorded his first DBX disc on the Creative World label.

On the equipment front, DBX has announced that two units (both encode/decode models that can be used for tape recording as well, and therefore quite different from our trial prototype) will be marketed. The Model 122 is a two-channel unit at \$259; the Model 124 is a

four-channel record-or-play model that, alternatively, can be used for simultaneous record-and-monitor in stereo and costs \$379. They have switches that select either the tape or the disc play mode, since expander characteristics are not identical in the two modes.

One element that's wanting at present, of course, is a broad range of attractive program material to play through the system. Says one company representative: "When will DBX sign the first major label? Not for quite a while. Maybe in a year when we get 10,000 decoders out into the market." In a nutshell, that's it.

CIRCLE 153 ON READER-SERVICE CARD

Be Your Own Binaural Dummy

You remember binaural recording. Sure you do—it was the means by which (thanks to Emory Cook) two-channel sound first was introduced to the American market.

The terminology hadn't been pinned down yet, but

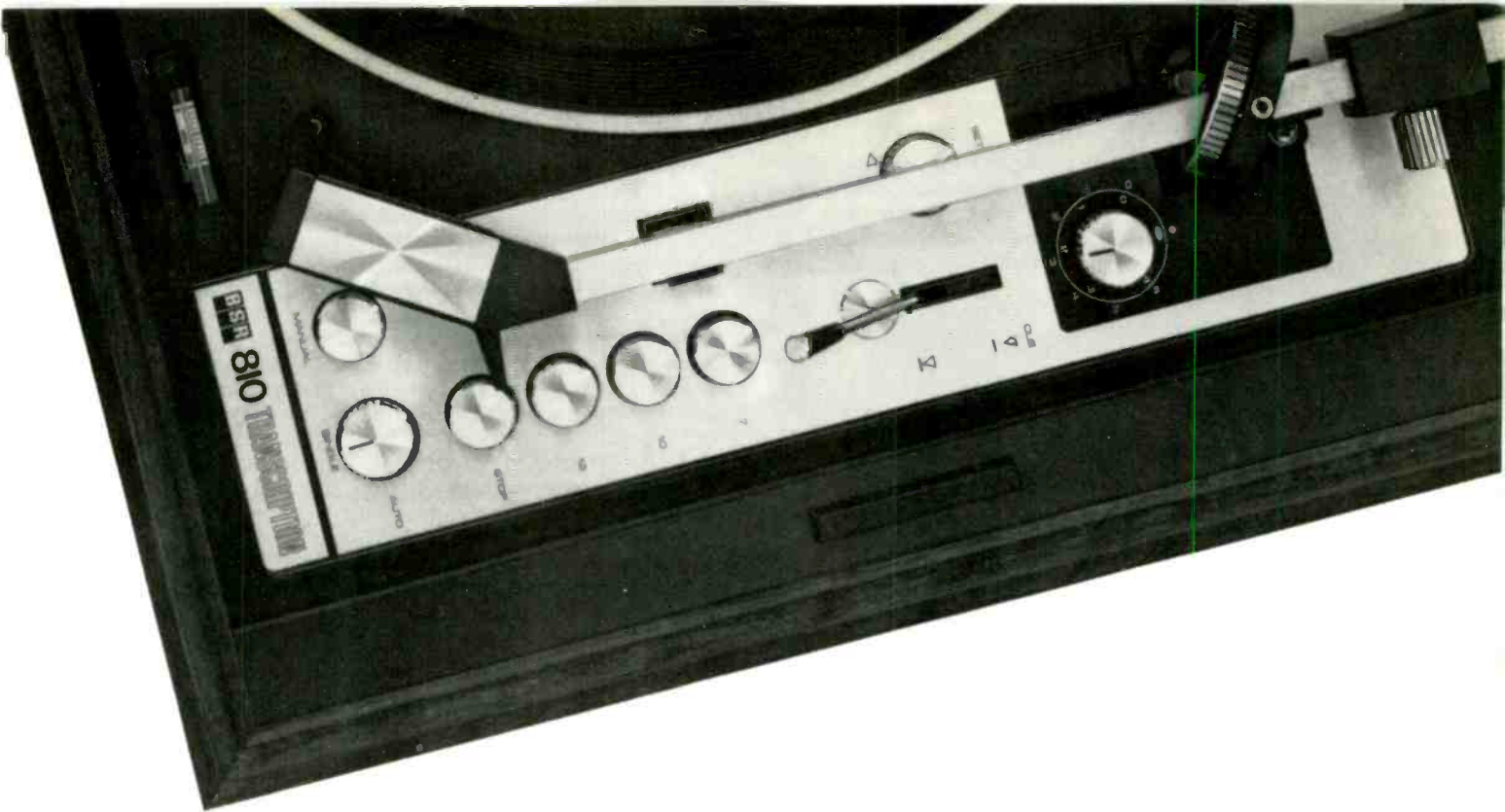

**It's one thing to make the most.
And another to make the best.**

We do both.

We make 2 out of every 3 automatic turntables in the world. That's more than all the other makes put together. So BSR is big, all right. But we also make what we sincerely believe is the best automatic turntable in the world. The BSR 810QX for sophisticated systems.

Don't take our word for it. Take it right from High Fidelity magazine's technical reviewer: "Taking it all together—performance, features, styling—the BSR 810QX moves into ranking place among the best automatics we know of."

The 810QX at fine audio retailers. Ask for a demonstration or write for free literature.



BSR

McDONALD

BSR (USA) Ltd
Blauvelt N.Y. 10913

CIRCLE 11 ON READER-SERVICE CARD

binaural sound eventually came to mean specifically a way of recording one channel for each ear, using mikes placed to simulate the listener's ears in the "hall." A dummy head, matched as closely as possible to the acoustic properties of the human head, might be used

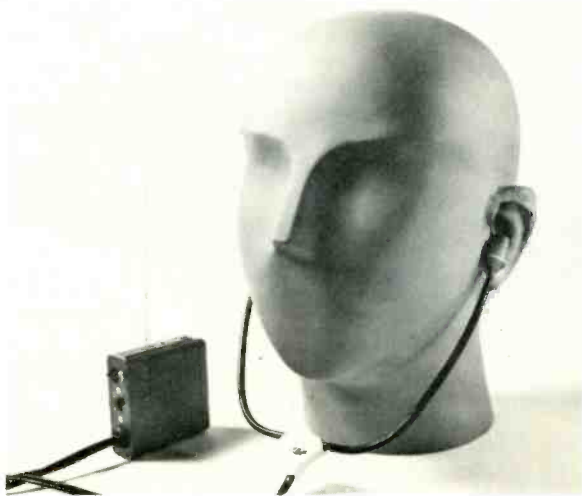

as a "mike stand" with the mikes mounted inside the dummy at eardrum position.

Binaural reproduction requires headphones. Each ear, in theory, receives exactly the sound it would if the listener were present at the original "event," and the entire spatial ambience of the original is reproduced. (This is, of course, very different from stereo, where multichannel sound is captured with the intent of reproduction on multiple loudspeakers.)

Sennheiser has resurrected binaural recording and done so in a way that means a break for the amateur

recording. The MKE-2002 microphone system comprises two tiny condenser elements mounted on a stethoscoped-like device that holds them over the ear cavities. The complete system (mikes, power supply, carrying case, and a plastic dummy head) costs \$300, substantially less than conventional high-quality binaural setups—if you could buy them.

But by mounting the mikes on the stethoscope (rather than in the dummy head, formerly the standard approach), Sennheiser allows you to be your own dummy—if you can (and want to) sit in one spot throughout the recording. Not only does that eliminate the bulkiest item of binaural paraphernalia, but presumably what you hear is precisely what you get, without headphone monitoring.

And later reproduction through headphones should create the aural sensation of being back at the recording. Just remember not to swivel your head around while you're recording.

CIRCLE 154 ON READER-SERVICE CARD

New Audio Company Formed

A new company called Neosonic Corp. of America is offering what it terms "selected audio products" in the U.S. under the Neosonic brand name. (Principals in the Westbury, New York, company are Joseph N. Benjamin, who founded Benjamin Electronic Sound and has been associated with Pilot Radio and Bogen Sound, and Joseph Longin, currently the president of Multi-Products International in Clifton, New Jersey.) Its first product will be the Sonosphere SPR-12, a \$30-\$35 spherically shaped speaker system manufactured by Audax of France for exclusive distribution through Neosonic in this country.

CIRCLE 155 ON READER-SERVICE CARD



equipment in the news

Altec offers two "Mini-Monitors"

Two low-cost systems have been added to Altec's speaker line. Model 891A—the Mini-Monitor I—is a two-way bookshelf system of approximately 2 cu. ft. with a 12-in. woofer and direct-radiator tweeter. It's available at \$149 in walnut, \$119 in walnut-grained vinyl. The 887A Capri, or Mini-Monitor II, is slightly smaller. It has an 8-in. woofer and a 3-in. direct-radiator tweeter and costs \$89. Altec says both speakers were designed to offer studio performance characteristics to those limited in space and/or budget.

CIRCLE 146 ON READER-SERVICE CARD

Marantz power amp has meter option

A stereo basic power amp, the latest addition to Marantz's electronics line, is available with or without power metering. The 400M has two 3½-in. VU meters and a meter-range switch (off, 0 dB, +10 dB, +20 dB). Both it and the Model 400 (without meters) have power-overload monitoring circuits and peak overload indicators, and are rated for a minimum continuous power of 200 watts per channel (continuous, full band) at 0.1% distortion. The Model 400 costs \$599.95; the Model 400M, \$699.95.

CIRCLE 147 ON READER-SERVICE CARD



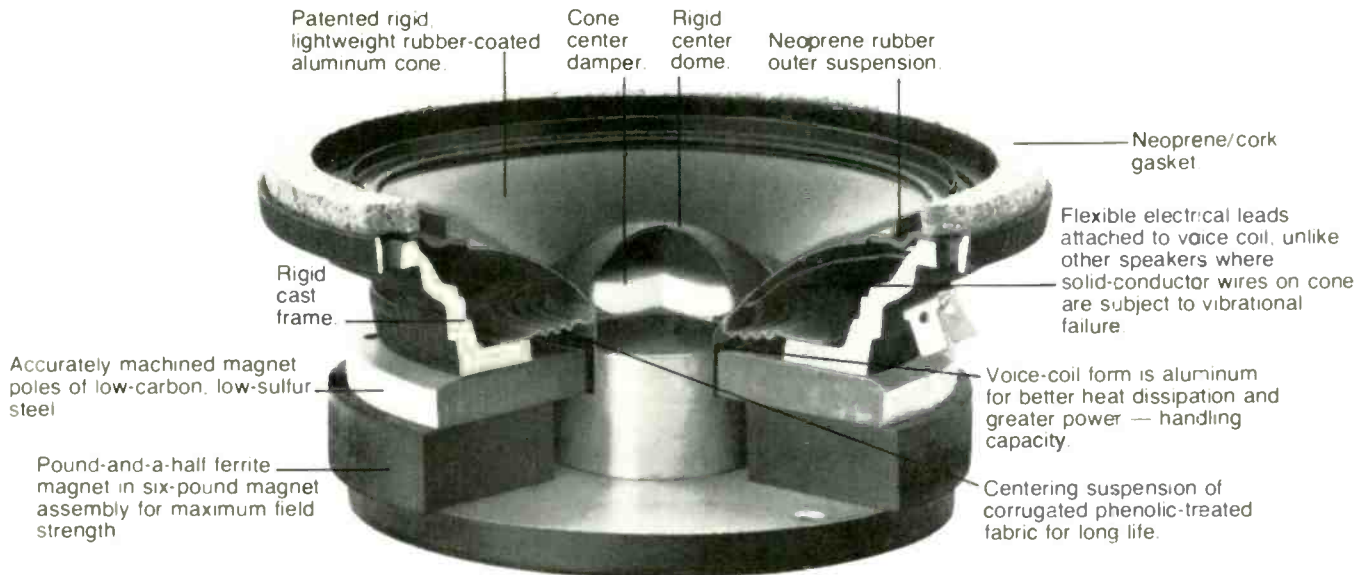

Our mid-range. Like no other.



B-209B mid-range driver assures velvet smooth reproduction of important middle frequencies in the famed Bozak B-4000A speaker system and in all three-way Bozak systems.

The mid-range of music — the region of melody — is the area in which most of the "timbre" of sounds occurs, the area which gives music its "definition."

When you consider the importance of the middle tones, you'll understand why Bozak developed its Mode B-209B mid-range driver. It's a mid-range speaker like none other on the market and it is the reason why, in Bozak three-way systems, every orchestral instrument is clearly distinguishable from every other. An English horn sounds like an English horn — not like an oboe in low register.

As you can see in the cutaway view above, there are good and scientifically valid reasons for Bozak's unparalleled mid-range performance. The neoprene-coated aluminum cone vibrates as a rigid disc without internal break-up which spells distortion common to conventional speakers. It is sized so that the cone diameter does not exceed the wave lengths of the mid-range notes.

What it all adds up to is velvet-smooth response and broad spatial coverage without artificial coloration.

When you consider the Bozak component speakers — bass, mid-range and treble — you'll understand why every Bozak speaker system represents the best possible reproduction — the greatest value — for the investment involved.

Our free booklet, *How to Evaluate a Loudspeaker System*, tells you what to look — and listen — for in selecting a loudspeaker. Write Bozak, Department B, Box 1166, Danen, Connecticut 06820, for your copy.

It's tough to compare something in a class by itself.



Unique Superex hybrid headphone

In the new Model EP-5 Electro-Pro headphone, Superex has coupled an electrostatic tweeter with a Mylar-diaphragm dynamic woofer. The intent, the company says, is to combine the clarity of the electrostatic with the deep bass response of the dynamic and make possible the high listening levels associated with rock music. The energizer unit, which is to be driven from amplifier speaker taps, includes crossover and power components plus a speaker/phones switch. Headset, energizer, and a coiled 15-ft. interconnect cord cost \$80.

CIRCLE 148 ON READER-SERVICE CARD

Digital FM tuner/preamp from Revox

Revox's A-720 digital FM tuner/preamp is part of its new electronic series styled to match the A-700 tape deck. A quartz-stabilized frequency synthesizer, signal-strength and frequency "lock-in" meters, and phase-lock-loop circuitry are incorporated into the tuner section. The digital readout returns to 87 MHz when tuned past 107.95 MHz. The preamp section includes stepped bass, presence, and treble controls; two front-panel headphone outputs; a special binaural headphone circuit; dubbing/monitoring facilities for two tape decks; screwdriver-adjustable preset levels for the five inputs; two switchable stereo outputs; and remote-control jack. The price is \$1,395.

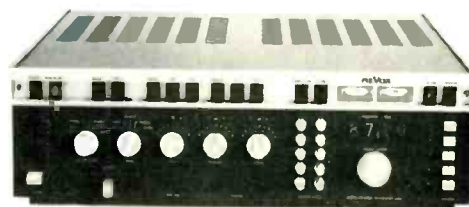

CIRCLE 149 ON READER-SERVICE CARD



Pioneer's new belt-drive automatic turntable

U.S. Pioneer has a second automated single-play turntable. The PL-A45D—a two-motor (one for the platter, one for automatic functions), two-speed (33 1/3 and 45 rpm), belt-drive model—incorporates an S-shaped tone arm and features automatic lead-in, return, and repeat. It can be used for manual play as well, of course. Also included are oil-damped cueing, direct-VTF-readout counterweight, lateral balance adjustment, antiskating control, and a plug-in cartridge shell. The PL-A45D costs \$169.95.

CIRCLE 150 ON READER-SERVICE CARD

First model in new Kenwood receiver line

The top-of-the-line KR-7400 is the first in a new assortment of stereo receivers from Kenwood. It has a tape-through circuit (if you have two decks, tapes may be copied while you listen to another source); two inputs each for phono, aux, and tape; and a four-channel FM detector jack. Amplifier circuitry is direct-coupled, and a dual protection circuit guards both speakers and transistors. Power rating is 63 watts continuous per channel. Phase-lock-loop circuitry and signal-strength and center-tuning meters are included in the tuner section. Cost is \$519.95.

CIRCLE 151 ON READER-SERVICE CARD



Onkyo adds "linear suspension" speaker

Onkyo's new Model 25A loudspeaker system is a three-way design featuring a 14-in. woofer. The woofer cone is molded (a process developed by Onkyo as an alternative to conventional pressure forming), has an extra-length voice coil, and uses a ported cone cap said to promote robust bass and control nonlinearity. The midrange driver is a 2-in. hard (Duraluminum) dome; the tweeter is a similar 1-in. dome. Rear-panel switches allow adjustment of midrange and highs in 2-dB steps. The 25A is rated to handle up to 60 watts; amps of at least 10 watts per channel are recommended. The Model 25A costs \$249.95.

CIRCLE 152 ON READER-SERVICE CARD

The Beogram™ 4002. If you are serious about your audio system, there is no alternative.

The Beogram 4002 began when Bang & Olufsen engineers were told to set aside the traditional solutions to turntable design and begin anew. Their goal was simply stated: Develop an electronically controlled turntable with optimum specifications. The result of their work was the Beogram 4002, an audio component unequalled in both concept and performance.

The cartridge. The quality of any turntable is easily negated by using an inferior or mismatched cartridge. Bang & Olufsen engineers felt it was essential to develop a cartridge which was an integral part of the turntable and not simply an appendage added later by the user. Therefore, an entirely new cartridge was developed which could meet the specification levels set for the turntable. This cartridge was the MMC 6000: a brilliant piece of miniaturization capable of reproducing a frequency spectrum from 20 to 45,000Hz. The MMC 6000 features the new multi-radial Pramanik stylus for exceptional high frequency tracing and has effective tip mass of only 0.22mg. It has a tip resonance point of over 45,000Hz, a compliance higher than 30×10^{-9} , and a recommended vertical tracking force of 1 gram.

The tone arm assembly. The Beogram 4002 features one of the most sophisticated tone arm assemblies ever developed. Its tangen-

tial tracking effectively eliminates tracking error and skating force. When a record is being played, each revolution brings the stylus one groove's width closer to the center. This inward movement causes the tone arm to pivot the equivalent fraction of a degree and reduce the amount of light received by a photocell within the tone arm's housing. This causes a servo motor to very slowly move the entire assembly the exact distance required to compensate for the angular deviation. Precision, low-friction

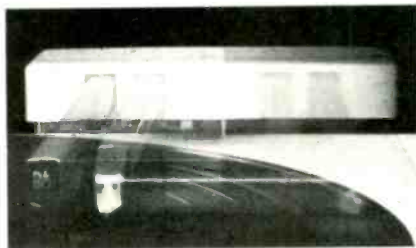

A color brochure presenting all Bang & Olufsen products in detail is available upon request.

Bang & Olufsen

Fine instruments for the reproduction of music.

Bang & Olufsen of America, Inc.
2271 Devon Avenue
Elk Grove Village, Illinois 60007

ball bearings keep the vertical and horizontal friction of the tone arm to between 5 and 15mg. As the tone arm is always kept tangent with the record groove, skating force is eliminated.

Operation. The Beogram 4002 utilizes computer logic circuits for automatic control of the operation cycle. Once you have depressed the "on" switch further assistance is unnecessary. The detector arm preceding the tone arm senses the presence and size of the record and transmits the appropriate information to the control unit. If there is no record on the platter, the arm will be instructed to return to the rest position and shut off the unit. When a record is detected, the correct speed is automatically set and the stylus cued in the first groove. A patented electro-pneumatic damping system lowers the tone arm at a precise, controlled speed to prevent damage to the stylus. The entire cueing cycle takes only two seconds. The control panel of the Beogram 4002 also permits power assisted manual operation. You may move the tone arm in either direction and scan the entire record at slow or rapid speed. A slight touch on the control panel will lower the arm exactly in the groove you have chosen; another touch will immediately lift it for recuing elsewhere. During any operation, either manual or automatic, you need never touch the tone arm.

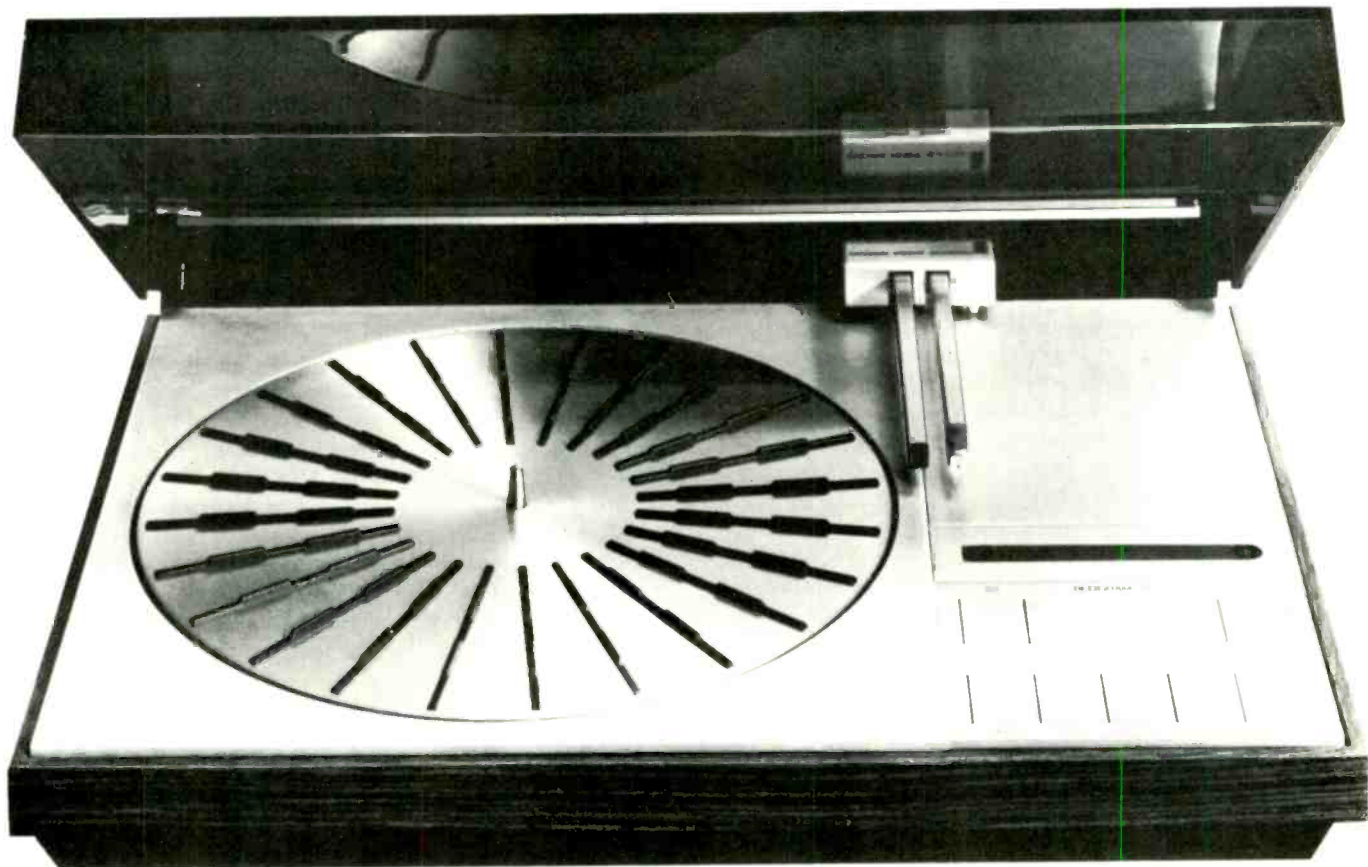

Bang & Olufsen components are in the permanent design collection of the Museum of Modern Art.

CIRCLE 7 ON READER-SERVICE CARD



by Larry Zide

Picking a Pickup

We all know that cartridge and arm must be matched for good results. But what governs the compatibility match, and why are some manufacturers reticent about recommendations?

WE TEND TO take for granted the interchangeability and compatibility of one component with another. And, for the most part, we do so with impunity. Nowhere, however, is the problem of matching components more critical than in those used for playing records.

Most pickup cartridges will, physically, fit into most tone arms today; that's not the problem. Dimensions are relatively standardized, but other factors are not. Will changer A trip properly with cartridge B? How will cartridge C track record warps in tone arm D? Do the adjustments on turntable ensemble E have sufficient range to allow use of pickup F?

Accompanying this article you will find lists of cartridge manufacturers showing their recommendations for the turntables that will perform correctly with their pickups. Why have such a list? Does it tell all you need to know? Read on.

The tone arm has only one job—holding the cartridge at the correct geometrical relationship to the record groove and at the correct tracking force. That sounds simple, but no arm does its job perfectly. Every arm has frictional resistance. The record groove is doing the actual work. Via the stylus assembly, it is dragging the arm across the record, revolution by revolution. No arm goes that route without *some* resistance.

A changer or automatic single-play turntable may compound the problems. [See Mr. Zide's article (with Michael Marcus) on turntables: HF, May 1974.] For present purposes the most important factor is tripping force. The changer may track satisfactorily at 1 gram while the record is playing but require more than 1 gram to trip the changer cycle at the end of the record. When this is true, the stylus may simply be pulled out of the leadout groove following the music and the changer will refuse to "change." And in the process the stylus assembly can even be damaged—a hard failing to diagnose, though the kind of lateral stylus displacement it causes can seriously affect separation.

In other words, it is not enough to compare rec-

ommended tracking force (of the pickup) with available tracking-force settings (on the arm) to determine compatibility. Nor is it necessarily safe to accept verbatim, in this respect, the manufacturers' specs for tripping force. Even if your turntable meets specs when it is new (and many companies specify on the basis of *average* predictable performance), it may not when dirt and wear begin to attack its innards. Some margin between specified tripping force and actual tracking-force settings certainly is desirable.

Vertical Tracking Force

In the jargon of high fidelity a "light-tracking" pickup has been equated with a "high-performance" pickup, though the two are not the same. While it's true that most of the best pickups generally can be tracked at very low VTFs (say, about 1 gram), misapplication of the fact has led to the irrational importance that has been placed on low tracking forces.

You must begin by understanding that lighter is good but lightest may not be. A stylus tracking at twice its optimum VTF is wearing itself and the groove a little faster than it might. Maybe you'll get only 800 plays out of the diamond instead of 1,000. But a stylus loaded with insufficient VTF will bounce around in heavily modulated grooves, banging against the walls and damaging them. That's not good. So in general, when a range of $\frac{3}{4}$ to $1\frac{1}{2}$ grams is given, assume that the $\frac{3}{4}$ refers only to a perfect mating of the cartridge to an ideal arm. It seldom happens. In the real world 1 gram usually is preferable to $\frac{3}{4}$ gram for a cartridge with such a rating.

But the undue emphasis on super-low tracking forces poses less obvious pitfalls for the user in search of high performance. Not only may he choose a pickup whose recommended tracking range is on the low side for his turntable assembly, but he may actually be encouraged to do so in some

cases by the manufacturer or dealer who sells the turntable!

Let's say that a popular high-performance cartridge is rated for $\frac{3}{4}$ to $1\frac{1}{2}$ grams; a changer manufacturer's top model will perform at $1\frac{1}{2}$ grams. The company doesn't want to rule out this popular cartridge (after all, some potential customers already will *have* the cartridge) and is, in fact, justified in specifying it as appropriate for the top changer—under ideal conditions. Less than ideal conditions (perhaps excessive speaker feedback or inordinately warped records or dust in the tone-arm bearings) *may*, however, prevent satisfactory performance. Where does one draw the line?

Or the purchaser may end up with a mismatch via another route. The dealer offers a series of turntables (including the top changer) on a one-cent deal with a series of cartridges—not including the $\frac{3}{4}$ - $1\frac{1}{2}$ gram model. Then, for an extra \$10 or \$20, he may offer the “step-up” cartridges like that model. This looks like a very good deal, though the match *may* be questionable.

So in matching pickup VTF recommendations to arm performance, just as in matching them to tripping-force specs, it is advisable to allow a little leeway.

Warped Records

Two aspects of cartridge-arm compatibility are dramatized by warped records. The first has to do with moving mass. A low-mass arm—meaning a light arm and one whose weight is concentrated as much as possible near the pivot—can be defeated by installing a heavy cartridge. If you are undecided between two cartridges and like their performance equally well, choose the lighter one; if the weight difference is significant, it probably will play warped records better.

The reason for this can be explained by remembering a law of physics: *A moving mass continues to “want” to move.* A heavy arm, rising to track a warp, wants to continue to rise for an instant at the top of the warp; and it wants to push down against the record (drastically increasing the momentary stylus force) at the trough. The low-mass arm wants to do the same things, of course, but with proportionately less force to its “desires.” So the stylus is less likely to lose contact with the groove at the peak of the upswing or to “bottom” during the downswing.

The other factor involved in proper tracking of warped discs (and no record is perfectly flat) is stylus compliance. Any cartridge-arm combination resonates at a particular frequency, the frequency and the severity of the resonance being dependent on both the arm's mass and the compliance of the stylus. For most combinations this resonance will occur at frequencies well below 20 Hz. Obviously, you will say, the resonance *should* be below audibil-

ity (that is, below 20 Hz) to prevent exaggeration of any rumble components derived from the turntable or from the record. True, but warp itself represents a kind of “rumble” to the extent that it is an extremely low-frequency “modulation” of the record's surface. And in fact a cartridge-arm resonance that is excessive in amplitude can exaggerate the problems of tracking warped discs, particularly when the resonance is *too* low in frequency.

It has been found that a resonance of 7 to 15 Hz is optimum since warp “frequencies” tend to be lower. The resonant frequency of the combination can be reduced either by increasing the mass of the arm (including the cartridge) or by increasing the dynamic compliance of the stylus assembly. Dynamic compliance is not the same thing as static compliance (the “compliance spec” normally shown), so even given the formula for the resonance frequency plus a “full” set of specs for both the cartridge and the arm it is not possible to calculate the resonance. But the mass of most current arms is low enough to allow use of very compliant styli without undue worry about warps. The possibility of mismatch remains, however.

It is exaggerated by the excessive emphasis that has been put on stylus compliance. Like tracking-force range, compliance has been assumed as a criterion of merit by the buying public: “The higher the compliance, the better the cartridge.” The proposition simply won't hold water, but it has cajoled turntable owners into choosing super-compliant cartridges—and therefore, on occasion, into greater tracking problems with warped discs than need be.

Evaluating the Specs

Some manufacturers are unwilling to say which of their pickups will track with another manufacturer's tone arm. They argue that they can control the quality and specifications of their own cartridges but not those of another company's product.

Not only may they find that a changer that “will track at 1 gram” actually needs 2 grams to trip, but there's no guarantee that a year from now the same model may not have been revised to trip at 1 gram, or 3 grams. Even if a cartridge manufacturer goes to the time (and expense) of testing a given turntable for compatibility, his findings can be invalidated in short order. And with so many models on the market the prospect of testing his pickup in each—and of doing so on a continuing basis—is not encouraging.

But without such complete testing some incompatibility “sleepers” are bound to remain. For example, the Decca pickups listed in the table have an unusually strong magnetic field. The Philips turntables shown as “compatible” for the pickups do not have nonferrous platters. The result, some

users report, is so much attraction between magnet and platter that the stylus assembly bottoms. Philips confirms this experience by stating that the combination is incompatible.

One of Decca's importers, in denying the incompatibility, states that his company regularly uses the combination in demonstrating speakers but never has had a case of bottoming. The importer adds, however, that tracking force on the Philips normally is set to 2 grams—rather low for this particular cartridge, though the magnetic attraction between pickup and platter presumably adds to the actual VTF.

Are the two incompatible? You can call it either way, depending on your point of view.

The question of compatibility does not admit of entirely unequivocal answers. But no manufacturer *wants* his product to be used in a combination that will reflect badly on it. And some cartridge makers (Stanton is among those on the chart that stand out) go to great lengths to help their customers choose wisely in spite of all that mitigates against their doing so.

In a way, the credibility crunch is hardest on those companies that offer both pickups *and* arms or turntable ensembles, because when specifying in

one area they must deal with competitors' products in the other. Let's say that you are a manufacturer and that you know your popular pickup to be only a marginal match for your competitor's Micro-miracle turntable. If you say the two are compatible, you may cause problems both for yourself and for your competitor. If you say they're incompatible, you leave yourself open to charges of letting commercial considerations cloud your judgment: Aren't you trying to downgrade the competing Micromiracle?

The charts that accompany this article were constructed entirely from information provided by the cartridge manufacturers. All of the problems discussed above can be read into those charts. This should not be taken as a condemnation of manufacturers' specifications. Rather, it is an index of a significant problem that exists and—so far—has resisted successful across-the-board solution. Use the tables as a starting point by all means, keeping in mind the basic rule that the better pickups are designed to work well in the better arms, and vice versa. That is, the manufacturer's need to produce equipment that will work well with other components *of the same class* generally is reliable insurance against serious problems. ●

Which Cartridges Go with Which Tone Arms?

17 Manufacturers State Their Recommendations

PHONO CARTRIDGES

TURNTABLES and TONE ARMS*

AUDIO DYNAMICS

Declines to provide information due to affiliation with BSR. Believes data could be misconstrued as knocking a competitor and would only add to customer's confusion.

AUDIO-TECHNICA

Audio-Technica Company has been gathering data on available turntables and tone arms, but no firm recommendations were available by press time.

B & O

MMC-6000

AUDIO-TECHNICA: AT-1003, AT-1005. **B & O:** Beogram 4002. **CONNOISSEUR:** BD-2/C. **SME:** 3009, 3009/S2. **SONY:** PS-2251. **STAX:** UA-7. **TECHNICS:** SP-1200, SP-1100A, SP-10. **THORENS:** TD-125AB.

MMC-4000

AUDIO-TECHNICA: AT-1003, AT-1005. **B & O:** Beogram 3000. **BSR:** 810. **CONNOISSEUR:** BD-2/C. **DUAL:** 1229, 1218, 1216, 1214, 701. **LENCO:** L-85, L-78, L-75. **MIRACORD:** 770H, 760, 660H, 50H Mk. II, 50H. **JVC:** VL-8. **PHILIPS:** GA-212, SL-8E, ST-4. **SANSUI:** SR-2050C. **SME:** 3009/2, 3009. **SONY:** PS-2251. **STAX:** UA-7. **TECHNICS:** SP-1200, SP-1100A. **THORENS:** TD-160C, TD-125AB. **YAMAHA:** YP-700.

SP-14

ACOUSTIC RESEARCH: AR-XB. **AUDIO-TECHNICA:** AT-1003, AT-1005. **B & O:** Beogram 3000. **BSR:** 810. **CONNOISSEUR:** BD-2/C. **DUAL:** 1229, 1218, 1216, 1214, 701. **EMPIRE:** 598-2. **GARRARD:** Zero 100C. **GLENBURN:** 2110. **JVC:** VL-8. **LENCO:** L-85, L-78, L-75, B-52. **MIRACORD:** 770H. **P-E:** PE-3015, PE-3012. **PHILIPS:** GA-308, GA-212. **PIONEER:** All models. **RABCO:** ST-4. **REALISTIC:** Lab 36-A. **REK-O-KUT:** CVS-12. **SANSUI:** SR-2050C, SR-1050C. **SANYO:** TP-805A. **SME:** 3009/2, 3009. **SONY:** PS-2251. **STAX:** UA-7. **TECHNICS:** SP-1200, SP-1100A, SP-10. **THORENS:** TD-160C, TD-125AB. **TOSHIBA:** SR-40E. **YAMAHA:** YP-700.

SP-12

AUDIO-TECHNICA: AT-1005, AT-1003. **B & O:** Beogram 3000. **CONNOISSEUR:** BD-2/C. **DUAL:** 1229, 1218, 1216, 1214, 701. **EMPIRE:** 598. **GARRARD:** Zero 100C, Zero 92, SL-95B. **JVC:** VL-8. **LENCO:** L-85, L-78, L-75, B-52. **MIRACORD:** 770H, 760, 660H, 50H Mk.

*Note: Model numbers represent integrated turntable-arm ensembles except for Ortofon, Rek-O-Kut, and SME, which offer separate tone arms. Compatibility information supplied by the cartridge manufacturers.

PHONO CARTRIDGES

TURNTABLE and TONE ARMS*

II, 50H. **PHILIPS:** GA-212. **PIONEER:** All models. **RABCO:** SL-8E, ST-4. **REALISTIC:** Lab-36A. **REK-O-KUT:** CVS-12. **SANSUI:** SR-2050C. **SANYO:** TP-805A. **SME:** 3009/S2, 3009. **SONY:** PS-2251. **STAX:** UA-7. **TECHNICS:** SP-1200, SP-1100A, SP-10. **THORENS:** TD-160C, TD-125AB. **YAMAHA:** YP-700.

DECCA

London

B & O: All models. **BSR:** All models. **CONNOISSEUR:** All models. **DECCA:** International tone arm. **DUAL:** All models. **EMPIRE:** All models. **GARRARD:** Zero 100, 401.

Export Mk.-5

JVC: All models. **LENCO:** All models. **LINNSONDER:** LP-12. **P-E:** All models. **PHILIPS:** All models. **RABCO:** SL-8E. **REK-O-KUT:** All models. **SANSUI:** All models. **SME:** 3009/S2. **SONY:** All models. **SSI:** All models. **TECHNICS:** All models. **THORENS:** 125 Mk. II.

London Mk.-5

Same as Export Model.

ELAC

STS-444-E

B & O: Beogram 3000. **BSR:** 810. **DUAL:** 1229, 701. **EMPIRE:** 208. **GARRARD:** Zero 100C. **LENCO:** L-85, L-78, L-75. **MIRACORD:** 770H, 760, 50H Mk. II. **P-E:** PE-3060. **PHILIPS:** GA-212. **PIONEER:** PL-51, PL-35. **SANSUI:** SR-2050C, SR-1050C, TP-80. **SONY:** PS-5520. **TECHNICS:** SL-1200, SL-1100. **THORENS:** TD-160C, TD-125 Mk. II. **YAMAHA:** YP-700.

STS-344-E

ACOUSTIC RESEARCH: AR-XB. **B & O:** Beogram 3000. **BSR:** 810, 710. **DUAL:** 1229, 1218, 1216, 701. **EMPIRE:** 208. **GARRARD:** Zero 100C. **LENCO:** L-85, L-78, L-75. **MIRACORD:** 770H, 760, 50H Mk. II. **P-E:** PE-3060, PE-3015. **PHILIPS:** GA-212. **PIONEER:** PL-51, PL-35. **SANSUI:** SR-2050C, SR-1050C, TP-80. **SONY:** PS-5520. **TECHNICS:** SL-1200, SL-1100. **THORENS:** TD-160C, TD-125 Mk. II. **YAMAHA:** YP-700.

STS-344-17

ACOUSTIC RESEARCH: AR-XB. **B & O:** Beogram 3000. **BSR:** 810, 710. **DUAL:** 1229, 1218, 1216, 1214, 701. **EMPIRE:** 208. **GARRARD:** Zero 100C, SL-92. **LENCO:** L-85, L-78, L-75, B-52. **MIRACORD:** 770H, 760, 625, 50H Mk. II. **P-E:** PE-3060, PE-3015, PE-3012. **PHILIPS:** GA-308, GA-212. **PIONEER:** PL-51, PL-35, PL-12D. **SANSUI:** SR-2050C, SR-1050C, TP-80. **SONY:** PS-5520. **TECHNICS:** SL-1200, SL-1100. **THORENS:** TD-160C, TD-125 Mk. II. **YAMAHA:** YP-700.

STS-244-E

ACOUSTIC RESEARCH: AR-XB. **B & O:** Beogram 3000. **BSR:** 810, 710. **DUAL:** 1218, 1216, 1214. **GARRARD:** SL-92. **LENCO:** L-75, B-52. **MIRACORD:** 625. **P-E:** PE-3015, PE-3012. **PHILIPS:** GA-308. **PIONEER:** PL-12D.

STS-244-17

Same as Model STS-244-E.

EMPIRE

4000D/III

DUAL: 1229. **EMPIRE:** 598, 498, 398. **GARRARD:** Zero 100C. **MIRACORD:** 770H, 50H. **PIONEER:** PL-61. **SME:** 3009. **SONY:** PS-2251. **TECHNICS:** SL-1200. **THORENS:** TD-125 Mk. II.

4000D/II

BIC: 980. **BSR:** 810. **DUAL:** 1229, 1218. **EMPIRE:** 598, 498, 398. **GARRARD:** Zero 100C, Zero 92. **MIRACORD:** 770H, 50H. **P-E:** PE-3060. **PIONEER:** PL-61. **SME:** 3009. **SONY:** PS-2251. **TECHNICS:** SL-1200. **THORENS:** TD-125 Mk. II.

4000D/I

BIC: 980, 960. **BSR:** 810, 610AX, 510. **DUAL:** 1218, 1216. **EMPIRE:** 598, 498, 398. **GARRARD:** Zero 100C, Zero 92. **GLENBURN:** All models. **LENCO:** All models. **MIRACORD:** 770H, 50H. **P-E:** PE-3060. **PIONEER:** PL-61. **SME:** 3009. **SONY:** PS-2251. **TECHNICS:** SL-1200. **THORENS:** TD-125 Mk. II.

2000E/III

BIC: 980, 960. **BSR:** 810. **DUAL:** 1219, 1218, 1216. **EMPIRE:** 598, 498, 398. **GARRARD:** Zero 100C. **LENCO:** All models. **MIRACORD:** 770H, 50H. **PIONEER:** PL-61. **SME:** 3009. **SONY:** PS-2251. **TECHNICS:** SL-1200. **THORENS:** TD-125 Mk. II.

2000E/II

BIC: 980, 960. **BSR:** 810, 610AX, 510. **DUAL:** 1228, 1218, 1216. **EMPIRE:** 598, 498, 398. **GARRARD:** Zero 100C, Zero 92. **GLENBURN:** All models. **LENCO:** All models. **MIRACORD:** 770H, 50H. **P-E:** PE-3060. **PIONEER:** PL-61. **SONY:** PS-2251. **THORENS:** TD-125 Mk. II.

2000E/I

ACOUSTIC RESEARCH: AR-XB. **BIC:** 960. **BSR:** 810, 610AX, 510. **DUAL:** 1218, 1216. **GARRARD:** Zero 100C, Zero 92, 82. **GLENBURN:** All models. **LENCO:** All models. **P-E:** PE-3060. **PIONEER:** PLA-35. **SONY:** PS-5520. **THORENS:** TD-160C.

2000E

ACOUSTIC RESEARCH: AR-XB. **BIC:** 980. **BSR:** 610AX, 510. **DUAL:** 1216. **GARRARD:** 82. **GLENBURN:** All models. **PIONEER:** PLA-35. **SONY:** PS-5520. **THORENS:** TD-160C.

2000

Same as Model 2000E, except not compatible with **BIC** 980.

1000ZE/X

DUAL: 1229. **EMPIRE:** 598, 498, 398. **GARRARD:** Zero 100C. **MIRACORD:** 770H, 50H. **PIONEER:** PL-61. **SME:** 3009. **SONY:** PS-2251. **TECHNICS:** SL-1200. **THORENS:** TD-125 Mk. II.

999VE/X

BSR: 810. **DUAL:** 1229, 1218. **EMPIRE:** 598, 498, 398. **GARRARD:** Zero 100C, Zero 92. **MIRACORD:** 770H, 50H. **P-E:** PE-3060. **PIONEER:** PL-61. **SME:** 3009. **SONY:** PS-2251. **TECHNICS:** SL-1200. **THORENS:** TD-125 Mk. II.

999TE/X

Same as Model 999VE/X, except also is compatible with **DUAL** 1216 and all **LENCO** models.

999SE/X

ACOUSTIC RESEARCH: AR-XB. **BSR:** 810, 610AX, 510. **DUAL:** 1218, 1216. **EMPIRE:** 598, 498, 398. **GARRARD:** Zero 100C, Zero 92. **GLENBURN:** All models. **LENCO:** All models. **MIRACORD:** 770H, 50H. **P-E:** PE-3060. **PIONEER:** PL-61, PLA-35. **SME:** 3009. **SONY:** PS-5520, PS-2251. **TECHNICS:** SL-1200. **THORENS:** TD-160C, TD-125 Mk. II.

999E/X

ACOUSTIC RESEARCH: AR-XB. **BSR:** 810, 610AX, 510. **DUAL:** 1218, 1216. **GARRARD:** Zero 100C, Zero 92, 82. **GLENBURN:** All models. **LENCO:** All models. **PIONEER:** PLA-35. **SONY:** PS-5520. **THORENS:** TD-160C.

90EE/X

ACOUSTIC RESEARCH: AR-XB. **BSR:** 610AX, 510. **GARRARD:** 82. **GLENBURN:** All models. **P-E:** PE-3060. **PIONEER:** PLA-35. **SONY:** PS-5520. **THORENS:** TD-160C.

909/X

Same as Model 90EE/X, except not compatible with **GARRARD** or **GLENBURN** models shown.

PHONO CARTRIDGES

TURNTABLE and TONE ARMS*

| | |
|---------------|---|
| 440D | Same as Model 999SE/X, except not compatible with ACOUSTIC RESEARCH AR-XB; is compatible with GARRARD 82. |
| 66QE/X | Same as Model 440D, except is not compatible with BSR 810. |
| 66PE/X | Same as Model 66QE/X. |
| 66LE/X | BSR: 610AX, 510. DUAL: 1216. GARRARD: Zero 92, 82. GLENBURN: All models. LENCO: All models. P-E: PE-3060. PIONEER: PLA-35. SONY: PS-5520. |
| 66E/X | Same as Model 66LE/X. |
| 66/X | Same as Model 66LE/X. |

GRADO

| | |
|----------------|--|
| FTR + | Works in all changers and turntables tracking between 1.5 and 3.0 grams. |
| FTE + | Same as Model FTR +. |
| FCR + | Same as Model FTR +. |
| FCE + | Same as Model FTR +. |
| FTR + 1 | Works in all changers and turntables tracking between 1.0 and 2.0 grams. |
| FCR + 1 | Same as Model FTR + 1. |
| F3E + | Same as Model FTR + 1. |
| F-2 + | Same as Model FTR + 1. |
| F-1 + | Same as Model FTR + 1. |

JVC

| | |
|----------------|-------------------------|
| 4MD-20X | JVC: VL-8, VL-5. |
|----------------|-------------------------|

MICRO-ACOUSTICS

| | |
|---------------------|--|
| QDC-1 Series | ACOUSTIC RESEARCH: All models. AUDIO-TECHNICA: All models. BSR: All models except 310X. CONNOISSEUR: All models. DUAL: All models. EMPIRE: All models. GARRARD: All models except 40B. JVC: All models. LENCO: All models. MIRACORD: All models. PANASONIC: All models. P-E: All models. PHILIPS: All models. PIONEER: All models. RABCO: All models. REK-O-KUT: All models. SANSUI: All models. SANYO: All models. SME: All models. SONY: All models. SSI: All models. TECHNICS: All models. THORENS: All models. YAMAHA: All models. |
|---------------------|--|

ORTOFON

| | |
|---------------|---|
| SL-15E | BSR: 810. DUAL: 1229, 1218, 701. EMPIRE: 598-2, 498A, 398A. GARRARD: Zero 100C, Zero 92. JVC: VL-8. MIRACORD: 770H, 760, 50H Mk. II. ORTOFON: AS212TA. P-E: PE-3060. PIONEER: PL-61. RABCO: SL-8E. SANSUI: SR-2050C, SR-212. SME: 3009/S2. SONY: PS-5520, PS-2251. TECHNICS: SL-1200, SP-12. THORENS: TD-165, TD-160C, TD-125 Mk. II. |
| M-15E | BSR: 810. DUAL: 1229, 1218, 701. GARRARD: Zero 100C, Zero 92. JVC: VL-8. MIRACORD: 770H, 760, 50H Mk. II. ORTOFON: AS-212TA. P-E: PE-3060. PHILIPS: GA-212. PIONEER: PL-61. RABCO: SL-8E. SANSUI: SR-2050C. SME: 3009/S2. SONY: PS-2251. TECHNICS: SL-1200, SP-12. THORENS: TD-160C, TD-125 Mk. II. |
| M-15 | Same as Model M-15E. |
| F-15E | ACOUSTIC RESEARCH: AR-XA. BSR: 810, 710, 610AX, 510, 310. DUAL: 1229, 1218, 1216, 1214, 701. EMPIRE: 598-2, 498, 398. GARRARD: Zero 100C, Zero 92, 82, A-70, 62, 40B. GLENBURN: All models. JVC: VL-8. LENCO: All models. MIRACORD: 770H, 760, 750 Mk. II, 50H Mk. II. ORTOFON: AS-212TA. P-E: PE-3060, PE-3015, PE-3012. PHILIPS: GA-407, GA-308, GA-212. PIONEER: PL-61, PL-12AC. RABCO: SL-8E, ST-4. SANSUI: SR-2050C, SR-212. SME: 3009/S2. SONY: PS-5520, PS-2251. TECHNICS: SL-1200, SP-12. THORENS: TD-165, TD-160C, TD-125 Mk. II. |
| F-15 | Same as Model F-15E. |

PANASONIC

| | |
|-----------------|--|
| EPC-460C | 3.2-gram cartridge is compatible with tone arms able to track at less than 2.5 grams. Needs bias voltage normally supplied by preamp in specially designed CD-4 demodulator. |
|-----------------|--|

PICKERING

| | |
|-----------------------------|---|
| XV-15DCF Series | ACOUSTIC RESEARCH: AR-XB. BIC: 980, 960. DUAL: 1228, 701, 601. GARRARD: Zero 100C, Zero 92, 82. P-E: PE-3048. PHILIPS: GA-209S. PIONEER: PL-45, PLA-35, PL-12D, PL-10. SONY: PS-5550, PS-5520, PS-2251, PS-2250. TECHNICS: SL-1200, SL-1100, SP-10. THORENS: TD-165, TD-125 Mk. II. |
| 1200E | Same as Model 1200E. |
| 750E | Same as Model 1200E, except also compatible with PHILIPS GA-407. |
| 400E | Same as model 400E. |
| 350 | BSR: 620, 520. DUAL: 1226, 1225, 1216, 1215, 1214. PHILIPS: GA-407. |
| 200E | Same as Model 200E. |
| 150 | BSR: 260. |
| 140E | Same as Model 140E. |
| 100 | Same as Model 140E. |
| V-15 Micro IV Series | |
| AME | Same as Model 400E. |
| ATE | Same as Model 200E. |
| ACE | Same as Model 140E. |
| AM | Same as Model 400E. |
| AT | Same as Model 200E. |
| AC | Same as Model 140E. |

PHONO CARTRIDGES

TURNTABLE and TONE ARMS*

RADIO SHACK

Realistic/Shure Series
R-700E
R-27E
R-47EB
R-7C

REALISTIC: Realistic/Miracord 45.
REALISTIC: Realistic/Miracord 40C, Realistic Lab-36A.
REALISTIC: Lab-34B.
REALISTIC: Lab-12B.

REK-O-KUT

F-3

REK-O-Kut: S-320.

SHURE

V-15 Type III

Compatible with precision quality tone arms and automatic turntables capable of tracking at 1.25 grams or less.

M91ED

Compatible with high-quality tone arms and automatic turntables capable of tracking at 1.5 grams or less.

M75ED Type 2

Same as Model M91ED.

M75EJ Type 2

Compatible with standard tone arms and automatic turntables tracking at from 1.5 to 3 grams.

M75ECS

Recommended for older manual tone arms and changers requiring 2 to 4 grams of tracking force.

M75CS

Recommended for upgrading older, heavier-tracking cartridges or for virtually any tone arm or changer tracking at from 3 to 5 grams.

STANTON

780/4DQ

Compatible with turntables properly wired for 100-pF capacitance load.

681EEE

ACOUSTIC RESEARCH: AR-XA, AR-XB. **BSR:** 810, 710. **DUAL:** 1229, 1219, 1218, 1019, 1015, 701, 601. **GARRARD:** Zero 100C, Zero 92, SL-95, SL-95B, 82. **LENCO:** L-85, L-78, L-75. **MIRACORD:** 770H, 760, 750, 660, 650, 50H Mk. II. **P-E:** PE-3060, PE-3048, PE-2040, PE-2038, PE-2035. **PHILIPS:** GA-212, 209S. **PIONEER:** PL-61, PL-51, PL-45, PL-41D, PLA-35, PL-12D. **RABCO:** SL-8E. **SANSUI:** SR-2050C, SR-1050C. **SONY:** PS-5550, PS-5520, S-2251, PS-2250, PS-1800, PS-1800A. **SME:** 3012, 3009. **TECHNICS:** SL-1200, SL-1100, SP-10. **THORENS:** TD-165C, TD-160C, TD-125AB Mk. II.

681EE

Same as Model 681EEE, except not compatible with **PIONEER** models shown.

681A

ACOUSTIC RESEARCH: AR-XA, AR-XB. **BSR:** 810, 710, 620, 610, 520, 510. **CONNOISSEUR:** BD-1, BD-2. **DUAL:** 1229, 1226, 1225, 1219, 1218, 1216, 1215, 1214, 1019, 1015, 1010. **GARRARD:** Zero 100, Zero 92, SL-95, SL-95B, SL-75, SL-72B, SL-55, Lab 80 Mk. II, Lab 80, A-70, 82, 70, 62. **GLENBURN:** 2155, 2130, 2110. **LENCO:** L-85, L-78, L-75, B-52. **MIRACORD:** 770H, 760, 750, 660, 650, 625, 50H Mk. II, 18H, M-10, M-10F, M-10H. **P-E:** PE-3060, PE-3048, PE-3015, PE-3012, PE-2040, PE-2038, PE-2035, PE-2010, PE-2005. **PHILIPS:** GA-407, GA-308, GA-212, 209S. **PIONEER:** PL-61, PL-51, PL-45, PL-41D, PLA-35, PL-12D. **RABCO:** SL-8E, ST-4. **SANSUI:** SR-2050C, SR-1050C. **SONY:** PS-5550, PS-5520, PS-2251, PS-2250, PS-1800, PS-1800A. **SME:** 3012, 3009. **TECHNICS:** SL-1200, SL-1100, SP-10. **THORENS:** TD-165C, TD-160C, TD-125AB Mk. II.

600EE

Same as Model 681EEE, except also compatible with **GLENBURN** 2155.

600E

BSR: 620, 610, 520, 510, 310, 260. **CONNOISSEUR:** BD-1, BD-2. **DUAL:** 1226, 1225, 1216, 1215, 1214, 1010. **GARRARD:** SL-75, SL-72B, SL-55, SL-40B, Lab 80 Mk. II, Lab 80, A-70, 70, 62, 50 Mk. II, 50, 40. **GLENBURN:** 2130, 2110. **LENCO:** B-52. **MIRACORD:** 625, 18H, M-10, M-10F, M-10H. **P-E:** PE-3015, PE-3012, PE-2010, PE-2005. **PHILIPS:** GA-407, GA-308. **RABCO:** ST-4.

600AA

P-E: PE-3060, PE-3048, PE-2040, PE-2038, PE-2035. **RABCO:** SL-8E.

600A

ACOUSTIC RESEARCH: AR-XA, AR-XB. **BSR:** 810, 710, 620, 610, 520, 510, 310, 260. **CONNOISSEUR:** BD-1, BD-2. **DUAL:** 1229, 1226, 1225, 1219, 1218, 1216, 1215, 1214, 1019, 1015, 1010, 701, 601. **GARRARD:** Zero 100, Zero 92, SL-95, SL-95B, SL-75, SL-72B, SL-55, SL-40B, Lab 80 Mk. II, Lab 80, A-70, 82, 70, 62, 50 Mk. II, 50, 40. **GLENBURN:** 2155, 2130, 2110. **LENCO:** L-85, L-78, L-75, B-52. **MIRACORD:** 770H, 760, 750, 660, 650, 625, 18H, M-10, M-10F, M-10H. **P-E:** PE-3015, PE-3012, PE-2010, PE-2005. **PHILIPS:** GA-407, GA-308, GA-212, 209S. **PIONEER:** PL-61, PL-51, PL-45, PL-41D, PLA-35, PL-12D. **RABCO:** ST-4. **SANSUI:** SR-2050C, SR-1050C. **SONY:** PS-5550, PS-5520, PS-2251, PS-2250, PS-1800, PS-1800A. **SME:** 3012, 3009. **TECHNICS:** SL-1200, SL-1100, SP-10. **THORENS:** TD-165C, TD-160C, TD-125AB Mk. II.

500EE

Same as Model 600EE.

500E

Same as Model 600E.

500AA

Same as Model 600EE.

500AL

BSR: 310, 260. **GARRARD:** SL-40B, 50 Mk. II, 50, 40.

500A

BSR: 620, 610, 520, 510, 310, 260. **DUAL:** 1226, 1225, 1216, 1215, 1214, 1010. **GARRARD:** SL-75, SL-72B, SL-55, SL-40B, Lab 80 Mk. II, Lab 80, A-70, 70, 62, 50 Mk. II, 50, 40. **GLENBURN:** 2130, 2110. **LENCO:** B-52. **MIRACORD:** 625, 18H, M-10, M-10F, M-10H. **P-E:** PE-3015, PE-3012, PE-2010, PE-2005. **PHILIPS:** GA-407, GA-308. **RABCO:** ST-4.

TOSHIBA

C401S/SZ200

ACOUSTIC RESEARCH: AR-XB. **AUDIO-TECHNICA:** AT-1005, AT-1003. **BSR:** 810, 710. **DUAL:** 1229, 1218, 1216, 701. **EMPIRE:** 598-2. **GARRARD:** Zero 100C, SL-95B. **JVC:** VL-8. **LENCO:** L-85, L-78. **MIRACORD:** 760, 50H Mk. II. **PHILIPS:** GA-212. **PIONEER:** PL-61, PL-51, PLA-35, PL-22D. **SME:** 3012, 3009. **TECHNICS:** SL-1200, SP-1100A. **THORENS:** 125B Mk. II. **TOSHIBA:** SR-80, SR-50, SR-40E.

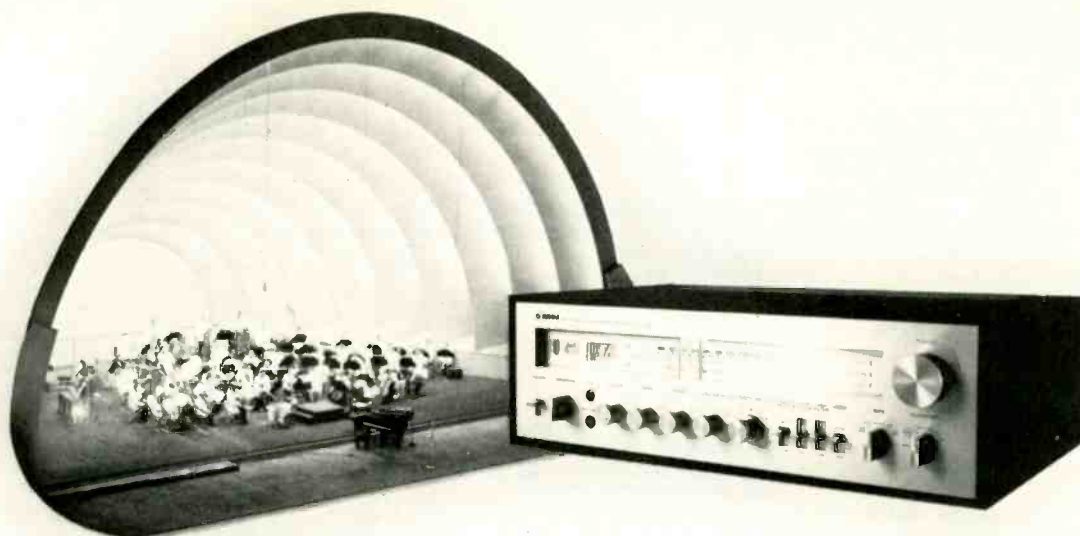

BEFORE WE MADE THE NEW YAMAHA RECEIVER, WE MADE THE ORCHESTRA.

The new Yamaha receiver and other stereo components emerged from a unique eighty-year involvement in music and sound.

Years ago Yamaha established new standards in wind instrument precision, piano sound, guitar craftsmanship, organ electronic technology.

Our engineers didn't just sit down and create those standards—they evolved them, and the same is true in their latest audio achievements.

To reach their goal of maximum truthful reproduction, they had Yamaha's three-quarters of a century sound experience to draw from.

And they developed new technology to match and exceed the kind of quality performance (low distortion) usually found on "separates" at the highest price levels.

A New Engineering.

They developed a new kind of engineering philosophy, too.

Because they conceived this quality standard not for just the highest priced Yamaha components, but for the whole line!

The result is low distortion performance, typically

at .08%, available to receiver and amplifier buyers in all competitive price ranges.

Compare the specs on the new Yamaha components to any of their competition.

But don't stop there—compare them to your idea of an ultimate component selling for any price.

We're confident of the outcome.

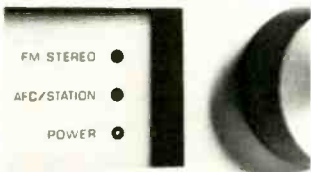

The Powerful Truth.

The new Yamaha CR-800 receiver, for example, packs a powerful 45 watts per channel RMS (both channels driven, 8 ohms, 20-20 kHz) to give you the full force of a big crescendo, or full audibility of a delicate piccolo solo.

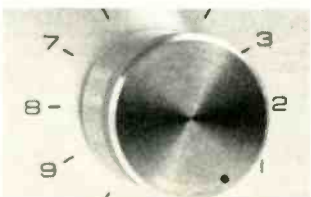

Sophisticated Tuner.

The CR-800's FM tuner section is the first to utilize negative feedback around the multiplex demodulator. This achieves superb separation (45 dB) and reduces MPX distortion to 0.05%.

And Yamaha Auto Touch tuning allows the electronics to fine tune the station for minimum distortion (and keeps it there).

A ten-position stepped loudness control takes speaker efficiency, room acoustics, and other factors into consideration, to give you the tonal balance of lows, middles, and highs you like at all volume levels.

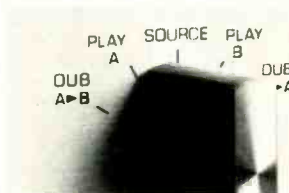

Multiples and Mixes.

For the multiple tape deck owner, the 800 has a five-position tape monitor selector to easily control two stereo tape record/playback circuits for recording on one or both decks simultaneously, for copying from one recorder to another, or for reproducing or monitoring on either.

Other features include a

separate microphone pre-amp and volume control, a two-position low filter (20 Hz-70 Hz) and a two-position high filter (8 kHz-blend). And LED's for critical indications.



Homemade Philosophy.

The 800 fully incorporates all the years of electronics technology, metal working, machining and wood working pioneered by Yamaha in the music field.

Most of the various parts of Yamaha stereo equipment are made by Yamaha, in our own facilities, for stronger quality control.

And like Yamaha music products, Yamaha components are covered by an unusually long warranty—5 year parts, 3 year labor—and a national service and dealer network.

Addition the Yamaha CR-800, and all our new components, at your nearby Yamaha dealer.



CIRCLE 71 ON READER-SERVICE CARD



THE CONSUMER'S GUIDE **new equipment**
TO HIGH FIDELITY EQUIPMENT **reports**

Ferrograph's Finest Deck Yet: The Super 7

The Equipment: Ferrograph Model 7504HDAW, a three-speed (15, 7½, and 3¼ ips), three-motor, quarter-track stereo open-reel tape deck with (optional) Dolby-B circuitry for both recording and playback (simultaneously), in wood case. Dimensions: 19¾ by 17 inches, approx. 8½ inches deep plus allowance for controls, etc.; 7-inch and larger reels overhang main plate, 8¼-inch and larger reels overhang wood case; can be used vertically or horizontally. Price: \$1,150; low-speed version (7½, 3¼, and 1½ ips) available at same price; same decks without Dolby circuits, \$1,025. Warranty: one year parts and labor. Manufacturer: The Ferrograph Co., Ltd., England; U.S. distributor: Elpa Marketing Industries, Inc., Thorens & Atlantic Aves., New Hyde Park, N.Y. 11040.

Comment: First, a word about model designations. The entire series is referred to as "Super 7" to distinguish the new models from the Series 7 units that preceded them and to which they bear a great deal of resemblance. It also is called the "Series 75," since all model numbers start with those two digits. The next digit specifies the channels of power amplification, the final one the number of tracks. Thus the Model 7522 is half-track with a built-in stereo amplifier; the 7504 reviewed here is quarter-track stereo with no amp. In the letter suffixes of the reviewed model, the "H" stands for high speed (15 ips top; all models are three-speed), the "D" is for Dolby, the "A" connotes the American version (60-Hz, 117-volt power supply, adjusted for NAB playback specs and Scotch 206 tape), and the "W" signifies the wood case.

For the American market we would expect the 7504, either with or without Dolby and in either speed version, to be the format of choice. Though the decks—even those with the wood case—have a carrying handle, they are too heavy to be readily portable (except by comparison to some other professional behemoths). Home users will therefore find little need for the monitoring system, preferring to listen via a home component sys-

tem. And the availability of many attractive quarter-track prerecorded tapes has steered American buyers away from the superior S/N ratios of half-track equipment.

The (relatively recent) availability of Dolby-processed tapes may likewise argue in favor of the Dolby deck. The speed choice is a tossup. In our quarter-track test sample the Dolby circuitry is defeated automatically at 15 ips though Elpa and the Ferrograph manual say the automatic defeat is intended only for half-track models, to oblige Dolby Labs' rule that only Dolby A equipment should be used with professional formats. This is perhaps unimportant, since—for all but mastering—few users will find noise reduction necessary at this speed.

The connections and controls are similar to those on the Ferrograph 7; the 7 itself was quite unconventional, and there are several important changes, so we will describe them in detail. The (rotary) on/off switch and the transport's speed selector are together between the reels. Also between the reels, but next to the head cover, is a four-digit turns counter with its reset button, a "reset" light, and the recording button.

As in the older model, the reset light glows red during any of several stop-and-reprogram situations: a mismatch between speed and equalization selectors, for example, or an automatic shutoff. The deck must be returned to stop and the situation corrected before the reset light will go out; only then can it be operated. Unlike the older model, the Super 7 *cannot* be put accidentally into recording. (We found it unlikely, though not impossible, with the older one.) Ferrograph has added a recording pilot light near the recording button and devised a more positive interlock with a small latch near the head cover. If one presses the recording button while going from "stop" to "pause" or "run," the unit will stay in recording unless one releases the latch. But when one is playing the tape to pick up a recording cue, it no longer is possible to switch to recording simply by pressing the recording button; one must also release the latch.

A second latch nearby, retained from the Ferrograph 7, prevents inadvertently going directly from the fast-wind modes to "run"; but the latch and the transport lever are so positioned that you can operate both with one hand if you wish, promoting fast operation. The positions of the lever are marked fast, stop (reset), pause, and run. Wind speed and direction for the "fast" position are controlled by a knob (actually a pair of rheostats that govern the two reel motors reciprocally) to the right of the head cover, giving unique flexibility of control over the speed, tightness, and evenness of the wind.

REPORT POLICY

Equipment reports are based on laboratory measurements and controlled listening tests. Unless otherwise noted, test data and measurements are obtained by CBS Laboratories, Stamford, Connecticut, a division of Columbia Broadcasting System, Inc., one of the nation's leading research organizations. The choice of equipment to be tested rests with the editors of HIGH FIDELITY. Manufacturers are not permitted to read reports in advance of publication, and no report, or portion thereof, may be reproduced for any purpose or in any form without written permission of the publisher. All reports should be construed as applying to the specific samples tested; neither HIGH FIDELITY nor CBS Laboratories assumes responsibility for product performance or quality.

Since there is some output from the tape in fast wind (slight withdrawal of the tape from the heads plus a high-frequency filter that switches in automatically on fast wind prevent excessive output and tweeter damage), you can use your left hand on the transport lever and fast-wind latch and your right hand on the fast-wind knob for an unusually efficient search-and-play technique, which is particularly helpful when editing.

To thread the machine you raise the head cover and pull out the loading latch, which withdraws the pressure pads. (Yes, Virginia, pressure pads—which, we must point out once again for the benefit of readers who associate this feature with "cheap" recorders, do not intrinsically reduce head life by contrast to designs without them as long as both are correctly adjusted to begin with and are well maintained.) The "tape lifters" are fixed studs that hold the tape slightly away from the heads unless the pressure pads are engaged, as they are in both "pause" and "run." Since the heads are live at all times, "rocking" the tape for physical editing is easy.

To the left of the head cover is a small tension arm that also acts as a contact for an automatic-stop system triggered by metal foil. Farther to the left is another tension arm that—unlike that on the earlier Ferrograph—will turn off the transport (after a short delay, so that it is not triggered by brief "bounces") whenever tension is lost, even if the tape has not broken or run out. Nearby is a small screw that adjusts the tension arm action for either vertical or horizontal operation. (Ferrograph provides accessory feet that tip the deck backward slightly in vertical operation to make threading easier and controls more readily visible.) The only other control in this area is the tension-adjustment knob: 10½-inch (reel size) only/other sizes.

The electronics panel at the bottom (with the deck standing vertically) has four large knobs. The outer ones are unganged two-element controls for mike and line inputs, those for the left ("upper") channel on the left and those for the right ("lower") channel on the right. Just inboard of the left-channel controls is the three-position equalization switch ("high/med/low"), corresponding to the transport's three speeds. Inboard of the right-channel controls is a dual output level control (unganged, though the elements for the two channels can easily be moved together). Between them are the two VU meters and a recording mode switch ("upper/stereo/lower"). Our only criticism of this arrangement—which apparently is dictated by separate input circuit boards for the two channels—is that stereo fades of either mike or line inputs require two hands. So, though the Super 7 offers line/mike mixing, some users may prefer an outboard mixer that allows better tracking between channels and one-hand operation.

Across the very bottom of the panel is a series of controls arranged symmetrically, with those for the left channel on the left and vice versa. In the outboard positions are bass-control knobs for each channel; next to them are treble controls. Next come monitor switches, the outer ones for source, the inner ones for tape. Then, under the meters, are pairs of screwdriver controls; the outer ones (marked "A") adjust playback levels (and metering) to match inputs, the inner ones ("B") adjust bias for each channel. At the center are "transfer" switches (upper to lower and lower to upper) that are used in sound-on-sound and tape echo and a similar switch for metering the bias current instead of audio signals. The tone controls are included in the transfer loops so that signal feeds for either sound-on-sound or echo can be equalized for special purposes. In mono recording this setup also makes it possible to record

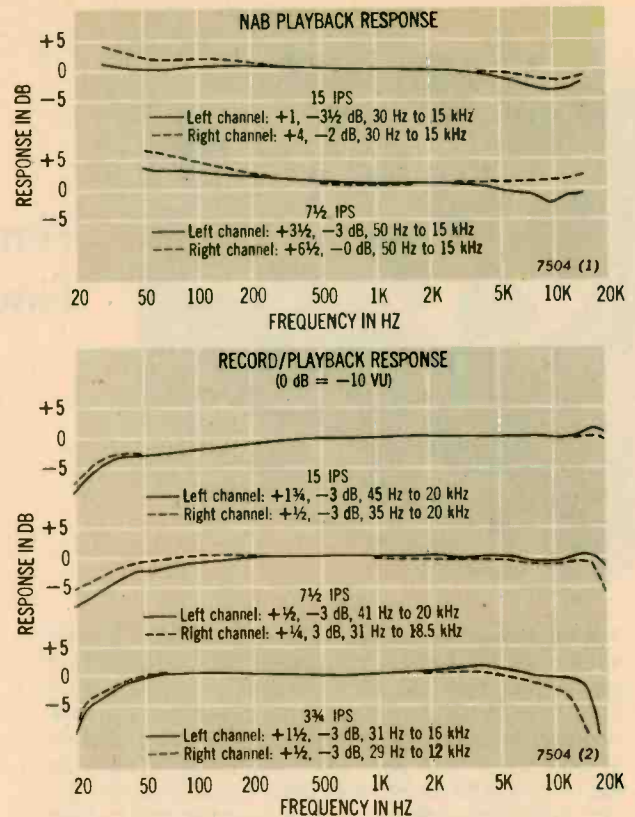

from two mikes and two line inputs with one of each passing through the tone controls and all four mixed together in the final recording on a single track.

Just above the last group of switches are two toggle switches. One puts a multiplex filter into the circuit for Dolby recordings of FM broadcasts. The other controls the Dolby circuitry itself; between "on" and "off" is a third position, marked simply with a straight line. In this position the Dolby recording circuit is off and the playback circuit is on, allowing you to record Dolby-encoded FM broadcasts or dub Dolby-encoded tapes and to monitor the decoded output.

The jack panel at the top of the unit (again, standing vertically) also is arranged symmetrically—or almost so. All of the jacks but one are, like the microphone inputs on the front panel near the input level controls, the phone type. In the outboard positions are the line inputs. Next come "low level" outputs that feed through the front-panel tone controls and deliver about 350 millivolts for a 0-VU recording level as measured at CBS Labs, enough to drive a monitoring amplifier (though not necessarily to rated output; check its sensitivity rating if you plan to use this setup).

Next in line are the "600-ohm" outputs normally used for line connections with a stereo system. They deliver just short of 2 volts for 0 VU and are unaffected by the tone controls (except, of course, in the "transfer" modes). Then come adjustable low-level outputs. Their output can be reduced from the 350 millivolts of their nonadjustable counterparts by way of the front-panel level control—which affects *only* these outputs in the deck model. (The level knob is used for the built-in monitoring system in the amped models.)

Just inboard of these left-channel jacks is a 7-pin DIN jack—but not the ordinary input/output variety. Two pins carry the 600-ohm hot outputs, and two more, the low-level outputs; the other three are for a 50-volt DC

supply, a connection for the "run" solenoid, and common ground. This jack is used with various accessory devices (none supplied): a foot switch, a remote start/stop and volume control (for which a schematic diagram is supplied in the owner's manual), or a magnetic-phono preamp powered by the 50-volt supply and feeding to the line input (plans offered by Ferrograph, according to the manual). For timed operation—either recording or playback—this socket is not needed. You simply plug the power cord into a timer (preferably one with a grounding socket, since Ferrograph gives you a three-prong plug) and set the controls appropriately.

We must apologize for so lengthy a description, but obviously many common presuppositions about tape-deck operation do not apply to the Super 7. Fortunately the story of its performance is more briefly conveyed: It is very good indeed and entirely consistent with the measurements CBS Labs regularly find in competing equipment. Speed accuracy is not quite as precise as some models, though the lab was unable to measure any change in speed with alterations in line voltage and even the worst-case measurement of less than 0.5% fast (at 15 ips) cannot really be faulted. Wow and flutter measurements (all peak measurements) are excellent. Dolby tracking checks out as particularly good, and the multiplex filter has an extremely sharp cutoff characteristic so that even with the filter in the circuit response is virtually unaffected to about 15 kHz. Scotch 206 tape was used for all measurements.

Obviously this is a deck that merits, and requires, careful consideration by a wide variety of users. Since its design is staunchly individualistic, it can't be appreciated—let alone related to a potential user's needs—in a brief once-over. In this connection we might suggest that prospective purchasers ask to see the manual. In many respects it is exceptionally fine and inclusive. It has, for example, a marvelous table of counter readings vs. tape thicknesses vs. tape lengths vs. elapsed times that we hope other manufacturers will copy.

But we should caution that the manual is written primarily with the non-Dolby versions in mind and almost exclusively for the domestic British user. But Elpa says it is at work on a supplement to the brochure for Americans. Bravo—it should make an immensely useful product even more so.

CIRCLE 142 ON READER-SERVICE CARD

Ferrograph Super 7 Additional Data

| | | | |
|---------------------------------------|-------------------------------------|---------------|--|
| Speed accuracy | | | |
| 15 ips | 0.47% fast at 105, 120, and 127 VAC | | |
| 7½ ips | 0.44% fast at 105, 120, and 127 VAC | | |
| 3¾ ips | 0.25% fast at 105, 120, and 127 VAC | | |
| Wow and flutter (ANSI weighted) | | | |
| 15 ips | playback: 0.02% | | |
| | record/play: 0.02% | | |
| 7½ ips | playback: 0.03% | | |
| | record/play: 0.03% | | |
| 3¾ ips | playback: 0.06% | | |
| | record/play: 0.06% | | |
| Rewind time, 7-in., 1,200-ft. reel | 1 min., 9 sec. (max.) | | |
| Fast-forward time, same reel | 1 min., 9 sec. (max.) | | |
| S/N ratio (re NAB 0 VU; 15 ips) | | | |
| playback | L ch: 60 dB | R ch: 56 dB | |
| record/play | L ch: 50 dB | R ch: 51 dB | |
| Erasure (400 Hz at normal level) | 60 dB | | |
| Crosstalk (at 400 Hz) | | | |
| record left, play right | 57 dB | | |
| record right, play left | 55 dB | | |
| Sensitivity (re NAB 0 VU) | | | |
| line input | L ch: 23 mV | R ch: 23 mV | |
| mike input | L ch: 0.18 mV | R ch: 0.18 mV | |
| Meter action (re NAB 0 VU) | externally adjustable | | |
| Total harmonic distortion (at -10 VU) | | | |
| 15 ips | L ch: <1.4%, 50 Hz to 10 kHz | | |
| | R ch: <1.0%, 50 Hz to 10 kHz | | |
| 7½ ips | L ch: <1.8%, 50 Hz to 10 kHz | | |
| | R ch: <2.1%, 50 Hz to 10 kHz | | |
| 3¾ ips | L ch: <2.0%, 50 Hz to 10 kHz | | |
| | R ch: <2.0%, 50 Hz to 10 kHz | | |
| IM distortion (record/play, -10 VU) | | | |
| 15 ips | L ch: 4% | R ch: 3% | |
| 7½ ips | L ch: 4% | R ch: 3% | |
| 3¾ ips | L ch: 5.5% | R ch: 4% | |
| Maximum output (line, 0 VU) | | | |
| 600-ohm | L ch: 1.8 V | R ch: 1.7 V | |
| low-level | L ch: 360 mV | R ch: 340 mV | |
| adjustable (max.) | L ch: 360 mV | R ch: 340 mV | |

Smooth Sounding "Noncompact" from Technics

The Equipment: Technics Model T-400, full-range speaker system in oiled walnut enclosure with removable wood base. Dimensions: 15 by 27 inches, 13¼ inches deep; can be used vertically, with or without base, or horizontally. Price: \$279.95. Warranty: five years parts and labor. Manufacturer: Matsushita Electric Corp., Japan; U.S. distributor: Matsushita Electric Corp. of America, Consumer Electronics Division, 200 Park Ave., New York, N.Y. 10017.

Comment: Technics has recently added to its line four speaker systems in the "T" series. The T-400, tested for this report, is somewhat larger than conventional bookshelf models and is, in fact, designed as a floor-standing system—the tweeters' orientation argues against horizontal use, though conceivably it could be fitted on a

shelf that is large and sturdy enough to support its 53 pounds.

A completely sealed system, the T-400 uses a 12-inch woofer, a 5-inch midrange cone, a 3½-inch tweeter cone, and two supertweeters each 2 inches in diameter. All five drivers are mounted on a front baffle with the pair of supertweeters angled outward for wide-angle sound dispersion. Crossover frequencies—handled by an internal network—are 700 Hz, 3 kHz, and 7.5 kHz. Nominal impedance is 8 ohms. The system is recommended for use with amplifiers capable of supplying at least 10 watts per channel and is rated for a power-handling capability of 90 watts (maximum sine-wave input at 400 Hz) for five minutes.

Connections are made at the rear via polarity-coded knurled-nut binding posts that accept stripped leads or

Technics T-400, though about the size of typical "bookshelf" systems, is designed to stand vertically; tweeters are angled outward for better dispersion.

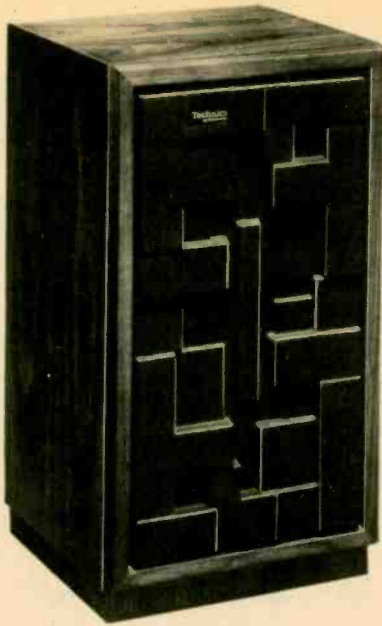

spade lugs. The rear panel also has two switches for midrange and tweeter level; each switch has two positions, with "up" representing "normal" response and "down" introducing a 3-dB attenuation. The blue removable grille has an abstract geometric or "sculptured" look.

In CBS Labs' tests, the measured impedance curve showed 7.5 ohms past the usual bass rise and averaged about 8 ohms across the audio range. The T-400 needed 2.2 watts to produce the standard test output level of 94 dB (at 1 meter on axis), which indicates moderately high efficiency and confirms the manufacturer's minimum recommendation for driving it with 10 watts of amplifier power. The speaker could handle steady-state power of 100 watts, before distorting significantly, to produce an output level of 109 dB—10 watts better power-handling capability than specified; it accepted an average pulse power of 240 watts (480 watts peak) to produce an undistorted output of 115.8 dB, which would indicate very good dynamic range combined with robust construction. These figures also document that the T-400 can be driven by the vast majority of amplifiers or receivers on today's market.

Pulse tests showed very good transient behavior with a minimum of bass hangover or high-frequency ringing. Frequency response, with the rear controls at their indicated normal positions, was clocked within ± 4 dB from 56 to 16,000 Hz, referenced to an output level of 83.5 dB. The high-frequency switch made a difference of about 1 dB starting at 4 kHz; this increased to 3 dB

above 7 kHz. The midrange switch made a 1-dB difference starting at about 800 Hz, increasing to 3 dB between 1.5 kHz and 2 kHz, then averaging 2 dB up to about 5 kHz.

On test tones, the audible bass response was clean and smooth down to 40 Hz. Some slight doubling was evident below 40 Hz, but it did not increase as frequency was lowered to 30 Hz. Below 30 Hz doubling increased, but some fundamental bass was still evident. The manufacturer's claim of useful low-end response to 38 Hz thus is not only confirmed, but seems, in light of the unit's actual performance, an unusually honest rating. They could have said 35 Hz without fear of serious debate.

Midrange and highs sound very smooth and evenly balanced. Dispersion is excellent all the way up the spectrum, with a 12-kHz tone clearly audible in a very wide angle about the system. A 13-kHz tone's spread narrows somewhat, but the tone still can be heard well off axis. A 15-kHz tone is audible mainly on axis, and at about 15.5 kHz the response begins its dip toward inaudibility.

White-noise response varies with the settings of the rear switches. With both switches in the "down" position, the white noise response is very smooth and very widely dispersed. With the midrange switch "up" and the high-range switch "down," a slight midrange signal component is audible. With the midrange switch "down" and the high-range switch "up," there is an even slighter treble component in the response pattern; that is, there is less audible difference than previously. With both switches "up," there is a pronounced upper-frequency signal component and increased directivity.

The fact that the midrange switch makes a more audible difference than does the high-range switch was verified in listening to program material, and the use of either or both of these switches will be, in our view, a matter of personal taste related to the nature of the program material and the acoustical quality of the listening room. After some experimenting, we opted to set the rear controls "down" for classical music but turned them "up" for rock and other pop.

Over-all, the sound produced by the T-400 is well balanced with respect to highs, lows and midrange: neutral and uncolored, and with very good internal separation on complex instrumental textures. It is easily discernible as one of the better "noncompact" speaker systems around and merits serious consideration whether your musical tastes run to Mozart or to Mott the Hoople.

CIRCLE 141 ON READER-SERVICE CARD

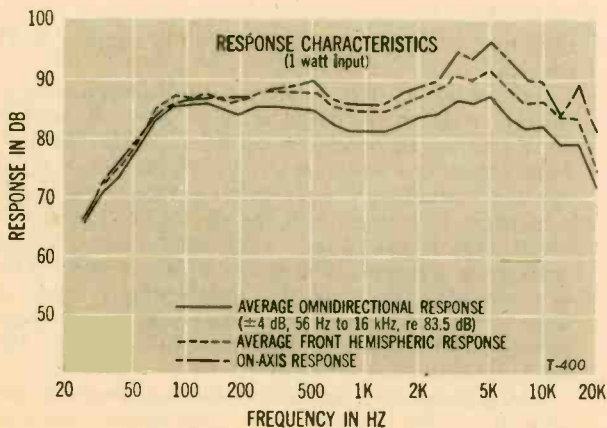

Technics T-400 Harmonic Distortion

| Output Level (dB) | Frequency | | | |
|-------------------|-----------|-------|--------|-------|
| | 80 Hz | | 300 Hz | |
| | % 2nd | % 3rd | % 2nd | % 3rd |
| 70 | 0.11 | 0.13 | 0.11 | 0.28 |
| 75 | 0.11 | 0.22 | 0.11 | 0.40 |
| 80 | 0.11 | 0.30 | 0.11 | 0.52 |
| 85 | 0.17 | 0.58 | 0.11 | 0.64 |
| 90 | 0.24 | 0.95 | 0.16 | 0.76 |
| 95 | 0.35 | 1.3 | 0.28 | 0.95 |
| 100 | 0.55 | 1.6 | 0.65 | 1.2 |
| 105 | | | 1.4 | 1.7 |
| 109 | | | 2.7 | 2.5 |

*Distortion data are taken on all tested speakers until distortion exceeds the 10% level or the speaker produces the spurious output known as buzzing, whichever occurs first.

Philips Turntable Packs Performance and Features

The Equipment: Philips GA-209, two-speed (33 and 45 rpm) single-play turntable-and-arm ensemble with automatic options; supplied with integral base and hinged dust cover. Dimensions: 17 1/4 by 12 1/4 by 6 9/16 inches. Price: \$349.50. Warranty: one year parts and labor. Manufacturer: Philips of Holland; U.S. distributor: No-reco, 100 E. 42nd St., New York, N.Y. 10017.

Comment: A number of useful features, some of them really unique, combined with excellent performance and attractive styling make the new Philips GA-209 a very desirable turntable for use in a high-quality playback system. It is, to begin with, a DC-motor/belt-driven model in which motor speed is electronically controlled. The system makes for accurate speed as well as low noise.

The turntable motor is not loaded with other functions; there actually are two more motors for tone-arm movement and cueing. Platter and tone arm share a subchassis that is suspended below the main chassis, a design feature that further isolates any motor vibrations and helps reduce the ensemble's susceptibility to external jarrings. The drive system enables the use of a relatively lightweight platter (the conventional need for a heavy platter to achieve good "flywheel effect" is obviated), and the motor's high torque makes for very brief startup time.

The platter is a two-piece affair, covered by a ridged rubberized mat on which are imprinted two strobe rings (one for 33, the other for 45 rpm) to help in fine-speed adjustments should they be needed. Actually, in CBS Labs tests, the unit—once adjusted for speed accuracy at 120 volts AC line power supply—showed no measurable error at varying line voltages for either of its operating speeds. The fine-speed adjustment itself is divided between two control knobs, one each for the two speeds. They provide a very generous margin for variation, should the owner opt to use them. The 33-rpm control varies speed over a range from -3.5 to +4.4%; the 45-rpm control, from -4.8 to +5.9%.

The platter weighs 2 lbs., 11 oz. Rumble is among the lowest ever measured: -62 dB (ARLL standard). Flutter (ANSI/IEEE weighting method) is insignificant at 0.03% average and 0.07% peak. Arm resonance was very well damped, showing a mere 3.5-dB rise at 6 Hz. Arm friction, vertically and laterally, is negligible.

The built-in stylus force gauge is utterly unique on the GA-209. It consists of a small weighing scale (a moving pointer under an imprinted transparent window) that is attached to a pressure-sensitive lever in the tone-arm rest. This device not only makes it easy to adjust the VTF, but it also serves as a constant check on VTF since you can read the amount readily each time the arm returns to rest. The gauge was checked against a laboratory gauge and found to be on the nose for settings of 1, 2, and 3 grams. For a setting of 1.5 it measured 1.6 grams; for 2.5 it measured 2.6 grams—both insignificant discrepancies. The antiskating adjustment (Philips calls it slide-thrust compensation) has separate scales for elliptical and conical stylus tips; the values measured seem well suited for each type.

The GA-209 may be used to play a record manually or automatically, and herein lie some more surprises. The



main power off/on switch is at the left, while at the right is an elaborate group of operating controls and indicators. At the head of this group are four panels that light up to show "automatic" or "manual" and "33" or "45." In front of them is a well, covered by a sliding plastic door, in which you will find the 33- and 45-rpm speed selectors, a stop bar, the individual fine-speed trimmers, and the antiskating dial. In front of the well are two more controls—touch-sensitive "buttons" that, on gentle contact, light up, raise or lower the tone arm, and mute the sound or let it come through. One touchplate, marked with the symbol of a stylus contacting a disc, is the "play" button; the other's symbol shows the stylus above the disc, and it acts as the "pause" control.

On the platter itself are three small pressure-sensitive pins, and one, two, or all three will be depressed depending on what size record you put on. These pins activate a sensing device that automatically selects the correct speed (33 for 10-inch and 12-inch discs; 45 for 7-inch discs) and that sets the arm down at the lead-in edge of the record.

To play a record automatically, you release the arm lock at the foot of its rest and make sure the sliding door over the control well is shut. The word "automatic" will be lighted, and—depending on what size record you put on the platter—the turntable will start at the appropriate speed and the arm will come off its rest and descend gently into the lead-in groove of the disc.

During automatic use, you may interrupt play by opening the control cover and pressing the stop bar. The arm will return to rest. Or you can leave the control cover shut and simply touch the pause touchplate. The arm will rise and the sound will be muted, but the platter will continue to rotate. Pressing the play touchplate will, of course, lower the arm (to the exact spot it left on the record) and restore the sound. You can repeat a record in the automatic mode simply by opening the cover and closing it again. At the end of play, the arm lifts off the record and returns to its rest. The turntable will stop.

To play a record manually, turn on the power as before but this time open the control door. The word "manual" will light up. Unlock the arm rest, place a disc on the platter, and select the correct speed. (The 33 and 45 buttons, in manual mode, override the three pins on the turntable; this feature enables you to play any size

record at either speed as you choose.) You may now cue manually or with the aid of the raise-and-lower buttons for the arm lift. At the end of the record, the arm will return to rest and the motor will switch off.

In addition to its novel control system the GA-209 has some familiar features, all of them worthwhile. The tone arm is fitted with a rear counterweight, adjustable for arm balance and VTF. The pickup fits onto a small platform that slides into the head to make positive electrical contact. Supplied with the GA-209 is an assortment of hardware to help fit any pickup to the shell, and a plastic gauge to adjust the position of the pickup for correct stylus overhang. The platter has a built-in "pop up" adapter for large-hole 45-rpm singles. The stylish base has a hinged dust cover made of sturdy plastic; the hinges are friction-regulated so that the cover will stay up in any position, and if it starts to slip you can turn the screws on the hinges to adjust the friction. The cover may be fully down while a record is playing.

The only feature of this machine one could possibly take exception to is the location of the strobe rings. Being right on the platter, they are hidden when there's a record on. However, once speed is adjusted, the addition of a disc will not change it. And since the turntable runs at constant speed despite line-voltage changes, there is no need to readjust fine-speed during use. Of course the strobe is not used for deliberate changes to alter musical pitch.

The GA-209 is, on all counts, a deluxe product. If it boasted only its more striking novelties, we would be apt to pat it gently on its tone arm and call it a harmless adult toy. However, the unit is quite obviously a technical triumph as well as a cosmetic coup. Purely from the standpoint of its function as a high-quality record player, it has a lot going for it, including its very quiet operation and its facility for accommodating the most refined of pickups.

CIRCLE 144 ON READER-SERVICE CARD

Sony's Ultimate Cassette Deck



The Equipment: Sony Model TC-177SD, a stereo cassette deck with Dolby noise reduction (including Dolby-FM switching); bias and equalization switching for ferric, ferrichrome, and chromium dioxide tapes; and separate recording and playback heads; in wood case. Dimensions: 17 by 12 11/16 inches (wood base), 6 inches high plus clearance for cassette-well cover. Price: \$699.95. Warranty: two years parts and labor, shipping paid one way. Manufacturer: Sony Corp., Japan; U.S. distributor: Superscope, Inc., 8150 Vineland Ave., Sun Valley, Calif. 91352.

Comment: This is Sony's fanciest cassette deck to date, and it's an impressive bruiser. Though it resembles Sony's more conventional decks, it's larger and more feature-laden than any Sony we've yet examined; in a sense it sums up everything the company has done in the medium.

The rear portion of the top panel is angled upward to make the VU meters and the pilot-light array more easily visible from a sitting position. The pilots are for limiter (green), Dolby (yellow), recording (red), and pause (orange). Next to them is a three-digit turns counter and a "memory rewind" on/off switch. A small red light between the meters indicates peak overload condition. In front of the meters is a series of buttons: FM-pilot filter (on/off); four Dolby-mode selectors (Dolby off, Dolby on, Dolby FM on, Dolby calibration tone); and limiter (on/off). Between the calibration-tone button and that for the limiter are two screwdriver controls for adjusting Dolby recording levels to the tape in use. (These controls are factory-adjusted for Sony's Ferrichrome, and little if any readjustment should be needed with most common tape types.) The 177's separate playback head makes Dolby adjustment unusually easy, since playback levels can be monitored on the meters while you record the tone.

It is a true playback head (not a monitor head intended only for double-checking recording properties) and fits into the space normally used for a record/play head. The recording head fits into the smaller cassette opening "upstream" (to the left, as one would visualize it, looking "through" the front of the unit toward a cassette in playing position) of the playback head. Since this opening has no pressure pad, Sony controls tape tension—and therefore tape-to-head contact—by applying its biperipheral drive system, the second capstan sharing with the erase head the larger opening still farther upstream.

The cassette well is otherwise of conventional construction, with a pop-up, windowed dust cover and a yellow tape-viewing light below the window area of the cassette itself. (We found it a pleasure to return to this high-visibility design after working with a few front-loading—or even unilluminated top-loading—models.) The transport controls in front of the well are solenoid-assisted; the TC-177 can be used safely with an AC-switching timer for wake-up playback or for recording (say, from FM) when you're away from home. The unit shuts off all transport modes automatically at the end of a cassette, so that no damage can occur in unattended operation even without the timer.

To the right of the cassette well are two three-position switches for bias and equalization. That for bias (which affects recording only, of course) has positions marked "low" (for most ferric tapes), "medium" (for ferrichromes and high-performance ferrics like Sony UHF

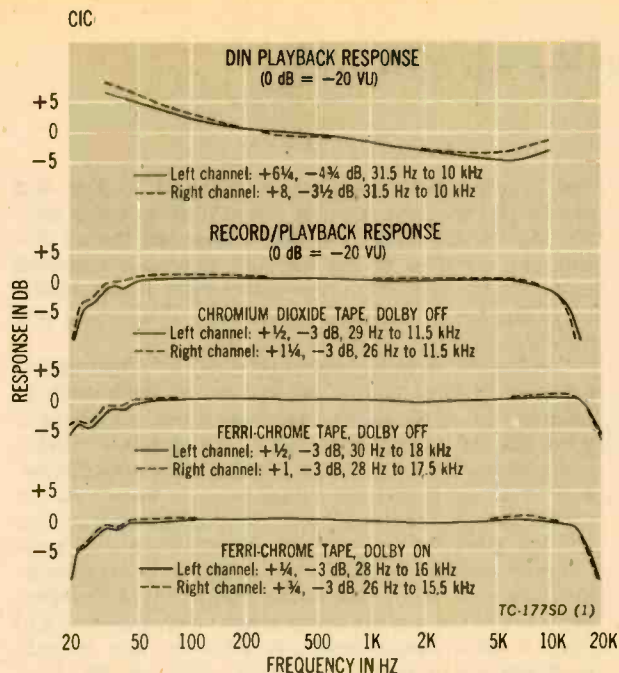

and Maxell UD), and "high" (for chromium dioxide). The equalization switch alters both recording and playback response; it has positions marked "normal" (for all ferric tapes), "Fe-Cr" (for ferrichromes), and "CrO₂" (for chromium dioxide). Sony Ferri-chrome cassettes, with which most of our tests were made, thus have a special playback—as well as recording—setting.

To the right of these switches are recording-level slider pairs—one for the mike inputs, one for line—that permit input mixing. Nearby are a rotary output-level control (which alters line levels only) and a source/tape monitor switch. With this switch in the "source" position incoming levels can be read on the meters whether or not the deck is in the recording mode, obviating the pause-mode premonitoring that is needed to set levels on so many decks. And of course the switch permits A/B comparison of the taped sound with that of the incoming signal.

A button at the extreme right front corner of the top plate switches AC power. In the front surface just below the edge of the top plate are a pair of phone jacks for mike inputs and a stereo headphone jack. Its output level is controlled by a two-position switch next to it. The back panel has pin-jack pairs for line input and output.

There are no further user-accessible Dolby controls. In adjusting tracking from Dolby broadcasts you must use the station's test tone to set the line-input controls for a "cal" (0-VU) reading in both channels.

The Dolby-FM setting does *not* have compensation for the new 25-microsecond broadcast time constant; it does, however, override the off position of the FM-pilot filter. That is, the filter is manually controlled by its own switch during regular Dolby operation but is inserted automatically when you press the Dolby-FM button.

Sony obviously has taken care that the TC-177 will make optimum use of its Ferri-chrome tape and has, in a sense, designed the unit around the tape. Record/play response with Ferri-chrome is spectacularly linear: almost ruler-flat from about 50 to 15,000 Hz, even with Dolby (which tends to exaggerate any nonlinearities of course). CBS Labs was not able to get as good response, in fact, with chromium dioxide. (We suspect

that this may be due in part to the greater high-frequency boost that "drives" the head harder at these frequencies with chrome than with Ferri-chrome.) We were not able to detect a significant difference with regular program material, however. The sparkling, open high end that the narrow-gap playback head makes possible is most easily discernible with Ferri-chrome and superb source material; with regular ferric tape inherent tape hiss is (predictably) more easily heard, though the highs do seem more open than with conventional record/play heads.

The deck can stand comparison with other top models both electrically and mechanically. Speed is quite accurate at 0.2% fast and was unaffected by line-voltage changes in CBS Labs' tests. Wow and flutter are low; so are noise and distortion. The operating "feel" of the controls is excellent, attesting to careful workmanship—as does the excellent finish of the parts.

Though the price no longer is as shocking as it once would have been, a \$700 cassette deck still isn't for everybody. The TC-177SD seems specifically designed for the home user who wants all the features that promote optimum performance but wants neither the most elaborate (and possibly confusing) controls of the professional or quasi-professional gear nor the mechanically complex (and possibly problematic) "convenience" features like automatic reverse and automatic bias/eq. switching. If that is the intent, we think Sony has succeeded. Even a novice can make first-rate tapes on the 177 (the limiter can help materially in live recording). Its designers have made a logical and consistent choice of features—both for inclusion and for exclusion.

CIRCLE 145 ON READER-SERVICE CARD

Sony TC-177SD Additional Data

| | | |
|---------------------------------------|--|---------------|
| Speed accuracy | 0.2% fast at 105, 120, and 127 VAC | |
| Wow and flutter | playback: 0.05% record/play: 0.08% | |
| Rewind time (C-60 cassette) | 82 sec. | |
| Fast forward time (same cassette) | 80 sec. | |
| S/N ratio (re DIN 0 VU; Dolby off) | | |
| playback | L ch: 50.5 dB | R ch: 53 dB |
| record/play | L ch: 50 dB | R ch: 52 dB |
| Erase (333 Hz at normal level) | 57 dB | |
| Crosstalk (at 333 Hz) | | |
| record left, play right | 35 dB | |
| record right, play left | 34 dB | |
| Sensitivity (re DIN 0 VU) | | |
| line | L ch: 58 mV | R ch: 54 mV |
| mike | L ch: 0.18 mV | R ch: 0.17 mV |
| Meter action (re DIN 0 VU) | L ch: 2.5 dB high R ch: 2 dB high | |
| Total harmonic distortion (at -10 VU) | L ch: <2.3%, 50 Hz to 5 kHz R ch: <2.3%, 50 Hz to 5 kHz | |
| IM distortion (at -10 VU) | L ch: 3.0% R ch: 3.5% | |
| Maximum output (line, 0 VU) | L ch: 1.0 V R ch: 0.9 V | |

Infinity's Monitor Re-Monitored



The Equipment: Infinity Monitor 1A, a floor-standing loudspeaker system in wood enclosure. Dimensions: 14 by 38 inches, 13 inches deep; stands vertically only. Price: \$429. Warranty: five years parts and labor (transferable); shipping not included. Manufacturer: Infinity Systems, Inc., 7930 Deering Ave., Canoga Park, Calif. 91304.

Comment: When Infinity's Monitor—a floor-standing speaker system with (briefly) a unique "wave transmission line" tweeter resembling the Walsh driver in operating principle, a midrange driver, and a woofer loaded by a conventional transmission-line system—first appeared, we were impressed. Our report (June 1973) commented favorably on it. But one aspect of that report raised more questions than it answered: the computer-generated response curves.

We take the "omnidirectional response" curves—actually an integration of many measurements, each using a pink-noise source and testing by one-third octaves with several different speaker-mike orientations—as most indicative of how the speaker under test will sound in a room. The Monitor's omnidirectional curve exhib-

ited a large (more than 10-dB) peak at 10 kHz and above. (When the computer showed up with the odd-looking curves, CBS Labs had rechecked them.) Our listening samples of the Monitor, however, sounded more like the on-axis curve—without the 10-dB peak—than like the omnidirectional curve. What could this mean?

The tweeter is totally unlike any we had attempted to measure before, and in the report we attributed the peak to "the application of a standard test procedure to a nonstandard tweeter design." One engineer closely associated with the design of the Monitor claimed, however, that the published measurements were "impossible" though they had been double-checked by the lab. We consulted a reputable and disinterested independent audio engineer for his analysis. In his opinion the curves were not impossible; they might be unrepresentative of the way the speaker sounded, but since 8 of the 14 microphone positions used for the omnidirectional curve and 3 of the 5 used for the front hemispheric curve are in the horizontal plane, he reasoned, cumulative emphasis of any nonlinearity peculiar to that horizontal plane was possible.

On this note of stalemate the matter rested for some time. But as we considered it, one point seemed to take on increased significance. During the course of testing, Infinity had made reference to a bead of damping "putty" at the base of the tweeter. We mentioned it to the test engineer at the lab, and he seemed unable to identify it. Was it perhaps missing from the lab test sample (though not from our listening samples)? Infinity insisted it was in the speaker when they shipped it; the lab didn't remember it; Infinity could not trace the test sample, which had meanwhile been returned to the company. We finally decided to test another sample of the unit. Here are the results.

The average omnidirectional response can be characterized as within ± 5.5 dB from 38 Hz to 17 kHz or, within the narrower margin of ± 3.5 dB, from 58 Hz to 11.5 kHz. The curve shows a slight peak at 10 kHz but nothing at all comparable to the peak in the original curves. In both smoothness and range the new curves relate closely to what can be heard in listening to the Monitors, which are excellent in both respects.

There are minor differences elsewhere in the test results on the new sample. Impedance is slightly higher below 1 kHz, for example, and slightly lower in the treble range. The first sample came in at 8.5 ohms nominal and remained very close to this value from the rating point on up to the limit of testing at 20 kHz; the new one measures 9 ohms at the rating point, approximately 12 ohms in the region around 500 Hz, and approximately 6 ohms from about 2 kHz upward. The differences are not significant in our opinion, however.

Obviously our earlier explanation of the microphone positions' not being suited to the Monitor's tweeter design—while in itself technically plausible—was not germane. Using the same microphone technique, the lab's measurements of the new sample show no significant peak at 10 kHz or at any other frequency. It is—and was—a fine speaker system; and now the measured response curves more closely demonstrate its listening quality.

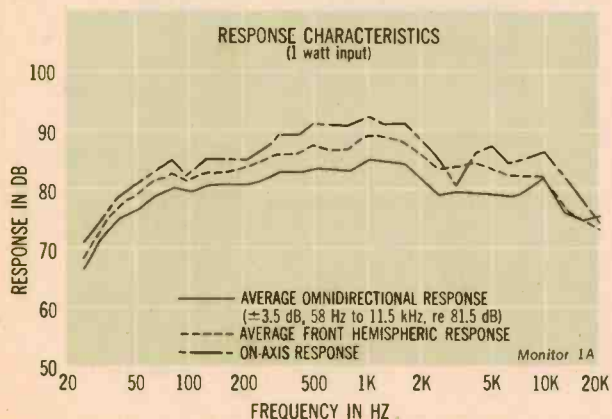

CIRCLE 143 ON READER-SERVICE CARD

THE HITACHI REPORT

No. 27 • Subject: Power Selection • 4/2-Channel Receivers

How to know from apples, oranges and ohms. The more power, the better the amplifier, right? The truth is, there are a lot of variables to consider before you can really decide. And Hitachi wants you to know what they are.

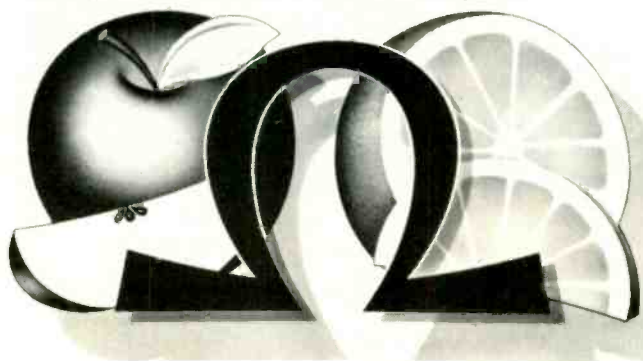

Never compare apples (RMS power) to oranges (IHF music power). RMS power means Root Mean Square; continuous rated or average usable power output. It's the most conservative measure and generally considered to be the industry standard. IHF is a standard measurement of power established by the Institute of High Fidelity, also conveniently referred to as music power. Rated this way, power tends to appear less conservative than RMS ratings. However, either way is acceptable as long as you're comparing like power ratings at the same speaker OHM ratings. Most mid-priced quality makers give their power ratings at 8Ω (OHM).

The cleaner the power, the cleaner the sound. Another key consideration in pinning down power is Total Harmonic Distortion (THD). This specification tells you how clean the resultant output signal is.

Any more than 1½% THD will result in noticeable distortion. Which means, all the power in the world won't give you pure sound unless the THD is within tolerable limits.

And on and on and on. The kind of music you like to hear can also have a bearing on your power requirements. Classical buffs usually require less power and lower volume than rock freaks. Then too, room size, approximate acoustic conditions, and the number of additional speakers the unit will be required to drive — are all factors that will help you make the right power choice.

The way we look at it, the more you know, the better equipped you'll be to compare the specs on our 4/2-channel (SQ, RM, Discrete) receivers. So do it, already. If you find something you don't understand, your nearby Hitachi dealer can set you straight. And that's getting to be a small wonder in itself.

SMR-7240

FM/AM/FM Stereo Discrete 4-Channel/2-Channel Receiver with BTL Circuits 85 W IHF music power, 15 W RMS x 4, 35 W RMS x 2 (less than 1.0% THD at 8 ohms, PBW 20Hz-25kHz IHF). FM sensitivity 2.2 μV. Capture Ratio 1.2 db. Two Tuning Meters. 2-channel and 4-channel Tape Monitors. Mike Mixing Jacks and Volume Control. SQ/RM Matrix Switch. Joystick 4-channel Balance Control. 4-channel Headphone Jack. Wood Cabinet.

SMR-5240

FM/AM/FM Stereo Discrete 4-Channel/2-Channel Receiver with BTL Circuits 70 W IHF music power, 10 W RMS x 4, 25 W RMS x 2 (less than 1.0% THD at 8 ohms, PBW 20Hz-25kHz IHF). FM sensitivity 2.2 μV. Capture Ratio 1.2 db. 2-channel and 4-channel Tape Monitors. Mike Mixing Jacks and Volume Control. SQ/RM Matrix Switch. 4-channel Headphone Jack. Wood Cabinet.

SMR-4040

FM/AM/FM Stereo Discrete 4-Channel Receiver 56 W IHF music power. 9 W per channel RMS (less than 1.0% THD at 8 ohms, PBW 20Hz-30kHz IHF). S/N Ratio 67 db. FET Tuning, 4-channel Indicator, Regular and SQ Matrix Switch, 2 Microphone Input Jacks, Microphone Mixing. Wood Cabinet. Optional "RQ-1" 4-channel Toggle-Type Remote Balance Control available.

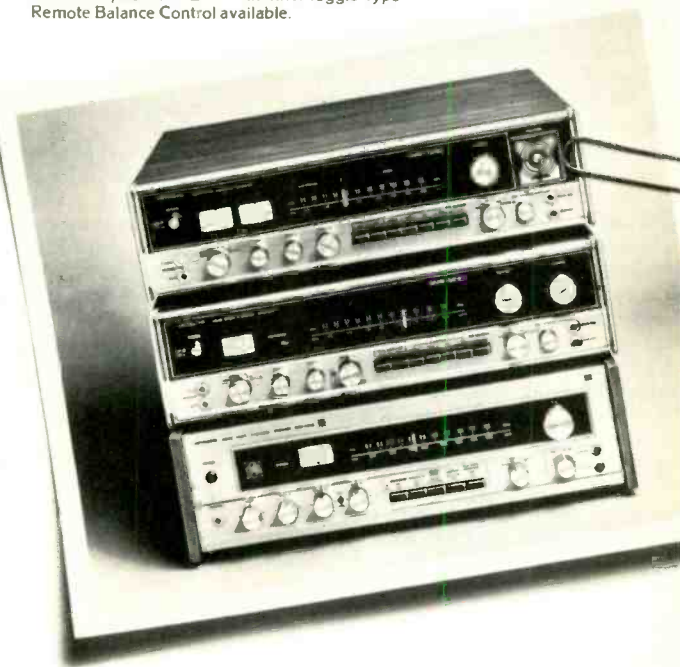

 **HITACHI**
working small wonders in sound

National Headquarters 401 West Artesia Boulevard, Compton, Calif. 90220

CIRCLE 30 ON READER-SERVICE CARD

Live versus recorded at Covent Garden



Rehearsal scene from Mozart's *Don Giovanni* at Covent Garden, London.

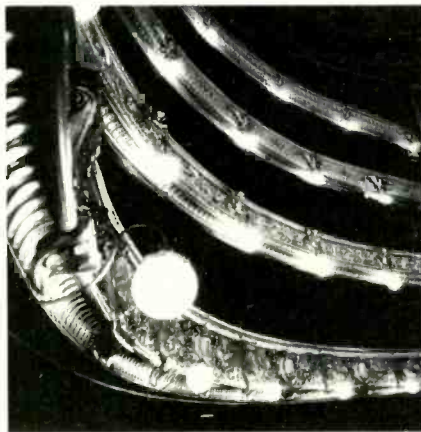

Twenty-four AR-6 speakers are installed at the Danish Royal Opera.



Four AR-LSTs are in use at La Scala, Milan.

The most severe test for a loudspeaker system is to be compared with live music. The ultimate success is for the music from the speakers to remain indistinguishable from the real thing.

This is exactly what is happening at The Royal Opera House, Covent Garden, London. Covent Garden has purchased five AR-LST speaker systems as well as a number of AR-7s. The AR speakers are in constant use in such 'roles' as the Commendatore or the voices of the underworld in *Don Giovanni*. They are also used for the offstage brass band in *Aida* and the taped sequences in the new production of Benjamin Britten's *Owen Wingrave*, as well as for many other purposes.

A recent article by Adrian Hope in England's *Hi-Fi Sound* magazine reported the comments of the Covent Garden technicians who installed the system: 'If you think about it, Covent Garden cannot make do with any audio equipment other than the very best. In a recording studio what you are putting out as a final end product is a recording. What

we are putting out here is a live performance and anything electronic is automatically the subject of the classic AB test — the audience can hear live sound *and* sound from a loudspeaker. So they have a perpetual yardstick to judge by.'

The idea of course is to create the illusion for the critical Covent Garden audience that they are always hearing live music.

AR itself has produced public live-versus-recorded concerts. Audiences were asked to distinguish between the performance of live musicians on stage and a recording of the same music reproduced over AR loudspeakers — the same AR loudspeakers that were designed for home listening. As at Covent Garden, the illusion of live music has been virtually 100-percent effective.

The use of AR speakers in live musical performances doesn't stop with Covent Garden's AR-LSTs and AR-7s. The Danish Royal Opera makes constant use of twenty-four AR-6s and six AR-LSTs. And La Scala has recently installed four AR-LSTs.

Try the grand illusion for yourself. There's a five-year guarantee that your AR speakers will perform as well as Covent Garden's. Or the Danish Royal Opera's. Or La Scala's.

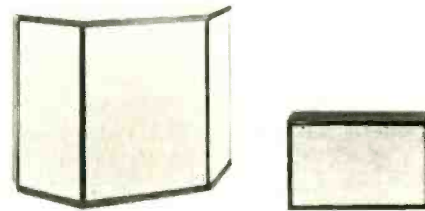

Acoustic Research

US office:
10 American Drive
Norwood, Massachusetts 02062
International office:
High Street, Houghton Regis,
Bedfordshire, England
In Canada:
A C Simmonds & Sons Ltd
Toronto



CIRCLE 1 ON READER-SERVICE CARD

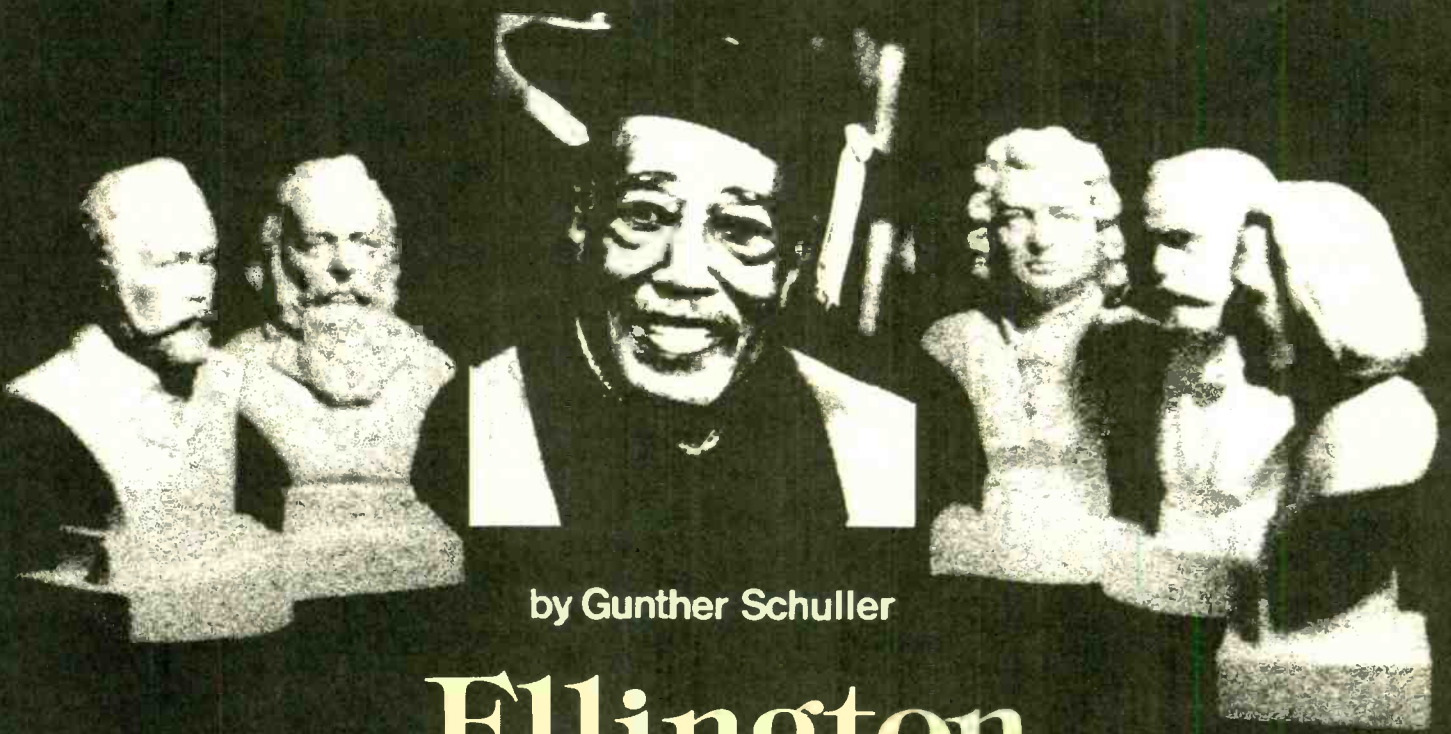

by Gunther Schuller

Ellington in the Pantheon

WHAT IS THERE left to say about the art of Duke Ellington, after a lifetime of successes caressed in superlatives and now, since his death, after months of I-knew-him-too tributes by musicians and fans alike?

Very little, I suppose—except that as usual, and perhaps understandably, much more attention has been given to the man, the charismatic Ellington personality, the inveterate traveler of thousands of one-night stands, Ellington the tune writer, than to his compositions. Admittedly, it is hard to talk about music in words: Music, especially Duke's music, speaks better for itself, and talk *about* music is often necessarily subjective and impressionistic. On the other hand, there are some things to be said about all great music that are more objective and factual than we sometimes care to admit. For greatness is not altogether accidental, altogether intuitive or mysterious. Much of it results from simple hard work, selflessly applied energy, and a fierce determination to learn and apply what has been learned.

Composer and conductor Gunther Schuller is president of the New England Conservatory of Music and music director of the Berkshire Music Center at Tanglewood.

If I dare to include Ellington in the pantheon of musical greats—the Beethovens, the Monteverdis, the Schoenbergs, the prime movers, the inspired innovators—it is precisely because Ellington had in common with them not only musical genius and talent, but an unquenchable thirst, an unrequitable passion for translating the raw materials of musical sounds into his own splendid visions. But that is still too general, something that can be said even of minor composers.

What distinguishes Ellington's best creations from those of other composers, jazz and otherwise, are their moments of total uniqueness and originality. There are many such flashes in his *oeuvre*, and it is a pity that they are virtually unknown to most non-jazz composer colleagues. Perhaps this is due to the fact that you cannot go into the nearest music store or library and obtain the orchestral scores of Duke Ellington. There is no Ellington *Gesamtausgabe*, alas, although this is something that should become someone's life work. However, even if such scores existed, they still would not readily disclose the uniqueness of which I speak. For Ellington's imagination was most fertile in the realm of harmony and timbre, usually in combination. And as played by some of the finest musicians jazz has ever

EXAMPLE 1

EXAMPLE 2

EXAMPLE 3A

EXAMPLE 3B

EXAMPLE 4*

known, the specific effect produced in performance and on records is such that no notation has yet been devised to capture it on paper.

Nevertheless they exist—alas *only* on records, and they are none the less real for that and no less significant. The opening measures of “Subtle Lament” (1939) (Ex. 1), and the second chorus of “Blue Light” (1939) (Ex. 2)—both wondrous harmonic transformations of the blues; the muted brass opening of “Mystery Song” (1931); the last chorus of “Azure” (Ex. 3a, 3b) with its remarkable chromatic alterations; or the total orchestral effect of the first bridge of “Jack the Bear” (1940) (Ex. 4), not to mention the uniquely pungent harmonies of “Clothed Woman” (1947): These are all moments that can literally not be found in anyone else’s music. They are as special and original in their way as the incredible D minor-D sharp minor mixture and instrumentation that opens the second part of the *Rite of Spring* or the final measures of Schoenberg’s *Erwartung*.

Citing musical examples can give only a severely limited impression of the total effect in performance. For finally it is the unique sound of a Tricky Sam Nanton, a Cootie Williams, a low-register

*“Jack the Bear” by Duke Ellington. Copyright © 1940, renewed 1967 Robbins Music Corp., New York, N.Y. Used by permission.

Barney Bigard that transmutes those harmonies into an experience that even master colorist/harmonists like Debussy and Ravel could not call upon from their orchestras.

It was part of Ellington’s genius—what I called earlier his fierce determination and unquenchable thirst—to assemble and maintain for over forty years his own private orchestra, comprising musicians more remarkable in their *individuality* than those of any symphony orchestra I know. Not since Esterhazy had there been such a private orchestra—and Esterhazy was not a composer. But like Haydn, who practiced daily on that band of Austrian/Hungarian musicians to develop the symphonic forms we now cherish, so Ellington practiced on his “instrument.” This is a luxury we other composers simply do not know, and the whole experience of writing consistently for a certain group of musicians is a phenomenon we have never savored.

In Ellington’s case, collaboration of such intimacy and durability was bound to produce unique musical results. These can be heard on literally hundreds of Ellington orchestra recordings in varying degrees of “uniqueness.” When that alchemy worked at its best, the result was such as cannot be heard anywhere else in the realm of music.

A large statement? Preposterous? Check it out for yourself. The originality of Ellington’s harmonic language, with its special voicings and timbres, gives the lie to the often-stated suggestion that he learned all this from Delius and Ravel. Rubbish! This is no more tenable than it is to say that Debussy and Ravel sound alike, even if they both use ninth chords. Like these masters, and others such as Scriabin and Delius, Ellington always found a special way of positioning that chord, of spreading or concentrating it, of giving it a unique sonority that cannot be mistaken for any other’s.

Like Webern, he limited himself to small forms—a few notable exceptions notwithstanding. In fact it was not entirely by choice in Ellington’s case, but the three-minute ten-inch-disc duration was simply imposed on jazz musicians for a variety of technical/practical/commercial/social/racial reasons. What matters is that he took this restriction and turned it into a virtue. He became the master in our time of the small form, the miniature, the vignette, the cameo portrait. What Chopin’s nocturnes and ballades are to mid-nineteenth-century European music, Ellington’s “Mood Indigo” and “Cotton Tail” are to mid-twentieth-century Afro-American music.

In his inimitable way the Duke towered over all his contemporaries in the jazz field and equaled much of what is considered sacred on the non-jazz side.

He is gone now, alas. Yet his music lives on and is still with us—at least on recordings. I believe that is not enough. But first, let’s consider those recordings in the following article by John S. Wilson.

by John S. Wilson

The Duke in the Recording Studio

Covering half a century and fifteen hundred records,
Ellington's recordings were an integral part of his musical creativity.

DUKE ELLINGTON'S RECORDING career was unique not only for its length—a full half-century—but because it encompassed so many aspects of musical creativity.

Simply as a band leader, the continuity of his work outstripped that of any other leader of an orchestra in either the jazz or pop fields (including his closest competitor for continuous recording with a band, Guy Lombardo). As a composer, he was the primary source for—at a rough estimate—90 percent of the material that his band recorded, ranging from pop songs, blues, and jazz riffs to extended concert works and sacred music. In each of these categories, he was in the top rank among his contemporaries.

Ellington was also one of the major products of that Harlem school of jazz piano in the early Twenties that grew out of Luckey Roberts, James P. Johnson, and Willie "the Lion" Smith and that also produced Fats Waller and Count Basie. In the early stages of his recording career—i.e., the first quarter-century—he tended to underplay his talents as a pianist, giving himself far less solo space than he gave to the remarkable instrumentalists with which he surrounded himself. But during his last twenty-five years, as the men on whose solo styles he had built the characteristic sound of the Ellington orchestra retired or died, the Duke emerged as a more prominent soloist.

And beyond all this, Ellington was a suave and highly polished entertainer, a characteristic that is not brought out to any great extent on his recordings, although we do get glimpses of it in the live performances that have been put on disc.

His work (and his records) as band leader and composer falls into readily identifiable periods, but most aspects of his work can be found in almost any of these periods. He began with the so-called "jungle" style of the late Twenties, when much of his composing and playing was keyed to the requirements of the shows and the patrons at the Cotton Club in New York. The 1930s marked his emergence as a composer of popular songs. Between 1940 and 1942 his band and his creativity in the jazz and jazz-cum-pop areas reached a peak. In 1943 he entered his phase of extended concert

works that continued through the rest of his career and that, after 1965, was broadened into concerts of sacred music. From beginning to end, there was a continuous flow of jazz tunes, blues, and lovely melodies that might lie deep in the recesses of some of his longer works or would emerge as brief cameos—either as a song or as a vehicle for one of his many distinctive soloists.

In view of the length of his career and the sheer quantity of his recorded output (approximately fifteen hundred recordings), it is startling to realize that Ellington was relatively old—certainly by the standards of jazz musicians—when he made his first discs. He was twenty-five and the year was 1924. To be technically correct, he had made a piano roll several years earlier that was dubbed on a 78-rpm disc, and in 1923, he had made two sides for Victor with Elmer Snowden's orchestra that were not issued. But his first released records were made in November 1924, two sides as accompanist for Alberta Hunter, a blues singer, and two as leader of his own band, the Washingtonians, a six-piece outgrowth of Snowden's band.

The Washingtonians' records have little indication that this group might be any different from other black bands of the mid-Twenties, aside from Fletcher Henderson's orchestra, which had already emerged from musical anonymity. It was not until two years later, November 1926, that the band, with its billing changed to Duke Ellington and His Kentucky Club Orchestra, made the first records that showed what proved to be its stylistic direction. The tunes were "East St. Louis Toodle-Oo" and "Birmingham Breakdown," and the key figures stylistically were Bubber Miley on trumpet and Tricky Sam Nanton on trombone, both playing their horns with mutes and plungers and creating growls and wah-wah effects that became a characteristic of the Ellington brass.

"East St. Louis Toodle-Oo" was the band's signature theme, and it was soon joined by three further exercises in varying shades of growling brass—"Black and Tan Fantasy," "Creole Love Call," and "The Mooche." All four exemplified what became identified as Ellington's "jungle" style after, in December 1927, he settled into the Cotton Club, a

base to which he constantly returned for long runs for the next eleven years.

He recorded "East St. Louis" six times and "Black and Tan" five times between 1926 and 1930. Along with "Creole Love Call" and "The Mooche," he continued to re-record them once every ten years or so, incorporating changes that reflected the band's over-all stylistic development at each period. His 1938 version of "Black and Tan," for instance, was slowed down considerably from the insistently driving beat of the original 1927 recording (which made it a great favorite of strippers), and it took on a rich, deep, majestic quality.

Along with his "jungle" works, Ellington was also turning out records that were brilliantly high-spirited, driving performances, such as "Jubilee Stomp" and "Cotton Club Stomp," or early indications of his personal and seemingly bottomless well of melodic creativity—"Black Beauty," for example, a charming musical portrait of the singer Florence Mills.

Like many jazz groups in the late Twenties and early Thirties, the Ellington band recorded under numerous pseudonyms as it jumped from label to label (often repeating the same tunes for different labels). It was identified variously as the Harlem Footwarmers, the Whoopee Makers, the Jungle Band (a name also used by Chick Webb and others), Joe Turner and His Memphis Men, Sonny Greer and His Memphis Men, the Ten Blackberries, the Harlem Hot Chocolates, the Harlem Music Masters, the Philadelphia Melodians, the Memphis Hot Shots, and Earl Jackson and His Musical Champions.

Until 1930, most of Ellington's records were geared to the somewhat modest audience for what was then known as "hot jazz." The tunes were almost all his own compositions for, aside from a collection of hits from the revue *Blackbirds of 1928*, he was rarely assigned current popular songs by record companies. But he began to move into the pop field when his band went to Hollywood in the summer of 1930 to be in the film *Check and Double Check* with Amos 'n' Andy. The score included "Three Little Words," written by two highly successful pop songwriters, Bert Kalmar and Harry Ruby. Ellington's recording of this tune, with a vocal by the Rhythm Boys (Bing Crosby, Al Rinker, and Harry Barris), was what might now be described as "easy listening" for the pop market, even though it was full of suave, nongrowling Ellington hallmarks. This led to some pointless pop assignments ("Hittin' the Bottle," "That Lindy Hop"), but it also paved the way for wide acceptance of a piece that was idiomatically but, again, suavely Ellington—"Mood Indigo," which was his first big hit as a composer.

He entered more deeply into the pop public's awareness in 1932 with "It Don't Mean a Thing if It Ain't Got That Swing," a song that not only



pointed up the Duke's way with words (he wrote the lyric), but also introduced Ivie Anderson, a singer whose coolly sensuous voice would be a distinctive part of the Ellington sound for the next decade.

By the early Thirties, the instrumental sounds out of which he wove the over-all Ellington style included Cootie Williams, who'd succeeded Bubber Miley as the growl trumpeter; Tricky Sam Nanton, still growling on trombone; Johnny Hodges, whose early driving attack on alto saxophone was in the process of giving way to rich blues performances on both alto and soprano sax and a uniquely melting approach to ballads; Barney Bigard, a master of the warm, woody, low-register clarinet style of New Orleans; and Harry Carney, whose vigorous, swaggering baritone saxophone anchored the reed section of the band from July 1927 until the day of the Duke's death May 24, 1974.

For the most part, Ellington used these specialists either as distinctive threads in his ensembles or for one or two chorus solos. But in 1932 his recording of "Rose Room" put clarinetist Bigard so firmly in the spotlight that it was, in effect, a showcase for him, and the tune remained associated with him throughout his career. This was the predecessor of a series of compositions Ellington started four years later, specifically designed to show off the special qualities of his soloists: "Clarinet Lament" for Bigard, "Echoes of Harlem" for Cootie Williams, "Trumpet in Spades" for Rex Stewart, and "Yearning for Love" for the elegantly lyrical trombone of Lawrence Brown.

Meanwhile Ellington's capability as a writer of



A suave and polished performer, Ellington was, with his musical alter ego, Billy Strayhorn (above right), responsible for composing roughly 90 per cent of the material his band recorded during its fifty years before the mikes.

popular songs was developing in his own inimitable way. In the wake of the gradual penetration of "Mood Indigo" to the pop audience, he wrote "Sophisticated Lady," which broke all the customary rules of structure and development for a popular song. But his recordings of the tune in 1933 (for Columbia and Brunswick) helped to adjust the public ear. He followed it in 1934 with "Solitude," composed in twenty minutes in the studio to fill out a recording date. "In a Sentimental Mood" in 1935, and "I Let a Song Go out of My Heart" and "Prelude to a Kiss" in 1938.

This was also a period when Juan Tizol, a valve trombonist from Puerto Rico, brought into the band musical ideas that, in performance, were often described as "near eastern" but that Tizol insisted were essentially Caribbean. The "near eastern" idea was largely instigated by the titles—"Caravan" and "Pyramid" were two of the best known—although Tizol also contributed haunting melodies that were neither "near eastern" nor Caribbean, such as "Lost in Meditation" and "A Gypsy Without a Song."

At the end of 1934 Ellington added a distinctive trumpet (and occasionally cornet) to his band in Rex Stewart, who supplemented Williams' growling with some growling of his own plus a sharp, punching manner of driving out a solo line and an adventurous use of a "half-valve" technique, in which the valves of his horn were only partially depressed. In 1938 Stewart and the Ellington band recorded a half-valve showpiece, "Boy Meets Horn," which still stands today as the exemplification of this unusual, if limited, manner of playing.

Late in 1936 Ellington followed—in his own way—a trend that had been started a year earlier by white swing bands: the use of small groups made up of men in the big band. Benny Goodman and others used their small groups (the Goodman trio and quartet, Artie Shaw's Gramercy Five, Tommy Dorsey's Clambake Seven, Woody Herman's Woodchoppers) as part of their regular performances. But Ellington's appeared only on records and under the leadership not of the Duke (although he usually played piano), but of one of four star sidemen—Stewart, Hodges, Williams, and Bigard. These recordings, usually by seven-piece combos, are a remarkable amalgam of the Ellington style and the personal style of whoever was the leader. They were not one-man shows, by any means, because the members of each group were the cream of the band, and some were small-group leaders themselves. These recordings continued until September 1941.

In March 1940 the band moved from the Columbia label to RCA Victor to begin a period of a little more than two years that then seemed incredibly fertile and exciting and that in retrospect can be confirmed as the peak period of both Ellington and the band. At that time the band had all its seminal stars (except Bubber Miley, whose replacement, Cootie Williams, had long since created his own contributory identity). All of them had been with Ellington for at least a decade (except Rex Stewart, who joined in 1934, and Lawrence Brown, who came in in 1932). And it was a superbly integrated and polished musical ensemble.

For added stimulation, the precedent-shattering young bassist Jimmy Blanton joined the band in November 1939, giving the rhythm section a lift and drive it had never had before. And tenor saxophonist Ben Webster arrived in February 1940 to give the band for the first time a tenor saxophone voice that was as distinctive and provocative as its alto (Hodges) and baritone (Carney) and clarinet (Bigard)—not to mention its trumpets (Williams and Stewart) and trombones (Nanton, Brown, and Tizol).

The presence of Blanton, who was nineteen years old when he joined the band and whose influence was so immediately pervasive that when he died two years later of tuberculosis he had changed the role of the bass in a jazz band from a time-keeper to a vitalizing swinger, seemed to stimulate Ellington. Duke recorded a pair of piano-bass duets with Blanton the first time he got him in a studio, something Ellington had never done before.

The Duke started a succession of recording sessions, coincidental with his joining Victor. Barring an occasional "dog" pop tune, he turned out record after record in which his creativity as a composer and arranger and the band's capabilities as a creative performing organization functioned at an incredibly high and consistent level.

His first Victor session on March 6, 1940, included "Jack the Bear," an orchestral piece written to feature Blanton's unusual virtuosity on bass; "Ko-Ko," a highly sophisticated but joyful piece in which the solos and the ensemble were integrated to a degree that, even today, would be unusual; and "Morning Glory," a warm and glowing showcase for Stewart's cornet. Ten days later, the band added "Conga Brava," a riproaring update of Tizol's Caribbean style; "Concerto for Cootie," a masterful exhibition piece for Williams' trumpet that, when lyrics were added later, became a pop hit as "Do Nothin' Till You Hear from Me"; and "Me and You," a brilliantly lighthearted swinger in which Ivie Anderson's voice was mingled with the horns of Hodges, Bigard, Williams, and Brown.

The next session, May 4, produced "Cotton Tail," the ultimate up-tempo challenge for tenor saxophonists laid down by Ben Webster; and a finger-snapper featuring Hodges called "Never No Lament," another song that underwent a change of title when it was given lyrics: "Don't Get Around Much Any More." Both "Concerto for Cootie" and "Never No Lament," it should be noted, were hits as instrumentals two years before they were being sung with lyrics.

Later in May, there came "Dusk," a mood piece featuring Bigard; two musical portraits, a foot-patting "Bojangles" (for Bill Robinson) with Blanton setting the beat and Webster filling the outlines, and "A Portrait of Bert Williams" with Nanton's trombone characterizing the great comedian; and "Blue Goose," another of Ellington's rhythmic mood pieces. The year continued with the boisterous "Harlem Air Shaft"; a gorgeous ballad "All Too Soon," a vehicle for Webster and Brown; a driving, rowdy "Rumpus in Richmond"; the now-standard "In a Mellotone," a countermelody for "Rose Room"; four piano-bass duets by the Duke and Blanton; "The Flaming Sword," a blazing, Latinized outgrowth of an earlier Ellington swinger called "Stompy Jones"; the haunting "Warm Valley" with Hodges' melting alto saxophone; a soft, subdued blues "Across the Tracks Blues"; and a remarkable interpretation of a song from the Twenties, "Chloe," in which Nanton's magnificent wah-wah effects found their perfect outlet. Before the year ended, the Duke had also recorded his interpretation of "The Sidewalks of New York," another unlikely but splendid vehicle for Tricky Sam, and one of the few Ellington-related songs that was not written by either him or his musical alter ego Billy Strayhorn—"Flamingo" (composed by Ted Grouya and Edmund Anderson), which featured Hodges' alto and made a singing star of Herb Jeffries.

There was enough outstanding material recorded in 1940 to keep any listener busy for a long time. But there was more to come in 1941 and 1942: "Take the 'A' Train," which featured Ray Nance,

the successor to Williams (who had joined Benny Goodman), and which became the band's theme; "Blue Serge," a brilliantly boiling piece by the Duke's son Mercer; "Just a-Settin' and a-Rockin'," which allowed Webster to sound just like that; selections from the Duke's score for the musical, *Jump for Joy*, including "I Got It Bad," sung by Ivie Anderson and seconded by Hodges' alto saxophone; "Chelsea Bridge," another richly textured Ellington ballad, this time featuring Webster's tenor saxophone; "The C Jam Blues," a riff that has become one of the most popular of jazz standards; and "Sentimental Lady" (also known as "I Didn't Know About You"), another pulsating ballad for Hodges.

But in August 1942 all recording stopped by command of James Caesar Petrillo. When he allowed the musicians to return to the studios more than two years later, the Ellington band had passed its peak. Not only was Williams gone, but when the band resumed recording in December 1944 Webster, Bigard, Stewart, Tizol, and Blanton were all missing.

During this enforced recording silence, the Duke had made a very significant move: At a Carnegie Hall concert in January 1943, he introduced a fifty-minute work *Black, Brown, and Beige*, a pioneering effort in extended composition for a field in which the norm for a piece was three minutes. Ellington had begun moving in this direction twelve years earlier when, in 1931, he recorded his *Creole Rhapsody* on two sides of a ten-inch, 78-rpm disc. In 1935 he went even farther with *Reminisce in Tempo*, covering four ten-inch sides. Three years later, on commission from Paul Whiteman, he wrote a concert work *Blue Belles of Harlem*, which was later played by the Ellington band but never recorded.

Black, Brown, and Beige represented the Duke's real plunge into concert composition, and extended works were a regular part of his output throughout the rest of his life. Almost two years after its Carnegie Hall premiere, he was finally able to record portions of *Black, Brown, and Beige*—"Work Song," "Three Dances," "The Blues," and the most memorable section, "Come Sunday," which was the only part the Ellington band continued to play regularly and which became a central theme in the Duke's two sacred concerts in the Sixties. When Ellington finally had an opportunity to record *Black, Brown, and Beige* on a twelve-inch LP with Mahalia Jackson in 1958, he did not do the whole work as he had originally written it, but chose to limit his portion of the recording to "Work Song" and "Come Sunday."

Less than a year after his introduction of *Black, Brown, and Beige*, at the second of what became for several years annual Carnegie Hall concerts by the Ellington band (December 11, 1943), the Duke introduced another extended work, *New World a-Comin'*, which also went unrecorded because of

AKAI's new cassette deck stands up for itself

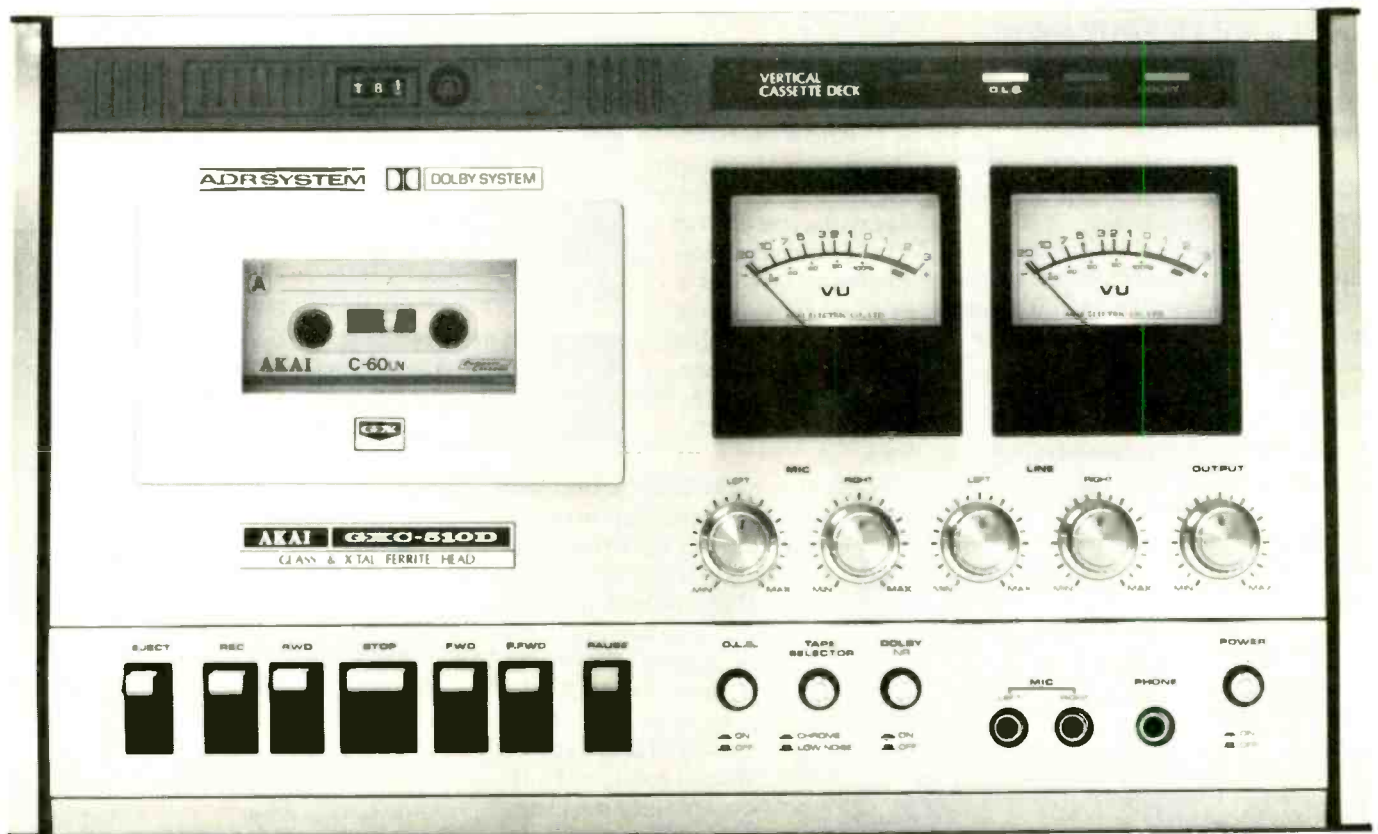

We decided to stand up and cheer! And AKAI's radically new cassette deck format is something to cheer about. The front-loading vertical design — with vertical head block assembly — combines the quality of open-reel and the convenience of cassette. We call the newest member of our cassette line the GXC-510D. You'll

call it supreme, with features like Dolby* noise reduction circuit plus AKAI's automatic distortion reduction system (ADRS), which eliminates distortion in the critical cassette range of 8 KHz and up; GX heads,

one of them a glass and crystal head for recording/playback; 0.08 percent wow and flutter; microphone and line mixing; full direct functions controls; output level control to match amplifier input; automatic stop and pause control; and many others. Step over to your nearest AKAI dealer and see how the GXC-510D stands up for itself. We think you will stand up and cheer right along with us. AKAI America, Ltd., 2139 East Del Amo Boulevard, Compton, California 90220. *Dolby is the trademark of Dolby Laboratories, Inc.

From

AKAITM
The Innovators



Dress it up with this 23" x 35" full-color poster. Just send name, address, and \$1.00 to "Wall Poster," AKAI America, Ltd.

Frequency response isn't everything.

If you're a real stereo buff, you know that flat frequency response means flat, uncolored sound.

Like several other manufacturers, we too try to build the flattest, most linear frequency response we can into our speakers.

But we don't stop there. Because we know that great sound depends on more than just frequency response.

Transient response, for instance.

It's all in your head

To understand transient response, it's important to understand how you hear.

You see, you don't really hear with your ears. You hear with your brain.

For instance, it's the brain that helps you identify what you're listening to. The direction it's coming from. And that re-creates that illusion of "being there."

The thing is, every musical note is really a complex tone. A basic tone — the fundamental — plus subtle musical overtones — harmonics — that give very instrument a unique personality.



Not only that, musical notes are constantly starting and stopping. When they do, the number and intensity of the harmonics change.

This basic tone, together with all those changing harmonics, is called a transient. The brain takes all of them into account in interpreting any sound the ear receives.

On making things imperfectly clear

It's when a speaker can't react quickly or accurately enough to all those changing musical notes, all those transients, that distortion can occur.

And distortion means muddy-sounding music. With little definition or clarity.

A bad situation made worse when a speaker over-reacts to all those changing tones. The speaker actually adds tones of its own. And that's bad.

Most experts feel the best way to measure transient response is with tone bursts. Pure tones of various frequencies are rapidly switched on and off to simulate the transient nature of voice and instrument signals.

In Pattern A, the speaker hasn't reproduced accurately. It's completely overshoot the level of the input signal. And the result is a sizzling, hot sound. Totally colored.

In Pattern B, the speaker has taken too long to react. This "hangover" can cause considerable blurring. So what you hear is dull and lifeless.

Now look at Pattern C. The speaker here has reacted both quickly and accurately. And the result is exceptional clarity and definition. The kind that Avid builds into all of its speakers.

The proof is in the hearing

Now you know there's a lot more to a speaker than just flat frequency response. Like good transient response.

But even the best, most accurate transient response in the world isn't the be-all and end-all of a superb speaker. There's more.

The point is, we're a company that is committed to one thing and one thing only. The design and construction of the clearest, best-sounding stereo speaker systems in their price range.

But you've got to hear for yourself. So go to your hi-fi store and listen to an Avid.

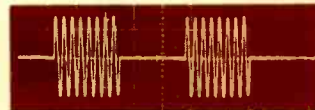

Input Signal

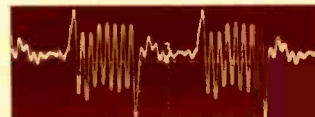

Pattern A

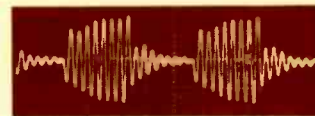

Pattern B

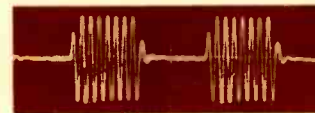

Pattern C

Then some other speaker in the same price category.

Then decide. We don't think you're going to have any trouble at all.

AVID

CORPORATION

10 Tripps Lane, East Providence, R.I. 02914
Distributed in Canada by:
Kairon Electronics, Montreal, Quebec.

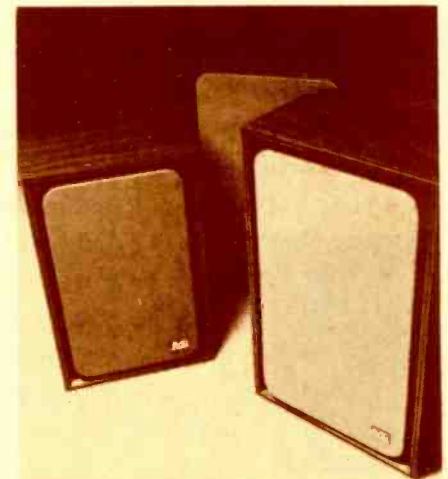

the ban. More than twenty years later, he finally recorded it with the Cincinnati Symphony.

In 1945 Ellington managed, for the first time, to record one of his extended compositions at the time of its introduction—the four sections of *The Perfume Suite*, written in collaboration with Strayhorn. It was relatively short and quite unpretentious, but it included the airy “Dancers in Love,” which stayed in the Ellington repertory, and a haunting tune called “Balcony Serenade,” which didn’t.

In 1946 Ellington finished a six-year relationship with Victor and signed with the newly ambitious Musicraft label, which had also signed Artie Shaw and Teddy Wilson. His only sessions on the label (in November and December) were, in effect, rehearsals for his annual Carnegie Hall concert later in December. They showed Ellington as a composer and the band as an ensemble in a state approaching the peak that they had achieved when they began with Victor in 1940. Unfortunately, the Musicraft relationship did not develop farther. But, transient as it was, it gave the Duke a helpful creative boost. These sessions, which largely reproduce his Carnegie Hall program, included an excerpt from the *Deep South Suite*—“Happy-Go-Lucky Local”—which in the Fifties provided the basis for a rhythm and blues hit “Night Train” (with no credit to Ellington).

His extended work for 1947 was *Liberian Suite*, composed on commission from the government of Liberia. Made up of a gospel-like vocal (“I Like the Sunrise” by Al Hibbler) and five dances, it was almost totally dependent on the soloists of the Ellington band rather than on the Duke’s composition.

In 1947 he also wrote a score for a musical version of *The Beggar’s Opera* (source of the Weill-Brecht *Three-Penny Opera*) called *Beggar’s Holiday*. The show failed, and there is no original cast album, but the Duke recorded four of the songs he wrote with John Latouche—“Women,” “Brown Penny,” “Take Love Easy,” and “Maybe I Should Change My Ways”—which suggests it could not have been the score that accounted for the musical’s failure at the box office.

From 1948 to 1950 was a period of marking time. But in 1951 Ellington produced *The Tattooed Bride*, one of his shorter, more closely edited extended pieces. It had structure and wit in the composition itself and in the Duke’s program notes, which were primarily concerned with explaining the title. In 1951 he also made his first recording of *A Tone Parallel to Harlem*, commissioned by the NBC Symphony in 1950. He wrote it on the Île de France while returning to New York from Europe. Although one would expect the definitive version of an Ellington composition to be the one made by his own band, *Harlem* was composed for the Ellington band and a symphony orchestra, so the 1951 recording does not convey quite the totality of the Duke’s intent that can be heard in a 1963 recording



Cootie Williams first joined the Ellington band as growl trumpeter in the '30s and inspired “Concerto for Cootie.”

on Reprise on which the Duke’s band was supplemented by strings from the Paris Symphony.

During the early Fifties the Ellington band went through one of its keenest personnel crises. Since 1940 when Cootie Williams left to join Benny Goodman, the stalwarts had been dropping off one by one. By 1950 the band was almost unrecognizable to its old followers. The few remaining veterans included Ray Nance, who was then in his tenth year, Lawrence Brown, Johnny Hodges (1928) and Harry Carney (1927) in the saxophones, and Sonny Greer, who had been drumming with the Duke since 1919.

But in 1951 the final blow appeared to have been struck: Hodges quit to form his own group, taking Brown with him, and Greer retired. Carney was the only one of the old Ellingtonians left.

At this point, Juan Tizol, who had played valve trombone with Ellington from 1929 until he joined Harry James in 1943, offered to return, bringing with him two colleagues from the James band: Willie Smith, an alto saxophonist second only to Hodges, and Louis Bellson, a drummer much more in tune with the Fifties than Greer.

But even with this rescue operation, the first half of the Fifties was hard going for the Duke. Although he was still under contract to Columbia, he recorded relatively little in 1951 and 1952. In the spring of 1953 he signed with Capitol, starting auspiciously with “Satin Doll,” his last pop hit and still one of his most ubiquitous tunes. But, aside from an album of piano solos, his relationship with Capitol was an unproductive one, in which he put in a great deal of time recording inferior versions of his earlier successes. Two sessions for Bethlehem in February 1956 were more of the same, followed by what must be considered the low point in Ellington’s recording career—an album of his compositions for which he recorded a background track

over which Rosemary Clooney sang lyrics, with Miss Clooney displayed on the album cover as the buying lure.

But, as the Duke pointed out in his autobiography *Music Is My Mistress*, "My mother always told me not to worry. . . . There always seemed to be someone on hand to point out the way for me to go."

This time several people seemed to be pointing the way. First, Hodges gave up his band and returned to the fold early in 1956. By the time the band got to the Newport Jazz Festival in July of that year, the sheer power of Hodges' presence was beginning to make the band sound like itself again. At the Festival the Ellington band gave one of the most explosive performances of its career. It started wanly with a special work for the occasion, *Festival Suite*. But then the Duke launched into "Diminuendo and Crescendo in Blue," a piece he had originally recorded in 1937, and with a tremendous rhythmic drive stimulated by the off-stage enthusiasm of Jo Jones, the onetime Count Basie drummer, tenor saxophonist Paul Gonsalves ground his way through twenty-seven furious solo choruses amid rising excitement that set off dancing in the aisles and landed the band in the pages of *Time* magazine.

This was a performance that had to be experienced visually and physically to be fully appreciated, so on the Columbia recording of the Festival it seems somewhat tame. But the program that the Duke moved into on the exhilarating wings of this triumph is superb (and it's on Columbia)—a definitive "Take the 'A' Train," Carney and "Sophisticated Lady," and Hodges on "Jeep's Blues" and "I Got It Bad."

Newport 1956 was a turning point. The band that had survived the early Fifties by making five-hundred-mile jumps to one-night stands in the boondocks was in demand again, and Ellington, at fifty-seven, had caught his second wind.

The most immediate result was a television production of his *A Drum Is a Woman*, which is both a history of jazz and a history of black people in America (a constantly recurring Ellington theme), done in Ellington terms of both music and narration. On records, it is often too glib. His sudden access to words needed the editing that came with further experience with spoken material, much as his first extended work, *Black, Brown, and Beige*, needed—and subsequently got—severe editing; the Duke learned quickly.

But if *A Drum Is a Woman* was an overambitious misfire, *Such Sweet Thunder* in 1957 was superb Ellington, superb jazz, superb music. This is a "suite" made up of short pieces theoretically inspired by passages from Shakespeare's plays and sonnets that the Duke undertook after he had played a concert at the Shakespeare Festival in Stratford, Ontario. With one or two exceptions, the twelve vi-



gnettes are an imposing display of the Ellington range (relative to both the band and the composer).

A project of a very different nature in 1957 was released as "Ella Fitzgerald Sings the Duke Ellington Songbook," a four-disc set in which Miss Fitzgerald sang or vocalized songs by the Duke, accompanied by the full band or a small group of Ellingtonians. There are times when there are complete meetings of minds and talents—on "All Too Soon," "Day Dream," "Sophisticated Lady," and "I Didn't Know About You." But the set is disappointing over-all (in relation to what one might expect), both because the Ellington band had difficulty pulling itself together and because Miss Fitzgerald was asked to carry in scat fashion too many songs that have no lyrics.

In 1959 Ellington wrote and recorded a score for the film *Anatomy of a Murder*, which as film scores go was a bit less bland than usual but scarcely top-drawer—or even middle-drawer—Ellington. However, in the same year he did a session for Verve with Hodges in an otherwise non-Ellington quintet that included Harry Edison on trumpet and that produced some magnificent conjunctions of the three of them. Oddly, a followup session in which Roy Eldridge replaced Edison and the rest of the group (aside from Jo Jones on drums) was drawn from the Ellington band (including a visit from alumnus Ben Webster) did not measure up to the first.

By 1960 Ellington was riding high enough to be able to afford foregone disasters—recordings of his arrangements of *The Nutcracker Suite* and *Peer Gynt Suites Nos. 1 and 2*. Fortunately, these were balanced by his *Suite Thursday*, an extended work commissioned by the Monterey Jazz Festival and premiered at Monterey in September 1960. Based on John Steinbeck's *Sweet Thursday*, it is a dazzling display of the Ellington imagination and instru-

mentation in full flight, and it ranks with *Such Sweet Thunder* as the most successful of his post-Newport-1956 long works.

A joint recording session by the Ellington band and Count Basie's orchestra in 1961 was not as productive as one might have hoped. The performances rise and fall on the soloists, while the styles of both bands fall into the background. Another visit with a peer—a 1962 session with Louis Armstrong—was more refreshing for Armstrong, who got to sing Ellington material that he was not normally associated with, than it was for Duke, who primarily played the role of accompanist.

But a series of ventures by Ellington with other prominent jazzmen in 1962, when he was between contracts, was more rewarding. He was joined by Coleman Hawkins and a small contingent of Ellingtonians on an Impulse record in the vein of his small-group recordings of the late Thirties and early Forties but with the crucial addition of Hawkins' tenor saxophone. The high point is a "Self-Portrait of the Bean" ("Bean" being Hawkins' nickname) theoretically composed by Ellington and Strayhorn in honor of the occasion but actually a reworking of a piece they wrote more than a decade earlier called "Snibor."

Ellington and Hawkins were contemporaries and related easily to each other. John Coltrane, however, with whom Ellington also made an Impulse set, was a generation removed in age and one might almost say in style were it not for the fact that, stylistically, Ellington could not be pushed into any period pigeonhole. Nonetheless, in his set with Coltrane, he stayed largely in the background, making his contributions primarily as a composer.

A third meeting with non-Ellingtonians—in a trio made up of Max Roach, drums, Charles Mingus, bass, and Ellington, piano—is, over-all, a masterpiece. Mingus, a creative influence who stands on a level close to Ellington, was strongly influenced by the Duke early in his career and later had the "honor" (as he described the incident in his book *Beneath the Underdog*) of being fired by him, was an ideal support and challenge to Ellington, who responded in kind. Roach had the good sense to stay out of the way, and the result is one of the finest and most adventurous of Ellington's recording sessions.

Later in 1962 he tied up with Reprise records, a connection that produced a mixture of mainstream Ellington and attempts at opportunistic contemporaneity in the form of (can you believe it?) songs from *Mary Poppins*, rehashes for the umpteenth time of his long-established hits, pop hits of the moment, and, on a more amusing level, versions of tunes associated with other big bands.

The Reprise series started off well with an album called "Afro-Bossa," made notable in part because of the return of a wandering Ellingtonian, Cootie Williams, after an absence of twenty years. The al-

bum, for which Duke also served as a&r man, saw him getting away from a tendency to do things the easy way—i.e., turning things over to the soloists—and returning to the essence of good Ellington by focusing on ensembles through which solos might be threaded.

This was followed in 1963 by a disc called "The Symphonic Ellington" with two of the Duke's earlier extended works, *Harlem* and *Night Creature* (commissioned in 1955 for the Symphony of the Air but not previously recorded), for which the Ellington band was supplemented by symphony musicians in Paris, Hamburg, and Stockholm. This version of *Harlem*, as noted previously, conveys Ellington's symphonic intentions more accurately than the 1951 recording by his band alone, while *Night Creature* is a delightfully evocative work, made even more delightful by a descriptive sleeve note by the Duke that must be one of the major put-ons of programmatic annotation.

In the summer of 1963 the Duke wrote and staged a production called *My People* for the Century of Negro Progress Exposition in Chicago. Neither he nor his band performed in *My People* or the recording of the score (although the recording band was made up, for the most part, of onetime Ellingtonians). But it is a particularly significant Ellington work, because it is largely based on his *Black, Brown, and Beige* of twenty years earlier and because it anticipated the sacred concerts that he would inaugurate two years later. The score included "The Blues Ain't" and "Come Sunday" from *Black, Brown, and Beige* (the latter would be used in the sacred concerts) and a new piece, "Ain't but One," which would also be in his *First Sacred Concert*.

That first venture into a concert of original sacred music was made by Ellington in the fall of 1965 at Grace Cathedral in San Francisco and was repeated in December at the Fifth Avenue Presbyterian Church in New York, where it was recorded. With Louis Bellson sitting in on drums, the Duke and his band made a truly joyful noise with the help of Brock Peters, whose big, resonant voice easily suggests the vastness of the Creation; Esther Marrow, a vibrant singer with a strong gospel style; Bunny Briggs, who added his dancing feet to the rhythms of "David Danced Before the Lord" (an up-tempo use of the melody of "Come Sunday"); and the Herman McCoy Choir, a swinging vocal ensemble. Add to this some fine plunger trumpet passages by Williams, a rare piano solo version by the Duke of an excerpt from his *New World a-Comin'*, and a totally melting performance of "Come Sunday" by Hodges.

It is one of Ellington's most consistently distinguished recordings. Yet his *Second Sacred Concert*, premiered in January 1968 at the Cathedral of St. John the Divine in New York, is even better. The Duke recorded it himself (a practice he got into in

st of each is up to us

professional 10½-inch tape reels. Its unique combination of bias and equalization switching controls give 12 different settings to optimize the performance of any tape on the market.

The RT-1050's 3-motor transport system is activated electronically by full logic, solid state circuitry, triggered by feather touch pushbutton controls. Its transport is completely jam- and spill-proof, permitting you to switch from Fast Forward to Fast Rewind, bypassing the Stop button.

The RT-1050 was specifically

designed for easy operation with a wide combination of professional features like extended linearity VU meters with adjustable sensitivity, mic/line mixing, pushbutton speed selection and reel tension adjustment buttons. There's also an exclusively designed pause control and independent control of left and right recording tracks.

The same 2-track recording system studios use for better signal-to-noise ratios and higher dynamic range is incorporated into the RT-1050. Yet it can be easily converted to 4-track use with an

optional plug-in head assembly. Everyone considered it's the most versatile open-reel deck you can buy. Professionals prefer it for its studio-quality performance. Everyone appreciates its completely simple operation.

Pioneer open-reel and cassette decks are built with the same outstanding quality, precision and performance of a Pioneer stereo component. That's why whichever you choose, you know it's completely professional and indisputably the finest value ever in a studio-quality tape deck.



PIONEER®

when you want something better

U.S. Pioneer Electronics Corp., 75 Oxford Drive, Monachio, New Jersey 07074
WeSk 13300 S. Estrella, Los Angeles 90248/Midwest: 1500 Greenleaf, Elk Grove Village, Ill. 60007/Canada: S.H. Parker Co.

CIRCLE 68 ON READER SERVICE CARD

**Whether you use
a cassette or
open reel deck
is up to you.**



Giving you the bes

High fidelity is important to us at Pioneer. It's all we do and it's all we care about. We are excited that cassette tape decks have reached a level of performance that meet the highest standards. We are excited because we know that it means more enjoyment for you from your high fidelity system. We also know that you can now get more versatility and more value out of your high fidelity system than ever before.

The great advances in cassette technology have had impact on the reel-to-reel tape deck concept as well. We believe that the era of the small, inexpensive 7-inch reel tape deck is past. Neither its convenience nor its performance make it a good value compared to the new cassette technology. And it is now possible for Pioneer to offer you a professional studio-quality 10½-inch reel deck at prices that compare favorably with what you might expect from old fashioned 7-inch reel units. In our judgment the old ideas must move aside for the new ideas. And Pioneer has some very intelligent new ideas in tape for you.

The convenience of cassette.

The performance of open-reel.

The stereo cassette deck has become a "must" in complete high fidelity systems. Because of its convenience, price and performance, it has virtually replaced the once popular 7-inch open-reel deck. As Julian D. Hirsch, prominent audio reviewer put it, "The best cassette machines compare favorably with a good open-reel recorder in listening quality." Pioneer proves it with four top-performing models.



Stacks compatibly with other components.

Our new CT-7171, with built-in Dolby, is a deck with a difference. It's designed with all controls up front so you can stack other components on or under it. Even the illuminated cassette compartment is front loading, for easy access and visibility.

Performance features stack up, too. Bias and equalization switches provide optimum recording and playback for every type of cassette tape made. You'll produce distortion-free recordings consistently with two oversized, illuminated VU meters plus an instant-acting peak level indicator light. And for those unpredictable program source peaks, there's a selectable Level Limiter circuit. It's similar to the type used in professional recording studios to prevent "clipping" distortion.

Finding a desired program point in a recorded cassette is simple with our new CT-7171. A memory rewind switch,

working together with the 3-digit tape counter, plus an exclusive Skip button, lets you monitor audibly at accelerated speed to make precision cueing a breeze.

Automatic tape-end stop, dual concentric level controls, separate mic/line inputs, pause control, in addition to many other features, make the CT-7171 the recording studio that fits on a shelf.

Whether you choose the sophistication of the CT-7171 or Pioneer's CT-5151, CT-4141A or CT-3131A, which share many of its features, you're assured optimum performance and maximum value. One tradition that never changes at Pioneer.

Open-reel. A professional recording studio in your home.

Professionalism comes with all three studio-quality open-reel models. The RT-1020L (7½, 3¾ ips) is unequalled in 4-track units. With three motors and three heads, it has virtually every professional feature you'd want. Yet it's extremely simple to use. In addition to stereo record/playback, it also highlights 4-channel playback. The complete extent of its capabilities becomes apparent only after you've worked with it. Then you'll recognize the magnitude of Pioneer's accomplishment.

Our RT-1050 is a 2-track, 2-speed (15, 7½ ips) 3-head deck which, like all our open-reel models, can handle



12 Bias & Equalization settings optimize performance.



Pick The Open-Reel Deck Features You Need

| Model | RT-1050 | RT-1020H | RT-1020L |
|-------------------------------|----------------|-------------|-------------|
| Maximum Reel Size | 10½" | 10½" | 10½" |
| Speeds | 15 & 7½ ips | 15 & 7½ ips | 7½ & 3¾ ips |
| Number of Tracks | 2 (4 optional) | 4 | 4 |
| Wow & Flutter (at high speed) | 0.06% | 0.06% | 0.10% |
| Frequency Response (±3dB) | 30Hz-22kHz | 30Hz-22kHz | 40Hz-20kHz |
| Tape Bias Selection | 3 position | 3 position | 3 position |
| S/N Ratio | 57dB | 55dB | 55dB |
| Equalizer Selection | 4-Position | 2-Position | 2-Position |
| Mic/Line Mixing | yes | yes | yes |
| LED Peak Indicator | yes | no | no |
| Memory Recording | yes | yes | yes |
| VU Meter Scale Selection | yes | no | no |
| 4-Channel Playback | no | yes | yes |
| Motors | 3 | 3 | 3 |
| Price | \$699.95 | \$649.95 | \$649.95 |

Pick the Cassette Features You Need

| Model | CT-7171 | CT-5151 | CT-4141A | CT-3131A* |
|-----------------------|---------------|---------------|---------------|-----------------------------|
| Dolby Noise Reduction | yes | yes | yes | no |
| Tape Selection | Bias & Equal. | Bias & Equal. | Bias & Equal. | Equalization |
| Auto. Tape Stop | yes | yes | yes | yes |
| Memory Rewind | yes | yes | no | no |
| Pause Control | yes | yes | yes | yes |
| Freq. Response* | 30-16,000 Hz | 30-16,000 Hz | 30-15,000 Hz | 30-15,000 Hz (*Chrome Tape) |
| Peak Indicator | yes | yes | no | no |
| Level limiter | yes | yes | no | no |
| Skip cueing | yes | yes | yes | no |
| Signal/Noise (Dolby) | 58 dB | 58 dB | 58 dB | — |
| S/N (Less Dolby) | 48 dB | 48 dB | 48 dB | 47 dB |
| Tape Heads | Ferrite | Ferrite | Permalloy | Permalloy |
| Motor Type | DC Servo | DC Servo | DC Servo | DC Servo |
| Wow & Flutter (WRMS) | 0.10% | 0.12% | 0.13% | 0.13% |
| Price | \$369.95 | \$269.95 | \$239.95 | \$179.95 |

*not shown



the Sixties, when it became evident that record companies in general were too busy recording hopeful rock groups to waste time on the most complete American musician of the twentieth century), and it was not released until three years later when Fantasy Records took a chance on it.

What Fantasy got included a performance of incredible brilliance by Alice Babs, a singer with a voice of such amazing range and control that she seems to have complete communion with the unusual (and extremely difficult) music with which Ellington challenged her. In addition, there are some choice matings of Ellington composition and Ellington instrumentalists—notably such old standbys as baritone saxophonist Carney (in his forty-first year with Ellington at the time), trumpeter Williams, and trombonist Brown. There are weak points, such as the choral recitatives (which worked when the Duke spoke them and phrased them but not when a chorus tries to follow a strict beat) and the overripe singing of Tony Watkins. But there is so much that is superbly right that the recording stands as a monument to the Duke.

He completed a *Third Sacred Concert* before his death, premiered it at Westminster Abbey, and was planning to play it for the first time in America at Stanford University on his seventy-fifth birthday. But he was in the hospital then, and he never got out.

Between these two sacred concerts came an outgrowth of the Duke's tour of India and points west to the Mediterranean in 1963 (a tour cut short when President Kennedy was assassinated). In *The Far East Suite*, recorded in 1966, the built-in exotica that was a natural part of the Ellington style was expanded by his interpretation of the sounds and rhythms he heard, filtered through the musical personalities of Hodges, Carney, and Brown. Some of the stylistic devices go back to the Duke's "jungle" period of the Twenties, but they lie cheek-by-jowl with what he brought back from his tour.

Another Ellington composition that took a while to get on records was *La Plus Belle Africaine*, written for his first visit to Africa in 1965 ("after writing African music for thirty-five years," as he was fond of noting) to attend the Dakar Arts Festival. It turned up in 1967 on a disc for which this sturdy bit of Ellingtonia with a rolling, rumbling, regal theme was a saving grace. In May of that year Strayhorn died, and a few months later the Duke took his band into a studio to record "... And His Mother Called Him Bill," an album of Strayhorn compositions that, inevitably, was dominated by Hodges, who was the definitive interpreter of Strayhorn's exquisite melodic lines.

A tour of Latin America in 1968 produced a *Latin American Suite*, which, unlike much of Ellington's later extended composition, was less a framework for the band's soloists than an ensemble piece with the Duke at the piano as the most ubiq-

uitous soloist. He caught the rhythms and spirit of Latin America without getting involved in Latin percussion or traditional Latin melodies. It was, as was usual in his musical reports of his travels, an Ellington reaction to sights and sounds, a melange of rugged pomp, silken melodies, and gently reflective moods.

Duke Ellington's seventieth birthday, in 1969, was greeted by American record companies in an odd way: During the year they neither recorded nor released a single Ellington record. While he was on tour in England in November, two of his concerts were recorded on a last-minute impulse, so a year later a so-called "70th Birthday Concert" recording appeared. In addition to the customary concert staples, the two-disc set included a rich array of new works and a welcome revival of an Ellington composition of the Twenties, "Black Butterfly."

For the New Orleans Jazz Festival of 1970, he wrote a *New Orleans Suite*—quintessential Ellington, beautifully played, with emphasis on the ensemble and solo characteristics of the band, and a rich evocation of the land of jazz. It includes the last recorded work of Hodges, who died between the two sessions required for the disc.

A commission from Togoland to compose a celebratory piece was worked out more or less in public performances by the Ellington band for a couple of years before it was finally recorded in 1971 during a concert in England. *Togo Brava-Brava Togo Suite* is a short work that encompasses most of the characteristics of a typical Ellington work—one of his meltingly lovely pastels, some contemporary "jungle" music, and a finale of "great gettin' up in the mornin'" music.

At his death, Ellington's recorded career was still incomplete. There are, to begin with, all the sessions that he recorded himself that have not yet found an outlet. Beyond that, there are an uncountable number of air checks and personal appearances that have been recorded by one means or another but that are just beginning to become available. Beyond that—and this is a most essential point for Ellington collectors—both Columbia's and RCA Victor's French affiliates are launched on programs of issuing, in consecutive order and in all "takes," all of his recordings for them, which means a basic library of his pre-LP work will eventually be available if you are willing to pay the import price.

The fact that it is the French affiliates that are doing this speaks for itself [see my article in these pages two months ago on "Does American Jazz Have to Be Imported from Europe?"]. The records were made in this country by American musicians but, as one high executive of one of these companies said, a complete release of Ellington's recordings on his label does not "fit in" with the company's current marketing plans. Nor is it ever likely to.

The Duke on Discs

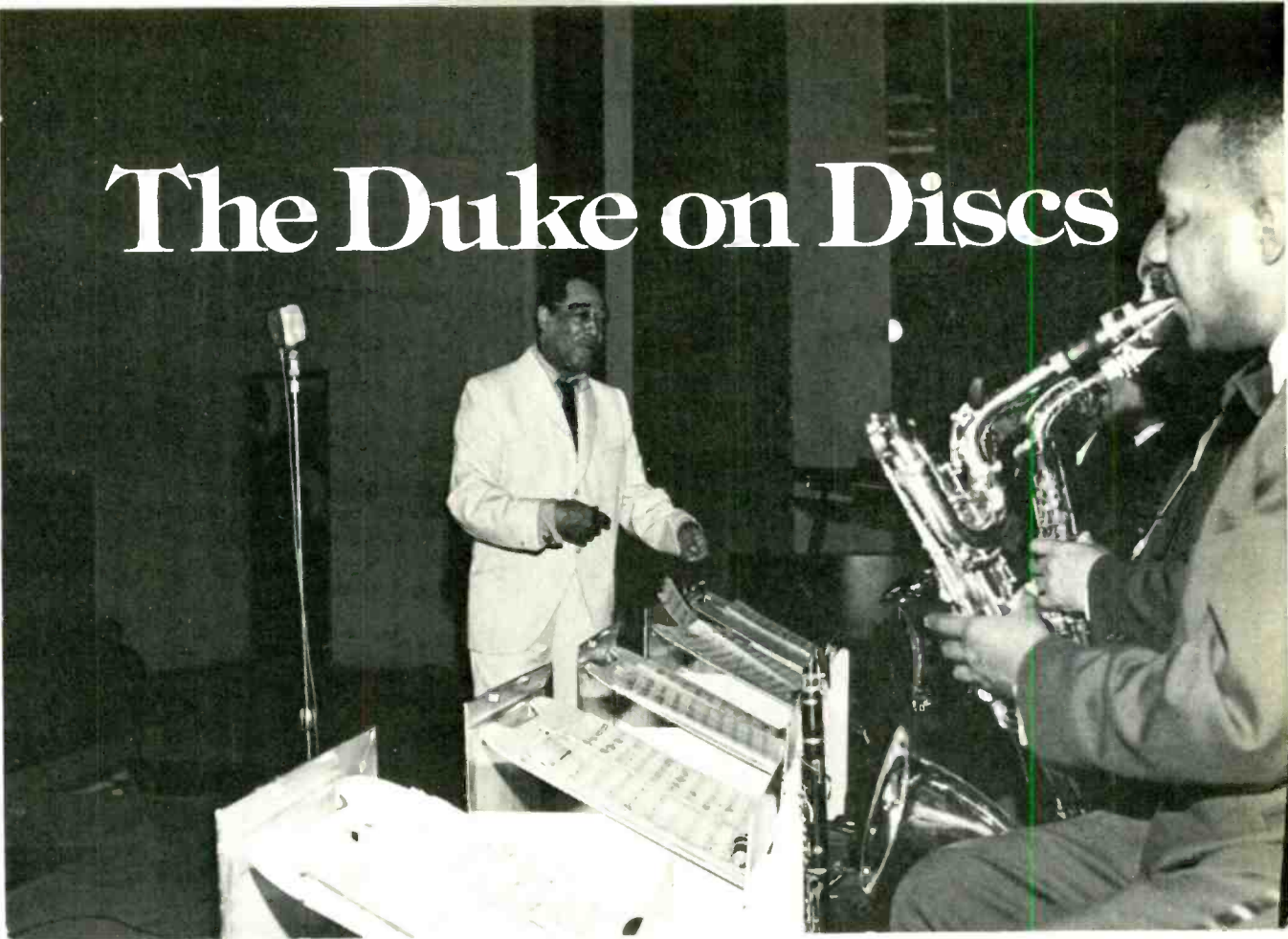

A key to all currently available recordings

DUKE ELLINGTON WROTE thousands of musical compositions ranging from simple songs to elaborate suites and concert pieces. Only a fraction of the whole has been recorded and only a fraction of the recordings is available.

The first list comprises all of the currently available long-playing records on which Ellington performed up to the time of his death May 24, 1974. A few recently deleted items are added in order to include the original versions of some of Duke's more memorable compositions, such as "In a Mellotone," and so that others, such as *The First Sacred Concert*, would not be excluded altogether. (These out-of-print recordings are marked OP.)

The discs are listed approximately chronologically. Each listing includes an identification number, the title of the record, the recording company, the catalogue

number, and the range of dates of the selections. Nos. 1-45 are either mono recordings or rechanneled stereo (indicated with an *E* after the catalogue number), and Nos. 46-81 are in stereo. Discs with an asterisk are John S. Wilson's recommendations for a basic Ellington library.

The second list is an alphabetical catalogue of every composition by Ellington, his longtime collaborator, Billy Strayhorn, and/or members of his orchestra. Each work is followed by the identification number of the record or records on which it appears and by the year of the performance.

The third list is a similar alphabetical compilation of performances by Ellington of songs by composers other than himself, Strayhorn, and orchestra members.

THE ALBUMS

1. **Complete Duke Ellington, Vol. 1.** COLUMBIA J 29 (two discs; 1925-28).
2. **The Beginning, Vol. 1.** DECCA 79224E (1926-28).
3. **Hot in Harlem, Vol. 2.** DECCA 79241E (1928-29).
4. **Rockin' in Rhythm, Vol. 3.** DECCA 79247E (1929-31).
5. **Ellington Era, Vol. 1.** COLUMBIA C3L 27 (three discs; 1927-40).
6. **Ellington Era, Vol. 2.** COLUMBIA C3L 39 (three discs; 1927-40).
7. **The Works of Duke, Vol. 1.** RCA 731043 (1927-28).
8. **The Works of Duke, Vol. 2.** RCA 741028 (1928-29).
9. **The Works of Duke, Vol. 3.** RCA 741029 (1929).
10. **The Works of Duke, Vol. 4.** RCA 741039 (1929-30).
11. **The Works of Duke, Vol. 5.** RCA 741048 (1930).
12. **The Works of Duke, Vol. 6.** RCA 741068 (1930-31).
13. **The Works of Duke, Vol. 7.** RCA 741085 (1931-32).
14. **The Works of Duke, Vol. 8.** RCA 741114 (1932-34).
15. **Flaming Youth.** RCA LPV 568 (1927-29).
16. **Daybreak Express.** RCA LPV 506 (1931-34).
17. **Mood Indigo.** CAMDEN ADL2 0152E (two discs; 1927-34).
18. **Early Ellington.** ARCHIVE OF FOLK & JAZZ MUSIC 221E (1933).
19. **Big Bands/1933.** PRESTIGE 7645E (1933).
20. **In My Solitude.** HARMONY 11323 E (1930-58).
21. **Presents Ivie Anderson.** COLUMBIA KG 32064 (two discs; 1932-40).
22. **Music of Ellington.** COLUMBIA CSP JCL 558 (1928-49).
23. **This Is Duke Ellington.** RCA VPM 6042 (two discs; 1927-45).
24. **The Duke's Men.** COLUMBIA CSP JEE 22005 (1936-39).
25. **Hodge Podge.** COLUMBIA GSP JEE 22001 (1938-39).
26. **Things Ain't What They Used to Be.** RCA LPV 533 (1940-41).
27. **Barney Bigard & Albert Nicholas.** RCA LPV 566 (1940-41).
28. **At His Very Best.** RCA LPM 1715 (1927, 1940-46).

This list of recordings was compiled by Morris Hodara of the Duke Ellington Society.

29. **The Indispensable Duke Ellington.** RCA LPM 6009 (OP; 1940-46).
30. **In a Mellotone.** RCA LPM 1364 (OP; 1940-42).
31. **Jumpin' Punksins.** RCA LPV 517 (1940-41).
32. **Johnny Come Lately.** RCA LPV 541 (1942-45).
33. **Pretty Woman.** RCA LPV 553 (1945-46).
34. **Golden Duke.** PRESTIGE 24029 (two discs; 1946, 1950).*
35. **World of Duke Ellington.** COLUMBIA G 32564E (two discs; 1947).
36. **Monologue.** COLUMBIA J 20 (1947-51).
37. **Liberian Suite/A Tone Parallel to Harlem.** COLUMBIA J 6 (1947, 1951).
38. **Primping for the Prom.** COLUMBIA J 11 (1947-61).
39. **Masterpieces.** COLUMBIA CSP JCL 825 (1950).
40. **Hi-Fi Ellington Uptown.** COLUMBIA CSP JCL 830 (1951-52).
41. **Piano Reflections.** CAPITOL M 11058 (1953).
42. **Best of Ellington.** CAPITOL DT 1602E (1953-54).
43. **A Drum Is a Woman.** COLUMBIA CSP JCL 951 (1956).
44. **Ellington at Newport.** COLUMBIA Cs 8648E (1956).
45. **Louis Armstrong & Duke Ellington at Newport.** COLUMBIA J 5 (1956).
46. **Such Sweet Thunder.** COLUMBIA CSP JCL 1033 (1957).*
47. **Ellington Indigos.** COLUMBIA Cs 8053 (1957).
48. **Black, Brown, and Beige.** COLUMBIA CSP JCS 8015 (1958).*
49. **Jazz at the Plaza, Vol. 2.** COLUMBIA C 32471 (1958).
50. **Blues Summit.** VERVE 68822 (two discs; 1958-59).
51. **Greatest Hits.** COLUMBIA 9629E (1947-60).
52. **First Time: The Count Meets the Duke.** COLUMBIA Cs 8515 (1961).
53. **Echoes of an Era; Duke Ellington-Louis Armstrong Years.** ROULETTE 108 (two discs; 1961).
54. **Fantasies.** HARMONY 11236 (1962).
55. **Duke Ellington Meets Coleman Hawkins.** IMPULSE 26 (1962).
56. **Duke Ellington & John Coltrane.** IMPULSE 30 (1962).
57. **Money Jungle.** UNITED ARTISTS 5632 (1962).
58. **Will the Big Bands Ever Come Back?** REPRIS 6168 (1962-63).
59. **Afro-Bossa.** PRESTIGE 6069 (1963).
60. **Greatest Hits.** REPRIS 6234 (1963).
61. **Great Paris Concert.** ATLANTIC 2-304 (two discs; 1963).*
62. **My People.** FLYING DUTCHMAN 10112 (1963).
63. **Ellington '65.** REPRIS 6122 (1964).
64. **Ellington '66.** REPRIS 6154 (1965).
65. **Ella at Duke's Place.** VERVE 64070 (1965).
66. **Duke at Tanglewood.** RCA LSC 2857 (1965).
67. **Concert of Sacred Music.** RCA LSP 3582 (OP; 1965).
68. **Far East Suite.** RCA LSP 3782 (OP; 1966).
69. **At the Cote d'Azur.** VERVE 64072 (two discs; 1966).
70. **Popular Duke Ellington.** RCA LSP 3576 (1966).
71. **And His Mother Called Him Bill.** RCA LSP 3906 (OP; 1967).
72. **Collages.** BASF 21704 (1967).
73. **Francis A. & Edward K.** REPRIS 1024 (1967).
74. **Second Sacred Concert.** FANTASY 8407/8 (two discs; 1968).*
75. **Latin American Suite.** FANTASY 8419 (1968).
76. **Yale Concert.** FANTASY 9433 (1968).
77. **70th-Birthday Concert.** SOLID 19000 (two discs; 1969).
78. **New Orleans Suite.** ATLANTIC 1580 (1970).
79. **Duke Ellington/Cincinnati Symphony Orchestra.** DECCA 71076 (1970).
80. **Togo Brava Suite.** UNITED ARTISTS UXS 92 (1971).*
81. **It Don't Mean a Thing if It Ain't Got That Swing.** FLYING DUTCHMAN 10166 (1973).

THE COMPOSITIONS

I. By Ellington, Strayhorn, and orchestra members

- Absinthe.** 59 (1963).
- Across the Tracks Blues.** 28 (1940).
- Ad Lib on Nippon.** 68 (1966).
- Addi.** 80 (1971).
- Admiration.** 4 (1930).
- Afro-Bossa.** 59 (1963).
- After All.** 31 (1941); 71 (1967).
- Agra.** 68 (1966).
- Ain't but One.** 62 (1963).
- Air-Conditioned Jungle.** 35 (1947).
- All Day Long.** 71 (1967).
- All Too Soon.** 30 (1940); 41 (1953); 69 (1966).
- Almighty God.** 74 (1968).
- Amad.** 68 (1966).
- Amour, Amour.** 80 (1971).
- Angelica.** 56 (1962).
- Angu.** 59 (1963).
- Are You Sticking?** 31 (1941).
- Aristocracy à la Jean Lafltte.** 78 (1970).
- Asphalt Jungle, Theme from.** 61 (1963).
- Asphalt Jungle Twist.** 38 (1961).
- Awful Sad.** 3 (1928).
- Azalea.** 53 (1961).
- Azure.** 6 (1937); 65 (1965); 77 (1969).
- BDB.** 52 (1961).
- B. P.** 77 (1969).
- B Sharp Blues.** 41 (1953).
- B Sharp Boston.** 38 (1949).
- Baby When You Ain't There.** 6 (1932).
- Back Room Romp.** 24 (1937).
- Bakiff.** 42 (1953).
- Balcony Serenade.** 29 (1945).
- Ballet of the Flying Saucers.** 43 (1956).
- Bang-Up Blues.** 34 (1950).
- Battle of Swing.** 5 (1938).
- Battle Royal.** 52 (1961).
- Beautiful American, The.** 53 (1961).
- Beautiful Indians, Hiawatha.** 34 (1946).
- Beautiful Indians, Minnehaha.** 34 (1946).
- Beggar's Blues.** 6 (1929).
- Bend One.** 50 (1958).
- Big Shoe.** 50 (1958).
- Biggest and the Busiest Intersection.** 74 (1968).
- Birmingham Breakdown.** 2 (1927).
- Black and Tan Fantasy.** 1, 5 (1927); 2 (1927); 7, 15, 17, 23 (1927); 13 (1932); 29 (1945); 42 (1954); 53 (1961); 60 (1963); 70 (1966).
- Black Beauty.** 1 (1928); 2 (1928); 7, 15, 17 (1928); 29 (1945).
- Black, Brown, and Beige.** 28 (1944); 48 (1958).
- Black Butterfly.** 77 (1969).
- Black Swan.** 77 (1969).
- Blip-Blip.** 31 (1941).
- Blood Count.** 71 (1967).
- Blow by Blow.** 69 (1966).
- Blue Bubbles.** 7, 15 (1927).
- Blue Cellophane.** 29 (1945).
- Blue Feeling.** 14, 16 (1934).
- Blue Goose.** 31 (1940).
- Blue Harlem.** 5, 20 (1932).
- Blue Pepper.** 68 (1966).
- Blue Ramble.** 5 (1932).
- Blue Reverie.** 24 (1937).
- Blue Serge.** 30 (1941).
- Blue Tune.** 5 (1932).
- Bluebird of Delhi.** 68 (1966).
- Blues, The.** 28 (1944).
- Blues Ain't, The.** 62 (1963).
- Blues for Blanton.** 34 (1950).
- Blues for New Orleans.** 78 (1970).
- Blues I Love to Sing, The.** 7, 15 (1927).
- Blues to Be There.** 44 (1956).
- Blues with a Feeling.** 5 (1928).
- Bojangles.** 29 (1940).
- Bonga.** 59 (1963).
- Boo-Dah.** 71 (1967).
- Boogie Bop Blues.** 35, 38 (1947).
- Bourbon Street Jingling Jollies.** 78 (1970).
- Boy Meets Horn.** 5 (1938).
- Brasilliance.** 75 (1968).
- Breakfast Dance.** 10 (1929).
- Brown Penny.** 35, 36 (1947).
- Brown Suede.** 27 (1941).
- Brownskin Gal in the Callico Gown.** 65 (1965).
- Buffet Flat.** 6 (1938).
- Bula.** 61 (1963).
- Bundle of Blues.** 5 (1933).
- "C" Blues.** 27 (1941).
- C Jam Blues.** 23, 32 (1942); 34 (1950); 51 (1959); 80 (1971).
- Caravan.** 24 (1936); 5, 22 (1937); 23, 32 (1945); 42 (1954); 57 (1962); 66 (1965); 77 (1969).
- Carnegie Blues.** 29 (1945).
- Carribee Joe.** 43 (1956).
- Charlie the Chulo.** 27 (1940).
- Charpoy.** 71 (1967).
- Checkered Hat.** 80 (1971).
- Chelsea Bridge.** 29 (1941).
- Chico Cuadrado.** 75 (1968).
- Chocolate Shake.** 31 (1941).
- Chromatic Love Affair, A.** 76 (1968).
- Cincinnati Daddy.** 4 (1929).
- Circle of Fourths.** 46 (1957).
- Clarinet Lament.** 5 (1936).
- Clementine.** 31 (1941).
- Clothed Woman, The.** 36 (1947).
- Clouds in My Heart.** 24 (1936).
- Coloratura.** 29 (1945).
- Come Sunday.** 28 (1944); 62 (1963); 67 (1965).
- Concerto for Cootie (Do Nothing Till You Hear from Me).** 23, 38 (1940); 61 (1963).
- Conga Brava.** 31 (1940).
- Congo Square.** 43 (1956).
- Controversial Suite.** 40 (1951).
- Cop Out.** 38 (1957); 61 (1963).
- Cotton Club Stomp.** 9 (1929); 9, 17 (1929); 4 (1930).
- Cotton Tail.** 23, 30 (1940); 34 (1950); 53 (1961); 65 (1965); 80 (1971).
- Creeper, The.** 2 (1927).
- Creole Love Call.** 7, 15, 23, 28 (1927); 6 (1932); 13 (1932); 22 (1949); 60 (1963); 70 (1966).
- Creole Rhapsody.** 12, 17 (1931); 4 (1931).
- Crescendo in Blue.** 5 (1937).
- Dallas Doings.** 14, 16 (1933).
- Dancers in Love.** 29 (1945); 41 (1953).
- Dancing on the Stars.** 25 (1938).
- David Danced.** 62 (1963); 67 (1965).
- Daybreak Express.** 14, 16 (1933).
- Day Dream.** 26 (1940); 71 (1967).
- Delta Serenade.** 14, 16, 23 (1934).
- Depk.** 68 (1966).
- Dicty Gilde, The.** 9 (1929).
- Diminuendo and Crescendo in Blue.** 44 (1956).
- Diminuendo in Blue.** 5 (1937); 34 (1946); 69 (1966).
- Dinah's in a Jam.** 6 (1938).
- Doin' the Voom Voom.** 3 (1929); 8 (1929).
- Do Nothing Till You Hear from Me.** 22, 51 (1947); 53 (1961); 60 (1963); 66 (1965); 70 (1966); 77 (1969).
- Don't Get Around Much Any More.** 20, 22, 35, 51 (1947); 53 (1961); 58 (1963); 60 (1963); 77 (1969); 81 (1973).
- Don't Get down on Your Knees to Pray.** 74 (1968).
- Dooji Wooji.** 25 (1939).
- Double Check Stomp.** 10 (1929); 4 (1930).
- Down in Our Alley Blues.** 1, 6 (1927).
- Drag.** 76 (1968).
- Drawing Room Blues.** 33 (1946).
- Dream Blues.** 25 (1939).
- Drop Me off in Harlem.** 5 (1933); 53 (1961).
- Drum Is a Woman, A.** 43 (1956).
- Ducky Wucky.** 5 (1932).
- Duke Steps Out, The.** 10 (1929).



Listen to your music, not your turntable.

You don't hear distortion, rumble, wow or flutter when you listen to the Philips GA 212. The audio pros already know this. Now it's your turn to hear the best your records have, without listening to the turntable.

Most turntable problems are mechanical. Motors, controls or massive platters usually introduce sounds of their own. The stiff suspensions required to support heavy platters also contribute to acoustic feedback. These sounds are eliminated in the GA 212.

Solid-state electronics simply work more efficiently—with less noise. You just touch a control switch, no pressure is necessary, it lights up to tell you the GA 212 is working.

There's even a mini-computer net-

work working with the tachogenerator at the heart of the GA 212. It constantly monitors the speed you select. Any deviation is instantly corrected.

The tone arm is as advanced as the electronic control system. Friction is less than 1/10th of the tracking force. There's nothing to interfere with sound reproduction. Moreover, an hydraulically damped, cueing mechanism protects your cartridge and records as well.

We could print specifications, charts and lists of many more features. But we'd rather you listen for yourself. To paraphrase, one demonstration is worth a thousand words. Visit your better audio dealer. Or write to us for more information and your dealer's name.



PHILIPS HIGH FIDELITY COMPONENTS.
Distributed by
NORTH AMERICAN PHILIPS CORPORATION
100 East 42 Street, New York, New York 10017

CIRCLE 45 ON READER-SERVICE CARD

The BASF Half-Price Sale: Enough free tape to record 60 minutes of music.

Introducing the new BASF/LH Super cassette: Buy one at the regular price and get another for half price. By taking advantage of our special offer you can record sixty minutes of your favorite music free on the LH Super C120.

And we're making the same introductory offer on the LH Super C60 and C90 cassettes. In addition we're making the same half-price offer on our BASF LH 8-track cartridges in 45, 64, and 90-minute lengths.

There's no better time to get the BASF/LH Super cassette. And there's no better high density ferric oxide tape than the LH Super. The tape for less noise and more sound. With a wider dynamic range than other high

density tapes, BASF/LH Super also provides 50% more playback volume at the same level. With a BASF/LH Super you're assured of a lot less distortion...and a lot more pure sound. And like all BASF cassettes it's guaranteed jamproof.

The BASF Half-Price Sale. Look at it this way: Buy two twin-pack LH Super C120's and record two hours of music free.

Stop into your nearest dealer and ask for the BASF Half-Price Sale while the supply lasts. For more information, call or write BASF Systems, Crosby Drive, Bedford, Mass. 01730.

Tel: (617)
271-4000.



Available at
participating dealers only.



Duke's Place (C Jam Blues). 53 (1961); 65 (1965).
 Dusk. 31 (1940).
 Dusk on the Desert. 6 (1937).
 East St. Louis Toodle-oo. 1, 5 (1927); 2 (1927); 7, 15, 17, 23 (1927); 1 (1928); 13 (1932).
 Echoes of Harlem. 5 (1936); 24 (1938); 60 (1963).
 Echoes of the Jungle. 12, 16 (1931).
 Eighth Veil. 59 (1963); 61 (1963).
 El Gato. 49 (1958); 77 (1969).
 Ellington '66. 64 (1965).
 Emancipation Celebration. 28 (1944).
 Empty Ballroom Blues. 25 (1938).
 Eque. 75 (1968).
 Esquire Swank. 33 (1946).
 Everything but You. 32 (1945).
 Exposition Swing. 6 (1936).
 Fancy Dan. 36 (1951).
 Father Forgive. 74 (1968).
 Feeling of Jazz, The. 56 (1962).
 Festival Junction. 44 (1956).
 Fifi. 77 (1969).
 Finesse. 25 (1939).
 Five O'Clock Drag. 31 (1941).
 Flaming Sword, The. 30 (1940).
 Flaming Youth. 8, 15 (1929); 6 (1929).
 Filippant Flurry. 34 (1946).
 Flower Is a Lovable Thing, A. 65 (1965).
 4:30 Blues. 77 (1969).
 Frolic Sam. 24 (1936).
 Gal from Joe's, The. 5 (1938).
 Gathering in a Clearing, A. 33 (1946).
 Giddybug Gallop, The. 31 (1941).
 Go Away Blues. 49 (1958).
 Going out the Back Way. 26 (1940).
 Goin' to Town. 6 (1928); 9 (1929).
 Going Up. 50 (1959).
 Golden Broom and the Green Apple, The. 79 (1970).
 Golden Cress. 35, 36 (1947).
 Golden Feather. 34 (1946).
 Good Gal Blues. 25 (1939).
 Good Queen Bess. 26 (1940).
 Goof. 80 (1971).
 Great Times. 34 (1950).
 Grievin'. 5 (1939).
 Guitar Amour. 54 (1962).
 Gypsy Without a Song, A. 6 (1938).
 Half the Fun. 46 (1957).
 Happy-Go-Lucky Local. 34 (1946); 61 (1963).
 Happy Reunion. 80 (1971).
 Harlem Air Shaft. 28 (1940).
 Harlem Flat Blues. 3 (1929).
 Harlem Speaks. 5 (1933); 18 (1933).
 Harlem Twist. 1 (1928).
 Harmony in Harlem. 5 (1937).
 Haunted Nights. 10 (1929).
 Heaven. 74 (1968).
 Hey Baby. 33 (1946).
 Hey, Buddy Bolden. 43 (1956).
 High Life. 8, 17 (1929).
 Hodge Podge. 25 (1938).
 Hometown Blues. 25 (1939).
 Hop Head. 1, 5 (1927).
 Hot and Bothered. 1, 5 (1928); 13 (1932).
 H'ya Sue. 35, 36 (1937).
 Hyde Park. 18 (1933).
 I Ain't Got Nothin' but the Blues. 32 (1944); 81 (1973).
 I Could Get a Man. 35 (1947).
 I Didn't Know About You. 29 (1942).
 I Don't Know What Kind of Blues I Got. 30 (1941).
 I Don't Mind. 32 (1942).
 I Got It Bad and That Ain't Good. 23, 30 (1941); 20, 45 (1956); 53 (1961); 66 (1965); 70 (1966); 80 (1971); 81 (1973).
 I Let a Song Go out of My Heart. 5, 22 (1938); 23, 33 (1945); 66 (1965); 77 (1969).
 I Like the Sunrise. 65 (1965); 73 (1967).
 If You Were in My Place. 21 (1938).



I'm Beginning to See the Light. 53 (1961); 66 (1965); 81 (1973).
 I'm Checkin' out, Goombye. 6, 21 (1939).
 I'm in Another World. 25 (1938).
 I'm Just a Lucky So and So. 33 (1945); 53 (1961); 77 (1969).
 I'm Satisfied. 6, 21 (1933).
 I'm So in Love with You. 11 (1930).
 Imagine My Frustration. 65 (1965).
 Immigration Blues. 2 (1927).
 In a Blue Summer Garden. 34 (1950).
 In a Jam. 5 (1936).
 In a Mellotone. 30 (1940); 53 (1961); 80 (1971).
 In a Sentimental Mood. 6, 22 (1935); 23 (1945); 41, 42 (1953); 56 (1962).
 In the Beginning God. 67 (1965).
 In Triplicate. 77 (1969).
 Intimacy of the Blues, The. 71 (1967).
 Isfahan. 68 (1966).
 It Don't Mean a Thing If It Ain't Got That Swing. 5, 21 (1932); 32 (1945); 53 (1961); 69 (1966); 81 (1973).
 It Shouldn't Happen to a Dream. 34 (1946).
 It's Freedom. 74 (1968).
 It's Glory. 13, 16 (1931).
 It's Kinda Lonesome out Tonight. 81 (1973).
 I've Got to Be a Rug Cutter. 21 (1937); 81 (1973).
 Jack the Bear. 28 (1940).
 Jail Blues. 62 (1963).
 Jam with Sam. 61 (1963).
 Jam-a-Ditty. 34 (1946).
 Janet. 41 (1953).
 Javapachacha. 54 (1962).
 Jazz Convulsions. 3 (1929).
 Jazz Lips. 10 (1929).
 Jazz Potpourri. 5 (1938).
 Jeep Is Jumpin', The. 55 (1962).
 Jeep's Blues. 25 (1938); 44 (1956).
 Jitterbug's Lullaby. 24 (1938).
 Jive Stomp. 6 (1933).
 John Hardy's Wife. 31 (1941).
 Johnny Come Lately. 32 (1942); 34 (1950).
 Jolly Wog. 3 (1929).
 Jones. 49 (1958).
 Jubilee Stomp. 1, 5 (1928); 1 (1928); 2 (1928); 7, 15, 17 (1928).
 Jump for Joy. 31 (1941).
 Jumpin' Punkins. 31 (1941).
 June. 27 (1941).
 Jungle Nights in Harlem. 10 (1930).
 Junior Hop. 26 (1940).

Just a-Settin' and a-Rockin'. 30 (1941).
 Just Squeeze Me. 33 (1946); 50 (1959); 53 (1961); 69 (1966); 77 (1969).
 Killing Myself. 21 (1939).
 Kinda Dukish. 41 (1953); 61 (1963).
 King Fit the Battle of Alabam'. 62 (1963).
 Kissing Bug. 32 (1945).
 Ko-Ko. 28 (1940).
 Krum Elbow Blues. 25 (1938).
 La Plus Belle Africaine. 80 (1971).
 Lady Mac. 46 (1957).
 Lady of the Lavender Mist. 35, 36 (1947).
 Lament for Javanette. 27 (1940).
 Latin American Sunshine. 75 (1968).
 Lay-By. 61 (1963).
 Laying on Mellow. 77 (1969).
 Lazy Duke. 5 (1929).
 Lazy Man's Shuffle. 24 (1936).
 Lazy Rhapsody. 5 (1932).
 Le Fleurs Africaines. 57 (1962).
 Liberian Suite. 37 (1947).
 Lightnin'. 5 (1932).
 Limbo Jazz. 55 (1962).
 Little Posey. 6 (1939).
 Little Purple Flower, The. 76 (1968).
 Lonely Coed, A. 21 (1939).
 Long, Strong, and Consecutive. 33 (1945).
 Lord's Prayer, The. 67 (1965).
 Lots o' Fingers. 13 (1932).
 Lotus Blossom. 71 (1967); 80 (1971).
 Love Scene. 66 (1965).
 Love's in My Heart. 24 (1937).
 Lovin' Lover. 62 (1963).
 Lull at Dawn, A. 27 (1940).
 Madam Zaji. 43 (1956).
 Madness in Great Ones. 46 (1957).
 Magenta Haze. 34 (1946).
 Mainstem. 30 (1942).
 Matador, The. 69 (1966).
 Maybe I Should Change My Ways. 35, 36 (1947).
 Me and You. 31 (1940).
 Meditation. 74 (1968).
 Melancholia. 41 (1953).
 Menelik. 26 (1941).
 Merry Go Round. 19 (1933); 5 (1935).
 Midnight in Paris, A. 54 (1962).
 Midriff. 33 (1946).
 Misfit Blues. 61 (1963).
 Misty Morning. 6 (1928); 9 (1929); 9 (1929).
 Mobile Bay. 26 (1940).

Money Jungle. 57 (1962).
Monologue (Pretty and the Wolf). 36 (1951).
Montage. 62 (1963).
Mooche, The. 1, 5, 22 (1928); 1 (1928); 3 (1928); 8, 15, 17, 23 (1928); 40 (1952); 53 (1961); 60 (1963); 66 (1965); 70 (1966).
Mood Indigo. 4, 20 (1930); 5 (1930); 12, 17, 23 (1930); 13 (1932); 21, 22 (1940); 29 (1945); 39 (1950); 47, 51 (1957); 53 (1961); 55 (1962); 66 (1965); 70 (1966); 77 (1969).
Mood to Be Woored. 32 (1945).
Moon Mist. 32 (1942).
Moonbow. 59 (1963).
Morning Glory. 29 (1940).
Mount Harissa. 68 (1966).
Move Over. 1, 6 (1928).
Mr. J. B. Blues. 29 (1940).
My Little Brown Book. 56 (1962).
My Man Sends Me. 62 (1963).
My Mother, My Father. 62 (1963).
My People. 62 (1963).
My Sunday Gal. 26 (1940).
Mystery Song, The. 13 (1931).
Naturellement. 80 (1971).
Never No Lament (Don't Get Around Much Anymore). 23, 29 (1940).
New Black and Tan Fantasy, The. 22 (1938).
New East St. Louis Toodle-oo, The. 22 (1937).
New Orleans. 43 (1956).
New Orleans Lowdown. 2 (1927).
New York City Blues. 36 (1951).
New World a-Coming. 67 (1965); 79 (1970).
Newport Jazz Festival Suite. 44 (1956).
Newport Up. 44 (1956).
Night at the Cotton Club, The. 9 (1929).
Night Time. 41 (1953).
Noir Bleu. 27 (1941).
Ocupaca. 75 (1968).
Oh Babe, Maybe Someday. 21 (1936).
Oklahoma Stomp. 3 (1929).
Old Circus Train Turn Around Blues, The. 69 (1966).
Old King Dooji. 6 (1938).
Old Man Blues. 5 (1930); 11 (1930).
On a Turquoise Cloud. 35, 36 (1947).
Oscarlypso. 34 (1950).
Overture to a Jam Session. 34 (1946).
Parlor Social Stomp. 1 (1926).
Paris Blues. 54 (1962).
Passion Flower. 26 (1941); 41, 42 (1953); 65 (1965).

Perdido. 23, 30 (1942); 34 (1950); 40 (1952); 51 (1960); 61 (1963); 70 (1966); 77 (1969).
Perfume Suite. 29 (1945).
Pitter Panther Patter. 29 (1940).
Poco Mucho. 81 (1973).
Poor Bubber. 26 (1941).
Portrait of Bert Williams, A. 30 (1940).
Portrait of Louis Armstrong. 78 (1970).
Portrait of Mahalla Jackson. 78 (1970).
Portrait of Sidney Bechet. 78 (1970).
Portrait of the Lion. 5 (1939).
Portrait of Wellman Braud. 78 (1970).
Praise God. 74 (1968).
Praise God and Dance. 74 (1968).
Prelude to a Kiss. 5 (1938); 32 (1945); 41, 42 (1953); 47, 51 (1957); 77 (1969).
Pretty Woman. 33 (1946).
Primping for the Prom. 38 (1952).
Progressive Gavotte. 35, 38 (1947).
Purple Gazelle. 59 (1963).
Pussy Willow. 6 (1939).
Put-Itn. 76 (1968).
Pyramid. 6 (1938); 24 (1938); 59 (1963); 60 (1963).
Rabbit's Jump, The. 24 (1939).
Raincheck. 29 (1941); 71 (1967).
Ray Charles Place. 55 (1962).
Ready Eddy. 27 (1940).
Ready Go. 49 (1958).
Red Carpet. 49 (1958).
Red Garter. 49 (1958).
Red Shoes. 49 (1958).
Reflections in D. 41 (1953).
Reminisclin' in Tempo (Parts I-IV). 6 (1935).
Rendezvous with Rhythm. 25 (1938).
Rent Party Blues. 3 (1929); 6 (1930); 25 (1939).
Retrospection. 41 (1953).
Rexatious. 24 (1936).
Rhumbop. 43 (1956).
Rhythm Pum Te Dum. 43 (1956).
Riclitic, The. 55 (1962).
Ridin' on a Blue Note. 5 (1938).
Right On Togo. 80 (1971).
Ring Dem Bells. 11, 17, 23 (1930).
Rock Skippin' at the Blue Note. 36 (1951); 71 (1967).
Rockabye River. 29 (1946).
Rockin' in Rhythm. 5 (1930); 4 (1931); 12, 17 (1931); 42 (1954); 61 (1963); 77 (1969).
Rocks in My Bed. 30 (1941).
Rude Interlude. 14, 16 (1933).
Ruint. 50 (1958).
Rumpus in Richmond. 30 (1940).
Saddest Tale. 5 (1934).
Saratoga Swing. 9 (1929).
Satin Doll. 42 (1953); 51 (1958); 60 (1963); 64 (1965); 66 (1965); 77 (1969); 81 (1973).
Saturday Night Function. 8 (1929).
Savoy Strut. 25 (1939).
Schwiphil. 61 (1963).
Second Line. 78 (1970).
Self-Portrait of the Bean. 55 (1962).
Sempre Amour. 59 (1963).
Sepia Panorama. 30 (1940).
Serenade to Sweden. 6 (1939).
Sergeant Was Shy, The. 5 (1939).
Shepherd, The. 74 (1968).
Sherman, Shuffle. 32 (1942).
Shout 'em Aunt Tillie. 10 (1930).
Showboat Shuffle. 6 (1935).
Silk Lace. 59 (1963).
Skin Deep. 40 (1952); 45 (1956).
Skunk Hollow Blues. 25 (1939).
Sky Fell Down, The. 47 (1957).
Slap Happy. 5 (1938).
Sleeping Lady and the Giant Who Watches over Her, The. 75 (1968).
Slip of the Lip, A. 32 (1942).
Slippery Horn. 5 (1933).
Sloppy Joe. 9 (1929).

Smada. 36 (1951).
Snibor. 38 (1949); 71 (1967).
Solitude. 5, 20, 22 (1934); 14, 16, 23 (1934); 21 (1940); 39 (1950); 47, 51 (1957); 53 (1961); 57 (1962); 66 (1965); 70 (1966).
Some Saturday. 26 (1941).
Someone. 32 (1942).
Something About Believing. 74 (1968).
Something to Live For. 6 (1939); 65 (1965).
Sonnet for Caesar. 46 (1957).
Sonnet for Sister Kate. 46 (1957).
Sonnet In Search of a Moor. 46 (1957).
Sonnet to Hank Cinq. 46 (1957).
Sophisticated Lady. 22 (1933); 19 (1933); 5 (1940); 23, 29 (1945); 39 (1950). 45 (1956); 66 (1965); 70 (1966); 77 (1969).
Soul Flute. 80 (1971).
Soul Soothing Beach. 80 (1971).
Squaty Roo. 26 (1941).
Star-Crossed Lovers, The. 46 (1957); 61 (1963).
Stepping Into Swing Society. 6 (1938).
Stevedore Stomp. 9 (1929).
Stevie. 55 (1962).
Stomp, Look, and Listen. 35, 36 (1947).
Stompy Jones. 14, 16 (1934); 24 (1936); 50 (1959).
Strange Feeling. 29 (1945).
Subtle Lament. 5 (1939).
Subtle Slough (Just Squeeze Me). 26 (1941).
Suburban Beauty. 38 (1956).
Such Sweet Thunder. 46 (1957).
Suddenly It Jumped. 29 (1946).
Sugar Hill Penthouse. 28 (1944).
Suite Thursday. 6 (1963).
Sultry Serenade. 35, 36 (1947).
Sultry Sunset. 34 (1946).
Sumplin' About Rhythm. 6 (1934).
Supreme Being. 74 (1968).
Swamp Goo. 76 (1968).
Swampy River. 1 (1928).
Sweet Charlot. 6 (1930).
Sweet Dreams of Love. 10 (1930).
Sweet Jazz o' Mine. 10 (1930).
Sweet Mama. 4 (1929).
Swing Low. 6 (1932).
Swing Pan Alley. 24 (1938).
Swinging in the Dell. 24 (1938).
Swingtime in Honolulu. 21 (1938).
Syncopated Shuffle. 6 (1929).
T.G.T.T. 74 (1968).
Take It Easy. 1, 6 (1928); 1 (1928); 2 (1928).
Take Love Easy. 35 (1947).
Take the "A" Train. 23, 30 (1941); 34 (1950); 40, 51 (1952); 45 (1956); 49 (1958); 52 (1961); 70 (1966); 76 (1968); 77 (1969).
Take the Coltrane. 56 (1962).
Tattooed Bride. 39 (1950).
Telecasters, The. 46 (1957).
Tell Me It's the Truth. 67 (1965).
Tigress. 59 (1963).
Thanks for the Beautiful Land on the Delta. 78 (1970).
That's the Blues Old Man. 26 (1940).
Things Ain't What They Used to Be. 26 (1941); 29 (1945); 41 (1953); 60 (1963); 77 (1969).
Three Cent Stomp. 35, 36 (1947).
Timon of Athens March. 66 (1965).
Tina. 75 (1968).
Togo Brava-Brava Togo Suite. 80 (1971).
Tone Parallel to Harlem, A. 37 (1951); 61 (1963); 79 (1970).
Tonk. 33 (1946); 34 (1950).
Tootle for Cootie. 77 (1969).
Tootin' Through the Roof. 6 (1939).
Tourist Point of View. 68 (1966).
Translucency. 28 (1946).
Trombonio-Bustoso-Issimo. 69 (1966).
Tulp or Turnip. 34 (1946); 81 (1973).
Tutti for Cootie. 61 (1963).
Twitche, The. 70 (1966).
Up and Down, Up and Down. 46 (1957).



Up-Jump. 76 (1968).
 Upper Manhattan Medical Group (UMMG). 71 (1967).
 Uptown Downbeat. 6 (1936).
 Very Special. 57 (1962).
 Volupté. 59 (1963).
 Walkin' and Singin' the Blues. 38 (1958).
 Wall Street Wail. 4 (1929).
 Wanderlust. 25 (1938); 55 (1962).
 Warm Valley. 28 (1940); 42 (1954); 57 (1962); 76 (1968).
 Washington Wobble. 7, 15, 17 (1927).
 Way Low. 6 (1939).
 Weely. 6 (1939).
 West Indian Dance. 28 (1944).
 What Am I Here For? 30 (1942); 65 (1965).
 What Color Is Virtue? 62 (1963).
 What Else Can You Do with a Drum? 43 (1956).
 Who Knows? 41 (1953).
 Wig Wise. 57 (1962).
 Wild Man. 52 (1961).
 Will You Be There? 62 (1963); 67 (1965).
 Women. 35, 36 (1947).
 Work Song. 28 (1944).
 Workin' Blues. 62 (1963).
 You Better Know It. 43 (1956).
 You Can Count on Me. 21 (1939).
 You Dirty Dog. 55 (1962).
 You Gotta Crawl. 35 (1947).
 You Need to Rock. 50 (1958).
 Your Love Has Faded. 21 (1939).
 Zaji's Dream. 43 (1956).
 Zweet Zurzday. 61 (1963).

II. By other composers

Ain't Misbehavin'. 18 (1933).
 Alabama Home. 21 (1937).
 All God's Chillun Got Rhythm. 6, 21 (1937).
 All I Need Is the Girl. 73 (1967).
 All My Loving. 64 (1965).
 All of Me. 49 (1958); 61 (1963).
 Arabian Lover. 9 (1929).
 Artistry in Rhythm. 58 (1963).
 Aurora Borealis. 72 (1967).
 Autumn Leaves. 20, 47 (1957).
 Back Home Again in Indiana. 33 (1946).
 Bandanna Babies. 8, 15 (1928).
 Basin Street Blues. 50 (1958).
 Beale Street Blues. 33 (1946); 50 (1958).
 Beautiful Friendship, A. 64 (1965).
 Big Nick. 56 (1962).
 Black and Blue. 3 (1929).
 Blowin' in the Wind. 63 (1964).
 Blue Again. 12 (1930).
 Blue Is the Night. 29 (1946).
 Blue Skies (Trumpet No End). 34 (1946).
 Boola-Boola. 76 (1968).
 Bugle Call Rag. 1 (1928); 13, 16 (1932).
 Call Me Irresponsible. 63 (1964).
 Charade. 64 (1965).
 Chicago. 18 (1933).
 Chicago Stomp Down. 1 (1927).
 Chole. 28 (1940).
 Collages #3. 72 (1967).
 Come Back to Me. 73 (1967).
 Comme Çi, Comme Ça. 54 (1962).
 Dancing in the Dark. 20, 47 (1957).
 Danke Schoen. 63 (1964).
 Days of Wine and Roses. 64 (1965).
 Dear Old Southland. 14, 16 (1933).
 Delta Bound. 21 (1932).
 Diga Diga Doo. 1 (1928); 8, 15, 17 (1928).
 Dinah. 13, 16 (1932).
 Doin' the Frog. 2 (1927).
 Doin' the New Low Down. 1 (1928).
 Done Caught You Blues. 8 (1928).
 Don't Explain. 49 (1958).

Down a Carolina Lane. 19 (1933).
 Ebony Rhapsody. 16 (1934).
 Fair Wind. 72 (1967).
 Five O'Clock Whistle. 31 (1940).
 Flamingo. 34 (1950); 42 (1953).
 Fly Me to the Moon. 63 (1964).
 Follow Me. 73 (1967).
 Freeze and Melt. 9 (1929).
 Georgia Grind. 1 (1926).
 Get Yourself a New Broom. 21 (1933).
 Good Life, The. 64 (1965).
 Goodbye. 58 (1963).
 Got Everything but You. 8, 15 (1928).
 Happy as the Day Is Long. 21 (1933).
 Harlem River Quiver. 7, 15 (1927).
 Harlemania. 9 (1929).
 Hayfoot Strawfoot. 32 (1942).
 Hello Dolly. 63 (1964).
 Hello, Little Girl. 49 (1958).
 Hittin' the Bottle. 11 (1930).
 Home Again Blues. 4 (1930).
 Hot Feet. 9 (1929).
 How High the Moon. 35 (1947).
 I Can't Believe That You're in Love with Me. 24 (1937); 35, 38 (1947).
 I Can't Give You Anything but Love. 8, 17 (1928).
 I Can't Stop Loving You. 64 (1965).
 I Done Caught You Blues. 8 (1928).
 I Left My Heart in San Francisco. 63 (1964).
 I Must Have That Man. 8, 15, 17 (1928).
 I Want to Hold Your Hand. 64 (1965).
 I Was Made to Love You. 10 (1929).
 I Wish You Love. 54 (1962).
 If You Can't Hold the Man You Love. 7 (1927).
 I'm Gonna Hang Around My Sugar. 1 (1925).
 In A Mizz. 21 (1939).
 In the Shade of the Old Apple Tree. 6 (1933).
 Indian Summer. 73 (1967).
 Is That Religion. 4 (1931).
 Isn't Love the Strangest Thing? 21 (1936).
 It Was a Sad Night in Harlem. 21 (1936).
 It's Mad, Mad, Mad. 35 (1947).
 It's Swell of You. 21 (1937).
 I've Got the World on a String. 19 (1933).
 Japanese Dream. 9 (1929).
 Jazz Cocktail. 6 (1932).
 Jingle Bells. 38 (1962).
 Jumpin' at the Woodside. 52 (1961).
 Jungle Jamboree. 3 (1929).
 Just a Memory. 50 (1958).
 Just You, Just Me. 29 (1946).
 Keep a Song in Your Soul. 12, 17 (1931).
 Kissin' My Baby Goodnight. 6, 21 (1936).
 Kitty. 35 (1947).
 Let's Fall in Love. 50 (1958).
 Limehouse Blues. 12, 16, 17 (1931).
 Linger Awhile. 26 (1940).
 Live and Love Tonight. 16 (1934).
 Louisiana. 3 (1928).
 Love Is Like a Cigarette. 21 (1936).
 Love to Hear My Baby Call My Name. 49 (1958).
 Loveless Love. 50 (1958).
 Mack the Knife. 69 (1966).
 Mademoiselle de Paris. 54 (1962).
 Maori. 14 (1932).
 March of the Hoodlums. 10 (1929).
 Memories of You. 11, 17 (1930).
 Memphis Blues. 33 (1946).
 Mississippi Dry. 10 (1929).
 Moon River. 64 (1965).
 More. 63 (1964).
 My Gal Is Good for Nothing but Love. 10 (1929).
 My Heart Sings. 54 (1962).
 My Honey's Lovin' Arms. 33 (1946).
 Nameless Hour. 72 (1967).
 Never on Sunday. 63 (1964).
 Nine Little Miles from Ten-Ten-Tennessee. 11 (1930).
 No Greater Love. 6 (1936).

No Papa No. 8, 15 (1928).
 No Regrets. 54 (1962).
 On the Sunny Side of the Street. 61 (1963).
 One O'Clock Jump. 58 (1963).
 Paducah. 3 (1928).
 People. 64 (1965).
 Petite Waltz. 54 (1962).
 Poor Butterfly. 20 (1958); 73 (1967).
 Raisin' the Rent. 21 (1933).
 Red Hot Band. 2 (1927).
 Red Roses for a Blue Lady. 64 (1965).
 Rhapsody in Blue. 58 (1962).
 Riff Staccato. 32 (1945).
 River and Me, The. 12 (1931).
 River Seine, The. 54 (1962).
 Rose of the Rio Grande. 5, 21 (1938); 61 (1963); 69 (1966).
 Rose Room. 6 (1932).
 Royal Garden Blues. 28 (1946); 50 (1958).
 Runnin' Wild. 4 (1930).
 St. Louis Blues. 8 (1928); 33 (1946); 50 (1958).
 Salome. 76 (1968).
 Sam and Delilah. 12 (1931).
 Santa Claus, Bring My Man Back. 8 (1928).
 Second Time Around, The. 63 (1964).
 Segue in C. 52 (1961).
 Sentimental Journey. 58 (1963).
 Sheik of Araby, The. 5, 20 (1932).
 Shoe Shine Boy. 21 (1936).
 Sidewalks of New York, The. 31 (1940).
 Silent Night, Lonely Night. 72 (1967).
 Singin' in the Rain. 35 (1947).
 Sleep, Sleep, Sleep. 58 (1963).
 Smoke Rings. 58 (1963).
 So Little Time. 63 (1964).
 Song and Dance. 72 (1967).
 Song of the Cotton Field. 2 (1927).
 Speak to Me of Love. 54 (1962).
 Stack O'Lee Blues. 1 (1928).
 Stormy Weather. 5, 21 (1940).
 Strangers on the Shore. 63 (1964).
 Sunny. 73 (1967).
 Swamp Fire. 29 (1946).
 Swanee Shuffle. 10 (1929).
 Sweet Mama. 1 (1928).
 Tenderly. 47 (1957).
 That Lindy Hop. 11 (1930).
 There's a Lull in My Life. 21 (1937).
 Three Little Words. 11 (1930).
 Tiger Rag (Parts I and II). 3 (1929).
 Tishomingo Blues. 2 (1928).
 To You. 52 (1961).
 Trombone Blues. 1 (1925).
 Troubled Waters. 16 (1934).
 Truckin'. 6, 21 (1935).
 Tuxedo Junction. 58 (1963).
 Twelfth Street Rag. 4 (1931).
 Under Paris Skies. 54 (1962).
 Until I Met You. 52 (1961).
 Wabash Blues. 50 (1958).
 Waltz You Saved for Me, The. 58 (1963).
 Wang Wang Blues. 4 (1930).
 Weary Blues. 50 (1958).
 What Can a Poor Fellow Do? 1 (1927).
 What Good Am I Without You? 12 (1930).
 When a Black Man's Blue. 12 (1930).
 When It's Sleepy Time down South. 58 (1963).
 When My Sugar Walks down the Street. 21 (1938).
 When Your Lover Has Gone. 49 (1958).
 When You're Smiling. 4 (1930).
 Where or When. 47 (1957).
 Willow Weep for Me. 47 (1957).
 Without a Song. 26 (1940).
 Woodchopper's Ball. 58 (1963).
 Yellow Days. 73 (1967).
 Yellow Dog Blues. 2 (1928).
 You Gave Me the Gate. 21 (1938).
 You're Lucky to Me. 11 (1930).



The Nakamichi Revolution

An extravagant statement? Not at all. For the Nakamichi 700 Tri-Tracer cassette system is so completely different from anything that has gone before that it truly represents a quantum jump in cassette technology.

A brilliantly engineered instrument, the Nakamichi 700 is an extraordinary blend of electronic and mechanical sophistication.

To cite a few innovative examples, three separate heads—erase, record, playback—afford off the tape monitoring, but more importantly, extend flat frequency response to beyond 20,000 Hz. A closed-loop dual capstan system employs a servo-controlled d.c. motor to maintain rock-steady, constant speed and a second motor takes over in fast forward and rewind. IC logic and feather-touch solenoids control all tape functions. A built-in record head azimuth-alignment beacon insures perfect recordings every time.

But enough. An extended technical description goes far beyond the scope of this ad.

Far more persuasive, we think, are these comments from a Hirsch-Houck Laboratories Test Report that appeared in the December 1973 issue of Stereo Review.

"As our test data indicate, the Nakamichi 700 is an extraordinary cassette recorder... With Nakamichi CrO₂ tape, the performance was... an almost incredible ± 1.5 dB from 46 to 22,500 Hz... The noise level, referred to the 3 per cent distortion level, was very low... -57 dB without Dolby and -62.5 dB with Dolby."

They go on to say, "We could not measure the 700's combined wow and flutter because it was below the residual level of our test tape."

Summing up, the Report declares, "... we would rank it (the Nakamichi 700) as the best cassette recorder we've tested and one of the best tape recorders of any type we have ever used."

See and hear the Nakamichi 700 and the companion Model 1000 at your dealer now. Then go out and start your own little revolution.

For complete information and the name of your nearest dealer write: Nakamichi Research (U.S.A.), Inc., 220 Westbury Avenue, Carle Place, N.Y. 11514. In California: 1101 Colorado Avenue, Santa Monica 90404.



PERFECTION THROUGH PRECISION.

NAKAMICHI

Epilogue

IS IT POSSIBLE—and is it right—that Ellington's music should be relegated to perpetuation solely by mechanical reproductive means? Is this remarkable musical output not to survive in live performances or perhaps only in transmutations and improvisations by others, based on the Duke's tunes?

Since Ellington's death, the factions have formed, in most cases rigidly affirming previously conceived notions. And curiously, much of the argumentation directly or indirectly opposes the perpetuation of his music as a living repertory.

The arguments run something like this. 1) Jazz is a spontaneously created, largely improvised music that cannot be recaptured for repetition. Some even say "should not." Therefore, jazz has no re-creatable repertory, as classical music does. It is constantly renewable but only in terms of improvisation, i.e. other "spontaneously created" versions of the original. It is not a music ever to be fixed.

2) Should one play Ellington's work while some of his musicians for whom the music was originally created are still alive? Indeed his orchestra continues under his son Mercer's leadership, presumably obviating the need for others to concern themselves about the preservation of Ellington's music.

3) Since it is impossible to imitate the great soloists/personalities of the Ellington ensemble—Johnny Hodges, Lawrence Brown, Rex Stewart—this whole body of music is relegated to survival only in archival form, in the "museum" of recordings.

In addition there are always certain obsessively possessive jazz critics who believe that jazz is some kind of exclusive area of music belonging to them and that treating it as repertory and thus making it available to other musicians and audiences will automatically dilute and desecrate its purity.

I cannot believe that a music as profoundly important as Ellington's (and Billy Strayhorn's) should meet such an uncertain fate. And indeed there is no reason why this music—or at least some of it—cannot continue to be played close to how it was originally conceived. The qualifying words here are "some of it" and "close."

There is, obviously, some jazz literature that could in fact never be re-created. One would not think of duplicating one of John Coltrane's thirty-five-minute improvisations or Eric Dolphy's amazing solos on "Stormy Weather" or indeed Hodges' "Warm Valley" performance. But Ellington's music is not limited to that kind of improvised jazz. It is well-known that the Duke rejected the narrowing stigmatization of the term "jazz" for his music. And in truth much, perhaps the greater part, of his output consists of *orchestral compositions*—for a jazz



Are the Recordings Enough?

by Gunther Schuller

orchestra perhaps, but an orchestra nevertheless—very often fully notated or fixed in some permanent way by himself or his musicians or both in combination. In many of these works the "improvised" solos are brief, incidental, and surprisingly "fixed" as a permanent feature of that performance. Certain "solos" were even handed down from player to player through the decades, as witness Bubber Miley's contributions from the late 1920s being played virtually the same way by his successors Cootie Williams, Ray Nance, Cat Anderson, Clark Terry, and several others. Such solos were never pure off-the-top-of-the-head improvisations to begin with. They were well-thought-out, prepared, and integrated into the total piece, and *because* this was so they were generally not tampered with by later incumbents of that chair.

This is not very far removed, if at all, from the instance of a classical composer writing a solo or a concerto, perhaps with a certain musician in mind (think of the Brahms concerto written for Joachim).

which is then played by others with a slightly different style, tone, interpretation, and character.

Apart from the "solo" question in such orchestral jazz pieces, the orchestral frame is, of course, even more specifically fixed, notated, rehearsed, and played more or less the same way in each performance. It seems to me that such pieces—and Ellington created hundreds of them—are eminently suitable to performance by others if sensitively and conscientiously approached.

In answer to the second point, even when Duke was still alive a huge number of his most famous compositions were not in the band's repertory. So there were no live performances by him of such masterpieces as "Ko-Ko" or "Blue Serge" or "Azure" or *Remiscin' in Tempo* or "Dusk." Duke undoubtedly had his reasons for not maintaining much of the old material, apart from the fact that it is simply not possible to keep over a thousand pieces in a single band's repertory. I think his reasons were mostly personal. For example, when Hodges died, virtually all the recent pieces associated with him were eliminated from the then repertory of the band, because, I think, Hodges' loss was such for Ellington that he could not bear to have anyone else play them—even if there had been someone in the band who *could* play them.

With all respect for Duke's feelings, one must say that once a composer creates a work it cannot remain the exclusive property of its creator or the person(s) for whom it was created. It belongs, in the broadest (non-copyright) sense, to the world. One simply comes back to the point that pieces as original, as perfect, as imaginative, as beautiful as Ellington's best cannot just be buried in the past. They must survive; they must be heard.

And something must be done about it before more of Ellington's music, scores and parts, disappear. Perhaps more exists than one can ascertain at this time, so soon after his death. I do know that in trying to obtain the parts for a half-dozen Ellington scores a few years ago, several days of diligent search on the part of Tom Whaley and Joe Benjamin produced nothing. Perhaps they'll turn up, but one shudders to think of the possibility that they may not.

Some will say it is enough to take some of Ellington's pieces—like "Satin Doll" or "Sophisticated Lady"—and use them as a basis for improvisations and arrangements. Unfortunately that preserves very little of Ellington. Miles Davis improvising on "Satin Doll" will come out much more Miles Davis than Duke Ellington. Furthermore most jazz musicians perform their own tunes, largely for financial reasons (like record royalties), and very few improvise on compositions by others. Beyond that, it is a fact that the majority of Ellington's music does not lend itself to that kind of improvisation. His pieces are always more than tunes, a set of changes, or a line. They are true fully thought-out compositions

written for orchestra, often very complex in structure and form. Should these perish simply because they do not conform to the norm of tunes on which musicians like to blow choruses?

The remarkable fact is that a great deal of Ellington's music is *not* dependent upon performance by his own orchestra or by the Browns, Carneys and Hodgeses. It transcends those personal qualities. It turns out that it ultimately doesn't matter whether an eight-bar "solo" by Brown, for example, in the middle of a mostly arranged composition has *exactly* Brown's tone or vibrato or slide technique. What is important is to preserve the essence and character and as much of the specifics of that "solo" as possible, because it would be difficult to conceive of anyone doing anything better in its place. Whether Brown or Ellington or both chose the notes, the result that was finally approved by Duke and performed or recorded in that form is without question the best possible realization of that musical idea or moment. *That* is what is important to preserve: the music as it was *originally* conceived either singly by Duke or jointly by him and his musicians.

There can be little doubt that the original creative impulses and the conditions under which they occurred constitute the most complete and perfect realization. These conditions include the inspiration Ellington received from his players to create certain pieces and musical ideas for them. But it does not necessarily follow that those musical creations are limited to performance by those who first inspired them. That is obviously not true in classical music and need not be in jazz either.

In truth, Ellington's compositions are, *as* compositions, so durable that they can be played by others sensitively re-creating the original notes, pitches, rhythms, timbres, etc. But what is most astonishing is that they can, in performances by fine musicians with fine ears, not only re-create the original, but bring to it an excitement and drive that has its own validity even though it may not be precisely the excitement that Ellington and his men got.

This is, of course, an exact parallel to classical repertory, where no two interpretations of a Brahms or Tchaikovsky symphony are the same, despite the fact that conductors and performers will be playing from the same notated parts and score. It is in that same sense that much of Ellington's music can be preserved—and *must* be. It is too important a part of our American musical legacy.

Ellington, who was always *sui generis* and conceptually ten years ahead of his contemporaries, produced an *oeuvre* that transcends the parochial views of most jazz purists. Indeed many of them did not accept or understand his musical innovations when they first appeared. It would be most inappropriate if they now would kill the growing movement towards the preservation of the jazz repertory, not only Ellington's. ●



The best!

Making a statement like that is really sticking your neck out. But not if you're SAE. We possess many sound facts to back up our claim: a decade of manufacturing experience; the most accomplished engineers; the finest parts; the most faithful reproduction of the recorded signal; unparalleled specifications and an unprecedented five year warranty.

A superb selection of "separates" allows you to create a variety of systems. Only SAE offers you this high degree of diversification while maintaining "state-of-the-art" quality.

Visit your nearest SAE dealer today for a demonstration. Hearing is believing.

SAE

Components for the Connoisseur

Mail coupon today for free detailed information on SAE components

SAE, Inc., Dep't. H.F. - 11/74
 P.O. Box 60271 Terminal Annex
 Los Angeles, Calif. 90060

Please send Free Product Information on SAE Components.

NAME _____

ADDRESS _____

CITY _____

STATE _____ ZIP _____

CIRCLE 53 ON READER-SERVICE CARD

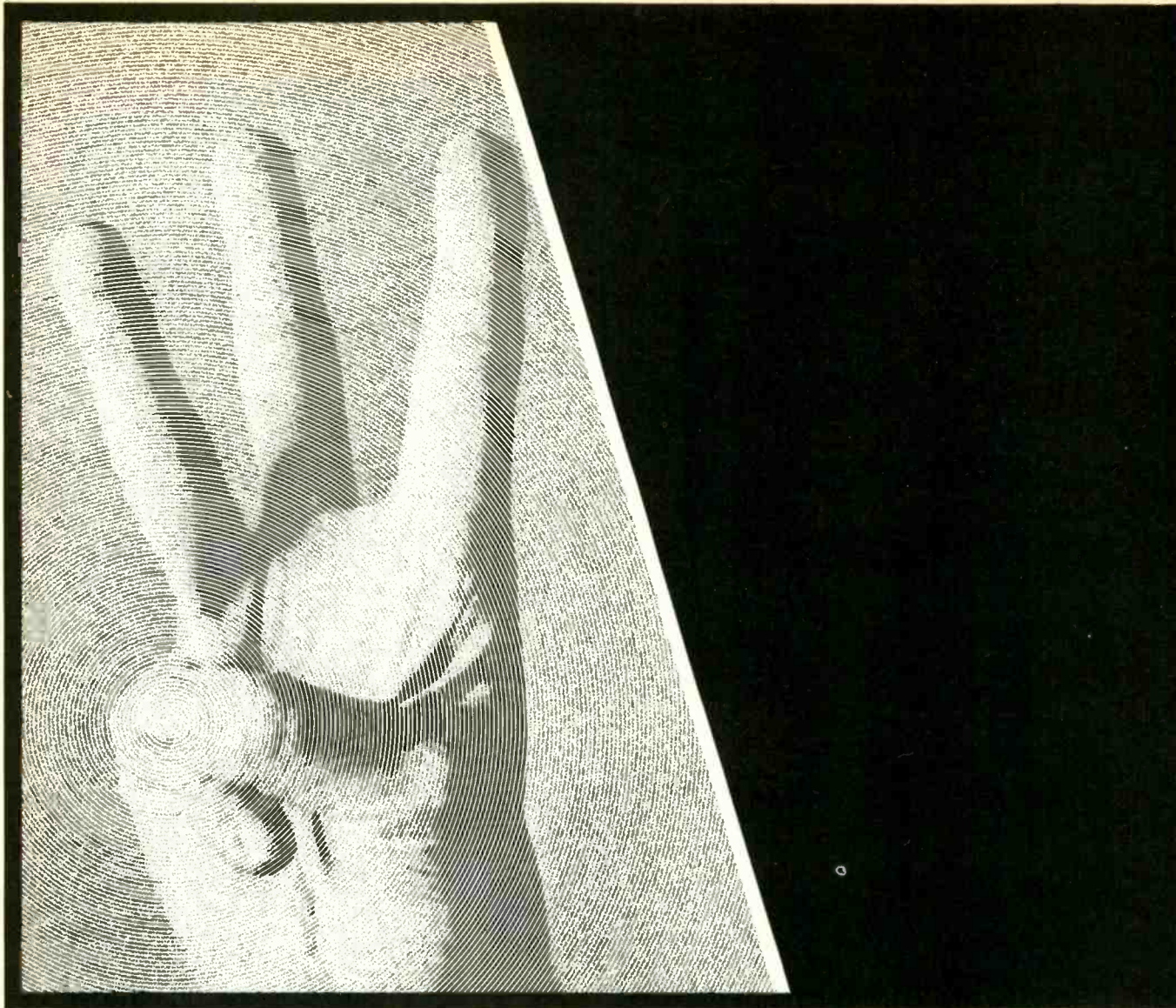

Best. Best. Best.



Permit us this momentary bit of self-indulgence, because our intentions are pure: to assist you in choosing the best phono cartridge for your hi-fi system, within the practical limitations of your audio budget. To begin, if you feel uncomfortable with anything less than state-of-the-art playback perfection, we heartily recommend the Shure V-15 Type III, a cartridge of such flawless performance it is the perfect companion to the finest turntables and tone arms available today — and those coming tomorrow. At a more moderate level of performance and price, we suggest the Shure M91ED, a superb performer second in trackability only to the Type III. Finally, for optimum performance under a budget austerity program, the yeoman Shure M44E is for you. All in all, these are three great ways to enjoy music with the kind of system you have decided is best for you.

Shure Brothers Inc.
222 Hartrey Ave., Evanston, Ill. 60204
In Canada: A. C. Simmonds & Sons Ltd.

CIRCLE 58 ON READER-SERVICE CARD





the new
releases

by R. D. Darrell

The Hyphenated Stokowski: Hail (Once Again) and Farewell (but Not for Good)

London Phase-4 and Odyssey releases prompt a fresh look at the controversial musical adaptations.

ONCE UPON A time much more circumscribed, far less sophisticated, than our own, few musical bylines were a stronger guarantee of record-sales success than that of Bach-Stokowski.* And perhaps none exerted, for a decade or so, a more powerfully significant influence on inexperienced listeners of all ages. Whole generations of music lovers who grew up in the Depression and World

War II eras will never be able to forget how electrifyingly they were first introduced to Bach—often indeed to symphonic music itself—by the Stokowskian transcription and recorded-performance series.

That series began with a then-unprecedented Big Bang (the explosion of a time bomb with a two-century-delay fuse) in January 1928 with the only later world-famous S. 565 Toccata and Fugue in D minor on Victor 6751. A steadily growing flood of further 78-rpm shellac discs and albums followed: the S. 853 E flat minor Prelude coupled with the S. 639 chorale-prelude "*Ich ruf' zu Dir*" on Victor 6786 in April 1928; the S. 582 Passacaglia and S. 680 chorale-prelude "*Wir glauben all*" (together with the Second *Brandenburg* Concerto, with the high trumpet parts transposed an octave down) in Victor album M 59 in December 1929; etc. Later, in the '40s, after the conductor had parted company with both the Phila-

*Ironically enough, the "hyphenated Stokowski" at one time coarced, not very seriously, anonymity. Although his S. 582 Passacaglia transcription was acknowledged in the conductor's own program-book notes on its first concert performance, from that of the S. 565 Toccata and Fugue in February 1926, omitted the transcriber's name in both program listing and notes. So did the 1928 first S. 565 recording and the others released in the next few years—although in both concert and record cases "everybody" knew very well who the seemingly overmodest transcriber actually was. If I haven't skipped an earlier example in my hasty search of the historical data, the outworn game was finally abandoned with the Bach-Stokowski accreditation of the *Rheingold* symphonic synthesis (then labeled merely "excerpts") in Victor album M 179 of June 1933.



STOKOWSKI *Continued*

delphia Orchestra and Victor, some of the most popular works were rather ineffectively re-recorded with the All-American Youth Orchestra for Columbia. But soon the period of changeover from 78s to LPs and 45s found Stokowski returning to what was now RCA Victor to conduct an all-star pickup ensemble grandly known as "His" Orchestra in a new series of almost exclusively re-recordings.

But also by this time, even before the monophonic era drew to a close, mass-public taste was changing and a connoisseur demand for "authentic" Bach recordings was insatiably growing. That the Bach-Stokowski byline no longer spelled sure success became undeniable when the first batch of re-recordings of the old favorites in stereo (with another of "His" orchestras for Capitol) was not followed by others. A decade or so later, a projected new series back with the Philadelphians for Columbia never actually materialized. And it is only now, a decade and a half or so still later, when the conductor's indefatigable peregrinations have taken him as far as Prague for guest appearances and recordings with the Czech Philharmonic, that a few of the Bach-Stokowski favorites reappear. (And not for the last time: RCA has recorded yet another LP's worth.)

Only those of us who lived through the '20s and '30s can appreciate how well-nigh impossible it is to make today's young listeners understand how incredibly the musical world has metamorphosed in the meantime.

In the first place, not only Bach, but most "old" masters were scantily represented at best in concert, even more rarely on records. Even worse—at least by today's standards—when they were heard at all they were generally in arrangements or transcriptions (piano instead of harpsichord or clavichord, for example). And when prescribed instruments *were* used, they were almost always anachronistic types (big iron-frame harpsichords, nineteenth-century "symphonic" organs, etc.).

Then, worst of all, the interpretations themselves were with rare exceptions characterized by "expressiveness" far more suitable for music of the Romantic period than of baroque and earlier times. Even such justly famed Bach specialists as Landowska, Schweitzer, and Casals were far from guiltless in this respect—yet it was impossible then to complain harshly about them or anyone who helped to refute the old canard that Bach's works were cerebrally devoid of feeling, even mainly *Augenmusik* better suited for pedantic analysis than for actual performance.

Hence the Stokowski transcriptions could be, and were, a thrillingly dramatic revelation to innumerable listeners for whom Bach first came vitally alive in them. And for a considerable time the potent combination of Stokowskian scoring and Stokowskian recorded performances played an incalculably influential role in the histories of both music "appreciation" and audio technology.

Even today, when "transcription" has become something of a dirty word and we better realize the artistic "wrongness" of Stokowski's sonic inflations and man-

nered shaping of phrases and tempos, it's not easy to condemn without qualification the Bach-Stokowski canon. A few of the worst examples are indeed unforgivable horrors—like that victim of musical elephantiasis, the Chaconne from the S. 1004 Unaccompanied Violin Sonata. (I've never forgotten Paul Henry Lang's observation that the poor Chaconne itself emerges from a performance of this transcription like an atom that has passed through an atom-smashing machine.) Then there are smaller lyrical pieces of which the Stokowskian versions (in performance perhaps more than in scoring) are only too accurately described by annotator Charles O'Connell's tropically luxuriant prose:

Phrases impalpably delicate, pathetic beyond words and colored beyond description, float in the air like prayers, and of them is created an atmosphere of reverent longing, of pathos, and of tenderness almost too beautiful to bear.

Amen. But we shouldn't forget to balance such schmaltz with the genuine poignance and eloquence of such true masterpieces as the S. 639 chorale-prelude "*Ich ruf zu Dir*" scoring (which I'm saddened not to find in the present collection). And, while there are undeniably anachronistic details in the big organ-work transcriptions (although more of them, to my mind, in Stokowski's performances than in the scores themselves), even purists must find it hard to resist the sheer dramatic power and impact of the symphonized S. 565 Toccata and Fugue and S. 582 Passacaglia and Fugue—especially the implacable horn-choir motif at the climactic ending of the latter. I sincerely believe that all of Bach's organ works are best heard on an authentic-period, or baroque-styled, instrument, yet as much as I enjoy them so played there still are moments in the larger-scaled works in particular when I can't help yearning for something *more* in the way of sheerly sonic weight and breadth.

Other Stokowski transcriptions are a very mixed bag indeed—some of them even internally, like the present S. 680 chorale-prelude "*Wir glauben all' an einen Gott*," whose "Giant Fugue" nickname has tempted Stokowski to tack a grossly inflated ending onto a score he began with such piquant restraint. None of the Bach works themselves was properly identified originally, even granted that S., or BWV, specifications were not available until 1950, and some still are confusingly titled: "Chorale from the Easter Cantata," for example. There are several "Easter Cantatas," and the excerpt chosen is not the final four-part chorale of the Cantata No. 4, *Christ lag in Todesbanden*, but the third verse set for choir tenors singing in unison the chorale theme against vigorous orchestral figures. (Like all the other current selections, this one has been recorded before, first with the Philadelphians in Victor album VM 401 of December 1937.)

The transcription of clavier pieces (like the stately S. 853 Prelude from Book I of the *Well-Tempered Clavier*, first recorded in 1928) and of "spiritual" songs (like the S. 487 "*Mein Jesu*," first recorded back in 1937 in the VM 401 album set) are particularly susceptible to romanticization at best, outright sentimentalization at worst. Yet

of course the scoring-enhanced emotional fervency is just what makes them so irresistibly appealing to so many listeners.

And however sternly Stokowski's *taste* may be questioned, his technical *skill* as an orchestrator/transcriber is best measured against scorings of some of the same works by such noted composers as Schoenberg and Respighi, such noted conductors as Sir Henry Wood ("Klenovsky") and Ormandy, among innumerable others. Surely Stokowski is seldom matched and never, I dare say, surpassed.

Against all this historical background, it is so appropriate that the long-triumphal recording career of Stokowski's Bach transcriptions should be commemorated and crowned by the fabulous nonagenarian's playing and recording of some of them for (not necessarily) the last time. And it's so stimulating to hear the searching new illuminations that present-day engineering techniques can throw on these inimitably Stokowskian scores that I shrink from objective evaluations—rightly fearing they'll turn out to be animadversions—of the present interpretations and performances, as distinct from the recordings themselves.

It's only with sadness that I'm forced to note that with time and age the conductor's readings have grown self-indulgently slower, more portentous (even pretentious), and more uninhibitedly emotional than ever before. And even the performances by the enthusiastically responsive Czech players (who make up a fine orchestra, even if they are no Philadelphians) lack the supreme tautness of tempo, balance, and attack control Stokowski would have demanded even relatively few years ago.

Sonically, however, the Old Magician is as spellbinding as ever, while Phase-4 engineer Arthur Lilley, even on location, works miracles in capturing the full range of Stokowskian thunders, glitters, and supersensuous lushness. If these are indeed live performances, as they are claimed to be, the recording crew must have carefully gagged and straitjacketed everyone in the Prague House of Artists audiences!

Remembering how well Victor's mono recordings of the late '20s still stand up and how truly incomparable the Philadelphia Orchestra was in that epoch (as we were reminded just recently by the RCA reissue of the Stokowski/Philadelphian Dvořák *New World* Symphony of 1927), I now pray harder than ever that RCA may reissue some of the first Bach-Stokowski recorded performances—above all that of my favorite "*Ich ruf' zu Dir*" chorale-prelude.

Patently, so successful a hyphenated Stokowski couldn't long confine his transcribing activities to Bach alone. He went on to score short pieces by other, mostly Italian, "old" composers and many later ones, among them Chopin, Scriabin, Shostakovich. But most of these were ephemeral encore pieces, and it was only with a new kind of opera arrangement/transcription, which he or someone ingeniously named "symphonic syntheses," that he was able at least to approach the success (and the controversies) of the Bach series.

His Wagnerian series began with a *Tristan und Isolde* synthesis (which included the prelude, love music, and Love-Death) in late 1932 and went on to *Parsifal* Act III in 1935 and all four *Ring* operas from 1933 to 1938. All these were with the Philadelphia Orchestra, of course, augmented in the *Walküre* and *Siegfried* albums with one or two vocal soloists. Later on the *Tristan* synthesis, easily the most popular of them all, was twice re-recorded by RCA Victor (1938 78s, 1952 LP with "His" Orchestra) and, in somewhat different form minus the prelude, with the All-American Youth Orchestra on Columbia 78s in 1941.

This latter form of the *Tristan* synthesis, retitled "Love Music from Acts II and III," was chosen when, in early 1960, Stokowski returned both to Columbia and to the Philadelphia Orchestra after an absence of almost two decades. (In addition to the Falla coupling for this *Tristan*, he was also rumored to have recorded around this time the Bach *Brandenburg* No. 5 and a batch of Bach transcriptions, and a complete Columbia recording of Schoenberg's mighty *Gurre-Lieder* was planned for later that year—none of which, as far as I know, ever actually appeared.)

In the works that did materialize, it's almost superfluous to note that the rejoining of conductor and orchestra first made world famous by each other became an occasion for inspired music-making. Here is all the conductor's tautness of control, as well as all the fervency, of the earlier years; here too is all the inimitable Stokowskian/Philadelphian "sound" of old—superbly captured by audio engineering that even fourteen years later remains persuasively gripping. Compared with my carefully preserved open-reel taping (long OP) of this program, the present Odyssey reissue strikes me as, if anything, a shade more crisply processed, yet with no dilution of the hypnotic, now-brooding, now-passionate evocation of the fated lovers' *Liebesnacht* and *Liebestod*.

For more than good measure, Stokowski's distillation of *Tristan und Isolde* is combined with his and Falla's no less potently evocative (however different it is in mood) tone picture of Spanish gypsy love and life in *El Amor brujo*—a blazing version notable too for Shirley Verrett's recording debut as the mezzo-soprano soloist. Issued at a budget price, this Odyssey reissue is not merely a bargain, it also is one of the Best Buys in the whole recorded discography today!

Of the London Phase-4 reissues, only one is outstanding for quintessentially Stokowskian illuminations as well as for spectacularly brilliant Phase-4 sonic technology. This is the Mussorgsky program that combines the 1966 New Philharmonia version of Stokowski's own (not Ravel's) orchestration of *Pictures at an Exhibition* (which he first recorded with the Philadelphians in RCA Victor M 706 of 1940) with the 1968 London Symphony version of *Night on Bald Mountain* (which he first recorded with the Philadelphians as an RCA Victor single, 17900, in 1941 and again with "His" Orchestra in the RCA Victor mono LP, LM 1816, of 1956), and the 1970 Orchestre de la Suisse Romande symphonic synthesis of

Boris Godunov (which he first recorded with the Philadelphia in RCA Victor M 391 of 1937 and again with the All-American Youth Orchestra in Columbia M 516 of 1942). All three works boast magnetic attractions, not least their extraordinarily virile, even barbaric, Slavic ferocity, which, while it well may be as much Stokowskian as Mussorgskian, is nonetheless dramatically (sometimes melodramatically) exciting.

The *Bald Mountain* fantasia bears an unhyphenated byline here, but it should have a double or triple one. As every discophile knows, the work as it's usually heard owes as much to Rimsky-Korsakov as it does to Mussorgsky himself; as played here, its score also owes a very considerable debt to the conductor's further coloristic touchings-up—a debt acknowledged with an "arr. Stokowski" in the original 78-rpm recording.

The daring, if not arrogant, challenge to the acclaimed Ravel orchestration of *Pictures* will never displace that favorite in the standard symphonic repertory, if only on account of an almost unrelieved grimness exacerbated by the omission of the lively "Tuilleries" and "Limoges" scenes (along with one of the "Promenades"), which Stokowski considers spurious additions to the original piano series. Yet in its very somberness and savage power this highly individual version exerts a malevolent Medusa-like fascination.

In earlier days, the *Boris* synthesis fired almost as many controversies as the Bach transcriptions, arousing fervent huzzas for its having gone directly to the original Mussorgsky version rather than to the extensively rewritten one by Rimsky-Korsakov that still remains (I'm ashamed to say) the better-known one. Stokowski has been no less fervently condemned for a seeming obsession with chime and gong sound effects and for the synthesis' patchwork construction. Yet it was Mussorgsky himself for whom tintinnabulation was an *idée fixe*; and whether or not one knows the protean opera itself, the present free-form mosaic makes its own dramatic sense and logic. Running through passages drawn in whole or part from the Introduction, Pilgrims' Chorus, Coronation Scene (complete), Varlaam's song, Revolutionary Scene (last part), Simpleton's Song, and the Death of Boris—with all the vocal materials given to instruments—this is, whatever else, incomparably plangent, sensibility-searing music. It also boasts sensationally electrifying Phase-4 sonics, but that's scarcely surprising since even back in 1937, evaluated by the standards of the mid-mono era, I uninhibitedly claimed that "even the [RCA Victor] recording itself, which in another work would be acclaimed as the last word in technical miracles, serves here only to give more golden voice to the tongues of men and angels with which Mussorgsky speaks for the soul of a whole nation."

All four of the remaining London "fantasias" may be safely skipped except by Phase-4 aficionados who somehow missed the differently combined original releases and by suckers for "Greatest Hits" or musical chicken-in-parts merchandising lures. But two special notes might be justified. One is to affix a "Beware" sign to the Debussy program (SPC 21109), which represents, as most Debussians must already know, some of Stokowski's most inexplicably willful interpretive eccentricities. (Even the conductor's staunchest admirers occasionally have to admit that, like the little girl with the curl right in the middle of her forehead, when he is bad, he is indeed horrid.)

The other note is to call special attention in the otherwise unremarkable "Ballet" grab bag to the one piece in all five "fantasias" that isn't a reissue: the expansive "Nimrod" episode from Elgar's *Enigma* Variations, a work that Stokowski has never recorded before but that in all likelihood may appear soon in a complete Czech Philharmonic/Phase-4 version of which the present excerpt is an advance sampler. If so, we are reminded that by adding—in his nineties—a new major work to his recorded repertory Stokowski not only proves anew that he is a true musical *polymath* (man of widely varied talents), but also reveals himself as an even rarer, in the world of music and elsewhere, *opsimath* (man capable of late-in-life learning).

Let's honor him while he's still with us and still so vitally productive. We'll never see or hear his like again!

BACH-STOKOWSKI: *Orchestral Transcriptions*. Czech Philharmonic Orchestra, Leopold Stokowski, cond. [Raymond Few, prod.] LONDON PHASE-4 SPC 21096, \$6.98. Tape: ●● L 475096, \$7.95; ● M 81096, \$6.95; ●● M 51096, \$6.95.

Cantata No. 4: No. 4, Jesus Christus, Gottes Sohn. Geistliches Lied, No. 51: Mein Jesu, was für Seelenweh, S. 487. Toccata and Fugue for Organ, in D minor, S. 565. Passacaglia and Fugue for Organ, in C minor, S. 582. Chorale-prelude, Wir glauben all' an einen Gott, S. 680 (Giant Fugue). Well-Tempered Clavier, Book I: Prelude No. 8, in E flat minor, S. 853.

WAGNER: *Tristan and Isolde: Love Music from Acts II and III* (symphonic synthesis, arr. Stokowski). **FALLA:** *El Amor brujo*. Shirley Verrett, mezzo-soprano (in the Falla); Philadelphia Orchestra, Leopold Stokowski, cond. [Howard Scott, prod.] ODYSSEY Y 32368, \$3.49 [from COLUMBIA MS 6147, 1960].

MUSSORGSKY FANTASIA. London Symphony Orchestra, Orchestre de la Suisse Romande, and New Philharmonia Orchestra, Leopold Stokowski, cond. [Tony d'Amato, prod.] LONDON PHASE-4 SPC 21110, \$6.98. Tape: ●● L 475110, \$7.95; ● M 81110, \$6.95; ●● M 51110, \$6.95.

Night on Bald Mountain [LSO; from SPC 21026, 1968]; *Boris Godunov: symphonic synthesis* (arr. Stokowski) [OSR; from SPC 21032, 1970]; *Pictures at an Exhibition* (orch. Stokowski) [NPO; from SPC 21006, 1966].

DEBUSSY FANTASIA. London Symphony Orchestra and New Philharmonia Orchestra, Leopold Stokowski, cond. [Tony d'Amato, prod.] LONDON PHASE-4 SPC 21109, \$6.98. Tape: ●● L 475109, \$7.95; ● M 81109, \$6.95; ●● M 51109, \$6.95.

La Mer [LSO; from SPC 21059, 1971]; *La Cathédrale engloutie* (orch. Stokowski) [NPO; from SPC 21006, 1966]; *Prélude à l'après-midi d'un faune* [LSO; from SPC 21090/1, 1973].

TCHAIKOVSKY FANTASIA. Various orchestras, Leopold Stokowski, cond. [Tony d'Amato, prod.] LONDON PHASE-4 SPC 21108, \$6.98 [from various originals]. Tape: ●● L 475108, \$7.95; ● M 81108, \$6.95; ●● M 51108, \$6.95.

Romeo and Juliet; Marche slave, Op. 31; 1812 Overture, Op. 49; Swan Lake: Waltz, Act I; Sleeping Beauty: Waltz, Act I.

RUSSIAN FANTASIA. Various orchestras, Leopold Stokowski, cond. [Tony d'Amato, prod.] LONDON PHASE-4 SPC 21111, \$6.98 [from various originals]. Tape: ●● L 475111, \$7.95; ● M 81111, \$6.95; ●● M 51111, \$6.95.

BORODIN: *Prince Igor: Polovtsian Dances* (with chorus). **GLAZUNOV:** *Concerto for Violin and Orchestra, in A minor, Op. 82* (with Silvia Marcovici, violin). **RIMSKY-KORSAKOV:** *Scheherazade, Op. 35: first movement*. **STRAVINSKY:** *The Firebird: Danse Infernale*. **TCHAIKOVSKY:** *Swan Lake: Dance of the Little Swans and Finale, Act IV.*

BALLET FANTASIA. Various orchestras, Leopold Stokowski, cond. [Tony d'Amato, prod.] LONDON PHASE-4 SPC 21112, \$6.98 [except for the new Elgar, from various originals]. Tape: ●● L 475112, \$7.95; ● M 81112, \$6.95; ●● M 51112, \$6.95.

BERLIOZ: *La Damnation de Faust: Danse des sylphes*. **ELGAR:** *Enigma Variations, Op. 36: Nimrod*. **RAVEL:** *Daphnis et Chloé: Suite No. 2* (with chorus). **STRAVINSKY:** *The Firebird: Berceuse and Finale*. **TCHAIKOVSKY:** *Swan Lake: Danse espagnole, Act III; Pas de trois, Act I: Variation III.*

Spotlite's
six-disc series
restores Charlie
Parker's vital Dial
recordings to
circulation.

Bird Rediscovered

by John McDonough



THE RECORDED DOCUMENTATION of Charlie Parker's musical legacy falls into three basic categories: the Savoy (1944-48), the Verve (1948-54), and the Dial (1946-47). These were the studio sessions that produced the bulk of his recorded works. (There are also, of course, the smattering of dates for independents and the many broadcast and concert performances that have been issued.)

The Savoy and Verve remain in the catalogue today. But for years the absence of the crucial Dial left a huge gap in the Parker picture (and an equally huge opportunity for bootleggers). Now Parker's biographer Ross Russell—whose remarkable study of him, *Bird Lives* (Charterhouse, 1973), has been both a major benefactor and beneficiary of the present Parker rediscovery—has moved to fill the gap with the American issue of all known masters and alternates done under the Dial banner by the great altoist: eighty-five versions of thirty-nine titles.

Issued in England a few years ago on the Spotlite label, Russell's six-volume edition is identical, down to liner notes, cover art, and catalogue numbers. So at last the Dial joins the Savoy and Verve on dealers' shelves.

The solos Parker recorded broke nearly all previous patterns of jazz playing. (Nearly but not all. The twelve-bar blues and thirty-two-bar ballad remained the framework for most jazz improvisation until the '60s.) In a sense the Parker revolution was a triumph of virtuosity over the musical instrument. It was not by chance that the great innovative breakthroughs prior to *Bird* were posted by a handful of virtuosos whose fluency became the key to the new way: Armstrong, Hines, Tatum, Eldridge, Goodman, Christian. In an art form that was still evolving from its folk beginnings, technology was the mother of invention.

Finally in Parker jazz found its Heifetz, its Horowitz—a man whose instrument was no barrier to his fiendishly intricate conceptual goals. If we could trace his work back to 1936 or '37, we would probably find a miniature Lester Young. A group of transcriptions recorded in late 1940 (Parker's first records, recently discovered and available on Onyx 221) reveal a mellowness of tone and flowing line in the Lesterian manner. But in "Hootie's Blues" (Decca 72935), made only a few months later, it was clear that this twenty-year-old prodigy was on to something more than a derivative style. To alert ears in 1941, it was evident that he had discovered a new route through the classic twelve-bar blues.

All the implications built into those twelve bars of music are defined and explored in the most prolific detail in the Spotlite albums. This is a mature Parker making the perfected statements that would set him apart from the jazz establishment in his own time, but that would come back to confront anyone who played or listened to jazz from then on.

What made it different? First there was rhythm. By the end of the swing era, masters like Goodman, Eldridge, Christian, and Young had become committed to the eighth note. Time was precisely parceled into chunks of a half-beat each. Notes were laced together in a continuous legato flow with an occasional triplet dropped in to gently jar the symmetrical momentum. Parker freed jazz from the eighth note. He ground time values into tiny fragments and treated regularity with contempt. What might have been a phrase of eighths became a blur of

thirty-second notes whizzing by so fast as to be almost swallowed. Notes became microscopic granules of sound virtually disappearing from sight. The phrase became the basic unit of a Parker solo.

And then there was what he played. The ideas. The devilishly complex chords full of the most startling harmonic relationships. Ideas and intervals that the traditional disciplines of jazz had not embraced. Lyrical passages mingled with whirling runs that pirouetted through his improvisations with a sonic power unheard of. Darting, sometimes fragmented lines of micro notes spun together in a precise logic of sound and silence that nevertheless defied prediction.

The Dial/Spotlite albums have been lovingly programmed for the collector and scholar. Titles are grouped chronologically down to the order of alternate takes. No one LP is in the "best of . . ." manner. Yet none is without great value. Even for the more casual listener—if indeed it's possible to confront Parker in a casual way—there is little room for boredom. Bird's inventive resources were enormous. Each set of takes is a search for the definitive statement, a sifting of ideas, a pattern of experimentation, rejection, and acceptance that is essential to any decision-making process.

Vol. 1 contains the session that produced "Ornithology," "Yardbird Suite," "Tunisia," and "Mooche." Parker is relaxed and elegant throughout, but Lucky Thompson's phrasing sounds commonplace next to his mercurial constructions. A second session, just hours before a mental collapse, finds Bird in total disarray. His ensembles with Howard McGhee at fast tempos ("Be-bop," "Max Making Wax") are disjointed and incoherent. The edgy, twitching lines on "Lover Man" are tormented and musically unrewarding.

In Vols. 2 and 3 Parker is restored to health and on the threshold of his most creative period. Earl Coleman's vocals ("Dark Shadows," "This Is Always") make Vol. 2 the weakest of the group, but Parker's playing, unfettered by illness, is once again the work of a master player in complete control. Erroll Garner, though speaking a somewhat different language, blends well. The same can be said of Wardell Gray, whose Lesterian lines on Vol. 3 offer a lighter, less fragmented sense of motion.

Vols. 4-6 feature Parker with his working combo back in New York: Miles Davis, Duke Jordan, Tommy Potter, and Max Roach. They cover the most sustained period of consistent creative brilliance in his career. The vital element is Roach—next to Kenny Clarke the first drummer actually to infiltrate the odd rhythmic logic of Bird's playing. He was among the first mature bop drummers. Everything Parker plays in this sympathetic context is an original statement. Perhaps his ballads are the most striking, if only because they are in such contrast to the many trip-hammer bop originals. "Out of Nowhere" (three versions) and "Embraceable You" (two) possess the most profound sense of melody and form.

"Drifting on a Reed," "Scrapple from the Apple," and "Klact-oveeseds-tene," with its splintered construction and unique resolution, are further highlights. Inexplicably, three cuts on earlier volumes are repeated on Vol. 5.

Some words are also in order for the Savoy and Verve LPs. On the market for years, the Savoy's could face an uncertain future with the death last June of Herman Lubinski, founder and owner of Savoy. Much of the mate-

rial coincides with the Dial period and is every bit as overwhelming. MG 12014 collates a well-rounded group of selections including two masterpieces: "Ko-Ko," with its explosive virtuosity always the servant of an incredible flow of ideas, and "Donna Lee," a countermelody navigating the progressions of "Indiana." Bird's first small-group date ("Red Cross" and "Tiny's Tempo") appears on MG 12001, the cornerstone of any modern jazz collection. Two other albums (MG 12000 and 12009) offer a mixture of other original and alternate masters from late '45 through '48. The complete "Ko-Ko" session appears in chronological sequence on MG 12079, repeating several tracks on earlier volumes. All but the last LP must be considered as vital as the Dials.

So too must "Dizzy Gillespie: The Small Groups" (Phoenix LP 2) containing two epic Bird/Diz Sessions from 1945. Among the fruits: "Shaw 'nuff," with a unison ensemble of spellbinding detail and nuance, proving that Gillespie was surely the other half of Parker's heartbeat.

The Verves pick up at a time when bop was gaining commercial acceptance, its days of insurgency nearly over, and show a concerted effort to cut its originator in on some of the bread. Hence the two volumes (V6 8003, 8004) setting Parker against a soft, passive string background. Though more decorative than inventive, "Just Friends" is on a level with his Dial ballad performances, and against a full big band he comes to life in superb versions of "Night and Day," "What Is This Thing Called Love," and "Lover." More in his native element are "Now's the Time" (V6 8005); "Bird and Diz" (V6 8006), a successful 1950 reunion helped by Buddy Rich's superb, albeit nonbop, support; and "Swedish Schnapps" (V6 8010), featuring two 1951 combos. The three-LP "Charlie Parker Story" (V6 8000/2) duplicates portions of other volumes and adds relatively little except a string set from Carnegie Hall and two outstanding choruses on "Lady Be Good."

To many young listeners the road to these classic performances will be paved with Supersax records. This superb group, perhaps the most unique of the decade, has taken Parker's work and miraculously separated the music from the musician. It has demonstrated in the process that Bird's inventions were of such overwhelming substance that they can thrive apart from their inventor. By building the repertoire of a reed quintet entirely on note-for-note scores of original improvisations, Supersax has shown that great jazz is less delicate than some would have us believe, that in Parker's case its essence is sturdy enough to survive a major transplant.

So Supersax versions of "Tunisia" (Capitol ST 11177) or "Embraceable You" (ST 11271) inevitably lead back to Spotlite 101 or 104—the source, still a challenge to searching young ears hatching from rock into a world of vast musical alternatives.

(At this writing the release date of the Dials was tentatively expected in November. If they are not immediately available, however, those imported from England may be obtained by writing to Zim Records, Box 158, Jericho, New York 11753.)

 **CHARLIE PARKER:** The Complete Dial Recordings. Charlie Parker, alto saxophone; various vocalists and instrumentalists. SPOTLITE 101/6, \$5.98 each disc (mono) [recorded 1946-47].



Wallingford Riegger

by Royal S. Brown

An Essential American-Music Document—from England



Roger Sessions

Argo offers first-rate performances of works by Riegger and Sessions.

IT IS IRONIC that Argo's superlatively conceived disc of some of the richest and most fertile directions taken by American music was produced in England. But listening to this absolutely essential document, it is perhaps not difficult to understand why Wallingford Riegger and Roger Sessions have received but a modicum of the attention they deserve.

Besides the apparent severity (the two make nonsystematic use of atonality, for example) and often incredible density of their styles (it takes several hearings to begin to get beneath the surface of these works, even though a single hearing proves immensely rewarding), both composers—especially in the works recorded here—have an international flavor to their music, which is basically devoid of the Americana that might make it easier to pinpoint idiomatically, both at home and abroad.

Yet what vitality and inventiveness pervade every measure of the Riegger and Sessions pieces! One thing the composers have in common is the strong forward movement of their music. In Riegger, this movement tends to grow from a rhythmic idiom that was ideally suited to the many modern-dance projects (Martha Graham et al.) he devoted himself to in the Thirties and Forties. Indeed, *Dichotomy*, an amazingly forward-looking work composed in 1931, has a dramatic angularity to it that seems almost to demand moving, abstract visualization. Also typical of Riegger in this work is the start-stop momentum acquired by the various instrumental fragments, while from the multi-layered, polyphonic complexity of some of the sections grows an extraordinary sense of spaciousness. (Interestingly, there are several points in the score that seem to foreshadow Messiaen, of all people.)

Sessions, on the other hand, creates his movement forward from a lyrical flow that is as strong and yet as subtle as anything you're apt to hear in nontonally oriented music. The short Eighth Symphony (1967-68), for instance, contains long, sustained thematic lines whose convolutions are felt as constantly present, even though the line may shift in instrumentation and travel through various colored planes of diverse textures before arriving at a resting point. Throughout, themes acquire emotional depth from their spatial and harmonic relationship to material surrounding them, and the ultimate unity of the symphony lies not simply in the repetition and development of melodic and rhythmic motives, but also in the particularly rich and original use of the instruments, including the maracas first mysteriously heard behind the opening theme. There are even points in the symphony where the composer creates large masses of sound that seem to be expanding in directions taken by the likes of Ligeti.

In spite of its title and recent date, the *Rhapsody for Orchestra* (1970) is a much more violent piece, divided into more recognizable movements and written in a style more identifiable with earlier Sessions than the Eighth Symphony. While the latter has the quality of an exceptionally beautiful meditation, the *Rhapsody* seems to have more dramatic implications that culminate, in the third section, in a grim, explosive episode that has somewhat the quality of a frenzied march. This type of intensity of feeling is counterbalanced, in both Sessions and Riegger, by the rigor and control of their compositional techniques, resulting in a kind of expressionism that is perhaps the essence of the composers' styles, although in two differing modes.

I'm not sure what Thea Musgrave's *Night Music* is doing on this disc. It is an effective enough work, living up to its title but featuring two concertante horns whose players wander about the orchestra creating a spatial dimension that is pretty well captured in this recording. But its static quality and the ultra-*divisi* verticality of some of its sections set it strongly against the Sessions and Riegger pieces, even though Riegger in particular uses some of the same techniques, and it suffers in comparison. It would seem much more logical to me to have filled out this release with, say, Riegger's still unrecorded *Passacaglia and Fugue for Orchestra*.

Nonetheless, program director David Drew deserves enormous credit for the releases and reissues that make up the Calouste Gulbenkian Foundation series on Argo. As was the case for the Messiaen/Tippett/recording (ZRG 703), I do not see how the reproduction of the orchestral sound in the two Sessions works could be improved upon, while the Riegger and Musgrave likewise benefit from exceptional, if less spectacular, clarity in the sonics.

The Sessions Eighth, which has been a Prausnitz specialty of late, receives the best performance. The playing in the other works is not always as precise as it might be, but this detracts little from the over-all quality. And this version of the Riegger *Dichotomy* is certainly to be preferred to Mester's on Louisville, particularly because of the accompanying material. The impressive program booklet, besides containing articles by Prausnitz on the Riegger and by Andrew Imbrie on the Sessions Eighth, has analyses by Musgrave and Sessions of their own works.

SESSIONS: Symphony No. 8; *Rhapsody for Orchestra*. **RIEGGER:** *Dichotomy for Chamber Orchestra*, Op. 12. **MUSGRAVE:** *Night Music*. Barry Tuckwell and Alan Chidell, horns (in the Musgrave); London Sinfonietta (in the Musgrave and Riegger) and New Philharmonia Orchestra (in the Sessions), Frederik Prausnitz, cond. [James Walker, prod.] ARGO ZRG 702, \$6.98.

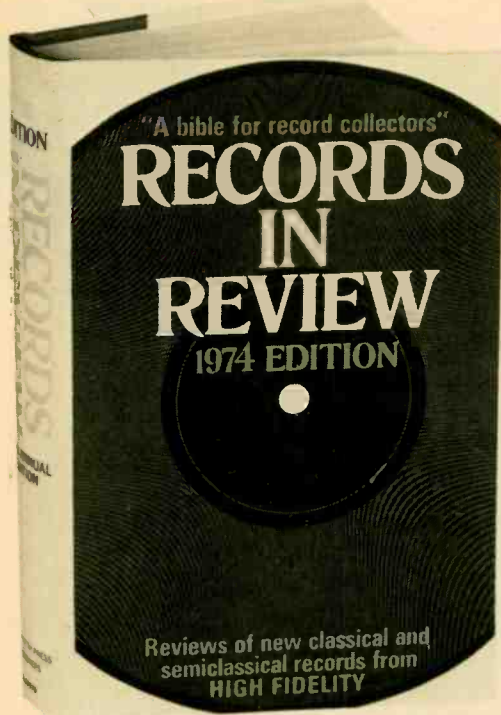

Coming Soon in a New Edition

RECORDS IN REVIEW

1974 EDITION

The Nineteenth annual collection of record reviews from High Fidelity

COMPREHENSIVE—Includes all record reviews of classical and semiclassical music that appeared in High Fidelity in 1973. The sturdy, hard-cover book reviews all types of music—vocal, orchestral, chamber and solo—from all periods—medieval to contemporary—and includes information about all formats—discs, open-reel tape, cartridges, and cassettes in both stereo and quadriphonic editions.

AUTHORITATIVE—High Fidelity's reviewing staff includes today's most knowledgeable and noted critics: Royal S. Brown, Abram Chipman, R. D. Darrell, Peter G. Davis, Shirley Fleming, Alfred Frankenstein, Kenneth Furie, Clifford F. Gilmore, Harris Goldsmith, David Hamilton, Dale Harris, Philip Hart, Paul Henry Lang, Robert C. Marsh, Robert P. Morgan, Andrew Porter, H. C. Robbins Landon, John Rockwell, and Susan T. Sommer. They discuss the composition, performance, and sonic quality of each recording and compare it with earlier releases and legendary performances.

CONVENIENT—Reviews are arranged alphabetically by composer. In the case of frequently recorded composers, reviews are further divided into categories such as Chamber Music, Vocal Music, etc. Moreover, there's a special section on Recitals

and Miscellany and a complete Artists' Index of all performers whose recordings were reviewed during the year, as well as composers mentioned only in the text.

With so many records being issued each year, you need a reliable source of information. What better source than reviews from the magazine that has been called "a bible for record collectors!" Reserve your copy now by filling in and returning the coupon below.

Wyeth Press, State Road, Great Barrington, MA 01230

Please send the following copies of *Records in Review*:

- 19th Annual (1974) @ \$9.95 plus \$1.00 for shipping and handling
- Please enter my standing order for all future editions of *Records in Review*
- I enclose payment (Check or Money Order only). Add sales tax where applicable. (Sorry—we cannot invoice!)

Name _____

Address _____

City _____

State _____ Zip _____

classical

reviewed by

ROYAL S. BROWN
 ABRAM CHIPMAN
 R. D. DARRELL
 PETER G. DAVIS
 SHIRLEY FLEMING
 ALFRED FRANKENSTEIN
 KENNETH FURIE
 CLIFFORD F. GILMORE
 HARRIS GOLDSMITH
 DAVID HAMILTON
 DALE S. HARRIS
 PHILIP HART
 PAUL HENRY LANG
 ROBERT C. MARSH
 ROBERT P. MORGAN
 ANDREW PORTER
 H. C. ROBBINS LONDON
 JOHN ROCKWELL
 PATRICK J. SMITH
 SUSAN THIEMANN SOMMER

BACH: English Suites (6), S. 806-11. Huguette Dreyfus, harpsichord (two eighteenth-century French harpsichords by Hemsch and Dubois). [Gerd Ploebisch, prod.] ARCHIV 2533 164, 2533 165, and 2533 166, \$7.98 each.

English Suites: No. 1, in A; No. 2, in A minor; No. 3, in G minor; No. 4, in F; No. 5, in E minor; No. 6, in D minor.

Comparisons:

Galling
 Walcha

Vox SVBX 5438
 Mace 9033, 9036

Bach was indeed a fortunate man, living as he did at the very end of an era: To him was granted the honor of saying the last word, of summarizing and drawing together many of the various threads that had been developed by his predecessors. Because he was also a genius, he was able, not only to say the last word, but to say it best. What is left to add to the art of fuguing after hearing Bach's *Art of Fugue*? Similarly with the keyboard suite of dance pieces: Bach brought the form to its highest peak of development with his three great collections, the partitas, *French Suites*, and *English Suites*.

Because these are such perfect works, so filled with compositional audacities and strokes of genius, it's really quite painful to hear someone like Huguette Dreyfus brainlessly dashing through the *English Suites*, giving not the slightest hint that she has even noticed any of the wonders contained therein. It's simply not enough to switch on the inner metronome and methodically thump out every one of the notes printed in the score.

To give credit where due: Her fingers do work remarkably well, she has set fairly brisk tempos for most movements, and she pushes all the right keys with great assurance. She has also done enough research to know that trills begin on the upper note and that sarabandes are slower than courantes. Otherwise she plays like a zombie, without the slightest tempo inflection from first measure to last and without the slightest bit of originality in dealing with ornaments or with passages of an improvisatory nature. Bach has given the player some unusually explicit hints in this set of pieces: Two of the sarabandes are written out a sec-

ond time with all the *agrèments* (trills, arpeggios, scale passages, roulades, etc.) carefully notated in full. Surely he intended these as samples and expected the performer to supply similar elaborations in similar sarabandes. Dreyfus plays from these alternate versions for the repeats of these two sarabandes, but in all the others the repeats are almost identical to the first time through.

This litany of missed musical opportunities could go on and on, but what of the competition? Pretty grim, I'm afraid. Walcha's two-record set is just as unimaginative, and he doesn't even make Dreyfus' attempt to enliven the proceedings with brisk tempos. These performances were available back in mono days on a pair of mono Electrola discs, which Mace is now offering as genuine stereo. Even if it is stereo (switching my amplifier from stereo to mono mode produces no noticeable difference in sound), it is still archaic, unattractive sound.

That leaves Galling's set on Vox (part of his complete edition of the harpsichord music). His playing has many admirable qualities combined with more than a touch of Teutonic pedanticism: He clearly understands the structure of these pieces and does a fairly good job of communicating it to the listener. For that reason alone he commands respect and admiration.

As for ornamentation and improvisatory elaboration, he does no more than Dreyfus, and his tempos are generally slower than hers. Dreyfus plays almost all repeats, while Galling is content with one run-through for most pieces. Since neither of them has anything more to say on the second go-round, Galling's abridgments are to be preferred, and they leave room in his three-record set for nine more pieces, including the *Italian Concerto* and *Chromatic Fantasy*.

If you must have a recommendation, I'll reluctantly suggest Galling. Behind the pedanticism there's an understanding brain at work, while Dreyfus seems to be thinking of nothing but finger exercises. And, need I add, the Vox set is far less expensive. C.F.G.

BACH-STOKOWSKI: Orchestral Transcriptions. For a feature review, see page 91.

B **BAX:** Tintagel; Northern Ballad No. 1; The Garden of Fand; Mediterranean. London Philharmonic Orchestra, Adrian Boult, cond. MUSICAL HERITAGE MHS 1769, \$3.50 (Musical Heritage Society, 1991 Broadway, New York, N.Y. 10023).

This program samples well the agreeable output of one of England's minor masters, as well as that country's most prolific independent record label, Lyrita, which has done yeoman service on behalf of such as Bax, Moeran, Holst, Parry, Bliss, Elgar, all loyally re-pressed here by MHS.

The Garden of Fand is a broad-brushed seascape that shimmers agreeably in its softer and slower pages. *Tintagel* is a semi-effective anglicization of the Tristan ambience. *Northern Ballad* No. 1 is an exuberant essay in Scottish lore, while *Mediterranean* reminds one of a sort of mini-*España*.

All are presented by Sir Adrian with reverent care and detail, though Barbirolli and Bee-



Adrian Boult

A minor master reverently recorded.

cham (whose versions were never very long available on these shores) have given us more volatile and sensuous phonographic statements of *Fand*.

In typical Lyrita fashion, these Boult recordings are clear and full-bodied, with effective stereo treatment. A.C.

B **BEETHOVEN:** Concerto for Piano and Orchestra, No. 5, in E flat, Op. 73 (*Emperor*). Walter Gieseking, piano; Vienna Philharmonic Orchestra, Bruno Walter, cond. TURNABOUT THS 65011, \$3.98 (rechanneled) [recorded mid-'30s].

Both of Gieseking's later *Emperors* are currently available at budget price: the 1953 performance with Karajan on *Odyssey* 32 16 0029 and the 1955 with Galliera on Seraphim S 60069 (real stereo). According to Schwann-2, the present account, resurrected from a long-famous Columbia 78-rpm album, has already been transferred to LP on Roco 2019, but this release in Turnabout's newly inaugurated Historical Series makes it readily available for the first time in a quarter century.

The transfer is an honest one, slightly rough in tone but eminently listenable. (A distracting invisible scratch on Side 2 persisting through the whole slow movement is, I hope, restricted to my copy.) The documentation, though, leaves much to be desired: nothing about either of the admittedly well-remembered artists, and even the recording date given (1938) is highly suspect since Walter fled Vienna after

Explanation of symbols

Classical:

- B** Budget
- H** Historical
- R** Reissue

Recorded tape:

- Open Reel
- ◐ 8-Track Cartridge
- Cassette

the *Anschluss*: 1933 or 1934 would seem more probable. (His live January 1938 Mahler Ninth—also recirculated in the Turnabout series—was the last thing he did with the Vienna Philharmonic until after the war.)

I am quite fond of the mercurial Gieseking/Galliera *Emperor* but heartily detest the Gieseking/Karajan, which is leaden in sonics and phrasing. Rehearing the Walter version convinces me again that Gieseking's first recording of the piece was also his best. In a certain intangible way it has more stature, more technical brilliance, more breadth of contour.

To be sure, Gieseking's way with this music was far less weighty and massive than Schnabel's, more oriented toward scintillant brilliance and digital symmetry. One might fairly describe his elegant pianism here as Mozartean. But where the later recordings occasionally sound a bit skimpy technically, lacking in power at the climaxes, no such reservation can be made about this wonderfully deft, assured reading. Walter's warm, forthright, muscular reading ideally complements the pianist's militancy (and, by the way, surpasses his later recording, with Rudolf Serkin).

In sum, a recorded performance one can heartily welcome back to circulation. H.G.

BERNSTEIN: *Dybbuk* (complete ballet). David Johnson, baritone; John Ostendorf, bass; New York City Ballet Orchestra, Leonard Bernstein, cond. [John McClure, prod.] COLUMBIA M 33082, \$6.98. Tape: ● MA 33082, \$7.98; ●● MT 33082, \$7.98. Quadriphonic: MQ 33082 (SQ-encoded disc), \$7.98; MAQ 33082 (Q-8 cartridge), \$7.98.

At first glance *Dybbuk* would seem to be a further exploration by Leonard Bernstein of his religious heritage—on the same lines, say, as his *Jeremiah* and *Kaddish* Symphonies. A *dybbuk* is the vagrant spirit of a dead person that in Central-European Jewish folklore can possess the body of a living one. The ballet, as choreographed by Jerome Robbins and presented last May by the New York City Ballet, appears to have been inspired by the Yiddish-language play on this subject by Shloyme Rappaport, better known as S. Ansky, 1863–1920.

In the play a young man uses cabalistic conjurations in an attempt to gain the hand of his beloved when, against her wishes, she is about to be wed to another. During the attempt he dies, and at her wedding his spirit takes possession of her. When she is exorcised by the elders of the religious community, she dies and is reunited with him in spirit forever.

Although a lengthy and detailed synopsis of this work was printed in the New York City Ballet program, the plot, disconcertingly enough, was preceded by a caveat: "The ballet is not a retelling of Ansky's play, but uses it only as a point of departure for a series of related dances concerning rituals and hallucinations which are present in the dark magico-religious ambience of the play and in the obsessions of its characters."

It is doubtless for reasons of this sort that the title of the ballet was originally not as *Dybbuk*, but as *Dybbuk Variations*. The latter, I suggest, is the truer indication of the work's essential nature. Robbins' ballet is hopelessly confused in intension—an abstract work with vague and fitful references to narrative ele-



Walter Gieseking—an Emperor with stature, brilliance, and breadth of contour.

ments that may, if one has read one's program ahead of time, be linked in some hazy fashion to Ansky's play. Even so, it is nearly impossible to tell what is supposed to be going on. Nor, beyond a few details of costuming, is it easy to see anything specifically Jewish in the spectacle. What we get in effect is an obscurely stated assertion of love's power to transcend death. It's as if the plot of *Wuthering Heights* were being retold by an incoherent and forgetful narrator.

Bernstein's music is on a par with Robbins' choreography. Apart from a few passages for baritone and bass in which Hebrew prayers are invoked, there is nothing specifically Jewish about his contribution either. One is told that the composer has made use of Hasidic melodies, but the ear fails to distinguish them.

More important by far, the ear fails to catch the slightest indication that this music is implicated in the "magico-religious." Bernstein has announced his dependence upon the cabalistic—that is, the mystical—manipulation of numbers for every bar in this score, and this led him to devise a nine-note scale. But, despite his recourse to serial techniques, the results sound very familiar. Bernstein, tonal or atonal, remains Bernstein.

In *Dybbuk* one hears precisely the kind of concoction one has heard so often before in his *oeuvre*. Here, because he has failed to pique our curiosity, to touch us or capture our imagination, we find ourselves noticing the poverty of his resources as never before: the same old over-reliance on syncopated rhythms, the same kind of trite thematic material, the same old-fashioned orchestral tricks and colorations (the time has come, I would suggest, for Bernstein to renounce the xylophone), the same reminiscences of Aaron Copland and Gustav Holst. As far as I'm concerned, it's all so instantly accessible, so slick, so unequal to the mystical occasion suggested by the ballet's ostensible theme, that you never want to hear it again.

Columbia has coped brilliantly with the sound, and the composer secures admirable playing from the New York City Ballet Orchestra. D.S.H.

CHOPIN: *Sonata for Piano, No. 3*—See Liszt. *Sonata for Piano*.

B **CRUMB:** *Madrigals*. Elizabeth Suderburg, soprano; David Shrader, percussion; Felix Skowronek, flute; Pamela Vokolek, harp; W. Ring Warner, double bass. TURNABOUT TV-S 34523, \$3.98.

Settings of fragments of texts by Federico García Lorca occupied George Crumb throughout most of the 1960s, and the *Madrigals* constitute one of the major works of the Lorca group. There are four books of these in all, each containing three madrigals; the first two were written in 1965, the last two in 1969.

The twelve madrigals, which are scored for soprano and a small instrumental ensemble that varies somewhat from piece to piece, are surprisingly effective when performed as a whole. Each song is a strongly characterized, rather impressionistic evocation of the mood and quality of its text, and each is sufficiently individualized to provide the needed contrast for the thirty-five-minute duration of the entire set. The highly expressive and beautifully shaped vocal lines, characterized by contrasts of chantlike incantation and lyrical arabesques, are effectively set off against extremely colorful instrumental accompaniments that seem to supply a sort of ritualistic commentary on the texts. As usual in Crumb's music, there are many moments of striking beauty brought about by his imaginative—and frequently unprecedented—handling of both voice and instruments. Each madrigal is rather like a complex jewel with its own unique coloration.

The last two books of these madrigals were specifically written for soprano Elizabeth Suderburg, who sings the whole set with a fine grasp of the rather special qualities of this music. She is ably accompanied by the four instrumentalists, all of whom are members of the Contemporary Group at the University of Washington in Seattle. R.P.M.

B **DAVIES:** *Vesalii Icones*. Jennifer Ward Clarke, cello; *The Fires of London*, Peter Maxwell Davies, cond. NONESUCH H 71295, \$3.98.

Peter Maxwell Davies' *Vesalii Icones*, written in 1969, is a set of fourteen dances, each based

on one of the famous anatomical drawings from *De humani corporis fabrica*, the principal work of the sixteenth-century anatomist Andreas Vesalius. (The drawings, which show the human body in the various stages—or muscular layers—of its anatomical structure, have more recently been attributed to Jan von Calcar.)

Davies associates each of the drawings he uses with one of the fourteen Stations of the Cross so that the work as a whole can be seen as a three-tiered "set of superpositions: 1) the Vesalius illustrations, 2) the Stations of the Cross, and 3) [the Dancer's] own body." Each dance begins with the Dancer assuming the body position of the relevant drawing; then he moves to express the corresponding station. The composer states, however, that "the dance is not an attempt literally to act out the Vesalius drawing or the 'station': It is an abstract of both, in which the Dancer explores the technical possibilities suggested by the Vesalius illustrations—in the light of the ritual and emotional experience suggested by the 'station'—in terms of his own body."

Clearly the visual and choreographic-dramatic aspects of the work are fundamental to its underlying conception, and the present recording of the music alone undoubtedly gives only a pale reflection of Davies' over-all intentions. Nevertheless, the music is of considerable interest in itself.

Scored for solo cello and a small instrumental group of five additional players, it mirrors the multilayered conception of the whole in its use of three distinct musical levels: plainsong, "popular" music, and Davies' "own" music. There is a considerable amount of quotation, both actual and "simulated." Particularly prominent is the use of Victorian hymns, which the composer considers "almost the ultimate blasphemy," as well as popular music from the same period. (During one section—"The Mocking of Christ"—such music is played by the Dancer himself, on an out-of-tune piano placed on the stage.)

Davies, by the strength of his musical personality and extent of his technical control, has somehow managed to prevent the resulting collage of disparate, frequently opposed materials from turning into an undifferentiated jumble. There are so many cross-references among the various musical strata—which are presumably to be experienced in symbolic analogy to the various muscular strata of the drawings—that these appear to be fused into a single, higher-leveled unit. Indeed, rarely is one of the "borrowed" elements heard in isolation, without some penetration from other, contrasting elements. It is rather like an aural kaleidoscope, but one whose transformations are ordered according to a larger, panoramic view. There is a decidedly grotesque, somewhat surrealistic quality about much of the piece; yet the over-all effect is one of considerable richness and expressivity.

The performance by cellist Jennifer Ward Clarke (to whom, along with dancer William Louthier, the work was dedicated) and members of The Fires of London, perhaps England's finest new-music group, is excellent. Davies, who conducts his own piece, has a clear picture of what he is after, and he maintains the larger motion of the work very well. The latter could be a problem, as *Vesalii Icones* is sharply divided into its fourteen sections, each signaled by a "ritualistic" jingling

of bells. Yet this reading manages to convey effectively a quality of unified progression and cohesiveness. R.P.M.

DEBUSSY FANTASIA. For a feature review, see page 91.

DEBUSSY: Quartet for Strings, in G minor, Op. 10. **RAVEL:** Quartet for Strings, in F, Danish Quartet. TELEFUNKEN SAT 22541, \$6.98.

The second-movement scherzo of Ravel's Quartet in F has always struck me as containing one of the best possible examples of musical inevitability. The opening two-theme episode culminates in a pianissimo descending tremolo figure that leads into a nonliteral repetition of the same episode. As the music climaxes a second time, however, the tremolo figure becomes a mysterious descending chromatic run that seems to have been intellectually prepared by every single note that has preceded it in the quartet.

No doubt one of the essential characteristics of a great composer is just such an ability to make the listener *feel* that what takes place musically at any given point in a work is the only possible solution. But I can think of few pieces in which the music flows ahead as effortlessly as it does in these two quartets, the only works in this genre written by these composers. (Ravel's was finished in 1903, some ten years after Debussy's.) It is as if the intervention of the composer in translating this movement into musical notes had hardly been necessary. In particular, the contours of the melodic and thematic fragments seem inextricably bound to the rich chordal structures and their unique progressions, perfectly conceived to highlight the interplay of the four strings.

But, for all the parallels between these two eternally coupled quartets, basic differences lie at the base of their over-all conception. For



Leonard Bernstein
Is still Bernstein.

one thing, I have always felt that the Debussy quartet is essentially a three-movement work; the somewhat bravura fourth movement seems almost like a crowd-pleasing afterthought. The Ravel quartet, on the other hand, fits much more comfortably into its four-movement form. And while Debussy seems essentially concerned with the interrelationships of string timbres and harmonic possibility (I know of few quartets that can approach the Debussy in sheer sonic sumptuousness), Ravel rather more conventionally concentrates on the harmony-theme relationships, with the sonorous potential of the strings used more for "effect."

These differences are reflected in the unequal success of the Danish Quartet's two interpretations. Its dynamic, full-toned approach to the Debussy could not be better suited to the work. Even the quiet, tense melancholy of the third movement has not escaped the group, which seems to grasp the full emotional breadth intended by Debussy.

But the more mellow lyricism of the Ravel work is rarely communicated here. One reason may be first violinist Arne Svendsen, whose weak tone and really poor bowing do little justice to the heavy lyrical demands of the first-violin part. Even so, there are some good moments in this performance—the scherzo in particular gets some fine, robust pizzicato playing.

In spite of the excellence of the Debussy performance, neither the recorded sound (good enough but hardly spectacular) nor the undertaking as a whole is attractive enough to bump at least four other ensembles—the Via Nova (Musical Heritage MHS 1211), La Salle (DG 2530 235), Juilliard (Columbia M 30650), and Stuyvesant (Nonesuch H 71007, a real sleeper)—out of the competition. R.S.B.

FALLA: *El Amor brujo*. For a feature review, see page 91.

Fux: *Concentus musico instrumentalis* (1701): *Serenada à 8*; *Rondeau à 7*; *Sonata à quattro*. Vienna Concentus Musicus, Nikolaus Harnoncourt, cond. TELEFUNKEN SAWT 9619, \$6.98.

Johann Joseph Fux (1660–1741) was a famous, respected, and highly influential Viennese musician in his day, but he is remembered today chiefly as the author of the world's most famous textbook on composition: the *Gradus ad Parnassum*, which appeared in 1725 in Latin. The first German translation of the work was done by Bach's pupil, Mizler, "under the very eyes of Bach, as it were," according to Spitta.

The book was thoroughly studied and assimilated by Haydn, Mozart, and Beethoven, who in turn used it as a basis for their own teaching. We can also follow the chain of his instruction in counterpoint and fugue to Schubert, Bruckner, and Brahms; and its use has continued in the hands of teachers of recent generations, among them Richard Strauss and Hindemith. Even today, modern English translations by Alfred Mann (in *The Study of Counterpoint* and *The Study of Fugue*, both published by Norton) are utilized by many teachers.

Contemporary attitudes are skeptical that one who could produce such a significant work on musical theory could also produce

significant music. Not necessarily so! This Viennese master, who served as court composer and Kapellmeister under three successive Hapsburg emperors, as well as director of music at St. Stephen's Cathedral, was also a skilled, thoroughly modern composer whose music combines French, Italian, and folk elements in a superb and entertaining manner.

The major piece on this record is a serenade for eight diverse instruments from his *Concentus musico instrumentalis* (1701), a collection of sonatas and suites with highly varying instrumentations. (The designation here is for three clarino trumpets, two oboes, two violins, bassoon, and continuo.) In the course of its sixteen short, mostly dance, movements these instruments are used in a wide variety of inter-

esting and unusual combinations. The three-movement *Sonata à quattro* offers an even more unusual grouping of instrumental colors (violin, baroque cornetto, baroque trombone, and bassoon, with organ). The *Rondeau à 7* is of interest chiefly for its unusual solo group: solos and duets for violino piccolo and bassoon are played, concerto-grosso style, against the *ripieno* of strings and continuo.

The music is all lively and entertaining, but the outstanding attraction of this marvelous record lies in the interesting and varied and lusciously beautiful instrumental sonorities, which Harnoncourt and his group of old-instrument specialists produce spectacularly well. Indeed, I can't imagine a better combination of performers and repertoire. C.F.G.

B **HANDEL:** *Water Music*; *Royal Fireworks Music*; *Concerto for Two Wind Choirs and Strings*, in B flat. La Grande Ecurie et la Chambre du Roy, Jean-Claude Malgoire, cond. COLUMBIA MG 32813, \$7.98 (two discs, manual sequence).

Comparisons—Water Music:
Menuhin/Bath Festival Orch. Ang. S 36173
Leppard/English Chamber Orch. Phi. 6500 047
Comparisons—Fireworks Music:
Menuhin/Festival Orch. Ang. S 36604
Leppard/English Chamber Orch. Phi. 6500 369

Among the innumerable things *not* new under the sun are our presumed novel "sonic spectaculars." They were in vogue back in the early eighteenth century, when they were performed live, of course, before out-of-doors crowds rather than from records in individual listeners' homes, but they provided their audiences with even more thrilling experiences, since sheerly aural appeals were enhanced by scenic ones.

Today we can only imagine how Handel's *Water Music* actually sounded on the Thames in 1715 or 1717 (or both), or how his *Royal Fireworks Music* actually sounded at Vauxhall Gardens in 1749. As we do know these works in present-day concert or recorded performance, many of us esteem them as some of the most, if not *the* most, invigorating and completely satisfying music of any period or by any composer. Yet how much we must be missing has been suggested in various earlier attempts to evoke period stylistic idioms, the fiercer, rougher tonal qualities of period instruments, and the special sonorities of greatly enlarged wind-instrument choirs (to say nothing of adding, in the *Fireworks Music*, appropriate obbligato sound effects).

The present Malgoire versions dispense with musically extraneous effects and don't make use of many extra wind players, but they do feature authentic period instruments and the free improvisation of elaborate melodic ornamentations—both more successfully, on the whole, than in any recordings I've encountered so far. There are inevitably some sour notes from the ensemble of "natural" (i.e., nonkeyed) horns, and the French baroque-era oboes are startlingly more penetrating and tartly astringent than their tamer descendants. (The old bassoons, however, are less pungent than one would expect.)

Yet there is nothing here that approaches the ear-twisting horrors of the deservedly unlamented Schulze/Vox period-instrument *Fireworks Music* of 1961. And while Leppard, among others, has been perhaps reasonably successful in resurrecting (or re-creating) presumed stylistic traditions, Malgoire's players strike me as doing so with much greater idiomatic ease—indeed true improvisatory panache and infectious personal relish.

How truly "authentic" all this is, either tonally or interpretively, I can't claim enough specialized knowledge to judge. But it sounds mightily persuasive, and even though I doubt that eighteenth-century players were accustomed to taking lively movements at such pell-mell speeds as Malgoire often sets, the over-all effect—intensified by very strong, close, and sharp-edged recording—is likely to be both stimulatingly distinctive and electrifyingly invigorating to all but tender-eared and conservative-minded listeners. (I must concede that the latter may properly complain of the

DUKE LIVES!



And more great Ellington in the Vintage Series.

- Daybreak Express LPV-506
- Flaming Youth LPV-568
- Johnny Come Lately LPV-541
- Jumpin' Punkins LPV-517
- Pretty Woman LPV-555

RCA Records and Tapes

CIRCLE 50 ON READER-SERVICE CARD

TDK ED: BEST FREQUENCY RESPONSE. FOR AN EXTRA BUCK.

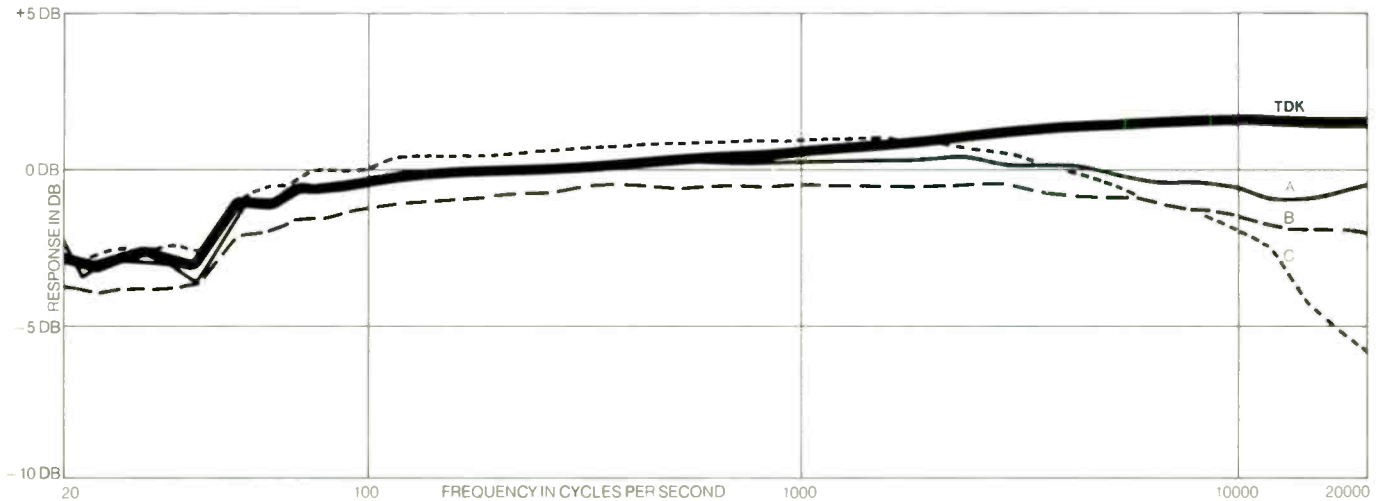

TDK ED tape was shown to have the best frequency response of four leading cassette tapes tested recently by an independent laboratory. The other three were large-selling popular competitors, retailing for about a dollar less than TDK ED. As you can see, their output tended to fall off noticeably in the high frequencies.

Even a slight loss of high-frequency reproduction can make a difference in clarity and detail to a discriminating ear. That quality of life that music should have just won't be there—the sheen on the violin note, the glitter on the cymbal finale.

Conclusion? If you're serious about the sound of music, try a TDK ED tape next time. It offers you that quality of lifelike brilliance you might otherwise have to buy a ticket to hear. And we think that's worth an extra buck.



Wait till you hear
what you've been missing.

CIRCLE 65 ON READER-SERVICE CARD

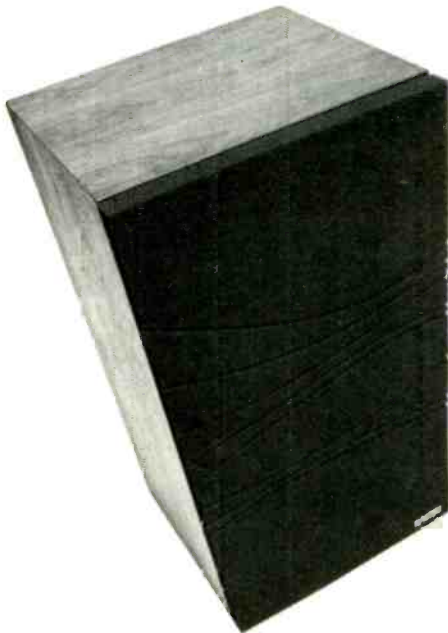

it's over!

To the serious listener in search of an accurate reproducer of sound, we offer the electrostatic principle. Listen, and your search will be over.

Janszen.
From \$120 to \$700

JANSZEN ELECTROSTATIC

7516 42nd Avenue North
Minneapolis, Minnesota 55427
a division of
Electronic Industries, Inc.

CIRCLE 33 ON READER-SERVICE CARD

Inside each of our 4-channel cartridges

AT12S
\$64.95

AT15S \$100.00 ■ AT20SL \$175.00

AT14S
\$75.00



lurks a Dual Magnet stereo cartridge waiting to please you.

Our sophisticated four-channel cartridges* are also stereo cartridges at heart. Very good ones. With ruler flat response outstanding stereo separation (especially above 1 kHz where it counts), and truly impressive high frequency tracking.

All these advantages are as important to good stereo as they are essential to CD-4. And they can be achieved

only by paying very close attention to detail. And using only the best. Like a genuine Shibata† stylus. Nothing less. The results are good for any record... whether stereo, matrix, or discrete 4-channel. But you should really hear for yourself. Write today for our dealer list. No matter how many channels you want to hear best.

*U.S. Pat. Nos. 3,720,796; 3,761,647
†Shibata stylus Pat. No. 3,774,918



audio-technica®

AUDIO-TECHNICA U.S. INC., Dept. 114H, 33 Shawnee Ave., Fairlawn, Ohio 44313
In Canada: Superior Electronics, Inc.

CIRCLE 4 ON READER-SERVICE CARD

decidedly thin-toned if not uncharacteristically French violin and trumpet qualities, and that the extraverted conductor gets carried away at times.)

My top prize for all-round musical satisfaction remains firmly given to the more orthodox but still superbly vital Menuhin versions of all three works in the present set. (Menuhin's B flat Concerto is included in his *Fireworks* disc.) But the newer Malgoire versions invaluably illuminate different facets of these many-sided Handelian—and baroque-era—masterpieces. And despite their occasional eccentricities, they proffer some unique sonic thrills that are also severe tests of the true catholicity of one's personal aural sensibilities. Certainly they are better suited than any previous versions for actual out-of-doors hearing—a further potent excuse for taking advantage of this bargain-priced set's novel attractions.

I'd like to know more about La Grande Ecurie et la Chambre du Roy than the bare facts of its being founded in 1966 by Malgoire to "perform late-Renaissance and baroque music in its original form." Apparently it has been recording for some time in France, but the only previous American representation I've spotted is a program of "Music in the Court of Henri VI" for Turnabout last July that I haven't yet heard or even seen reviewed. The name itself provokes curiosity: until I'm enlightened I can only assume that, if *écurie* is used in its normal sense of "stable," the name must be intended to suggest a royal ensemble that includes mounted as well as chamber players, one suitable for hunt or other out-of-doors music-making as well as for indoor musical entertainments.

R.D.D.



HUMPERDINCK: Hänsel und Gretel.

| | |
|-----------|------------------------------|
| Peter | Dietrich Fischer-Dieskau (b) |
| Mother | Charlotte Berthold (ms) |
| Hänsel | Anna Moffo (s) |
| Gretel | Helen Donath (s) |
| The Witch | Christa Ludwig (ms) |
| Sandman | Arielen Auger (s) |
| Dew Fairy | Lucia Popp (s) |

Tölz Boys' Choir; Bavarian Radio Orchestra, Kurt Eichhorn, cond. [Fritz Ganss and Theodor Holzinger, prod.] RCA RED SEAL ARL 2-0637, \$11.98 (two discs, automatic sequence) [from EURODISC 85 340, 1972].

Kiddie Art has produced a very few works of real sensitivity and a mountain of twaddle, but nothing else quite like Humperdinck's *Hänsel*, a simple fairy tale inflated to the proportions and musical language of a sub-Wagner epic. Between the Scylla of preciosity and the Charybdis of ponderousness, performances are well-nigh doomed to cloying, lumpish embarrassment.

And yet there is that middle ground. Give the score the proper respect, and you discover a work of prodigious—even prodigal—genius. It was in fact this recording's original Eurodisc issue that persuaded me of what had previously been unthinkable: that *Hänsel* is a great opera. I doubt that it could be made to work in the theater, given the gap between matter and manner (and what opera house would give it the musical care it needs?), but this recording seems to me a must for any operatic collection. A less-than-first-rate *Hänsel* is hardly better than nothing.

If Humperdinck learned his harmonic language and use of motifs from Wagner, his own fertile imagination took it from there. The melodies are lavish and first-rate. The orches-

Superb performance - lavish engineering
- a new standard in high fidelity



THE ALL NEW **REVOX** 700 SERIES

Stereo Tape Recorder A700 Digital Stereo Tuner/Pre-amplifier A720 Power Amplifier A722

The Illustration Contains Optional Extras

Revox Corporation in USA; 155 Michael Dr., Syosset, NY 11791 & 3637 Cahuenga Blvd. West, Hollywood, Calif. 90068

Revox in England; Lamb House, Church Street, Chiswick, London W4 2PB. Revox Sales and Service in Canada.

For other countries; Revox International, Regensdorf 8105ZH Althardstrasse 146, Switzerland.

KARAJAN



(...a man possessed by music.)

So Claudia Cassidy described him in *The Chicago Tribune*. Today, he is also very much in possession of the world of music.

No other conductor even approaches his dominance of European opera, the concert stage, music festivals, even films. He knows no rival in recording.

In November, he brings his Berlin Philharmonic here for its first U.S. tour in 9 years. For the occasion, we are releasing his acclaimed *Otello*, along with 3 other new albums. They bring to 43 the number of current Angel performances by Herbert von Karajan.



SCLX-3809

S-37059



S-37062

S-37063



Discography brochure: free from record dealers or Angel Records.

CIRCLE 3 ON READER-SERVICE CARD

tration is unceasingly active and inventive. Humperdinck seems paranoid about repeating himself, endlessly twisting strophic repetitions and concocting new accompaniments for melodic repetitions. The Father's entrance song, for example, can seem endless; by executing the score scrupulously, Fischer-Dieskau and Eichhorn produce a bravura vignette.

What makes *Hänsel* so difficult is the simple, though solid, nature of its musical materials: The melodic motifs and rhythms with which Humperdinck builds his rich, ever-shifting textures can, if underarticulated, lapse into triviality. But if properly executed, the music has enormous depth and point—and, thanks to that very simplicity of its components, the textures remain transparent however complex the scoring gets.

I'm sorry to see that Capitol's fine English-language recording (from the Saddler's Wells production) is no longer listed, but the Eichhorn version pretty well eclipses all the competition—I like it even more than Peter G. Davis did in his glowing review two years ago.

Instead of projecting "personality," Moffo and Donath simply sing their parts. It's remarkable how the dance duet becomes spritely instead of simpleminded when it's sung rather than hiccupped, or how the quiet, simple beauty of the prayer can match the eloquence of its initial statement at the beginning of the overture.

Fischer-Dieskau and Ludwig (in her very best voice) have a grand, rug-chewing time with their parts but never (well, hardly ever) at the expense of the musical line. Berthold's hooty, tonally uningratiating Mother is the weak link here. The Capitol set boasted no less than Rita Hunter in the part—with Raimund Herincx's sturdy Father, that made a pretty strong pair of parents.

Eichhorn and his excellent orchestra lay out the orchestral textures in all their glory, with a really vital rhythmic underpinning. RCA has preserved Eurodisc's superlative engineering: rich, transparent, beautifully balanced—I don't even mind the hokey echo around Ludwig's "*Hokus pokus*." When you can track a Dynaflex disc, the sound can be spectacular (and one of my review discs was actually unwrapped!).

K.F.

JANÁČEK: *Missa Glagolitica* (Slavonic Mass). Teresa Kubiak, soprano; Anne Collins, mezzo; Robert Tear, tenor; Wolfgang Schöne, bass; John Birch, organ; Brighton Festival Chorus; Royal Philharmonic Orchestra, Rudolf Kempe, cond. [James Mallinson, prod.] LONDON OS 26338, \$6.98.

Comparison:

Kubelik/Bavarian Radio Sym.

DG 138 954

It is frequently said, and not so flippantly, that the *Manzoni* Requiem is Verdi's best opera. By the same token, the Moravian genius Leoš Janáček may never have written a more intensely human or theatrically memorable vocal work than this 1926 setting of the liturgy in Old Slavonic (for which the Glagolitic alphabet was devised).

Replete with brass fanfares, solo parts—particularly the soprano's and tenor's—that are rhapsodically tender and stretch the upper register, timpani writing that will shake loose every bit of crockery in your living room, and

two substantial organ interludes that remind one of some zany horror movie (you know, the scene with the wild-eyed creature in the church belfry), this Slavonic Mass stands in splendid isolation in an inimitably eccentric corner of the repertory. As for the operatic quality, the closing pages of Janáček's Credo setting reach a climax of overpowering splendor that is uncannily reminiscent of the scene of the fifth door (the vast and majestic domain) from Bartók's *Bluebeard's Castle* of fifteen years earlier.

The new issue at hand is by my count the fourth in stereo; the best of the predecessors, the Kubelik/DG, is also the only survivor in Schwann.

The new disc's greatest virtue is the roundness, breadth, and sheer massive power of the sound captured in Kingsway Hall by the Decca/London team. The bass response alone should bring this record into the audio showrooms. Furthermore, the RPO reveals itself in this, one of its all-too-few recordings under its departing maestro, as still in excellent health and quite able to handle the technical and coloristic requirements of the piece. The Brighton Festival Chorus deserves credit for its pitch, ensemble, and grasp of expressive shadings. The chorus is somewhat backwardly mixed, however, for the moments when the orchestra is giving it real competition.

The solo quartet here appears stubbornly to conceive of the music as oratorio. Their delivery stresses metrical evenness, subdued vibrato, and loud projection to the balcony. Soprano Kubiak is steady in her fearsomely tough part, though the tone produced is hardly a meltingly lovely one. Tear neither pleads with nor confides to the Almighty, but harangues Him—a mannerism that was also the bane of his Argo recording of Janáček's *Diary of One Who Disappeared*.

In his approach to pacing, rhythm, and the building of climaxes, Kempe stresses a monolithic bigness at all times. Admirers of the pioneering Bakala mono edition (made in Janáček's Moravia and briefly available on Urania, thenceforth as a Supraphon import) will find the massive power of that impressive performance duplicated here in modern sound.

The big problem with Kempe is that he is too much the German Romanticist to let himself go where the sheer wildness and jaggedness of the music is concerned, and so we turn to Kubelik, whose reading is never stolid, as the new one sometimes seems, but is possessed of a white-hot animal vigor. It isn't just his native feel for the Slavic speech rhythms that informs the instrumental as well as vocal writing (though surely that goes a long way!), but also the greater incisiveness of his beat, the faster tempos, and the willingness to allow his forces to throw caution to the wind.

DG's solo lineup is generally excellent, and the closer pickup permits the singers a more intimate vein of lyricism than their counterparts in the London issue. For a sampler, listen to Evelyn Lear negotiate the opening of the Gloria and Sanctus, or Häfliger the Credo.

The decade-old Munich recording, though less opulent than London's, benefits from the conductor's lateral division of first and second violins and the drier ambience surrounding the brass. Janáček was called a "primitive," and it is that peasantlike gruffness, warmth, and headstrongness that the Kubelik produc-

The Infinity Monitor has an acoustic accuracy that is unsurpassed. (Except by our own \$3000 Servo-Statik 1A.) It gives you all of the overtones and timbres of the original source, in perfect balance and ambience.

The Monitor is unhampered by the electronic limitations of traditional speaker systems. An oboe sounds like an oboe — not like an amplified oboe. The gut strings of a Martin sound like gut strings — not like steel strings. And you feel the stab of a great Fender bass line with perfect clarity and

articulation — free from the muddy mid-bass thunder that passes for bass in many of today's expensive speakers.

Technically, the achievement is formidable. Our patented Wave Transmission Line tweeter is the first transient-perfect, totally coherent 360° tweeter in the world.* Our midrange driver has an incredibly flat response, with brilliant, active transients. Our patented 12" woofer is mounted in our Transmission Line enclosure.

And there's more. Listen to the Monitor and you'll know why it has

become a charismatic speaker system.

You see, at Infinity we're music nuts — in addition to being very stubborn physicists and engineers. All we insist upon is perfection — and at a reasonable price.

At \$429* each, we're pretty well on target.

**INFINITY
SYSTEMS, INC.**



9001 Fullbright Ave., Chatsworth, Calif. 91311

The Infinity Monitor gets you back to what it's all about. Music.

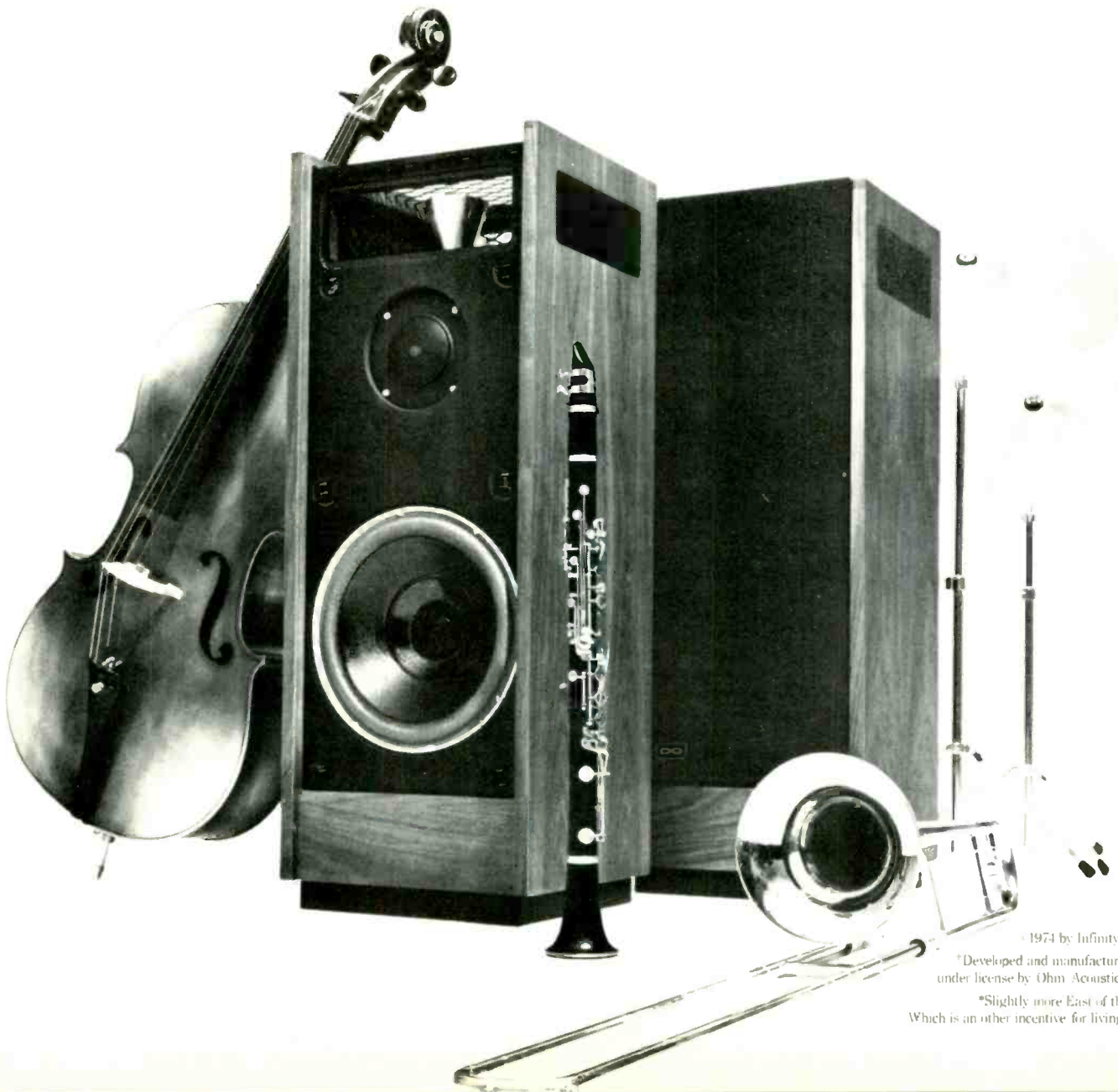

©1974 by Infinity Systems, Inc.

*Developed and manufactured by Infinity under license by Ohm Acoustics Corporation.

*Slightly more East of the Mississippi. Which is an other incentive for living in California.

Who else could put so much into something so small?



**CR 134
STEREO**

Uher does it again!

The world's smallest portable hi-fi stereo cassette machine ■ Unique photo-sensitive electronic control of the tape-drive mechanism ■ Automatic tape reversal ■ Newly developed special head design ■ Switchable ALC ■ Built-in Condenser Microphone ■ Operates in any position ■ Variable power supply (AC, 6 "C" cells or automobile battery) ■ Great for film dubbing, "sound hunting", as a vacation partner, a non-stop entertainer or a car companion.



For Further Information, write to

Uher of America Inc.

621 S. HINDRY AVENUE
INGLEWOOD, CA 90301

CIRCLE 67 ON READER-SERVICE CARD

Some people make 2-faced speakers



We make 4-faced, 6-faced, and 12-faced speakers

Why so many faces? Because we believe the best way to achieve true omni-directionality, while maintaining all other desirable characteristics, is through multiple radiating surfaces.

When Julian Hirsch reviewed the D-6, he said, "In our simulated live vs. recorded listening test, the D-6 (with controls in the up position) was 100% perfect at any point in the listening room! The D-6 is the *only* speaker in our experience to achieve this." (Stereo Review, September 1973)

Our 4-faced D-4 is just being introduced and sells for a surprising \$199. It has many of the same dispersion characteristics and design elements of our D-6. We invite you to hear it at your local dealer and judge for yourself.

Write us for brochures and test reports.



Design Acoustics, Inc.
2909 Oregon Court
Torrance, CA 90503
(213) 320-4981

(Photo: D-12, \$399 to \$425; D-4, \$199; D-6, \$279.)

CIRCLE 18 ON READER-SERVICE CARD

tion captures to perfection. Kempe's skilled presentation may ultimately do itself in by its very sophistication. A.C.

KABALEVSKY: Concerto for Piano and Orchestra, No. 3—See Rubinstein: Concerto for Piano and Orchestra, No. 3.

B KALLIWODA: Symphony No. 1, in F minor, Op. 1. **TOMÁŠEK:** Concerto for Piano and Orchestra, No. 1, in C, Op. 18. Petr Toperczer, piano (in the Tomášek); Prague Symphony Orchestra, Jindrich Rohan, cond. CAN-DIDE CE 31073, \$4.98.

Burney called Bohemia "the conservatory of Europe," and indeed this part of the old Hapsburg empire furnished excellent musicians to all other countries. What we (incorrectly) call the Viennese School had a sizable Czech component, and the two composers recorded here were part of it. At the same time it must be admitted that Czech protestations notwithstanding, these composers are indistinguishable from their Austro-German colleagues—they are wholly in the mainstream of Central European music and without any national characteristics.

Kalliwoda (1801-66) occupied an eminent position in this mainstream until the middle of the nineteenth century; even the New York Philharmonic played one of his works at its opening concert. His Symphony No. 1 (1826) was for a generation a favorite repertory item everywhere, but afterwards it lost its popularity and faded altogether. Yet it is a good piece and could stand occasional revivals.

Kalliwoda was an inventive melodist, solid in counterpoint, and a brilliant orchestrator, but he did not develop. The twenty-five-year-old who composed this symphony gave the impression of being a major talent and was so greeted, but while he composed other viable works (I know only Symphony No. 3, which is very attractive), he never appreciably deepened and extended his talent.

This first symphony has the genuine symphonic spirit, there is passion in it, and except for an overextended slow movement the proportions are fine. There is little impact in this music of Kalliwoda's titanic contemporary, much more of Mozart and Cherubini, and perhaps a trace of Weber. The "minuet" is a real swift symphonic scherzo, but the conductor reduces its effect by taking the title at its face value—it is too slowly played. Otherwise the performance is very good.

Václav Jan Tomášek (1774-1850) was an extremely prolific composer, a good teacher, and a remarkably many-sided man. He was a friend of Goethe and set a number of his poems. While he wrote many large works, his fame rests on his neat piano pieces, which inaugurated Romantic instrumental lyricism and considerably influenced Schubert.

The piano concerto on this record starts with elaborate symphonic bustle, but the promises in the grandiose exposition are not fulfilled. The writing is very competent. Tomášek having complete command of style and idiom, but the fluent Mozart-Hummel garlands never go beyond conventionality. Interesting how one can pinpoint with accuracy all these same clichés and turns in Beethoven's concertos; yet see what happens to them when manipulated by a genius!

Music to grow by.



M 32937
Three eminent Mozartean virtuosos in superb performances with the English Chamber Orchestra.



M2X 33044§
A multi-media extra-vaganza. Alan Rich of *New York* magazine called it "the best piece of new music I've heard all year."



M 32938
Here is the debut Columbia recording of one of the most exciting young pianists of the '70's. A triumphant entrance.

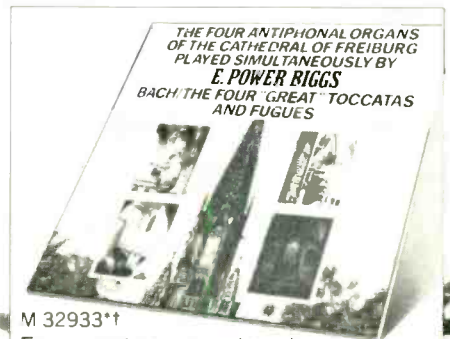

M 32933*†
Four great organs, played from a single console, in a thundering sonic spectacular that's especially smashing in quad.



M 32932*†
Dazzling new performances of Chopin favorites to celebrate Horowitz's renewed appearances on the concert stages of America.



M 32969*†
Catchy Americana indelibly stamped with Ives' fascinating musical personality.

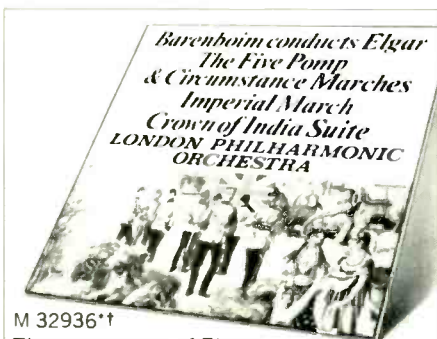

M 32936*†
The pageantry of Elgar is the perfect vehicle for Barenboim's majestic style of conducting.



M 33013
They're back! And lending their unmistakable touch of grace to 16th and 17th century love madrigals.

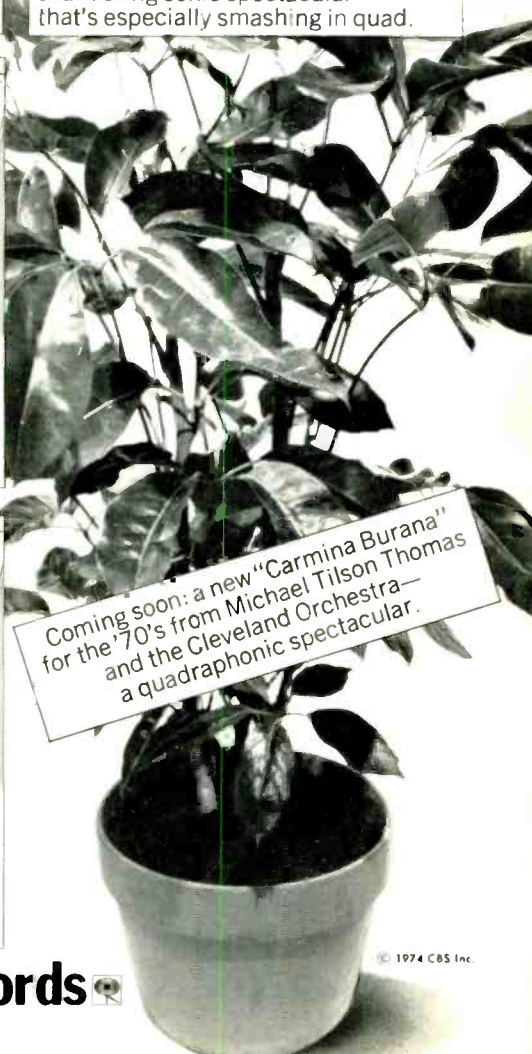

* Also available on tape. † Also available on quadrasonic records and tapes. § A specially priced 2-record set.

free The "NEW LOOK"
1975
Lafayette
catalog

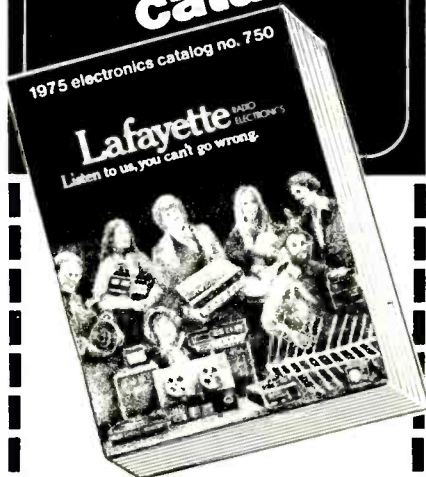

NEW!
 Larger
 Page Size

NEW!
 More
 Full Color

NEW!
 Easy-Read
 Typeface

SAVE On
LAFAYETTE PRODUCTS
 Plus Major Brand Names

- Pioneer • Garrard • Dual • AR
- Dyna • Sanyo • Marantz • BIC
- BSR • Phillips • Koss • JBL
- Pickering • Kenwood • Shure
- Sennheiser • Technics

Plus EXCLUSIVE
LAFAYETTE PRODUCTS

(MANY WITH OUR SQ-FULL LOGIC
 —THE MOST ADVANCED SQ-4-
 CHANNEL CIRCUIT AVAILABLE ON
 ANY EQUIPMENT)

Lafayette

Listen to us, you can't go wrong.

Mail this coupon today **FREE!**

Dept. 19114

Lafayette Radio Electronics
 111 Jericho Tpk., Syosset, LI, NY 11791

Send me your **FREE** 1975 Catalog

Name Apt.

Street

City State

Zip

Send a 1975 Catalog to my friend

Name Apt.

Street

City State

Zip

CIRCLE 38 ON READER-SERVICE CARD

Conductor and orchestra are first-class in both works, and the able soloist Petr Toperczer makes the concerto sound better than it is.

P.H.L.

LISZT: Sonata for Piano, in B minor. **CHOPIN:** Sonata for Piano, No. 3, in B minor, Op. 58. Agustin Anievas, piano. [Suvi Raj Grubb, prod.] ANGEL S 36784, \$6.98.

B **LISZT:** Sonata for Piano, in B minor; Funérailles; Gnomesreigen; Liebestraum; Waltz from Gounod's "Faust." Simon Barere, piano. **TURNABOUT** THS 65001, \$3.98 (rechanneled) [from various REMINGTON originals, recorded c. 1949-50].

H **LISZT:** Sonata for Piano, in B minor. **CHOPIN:** Sonata for Piano, No. 3, in B minor, Op. 58. Alfred Cortot, piano. **DACAPO** C 047 01504M, \$5.98 (mono) [from HMV/VICTOR 78-rpm originals, recorded 1929 (Liszt) and 1933 (Chopin)].

I list these records in alphabetical order (which happens to be the inverse order of my preference), but all three artists plainly know their pianistic ABCs.

The youngish American pianist Anievas recorded the Liszt B minor once before (for the defunct St/And label), and his new version, a bit more flexible and improvisatory than its predecessor, largely duplicates the muscular, vigorous account of yore. Anievas, one suspects, has huge hands; he deals with the octave passages as if they were child's play. He turns in large-scaled, direct, structural, unaffected conceptions of both pieces, which could nevertheless go even further in terms of nuance, voicing, and sheer expressiveness. One has to admire such unostentatious craftsmanship, but the Liszt playing of the two resurrected titans proves all too plainly what is lacking in Anievas' praiseworthy if rarely inspirational pianism. The Angel disc, though, is beautifully solid in tone.

Despite the obvious chinks in Cortot's pianistic armor (his octave playing is simply horrendous half of the time and superbly assured elsewhere; he was a great virtuoso who was simply too busy and intelligent to practice!), he rises Galahad-like to the gargantuan demands of the Liszt. He does many strange things to the music: He stretches and groups certain phrases in a seemingly arbitrary manner (which invariably proves entirely logical, even inevitable, the second or third time around); he inserts alien low "harmonics" of uncertain pitch (e.g., just before the fugue third movement); he pedals in such a manner as to suggest a witches' cauldron.

But what breadth and dignity in his conception, what a wealth of color and nuance! Cortot's sonority is a compendium of velvet and bronze.

Indeed, I like everything about his performance, even the wrong notes! Cortot once commented, upon hearing the record of a lesser pianist, "That fellow hasn't enough technique to hit wrong notes!" This Liszt B minor eloquently proves the point. There is a charged freedom and constant motion in the playing that is assurance itself—one accepts the imperfections as if they were part of a rough-hewn Jacob Epstein statue.

Surprisingly, Cortot's account of the Chopin B minor is less convincing. His perform-

ance has its fitful moments, and much of his extravagant rubato I find lurching and discontinuous. Still, there is superb authority in much of the playing—an authority that could come only from a great master.

As usual in its DaCapo series, Electrola's lab work is of the highest order, and the sound on both sides is strong and vital. Fortunately filtering is moderate, and I for one much prefer a bit of original surface noise to muffled sonics. (DaCapo is imported by Peters International.)

Vox has done similarly salutary work with the much more recent Barere masters. As with all of the Turnabout Historical Series, the engineers have wisely "rechanneled" the original mono tapes only to the extent of running the same signal in duplicate. The result in this instance is a startlingly lifelike evocation of Barere's long-silenced piano—bright, solid, and clear, lacking only the merest overtones now and then. Many less good piano recordings are being made today! If one *must* find fault it could be noted that there is an audible break in continuity just before the fugue in the Liszt sonata, at the spot where the original Remington LP turned over.

Barere was a sort of pianistic Billy the Kid, an instrumentalist quick on the draw digitally if not always mentally. In some music—Chopin's F minor Fantasy and Schumann's toccata, to cite two examples—his renditions could sound rushed and scatterbrained, too fast for any sort of shaping or logic. In the works on this record, however, the Russian-American pianist was completely in his element. The Liszt sonata gets a magnificently self-indulgent statement. Barere dwells upon many details, stretching phrases, altering a few harmonies, but always achieving a convincing approximation of the authentic Liszt. His is not the intellectualized playing of a Cortot, but nevertheless is decidedly music-making in the grand manner.

The shorter pieces are similarly stunning. The *Faust* waltz is played with bold, full-bodied fortes and gorgeous filigree detail. For all the brilliance and glitter of Barere's fingerwork, he always achieves a limpid, singing sonority. The *Funérailles* performance is broader than most in its pacing but noble in design, the *Gnomesreigen* breathtakingly light and fast (a real Rachmaninoff tempo, this!). One can, in the present circumstances, even endure the treacly *Liebestraum*. H.G.

LISZT: Via crucis; Inno a Maria Vergine. Eva Marton, Eva Andor, and Adrienne Csengery, sopranos; Erzsébet Komlóssy and Zsuzsa Németh, altos; Attila Fülöp, tenor; Sándor Sólyom Nagy, baritone; Ferenc Bégányi, bass (all in *Via crucis*); Hédi Lubik, harp (in *Inno*); Gábor Lehotka, organ; Budapest Choir, Miklós Szabó, cond. [János Mátyás, prod.] HUNGAROTON LPX 11575, \$6.98.

The two works recorded here are a puzzle within a puzzle.

Catholic "sacred music" in the second half of the nineteenth century was either flamboyant-dramatic (Berlioz, Verdi, Liszt—Bruckner being the exception) or steeped in sweet-scented incense (the Caecilians, Gounod) or bogged down in Romantic historicism, an anachronistic Gregorianism and Palestrinianism (Witt and his numerous followers). This is

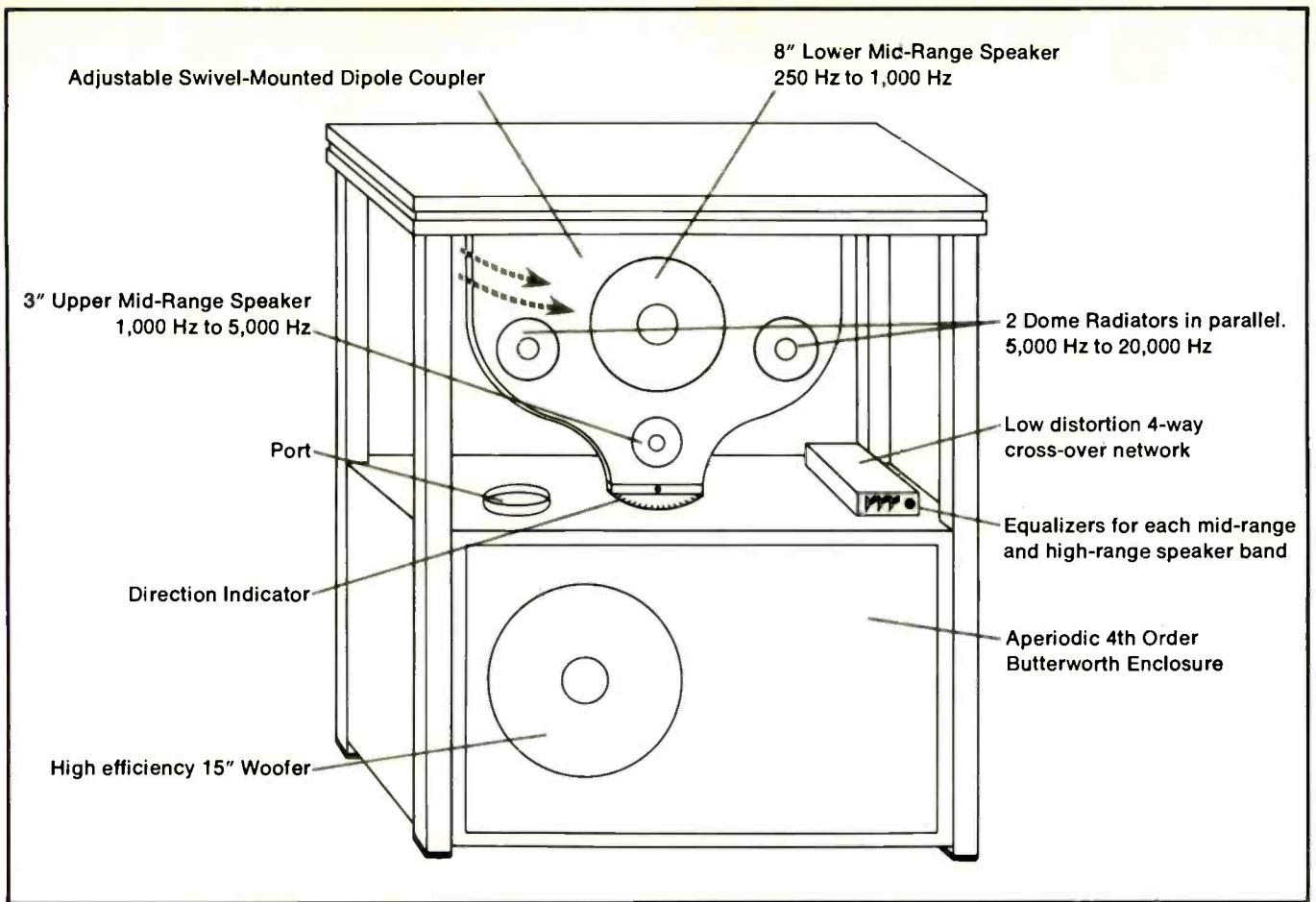

The new Leslie DVX Speaker: it adjusts to the geometry of your room!

CBS Laboratories and Leslie Speakers have now developed an amazing new loudspeaker system that is...quite frankly...amazing!

The Leslie DVX speaker is a unique high performance, low distortion four-way system. Its exclusive dipole coupler is swivel mounted...so that you can "aim" the mid-range and high frequency speakers to fit the geometry of your room. This dipole coupler also gives you the optimum balance of direct and reflected energy to pinpoint and anchor the stereo image in the manner intended by the recording director.

The bass frequencies are reproduced by a high energy 15" woofer housed in an aperiodic 4th order Butterworth ported enclosure and descend smoothly to the lowest registers.

Leslie Speakers was the first company to introduce a truly effective "augmentation" system (the Plus 2 speaker) to eliminate the standing waves in your room. Now comes the amazing DVX speaker. D for dipolar. VX for variable axis. A whole new alphabet for sound! Hear it at your nearest Leslie Plus 2/DVX dealer.

Leslie[®]
SPEAKERS

DVX MODEL 580
STUDIO/LAB MODEL



DVX MODEL 570



ELECTRO MUSIC/CBS MUSICAL INSTRUMENTS, A DIVISION OF CBS INC., 56 WEST DEL MAR BLVD., PASADENA, CA. 91105

CIRCLE 74 ON READER-SERVICE CARD

the outer puzzle: the inner puzzle is Liszt himself.

His was undoubtedly a most original and prophetic musical mind that overwhelmed musicians for two generations—Wagner, Strauss, the Russians, and all the way to the Impressionists. Such of his works as the B minor Sonata or the E flat Concerto solved with remarkable originality, albeit with a little bombast, the formal-structural problems that haunted all composers trying to escape Beethoven's oppressing shadow. But again, what a puzzle when we look at the makeup of this highly original talent: German, Hungarian, Italian, French, Gregorian, and the Lord only knows what other elements mingle in this bold and astonishingly modern music, giving it a restless quality that nearly always intrigues but seldom satisfies.

And then the aging lion and romantic lover decides to compose nothing but church music: the incomparable virtuoso of keyboard and orchestra turns to the organ and the *schola cantorum*.

Liszt moved to Rome in 1861, where he stayed until 1869. To be sure, the first aim was to secure annulment of Princess Carolyn Wittgenstein's marriage so that he could marry her, but since the Pope would not hear of it, Liszt abandoned the plan and took the lower degrees of holy orders. The new abbe promptly sat down to compose religious music. Princess Wittgenstein, also newly devout, still stood by, arranging the text of *Via crucis* (Liszt's paramours were usually cultivated women of letters who wrote his books). Her concoction turned out to be a heterogeneous selection, with Latin, French, German—even

Aramaic—texts and superscriptions woven together, as well as alternating Catholic and Protestant elements from Latin hymns to Lutheran chorales: an early example of confused ecumenism.

The composition was finished in 1879, but *Via crucis* was not performed until fifty years later, because the unusual score scared away church musicians. Liszt was indeed far ahead of his time, not only with his chromaticism, augmented harmonies, and instances of polytonality, but with suggestions that more nearly fit the age of Scriabin and beyond than his own. He wanted the score published with illustrations of the Passion taken from Dürer. The idea has been taken up with a vengeance in our day by producers in Europe who use projections while the music is being sung and played.

Basically, *Via crucis* is not a vocal work, but instrumental program music with vocal inlays, most of them very brief choral ejaculations. The organ pieces that carry out the scheme are highly original and reach well into the twentieth century, indeed almost to Tournemire: no wonder that church musicians around the end of the century were intimidated by these harmonies.

Just the same, it is rather tenuous to maintain that these organ pieces can represent such concrete events of the Stations of the Cross as Jesus meeting Mary or the scene where Jesus' garments are torn from Him. Yes, the chorus thunders "*Jesus cadit*" ("Jesus has fallen") or "*Crucifige!*" ("crucify Him!"), but the end result is what usually befalls program music: It needs external, verbal guidance; otherwise it falls far short of its aim.

Though Liszt operates with very sophisticated devices such as recurring motifs (the 14th Station is a skillful weaving together of several of them) and with timely repetitions, the abstract musical unity and logic are sorely tried by the stylistic hodgepodge. Gregorian and Palestrinian echoes are accompanied with avant-garde harmonic subtleties; occasionally the old blatant rhetoric shows through; then again the venerable Passion chorale "*O Haupt voll Blut*" suddenly makes its appearance in the original language and harmonization, which is the more disconcerting because of the little postlude Liszt attaches to it in his very own language.

So in the end the impression one gains is something *decousu*: the composition is not convincing. A suspicious Romantic sanctimoniousness hovers over it, or perhaps we should more charitably say a mistaken concept on the part of an essentially robust hedonist of what is religious music.

The performance is excellent, the numerous soloists (who have not much to do), chorus, orchestra, organist, and conductor, as well as the "mono-stereo" sound, all being very good. Though the tricky harmonic underpinning of the modal melodies at times almost trips these fine singers, they hold their own admirably.

The Italian *Hymn to the Virgin* is quite another piece—and it is a good one, only being a little abrupt in its ending. It was composed ten years before *Via crucis*, when Liszt was still trying to curry favor with the Pope, whom he extolled as a great spiritual and secular ruler. Unfortunately, by the time the composition was to be performed the Papal States had ceased to exist and the encomiums became moot. So this piece too was put aside, not to be revived until 1936.

The hedonist is not at all inhibited here; he



Next time you plan a trip to Europe, make sure you visit the unique country.

Where can you find: Europe's largest waterfalls?
Europe's blondest blondes?
Europe's highest geysers?
Europe's greatest glaciers?

And where can you find moonlike craters where the astronauts trained? More volcanos than anywhere else on earth? Historic landmarks of the world's oldest continuous parliament? Celebrations marking Europe's youngest republic?

The answer to all of these questions is—ICELAND. Next time you plan a trip to Europe, make sure you visit Iceland.

The only thing it may cost you is time well spent. Because you'll save enough money on Icelandic's lowest jet fares to Luxembourg to pay for your stopover in Iceland. Or, you can hop over from New York or Chicago for longer tours. See an erupting volcano. Take a cross-country pony trek.

Next time you plan a trip to Europe, ask your travel agent about Icelandic Airlines. Or phone Icelandic Airlines, for folders about Iceland and lowest jet fares to Europe. In New York State, phone (212) 757-8585. Elsewhere in U.S., phone (800) 555-1212 for local toll free number.

CIRCLE 31 ON READER-SERVICE CARD

Introducing the MX-12.

A new speaker for a new problem.

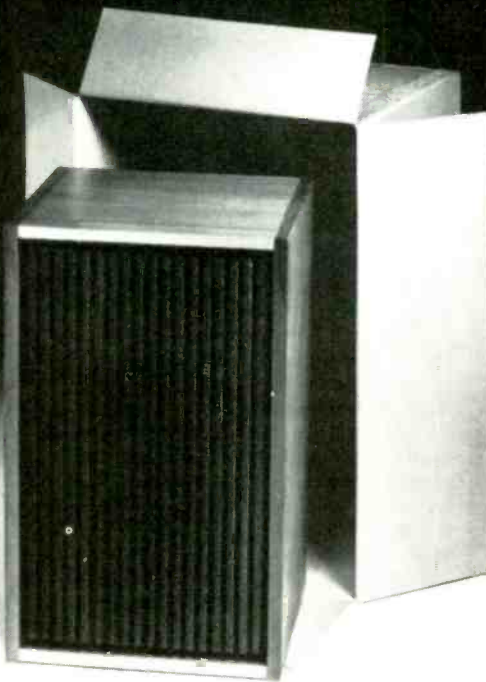

When receivers boasted modest power, virtually any well-designed speaker system could handle the load.

But this is the Super Ear era; a musical age of bass-heavy rock, driven by super-powered receivers and amps.

And that's a problem—if your ears and speakers can't stand the strain without squawking.

The MX-12 can. It's a new 3-way acoustic-suspension speaker system designed to cruise smoothly and effortlessly at today's listening levels by a new division of the company that invented moving-coil loudspeakers in 1915.

Unheard of power-handling capacity from a speaker nobody ever heard of before.

The power-handling capacity of the MX-12 is impressive. In tests at 30 Hz, it withstood an applied voltage (necessary to produce rated watts) of 25 volts. (Speakers with more famous names grumbled and rumbled at 15 volts.)

The MX-12's high power-handling ability—made possible by a rugged box and high-temperature cement in the long-throw voice coil—permits you to use enough power to fill even the largest living room with music

at satisfying loud levels, with gratifying low distortion.

Linear response for natural sounds. Naturally.

Moreover, the response is slab flat. From the deep frequencies super receivers are capable of (and the MX-12's low resonance reproduces accurately), clear across the spectrum to 20 kHz.

And because the MX-12 is more efficient than many other speakers of its class, you enjoy smooth listening even when you drive it with amplifiers of modest power.

Dispersion is excellent, too, the result of high-frequency drivers of exceptional off-axis response and wide cutouts on the grille—an extra nicety you'll learn to expect from MX Components.

But that's our philosophy: a lot of extras at no extra charge. So, before you go out to A-B any speakers, we suggest you listen to this page.

To learn more about the MX-12—and

the MX-1C (10" woofer), the MX-15 (15" woofer), and MX turntables, stereo and quad receivers—see your MX dealer. For his name, write: MX High Fidelity Component Series, The Magnavox Company, 1700 Magnavox Way, Fort Wayne, Indiana 46804.

Specifications:

| | |
|---|---|
| Woofer: | 12" high-compliance (long-throw voice coil) |
| Mid-range: | 2" hemispherical dome |
| Tweeter: | 2" phenolic ring cone |
| Impedance: | 8 ohms |
| Frequency response: | 25 Hz to 20 kHz |
| System resonance: | 45 Hz |
| Front-mounted controls under removable, acoustically transparent foam grille: | |
| Mid-range level: | + 3 dB, nominal, - 3 dB |
| Tweeter level: | + 3 dB, nominal, - 3 dB |
| Crossover freqs.: | 1500 Hz, 4500 Hz |
| Cabinet finish: | Oiled walnut veneer |
| Dimensions: | 25 3/4" x 15 3/4" x 13 1/4" |
| Weight: | 40 lbs. (approx.) |
| Recommended minimum amplifier input power: | 10 watts FTC |
| Maximum power handling: | 75 watts RMS* |

*RMS continuous power at 200 Hz, measured by applying the voltage necessary to produce rated watts into an 8 ohm load. At standard room conditions, the unit would be capable of sustained operation at test voltage. MX engineers consider this rating to be very conservative; this is a much more stringent continuous power test than would be encountered in musical programs.



We'll be heard from.

sets the text faithfully, writing well-sounding music with good melodies and euphonious choral setting. Well, there is a little fake Gregorianism and Palestrinianism here and there, balanced by the distinctly secular accents of the harp.

Both chorus and conductor are fully equal to the task of good, straightforward music-making. P.H.L.

MENDELSSOHN: Die erste Walpurgisnacht, Op. 60; Infelice, Op. 94. Annelies Burmeister, mezzo-soprano; Eberhard Buchner, tenor; Siegfried Lorenz, baritone; Siegfried Vogel, bass (all in Op. 60); Edda Moser, soprano (in Op. 94); Leipzig Radio Chorus; Leipzig Gewandhaus Orchestra, Kurt Masur, cond. [Bernd Runge, prod.] ANGEL S 37016, \$6.98.

Here at long last is a fine recording of a work that Berlioz hailed as "a masterpiece of Romanticism." From the Everest version by other performers from Leipzig, it was impossible to realize what so excited Berlioz in *The First Walpurgis Night*, but now we know.

Goethe's impact on the music and literature of the nineteenth century is too well known to require elaboration here. But of all the composers inspired by the poet, Mendelssohn in many ways captured him most authentically. Liszt, Berlioz, Wagner, and Gounod, for instance, used his poetry as a point of departure for their own interpretations. Schumann, with a rapport comparable to Mendelssohn's, unfortunately produced a flawed and uneven tribute in his *Scenes from "Faust."*

Mendelssohn's affinity with Goethe was much more than merely his childhood meeting with the great man or Zelter's influence on his education. Like Goethe, he always tempered his Romanticism with strong classical control and discipline.

Although this balance pervaded much of Mendelssohn's music implicitly, the most explicit artistic bond between composer and poet is the cantata *The First Walpurgis Night*. Here Mendelssohn describes vividly the pagan Druid resistance to Christianity in music that is always expressive but never carried away by the rhetoric of the subject.

Some of its most effective pages are the opening sections describing the waning of winter and flowering of spring—nature music at its best. Later sections, narrating the Druids' mobilization against their Christian foes, wear less well, but the final invocation of the Druid priest and flight of the Christians is extremely effective.

Angel's four excellent soloists, strong chorus, and superb orchestra are masterfully conducted by Kurt Masur in a performance that fully captures this masterful Romantic music.

The concert aria "*Infelice*" is a considerably lesser work, but it is beautifully sung by Edda Moser with the same supporting forces. P.H.

MOZART: Arias. Elly Ameling, soprano, English Chamber Orchestra, Edo de Waart, cond. PHILIPS 6500 544, \$7.98.

Le Nozze di Figaro. Non so più; Voi che sapete; Giunse all'in il momento. . . . Deh vieni, non tardar. *Don Giovanni.* Batti, batti; Vedrai, carino; Così fan tutte; Temerari. . . . Come scoglio. Concert arias: Misera, dove son?, K. 369; Ch'io mi scordi di te?, K. 505; Chi sa, chi sa, qual sia, K. 582; Vado, ma dove?, K. 583.



Felix Mendelssohn
A masterpiece of Romanticism.

Elly Ameling is the perfect miniaturist. As her recordings of Mozart, Schubert, Schumann, Brahms, and Wolf demonstrate, she willingly accepts the narrow confines of the Lied, rejecting every temptation to inflate her material or give it unwonted emphasis. Yet her cool-headed, direct approach does not preclude either subtlety or feeling. Like Jane Austen, who, as she put it, worked on two inches of ivory with a fine brush, Ameling discovers great human truths in intimate circumstances. How fortunate, after the long Schwarzkopf years, to have a recitalist of such musical probity among us once again.

Ameling's clear and serviceable soprano is capable of expressing many fine shades of meaning, but it is not by any stretch of the imagination an outstanding instrument, being neither powerful nor affectingly sensuous. Because of its limitations in amplitude and color, its scope is of necessity fairly limited. It is best suited to introspection. Drama—the presentation of personality in action—lies outside its effective range. Or so one must conclude from the present recital, which is something of a disappointment.

Neither opera nor the Mozartean concert aria would seem to suit Ameling's gifts, both of these forms calling for greater dynamism in projection than she can provide. In addition, most of the concert arias demand a virtuoso technique she simply doesn't possess.

In these great showpieces—poised, for the most part, midway between *scena* and vocal concertante—Ameling manages matters with charm and sweetness. She can trill, she commands an exemplary legato, her floritura is clean. Yet she sometimes finds herself troubled by low notes (anything below the staff tends to be sketchy—except, oddly enough, in "*Come scoglio*"); once or twice she runs out of breath; and the gruppettos of "*Ch'io mi scordi di te?*" are quite beyond her. More damagingly still, so is the kind of grandeur and authority called for by a piece like the latter, a noble statement of faithfulness in adversity, set to

Idamante's lines from Act II, Scene I of *Idomeneo*.

But the problem is wider than this suggests, since even the intimate music on this disc is comparatively unrealized. "*Deh vieni, non tardar*" is bland. One cannot ever grasp the dramatic occasion, the psychology, the sensuous rapture, as one immediately can, for example, in Mirella Freni's Susanna in Colin Davis' complete *Figaro*. Similarly, Ameling fails to convince one of Zerlina's beguiling playfulness—a quality Freni also establishes immediately in her recording of *Don Giovanni* with Davis. Ameling's art cannot fill out the expressive contours of this kind of music. She doesn't have the right sense of scale.

Edo de Waart is not much help here. He is neat too, but unimaginative. The English Chamber Orchestra, however, is a fine body of players, and much of the solo work is outstanding. Dalton Baldwin's playing of the piano obbligato in K. 505 is superb.

Texts, translations, insufficient notes. The recording is fine, the pressings immaculate.

D.S.H.

MOZART: Fantasy in C minor, K. 475; Rondo in D, K. 485; Sonata for Piano, in A, K. 331.

BACH-BUSONI: Chaconne in D minor. Alicia de Larrocha, piano. LONDON CS 6866, \$6.98.

This mostly admirable collection was issued to coincide with New York's summer Mostly Mozart Festival. De Larrocha is a superb pianist. She has a bright, almost brittle clarity, her fingerwork boasts an easy, pearly evenness, and her always-musical outlook combines rhythmic incisiveness and flowing grace that work well for Mozart. She is not quite a stylist in this music, though: She is sometimes a shade cavalier about the proper treatment of trills, appoggiaturas, and the like, and as often as not she uses discredited texts in place of the easily obtainable authentic ones.

I found her festival performances of the C major (K. 330) and D major (K. 311) Sonatas (and of Schubert's posthumous B flat) a bit superficial and bland, and I have a similar "half" complaint about her recorded performances here of the D major Rondo and A major Sonata. The rondo drags a bit, for all the clarity and attack. The sonata comes off better (especially in the vigorously graceful Rondo alla turca) but nevertheless seems a trifle square and plain.

In the dramatic K. 475 *Fantasy* (here given without the related sonata in the same key, K. 457), Mme. de Larrocha energizes her playing more and turns in a potent, yet still civilized reading. This suits the music ideally, for it gives both the molten desperation and the cool-headed composure to make that quality even more poignant.

The Busoni arrangement of the Bach chaconne doesn't turn up on records too often but this month brought two versions to my turntable (not to mention Seraphim's reissued Heifetz recording of the violin original). Whereas Jorge Bolet's RCA concert performance presented a conventionally grand, massive account exploiting every iota of bourgeois sonic grandeur, Mme. de Larrocha prefers to keep the music volatile and mercurial. Some of her brisk tempos and subtle colorations, also the biting detachment of her fingerwork, made me think of Walter Gieseking's old mono Columbia LP of the Bach Sixth Partita.

We give you the softest soft to the loudest loud. Choose any model. You won't get 'clipped.'

Today's best recordings can reproduce music's full dynamic range, from the softest soft to the loudest loud. Most of today's popular low and moderate efficiency speaker systems can't. But BIC VENTURI™ speakers do.

A speaker's dynamic range depends mainly on its efficiency and power handling capacity. Low-efficiency speakers can't get started without a good deal of input power. And, they tend to get stifled when driven beyond their capability.

BIC VENTURI speakers are efficient! They need as little as one fifth the amplifier power of most air suspension systems for the same sound output. So, you can listen louder without pushing your amplifier to the point where it starts clipping the tops and bottoms of musical peaks.

Today's popular, low-efficiency speakers require about a 50-watt per channel amplifier to deliver lifelike sound levels. Even our Formula 2 will deliver that same sound level with only 25 watts of amplifier power; the Formula 4 with 20 watts and our Formula 6 with only 9 watts! With BIC VENTURI, your amplifier can loaf along with plenty of reserve "headroom" to reproduce musical peaks cleanly, effortlessly. It's as if your present amplifier suddenly became two to five times as powerful. BIC VENTURI can handle lots of power, too. A typical, low-efficiency system is rated for a maximum safe power input of about 50 watts. Feed it more power and you're likely to push it into distortion, or even self-destruction!

With a BIC VENTURI you can turn up the power, without distortion or speaker damage. Even our compact Formula 2 can safely handle 75 watts per channel. With that much power feeding it, it will deliver 210% more sound output than a low-efficiency system will at its

power limit. Drive our super efficient Formula 6 at its maximum, and it will deliver nearly 1300% more sound power!

That's the loud half of the story.

With soft music (or when you turn down the volume) you want to hear it soft.

With most speakers, turn down the volume slowly and you reach a point where the sound suddenly fades out because the speakers aren't linear anymore.

But BIC VENTURI's are. The sound goes smoothly softer, without any sudden fadeout,

retaining all the subtle nuances that add to the character of the music.

But, even though BIC VENTURI speakers remain linear, there is a point where your ears do not. At lower sound levels, your ears lose their bass and treble sensitivity. So, our DYNAMIC TONAL BALANCE circuit (pat. pend.) takes over. As the volume goes down it adjusts frequency response, automatically to compensate for the ear's deficiencies. The result: aurally "flat" response, always!

Our Formula 2 is the most efficient of its size. The Formula 4 offers even greater efficiency and power handling. And the most efficient is the Formula 6. The Formula 1, our newest and smallest model, outperforms all other speakers of its size and in its under-\$75 price class. BRITISH INDUSTRIES CO. Westbury, N.Y. 11590. Div. of Avnet, Inc. Canada: C.W. Poirton, Ltd., Ont.

B·I·C VENTURI

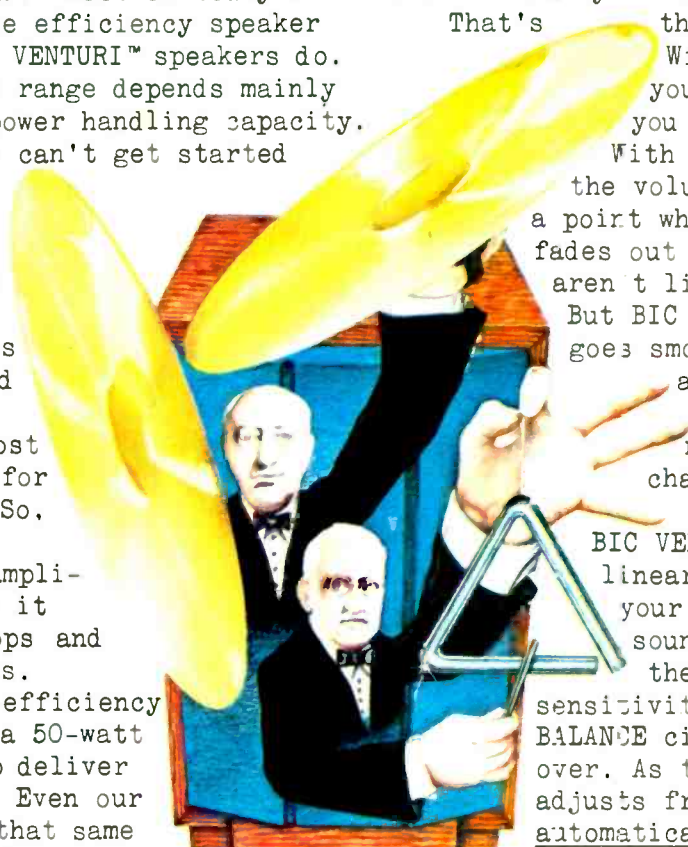



Choosing a blank tape is like selecting a wine

Ever notice how the audiophile (and oenophile) has built a wall of words—a sound barrier—around selecting a quality blank tape (and a fine wine). Neither should be so complicated to enjoy.

Now you needn't be a sound engineer to buy tape. Now there's the music tape BY CAPITOL.

Just choose tape (like wine) to suit the occasion. For everyday dictation or class lectures, use an ordinary tape (like vin ordinaire). But when you record music spend a little more for premium, the music tape BY CAPITOL.

If you insist, we can put it in audiophile terms: the music tape BY CAPITOL is "brighter" tape. Extra high output/low noise. It will extend the frequency response of any tape recorder.

Our backcoated cassettes are guaranteed jamproof. Our 8-track cartridge is the industry standard—professionals buy more of it than any other. And our backcoated open reel tape is the same high quality as studio mastering tape.

Got it? Now forget it. Why work so hard? When all you have to know is:

When you record ordinary things, use an ordinary tape. But when you record music, record on

the music tape
cassette • cartridge • open reel
BY CAPITOL

CIRCLE 12 ON READER-SERVICE CARD



Capitol

REG. TM OF CRI. CAPITOL MAGNETIC PRODUCTS A DIVISION OF CAPITOL RECORDS, INC. LOS ANGELES, CALIFORNIA 90028



TM OF EMI LIMITED
A MEMBER OF THE EMI GROUP

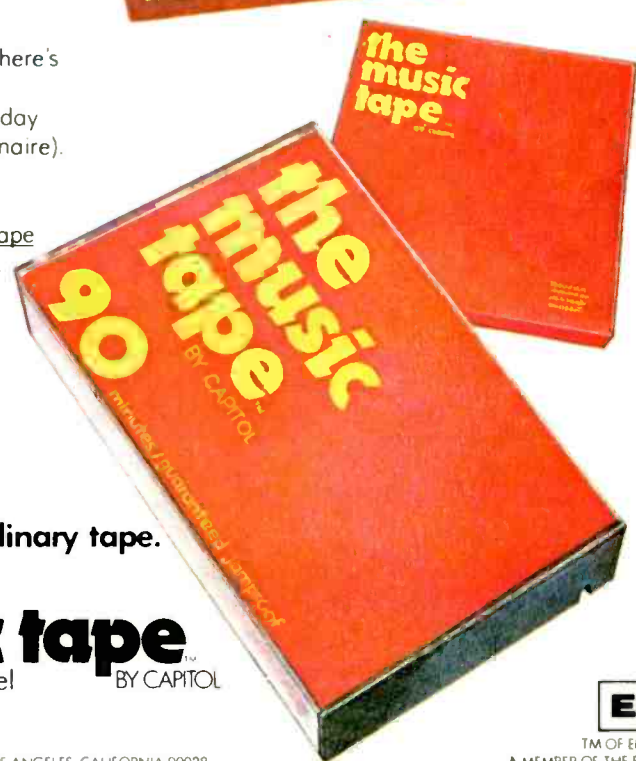

It's an unusual outlook for a piece ordinarily treated solemnly, and I rather like it.

Good, biting, almost brittle piano reproduction, but never without requisite coloristic values. H.G.

MUSGRAVE: Night Music. For a feature review, see page 97.

MUSSORGSKY FANTASIA. For a feature review, see page 91.

MUSSORGSKY: Pictures at an Exhibition (orch. Ravel); Khovanshchina: Prelude (orch. Rimsky-Korsakov). New Philharmonia Orchestra, Charles Mackerras, cond. [Seymour Solomon, prod.] VANGUARD VSD 71188, \$6.98. Quadriphonic: VSQ 30032 (SQ-encoded disc), \$6.98.

Pictures and the 1919 version of Stravinsky's *Firebird* Suite are the current top two among the big Slavic wow numbers, hence their present availability in some two dozen orchestral versions. In stereo the Mackerras set really is not especially competitive; although the performance of *Pictures* is one of real merit, it lacks the immediacy, the big, walloping sense of performance that several of its rivals can produce.

Quad changes the situation. Distribute the orchestra around the room, get the whole joint rockin', and make clear the wonderfully imaginative character of Ravel's scoring, and you hear things that not even the best of the stereo versions can duplicate. This therefore becomes a real encounter with the music, providing a high sense of involvement made all the more vivid by the unusually wide dynamic range that is possible. Anyone who has quad equipment should make use of the possibilities this version offers. The most exciting moments are very exciting indeed. R.C.M.

NIELSEN: Symphony No. 4 (*Inextinguishable*). Los Angeles Philharmonic Orchestra, Zubin Mehta, cond. LONDON CS 6848, \$6.98.

Comparisons:
Bernstein/N.Y. Phil. Col. M 30293
Markevitch/Royal Danish Orch. Turn. TV-S 34050
Martinon/Chicago Sym. RCA LSC 2958

In substance if not in manner, the Nielsen Fourth is the closest thing I know of to a twentieth-century *Eroica* Symphony. Deservedly it has been the most recorded of Nielsen's six symphonies, although an absolutely perfect disc version continues to elude us.

The pioneering HMV performance by Launy Grondahl and the Danish State Radio Orchestra, authoritative in both conception and execution, no longer wears its quarter-century easily. Though the Danish and British LP transfers were better than the wan and dull American Victor (long vanished), the music cries out for stereo, if only for the finale's battle scene between two antiphonal sets of timpani.

The stereo premiere was a respectable interpretation by Barbirolli with poetic playing from the Halle winds, but the Pye recording (briefly available here on Vanguard Everyman) suffered atrocious balance (e.g., try detecting the violins' Italianate response to the low brass fanfares at No. 25 in the first move-

ment). Shortly thereafter, on the heels of a pallid Rudolf/Cincinnati edition on Decca, came Markevitch's propulsive Turnabout reading, marred by shallow and gritty sonics.

Though fully equal to the vehement force and riotous color of the music, Martinon's super-virtuosic RCA performance has its tragic flaw—a side break that interrupts the momentum of the transition from the adagio to the finale. If only the *Helios* Overture had been placed as a curtain-raiser rather than a Side 2 filler, this could have been avoided. Perhaps a transfer of the Chicago rendition to the Victrola line could afford RCA opportunity for rectification.

The engineers are also responsible for the most controversial touch in the Bernstein: a jolting tape splice at No. 61 in the finale, cutting off the resonance at the end of the timpani duel to make more audible the attack on the string fugato that follows. Otherwise, this is a well-balanced, detailed recording of a broadly paced reading, which thereby gains impact in such a pompous outburst as the Sousa quote four measures past No. 8 in the first movement, but overburdens the second-movement Poco allegretto with more point and deliberation than the simple, folksy intermezzo can really take.

The Mehta performance has much going for it. The Indian conductor sets lively tempos, yet without unduly pressing his ensemble. The Poco adagio third movement has the contrasting repose to the preceding Poco allegretto. In that slow movement's "un poco agitato" section, he pays closer heed than anyone else to the time values of dotted eighths and sixteenths in the triplet figures, making the music sound for all the world like it has turned suddenly into a French overture! The finale goes lickety-split, if without the rhythmic panache of Martinon, yet Mehta—like Bernstein before him—observes tellingly the "piu mosso" four bars after No. 58, a moment of high tension where that extra tightening of the screws goes a long way indeed.

My principal objection to this latest issue may or may not be the fault of the artists. There is little here that goes below a mezzo-



George Rochberg (in 1960)
A strong quartet worth repeated hearings.

forte, and in part I blame the technical team. For optimal clarity does not always portend ideal musical balance.

This recording is full of details that rise glaringly out of the ensemble larger than life—a low woodwind harmonization here, a cello solo there. Since the Los Angeles Philharmonic is not the most suave orchestra tonally, the scrutiny is not always flattering, though the brilliance and impact of UCLA's Royce Hall, where the orchestra records, is as always a help—and those timpani *do* sound!

The buyer who values economy over sonic fidelity will opt for Markevitch. Audio buffs will want the new Mehta, which along with the Martinon will appeal to those who like their Nielsen impulsive and frenetic. Bernstein is the best foil for any of the above, and the affluent will benefit from having more than one Nielsen Fourth. The work is lucky to retain its "inextinguishable" popularity, which may someday lead to a definitive edition, interpretively and acoustically. A.C.

RAVEL: Quartet for Strings, in F—See Debussy: Quartet for Strings

RIEGGER: Dichotomy for Chamber Orchestra. For a feature review, see page 97.

B **ROCHBERG:** Quartet for Strings, No. 2. **SUDERBURG:** Chamber Music II. Phyllis Bryn-Julson, soprano; Concord String Quartet (in the Rochberg); Philadelphia String Quartet (in the Suderburg). TURNABOUT TV-S 34524, \$3.98.

Those who know George Rochberg only through his recent, largely tonal Third String Quartet will be in for a surprise when they hear the Second. Completed in 1961 when Rochberg was still writing twelve-tone music, the work is a rigorous, tightly organized serial composition written in an uncompromising dissonant, melodically disjunct, and rhythmically fragmented style. Its complexities are considerable, particularly in the rhythmic domain, where different tempos are frequently employed simultaneously. Yet the work makes an immediate and arresting impression. The basic rhythmic and melodic gestures are all so strongly characterized that they are able to carry the listener over the conceptual hurdles.

The quartet is organized into two extended movements, the second of which includes a setting for soprano of Rilke's Ninth Duino Elegy. The abrupt contrasts between explosive rhythmic motions and more sustained passages in the first movement are mirrored in the second by the contrast between the lyrical voice line and the dislocated, fragmented character of the accompanying strings. ("Accompanying" is perhaps not quite the right word, as the strings seem to run a sort of parallel, yet essentially independent, path throughout the latter movement.) Moreover, in both movements there is a tendency for the contrasts to be reconciled as the end is approached, a procedure that does much to provide a sense of formal unity, not only within each movement, but for the work as a whole. It is a very strong piece, and one that will wear well with repeated hearings.

Given the difficulties involved, the performance by the Concord String Quartet and soprano Phyllis Bryn-Julson is quite extraordinary. The quartet plays the piece with the kind of assurance and expressive conviction one associates mainly with performances of the "great works" but rarely with difficult new music. And Miss Bryn-Julson sings her part with disarming ease; her pitch sense is something quite remarkable, and she manages the complex rhythmic relationships with complete authority.

Interesting, the Philadelphia String Quartet, which plays the other work on this disc, gave the first performance of the Rochberg quartet some years ago and recorded it for CRI with soprano Janice Harsanyi (still listed in Schwann II but now clearly superseded by this new version). It turns in a fine performance here of Robert Suderburg's Chamber Music II, although both the performance and the work seem to me to lack the impact of the other side.

Suderburg's quartet, written in the late 1960s, is quite up to date in its materials, making use of all kinds of special sound effects on the instruments, yet the piece is basically quite conventional and simple in organization. Despite its considerable length (almost thirty minutes), it is so overarticulated as to seem rather short-winded. Ultimately it breaks up into an extended series of isolated gestures that, at least to my ears, fail to add up to a unified statement. Chamber Music II is extremely eclectic, and although there are some very nice moments it strives too hard—and too exclusively—for its effects. P.H.M.

RUBINSTEIN: Concerto for Piano and Orchestra, No. 3, in G, Op. 45. **KABALEVSKY:** Concerto for Piano and Orchestra, No. 3, in D, Op. 50. Robert Preston, piano; Westphalian Symphony Orchestra, Paul Freeman, cond. ORION ORS 74149, \$6.98.

At a time when up-and-coming European soloists and conductors can attain first recordings on major labels with the best orchestras of their homelands, two young Americans have to go abroad to collaborate with a second-rate German orchestra for release by a small but enterprising West Coast label. Nevertheless they have produced first-rate recordings of two large-scale virtuoso concertos.

Robert Preston comes from the New York area, and I first heard him play when he was a student at Juilliard. Always a strong player, somewhat inclined to substitute power for insight, he has matured considerably, so far as one can tell from hearing him here in music that is essentially virtuosic. I should like to hear him in works of greater artistic stature.

Paul Freeman is a truly American conductor, having served his apprenticeship in a variety of minor-league posts before becoming conductor in residence of the Detroit Symphony and artistic director of the Columbia Records' Black Composers Series. His experience stood him in good stead at these recording sessions, for he obviously is in command of the admittedly weak orchestral resources at hand. The Westphalian Symphony lacks any strong solo players, though the strings and ensemble in general play with discipline if not much distinction. Freeman certainly gets from the orchestra solid and well-ordered support for Preston's solo pyrotechnics.



Camille Saint-Saëns
Enjoying a boomlet.

The young pianist makes the best of Rubinstein's early showpiece, which requires only that the orchestra stay out of the way of the soloist's virtuoso display. Kabalevsky makes more demands on the orchestra and is somewhat less exacting of the soloist; though the music has a certain cleverness, I seldom find it engaging.

The recording, apparently made in a close studio, has no special ambience and at times sounds rather coarse. P.H.

SAINT-SAËNS: Danse macabre; Le Rouet d'Omphale; La Jeunesse d'Hercule; Phaëton. Orchestre de Paris, Pierre Dervaux, cond. [René Challan, prod.] ANGEL S 37009, \$6.98.

There seems to be a Saint-Saëns boomlet in progress, at least as far as Angel Records is concerned, judging from its releases of the past year. The five piano concertos have been issued in one package on its Seraphim label, and the First and Second Symphonies by Angel. The present record is the first that brings together all four of Saint-Saëns's orchestral tone poems. (In addition, Jean Martinon will introduce to the U.S. the recently resurrected "Fourth" Symphony, written when Saint-Saëns was in his teens—it should by Brucknerian rights be termed "le Zéro"—with the San Francisco Symphony this winter, and doubtless a recording is in the works.)

Of the four tone poems, *Danse macabre*, of course, is the warhorse for which the composer is remembered, and it remains an effective, if not exactly memorable, piece. But his other three are well worth investigating. They are good examples of the genre that Liszt popularized but that had a large part of its history in French music at the end of the nineteenth century, thanks to Saint-Saëns's lead.

The salient feature of the tone poem lies in its ability to be "read" two ways, either as "pure" music or as a story or visualization in sound. An extension of this last is the portrayal not only of story, but of character and mood, which was a Liszt specialty (the Gretchen movement of the *Faust* Symphony being one of the supreme character portraits in "pure" music). I suspect that the visual aspect of the tone poem appealed especially to the French, who have always been more literally and visually than purely musically inclined, and that it is closely allied to the ballets and operatic intermezzos that are so much a feature of their

music. In any case, this combination of "pure" music structure and story and characterization obviously appealed to Saint-Saëns's musical makeup, and the results justify his interest.

His four tone poems were all written between 1871 and 1877, an especially productive period in his life. Three are based on mythological stories. The earliest written, *Omphale's Spinning Wheel*, is perhaps best known of the three, because of the beguiling performances Sir Thomas Beecham used to give, and in the hands of an orchestral colorist its very real grace and charm overcome the inevitable comparisons to other "spinning musics," the tinkly nature of its main theme, and the echoes of Mendelssohn and Berlioz in their magic moods.

Phaëton is my favorite: superbly propulsive and energetic (it influenced Franck's *Le Chasseur maudit* in its onrushing inevitability), yet with a tenderness in the second theme appropriate to the story, and a lovely "uniting" coda. In many ways *Phaëton* is the best example of the bifurcated balance mentioned above that is the hallmark of the tone poem.

Danse macabre is too well-known for comment. The last written, *La Jeunesse d'Hercule*, is the longest and in some ways the least successful, in that its very length carries it beyond the tone-poem scale and into being an orchestral work in and of itself. Saint-Saëns did not have Richard Strauss's grasp of larger tone-poem structure (it can be argued that Strauss did not have it, either!), and *La Jeunesse*, despite some effective pages and a noble close, seems bloated in comparison to the other three. It is not helped by the commonplace nature of the theme of Hercules' Virtue—but then, in music as in life, good is far harder to create than bad. (The "story" here, by the way, concerns Hercules' Tannhäuserlike choice between Virtue and Vice. Besides owing more than a little to Wagner, it is interesting because it can probably be considered one of the few times Saint-Saëns ever put aspects of his own life into his music.)

The present performance is mandatory if you want all four works. On the whole, it is a solid, very good job, in rather resonant (as opposed to close-in) acoustics. Dervaux misses the dynamic gradations and some of the coloristic ones in the works, and he generally chooses expansive tempos (Saint-Saëns, from what we know of his conducting of his own works, liked fast tempos). But there is plenty of power and drive in Dervaux's playing. If *Danse macabre* has been recorded more brilliantly, however, he is only slightly inferior over-all to Martinon's performance of *Omphale* on London Treasury (STS 15093), although he does get the important *tranquillo* feeling in the final section—representative of *Omphale's* quiet triumph over Hercules—better than the febrile Martinon. In the other two works, Dervaux has no competition in the current Schwann. P.J.S.

SCHUBERT: Vocal Quartets. Elly Ameling, soprano; Janet Baker, mezzo; Peter Schreier, tenor; Dietrich Fischer-Dieskau, baritone; Gerald Moore, piano. [Cord Garben, prod.] DEUTSCHE GRAMMOPHON 2530 409, \$7.98.

Der Tanz; Des Tages Welhe; Hymne an den Unendlichen; An die Sonne, Begräbnislied; Gott im Ungewitter; Gott der Weltshöcher; Lebenslust; Gebet.

DIETRICH FISCHER-DIESKAU: Petrarch Sonnets. Dietrich Fischer-Dieskau, baritone;

THE CASE OF THE ELUSIVE MIRACORD

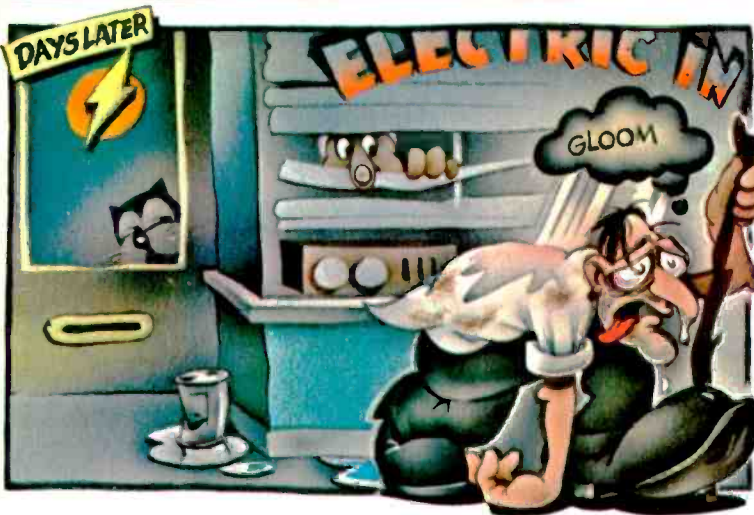
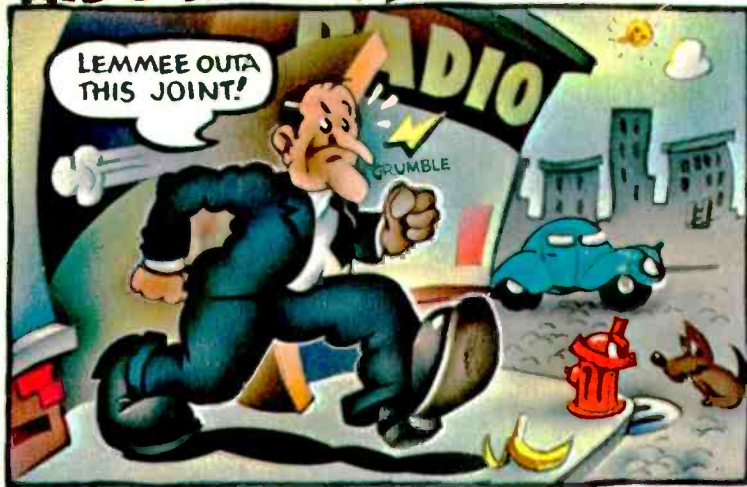

THE AGONY OF BUYING A MIRACORD.

First, the good news. We're proud to announce the arrival of a brand new automatic turntable. The Miracord 820 by name.

Next, the not-so-good news. You shouldn't expect to find one in just any old store.

Your feet may hurt, your eyes may burn, and your head may throb, but you'll congratulate yourself for being so intelligent for wanting one. And so persistent for locating one.

You see, we're very particular about the way we build our new Miracord 820. And just as particular about where we sell it.

But once you experience the pleasure of playing your favorite record on a Miracord turntable, you'll know it was worth the slight inconvenience.

The reason is that the 820 operates simply and beautifully.

Setting the turntable speed for 33-1/3 or 45 rpm automatically programs the tonearm for the proper record size. A touch of the button lifts and positions the tonearm, gently and automatically setting the stylus in place.

The features in the 820 are the kind you'd expect to find in turntables costing much, much more.

You get things like our asynchronous motor. Light-touch push button start and stop. Variable pitch control — up to 5% range — with built-in stroboscope ring for 'perfect pitch.' Calibrated anti-skate for both elliptical and conical styli. Cueing that is viscous-damped both up and down. Tracking as low as one gram. Plus our exclusive Magic Wand spindle that holds up to 10 records. And another spindle for playing a single record.

The 820 is the newest member of the Miracord family of automatic turntables. If you'd like the full story on our full line, just drop a line to: Miracord Products, Benjamin Electronic Sound Co., 40 Smith Street, Farmingdale, New York 11735.

Yes, searching for a Miracord can be a bit of an agony.

But finding one is pure ecstasy.



THE MIRACORD 820.

Damn hard to find. Damn hard to beat.

A Touch of Elegance

The loudspeaker that has achieved international distinction as the most highly reviewed speaker, regardless of size or price, is now available in a new, exciting continental styling option.



The Mark of Excellence.

BOSE 901
Continental

For information, write: BOSE, Dept., Hc, The Mountain,
Framingham, Massachusetts 01701.

Gerald Moore, piano (in Schubert); Jörg Demus, piano (in others). [Cord Garben, prod.] DEUTSCHE GRAMMOPHON 2530 332, \$7.98.

J. F. REICHARDT: Canzon, s'al dolce loco; Erano I capei d'oro; O poggi, o valli, o fiume, o selve, o campi; Più volte già dal bel sembiante umano; Di tempo in tempo mi si fa men dura; Or che'l ciel e la terra. **SCHUBERT:** Apollo, lebet noch dein hold Verlangen; Allein, nachdenklich, wie gelähmt; Nunmehr, da Himmel, Erde schweigt und Winde. **LISZT:** Benedetto sia 'l giorno, e'l mese e'l anno; Pace non trovo e non ho da far guerra; I vidl in terra angelici costumi. **PFTZNER:** Voll Jener Süsse.

SCHUBERT: Songs. Christa Ludwig, mezzo-soprano; Irwin Gago, piano. [Cord Garben, prod.] DEUTSCHE GRAMMOPHON 2530 404, \$7.98.

Gretchen am Spinnrade; Der Tod und das Mädchen; Lachen und Weinen; Die junge Nonne; Der König im Thule; Mignon (D. 877.4); Frühlingsglaube; Am Bach im Frühling; Die Rose; Auf der Donau; Das Mädchens Klage (D. 191b); Im Abendrot; Romanze (from *Rosamunde*); An die Nachtigall (D. 497); Ave. Maria.

In 1839, an English critic voiced suspicion at the flood of newly published Schubert songs, at a time when "one would think his ashes were resting at peace in Vienna." The modern, phonographic equivalent of that flood continues, and there are still Schubert songs that haven't been recorded. Even after the monster packages of Fischer-Dieskau, and last season's addenda of duets and trios, Deutsche Grammophon forges ahead with yet more premieres, duplications, and repackagings.

Most of the novelties in this lot are on the "Vocal Quartets" record, a bag as mixed as its three-voiced predecessor (DG 2530 361). Alongside two bits of rather conventional jollity is a variety of more hymnic material, of which the 1824 setting of De la Motte Fouqué's "Gebei" and the 1822 "Des Tages Weihe" are particularly eloquent. The last of these is nicely done on the new disc, but the four star soloists do not always yield a consistently fine blend (nor is Fischer-Dieskau the true bass required by some of these pieces: at the bottom of the staff he almost vanishes, and a very deep phrase in "Gebei" has been moved up an octave). "Gebei" is particularly choppy, in fact, and it's a good thing these singers will be remembered by posterity for something other than their work in this piece.

The less-celebrated soloists who join the Elizabethan Singers for their recording of "Gebei" (Argo ZRG 527, also duplicating "Gott im Ungewitter") give more pleasure, especially since Viola Tunnard makes Schubert's ostinato accompaniment figures move more vibrantly than does Gerald Moore. If you're just beginning to investigate Schubert's part-songs, by all means go to the Argo record first; it includes several real masterpieces ("Nachtelle," with its quicksilver harmonic changes, and the gorgeous "Ständchen" with alto solo), and most of this music works better with a chorus anyway.

One of Schubert's predecessors about whom we read much in the history books is Johann Friedrich Reichardt (1752-1814), and Fischer-Dieskau's contribution to the Petrarch anniversary year includes six settings by Reichardt—not all of them sonnets, actually (the original publication was entitled *Sonetti e Canzoni di Petrarca* and appeared in Berlin around 1800). These are most Italianate in style, with graceful ornamentation and charming details, although little breadth or expansiveness to match the poet's scope. The exception is a setting of "Or che'l ciel e la terra" that reaches into a kind of nature- and mood-



Janet Baker

A mixed bag of Schubert quartets.

painting that we have come to associate with Schubert. Melismatic writing drives Dieskau to some choppy expedients, but he achieves some nice effects as well.

The third of Schubert's Petrarch settings (in German translations by A. W. Schlegel and Gries) uses the same "Or che'l ciel" sonnet, although DG does not trouble to tell us this. None of these records, incidentally, includes a single word of annotation copy, although texts and translations are faithfully provided.

Schubert's songs are very freely formed, abjuring the older composer's homogeneous textures in favor of a mix of recitative, arioso, and cantilena that works rather well. These performances, effectively declaimed, are reissued from Vol. 1 of the big Schubert set.

On the verso of this disc, we find a real treasure. Dieskau's 1962 recording of Liszt's three Petrarch sonnets. Although better known in the solo-piano versions, these are among the greatest of Romantic love songs, as the poems are among the greatest of all time. Liszt matches all their nuances, with smooth transitions from recitative to broad flowing lines, embedded effectively in richly inventive accompaniments (discreetly simpler than the writing in the solo versions). Dieskau's Liszt record was one of his best, and it's good to have even this much of it back again.

After this, the single Pfitzner song is a let-down—not a bad piece, but its introspection, and Dieskau's occasionally explosive singing, are poorly placed after the gorgeous Liszt.

Finally, we have Christa Ludwig, offering not a supplement to Dieskau's efforts, but another version of the standard female Schubert recital, liberally sweetened with chestnuts we all know and love. Five of these songs were also on her earlier Schubert disc (Angel S 36462). Seven of them are not to be found in the Dieskau series (usually for obvious reasons), and one of these ("Die Rose") seems to be a first recording.

This is, I am sorry to say, a very monotonous recital. Miss Ludwig has chosen predominantly sad/mournful/elegiac songs. She has transposed most of them down—not in itself a reprehensible practice, but *in extenso* somewhat dampening. Her basic timbre is dark to begin with; on this occasion, at least, the tone is also slightly soggy, and hardly varied in color throughout; a note of wounded femininity, of barely suppressed anguish, is appro-

priate enough in some of these songs, but at forty-five minutes' length this unrelieved tonal color dangerously courts antipathy on the part of the listener.

The piano tone as recorded is muffled, never bright—a good match for this voice, in one sense, but contributory to the prevalent gloom. Mr. Gage is a dab hand at vitalizing Schubert's repetitious accompaniment patterns, but he isn't given much opportunity here to show his full range, either musically or sonorously. A very disappointing disc, for Miss Ludwig has elsewhere shown herself to be a singer of more imagination than can be discerned here. D.H.

B SCHUBERT: Works for Piano and Strings. Heidrun Ganz, violin; Helmar Stiehler, cello; Benedikt Kehlen, piano (in the trios). Carroll Glenn, violin; Francis Tursi, viola; Alan Harris, cello; Oscar Zimmermann, double bass; Eugene List, piano (in the remaining works). Vox SVBX 600, \$9.95 (three discs, manual sequence).

Trios for Violin, Cello, and Piano: No. 1, in B flat, D. 898; No. 2, in E flat, D. 929. Notturmo for Violin, Cello, and Piano, in E flat, D. 897. Sonata for Violin, Cello, and Piano, in B flat, D. 28. Quintet for Piano and Strings, in A, D. 667 (*Trout*). Adagio and Rondo concertante for Piano and Strings, in F, D. 487.

Comparison—Trios Nos. 1, 2: Stern, Rose, Istomin Col. MS 6716 and 7419
Comparisons—*Trout* Quintet: F. Serkin, Laredo, et al. Col. MS 7067
F. Serkin, Schnelder, et al. Van. VSD 71145

It's a pity that while Vox was boxing the complete Schubert chamber music for piano and strings they could not have done it with the same performers throughout—one could then at least accept or reject the set as a whole. For the lines are pretty clearly drawn here: Eugene List and his colleagues at the Eastman School of Music proffer very good performances of the *Trout* Quintet and the strange D. 487 Piano Quartet, with generally acceptable recorded sound and good instrumental balances; on the other hand, the two famous piano trios and other assorted oddities played by the Kehlen/Stiehler ensemble can't hold a candle to the tough competition, are pinched in sound and atrociously balanced in a number of instances. So you must take the good with the bad, and my advice would be to buy these works separately.

But to be specific. It takes only a quick dip into the Istomin/Stern/Rose versions of the B flat and E flat Trios to realize all over again how articulate, intelligent, exciting they are; by comparison, the Vox group is stiltish, dull-toned, flatter in nuance—all of which would steer one away even if the pinched recorded sound did not.

The Vox Box does include two curiosities. The excessively sweet *Notturmo*, an awkwardly scored essay, may according to some speculations be simply an exercise in piano-trio writing undertaken by the composer before he embarked on the magnificent B flat Trio. The sonata for violin, cello, and piano was composed when Schubert was fifteen and contains a good bit of formula writing; the piano is so underrecorded at moments here that it vitiates whatever effectiveness the piece might have had.

The *Trout* Quintet performance contains a moral: Never underrate a performing group because it may be less prominent than some

others. The List/Eastman ensemble plays with propulsion, rhythmic vitality, and a sense for the over-all flow of the music. Theirs is a less individualized approach than either Rudolf Serkin's group on Columbia or Peter Serkin's on Vanguard—the latter in particular verging on self-consciousness at times, almost preciousness in the scherzo. In general the List ensemble chooses faster tempos than do either of the others, and the result is a clean, clear, articulate, and uncomplicated *Trout* that can hold its own in any company. The only problem that struck me was the balance in the second variation of the fourth movement, in which the violin is underemphasized.

The piano quartet, also known as the *Adagio and Rondo concertante*, is the nearest Schubert ever came to writing a piano concerto, and the keyboard has its way throughout, the strings merely assisting. List lets his part sing and flow, displays discretion in the more delicate passages, and creates an appropriate bright pianism that doesn't have much in the way of depth but produces some very pleasant surfaces indeed. S.F.

SCHUMANN: Concerto for Piano and Orchestra, in A minor, Op. 54. **GRIEG:** Concerto for Piano and Orchestra, in A minor, Op. 16. Radu Lupu, piano; London Symphony Orchestra, André Previn, cond. [Christopher Raeburn (in the Schumann) and Michael Woolcock (in the Grieg), prod.] LONDON CS 6840, \$6.98.

For Lupu this is surprisingly straight playing. One might, on the basis of his prior work on record and in the concert hall, have expected that these two popular works—the ham 'n' eggs of the Romantic concerto literature—would have encouraged all sorts of theatricalities from a player obviously prone to them, but instead we are given a pair of readings that are lyrical and coloristic, to be sure, but with no alarming mannerisms of phrasing or tempo.

These interpretations do not have the feeling of symmetry and containment of the old Lipatti coupling (Odyssey 31 16 0141), and the plushy ambience of the recorded acoustic further softens the over-all line (without, however, losing detail; balance is good). For all that, tempos are on the brisk side, phrasing is cogent, and those who want these works to sing should be very happy with these statements. Previn proves an alert, sympathetic collaborator.

Definitely one of the more recommendable offerings of this perennial coupling. H.G.

SCHUMANN: Piano Works, Vol. 2. Karl Engel, piano. TELEFUNKEN SKA 25085, \$27.92 (four discs, manual sequence).

Fantasiestücke, Opp. 12 and 111; Kinderszenen, Op. 15; Kreisleriana, Op. 16; Fantasy in C, Op. 17; Arabeske in C, Op. 18; Blumenstück in D flat, Op. 19; Faschingsschwank aus Wien, Op. 26; Romances (3), Op. 28; Marches (4), Op. 76; Stücke in Fughettaform (7), Op. 126; Gesänge der Frühe, Op. 133.

SCHUMANN: Humoreske, Op. 20; Waldszenen, Op. 82. Wilhelm Kempff, piano. [Cord Garben, prod.] DEUTSCHE GRAMMOPHON 2530 410, \$7.98.

Consistency is the word that best describes Karl Engel's unfolding Schumann piano cycle. Vol. 2 comes in the same dignified



Wilhelm Kempff—Schumann with a genial, low-keyed approach.

brown album, continues the essay about the music begun in the first four-disc set (SKA 25082, reviewed in May), and like its predecessor is beautifully recorded and pressed.

And the playing style is all of a piece. This is not to say that Engel enjoys equal success with every piece or that there are no fanciful moments or other surprises in his performances. Vol. 1 ranged from a bleak, unimaginative *Carnaval* to fine, classically poised accounts of the *Davidsbündler* and *Intermezzi*. But all the renditions, good and bad, are characterized by a basic integrity, a tough-skinned structuralism, and a respect for the printed page that occasionally verges on the overearnest in such impulsively emotional repertory—almost a welcome variant in music so frequently manhandled!

The works in Vol. 2 are without exception well suited to Engel's basic outlook. The great *Fantasy* doesn't erase memories of Curzon, Arrau, and Kempff, but it is well knit, rhythmically convincing, clear in its contrapuntal strands, and (in such well-known trouble spots as the coda to the alla marcia second movement) impressively clean technically. A little more ardor, lots more color (though Engel's restricted sonority is never unpleasant to the ear or even without a certain chiaroscuro), and this would have been a truly great account of a problematic work.

Engel is as cognizant as Arrau of those often misunderstood forte-pianos in section two of the *Arabeske* and, like that master, turns in a strong, succinct interpretation minus the usual coy banalities. The Op. 12 set of *Fantasy Pieces* is well shaped, though at times slightly hard-toned and prosaic; Engel seems more songful and relaxed in the Op. 111 set. The final section of *Kreisleriana* with its "misplaced" bass line gets a tidy, sprightly account, although some of the earlier sections in the same work are a shade too literal for maximum effectiveness.

The *Carnival Jest from Vienna* (which Engel previously recorded on a long-deleted Epic mono disc) is admirably forthright, and so are the Op. 76 marches, although I question the pianist's tempos in Nos. 3 and 4. The third march, marked "very moderate" and subtitled "*Lager-Szene*" ("At the Campsite"), should, in my opinion, supply the needed repose of a slow movement; Engel, in his desire to set a single tempo for this elusive piece, seems almost brutally flippant in the outer section and, conversely, too sober and angular in the cen-

tral, darting trio. March No. 4 is excessively heavy and lumbering as he gives it. Still, the playing has point, clarity, and rhythmic vitality.

I like the unusual classicism of Engel's *Kinderszenen*: The judiciously gauged poco ritenutos and *a tempos* in "At the Fireside" are indicative of the finely conceived readings as a whole. If both the *Blumenstück* and the Op. 28 *Romances* could have more warmth and poetry, the very late *Songs of Morning*—brooding essays with late-Brahms chromaticisms and harmonies—are given with more sanity and strength than I would have imagined possible. Engel similarly presents the quasi-étude *Pieces in Fugue Form* in as strong a light as possible. This is all purposeful playing without ostentation or fuss, sympathetic if not terribly imaginative, and digitally well above average.

Kempff presents gracious accounts of two Schumann cycles previously unrecorded by him. Of the two, *Waldszenen* profits more from his genial, low-keyed approach. His playing of these vignettes is midway between the magical fleetness of Richter's long-vanished mono recording and the ample, burgher values of Arrau's recently issued Philips disc (6500 423).

The tender, simple, homely qualities of Kempff's latter-day pianism are less convincingly applied to the changing "humors" of Op. 20. He tends to flatten out contrasts excessively by setting cautious tempos in the scurrying interludes and almost perfunctory ones in the leisurely passages. While every note of his performance is artistic and sensitively conceived, it seems to me that he is outclassed in this score by both Arrau (Philips 839 709) and Richter (Monitor MC 2022, mono).

DG's sound is beautifully atmospheric.

H.G.

B **SCRIABIN:** Piano Works, Vols. 2-3. Michael Ponti, piano. Vox SVBX 5462 and 5463, \$10.95 each three-disc set (manual sequence).

Vol. 2: Preludes (83); Egoroff Variations; Allegro appassionato, Op. 4; Allegro de concert, Op. 18; Polonaise, Op. 21; Fantasy, Op. 28. Vol. 3: Etudes (23), two alternate versions of Op. 8, No. 12; Mazurkas (23); Plus Impromptu à la Mazur, Op. 7; Waltzes (4); Quasi-Waltz in F, Op. 47.

Comparisons:
Estrin (Op. 8 études) Conn. Soc. CS 2009
Laredo (Opp. 11, 74 preludes) Desto DC 7145
Laredo (Op. 42 études) Conn. Soc. CS 2032
Kuerti (Op. 65 preludes, Op. 74 études) Mon. MCS 2134
Horowitz (various preludes) RCA LM 2005

The Rectilinear 5: end of the myth of rock speakers vs. classical speakers.

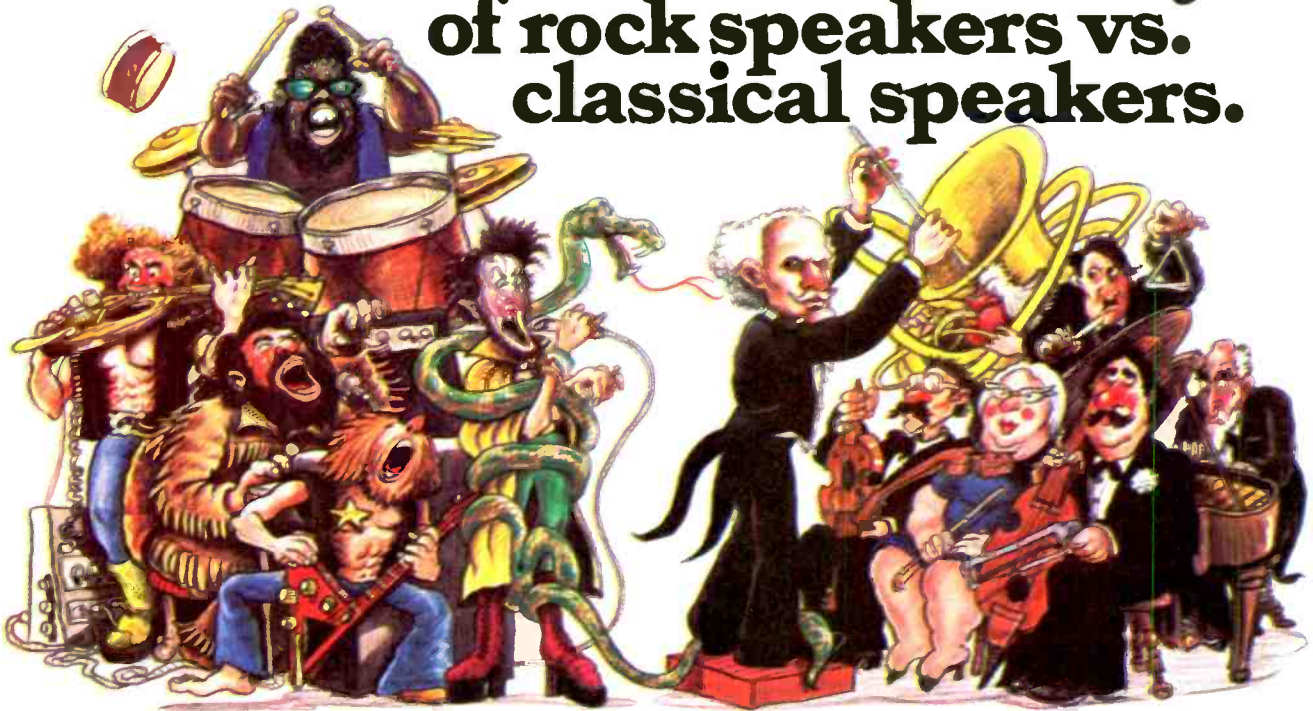

The new Rectilinear 5 is capable of playing very, very loud. Rock-festival loud. Even with a medium-powered amplifier.

At the same time, it's uncannily accurate. It sounds sweet, unstrained and just plain lifelike at all volume levels.

The temptation is great, therefore, to one-up that prestigious manufacturer who some time ago announced "The first *accurate* speaker for rock music."

But we refuse to perpetuate that mythology. It's perfectly obvious that the Rectilinear 5 reproduces classical music just as accurately as rock. We could never see how a voice coil or a magnet would know the difference between Jimi Hendrix and Gustav Mahler.

So we'd rather use this opportunity to set things straight once and for all.

Thus:

There's no such thing as a rock speaker or a classical speaker. Any more than there's a late-show TV set or a football-game TV set.

There are, however, speakers that impose a hard, sizzling treble and a huge bass on *any* music. And others that round off the edges and soften up the transient details of *any* music. That's the probable origin of the myth; but these aren't rock and classical speakers, respectively.

They're *inaccurate* speakers.

It's true that an aggressive treble and a heavy bass are characteristic of most rock music, even when heard live. It's also true that some record producers exaggerate these qualities, sometimes to a freakish degree, in their final mix of the recorded sound.

But that doesn't mean the speaker can be allowed to add its own exaggerations on top of the others.

A loudspeaker is a conduit. Its job is to convey musical or other audio information unaltered. If the producer wants to monkey around with the natural sound that originally entered the microphones, that's his creative privilege. He'll be judged by the musical end results. But if the speaker becomes creative, that's bad design.

By the same token, if some classical record producers prefer a warm, pillowy, edgeless string sound, that

doesn't mean your speakers should impart those same qualities to cymbals, triangles or high trumpets. (Stravinsky's transients can be as hard as rock.)

And if you like to listen at very high volume levels after all, that's what rock is about—

but so is *Die Götterdämmerung*,

you still don't need a speaker that

achieves high efficiency through spurious resonances. What you need is something like the Rectilinear 5.

Everything in this remarkably original design was conceived to end the trade-off between efficiency and accuracy. The four drivers are made to an entirely new set of specifications. The filter network that feeds the drivers is



Equally wrong: Classical sound made vague and spineless by the speaker.

totally unlike the traditional crossover network. Even the cabinet material is new and different.

Of course, those who feel threatened by all this fuss about accuracy and naturalness will point out that the monitor speakers preferred by engineers and producers in recording studios are usually of the zippy, super-aggressive variety.

That's perfectly true, but the reason happens to be strictly nonmusical.

"I use the XYZ speaker only as a tool," a top producer explained to us. "I wouldn't have it in my house. It really blasts at you when you crank up the volume, so that any little glitch on the tape hits you over the head. After eight hours in the studio, that's what it takes to get your attention. I know how to deal with those unpleasant highs; they're in the speaker, not on my tape."

It's easy enough to find out for yourself.

Any reputable dealer will let you hear the Rectilinear 5 side by side with a "rock" or "monitor-type" speaker. Adjust each speaker by ear to the *same* high volume level, making sure the amplifiers are of good quality. Then listen. To rock or classical.

Then and there, the myth will crumble.

RECTILINEAR®

Rectilinear Research Corp., 107 Bruckner Blvd., Bronx, N.Y. 10454
Canada: H. Roy Gray Limited, Ontario



Rectilinear 5
Contemporary
Laboratory Series
bookshelf/floor
speaker system,
\$299.00
Rectilinear
Dispersion
Base (patent
pending)
optional.



Wrong: Freaky sound made even freakier by the speaker.

SPECIFICATIONS

| Specification | Measured In | STR-7065 | STR-7055 | STR-7045 | STR-7045 |
|--------------------------------------|-------------|------------------------|------------------------|-----------------------|----------------|
| TUNER SECTIONS | | | | | |
| Sensitivity, IHF | μ V | 2.0 | 2.0 | 2.6 | 2.6 |
| S/N ratio | dB | 70 | 70 | 70 | 1.5 |
| Capture ratio | dB | 70 | 70 | 70 | 70 |
| Selectivity, IHF | dB | 70 | 70 | 70 | 70 |
| Image rejection | dB | 100 | 100 | 90 | 90 |
| IF rejection | dB | 90 | 90 | 56 | 56 |
| Spurious rejection | dB | 56 | 56 | 56 | 56 |
| AM suppression | | | | | |
| Harmonic distortion (@ 400Hz) | % | 0.2 | 0.2 | 0.2 | 0.2 |
| Mono | % | 0.5 | 0.5 | 0.5 | 0.5 |
| Stereo | % | 38 | 38 | 38 | 38 |
| FM stereo separation (@ 400Hz) | dB | | | | 30 |
| FM frequency response | | 20Hz-15kHz -1dB | 20Hz-15kHz -1dB | 20Hz-15kHz -1dB | 30Hz |
| AM harmonic distortion | % | 0.8 | 0.8 | 0.8 | 0.8 |
| AM S/N ratio | dB | 50 | 50 | 50 | 50 |
| PREAMPLIFIER SECTION | | | | | |
| Input sensitivity and impedance | | | | | |
| Phono | mV ohms | 2.0 / 47k | 2.0 / 50k | 1.8 / 47k | 2.5 |
| Phono-low | mV ohms | | | | 2.0 |
| Microphone | mV ohms | 1.0 / 47k | 1.0 / 50k | 1.0 / 100k | 250 |
| Tuner, Aux., Tape, REC/PB | mV ohms | 150 / 50k | 150 / 50k | 140 / 100k | 250 |
| Output voltage and impedance | V ohms | 1.0 / 4.7k | 1.0 / 4.7k | 1.0 / 250 | 0.5 |
| Preamp | mV ohms | 250 / 10k | 250 / 10k | 250 / 82k | 30 |
| Rec out | mV ohms | 30 / 82k | 30 / 82k | 30 / 82k | 30 |
| REC/PB | mV ohms | 30 / 82k | 30 / 82k | 30 / 82k | 30 |
| THD @ rated output* | % | 0.2 | 0.2 | 0.2 | 0.2 |
| IM distortion @ rated output** | % | 0.2 | 0.2 | 0.2 | 0.2 |
| S/N ratio, IHF | dB | 72 | 70 | 70 | 70 |
| Phono | dB | | | | |
| Phono-low | dB | | | | |
| Microphone | dB | 65 | 90 | 90 | 90 |
| Tuner, Aux., Tape, REC/PB | dB | 90 | 90 | 90 | 90 |
| POWER AMPLIFIER SECTION | | | | | |
| RMS power per channel 20Hz-20kHz | Watts | 60 | 35 | 30 | 2 |
| 2-Ch., both channels driven @ 8 ohms | Watts | | | | |
| 4-Ch., all channels driven @ 8 ohms | Watts | | | | |
| THD @ rated output | % | 0.2 | 0.2 | 0.2 | 0.2 |
| 2-Ch./4-Ch. | % | | | | |
| IM distortion @ rated output | % | 0.2 | 0.2 | 0.2 | 0.2 |
| 2-Ch./4-Ch. | % | | | | |
| Power bandwidth, IHF | | 15Hz-35kHz | 15Hz-35kHz | 15Hz-30kHz | 10Hz |
| Frequency response @ 1W output | | 10Hz-100kHz +0 -1dB | 10Hz-100kHz +0 -1dB | 10Hz-60kHz +0 -3dB | 10Hz +0 |
| S/N ratio | dB | 110 | 100 | 100 | 100 |
| Damping factor (@ 8 ohms) | | 50 | 50 | 50 | 50 |
| Dimensions (height, width, depth) | inches | 6" x 18" x 14" | 6" x 18" x 14" | 6" x 18" x 14" | 5" x 18" x 14" |
| Weight | | 33 lbs 8oz | 33 lbs 11 oz | 31 lbs 1 oz | 19 lbs |

*Aux. input @ 1kHz **Aux. input, 60Hz: 7Hz = 4:1

STR-7065

"If the tuner section of the STR-7065 were categorized as basically meeting its excellent specification, we'd have to rate the amplifier as one that exceeds its claims by far...THD reached the manufacturer's rated (and very low) value of 0.2% at an incredible 85 watts per channel. Remember, that Sony rates the amplifier at 70 watts mid-band, per channel and, even more conservatively, at 60 watts/channel for all frequencies from 20 Hz to 20,000 Hz. At all power levels below 60 watts, THD measured well below 0.15%, while IM distortion measured under 0.1% for all power levels up to 45 watts, rising to the rated 0.2% at 60 watts and remaining at less than 1.0% even at 65 watts per channel and higher."

—Reprinted from Audio, Nov. 1973

STR-7055

"The audio amplifiers of the STR-7055 delivered 51.5 watts per channel into 8 ohms at the clipping point with both channels driven..."

—Reprinted from Stereo Rev., Nov. 1973

"Using Sony's rated 35 watts per channel as a reference full-power level, harmonic distortion was under 0.1 per cent from 30 to 20,000 Hz at full power or less, rising to the rated 0.2 per cent at 20 Hz. Typically, distortion was less than 0.05 per cent."

—Reprinted from Stereo Rev., Nov. 1973

STR-7055

"The overall performance of the Sony STR-7055 left nothing to be desired, and our positive reaction to the receiver was enhanced by the smoothness of its controls, its noncritical tuning, and its noise-free FM muting system."

—Reprinted from Stereo Rev., Nov. 1973

STR-7045

"The IM distortion, starting from 0.1 percent at 0.1 watt, increased to 0.2 percent at 30 watts and 0.5 percent at 40 watts...IM distortion was less than 0.2 percent at all power levels from 30 watts down to a mere 1 milliwatt!"

—Reprinted from Popular Electronics June 1974

"Sony's conservative power ratings were emphasized by the fact that at the rated 30 watts/channel (or less), the THD was under 0.1 percent at any frequency from 20 to 20,000 Hz and was typically about 0.02 percent!"

—June 1974 issue of Popular Electronics

"The published ratings of the STR-7045, good as they are, do not do justice to this fine receiver."

—June 1974 issue of Popular Electronics

No matter how good we think we are, there are people who think we're better.

Understatement is as rare in the business of componentry as it is in the business of politics.

Yet respected and responsible audio publications have seen fit, time and time again, to point out that Sony has a curious habit of underrating itself.

Our predilection for this comes from two things. We tend to be conservative because we shudder at the exaggerations

that others fling about. And we know that even though we play ourselves down, our specs still emerge as deeply impressive. And certainly, once you actually *hear* our underrated components, you will be deeply impressed.

You see at Sony, we're not only tough on ourselves *while* we're making our equipment. We're also tough on ourselves after we make it.

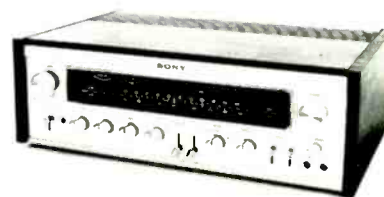

SONY®

When (and if) I grow old and I sit by the fire musing over the various banes of my existence, I'm sure that the "Complete Works (or Symphonies, Sonatas, etc.) of ..." mania that has been growing within the record industry will be one of the first that comes to mind. Time was when one of the perverse joys of record collecting lay in slowly building up, say, the complete Scriabin études by discovering isolated excerpts on recital discs and once in a while hitting upon a complete opus number recorded by an artist particularly in tune with that set. Now, as soon as a certain composer hits a vogue of sorts, the record collector can be sure that, especially in the case of solo or small-ensemble compositions, some devoted artists will be willing to tackle the quasi-entire *oeuvre* for some record company.

I can't help feeling that the efforts necessary, both by the artists and the record producers, to commit to disc all in one gulp considerable volumes of similar music produce results that are inevitably below the best everyone concerned is capable of. Even in the case of the superlative series of Scriabin piano sonatas done by Ruth Laredo for Connoisseur Society, the last two discs rarely seemed to show the enthusiasm and involvement evident in almost every note of the first. In the case of Michael Ponti's ongoing struggle to get through the complete Scriabin piano works (and the composer wrote principally for that instrument), such things as a slightly out-of-tune F (on the third disc of Vol. 2) and some unpleasant clinkers (such as in the ever-popular Twelfth Etude from Op. 8, where everybody will recognize them) have been allowed to go through.

The adverse effects of such undertakings extend as well to the listener, who begins to get jaded after hearing, say, the thirty-seventh piece entitled "Prelude" from the composer's early period. It is not simply a matter of being sated. In some cases, there are good reasons why certain previously unrecorded works are rarely performed. I was beginning to feel, for instance, that the sheer volume of Scriabin preludes, with their eternal Chopinisms, was beginning to get to me when suddenly, as of Op. 48, I began to perk up again as the full, striking originality and the frequently chilling bleakness of his later style began to come into full evidence.

Not that I dislike Scriabin's early work. But the Chopin-Liszt orientation of his earlier piano endeavors proves much more substantial in works such as the Op. 8 études or the first three sonatas than in the more wispy preludes, in spite of the excellence of some (such as the five preludes of Op. 15, some of which are already taken over by a wistful vagueness that eventually translated itself into every element of the composer's style).

All these drawbacks would matter little, however, if you could just sit back and revel in the performer's artistry. And while I will immediately say that I like Ponti much better in these performances of less-developed works than in his renditions of the sonatas (Vox SVBX 5461), I can nonetheless think of at least two non-superstar artists—Ruth Laredo and Anton Kuerti—whom I would rather have seen undertake this project. Thus, while Ponti performs the Op. 42 études, which are among my favorite short pieces by Scriabin, with excellent tone and a great deal of subtlety, he does not match the depth of the Laredo version; and similar remarks can be made vis-à-

vis Kuerti's brilliant interpretations of the startling Op. 65 études.

In other instances, Ponti fares even less well. He has a general tendency, I feel, to play on the surface of the keys so that the fast passage-work of a piece, such as the third of the Op. 31 preludes, simply does not have the clarity it needs, in spite of his generally brilliant technique. On the other hand, in the more "heroic" pieces, including the hammy Op. 28 *Fantasy* (which neither Zhukov, Szidon, nor Ponti has convinced me is worth engraving in vinyl), Ponti can become impetuous to the point of sounding labored, paradoxical as that may seem. I will say, however, that he is capable of striking just the right balance on some of the slower, more plaintive works—a number of the preludes, for example.

Of the two sets, Vol. 3 is definitely more enticing. Not only are the rarely heard mazurkas it contains among the best of Scriabin's Chopiniana, but Ponti imparts perfect spirit and pulse to them. If he suffers in comparison with Estrin, Laredo, and Kuerti in the études, his interpretations are nonetheless quite convincing, particularly in Opp. 42 and 65. And the alternate version of the famous D sharp minor Etude (Op. 8, No. 12) is sure to jolt those imbued with the "definitive" version into thinking the pianist has forgotten the music and is trying to improvise his way back home—it couldn't happen to a nicer warhorse.

Vol. 2, on the other hand, is dominated by the preludes, a number of which have better performances on other recordings, including Laredo's Op. 11 and Kuerti's extraordinary Op. 74 (and an ancient RCA disc contains a good sampling from Opp. 11, 13, 16, 27, 48, 51, 59 and 67 by Vladimir Horowitz). The other works in this volume are generally written in a "heroic" idiom that was basically ill suited to Scriabin's gifts.

As for the recorded sound, it tends to be very good to spectacular in the bass and mid-range, occasionally shrill and tinny (as if Ponti's Bechstein had thumbtacks in the hammers) in the upper. The quality of the pressings vary considerably from disc to disc, some of the more subdued numbers suffering from very low recording levels.

The twenty-page program booklet prepared by Donald Garvelmann (identical for Vols. 2, 3, and the up-and-coming 4, but different from that of the sonata volume, also done by Garvelmann) is one of the most useful Scriabin documents around. Besides the cogency of his observations (although some of his short descriptions of the music are worth little), the notes contain a complete catalogue of the published piano works (complete with Vox Box location), a selected bibliography (which pointedly excludes the Faubion Bowers opus), a list of musical scores, and a thematic index of all the piano works save the sonatas, which are indexed in Vol. 1. Inasmuch as one of the chief values of the recordings themselves is as a scholarly tool, the Garvelmann booklet is exceedingly apropos.

One final comment. Garvelmann mentions in his notes the name of Ivan Vishnegradsky (or Wyschnegradsky), who avoided the pitfalls of Scriabin copycatism by developing a quarter-tone idiom in which many of his compositions are written. There is a certain value to "filling in," as Vox is doing, the still unrecorded works of a major composer, but I would personally be willing to trade in both of these volumes for a single disc containing



Michael Tippett
Making a humanistic journey.

works by Vishnegradsky and/or, to give another example, Nicolai Roslavetz, a Russian pioneer in atonality whose output has been almost entirely buried (although a *Nocturno* recently surfaced in New York). R.S.B.

SESSIONS: Symphony No. 8; Rhapsody for Orchestra. For a feature review, see page 97.

SUDERBURG: Chamber Music II—See Rothenberg: Quartet for Strings, No. 2.

TCHAIKOVSKY FANTASIA. For a feature review, see page 91.

TIPPETT: The Vision of Saint Augustine; Fantasia on a Theme by Handel. John Shirley-Quirk, baritone (in *Vision*); Margaret Kitchin, piano (in the *Fantasia*); London Symphony Chorus and Orchestra, Sir Michael Tippett, cond. RCA RED SEAL SER 5620, \$6.98.

Visions, particularly those of the religious variety, are not very welcome these days. Even the Catholic church tends to talk around St. Augustine's visionary experiences, and one feels that current theology finds them a bit too melodramatic to be taken altogether seriously. Today the *Confessions* are read primarily as secular works, admired chiefly for their rich humanity and the self-revelations of an extraordinarily complex and fascinating individual.

Certainly one comes away from Michael Tippett's cantata *The Vision of Saint Augustine* with the knowledge of having made an intensely humanistic journey. Tippett is not a practicing believer, and it's not difficult to see why Augustine's highly colored word associations would appeal so strongly to a thinker who, like Augustine himself, is also something of a mystic with a keen sense of the flesh.

It would be wrong, then, to approach *The Vision of Saint Augustine* as a religious work: it is instead an expression of how the artist seeks, glimpses, and tries to retain his own vision of eternity through the creation and the actual physical practice of the art itself. I have the feeling that such an attitude would hardly be enthusiastically endorsed in most aesthetic circles nowadays, any more than the religious community seeks to encourage its visionaries, but Tippett believes and has gone about the task of communicating his convictions with his customary individuality, vigor, and inventive power.

The cantata is in three parts with a Latin text, devised by Tippett, that ingeniously operates on several simultaneous levels. The baritone soloist sings Augustine's own account of his joint vision with his mother, Monica, and there is additional choral commentary drawn from the saint's confessions, relevant Biblical quotations, the hymn "Deus, creator omnium" (by Bishop Ambrose, Augustine's early spiritual adviser), and outbursts of glossolalia, melismatic vowel sounds ("alleluia" being the most familiar) that in ancient music expressed an ecstasy that went beyond words.

Part one prepares us for the vision as Augustine and Monica rest in Ostia, the port of Rome, before traveling on to Africa; part two is the vision itself ("And higher still we soared thinking inwardly and speaking and marveling at your works: and so we came to our own souls and went beyond them . . . And while we were talking of eternal life and panting for it we touched it for a moment with a supreme effort of our heart"); part three is Augustine's reflections on the vision, an incredibly prolonged rhetorical "if" ending with the thought that, if this vision could be extended indefinitely, he would truly experience the eternal life of the saints.

Tippett wrote *The Vision of Saint Augustine* between 1963 and 1965. Stylistically it seems to represent something of a synthesis of the florid, proliferating richness of *The Midsummer Marriage* (1954) and the harmonic pungency and linear angularity of *King Priam* (1962). In any case, it is an extremely dense and complicated score that requires several hearings before all the various philosophical and musical levels become firmly fixed in the mind and ear.

Once digested, however, there is no resisting the singular impact of the piece, which consistently burns with an intensity that rarely subsides. Even in moments of relative repose, the ecstatic visionary quality of the piece erupts without warning, taking the chorus sopranos over a full two and one-half octaves or exciting the baritone to turn isolated vowel sounds into extravagant cadenzas with Monteverdian *trillo* ornamentations. For the final section, Tippett matches Augustine's seemingly endless conditional "if" clause with a breathlessly sustained musical paragraph that resolves itself into a spell-inducing cadence on St. Paul's words, "I count not myself to have apprehended," whispered by the chorus, first in Greek and then in English.

The recorded performance is an exceptionally fine one considering the awesome executive challenges. Tippett, unlike Britten, is not a naturally gifted conductor, and quite frankly one can imagine a reading of greater rhythmic definition and sweep. Even at that, John Shirley-Quirk, the chorus, and the orchestra sing and play their hearts out with the kind of skill and dedication that comes only from a total

belief in the labor at hand. The recording on this imported British RCA disc is subtly spectacular, managing to blend all the diverse elements into a superbly balanced entity in which virtually every element of the musical discourse is immediately audible.

The early *Handel Fantasia* (1939-41), five variations and a fugue on the prelude to an air with variations from Handel's *Suites de pièces pour le clavecin* (1733), is an attractive work in Tippett's most robust, luxuriant tonal style. Its juxtaposition with the Augustine cantata is instructive in view of the composer's eventual development, but surely it would have made more sense to place the *Fantasia* on Side 1 rather than at the end of Side 2, where it rudely breaks in on the meditative hush of the cantata's final measures. P.G.D.

TOMASEK: Concerto for Piano and Orchestra, No. 1.—See Kalliwoda: Symphony No. 1.

WAGNER: Orchestral Excerpts, Album 2. London Philharmonic Orchestra, Adrian Boult, cond. [Christopher Bishop, prod.] ANGEL S 36998, \$6.98.

Die Walküre: Ride of the Valkyries, Siegfried: Forest Murmurs, Gotterdammerung: Dawn and Rhine Journey, Funeral Music, Tannhäuser: Prelude to Act III (original version), Tristan und Isolde: Prelude to Act III.

Sir Adrian Boult's second Wagner disc includes one special enticement: Wagner's original version of the prelude to Act III of *Tannhäuser*, which recounts, in much greater detail than the familiar final recension, the hero's pilgrimage to Rome. If there has been a previous commercial recording of this, it has escaped my attention. Wagner decided early on that in the opera house, with the Rome Narrative yet to come, the longer version would be redundant—but for concert use it is eminently satisfactory; well shaped and full of effective gestures.

Sir Adrian gives us yet another novelty in his treatment of the *Tristan* third-act prelude: Instead of the solo version of the English horn tune, he reaches later into the act (to Tristan's "Muss ich dich so verstehn, du alte ernste Weise") for an accompanied presentation (mostly soft tremolando strings), and then rounds it off in the usual way. The resulting slight gain in textural cohesion is useful, for the long unaccompanied passage, so atmospheric in the stage version, tends to tear the piece apart as a concert number.

However, not even Sir Adrian's just, meticulous readings can reconcile me to those static patchworks, the *Ride of the Valkyries* and the *Forest Murmurs*. Nor does the peregrinating transitional music of the *Rhine Journey* make much sense on its own (Boult omits the portion of the duet music usually retained in concert versions of the piece, and ends in B minor, as in the opera). Even the *Funeral Music*, which owns a certain unity of key and rhythmic motive, does not gain by abstraction from its context.

Still, if you get a kick out of these *Ring* extracts, you could do worse—but also, perhaps, better. On Angel S 35947, Klemperer adds to Boult's *Ring* selections the *Entrance of the Gods* but omits the *Funeral Music* (the disc also includes the *Parsifal* Prelude and the shorter version of *Tannhäuser* Act III). Klemperer's *Ride* is briefer (just the first time

through the big tune and then cutting to the battle-cry music—no splicing back for a reprise), and so is his *Rhine Journey* (which starts after the duet). Both excerpts gain in coherence, and the performances are stately, coloristically more varied than Boult's, and more lucidly recorded.

Szell's *Ring* disc (Columbia MS 7291) offers the *Entrance of the Gods*, *Ride*, *Magic Fire*, *Forest Murmurs*, and the usual *Gotterdammerung* extracts (plus the final pages of the opera)—lithe, almost edgy performances of dazzling executive brilliance. Szell slightly improves the *Forest Murmurs* by skipping the irrelevant opening of the concert version and further vulgarizes the *Ride* by cueing additional vocal parts into the brass.

As I have suggested, the main inducement for acquiring this record should be that *Tannhäuser* excerpt. Sir Adrian never does anything unmusical, never impedes the progress of the musical line, and secures lively, intelligent phrasing and accenting from the less-than-first-rate band. Angel's sound is on the overripe side, confusingly resonant in the tuttis—some details here and there are not as clear as in Toscanini's old mono versions, and the sound of the orchestra in full cry is not as cohesive as it might be.

Sir Adrian is an admirable conductor of the German Romantic repertory, but our pleasure would be greatly enhanced were he put to work on proper concert fare, rather than on bits and showpieces. For a start, Angel might issue his excellent set of Brahms symphonies, of which only the Second has so far been released domestically. D.H.

WAGNER: Tristan und Isolde: symphonic synthesis. For a feature review, see page 91.

recitals and miscellany

BALLET FANTASIA. For a feature review, see page 91.

RUSSIAN FANTASIA. For a feature review, see page 91.

ART OF AKSEL SCHIÖTZ, ALBUM 3: Oratorio Arias; Mozart Opera Arias. Aksel Schiøtz, tenor; Royal Danish Orchestra, Egisto Tango, cond. (in the Mozart); orchestras, Mogens Wöldike, cond. (in the remaining works). SERAPHIM 60277, \$3.98 (mono) [recorded 1940-46].

BUXTEHUDE: Aperi-te mihi Justitiae portas. **HANDEL:** Messiah: Comfort ye . . . Ev'ry valley. **BACH:** St. Matthew Passion: O Schmerz! . . . Ich will bei meinem Jesu wachen. **HAYDN:** Die Schöpfung: Mit Würd und Hohelit angetan. **MOZART:** Die Entführung aus dem Serail: Hier soll Ich dich denn sehen; Im Mohrenland gefangen war. Don Giovanni: Dalla sua pace; Il mio tesoro. Così fan tutte: Un'aura amorosa. Die Zauberflöte: Bildnisarie.

This record is exactly the same as Danish Odeon MOAK 2, except in one important respect: The quality of sound on the Mozart side

"Get it on together."

"You know, I've always thought of music as a universal language. In fact, that's probably the reason my daughter Nancy and I get along so well together. So when it's time for some easy listening, we get it on together with Koss Stereophones. Because nothing brings back the excitement of a live performance like the Sound of Koss.

"This year the engineers at Koss have made that sound better than ever, with an all new Decilite™ driver assembly. It's the first High Velocity driver element to deliver all 10 audible octaves, and it's featured in the new HV/1a and the HV/1LC Stereophones. Take it from old 'Doc', the new Koss High Velocity Stereophones deliver a fidelity and wide

range frequency response unmatched by any other lightweight stereophone.

"So if you'd like to hear some lightweight, hear-through Stereophones that'll curl your toes, slip into the new HV/1a or the HV/1LC with volume-balance controls at your Audio Specialist. Or write for the free Koss full-color catalog, c/o 'Doc and Nancy'. With a pair of the new Koss

High Velocity Stereophones and any of the Koss Listening Stations, you can really get it on together." ©Koss Corporation



Doc Severinsen & Daughter Nancy

 **KOSS**® stereophones
from the people who invented Stereophones.

KOSS CORPORATION, 4129 N. Port Washington Ave., Milwaukee, Wisconsin 53212 • Koss S.r.l., Via dei Valtorta, 21 20127, Milan, Italy • Koss Limited, Burlington, Ontario



If Bach were alive today, he'd be recording on "Scotch" brand recording tape.

It's been said it would take a present-day copyist seventy years just to *copy* all the music Bach composed.

So, next time you record something take a hint from the master.

Use "Scotch" brand—the Master Tape.

The quantity of his work is staggering. But so is the quality.

And *that's* what made Bach the pro he was.

And that's why, if he were recording today, he'd be recording on "Scotch" brand recording tape. Just like the pros in today's music business.

After all, nearly 80% of all master recording studios use "Scotch" brand.



3M
COMPANY

"Scotch" is a Registered Trademark of 3M Co.

The Master Tape.

has deteriorated badly. Though this particular group of 78s dates from 1942-43, there is a lot more life in them than is suggested by their latest incarnation, in which they sound muddy and distant. Intending purchasers would therefore do better to seek out the Odeon disc in import shops.

Aksel Schjøtz had a blighted career as a singer. He did not make his operatic debut until 1939, when he was thirty-three. The outbreak of World War II in September of that year kept him confined to Denmark until 1945. After the liberation of Europe, he immediately made a name for himself outside his native country, both through live appearances and recordings. In the following year, however, he was operated on for *tumor acusticus*, and though he eventually reappeared as a baritone he never really enjoyed the same sort of success again. Today he teaches singing.

The 78s collected on this recital caused something of a sensation when, after the war, they were finally issued in the U.S. and Britain. Their musicality and the wide range of styles and languages they covered seemed startling at the time. Everyone marveled at Schjøtz's English in "Ev'ry valley." So they did too at his unflinching tastefulness, his restraint and unmannered style.

The perpetuation of these records on LP would indicate that Schjøtz still has a large following. Nevertheless, listening to them after a lapse of time has proved a sobering experience. The musicianship, especially in the Buxtehude and Bach selections, is as apparent as ever, but so is a certain dispassion. One feels this even in "Ev'ry valley," despite the good breath control and the cleanness of the runs. During the aria from *Die Schöpfung* one thinks longingly of Julius Patzak's individuality and the way he relishes the text. The Mozart side is, in the end, monotonous, though Pedrillo's serenade is not without its charm, even now.

The passage of nearly thirty years causes one to listen afresh. How clearly today one hears the limitations of Schjøtz's voice: its dry, somewhat throaty sound, its lack of tonal variety, the absence of muscle. How clearly too one is aware of his tendency to rhythmic flabbiness, the scanted syllables. At this juncture, moreover, one tends to notice the fact that his German and Italian are not quite good enough, the former being softened by the suppression of consonants, the latter spoiled by incorrect vowels.

Synopses but no texts.

D.S.H.

B GERARD SCHWARZ: Cornet Favorites. Gerard Schwarz, cornet; William Bolcom, piano. [Marc J. Aubort and Joanna Nickrenz, prod.] NONESUCH H 71298, \$3.98.

HERBERT L. CLARKE: From the Shores of the Mighty Pacific (rondo caprice); Sounds from the Hudson (valse brillante); The Debutante (caprice brillante); The Bride of the Waves (polka brillante). **FRANK SIMON:** Willow Echoes. **JEAN-BAPTISTE ARBAN:** Fantasie and Variations on "The Carnival of Venice." **VIRGIL THOMSON:** At the Beach (concert waltz). **CARL HÖHNE:** Slavische Fantasie.

To such intoxicatingly fragrant evocations of musical Americana as those in its Stephen Foster songs and Scott Joplin rags, Nonesuch's nostalgia series now adds loving tribute to those fabulous coloratura heroes of summer bandstands, soloists on the cornet—the trumpet's stubbier, blander-toned, but fabulously

agile poor-man cousin. A whole realm of the band-music repertoire is devoted to show-pieces for cornet virtuosos, much of it written by such outstanding stars themselves as the Americans Clarke and Simon (both soloists with Sousa's band); the pioneering Frenchman, Arban, who published the still-standard Cornet-Method in 1864; and the more shadowy German, or Austrian, Höhne, who composed the Slavic Fantasie for a celebrated late-nineteenth-century Austrian cornetist, Fritz Werner.

This music is as naive, old-fashioned, ingratiating, and floridly showy as the selections' titles and subtitles suggest—perhaps none of it more so than Virgil Thomson's tender rather than satirical reminiscence of his own childhood relish of this genre. This piece originally was composed (1929) for violin and piano and some twenty years later was revamped and elaborated for trumpet and piano.

Already outstanding among young American trumpeters, Gerard Schwarz was born (1947) long after the era when star cornetists were as famous as top pro quarterbacks are today, but he has an obvious affinity for old-fashioned pyrotechnical bravura, and he has shifted from trumpet to cornet with disdainful ease in the face of all the super-speed, double- and triple-tongued demands on him. Both he and his pianistic partner Bolcom (another who brings properly idiomatic panache to this bandstanding music) are captured in admirably clean, bright, un gimmicked recording.

For full measure, the jacket notes, by Bolcom himself, are lively as well as informative reading. But as always, it's the music that's the prime attraction—not a strictly serious or substantial one, perhaps, but a unique kind of camp-in-good-taste that is also of authentic documentary value. R.D.D.

A SURVEY OF THE WORLD'S GREATEST ORGAN MUSIC: GERMANY: Vol. 1, North Germany; Vol. 2, South Germany; Vol. 3, Central Germany. Helmuth Rilling (Vol. 1) and Franz Lehnrdorfer (Vols. 2 and 3), organ (various historic and new organs). Vox SVBX 5316, 5317, and 5318, \$10.95 each three-disc set.

Vox's monumental "Survey of the World's Greatest Organ Music" aims to present a comprehensive picture of the development of organ music from its very beginnings down to the present day. So far, the series has been remarkably successful in presenting this vast amount of material in a realistic and reasonably complete perspective, with few serious omissions and with an excellent balance and emphasis throughout. The series is subdivided by country: When complete there will be six three-disc boxes each, devoted to France, Germany, and Italy. (For a review of all six volumes of French organ music, see the August issue; the Italian records will be discussed in a future issue.)

The very first few fragmentary manuscripts of keyboard music of any kind come from England and Italy and date back to the early 14th century. Throughout the 15th century, though, Germany reigned supreme, and many manuscripts survive. Of particular importance are Conrad Paumann's *Fundamentum organisandi* of 1452 (primarily an instruction manual) and the Buxheim Organ Book of 1470, a

huge collection of more than 250 pieces, which represents the last great example of medieval organ music (a few of these pieces are included in Vol. 2). Particularly at this early date, German production is divided into three distinct geographical areas—southern, central, and northwestern—and the Vox series is similarly subdivided.

In the 16th century, keyboard music expanded rapidly, and five countries participated actively: Germany, Italy, Spain, England, and France. Germany (and France), however, played a minor role in the development at this time, only to rise again to supremacy early in the 17th century, and it has maintained that dominant position ever since. Only during the reign of Louis XIV and again toward the end of the 19th century did French keyboard music seriously challenge Germany's position.

Before proceeding to a more detailed description of the separate volumes, I must point out that two of the greatest of German keyboard composers are absent from this series altogether: Bach and Buxtehude have been banished, not for unworthiness, but because Vox has already recorded the complete organ works of both men. In spite of the distortion in perspective that their absence necessarily produces, there would be an even greater danger of distortion if these two giants had been permitted to cast their shadows over the works of their colleagues. Bach and Buxtehude must be dealt with separately.

Within the geographical subdivisions, the various works in the German series are loosely arranged chronologically. Vol. 1, "North Germany," begins with Sweelinck and other late-16th-century composers, covers the 17th century, and overlaps slightly into the 18th. Vol. 2, "South Germany," is centered largely around Munich and includes the very earliest German keyboard pieces, from the mid-15th century. The remainder of the composers are spread fairly evenly through the 16th, 17th, and 18th centuries. Vol. 3, "Central Germany," concentrates on a narrower time span—mid-17th through the 18th century—and centers around the Bach family. Nearly every composer in this volume was associated with Bach in some manner.

Vol. 4 will be devoted to the Vienna school, including a number of Bohemian and Czech composers. After a few 17th-century works (by Froberger and Muffat), it will concentrate on the 18th- and 19th-century giants (Mozart, Beethoven, Mendelssohn, Schumann, Brahms, and several others). Vols. 5 and 6 will round out the 19th century (works by Bruckner, Reubke, Rheinberger, Reger, and others), and focus a good deal of attention on 20th-century composers (Schoenberg, Hindemith, Pepping, Schroeder, and Distler are the best known among them).

Quite a few of the French volumes included performances that had been previously available on single Turnabout discs. But all of the German and Italian records seem to contain only new releases, and, needless to say, the majority of the repertoire (in the early volumes at least) has never been recorded by anyone before now.

Vol. 1, "North Germany," presents 23 works by 18 composers, centered mainly around Hamburg and Lübeck. It begins, however, with a full record side devoted to three works (two fantasias and the poignantly beau-

ADVERTISING INDEX

| Key No. | | Page No. |
|---------|--|----------------|
| 1 | Acoustic Research, Inc. | 62 |
| | Akai America, Ltd. | 69 |
| 2 | Altec | 8, 9 |
| 3 | Angel Records | 106 |
| | Audio Dynamics Corp. | 34 |
| 4 | Audio Technica, U.S., Inc. | 104 |
| 5 | Audio Warehouse | 140 |
| 6 | Avid Corp. | 70 |
| 7 | Bang & Olufsen, Inc. | 45 |
| 8 | BASF Systems | 82 |
| | Bose Corp. | 120 |
| | Bozak, Inc. | 43 |
| 9 | British Industries Co. | 7 |
| 10 | British Industries Co. | 115 |
| 11 | B.S.R. (U.S.A.) Ltd. | 41 |
| 12 | Capitol Magnetic Products | 116 |
| 13 | Caprice Records | 138 |
| | Classified Ads. | 144, 145 |
| 14 | Clifford's Hi-Fi Wholesalers | 143 |
| | Columbia Records | 109 |
| 15 | Concord Products | |
| | Benjamin Electronic Sound Co. | 21 |
| 16 | Crown International | 24 |
| 18 | Design Acoustics | 108 |
| 19 | District Sound | 138 |
| | Dixie Hi Fi Wholesalers | 142 |
| 23 | Dokorder | 19 |
| 17 | Dual | 22 |
| 24 | Dynaco, Inc. | 139 |
| 25 | Elac Products | |
| | Benjamin Electronics Sound Co. | 119 |
| 26 | Electro-Voice, Inc. | 31 |
| | Elpa Marketing Industries | 11 |
| 21 | Empire Scientific Corp. | 25 |
| 99 | Empire Scientific Corp. | 33 |
| 20 | Fisher Radio | Cover II, I |
| 22 | Garrard | Cover IV |
| 28 | Harman-Kardon | 14, 15 |
| 29 | Heath Co. | 35, 37 |
| 30 | Hitachi Sales Corp. of America | 61 |
| 31 | Icelandic Airlines | 112 |
| 32 | Illinois Audio | 143 |
| 73 | Infinity Systems | 107 |
| | International Festival of Great Orchestras | 5 |
| 75 | International Hi-Fi Distributors | 140 |
| 33 | Janszen Electrostatic | 104 |
| 34 | Kenwood | 137 |
| 35 | Kirsch Co. | 32 |
| 36 | Koss Corp. | 127 |
| 37 | Lafayette Radio Electronics | 12 |
| 38 | Lafayette Radio Electronics | 110 |
| 74 | Leslie Speakers | 111 |
| 39 | Magnavox | 113 |
| 43 | Marantz | 148, Cover III |
| 40 | Maxell Corp. of America | 20 |
| 41 | McIntosh Laboratory | 32 |
| 42 | Midwest HiFi Wholesale | 145 |
| | Nakamichi Research (U.S.A.) Inc. | 86 |
| 45 | North American Philips | 81 |
| 46 | Nova Audio | 143 |
| 47 | Polydor, Inc. | 27 |
| 48 | Rabson's | 143 |
| 49 | Radio Shack | 16 |
| 50 | RCA Records | 102 |
| 51 | Rectilinear Research Corp. | 123 |
| | Revox Corp. | 105 |
| 52 | RTR Industries | 39 |
| 53 | SAE, Inc. | 89 |
| 54 | Sansui Electronic Corp. | 10 |
| 55 | Scott, H. H., Inc. | 141 |
| 56 | Sharp Electronics Corp. | 30 |
| 76 | Sheraton Electronics | 138 |
| 57 | Sherwood Electronic Laboratories | 13 |
| 58 | Shure Brothers | 90 |
| 59 | Sony Corp. | 124 |
| 60 | Stanton Magnetics | 2 |
| 61 | Stereo Corp. of America | 142 |
| 62 | Stereo Wholesalers | 145 |
| 64 | Suprex Electronics | 4 |
| 65 | TDK Electronics Corp. | 103 |
| 66 | Technics by Panasonic | 26 |
| | 3M Company | 128 |
| 67 | Uher of America, Inc. | 108 |
| 17 | United Audio | 22 |
| 68 | U.S. Pioneer Electronics | 74, 77 |
| 69 | Utah Electronics | 147 |
| 10 | Venturi | 115 |
| 70 | Walco-Linck Corp. | 34 |
| | Watts | 11 |
| | Wyeth Press | 98 |
| 71 | Yamaha Audio Division | 52 |
| 72 | Zenith Radio Corp. | 29 |

tiful variations on "My Young Life Has Come to an End") by the Dutchman Sweelinck (1562-1621). This Italian-trained, Amsterdam-based organist/composer/teacher is the real father of the North German school: at least six other composers in this volume studied with him directly, and his influence continued to be felt in North Germany for generations.

One of Sweelinck's most important pupils was Samuel Scheidt (1587-1654), a friend of Schütz. He also earns a full record side, devoted to three works (a set of chorale variations and two free works, from his *Tabulatura nova* of 1624).

This North German school continued to develop throughout the 17th century the brilliant style that culminated in the works of Buxtehude, Böhm, and Lübeck and their predecessors, Tunder, Bruhns, and Reinken. Inexplicably, three of the most important North Germans (Reinken, Böhm, and Lübeck) turn up in Vol. 3, grouped with the Central German composers.

The North German school of organ building, also descended directly from Dutch influence, continued to emphasize strong, independent divisions, especially a complete and independent pedal. It reached its culmination in the instruments of Arp Schnitger around the turn of the 18th century.

All the works in this first volume are played by the well-known organist and conductor, Helmuth Rilling, whose technical facility and historical understanding are certainly more than adequate to the task. His approach to this early music, though, is that of the scholarly, pure, and pedantic old German professor. His tempos are slow and careful, and hardly a trill or ornament or rhythmic alteration or tempo inflection is allowed to mar the purity of these "Urtext" performances. There's not much excitement, but he does offer clear aural pictures of the Urtext scores.

Rilling plays on four very fine organs: the famous Schnitger in Stade and three new instruments built by Karl Schuke of Berlin, including the magnificent big instrument in Berlin's Kaiser Wilhelm Gedächtniskirche. All are beautifully recorded, as well.

Vol. 2, "South Germany," includes the earliest keyboard music in Vox's entire series: a pair of short works from the important Buxheim Organ Book, compiled in Munich in about 1470. There are also short works by four other composers, born in the 15th century, who began the tradition of bringing Italian influence to southern Germany: Isaac, Hofhaimer, Buchner, and Sicher. Unfortunately, one of the greatest and most fascinating composers of this time, Arnolt Schlick, is not represented. Among his liturgical organ works is a setting of the antiphon *Ascendo ad Patrem*, a ten-voiced composition with six independent parts for the manuals and four for the pedals!

This volume includes a total of 37 works by 25 composers: taken together, they show the steady development of keyboard composition in the Catholic south through the 16th, 17th, and 18th centuries and even into the early 19th. Fewer of the names here will be familiar to the nonspecialist than those in Vol. 1.

The most famous among them, and the one allotted the most disc space, Johann Pachelbel (1653-1706), would rest more comfortably with his fellow Protestant Central German composers than in this volume. Side 6 is de-

voted to four of his free works and three chorale settings, all of which exerted a strong influence on Bach.

Vol. 3, "Central Germany," is for a variety of reasons the most interesting and enjoyable of the three volumes now available. It is devoted almost entirely to nine members of the Bach family (omitting Johann Sebastian) and to various composers associated with the family.

The earliest musical members of the Bach clan are Heinrich (1615-1692), a brother of Sebastian's grandfather, and two of his sons, J. Michael and J. Christoph. Also included are J. Bernhard, J. Ernst, and Lorenz, as well as three of Sebastian's sons, Friedemann, Emanuel, and Johann Christian. Though it should be news to no one, these records emphasize once again what a remarkable dynasty it was: Virtually every one of the ten carefully chosen works by these nine composers are among the best in the series.

Among the remaining thirteen composers in the volume are Reinken and Böhm, who exerted a strong influence on the young Sebastian; Kuhnau, his predecessor in Leipzig; his friends Walther and Telemann; and four of his pupils, Vogler, Krebs, Homilius, and Kirnberger.

The organist in all volumes of the German series except the first is Franz Lehnrdorfer, a professor at the Musikhochschule in Munich and organist at the Cathedral there. He is a well known and frequently recorded artist in Germany, though few of his records are available here. His performances are considerably more lively and entertaining than Rilling's, though he is still definitely a member of that peculiarly German old school of scholarly purists. He ornaments a little and is partial to fussy, sometimes eccentric phrasings, and frequent registration and manual changes.

In the early, unfamiliar pieces, his playing is often particularly academic and dull, but in the majority of the later, more familiar music Lehnrdorfer sounds much more at ease and plays with a great deal of flexibility and rhythmic fluidity. He's not the most gifted technician I've heard, but wrong notes and smudged passagework are held to an acceptable minimum.

The six organs used in Vols. 2 and 3 (four old, two new) are all fine instruments, well recorded.

Each volume comes with an eight-page booklet outlining in detail the development of keyboard music in Germany. It is much better organized and more readable than the booklet accompanying the French records, but there are a few rather serious errors—especially in the section dealing with 15th century music—probably attributable more to sloppy editing than to sloppy research. In addition, each volume contains a single sheet listing its complete contents. The outsides of the boxes list only a few of the composers included and none of the pieces.

In sum, Vox is providing a wonderfully informative as well as entertaining series of records, and my few criticisms of details should dissuade no one interested in the development of keyboard music from obtaining the entire series. The records and accompanying printed matter provide an overview and insight that cannot easily be acquired in any other manner.

C.F.G.

4-channel discs/tapes BY ROBERT LONG

Bouncing Bach. Surely Johann Sebastian is the most indestructible of composers. He has been crooned, Mooged, tootled, and droned—one would think—to death; but every time he bounces back (pun intended), ready for another encounter with the arrangers.

The latest in quad is John Lewis of the Modern Jazz Quartet with his "Blues on Bach" record (reviewed from the stereo version in the August issue—see "Jazz"). Lewis, together with vibist Milt Jackson, has devised a sort of suite that I find entirely engrossing—partly because of its lively use of quad. Lewis plays five Bach pieces (including the *Ein' feste Burg* chorale and the inevitable "Jesu, joy of man's desiring") on the harpsichord with the other three MJQ members. In between he switches to the piano, and the four play original blues (two by Lewis, two by Jackson) that, in their key signatures, spell out Bach's name: They're in **B** flat, **A** minor, **C** minor, and **H** (German usage for B natural). Hardly an original device.

The music is highly original, however. The Bach portions glitter with cymbal effects that complement the harpsichord sound. One of the blues pieces has some marvelously expressive bass portamentos by Percy Heath. The whole is far more musically intelligent than most of the Bach-derived specialties around, and I'm less disturbed by the Bach/blues dichotomy than John S. Wilson was in the earlier review.

Vibes and keyboard parts dominate the front of the quad perspective; the rhythm is toward the back (though the bass sometimes counts for far more than mere continuo). The sound uses the spatial separation to advantage, but it is very well integrated, with absolutely no sense of its having been pieced together by overdub—which, I assume, it wasn't.

The recording is on an Atlantic Quadradisc (QD 1652, \$6.98). My review copy was rather warped and a bit noisy—particularly between cuts, where it doesn't matter so much. The sound otherwise is crystalline and the shortcomings less than obtrusive.

A Gamelan Glint. The first Nonesuch Quadradisc release list consisted of recordings that seemed to be remixed from earlier stereo releases. If the more recent batch is likewise remixed, I can't find any evidence of it. Not only do they sound like "real" quadriphonics, but they (or rather their producers) seem to feel free to use all four channels or not,

as the material demands—a luxury that's hard to command when you're struggling to create quadriphonic effects from (stereo) scratch.

A most striking example is in the New Jersey Percussion Ensemble's disc (Nonesuch HQ 1291, \$3.98) of works by Varèse, Colgrass, Cowell, Saperstein, and Oak. I'd heard—and been much taken by—the stereo version of this recording (HF, "Recitals and Miscellany," August 1974), but the Quadradisc is far more effective. Varèse's tumultuous *Ionisation* virtually requires four channels, in fact. So much is going on within it that the stereo version no longer seems even adequate.

The far lovelier *Fantasy-Variations* by Michael Colgrass, on the other hand, hardly needs quadriphonics, though it profits materially from the medium. Its gamelan-like sonorites would glint as attractively in mono, but the miking of related instruments presumably played by a single percussionist (the chromatic drums, for example) spreads them out into an *area*—rather than at a fixed point—within the room, and these areas then interact to fill the room with a scintillating web of sound. The effect is quite fascinating without detracting in any way from the marvelous sonic textures themselves.

The texture of Cowell's *Ostinato pianissimo* also is marvelous: but this is the one piece in the group that is built on "conventional" musical ideas, and Nonesuch has chosen to treat it in relatively conventional fashion—substantially centered in the front of the room. To have spread it out would have been to dilute its impact.

The original recording is exceptionally wide range—both in frequency response and dynamics—but this unfortunately works against its success in quad. Noise is all too audible in the "holes" between the percussion transients, and some of the highest sounds seem rather less stable in placement than the lower ones. And my review copy, like several I've had from the WEA group, is visibly eccentric. Fortunately much of this is music in which wow due to eccentricity is hard to hear. All told, the sound *as sound* is better on the stereo disc; but the Quadradisc is extremely successful and I suspect I'll continue to prefer it, noise or no noise.

It Tolls for Me! One of the joys of doing a column like this is that you're given all sorts of records that you never would

stumble across otherwise. A case in point is the Victor Young film score for *For Whom the Bell Tolls* conducted by Ray Heindorf and done up in SQ by Stanyan Records (SRQ 4013, \$5.00; available by mail from Stanyan Record Co., P.O. Box 2783, Hollywood, Calif. 90028).

I'm not a movie-music (nor even movie) buff; nor am I particularly an admirer of Victor Young. But here was the record, so I tried it. It is a studio job in real SQ, not a rechanneling from the soundtrack recording. And—in the sonic equivalent of glorious Technicolor—it gives you ten musical selections from the score.

It's not what I'd call particularly memorable music, but it does get to me in a peculiar way. Here is all this music written to go behind Gary Cooper, Ingrid Bergman, et al. and meant to be encountered (along with them) in a public theater. And now, with no competition from visual images, dialogue, high-priced movie stars, popcorn-munching neighbors, or dank air-conditioning, it suddenly is unfolding for my benefit alone. That remote, often muffled, and usually obscured orchestra suddenly has come down off the Rivoli screen and assembled around me. Somehow I find the experience pleasurable jarring.

Pops Up to Date? One of Arthur Fiedler's "Greatest Hits" albums—"The '70s, Vol. 2" (RCA ARC1 0052, \$7.98)—has come in in Quadradisc form and, for the benefit of readers who admire the Boston Pops, I should mention that the sound is excellent, the quad engulfing, and the Pops its ultraprofessional self. The Bostonians always seem deadly sober to me in such collections of popular tunes, and the arrangements so overblown that otherwise unassuming tunes like "Leave Me Alone" sound downright tacky. But there; Fiedler and friends obviously have a fond following that will enjoy this disc.

P.D.Q. Again. Vanguard has issued another SQ record of the Fictitious Bach ("The Intimate P.D.Q. Bach"; Vanguard VSD 79335, \$6.98). The sound remains excellent (as most of "The Wurst of . . ." was), though, again, the audience-vs.-performers placement is not what one would expect in a normal theater situation. The audience seems to be everywhere, and you sit not among them, but among the performers.

The quad does let you hear a great deal of contrapuntal textures (in this case signifying that the performers are punting upstream against the current trends of musical thought and sanity)—for example, in the *The Art of the Ground Round*, a series of canons to ground basses—and therefore lets you savor the fun a little more piquantly than stereo could. ●

Doug Dillard—a fine, spunky fiddle-and-banjo album.



the lighter side



reviewed by

MORGAN AMES
ROYAL S. BROWN
R.D. DARRELL
HENRY EDWARDS
KENNETH FURIE
MIKE JAHN
JOHN ROCKWELL
JOHN S. WILSON

Explanation of symbols

 exceptional recording

Recorded tape:

-  Open Reel
-  8-Track Cartridge
-  Cassette

 **DOUGLAS FLINT DILLARD:** You Don't Need a Reason to Sing. Douglas Flint Dillard, vocals and banjo; vocal and instrumental accompaniment. *Fiddle 'n' Banjo; You Don't Need a Reason; Sittin' in Limbo; Ninety Miles*; seven more. [Rodney Dillard, prod.] 20TH CENTURY T 426. \$6.98.

Doug Dillard has for more than ten years been a significant figure in country and folk music, and has even made tentative stabs into what used to be called folk rock with the short-lived but fairly popular Dillard & Clark. He is a fine banjoist and has, for this album, assembled a stunning array of country pickers, including Vassal Clements, Buddy Emmons, John Hartford, and Billy Ray Latham.

The material is likewise well-chosen. Best are the up-tempo tunes, and the best of these is the sterling rendition of "Sittin' in Limbo." "Ninety Miles" is a competent ballad.

Dillard's voice is a mite light and at times uncertain, but it is by no means deficient enough to mar the over-all luster. "You Don't Need a Reason to Sing" is a fine, spunky fiddle-and-banjo album. M.J.

 **VIENNESE OPERETTA FAVORITES:** Music of J. Strauss, Millöcker, Suppé, Kálman, and others. Renate Holm, soprano; Werner Krenn, tenor; Vienna Volksoper Orchestra, Anton Paulik, cond. *Wer uns getraut; Treu sein; Soll ich reden*; ten more. LONDON OS 26219, \$6.98.

If, like most American devotees of easy-listening, honest-to-god tuneful music, you know some of the superbly mellifluous hits of the Viennese operetta stage only in Broadway translations and disarrangements, you're in for a delightful surprise when you encounter the Real McCoy and learn to discriminate between flat tonal soda pop and effervescent musical champagne. You may recognize only two of the composers' names represented here (Strauss and Suppé), but their melodies are no more insidiously catchy than those of the less famous internationally but scarcely less esteemed locally, Millöcker, Kálman, Dostal, Künneke, Kattnigg, and the Italian Czernik. Indeed, this program's high points are the soprano air "Spiel mir das Lied" from Dostal's *Die ungarische Hochzeit* and Czernik's bravura showpiece "Chi sa? Nel mio giardino d'amore."

But that may not be entirely to the two composers' credit. Renate Holm boasts one of the best, most brilliant, and most surely controlled soprano voices you're likely to hear anywhere today, on or off records. Her partner in several duets and tenor soloist on his own is the better-known (so far) Werner Krenn, who also possesses a fine voice but who is often interpretively too lachrymose and schmaltzy—especially in some of the airs that Viennese operetta connoisseurs remember best as sung so incomparably by Richard Tauber. But, besides Ms. Holm, there's a wealth of sheer melodism here, deftly accompanied in authentic Viennese style by the expert Anton Paulik.



Incidentally, the present disc sides are numbered 1 and 4; the all-Lehár Sides 2 and 3 were issued last year as OS 26220. R.D.D.

MARTIN MULL: In the Soop. Martin Mull, vocals and guitar; Ed Wise, vocals and keyboards; Les Daniels, vocals; Charles La Chappelle, bass; Al Kaufman, drums. *Auto Mechanic; Consuela Was a Mexican; Tuna Fish Salad; Margie the Midget*; seven more. [Sam Charters, prod.] VANGUARD VSD 79338, \$6.98.

Since Martin Mull became both famous and infamous with his comedy song routines and his records of the same on the Capricorn label, it seemed inevitable that Vanguard would issue this early LP, recorded in 1967 but never released.

Inevitable but unfortunate. The material is for the most part weak and unfunny, a seeming attempt to do a Mothers of Invention chatty-nonsense number, most popular in 1967. The music is also light, of a namby-pamby sort that might be termed cocktail-lounge rock.

Mull's best is the "live" recording "Martin Mull and His Fabulous Furniture in Your Living Room," on Capricorn. This Vanguard release is to be avoided. M.J.

JACKIE DESHANNON: Your Baby Is a Lady. Jackie DeShannon, vocals; strings, rhythm, synthesizer, horns, and vocal accompaniment. *Small Town Talk; Jimmie, Just Sing Me One More Song; I Won't Let You Go*; seven more. [Antisia Music, prod.] ATLANTIC SD 7303, \$6.98. Tape:  TP 7303, \$7.97;  CS 7303, \$7.97.

This long-awaited Jackie DeShannon LP is a pleasant divertissement. DeShannon displays a svelte, slick, insinuating vocal style as well as a powerful, full-bodied approach and a gritty, guttural growl. She rides on top of a series of chugging bass lines and makes pulsating soul music. She also throws in a Neil Sedaka song done in a wispy manner that doesn't quite work and a Stephen Schwartz song whose lyric is given an intelligent reading. On "I Don't Know What's the Matter with My Baby" she delivers a jolly Aretha impersonation.

Somewhere along the way, however, I sense that DeShannon has been arbitrarily forced into an assumed commercial mold. These arrangements—all done by Antisia Music—are reasonably professional soul charts, but they do lack intrinsic interest. The search for a commercial format is usually self-defeating; one must produce something that has a life of its own—and then one gets a commercial result. H.E.

 **BILL AMESBURY:** Jus' a Taste of the Kid. Bill Amesbury, vocals, songs, arrangements, guitar, bass, and mandolin. *Justin; On the Matter of Direction; Lakehead*; nine more. [Bill Amesbury and Bill Gilliland, prod.] CASABLANCA NB 9005, \$6.98.

This guy is a dynamo, and, if the record business were not hugging itself so tightly these days to save what's established, there would be room for him to slip into the big time. He has had considerable L.A. air play (mostly AM easy-listening stations) with a fabulous track called "Virginia (Touch Me Like You Do)."



Dianne Steinberg—maybe the stage is the place for her.

People in records always say to the young hopefuls. "You gotta come up with a sound, kid." Bill Amesbury even did that. "Virginia" is live and hot and noisy, freshly mixing acoustic guitar, handclaps, and mandolin plus an excellent song and singing—the whole thing is in the pocket. Even all that has not yet pushed him over the edge into the real action.

Amesbury is twenty-four and Canadian, "I've worked with a lot of people," he says in his bio, "but I'm my first big endeavor." He has a hand in everything. "Sailin'" has an interesting string concept and excellent backup singing by himself, pure and straight-toned.

This is the sort of album that could sell later, as did Carole King's first albums once "Tapestry" hit big. Amesbury definitely has got the goods, and I'd bet a lot that he is hell-bent on being a star. Anyone who isn't better stay out of today's record business. The company, Casablanca, subsidiary of Warners, must know all this about Amesbury. What goes around comes around. For Bill Amesbury it's only a matter of time. M.A.

SYD BARRETT: The Madcap Laughs. Syd Barrett, guitars and vocals; Jerry Shirley, drums; David Gilmour, bass; Richard Wright, keyboards. *Here I Go; Late Night*; twenty-three more. [David Gilmour, Roger Waters, and Malcolm Jones, prod.] HARVEST SABB 11314, \$7.98 (two discs). Tape: ● 8XVV 11314, \$8.98.

Syd Barrett is a former member of Pink Floyd, the British band for whom he played guitar and was lead voice. It was his voice and flair for the weird that made PF's initial LP, "The Piper at the Gates of Dawn," released on Tower in 1967, so fascinating.

Since then, Pink Floyd has turned in the direction of Moog rock, and Barrett, it would seem, wishes to recall the old days. That is what he has done with this two-disc set, which is fascinating without being compelling. An acoustic guitar drones atonally. Barrett mumbles words that either make little sense or fail to draw attention to themselves. Melodies, when they exist, are barely distinguishable from one another. The whole thing has the aura of a long chant, an exercise beneficial mainly to the chanter.

Some of it is better than the rest. "Here I

Go" is a pleasant little ditty reminiscent of post-Beatles British rock.

Barrett gives the impression that he put a great deal of thought into this album, but I am afraid he is talking to himself. It is adventurous in that he resisted the wholly British temptation to grab an electric guitar and blast away at the ceiling. It is adventurous in that he plays with atonality and isn't afraid to sing off key when it suits the purpose of the song. But it is, unfortunately, more masturbation than revelation. M.J.

* **DIANNE STEINBERG.** Dianne Steinberg, vocals; vocal and orchestral accompaniment; Tony Bell, Richard Rome, Perry Botkin Jr., and Ann Swain Clark, arr. *Enough for You; One More Time; Sunny One*; seven more. [LeBaron Taylor, Phil Hurt, and Tony Bell, prod.] ATLANTIC SD 7309, \$6.98. Tape: ● TP 7309, \$7.97; ●● CS 7309, \$7.97.

It's hard to find much wrong with this debut album (I think it is a debut), except that it's all but impossible to break an album like this. It is almost all ballads, which eliminates the dancers, who break the newcomers. (Everyone else has opinions, but it's the kids who buy records.)

Dianne Steinberg is an interesting young lady, photographed (no credit) on front and back to look like a high fashion model—a dubious graphics notion, if you ask me. She sings quite well in sad colors that sometimes bend toward Laura Nyro or one or another r&b ballad mode. The songs, some by the singer, are pensive and pensively produced, featuring large and well-written orchestrations and varying tempos. The outlook is theatrical and valid, so long as you give it your entire concentration. This is precisely what record buyers refuse to do for new artists. People will concentrate for familiar artists who have earned it—Stevie Wonder and occasionally a Bette Midler.

I find the background vocals pretty choir-lofty and overdone, and the first track is called "Dianne Who?", which is a pushy production idea for an unknown.

Over-all, Dianne Steinberg is an unhappy lady where love is concerned. That is the mes-

sage, and no answer is offered. Then out of nowhere is the addition of "Gee Whiz," a mindless hit of the the '50's that sounded fine in its own pointless context. In this album it's like the third arm in a sweater.

If Ms. Steinberg is a good stage performer, and I suspect she is, then she will be all right. She can then build her career slowly without starving or getting rusty waiting to record. She has a soft sweet quality that gives her great possibilities in the proper setting. Good luck. M.A.

JIM WEATHERLY: Songs of. Jim Weatherly, vocals; rhythm, strings, and vocal accompaniment. *I'll Still Love You; Where Do I Put Her Memory; Coming Apart*; seven more. [Jimmy Bowen, prod.] BUDDAH BDS 5608, \$6.98.

More than two hundred versions of the songs of Jim Weatherly have been done by the nation's top recording artists. This creator of country-flavored tunes is obviously a man whose song-writing talents are respected.

Yes, Weatherly has had his hits. And some of them have been monster-sized. Gladys Knight and the Pips, for example, adding a heavy dose of soul-funk to the down-home Weatherly songbook, materialized three of them: "Midnight Train to Georgia," "Neither One of Us (Wants to Be the First to Say Good-bye)," and "Best Thing That Ever Happened to Me."

After these super-successes, it was inevitable that Weatherly would cut his own album. Simply titled "The Songs of Jim Weatherly," it is a disciplined, classily and sparingly arranged LP, designed to present him as both an attractive country singer and a songwriter of distinctive abilities. The result is engaging but not enthralling. These country-style love songs are reassuring and sentimental, and they are skillfully crafted. They cry out, however, for a dramatic vocal approach. It's obvious now why they are given to soul singers. Lack of restraint is the one thing they do need. Every cut on this disk has the potential to be a hit. Weatherly, however, may be too spare an artist to be his own hit-maker. H.E.

* **VINTAGE BOB AND RAY.** Performed by Bob Elliott and Ray Goulding. *Wally Ballou Visits a Glass Fruit Factory; Mister Science: How Gas Refrigeration Works; Aunt Penny's Sunlit Kitchen; One Fella's Family: Bringing Out the New Garbage*; sixteen more. [Robert F. Commagere, prod.] GENESIS GS 1047, \$5.98 (mono).

* **DAVID STEINBERG:** Booga! Booga! Performed by David Steinberg. *Take My Wife, Please; Thirty-Three Revisited; Remember Pat Boone; Prejudice*; six more. [Michael Brandman, prod.] COLUMBIA KC 32563, \$5.98. Tape: ● CA 32563, \$6.98.

"All laughter is merely a compensatory reflex to take the place of sneezing. . . . We sneeze because we are thwarted, discouraged, or devil-may-care. Failing a sneeze, we laugh, *faute de mieux*. Analyze any funny story or comic situation at which we 'laugh,' and it will be seen that this theory is correct. Incidentally, by

the time you have the 'humor' analyzed, it will be found that the necessity for laughing has been relieved."

Thus the great Robert Benchley in "Why We Laugh—or Do We?," the most concentrated of his many one-sided tilts with the humorologists. ("Why We Laugh" is included in the posthumously collected *Benchley Round-up*. This is perhaps the place to note that the paltry amount of Benchley now in print is a major scandal.) With Benchley enmeshed in the consciousness, it is utter folly to analyze humor, and yet the temptation proves irresistible. Probably I should merely say that both these records are wonderfully funny and leave it at that.

Genesis' Bob and Ray album is a generous (more than an hour) sampling of their radio material from the Fifties and Sixties, two sides of soft-spoken, wild brilliance. Genesis president Robert Commagere, appalled that the only Bob and Ray record in print is the album of their recent two-man Broadway show, *The Two and Only* (Columbia S 30412), decided to do something about it. From the enormous amount of taped radio material, this disc and a forthcoming sequel, "More Vintage Bob and Ray," were put together, with the stars' blessing (this is *not* a pirate record). There is also talk of making a new record.

Perhaps the time is right for a Bob and Ray boom. They're now firmly ensconced in their highly successful four-hours-daily "Radio New York" show for New York's WOR. Last year, as a matter of fact, was a big one for them, what with the new show, Wally Ballou's unsuccessful but heroic race for the mayoralty, and a *New Yorker* profile.

Why all the fuss? Well, either you're a Bob and Ray devotee, in which case no explanation is needed, or you're not, in which case we have nothing to talk about.

In the early radio years of their long partnership, they developed an uncanny sense of composity-shattering whimsy, both as writers and as performers. While they're fully at home with the most practiced comic technique, exaggeration, they are above all the master practitioners of its opposite, understatement. One of my favorite moments on the Genesis disc is the tearless reunion of a brother and sister who haven't seen each other for seventy years (or sixty-seven, depending on whose version you believe); all Frank can think of to say to Tabetha (pronounced TA-BETH-a) is, "You've changed." Or there is "the very sad and unsuccessful story" of Waycroft U. Fergus, "a complete failure."

Even when the material is red-hot, the delivery remains so unhysterical that they can get away with all sorts of wickedness. *The Two and Only* contains a devastating interview with "the corrupt mayor of Skunk Haven, New Jersey" (Ray), in which the admiring interviewer elicits from his subject the secret of his success. Anyone who wonders about the Nixon army of bright, energetic yes-men will hear part of the answer here.

Most of the routines on the Genesis disc are broadcast parodies. Aunt Jenny, who was sponsored by Crisco, is metamorphosed into Aunt Penny, who does all her cooking and baking with chicken fat ("it's so digestible; it just sits in your stomach like a commemorative half-dollar piece"). "Mister Science" explains the miracle of gas refrigeration to his young friend Sandy, and you won't believe you're hearing right.

Although Bob and Ray can work brilliantly



Stevie Wonder
A flawless and golden moment in music.

on television and stage, they have always been radio-oriented, where their range of voices and characters is unimpeded by mere visual reality. Consequently their material is ideally suited to disc. Given their inexhaustible inventiveness, there can't be enough for me.

What David Steinberg has in common with Bob and Ray is a sharp ear for details of behavior and speech patterns, which are highlighted, twisted, scaled up or down. Steinberg's routines are laced with one-liners, but that isn't what makes them distinctive—it's rather the sustained control of mood and verbal texture. His material relies heavily on elevating dark shadows from the American subconscious into comic archetypes. "I feel that the Doublemint Twins by comparison make Tricia Nixon seem mysterious." "At nineteen, Alexander the Great had conquered Gaul [?] and Mesopotamia, was known clear around the world, and didn't even have to do the Mike Douglas show."

Steinberg deals easily and un-self-consciously with sex, television, politics, pop culture, being Jewish (but not with the familiar New York sensibility; he's from western Canada), growing up. One routine begins with a straight parody of the endless TV nostalgia-record commercials and proceeds to such embellishments as: "Hi, I'm Feodor Mikhailovich Dostoevsky, remember me? *The Idiot?* ..." or, for 1983, "Hi, I'm Richard Nixon, remember me? Remember Agnew? Remember me? Remember paper?"

The record, made at the Cellar Door in Washington, concludes with a version of Steinberg's classic demented-psychiatrist routine, whence the album title. What surprises me is how well this physical and verbal tour de force works without being seen.

Is it possible after all to analyze humor? Père Benchley himself provided five checkpoints for a joke ("besides wanting to make us sneeze"), including: "The joke must be in a language we can understand." "It must be about *something*. You can't just say, 'Here's a good joke' and let it go at that. (You *can*, but don't wait for the laugh.)" "It must begin with

the letter *W*." (This latter, a footnote tells us, is hotly disputed.)

So there.

K.F.



STEVIE WONDER: Fulfillingness' First Finale. Stevie Wonder, vocals, songs, arrangements, drums, keyboards, harmonica, and synthesizers; vocal accompaniment. *Smile Please; It Ain't No Use; Please Don't Go*; seven more. [Stevie Wonder, prod.] TAMLA T6 332S1, \$6.98. Tape: ● T 332T, \$7.98; ●● T 332C, \$7.98.

Stevie Wonder is royalty. Musically he can't do anything wrong at this point. We need only wait to see where he wants to go next. Word has it that he wakes in the morning, reaches for his cassette recorder, and just goes.

Wonder's new album represents an incalculable amount and intensity of work energy. It is the statement of a man totally in touch with his own musical powers and intentions. So total is his concentration that it is also effortless, leading other contributors along easily—people such as Minnie Riperton, the Jackson 5 (for whom Wonder just produced an album), Sneaky Pete, James Jamerson, Michael Sembello, and Reggie McBride.

This is his most romantic album. It is like suddenly finding oneself in an affair with someone who has always been a wonderful platonic friend. Wonder and Elton John are the two hottest personalities in records today. But while John appeals to our restless energies and high volume hungers, sweet Stevie Wonder appeals to our hearts and spirits.

Nothing on this album is left to chance. It is not that every note of music was worked out beforehand, but that each setting is purely structured and harmonically/rhythmically surefooted. Wonder plays drums for himself, doing things that no "drummer" would do but that always feel perfect.

"Smile Please" has an irresistible vocal chorus (Jim Gilstrap, Denise Williams). "You Haven't Done Nothin'" is the first single release from the set and is a timely statement about Nixon, whom you may remember in connection with Watergate. The song makes purely perfect use of the Jackson 5 as background singers. "Please Don't Go" has such an energy level that it nearly soars off the turntable.

It is with sweetest pleasure that I say to you that, as far as I'm concerned, this is a flawless and golden moment in music, and its existence makes it possible for me to put up with a lot more jive than I could otherwise. Thank you, Stevie Wonder.

M.A.



MARVIN GAYE: Live! Marvin Gaye, vocals; Ed Green, James Jamerson, David T. Walker, Ray Parker, Joe Sample, John Arnold, and Joe Clayton, rhythm; strings, horns, and vocal accompaniment; Gene Page and Lesley Drayton, cond. *Trouble Man; Distant Lover; How Sweet It Is*; ten more [E. G. Abner, exec. prod.] TAMLA T6 333S1, \$6.98. Tape: ● T 333T, \$7.98; ●● T 333C, \$7.98.

Marvin Gaye is one of the great veterans of American musical wars. He has been around long enough to have been Negro and colored and you name it, and now he is black.

In a quandary about quad?

KENWOOD gets it together for you with two new 4-channel receivers that feature built-in SQ, RM, and CD-4

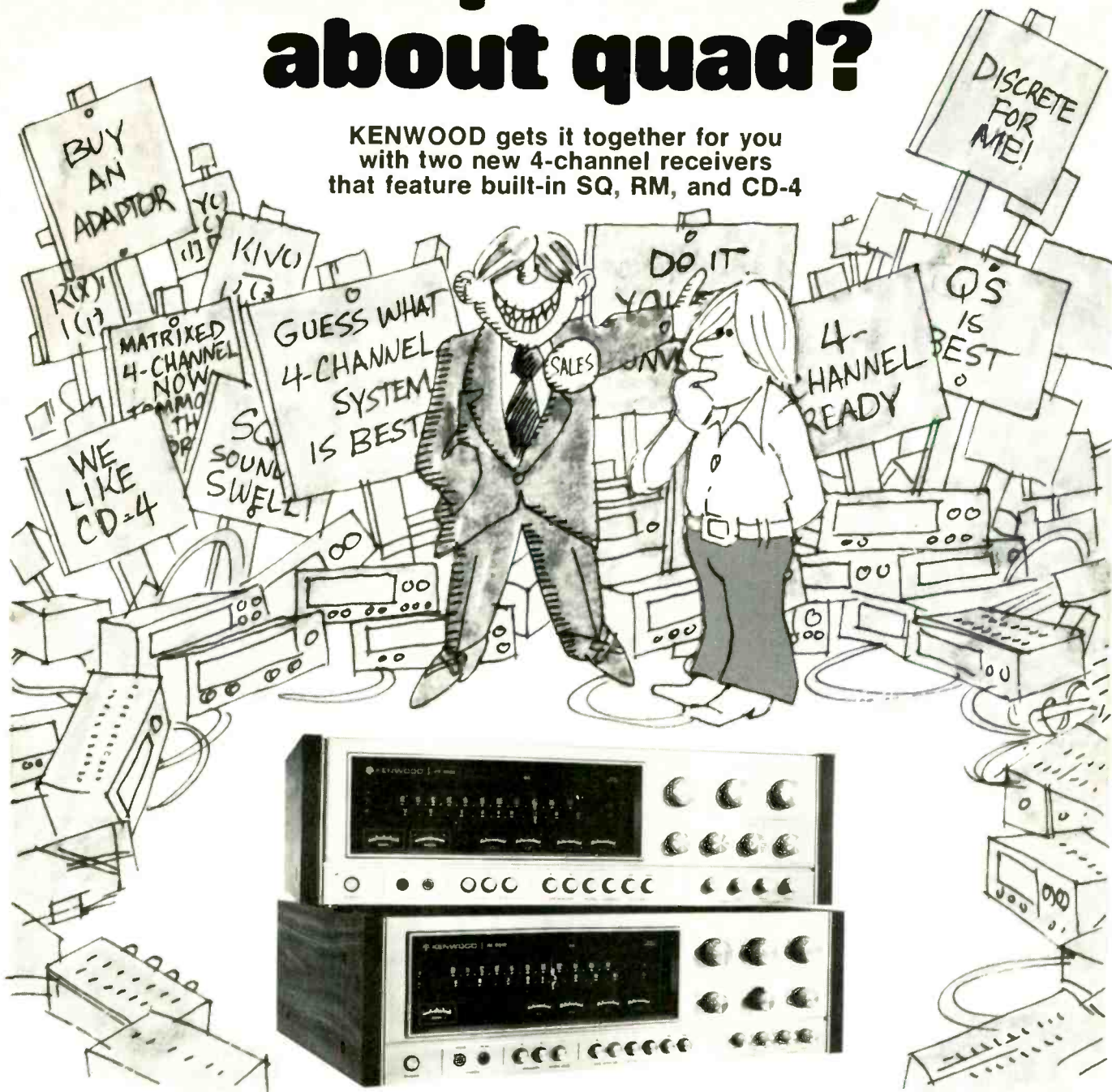

If conflicting claims and conflicting names for 4-channel reproduction have your mind in a whirl, KENWOOD takes the worry out of 4-channel buying with two new luxury receivers that let you explore every 4-channel program source and enjoy the best from all.

Consider the built-in CD-4 decoder/demodulator, for example. It recovers the four separate signals of CD-4 discrete discs with extreme accuracy and an exceptionally high order of separation — as high as 25 dB between front and rear signals, 50 dB between left and right channels.

With comparable excellence the built-in SQ decoder incorporates full logic and variable blend circuitry. Esoteric-sounding, to be sure, but delivering definitive spatial localization of all signals contained in the SQ disc, from center front and back to the four corners of your listening room.

For optimum flexibility, a Regular Matrix decoder, too, is incorporated into each unit's sophisticated engineering, to handle all other matrixed sources or to synthesize 4-channel sound from existing 2-channel sources.

What more could you want? How about a dual 4-channel tape system with a unique 'tape-through' circuit! Or the fully responsive controls that adjust 4-channel balance, tone and volume precisely for optimum quality.

In every aspect of design, the KENWOOD KR-9940 and KR-8840 are masterpieces of 4-channel engineering. The only significant difference between them: Power. The KR-9940 boasts 50 watts per channel (x4), Minimum RMS at 8 ohms from 20-20k Hz, at 0.5% total harmonic distortion; the KR-8840, 40 watts per channel (x4), Minimum RMS at 8 ohms from 20-20k Hz, at 0.8% THD.

For complete information, visit your nearest KENWOOD Dealer, or write . . .



KENWOOD

15777 S. Broadway, Gardena, CA 90248 • 72-02 Fifty-First Avenue, Woodside, N.Y. 11377

CIRCLE 34 ON READER-SERVICE CARD

DISCOUNTS
WASH. D.C.
HAS NO FAIR
TRADE
LAWS!

ON
STEREO
COMPONENTS

PLEASE REQUEST
 Prices for your choice of
 Changers, Receivers, Tape
 Recorders, Speakers, etc.

PROMPT DELIVERY
 IN FACTORY
 SEALED
 CARTONS.

DISTRICT
SOUND INC.
 2316 Rhode Island Ave. N.E.
 Washington, D.C. 20018
 202-832-1900

CIRCLE 19 ON READER-SERVICE CARD

Caprice

records from Sweden

Swedish modernists, classical music, electronic music, jazz, folk music, exotic music. Excellent recordings, highest musical and technical quality, beautiful sleeves with extensive documentary commentary in English and other languages.

To Caprice records,
 Rikskonserten,
 Box 1225,
 S-111 82 Stockholm,
 Sweden



Send free catalogue and list of Caprice dealers in the United States.

Name

Address

State

Zip code

CIRCLE 13 ON READER-SERVICE CARD

Through it all, the main thing he got was better—and he started out stronger than most of the competition. I recently saw on television a ten-year-old clip of Gaye doing the same thing he does today and being generally ignored for it. Ahead of his time, as the saying goes.

Marvin Gaye is not a shouter, though he surely has the power. He chose a subtler, slower method of expression on the open market. Never has his choice paid off more triumphantly than in this live album, which has already jumped to No. 20 with a bullet in the charts. (He has three albums in the Top 200 simultaneously.)

The audience goes wild between and during tracks on this set, but, instead of being irritating to hear at home, it is energizing. We all participate as Gaye and his audience pass joy back and forth. He is at the top of his form; I've never heard him anywhere else.

The most touching aspect of things is that they nearly didn't happen. Gaye has not performed much for several years, though he remained active on records. The reason is too simple to stand: He's shy. The man who looks like he could whip the Green Bay Packers in line can't handle the idea that he might fail with an audience. He'd rather retreat than take the chance. But all artists are subject to the whims of their own sense of drive, however fragile. Evidently it was time for Gaye to face the arena, panic or not. With that in mind, the adoring audience reaction is doubly human and things couldn't have been warmer.

Gaye includes one blockbuster after another: "Trouble Man," "Inner City Blues."

"How Sweet It Is," "Let's Get It On," and "What's Going On." The musical setting of many of the songs is the same both chordally and rhythmically. But the groove is so infectious and the harmonics so pure that I'd hate to hear anything else.

Musical supervisor Gene Page is a superb conductor/director, and he keeps Gaye fully supported throughout, as does the brilliantly appropriate rhythm section. This may be the most satisfying live album I've ever heard.

M.A.

theater and film

* **THE GOLDEN VOYAGE OF SINBAD.** Original film soundtrack recording. Composed by Miklós Rózsa. Rome Symphony Orchestra, Miklós Rózsa, cond. UNITED ARTISTS UA-LA 308G, \$6.98.

There is much to be happy about here. Miklós Rózsa has not written a completely new film score since *The Power* (1968). *The Private Life of Sherlock Holmes* (1970) being based largely on the composer's splendid violin concerto. And no new Rózsa film music has appeared on disc since *The VIPs* (1963), even though releases were apparently scheduled and then dropped for the Sherlock Holmes film, which did contain some new music, and, pardon the expression, *The Green Berets* (1968).

Listening to this record is like renewing the acquaintance of an old friend. You discover that he is wearing the same styles he has worn for twenty, thirty, even forty years; but this particular friend has kept his clothing in such impeccable shape, has such an interesting wardrobe, and wears it all with such flair that you could not imagine him in any other garb. It is simply amazing how much Rózsa continues to sound like Rózsa.

Few composers, for instance, could write a title theme with quite the exotic romance and sweep that hits you immediately in the prelude, which sounds ever so much like a theme from Rózsa's *Sodom and Gomorrah* score. The theme itself is good enough; but what really gives it movement and life are the various instrumental overlappings and filigrees that pervade every Rózsa score. Similarly, he proves masterful in creating diverse moods of suspense, excitement, and grotesquerie, the latter being particularly characteristic of the "Centaur and Gryphon" cut, with its bass tubas.

Granted, much of the film music Rózsa has written over almost the last forty years can be felt, in one form or another, throughout the twenty cuts on this disc, which runs almost fifty-five minutes. I was particularly struck by the *Spellbound* overtones in the "Dream" and "Koura's Pursuit" sequences (Rózsa even uses an electronic instrument, not identified in the liner notes, which may be an ondes martenot or perhaps a Moog synthesizer; but the effect is very much that of the theremin he has used to good effect in several scores, including *Spellbound*). Yet for all the parallels, the score rarely actually duplicates previous material, and the listener can basically sit back and delight in the new contours taken on by a familiar style.

NO FAIR TRADE LAW IN WASH., D.C.!

Fair Trade Laws prohibit discounts on famous brand components.

If you live in a Fair Trade State (such as NY, NJ, PA, Mass., Conn., VA, MD, Ill., Ohio, Fla., Mich., etc.) . . . you can shop by mail and save a lot of money on top name brand audio components in factory-sealed cartons.

Receivers Speakers Turntables Tape Recorders Cartridges Amplifiers Compacts.

Write for our discount prices . . . lowest in U.S.! . . . on any nationally advertised brand name component or audio system plus our authoritative and informative Audio Buying Guide "Sound Investment." Same-day action on quotation requests.

Sheraton Electronics

Mail Order Division • 930 9th St. N.W.
 Washington, D.C. 20001
 Tel.: (202) 737-2597

CIRCLE 76 ON READER-SERVICE CARD

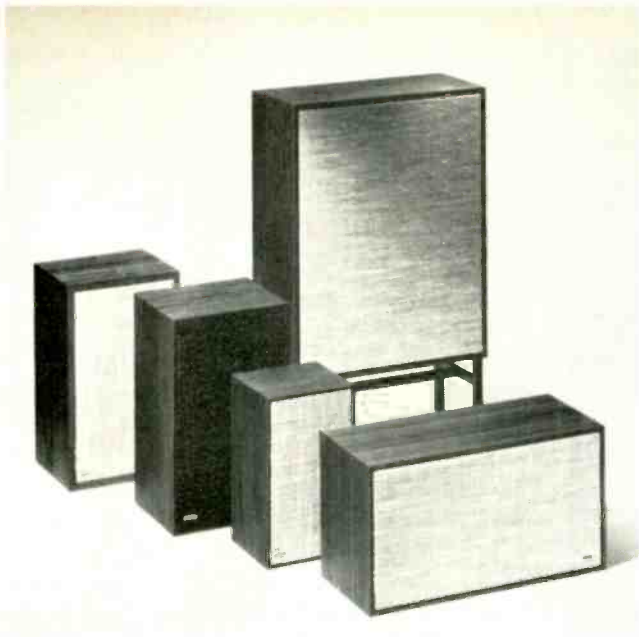

You can expect sound value from **dynaco**



If the *quality* of your music system is important to you, please critically listen to and examine Dynaco components. We'll help by sending you factual specifications and detailed information, plus impartial published test reports on request. And our Customer Service Department is available by mail or phone.

You'll find Dynaco speakers, amplifiers and tuners properly demonstrated by the dealer who cares. The one who does care—about you as a happy customer, and about

good music for the joy of it—is worth your full attention. He doesn't make a mint on Dynaco, so he'll sell it only if you insist on it, or if he's as enthusiastic about good sound as we are.

We build hi fi products we believe in—and the sheer power of their performance has pushed many of them to the top in sales. But the value implicit in making them sound better, longer, is what turns us (and hopefully you) on.

You save even more when you build Dynakits. They're far easier than most, even for begin-

ners. Just look inside one at your dealer's. And our reputation has been achieved on the consistency with which home-built Dynakits meet or exceed the same specs we publish for our assembled units.

Whether you are looking for the best super-amp, the Stereo 400; or the leading stereo/quad amplifier, the SCA-80Q; or for the most chosen speaker in the world, the A-25; STOP, LOOK and LISTEN. You'll see why Dynaco is **INCREDIBLE**.

dynaco

Division Tyco Laboratories

Box 88, Blackwood, N.J. 08012

Also available in Canada from Dynaco of Canada Ltd.

Please send complete test reports and full specifications on all Dynaco amplifiers, tuners and loudspeaker systems.

Name _____

Address _____

City _____ State _____ Zip _____

BIG DISCOUNTS

STEREO COMPONENTS

Largest selection of top name brands...try us and see...

It's worth a call
(301) 488-9600



6330 Frankford Ave.
Baltimore, Md. 21206

All mail answered within 24 hours

Phone Daily 9 AM to 9 PM
Saturday 9 AM to 4 PM
Phone (301) 488-9600

CIRCLE 75 ON READER-SERVICE CARD

HUGE SAVINGS ON FAMOUS BRAND STEREO COMPONENTS

DISCOUNTS

ON NATIONALLY ADVERTISED

TURNABLES • CARTRIDGES

COMPACTS • RECEIVERS

AMPLIFIERS • TAPE RECORDERS

Wholesale Prices! Audio Warehouse Sales, one of the Capitol's largest stereo wholesalers will fill and deliver all your mail orders promptly in factory sealed cartons, at prices that will amaze you.

Write for quote on Famous Brand, Stereo Components.
We guarantee satisfaction.

AUDIO
WAREHOUSE SALES
3310 NEW YORK AVE. N.E.
WASHINGTON, D.C. 20002
(202) 832-1616

CIRCLE 5 ON READER-SERVICE CARD

Only one or two things distract from this delight. I have heard many amateur groups that play with more accuracy and gusto than the Rome Symphony Orchestra, which on occasion, especially in the prelude, sounds suspiciously like a five-piece band. And no effort seems to have been made to counteract at least partially the orchestra's shortcomings by beefing up the sound, which instead is appallingly tubby at times, again particularly in the prelude. But after the initial shock of the latter, things seem to get better, for one reason or another (although the stereo channels have been reversed from one side to the other), and for the most part the entire project is one that film music buffs should be most grateful for. R.S.B.

THE LORDS OF FLATBUSH. Original film soundtrack recording. Music composed, arranged, and conducted by Joe Brooks. *You and Me (Montage); Rock & Roll Music; Oh What a Night for Love*; seven more. [Joe Brooks, prod.] ABC ABCD 828, \$6.98.

The music on the soundtrack from this latest film lionizing the 1950s—which to me is like lionizing a bad case of athlete's foot—is new music written to sound like old music. There is a lack of feeling inherent in such a process. Thus this sounds a bit like Lawrence Welk demonstrating rock and roll.

In short, a waste of time. With all the authentic rock and roll tunes ready for revival, I see no good artistic reason for writing new ones. M.J.

SAVE THE CHILDREN. Film soundtrack. Cannonball Adderley, Jerry Butler, Sammy Davis Jr., Roberta Flack, Marvin Gaye, Jackson Five, Quincy Jones, Gladys Knight and the Pips, Main Ingredient, Curtis Mayfield, Temptations, Bill Withers, and other performers; Iris Gordy and Mark Davis, coordinating and editing supervision. [E. G. Abner, exec. prod.] Motown M 800R2, \$6.98 (two discs). Tape: ♫ M 800T, \$7.98; ♫ M 800C, \$7.98.

This highly emotional album was inspired by the Rev. Jesse Jackson, leader of Operation Push headquartered in Chicago. He was deeply involved with the work of Dr. Martin Luther King and later with that of the Rev. Ralph Abernathy. Later Jackson organized Operation Push and emerged as a natural leader of the movement toward black pride and effectiveness. It is impossible to be unmoved when hearing him say, "I Am Somebody, I may be poor, but I am somebody. I am God's child..."

Jackson's power as a human being was, I believe, the mobilizing factor in organizing this project called "Save the Children." It was performed in Chicago in 1973 at the Black Exposition sponsored by Operation Push. The best black talent in the country came to keep the faith, and the emotionalism ran high, all of it focused on a universal urge. As Dick Gregory put it: "All my life America has always taught me to raise the children and save America, and now we talkin' about raising America and saving the children."

Even if you ignore all that, you still have a highly entertaining album, and Motown is to be praised for that. Among the most stirring moments are Marvin Gaye singing "Save the Children," Cannonball Adderley's "Country

Preacher" (dedicated to Jackson), Bill Withers' "Lean on Me," and the Rev. James Cleaveland's work with the Push Expo Choir. As a listening experience, the best is at the first, but even then there is enough to hold throughout.

I don't know who gets what royalties from what aspects of this multibranching project, but we can hope a lot of it goes to Jesse Jackson and his people in Chicago. If anyone can help to save the babies, it is these people. M.A.

jazz

* **LESTER YOUNG: Jammin' with Lester.** Lester Young, Illinois Jacquet, and Coleman Hawkins, tenor saxophones; Harry Edison, Buck Clayton, and Joe Guy, trumpets; Dicky Wells, trombone; Marlowe Morris and Ken Kersey, pianos; Barney Kessel, guitar; Red Callender, John Simmons, and Al McKibbon, basses; Sid Catlett, Jo Jones, and J. C. Heard, drums; Marie Bryant, vocals. *Blues for Marvin; Tea for Two; Oh, Lady Be Good*; six more. JAZZ ARCHIVES 18, \$5.98 (mono).

* **COUNT BASIE AND HIS ORCHESTRA: The Count at the Chatterbox.** Joe Keys, Tatti Smith, and Buck Clayton, trumpets; Dan Minor and George Hunt, trombones; Lester Young, Herschel Evans, Caughey Roberts, and Jack Washington, saxophones; Count Basie, piano; Claude Williams, guitar and violin; Walter Page, bass; Jo Jones, drums; James Rushing, vocals. *Shoe Shine Swing; St. Louis Blues; Swinging at the Daisy Chain*; nine more. JAZZ ARCHIVES 16, \$5.98 (mono).

(Both available from Jazz Archives Recordings, Box 194, Plainview, N.Y. 11803.)

Both of these discs are bonanzas for Lester Young fans, but the appearance of Jazz Archives 18 is a particularly notable event.

One side is devoted to the music from one of the most celebrated jazz films ever made: Gjon Mili's *Jammin' the Blues*. It comprises not only the music heard in the film, but also several numbers recorded for the film but not used. Two of these unused pieces—"One Hour" and "Sweet Georgia Brown"—include some delightful Young solos as well as provocatively personal appearances by Dicky Wells, Harry Edison, and Big Sid Catlett. There is more top-drawer Young and Edison on "Midnight Symphony" and "Jammin' the Blues," both part of the final film track.

Illinois Jacquet turns up on a couple of occasions, practicing that development of a driving tenor saxophone figure from full-bodied roar to plaintive shriek that was to become his trademark with Jazz at the Philharmonic, and Marlowe Morris plays pleasant, sub-Basie piano. But young Barney Kessel is out of his depth in this company, bumbling through his solos in routine fashion.

The other side is highlighted by a superb treatment of "I Can't Get Started," recorded in 1946 by a group that included Young, Buck Clayton, and Coleman Hawkins, all respond-



buy a **Scott original**

Maybe you hadn't thought of it, but when you buy a Scott audio component, you buy an original, not a copy. Scott originated many of the standard features of today's stereo systems during its past quarter century of innovation in high fidelity. The first stereo amplifier, the first stereo multiplex FM tuner, the first successful solid state receiver, the first FET transistor front end, the first high fidelity components to make use of integrated circuits, the first complementary power output stage, the first four-channel amplifier, the first digital FM tuner and many other developments were introduced by Scott, only to be copied later by others. Many of the brand names widely advertised today weren't even around when Scott introduced the first stereo components commercially in 1958.

When your plans call for the purchase of a high quality receiver, tuner, amplifier or pair of speakers, don't settle for a copy. Buy a Scott original. It costs no more. See your Scott dealer today for a demonstration of the Scott originals. Or circle reader service number for complete product information and list of demonstrating Scott dealers in your area.

W SCOTT[®]
where innovation is a tradition
H.H. Scott, Inc., 111 Powdermill Road, Maynard, Mass. 01754
CIRCLE 55 ON READER-SERVICE CARD



SAVE MONEY NOW!! As one of America's largest wholesale distributors, our buying volume has kept our prices the lowest. We pass the savings on to you.



TERRIFIC... Equipment at terrific prices. We carry over 60 major brands, all factory sealed cartons, fully warranted, shipped from our warehouse fully insured.



OUTSTANDING VALUE... We are proud of the fact that we offer the best value anywhere in this industry.



PRICES... Ours are the lowest of the low. Write us now for a lowest of the low quote.

OVERPAYING FOR AUDIO EQUIP.

Write us today — or better yet come down and see for yourself. "We're taking the High Price out of Hi-Fi"

STEREO CORPORATION OF AMERICA

Dept. H-F — 2122 Utica Ave.
Brooklyn, N.Y. 11234
Tel. (212) 338-0263

In L.I. 1180 HEMPSTEAD TPK., UNIONDALE

CIRCLE 61 ON READER-SERVICE CARD



SAVE ON Brand Name Audio Components BY MAIL

Write Today for Our FREE Wholesale Audio Catalog

DIXIE, one of the largest stereo wholesalers fills your orders at prices actually LOWER than "Discounters." See our exciting Wholesale Price Catalog or write for quotes. Choose the famous brand stereo equipment and accessories you desire. Everything shipped factory sealed.



DIXIE HI-FI WHOLESALE

5600 Second St., N. E., Washington, D. C. 20011
Phone: 1-202-635-4900

Please rush me your FREE Wholesale Audio Catalog and complete information. I understand there is no obligation.

Please Check Your Music Preference: (1 only)
 Rock Classical Country

Name _____
Address _____
City _____
State _____ Zip _____ HF-11

ing brilliantly to the inspirational juxtaposition of each other.

The Basic set is made up of air shots from the William Penn Hotel in Pittsburgh in 1937, when the band was in the first months of its existence. Basie's piano was carrying the band much of the way then, with more emphasis on his stride origins than on the sparse shorthand style he developed later. Young and occasionally Herschel Evans were the principal soloists along with Basie, so they appear on almost every number. Evans' big, warm tone is a provocative contrast to Young's light but insistent lines—lines that seem to float even when they are charged with tension.

Fletcher Henderson was helping out the chart-poor Basie band at this time by lending arrangements, and it is interesting to hear the Basie version of such Henderson specialties as "King Porter Stomp," "Rug Cutter's Swing," and "Deep Henderson" (disguised here as "Tattersfield Stomp").

The sound is generally good by 1930s broadcast standards although two or three tracks, buried at the end of each side, are rough by any standard. J.S.W.

CHARLIE PARKER: The Complete Dial Recordings. For a feature review of these recordings, see page 95.



ANITA O'DAY: Hi Ho Trailus Boot Whip. Anita O'Day, vocals; orchestras led by Alvy West, Will Bradley, Ralph Burns, and Benny Carter. *Sometimes I'm Happy; How High the Moon; Key Largo*; seven more. BOB THIELE MUSIC BBM 1-0595, \$6.98 (mono) [recorded 1947-48].

These records, made in 1947 and 1948 for Bob Thiele's Signature label, were Anita O'Day's first recordings on her own. She had by then established both her reputation and her influential style through her work with the bands of Gene Krupa and Stan Kenton. None of this work, however, prepared listeners for her debut recording as a single: "Ace in the Hole," an old saloon song done with period color at the opening and close. Miss O'Day added to the period flavor by singing the verse with a suggestion of an old-time saloon singer who had become surprisingly hip and then shifting in the chorus to a swinging attack. It was a revealing indication of what she could do away from the confining tempos imposed on a band singer.

This recording managed to be both a successful novelty and a successful jazz record. But the best of her work during these sessions (all are collected on this disc) reflected her qualities as a band singer—her wordless vocalizing on "Malaguena" and in parts of "What Is This Thing Called Love" (a beautiful showcase for her urgent phrasing), her haunting sound on Benny Carter's "Key Largo," and the explosive "How High the Moon," which for many years was her trademark.

Her skill on a ballad—and a relatively indifferent ballad, at that—comes out on "It's Different When It Happens to You" as she twists her way through the melody, providing little lifts and turns that give it momentum. And "Hi Ho Trailus Boot Whip" challenges the virtuosity of her husky voice as she alternately lingers over the hip lyrics and rushes through

them at a breakneck pace. She has to contend with some dull tunes and dull arrangements, but over-all it is a vital and significant collection, comparable on its own terms to the small group of recordings that formed the foundation of Billie Holiday's success. J.S.W.



DICK WELLSTOOD AND HIS FAMOUS ORCHESTRA: Featuring Kenny Davern. Kenny Davern, soprano saxophone; Dick Wellstood, piano. *Wild Man Blues; Smiles; Sweet Substitute*; seven more. CHIAROSCURO 129, \$6.98.

One of the most encouraging aspects of jazz in the past year or so is the fact that musicians such as Dick Wellstood and Kenny Davern have been coming out of hiding and finding warmly welcoming audiences.

For years Wellstood and Davern worked in obscure, unlikely places on the New Jersey shore, perfecting a repertoire and a relationship that have resulted in this practically flawless record. A key to their performances is a mutual sense of irreverence, which is indicated by the title of this disc: "Dick Wellstood and His Famous Orchestra [or, according to the back of the sleeve, "His All Star Orchestra"] featuring Kenny Davern." This awesome and nominally trite billing covers an "orchestra" consisting entirely of Wellstood and Davern, a twosome that sometimes actually sounds like an entire orchestra.

On soprano saxophone, Davern has the richness, the sweep, and the scope associated with Sidney Bechet, but he manages to project all this without resorting to Bechet's highly personal phrasing.

Wellstood is a pianist with a roving ear who obviously plays for the joy of it whether he is into rags, piano novelties, the blues, or pop tunes. He can play Jelly Roll Morton tunes (there are three here) without feeling that he has to bow to Jelly's style. He finds an unlikely piano rag in a Cole Porter show tune, "So in Love." And he combines with Davern in taking Duke Ellington's "Jubilee Stomp" at such a furious pace that they have retitled it, appropriately, "Fast as a Bastard."

On the surface, a piano-and-soprano saxophone duo might seem somewhat limited. But when the duo is made up of musical personalities as forceful and inventive as Wellstood and Davern, there seems to be no limit to the possibilities. J.S.W.

JIMMIE LUNCEFORD AND HIS BAND/BENNY CARTER AND HIS BAND: Big Band Battle—Live! Freddy Webster and Russell Green, trumpets; Trummy Young, trombone; Joe Thomas, tenor saxophone; Eddie Wilcox, piano; et al. *Little John; Minor Riff; Mandy*; three more. Benny Carter, alto saxophone and trumpet; Candy Ross, trombone; Bumps Myers, tenor saxophone; Sonny White, piano; et al. *Cuttin' Time; The Early Bird; Bugle Call Rag*; three more. EXTREME RARITIES 1007, \$5.50 (mono).

GLEN GRAY AND THE CASA LOMA ORCHESTRA: On the Air—1934. Grady Watts, Bobby Jones, and Sonny Dunham, trumpets; Pee Wee Hunt and Bill Rauch, trombones; Glen Gray, Clarence Hutchenrider, Pat Davis, and Kenny Sargent, saxophones; Joe Hall, piano; Gene Gifford, guitar; Stanley Dennis, bass;

Tony Briglia, drums. *Maniac's Ball; Black Jazz; Wolverine Blues*; thirteen more. EXTREME RARITIES 1005, \$5.50 (mono). (Both available from Ken Crawford Jr., 215 Steuben Ave., Pittsburgh, Pa. 15205.)

The Jimmie Lunceford and Benny Carter bands heard on Extreme Rarities 1007 are both of mid-Forties vintage, close to the end of the road for each. (Lunceford died in 1947, and Carter disappeared into the film studios at about the same time.)

The Lunceford band is solid and crisp, apparently on the way to recovering from the letdown it suffered during the war. It is interesting to hear how close its sound was getting to that of Stan Kenton, who had been trying to get a Lunceford sound a few years earlier. The Carter band, like all Carter bands, is immaculate—polished, professional, and swinging, with Carter showing his virtuosity on both alto and trumpet.

These so-called "live" recordings include a hyped-up announcer whose presence makes them sound like broadcasts, although there is no indication on the liner that this is so. The Glen Gray set "On the Air—1934" is played against such a blank and silent background that it sounds like a studio recording. The performances also have the rather sterile feeling of studio work. The only piece that generates the drive that the Casa Loma Band could achieve on the bandstand is "Ol' Man River." J.S.W.

* **MARY LOU WILLIAMS:** Zoning. Mary Lou Williams and Zita Carno, pianos; Bob Cranshaw and Milton Suggs, basses; Mickey Roker, drums; Tony Waters, conga. *Holy Ghost; Zoning Fungus II; Rosa Mae*; eight more. MARY 103, \$6.35 (Mary Records, Box 32, Hamilton Grange, N.Y. 10031).

Mary Lou Williams has been a unique figure in the jazz world ever since she came to attention more than forty years ago with Andy Kirk's band. Her unique stature came not just from the fact that she was a highly successful woman in a field otherwise almost totally taken over by men, but also from the fact that she was, and continues to be, an innately swinging pianist who moves ahead as the years pass without ever leaving or losing her strong, swinging core. Boogie-woogie, bebop, swing band "killer dillers," religious music—whatever came along, Miss Williams' playing was always firmly rooted in a strong, pulsing attack that simply swept across whatever area she was dealing with.

This new collection, on her own label, is a cross section of her recent work, played in most cases by two trios, although there are a pair of two-piano numbers by Miss Williams and Zita Carno, a pair of piano-bass duets with Bob Cranshaw, and one piano solo. Its common denominator is a joyful, lifting pulse that she uses most effectively with the trio in which Cranshaw is on bass and Mickey Roker is on drums.

Focusing on Cranshaw's strong bass figures, she constructs performances that are full trio efforts rather than piano solos as she weaves reflective passages around the bass line. This is a device that gave Ahmad Jamal some distinction in the 1950s, but Miss Williams colors it with her virtuosity and rock-solid sense of rhythmic style. J.S.W.

LARGE-LARGE DISCOUNTS LOW - LOW PRICES

NATIONALLY ADVERTISED STEREO EQUIPMENT AT LOWEST PRICES!

TURNABLES · SPEAKERS · RECEIVERS
AMPLIFIERS · TAPE RECORDERS

WRITE FOR QUOTE ON
NATIONALLY ADVERTISED BRANDS OF STEREO
COMPONENTS. SATISFACTION
GUARANTEED!

Clifford's

HI-FI WHOLESALERS
231 W. COURT ST.
Kankakee, Illinois 60901
(815)-939-7868

CIRCLE 14 ON READER-SERVICE CARD

SAVE!

MONEY • TIME • FREIGHT

QUALITY STEREO EQUIPMENT AT LOWEST PRICES.

YOUR REQUEST FOR QUOTATION RETURNED SAME DAY.

FACTORY SEALED CARTONS—GUARANTEED AND INSURED.

SAVE ON NAME BRANDS LIKE:

| | |
|--------|-------|
| A.D.C. | KLH |
| A.R. | SHURE |
| DYNACO | KOSS |
| FISHER | SONY |

AND MORE THAN 50 OTHERS

BUY THE MODERN WAY
BY MAIL—FROM

illinois audio

Department 217H
12 E. Delaware Place
Chicago, Illinois 60611
312-664-0020

CIRCLE 32 ON READER-SERVICE CARD

R
A
B
S
O
N
S

RELIABILITY . . . Rabsons means reliability. Over 69 years of experience.

AUDIO SPECIALISTS . . . Our staff at Rabsons are all knowledgeable audio specialists. Personal service has been a byword for over 69 years.

BEST PRICES! . . . Our prices are really wholesale, actually lower than discount. Requests for quotes are immediately given.

SATISFACTION . . . Is guaranteed. All merchandise brand new in factory sealed cartons, shipped double-packed, fully insured from our warehouse.

OUTSTANDING VALUE . . . As one of America's largest mail order houses we pass our volume and buying power along to you.

NATIONALLY ADVERTISED BRANDS . . . We carry over 60 brands.

SAVE MONEY NOW! Write us now or even better, come down and see for yourself . . .

RABSONS

119 W. 57 ST.
N.Y.C., N.Y. 10019
Tel. (212) 338-2268

69 years

CIRCLE 48 ON READER-SERVICE CARD

NOVA AUDIO

The Brightest Super Star
In Stereo Today

At Last!

- MAIL ORDER — Plus —
- SERVICE — Plus —
- FINANCING — Plus —
- TOP MAJOR BRANDS

Nationwide Financing

Also Bank Americard & Mastercharge

We carry all the Fair Trade Brands
Whenever Possible these makes are quoted 'In Systems'

We quote on ALL Major Brands

Large complete inventory on everything we sell

We provide our own
Factory Authorized Service on everything we sell

YOU CAN TRUST US!

Write for our price and quotations on complete systems or individual items. Whatever your needs, we'll fill them and SAVE you money, time and worry!

Box 542, 2940 A Prosperity Ave.
Fairfax, VA 22030
(703) 280-4500

CIRCLE 46 ON READER-SERVICE CARD

HIGH FIDELITY CLASSIFIED

130 East 59th St., New York, N.Y. 10022
Phone: (212) 581-7777

CLASSIFIED RATES: 1-time \$1.20 per word per issue, minimum \$12. 6 consecutive issues—\$1.10 per word per issue. 12 consecutive issues—\$1.00 per word per issue. Words in caps—10¢ extra each. Box Numbers: \$1.00 additional per insertion to cover cost of handling and forwarding mail. Count 10 extra words for box number and address. DISPLAY CLASSIFIED AND DISCOUNTS: 1 inch by 1 column—\$200. 2 inch by 1 column—\$400. 3 inch by 1 column—\$600. 5% discount 6 consecutive issues. 10% discount 12 consecutive issues. Deadline is two months prior to publication date. Full payment must accompany All copy for classified ads.

for sale

AR, KLH, ADVENT, DYNACO, RECTILINEAR, ADC OWNERS—Our electronic equalizer gives your speakers full octave of new bass, plus three broadband tone controls. Three reviews, literature from NORMAN LABORATORIES, 2280 Industrial Boulevard, Norman, Oklahoma 73069.

RARE ROMANTIC PIANO SCORES—Moscheles, Henselt, Herz, Liszt, Scharwenka, Scriabin, etc. Free catalog. MUSIC TREASURE PUBLICATIONS, 620 Ft. Washington Ave., 1-F, New York, N.Y. 10040.

BUILD YOUR OWN SPEAKERS AND SAVE UP TO 50%. You can assemble your own high quality, multi-element stereo speakers in a few hours and save up to half the cost of comparable speakers. Send for our free 32-page catalog of speaker kits, raw speakers and accessories. SPEAKERLAB, Dept. HF2, 5500-35th N.E., Seattle, WA 98105.

NOW AVAILABLE... FAMOUS REFLECTING SYSTEM'S 4 1/4" REPLACEMENT DRIVERS, \$7.98 POSTPAID. BIG QUANTITY DISCOUNTS. FREE SPECIFICATIONS. AURATONE, BOX-H4, DEL MAR, CALIFORNIA 92014.

DYNAKITS, LOWEST PRICES, SYSTEM QUOTES, Underground HiFi, Rt. 1, Box 177, Arnold, Maryland 21012. (301) 647-0919.

NOSTALGIC OPERA POSTERS, METROPOLITAN, La Scala, Classic First Performances. Free Brochure. Fleeta Arts Inc., Greenvale, N.Y. 11548.

TAPES, RECORDERS, EQUIPMENT, DISCOUNTS. Catalog \$1.00 (refunded—first order). Tower, # 33098, Washington, 20028.

NOTES ON DEMAGNETIZING written for Tape Records. Available on request. Annisco, 1107 N. Delaware, Indianapolis, Indiana 46202.

miscellaneous

DIAMOND NEEDLES and Stereo Cartridges at Discount prices for Shure, Pickering, Stanton, Empire, Grado and ADC. Send for free catalog. All merchandise brand new and factory sealed. LYLE CARTRIDGES, Dept. H, Box 69, Kensington Station, Brooklyn, New York 11218.

HIGH FIDELITY'S TEST REPORTS—Over 175 currently available audio products. Tests, analyses, prices. Send \$2.25, includes 30¢ postage & handling, to High Fidelity's Test Reports, Box HF, 2160 Patterson St., Cincinnati, Ohio 45214.

SLEEP-LEARNING—HYPNOTISM! Strange catalog free. Autosuggestion, Box 24-F, Olympia, Washington 98501.

Protect your records Poly sleeves for jackets 8¢ Roundbottom inner sleeves 6¢ Poly lined paper sleeves 15¢ White jackets 30¢ Postage \$1.00. Record Supply House, Hillburn, New York 10931.

SEARCHING? WRITE DISCONTINUED RECORDS 216 NORTH ROSE, BURBANK, California 91505.

CONGRATULATIONS! YOU ARE NOW READING ONE OF HIGH FIDELITY'S best read pages! Use it yourself when you want to sell equipment, or a service, or want to let the avid music listener know about anything. High Fidelity Classified, 130 East 59th St., N.Y. 10022.

new equipment for sale

DON'T PAY THE HIGH MAIL ORDER PRICES. THIEVES WAREHOUSE OF TAMPA, 1531 SOUTH DALE MABRY, TAMPA, FLORIDA 33609.

DON'T PAY THE HIGH MAIL ORDER PRICES, THIEVES WAREHOUSE IS COMING TO YOUR AREA. FRANCHISES AVAILABLE. THIEVES WAREHOUSE, P.O. BOX 8057, PENSACOLA, FLORIDA 32505.

Listen to TELEVISION IN STEREO



The TE-200 TELEDAPTER EASILY CONNECTS TO ANY TV & STEREO SYSTEM. Using our coupling and matrix circuit, teledapter takes a low impedance output from the television and delivers two HIGH IMPEDANCE CHANNELS OF SIMULATED STEREO, to drive any amplifier. Frequency response is maintained so you can hear the tinkle of bells or booming bass sounds as it happens on TV. With service warranty and hookup instructions \$16.95 ppd. Guaranteed to make your TV 100% more enjoyable.

OUR NEW TE-300 VHF-UHF HI-FI TUNER IS NOW AVAILABLE. A complete and self contained 110 volt tuner. VHF UHF antenna connections. Recording and amp output jacks. Five year service warranty \$149.95 ppd. From our factory.

SEND: CHECK MASTER CHARGE NO. for TE-200 TE-300 or \$5.00 for C.O.D. TO: RHOADES NATIONAL CO. DEPT ST P.O. BOX 817 HENDERSONVILLE, TENNESSEE 37075

NAME _____

ADDRESS _____

CITY _____ STATE _____ ZIP _____

SEND NO. COMPLETE CATALOG

35% to 55% DISCOUNT on Professional Guitars, Amplifiers, P.A. Systems. Free Catalog. Carvin, Escondido, Calif. 92029.

"BUY DIRECT FROM ENGLAND. Save Money! B & O, Cambridge, Decca, Goldring, Gold Speakers, Jordan-Watts, KEF, Leak, Lowther, Ortofon, Revox, Rogers, SME, Tandberg, Transcriptors, Wharfedale. Price and shipping list free or send \$3 bills to include literature airmail. Goodwins, 7 The Broadway, Wood Green, London, N.22. 6DU. Phone 888 0077. Visitors Welcome."

Don't pay the high mail order prices Thieves Warehouse of New Orleans, 3528 18th St., Unit 2, Metairie, LA. 70002.

DON'T PAY THE HIGH MAIL ORDER PRICES. THIEVES WAREHOUSE OF BETHESDA, P.O. BOX 34251, WEST BETHESDA, MD 20034.

AUDIO COMPONENTS at guaranteed lowest prices. Specializing in PIONEER, MARANTZ, SANSUI, DUAL, and SONY. Write for catalog on over 60 brands, including color televisions. DISCOUNT SOUND, P.O. Box 6346, Washington, D.C. 20015.

tapes & records

PERFECTLY CLEAR ® ultra hi-fi record Burwen Laboratories BL-2. The East Bay City Jazz Band—Big Bear Stomp, Oriental Strut, Louis-i-an-i-a, Blues My Naughty Sweetie Gives to Me, Dans Le rue d'Antibes, etc. \$10.50 each postpaid, \$70.00 postpaid in lots of 10. Send check or money order. Massachusetts residents add 3% sales tax. Dealers wanted. Burwen Laboratories, Inc., 209 Middlesex Turnpike, Burlington, Massachusetts 01803 617-273-1488.

OPERA TAPES—DISCS OPEN REEL AND CASSETTES—historical performances of last 40 years—Unbelievable treasure and rarities—ALSO LP RECORDS. Ed Rosen, 66-33 Saunders St., Rego Park, N.Y. 11374.

"HARD TO GET" RECORDS—ALL SPEEDS, RECORD Exchange, 842 Seventh Avenue, New York, N.Y. 10019.

Basf, Memorex, Scotch, TDK, Reels, Cassette, 8-tracks. Lowest Prices. S & S Audio, P.O. Box 523, Skokie, Ill. 60076.

EVERYTHING ON OPEN REEL! Prerecorded classical/popular tapes. Latest releases. Dolby Quad. 96-page catalogue \$1. Barclay-Crocker, Room 857H, 11 Broadway, NYC 10004.

LIVE OPERA, CONCERTO, SYMPHONIC, TAPE BARGAINS, \$3.50—(REELS & CASSETTES), BOX 1101. WOODHAVEN, NEW YORK 11421.

SOUNDTRACKS, Lowest Prices. Catalog: 25 cents. Write: Hi Fi, Box 715, Florissant, MO 63033

FREE Movie Classics Soundtrack Catalog. Wilson, 823 Timberlane, Galion, Ohio 44833.

SOUND TRACK-RECORD-ALBUMS—MAIL AUCTION—FREE LIST—Whalon, 2321-C-Hill, Redondo Beach, Calif. 90278.

RARE OPERA, symphonic music on tape. Historic performances. European, domestic. Free catalogue. Underhill, Bellport, N.Y. 11713.

LIVE OPERA PERFORMANCES ON OPEN REEL TAPES. Incredible performances, 1926-74. Catalog: MR. TAPE, Box 138, Murray Hill Station, N.Y.C. 10016.

Golden Age Radio—your best source for radio tapes. Box 25215-J, Portland, Oregon 97225.

FILM-STAGE SOUNDTRACKS. Large free list. A. Lutsky, Box 557342, Miami, Fla. 33155.

SHOW ALBUMS—Rare, out-of-print LP's, 52-page list 50¢. Broadway/Hollywood Recordings, Georgetown, CT 06829.

1930-1962 RADIO PROGRAMS, REELS, \$1.00 HOUR! CASSETTES, \$2.00 hour! Catalog, \$1.25, AM Treasures, Box 192W, Babylon, N.Y. 11702.

LIVE OPERA tapes. Professional reel, cassette copies. Extensive sound coded catalogue. Quality guaranteed. Also records. A. Fischer, Box 83 Fordham Station, Bronx, N.Y. 10458.

"SOUNDTRACKS, Jazz, Swing LP's—reasonable—free mists—Box 1138-H, Whittier, Calif. 90609.

"SOUNDTRACKS, SHOWS & NOSTALGIA—free catalog & auction list—A-1 Record Finders, P.O. Box 75071-H, L.A., Calif. 90075."

SALE 1,000 JAZZ RECORDS. JAZZ RECORDS, BOX 71, HICKSVILLE, N.Y. 11801.

YESTERDAY LIVES! LPs of great jazz, big bands, radio shows, Broadway, soundtracks. Send 10¢ for catalog to Tulip Records, P.O. Box 3155-H, San Rafael, CA. 94902.

OLD RADIO PROGRAMS ON TAPE AND CASSETTE. Catalogue 50¢. 30 minute sample tape with catalogue \$1.25. Satellite Broadcasting, Box 512, Miami, Florida 33165.

8 TRACK TAPES. 55¢ DIRECTORY MANUFACTURERS. SEND \$3, STAR ENTERPRISES, 35—HFM Woodcrest, Dayton, Ohio 45405.

HIGH FIDELITY Classified Advertising Department
130 East 59th St., New York, N.Y. 10022 Phone: 212-581-7777
Michael Littleford, Classified Advertising Manager

Please run the following classified advertisement in the next available issue.

Name _____
Address _____
City _____ State _____ Zip _____
Telephone _____

RATE: For Regular and Display, see schedule above. *CASH MUST ACCOMPANY ORDER. Closing two months prior to issue.

5000 RECORDS! ALL RARE/OUT-OF-PRINT. Soundtracks, Shows, Personality, Jazz, TV, Comedy, Spoken. MOST COMPLETE LISTING AVAILABLE. 105 page catalog \$2.00; Refundable Check/MO To: Records Revived, P.O. Box 302, San Ramon, CA 94583.

MOVIE SOUND TRACKS LOW prices. Free List. Gerald Tamburino, 646 East 234 St. N.Y., N.Y. 10466.

LP'S FOR COLLECTORS. Everything Except Classical—"Mail Only" Z-Disc, 1419 Jesup Avenue, Bronx 10452.

ROCO AND CANTILENA RECORDS, new release sheets, latest numerical catalogue free, detailed catalogue and supplements \$3. Ross, Box 391824 Miami Beach, Fla. 33139. Enquiries for records handled.

CLASSICAL RADIO RECITALS—Famous conductors, instrumentalists—good acetates or tapes wanted. Communicate availability and conditions of supply. Archivist, School of Music, University of Miami, Coral Gables, Fla. 33124.

OPEN REEL STEREO TAPE BUYERS!

At last! An open reel catalog, including titles, songs, etc. of 95 long play, 1 1/2 hour albums, by American Airlines, Continental Airlines, and Ampex 4 track stereo tapes (includes a group of "sound effects" tapes by Audio Fidelity). Send \$1.00 — and we will also mail you a 140-page Harrison stereo tape catalog — so you'll get both for \$1.00 — and this \$1.00 is refundable on your first \$10.00 purchase of open reel stereo tapes at our 30% discount.



CASSETTE LABELS

PLAIN WHITE CASSETTE LABELS, NORELO CASSETTE CLEANERS, FAMOUS BRAND CASSETTES, METAL OR FIBERGLASS 10" REELS. (SEND FOR TAPE DISCOUNT SHEETS).

| *QUANTITY | 1-9 | 10-99 | 100 | 1000 |
|-------------------------------|------|-----------------------|------|------|
| CASSETTE LABELS (UNITS OF 10) | — | .02 | 0.15 | .01 |
| NORELO CASSETTE CLEANER | .65 | .60 | .55 | .50 |
| CASSETTE MAILER BOXES | .03 | .025 | .022 | .02 |
| SCOTCH CASSETTE SC90-HE | 2.72 | (BUY 2, GET ONE FREE) | | |
| 10" FIBERGLASS REELS, USED | .50 | .50 | .40 | .35 |
| 10" METAL, NEW, UNUSED | 1.00 | 1.00 | .90 | .80 |

*PLUS POSTAGE BY WEIGHT AND ZONE, MINIMUM ORDER, \$5.00

SAXITONE TAPE SALES, 1776 Columbia Road, N.W. Washington, D.C. 20009

DISCONTINUED RECORDS, CLASSICAL, Popular, Jazz, Lists, Steinmetz, One Seaview Avenue, Massapequa, N.Y. 11758.

"RARE" Verdi Opera "JERUSALEM." "Rare Fur-twangler, Kousevitsky, Strauss, Fried, Melba, Coates. Other artists. Records, Tapes or Cassettes \$4.00. European pressings. Write "Legendary Performers Society" Box 77022, San Francisco, CA 94107.

RARE RECORDS FOR DISCRIMINATING collectors. Over 40,000 LP's in stock: Shows, Soundtracks, Popular, Classical, Jazz, Spoken, Comedy. Lists 50¢ refundable. Roundsound West, Box 1053, Del Mar, CA 92014.

NOSTALGIA AND JAZZ COLLECTORS Rare and hard to get LP's. Relive the golden age of radio, vaudeville, variety, music hall, early t.v., and the Big Band era. Pioneers of jazz, blues, ragtime, swing, etc. Also rare & out of print lp's & tapes. Free Catalog. P.D.Q. PROMOTIONS p.o. box 414201, Miami Beach, Fla. 33141.

QUADRAPHONIC RECORDS AND TAPES—All labels, over 800 titles—at discount prices! For your free illustrated copy of the world's most complete quad catalog. Write: SOUND CONCEPTS, 2713 West Radan, Dept. B11, Peoria, Illinois 61604.

wanted to buy

CASH FOR UNWANTED STEREO LPS AND REEL TO REEL TAPES. Reder, 81 Forshay Road, Monsey, New York 10952.

ELECTRO-VOICE PATRICIANS, SELLMAN, LSI. APO SF 96234.

WANTED: Monaural tuner; McIntosh, Fisher, Pioneer, Scott, Harman-Kardon, Marantz. Box 125, Naugatuck, CT 06770.

real estate

EXCEPTIONAL 5-ACRE RANCH. Lake Conchas, New Mexico. Only \$995 per acre. Vacation Paradise. Good long term investment. Easy Terms. Free brochure. Ranchos Box 2006HD Alameda, California 94501.

books

CALLAS: THE ARTIST AND THE WOMAN by John Ardoin & Gerald Fitzgerald. The Definitive book on "La Divina" in evocative text and 300 exciting duotone photographs. Large 9x12 luxury format. \$27.50 regularly, only \$22.95 postpaid if ordered before October 15th. BOOK-FINDERS, Box 13857, Atlanta, Georgia 30324.

in brief

JOBRIATH: Creatures of the Street. ELEKTRA 7E 1010, \$6.98.

This bleached and painted creature is mad; so is his music. Even so, Jobriath is—within this tiresome reworking of the "glitter rock" format—able to create a number of substantial songs highlighted by a set of throbbing vocals. H.E.

MICHAEL DINNER: The Great Pretender. FANTASY F 9454, \$6.98.

Dinner is twenty-one, from Denver, writes all his stuff, and plays acoustic guitar. His album was produced by John Boylan, who produced Linda Ronstadt, Brewer & Shipley, and others. This is an excellent debut with a city-country orientation and features a great band of people associated with Ms. Ronstadt, Jackson Browne, Eagles, Bread, etc. Easy as a breeze to listen to. Highly recommended. M.A.

RICHARD HARRIS: I, in the Membership of My Days. ABC DSD 50159, \$6.98.

This opus consists of chorales, orchestral music, poems, and songs. Undoubtedly it will please those who confuse art with pretentiousness. H.E.

LARRY CORYELL: Spaces. VANGUARD VSD 79345, \$6.98.

This is a reissue of Coryell's excellent late-'60s recording, issued as Vanguard Apostolic VSD 6558 with the same title. If you don't have it already, it's well worth acquiring. M.J.

TOM BROCK: I Love You More and More. 20TH CENTURY T 430, \$6.98.

This album is produced by Barry White and arranged by Gene Page, so you know its general set. Brock is a nice writer and a pleasant singer, but my favorite song is "Naked as the Day I Was Born" by Gene Page and his brother Billy. No reason why the set shouldn't appeal to the Barry White crowd; this guy has a better voice. M.A.

MATTHEW FISHER: I'll Be There. RCA APL 1-0325, \$5.98. Tape: ●APS 1-0325, \$6.95. ●●APK 1-0325, \$6.95.

These conventional rock songs vary in quality; for the most part they are uninspired. It probably takes a great many hearings to convert Fisher's songbook into an entertaining listening experience. If you have the time, go to it! H.E.

SANTANA: Santana's Greatest Hits. COLUMBIA PC 33050, \$6.98. Tape: ●PCA 33050, \$7.98; ●●PCT 33050, \$7.98.

The first anthology of popular songs by the popular San Francisco Latin-jazz-rock band. Less flowing and integrated than its best previous albums, but otherwise very nice. M.J.

EDWIN HAWKINS SINGERS: Live. BUDDAH BDS 5606, \$6.98.

The Edwin Hawkins Singers is the group that originated the rollicking "Oh Happy Day." Nevertheless, most of the singers' music is pleasant rather than steamy electric-gospel. I prefer my religious music at least twenty degrees hotter. H.E.

Great Listening Pleasure Doesn't Come Cheap. ...Or Does It?

Yes, it does! We're one of the country's largest Mail Order Houses of Stereo Equipment and components. We pass our volume buying power right along to you.

Stereo Wholesalers

WRITE OR PHONE FOR QUOTATIONS AND OUR LATEST FREE CATALOG
7A Aylesbury Road
Timonium, Md. 21093 • 301,252-6880

CIRCLE 62 ON READER-SERVICE CARD

spend a dime, save a mint.

Invest a dime and send for our catalog. We'll prove to you that you can have selection and convenience and still get a great price.

For an immediate FREE copy of our 64-page catalog, including pull-out "Hifi Primer" section, mail the coupon below to the location nearest you. Please print.

Midwest Hifi Wholesale

& MAIL ORDER DIVISION
1626 Ogden Ave. (US 34), Downers Grove, Ill. 60515
3309 E. Carpenter Frwy. (Texas 183), Irving, Tex. 75062

NAME _____
ADDRESS _____
CITY/STATE _____ ZIP _____ (MF4-11)

CIRCLE 42 ON READER-SERVICE CARD

the tape deck

BY R.D. DARRELL

The Advent of Advent—with a catalogue of deluxe musicassettes, that is. The enterprising Cambridge corporation (not to be confused with a smaller, newer record company in Cleveland) long has been esteemed for its audio-equipment products, of which I can speak from first-hand knowledge since I was one of the early purchasers of the 101 Dolby-B unit, 200 cassette recorder/player, and more recently the extraordinary 202 cassette player. My consistent satisfaction with these units quite possibly biases my reception of the long-anticipated Advent musicassettes.

Yet no pre-favoring is needed to appreciate the technological advantages of the new CR/70 Process' unique features—chromium-dioxide-base tape and a duplication speed ratio of only four to one—or the benefits of the invariable use of Dolby-B noise reduction, screwed (rather than welded) cassette shells, 100% quality-control sampling, and brief notes with the cassettes themselves and more detailed annotations on request via a supplied postcard. Another attraction speaks persuasively for itself: a sliding price scale that not only lists normal-length and some double-length programs at the industry's \$6.95 standard, but also proffers some "budget" (but not necessarily short) programs at \$5.95 and even \$4.95.

High as expectations have been for such a Rolls-Royce cassette series, the actuality lives up to them, and not the least of the processing excellences are—in Dolby-B playback—quieter surfaces than any commercial musicassettes have achieved hitherto. Individual releases' musical appeals and recorded-performance qualities naturally vary considerably, but since many programs stem from the widely acclaimed Nonesuch and Connoisseur Society catalogues (augmented by several Advent Corporation "originals") the over-all artistic as well as technical level is impressively high. I hope to report later on many of the twenty-eight items in the first Process CR/70 list, but for the moment just two provide some index to the panoramic attractions of the series as a whole.

Entertainers—Now and Then. The sure first best-seller is Nonesuch/Advent E 1013, \$6.95, which couples polymath Joshua Rifkin's spectacularly successful (on disc) "Scott Joplin Rags, Vol. 1," with the more extraverted pianist William Bolcom's "Heliotrope Bouquet" anthology comprising rags by Lamb, Turpin, Roberts, and himself, as well as by Joplin. If you've already heard any of

these, you don't need me to tell you that the Joplin/Rifkin combination is not only rhythmically but lyrically irresistible, that Bolcom stresses more overtly the kinship between ragtime and jazz, and that both are appropriately recorded: Rifkin with gleaming sonic purity, Bolcom with startlingly realistic power.

Over four centuries separate today's (and yesterday's) ragtime piano players from the vagabond singers/instrumentalists of around 1500. But the Cambridge Consort's "Songs of a Traveling Apprentice," in German taverns and churches and on the roads to Flanders and Venice, have a freshness and relish that belie the chronological age of this music by Isaac, Josquin des Prez, Hofhaimer, Agricola, Senfl, and others whose names figure less prominently in, or have been entirely lost from, the history books. Joel Cohen and his six versatile colleagues sing and play, solo and in ensemble, with infectious zest, and they have been well-nigh ideally recorded (Advent Corp. C 1023, 41 minutes, \$4.95).

Tapes from Golden Crest. Leaping vertiginously back across the time gulf between Josquin and Joplin, I can now report on Golden Crest's Schuller/New England Conservatory sequel to their hit "Red Back Book" (1973) for Angel, to which I alluded with keen anticipation in September. The imaginative little Golden Crest company, which knows a good thing when it has it, lost no time in crashing the tape world with "More Scott Joplin Rags" (CRS 5-31031/8-31031, cassette/eight-track cartridge, \$7.98 each).

As in producer George Sponhaltz's Angel program, also noted in September, Schuller plays several of the rags featured in the film *The Sting*, plus seven not included by Sponhaltz: *Elite Syncopations*, *Solace*, and the *Original*, *Magnetic*, *Peacherine*, *Pine Apple*, and *Scott Joplin's New Rags*. Listeners who first succumbed to the insidious appeal of ragtime at its best via "Red Back Book" (or via Rifkin's piano collections) will need no special recommendation to this latest program, nor will they be deterred by a trace of coarseness in the otherwise effective recording or by some very slight non-Dolby surface noise that in any case is generally covered up by the lively music itself.

And Golden Crest (hitherto best known for its specialized-instrument, band, and school-music discography) goes on to honor the greatest white ragtime master, Joe Lamb. As persuasively interpreted by Milton Kaye (best known as a "classical" pianist), such pieces as the toe- and ear-tickling *Ragtime Nightingale* and *Topliner Rag*, and the nostalgically haunting *Bobolink* and *Alaskan*

Rag, prove to be true musical gems (CRS 5-4127/8-4127, cassette/cartridge, \$7.98 each).

Dvořákian Delectations. You don't need to share my personal susceptibility to Czech music to be bewitched by the mellifluous charms of Dvořák's Op. 22 Serenade in E, long a disc favorite but hitherto available on tape only in Alfred Scholz's budget Ampex editions. And *they* can't come close to competing with Colin Davis' enchanting performance (1969) with the London Symphony strings, appetizingly coupled with the inexplicably less-familiar but gloriously invigorating *Symphonic Variations*, Op. 78, plus—on tape only—an incongruous "filler" waltz for string quintet (Philips 18423 CAA, Dolby-B cassette, \$6.95).

Incidentally, I've learned since my comments last month that Philips' downplaying of its recently begun Dolbyization policy was only a temporary measure. By the time this appears in print, a new Philips musicassette catalogue should be available that frankly boasts—as it justly should—of its Dolby-B items. Eventually these may include many bigger and more spectacular works than the present unpretentious Dvořák program, but I doubt that any ever can provide more immediately heart-warming musical pleasure.

Better Late. . . . After a considerable hiatus in Ampex's normally extensive and regular provision of open-reel tapes for review, I'm relieved to welcome a belated batch from which I hastily grab two releases that my ears have been impatiently hanging out for. One is the Ashkenazy Rachmaninoff program I mentioned back in August, which proves to be everything I had anticipated. It has superbly magisterial yet distinctively personal playing and tremendously impressive sonic weight and presence in what are the most idiomatically pianistic (*klaviermässig*) works since Chopin: the intricate Op. 39 *Etudes tableaux* and the mighty Op. 42 *Corelli Variations* (London/Ampex L 480276, Dolby-B 7½-ips reel, \$7.95; also M 10276/M 67276, cassette/cartridge, \$6.95 each).

The other is the reel edition of the Bach-transcriptions program included in my "Hyphenated Stokowski" feature review this month (London/Ampex L 421096, Dolby-B 7½-ips reel, \$7.95; also M 521096/M 821096, cassette/cartridge, \$6.95 each). It's no less ambivalently fascinating than the disc edition, yet it not only confirms the disc's interpretive tilt toward Stokowski and away from Bach, but tilts the frequency-spectrum balance even further toward the lows and away from the highs. Indeed the reel sonics are even more—almost incredibly—big and weighty, but they are quite unlike anything one ever hears in the concert hall. ■

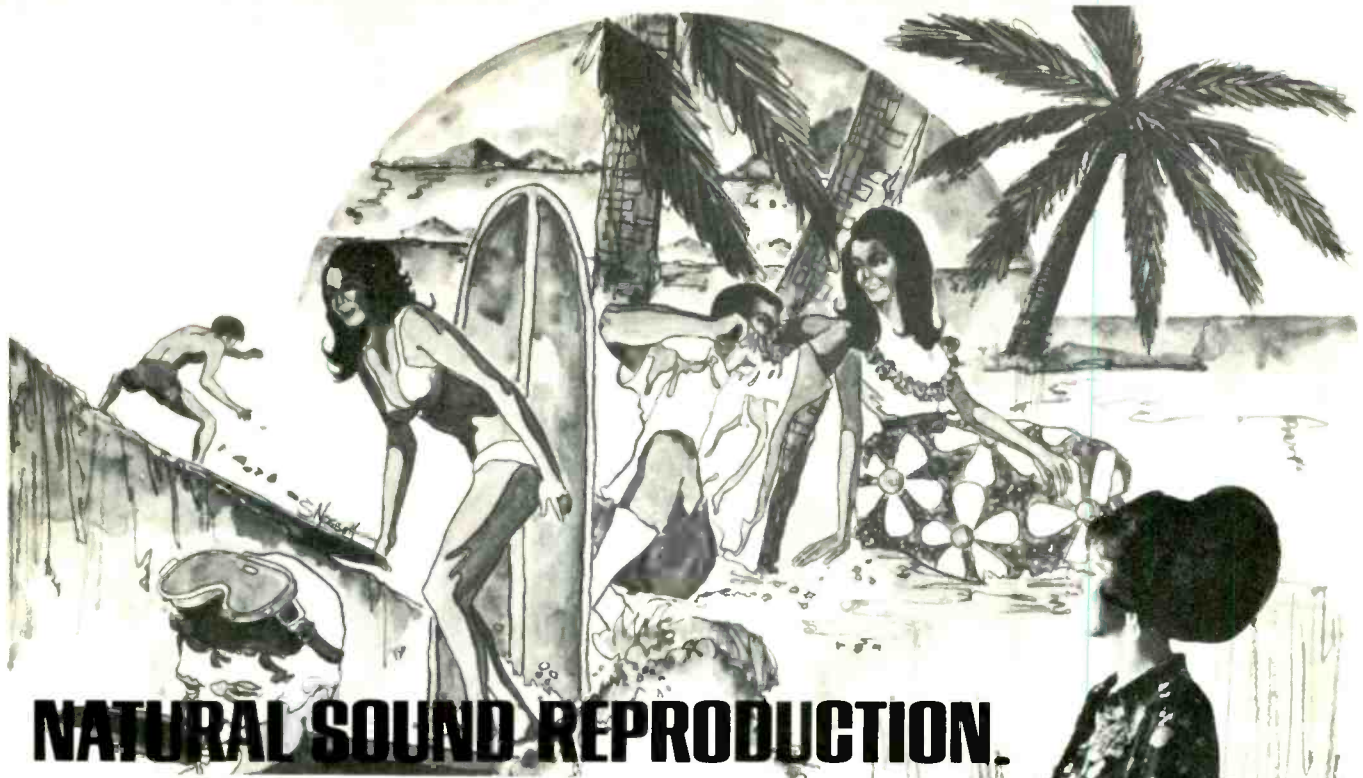

NATURAL SOUND REPRODUCTION.

The Thrill of it all...

What's natural sound reproduction? It's sound so real you can see swaying palm trees and grass skirted dancers... feel the sun-warm sand beneath your feet... and smell the salt sea air... right in your own living room.

Making a speaker deliver sound this accurate takes years of experimenting and testing as well as solid engineering know-how. Here at UTAH, speakers are our only business. Our sound specialists never stop trying to find ways to improve the quality of our speakers. In fact, we design, engineer, and produce more speakers and speaker systems than any other manufacturer in the country.

When you play your favorite music through a UTAH speaker, you're hearing those clear, thrilling highs, deep, resonant bass notes, and smooth, mellow mid-range tones as closely as you can to the way they were originally recorded.

Natural sound reproduction. What else did you expect from the country's largest speaker manufacturer? The best... naturally. Write for the name of the UTAH dealer nearest you.

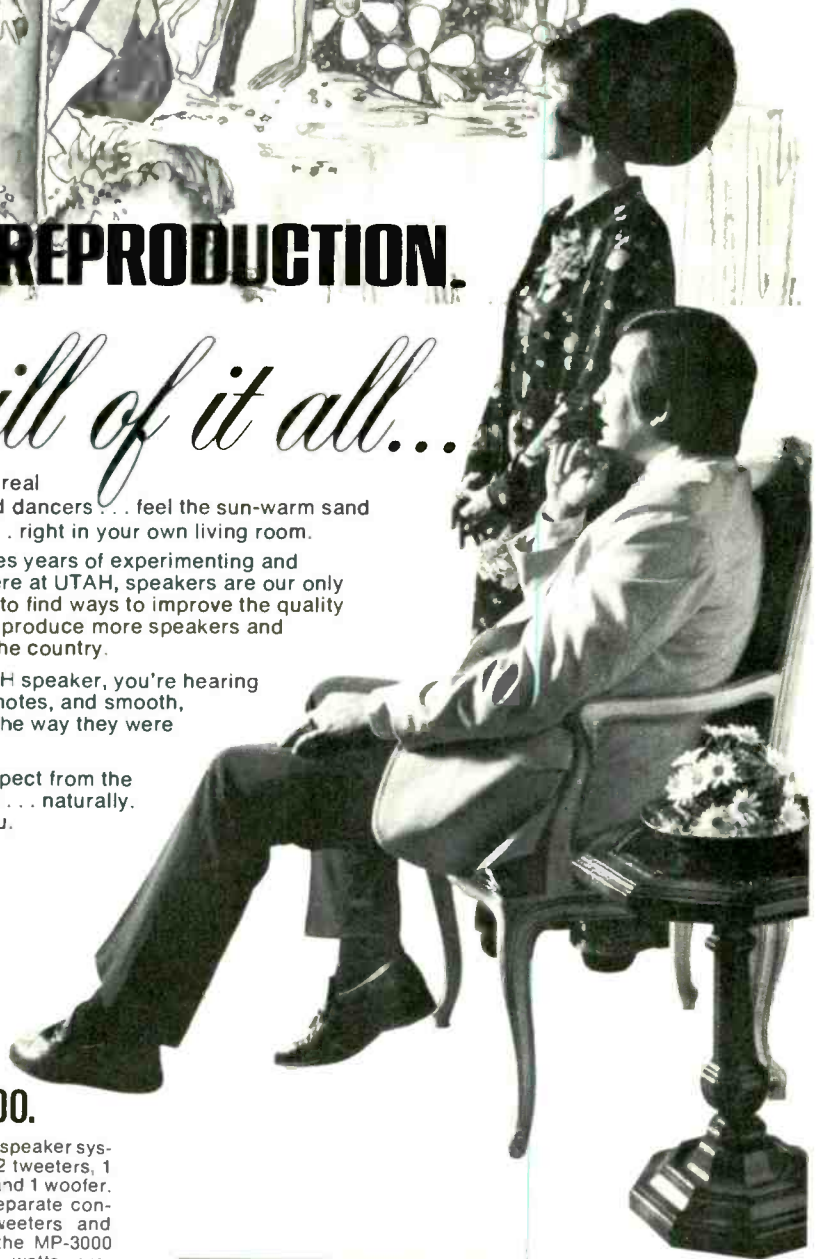

MP 3000.

This superb speaker system boasts 2 tweeters, 1 mid-range, and 1 woofer. Featuring separate controls for tweeters and mid-range, the MP-3000 handles 50 watts program material (100 watts peak). Frequency response: 20-20,000 Hz. Cabinet: 27" x 20½" x 14". Shipping weight: 70 lbs. \$199.95



UTAH ELECTRONICS

1124 E. FRANKLIN ST. • HUNTINGTON, INDIANA 46750

MARANTZ

4400

Model 4400 Receiver

marantz

L - PLAY - R CAL

DOLBY SYSTEM
L RECORD R LEVEL

DOLBY LEVEL

400Hz TONE ON

SCOPE DISPLAY
AUDIO TUNING MULTIPATH

STEREO AM FM PHONO

FM 88 90 92 94

AM 540 600 700

balance

L FRONT R FRONT

FRONT REAR

phones dolby selector monitor mode din

PLAY OFF RECORD

PHONO CD-4/AUX TAPE 1 TAPE 2

SOURCE TAPE 1 TAPE 2

DISCRETE 2 CH MONO VARI-MATRIX SQ-DECODER

FM DOLBY

AM

The Marantz 4400 outperforms just about every receiver in the world. Stereo or 4-channel. (It's both.) In stereo it delivers an astounding 125 watts continuous power per channel at 8 ohms from 20Hz to 20kHz with less than 0.15% total harmonic distortion. In 4-channel it's rated at an impressive 50 watts continuous power per channel at 8 ohms from 20Hz to 20kHz with less than 0.15% total harmonic distortion. It offers the same wallop performance as the finest separate components, yet the feature-packed Marantz 4400 costs about 25% less. Just \$1250 for virtually the highest output and the lowest total harmonic distortion available in any receiver at any price.

The Marantz 4400 with "Stereo 2 + Quadradial® 4" design will never be obsolete. That's because Marantz does not have an inflexible matrix system permanently installed in the equip-

ment. Instead, Marantz receivers have an exclusive 4-channel matrix decoder pocket for plug-in/plug-out SQ¹, plus facilities for a CD-4² adaptor. Result: you can use any or all of the optional systems currently available, and easily and economically change to any future 4-channel improvements without obsoleting your entire receiver investment. Simply plug-in the latest Marantz decoder circuit.

And Marantz 4400 superiority doesn't stop there. There's built-in Dolby³ Noise Reduction with six controls for the ultimate in flexibility. Quadra Power[®] bridging for super stereo performance. An oscilloscope with three separate functions for precise visual display. And much more.

The 4400 brute receiver, like all Marantz products, is backed by a full, three-year guarantee⁴. See it at your Marantz dealer.

marantz.
We sound better.

¹SQ is a trademark of CBS Inc. ²CD-4 is a trademark of Victor Company of Japan. ³Dolby is a trademark of Dolby Labs, Inc. ⁴Marantz Co., Inc. guarantees the original registered owner that all parts are free from operating defects for three years from purchase date except tubes which are guaranteed for 90 days. Products are repaired or replaced free of charge during this period provided you bought them in the U.S.A. from an authorized dealer. Naturally the serial number cannot be altered or removed. ©Marantz Co., Inc., a subsidiary of Superscope, Inc., P.O. Box 99A, Sun Valley, Calif. 91352. In Europe: Superscope Europe, S.A. Brussels, Belgium. Available in Canada. Prices subject to change without notice. Send for free catalog.



Why nearly every record player is like a car that doesn't steer straight.

If you've ever driven a car with badly aligned front wheels or a defective steering mechanism, you know what we're talking about.

It's a queasy feeling when you can't make the car point in the same direction as the road is pointing.

There happens to be a distinctly comparable problem with record players, except that it's a nearly universal deficiency, not just a malfunction.

Of course, in this case there's no human life at stake, only the fidelity of the reproduced sound. And sometimes the life of the record.

Like a car, the phono cartridge (or pickup head) should point where it's going. Right down the middle of the groove. Not at an angle to it.

A more scientific way of saying the same thing is that the head should remain perpendicular to the line drawn through the stylus tip and the turntable spindle.

Any deviation from this ideal is known as tracking error. It's measured in degrees and it causes distortion. Inevitably.

The trouble is that there's no way to avoid tracking error and the resulting distortion with any conventional pivoted tonearm. Why? Because the head

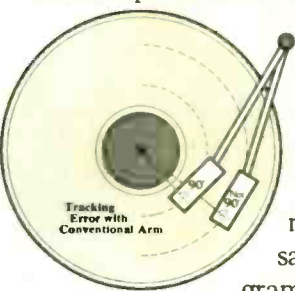

swings in an arc and is therefore at a continuously changing angle to the groove as it travels across the record.

The problem has remained fundamentally the same since the Emile Berliner gramophone of 1887. It has been minimized, thanks to improvements in tonearm geometry, but it hasn't been eliminated.

With one important exception.

In the current line of Garrard automatic turntables, the top models are equipped with Garrard's unique Zero Tracking Error Tonearm.

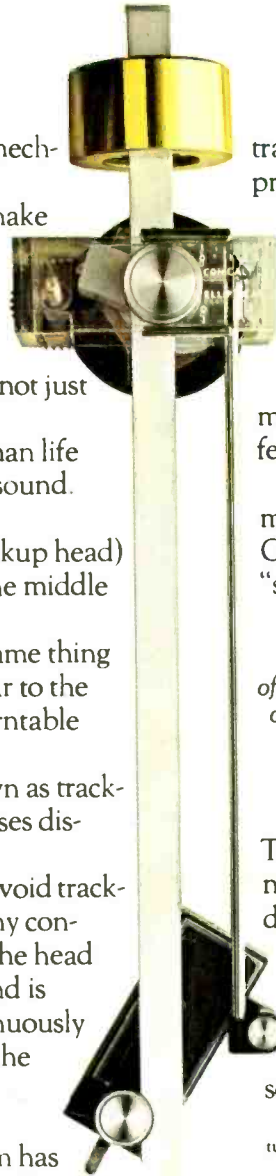

This remarkable invention ends tracking error once and for all. The head is always properly lined up with the groove because it's hinged instead of fixed and keeps adjusting its angle during play. A simple idea, yes, but the engineering details took the world's leading manufacturer of turntables seven years to perfect.

The Zero Tracking Error Tonearm is a major technological coup, not just a glamour feature. You can hear the difference.

The "Acoustics" column of *Rolling Stone* magazine, for example, reported that the original Garrard turntable equipped with the new arm "sounded markedly 'crisper' than the other turn-

tables" under otherwise identical test conditions. It's true. Just like a car that doesn't steer straight, tracking error can make a

nasty sound. It can even cause unnecessary record wear. The information engraved in the grooves of the new CD-4 discrete four channel records is so finely detailed that it can be partially wiped out by a stylus that doesn't sit absolutely square and true.

Ask your nearest Garrard dealer about the Zero Tracking Error Tonearm.

It's absurd to tolerate a problem that somebody has already solved.

Top of the line: Garrard Zero 100c, \$209.95. Other Garrard automatic turntables from \$49.95 up. To get your free copy of the new 16 page full color Garrard Guide, write Garrard, Dept. G-9, 100 Commercial St., Plainview, N.Y. 11803.



Garrard

Division of Plessey Consumer Products, 100 Commercial Street, Plainview, New York 11803
CIRCLE 22 ON READER-SERVICE CARD