

High Fidelity

March

The Magazine for Music Listeners

60 cents

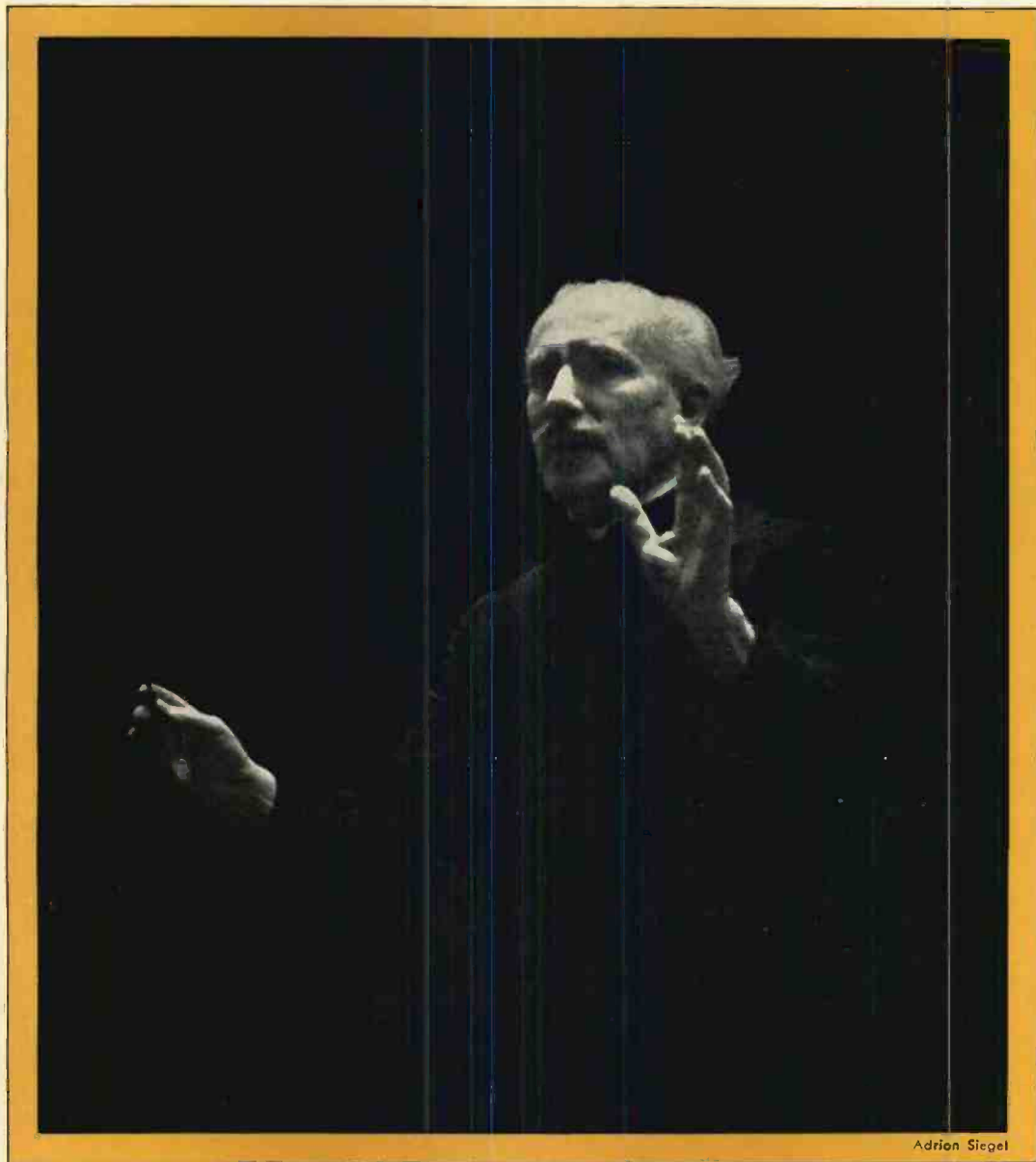

Adrian Siegel

Ninety Years of Arturo Toscanini
by Vincent Sheean

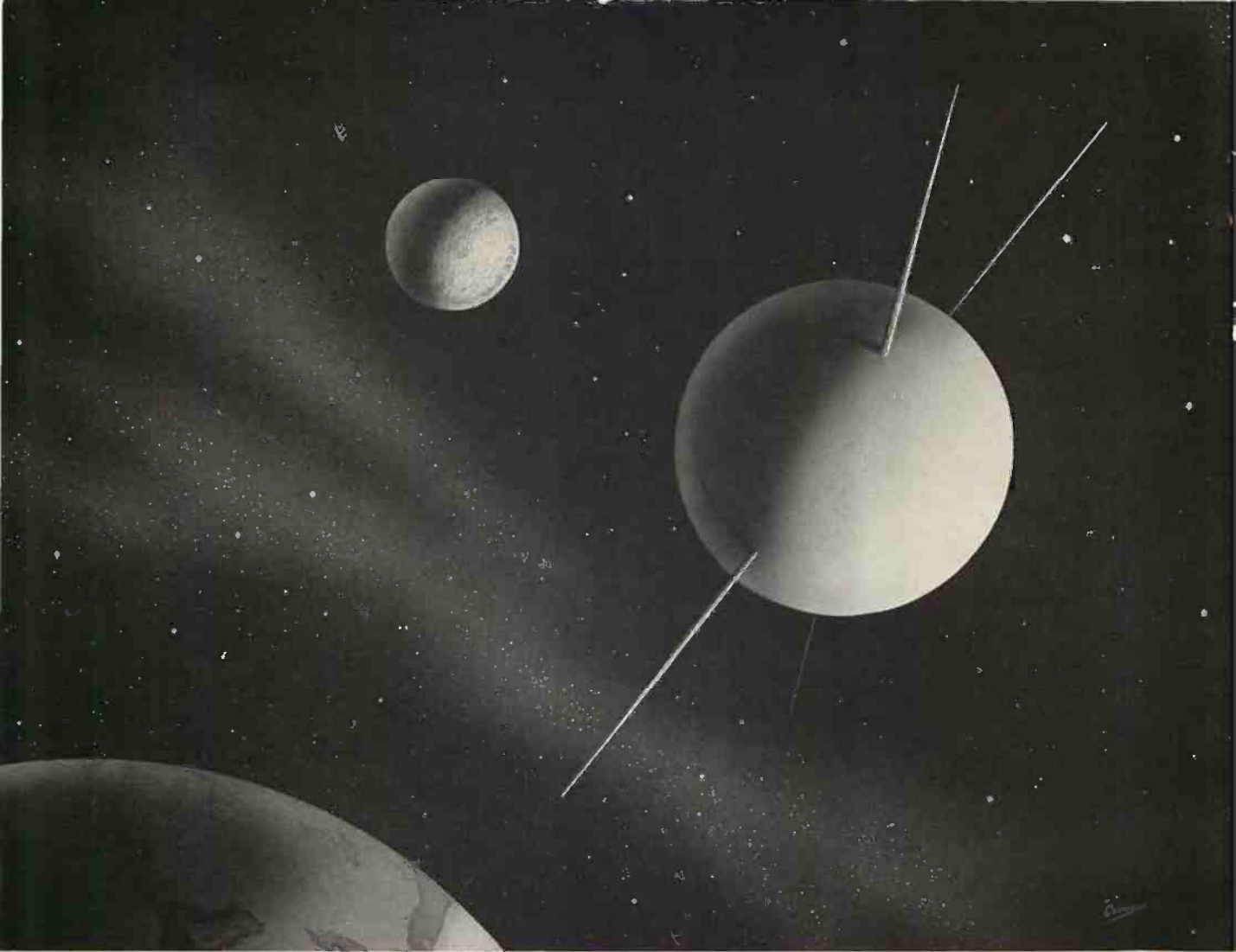

recording the "man-made moon" on extra-precision audiotape

EARLY in 1958 there will be a "new moon" in the sky — a 22-inch sphere circling the earth at a speed of 18,000 mph. Unlike our real moon, this one will be able to "talk" to Earth. And engineers from Army Ordnance Ballistic Research Laboratories at Aberdeen Proving Ground, Maryland will study these messages to learn new facts about our solar system.

This "moon-talk" — radio signals emanating from precision instruments inside the satellite — is so vital that it will be tape recorded for later analysis, interpretation and preservation.

The highest standards of reproduction must be met. There can be no distortion, voids, or other imperfections.

The tape chosen was extra-precision Type EP Audiotape.

The highest professional standards of quality and uniformity extend throughout the *entire Audiotape line*,

making it the best selection for any recording application.

Whether you are an engineer recording highly technical information or a neophyte placing his first reel on a tape recorder, Audiotape will speak for itself. It is now available in *five different types* to meet every recording need and every tape budget. ® trademark

For complete information on the earth satellite recording project write us for a free copy of the December issue of Audio Record.

AUDIO DEVICES, Inc.

444 Madison Avenue, New York 22, N.Y.

Offices in Hollywood — Chicago

Export Dept., 13 E. 40th St., New York, N.Y.

*Great
performance...*

*with your living room
in mind...*



Jensen CT-100 Concerto in Mahogany \$189.50, Blonde Korina \$194.50

Jensen TRIPLEX and CONCERTO *Authentic* HIGH FIDELITY LOUDSPEAKERS

All of us know that big speakers should make better hi-fi sound than smaller ones; the difference lies in the extreme low end. But more often than not space and decor problems just won't allow the big reproducer in the living room.

However, your fidelity can be very high indeed in more modestly dimensioned cabinetry. For your living room we suggest you consider Jensen's fine reproducers the Triplex and Concerto 3-way and 2-way systems. They are distinguished by *authentic* high fidelity performance far beyond their modest size and cost. Speaker kits are available, too, if you wish to build or build-in your speaker system.

DO IT YOURSELF AND SAVE!

You can have the fun of building your own hi-fi speaker system (and save money, too) Jensen Manual 1060 simplifies it for you. Complete instructions for 18 free-standing or built-in systems with simplified drawings, parts lists, circuit and wiring diagrams.

Send 50¢ today for Jensen Manual 1060



Jensen TP-200 Triplex in Mahogany \$347.00 Blonde Korina \$352.00

Jensen

Division of The Muter Company •

MANUFACTURING COMPANY

6601 S. Laramie Ave., Chicago 38, Illinois • In Canada: Copper Wire Products Ltd., Licensee

MARCH 1957

I

there is ONE pickup for calibrating and evaluating records! (including test records)

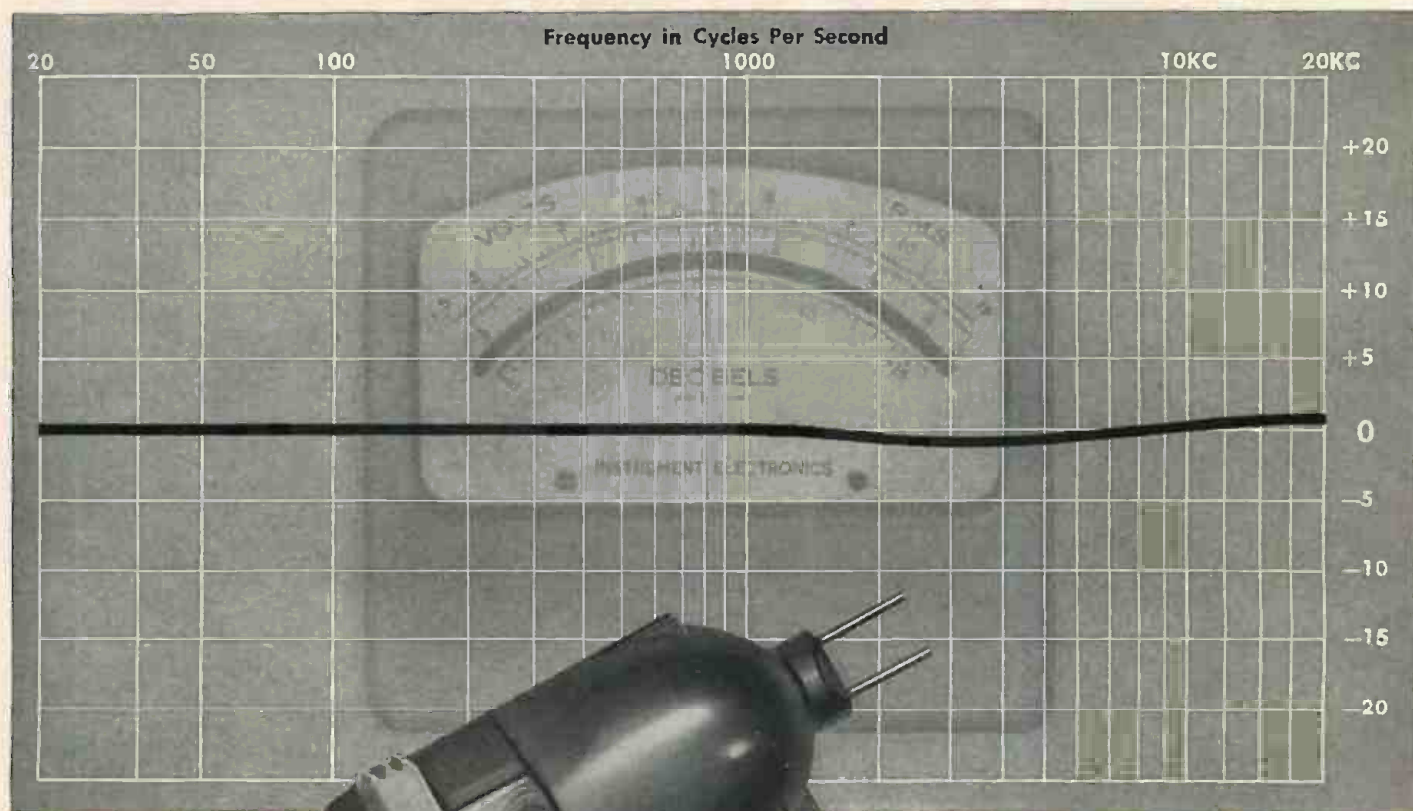

THE *Fluxvalve* PICKUP

Important as it is to the recording industry, the FLUXVALVE offers values never before available to thousands of record playing enthusiasts!

- Very Wide Range (VWR)
- Unequaled transient response
- Long record and stylus life
- Low overall distortion
- Hermetically sealed
- Easily replaceable styli *

* Less than 1 mil stylus on special order

THE FLUXVALVE PICKUP was originally developed for professional applications, particularly recording studios where accurate correlation between lacquer, master and pressings is essential, and has always been difficult. Now with the FLUXVALVE magnetic turn-over pickup with which to make precise and *reproducible* record-measurements, a vital control step is simplified.

For a new listening experience, ask your dealer to demonstrate the new FLUXVALVE . . . words cannot describe the difference . . . but you will hear it!



PICKERING & CO., INC. OCEANSIDE, N. Y.

Professional Audio Components

"For those who can hear the difference"

. . . Demonstrated and sold by Leading Radio Parts Distributors everywhere. For the one nearest you and for detailed literature: write Dept. H-19 EXPORT: AD. AURIEMA, INC., 89 BROAD ST., NEW YORK / CANADA: CHARLES W. POINTON LTD., 6 ALCINA AVE., TORONTO



High Fidelity

THE MAGAZINE FOR MUSIC LISTENERS

The Cover. Nearly every photograph of Toscanini conducting has been published many times; this one is no exception — but it remains a beautiful picture. It was taken by Adrian Siegel, cellist in the Philadelphia Orchestra, while Toscanini was in Philadelphia as guest conductor in early 1942.

This Issue. It is our good fortune that Toscanini lived into the age of high fidelity recording: all the instruments of his NBC Symphony can be heard in their parts, for our study or delectation. But in sound reproduction, progress never stops, so there is always something to regret. It would have been good to have the Maestro in stereo sound. — Home stereo is, we think, if not *the* coming thing, certainly *a* coming thing of considerable importance to living room listeners — and not only those numbered among the audio *avant-garde*. Indeed, these latter may benefit (in some cases) least, since monaural reproduction most nearly approaches realism coming loudly from an elaborate speaker system in a big room. For the listener with a small room and neighbors close next door, perhaps the only way to capture what may be called musical vista is through stereo. For these and other obvious reasons, we expect to offer articles on this development with fair regularity. Note pages 41-42.

CHARLES FOWLER, *Publisher*

JOHN M. CONLY, *Editor*

ROLAND GELATT, *New York Editor*

J. GORDON HOLT, *Technical Editor*

ROY LINDSTROM, *Art Director*

Assistant Editors

MIRIAM D. MANNING; JOAN GRIFFITHS

Editorial Assistant

ANNA M. FURLANI

Manager, Book Division

FRANCES A. NEWBURY

Contributing Editors

C. G. BURKE

R. D. DARRELL

JAMES HINTON, JR.

ROBERT CHARLES MARSH

WARREN B. SYER, *Business Manager*

CLAIRE N. EDDINGS, *Advertising Sales Manager*

ARTHUR J. GRIFFIN, *Circulation Manager*

Advertising

Main Office — Claire Eddings, The Publishing House, Great Barrington, Mass. Telephone: Great Barrington 1300. Leased line from New York City: Dial Walker 5-2863.

Chicago — John R. Rutherford & Associates, Inc., 230 East Ohio St. Telephone: Whitehall 4-6715.

Los Angeles — Brand & Brand, Inc., 6314 San Vicente Blvd. Telephone: Webster 8-3971.

Volume 7 Number 3

March 1957

AUTHORitatively Speaking	4
Letters	6
Noted With Interest	11
On The Counter	20
Books in Review	25
As The Editors See It	37
Ninety Years of Arturo Toscanini, by Vincent Sheean	38
<i>A retrospective appreciation.</i>	
The Recording and Reproduction of Space, by Chuck Gerhardt	41
<i>An inside view of the progress of stereophony.</i>	
Prima Donnas I Have Sung Against, by George London	43
<i>A famous baritone tells what he thinks of some of operas leading ladies.</i>	
The Wonderful Rotary Singing Coach, by John McCollum	46
<i>Records can help a singer prepare — but caution is needed, too.</i>	
The Infidelical Spouse, by S. Strindberg Schopenhauer	48
<i>A fearless but anonymous hi-fi husband defies all low-fi wives.</i>	
Music Makers, by Roland Gelatt	55
Record Section	59-101
<i>Records in Review; Dialing Your Discs; Building Your Record Library; César Franck on Microgroove, by Paul Affelder.</i>	
The Tape Deck, by R. D. Darrell	103
Tested in the Home	113
<i>Dual Micro Pianissimo record cleaner; Sherwood S-2000 tuner; Cabinart record storage bins; Bib tape splicer; Gellar plastic equipment covers; Old Colony record filing system; Connoisseur pickup; Rogers Symphony speaker system; Bard Orto-Sonic V/4 pickup arm.</i>	
Audio Forum	135
Professional Directory	138
Trader's Marketplace	139
Advertising Index	143

High Fidelity Magazine is published monthly by Audiocom, Inc., at Great Barrington, Mass. Telephone: Great Barrington 1300. Editorial, publication, and circulation offices at: The Publishing House, Great Barrington, Mass. Subscriptions: \$6.00 per year in the United States and Canada. Single copies: 60 cents each. Editorial contributions will be welcomed by the editor. Payment for articles accepted will be arranged prior to publication. Unsolicited manuscripts should be accompanied by return postage. Entered as second-class matter April 27, 1951 at the post office at Great Barrington, Mass., under the act of March 3, 1879. Additional entry at the post office, Pittsfield, Mass. Member Audit Bureau of Circulation. Printed in the U. S. A. by the Ben Franklin Press, Pittsfield, Mass. Copyright 1957 by Audiocom, Inc. The cover design and contents of High Fidelity Magazine are fully protected by copyrights and must not be reproduced in any manner.

SARGENT - RAYMENT

This young lady is simply enraptured by the sight and sound of her new Sargent-Rayment hi-fi. She had been in the usual dilemma of how to find real custom hi-fi that would still blend well with her decor. She recently discovered the new Sargent-Rayment and found it the practical solution to this very big problem. You can see how charmed she is now.

Husbands take heed: You will find that every Sargent-Rayment model will pass the careful scrutiny of your fair lady. Each model is "home-maker approved", an important seal of approval when buying custom hi-fi. In fact, our new line has been designed and engineered to captivate the whole family.

Pictured here are the SR-100 "Brentwood" Deluxe AM-FM Tuner at \$139.95, and the SR-200 "Claremont" Deluxe Control Amplifier at \$149.95. Both are filled with many new engineering advances. We shall be most happy to send you complete specifications on these and other models. Just write



SARGENT - RAYMENT CO.

4926 East 12th Street, Oakland 1, California

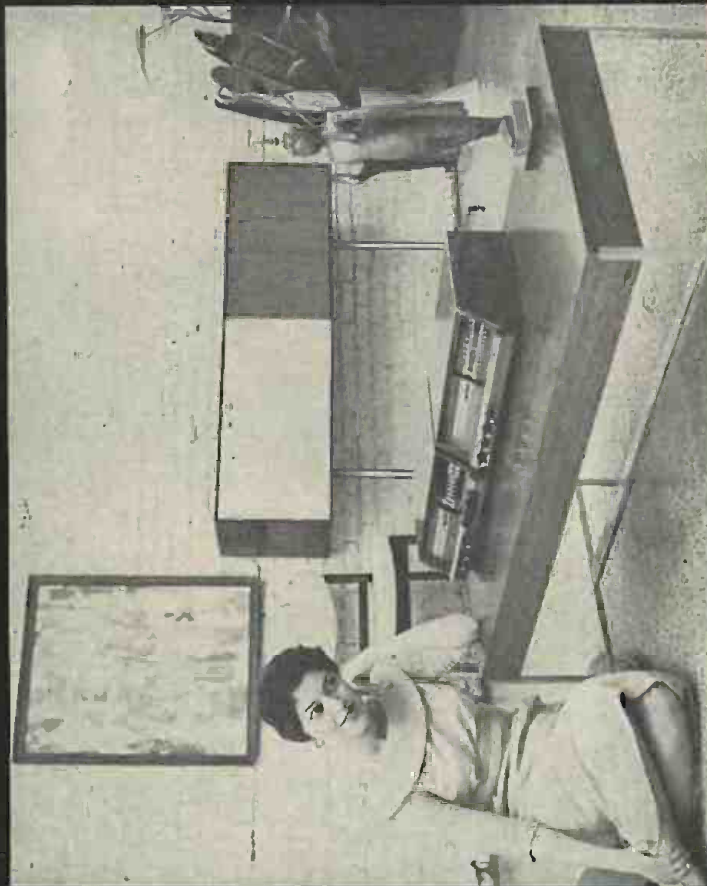

AUTHORitatively Speaking

It would be slightly insulting to all concerned to imply that the readers of HIGH FIDELITY need be told who Vincent Sheean is, and if they want to know more about how he got to be *what* he is, the easiest way is to read any of more than twenty books by Vincent Sheean. Best for the purpose, perhaps, are two: *Personal History* (1953) and *First and Last Love* (Random House, 1956). The love in the latter is, of course, music.

Chuck Gerhardt, who discusses *his* newest love, stereophony, on page 41, has been for nearly two years recording director for Westminster, which now also produces Sonotapes. Prior to that he was an RCA Victor engineer concerned largely with the processing of the Toscanini archive of transcriptions and with the production of Collectors' Treasury re-pressings. He studied music at the University of Illinois and learned tape craft from Peter Bartók.

George London, the famous Canadian-born baritone who likes women as much as S. S. Schopenhauer (see below) doesn't, has been one of the busiest men in the opera world this season — *Boris* and *Don Giovanni* in Belgrade and Zagreb; *Flying Dutchman* in Bayreuth (first American to sing the title role there); South American debut in *Don Giovanni*; *Aida*, *Tosca*, *Carmen*, *Arabella*, and *Tales of Hoffman* at the Met. In his spare time an article on prima donnas for HIGH FIDELITY. See page 43.

The fearless hi-fi peddler and hi-fi husband who covers (these are his own words) behind the *nom de plume* of S. Strindberg Schopenhauer identifies himself about as clearly as it is safe to do in his article on the ladies and their shortcomings as listeners. We will not give him away, having well in mind the wise words of Kipling about the female of the species. Besides, we expect other and less controversial articles from S. S. S., at which time we can tell you more about him. Meanwhile he assures us that "The Infidelical Spouse" (page 48) was written all — or mostly — in fun, and that some of his (S. S. S.'s) best friends are women. Uh huh.

John McCollum, author of "The Wonderful Rotary Singing Coach" (page 46), is a young tenor but one very well known to audiences — especially oratorio audiences — all over the United States. Oddly (and helpfully to us), his college degree is in journalism, and he was news editor of his home town paper for four years before becoming a professional singer. Later he was a Naval aviator, which he found dull. Things he doesn't find dull include professional football, politics, carpentry, family life, and his black cat, name of Jason.

Some readers will remember Vilmos Gergely, a witty, charming, and erudite editor and musicologist of Budapest, Hungary. He wrote twice for us — a description of the great Liszt-Wagner concert of 1875, and an interview with Zoltán Kodály. We hoped to have more Gergely writings, but we won't. Early in 1957 we were informed of his death in November after a long illness. His widow, Mrs. Ilona Behrend Gergely, is the artist who illustrated his Kodály interview.

FREE... ANY 3

OF THESE SUPERB HIGH-FIDELITY

12" COLUMBIA LP RECORDS

If you join the Columbia LP Record Club now — and agree to accept as few as 4 selections during the coming 12 months



The most exciting high-fidelity performances



ever offered to new members

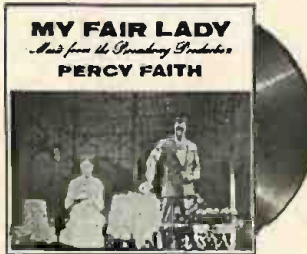

of the Columbia LP Record Club

© "Columbia" LP, MCA Records

YES! You may have, FREE, ANY 3 of these best-selling 12" Columbia LP records. We make this unique offer to introduce you to the money-saving program of the Columbia LP Record Club . . . a program that selects for you each month the greatest works in every field of music—performed by the world's finest artists, brilliantly reproduced on Columbia LP records.

HOW THE CLUB OPERATES: To enjoy the Club's benefits — mail the coupon, indicating which one of the four Club divisions best suits your musical taste: Classical; Jazz; Listening and Dancing; Broadway, Movies, Television and Musical Comedies.

Each month you will receive free the Club Magazine which describes the current selections in all four divisions. You may accept or reject the monthly selection for your division . . . or you may take records from other Club divisions . . . thereby assuring you the widest possible choice of recorded entertainment. Or you may tell us to send you NO record in any month.

Your only obligation is to accept as few as 4 selections from the almost 100 that will be offered during the next 12 months. The records you want are mailed and billed to you at only \$3.98 (original cast Broadway Shows somewhat higher), plus a small mailing charge.

FREE BONUS RECORDS GIVEN REGULARLY: The 3 records sent to you now represent an "advance" of the Club's bonus system — given to you at once. After you have fulfilled your membership obligation by purchasing four records, you will receive an additional free Bonus record of your choice for every two additional Club selections you accept. Bonus records are superb 12" Columbia LP records—the very best of the Columbia LP catalog—just like those shown here.

Indicate on the coupon which 3 records you want free, and the division you prefer. Then mail the coupon at once. You must be delighted with membership or you may cancel it by returning the free records within 10 days.

COLUMBIA LP RECORD CLUB
Terre Haute, Indiana

COLUMBIA LP RECORD CLUB,
Dept. 696, Terre Haute, Indiana

Please send me as my FREE gift the 3 records indicated here: (Select the records you want by checking the 3 boxes in the list at the right).

. . . and enroll me in the following Division of the Club:

(check one box only)

- Classical Listening and Dancing
 Broadway, Movies, Television and Musical Comedies Jazz

Each month you will send me the Columbia LP Record Club Magazine which describes the records offered in all four Club divisions. I have the privilege of accepting the monthly selection in the division checked above, or any other selection described, or none at all. My only obligation is to accept a minimum of four records in the next 12 months at the regular list price plus a small mailing charge. After accepting 4 records, I will receive a free Bonus record for every two additional records I purchase. If not delighted with membership, I may cancel within 10 days by returning all records.

Name.....
(Please Print)

Address.....

City..... Zone..... State.....

CANADA: Prices slightly higher.
Address 11-13 Soho St., Toronto 2B

If you wish to have this membership credited to an established Columbia Records dealer, authorized to accept subscriptions, please fill in the dealer's name and address also.

CHECK THE 3 RECORDS YOU WANT:

- | | |
|--|--|
| <input type="checkbox"/> Levant Plays Gershwin
3 works — Rhapsody In Blue; Concerto in F; An American in Paris. | <input type="checkbox"/> Brahms: Double Concerto; Variations on a Theme by Haydn; Tragic Overture
Stern, violin; Rose, cello; N. Y. Philharmonic, Walter, cond. |
| <input type="checkbox"/> Ports of Call
Philadelphia Orchestra, Ormandy, cond. 6 works: Bolero, Pavane, Espana, La Valse, etc. | <input type="checkbox"/> Schubert: Quintet in A Major ("Trout")
Members of Budapest String Quartet with M. Horszowski, piano; G. Moleux, bass. |
| <input type="checkbox"/> Mendelssohn: Symphony No. 3 ("Scotch")
Symphony No. 5 ("Reformation")
N. Y. Philharmonic, Mitropoulos, cond. | <input type="checkbox"/> My Fair Lady
Percy Faith and his Orchestra play music from this hit show. |
| <input type="checkbox"/> Debussy:
La Mer; Iberla
N. Y. Philharmonic, Mitropoulos, conductor.
Philadelphia Orchestra, Ormandy, cond. | <input type="checkbox"/> King of Swing: Vol. 1
Benny Goodman and Original Orch., Trio Quartet. Ridin' High, Moonlight—9 more. |
| <input type="checkbox"/> Rimsky-Korsakov: Scheherazade
Philadelphia Orchestra, Ormandy, cond. | <input type="checkbox"/> The Voice
Frank Sinatra in 12 songs that first made him famous — Lover, Fools Rush In, etc. |
| <input type="checkbox"/> In The Gardens of Mirabell
Bruno Walter conducts Columbia Symphony Orch. in 9 works by Mozart — Eine Kleine Nachtmusik, etc. | <input type="checkbox"/> Day Dreams
Doris Day sings 12 popular songs—including Sometimes I'm Happy, You Go To My Head, etc. |

Dealer's Name.....
Dealer's Address.....-60-V



LARGE
 enough to reproduce
 the full Voice of the
 Concert Hall...

...yet **small**
 enough to slip
 into any setting!



KAL

Audette

2-Way Speaker System



LP-215 Woofer HP-1 High Pass Filter LP-65 Tweeter

SPECIFICATIONS: Lorenz LP-215 Woofer, Lorenz LP-65 Tweeter and Lorenz HP-1 High Pass Filter. 14 watts power handling capacity. Cabinet Size: 11" H, 23 3/4" W, 10" D.

KAL-B Rich-grained brown leatherette
 KAL-T Natural blonde tan leatherette

Net **\$49.50**

Matching 15" brass legs with screws and self-leveling ends. Net **\$5.95**

Truly one of the most versatile speaker systems ever to appear on the high fidelity scene. A triumph in acoustic engineering, Kal Audette employs highly refined Helmholtz resonator and phase inversion techniques to produce a unit of convenient size yet with the breathtaking voice of the concert hall.

Kal Audette is a true 2-way high fidelity system with separate speakers for lows and highs. Beautifully recreates even the most delicate violin pianissimo, yet delivers the surging fullness of the entire orchestra with amazing "up front" clarity and tonal definition from 45 to 17,000 cycles.

Use Audette Anywhere! Fits easily on bookshelf, table or cabinet top. Ideal in custom installations. Make excellent branch speakers for your home, or as matching units for a new stereophonic system. Attach handsome 15" polished brass legs and Audette becomes a convenient standing console.

Write for complete folder of speakers and enclosures.

Kingdom PRODUCTS, Ltd.

514 Broadway, New York 12, N. Y. - WOrth 6-0800

OFF THE FLOOR and OUT OF THE WAY!



2-Way Space-Saver Speaker System

Occupies no floor space yet delivers bass response equal to very large horn-loaded floor units, because it uses the walls and ceiling of your room as working parts of the system. Delivers crisp highs and rich, fully developed lows with a wonderful "music all around" sound. Perfect as extension speakers or in pairs for new stereophonic systems. 40-17,000 cps, 8 ohm impedance, 14 watts. Size: 31" H, 27 1/2" W, 11 3/4" D. Blonde, Net **\$59.50**



Build Your Own System with Lorenz...
 World famous Lorenz speakers are available separately in many sizes for custom installation. They are especially designed for future expansion into deluxe systems without obsolescence of any component.



LETTERS



SIR:

Your editorial on page 51 of the January issue was a small masterpiece. Perhaps you are familiar with John Locke's description of the differences between the pleasures of seeing and the pleasures of understanding. The superficial, hedonistic recreations, as exemplified in most television shows and most popular music, can never do more than strike and glance off, being neither of sufficient force nor importance to penetrate deeply. On the other hand, good music, whether it be of the inadequately described "classical" or of the equally moving Dixieland variety offers a challenge to the understanding. The pleasure of the understanding is adequate enough reason. Those who search will find it. Those who see no need to search must be allowed their little pleasures.

Robert J. Needles, M.D.
 St. Petersburg, Fla.

SIR:

I have two specific reasons for writing this letter, but first of all allow me to say I... think your record reviews excellent. . . . They are detailed, well thought out, honest, not too terribly prejudiced, and (which I like best) the writers compare the various recordings at length. For those of us who cannot hear every new record, this is a great aid.

When the excerpt from Mr. Kerman's book *Opera as Drama* first appeared in your magazine (Sept. 1956), I almost wrote in a letter. . . . However, by dint of sheer force of will, I restrained myself to inward seething. . . . I can no longer. I do not believe that anyone will seriously question the statement that *Tosca* is an out-and-out melodramatic thriller, on a totally different level from *Otello*, written from a different point of view with different aims, and with a resulting totally different set of values. Mr. Kerman places it on a far lower plane — perhaps on an absolute scale he is correct — but that to me fur-

Continued on page 8

Try this self-demonstration:

*that you will enjoy music much more
when you know what to listen for*

THIS IS THE SENSIBLE IDEA OF *MUSIC-APPRECIATION RECORDS*



ON TWO SIDES OF A TWELVE-INCH RECORD there is a full, uninterrupted performance of a great musical work featuring orchestras and soloists of recognized distinction both in this country and abroad. You listen to this performance record before or after, as you desire, and then . . .



ON AN ACCOMPANYING TEN-INCH RECORD, when you want it, there is an illuminating analysis of the music, with the various themes and other main features of the work demonstrated separately by orchestra or soloist, with running explanatory comment, so that you can learn *what to listen for* in order to appreciate the work fully.

ALL TOO FREQUENTLY, most of us are aware, we do not listen to good music with due understanding and appreciation. Our minds wander, and we realize afterward that we have missed most of the beauties of the work. There is no doubt about the reason: most of us are not primed about what to listen for.

THIS SENSIBLE PLAN—to help music-lovers increase their enjoyment and understanding of music—was originated by the Book-of-the-Month Club two years ago. The Club recently commissioned Leonard Bernstein, the brilliant American conductor, to perform and analyze five orchestral works on MUSIC-APPRECIATION RECORDS. You will appreciate

their quality if you heard Mr. Bernstein on television's "Omnibus" program, in which he demonstrated his extraordinary ability to explain the technical aspects of music in an enjoyable way.

A PERFORMANCE of Beethoven's *Eroica* Symphony, conducted by Leonard Bernstein, with The Stadium Concerts Symphony Orchestra—together with an analysis of the work also written and conducted by Mr. Bernstein—has been recently distributed to subscribers. Because these two records demonstrate in a particularly exciting way the MUSIC-APPRECIATION RECORDS idea, we will send them to you at once — without charge — on this special trial offer.

THE REGULAR PRICE of these double-disc recordings is \$3.90 (plus a small mailing charge). After hearing the *Eroica*, should you not want to receive other great works of music performed and analyzed in this way you may return the recording within ten days and be under no further obligation. If you decide to continue, you need take only two other recordings out of 15 to 20 to be made available during the next year.

A different work is announced in advance each month to subscribers, described interestingly by Deems Taylor. As a subscriber you may accept only those recordings you are sure you want for your permanent record library.

AS A DEMONSTRATION

This Two-Record Album GIVEN TO YOU

IF YOU AGREE TO BUY TWO OTHER RECORDINGS DURING THE NEXT YEAR

BEETHOVEN'S *Eroica*

Conducted and analyzed by LEONARD BERNSTEIN



PLEASE RETURN ONLY IF YOU HAVE A 33 1/3 R.P.M. RECORD PLAYER

MUSIC-APPRECIATION RECORDS R10-3
c/o Book-of-the-Month Club, Inc.
345 Hudson Street, New York 14, N. Y.

Please send me at once the 12-inch 33 1/3 R.P.M. Demonstration Record of Beethoven's *Eroica* Symphony together with its 10-inch Analysis Record, without charge, and enroll me in a trial subscription to Music-Appreciation Records. I may return the recording within 10 days and be under no further obligation. Otherwise, on this special offer, I need buy only two Music-Appreciation selections during the next year, and I may cancel my subscription any time thereafter.

MR. {
MRS. {
MISS {
(PLEASE PRINT PLAINLY)

Address.....

City.....Postal Zone No.....State.....

Record prices are the same in Canada, and the Club ships to Canadian members, without any charge for duty, through Book-of-the-Month Club (Canada), Ltd.

MAR 89

the Magnificent Ferrograph

The world's finest hi-fi tape recorder

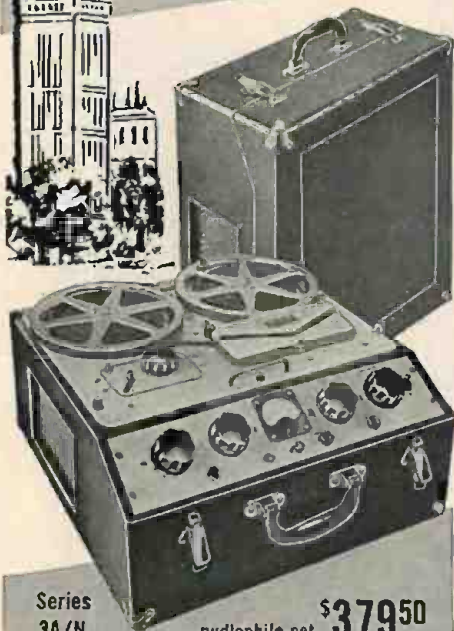

Series 3A/N audiophile net \$379.50

professional quality at nominal cost

The world-famous FERROGRAPH magnetic tape recorder, designed and developed primarily for professional use, has been re-styled for YOU — the discriminating audiophile, the progressive educator, the efficient businessman, the music lover.

Standard equipment with the British Broadcasting Corporation, it is a byword with cultural, educational and scientific users throughout Europe. The FERROGRAPH is unconditionally guaranteed to meet the most critical performance requirements.

Two models of this versatile dual-speed, dual track recorder are now available in LIMITED QUANTITIES, with tape speeds of 3 3/4" and 7 1/2" or 7 1/2" and 15" per second. Both models feature the employment of a synchronous hysteresis capstan motor providing unparalleled long-term speed stability, thus avoiding pitch errors on playback.



ALL FERROGRAPH RECORDERS AND TAPE DECKS have three motors. Custom installation models with tape speeds of either 7 1/2 and 15 ips or 3 3/4 and 7 1/2 ips are available. (Custom model 66/H illus. at left).



Write for performance specifications and the name of the franchised dealer in your area.

ERCONA CORPORATION
(Electronic Division)
551 Fifth Ave., Dept. 61 New York, N. Y.

In Canada: Astral Electric Co., Ltd.,
44 Danforth Rd., Toronto 13

If You're a Connoisseur... you'll want a Connoisseur TURNTABLE



\$110.00

Compare the Connoisseur with any turntable and you'll marvel at its performance. Non-magnetic, 12" lath-turned table; precision ground spindle; phosphor bronze turntable bearing. ±2% variation provided for all 3 speeds; hysteresis motor.

TURNTABLE: Rumble—better than 50 db down; Wow—less than 0.15% of rated speed; Dimensions: 13 1/2"x15 1/4".

PICKUP: Frequency Response — 20-20,000 cps ±2 db at 33 1/2 rpm; Effective Mass—4 mg; Impedance—400 ohms at 1000 cps.



"Dynabanced" tone arm with Mark II super-lightweight pickup w/diamond stylus \$49.50... w/sapphire stylus \$34.50.

ERCONA CORPORATION

(Electronic Division)

551 Fifth Ave., Dept. 63, New York 17
In Canada, write Astral Electric Company Limited, 44 Danforth Road, Toronto 13

part Beethoven part...what?

It is one thing to hear a few bars of a sonata—it whets the appetite of the connoisseur and gives him a foretaste of future enjoyment. But to hear half of a complete symphony is more than disappointing.

Yet, you can play a recording from end to end and you can't hear ALL the music unless your hi-fi equipment includes a KELLY Ribbon "tweeter". Then, you can be sure that you've heard EVERYTHING that's on the record... SO, for music's sake, add a KELLY... made in England!



SPECIFICATIONS

- Frequency response — 3000-20,000 cps
- Horn loading — 1000 cps cutoff
- Dimensions — 8 1/2" x 5 1/2" x 4 1/2"
- Force mass ratio — 4 x 10⁷ dynes/gm.

Audiophile Net \$69.95

Crossover network \$22.95 (3000 cps) Model ON/1

Write for complete information on The **KELLY** UHF reproducer.

AT LEADING HI-FI MUSIC CENTERS
ERCONA CORPORATION
(Electronic Division)
551 Fifth Ave., Dept. 62, New York, N. Y.

LETTERS

Continued from page 6

nishes the best reason why the two cannot be compared. . . . No critic worth his standing has the right to use one genre to show up its inadequacies as a creature of another genre. It is similar to my showing someone a trout, and saying: "Well, of course, on the evolutionary scale, this animal has not progressed from the sea onto the dry land, has not developed legs and fur and become a dog. And you see, therefore, what a terrible dog this trout is. It has gills, which no dog has; it doesn't have the bark of a dog; most of all, it doesn't possess the developed brain of a dog. It is a 'cheap Piece,' 'second-rate through and through' (as compared with a dog)."

Mr. Kerman . . . arbitrarily sets up a 'great opera' (one that, by the way, most people today consider 'great'), and then, instead of finding a comparable work to evaluate with it, chooses a work entirely unrelated to it (except that they are both 'animals' called 'opera, grand'). He then proceeds to hold the second one up to ridicule from the point of view of the first. I must agree with him: *Tosca* is a miserable attempt at *Otello*. . . . But let us for a moment turn the coin around. . . . Let us set up a different "standard": a standard which says, more or less: "Every opera must be a melodrama, with plenty of good meaty arias, with welters of song rising from the orchestra, and with plenty of solid action." How pale is poor *Otello*. The orchestration, as compared to our 'standard,' . . . is "musty pedantry of small-minded scholars who don't know what music really is." The modulation of keys etc. is bad, it is dry pedantic exercise, and the "Willow Song," far from being great, violates the requirement for a good meaty aria. Here is a pale replica to put beside "*Vissi d'Arte*"—no decent high notes to swell on. And the end of the opera—no rousing cabalera. Shame: shame: a snivelling way to end a Grand Opera. . . .

Mr. Kerman's article, therefore, only goes to prove that average critics of every age will insist on imposing the current set of values in vogue in the critical world (Mr. Kerman quotes Eliot as if quoting scripture) upon all art forms that come before them, and any that do not fit are automatically "second-rate," "café-music," and any of the other facile terms of dis-

approbation current in their milieu. I am only trying to say that, in my opinion, the work of every artist differs from the work of every other (and, often, the works of the same artist differ among themselves). Therefore, each must be judged with the critical tools applicable. . . . Mr. Kerman would have done better to compare *Otello* with a work having the same general aims. Puccini's aims were: good 'melo'-drama, good arias, and a base of leitmotif orchestral accompaniment. *Tosca* is not to be placed in competition with *Otello*, any more than a fish with a dog, or *Cyrano* with *Hamlet*. . . .

Patrick J. Smith
New York, N. Y.

SIR:

There aren't more than fifty or so 78-albums left in my record collection, the consequence of living the life of a widely wandering scholar since the advent of microgroove, but one of them is Columbia MM 337, and I can therefore take exception to John Ball Jr.'s statement (HIGH FIDELITY, Nov. 1956, p. 67) that the Muck recording of the "Transformation Scene" ends with "the crashing impact of timpani. . . ."

What he heard, is, in fact, the only recorded sound of Mottl's famed "bell machine" designed by the conductor to play just these four notes in *Parsifal* and spare Bayreuth the need of constructing a belfry for the rather large bells which would otherwise have been required.

In his standard treatise on orchestration, Cecil Forsyth describes the unit (p. 54) as "somewhat startling" in appearance.

"It is as if an amateur carpenter had been trying to convert a billiard table into a grand pianoforte, and in the course of his experiments had left the works outside." Essentially the device was a boxlike sounding board strung with twenty-four piano strings (six for each note, three of them tuned an octave higher). It was played with a large, soft hammer and doubled by a tuba and other percussion. Bayreuth gave it up some time in the Thirties, but its sonic possibilities deserved preservation, just as that old Muck set deserves reissue as a collector's item.

Robert C. Marsh
Chicago, Ill.



MARCH 1957

Save on Famous **knight Hi-Fi**

THE VERY FINEST FOR LESS:



Knight Custom components are built to ALLIED's own special high standards to deliver outstanding musical quality with distinguished appearance at money-saving minimum cost. Each unit is unconditionally guaranteed for one full year.

ALLIED
EXCLUSIVES

Top Value knight Hi-Fi Components



ONLY
\$94⁵⁰

Deluxe 24-Watt Amplifier. "Space-Saver" design; response, ± 0.75 db, 20-40,000 cps; 12-position compensation; variable damping; loudness control; rumble filter; tape head input; hum balance. U.L. Approved. Shpg. wt., 30 lbs. Net. . . . \$94.50



ONLY
\$99⁵⁰

Deluxe Basic FM-AM Tuner. Matches Deluxe amplifier; AFC; tuning meter; tuned RF on FM and AM; FM discriminator; 2 cathode followers; exceptional sensitivity. FCC Approved Radiation; U.L. Approved. Shpg. wt., 17 lbs. Net. . . . \$99.50



ONLY
\$64⁵⁰

"Bantam" 12-Watt Amplifier. Response, ± 0.5 db, 20-20,000 cps; 3-position compensation; variable damping; loudness control; built-in preamp; tape head input; 7 inputs; "Space-Saver" design. U.L. Approved. Shpg. wt., 18 lbs. Net. . . . \$64.50



ONLY
\$74⁵⁰

"Bantam" Basic FM-AM Tuner. Matches "Bantam" Amplifier; AFC; FM limiter and discriminator; output level control; RF stage; high sensitivity; temperature-compensated oscillator. FCC Approved Radiation; U.L. App. 13 lbs. Net. . . . \$74.50



ONLY
\$104⁹⁵

"Uni-Fi" Tuner-Amplifier Combination. Single chassis construction; complete FM-AM Tuner, Preamplifier and Amplifier all in one; compact, $4\frac{1}{4} \times 15 \times 10\frac{1}{2}$ "; 10-watt amplifier has every advanced feature; FCC Radiation Approved. "Uni-Fi" chassis only. 17 lbs. Net. \$104.95 "Uni-Fi" complete in "Space-Saver" cabinet. 21 lbs. Net. . . . \$109.95



LOW-COST knight PHONO SYSTEM

ONLY
\$174⁵⁰ Top value in a fine Hi-Fi music system. You save \$18.32 over cost of individual components. No cabinets required. Includes Knight "Bantam" amplifier; E-V Baronet Speaker System (specify limed oak or mahogany finish); Webcor 1632-27B Changer with G.E. RPX-050A Triple Play Cartridge (dual sapphire styli). Easy installation. Shpg. wt., 67 lbs. 94 PA 600. Complete System. . . . \$174.50



ONLY
\$44⁵⁰

Preamp-Equalizer. Lowest-cost self-powered preamplifier. 3-position compensation; rumble switch; loudness switch; ± 1 db, 30-30,000 cps. U.L. Approved. Shpg. wt., 8 lbs. Net. . . . \$44.50

ALL PRICES NET, F.O.B. CHICAGO



FREE
ALLIED'S 1957
356-PAGE CATALOG

Send for this value-packed catalog featuring the world's largest selection of Hi-Fi components and systems, as well as everything in Electronics.

Write for your copy today.

ALLIED RADIO
America's Hi-Fi Center

OUR
34th
YEAR

ALLIED RADIO CORP., Dept. 49-C-7
100 N. Western Ave., Chicago 80, Ill.

Ship the following KNIGHT Hi-Fi equipment _____

\$ _____ enclosed

Send FREE 356-page ALLIED 1957 Catalog

Name _____

Address _____

City _____ Zone _____ State _____

why
step in
to
replace?

step up to a **RONDINE**
the first time!

Invest once — buy a REK-O-KUT precision turntable. Your purchase of a Rondine turntable is an investment in *the best* in sound and record care! Because Rondine is "quiet for keeps! . . . it will remain your one abiding component even when you improve on other equipment in your system. For those first venturing into "high fidelity" . . . Rondine will be your *first* and *last* investment in a turntable! Rondine precision turntables suit every budget — Rondine Jr., 2-speed — \$59.95 . . . Rondine Standard, 3-speed — \$84.95 . . . Rondine DeLuxe (hysteresis motor), \$120.95.

write for colorful booklet — "Turntable or Record Changer — Which Shall I Buy?"



REK-O-KUT COMPANY, INC., 38-01 QUEENS BLVD., LONG ISLAND CITY 1, N. Y.

EXPORT: Morhag Exporting Corp., 438 Broadway, N. Y. 13, N. Y. • CANADA: Atlas Radio Corp., 50 Wingold Ave., Toronto 10, Ontario





Hi-Fi Phrenia

In the second issue of HIGH FIDELITY Magazine (Fall 1951) there appeared an article which bore the title used above. It was written by a layman, then well known as a writer but now much more familiar to our readers: editor John Conly.

Mr. Conly did not then claim any deep knowledge of psychiatry, nor had he achieved a reputation as predictor. He did, however, size up hi-fi phrenia as a disease. In this, he was some five years ahead of his time, for it is only within the past three months that hi-fi phrenia has been recognized by professional psychiatrists and openly brought to public attention. *Time* Magazine (January 14, 1957) credits Dr. Henry Angus Bowes, clinical director in psychiatry at Ste. Anne's Hospital at Ste. Anne de Bellevue, Quebec, with discovery of a "new neurosis: audiophilix." *Time* goes on to quote from a talk Dr. Bowes gave to a divisional meeting of the American Psychiatric Association in Montreal.

We obtained a copy of the talk from Dr. Bowes, and admit that we haven't had as much of a chuckle in a long time. We recognized many of our hi-fi friends and even some members of the staff; we ourselves have not looked in the mirror lately. But we have been in touch with Dr. Bowes and are urging him to write an article for HIGH FIDELITY, even though the subject is a touchy one. We are confident that Dr. Bowes has the skill to handle it without offense, although we think he might reconsider his conclusion about why a wife doesn't like high volume levels: "Perhaps in the male's interest in hi-fi she senses a rival, as shrill and discordant as herself." Such statements will not help our campaign to get high fidelity out of the cellar and into the living room. Not that the statement may not be entirely true; rather, we foresee a rash

Continued on next page



ON ONE COMPACT CHASSIS! FISHER FM-AM TUNER, AUDIO CONTROL AND 30-WATT AMPLIFIER!

New!

EVERYTHING YOU NEED!
ON ONE SUPERB CHASSIS!

THE FISHER "500"

THOUSANDS have asked us for it—and here it is! An extreme-sensitivity FM-AM tuner, a powerful 30-watt amplifier, and a Master Audio Control—all built on one compact chassis. Simply add a record changer and loudspeaker to the FISHER "500" and, as easily as that, you have a complete high fidelity system. Its quality—in the finest FISHER tradition. Its appearance—the timeless beauty of classic simplicity. Here is the most economical form in which you can own FISHER equipment.

Chassis Only, **\$239.50**

Mahogany or Blonde Cabinet, **\$19.95**

Outstanding Features of THE FISHER "500"

- Extreme sensitivity on FM and AM. Meter for micro-accurate tuning. ■ Full wide-band FM detector for maximum capture ratio. ■ Powerful, 30-watt amplifier; handles 60-watt peaks. ■ Uniform response, 16 to 32,000 cycles. ■ 4 inputs, including separate tape playback preamp-equalizer. ■ 4, 8 and 16-ohm outputs match all existing speakers. ■ Recorder output ahead of volume and tone controls. ■ 7 Controls, including 9-position Channel Selector (AM, FM, AES, RIAA, LP, NAB, TAPE, AUX 1 and AUX 2), Loudness Contour (4-position), Volume, Bass, Treble, AC-Power, Station Selector. ■ Beautiful, die-cast, brushed brass escutcheon and control panel. ■ Pin-point, channel indicator lights. ■ Smooth, flywheel tuning. ■ Largest, easy-to-read, slide-rule dial, with logging scale. ■ High efficiency FM and AM antennas supplied. ■ 14 tubes plus 2 matched germanium diodes. ■ SIZE: 13 7/16" w. x 12 1/4" d. (excluding knobs) x 6 1/4" high.

Prices Slightly Higher In The Far West

WRITE TODAY FOR COMPLETE SPECIFICATIONS

FISHER RADIO CORP., 21-25 44th DRIVE • L. I. CITY 1 • N. Y.

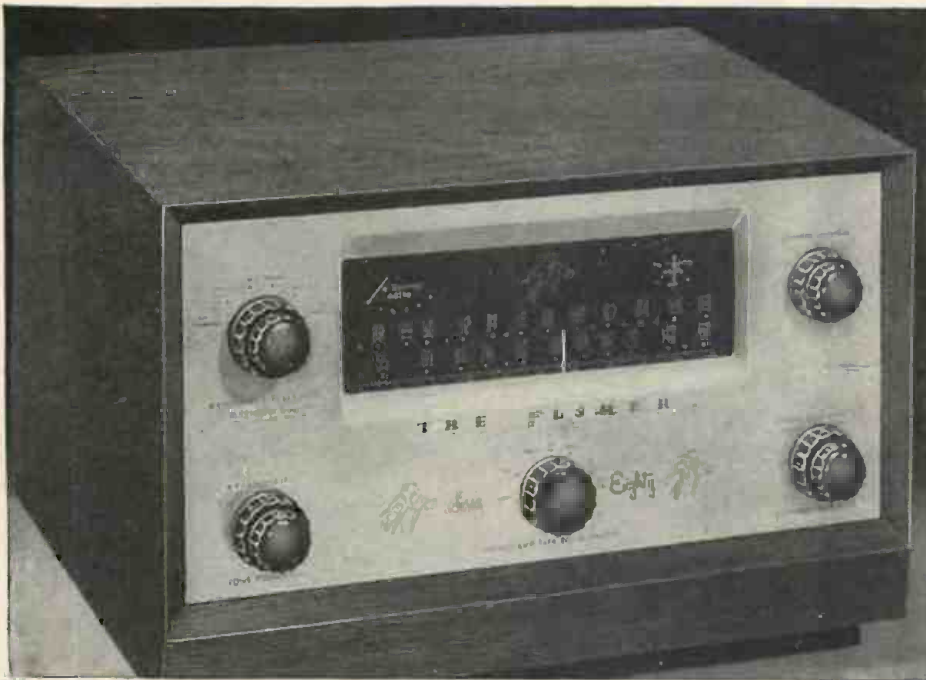

MODEL 80-T • MOST ADVANCED PROFESSIONAL TUNER WITH COMPLETE AUDIO CONTROLS

Outperforms Them All!

THE FISHER

MODEL 80-T • MODEL 80-R

FM-AM TUNERS

HERE ARE AMERICA'S only FM-AM Tuners with TWO meters for micro-accurate tuning—just one of their many unique features. THE FISHER Series 80 FM-AM Tuners enjoy an unparalleled reputation as the leaders in high fidelity. The roster of professionals using THE FISHER tuners include the names of some of the most outstanding organizations in the research, broadcasting, and educational fields. In every case, THE FISHER was chosen because, unquestionably, it provides a level of performance that exceeds even the most critical requirements. "Performance, flexibility, and all-around 'usefulness' are excellent!"—*High Fidelity Magazine*.

Outstanding Features of THE FISHER Series 80

- The Model 80-T features extreme FM sensitivity—1.5 microvolts for 20 db of quieting. ■ Full limiting on signals as low as one microvolt. ■ Separate FM and AM front ends, completely shielded and shock-mounted. ■ Separate tuning meters for FM and AM. ■ 72-ohm, plus exclusive balanced, 300-ohm antenna inputs for increased signal-to-noise ratio. ■ Supplied with AM loop and FM dipole antennas. ■ Adjustable AM selectivity. ■ AM sensitivity better than one microvolt for full output. ■ Inherent hum non-measurable. ■ Distortion below 0.04% for 1 volt output. ■ Four inputs. ■ Separate tape-head playback preamplifier (with NARTB equalization.) ■ Preamplifier-equalizer has sufficient gain to operate lowest level magnetic cartridges. ■ Six choices of record equalization. ■ Multiplex and cathode follower outputs. Frequency response, on FM, within 0.5 db, 20 to 20,000 cycles. ■ Super-smooth flywheel tuning mechanism. ■ 16 tubes. (Model 80-R: 13 tubes.) ■ EIGHT CONTROLS: Selector, Variable APC/Line Switch, Station Selector, Bass, Treble, Equalization, Volume, 4-Position Loudness Contour. ■ Self powered. ■ DC on all audio filaments. ■ Beautiful brushed-brass front panel. ■ SIZE: 12 3/4" wide x 8 1/4" deep x 6" high. (Model 80-R: 4" high.) ■ WEIGHT: 21 pounds. (Model 80-R: 16 pounds.) ■ NOTE: Model 80-R is identical to the above, but is designed for use with an external audio control, such as THE FISHER Series 80-C Master Audio Control.

MODEL 80-R • FOR USE WITH EXTERNAL AUDIO CONTROL



MODEL 80-T
\$199⁵⁰

MODEL 80-R
\$169⁵⁰

MAHOGANY OR BLONDE
CABINET: \$1795

Prices Slightly More
In The Far West

Write For FULL Details

FISHER RADIO CORP.

21-25 44th Dr., L.I.C. 1, N.Y.

NOTED WITH INTEREST

Continued from preceding page

of husbands rushing to their doctors, many of whom are hi-fi enthusiasts themselves (encephalographic equipment could be attached to an inter-modulation distortion meter). We do not think such experiments would be greeted with cordiality by the other (better?) half of the family.

Anyhow . . . (1) we compliment John Conly on his farsightedness. He concluded his article with this significant sentence: "Those thus afflicted are harmless, happy people, and as the disease is incurable, no effort should be made to restrain them."

(2) We hope Dr. Bowes will have the time and inclination to write for us.

And (3), we want to thank the doctors among our readers for their alertness in sending us clippings about Dr. Bowes's talk.

Audio Consultants, continued.

The note in the January NWI column about audio consultants brought some more names: in Chicago, Urbain-Wilson, 6229 N. Wayne Ave., wrote a good letter pointing out that they carry no stock—in fact, charge extra if they have to buy equipment! Their consulting work for high fidelity started as a hobby, Leon Urbain being a registered engineer and designer of industrial plants.

In Endicott, N. Y., Tom Worthington (107 W. Valley St.) is also moving a hobby into a business. He writes that he has been doing audio consulting on a very informal basis for about a year. He and a friend, incidentally, are starting an audio society and would appreciate a call (phone is Endicott 8-0716) from anyone interested.

In Wichita

Like many another store these days, the Bennett Music House in Wichita moved out to the wide open spaces where parking was simple. This is standard practice, all readers know about it, and would not be worth NWI mention . . . except that Bennett's announcement included two sentences which we'd like to quote, since we feel they indicate a bit of understanding about buying habits which other dealers would do well to recognize. Said Bennett: "Our surveys in-

licated that many of our customers want to take their family as a group when shopping for pianos, organs, band instruments, hi-fi components, even records. This, in most cases, means that such shopping must be done evenings after dinner. Also, it really takes longer to buy a piano, high-fidelity, or television set than many other purchases." So Bennett set up new store hours which are tough on the clerks but wonderful for customers: 9 a.m. to 9 p.m. six days a week, plus 1 p.m. to 6 p.m. on Sundays.

Hi-Fi Shows

The latest schedule from Rigo Enterprises, Inc., announces the following shows:

- Pittsburgh: March 8, 9, 10
- Philadelphia: March 29, 30, 31 (at the Benjamin Franklin)
- Baltimore: April 5, 6, 7 (at the Lord Baltimore)
- Cincinnati: September 20, 21, 22
- Miami: October 18, 19, 20
- St. Louis: November 22, 23, 24

We Zinc Not

Our habit of collecting reference manuals has, for once, not been of any help.

This episode in the career of HIGH FIDELITY's NWI writer starts calmly enough with an article in our December issue about Christmas stockings and presents therefor, in which solder was suggested. The author of that article neglected to mention that very fine solder is made by the American Smelting and Refining Company, a point that was tactfully brought out in a nice letter from S. Glueck, General Manager, Eastern Department, Ferrated Metals Division. Mr. Glueck went on to say that one reason, he thought, for the wide acceptance of his company's solder was the fact that it was made of tin and lead, not zinc and lead as referred to in the article.

On further examination of the matter, it would seem that our author was being entirely too esoteric . . . zinc is used in solder, but not in the types customarily used in audio (or radio) work.

Reference hunting in the *American Machinists' Handbook* indicates that most solders are made of tin and lead but it also suggests a "hard" solder composed of silver, copper, and zinc

Continued on next page



AMERICA'S LEADING FM TUNER • IN SENSITIVITY, APPEARANCE AND WORKMANSHIP

ANOTHER FISHER FIRST!

THE REVOLUTIONARY

FISHER FM-90X

Gold Cascode FM Tuner

HARD ON THE HEELS of the new Model FM-90, we are proud to present the Model FM-90X with its revolutionary GOLD CASCODE RF amplifier. Precision manufactured, this tube is the costliest of its type in the world! It carries a *two-year warranty*. The use of the gold cascode and special circuitry has brought the FM-90X to the theoretical limits of sensitivity — an achievement never before possible. *Only the FISHER has it!* The standard FM-90, with its silver-plated RF shield, already surpasses ALL other FM tuners — excepting the FISHER GOLD CASCODE 90X.

Basic Features of the Series FM-90

- TWO meters, for micro-accurate tuning. • Revolutionary, dual dynamic limiters, assure noise-free reception where all others fail. • Full wide-band detector for maximum capture ratio. • *Exclusive*, variable inter-station noise eliminator. • Full limiting on signals as low as 1 microvolt. • Dual triode, cascode-tuned RF stage, four IF stages. • Uniform response, 20 to 20,000 cycles. • Three outputs (Main, Recorder and Multiplex). • Dual antenna inputs (72 ohms or 300 ohms balanced). • Four controls, • 10 tubes plus four matched germanium crystal diodes. • Special circuits for meter operation. • Chassis completely shielded and shock-mounted. • Beautiful, die-cast, brushed brass escutcheon and control panel. • Dipole antenna supplied. • SIZE: 13 7/16" w. x 6 1/4" high x 8 3/4" deep (plus 1" for knobs). • wgt: 15 lbs.

FM-90X • Gold Cascode FM Tuner • \$169.50

FM-90 • Professional FM Tuner • \$149.50

MAHOGANY OR BLONDE CABINET: \$17.95

Prices Slightly Higher in the Far West

WRITE TODAY FOR COMPLETE SPECIFICATIONS

FISHER RADIO CORP., 21-25 44th DRIVE • L. I. CITY 1 • N. Y.



THE FISHER 25-WATT

Master Control-Amplifier · CA-40

■ Complete in every respect — and it's by FISHER! A new 25-watt amplifier with *complete* Audio Controls. Less than 1% distortion at 25 watts! Six inputs. Six equalization positions. *Exclusive* FISHER TONE-SCOPE provides graph-form indication of Tone Control settings. Direct, tape-head playback and microphone preamplifier. Uniform frequency response within 0.5 db, 10 to 90,000 cycles. Less than 1% IM distortion at 15 watts. Hum and noise level better than 90 db below full output. Cathode-follower tape recorder output. Speaker output impedances: 4, 8 and 16-ohms. Nine controls. TUBE COMPLEMENT: 1-12AU7A, 3-12AX7, 4-EL84, 2-6BW4. SIZE: 12 $\frac{3}{4}$ " wide x 10 $\frac{3}{4}$ " deep x 5" high. WEIGHT: 24 pounds.

\$139.50

Two Great Audio Units!

THE FISHER

MODEL CA-40 · MODEL 80-C

THE FISHER

Master Audio Control · 80-C

■ "Breathtaking!"—*Edward Tamall Canby*. The Master Audio Control can be used with any amplifier. Provides professional phono and tape-head equalization, plus full mixing and fading facilities for from two to five channels. Seven inputs. Two cathode-follower outputs. Uniform response within 0.25 db, 20 to 20,000 cycles. IM distortion and hum virtually non-measurable. DC on all filaments. Separate equalization and preamplification *directly* from tape playback head. Eight controls. TUBE COMPLEMENT: 3-12AX7, 1-12AU7A. SIZE: 12 $\frac{3}{4}$ " wide x 7 $\frac{3}{4}$ " deep x 4 $\frac{1}{4}$ " high. WEIGHT: 10 pounds.

\$99.50

Prices Slightly Higher In The Far West Mahogany or Blonde Cabinet \$9.95

WRITE TODAY FOR COMPLETE SPECIFICATIONS

FISHER RADIO CORP. · 21-25 44th DRIVE · L. I. CITY 1, N. Y.



NOTED WITH INTEREST

Continued from preceding page

for use when high strength is essential. Further reference searching came to grief, however, when we started in on *The Handbook of Chemistry and Physics*, because the next item on the page had to do with stopcock grease, the formula for a light lubricant variety being 10 parts smoked pale crepe rubber, 18 parts vaseline, and 1 part paraffin. Which sounds more like a formula for crepes suzette . . . anyway, enough of that.

As far as solder is concerned: let it rest at lead and tin . . . and we will do no further research.

Pickup Pickuppers

In January "Noted With Interest" we published the plea of Rene Willdorf for a clip to be attached to the side of pickup cartridge holders etc. to facilitate picking up the pickup.

Reader Knight of Dunnville, Ontario, sent us a sample doodad he had designed. Material of construction: approximately two-thirds of one bobby pin. Has enough spring to it to snap over the cartridge shell, yet can be bent and will hold its shape.

Reader Russell E. Oakes of Waukesha says he has successfully used Johnson and Johnson's tape type dental floss. He says this type of tape is flexible enough to permit easy grasping 'twixt thumb and forefinger, yet stiff enough to stand up.

Another idea from Mr. Oakes is to snip out a tiny arrow from reflective tape (such as that used on auto bumpers) and attach it to the center of the cartridge, to serve as a guide in locating the position of the stylus tip when spotting the pickup on a particular band or portion of the record. Advantage of the reflector tape is that it shows up better in the poor illumination usually found around turntables.

The Shape of Things

Ever since we first saw the Stephens advertisements for their Eames-designed speaker enclosures, we have been wondering just why the rectangular box, or the corner triangle, is about all you ever see. The bass reflex is supposed to be a Helmholtz resonator, yet the "perfect" Helmholtz resonator is a sphere. The rectangular box produces all sorts of resonances

that Helmholtz would have shunned violently (so we have to use a lot of padding inside the boxes to mute the resonances). The triangular aspect of a corner enclosure may be inescapable. But there are a few departures; Westminster Records had one, designed by George Varkonyi, and we have had a sphere for a "Tested in the Home" report.

Seems to us there is lots of room for exploration and redesign in this direction. Congratulations to Stephens and designer Eames for taking a second look at speaker enclosures.

Guarantee

An announcement from Philco says that for the first time in history, you can buy a radio guaranteed for five years. This guarantee applies to their all-transistor "cordless" home radio and covers not only parts but service as well. In addition, Philco dealers will replace the two ordinary flashlight cells, which power the transistor radio, free of charge if they wear out within one year.

The release goes on to say that the radio is capable of playing over 250 hours on the two flashlight cells.

This is a most interesting development. Most radio (and audio) guarantees are limited by tube life; they read guaranteed for so many months or years exclusive of tubes. Some of the guarantees (exclusive of tubes!) are for substantially long periods of time. If transistors can replace tubes, particularly in some applications, we may get lifetime guarantees on audio equipment as well as on fountain pens.

On the Level

Keeping turntables that way is much more important than many people realize. Unlevel TT's cause distortion and record wear. Check it from time to time; levels are cheap. Stanley, for instance, makes one out of plastic for 98¢ which magnifies the bubble for critical leveling; there are many others.

Music By . . .

New Year's Eve caught the Hutchinson, Kansas, Prairie Dunes Country Club with its band down, so enterprising music dealer Marcin Mayfield provided the best in bands, courtesy of — and this is what the announcement to the public said — "courtesy of Mayfield

Continued on next page



THE FISHER

FM Tuner • Model FM-40

■ A beautifully designed FISHER FM Tuner — with all that the name implies — and only \$99.50! Stable circuitry and simplified controls. Meter for micro-accurate tuning. Sensitivity—3 microvolts for 20 db of quieting. Uniform response ± 1 db, 20 to 20,000 cycles. 72 and 300-ohm antenna facilities. Three outputs: Detector/Multiplex, plus cathode follower main output, permitting leads up to 200 feet. Self-powered. Beautiful, brushed-brass front panel. TUBE COMPLEMENT: 1-6BQ7A, 1-6U8, 3-6BH6, 1-6AL5, 1-12AU7A, 1-6X4. SIZE: 12 $\frac{3}{4}$ " wide x 7 $\frac{1}{4}$ " deep x 4" high. WEIGHT: 15 pounds. **\$99.50**

World Leader in Quality

THE FISHER

MODEL FM-40 • MODEL AM-80

THE FISHER

AM Tuner • Model AM-80

■ Combines the pulling power of a professional communications receiver with the broad tuning necessary for high fidelity reception. Features a tuning meter for micro-accurate station selection. Adjustable bandwidth (three-position.) Remarkable sensitivity—less than one microvolt produces maximum output! Elusive and distant stations are brought in with ease. Built-in 10 Kc whistle filter. Dual antenna inputs. Three high-impedance inputs. Cathode follower output permits leads up to 200 feet. Self-powered. Brushed-brass front panel. TUBE COMPLEMENT: 3-6BJ6, 1-6BE6, 1-6AL5, 2-6C4, 1-6X4, SIZE: 12 $\frac{3}{4}$ " wide x 7 $\frac{1}{4}$ " deep x 4" high. WEIGHT: 15 pounds. **\$119.50**

Cabinets Available for FM-40 and AM-80, Blonde or Mahog., \$17.95

WRITE TODAY FOR COMPLETE SPECIFICATIONS

FISHER RADIO CORP. • 21-25 44th DRIVE • L. I. C. 1, N. Y.





90
WATTS
\$229.50

THE FISHER

Lab Standard Amplifier • 90-A

■ At your command — 90 watts of audio power, with less than ½% distortion at full output. Two power supplies assure optimum amplifier operation. *Exclusive* PERFORMANCE MONITOR meter indicates correct adjustments of tube bias, screen voltage and output balance. It also shows average power output. FEATURES: Less than 1% IM distortion at 75 watts! Frequency response ±0.1 db, 20 to 20,000 cycles. Hum and noise better than 92 db below full output. 8 and 16-ohm speaker output impedances. Power socket supplies all necessary voltages for operation of unpowered auxiliary components. CONTROLS: Input Level, Speaker Impedance Switch, Meter Switch, Bias, Screen Voltage, Output Balance, Driver Balance, Z-MATIC. TUBE COMPLEMENT: 1-12AU7A, 1-12AX7, 4-EL34 (6CA7), 1-6Y6, 1-6AU6, 2-5R4GY, plus 2-NE16 regulators. SIZE: 14" wide x 11¼" deep x 8¼" high.

New! And Unequaled!
THE FISHER
AUDIO AMPLIFIERS

THE FISHER

Lab Standard Amplifier • 55-A

■ Plenty of power for your present — and any possible *future* needs. THE FISHER Model 55-A is a *laboratory* instrument designed for *home* use. Delivers 55 watts at less than 1% distortion. Drives even the lowest efficiency speaker system to full output. *Exclusive* FISHER POWER MONITOR meter shows correct adjustment of output tube bias, and indicates average power output. IM distortion below 2% at 50 watts, 0.8% at 45 watts, 0.4% at 10 watts. Harmonic distortion less than 0.08% at 10 watts, 0.05% at 5 watts. Frequency response within 0.1 db, 20 to 20,000 cycles. Hum and noise better than 92 db below full output! 8 and 16-ohm speaker outputs. Octal socket supplies all voltages for operating unpowered components. CONTROLS: Input Level, Bias, Speaker Impedance Switch, Z-MATIC. TUBE COMPLEMENT: 3-12AU7A, 2-6CL6, 2-6550, 2-5AW4. SIZE: 14¼" wide x 9¾" deep x 8¼" high. WEIGHT: 50 pounds.

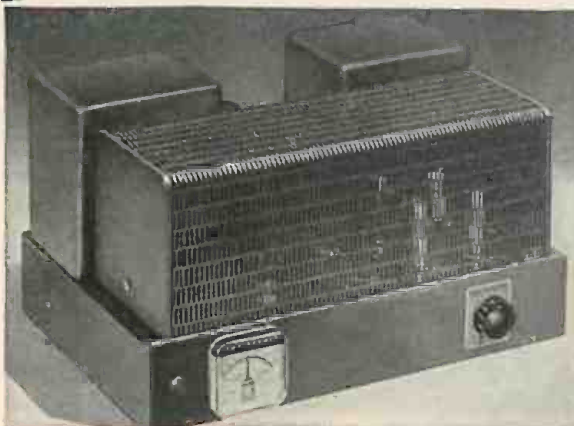

55
WATTS
\$169.50

Write For FULL Details
FISHER RADIO CORP.
21-25 44th DRIVE
Long Island City 1, N. Y.

NOTED WITH INTEREST

Continued from preceding page

Music, Klipsch, Garrard, Scott, and other friends."

That's starting the New Year off right! Smart publicity for high-fidelity custom installations.

And our thanks to reader Erzler, of Hurchinson, for sending us a copy of the country club's announcement.

Minneapolis-St. Paul, please note

Is everyone within FM listening range of the Twin Cities aware that there is a new FM station on the air? KWFM is the only Twin Cities FM-only station; it's a fine music station; the frequency is 97.1 mc. It went on the air the first of the year. Clippings, sent to us by several readers, indicated that KWFM was scheduled from 6 p.m. weekdays, from noon Saturdays and Sundays.

Best of success to KWFM . . . keep us informed of what's going on, please. And thanks to readers for the clippings.

Missing Person

Not seen for the past several days has been Business Manager Warren Syer. It is reliably reported that, the day before his disappearance, an Electro-Voice Patrician kit was delivered to his house.

Joking aside, he is working on the kit . . . and had much praise for one of the smallest items in the whole assemblage: the finishing kit. It comes in six different finishes, and contains all the necessary items, including brushes and even sandpaper.

Sizzler

Canadians in the Montreal area should drop a line to SoundScription Service, 5239 Park Ave., Montreal to receive, free of charge, forthcoming issues of their *Sizzler* — a worthwhile house organ and news bulletin.

Hi-Fi Defined

Reader J. G. Moody, minister of the Canfield Methodist Church in Canfield, Ohio, was good enough to send us a copy of his sermon for December 30. It was entitled "High Fidelity Living," and included an indeed excellent explanation of high-fidelity sound: "A high-fidelity music system

provides the realism which makes a wonderful difference in your listening pleasure in three ways. First, it has a wide frequency range. The lowest notes of the organ, and the highest tones of the triangle, are reproduced clearly and faithfully. Second, there is a minimum of distortion. You may have looked at a picture that is out of focus. The fuzzy, blurred image seriously disturbs your eye. Sound can be similarly distorted, and it is equally disturbing to the ear. A high-fidelity music system is designed to keep distortion at a minimum, so that full and sharply defined tones are heard through the entire musical range. Third, a high-fidelity music system has a balance of tone. A washed out, or gaudily overemphasized color picture has no appeal. In a similar way, the tone colors of a musical performance must be balanced. The high and low notes must be retained in the same relationship as in the original."

Record Cataloguing

Stanley Metalitz of College Park, Md., noted the comments in past issues of **HIGH FIDELITY** about the problem of record indexing and cataloguing. He was kind enough to send us thermocopies of those parts of the U. S. Navy's Special Services manual which deal with record cataloguing. The system must be good, as Mr. Metalitz points out, because he uses it in spite of being a G. I.

We'll try to outline the system briefly (it takes four pages of the Manual), and will ask readers' pardon for inadvertently aping naval terminology: we may, for example, write about stowing records, since that's the way it's done in the Navy.

Start by stowing all 78-rpm records in albums; LPs in their own sleeves. Keep like sizes together, to save space. Do not arrange by title or composer; stow by a number system, which should not be that of the record manufacturer (danger of duplication) and which must be simple. Then use a card file system, and keep this simple. For classical records, the Navy feels a single card by composer's name is sufficient, except for recitals. These should be indexed by artist's name with a cross-reference card by composer, if not too complicated.

Popular music requires more elaborate treatment. A card is recommended for artist, name of show, and name of song.



MODEL 125 — ABSOLUTE DEPENDABILITY AND POWER FOR EVERY APPLICATION

NEW! 125 WATTS!

Power For *EVERY* Purpose

THE FISHER MODEL 125 AMPLIFIER

WITH the introduction of the magnificent, new FISHER Model 125 and its companion, the FISHER Model 55-A, the discriminating user can now select a quality amplifier that will meet his *every* need now, or in the future — on the score of ample *reserve* power and quality reproduction.

OUTSTANDING SPECIFICATIONS

THE FISHER MODEL 125

- Less than 0.6% distortion at 125 watts.
- Less than 1% IM distortion at 100 watts.
- Frequency response ± 0.1 db 20-20,000 cycles.
- Hum and noise better than 92 db below full output.
- Two power supplies.
- Exclusive FISHER Performance Monitor Meter.
- 8 and 16 ohm output impedances.
- Size: 14" x 11 $\frac{1}{4}$ " x 8 $\frac{3}{4}$ " high.

Price **\$229.50**

THE FISHER MODEL 55-A

- Less than 1% distortion at 55 watts.
- Frequency response ± 0.1 db from 20-20,000 cycles.
- Hum and noise better than 92 db below full output.
- Exclusive FISHER Performance Monitor shows correct adjustment of tube bias and indicates average power output.
- 8 and 16 ohm speaker output impedances.
- Size: 14 $\frac{1}{4}$ " wide x 9 $\frac{3}{4}$ " deep x 8-3/16" high.

Price **\$169.50**

MODEL 55-A • LABORATORY STANDARD AMPLIFIER

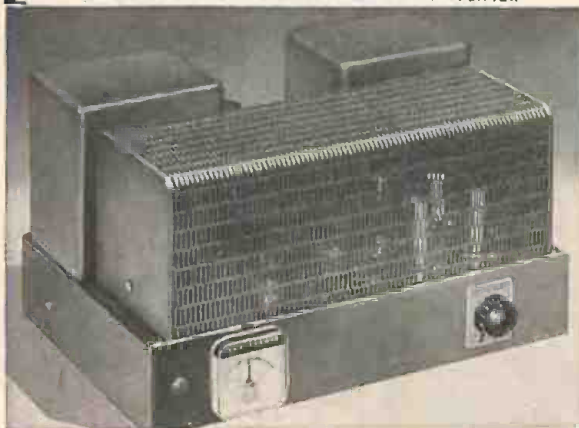

MODEL 55-A

55 WATTS

Write For **FULL** Details
FISHER RADIO
21-25 44th DRIVE
Long Island City 1, N. Y.

McIntosh

matched perfection...

The ultimate in listening pleasure is achieved when the McIntosh 60 basic amplifier is used with the companion Professional Audio Compensator C-8.

Here is unparalleled brilliance of performance to bring you clean, vibrant living sound. Enjoy the outstanding listening quality and ease of the McIntosh, for here is the Heart of True High Fidelity!



C-8
\$88.50
(less cabinet)

professional AUDIO COMPENSATOR

The surpassingly versatile C-8 provides complete and precise audio control. Exclusive McIntosh engineering features bring you an accurate replica of the original program—without compromise. Quality features include great stability, wide-band frequency response, low distortion and extremely quiet operation. Superbly crafted to laboratory standards, the McIntosh C-8 is a criterion for listening pleasure and value. Hear its flawless performance at your dealer's.



MC-60
\$198.50

60 watts of the purest power audio science has yet made available!

A crowning engineering achievement, the McIntosh 60 stands foremost in quality, sets a new standard of excellence, for it performs within 4/10 of 1% of theoretical perfection! The McIntosh patented circuitry operates with great stability and highest efficiency. It delivers full 60 watts throughout 20 to 20,000 cycles, yet limits distortion to a virtually non-existent 1/2% IM and 1/3% Harmonic, maximum! The superlative performance of the McIntosh is *guaranteed* for your protection of quality sound.

SEE YOUR NEAREST AUTHORIZED DEALER FOR

Complete Details on Request

McIntosh

LABORATORY, INC.

4 Chambers St., Binghamton, N. Y.

Export Division: 25 Warren St., New York 7, N. Y. Cable: SIMONTRICE N. Y.

COMPARE . . . you will agree

SHERWOOD

high fidelity is the ultimate



The all new S-1000 II 20 watt amplifier

Only Sherwood tuners feature 0.95 μ v FM sensitivity

	Sherwood S-1000 II \$ 99.50	A \$ 98.95	B \$108.95	C \$108.50	D \$115.00	E \$ 99.75	F \$ 95.00	G \$124.50	H \$139.50	I \$ 99.50	J \$ 99.50	K \$124.50
Feedback tone controls	✓	•	✓	•	✓	✓	✓	•	✓	•	✓	•
EF86 low-noise preamp. tube	✓	•	•	•	•	•	•	•	•	•	•	•
Presence-rise control	✓	•	•	•	•	•	•	✓	•	•	•	•
Tape-head equalization	✓	✓	✓	•	✓	•	✓	✓	✓	•	•	•
Inputs, selectable at front panel	6	5	5	4	6	4	5	5	6	5	4	5
Microphone equalization	✓	•	•	•	•	•	•	•	✓	•	•	✓
Tape-monitor switch	✓	•	•	•	•	✓	•	•	•	•	•	•
Damping-factor selection	✓	•	•	•	✓	•	•	✓	•	•	•	✓
1M distortion at 20 watts	1.0	1.0	1.0	1.4	1.0	2.0	2.0	1.2	1.6	1.5	2.4	2.0
12db/oct. scratch filter	✓	•	✓	✓	✓	•	•	•	✓	✓	•	•
12db/oct. rumble filter	✓	•	✓	✓	✓	✓	✓	•	✓	✓	✓	✓
Cathode-follower recording output	✓	•	•	✓	•	•	✓	•	✓	•	•	•
Phono sensitivity (mv) for full output	3	6	5	6	5	5	6	12	5	3	10	15
Unused inputs shorted to prevent crosstalk	✓	•	•	•	✓	✓	•	✓	✓	✓	•	✓

*With sharp turnover provided by inverse feedback or inductor.

Data is manufacturers' published specifications for current "flat-cabinet" amplifiers (20 or more watts).

Technical literature available on request. Write Dept. HF3.

Sherwood ELECTRONIC LABORATORIES, INC.
2802 West Cullom Avenue, Chicago 18, Illinois

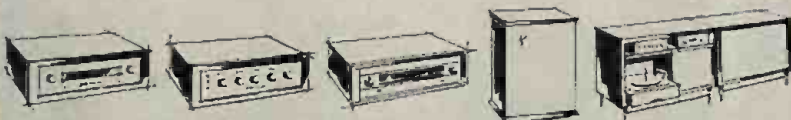

The complete home music center



In New York, hear "Accent on Sound" with Skip Washner, WBAJ-FM, week nights, 9 P.M.



These seem to be the days of booklets and explanatory catalogues.

Bozak has released a detailed CATALOGUE describing their five speaker systems as well as their three basic speakers and several dividing networks. Two pages of theory start things off.

Fairchild has issued a BOOKLET entitled *How Good Is Your Arm?*, which discusses key features of pickup arm design, such as resonance, tracking, tracking error, torsional resonance, pivot design, side thrust, and operating convenience.

Another Fairchild BOOKLET is called *In the Groove* and has to do, as you can guess, with cartridges. Major types of cartridges are described and discussed.

From H. H. Scott comes a CATALOGUE with detailed descriptions and specifications for their line of audio components. The last page is a system planning guide.

Sargent-Rayment announces the Brentwood, a de luxe AM-FM TUNER for \$139.95. Two-position AM is provided; FM sensitivity is 3 μ v for 20 db of quieting. Matching this unit is the Claremont, a CONTROL AMPLIFIER for \$149.95. Among its features are: variable rumble filter; variable scratch filter; nine-position slide rule dial; six-position equalization; 1.5% IM at 20 watts output. Another arrangement of the units produces an AM-FM tuner with control preamplifier on one chassis, the power amplifier on a separate chassis.

Livingston Audio Products has confirmed that it will continue to offer its STEREO TAPES in both stacked- and staggered-head versions.

Allied Radio has added to its Knight line an FM TUNER KIT which will sell for \$37.75, complete with cabinet. It features AFC (defeatable); 10 μ v sensitivity for 20 db of quieting; two output jacks; cathode follower output; and a prewired printed-circuit board.

Fairchild has increased the power rating of their model 255 AMPLIFIER from 25 to 30 watts. Stability and transient response have been improved; IM distortion averages below 0.1% at full output. Price is \$99.50.

Granco Products has announced an

FM-AM TUNER, featuring drift-free tuning and built-in FM and AM antennas housed in a polystyrene cabinet. — Price not given.

Sherwood's new 20-watt AMPLIFIER has, it is asserted, more of everything. To start with, the price is \$99.50; some of the other features include: six inputs; presence control; tape-head equalization; microphone equalization; tape-monitor switch; damping factor selection; 1% IM at 20 watts; scratch filter; rumble filter; frequency response 20 to 20,000 cps ± 0.5 db; and a loudness control.

Harman-Kardon has announced a series of new high-fidelity components in three lines. The Custom Group includes the Trend II AMPLIFIER-PRE-AMPLIFIER rated at 40 watts, with variable damping, rumble filter, three tape equalization positions, three-position speaker selector switch; price is \$125. The Theme II is an FM-AM TUNER with variable AFC and a variable noise gate; FM rumble filter; dimensions match the Trend II, and the price is \$140. Final item in the Custom Group is the Festival II which is a single-chassis TUNER and AMPLIFIER combining the features of the Trend and the Theme units just described. — The De Luxe group includes the Rondo, and FM-AM TUNER with many of the features and performance characteristics of the Theme II but a price tag reading only \$95. The Melody II is a 20-watt AMPLIFIER with full equalization (both phono and tape) and tone control facilities; price is \$95. The Counterpoint II is an FM-only TUNER featuring high sensitivity and variable AFC as well as an automatic noise gate (interstation noise suppressor). Price is \$95. Paralleling the Festival II is the Recital II, which combines all the features of the Melody II and Rondo into a single-chassis TUNER-AMPLIFIER; price, \$175.00. — The Economy line provides hi-fi circuits and features at modest cost. The FM-AM TUNER is called the Overture; variable AFC and a counter-weighted tuning control are among its features; price: \$79.50. The AMPLIFIER is a 10-watter with such features as a rumble filter; equalization and tone controls; price, \$55.00. The Solo combines the features of these two units for a price of \$129.50.

Duotone offers a static-resistant RECORD BRUSH for \$1.00; it clips to

Continued on page 23

the ALTEC BIFLEX principle

(A new development in loudspeaker design)

Biflex loudspeakers are the product of a new principle in loudspeaker design developed by Altec. They have an efficient frequency range far greater than any other type of single voice-coil speaker and equal to or exceeding the majority of two or three-way units. This truly amazing frequency range, which is guaranteed when the speaker is properly baffled, is the result of the Altec developed viscous damped concentric mid-cone compliance.

This compliance serves as a mechanical crossover providing the single voice-coil with the area of the entire cone for the propagation of the lower frequencies and reducing this area and mass for the more efficient reproduction of the higher ranges. Below 1000 cycles per second the inherent stiffness of the Biflex compliance is such that it effectively couples the inner and outer sections of the cone into a single integral unit. The stiffness of the compliance is balanced to the mechanical resistance and inertia of the peripheral cone sec-

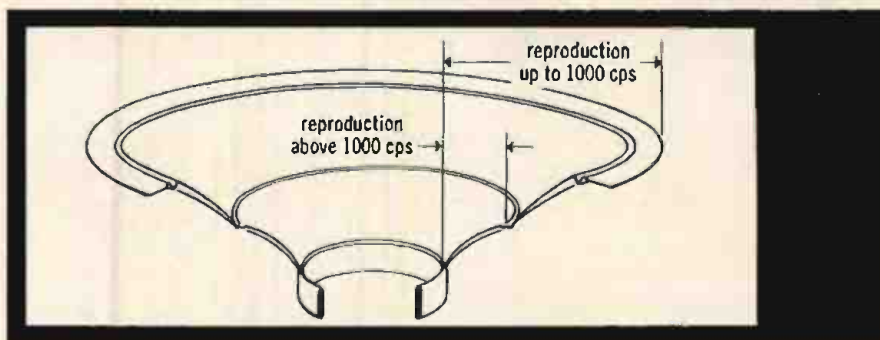

tion so that the mass of this outer section effectively prevents the transmission of sounds above 1000 cycles beyond the mid-compliance and the cone uncouples at this point permitting the inner section to operate independently for the reproduction of tones above 1000 cycles. Proper phasing between the two cone sections is assured by the controlled mechanical resistance provided by the viscous damping applied to the compliance.

In each of the three Biflex speakers, this mid-compliance cone is driven by an edge-wound aluminum voice-coil operating in an extremely deep gap of regular flux density provided by an Alnico V magnetic circuit shaped for maximum efficiency.

If you have not had an opportunity to listen to the Altec Biflex speakers, do so soon. You will be surprised by their quality and efficiency. Compare them with any single voice-coil speaker made; you will find them far superior. You will also find them comparable to many higher-priced coaxial and three-way speaker systems.

An Altec Biflex is the world's greatest value in high fidelity loudspeakers.

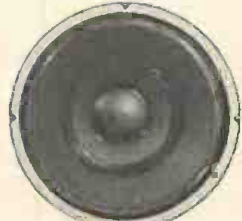
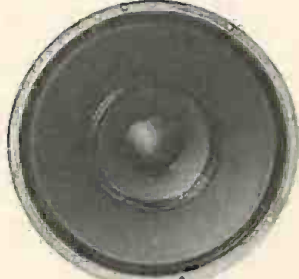
			
Diameter:	408A 8 1/4"	412A 12 1/4"	415A 15 3/8"
Guaranteed Frequency Range:	60 to 16,000 cycles	40 to 15,000 cycles	30 to 14,000 cycles
Price:	\$27.00	\$48.00	\$63.00

ALTEC FIDELITY IS HIGHEST FIDELITY



ALTEC
LANSING CORPORATION

Dept. 3-H
1515 So. Manchester Avenue, Anaheim, Calif.
161 Sixth Avenue, New York 13, N. Y.

At home with the finest...



The METZNER

Starlight

HIGH FIDELITY TURNTABLE



Base
Turntable
Transcription Arm
Complete
\$94.50
Incl. Fed. Tax

Stars in her eyes... romance in her heart... music in the air... and not even a whisper from the Starlight Turntable to disturb her reverie! Mechanical noises that snuff out delicate pianissimo passages are a thing of the past when you own the fabulous Starlight with exclusive center-drive system! No slapping belts—no noisy pulleys—no growling idlers... nothing to mar the sheer enjoyment of the music you love to hear.

See Starlight today... you'll learn why it is the first choice of discriminating music lovers!

Sold by Leading Hi Fidelity Dealers... EVERYWHERE!

- ★ Illuminated Stroboscope — reads while the record is playing.
- ★ Continuously variable speed control with exact settings for 16 $\frac{2}{3}$, 33 $\frac{1}{3}$, 45 & 78.26 RPM.
- ★ Rumble and noise more than 40db below NARTB standard reference level of 7 cm/sec. at 500 cps.
- ★ Wow and flutter less than 0.2% RMS.
- ★ Exclusive double wrist action transcription arm with instant adjustment from 4 to 14 grams.
- ★ Massive base of 1 inch laminated hardwood in Blond or Decorator Black finish.

Turntable \$59.50 Arm \$22.50 Base \$17.50

Metzner ENGINEERING CORPORATION
1041 NORTH SYCAMORE AVE., HOLLYWOOD 38, CALIF

ON THE COUNTER

Continued from page 21

the cartridge or arm shell and runs just ahead of the stylus. Made of finest sable hair.

Philco is entering the TAPE RECORDER field with two units. The TR-200 features stereophonic sound playback and lists at \$219.95. The TR-100, not equipped for stereo playback, lists at \$199.95. Among the features on both models are monitor switch, index timer, push-button controls, dual speaker system, tape speed control, and pause control. Response range is from 40 to 15,000 cycles; wow and flutter is less than 0.5%; and the signal to noise ratio is 45 db. Tape operating speeds not stated.

Fairchild has released the information that experimental products of unusual merit and interest are made available in limited quantities from time to time by Fairchild Recording in order to provide advanced experimenters with the latest advances in the audio field. The XP-2 CARTRIDGE is the latest in this series and is priced at \$60 through regular audio and sound equipment dealers.

Pentron TAPE RECORDERS can now be converted to stereo by means of the Pentron Stereo-Magic kit, which sells for \$16.95, list. It can be used with any Pentron recorder sold during the past five years except models RWN and CT-1, according to the manufacturer.

Wellcor, Inc. is offering an all-new line of SPEAKER BAFFLES. The line includes wall and corner baffles as well as console enclosures. The corner baffles tilt downward, directing the sound toward the listener.

Quality Electronics has announced an AMPLIFIER KIT; features are 12 watts output, built-in preamplifier, output impedances of 4, 8, and 500 ohms. Price not stated. Matching this unit is an FM-AM TUNER KIT featuring an Armstrong circuit and high sensitivity, stated to be 5 μ v for 30 db of quieting on FM.

Fisher is already shipping their latest FM TUNER, the Model FM-90. It uses a full wide-band detector, dual dynamic limiters which are said to reject completely noise and interference caused by automobile or oil burner ignition systems and household appliances. Two tuning meters are used; variable AFC and interchannel muting are provided. Price: \$149.50, less cabinet.

The Altec 3000A loudspeaker the ONLY 22,000 cycle tweeter

The Altec 3000A high frequency speaker is the only tweeter or so-called "super-tweeter" made which has a guaranteed range extending to 22,000 cycles. Many people question the necessity of a high frequency speaker with a range extending half an octave beyond that of the human ear. The extra range has been provided to assure smooth reproduction throughout the entire audible range. In frequency response the 3000A is down approximately seven decibels at 22,000 cycles but is essentially flat from 3000 cycles to the upper limit of human hearing.

Another popular tweeter with an advertised range to 16,000 cycles, the upper limit of human hearing, is down five decibels at 16,000 cycles and this roll-off or loss of high frequency reproduction actually starts at 11,000 cycles. In comparison it can be seen that the extension of the Altec 3000A to 22,000 cycles results in a better response throughout the top 5,000 cycles of the audible range.

Heart of the 3000A speaker, its driving element, is the L1 Pressure Unit. This compression driver without its exponential horn has a useful frequency response to 60,000 cycles and is down only 25 decibels at 100,000 cycles.* This range above 22,000 cycles, which is of no use in high fidelity reproduction, has been reduced in the 3000A in order to achieve the smoothest possible distribution and high efficiency.

The Altec 3000A high frequency speaker is exceptional in its smooth frequency response from 3,000 to 22,000 cycles, and in its even distribution pattern, high efficiency and freedom from tonal coloration. It is ideal for extending the high frequency range of existing speaker systems or as the high frequency component of new low and medium power two-way speaker systems.



L1 Pressure Unit

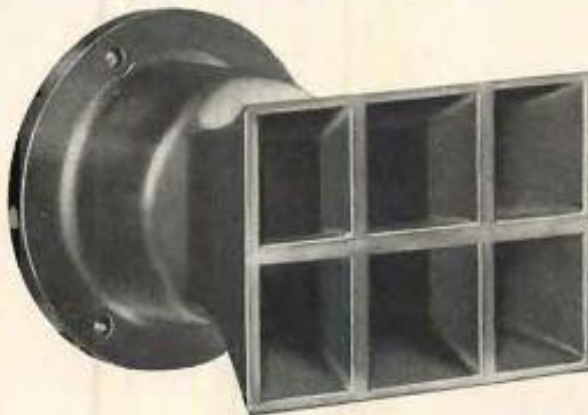

* For those interested in the detailed performance above 22,000 cycles, we will be glad to provide references to the acoustical textbooks which contain charts and data on the L1 Pressure Unit.

Price \$36.00
N-3000A Network \$18.00

ALTEC FIDELITY IS HIGHEST FIDELITY



ALTEC
LANEING CORPORATION

Dept. 3-H
1515 So. Manchester Avenue, Anaheim, Calif.
161 Sixth Avenue, New York 13, N.Y.

WHEN ONLY
THE BEST IS
GOOD ENOUGH...

SOUNDCRAFT "Mylar" [®] BASE

RECORDING TAPES WITH EXCLUSIVE
PLASTICIZER-FREE OXIDE COATING



Stradivarius
courtesy R. Wurlitzer Collection
PLUS 50 by Soundcraft

Soundcraft tape... and Stradivarius!
Both are acclaimed for lasting perfection. On a Stradivarius, the artist re-creates immortal music. On Soundcraft "Mylar" base tapes, this music is preserved forever. Like the "Mylar" base... Soundcraft's exclusive oxide is *plasticizer-free*—won't age. For enduring—true high fidelity recordings, use these Soundcraft tapes with exclusive Oscar-winning Soundcraft oxide on "Mylar" base.

PLUS 50—get 50% longer play
PLUS 100—twice as much on a reel
"LIFETIME"—guaranteed for life



FOR EVERY SOUND REASON

REEVES SOUNDCRAFT CORP.

10 East 52nd Street, New York 22, N. Y.

 DuPont trademark



Books in Review

GIBBON'S barbed summary of his monumental *Decline and Fall of the Roman Empire*—"I have celebrated the triumph of barbarism and Christianity"—was scarcely calculated to endear him to his pious contemporaries: a warning any sensible commentator on the present-day scene should ponder before running the risk of outraging his own special public, in this instance by implying that the current triumphs of high-fidelity sound are ambiguous or purchased at excessive cost. Yet enthusiastically as I delight in the mushrooming expansion of the recorded repertory and its home audience, I can't help wondering occasionally how truly deep and seminal the new popular interest in serious music actually is.

What worries me most is that the revolutionary expansion of listening experience and vastly enhanced catholicity of aural tastes are obviously not being matched by comparable extensions of listeners' intellectual interests. It would seem only natural that any hi-fi fan who has attempted to master at least the rudiments of electro-acoustical technology would be equally assiduous in educating himself in the basic techniques of musicianship; or that the "connoisseur" who has come to know well many of the obscurer works of the baroque and rococo eras, say, would become no less interested a student of the considerable literature devoted to these periods. But it just doesn't seem to work out that way, as becomes painfully evident when one contrasts the extraordinary sale of such comparatively specialized recordings with the scanty sales of books dealing directly with the music itself.

Looking back over the music-book lists of the past few years, one may see marked activity in such fields as those directed to annotated discographies, home sound systems, acoustics in general, the ballet, jazz, and (for the bicentennial year 1956) Mozart. On the other hand, even general "appreciation" books (for which one would assume the demand must be greater than ever) have dwindled to

a comparatively thin flow, while both generalized histories and particularized studies of individual composers and subjects seem to be, if not rarer today than any time in recent decades, then surely even less widely bought and read.

Perhaps the fault lies less with audiophile nonreaders themselves than with authors' and publishers' inability to comprehend or meet the changed needs of today's music lovers. Certainly the most recent examples of general music histories scarcely represent any genuine attempt to refurbish and reinvigorate the old methods of treating such materials, for readers who are vastly more experienced in actual listening than the average concertgoer of a generation past. Nevertheless, the various ways in which these books do try to meet—however tentatively and experimentally—changed conditions warrant sympathetic attention.

History as "Evolution"

The safest, but I'm afraid least promising, attack is simply to bring up to date a textbook which has enjoyed considerable success in the past. In the case of H. C. Colles's history, *The Growth of Music* ("From the Troubadours to J. S. Bach," "The Age of the Sonata from C. P. E. Bach to Beethoven," and "The Ideals of the Nineteenth Century"), which originated in 1912-6, the updating has been entrusted to Eric Blom; the subtitle now reads "A Study in Musical History" with the earlier "for Schools" omitted; and a final chapter, "The Twentieth Century," has been added in this revised third edition (Oxford University Press, \$7.00). But as the editor himself admits, "revision" is an inept term for such modernization, for little can be done to alter the fundamental evolutionary concept of the original author.

What we have here is essentially an outmoded nineteenth-century view of musical developments as "growth," as distinct from the philosophy now

avored of simple "change." Nevertheless it remains reasonably effective in Colles's sober, highly informative (if seldom particularly stimulating) survey of the classical and romantic eras; plus Blom's sketchy census of leading twentieth-century composers and styles. There is little of any real value on the middle ages and renaissance; and while the baroque era is treated in more detail, present-day students of this period are not likely to derive much real enlightenment. For sheerly instructional purposes, the work remains useful enough, but it falls far below such more tautly organized and more rationally oriented one-volume works as Einstein's *Short History* (Knopf, 1947; Vintage paperback, 1954) and Sachs's *Our Musical Heritage* (Prentice Hall, 2nd ed. 1955). The only feature here I can commend wholeheartedly is the series of "Suggestions for Further Reading and Listening" appended to each chapter by Blom, for these brief notes are not only right up to date, but contain a condensed wealth of invaluable clues to the more substantial enrichment of one's experience.

Local- vs. Non-Colored History

When the tide turned against the quasi-Darwinian notion of steady musical progress from simple to complex, as exemplified in Colles's "Growth," Parry's "Evolution," and innumerable other nineteenth and early twentieth-century histories, it became the fashion to treat musical, like other, history in terms of "cycles" and "spirals," and/or to relate it closely to contemporary activities in other arts, to politics, sociology, and even—by the Marxists—to economics. One of the most stimulating of such attempts was Hugo Leichentritt's *Music, History, and Ideas* (Harvard, 1938, still in print), a series of scholarly yet lively studies in the integration of music in general culture. Before his death in 1951, Dr. Leichentritt planned

Continued on next page

KLIPSCH



SHORTHORN®

CORNER HORN
LOUDSPEAKER SYSTEM

New **MODEL T**
HAS WIDER RANGE...
LOWER SILHOUETTE

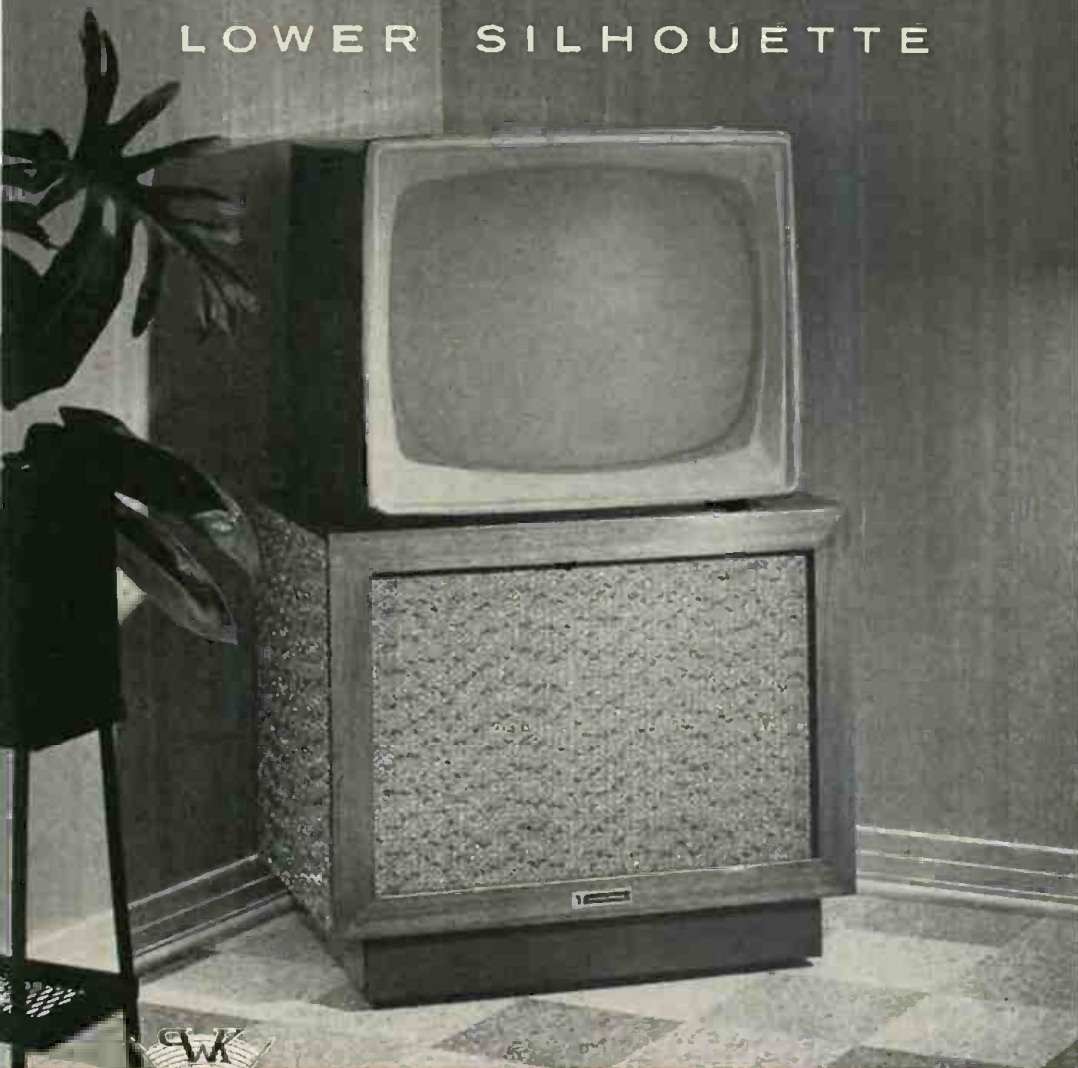

THE NEW SHORTHORN MODEL T, designed by PAUL W. KLIPSCH, offers even greater range than its well known companion, MODEL S. And its dimensions make it adaptable to locations where low height is desirable. When used with table model television sets, it permits picture and wide range sound to originate from the same place.

Like the MODEL S, the MODEL T approaches KLIPSCHORN performance in reproduction of original sound.

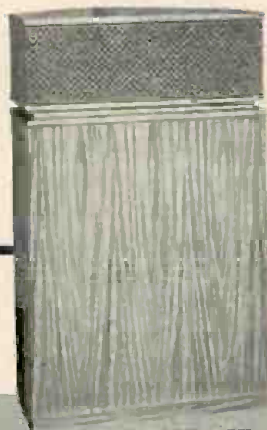

The KLIPSCHORN system, finest product of PAUL W. KLIPSCH, offers the ultimate in fidelity of sound reproduction.

The SHORTHORN MODEL S combines small floor area with desirable ear-level placement of mid-range and tweeter horns.

Write for our new 1957 brochure on KLIPSCHORN and SHORTHORN loudspeaker systems and K-ORTHO drive systems.



KLIPSCH

AND ASSOCIATES
HOPE, ARKANSAS

BOOKS IN REVIEW

Continued from preceding page

and partially completed a companion volume in which most of the same materials are re-examined, this time primarily from the special points of view of nationalism and inter- or supranationalism. Now, thanks to his indefatigable friend, Nicolas Slonimsky (himself one of the most exhilarating writers on music today), Leichentritt's manuscript has been prepared and augmented for publication as *Music of the Western Nations* (Harvard University Press, \$5.00).

Musical nationalism has figured largely, of course, in most historical works, but too often superficially or with chauvinistic biases; while the influences which have cut across national boundaries or often resulted in completely supranational attitudes seldom have been examined in close detail. Leichentritt was a true, many-faceted, if sometimes highly opinionated, scholar. Remembering the stimulation afforded so richly by his earlier book, with its successful organization of a wealth of disparate material, I tackled his posthumous volume with avidity.

Unhappily it lives up to its high promise only in the opening chapters on the "phantom" of Greek music (an incredibly ageless and significant influence despite the plain fact that nobody since, say, the sack of Rome and the destruction of the Alexandrine Library has had the least idea of what it really sounded like); the almost equally mysterious yet influential musical contributions of the Hebrews; and the "Supranational Polyphony" of mediæval Europe. After this fine beginning it trails off into a conventional appreciative recital of various countries' leading composers and achievements. While Leichentritt died before the LP revolution had attained full impetus, at this late date no book intended for general readers can safely ignore the phenomenon that a great many of these readers already have first-hand acquaintanceship with even relatively obscure composers. It is painfully evident here that Leichentritt was largely lecturing to an audience credited with little aural experience, and at that lecturing about men and works, many of which he himself appears to have had no more than book-and-score knowledge of.

However, any alert disc-manufacturer's repertory director should be able to make some valuable discoveries

from Leichentrüt's inclusion of less familiar men, many of whom are still unrepresented by recordings; and anyone seriously worried about the lack of fresh materials for records should be markedly encouraged. Not all such discoveries are likely to be truly noteworthy, of course, but the comparatively recent experiments in resuscitating such men as Ives, Janáček, and Nielsen provide at least some assurance that there must be many others [I'd suggest Charles Alkan, Bernard van Dieren, and our own Henry F. Gilbert] well worth similar exhumation. And I also can warmly praise *Music of the Western Nations* for generous citations of the outstanding achievements of each country's musical scholars and performers, as well as composers.

Pocket "Nutshell" History

The extremely concise or "high-lighted" music history, written especially for listeners of little or no musical background and published at enticingly low cost, is hardly a novelty in this age of digests and paperbacks. Too often, however, works of this kind are either grossly inaccurate in their facts or merely parrot the bare information (divested of enlivening expansions) of the standard textbooks. Even at their best they can do little more than skim the surfaces. Nevertheless, such quick "once-over-lightlies" can have considerable value for readers who shun more detailed studies; and to my mind they are particularly helpful when even the briefest mentions of men or works are couched in terms which are not only accurate characterizations but are arresting enough to galvanize even the most casual reader's curiosity. Even more importantly, perhaps, it also is possible within an extremely limited scope to "orient" largely unread listeners so that whatever they already do know in music can be logically related to the vast unknown.

The current example of this treatment at something very near its practicable best is Carter Harmon's *Popular History of Music* (Dell paperback, 50¢). Although fairly orthodox in general plan and devoting less attention to pre-Bach eras than suits my taste, Harmon has the notable virtues of briskness, freedom from polemics and biases, and the ability to concen-

Continued on page 30



BEST BUY IN HI-FI

Premier

THE Grommes 212

New deluxe Equalizer Pre-amplifier Control Center designed for those who want the ultimate in high fidelity. Self powered with DC filaments for use with any high quality basic power amplifier. Now, extreme flexibility can be yours with 13 front panel controls. Check these exclusive features: 6 position separate turnover and roll-off record compensators, calibrated bass and treble controls with true flat positions, presence control, low frequency balance control for boosting the lower bass range, feedback around each stage, and 8 inputs which include 2 phono channels and equalized tape head input. The 212 together with the Grommes 260 basic amplifier make the finest combination obtainable. Frequency Response: $\pm 0.1\text{dB}$, 10 to 20,000 CPS. Distortion: 0.5% harmonic and 0.1% intermodulation at 10V. output. Finish: Charcoal Gray and Brass. For tabletop or cabinet installation. Size: 12 $\frac{3}{4}$ " W x 4" H x 7" D. Shpg. Wt. 12 lbs.

Net 129.50



**BEST BUY
IN HI-FI**

**GROMMES
Premier 260**

New 60 Watt Hi-Fi Basic Amplifier. Designed for the very finest Hi-Fi system. New advanced circuitry with stability built around an Ultra-Linear output stage gives performance far superior to ordinary power amplifiers. Circuit features direct coupling; cathode coupled phase inverter; feedback cathode follower drivers and push pull 6550 tubes with fixed bias. Output transformer is special design tapped screen type. Power: 60 watts, with 120 watts peak. Distortion: 0.25% harmonic and 0.5% intermodulation at 60 watts (all distortions under 0.1% at 20 watt level or less). Frequency Response: $\pm 5\text{dB}$, 5 to 50,000 CPS (Attenuated beyond 1,000,000 CPS). Power Response: $\pm 5\text{dB}$, 20 to 20,000 CPS. at 60 watts. Premier fidelity assured when combined with the Grommes 212. Size: 14" W x 8 $\frac{1}{4}$ " H x 8" D. Shpg. Wt. 40 lbs.

Net 169.50

Ask your Hi-Fi Dealer to demonstrate the Best Buy in Hi-Fi, the Grommes Premier Line. And be sure you see the complete new line of Grommes High Fidelity Amplifiers, the 10PG, 15PG and the 20PG. If your Dealer cannot help you, write



Grommes

DIV. OF PRECISION ELECTRONICS, INC.

Dept. H-3, 9101 King St., Franklin Park, Illinois

Send Free Hi-Fi Equipment Brochure

Name _____

Address _____

City _____ Zone _____ State _____

ENJOY THE DIFFERENCE SOON!

Electro-Voice® HIGH FIDELITY EQUIPMENT IS AVAILABLE AT:

- ALABAMA**
Anniston: RADIO DIS. & SUPPLY CO. 125-27 W. 10th St.
Birmingham: TANNER COMM. CO. 304 N. 26th St.
Tuscaloosa: SCOTT RECORDING LAB. Municipal Airport
- ARKANSAS**
Little Rock: MOSES MELODY SHOP 311 Main St.
- CALIFORNIA**
Bakersfield: BAKERSFIELD AUDIO & ALARM DEVICES 2531 F St.
Burbank: VALLEY ELECTRONIC SUPPLY CO. 1302 W. Magnolia
Hollywood: HOLLYWOOD ELECTRONICS 7460 Melrose Ave.
Western States Electronics 1509 N. Western Ave.
Inglewood: INGLEWOOD ELECTRONIC SUPPLY 836 S. LaBac Ave.
Newark: NEWARK ELECTRIC CO. 4736 W. Century Blvd.
Lodi: GUPTELL'S HI FI 22 S. School St.
Los Angeles: CRENSHAW HI-FI CENTER 107 Santa Barbara Pl.
Henry Radio 41240 W. Olympic
Menlo Park: HIGH FIDELITY UNLIMITED 935 El Camino Real
Oakland: COAST ELECTRONICS 4166 Broadway
Pasadena: DOW RADIO INC. 1759 E. Colorado St.
High-Fidelity House 536 S. Fair Oaks
San Bernardino: HOLLYWOOD HI-FI SHOP 1839 E. St.
San Francisco: THE LISTENING POST 2390 Filmore St.
SAN FRANCISCO RADIO SUPPLY 1284 Market St.
TELEVISION RADIO SUPPLY 1321 Mission St.
San Rafael: CATANIA SOUND 1607 Fourth St.
Santa Ana: LOWENSTEINS 1508 S. Main St.
Santa Monica: CLEF TELEVISION 1642 Ocean Park Blvd.
Van Nuys: VALLEY ELECTRONIC SUPPLY CO. 17647 Sherman Way
- COLORADO**
Colorado Springs: DRITS BROS. 119 E. Pikes Peak
Denver: ALLEGRO MUSIC SHOP INC. 262 Fillmore St.
The CHAS. E. WELLS MUSIC CO. 1629 California St.
C. V. A. HI FI CENTERS 1624 Broadway
C. V. A. HI FI CENTERS 434 16th St.
LOYD'S HI-FI RECORD SHOP 6110 E. Colfax
- CONNECTICUT**
Hartford: BELMONT RECORD SHOP 163 Washington St.
MARGOLIS HIGH FIDELITY STUDIO 28 High St.
Litchfield: THE MUSIC SHED INC. Trader Lane
New Haven: DAVID DEAN SMITH 262 Elm St.
Radio Shack Corp. 230 Crown St.
New London: DOUGLAS AUDIOTRONICS 15 Maple Terrace
West Hartford: AUDIO WORKSHOP INC. 1 South Main St.
- DELAWARE**
Wilmington: RADIO ELECTRIC SERVICE CO. OF DELAWARE 3rd & Tenthall
- DISTRICT OF COLUMBIA**
Washington: ELECTRONIC WHOLESALEERS, INC. 2345 Sherman Avenue, N.W.
- FLORIDA**
Fort Lauderdale: CERTIFIED ELECTRONIC DISTRIBUTORS INC. 2606 S. Fed. Highway
Gainesville: GODDARD-GAINESVILLE, INC. 1031 S. Main St.
Melbourne: MELODY ELECTRONICS 640 New Haven Ave.
Miami: FLAGLER RADIO CO., INC. 1068 W. Flagler St.
High Fidelity Associates 3888 Biscayne Blvd.
Orlando: GODDARD-ORLANDO 631 W. Central Ave.
Tampa: GODDARD-TAMPA INC. 601 S. Morgan St.
West Palm Beach: GODDARD DISTRIBUTORS, INC. 1309 N. Dixie
THE HOUSE OF HIGH FIDELITY 205 Datura St.
- GEORGIA**
Atlanta: HIGH FIDELITY S. S. S. 608-610 Peachtree St.
Augusta: THE SOUND CENTER 1824 Walton Way
- ILLINOIS**
Bloomington: MILLER MUSIC CO. 417 N. Main St.
MOLLIC SPECIALTIES CO. 1005-1007 W. Wash.
Bridgeway: HI-FI UNLIMITED 235 Roosevelt Rd.
Champaign: RADIO DOCTORS 811 W. Springfield
Chicago: ALLIED RADIO CORP. 100 N. Western Ave.
ARTHUR NAGLE INC. 913 E. 55th St.
ATRONIC CORP. 6566 Sheridan Rd.
ELECTRONIC EXPEDITORS INC. The Hi-Fi Center 2909 W. Devon Ave.
NEWARK ELECTRIC CO. 223 W. Madison St.
PREMIER RADIO 3239 W. North Ave.
SCHWARTZ BROS. HI-FI STUDIOS 1215 E. 63rd St.
VOICE & VISION, INC. 927 N. Rush St.
Riverdale: AUDIO DISTRIBUTORS 14218 S. Indiana Ave.
Rockford: H & H ELECTRONIC SUPPLY, INC. 506-510 Kishwaukee
- INDIANA**
Elkhart: FRICK ELECTRIC & TV, INC. 520 S. Main St.
Gary: VILLAGE HOME APPLIANCE CO., INC. 3592 Village Court
Hammond: HALL'S TELEVISION SERVICE 7430 Calumet Ave.
Indianapolis: GOLDEN EAR 15 E. 16th St.
GRIAM ELECTRONICS SUPPLY 102 S. Pennsylvania
South Bend: FRICK ELECTRIC & TV, INC. 1001 Main St.
West Lafayette: GOLDEN EAR 308 Northwestern Ave.
- IOWA**
Burlington: ELECTRONIC ENGRG. AND SUPPLY CO. F. & M. Bank Bldg.
Cedar Rapids: IOWA RADIO SUPPLY CO. 719 Center Point Rd., N.E.
Des Moines: IOWA SOUND SERVICE 1210 Grand Ave.
Jawa City: WOODBURN SOUND SERVICE 218 E. College St.
- KENTUCKY**
Louisville: GOLDEN EAR 610 S. Third St.
UNIVERSAL RADIO SUPPLY CO. 533 S. 7th St.
- LOUISIANA**
New Orleans: HI FI, INC. 3303 Tulane Ave.
THE MUSIC SHOP INC. 4215 S. Claiborne Ave.
Shreveport: HIGH FIDELITY CENTER 2530 Linwood Ave.
- MAINE**
Bangor: ANDREWS MUSIC HOUSE 118 Main St.
LAWSON: DEORSEY'S RECORD SHOP 23 Lisbon St.
Portland: H. D. BURRAGE & CO. 92 Exchange St.
CANFIELD FLEXIGONE CO. 57 Portland St.
- MARYLAND**
Baltimore: HI FI SHOP 2 N. Howard St.
PARK RADIO & T.V. CO. CUSTOM-CRAFT SOUND STUDIOS 106 W. Fayette St.
SIRMS MUSIC 4010 Glenysle Ave.
Salisbury: RADIO ELECTRIC SERVICE CO. OF DELAWARE
- MASSACHUSETTS**
Boston: CRANER ELECTRONICS 811 Boylston St.
DEMANDO RADIO SUPPLY CO. 1095 Commonw. Ave.
LAFAYETTE RADIO 110 Federal St.
RADIO SHACK CORP. 167 Washington St.
YANKEE ELECTRONICS 257 Huntington Ave.
Cambridge: HI FI LABS 1077 Mass. Ave.
Holyoke: TEL-O-WIRE SOUND CO. INC. 37 Railroad St.
Lawrence: YOUNG & YOUNG OF LAWRENCE INC. 198 Broadway
Pittsfield: SAMMY VINCENT'S INC. 23 North St.
Springfield: SOUND CO ELECTRONICS 147 Dwight St.
Wellesley: THE MUSIC BOX 58 Central St.
Worcester: FRED G. WALTERS CO., INC. 1308 Grafton St.
- MICHIGAN**
Ann Arbor: HI FI STUDIO 1317 S. University Av.
Battle Creek: ELECTRONIC SUPPLY CORPORATION 94 Hamblin
Birmingham: MCCALLUM & DEAN 409-11 E. Maple Ave.
Dearborn: AUDIO HOUSE INC. 19771 Conant
HACO DISTRIBUTING CO. 9730 Burnette St. at Grand River Ave.
Hi-Fi Studios 8300 Fenkel
K. L. A. LABORATORIES 7375 Woodward Ave.
PECAR ELECTRONICS 10729 Morriss
SHILER'S RADIO SHOP INC. 15822 Grand River
East Lansing: CAMERON MUSIC SHOP 106 W. Grand River
Ave.
Manitowish: GARDNER ELECTRONIC SUPPLY 258 River St.
New London: AUDIO COMM. CO. 1511 James St.
St. Joseph: R. A. HOWARD-CUSTOM HI FI 2938 Niles Ave.
Sault Ste. Marie: JOHN P. LEBLANC 321 E. Spruce St.
- MINNESOTA**
Minneapolis: AUDIO KING CO. 1827 E. Lake St.
- MISSISSIPPI**
Pass Christian: THE MUSIC BOX 121 Davis Ave.
- MISSOURI**
Kansas City: DAVE BEATTY CUSTOM HI FI & TV 1616 W. 43rd (Westport Rd.)
St. Louis: NAPPER RADIO CO. 3117 Washington Ave.
VAN SICKLE RADIO CO. 1113 Pine St.
- NEBRASKA**
Omaha: HOUSE OF HI FI 4628 W. Dodge
OMAHA APPLIANCE CO. 18th and St. Mary's
NEW HAMPSHIRE
Concord: EVANS RADIO INC. Route 3A, Bow Jet.
- NEW JERSEY**
Eatonville: HIGH FIDELITY SOUND CENTER Route No. 35
Mauritown: FEDERATED PURCHASER, INC. 1021 U.S. Highway 22
Municipal: PERDUE RADIO CO., INC. 8 S. Park St.
Newark: FEDERATED PURCHASER, INC. 114 Hudson St.
HUDSON RADIO & TV 35 Williams St.
LAFAYETTE RADIO 24 Central St.
Plainfield: LAFAYETTE RADIO 379 W. Second St.
Springfield: CREATIVE AUDIO 40 Briar Hills Circle
- NEW MEXICO**
Albuquerque: HI-FI EQUIPMENT INC. 816 San Mateo S.E.
THE HI-FI HOUSE SOUND ENGRG. & EQUIP. CO. 3011 Monie Vista Blvd. N.E.
- NEW YORK**
Albany: HI-FIDELITY CENTER, INC. 324 Central Ave.
Brooklyn: BENRAY ELECTRONIC CORP. 485 Concy Island Av.
BROOKLYN HI-FI CENTER 836 Flatbush Ave.
Buffalo: BUFFALO AUDIO CENTER 161 Genesee St.
FRONTIER ELECTRONICS, INC. 1505 Main St.
Hempstead: ISLAND AUDIO CO. INC. 414 Fifth Ave.
NEWARK & LEWIS 43 Main St.
Jamaica: AUDIO EXCHANGE 159-19 Hillside Ave.
Jamestown: WARREN RADIO INC. 31 Forest Ave.
Mineola, L.I.: ARROW ELECTRONICS, INC. 525 Jericho Turnpike
New York: ARROW ELECTRONICS, INC. 65 Cortlandt St.
ASCO SOUND CORP. 115 West 45th St. (3rd Floor)
CONSOLIDATED RADIO SALES 768 Amsterdam Ave.
FEDERATED PURCHASER, INC. 66 Dey St.
GRAND CENTRAL RADIO INC. 124 E. 44th St.
HARVEY RADIO CO., INC. 103 W. 43rd St.
HEINS & BOLEY 68 Cortlandt St.
- OHIO**
Akron: OLSON RADIO WAREHOUSE, INC. 73 E. Mill St.
Ashabun: MORRISON'S RADIO SUPPLY 321 Center St.
Canton: GEORGE F. EBEL CO. 3017 Cleveland Ave. N.W.
Cincinnati: CUSTOMCRAFTERS AUDIO INC. 3259 Gilbert St.
Cleveland: AUDIO CRAFT CO. 2915 Prospect Ave.
PROGRESS RADIO SUPPLY CO. 413-415 Huron Road
Columbus: ELECTRONIC SUPPLY CORP. 134 E. Long St.
SHAEFFER MUSIC CO. 849 N. High St.
Dayton: CUSTOM ELECTRONICS INC. 1000 S. Main St.
THE STOTTS-FRIEDMAN CO. 135 E. Second St.
Toledo: JAMIESON'S HI-FIDELITY 840 W. Central
Youngstown: RADIO & TV PARTS INC. 230 E. Boardman St.
- OKLAHOMA**
Oklahoma City: RADIO & SOUND CLINIC 1239 W. Main
- OREGON**
Portland: BURKE-ARENZ MUSIC CO. (formerly L.D. Heater Co.) 1001 S.W. Morrison
Scienc: CREIL FARNES CO. 440 N. Church St.
- PENNSYLVANIA**
Allentown: FEDERATED PURCHASER, INC. 1115 Hamilton St.
RADIO ELECTRIC SERVICE CO. OF PA. 1042 Hamilton St.
Chester: A.C. RADIO SUPPLY CO. Easton: RADIO ELECTRIC SERVICE CO. OF PA., INC. 916 Northampton St.
Erie: WARREN RADIO, INC. 1315 Peach St.
Johnstown: TELEVISION & RADIO PARTS CO. 1102 Main St.
LANCASTER: GEORGE D. BARBEY CO. 622 Columbia Ave.
Lebanon: GEORGE D. BARBEY CO. 821 Quailin Road
Lewistown: ALVO ELECTRONICS DISTRIBUTORS, INC. Meadville: WARREN RADIO, INC. 1057 S. Main
New Kensington: RPC ELECTRONICS CO. 1102-1106 2nd Ave.
Philadelphia: ALMO RADIO CO. 509 Arch St.
A. C. RADIO SUPPLY CO. 1539 Passyunk Ave.
FRINK'S WHOLESALE DISTRIBUTORS 61 Arch St.
RADIO ELECTRIC SERVICE CO. OF PENNA., INC. HIGH FIDELITY AND COMMERCIAL SOUND STUDIO 709 Arch St.
RADIO ELECTRIC SERVICE CO. OF PENNA., INC. 939 Liberty Ave.
RADIO ELECTRIC SERVICE CO. OF PENNA., INC. 5930 Market St.
Pittsburgh: M. V. MANFIELD CO. 937 Liberty Ave.
RADIO PARTS CO., INC. 3412 Germantown Av.
RADIO PARTS CO., INC. 6339 Penn Ave.
Pottstown: GEORGE D. BARBEY CO. 205 N. York St.
Reading: GEORGE D. BARBEY CO., INC. 2nd & Penn Sts.
State College: ALVO ELECTRONICS DISTRIBUTORS INC. 103 S. Pugh St.
Wynnewood: SHRYVEG HI-FIDELITY RADIO & TV CO. Bonwill-Teller Bldg.
Villiamspori: ALVO ELECTRONIC DISTRIBUTING CO. 240 Pine St.
York: RADIO ELECTRIC SERVICE CO. OF DELAWARE 2nd & Penn Sts.
- RHODE ISLAND**
Providence: AUDIOPHONICS CO. NEW ENGLAND'S HI-FI CENTER 790 N. Main St.
U. S. Route No. 1
- SOUTH CAROLINA**
Columbia: DIXIE RADIO SUPPLY CO. INDUSTRIAL ELECTRONIC DIVISION 1628 Laurel St.
TENNESSEE
Kingsport: RADIO ELECTRIC SUPPLY 245 E. Market St.
Knoxville: MCCLUNG APPLIANCES 310 Georgia St., N.E.
Memphis: FERGUSON'S RECORD SHOP 2837 Poplar Ave.
TEXAS
Austin: HIGH FIDELITY INC. 3004 Guadalupe St.
Beaumont: THOMPSON AUDIO CTR. 1090 Alma at Park
Dallas: CRANTREE'S WHOLESALE MAURICE ST.-CVR 706 Blvd. Charrest East
- UTAH**
Salt Lake City: DESERT BOOK CO. 44 E. So. Temple St.
- VERMONT**
Rutland: FLEETWOOD SOUND STUDIO 285 S. Main St.
OAKMAN ELECTRIC SUPPLY 12 Wales St.
- VIRGINIA**
Bristol: BRISTOL RADIO SUPPLY CO. 31 Moore St.
Charlottesville: CHARLOTTESVILLE MUSIC CENTER 105 E. Main St.
Norfolk: ELECTRONIC ENGINEERING CO. 316 W. Olney Road
- WASHINGTON**
Seattle: OLYMPIC ENGINEERING CO. 2008 Westlake Ave.
Spokane: HOUSE OF HIGH FIDELITY, 20TH CENTURY SALES INC. 1021 W. First Ave.
- WEST VIRGINIA**
Charleston: ELECTRONIC SPECIALTY CO. Virginia St. W. at Park
- WISCONSIN**
Janesville: THE AUDIO SHACK 1208 Milwaukee Ave.
Madison: THE HI FI CORNER State at Gorbam
Milwaukee: THE HI-FI CENTER, INC. 4236 W. Canitol Drive
PHOTOART VISUAL SERVICE 840 N. Plankinton
- CANADA**
New Brunswick: St. John: THE NEW BRUNSWICK RADIO CO. 7-11 Gernajn St.
Nova Scotia: Halifax: CONSOLIDATED SUPPLY CO. LTD.
Ontario: Kitchener: PEPPER SOUND EQUIPMENT CO.
Ottawa: CANADIAN ELECTRICAL SUPPLY CO., LTD. 836 Somerset W.
Toronto: BAY-BLOOM RADIO 1206 Bay St.
CANADIAN ELECTRICAL SUPPLY CO., LTD. 523 Yonge St.
ENGINEERED SOUND SYSTEMS LTD. 169 Kipling Ave., S.
Quebec: Montreal: CANADIAN ELECTRICAL SUPPLY CO., LTD. 275 Craig St. W.
ENCO DISTRIBUTING INC. 690 St. James St. W.
PAYETTE RADIO LIMITED 730 St. James St. W.
THE RADIO CENTRE Craig at St. Urbain
Quebec: MAURICE ST.-CVR 706 Blvd. Charrest East
- SONOTEC S. A.** La Gran Avenida, Sabana Grande, Caracas, Venezuela.

The Incomparable Patrician

**THERE IS A DIFFERENCE
IN HIGH-FIDELITY EQUIPMENT!**

Hear it!
See it!
Thrill to it!

it's **Electro-Voice**



The Patrician IV is designed for enduring beauty. It is custom-crafted of selected hardwoods with exquisite mahogany or blonde veneers and inlays in hand-rubbed Heirloom finish. Size: 62" high, 39" wide, 29" deep. The Patrician IV comes complete with 4-way loudspeaker system wired and installed. Impedance is 16 ohms. Power handling capacity: 35 watts of program material; 70

watts on peaks. Mahogany, Net \$865.00. Blonde (Lined Oak), Net \$885.00. Walnut, Net \$958.00. The Patrician IV 4-way speaker units are available separately as the working combination 103C, Net \$393.00. The interior horn assembly is available separately as the Model 115, Net \$200.00. Patrician IV Ready-to-Assemble Interior Horn Assembly Kit, the KD1, Net.....\$118.00.

In loudspeakers, in loudspeaker systems, **THE PATRICIAN IV** dramatizes imposingly the differences, the benefits, that are yours in Electro-Voice research, design, development. **THE PATRICIAN IV** is the difference in high fidelity music reproduction with its 18-inch low, low frequency driver; two unique horns for the rhythmic mid-bass range; diffraction horn for the vital, presence range; VHF driver for silky highs. **THE PATRICIAN IV** is the speaker system that reproduces more than nine of the ten octaves heard by the human ear.

The Patrician IV 4-Way Loudspeaker System . . .

Low-Bass Section. The Patrician IV utilizes a "K" type indirect radiator folded-horn and an E-V Model 18WK low-frequency driver for frequencies up to 200 cps. In a corner, the folded throat of the bass horn becomes part of the entire room to extend bass reproduction below 30 cps.

Mid-Bass Section. Two E-V 829HF mid bass drivers with A8419LF phenolic horn sections handle the 200 cps to 600 cps range. The horn load for the intermediate bass drivers is made of wood and phenolic tubes to reproduce this important mid-bass range.

Treble Section. The Electro-Voice Model T25A Treble Driver with the Model 6HD Diffraction Horn covers the 600 cps to 3,500 cps range. This diffraction horn, employing principles of optical diffraction to disperse high frequencies uniformly, assures complete and proper transmission of the vital "presence" range.

Very-High Range. The Electro-Voice Model T35 Super-Sonax Very-High-Frequency Driver, which utilizes an integral diffraction horn, reproduces the remaining octaves of the audible range above 3,500 cps with almost no measurable distortion.

Crossover Network. The Electro-Voice Model X2635 Crossover Network divides the amplifier power into four separate portions. It eliminates harmonic and intermodulation distortion from one driver in the region covered by the next.

Listening Character. Careful compensation has been made for the sensitivity of the human ear when high orchestral volumes are played back at those levels permissible in your living room. Three level controls permit complete compatibility to any room size or condition for flawless, life-like fidelity.



Model PC1 Music Control Center.

Beautiful preamplifier-equalizer unit for use with all amplifiers. Has self-contained, shielded, low-noise power supply. Controls include: (1) Power (2) Playing Selector; tuner, tape, TV, aux., 6-position phono equalizer. (3) Volume. (4) Loudness. (5) Exclusive Vital "Presence." (6) Treble. (7) Bass. (8) 3-position scratch filter. (9) 3-position rumble filter. Response: ± 1 db 20 to 20,000 cps. Distortion: Harmonic, less than 0.3%; I.M., less than 0.5%. Hum and noise: 75 db below rated output. Net.....\$99.50*.



Model 84D Ultra-linear Ceramic Phono Cartridge

with a 1-mil natural diamond playing tip has high compliance, wide-range response, no hum pickup, highest signal-to-scratch ratio and lowest intermodulation distortion. It improves even the finest high-fidelity systems. Net.....\$23.10.



Model A50 Circlotron High-Fidelity Amplifier

has no collapsing current in the output transformer . . . you get NO switching transients and NO listening fatigue. Model A50 is an excellent companion unit to the PC1 preamplifier. Power output: 50 watts rated, 100 watts on peaks. Response: ± 0.5 db 20-75,000 cps. Harmonic distortion at rated output, less than 0.5%. I.M. distortion at rated output, less than 1%. Hum and noise: 85 db below rated output. Output impedances: 4, 8, 16 ohms; 70-volt line balanced. Feedback: 30 db negative. Controls: (1) Power. (2) Critical Damping (adjustable between 0.1 and 10). (3) Input Level. Net.....\$169.00*.

NO FINER CHOICE THAN

Electro-Voice®

ELECTRO-VOICE, INC. • BUCHANAN, MICHIGAN
Canada: E-V of Canada Ltd., 73 Crookford Boulevard,
Scarboro, Ontario. Export: 10 East 40th Street, New
York 10, U.S.A. Cable: ARLAB

Electro-Voice, manufacturer of the most complete high-fidelity product range—speakers, speaker enclosures, systems, amplifiers, preamps, tuners, phono cartridges, Do-It-Yourself enclosure kits and microphones. Available everywhere.

*Slightly higher in the West.

WORLD PREMIERE



A king can have no better than this "2300" . . . the newest look and performance in High Fidelity amplifiers.

Pictured above is the *new* Bell "2300", twenty watt. Other *new* designs are available in 10 to 40 watts. The specifications of these *new* Bell amplifiers are the best in the world today.

The controls, all closely grouped in the center panel, present conveniences you've always longed for. You cannot buy a better engineered or better styled High Fidelity amplifier . . . anywhere.

NOT JUST NEW VERSIONS OF OLD MODELS but . . . COMPLETELY NEW DESIGNS

For "Operation 2300", Bell assembled a group of electronic engineers with knowhow . . . a group of designers with imagination . . . and gave them an order—"Create a line of High Fidelity Amplifiers that will produce breathtakingly-realistic sounds—and will be styled for traditional, contemporary and modern living."

The "2300" line is the result of this far-reaching project. You should see and hear it. Your nearest Bell dealer will gladly demonstrate, for you, a remarkable "2300". Write us for his name and detailed "2300" literature. Bell Sound Systems, Inc., (A subsidiary of Thompson Products, Inc.) 559 Marion Road, Columbus 7, Ohio.

Bell "World Renowned For the Best in Sound"

BOOKS IN REVIEW

Continued from page 27

trate a maximum of information into a minimum of extremely readable pages (some 350 in all). I like especially his interlude chapters wherein the steady procession of composers is interrupted momentarily for discussions of the organ, piano, and orchestra—and their consequences both for music itself and the stylistic idiosyncrasies of individual composers. The scanty bibliography lacks the annotations essential for relatively uninformed readers, and the occasional black-and-white illustrations are crude and unreliable; but there's a good index, helpful glossary of terms, and—best of all—the author's own highly infectious enthusiasm. . . . In short, a very big fifty-cents' worth.

Composers as Spokesmen

It may have been unduly harsh of Montaigne to maintain that "the *only* [my italics] good histories are those written by those who had command in the events they describe," yet there is more than a germ of truth in his contention. Luckily, there is a vast potential of historical materials provided by composers, both as apologia for their own music and—often even more pungently—in attack or defense of their contemporaries' compositions.

It's a joy to welcome, then, the hefty, some 600-page anthology, *Composers on Music* (Pantheon, \$7.50), discerningly selected and edited by Sam Morgenstern, who here performs a labor of love scarcely less impressive than that of his (and Harold Barlow's) indispensable *Dictionaries of Musical and Vocal Themes* (Crown, 1948-50). Some ninety composers are represented here in chronological order from Palestrina to Copland, most of them at some length, and many of them (especially among the men of our times) by material hitherto un-anthologized or inaccessible except to specialists. Away from their scores, the composers often prove to be extraordinarily articulate and almost invariably extremely interesting. And while this is too long and diversified a book to be read through in one or several sittings, it is an ideal listener's bedside or turntable companion, to be dipped into regularly for sheer pleasure as well as regularly consulted as

an inimitably authoritative reference source.

GRACE NOTES

Record Guide Supplement. No large-scale annotated discography ever can be completely up-to-date with current disc-release lists, but those enterprising and urbane British gramophiles—Edward Sackville-West, Desmond Shawe-Taylor, Andrew Porter, and William Mann—are obviously determined not to let their bulky *Record Guide* of 1955 (reviewed here in July 1956) fall too far behind. The present 191-page *Supplement* covers British recordings (from Albéniz's *Iberia* to Wolf's *Italian Songbook*) released between late 1954 and mid-1955, some of which are merely listed, but most of which are discussed in considerable detail and with a discriminating sense of critical values (Wm. Collins & Sons, London, \$2.50 in the United States).

Opera Annual. Another, more specialized, British series is represented by Harold Rosenthal's third opera year-book, the first to be issued under the imprint of an American publisher and with credit to an American coeditor, Raymond Ericson. As in the second (Mozart year) *Annual* (reviewed here in Feb. 1956), there are extensive summaries of the season's activities in the United States, England, and European countries; specialized essays on "Verdi and Schiller" (Porter), Puccini (Reid), Opera as "an unrealistic art-form" (Rennert), opera production in general (Arundel), and special problems of television opera production (Graf); plus documentary tabulations of world opera houses, artists, repertoires, premières, and 1955-6 obituaries. But again the most immediate attractions are the handsome format and the superb photographs—some forty-nine pages of these, including no less than nine in full color (Lantern Press, \$5.00).

The Forms of Music. A "fact" book of quite different sort and vastly more mature approach is the paperback reprint of one of the late Sir Donald Tovey's most valuable (and probably least-known) publications, originally titled *Musical Articles from the Encyclopaedia Britannica* (Oxford, 1944). Twenty-one of these essays are devoted to discussions of the "forms"

Continued on next page

even with moderate-priced speakers...

KARLSON TRANSDUCERS*

attain higher performance ratings
than any other speaker system!

KARLSON TRANSDUCER	KARLSON 8	KARLSON 12	KARLSON 15	
SPEAKER	8" Utah G8J	12" Axiom 22	15" University 315	
PRESSURE FREQUENCY RESPONSE	40-12000 cps ±4db (high end limited by speaker performance only)	30-15000 cps ±2db	20-15000 cps ±2db	Covers complete range of sound on records today!
SPEAKER EFFICIENCY	20% above 40 cps	30% above 30 cps	33% above 20 cps	Provides maximum sock for given amplifier and speaker.
TRANSIENT RESPONSE (attenuation rate on interrupted steady state signal)	—35db from 40-1000 cps	—40db from 30-1000 cps after 10 milliseconds	—35db from 20-1000 cps	Clean sound with- out blurring or hangover. No other system meets these performance ratings!
	—45db from 40-1000 cps	—50db from 30-1000 cps after 20 milliseconds	—45db from 20-1000 cps	
Attenuation rates above 1000 cps are in excess of these values.				
DISPERSION	Minimum of 120° for all speakers regardless of tweeter design.			Sound is uniform in all parts of room. Rids strident effect.
HARMONIC DISTORTION	Less than 10% at 40 cps	Less than 5% at 30 cps	Less than 5% at 20 cps	Provides clean fundamental bass.

These Karlson Ratings are the result of research on comparative performance of speaker systems. They are not equalled by performances of any other enclosures tested — nor do they represent the fullest capabilities of Karlson enclosures with still finer speakers.

"new and basic enclosure invention for improved conversion of mechanical vibrations into sound.

**KARLSON
TRANSDUCERS**
\$18.60 to \$174 net
AT YOUR DEALER OR
WRITE



KARLSON ASSOCIATES INC.
Dept. HF 1610 Neck Road, Brooklyn 29, N. Y.

NOW THE

improved

SHURE

UNIDYNES

the world's most
widely used
fine microphones

PROVIDE

- 41% higher output!
- The perfect microphone choice for use with low-gain P. A. systems and tape recorders... in addition to their famed usage in finest quality public address systems.

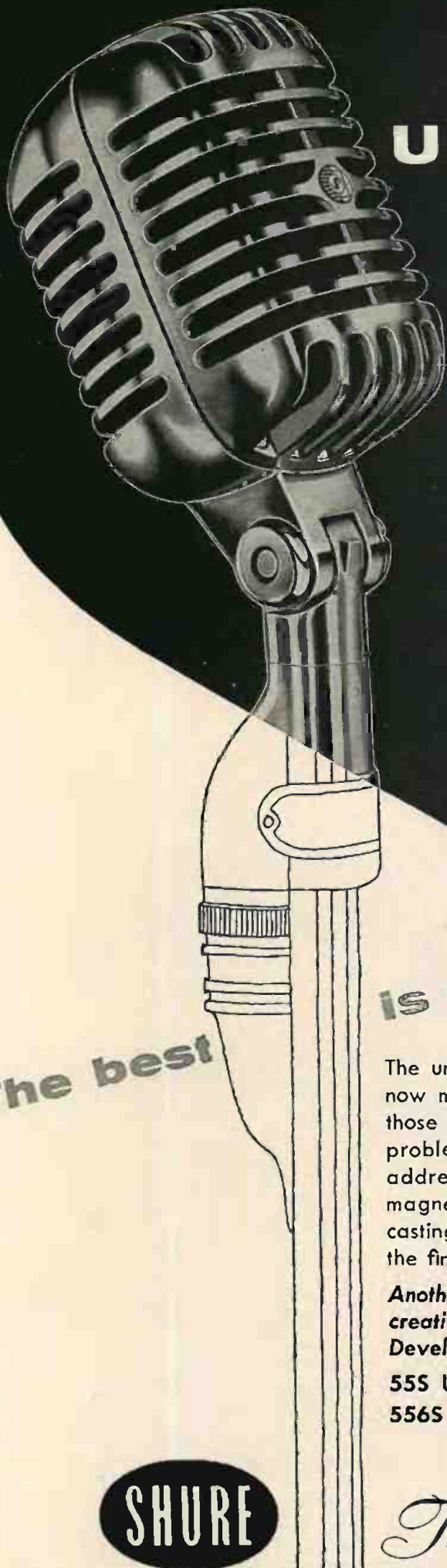

The best

is even better!

The unidirectional dynamic Unidynes are now more than ever your best choice in those installations where feedback is a problem, and for all fine-quality public address, theatre-stage sound systems, magnetic recording and remote broadcasting—where critical standards call for the finest-quality microphone operation.

Another example of the continuous creativity of the Shure Research and Development Laboratories.

55S Unidyne List Price \$79⁵⁰

556S Broadcast Unidyne List Price \$120⁰⁰

IN ELECTRONICS SINCE 1925

The Mark of Quality



SHURE BROTHERS, INC.

Microphones ~ Electronic Components

220 HARTREY AVENUE • EVANSTON, ILLINOIS

www.americanradiohistory.com

BOOKS IN REVIEW

Continued from preceding page

themselves, from *Aria* to *Variations*; the remaining seven to the larger topics of *Chamber Music*, *Melody*, *Rhythm*, etc.—crowned by the finest short article I know on the ecumenical subject of "Music" itself. They are a sheer delight to read, and no less valuable for constant, reliable, and enlightening reference use (*Meridian*, \$1.35).

Terman: Bigger and Better. In the field of true engineering handbooks, probably none has been more widely used and cited than Frederick E. Terman's, which originally appeared in 1943 as largely a solo creation and now returns in a completely revised and updated fourth edition as *Electronic and Radio Engineering*, Terman now being aided by four no less authoritative and able collaborators. It's a monstrously big (1078 pages), heavy, and lavishly illustrated work, with not only the original basic materials re-examined in the light of current theory, but with new chapters on transistors and microwave tubes. And if audio doesn't figure notably (outside the amplifier and feedback sections), every serious audio as well as radio engineer will continue to find the "new Terman" an invaluable reference source on fundamental electronic theory and practice (*McGraw-Hill*, \$12.50).

Audio Anthology III. The sensational success of the first anthology (1950) from what was then *Audio Engineering* magazine naturally led to a second (1953) and the present third—for which Editor C. G. McProud has skimmed the files for *Audio* from August 1952 to June 1955 for some forty-three of the articles (mainly on amplifiers, preamps and control circuits, and loudspeaker enclosures) most in demand by equipment builders and students. Excellently reproduced in text, "curves," and illustrations, No. 3 should be every bit as popular as its now out-of-print predecessors (*Radio Magazines*, paper, \$2.50).

R. D. D.



"We're building a
HEATHKIT[®]...

BECAUSE IT'S SUCH GREAT FUN... AND BECAUSE WE GET SO MUCH MORE FOR OUR MONEY!"

Every day more and more people (just like you) are finding out why it's smart to "do-it-yourself" and save by building HEATHKIT high fidelity components. These people have discovered that they get high-quality electronic equipment at approximately one-half the usual cost by dealing directly with the manufacturer, and by doing their own assembly work. It's real fun—and it's real easy too! You don't need a fancy work shop, special tools or special knowledge to put a Heathkit together. You just assemble the individual parts according to complete step-by-step instructions and large picture-diagrams. Anyone can do it!

Heathkit Model SS-1 Speaker System Kit

This high fidelity speaker system is designed to operate by itself, or with the range extending unit listed below. It covers the frequency range of 50 to 12,000 CPS within ± 5 db. Two high-quality Jensen speakers are employed. Impedance is 16 ohms, and power rating is 25 watts. Can be built in just one evening. **\$39⁹⁵**
Shpg. Wt. 30 lbs.

Heathkit Model SS-1B Speaker System Kit

This high fidelity speaker system kit extends the range of the model SS-1 described above. It employs a 15" woofer and a super-tweeter to provide additional bass and treble response. Combined frequency response of both speaker systems is ± 5 db from 35 to 16,000 CPS. Impedance is 16 ohms, and power is 35 watts. Attractive styling matches SS-1. Shpg. Wt. **\$99⁹⁵**
80 lbs.

HEATHKIT

"LEGATO" SPEAKER SYSTEM KIT

Months of painstaking engineering by Heath and Altec-Lansing engineers has culminated in the design of the Legato, featuring "CP" (critical phasing) and "LB" (level balance). The result is a *new kind* of high fidelity sound, to satisfy even the most critical audio requirements. Two high-quality 15" theater-type speakers and a high-frequency driver with sectoral horn combine to cover 25 to 20,000 cycles without peaks or valleys. "CP" and "LB" assure you of the smooth, flat audio response so essential to faithful reproduction. Choice of two beautiful cabinet styles below.

"Legato" Traditional Model HH-1-T

Styled in classic lines to blend with period furniture of all types. Doors attractively paneled. African mahogany for dark finishes unless you specify imported white birch for light finishes. Shpg. Wt. 246 lbs. **\$345⁰⁰**

"Legato" Contemporary Model HH-1-C

This fine cabinet features straightforward design to blend with your modern furnishings. Slim, tapered struts run vertically across the grille cloth to produce a strikingly attractive shadowline. Wood parts are precut and predrilled for simple assembly. Supplied in African mahogany for dark finishes unless you specify imported white birch for light finishes. Shpg. Wt. **\$325⁰⁰**
231 lbs.



\$4.00 dwn.
\$3.36 mo.



\$10.00 dwn.
\$8.40 mo.



\$34.50 dwn.
\$28.98 mo.



\$32.50 dwn.
\$27.30 mo.



HEATH COMPANY

A Subsidiary of Daystrom, Inc.

BENTON HARBOR 8, MICHIGAN

Make yours a **HEATHKIT**[®]

**It's Easy (and fun) to Plan Your Own Hi-Fi Installation
By Choosing the Heathkit Components
That Best Suit Your Particular Needs.**

As the world's largest manufacturer of electronic equipment in kit form, Heath Company can provide you with a maximum variety of units from which to choose. You can select just the amplifier you need from five different models, ranging in power from 7 watts to 25 watts, some with preamplifiers, and some requiring a separate preamplifier. You can pick your speaker system from four outstanding high fidelity units ranging in price from only \$39.95 to \$345.00. You can even select a fine Heathkit FM or AM Tuner! Should there be a question in your mind about the requirements of an audio system, or about planning your particular hi-fi installation, don't hesitate to contact us. We will be pleased to assist you.

MATCHING CABINETS . . .

The Heath AM Tuner, FM Tuner and Preamplifier are housed in matching satin-gold finished cabinets to blend with any room decorating scheme. Can be stacked one over the other to create a central control unit for the complete high fidelity system.

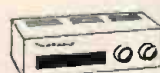

MODEL FM-3A



MODEL BC-1

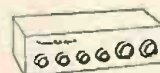

MODEL WA-P2



PRE-ALIGNED TUNERS . . .

A unique feature of the Heathkit AM and FM Tuners is the fact that both units are pre-aligned. A signal generator is not necessary! IF and ratio transformers are pretuned at the factory, and some front-end components are preassembled and pretuned. Another "extra" to assure you of easy kit assembly.



HEATH COMPANY

A Subsidiary of Daystrom, Inc.
BENTON HARBOR 8, MICHIGAN

EASY TIME PAYMENTS . . . We invite you to take advantage of the Heath Time Payment Plan on any order amounting to \$90.00 or more. Just 10% down and the balance in twelve monthly payments. **WRITE FOR COMPLETE DETAILS.**

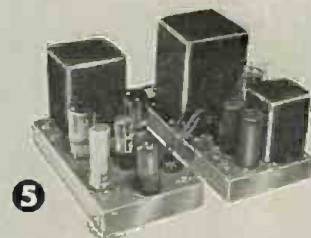

HIGH FIDELITY SYSTEM

1 HEATHKIT HIGH FIDELITY FM TUNER KIT Features AGC and stabilized, temperature-compensated oscillator. Sensitivity is 10 microvolts for 20 db of quieting. Modern circuit covers standard FM band from 88 to 108 mc. Employs ratio detector for efficient hi-fi performance. Power supply is built in. Illuminated slide rule dial for easy tuning. Housed in compact satin-gold enamel cabinet. Features prealigned transformers and front end tuning unit. Shpg. Wt. 7 lbs.

MODEL FM-3A Incl. Excise Tax (with cab.) **\$25⁹⁵**
\$2.60 dwn., \$2.18 mo.

2 HEATHKIT BROADBAND AM TUNER KIT This fine AM Tuner was designed especially for use in high fidelity applications, and features broad bandwidth, high sensitivity and good selectivity. Employs special detector circuit using crystal diodes for minimum signal distortion, even at high levels. Covers 550 to 1600 kc. RF and IF coils are prealigned. Power supply is built in. Housed in attractive satin-gold enamel cabinet. Shpg. Wt. 8 lbs.

MODEL BC-1 Incl. Excise Tax (with cab.) **\$25⁹⁵**
\$2.60 dwn., \$2.18 mo.

3 HEATHKIT HIGH FIDELITY PREAMPLIFIER KIT This preamplifier meets or exceeds specifications for even the most rigorous high fidelity applications. It provides a total of 5 inputs, each with individual level controls. Hum and noise are extremely low, with special balance control for absolute minimum hum level. Tone controls provide 18 db boost and 12 db cut at 50 cps, and 15 db boost and 20 db cut at 15,000 cps. Four-position turn-over and four-position rolloff controls for "LP", "RIAA", "AES", and "early 78" equalization. Derives power from main amplifier, requiring only 6.3 VAC at 1A and 300 VDC at 10MA. Beautiful satin-gold enamel finish. Shpg. Wt. 7 lbs.

MODEL WA-P2 (with cab.) **\$19⁷⁵**
\$1.98 dwn., \$1.66 mo.

4 HEATHKIT ADVANCED-DESIGN HI-FI AMPLIFIER KIT This fine 25-watt high fidelity amplifier employs KT66 output tubes by Genalex and a Peerless output transformer for top performance. Frequency response ± 1 db from 5 to 160,000 cps at 1 watt. Harmonic distortion less than 1% at 25 watts, an IM distortion less than 1% at 20 watts. Hum and noise are 99 db below 25 watts. Output impedance is 4, 8 or 16 ohms. Extremely stable circuit with "extra" features.

MODEL W-5: Consists of W-5M plus WA-P2 Preamplifier **\$59⁷⁵** \$5.98 dwn., \$5.02 mo.
Shpg. Wt. 38 lbs. **\$79.50** \$7.95 dwn., \$6.68 mo.
Express only

5 HEATHKIT DUAL-CHASSIS HI-FI AMPLIFIER KIT This 20-watt Williamson-type amplifier employs the famous Acrosound model TO-300 output transformer, and uses 5881 tubes. Frequency response is ± 1 db from 6 cps to 150 kc at 1 watt. Harmonic distortion less than 1% at 21 watts, and IM distortion less than 1.3% at 20 watts. Output impedance is 4, 8 or 16 ohms. Hum and noise are 88 db below 20 watts.

MODEL W-3: Consists of W-3M plus WA-P2 Preamplifier **\$49⁷⁵** \$4.98 dwn., \$4.18 mo.
Shpg. Wt. 37 lbs. **\$69.50** \$6.95 dwn., \$5.84 mo.
Express only

6 HEATHKIT SINGLE-CHASSIS HI-FI AMPLIFIER KIT This 20-watt Williamson-type amplifier combines high performance with economy. Employs Chicago-Standard output transformer and 5881 tubes. Frequency response ± 1 db from 10 cps to 100 kc at 1 watt. Harmonic distortion less than 1.5% and IM distortion less than 2.7% at full output. Output 4, 8 or 16 ohms. Hum and noise—95 db below 20 watts.

MODEL W-4A: Consists of W-4AM plus WA-P2 Preamplifier **\$39⁷⁵** \$3.98 dwn., \$3.34 mo.
Shpg. Wt. 35 lbs. **\$59.50** \$5.95 dwn., \$5.00 mo.
Express only

7 HEATHKIT 20-WATT HIGH FIDELITY AMPLIFIER KIT Features full 20 watt output using push-pull 6L6 tubes. Built-in preamplifier provides four separate inputs. Separate bass and treble controls. Output transformer tapped at 4, 8, 16 and 500 ohms. Designed for home use, but also fine for public address work. Response is ± 1 db from 20 to 20,000 cps. Harmonic distortion less than 1% at 3 db below rated output. Shpg. Wt. 23 lbs.

MODEL A-9B **\$35⁵⁰**
\$3.55 dwn., \$2.98 mo.

8 HEATHKIT ELECTRONIC CROSS-OVER KIT This device separates high and low frequencies electronically, so they may be fed through two separate amplifiers driving separate speakers. Eliminates the need for conventional cross-over. Selectable cross-over frequencies are 100, 200, 400, 700, 1200, 2000 and 3500 cps. Separate level controls for high and low frequency channels. Attenuation 12 db per octave. Shpg. Wt. 6 lbs.

MODEL XO-1 **\$18⁹⁵** \$1.90 dwn., \$1.59 mo.

9 HEATHKIT 7-WATT ECONOMY AMPLIFIER KIT Qualifies for high fidelity even though more limited in power than other Heathkit models. Frequency response is $\pm 1\frac{1}{2}$ db from 20 to 20,000 cps. Push-pull output and separate bass and treble tone controls. Good high fidelity at minimum cost. Uses special tapped-screen output transformer.

MODEL A-7E: Same as A-7D except one more tube added for extra preamplification. Two inputs, RIAA compensation and extra gain. **MODEL A-7D** **\$17⁹⁵** \$1.80 dwn., \$1.51 mo.
Shpg. Wt. 10 lbs. **\$19.95** \$2.00 dwn., \$1.68 mo.
Incl. Excise Tax Shpg. Wt. 10 lbs.

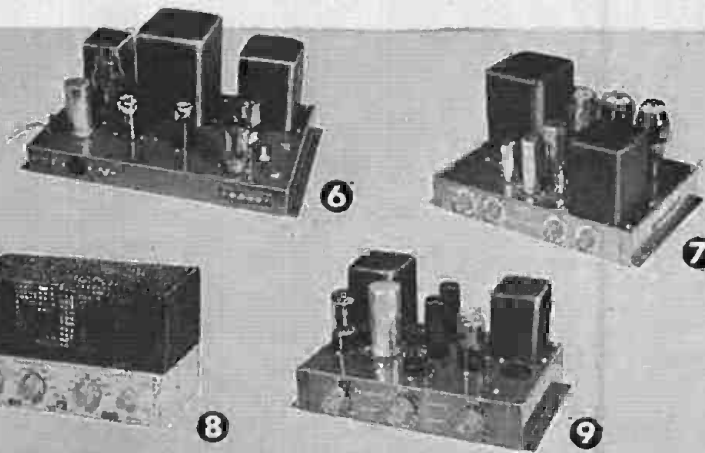

Write for Free Catalog

HOW TO ORDER

Just identify kit by model number and send order to address below. Write for further details if you wish to budget your purchase on the HEATH TIME PAYMENT PLAN.

HEATH COMPANY

A Subsidiary of Daystrom, Inc.
BENTON HARBOR 8, MICHIGAN
Please send Free HEATHKIT catalog.

Name _____
Address _____
City & Zone _____ State _____

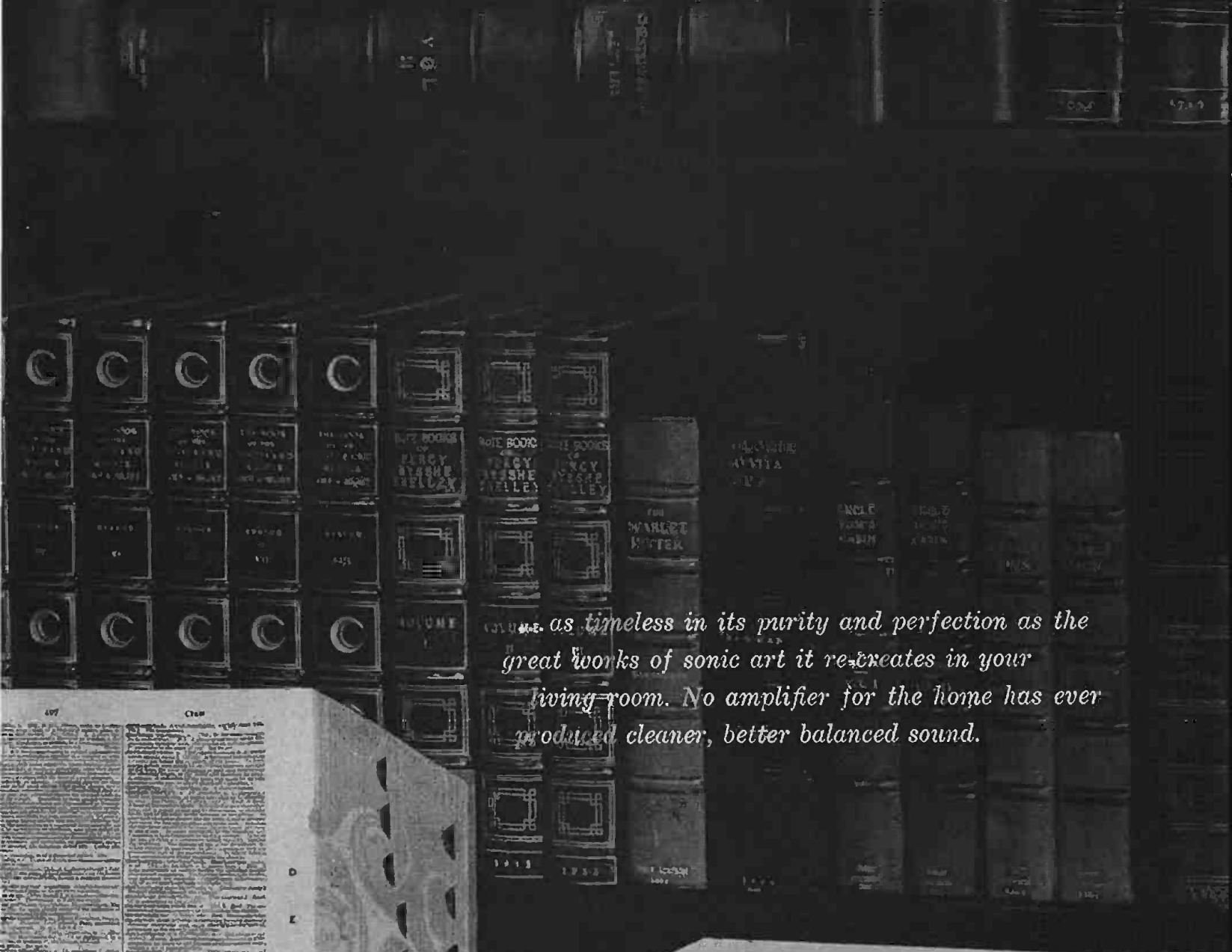

... as timeless in its purity and perfection as the great works of sonic art it re-creates in your living room. No amplifier for the home has ever produced cleaner, better balanced sound.



classic (klas'ik), n. An artistic work of acknowledged superiority whose excellence has been repeatedly affirmed throughout the years.



THE NEWCOMB CLASSIC 2500R

A limited number of Newcomb Classic preamplifier-power amplifiers, Model 2500R with remote control and Model 2500 without, will be released from the Newcomb laboratory during 1957. If you desire further details of these custom fabricated, laboratory standard high fidelity components, write: Newcomb Audio Products Co., Department W-3, 6824 Lexington Avenue, Hollywood 38, California.

NEWCOMB

... since 1937 Hollywood's leading producer of precision instruments for the control and amplification of sound—high fidelity components, record and transcription players for the professional, radios, public address systems.

EXPORT DEPARTMENT: 431 Fifth Avenue, New York 16, New York

Con Amore

ARTURO TOSCANINI described himself once during World War II as a man who stood and waved a stick while civilization was being destroyed.

Civilization was not destroyed, and partly because Arturo Toscanini had stood so long so steadfastly, waving his stick.

All artists apparently suffer sometimes this kind of mis-giving. Their concern for mankind must be broad and deep, if they are good artists. It must bear upon fundamental things—love, war, hunger, heroism, misery, patience, pain, fear, freedom. Yet if they are to be perfect instruments of their task, they must not participate in their subject matter. It is for them to refine and reflect; it is not for them to join the battle or the bread riot. This is a deprivation, and often they feel it, and no doubt at such times they hate their pens and their palettes and their pianos for setting them apart from the risks of common men, and they wish perhaps that their brains had been built different.

I speak of course about conscientious artists, for it is they who worry at being isolated from other human endeavor, and who wonder whether or not their work is worthwhile. Lesser ones happily accept the evidence of their incomes; they are satisfied to take, and do not fret over the quality and effectiveness of their giving.

The latter present us with no problems. The former do, for even the presence of a visible and constant following—necessarily small—does not convince them that they really have reached the world with their offering, or that it has done any abiding good.

Perhaps we should tell them more often than we do, and more plainly, that we know they are there, that we value them, and that we heed them. We should, but can we? To the artist, praise from critics is, of course, welcome, and so is the applause of the loyal regulars, but it is where these leave off that the uncertainty begins. Who can speak for the people who do not, as regularly as they might, get to concert halls, art galleries, theaters, and even bookstores?

Maybe no one can in any large and authoritative way, but in small ways, many can. In this case, I can. At the time Toscanini spoke of his stick waving, I was a Pfc in an Army camp in the deep South. Further, I was the owner of a short-wave receiver, a special asset to this observation. There was no full-time NBC radio station nearby, which meant no Toscanini by standard broadcast. However, after each weekly concert, NBC's foreign service at Bound Brook beamed transcriptions of the concerts to South America, and these we got, strong and clear.

It would be pleasant to picture a whole tent street of artillerymen listening entranced to Mozart and Brahms,

but this didn't happen; the majority preference was for the USO and the strains of the *Jersey Bounce*. Our audience steadily averaged between six and ten, but its composition changed constantly, as members moved up out of the ranks, advancing to special duties, studies, and responsibilities. There is no doubt in my mind that these were very much the kind of people Toscanini—or Mozart and Brahms—would most have wanted to reach.

Few or none of this transient group would have laid any claim to a knowledge of music, but (as the saying is) we knew what we liked. More important, we knew why we liked it. In our feelings toward Toscanini there was nothing sentimental, nor were we englamored. It was quite simply that he didn't, and we knew he never would, stand between us and the music.

How or why we knew this so certainly it is hard to say; few of us were well read in the Toscanini legend. I think it could be sensed in the performances themselves. At any rate it marked a conclusive victory in another war, one which Toscanini may almost be said to have started, and one in which, though he was not alone, he was certainly the greatest general and mightiest champion. This was the war to restore music's stature—the winning of which has spread the benison of this universal art over millions more people than ever enjoyed it before, in any of the world's ages.

He began his career in an era of hardy materialism and equally hardy tastelessness. Music was not neglected; it was fashionable, but it had been downgraded to the rank of entertainment, and it was abused. Star conductors and star sopranos occluded the stars of Bach and Beethoven. Toscanini became a star, but a star with a difference. He seized the world's attention. Having seized it, he diverted it violently where he thought it should be aimed. He used his eminence for a display of humility so fierce that some thought it false. He became as heartless as fearless in his undeviant devotion to his cause: he could reprove the idolized Caruso during a Metropolitan performance, he could crush a terrified bassoonist for bobbling an inflection.

He was a hard man, but he came at a time when music badly needed a hard man. Now we have music played as written. The Toscanini attitude, if not the Toscanini style, extends potently through all Western music-making, and not only orchestral. Mozart's *Figaro* and Gluck's *Orfeo* can fill opera houses now partly because Toscanini has taught us to seek the music beyond virtuosity. And that a string quartet or a young pianist today can capitalize profitably on strict musical rectitude owes very largely to the long and furious protestations of the man who insisted that there was no such thing as Toscanini's Beethoven, there was only Beethoven.

J.M.C.

by VINCENT SHEEAN

LONG, USEFUL LIVES of unremitting service to mankind have not been unknown in this century, but Toscanini's near ninety years held truer to the single purpose, the undeviating line, than any other we know. Gandhi, Churchill, Shaw, and a considerable number of their contemporaries in many countries proved one point, certainly, which was that age often crowns the work. Toscanini's essential point is somewhat different: it is that the work of genius can be uniform. In other words, there can once in a while occur in this vale of tears an artist of such quality that he never seems to change at all—to improve or deteriorate, enlarge or diminish. From beginning to end of a career beyond comparison to any other, this artist seemed to have struck a note and held it.

We miss him—Ah, how we miss him! But we should have missed him just as much if he had left us thirty or forty years ago, or twenty, or ten. So far as I can tell he always was unique, and the enhancement or enlightenment—or, if you like, simple pleasure—which he had to give through music was always unlike that produced by other talents. It seems to have been much the same in kind when he was twenty years old as it was when, after almost seven decades of service to music, he made his final bow in Carnegie Hall.

Just lately I have been pondering over some of the printed records of his early years, and the astonishment of later days is indubitably in them. What are we to

was, but what kind of an explanation is that? To remember creatively, that is to be able to give forth in revived form something which has been thoroughly taken in, is the further step which makes the process inexplicable. Many musicians of the highest rank, even composers, cannot take this step—even with their own work. It seems to have been native or innate with Toscanini from childhood.

Memory with the effortless precision which characterized Toscanini's, of course, cannot often be found. He remembered poetry and whole scenes of drama as easily as he did musical scores (this made him a lover of literature and the theater even when he had no time for them!). He always knew the words of any opera better than the singers did, apparently, judging by these early accounts. He mouthed the words at them and molded the phrasing with his hands, even at a time when he was without experience and dealing with performers who had been on the stage for many years. He *interpreted* for the interpreters, according to some of the accounts which were printed when he was quite unknown. The exact kind of thinking which was shown by Toscanini's critical judges within the last two decades was shown by his critical judges seventy years ago. They all said (in Rio de Janeiro, Turin, Genoa, before he even got to Milan) that this youth evoked the music from his interpreters by some form of exchange, some give-and-take, hitherto unknown.

The "genius," as he was called from early childhood, and not always amiably, was the son of a tailor in Parma who liked music but knew nothing of it. One year of ordinary schooling was all the boy had; they started at eight in those days, and at nine he was put into the Conservatory. The "genius" had a scholarship, after his first year, for the rest of his time there, and received his diploma July 14, 1885, with the highest marks it was possible to obtain in his own subjects (cello, piano, and composition). He had composed a little and con-

Ninety Years of Arturo Toscanini

think of a twelve-year-old boy who, after reading the orchestral score of the *Tannhäuser* prelude through just once, can sit down and write it all out note for note and present it to his teacher, each orchestral part complete? Or of a child cellist who can repeat any piece of music by memory impeccably after having played it through once with the notes? Or—later on—of a boy of nineteen who can conduct *Aida* without a score, without a rehearsal, without ever having conducted an opera in his life before?

These and other miraculous occurrences of Toscanini's earliest youth indicate innate powers. Such things can never be taught and it is scarcely probable that maturity, even the maturity of a great musical intelligence, could improve upon their essential God-given security. Something occurred here which we are helpless to explain. A "phenomenal memory," as the books say, there certainly

ducted a little, in a student manner, and had also transcribed for his own pleasure a great many orchestral and operatic scores, thus—by some wizardry not even conscious—committing them to memory against a future need. When he left the Conservatory he was just over eighteen, having been born on March 25, 1867. He played cello and taught singing for a while until an impresario engaged him to go with a traveling opera company to Brazil.

The debut of Toscanini as a conductor (June 25, 1886) was one of the most astonishing events of its kind in the history of music. The story has been told but never too often: Rio de Janeiro was in a state of passionate operatic feud, refusing any conductor except a native Brazilian who refused to work that night. Italians who attempted to take over were hissed down—two of them. It seemed likely that the performance must be canceled

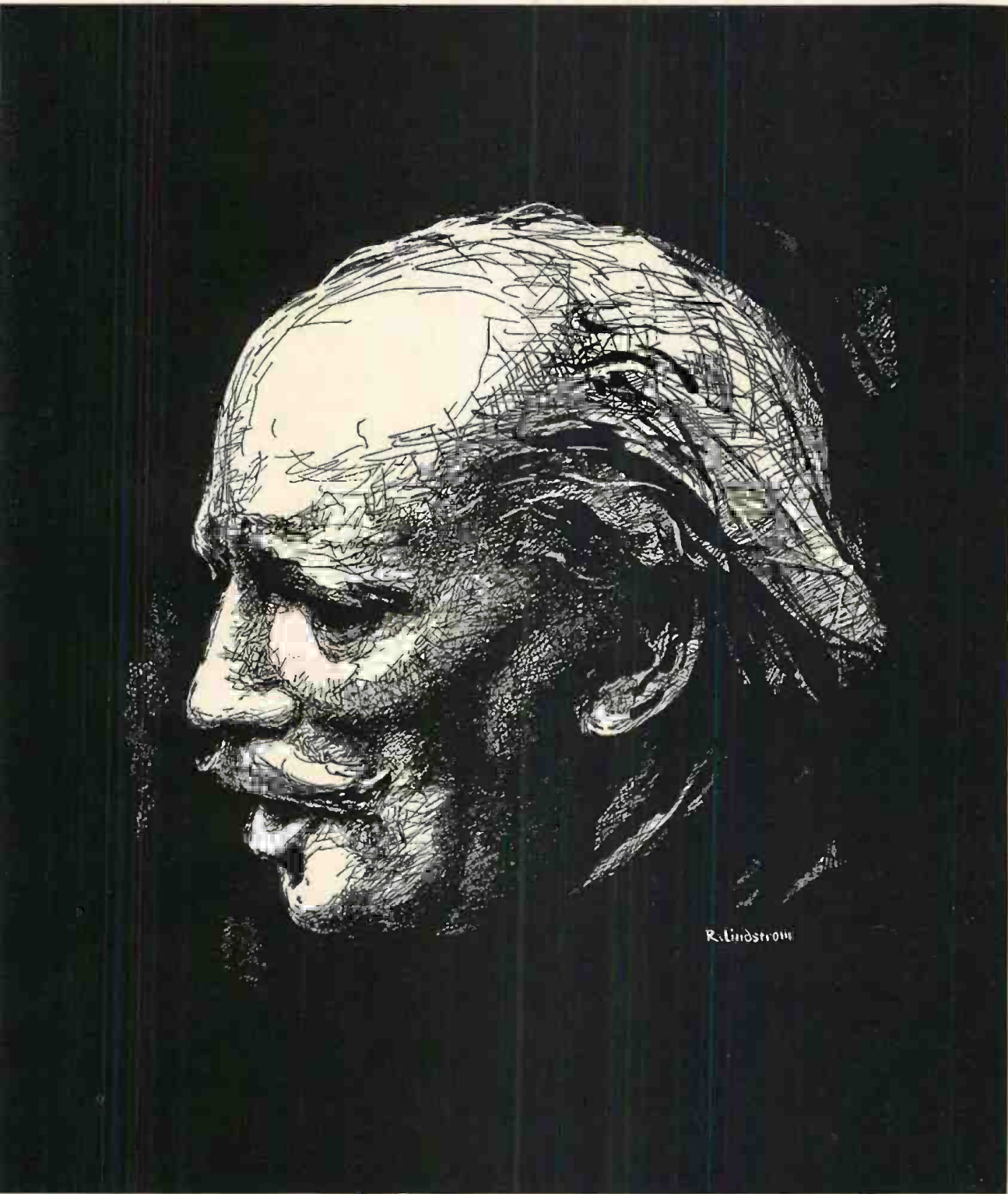



Toscanini's extreme youth inspired this caricature, which appeared in Turin during his first Italian opera season.

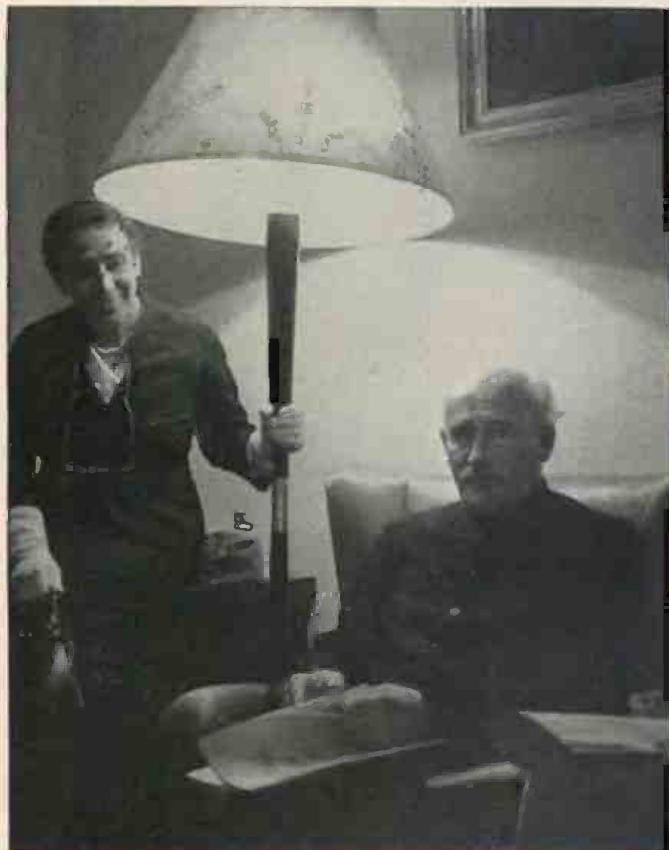

Maestro Toscanini and his daughter Countess Castelbarco, shown at Teatro alla Scala during his last trip to Italy.

and, under the circumstances, the company would disband without enough money to return to Italy. A woman singer remembered the boy Toscanini because of his memory (he had rehearsed singers and chorus without a score) and suggested, in this moment of panic, that he be tried. The harassed manager was ready to try anything, since the house was in a turmoil beyond control. Toscanini, who was nineteen but apparently looked about sixteen, was thrust into the place, and his look of extreme youth did a great deal to quiet the tumult. After he got started there was no argument, and at the end of the first act he was cheered wildly by the very Brazilian patriots who had been unwilling to accept an Italian.

It seems—this is the most extraordinary fact—that in this first performance, for which he had about ten minutes' notice, he did that same give-and-take miracle of pulling them out and pushing them in, molding their phrases and composing their differences, which made him unique throughout the world for the next seventy years. He had never conducted anything before except some compositions of his own, for small orchestra, in his conservatory days. He knew nothing of the technique of the baton, hands or arms. He knew *Aida* by heart only, as you might say, by accident, because he had the habit of learning all the operas by heart when he had to play in them. (He transcribed scores for his own private pleasure, be it remembered!)

The boy Toscanini continued to conduct for the rest of that South American season—thirteen operas, every one of them in the same way, from memory. Nothing so complicated or difficult as *Aida*, of course. He began at the top. After that he conducted *Rigoletto*, *Il Trovatore*, *Faust*, *La Favorita*, and *Les Huguenots*, along with seven less memorable compositions. His control over the vocalists in the operas where they usually had their own way was notable from the very beginning, and the gratitude of the vocalists for this control was also expressed. We note both these facts as characteristic of his entire career for the next seventy years. When the troupe got back to Italy it was actually a tenor—a tenor!—who showed his gratitude to this ferocious young man by giving him the decisive opportunity.

The tenor was Nicola Figner, who had been engaged to sing in some performances of Catalani's *Edmea* in Turin. Catalani wanted a conductor (Faccio, considered the best in Italy, did not please him). Figner suggested Toscanini. It worked with such magic that for a few brief years Catalani could hardly endure having his popular operas conducted by anybody but this young man; and Toscanini's two elder children were named (Walter and Wally) out of Catalani's last opera.

These are only a few of the miracles of that far-off youth which, at the hour of our writing, so very few can now remember. Yet there must be thousands who remember Toscanini's years at the Scala in Milan in the beginning of this century, more thousands who remember his years at the Metropolitan in New York (1908-1915), and far more who remember the golden era when he had the New York Philharmonic-Symphony Orchestra, at the end of the 1920s and

Continued on page 130

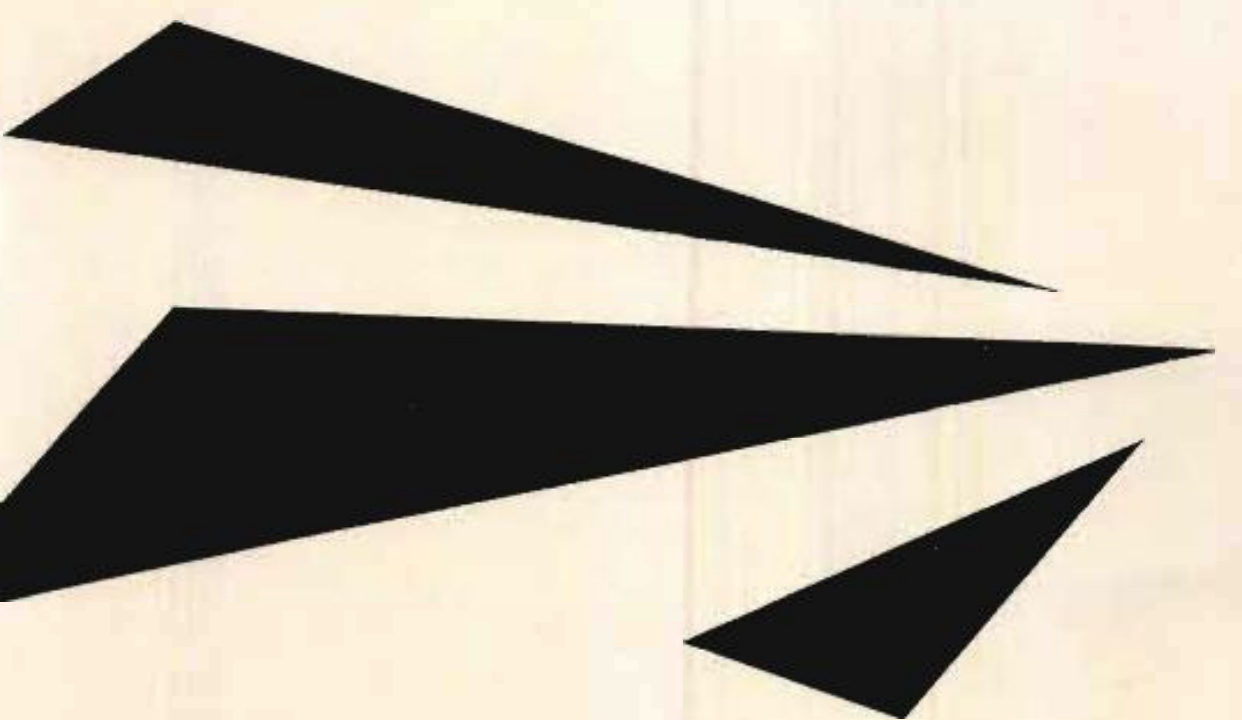

by Chuck Gerhardt

The Recording and Reproduction of Space

The author is a recording engineer for Westminster-Sonotape, and hence became entrapped in stereophilia in the course of his duty.

IF YOU HAPPEN to be a seasoned devotee of the re-production of good music, you may have at one time or another in your search for realism set up a second speaker in your living room. If this is so, you probably are well aware that in reproducing certain sounds (organ, big orchestral scores without solo instruments) there was a definite improvement and an enlargement of the source of sound which was appropriate for these massive sonics. For other sounds (solo piano, opera, etc.) there are times when cancellations of frequencies and/or a doubling up of the lower frequencies produced what I consider to be a false picture of these sonics. Let us not be deceived by the additional volume attained when one switches in another speaker; the ideal A-B test for a choice between one or two speakers should also compensate for the total level which reaches the listener and would be practically impossible under home listening conditions.

The method of playback which we have known and used in our homes for these past fifty years, whether produced acoustically or electrically, is known as a monaural system. We have weathered many changes and conversions, as recording methods improved and commercial manufacturers changed speeds of their products. But whether horn, earphone, cylinder, wax, acetate, 33 $\frac{1}{3}$, 45, 78, or tape, it was all monaural sound. Multi-microphone setups and advanced methods of magnetic recording greatly improved balance and perspective, but it must be remembered

that at some point all these many channels had to be 'malted' together and thereby gave the impression that the original sound source was heard by a "single ear." Only now, with the advantages of separate track tape recording reproduced on separate speakers, can we experience the nearness or distance from the original sound source, since now the position and volume of a given sound source can be recorded in more than one way and reproduced with the differences with which it was recorded *intact*.

If you have heard stereophonic sound in a movie house or at one of the audio shows or a radio broadcast using AM and FM channels, you have probably decided that once again the manufacturers of high-fidelity products have placed before you a delicious sweet, too tempting not to be tasted. I would not blame anyone for being slightly annoyed at the prospects of converting again, especially if he has strained his exchequer to get the best possible monaural reproduction. It will, I must admit, cost money to go stereophonic; how much money may depend on whether you can do some of the work yourself, or persuade a knowledgeable friend to do it. If you were fortunate enough to hear and see the Ampex or Sonotape stereophonic exhibits² at the 1956 Audio Show, you will know how rich the reward can be.

¹A recording studio coinage, meaning fed-mixed-merged — *multa in unum*.
²There were several other stereo exhibits, I am aware, but I was too busy with our own to visit them.



G. D. HACKETT PHOTO

Conductor Mandell and percussionist Lang exult during the making of *L'histoire*. Stereophony did the oboe a favor.

What will you need? In addition to our present turntable, preamp, amplifier, and speaker, you will need a second amplifier and speaker and a 7½-inch-per-second tape machine with two-track stereophonic heads. Several very good models are commercially available. If you have a good monaural tape machine, it can be converted to a stereophonic playback machine. I have done this myself with mine, by purchasing for \$25 a stereophonic playback head, for \$12 an additional preamplifier for the bottom track of the head (the preamp in my tape machine being perfectly adequate for the top track), and another amplifier and speaker of similar quality to the ones which I already had. The price of the installation of the head on the tape machine must be added to the cost, as it must be lined up by a technician who understands tape deck mechanisms. If space permits, I would recommend setting-up your two speakers against one wall 7-10 feet apart, the



RICHMOND TIMES-DISPATCH

Organist Leibert, engineer Magocsi, organ-builder Burdick, and the author in Richmond. A musical vista was captured.

enclosures flat against the wall rather than angled toward each other, as used to be advised. Before you play a stereophonic tape, the speakers should be balanced out, with reference to volume, and here is one place where your own ears must be the judge. Taking meter readings of the amount of signal provided by each amplifier as it goes into the speakers is inadequate, as the speakers may vary in their efficiency. The perfect test would be to acquire a full track monaural tape and play it on your stereophonic heads, turning up the volume control of the amplifiers one at a time, not together, until the sound is as similar as possible from the two speakers. Doubtless the sound will never match perfectly, and one speaker may be brighter than the other. If this is so, I would recommend playing the brighter speaker on your left. If your speakers are well balanced, you should then be able to experience single sources of sound such as the voice of Lloyd Moss, at the beginning of our Sonotape Stereo Demonstration tape, as coming not from either the left or right speaker, or blasting out from both speakers (as in the old two-speaker setup in playing records of which I spoke earlier) but actually standing right at the center point between the two speakers.

While I was working at the 1956 New York audio show, almost every listener who came out of the room after the demonstration asked the same question: "What is the difference between binaural and stereophonic sound?" You may know very well but I will say it again: stereophonic sound is produced in two or more channels with a microphone setup arranged for purposes of panoramic *loudspeaker* reproduction, whereas binaural sound applies only to two channels designed for reproduction on *earphones*. Our exhibit at the audio show attempted to prove that simply setting up two microphones to record, and reproducing the sound from two tracks in no way guaranteed even an approximation of either the mental image or the physical performance of good music. Therefore, tapes recorded for strictly binaural purposes (there are a few around, of amateur origin) should not be expected to sound well on a two-speaker stereophonic setup in your home.

Now that we have Mr. Moss's voice dead center, we should go on through the demonstration tape and see if with our present setup the other tremendous advantages of stereophonic reproduction are in effect. During the section in which Robert Owen plays selections from his album *Toccatas for Organ* on the organ in Christ Church in Bronxville, New York, an interesting test can be made. Here is a place where having the advantage of the reproduction of the original acoustics of the studio in which the selections were recorded will be very apparent. Your listening room should actually take on an enormous (acoustical) size. Turn out the lights in the listening room, start the tape, and then leave the room. Upon re-entering the darkened room, whose actual size and shape are very familiar to you, you should experience an upset of your sense of orientation. The massive forces of the pipe organ with its separate choirs of great, swell, solo, and echo organs show up marvelously in stereo. A monaural recording, however good, can only partially approximate the sound in a church when an organ is being played.

Of course, a simple

Continued on page 131

Prima Donnas I Have Sung Against



by GEORGE LONDON

A toast to the ladies—God bless them all—by an operatic baritone. The author, a student of the fair sex and a gentleman, casts his vote in favor of the prerogatives of the prima donna and the principle of glamour.

THE OPERA SEASON of 1956-57 will, I believe, go down in New York music annals as the season when prima donnas became prima donnas once more and lost all resemblance to "the girl next door." And this, in my humble opinion, is exactly as it should be. For, when you come down to it, the world of grand opera itself is an improbable place and opera lovers just don't want to know that their favorite Brünnhildes or Carmens are the best of housecleaners or sweater knitters, even if this should be the truth. Opera lovers, as opera singers, are a strange people, who feed on illusion. Opera *is* illusion. For, exquisite as its sounds may be, it is certainly outside the realm of logic that a character's innermost emotions should be sung in fortissimo tones. Yet, both opera devotees and opera singers believe in this self-contradictory medium as a vitally true and valid means of expression.

I had feared that most of the glamour of past operatic life had vanished, and that personalities like Mary Garden, Fremstad, Jeritza, and Farrar had been displaced (in an-

other medium) by Lana Turner, Betty Grable, Marilyn Monroe, and Gina Lollobrigida. I hasten to add that I have nothing but admiration for these vestals of Vista-Vision, but I cannot help feeling sorrowful that they focused attention on glamour in an area other than opera.

Gone forever, I believed, were those fabulous days when headlines reported all over Europe that a world-famous contralto of the Vienna Opera, had—during the long monologue of Fricka in Wagner's *Die Walküre*—found time during a few unoccupied bars to spit at an even more famous and glamorous soprano from the lofty terrain of the *Walküre* rock, because the soprano and the rest of the Valkyries were telling jokes in the wing. (Actually, remarkable as the contralto's range turned out to be, her aim did not match. In the best *opera buffa* tradition, she did not reach her adversary but—inevitably—involved an innocent bystander: a minor contralto, who understandably complained to the management.)

The present renaissance of the prima donna can be



FRANK LERNER

London and Milanov: a curtain call for *Amonasro* and *Aida*.



Callas and London: *Tosca* and Baron Scarpia on television.



The Marriage of Figaro with London, Schwarzkopf, and Seefried.

traced directly to Maria Callas, a singer who, long before she made her Met debut, had evoked the kind of excitement (both on stage and off) which is the all-important by-product of the genre. Callas arrived in New York and the title "prima donna" was reactivated. Suddenly newspapers all over America were printing it with relish, in many cases explaining to a new generation of readers what the term really meant. Callas was quoted and misquoted and—during her two months tenure at the Met—there was hardly a day when her name or her face or her poodle did not make at least the inside pages.

The words "prima donna" mean, of course "first lady." And the behavior expected of a first lady of opera is not necessarily identical with that of other "first ladies." Since there always seem to have been, in any opera company, several "first ladies" at a given time, the phrase "prima donna assoluta" was coined. This has a very special meaning, but does not quite denote uniqueness. We have, this year, three "prima donnas assolute" in the soprano wing of the Met—which certainly makes for a lively and prosperous season.

There is the aforementioned Maria Callas, who came and sang three such different roles as Norma, Lucia, and Tosca; there is Zinka Milanov, an all-time queen of opera, both in America and Europe; and Renata Tebaldi, who made a tremendous impression on New York devotees last season. Each has her own idolatrous following; each is an outstanding singer; and each has that certain indefinable "something" which marks the prima donna.

I have had the good fortune to sing with both Mme. Milanov and Mme. Callas, and am looking forward to singing with Mme. Tebaldi during the Met's spring tour. During my career I have also encountered a host of other prima donnas, not only at the Met but in Vienna, Bayreuth, Belgrade, and Buenos Aires. I have shared with them exhilarating, exciting performances, many a laugh, and lots of hard work; but I hate to admit that I never had a scrap with any of them. Now please don't think: "Oh, this George London is a diplomat! He just won't tell." I am the last person to want to seem a saint; neither do I want to make these great ladies appear to be operatic Pollyannas. I just haven't had any trouble with them and, this—I think—can be explained quite easily.

First of all: I think women are wonderful! And prima donnas *are*, after all, women. Secondly, don't forget, I'm a baritone and therefore not in the direct firing line of sopranos. Thirdly, I'm six feet two, and it is a bit difficult to "upstage" me. No matter how much "blocked" I am, I can always clutch a given prima donna in my arms, hold her tight, and still have "headspace" enough to sing out over her. And, then, there is the fourth reason: I believe strongly in the old adage, "Sing and let sing." In my own experience I've never seen it fail. I recall only too vividly the time, five years ago, when I was rehearsing Amonasro in Verdi's *Aida*, which not only opened the season, but also marked my Met debut. I was told that Mme. Milanov—who was singing the title role—had had tenor troubles during the course of her distinguished career. Although I had never had any tenorial ambitions, I did feel a certain cool reserve directed toward me during the first rehearsals. I had the distinct impression she was biding her time to see what this baritone, fresh from two seasons' apprenticeship at the Vienna Staatsoper, was going to do.

As rehearsals progressed and we got to know each other, she visibly warmed up to her new operatic "father," and on opening night she could not have been more helpful. She told me from which spots on the vast stage I could best be heard, and helped me considerably in making this the most memorable evening of my career.

I was reminded of this initial "coolness" only the other night when—again—we were singing together in *Aida*. I had just arrived from Buenos Aires, and before that, had had a summer of operatic appearances in Yugoslavia, Bayreuth, Vienna, and Milan—while she had been in London, where she had triumphed as Tosca. So we actually met for the first time this season on stage, during the second act of *Aida*. After the performance, my wife Nora said, "You put in some new business during the triumphal scene when you meet Aida. I've never seen you *smile* when you tell her all about Ethiopia's defeat."

What actually had happened was this: I sang my first aria to the King of Egypt, then—according to stage direction—embraced Aida, while the chorus sang about Egypt's glory and victory. And just at that moment, Mme. Milanov turned to me, her back to the audience, and whispered, "George, how is the baby? I understand she's a darling . . ."

Perhaps the greatest shock a prima donna ever gave me was in Vienna. I had been entrusted with the Four Villains in Offenbach's *Tales of Hoffmann*. It was a big assignment for a comparative newcomer and a star-studded cast had been assembled. Wilma Lipp was Olympia, Sena Jurinac, Giulietta, and Irmgard Seefried, Antonia. We had ample rehearsal time and I knew then and there that those four sinister characters would be among my favorite operatic roles. As music lovers who have seen her know, Miss Jurinac is not only a wonderful singer but a beautiful slender woman and, although she is now better known for her interpretation of Antonia, she also was an ideal Giulietta, a most glamorous "Venetian Courtesan." The Venice Scene had been staged



Tebaldi

so that—on a given musical cue—I emerged from complete darkness and immediately began to sing. The big night came and every thing went very well until we hit the Venice Scene. I emerged, turned on cue—and nearly missed it. There, facing me, was not my lissome *Giulietta*, but something like a light cruiser in spangles. I don't remember how I finished the act, but I would have appreciated it if someone had warned me that Miss Jurinac had suddenly been taken ill and that a guest artist of mammoth proportions had come to our rescue.

And speaking of overupholstered prima donnas: when I sang *Escamillo* in Europe, I always had sung it with Carmens who possessed the stature and temperament of Helen Hokinson club women. When, true to my role, I gave one of these ladies, as they say, the eye, she said to me under her breath, greatly disturbed, "Mr. London, why do you look at me so lecherously?" So you can understand my delight when, for my first Met *Escamillo*, Risë Stevens was Carmen. As everyone knows, Miss Stevens is every inch the operatic seductress, and she believes, as do I, that a passionate stage kiss is something that should not be simulated. When you kiss Risë—a most pleasant task, by the way—you kiss! There was only one problem; for her portrayal of Carmen, she naturally uses heavy, dark grease paint. This she covers with a layer of powder—so it won't rub off. One night, when we were especially inspired by our operatic roles, just after our last act duet and before going to the "arena" to face the bull, I embraced her passionately. Came the time to release her. We tried to part—but our lips wouldn't! Our two make-ups had gotten stuck, and when we finally did tear ourselves apart it was with a fortissimo "plop!" I don't know how Risë was able to finish the act. I ran for the arena and collapsed, helpless and hysterical, in the wings. . . .

One of the most wonderful prima donnas I know is Irmgard Seefried. Miss Seefried is known in the United States mainly for her lieder recitals but in Vienna she is a great operatic favorite. We have appeared together in innumerable performances of *Don Giovanni* and *The Marriage of Figaro*, both in German and in Italian, and—with Schwarzkopf and Jurinac—have recorded *Figaro* under Von Karajan's baton. In my opinion Miss Seefried is the greatest Mozart singer of our day. Her wonderful gift of improvisation makes every appearance with her a fresh delight and, with Seefried opposite you, there never is any possibility of a routine performance. Here in America, I was privileged to appear with her in joint recitals and—with Paul Ulanowsky, the wonderful accompanist—we traveled from coast to coast. I don't know of any other soprano whose laughter comes so directly from the heart,

and during our tour we had ample reason to laugh. Once, in a Southern town which shall be nameless, we had an especially successful recital. We were in high spirits as the three of us drove to the house of a prominent local hostess who was giving a reception in our honor. As we rolled up to the mansion, it was evident that the party had been going on while we were singing, and that it was even more successful than our effort. As Seefried, Ulanowsky, and I walked up the steps to the huge Greek revival portal, the entrance door was flung open by our hostess. In a happy and bourbon-fortified voice she called out to the rest of her guests. "Here are the artists! May I introduce to all my friends: IMGRAD SIEGFRIED, JACK LONDON, and PAUL ALEXANDER!"

Since that day, Ulanowsky calls me "Jack" and I call him "Al" and whenever Seefried gets in a pensive mood, we both call her "Siegfried" and she immediately cheers up.

Three of the most beautiful prima donnas with whom I've ever sung are Lisa della Casa, Hilde Gueden, and Elisabeth Schwarzkopf. Lisa della Casa, with whom it was my good fortune to sing this season in Strauss's *Arabella*—a characterization which has endeared her to thousands of opera lovers throughout Europe, though this was her first appearance in it at the Met—has a wonderful, indescribable "aloofness" which makes her the ideal interpreter of operatic heroines of aristocratic background. Please don't confuse "aloofness" with "coolness"! Anyone who has seen Della Casa's *Marschallin* in *Rosenkavalier* or her *Contessa* in *Figaro* knows that there is nothing cool about her artistry. She combines wit, charm, and great beauty, but somehow, always conveys this fascinating "distance" of those born to the purple.

Hilde Gueden's pure, silvery voice has wrought magic all over the world. This season, Hilde has been Susanna to my Count and she will, again, be Zdenka in *Arabella* when I will be Mandryka. We have appeared together in *Don Giovanni*, both in Vienna and at the Met. During the Salzburg Festival her *Cherubino* (with Seefried as Susanna and Schwarzkopf as *Contessa*) was one of the highlights of that Festival. Hilde is not only one of the most glamorous of prima donnas but one of the nicest.

Miss Schwarzkopf is perhaps the most meticulous worker I know. She rehearses with a vengeance, is never really satisfied with perfect performances, and suffers more from stage nerves than any other singer I've sung with.

As I write this, I have a dreadful feeling that I may be omitting some of the great singers with whom I've appeared—Eleanor Steber, not only a splendid artist but a wonderful colleague; Victoria de los Angeles, she of the angelic voice; Astrid Varnay, *Continued on page 126*



Della Casa



Jurinac



Gueden



Welitch



Stevens



Seefried

The Wonderful Rotary Singing Coach

by John McCollum



HE WAS clearly an Italian tenor. Short, stocky, curly black hair. Good interpretation. Plenty of dramatic flair. And singing, of course, an Italian operatic aria.

He sat down and was, presumably, relieved of the almost unbearable tension which gnawed at all twenty-five or thirty auditionees. He was number twenty-one. I had been number seventeen. As usual, the auditorium was silent after his aria, except for the scribbling of the five judges and a few whispers — among them mine.

"What did you think of that singer?" I asked a friend (also a singer) who had come along to bolster my morale. He answered without hesitating: "It sounds as if he studied voice by listening to worn-out Caruso records."

Exactly the same thought had occurred to me.

Certainly the young tenor could not have picked a better model, but obviously, since this was less than ten years ago, his vocal image of Caruso was the recorded version. And while it is wonderful indeed to have that recorded version, it can't do justice to the real greatness of Caruso's voice. With the recording equipment of his time it simply was not possible to represent Caruso as he really was. Further, most Caruso records in private homes in the 1940s had been played hundreds of times with steel needles in heavy old-style tone-arms, an abrasive process which eventually gave them an eerie, faraway sound. It must have been hard for the young singer to learn to imitate this, but he had.



JOHN BROOK

The author and Sara Mae Endich in the New England Opera Theatre production of Chabrier's *Une Education Manquée*.

Fortunately recording techniques have advanced phenomenally since the days of the great Enrico. What, then, about modern recordings as aids to the singer?

My own experience convinces me that a first-class recording can be of enormous value to the singer in preparing for performance with orchestra. But he must have a complete understanding of the risks involved, and he must have solid musical background to run those risks successfully.

I have found recordings particularly helpful when faced with limited study and rehearsal time. As most concert singers have discovered, the first rehearsal with orchestra can come as quite a shock. The piece may be thoroughly studied and coached, and the singer may feel confident that he has it under control musically and interpretatively. But, unless he has had opportunity to hear it performed in concert or on records, he has heard only the piano score. For Handel or Mozart this may be all he needs for a sure performance, with or without adequate orchestra rehearsal. But with music of most later composers, it is not. No matter how well the piece is played by the singer's coach, it is impossible for the coach's piano to duplicate the orchestral sound.

The singer arrives at orchestra rehearsal and, for the first time, hears the piece played with full orchestration. What a difference! For a few moments he may experience that "thrown to the wolves" feeling. Now comes a real test of his musicianship. He must depend on his basic knowledge and understanding of the piece, acquired through study, and simultaneously orient himself to the orchestral structure looming about him.

He has been accustomed to hearing the music from one instrument. He has heard the harmonies played with the percussiveness of the piano. He has heard the melodic lines played with the piano's relatively limited color. Now, with up to a hundred instruments of vastly varying character and color playing in the orchestra, he hears a familiar bit from the violin. Suddenly it's gone. No, it's in the oboe. Now the cello is playing what he has relied on as a musical landmark or cue. The steady percussive rhythms of the piano are not there. Instead, there is a shimmer of sound from the strings. Or, perhaps he has depended upon a low pitch played repeatedly in the bass clef by the piano.

But now where is that pitch? A kettledrum has it. But what exactly is the pitch? It's hard at first to adjust to the sound of the timpani, when one is used to the piano.

From his first orchestral rehearsal, many a singer comes away feeling like the schoolboy who's had his first ride on a roller coaster. The ride was exciting—but how he had to hang on around the curves! In time, no doubt, he will become as blasé about the coaster as if he'd built it himself. But he'll never fully forget that first ride.

So it is with the singer. After the first rehearsal he holes up at home or at his hotel and tries to think away the butterflies in his stomach, a procedure which may or may not work. If he's lucky he has another orchestra rehearsal, and finds many of the rough edges have become smooth. The actual performance rolls around and he does a fine artistic job, butterflies or not.

However, few singers ever feel their performances are completely satisfactory. "If only we had one more rehearsal," is a common complaint. But rehearsals cost money and take time. A conductor often must schedule fewer rehearsals than he'd like to because of budget limitations.

Here, then, is the value of a recording for study. Playing the record several times, the singer becomes familiar with the orchestral sound prior to rehearsal. Now he does not have to cling to basics while mentally scrambling for orientation. He is more at home with the orchestra and is freer to pursue the interpretative possibilities of the piece.

I have used recordings to definite advantage in studying difficult works under difficult conditions. To cite two examples, they were of utmost value to me in preparing the role of Faust in Berlioz's *The Damnation of Faust* and the role of Pelléas in Debussy's *Pelléas et Mélisande*. My performance of the former role took place under extremely precarious circumstances. I had been asked to replace an indisposed tenor, in three performances of the *Damnation* with the Boston Symphony Orchestra. I was given five days' notice. I had never heard the work nor had I seen the score.

This, of course, was an unusual test. I had no orchestral rehearsal. My only time with the conductor, Mr. Charles Munch, was in conference during a one hour flight from New York to Washington, D. C., where my first performance was to be. This conference dealt mainly with tempos and interpretation. I am happy to say that the performance was successful and I give a large measure of credit for my part in it to the use of the recording.

And how wonderful it was to have the Boston Symphony's own recording of the work for study! This was as close a substitute for actual orchestra rehearsal as one could hope for, with the very symphony, conductor, chorus, and soloists with whom one was to perform in one's own studio or living room for rehearsal.

Studying Pelléas was another matter. This time I had about six weeks to prepare the role for performance with the New England Opera Theatre in Boston. To be sure,

I had ample coaching by Mr. Boris Goldovsky, artistic director of the N.E.O.T., but for home study I used a French recording of the opera. Anyone who has studied it will agree it is one of the most difficult operas to perform, and probably most authorities would call it fatuous of me to expect to learn it in six weeks. Many would advise spending years of study into the psychological meaning and symbolism of the opera, rather than risk "inflicting a shallow interpretation on the unsuspecting public." But that is not the question here. The recording of *Pelléas et Mélisande* was a great help to me, even though we used an English translation whereas the recording was in French. This presented problems certainly not ideal (particularly concerning word accents and rhythms), but it serves again to prove the value of recordings for study.

Now, as to the risks mentioned earlier.

Recordings are no substitute for musicianship. Really mastering a difficult piece on the basis of true musical understanding is something very different from learning it parrotlike, by rote. In fact, I think it inadvisable for a singer whose musicianship is insecure to use recordings for study except in a very limited way, to augment thorough coaching. Above all, he must not assume that listening to a recording is a perfect or even a passable substitute for coaching by a known authority in the kind of music being prepared.

Recordings are seldom musically flawless. The singer must be a sure enough musician to recognize mistakes and not be influenced by them. The more complicated the piece, especially in its ensemble singing—as in operatic scenes of three or more characters—the more help the recordings can be for individual study. At the same time, the more difficult it is for the shaky musician to detect mistakes. He may even, indeed, learn the mistakes along with the music, and some are hard to unlearn.

I happen to be fortunate in having had a long background of instrumental experience before becoming a singer, since I studied piano as a child, and cornet and trombone in secondary school and college. I played in orchestras, concert bands, and dance bands, where fast reading was a must. I have always prized this as an important asset. Hence, I was shocked and somewhat mortified not long ago when a conductor pointed out a minor, but obvious rhythmic mistake I made in rehearsal. I couldn't believe I had made such a mistake, but he assured me I did. At home, later, I brought out a recording of a famous artist singing the piece, a favorite record of mine and one I had played many times. On checking it I found exactly the same mistake, which I had inadvertently memorized.

Conductors' tempos and interpretations vary. The singer must always be prepared for a contrast in these variables when he has heard a recording made by one conductor but is to perform with another. If he uses records for study, it is advisable to listen to more than one recording whenever possible.

Continued on page 133



JAMES ALBRESCH
John McCollum

*What shall we do
with the tin-eared ladies?*

the infidelical spouse

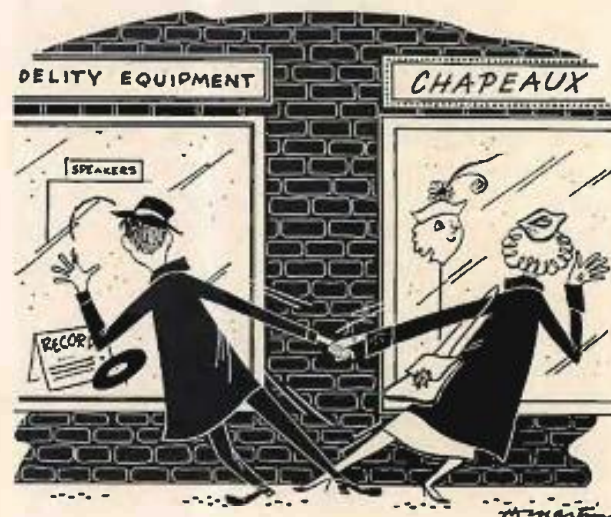

by S. Strindberg Schopenhauer

For reasons which soon will be apparent, the author has chosen to write under a pseudonym, compounded from the names of two famous misogynists.

IN the past few years we have all read many essays by suffering hi-fi wives about the sufferings of the hi-fi wife. These essays, generally literate, invariably written in a brightly rueful tone, have managed to suggest that, all kidding aside, the coming of hi-fi into the home usually provides yet another opportunity for the typical, red-blooded American wife to exemplify noble self-sacrifice of the sort that commonly attracts the sponsorship of manufacturers of cleaning material (or cleansing material, as we non-Bostonians hardly ever put it).

To the best of my knowledge, no answering essays have been written—at least I have seen none published—by suffering hi-fi husbands. Is this because no hi-fi husband has anything to suffer about? No indeed; it is merely because any husband knows that there is no point in making a bad situation worse just for the sake of an abstraction like truth. Eventually, however, there had to arise a man who, pausing only to echo Farragut re torpedoes, would proceed to do for other hi-fi husbands what they wouldn't do for themselves. I am the man; I suffered; I was there.

Allow me to present my credentials. In the first place, I am a hi-fi husband. This fact alone would qualify me to purvey a little *katharsis* for my fellow hi-fi husbands, which is all, I suppose, I can hope to accomplish. In the second place, I sell hi-fi equipment. Professionally, that is. This means that I have served as father confessor to many a hi-fi husband in this Midwestern city of something less than 100,000 souls. It's a good hi-fi town, and there are a lot of hi-fi husbands in it. In short, I think that when I generalize about hi-fi husbands, my conclusions are based on what the pollsters would call an adequate sampling.

Oddly enough, though, the incident that precipitated this essay merely caused me to juxtapose with hi-fi a conclusion reached less on the basis of three years of professional dealings with hi-fi husbands than on the basis of some

twenty years of considerable contact with music, musicians, and musical organizations. It is a conclusion which simply serves to identify the major thorn in the flesh of the hi-fi husband.

This essay, then, became inevitable the day my sister-in-law (a musician and one of a fair number of exceptions to the rule I am about to state), in the course of some general chitchat on the hi-fi trade, observed: "I suppose that most of your customers are women." I fear that I laughed; in fact, only the rigorous code of the Schopenhauers kept me from guffawing at the naïveté of the notion. "You're 180 degrees out of phase," I rejoined, involuntarily lapsing into technical jargon. "Very few of my customers are women, for several reasons, of which the principal one is that very few women really like music."

She seemed amused in her turn at this patently ridiculous proposition, and at once commenced adducing arguments to the contrary. For instance, she said, drawing on her own background, look how many more female than male music students there are. Passing over a number of ready explanations for this fact, I pointed out merely that I was concerned with quality, not quantity, and reviewed a never-to-be-forgotten highlight of my college days: an episode in which I chanced to be on hand when a pair of the campus' leading female music majors undertook to do a spot of cramming for the next day's examination in their Music Appreciation course. "First I'll play the records," said the one, "and you try to guess what they are." While I made a mental note of that verb, she put *Finlandia* on the turntable and the would-be "guesser" listened to about a third of it with knitted brows. Suddenly, while the trombones were blating away at full tilt and the rest of the orchestra was holding nothing back, the brows unknitted and there came the hopeful inquiry: "Is it by Mozart?"

My good sister-in-law then advanced the argument that

it is the women's committee that keeps virtually all community musical organizations going. I admitted this; I piously thanked the Lord for it; and I pointed out what many thousands have pointed out before me: that if it were not for the social cachet attendant upon such activities, half of those women would have nothing to do with such committees. I also added an observation which I suspect that Hotspur would have made had the question been invited to his attention: "Out of this nettle, snobbery, we pluck this flower, music." However, I went on, this was beside the point, which was simply that of the other fifty per cent of the committee members, relatively few really like music. The argument continued; I defended my thesis at some length; and I'm prepared, in briefer form and with more specific connection with hi-fi, to do it again.

It is my judgment that far more men than women profoundly love music—a judgment not in the least affected by my willing concession that probably more women than men have a shallow liking for music. The test is a very simple one: does a given woman prefer really to pay attention to music, or would she rather talk? There is a common notion that women's ears are more sensitive to distortion than men's and that therefore women cannot stand as much volume. I am rather skeptical about this notion. My own theory—neither provable nor disprovable—is that most women object to hearing music reproduced at anything like concert-hall volume because it intrudes itself upon their attention and keeps them from (a) thinking their own thoughts or (b) talking. Any woman worth her salt is likely to be convinced that what she has to say is more important than what Beethoven has to say. I painfully recall an episode in a certain living room wherein a hi-fi wife, after waiting patiently through some vigorous Beethoven passages, seized the opportunity afforded by an ensuing quiet passage to remark to a female guest: "I love your hat." I once emerged just ahead of two middle-aged damsels from a concert hall in which had been offered, for those who had ears to hear, a shattering performance of the *Eroica* symphony. Said the one: "Wasn't the Beethoven pretty?" Said the other: "Yes, indeed." Where were they when the heavens were being stormed?

The chances are that almost any hi-fi husband has played an unwilling part in a scene like the following, which I reproduce from memory: It is a party. Music-loving friends are present and the hi-fi husband has played a couple of records on the prized rig.

Hi-Fi wife: "Can't we turn it off now and talk, dear?"

A male guest: "Oh, I'm enjoying this. It's wonderful. Let's have more music."

Hi-fi wife (stung because her devotion to Culture apparently has been challenged): "Oh, I just love music. It's just that I think it's better to talk. Isn't it?"

The fact that most women don't really like to listen to music has grievous consequences for the hi-fi husband. Presumably on the grounds that what is not worth listening to attentively

is not worth reproducing well, a sadly large proportion of hi-fi-wives-to-be are unwilling to countenance the spending of enough money to buy equipment capable of really good reproduction. It is conceivable that some of this opposition would vanish if the thing could be put on a keep-up-with-the-Joneses basis, but no dedicated hi-fi salesman wants to do *that*.

Since his wife normally feels that the money could be better spent on new draperies (try to win over a recalcitrant hi-fi wife by pointing out the distinction between mere decoration on the one hand and spiritual nourishment on the other and you're likely to be brought up suddenly with the realization that to her *music* is mere decoration too, and much less concretely real than draperies), the hi-fi husband frequently has to resort to harmless subterfuges in order to acquire equipment of the quality that he craves. The man sufficiently affluent to have both a joint and a private checking account is in like Flynn: he simply writes two checks. His less prosperous brother, with a single checking account and a wife who looks at the check stubs, pays part by check and part in cash. Still others must employ barefaced prevarication. A couple of years ago one of my customers had his spouse safely convinced that his new pickup cartridge had cost but \$10, when a blundering friend (undoubtedly a bachelor) entered the house one night, made a beeline for the high-fidelity rig, and observed in ringing tones: "I see you have a new Fairchild cartridge. Sure was a break when they reduced the price to \$37.50, wasn't it?" I believe this innocent boner cost the unfortunate husband a couple of dresses.

As a matter of fact, I consider it extremely significant that in a considerable percentage of cases wives who have consented to the acquisition of a hi-fi rig (many of them wives who would protest that they too just love music) demand a *quid pro quo*, the clear implication being: "You're the one who'll be getting all the enjoyment out of the hi-fi rig, so you ought to buy me something of equal value."

If the hi-fi husband has trouble getting his equipment into the house in the first place, this is nothing compared to the amount of trouble he may have getting to use it once it's in. The principal asp in the grass, my investigations convince me, is television. Other issues separate the men from the boys; this one separates the men from the women. The cleavage seems to come on this point: most men are aware that a TV set may be turned on, off, and then on again; women often seem to feel that for some vague reason it is harmful to turn off the TV until the very last possible minute. A hi-fi wife whose habits have come to my attention illustrates this conviction: after she has watched the last program that can hold her, she arises from her chair, checks the doors, turns down the heat, performs various ablutionary rites, and *then*, on her way up to bed, turns off the TV set she stopped watching ten or fifteen minutes ago.

In the face of such dogged devotion



to the window on the world (mostly the improbable world of mass-produced drama and simple-minded comedy), what is the hi-fi husband to do? Well, he has several choices. For one thing, he can give up completely and just *look* at his equipment without playing it—except perhaps when his wife is out with the girls. Or watching TV at a neighbor's house. I'd hate to think that many hi-fi husbands make so abject a surrender, but I fear some of them do.

The second possibility is that the hi-fi husband comes to a working agreement with his wife: certain nights of the week shall be sacred to TV, others to music. Even this arrangement has a flaw in it: assuming that the husband's tastes diverge from the sort of programming favored by the women's committees of our community orchestras and concert associations, he *still* had better save his Bach and Bartók (since it is a sorry fact that to most women even these composers are esoteric) until his helpmeet is out of the house or asleep. Unless he wants to listen against a background of feminine fuming, that is.

The third, and most drastic expedient, especially in that it may involve buying a house, is for the husband simply to get the hi-fi rig out of earshot of the TV set. Husband and wife then go their own ways: he to solace his spirit with music; she to anestherize her brain and titillate her emotions with TV. I'll admit, if you like, (and it's big of you, Schopenhauer, *big*), that a housewife—unlike her husband—is deprived during her working hours of human companionship, even synthetic, and hence craves people and chatter in the evening. But let's face it: sympathizing with your wife is no substitute for hearing the *Goldberg Variations*.

I hold that these and other sorrows of the hi-fi husband arise not only from the fact that, as stated, very few women really like music, but also from the related fact that far more women than men have no better than mediocre taste in music. Note well that this is not the same thing as having *no* taste—a state which, while deplorable, at least is relatively free of cant and pretense. How often has one heard with some pleasure a woman announce, "I just love good music," and then been let down by the ghastly addendum "especially the way Liberace (or Mantovani) plays it." And for every woman who knows no better than to admit that she prefers music sentimentalized, saccharinized, slicked-up, I suspect that there is another sophisticated enough to know that for reasons of snobbery she had better keep her real preferences to herself. Who put Liberace where he is today—men?

I do not wish to be understood as claiming that the male sex is one enhaloed mass of James Gibbons Hunekers or Bernard Berensons, let alone a phalanx of Walter Paters, burning with a hard, gemlike flame.

All I allege is that men seem much more likely than women, by and large, to regard music as food for the spirit, worth paying attention to, than as a mere soothing balm for the eardrums.

At this point I sense that numerous female readers have already asked themselves the comforting question:



"Is this fellow not talking about the general level of taste among the women of Podunk?" No, he isn't. The level of taste in our city is rather unusually high. There aren't many smallish cities which can point to such resources as three colleges (one good-sized state institution, two private liberal-arts colleges, one of high national repute) with all the cultural activities and leavening influence to be expected therefrom; a long-established symphony orchestra as well as a flourishing junior symphony; an annual music festival devoted entirely to the works of one of the very few composers who merit such devotion; plus many other musical activities and such significant nonmusical ones as a nationally known civic theater. In short, we are not talking about the ladies of Podunk, except by extension. By extension, in fact, we are talking about everywhere.

Allow me a final illustrative anecdote. One of the leading female music clubs of the city, proudly flaunting membership in the National Federation of Music Clubs, once, in a moment of fine recklessness, invited me to give a small lecture-demonstration on high fidelity. In those days (not so long ago—one matures rapidly in a couple of years' standing in the middle of the battlefield) I was more naïve than I am now, so I thought to myself: "Hot damn! Here's a chance to demonstrate with some real music, for some people who really will appreciate it." So I pitched my prepared opening remarks to the proposition that in a sense the real glory of hi-fi was its ability to bring us into intimate contact with profound and subtle music, such as chamber music. But I did fudge a little on the record I took along: instead of a late Beethoven quartet, the Schubert Trio, Op. 100. I was the second half of the program; performances by various of the members constituted the first half. I draw a curtain over the harrowing details of that first half; I say naught of the indomitable ennui with which most of the girls endured the first movement of the Schubert. I sum the whole thing up by asking one question: what possible conclusion can one draw when in such a setting, under such auspices, a soprano member programmed for some art songs arises and announces that her first song will be *When Irish Eyes Are Smiling*?

There is only one conclusion. It has to do with taste; and, as I'm sure that most of you know, that conclusion either needs no explanation or can't be explained. This is not just a matter of "*de gustibus. . .*" That ancient bromide has retained its popularity for centuries principally because it is an easy formula for getting out of an embarrassing situation, but it never deserved to win any prizes for profundity. Two people of even relatively cultivated taste can, and often do, argue fruitfully about matters of taste, to their mutual enlightenment. The bromide really was brought to grips with painful truth when Huneker (I believe) amended it by adding a stinger: "There is no arguing about matters of taste—with the tasteless." That is why this essay is not being written with the aim of convincing anyone of anything; as hitherto noted, its purpose is

Continued on page 130

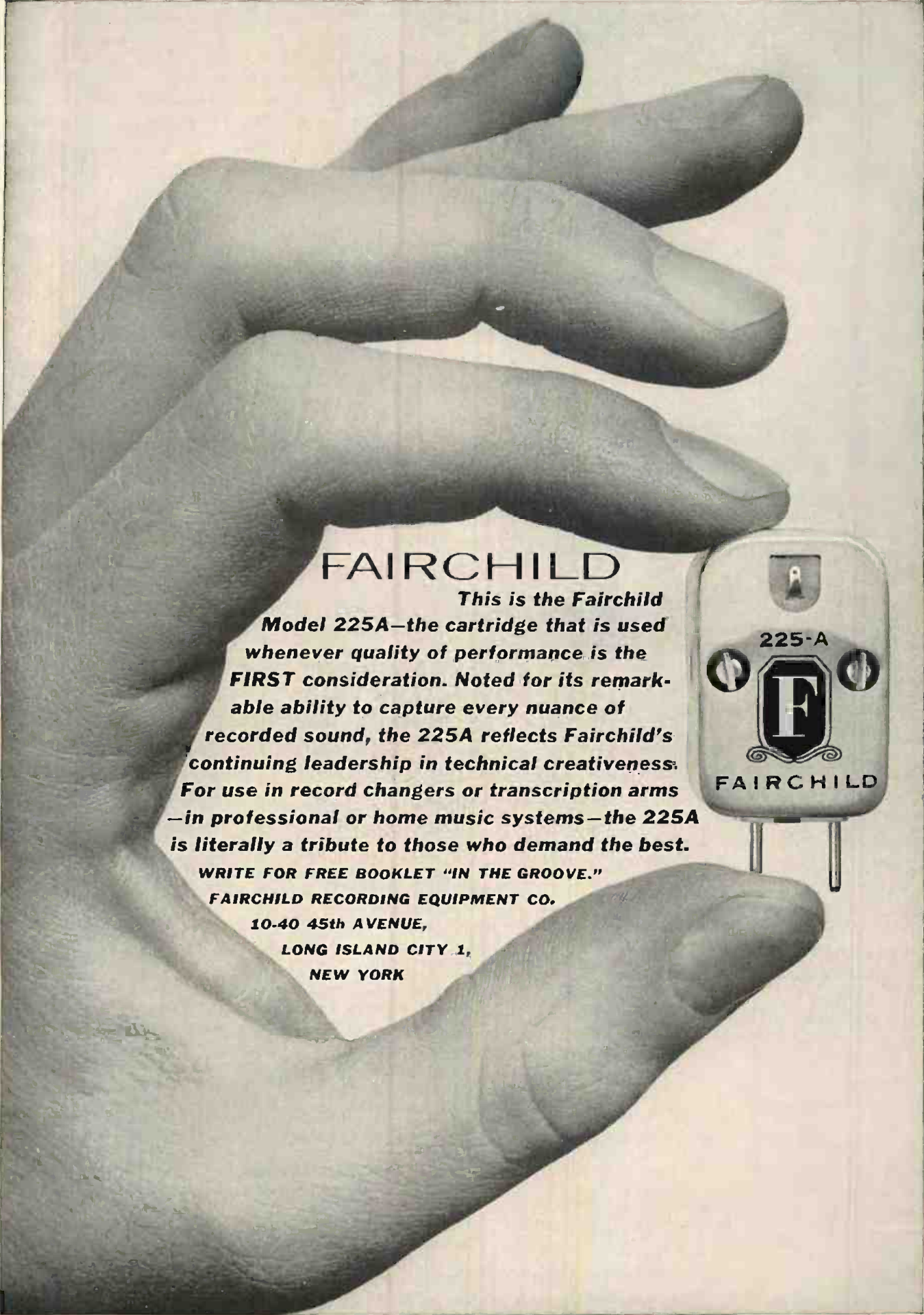

FAIRCHILD

*This is the Fairchild Model 225A—the cartridge that is used whenever quality of performance is the **FIRST** consideration. Noted for its remarkable ability to capture every nuance of recorded sound, the 225A reflects Fairchild's continuing leadership in technical creativeness. For use in record changers or transcription arms—in professional or home music systems—the 225A is literally a tribute to those who demand the best.*

WRITE FOR FREE BOOKLET "IN THE GROOVE."

FAIRCHILD RECORDING EQUIPMENT CO.

10-40 45th AVENUE,

LONG ISLAND CITY 1,

NEW YORK

EYE FIDELITY FOR



The same magnificent quality of reproduction that sets high fidelity sound apart from ordinary sound sets a Fleetwood picture apart from an ordinary television picture. This high quality, which has made Fleetwood the professional's television system, has been achieved by building Fleetwood to the same rigid standards as television network monitors ... also made by Fleetwood.

Fleetwood's superlative picture quality is further enhanced by a Fleetwood exclusive — the Definition



The Fleetwood "Lo-Boy" Cabinet lives well with any decor. It carries the "Wife's Seal of Approval."



ARIZONA

AUDIO SPECIALISTS

333 East Camelback Road, Phoenix
Phone: AMherst 5-0447

NILES RADIO & TV CENTER

400 N. 4th Avenue, Tucson
Phone: MA 3-2537

CALIFORNIA

NEWARK ELECTRIC COMPANY

4736 W. Century Blvd., Inglewood
Phone: OREGon 8-5344
ORchard 7-1127

BUSHNELL ELECTRONICS

12026 Wilshire Blvd., Los Angeles 25
Phone: BRadshaw 2-7537

CRENSHAW HI-FI CENTER

107 Santa Barbara Plaza, Los Angeles 8
Phone: AXminster 3-8201

MIDWAY ELECTRONIC SUPPLY CO.

2817 Crenshaw Blvd., Los Angeles 16
Phone: REpublic 1-2451

BUSHNELL'S HARBOR HI-FI

3333 Newport Blvd., Newport Beach
Phone: Harbor 4681

GENERAL ELECTRONICS

4156 Piedmont Ave., Oakland
Phone: OLYmpic 5-2711

HOLLYWOOD HI-FI

1839 E Street, San Bernardino
Phone: 8-36101

GRACIE'S RECORDS

304 West Third Street, Santa Ana
Phone: KI 3-2684

COLORADO

ALLEGRO MUSIC SHOP, INC.

262 Fillmore, Denver
Phone: EAst 2-1869

CONNECTICUT

DAVID DEAN SMITH

262 Elm Street, New Haven 11
Phone: UNiversity 5-1101

FLORIDA

BURDETT SOUND AND RECORDING COMPANY

3619 Henderson Blvd., Tampa
Phone: 73-6091

ILLINOIS

THE NEW SOUND

35 E. Springfield Avenue, Champaign
Phone: 6-119

ALLIED RADIO CORPORATION

100 N. Western Avenue, Chicago 80
Phone: HAymarket 1-6800

ELECTRONIC EXPEDITERS, INC.

THE HI-FI CENTER
2909 West Devon Ave., Chicago 45
Phone: RO 4-8640

NEWARK ELECTRIC COMPANY

223 W. Madison Street, Chicago 6
Phone: STate 2-2950

INDIANA

THE GOLDEN EAR, INC.

15 E. 16th St., Indianapolis
Phone: MEIrose 5-4915

THE GOLDEN EAR, INC.

610 Main Street, Lafayette
Phone: 2-2917

KANSAS

PHIL WOODBURY SOUND

1103 Commercial, Emporia
Phone: 20

PLAZA TELEVISION

1408 Huntoon, Topeka
Phone: 25007

THE BENNETT MUSIC HOUSE

East Central at Oliver, Wichita
Phone: MUrray 2-6578

KENTUCKY

J. M. HISLE AND ASSOCIATES

405-9 South Upper Street, Lexington
Phone: 2-7884

THE GOLDEN EAR, INC.

610 South 3rd Street, Louisville,
Phone: CL 4531

MARYLAND

HI-FI SHOP

153 No. Mechanic Street, Cumberland
Phone: PArkview 2-0050

MASSACHUSETTS

THE LISTENING POST, INC.

161 Newbury Street, Boston 16
Phone: COpley 7-7530

MICHIGAN

K.I.A. LABORATORIES, INC.

7422 Woodward Avenue, Detroit 2
Phone: TRinity 4-1100

R. L. KARNS ELECTRONICS

910 E. Fulton Street, Grand Rapids 3
Phone: GLendale 8-5869

WEST MICHIGAN SOUND CO.

1932 Peck Street, Muskegon
Phone: 2-5910

MINNESOTA

AUDIO EQUIPMENT COMPANY

Highway 65 & St. John Avenue,
Albert Lea
Phone: 3568

AUDIO KING COMPANY

1827 East Lake Street, Minneapolis 7
Phone: PArkway 9-7451

MISSOURI

THE HIGH FIDELITY SHOWROOM, INC.

6383 Clayton Road, St. Louis 17
Phone: PArkview 1-6500

NEW JERSEY

M & M ELECTRONICS & TELEVISION CO., INC.

7 Maple Avenue, Morristown,
Phone: JEFFerson 8-5274

SOUND REPRODUCTION, INC.

34 New Street, Newark 2
Phone: MI 2-6816

CASEY HI FI INSTALLATION CORP.

205 W. Englewood Ave.,
West Englewood
Phone: TE 6-4200

NEW YORK

BUFFALO AUDIO CENTER

161 Genesee Street, Buffalo 3
Phone: MOhawk 1368

ISLAND RADIO DISTRIBUTOR

412 Fulton Avenue, Hempstead
Phone: IV 1-8160

NEWMARK & LEWIS, INC.

43 Main Street, Hempstead, L. I.
Phone: IVanhoe 1-6890

THE AUDIO EXCHANGE, INC.

159-19 Hillside Avenue, Jamaica 32
Phone: AXtell 7-7577-8-9

Free booklet



of installation ideas available from

YOUR HIGH FIDELITY

Control. This control allows you to tailor the picture to your individual taste — from soft and diffused to sharp and clear.

You'll enjoy two other Fleetwood advantages, too. Fleetwood has full electronic remote tuning... a remote control that doesn't just change channels or volume but gives complete tuning from the remote location. Fleetwood also provides outputs for your high fidelity sound system... and with television, too, this makes a big difference in sound quality.

For a Free Booklet of Installation Ideas, complete information and the name of your nearest dealer write:

Fleetwood[®]
CUSTOM TELEVISION
 Crafted by CONRAC, INC.
 Department A, Glendora, California

Export Division: Fraxar & Hansen, Ltd., 301 Clay St., San Francisco, California
 Conrac is the Canadian Name for Fleetwood
 ©Conrac, Inc. 1957



NEW YORK (Continued)

HOUSE OF HI-FI
 605 Plandome Road, Manhasset, L. I.
 Phone: MA 7-1376

ARROW ELECTRONICS, INC.
 65 Cortlandt Street, New York 7
 Phone: DIgby 9-4730

ASCO SOUND CORPORATION
 115 West 45th Street, New York 36
 Phone: JUdson 2-1750

HI-FI HQ
 (for those who demand the finest)
 150 East 46th Street, New York 17
 Phone: PLaza 5-2650

LEONARD RADIO, INC.
 "AUDIO MART"
 69 Cortlandt Street, New York 7
 Phone: CO 7-0315

TERMINAL RADIO CORP.
 85 Cortlandt Street, New York 7
 Phone: WOrth 4-3311

CONCERT-CRAFT, INC.
 P.O. 66, Brandywine Station,
 Schenectady 4
 Phone: FR 2-8989

**W. G. BROWN SOUND
 EQUIPMENT CORP.**
 521-27 E. Washington Sr., Syracuse 2
 Phone: 2-8979

THE AUDIO EXCHANGE
 367 Mamaroneck Ave., White Plains

**NORTH CAROLINA
 DALTON-HEGE RADIO
 SUPPLY CO.**
 912 W. 4th St., Winston-Salem
 Phone: 5-8711

OHIO

AUDIO CRAFT CO.
 2915 Prospect Avenue, Cleveland 15
 Phone: CHerry 1-5560

COUNTERPOINT
 20971 Westgate
 (Westgate Shopping Center)
 Cleveland 26
 Phone: ED 1-6448

CUSTOM CLASSICS
 13421 Euclid Ave., East Cleveland 12
 Phone: GL 1-0256

PIONEER ELECTRONIC SUPPLY CO.
 2115 Prospect, Cleveland 15
 Phone: SU 1-9410

R. S. T. LABS
 14511 Granger Road, Maple Heights
 Phone: MOntrorse 2-3213

**RICHARD J. SAUER
 CUSTOM ELECTRONICS, INC.**
 1000 South Main Street, Dayton 9
 Phone: ADams 3158

OREGON

SANDY'S CAMERA SHOPS
 635 S. W. Alder
 714 S. W. Washington, Portland 5
 Phone: CApitol 8-1345

PENNSYLVANIA

BAKER COMMUNICATIONS
 9 South 12th Street, Allentown
 Phone: HEmlock 3-3326

AUDIO LABORATORIES, INC.
 808 Mohican Street, Bethlehem
 Phone: UNiversity 7-3909

DANBY RADIO CORP.

19 South 21st Street, Philadelphia 3
 Phone: RIttenhouse 6-5686

ELECTRONICS OF CITY LINE CENTER, INC.

7644 City Line Avenue
 (City Line Center) Philadelphia 31
 Phone: GRGreenwood 7-9535
 GRGreenwood 7-7144

TEN CATE ASSOCIATES

6128 Morton Street, Philadelphia 44
 Phone: GERMantown 8-5448

RADER & FASIG, INC.

704 Walnut Street, Reading
 Phone: 4-7831

RHODE ISLAND

AUDIONICS COMPANY
 NEW ENGLAND'S HI FI CENTER
 790 North Main Street, Providence
 Phone: DEXter 1-4242

GERTZ, INCORPORATED
 257 Adelaide Avenue, Providence 7
 Phone: STUart 1-4200

TEXAS

WRYE CO., LTD.
 2410 W. Alabama, Houston 6
 Phone: JA 3-7874

UTAH

DAYNES MUSIC CO.
 15 East 1st So., Salt Lake City
 Phone: ELgin 9-7633

WASHINGTON

OLYMPIC ENGINEERING CO.
 2008 Westlake Avenue, Seattle 1
 Phone: ELior 4650

WISCONSIN

HI-FI HOUSE, INC.
 2630 North Downer Avenue,
 Milwaukee 11
 Phone: EDgewood 2-1700

THE HI-FI CENTER, INC.
 4236 West Capitol Dr., Milwaukee 16
 Phone: UPrown 1-2133

CANADA

HI FI SALES LTD.
 2714 West Broadway, Vancouver, B.C.
 Phone: CEdar 8716

PAYETTE RADIO LIMITED
 730 St. James Street, W., Montreal 3,
 Quebec
 Phone: UN 6-6681

TREVOR PECK COMPANY LTD.
 1498 Sherbrooke Street, West,
 Montreal, Quebec
 Phone: FI 4685

H. R. SAVARD RADIO LTD.
 910 Bleury Street, Montreal, Quebec
 Phone: UNiversity 6-9202

CROBEL, LTD.
 790 East Blvd., Charest, Quebec City,
 Quebec
 Phone: LAfontaine 4-5201

MAGUIRE ELECTRIC LTD.
 1330 Maguire, Sillery, Quebec
 Phone: MU 1-2333

THE HIGH FIDELITY SHOP
 557 Mount Pleasant Road,
 Toronto 7, Ontario
 Phone: HUDson 8-6443

HAWAII

TELCO LTD.
 605-607 South Queen St., Honolulu
 Phone: 50-2964

your Fleetwood[®] dealer or write: Conrac, Inc., Glendora, Cal.

why the Collaro

RC-456

is today's outstanding
HIGH FIDELITY RECORD CHANGER



**Minimum
Noise and
Distortion**

Balanced, heavy 4-pole motor . . .
balanced pulley and coupler reduce
rumble to an inaudible minimum.
Automatic muting switch and R/C
network eliminate 'clicks.'

**Accurate
Speed & Pitch**

Collaro quality control limits for the
RC-456 are .25% waw and flutter
. . . unmatched by any other
record changer.

Jam-Proof

Collaro safety-clutch prevents
damage even if tone-arm is held
or moved during change cycle.

Four Speeds

Plays all 78, 45 and 33 1/3 rpm
records . . . plus new types designed
for 16 2/3 rpm speed.

**Automatic
Intermix**

Plays 7, 10 and 12-inch records
stacked in any order —
automatically.

**Manual
Operation**

For playing records individually or
for selecting and playing specific
bands and parts of a record.

**Simple
Installation**

Prewired power and audio connections
eliminate soldering. Pre-cut
mounting board available.

...Plus

- ★ Rapid change cycle independent of record speed.
- ★ Automatic 'shut-off' after last record.
- ★ Simple, one-knob speed selection.
- ★ Gentle, straight-spindle record handling.
- ★ Interchangeable, plug-in cartridge shells.
- ★ Heavy, rim-weighted turntable for flywheel action.
- ★ Automatic idler-disengage prevents idler flats.

At leading sound dealers, or write Dept. XC-2

ROCKBAR CORPORATION • 650 Halstead Avenue, Mamaroneck, N. Y.



by  Roland Gelatt

music makers

ARTURO TOSCANINI left behind a greater number of unpublished recordings than any other musician in the eighty-year history of the phonograph. If demand for them continues, RCA Victor will be releasing new Toscanini records for years to come. And in that there is considerable consolation.

Almost all the forthcoming items will be derived from tapes of broadcasts. The last important "studio session" material in RCA's vault is being published this month as part of the complete *Aida*. Although the major portion of this album is taken from a 1949 broadcast performance, it contains certain remakes that Toscanini conducted in June 1954 following his formal retirement from the podium. This future dependence on broadcast tapes means that the still-to-be-issued records are bound to have some sonic deficiencies, but from a musical standpoint they will carry the late Maestro's approval.

As readers of Richard B. Gardner's "The Riverdale Project" (HIGH FIDELITY, April 1956) know, Toscanini spent the last two years of his life in close co-operation with the engineers whose task it was to produce technically acceptable versions of his many, many musical performances recorded on acetates or tapes. "He is always willing and even anxious," Gardner wrote a year ago, "to listen to anything that requires his decision, whether it be an entire symphony or just a few questionable bars." The process of collating that great mass of recorded material was a slow one, but before his death Toscanini had listened to almost everything that the microphones had captured. And on many recordings he had bestowed the magic word "Bene," indicating thereby that the performances came up to his exacting standards.

Walter Toscanini, the conductor's son, estimates that his father had approved about thirty unpublished recordings at the time of his death. Among these are the Brahms Double Concerto, the complete *Romeo and Juliet* music of Berlioz, excerpts from Dukas' *Ariane et Barbe-Blue*, *The*

Spider's Feast by Roussel, and the Second and Fourth Symphonies of Sibelius. Recordings in the "Definitely Yes" category are all cleared for eventual release on the RCA Victor label. Conversely, those performances of which the Maestro strongly disapproved, the "Definitely No" category, will never be issued as long as Walter Toscanini has any say.

There remains an in-between area, the "Maybe" category, about which no policy has been formulated. These are the performances which Toscanini basically liked but which had been blemished by extremely minor lapses. In such instances the tiny specks so upset the conductor that he could not quite bring himself to the point of saying "Bene" even though the totality pleased him. "Sometimes," says Toscanini's son, "my father's standards may have been too high. Nobody



Robert Craft presents Webern in toto.

would ever notice that a third clarinet played a passage too softly, but a little thing like that would make my father withhold approval." The disposition of the "Maybe" recordings is to be decided at a full conclave of the Toscanini family.

Another undecided question concerns the issuance of Toscanini rehearsal records. Documentation of the late conductor's rehearsal methods

would have immense interest not only for the student of music but for the general music lover. Ever since Columbia broke the ice by issuing Bruno Walter's *Birth of a Performance*, there has been a persistent demand for a similar Toscanini album. RCA Victor is presumably willing, but Walter Toscanini so far is not. "I think a rehearsal is private business between the conductor and the orchestra men," he told me. "To have it sold over the counter would be like taking a bath in public." However, Walter Toscanini is aware that there are persuasive counterarguments, and I hope that he will eventually yield to them. A Toscanini rehearsal on records (many bootlegged examples are in circulation) is a tremendously exciting musical experience. If nothing else, RCA ought to be allowed to publish one of the preliminary orchestra rehearsals for an opera, during which Toscanini was wont to sing all the principal vocal parts and the choral passages too.

ANTON WEBERN, Arnold Schoenberg's first and most dedicated disciple, was born in Vienna in 1883 and died in Mittersill in 1945 as the result of an accidental shot by an American soldier on occupation duty. In his sixty-two years Webern wrote thirty-two compositions. The longest was his first, a quintet for strings and piano without opus number dating from 1906. It lasts 11 minutes, 38 seconds. The shortest is the Opus 8 of 1910, consisting of two songs for voice and instrumental ensemble to texts by Rainer Maria Rilke. Together they last 1 minute, 45 seconds. The timings are those of the young California-based conductor Robert Craft, who is responsible for a four-LP album issued by Columbia this month entitled *The Complete Works of Anton Webern*. For the first time, a composer's entire lifework has been published on records in one fell swoop.

The distinction could not have fallen on a less "commercial" com-

Continued on page 57



Ellington Photo by Aram Avakian

The Duke was made for High Fidelity

Ferde Grofe, who went on to write for Toscanini, used to sit all night in the old Cotton Club, moved and mystified by the music of Ellington. He finally confessed that the Duke's magic could not be set down as so many notes on a piece of paper. The phonograph records of those days in the late twenties, treasures though they are, give us little more than the shadows of what Ferde Grofe heard.

The elegance which is Ellington's now was there 30 years ago when he and his five Washingtonians sat down to make their first records before a solitary horn pick-up in a New York loft. It is still there in muffled echo for those lucky enough to have the old recordings. For the essence of jazz is the impulse of the man who plays it; and the essence of the Duke is not one instrument—but 15—because he alone among jazz composers has made the whole orchestra his instrument.

Today, for the first time, we are as rich as he, for the records we play at home over high fidelity, or the performances we listen to over FM, have all the sumptuous texture that taunted Ferde Grofe because it seemed to him then beyond recapture.

High fidelity has come of age and many excellent instruments are available today. The distinction that is Harman-Kardon's comes, perhaps, from the sensitivity and understanding its people have for the work their products do. There is more here than simple devotion to perfection in curves and percentages. That surely exists at Harman-Kardon; but a genuine feeling for the "bursting white lights" and the limitless shadings of the music is also there. Inescapably, this special sensitivity to the music—whether Ellington's or Mozart's—is expressed in the way operating controls are organized, in the emphasis placed on one function over another and in the way the product looks.

Perhaps the finest expression of this marriage of engineering skill and feeling for the art is the Harman-Kardon Festival II, Model TA-1040, shown above. Here in a graceful compact unit is a complete and powerful high fidelity electronic center. Simply connect it to an equally fine record player and speaker, and a high fidelity system of incomparable performance is yours.

The Festival combines a highly sensitive AM-FM tuner, a complete preamplifier and a 40 watt hum-free, distortion-free power amplifier. It features: magnificent Armstrong FM with Automatic Frequency Control to insure accurate tuning *automatically*; Automatic Noise Gate to eliminate noise between stations when tuning; sensitive AM with 10KC whistle filter; Dynamic Loudness Contour Control to provide precise balance for your own hearing characteristics; enormously effective treble and bass controls to adjust for the acoustics of your room; selectable record equalization; remote speaker selector switch; illuminated tuning meter and rumble filter. All this expressed in six easy to operate controls.

The cage and control panel are finished in brushed copper; the knobs and escutcheon frame in matte black. The Festival stands 4-5/16" high, 16-1/8" wide and 14" deep.

The Festival price is \$225.00

We have little regard for the typical commercial testimonial, but happily, our admiration for Edward Kennedy Ellington is reciprocated by the Duke. Long before this advertisement was contemplated, he had chosen Harman-Kardon tuners and amplifiers for his personal and professional use. The Festival, he tells us, is his favorite for listening at home.



FREE: beautiful, new, fully illustrated catalog. Describes complete Harman-Kardon line and includes guides on how and where to buy high fidelity. Send for your copy now. Write: Harman-Kardon, Inc. Department H-03, 520 Main Street, Westbury, New York.

harman kardon

INCORPORATED

poser, and Bob Craft still does not quite understand how it all came to pass. The Webern project began in January 1954. Craft had directed a recording for Columbia of Schoenberg's Suite, Op. 29, and as a "filler" had taped some songs by Webern. Word then came from above that an all-Schoenberg record was wanted, so Craft proceeded to record some Schoenberg songs to fill out the LP. That resulted in a small quantity of left-over Webern, and provided him with the nucleus for a single all-Webern LP, which was completed in Hollywood and forwarded to Columbia's classical artist-and-repertoire chief, David Oppenheim, in New York. Oppenheim listened, pondered, and came to a startling conclusion. "It's of no interest this way," he told Craft. "Let's use it as a starting point and record everything Webern wrote."

That, Craft declares, was more easily said than done. Webern's brief compositions make not only difficult listening but exceedingly difficult playing. Opus 18 ("the most difficult of all"), consisting of three songs for soprano, clarinet, and guitar, required—says Craft—about fifty hours of rehearsal and studio work; in performance it times out to 3 minutes, 19 seconds. Fortunately, Hollywood is peopled with a large number of accomplished young musicians, and with their co-operation the project was gradually completed. Help came also from Igor Stravinsky, who greatly admires the music of Webern and was on hand with useful suggestions at almost every session.

During his lifetime Webern received a full quota of critical obloquy. Nicolas Slonimsky in his *Lexicon of Musical Invektive* gives a sampling of how American critics responded to Webern's music on the occasions when it was performed here in the Twenties and Thirties. Lawrence Gilman opined that "Webern's Five Pieces were as clearly significant and symptomatic as a toothache." To Olin Downes "Webern's little orchestra suggested nothing so much as a cat that, arching its back, glared and bristled its fur, and moaned or growled or spat." Samuel Chorzinoff described Webern's Symphony as compounded of "the fractional sounds uttered at night by the sleeping inhabitants of a zoo."

In Europe the music fared very little better, and in Nazi-dominated countries (including Webern's native Austria, after 1938) it was—like all twelve-tone music—absolutely *ver-*

boten. Except for a single performance of the *Variations for Orchestra*, Op. 30, given by Hermann Scherchen at Winterthur, Switzerland, in 1943, Webern heard none of his music publicly performed during the last decade of his life. This lack of recognition seems not to have disheartened the composer or deflected him from his ideals. "There are few comparable examples in any activity," writes Craft in his album notes, "of such purpose, of such disregard of the world, of a man hissed and ridiculed his entire life going his own way with such infallibility."

The postwar rise in Webern's reputation began in France. The young composers—Messiaen, Boulez, and Leibowitz in particular—proselytized the Webern cause throughout Europe. Today, Craft reports, the mid-century musical era is characterized by a majority of the youngest Western European musicians as "the age of Webern." What appeals to them is the utter modernity of Webern's musical structures. Schoenberg, who created the twelve-tone technique, was usually content to adapt it to classic forms. "Schoenberg," Craft explains, "is essentially Brahms. Webern, on the other hand, invented a new way of composing with the twelve-tone technique. His music is referable to none other." Listeners can now judge for themselves the aesthetic validity of Webern's creations, thanks to a documentation in sound achieved by American musicians and sponsored by American commercial enterprise.

A. HYATT KING, chief music librarian at the British Museum, in his fascinating collection of essays entitled *Mozart in Retrospect* (Oxford University Press, 1955) has this to say about the man who first catalogued Mozart's works:

"Few men of the nineteenth or any other century have become universally known through a single letter of their name. Outside the field of science—where, for instance, the 'M' numbers of certain nebulae have perpetuated the name of Charles Messier, the French astronomer—it is doubtful if this honor has come to anyone save Ludwig Ritter von Köchel, the 'K' of whose surname is seen in print wherever Mozart's music is played. Such literal distinction is of course now facilitated by the passion of the twentieth century for compressing organizations and persons into strings of un-

punctuated letters, GATT, GBS, SHAPE, and so on *ad nauseum*. After some sixty years of general acceptance as 'K.V.', Köchel's great catalogue has now become known simply as 'K'."

Perhaps this somewhat overemphasizes the singularity of the K numbers; we identify Scarlatti works by L numbers (Alessandro Longo) and are beginning to identify Vivaldi by P numbers (Marc Pincherle) and Schubert by D numbers (Otto Erich Deutsch). But Mr. King quite rightly infers that anyone who undertakes such scholarly labors of love is deserving of a certain immortality.

What, then, about Wolfgang Schmieder, whose *Thematisch-systematisches Verzeichnis der musikalischen Werke von Johann Sebastian Bach* (Leipzig, 1950) is rapidly gaining widespread acceptance as an identifying tool for Bach's prolific output? But have S numbers become standard? Alas, no. Musicologists have thoughtlessly adopted Schmieder's numbering without using his name. BWV (for Bach Werke Verzeichnis) has been favored as prelude to the numbers, leaving the cataloguer little personal glory.

Considering his travails in completing the Bach catalogue, Schmieder deserves better recognition. He began his Bachian labors in 1937 at the behest of Breitkopf & Härtel, the famous Leipzig music publishers, and by the spring of 1943 had completed his work: the catalogue was set in type and ready to go on press. Certain technical difficulties caused a postponement of the actual printing, however; and while these were awaiting solution, the Allied air force dealt Schmieder's Bach catalogue a hard blow. In December 1943 a bombing raid on Leipzig destroyed a good part of Breitkopf & Härtel's premises—including most of the Bach catalogue plates and all of Schmieder's manuscript. Like all prudent authors, Schmieder had made a duplicate copy of his manuscript; but that duplicate had previously been destroyed in a raid on Frankfurt. Schmieder gave up for the duration. At the war's end some galley proofs and undamaged plates were found, and this encouraged him to recompile the Bach catalogue. It finally was published in 1950.

Beginning with this issue, HIGH FIDELITY is renouncing BWV in favor of S. Nathan Broder has agreed to do likewise in *Musical Quarterly*. Herr Schmieder, we salute you!

Pisces



March

La Scala Opera

IL TROVATORE (Verdi)

Another definitive opera recording in the famous Angel-Scala Series . . . Magnificent cast and performance.

- Leonora Maria Meneghini Callas
- Azucena Fedora Barbieri
- Manrico Giuseppe Di Stefano
- Count di Luna Rolando Panerai

Conductor: Herbert von Karajan La Scala Orchestra, Chorus
Angel Album 3554-S sides/L (35422-3-4)

"Her fourth act was a wonder of the western world. Her aria was so breathtakingly beautiful it stopped the show."
(Claudia Cassidy, writing in the *Chicago Tribune* of Callas' performance as Leonora.)

'The Wheel of Fortune'

CARMINA BURANA (Carl Orff)

Wandering monks and scholars and vagabond poets wrote the medieval poems on which this sensational "modern work" is based. Prologue and Epilogue lament the fate of man, victim of the Wheel of Fortune at whose turn "one is deposed, another lifted high" . . . The three main parts celebrate the joys and rites of Spring, Drink and Love.

Irresistible recording supervised by the composer.
Conductor: Wolfgang Sawallisch. Soloists: Agnes Giebel, Marcel Cordes, Paul Kuen. Chorus of West German Radio, Cologne Radio Symphony. Angel 35415

Gala Factory-Sealed Package includes illustrated booklet with notes, text, translation.

Reminder: Orff's opera: 'Die Kluge' (The Story of the King and The Wise Woman) with Elisabeth Schwarzkopf. "The work has the immediate appeal of an American musical," *Washington, D. C. News*. "Utterly fascinating", *San Francisco Examiner*. (Angel Album 3551 B/L)

Piano and Violin

GIESEKING-BEETHOVEN SONATA SERIES

- No. 30 in E, Op. 109
- No. 31 in A flat, Op. 110 Angel 35363

Walter Giesecking had planned to record all the Beethoven Sonatas. Before his death he had completed 23. . . .
Previously released: 'Moonlight' and 'Pathetique' (35025), 'Appassionata' and 'Waldstein' (35024), 'Tempest' Sonata No. 17 in D minor and No. 18 in E flat (35352).

ITURBI TREASURES

Granados, Mozart, Debussy, Schubert, Lazar, Chopin. Includes 'Clair de Lune,' two Moments Musicaux, and Chopin 'Heroique' Polonaise in A flat. Angel 35347

Reminder: Iturbi plays Beethoven 'Moonlight' and two Mozart Sonatas (35378).

BRAHMS VIOLIN CONCERTO: Leonid Kogan

Paris Conservatoire Orchestra. Conductor, Charles Bruck. Angel 35412

Reminder: Kogan plays Brahms Sonatas 1 and 2 (35332); Bach—Violin Concerto in E, Sarabande from Partita No. 1, and Concerto in D minor for Two Violins, with Elisabeth Gilels (35343).

Orchestra

SIR THOMAS BEECHAM conducts

Balakirev Symphony No. 1 in C
Royal Philharmonic. 1st Lp recording. Angel 35399

OTTO KLEMPERER conducts

Beethoven Grosse Fuge
Mozart Serenade No. 6 in D, K.239
and Adagio and Fugue for Strings, K.546
Philharmonia Orchestra. *The Observer* (London):
"Klemperer has emerged into an Olympian old age as the supreme interpreter of the classics since Toscanini."
Angel 35401

PAUL KLETZKI conducts

Sibelius Symphony No. 1 in E minor
Philharmonia Orchestra. Angel 35313
Sibelius Symphonies on Angel + Kletzki-Philharmonia:
No. 2 (35314), No. 3 coupled with Oistrakh playing Sibelius Violin Concerto with Stockholm Orch. (35315).
Karajan-Philharmonia: No. 4 and 'Tapiola' (35082), No. 5 and 'Finlandia' (35002): No. 6 and No. 7 (35316).

ALCEO GALLIERA conducts

Borodin Symphony No. 1 in E flat
Rimsky-Korsakov Capriccio Espagnol
Colorful music, brilliantly played, colorfully packaged.
Philharmonia. Angel 35346

SCARLATTI ORCHESTRA of Naples plays

Two Boccherini Symphonies:
in A (1787); in C minor (1788)—1st recording
Franco Caracciolo, conductor. Angel 35384

Favorite Ballets

RUSSIAN BALLET, Album 2
conducted by Igor Markevitch

Tchaikovsky: Swan Lake. Chopin: Les Sylphides.
Scarlati-Tommasini: The Good-Humored Ladies.
De Falla: Miller's Dance from Three-Cornered Hat.
Philharmonia Orchestra. Angel 35152
2nd of 3 albums, originally issued in de luxe edition called *Hommage à Diaghilev*. Attractive package, illustrated notes.

The Angel 'Band Wagon'

REGIMENTAL BAND of THE COLDSTREAM GUARDS

Major Douglas Alexander Pope, Director of Music
Founded in 1785, the spirit of this famous Band is expressed in the Regimental motto, "Nulli Secundus" . . . Second to None . . . It partakes in the Trooping of the Colour Parade each year, plays at Buckingham Palace, has performed Tattoos in 5 capitals: London, Edinburgh, Vienna, Berlin, Copenhagen . . . Rousing, thrilling record . . .
fanfare, marches, medleys, fantasia, piccolo solo, bugle solo, 'novelty' for massed clarinets . . . Angel 35370
Reminder: Scots Guards (35271), Scots Guards on Parade (35337).

On the "Light" Blue Label

MICK MICHEYL of Paris Singing Her Own Songs

When you hear this record (including *Continent Perdu, Cano Canoc, Bel Ami, Mon Amour*, etc.) you will know why it won the Grand Prix du Disque de Bonheur in France. Mick Micheyl is "the spirit of Paris . . . her songs like a good bottle of Beaujolais."
Angel Blue Label 65032



ANGEL RECORDS, ELECTRIC & MUSICAL INDUSTRIES (U.S.) LIMITED, 38 WEST 48 ST., NEW YORK CITY
a subsidiary of Electric & Musical Industries Ltd., Hayes, Middlesex, England

Records in Review

Reviewed by PAUL AFFELDÈR NATHAN BRODER C. G. BURKE JOHN M. CONLY
 MAX DE SCHAUENSEE RAY ERICSON ALFRED FRANKENSTEIN JOAN GRIFFITHS
 JAMES HINTON, JR. ROY H. HOOPES, JR. HOWARD LAFAY ROBERT C. MARSH
 J. CARTIN MC KINNEY MURRAY SCHUMACH JOHN S. WILSON

Classical Music	59	Music Between	85
Advertising Index	60	Dialing Your Discs	86
Building Your Record Library	65	Folk Music	87
Recitals and Miscellany	74	Best of Jazz	88
Spoken Word	80	César Franck on Microgroove	93

CLASSICAL

BACH: *St. Matthew Passion*

Agnes Giebel, soprano; Lore Fischer, contralto; Helmut Kretschmar, tenor; Horst Günter, bass; Kantorei der Dreikönigskirche (Frankfurt); Collegium Musicum Orchestra, Kurt Thomas, cond.
 OISEAU-LYRE OL 50113/16. Four 12-in. \$19.92.

So many things can be wrong about a recorded performance of the *St. Matthew Passion* that when one comes along in which the conductor has complete control over his forces, the tempos are sensible, everybody sings and plays the right notes, and the sound is reproduced more or less faithfully—when all this happens, one can only be grateful. For this is so overwhelming a work that, given an adequate performance, it is bound to stir the soul.

Here is one of its better recordings. The vocal soloists are pretty much all of the same grade: they understand what they are about, and they do much pleasing work, though none of them has the virtuosity required to execute all of his or her music equally well. The chorus is properly balanced most of the time and has a good tone, which is not often distorted by the engineers. Kurt Thomas does his job without any frills or mannerisms, managing especially well the great final chorus, where the bass line is unusually clean and sturdy. It sounds as though he added bassoons there, with excellent effect. Here, and in one or two other places, such as the accompanied recitative for tenor with chorus in Part I, there is a special glow, which makes one think longingly about how a performance would

sound that was first-class throughout. There is a greater amount of such occasional illumination in the Scherchen performance on Westminster. N.B.

BEETHOVEN: *Quartet No. 14, in C sharp minor, Op. 131*

Koeckert Quartet.
 DECCA 9863. 12-in. \$3.98.

By tranquilizing the passions which music lovers for a century have believed inseparable from this quartet, by transmuting rhapsody and struggle—as far as that is possible—into a treatise on the imperium of mathematics in music, with an exaltation of symmetry and pure linearity, the Koeckerts have required a growing contemporary admiration for this kind of absolute abstraction. They have tried to subjugate fever by reason.

The C sharp minor Quartet as they give it, they alone, is a champion of gradualism. The normally quick sections are slow, and the slow sections are less slow than usual, in a glide from one to the other without jolt. Crescendos and diminuendos are not steep, the rhythmic impact is blunted, and inflections never retained more dignity under greater trial. The peremptory interjections heralding a new direction for the coursing of the savage Beethoven blood are made seemly by the Koeckerts in a reduction artfully contrived not to interrupt the serenity of their own course.

All this is a rejection of the human stuff that Beethoven (perhaps sinfully) put into his music. It could be called an emasculation to satisfy a theory; but the word is harsh for anything so beautiful, and unfair to the devotion that has illumined a theory so graciously. And no other group has shown so plainly (because the others show concurrently something else too) how richly Beethoven has

put tones into layers. Examined from top to bottom, this tough texture, in the measured weaving of the Koeckerts who allow a minimum of private eminence to any of their members, reveals a smooth nap and a soft blending of colors independently often hard. In this performance much of the C sharp minor Quartet is beguiling, and there lies the measure of the success and the failure of the playing.

The tonal appeal is of course the achievement of the musicians primarily, but since reproduction is warm, without strain, exact in balance and singularly free of background noise, the technicians deserve credit for presenting with calm realism what was played. Incredibly, the violins do not once scream. C.G.B.

BEETHOVEN: *Sonatas for Piano: No. 8, in C minor, Op. 13 ("Pathétique"); No. 14, in C sharp minor, Op. 27, No. 2 ("Moonlight"); No. 23, in F minor, Op. 57 ("Appassionata")*

Egon Perri, piano.
 WESTMINSTER 18255. 12-in. \$3.98.

Heartily devout playing that makes much of round-shaping a phrase and warming a chord in a frank exploitation of expression neatly eluding extravagance. This involves some belittlement of grace, but all three sonatas are convincing and indeed commanding in the solid sound devised for them, strong and accurate, just faintly tainted by pre-echo. C.G.B.

BEETHOVEN: *Sonatas for Piano: No. 17, in D minor, Op. 31, No. 2 ("The Tempest"); No. 18, in E flat, Op. 31, No. 3*

Walter Gieseking, piano.
 ANGEL 35352. 12-in. \$4.98 (or \$3.48).

The sonata that Beethoven said he wrote

after reading *The Tempest* established Walter Gieseking's phonographic reputation in a 78-rpm recording made for English Columbia in the early 1930s. The new version by the pianist so recently dead will sharpen regret at his disappearance, and the Eighteenth Sonata in this playing emphasizes the loss as keenly. Until now, there was no absolutely first-rate edition of the lively, inventive, and enchanting work in E flat that haunted Schubert, but the posthumous Gieseking recording, on its combination of musical and sonic skills, at once assumes the leadership. The over-side too ranks high, but the D minor sonata is well supplied with commanding editions.

Gieseking was one of the few pianists of whom it could decently be said that he habitually coaxed color from his instrument — pastels, in his case, that glow and do not glitter. The alterant tone and light in these two sonatas glide like the play of the sun through thick moving foliage, and the curious Gieseking talent for seeming relaxed in the midst of stress is continually evident. Withal, the phrasing is remarkably full and definite, obviating any impression of mere pianistic artfulness, and the basic rhythms are almost didactically clear.

Nowadays, with masterly examples of the thirty-two sonatas on records, it is hard to be enthusiastic about a new version of any. This disc excites enthusiasm for a pair. C.G.B.

BEETHOVEN: *Symphony No. 9, in D minor, Op. 125 ("Choral")*

Franzi Wachmann (s), Margarete Bence (c), Fritz Wunderlich (t), Otto von Rohr (bs); Stuttgart Philharmonic Orchestra and a Chorus, Isaie Disenhaus, cond.

PERIOD SPL 305. 12-in. \$1.98.

The \$1.98 forces the Ninth Symphony to suffer the degradation of a monetary scrutiny. The cost is half that of the next cheapest, and only a quarter of that of those editions issued under what are vaguely thought of as standard labels. There have been times when a recorded Ninth cost sixteen dollars, and the second version (Mörike) in the history of recording occupied eighteen 78-rpm sides. Two months ago Vox contrived an edition confined to the two faces of one LP, and Period now, following that procedure, has chosen to underline the bargain by installing the disc in the lowest category of prices. The music is complete, but the turn of sides interrupts the slow movement.

\$1.98 brings a recording competent as a whole, one considerably better than the poorest of its rivals and notably poorer than the best. Although finesse is absent from the performance and a certain inflexibility prevails, the leadership is direct and intelligent, and the limitations of expression were probably dictated by prudence rather than musical inclination. The projection is positive and energetic and will not be disputed in its major lines. Reproduction — which requires unusually strong output from the amplifier — is of good standard quality for the orchestra and above the average for this music, while the choral section, disappointing on all

records, fails as usual to overwhelm but in compensation is marred by a minimum of soprano hoars. In fact the registration is throughout free of discomfort for the reproducer. Orchestra and chorus are competent, no more, the first apparently with a smaller complement than usual; the solo bass is not at ease but the solo tenor is appealing although hurried, and the ladies go through their little hell valiantly and without disgrace.

Call it a plain but honest and telling production, worth respectful attention and more than \$1.98. C.G.B.

BERGSMA: *The Wife of Martin Guerre* (excerpts)

Mary Judd, soprano; Regina Sarfaty, contralto; Stephen Harbachick, baritone, and others; chamber orchestra, Frederic Waldman, cond.

COMPOSERS RECORDINGS CRI 105. 12-in. \$4.98.

There is hope for American opera when a work as sound as this can be performed and immediately thereafter recorded, even if only in part. Unlike so many Americans who attempt the lyric theater, William Bergsma really knows how to write a vocal line. His characters really have something to say in a musical sense; he is a shrewd master of the ensemble as well as the aria; and his dialogue does not depend entirely on the text for its dramatic movement. In addition, he can create a melody, and his handling of the orchestra is extremely imaginative. One regrets only that the entire opera has not been made available on discs.

The libretto, by Janet Lewis, has great psychological and dramatic interest. Martin Guerre, sixteenth-century French peasant, disappears from home to escape his father's wrath. He intends only to hide for a few days, but he does not return for eight years, and when he does come

back it is apparent that his experiences have changed him. Gradually his wife comes to realize that she has become the victim of a Satanic deception: the man she has taken for her husband is not Martin Guerre but an impostor. The pseudo-Martin is tried and condemned to death, whereupon his wife discovers that she loves him more than she ever loved the man whose place he has usurped. There is a second trial which reaches its climax in the reappearance of the real Martin, and he, with marvelous irony, denounces his wife for her faithlessness.

The splendid performance is by the cast which performed this work last year at the Juilliard School. The recording is excellent. A.F.

BERWALD: *Symphonies: No. 5, in C ("Singulière"); No. 6, in E flat*

Berlin Philharmonic Orchestra, Igor Markevitch, cond.

DECCA DL 9853. 12-in. \$3.98.

This recording introduces to the domestic LP catalogue Franz Adolph Berwald, previously encountered mainly in reference books, where his uncle, Johann Friedrich Berwald (1787-1861), may also be found. Franz (his dates are 1796-1868) was, like his uncle, a violin virtuoso in his native Sweden, but he was also a composer of uncommon skill. Practically unknown in this role through most of his life, he began to find posthumous fame in the early years of this century, and there is now a Berwald Foundation to advance the cause of his music.

No better testimonial could be imagined than this recording, which seems wholly sympathetic and captures the delicacy and romanticism of these symphonies without excesses in any direction.

If one must make comparisons, the works are reminiscent of early Schubert, with occasional touches of Schumann and even Bruckner. In terms of musical substance, they are every bit as fine as all but the late Schubert symphonies, which means that this is music of considerable importance. The *Symphonie Singulière* has only three movements, its title being justified by an unexpected timpani entrance and a good many harmonic turns unusual for 1845. The later work in E flat is more conventional, but has its own tricks to avoid the hackneyed.

The recording, resonant and soft in focus, is thoroughly agreeable. Those who savor the early romantic idiom will want this disc. R.C.M.

BLOCH: *Suite for Viola; Suite Hebraïque; Meditation and Processional*

William Primrose, viola; David Stimer, piano.

CAPITOL P 8355. 12-in. \$3.98.

Bloch's Viola Suite won the Coolidge Prize in 1919 and thereby served to introduce the pungent, rhapsodic, epical, declamatory style of its composer to American audiences. In the intervening years Bloch has written many other works in the same vein, but he has never topped this early masterpiece. So, at least, it seems when it is played by the greatest living violist, assisted by an

ADVERTISING INDEX

Angel Records	58
Audio Fidelity Records	82, 84
Capitol Records	63, 95
Columbia Records	71
Concord Record Corp.	88
Cook Laboratories	79
Dauntless International	82, 84
Decca Records, Inc.	77
Elektra Records	100
Epic Records	96
Expériences Anonymes	98
Leslie Creations	100
Livingston Electronic Corp.	99
London International	91
London Records	97
Mercury Record Corp.	92
Montilla Records	98
Nuclear Products Co.	101
RCA Victor Division	69, 81
Record Market	100
Record Review Index	101
Reiter, F. Co.	100
Replica Records	75
Robins Industries Corp.	100
Stratejackets	100
Unicorn Records	87
Vanguard Recording Corp.	89
Vox Productions, Inc.	90
Walco (Electrovox Co., Inc.)	94
Westminster Recording Co.	67

extremely good pianist, and their joint efforts are recorded to perfection, as they are here.

The *Suite Hébraïque* and the *Meditation and Processional* are works of decidedly smaller stature, artistically as well as in scale, but they provide effective and picturesque contrast to the main attraction. A.F.

BORODIN: *Prince Igor*, Act II: *Poloitsi Dances* (Operatic text)
†Rimsky-Korsakov: *Le Coq d'or*, Suite
London Symphony Orchestra, Antal Dorati, cond., with chorus (in the Borodin).
MERCURY MG 50122. 12-in. \$4.00.

Mercury now joins the roster of record companies who have carried their equipment to Walthamstow Town Hall (i.e., community auditorium) in northeast London to record in a cheerless, boomy room which has become one of the international shrines of high fidelity. Most of the Westminster LAB series originates there, and audiophiles can compare the engineering of this disc and make their own judgments.

The chorus sings in a language which at first I took for a Slavic tongue until some random phrase revealed it to be English—in one of those translations so clumsy that all intelligibility vanishes. No text appears on the sleeve, an omission which may be all for the best. Moreover these deficiencies in the Borodin are not improved by either a badly overloaded cutter or poor transient response.

Dorati here presides over the Mercury debut of the London Symphony, not the world's smoothest orchestra, but in unusually good form here. Both scores are boldly and effectively stated in a bright palette of sonic hues. The suite from *Coq d'or* is not the one I am familiar with, and those who share my admiration for the opera will enjoy the finesse of Dorati's performance. R.C.M.

BRAHMS: *Concerto for Piano and Orchestra, No. 1, in D minor, Op. 15*
Rudolf Firkusny, piano; Pittsburgh Symphony Orchestra, William Steinberg, cond.
CAPITOL P 8356. 12-in. \$3.98.

Although a pretentious work, this concerto has passages of great beauty here made clear in a recording which, unlike some of its rivals, does not set the piano in opposition to the orchestra but has them singing together. I found the resultant balance and blending of voices ideal.

The performance is more in the European manner than the American (for that see the fine Rubinstein-Reiner edition on RCA Victor). The pace is not rushed (nor is it slack); the music has every chance to develop at its own preferred speed. On the whole the edition is in the same spirit as Epic's release of the Second Piano Concerto reviewed in February—forceful without suggesting the percussive or overstressing rhetoric, conceived in the ripest Brahmsian eloquence, and stated in beautiful orchestral and pianistic sonorities which the engineers have preserved with unusual refinement. This is for those who prefer majesty to virtuosity. R.C.M.

BRAHMS: *Variations and Fugue on a Theme by Handel, Op. 24; Intermezzo in E flat minor, Op. 118, No. 6; Rhapsody in G minor, Op. 79, No. 2*

Witold Malcuzyński, piano.
ANGEL 35349. 12-in. \$4.98 (or \$3.48).

Mr. Malcuzyński has produced a spacious, often lyrical, varicolored performance of the *Handel Variations*. To my taste it is the best one now on records, although many may find it too unorthodox in its slow tempos. Some of the variations in this performance are dangerously slow—No. 21 is far from a *Vivace*, yet the result is enchanting; and in a relaxed style, No. 16 eschews dazzle for charm. Mr. Malcuzyński's deliberations push the closing fugue on to the second side of the disc, but the break here is not unpleasant. While the performance lacks virtuosity, this is replaced by a concern for tonal color, inner voices, harmonic movement, and expressivity—in other words, musical substance.

Neither the *Intermezzo* nor the *Rhapsody* comes off quite so well, although both

are admirably played. Whereas the individual variations never lose their momentum, seemingly forced on the pianist by the large form, the shorter works, left to themselves, tend to fall apart while he pauses over niceties of phrasing and tone. R.E.

CHARPENTIER: *Impressions d'Italie*
Orchestre de la Société des Concerts du Conservatoire de Paris, Albert Wolff, cond.
LONDON LL 1511. 12-in. \$3.98.

The late Gustave Charpentier set down these five *Impressions of Italy* back in 1887 while he was studying in the Eternal City as a winner of the *Prix de Rome*. To judge from the music, he had a rather quiet time in Italy, and was not unduly influenced by local rhythms and melodies. The *Impressions* seem impressions of Berlioz and Massenet rather than of Rome.

For me, chief interest is to be found in the opening movement, particularly its long, incisive passages for the cello section alone, echoed later by a viola solo

A Batch of Bachs, Without the Big One

FOURTEEN Bachs are represented here, all of them related in one way or another to Johann Sebastian. The oldest of them is Johann (1604–1673), Sebastian's granduncle, and the youngest is Wilhelm Friedrich Ernst (1759–1845), Sebastian's grandson. Among those in between are no fewer than four sons of Sebastian. The story of this astonishing clan was told by Karl Geiringer in his excellent book, *The Bach Family* (1954). The book was followed the next year by an anthology of music of the Bachs, collected and edited by Mr. Geiringer and published by Harvard University Press. It is this anthology that is here recorded and that is included with the four discs in one "package."

While the music varies greatly in quality, much of it is extremely interesting. In style it spans two centuries, from Johann's motet, *Unser Leben ist ein Schatten*, which has elements of the madrigal and reminds one of Schütz, to the Weber-like Sextet by Wilhelm Friedrich Ernst. One of the most striking works is the cantata *Es erhub sich ein Streit* by Johann Christoph (1642–1703), an older second cousin of Sebastian's. This is a graphic depiction of the battle between the forces of Michael and Satan. The air is filled with trumpet calls and vibrates with martial rhythms. Another fine work, of an entirely different kind, is the orchestral *Overture* by Johann Bernhard (1676–1749), a distant cousin of Sebastian. This is elegant music, French in style. While its tunes are not as memorable as those in Sebastian's suites, its form is more rounded and pleasing: it is not as top-heavy as they are. Also noteworthy are the excerpts from two works by Johann Ernst (1722–1777), pupil as well as kinsman of Sebastian. There is an impressive setting of portions of Psalm VI, and two movements from an attractive violin sonata, in which *galant* materials are subjected to baroque procedures.

As for the four sons of Sebastian, only



W. B. SYER
Richard Burgin

Johann Christoph Friedrich is completely disappointing, in a trivial minuet, a tiresome aria, and an overlong sonata full of clichés. Johann Christian, on the other hand, has two charming pieces, of an Italian melodiousness and a pre-Mozartean grace. Of the three works of Carl Philipp Emanuel one is outstanding—a dark and passionate *Sinfonia in E minor*. Curiously mixed qualities are demonstrated in an unfinished clavier concerto by Wilhelm Friedemann. Here are expressive, original materials, reaching at times a subjectivity that reminds one of Schumann; but their working-out is inept and meandering.

All the performances were supervised by Mr. Geiringer. The soloists and chorus are quite serviceable, and the orchestra and recording are on the whole excellent.

NATHAN BRODER

BACH: *Music of the Bach Family*

Marguerite Willauer (s); Betty Lou Allen (ms); David Lloyd (t); McHenry Boardwright (bs); Chorus of Boston University, Allan Lannom, dir; Zimble Sinfonietta, Richard Burgin, cond.
BOSTON BUA 1. Four 12-in. \$21.02 (with complete score).

played offstage — which passages have been captured with startling realism by London's sound engineers, incidentally. Wolff, whose recent discs have brought welcome illumination to works by Auber, Berlioz, and Massenet, is somewhat less convincing here. While insisting on tonal opulence, he is inclined to be rather cautious—even tame—in his handling of the few dramatic pages that the work contains. This is especially apparent in the final tarantella with its interweavings of several Neapolitan themes. Fourestier's performance for Angel is, all things considered, the preferable recorded version. P.A.

CHOPIN: *Concerto for Piano and Orchestra, No. 2, in F minor, Op. 21*
Ballade No. 2, in F major, Op. 38;
Etudes No. 1, in C major, Op. 10, No. 1, and No. 15, in F major, Op. 25, No. 3; Mazurkas No. 21, in C sharp minor, Op. 30, No. 4, and No. 29, in A flat major, Op. 41, No. 4; Scherzo No. 4, in E major, Op. 54

Vladimir Ashkenazy, piano; Warsaw Philharmonic Orchestra, Zdzislaw Gorzynski, cond.
 ANGEL 35403. 12-in. \$4.98 (or \$3.48).

Vladimir Ashkenazy was seventeen when he left his native Russia for the first time, in 1955, to compete in the Chopin contest in Warsaw. Although he placed second, these performances were recorded at that time. Listening to them, one can only speculate about the talents of the winner, a Polish pianist named Adam Harasiewicz. Young Ashkenazy went on to win the Queen Elisabeth of Belgium Contest in Brussels the following year, which seems only fair.

The pianist has been described as a potential Gilels, but I think a potential Rubinstein comes closer to the mark—his sensitive, romantic temperament wears a more aristocratic air than does Gilels'. Ashkenazy's technique is spectacular, and his tone is beautiful at any dynamic level, but these qualities tell only part of the story. What is impressive for a pianist of his or any age is innate musical awareness. Poetry is omnipresent in his playing of Chopin's melodic lines, but it is not self-conscious, not pointed up, not an overbalancing factor. This is perhaps most obviously demonstrated in the *Larghetto* of the Concerto, where the solo part moves along serenely, emotionally poised, with not a lovely nuance lost. The pianist's youthful exuberance gets the upper hand towards the end of the concerto, where his playing is almost too fast for the music, but even here it has delicacy and control, and the results are exhilarating.

Of the solo works, the Ballade and Scherzo give Ashkenazy a wide emotional range that he spans superbly, with a controlled passion. The études are wonderfully virtuosic within musical bounds, and the mazurkas could not be more hauntingly elegant.

The pianist gets very good support from the Warsaw orchestra in the concerto. Unfortunately, the engineering is not up to Angel's standards, and the sound is somewhat muffled and unclear. But Ashkenazy's great talent and gifts shine through and they are enough. R.E.

CIMAROSA: *Il Matrimonio Segreto*

Graziella Sciutti (s), Carolina; Eugenia Ratti (s), Elisetta; Ebe Stignani (ms), Fidalma; Luigi Alva (t), Paolino; Carlo Badioli (bs), Geronimo; Franco Calabrese (bs), Count Robinson. Orchestra of La Piccola Scala, Milan, Nino Sanzogno, cond.
 ANGEL 3549. Three 12-in. \$14.94.

Like Pergolesi's *La Serva Padrona*, composed sixty years earlier, *Il Matrimonio Segreto* is more surely music of its age than of all time. Yet it has survived not only as an opera-book entry but as a sort of brevier masterpiece, semiretired but always on call for special service. When, a year ago, the Teatro alla Scala finally opened La Piccola Scala (a long-planned new *teatrino* designed to be used for operas suited to an intimate stage or a limited audience) Cimarosa's opera was uniquely fitted for the honor of opening the new house. Now, using the principal elements of the occasion, Angel has issued a recording that has an admirable unity of approach, good ensemble, and a quality of sound far fresher than that of the nominally competitive Cetra set, in which engineering much below the 1949-50 optimum clouds a performance that is sometimes superior in details but not so well integrated. There is also a goodish Vox side of soprano-tenor excerpts, but as a total representation of the work the Angel release is in a class apart.

The standard—perhaps inescapable—reaction is that Cimarosa's music sounds a bit like Mozart, but without the depth and range of humanity; a bit like Rossini, but without the vigorous rhythmic spirits or specifically national lilt of his pioneer romanticism; and that it wants the strength of musical-dramatic characterization of either. True enough, but in actuality the Mozartean resemblances are common eighteenth-century musical properties, and the Rossinian resemblances are more properly the inflections of a shared inheritance. In any case, *Il Matrimonio Segreto* is a score of great elegance and charm and musical expressiveness—and, if divorced from expectations other than those it itself asks, of rather greater theatrical interest than one might suspect from listening to it with *Figaro* and *Il Barbiere* as standards of comparison.

The libretto, which has its roots in *The Clandestine Marriage*, is several cuts above the average *buffa* level—and, incidentally, is a very interesting study in the adaptation of a play to operatic use. Its plot has to do with the complicated household of one Geronimo, a new-rich merchant with social ambitions. His ménage includes two daughters, Elisetta and Carolina; a widowed sister, Fidalma; and a young confidential employee, Paolino. Carolina and Paolino are secretly married, as the title says—not a match likely to be approved by papa. So Paolino introduces his friend Count Robinson, on the hopeful theory that he will make Elisetta a countess, himself rich as well as noble, and Geronimo happy enough to bless Carolina's choice of a husband. The stratagem misentrap, but eventually all the cross-purposes are unsnarled—without (blessedly) the frenetic scufflings that make so many *buffa*-adapted plots as near-impossible to follow as a court-tennis scorecard.

In fact, what most truly differentiates *Il Matrimonio Segreto* from the run of still viable pieces of the genre is the unhurried formality of Cimarosa's treatment. Set beside the obvious measures, it is all very pre-*preromantic* in its musical patterns, with proportions as elegant as those of a finely-made sonata—and, of course, with exquisitely hierarchical allotment of vocal opportunities. But without compromising tradition, Cimarosa composed a score that has something more than purely musical charm.

The duets of the married lovers, in particular, are delicately tender and of an expressiveness sufficiently individual to make these characterizations the completest as well as the most engaging in the work. And, for Angel, Graziella Sciutti sings Carolina tidily, with pure line and often exceedingly attractive tone, although without melting the soubrette glaze quite enough to seem as romantic as she might; while the young Peruvian tenor Luigi Alva uses his lovely *leggero* voice (not yet quite even in scale) with a stylistic sense that may easily develop into mature distinction. Elisetta is a part that is less individual, pretty much in the snappy *sizzoso* vein, and although Eugenia Ratti sings it competently and with tone that is fresh, she works through all her ideas of vocal acting well before the halfway mark and ends by seeming more a mannerism than a person. Fidalma—her half-wistful hopes of recapturing youthful love treated without grotesquerie—is, by contrast, not at all a stock type. And if Ebe Stignani (the only ringer in the otherwise Piccola Scala cast) sounds to be fraying, her style is that of one of the unfull hand of truly great singers now active.

Beside Fidalma, Geronimo is almost entirely a standard-gauge *buffo* part, and Carlo Badioli's accurate readings bring little particularity to it. The demands of Count Robinson's role, with its necessity for keeping a delicate balance between faruity and almost arrogant egoism, make it not an easy part to do in any terms; but Franco Calabrese manages to hang onto a character of sorts while singing rather more suavely than does his colleague in the famous bass duet that set a fashion reflected in (for just one instance) Rossini's *Il Turco in Italia*.

But the most intriguing musical constructs in the work are the two finales—long, free, classic rondos that knit up the action most elegantly. They are quite good enough to show why Verdi regarded *Il Matrimonio Segreto* as the model of what an *opera buffa* ought to be—while regarding *Il Barbiere* as the finest. A nice distinction, but not quite so paradoxical as it may seem. In these elaborate *concertante* pages the obvious care and sensibility of Nino Sanzogno's work as preparer and conductor yield notably satisfying results. The sound from the grooves is clean and true, with balances perhaps overfavorable to the voices. Full text (the cuts, of generally nonstrategic material, are numerous, but no more than tradition admits), with an excellent translation by William Fense Weaver. All told, an excellent work, the only one of just its kind on records, and

Continued on page 64

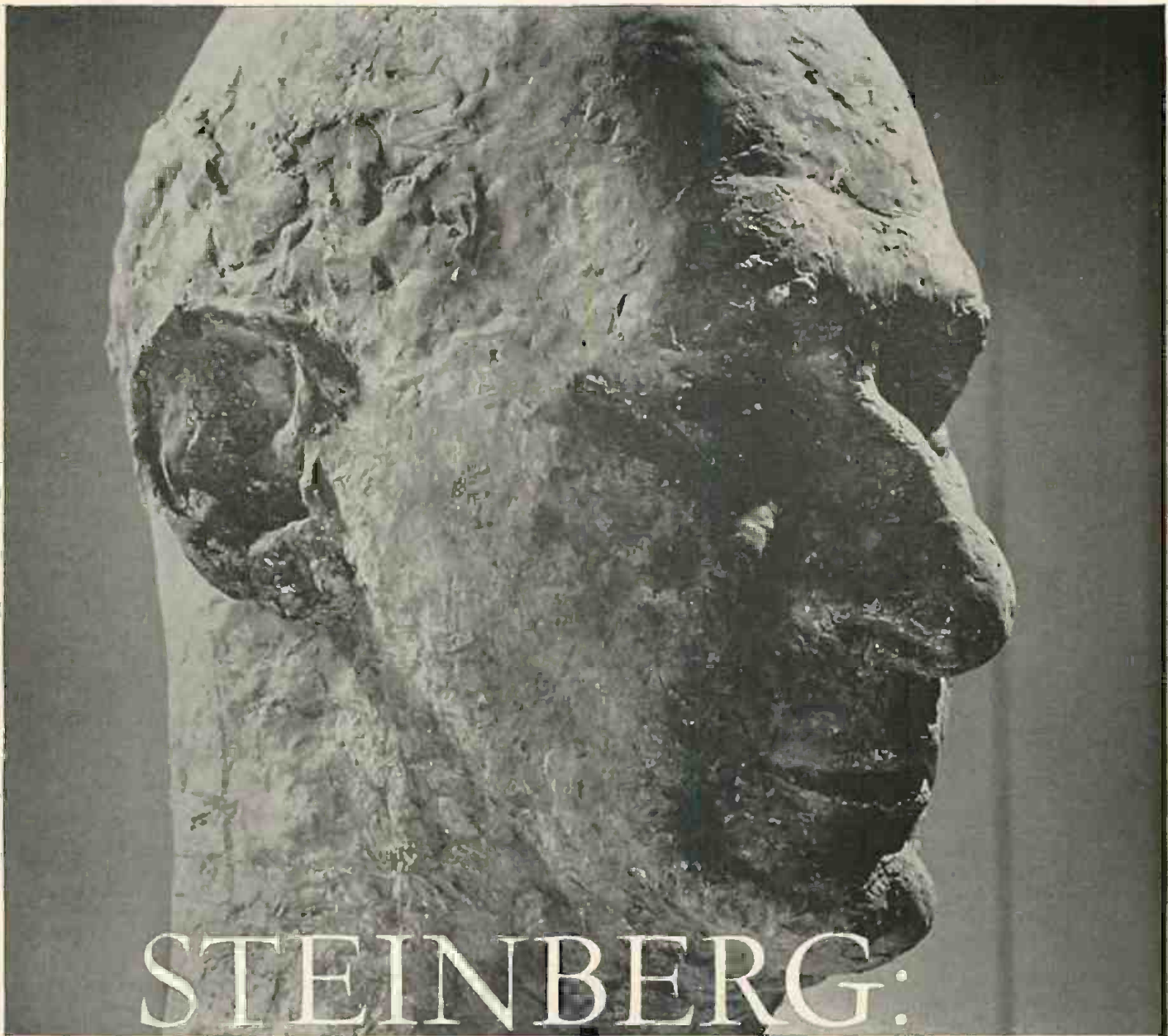

SCULPTURE BY ANNA MAHLER

Is it crowded at the summit?

In conducting, there are no prodigies at the top. It takes years to master the art, to achieve understanding. It takes more years to establish a reputation. Few are called, incredibly few chosen.

But 'arrival' seems breathtakingly sudden. With every performance of the great Pittsburgh Symphony, with every recording, William Steinberg makes it pointedly clear that he has reached, not merely the upper ranks, but the lonely, uncrowded summit of his profession.

A case in point: Steinberg's newest album is a performance with the Pittsburgh Symphony of Hindemith's famed *Mathis Der Maler* and the premiere recording of Toch's Pulitzer Prize-winning *Third Symphony*. For

lovers of contemporary music, it is pure delight.

But the same baton dictated the greatest Beethoven *Third Symphony* ("Eroica") in recorded music. And Steinberg's reading of Rimsky-Korsakov's *Scheherazade* is as wild, as pagan, as Asiatic as his Beethoven is noble. In a field where most men specialize, Steinberg's realm is the wide, wide world.

Every glimpse of this rich world of music has been captured by Capitol Records in superb "Full Dimensional Sound," the highest fidelity known to the recorder's art.

May we suggest one or two "Steinbergs" for your collection?

Six unchallenged Steinberg albums:

Beethoven: *Symphony No. 3* ("Eroica") P8334
Beethoven: *Symphony No. 6* ("Pastoral") P8159
Brahms: *Symphony No. 1* P8340

Rachmaninoff: *Symphony No. 2* P8293
Rimsky-Korsakov: *Scheherazade* P8305
Hindemith: *Mathis Der Maler*
Toch: *Symphony No. 3* P8364



charming music, in as good a performance as one is likely to be offered. J.H.JR.

COWELL: *Six Piano Pieces; Prelude for Violin and Harpsichord*

†Hovhanness: *Duet for Violin and Harpsichord*

†Pinkham: *Concerto for Celesta and Harpsichord Soli; Cantilena and Capriccio for Violin and Harpsichord*

Henry Cowell, piano; Robert Brink, violin; Edward Low, celesta; Daniel Pinkham, harpsichord.

COMPOSERS RECORDINGS CRI 109. 12-in. \$4.98.

Henry Cowell's early piano pieces, six of which fill one side of this disc, are among the classics of modern American music. Cowell pioneered in a new approach to the piano, handling it in all manner of unorthodox ways, and most of them are exemplified here.

Advertisement uses Cowell's famous tone-cluster technique—groups of adjacent notes struck with the fist or the flat of the hand—to provide a sizzling, juggling study that suggests the kaleidoscopic colors and shapes of a large electric sign. In *The Banshee* and *Aeolian Harp* he abandons the keyboard to pluck and stroke the strings directly, and in *The Tides of Mananaun* he plays with one hand on the keyboard and the other on the bare wires. *Sinister Resonance* is an early experiment in the "preparation" of the piano with various objects inserted among the strings to produce eerie, choked effects. *Lili of the Reel* uses more tone clusters to spark up its rhythms.

All this is essentially very simple, conservative music with a strong infusion of Irish folklore in its substance, but its daring colors and its exceptional mechanics were highly iconoclastic in their time and still seem so. The most fascinating thing about it, however, is its prediction of *musique concrète*. As early as 1912 Henry Cowell was producing sounds startlingly like those which the *musique concrète* school did not discover until very recently; and he produced them by a direct, uncomplicated, frontal attack on a musical instrument rather than going around Robin Hood's barn with a tape recorder.

For some years past Robert Brink and Daniel Pinkham have been before the public as a violin-and-harpsichord team, and the second side of the present disc is largely filled with works from their special repertoire. First, however, comes Pinkham's absolutely enchanting *Concerto for Celesta and Harpsichord Soli*, a brilliantly classical piece wherein timbre is used to reinforce line much as Bartók used color to clarify the voices in his edition of Bach's *Well-Tempered Clavier*. The bright and tingly sounds of this concerto are completely delightful in themselves, but that is not why they are employed.

The pieces for violin and harpsichord are, to say the least, entertaining, and the Hovhanness is quite powerful as well. Performances are the last word, and so is the recording. A.F.

FALLA: *El Amor Brujo; Noches en los jardines de España*

Corrinne Vozza, contralto; Lamoureux Or-

chestra, Jean Martinon, cond. (in *Amor Brujo*); Eduardo Del Pueyo, piano (in *Noches*); Orchestre des Concerts Lamoureux, Jean Martinon, cond. EPIC LC 3305. 12-in. \$3.98.

These are bright, animated performances with clear, well-defined sound. The approach to the music is in both cases vigorous and direct, and some may find the results wholly to their liking. I prefer the Ansermet version of *Amor Brujo* (reviewed in December) because it has an atmospheric quality and dramatic impact I do not find here, because the soloist is happier and more effective in the gypsy idiom, and because Ansermet's restraint allows him to build to a more effective climax at the end.

Del Pueyo plays *Nights in the Gardens of Spain* with exceptional feeling for the style, and the orchestral part is sympathetically stated to produce the very lovely effects these nocturnes can yield.

There are, however, some unpleasant highs on both sides that will want to be toned down. R.C.M.

FRESCOBALDI: *Fiori musicali; Toccate d'Intavolatura*

Eduard Müller, organ; Fritz Neumeyer, harpsichord.

ARCHIVE ARC 3054. 12-in. \$5.98.

Girolamo Frescobaldi (1583-1643) was the organist at St. Peter's in Rome for a good part of his life. His music is important for historical reasons but, more than that, it has a special quality. Despite an occasional liveliness and sudden shifts of mode, it has, by and large, a certain gentle gravity, an elevated seriousness, that make it ideal music to meditate by. The works presented here are sacred and secular compositions from three different collec-



Henry Cowell: classics of unorthodoxy.

tions published by Frescobaldi. About half of them are played on a sixteenth-century Italian organ at Innsbruck; the other half on a harpsichord. I found the latter group the more interesting; some of the organ pieces, as performed here, do not escape monotony. N.B.

HANDEL: *Concertos for Oboe and Orchestra: in B flat; in G minor*
Concerto for Orchestra, No. 3, in G, Op. 3, No. 3
Music for the Royal Fireworks

Hermann Tötcher, solo oboe; Bach Or-

chestra (Berlin), Carl Gorvin, cond. (in the *Concertos*). Berlin Philharmonic Orchestra, Fritz Lehmann, cond. (in the *Royal Fireworks*).

ARCHIVE ARC 3059. 12-in. \$5.98.

The Oboe Concertos fit our contemporary notion of what a concerto should be: solo against group; and they are the cream of this record, beautifully played and immaculately registered, as is the Op. 3, No. 3. The last has been cursed, with its five brothers of Op. 3, by a floating nomenclature designating them sometimes as "Concerti Grossi," at the risk of confusing them with the more famous Op. 6; sometimes as "Oboe Concertos," confounding them with the real oboe concertos; and sometimes as "Concertos for Orchestra," a cowardly title that has nevertheless the advantage of avoiding confusion with anything else of Handel's. Fine as it is, the present version of No. 3 is tactically weak in confrontation of complete versions of the six concertos on Vanguard and London.

The Royal Fireworks is here refurbished from the tape that fathered a Decca disc issued about four years ago. Cleared of fuzz and murk, the correction is a gratifying improvement and is a good record as records are estimated; but the magnificent blatancy of the music still balks at imprisonment in a groove, and none of the recorded versions is truly satisfactory. C.G.B.

HOVHANESS: *Duet for Violin and Harpsichord*—See Cowell: *Six Piano Pieces*.

KABALEVSKY: *The Comedians, Op. 26*
—See Khachaturian: *Gayne: Ballet Suite*.

KHACHATURIAN: *Gayne: Ballet Suite*
†Kabalevsky: *The Comedians, Op. 26*

Philadelphia Orchestra, Eugene Ormandy, cond.

COLUMBIA CL 917. 12-in. \$3.98.

Here in "'360' hemispheric sound" with the rich ensemble tone and persuasive drive long associated with the Philadelphians are two basic quasi-pop items. The less one thinks of the scenario of the *Gayne* ballet with its dramatic tale of evil machinations on the old collective farm, the more one is likely to enjoy the music. The Kabalevsky is nonpolitical in both its score and action, but it lacks such obvious "hits" as the *Saber Dance* and the *Rose Maidens*.

Two attractive suites of light music, then, extremely well played and well recorded. R.C.M.

LOCATELLI: *Concerti Grossi (12), Op. 1*

I Musici Virtuosi di Milano, Dean Eckertsen, cond.

VOX DL 333. Three 12-in. \$14.94.

Pietro Locatelli is best known in musical history as a violinist-composer who extended considerably the technical capacities

Continued on page 66

HIGH FIDELITY MAGAZINE



ROBERT CHARLES MARSH SELECTS TEN RECORDINGS
TO ILLUSTRATE THE TOSCANINI REPERTOIRE



building your record library

number thirty-five

TOSCANINI died in his seventy-first year as a conductor, within a few weeks of the ninetieth anniversary of his birth. His passing was as he wished it, allowing him to leave the stage quietly with his final illness known only to his family and most intimate friends. As I read the news of his death, it seemed that only a few days before I had received his Christmas greeting, a square of elegant Italian notepaper printed in scarlet with his monogram and a photoengraving of a salutation he had penned in his distinctive hand. It ended with phrase that had a prophetic quality of farewell: ". . . in cordial remembrance of Arturo Toscanini."

That he was one of the supremely great musicians of all time hardly requires further discussion. His influence is certain to be threefold. First, he condemned by example the tradition of "expressive interpretation" and reaffirmed the need to search endlessly and scrupulously for the composer's intentions and to reproduce them honestly. Second, he revealed unsuspected possibilities in virtuoso orchestral playing and showed what could be achieved when technique and understanding were combined with uncompromising perfectionism. Third, he proved that a life dedicated to the highest standards of a most demanding art could be lived heroically, creatively, and triumphantly.

Ten Toscanini recordings provide five pairs of illustrations showing his treatment of types of music for which he revealed a special affinity. Beginning with religious music, I go on to its antithesis in opera, and conclude with a kind of three-fold synthesis in the overture, the tone poem, and the symphony. In each of these groups certain Toscanini recordings spring immediately to mind. For that reason I shall not discuss them here. What I wish to do at this time is suggest other works which have called forth the highest levels of Toscanini's artistry without always receiving comparable notice.

To consider first religious music, LM-1849 (all numbers are RCA Victor) gives us the Verdi *Te Deum* (with the prologue to Boito's *Mefistofele*)—a hymn to the divine, rising from the years of ripest wisdom at the very close of the composer's career and stated with the eloquence of his ablest disciple. I was in Carnegie Hall when the recording was made, and I can truthfully say that the sound and the atmosphere of the performance are transmitted with uncanny effect. When I play it, Toscanini's personal force and communicative power present themselves seemingly undimmed by the electronic medium that transmits this music to me.

Hardly less moving is the 1950 broadcast recording of the *Mass in C minor (Requiem)* of Cherubini, recently issued on LM-2000. Less startling in effect than the Verdi *Requiem*, it paints no portentous scene of final judgment, but speaks with a degree of nobility and a depth of religious feeling that give it, in its own way, force equal to the Verdi masterpiece. Its appearance from the master hoard at Riverdale was worth celebrating, for like many Toscanini broadcasts that lingered in the mind as unique revelations of profound beauty, it seemed to be gone for good. To find that it wasn't and to relive in this record that often remembered concert was a satisfaction such as one knows only too rarely.

Toscanini was one of the great operatic conductors of all time and must be represented in that role, although one faces the problem that his recording career and his chief years as an operatic conductor belong to different periods in his life. A Wagnerian of heroic stature, he recorded but a single excerpt of that composer with a voice added to the orchestral textures; and the very abundance of his performances of the *Meistersinger* Prelude make comment on the two recorded versions superfluous for my immediate purpose.

For Toscanini opera I suggest his version of *La Bobème* in LM 6006 (2 records), for the Puccini score is distinctly his—the recording commemorated the fiftieth anniversary of his world première of the work at Turin in 1896—and the recording, although somewhat defective in its sonics by contemporary standards, still offers a remarkable degree of presence. Toscanini is there. He sings the big tenor aria (two octaves down, slubbing the top note in a way that can't help bringing a smile); he shouts, mutters, purrs like a contented lion, and dominates everything. Editions of this work may come and go, but those who want to learn the style of the old master must come to this one.

While normally one does not think of Toscanini in connection with music of the first half of the eighteenth century, the history of his operatic productions contains a number of important revivals of Gluck. The second act of *Orphée et Eurydice*, contained on LM 1850, offers not merely some exceptionally beautiful music in a stunning performance, but it shows us Toscanini's understanding of the composer and provides the Maestro's classicism with a perfect vehicle for the expression of its many facets.

Less need be said of the remaining half-dozen selections. Two overtures on LM 9022 make an interesting pair, reflecting different aspects of the Maestro's art. The Schumann *Manfred*, Op. 115 documents Toscanini's affection for the composer and preserves the sensitivity and vitality of his readings of this music. The Beethoven overture *Zur Weihe des Hauses*, Op. 124 is an interpretative *tour de force*, since the composer did not intend it to sound "Beethovenish" and Toscanini takes him at his word, producing a version that is not merely unique in approach but highly effective musically.

Although Tchaikovsky never played a large part in the Maestro's repertory, his music has always been offered with a degree of drama and polish that made Toscanini performances hard to forget. For instance, in reviving the *Manfred Symphony*, Op. 58, really a very long tone poem, Toscanini restored to the current repertory a work that should never have been neglected. The difficulty with *Manfred* was the problem of how it ought to be paced, and the Toscanini recording on LM 1037 is a model to be studied along with the score. Toscanini has called the music an opera without human voices, and a very thrilling opera it becomes under his hand.

In his edition of *Till Eulenspiegels lustige Streiche*, Op. 28 (LM 1891 with *Tod und Verklärung*, Op. 24) Toscanini also has rendered a needed service to Richard Strauss, for this is just about the only version of this much-recorded work in which all the detail of a very complex instrumentation emerges. This is partly achieved by means of a slower than average tempo, but the primary reason is the miraculous balance which Toscanini secures—and which the microphone accurately registers.

Now for two symphonies: I suggest the *Symphony in D* of Cherubini (LM 1745 with Beethoven's *Septet*) and the great No. 9 in C, D. 944 of Schubert (LM 1835). Both receive performances *con amore*, are well recorded, and are individual enough to retain interest whatever future versions the record industry may release. The Cherubini could be dull in a dull performance, but this one is full of life. The Schubert is Toscanini's personal statement of the score, fired with his conviction that he is rightly expressing the composer's intentions. The Maestro's reading disregards convention repeatedly, yet its cumulative power is tremendous; at the end, it has always produced in me a sense of supreme conviction of its rightness. Those who prefer a more usual view of the score may want to have another recording, but all who love Schubert ought to possess this one as a great and unique interpretation.

of his instrument. To judge by these concertos, he was a gifted composer as well as an imaginative fiddler. Like those of his teacher, Corelli, they contain a variety of interesting ideas, are smoothly constructed, and show a command of expressive melody and skilled counterpoint. Again as with Corelli, No. 8 is a Christmas concerto; this one has a particularly lively first movement and a fine fugue. I liked especially, too, the jolly finale of No. 5, the rather affecting quality of the first movement of No. 6 (which by the way is in C minor as on the label, not E flat major as in the notes), and the harmonic progressions in the Largo of No. 9. But any one of the twelve would make an attractive opening number in a recorded concert.

The performances have a good deal of spirit but would have benefited from a little more finesse. Vox has taken much care with the notes and with the appearance of the album; unfortunately, less was exercised in connection with the musical execution, which is not free of small blemishes like a careless attack, an occasional coarseness in the tone, and, once or twice, off-pitch playing. N.B.

MARTIN: Sechs Monologe aus "Jedermann"

Ist alles zu Ende?; Ach Gott, wie graust mir; Ist als wenn eins gerufen häst; So wollt ich ganz zernichtet sein; Ja! Ich glaub; O ewiger Gott.

†Schubert: *Lieder Recital*

Der Strom; Der Wanderer, Op. 65, No. 2; *Totengräbers Heimweh; Auf der Donau*, Op. 21, No. 1; *Fischerweise*, Op. 96, No. 4; *Der zürnende Barde; Gruppe aus dem Tartarus*.

Heinz Rehfuss, baritone; Frank Martin, piano.
LONDON LL 1405. 12-in. \$3.98.

All of the music here has quality; much of it is new to records; and there is consistent sense and integrity in the collaboration of the Swiss bass baritone Heinz Rehfuss and the Swiss composer Frank Martin, who turns out to be a very respectable pianist as well.

Martin's opera on Shakespeare's *The Tempest* had its American première in New York during the fall, as did the *Sechs Monologe aus "Jedermann"*, in its later orchestral version. In the original version, as heard in the recording, the cycle dates from 1943. It is a concert sequence of six longish reflective speeches by the central character in Hugo von Hofmannsthal's 1912 adaptation of the medieval English morality *Everyman*, long a standard presentation at the Salzburg Festival. The settings show an almost Debussy-like care for language, with the musical patterns taking shape from the words as a sort of extended quasi-melodic declamation, the close-spaced vocal intervals supported over constantly evolving chordal textures blocked out in the piano part. Not an assertive score but one of exact responses and subtle tensions, it is very impressive when heard on its own terms. But on first hearing, its refusal of independent rhetorical comment on the progress of *Everyman* towards the grave

is liable to make it seem pale and indecisive—especially if the text cannot be followed intimately. The London jacker, sad to say, gives only the barest précis of the monologues (and since Hofmannsthal adapted freely, adding much material, the original *Everyman* is but a lame pony to rely on). The performance is excellent, and presumably definitive as to the composer's original intentions.

In view of Schubert's special regard for Johann Michael Vogl, it seems odd that the songs he shaped specifically for low voice have been so generally ignored by men with proper resources. Of the seven here, only *Fischerweise* is common repertoire; and three—apparently never recorded until now—are real rarities. Among these, the most congenial to Mr. Rehfuss' strong, masculine delivery is *Der Strom*, a finely energetic poet-river-wanderers song. *Auf der Donau*, an evocative setting of sadder river thoughts, also goes well until the singer loses the mood while he gets set for the low F sharp at the end (he makes it, gingerly). This *Der Wanderer* is not *the*, but a later song in much blither mood, with a charmingly lyrical tune—a shade too lyrical for the voice. Similarly, the Rehfuss *Fischerweise* has not the grace of Gérard Souzay's; and although most of his *Totengräbers Heimweh* is strong and telling, his voice will not spin out the last bars. Contrariwise, in *Gruppe aus dem Tartarus*—as inhuman in its declamatory requirements as it is great in conception—he comes strikingly close to full realization. Again, no texts and spotty notes, but repertoire of really exceptional interest in performances only just below the top level. J.H.,JR.

MILHAUD: Suite Provençale; Saudades do Brasil

Concert Hall Orchestra, Darius Milhaud, cond.
CAPITOL P 8358. 12-in. \$3.98.

The *Saudades do Brasil*, composed in 1920, after Milhaud's return to Europe from his two-year sojourn in Rio de Janeiro, accomplished more than any other work to establish this composer's reputation in America. It has been recorded in its original version for piano, as well as in Paul Kochanski's abbreviated version for the violin, but this is its first recording in the orchestral transcription which is the most colorful of all. By turns languid, savage, and coruscatingly brilliant, these twelve short pieces push the resources of a chamber orchestra to their limits; they provide a veritable Brazilian carnival of the musical imagination. The *Suite Provençale*, on the other side, is a work of quite different character. Written for a very large orchestra, it evokes the atmosphere of medieval Provence and makes much use of old Provençal melodies. Recordings are excellent, and the interpretation is supremely authoritative. A.F.

MOZART: Bastien und Bastienne, K. 50

Rita Streich (s), Bastienne; Richard Holm (t), Bastien; Toni Blankenheim (bs), Colas. Munich Chamber Orchestra, Christoph Stepp, cond.
DECCA DL 9860. 12-in. \$4.98.

Because of its historical status as Mozart's first produced opera and its modest demands as a piece written for a small private theater, *Bastien und Bastienne* has had a fairly extensive performance history, under auspices ranging from the Opéra-Comique through the Wiener Sängerknaben and puppet theaters. And although it is no significant contribution to the history of musical drama, it is flowing, fresh, and often commentably Mozartean in its bland distillate-of-eighteenth-century way; in fact, it is quite likely the prettiest little operatype piece ever composed by a twelve-year-old.

The libretto frames a sort of village pastorale and, as ever, the problem is one of love-thought-unrequited. Bastienne is sad: her Bastien has strayed, leaving her, so to speak, with the lambs. She asks advice of Colas—shepherd, bagpiper, soothsayer, and (it develops) psychotherapeutic magician. He tells her that Bastien is just a bit unstable and too fond of admiration. She should pretend not to care for him. Then he tells Bastienne that Bastienne has found a new admirer. Now everyone but Colas is distraught, and he casts a great spell, ending with the suggestion that now all will be well in the inter-B-and-B relationship. And sure enough, only five numbers later, all is. Q. E. D. Trio finale, all in praise of Colas.

The new Decca set (by, or out of, Deutsche Grammophon) has the effect, common to D. G. G. opera recordings, of sounding as if it had been made in a huge, empty packing case. Even in my ascetic speaker the inescapable courtesy resonances tend to swallow spoken passages and super-enrich musical textures. But in these disconcerting terms the reproduction is full-range and balanced—better than that in the Period (well sung, with dialogue; but Bastien is a lady, and the sound is deadish) or Columbia (so-so all round, with the recitatives written for a Salzburg performance).

The Decca cast is very good indeed, the reading by Christoph Stepp controlled and graceful. Rita Streich is expert vocally, and so spontaneous in emotional reactions that her Bastienne seems almost real. Richard Holm, as Bastien, sings as well as one could wish, and also makes sense of the part, if without rivaling Miss Streich in charm. And Toni Blankenheim is excellently firm-voiced and agile as Colas. No notes, but a good libretto. J.H.,JR.

**MOZART: Concerto for Clarinet and Orchestra, in A; K. 622
Symphony No. 39, in E flat, K. 543**

Bernard Walton, clarinet; Philharmonia Orchestra. Herbert von Karajan, cond.
ANGEL 35323. 12-in. \$4.98 (or \$3.48).

Complaints are limited to the inconvenience of the coupling, for although the Von Karajan of this record is circumspect compared to the younger Karajan in the E flat Symphony cut to a Straussian, sharp vehemence on Columbia RL 3068, the present version is bolder than most, more masculine in temper, and less concerned with trappings than with spirit. The im-

Continued on page 68

SPECTACULAR

music...
interpretation...
recording...

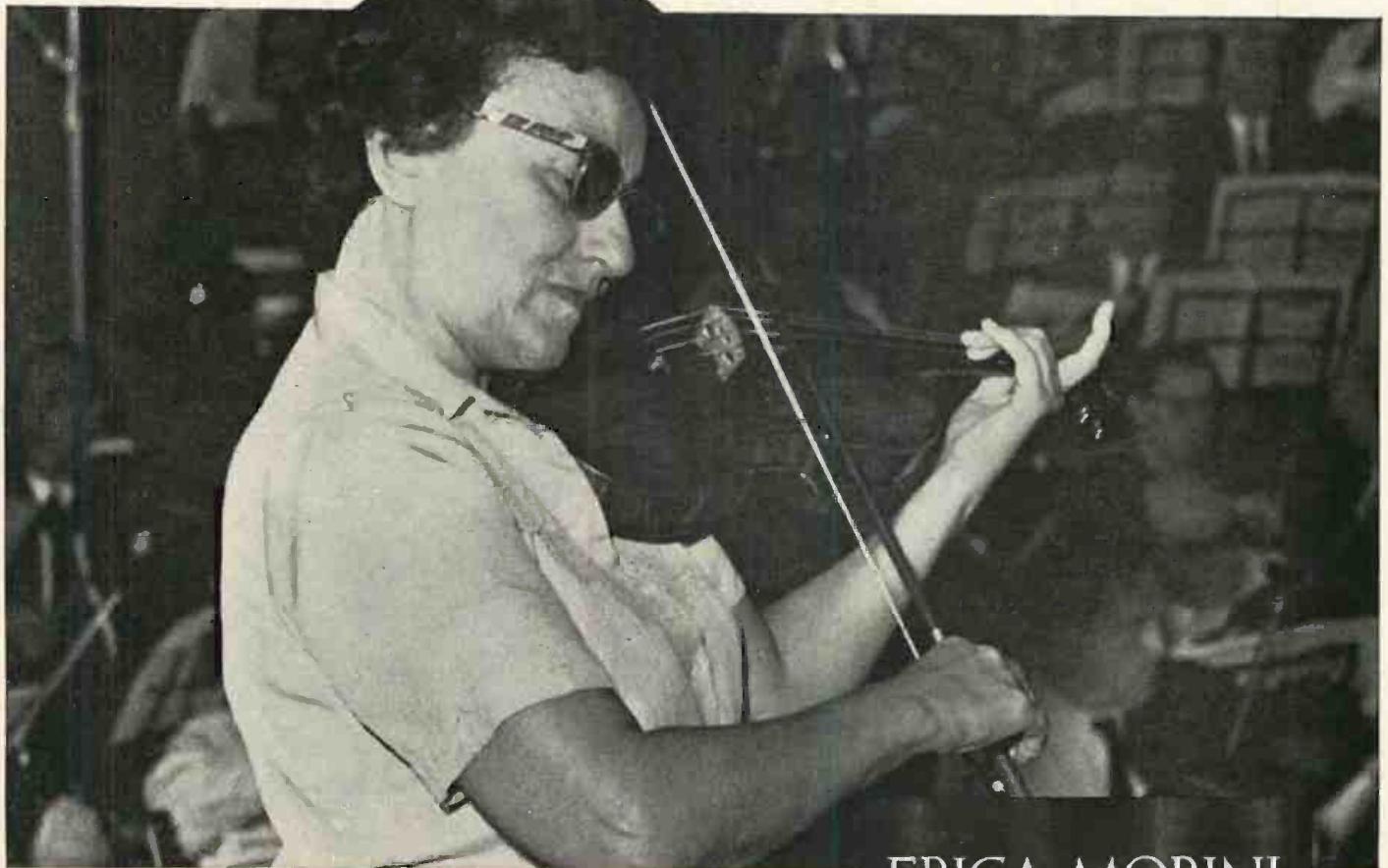

ERICA

MORINI

ARTUR

RODZINSKI

Philharmonic Symph. Orch. of London



TCHAIKOVSKY VIOLIN CONCERTO

XWN 18397

Morini's penetrating interpretation is known to concert goers the world over. Rodzinski's readings of Tchaikovsky are milestones in musical history. Together, and recorded in Westminster-exclusive "Natural Balance", they create a record not short of inspired! At your dealer now.



pression is of healthy strength, and the impression is fortified by the solidity of the best sound given to this music. The conductor in accordance with his habit makes the introduction grave and portentous, and very impressive here, but respects established tempos as a whole throughout the work; and the vigorous attack illustrates nicely how an orchestra can have finesse without flaunting graces. No harm in the graces when they are right, but the inherent manliness of the Philharmonia (and the Berlin Philharmonic) is a virtue with a special kind of suppleness not dazzling enough to draw the praise it deserves.

In the Concerto, the soloist weaves in and out of the orchestra like a member thereof — which in fact he is — called upon for special duty. The well-aired, graceful, and restrained performance belittles contrast to favor fluency, and the small body of Philharmonia strings makes lissomeness a matter of course, on this record. The clarinet, neither fat nor acrid, is classic in its soft colors as well as in its even continuance of line. The hues are not an inspiration but an adornment, and agreeable from start to finish of the most aristocratic projection of K. 622 on records. Suave sonics. C.G.B.

MOZART: *Die Entführung aus dem Serail*, K. 384

Lois Marshall (s), Constanze; Ilse Hollweg (s), Blonde; Leopold Simoneau (t), Belmonte; Gerhard Unger (t), Pedrillo; Gottlob Frick (bs), Osmin. Royal Philharmonic Orchestra. Sir Thomas Beecham, cond.

ANGEL 3555 B/L. Two 12-in. \$10.98.

Die Entführung aus dem Serail has never attained the popularity outside German-speaking countries that its sister *singspiel*, *Die Zauberflöte*, has. Perhaps that is because most of its melodies are not as memorable, or because its plot is too simple, or because a set of singers capable of doing justice to all its parts is too hard to assemble. Nevertheless there are wonderful things in it, and anyone who doesn't know it well is, I think, depriving himself of a good deal of pleasure.

Even to those benighted souls, like myself, for whom not every Beecham performance of Mozart is necessarily divine revelation, this recording will stand out in certain respects above all others. Sir Thomas' tempos here are quite convincing. He tends to take slow sections more slowly than his colleagues, but he does not drag; and the result is, for example, that the recitative for Belmonte's "*O wie ängstlich*," as well as the aria itself, has a kind of yearning ecstasy absent in the other recordings. His orchestra is bright and clear; there is never any muddying of detail. There are some idiosyncrasies — extra accents in Blonde's "*Welche Wonne*," slowings-up in Osmin's "*Hu! wie will ich triumphieren*," a cut in addition to the usual one in the duct between Belmonte and Constanze. But these shouldn't really bother anyone. What is more difficult to understand is Sir Thomas' switching of "*Martern aller Arien*" from the second act to the third. His reason — that while Constanze sings it "the unhappy Pasha has either to sit or stand listening

to her" for some seven minutes — does not seem to have any validity in a recording.

Both of Sir Thomas' tenors sing with attractive tone and musicianly phrasing. As regards the ladies, Miss Marshall does acceptably with the role of Constanze. There should, of course, be a law against "*Martern aller Arien*"; but as long as sopranos are expected to sing this incredibly difficult aria, we should be thankful, I suppose, when they do it as neatly and cleanly as Miss Marshall does it here. There is, however, a little more character in the tone and a little more bravura in the style of Maria Stader in the Decca recording. Miss Hollweg is slightly tremulous in parts of "*Durch Zärtlichkeit*" and while she manages a good top E, her tones below the staff are hollow. Emmy Loose, the London Blonde, is steadier, but both ladies must yield to the remarkable Rita Streich, of the Decca set. Because of the consistently lovely quality of her voice, and because of the ease with which she can either climb below the staff or scamper up to a ringing high E, Miss Streich is the outstanding singer in all three sets.

From the standpoint of recording, the Angel set is superior to the London but not to the Decca, in which the violins come through with less distortion. All in all, I should say that if you own the Decca set, there is no urgent need to replace it. If, however, you are shopping for a *Seraglio*, Beecham's on balance may have a slight edge. N.B.

MOZART: *Sonatas for Piano: No. 12, in F, K. 332; No. 13, in B flat, K. 333; No. 14, in C minor, K. 457; No. 17, in D, K. 576*

Robert Casadesu, piano. COLUMBIA ML 5149. 12-in. \$3.98.

These are fine examples of the blooded but rather bloodless style of this pianist in Mozart. Animated and nimble, poised and aloof, the playing spreads a clear tapestry sure to be admired by everyone who does not demand a flourish of feeling. No doubt that the grim C minor work seems incomplete in such a calm appraisal of its vexations, but there is a strong counterappeal of delicate incongruity in the imperturbable flight of all these measured and pomaded notes through the sulphurous air. Giesecking comes to mind, but the excellent piano sound of this record is much nearer truth and far more robust than the reproduction given to Giesecking's complete Mozart. The other three sonatas, under the same worldly treatment, are less restive and will be considered admirable by all those who favor a detached approach to Mozart. C.G.B.

MUSSORGSKY: *Boris Godunov*

Zlata Sesardich (s), Xenya; Militza Miladinovich (ms), Nurse; Sofiya Jankovich (ms), Feodor; Melanie Bugarinovich (ms), Marina; Stepan Andrashevich (t), Shuisky; Miro Brajnik (t), Grigori (the False Dmitri); Stepan Vukashovich (t), Missail; Dushan Popovich (b), Shchelkalov; Miro Chagalovich (bs), Boris Godunov; Branko Pivnichki (bs), Pimen; Zharko Tzveych (bs), Varlaam; *et al.* Chorus and Orches-

tra of the National Opera (Belgrade), Kreshimir Baranovich, cond.

LONDON XLLA 31. Three 12-in. \$14.94.

Only in the matter of economy can this compete with the RCA Victor-Boris Christoff recording. It would be false economy at that. Victor, with four discs, offers the complete 1908 edition of Rimsky-Korsakov's revision (the fourth version, incidentally — two by Mussorgsky himself, and two by Rimsky). London in its three discs, on the other hand, offers a production closer to the 1896 edition of Rimsky-Korsakov. Scene I of Act III is not presented and several other sections are partially sliced, if not altogether cut. Miro Chagalovich is a vocally solid Boris (he sounds even more impressive in person), but he is no match for Christoff dramatically. He strikes one as being young for a Czar and unimaginative for a man ridden with hallucinations. The outstanding principal is Miro Brajnik, possessor of a fine, ringing tenor. His is the most compelling Dmitri on records. Branko Pivnichki's bass is quite heavy enough for Pimen, but too unwieldy for consistent effect. The others are without exception solidly routinized, and not much else. Kreshimir Baranovich conducts an uneven performance: when he does finally bear down for a moment of climax, he fails to approach the late Dobrowen in the RCA Victor set. London's three-part libretto includes Russian text, transliteration, and line-by-line translation. Fair-to-good sound. J. C. McK.

MUSSORGSKY: *Night on the Bare Mountain* — See Tchaikovsky: *Symphony No. 2, in C minor, Op. 17, ("Little Russian")*

PEPUSCH-AUSTIN: *The Beggar's Opera*

(Members of the speaking cast are listed second.) Elsie Morison (s) and Zena Walker, Polly Peachum; Monica Sinclair (ms) and Rachel Roberts, Lucy Lockit; Constance Shacklock (ms) and Daphne Heard, Mrs. Peachum, Mrs. Trapes; Anna Pollak (ms) and Jane Jacobs, Jenny Diver; Alexander Young (t) and Robert Hardy, Filch; John Cameron (b) and John Neville, Macheath; Owen Brannigan (bs) and Paul Rogers, Peachum; Ian Wallace (bs) and Eric Porter, Lockit; Laurence Hardy, Beggar, Gaoler; Robert Hardy, Matt; Ronald Fraser, Highwayman; Aubrey Morris, Player, Drawer; Eleanor Bryan, Anne Robson, and Loretra Davett, Whores. Pro Arte Chorus and Orchestra, Sir Malcolm Sargent, cond. RCA VICTOR LM 6048. Two 12-in. \$7.96.

Mere currency in the theater, to be sure, is a notoriously fallible index of worth. But *The Beggar's Opera* — that lewd, rakehell, colorful masterpiece of defamatory satire, shaped into words and verses by (most of them) John Gay, and fitted out by him and Dr. Johann-Christoph Pepusch with a lucky-bag assortment of borrowed tunes has worn so uncommonly well that it is now one of the oldest pieces of musical theater to be heard as an entertainment sufficient to itself rather than as

Continued on page 70

phrasing, dynamics — and his is an attractive voice. Whether the degree of communication he provides is satisfactory depends on the listener. There is sensitivity and intelligence here, and for some it will be in the right proportions. For myself the singing wants the final degree of intensity, and in fast songs there is just a touch of preciousness. Dalton Baldwin's accompaniments are somewhat subdued, delicately fashioned, but with occasional chords not fully articulated when it matters, as in *Schlafendes Jesuskind*. German and English texts are given. R.E.

SCHUMANN: *Symphony No. 2, in C, Op. 61; Overture, Scherzo and Finale, in E, Op. 52*

Israel Philharmonic Orchestra, Paul Kletzki, cond.

ANGEL 35373. 12-in. \$4.98 (or \$3.48).

Is not an instinct or serious preparation for classical circumspection more valuable to the interpreter of any music than an equivalent instinct or preparation for the hot courses of romanticism? The classical training would make the interpreter at least acceptable as an exponent of classicism, whereas catastrophe is likely and

occurs when classicism is steered by a romanticist. And the romantic composer has filled his score with romantic exaltations: will not the romantic interpreter endanger them to the point of burlesque in adding his own exaltations to the composer's? The evidence suggests that a few pinches of romanticism are helpful in classic music, and large infusions of classicism are indispensable to romanticism.

A number of definitions for which there is not space would show more clearly that the idea underlying this rather loose talk is tenable. The conductor of the record supposedly under discussion inspired these ruminations by his work in Schumann's orchestral music, fervent romantic work a little too irregular for the First and Fourth Symphonies to bear in comfort. That fervor and irregularity are not lessened for the pieces on this disc, but they are hardly noticeable and do more good than harm. For the music is spasmodic and discontinuous, the symphony especially, although Schumann was so well aware of the short breath of the O, S, and F that he denied it the title of symphony intended for it.

The Second Symphony gasps its phrases, the spasmodic efforts of an imperiled talent

to pull itself together. No one can withhold compassion at the desperate snatches of feeling striving for a cohesive message, and the Israeli orchestra withholds none of the artifices of persuasion in making the emotional disorder vivid. Like the preceding record in the series dedicated to Schumann's memory on the centennial of his death, this one carries a realistic and ample semblance of a virile orchestra, at the top of Angel's sonic form. C.G.B.

TANSMAN: *Isaiab, the Prophet*

Radio Philharmonic Orchestra and Choir of Hilversum, Paul van Kempen, cond.

EPIC LC 3298. 12-in. \$3.98.

The recording is not very good, but the work is of the highest interest and its performance is superb. A prolific composer and one who has had international recognition for more than thirty years, Alexandre Tansman has previously been represented in the LP catalogues only by his short, light *Triptych For String Orchestra*. *Isaiab, the Prophet*, however, should go far toward bringing him to the attention of discophiles as a major figure.

The work is a "symphonic oratorio"

London Gives Us a Fine, High-Flying Dutchman

RIPENED in concept and brought almost to final form near the close of those frustrating years of effort to win recognition in Paris, during 1840-42, Richard Wagner's *Der Fliegende Holländer* was composed in a mood of reaction against the grand *opéra* composites of *Rienzi* — and against the *Opéra* ("the horrible theater") for declining to make them public. Today, *Rienzi* is only a label for its overture, while *Der Fliegende Holländer* — bowever grim and weird it seemed (as it did) to its first hearers, however un-homogeneously old-fashioned it may seem today — holds a place in the recurrent repertoire, and, as at least an occasional celebrant, in the ritual observances at Bayreuth, where this new London recording was taped during actual performances at the Festspielhaus in the summer of 1955.

Some years ago W. J. Henderson stated its great historic importance as the only proper starting point for a consideration of what Wagner came to be and discussed its intrinsic merits, for all that it "... falls between two fires. . . not sufficiently naïve to please admirers of *La Sonnambula*, nor yet Wagnerian enough to touch the devotees of *Tristan* and *Parsifal*." In it Wagner took a defining step towards a specifically German kind of musical theater — defining because of its direction rather than because of its measure against the total journey. Here, for the first time, the essential matter and germinal methods of music drama make up the bulk of the load: A legendary subject, acted out by characters some of whom are already super-human in attributes; the concentration on true evocation of mood rather than on a series of pleasing tunes; the weaving (tentative but suggestive of later practices in the *Ring*) of leading motives.

The story — once the listener grants its

people their symbolic identities, and, of course, their concomitant freedom to act on sublime motivations — is simple and, for Wagner, compact in event. The title character, adopted from Heinrich Heine's Schnabelewopski memoirs, is otherwise of very ancient lineage — the Wandering Jew of medieval tradition. Altered in genotype and profession, he is a Dutch shipmaster, doomed (as the rather excessive consequence of a single diabolistic oath sworn in defiance of storms thwarting his passage of the Cape of Good Hope) to sail on and on forever — except that every seventh year he may make land and seek the bride whose Love Unto Death can end his voyaging.

Thus far, Heine. But he introduced the true-love condition as a will-o'-the-wisp to light the ironic authorial comment that women might well avoid so dubious a matrimonial prospect as an accursed sailor, and that men might even better avoid the faithless sex entirely. It remained for Wagner to state the opposite — and for him the only — case.

He had his shortcomings as a social animal; but a lack of enthusiasm for the salving potentialities of womanly devotion was not among them. Thus, in the long view, *Der Fliegende Holländer* is but the barest preliminary statement of the theme, which recurs with near-obsessive frequency in his subsequent stage works, its various aspects ever more elaborated — until the spiritual union of *Tristan* and *Isolde*, the Nordic suttee of *Brünnhilde* for *Siegfried*, are sublimated at last in the life-bestowing mystique of a vessel no longer shaped of earthly flesh at all, the Grail of *Parsifal*. This is at once the claim to theatrical life of *Der Fliegende Holländer* and, tacitly, the admission that it needs a degree of indulgence. For the apotheosizing tableau

that ends it is also the *no plus nulla* of its very existence; and, if in working towards it Wagner ordered matters more compactly than his later symphonic procedures would have allowed, he did not always succeed in giving economy the virtues of old-style operatic interest — partly because of the unhomogeneity of the score, more specifically because in it only the central symbolic pair rise above stock-type status and only they are really functional in the *mythos* defined by the text.

And this, even, may stretch the point. Actually, once the mood has been fixed by the magnificently salty tone-painting of the overture, the burden of dramatic interest rests squarely on the *Holländer* — and his gloomily fate-struck entrance monologue is his strongest material. His problem defined, it begins at once to dissolve when Daland turns out to have a marriageable daughter; obviously, this is a meeting by *wyrd*, for all that Daland's Italianate *buffo* patter in their duet does little to elevate the occasion. At the start of Act II, the end is in sight as Senta sits hallucinating about a picture (apparently part of the Daland family collection) of the *Holländer* himself. Like all early Wagner heroines, she may not seem quite adjusted; but she does have purpose and an active will (the second time she opens her mouth, she orders the assembled female chorus to shut up), and nothing could be surer than that she is destined to save the hero. And so she does, after an act and a half of make-work conflict generated by her tenor ex-fiancé, who is left on the rocky shore as the *Holländer* and his eternal-feminine redeemer float heavenward and the ghostly ship crumbles into the sea — a dénouement that, as Ernest Newman has remarked, provides salvation for no one below the rank of captain.



THE RELAXED HORN OF MILES DAVIS

One of the brightest lights on the modern jazz scene, and unofficial headmaster of the new school of relaxed trumpet playing is 30-year-old Miles Davis. The Davis tone is soft, rich, intimate in its breathy warmth. He seldom goes in for frantic effects. His style is an almost paradoxical blend of outward relaxation and inner, emotional tension. Davis, whose sound reminds old-time fans of the great Joe Smith, served his apprenticeship with Dizzie Gillespie; learned the ground rules of harmony at the Juilliard School and figured as one of Charlie Parker's henchmen on 52nd Street, just before the strip-teasers took over. In 1955 he organized the phenomenally popular Miles Davis Quintet, which makes its Columbia debut this month.

ROUND ABOUT MIDNIGHT: The Miles Davis Quintet. CL 949 \$3.98

MR. BIGGS CONTINUES HIS TRAVELS

This past summer, organist E. Power Biggs made a project of performing and recording the little known organ music of Spain and Portugal on the centuries-old instruments found in those countries. Mr. Biggs, who goes about his profession in a very scholarly manner, insists that organ music should be played on the instruments for which it was written . . . in this case the Iberian organs, whose Trompeta Real (external trumpet stops, in fan-like array) are spectacular to eye and ear alike. This adventure in sound is the second in a series which began with "A Mozart Organ Tour" last year.

ORGAN MUSIC OF SPAIN AND PORTUGAL: E. Power Biggs. KL 5167 \$5.98

HAPPY HOLLIDAY

There is a school of thought which holds that Judy Holliday could make even Lady Macbeth a lovable, ingratiating character. In fact, if she ever undertakes the part, we intend to see every performance for a week solid. In the meantime, however, Miss Holliday is illuminating a breezy musical called "Bells Are Ringing," and the glow she puts forth is visible for miles at sea. Judy, in case you haven't heard, plays a switchboard operator for a telephone answering service, who is secretly in love with a subscriber she has never seen. She sings, in a voice with a power and range that will surprise those who know only her dramatic roles. With a sure comic touch, she builds her part into a touching, heart-warming individual . . . a happy achievement that is just as evident in this recording as it is on stage at the Shubert Theatre.

BELLS ARE RINGING: The original Broadway cast. OL 5170 Specially priced for a limited time only.

OUR FAIR LADY

The SRO sign has been up at the Mark Hellinger Theatre for exactly one year, and unless the management decides to move "My Fair Lady" over to Madison Square Garden, the Polo Grounds or the Colosseum in Rome, it looks as if the sign will stay there permanently. Meanwhile, for the 168,000,000 Americans who still haven't seen it, there's consolation in this original cast recording . . . a joyous experience in itself!

MY FAIR LADY: The original Broadway cast. OL 5090 Specially priced for a limited time only.

THE SOUND OF GENIUS IS ON

COLUMBIA RECORDS

A Division of CBS
"Columbia" and "Columbia" are registered trademarks.
Prices are suggested list.



a subject for devoted revival on special occasions.

Taking his lead from Jonathan Swift's now famous musing on "what an odd pretty thing a Newgate pastorate might be," Gay wrote, or concocted, a highly topical entertainment that made its effect largely through incongruous juxtapositioning of the familiar. He was more than successful. *The Beggar's Opera* ran for almost seventy performances (not bad at all in the London of 1728), and set a firm stop to the social vogue of opera in Italian by lampooning Handel out of business at the Academy of Music. It also established itself as the prototypic ballad opera, and so the direct forebear of English vernacular musical theater.

While by now the particular relevances of Gay's satire are far away in time and milieu, somehow *The Beggar's Opera* continues to work. No doubt this is partly because the bawdiness of the text—noticeable even by Georgian standards of indelicacy—has an even more titillating effect on post-Victorian ears; partly, too, because the tunes, regarded as familiar or as periodically charming, are very fetching, easy-to-take musics. But most defining is the fact (deplorable, of course) that Gay's bandits and doxies and cony-catcher syndics, however costumed and however given to archaic language, are humanly as much of our time as they have been of any at all since Eve, so to say, outspan Adam, and Adam looked sidewise at Lilith.

The newest revalidation of Gay's seamy-sided universality is this finely engineered recording by RCA Victor, the third LP representation of the title. As in the Westminster (*via* Argo) set issued last year, the version offered is sea-changed harmonically by Frederick Austin—but with the later, more elaborate of his two scorings, and with quite different, musically more extensive cuts. Both offer better than reputable performances, but are different enough in content to raise the question of just what does constitute a valid here-and-now presentation of *The Beggar's Opera*. Since only the Pepusch overture has come down in full score to give an indication of the instruments probably used and since the airs were printed with no more than sketchy one-line bass figurings, no contemporary performance can lay claim to absolute authenticity. When Austin came to work up a revival for production in London in 1920, he worked with a free hand—jettisoning some tunes, reharmonizing the others so as to sound eighteenth-century to twentieth-century ears, rescoring the overture, and adding between-scenes music of his own.

The principal textural difference between the recorded performances has to do with this: the Westminster uses the almost chamber-scale 1920 scoring, while the new RCA Victor uses a 1940 rescoring for larger orchestra relieved of requirements for eighteenth-century instruments. My own preference is for the earlier, lighter instrumentation—probably because of a rather specious willingness to accept it as suggesting an archaism not in the harmonies themselves. But the actual qualitative disparity is not very extreme, even though Sir Malcolm Sargent, in the RCA, tends towards a beefier, more Handelian evocation of the period than does the

adapter's son, Richard Austin, in the Westminster.

The differences in cuts are more telling. To begin with, the Austin adaptation dispensed with a number of airs. Of the verses assigned melodies in the original, the two recordings between them contain forty-four of the sixty-eight. Of these forty-four, the Westminster performance cuts two that are included in the RCA; the RCA cuts six that are included in the Westminster, but includes somewhat more dialogue. The cuts common to both recordings are least extensive in Act I, and the RCA cut of one of Polly's songs is just about balanced by the Westminster cut of one of Mrs. Peachum's. In Acts II and III the losses are more important—and the extra cuts in the RCA more questionable. In both, the claim of Lucy to Macheath is treated cursorily, and the parallel father-daughter interviews between Peachum and Polly and Lockit and Lucy left without more than a flick of a glance. Where Westminster omits Dean Swift's famous contribution ("When you censure the age," an attack-direct on corruption in the government), RCA dispenses with five other numbers—all but eliminating the Lockit family discussion and a good part of the scene between Lucy and Polly. The two sets agree in the Act III musical cuts, which again take heavy toll amongst the Lockits and radically telescope Macheath's big pre-gallows *scena*. In brief, while both sets unbalance the activities of Peachums and Lockits, the RCA comes near to depriving Newgate of gaoler and gaoler's daughter entirely. Both sets leave enough dialogue for a reasonable continuity, while tending to leave less than just measure of bawdiness for its own sake.

Leaving out of debate a firm personal conviction that double-casting of actors and singers hurts more than it helps a recorded performance, the merits and demerits of the two sets add up to sums not very different, with somewhat better vocal quality in the RCA set, largely cast with Sadler's Wells singers, but no higher level of average competence than in the Westminster. The RCA actors, drawn from the Old Vic, produce a lower incidence of outright annoying readings than their opposite numbers, with an excellent Macheath by John Neville and a good Filch by Robert Hardy. Paul Rogers is not so good a Peachum as one might imagine, and is too light-voiced in delivery here to make transitions to Owen Brannigan's full bass credible; Zena Walker is appallingly mannered as Polly.

All told, if qualities of purely musical performance are determinant, there is not a great deal to choose; if acting, the RCA has a slight margin. But Westminster offers more of the music and shows the temper of the work at least as well. Westminster provides a text, RCA does not—only a synopsis in a handsome booklet.

J. H., JR.

PINKHAM: *Concerto for Celesta and Harpsichord Soli; Cantilena and Capriccio for Violin and Harpsichord*—See Cowell: *Six Piano Pieces*.

RIMSKY-KORSAKOV: *The Czar's Bride*

Elizaveta Chavdar (s), Marfa; Vera Lyu-

bimova (s), Domna Ivanovna Saburova; Irina Trofimova (s), maid; Larisa Rudenko (ms), Lubasha; Zinaida Kushnareva (ms), Petrovna; Antonina Sopova (c), Dunyasha; Pyotr Belinnik (t), Ivan Sergeevich Lyikov; Pavel Ivanov (t), Elisey Bomelius; Ivan Klyakun (t), a young man; Mikhail Grishko (b), Grigory Grigoryevich Gryaznoy; Boris Gmirya (bs), Vasily Stepanovich Sobakin; Vladimir Matveyev (bs), Grigory Lukianovich Malutaskuratov; Vasily Babenko (bs), the Czar's janitor. Chorus and Orchestra of the Taras Shevchenko Theater (Kiev), Vladimir Piradov, cond. WESTMINSTER OPW 1301. Four 12-in. \$15.92.

The Czar's Bride (which had its première in Moscow, on November 3, 1899—not 1889 as stated in the album notes), is an opera in three acts (here divided into four) to a libretto based on a play by Lev Alexandrovich Mey, with changes by I. F. Tyumenev. The pseudohistorical story, set in the reign of Ivan the Terrible (1533-84), deals with the tragic fate of Marfa, daughter of Vasily Sobakin. She loves her childhood friend Ivan Lyikov; is loved by an *oprichnik*, Grigory Gryaznoy; and is selected to be the bride of the czar. The story culminates in deception, murder, and delirium. Although Ivan the Terrible appears on the stage, he remains silent, this peculiarity having resulted from a law against a czar's singing in opera.

The Westminster recording, the first complete (?) version of this opera on discs, is earnest and well meaning, but dull. The recording, made from tapes taken in Kiev, is muddy and confused in sound. The singers are uniformly second-rate; the orchestral playing lacks definition and sharpness. I should be sadder than I find myself about this if I were convinced that *The Czar's Bride* is a very rewarding opera. It has bright Rimskyan touches, of course, but except for Marfa's Act II love song "In Novgorod" and her Act III scene of delirium "Ivan Sergeevich, shall we go into the garden?," it is all empty gesture and routine. This recording may interest students of Russian opera or of Rimsky-Korsakov, but it brings few delights to listeners without these special interests.

HERBERT WEINSTOCK

RIMSKY-KORSAKOV: *Le Coq d'or*, Suite—See Borodin: *Prince Igor*, Act II: *Polovtsi Dances*.

SCHUBERT: *Lieder Recital*—See Martin: *Sechs Monologe aus "Jedermann."*

SCHUMANN: *Liederkreis, Op. 24*
†Wolf: *Mörke Lieder (8): Schlafendes Jesuskind; Um Mitternacht; Begegnung; Fussreise; In der Frühe; Der Gärtner; Verborgeneheit; Gesang Weylas*

Gerard Souzay, baritone; Dalton Baldwin, piano.
LONDON LL 1476. 12-in. \$3.98.

Mr. Souzay is the faithful interpreter of these masterpieces in all things—diction,

Continued on page 72

INTRODUCING THE SABRES!

MOST SENSATIONAL NEW SINGING GROUP IN AMERICA TODAY!

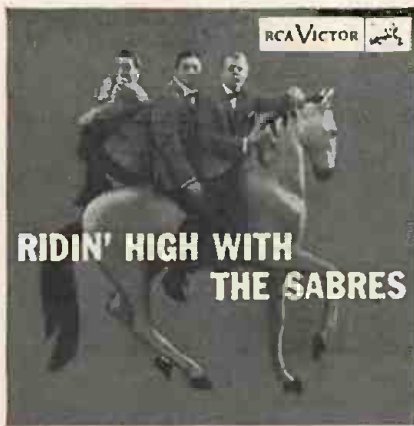

***RIDIN' HIGH WITH THE SABRES.** The first album for this supercharged vocal group. Packed with talent and high-voltage enthusiasm, they add new bounce and sparkle to your favorite music. With Dennis Farnon and His Orch.

***SWINGIN' SINGIN'.** Randy van Horne and His Swinging Chorus. An album that really *moves*: mood music, blithe ballads, a vivacious beat, and exciting touches of modern jazz. Fresh, new boy/girl music.

***UNDER ANALYSIS.** Eddie Sauter and Bill Finegan psychoanalyze some big-band hits of the past, and come up with stunning new musical treatments. These are the modern hi-fi sounds you like — adding up to an unforgettable musical experience.

RIDIN' HIGH WITH THE SABRES

NEW SENSATIONS IN SOUND FOR MARCH

from

RCA VICTOR

***Brilliant New Orthophonic High Fidelity recordings. Only \$3.98 for each Long Play; 45 EP versions at the new low price... only \$1.29 ea.**

***MIDNIGHT FOR TWO.** Here's an album that has everything!—the great talent of The Three Suns combined with Ray Bohr at the pipe organ. New moods in mood music plus an electrifying sound that makes each selection a new adventure in high fidelity!

***BEAUTY AND THE BEAT.** Bob Scobey's Frisco Jazz Band with a bright, free-swinging style that's not tied to any "school" lines. 12 "pretty girl" tunes set to a solid jazz beat.

***MAGOO IN HI-FI.** Mister Magoo tells his hilarious experiences as a hi-fi do-it-yourselfer. Serves as a showcase for exciting hi-fi sounds and fresh original music. A great party record, a riot of fun for all.

***MELACHRINO ON BROADWAY.** What could be more natural than to combine the sweeping sounds of the Melachrino Orch. with the sweeping melodies of Broadway's big-hit shows! My Fair Lady, Guys and Dolls, The King and I, Damn Yankees, South Pacific, Carousel, Can Can.

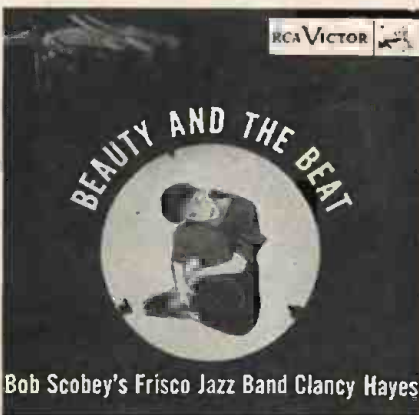

Nationally Advertised Prices
 *Hear these exciting albums best on an RCA Victor New Orthophonic High Fidelity "Victrola."®

in seven movements, two of them for orchestra alone. Except for one movement wherein a tenor solo intones "*Schma Yisrael*," the vocal sections are entirely choral and employ passages from the Book of Isaiah, sung in French. They set forth the progress of prophetic thought from the God of wrath through the God of justice to the God of mercy and compassion. The music is distinguished for its richness, its depth of sonority, and its exquisite refinement; one has a feeling that it must have been pondered for many years and that it is a product of the most intense, sincere, and lofty conviction. A.F.

TCHAIKOVSKY: *Symphony No. 2, in C minor, Op. 17, ("Little Russian")*

Paris Conservatory Orchestra, Georg Solti, cond.

LONDON LL 1507. 12-in. \$3.98.

Philharmonia Orchestra of Hamburg, Arthur Winograd, cond.

M-G-M E 3433. 12-in. \$3.98 (with Mussorgsky: *Night on the Bare Mountain*).

Both of these performances are effective and each is, in its own way, well recorded.

The Solti edition has the richness of

sound produced by a rather reverberant hall, and it is the more exciting of the two, revealing a gift for the sweeping line and the powerfully built climax. Winograd, if somewhat more reserved, is in no way dull. He gives the fine, bold themes their due, and he has a feeling for detail. The M-G-M sound is much less resonant than that of the London disc, and its clean over-all effect and transparency may seem more desirable in the long run.

If bonuses are a factor, the M-G-M record offers as fine a performance of the Mussorgsky score as I've heard in a long time, recorded with notable skill and taste. R.C.M.

VERDI: *Otello*

Maria Carbone (s), Desdemona; Tamara Beltracchi (ms), Emilia; Nicola Fusati (t), Otello; Piero Girardi (t), Cassio; Nello Palai (t), Roderigo; Apollo Granforte (b), Iago; Enrico Spada (b), Montann and a Herald; Corrado Zambelli (bs), Lodovico. Chorus and Orchestra of La Scala (Milan), Carlo Sabajno, cond.

RCA CAMDEN CCL 101. Three 12-in. \$5.94.

Although it is not a long work, even in extra-Wagnerian measure, *Der Fliegende Holländer* is generally given as published, in three acts. At Bayreuth, though, it has always been given as Wagner conceived it — in one act of three episodes, a plan that involves no added material but makes desirable the cutting of a few repetitive orchestral bars.

From the 1955 tapings, London has organized a composite that in homogeneity of sound and sense of occasion is comparable to the earlier Bayreuth *Parsifal* — quite good enough technically to withstand some rustle-tussal punctuation by the audience; such a bad side-break as the one (hard to avoid) that unjoins Senta's Act I *scena* is more distracting.

The performing level is not that high — on the whole, reputable, but without overpoising distinctions to cancel some black deficiencies. Josef Keilberth's conducting shapes the elements into a performance that is careful, controlled — never superficial, but never deeply compelling, with an orchestral standard impalpably below festival ideals. The impact is solid, but not so sharp as that of the playing obtained by Ferenc Fricsay in the brilliantly studio-resonant Decca set, nor so vitally individual in delivery as that by Clemens Krauss in the Mercury — which, for all its coarse-grained sound, does have an important claim to attention in documenting, somehow, the tremendous *Holländer* of Hans Hotter, one of the few truly great operatic characterizations of our time.

Matched against this standard, Hermann Uhde is smaller-scale, with a voice comparatively lacking in mass and color (although much righter in character than the almost Italian brightness of Josef Merternich's, which all but disqualifies the Decca set). His readings are intelligent and to the purpose, sometimes quite moving; but the grand romantic arch is only faired in, not built solid.

If Senta is to seem what might be called ideally endurable, the role ought be sung by an evangelical sixteen-year-old with the voice of a Flagstad. Astrid Varnay is scarcely that, but her grasp of character is so intellectually complete, her singing so surely to the musical point, that not even the continual threat of tremolo can seriously prejudice the effectiveness of her performance. What a wonderful artist she is! In the Decca, Annaliese Kupper also has unsteadiness, in a voice not as fine in basic fiber, and a less ponderable artistic format; in the Mercury, Viorica Ursuleac is too far past it vocally to make her points convincingly. As Daland, Ludwig Weber sounds what he is: an artist of major importance, his voice fading and fraying but still sufficient for projection of a warm, direct characterization. The sum of his

The RCA Camden transfer to LP of HMV's twenty-five-year-old performance of *Otello* is an amazingly successful job in which too much electronic echo has been wisely avoided. It is remarkable how much of the orchestral detail comes through, how the voices attain a "presence" comparable, in a measure, to that of some recently recorded voices.

The performance was always interesting rather than definitive. Carlo Sabajno, house conductor for Italian HMV since the earliest days, takes Verdi's great score much too fast. Instances of this driving speed are felt during the love duet, the second-act maidens' chorus, Iago's telling of Cassio's dream, and Desdemona's "*Salce, salce*," which has an inexplicable cut of thirty-one bars. However, it is the only cut made by Sabajno. Whether this slice and the driving pace were due to an attempt at compressing the opera on a stated number of record sides or whether they were owing to the taste of the conductor will probably never be known, for Sabajno is no longer among the living. It will suffice to report that he beats Toscanini to the finish line by seven minutes (the cut considered); and, as everyone knows,

contribution is no greater than that of the late, short-lived Georg Hann (Mercury); both are on a different artistic plane than Josef Greindl (Decca), competent though he is.

Of all Wagner's tenor roles, Erik is the least rewarding — pages of compulsive exposition, with no ray of dramatic hope, written in a style that is sufficiently old-fashioned in its gingerbread decorations to give great trouble to most music-drama-oriented singers. In the London performance, Rudolf Lustig is no exception, alternately driving his voice to the limit and pressing it into a tight, palatal focus, as he tries to make it conform to some approximation of *legato* phrasings. Wolfgang Windgassen (Decca), who was the first-choice Bayreuth Erik in 1955, is rather better; Karl Ostertag (Mercury), with little positive in his favor, easily as good. By contrast, Josef Traxl's singing as the Steersman is one of the loveliest minor Wagnerian bits on records at all, his voice by far the loveliest in the cast. Elisabeth Schärtel is a good, convincing Mary, and the Bayreuth chorus is first-rate.

In sum of artistic and technical qualities, this is the most representative of the three recorded versions, likely to be decisively bettered only when someone makes a set with Mr. Hotter, a top-ranking conductor, and (if there is any such thing) a really good Erik.

JAMES HINTON, JR.

WAGNER: *Der Fliegende Holländer*

Astrid Varnay (s), Senta; Elisabeth Schärtel (ms), Mary; Rudolf Lustig (t), Erik; Josef Traxl (t), Steersman; Hermann Uhde (b), *Der Holländer*; Ludwig Weber (bs), Daland. Chorus and Orchestra of the Bayreuth Festival (1955), Josef Keilberth, cond.

LONDON XLI 42. Three 12-in. \$14.94.



GERMAN TOURIST INFORMATION OFFICE

Varnay: Senta is skillfully maladjusted.

the late Maestro was no idler when it came to keeping things moving.

While this *Otello* cannot compare with the Toscanini or London versions, it does boast one incomparable asset: the finest Iago on records — Apollo Granforte. Here flames a wonderful integration of speech and tone, a subtlety that the Messrs. Valdengo (RCA), Protti (London), and Manca Serra (Urania) do not achieve. Granforte's voice, with its spacious resonance and ease in *mezza voce* conveys the villainies of Iago in a compellingly vivid manner. And this was a voice that always recorded well.

The Otello of Nicola Fusati, a popular interpreter of the role during the Twenties and Thirties, is merely conventional. Fusati doesn't dwell on the climaxes and seems always glad to descend as soon as possible from these clarion heights. His Otello, however, is a thoroughly professional job. He is inferior to Vinay and Del Monaco, but on the whole better than Urania's Gino Sarri. Maria Carbone has a real Desdemona voice, but it is she who suffers most from the rushing of Sabajno. The lower third of her scale is a trifle weak, but the voice gains in brilliance as it ascends. The La Scala Chorus rates our respect; undoubtedly its performance would be even more effective if recorded under today's conditions. The orchestra is also on its toes, as it has to be at this pace, and the supporting cast is good, though there are better Cassios than Piero Girardi.

At the price, this is a tempting buy. Excellent and informative notes by James Hinton, Jr., are among the set's decided virtues. M. DE S.

WAGNER: *Wesendonck Lieder. Lohengrin: Elsas Traum. Parsifal: Ich sah' das Kind. Die Walküre: Der Männer Sippe; Du bist der Lenz*

Kirsten Flagstad, soprano; Vienna Philharmonic Orchestra, Hans Knappertsbusch, cond.

LONDON LL 1533. 12-in. \$3.98.

The really remarkable feature of this recording is Flagstad's voice at sixty-one. While it would be too much to call it as good as ever, it remains a unique instrument, to which its younger rivals hardly can be compared. Occasionally a high tone does not come off with the old freedom, and sometimes there is a sag when a tone has to be sustained, but at all times this is patently the voice we have long known and wondered at.

The five songs Wagner composed to Mathilde Wesendonck's texts were written for voice and piano; Wagner orchestrated only the last of them, *Träume*. Still, there is ample justification for such a performance as this in Felix Mottl's instrumentation. Since two of the set are labeled "studies for *Tristan und Isolde*" and share their themes with that work, it would seem a Tristanish orchestration is implied. As it happens, this is Flagstad's second recording of the cycle but her first with orchestra. One song from the set she made with Gerald Moore in England found its way as an odd side into the American issue of her *Tristan* narrative. This was the longest and most sustained of the set, *Im Treibhaus*. It may be that the difference

in tempo here is due to the fact that the older version was recorded to fit on a 78-rpm side; on the other hand, it is not impossible that the singer felt the song differently with the lighter, more intimate, background. In any case it is much slower and more weighted here. The whole cycle is done with great dignity, the words as well as the music being given full value.

Of the operatic selections only one was not previously represented in the Flagstad discography, and this one receives the most vital performance here, "*Der Männer Sippe*." For all the authority of her delivery, her Elsa was never her most convincing characterization; we have had more youthful performances of the "Dream." The *Parsifal* excerpt is on the ponderous side, due perhaps to the conductor's conception, and "*Du bist der Lenz*" could be more ecstatically sung. One can only regret that when she recorded these scenes before, with fresher voice, she was not often so well reproduced.

PHILIP L. MILLER

WOLF: *Mörke Lieder (8)*—See Schumann: *Liederkries, Op. 24*

More Briefly Noted

Mozart: Overtures. Vox 8720.

Ten overtures to Mozartean operas, performed by the Pro Musica Orchestra (Vienna) under Jonel Perlea, with respectable, if prosy, literalness of interpretation. Turn down the treble, and the wood winds will be admirably alive and the orchestral sound better than tolerable.

Perotinus: *Sederunt principes* (with Leoninus: *Judaea et Jerusalem*; Chansons and Motets of the Thirteenth Century). Archive ARC 3051.

The Pro Musica Antiqua, directed by Safford Cape, perform an organum quadruplum dating from about 1200. Sung here by four male voices, it is a fascinating work. The two-part organum of Leoninus is an interesting plain chant. Four anonymous motets and eight troubadour songs also are included.

Rossini: Overtures: *Guillaume Tell; La Gazza Ladra*. Westminster W-LAB 7050. *William Tell* is much better served by Toscanini than by Scherchen and the Philharmonic Symphony of London. In the *Thieving Magpie* the tempos never seem to be hit right, and Westminster's usually excellent engineering overstates the dynamic contrasts. Decidedly not a bargain for \$7.50.

Strauss, Johann: *Graduation Ball*, arr. Dorati (with Meyerbeer: *Les Paineurs*, arr. Lambert). Capitol P 8360.

A vigorous performance by the Ballet Theatre Orchestra, conducted by Joseph Levine, of a lively *Graduation Ball*, plus a Meyerbeer piece which makes admirable background music. Vivid recording.

Tchaikovsky: Symphony No. 1, in G minor ("*Winter Reveries*"); Concerto No. 1, in B flat minor, Op. 23 (with Rubinstein: Concerto No. 4, for Piano and Orchestra). Westminster XWN 18179.

The Bolshoi Symphony plays the Tchaikovsky First, and the Leningrad Philharmonic with Pavel Serebriankov at the piano offers the Concerto. The pianist is effective and the over-all performance good, in both works. In spite of the competence of the soloist, Grigory Ginsberg, the Rubinstein symphony as presented here is uninteresting. And the whole disc is definitely low-fidelity.

Vivaldi: Concerto for Viola d'Amore and Strings, in A, P. 233; Concerto in D minor, Op. 3, No. 11 (with Corelli: Concerto Grosso in D, Op. 6, No. 1 and Martini: Concerto for Piano and Strings, in F). Angel 35253.

The Musici, with Bruno Giuranna, viola d'amore, and Maria Teresa Garatti, piano, play here with vivacity and elegance two first-rate Vivaldi works. A most welcome disc, all in all, but turn the highs down for good violin sound.

RECITALS AND MISCELLANY

LICIA ALBANESE: *Puccini Arias*

Tosca: Vissi d'arte. Turandot: Signore, ascolta; Tu che di gel sei cinta. Le Villi: Se come voi piccina io fossi, o vaghi fior. La Rondine: Chi il bel sogno di Doretta; Ore dolci e divine. La Bohème: Musetta's Waltz; Mi chiamano Mimì. Manon Lescaut: In quelle trine morbide. Suor Angelica: Senza mamma. Mimbo tu sei morto. Madama Butterfly: Ancora un passo; Un bel di, vedremo; Death of Butterfly.

Licia Albanese, soprano; RCA Victor Orchestra, Jonel Perlea and Victor Trucco, conds.; Rome Opera House Orchestra, Vincenzo Bellezza and Jonel Perlea, conds. RCA VICTOR LM 2033. 12-in. \$3.98.

Licia Albanese's peculiar distinction as an interpreter of Puccini's music derives from the exquisite blending in her singing of delicacy and dramatic intensity. On this new disc the admired Italian soprano offers selections from many of the Puccini operas in which she has so successfully appeared in this country. Here is the familiar sweetness of tone and the complete absorption in the dramatic and musical demands of the roles.

This poetic awareness of the text is coupled with an almost reckless generosity in climaxes, and to some extent the Albanese temperament exceeds the singer's physical equipment. Because of this, she sometimes drives an essentially lyric voice, making it difficult for her to sing pianissimo in the upper register, and causing some of these normally brilliant upper tones to sag from pitch, as in the climax of Butterfly's Entrance Song and in one of the two welcome excerpts from *La Rondine*. Some listeners also may find excessive the sobs, gasps, and breathless exclamations employed to characterize tragic moments, but the complete sincerity of intention cannot be questioned.

There is interesting new material here.

Continued on page 76

HIGH FIDELITY MAGAZINE



It is indeed — breaking through the frequency response barrier to new dimensions of sound entertainment. Again Melgard, but this time so different in pattern and touch — displaying a new virtuosity on the exclusive Replica “King of Instruments,” the unit orchestra; everything from Glockenspiel to Wah-wah trumpet — a complete orchestral panoply and then some.....No. 518

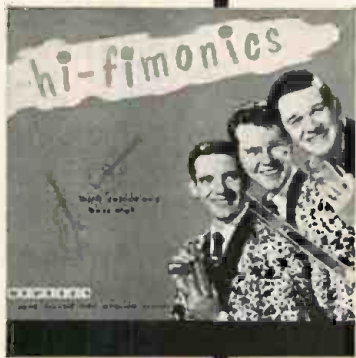

Hi-Fimonics

You'll never believe three harmonicas, guitar and bass could create such special sounds — a musical treat to delight the most fastidious audiophile.....No. 1001

sound perfection

brilliant tone color

infinite harmonic variety

ultra-modern miking techniques

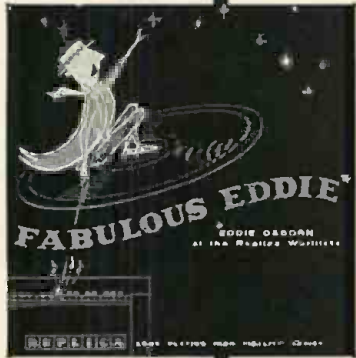

Fabulous Eddie (vol. 2)

A super-sonic organ romp by the hit performer of the '55-'56 Hi-Fi Show series — a re-birth of exciting organ music not heard since talking pictures.....No. 515

REPLICA RECORDS

your best buy in Hi-Fi...

at your dealers'...

or write to 7210 Westview Drive,

Des Plaines, Ill.



Musical Gadgets

A new adventure in old sounds — re-living four decades of musical history — perfect duplication of nostalgic coin-operated instrument sounds.....No. 1002

Paul Severson

Intricate modern arrangements beautifully interblended—an unbelievably perfect performance of progressive jazz.

No. 1003



An aria from the early opera *Le Villi*, with its suggestions of *Manon Lescaut*, which was to follow so closely, is especially provocative. This excerpt has never been recorded before; it stimulates a desire to hear this early work performed.

The two arias from *La Rondine* show what a delightful and authentic Magda this singer would make. (Would that RCA Victor's sense of artistic responsibility might provide a complete *Rondine*, starring Albanese. The only complete one is hardly acceptable.) Her portrayal of Liù displays an ideal voice for this romantic role. Beguiling also is her Musetta's Waltz, which she has never sung on the stage and to which she brings a sentiment that is almost always absent. The *Butterfly* excerpts, are from RCA's new highlights starring Albanese and Jan Peerce. They outdo anything the soprano has previously recorded from this opera and prove moving documents of artistic perception. All these selections are admirably recorded.

There are prima donnas with more sumptuous, with bigger voices than Licia Albanese's but not one of these ladies strikes at the very core of a Puccini role as does the soprano from Bari. M. DE S.

RICHARD DYER-BENNET: *Richard Dyer-Bennet Volume 2*

When Cocklesbells Turn Silverbells; Corn Rigs are Bonnie; The Garden Where the Prairies Grow; The Bailiff's Daughter of Islington; Two Maidens Went Milking; Who Killed Cock Robin?; Veillée de Noël; Jan Hinnerk; Woman Go Home!; Blow the Candles Out; Eggs and Marrowbone; The Beggar Man; The Turkish Revery.

Richard Dyer-Bennet, tenor, accompanying himself on the guitar.
DYER-BENNET 2. 12-in. \$4.98.

Richard Dyer-Bennet is America's finest singer of folk songs. This is not to say that he is a folk singer; in point of fact, he is not.

What Dyer-Bennet does is to take a folk song and transmute it—always with impeccable taste—into an art song. Some folklorists regard such a practice as inexcusable. Others, and I believe the majority, will agree that the artistic integrity of a Dyer-Bennet can impart new dimensions to a ballad. Among my own most vivid musical memories is an occasion in Los Angeles when I heard Dyer-Bennet sing *I Ride an Old Paint*. Although he was incongruously—almost ludicrously—clad in white tie and tails, he held the audience spellbound by what was obviously the most moving rendition of the song any of those present had ever heard.

For years Dyer-Bennet shuttled from one record company to another. All served him ill. Release after release was marred by dull repertory and lamentable engineering. Some time ago, in disgust, he reportedly swore off further recording. All of us can be grateful that this decision was amended a year ago with the release, under his own label, of a splendidly engineered example of his art.

We can now be equally grateful for the second such release. All the qualities that shape his pre-eminence are present in abundance: the purity and control of

his high, haunting tenor; the clarity of diction; the faultless musicianship.

The single mild demer one might register is a wish that *Jan Hinnerk* and *Woman Go Home!* had been sung in the original German rather than in translation.

This recording was taped in the living room of a certain editor whose initials are J.M.C., and the recording engineer—who acquits himself nobly—is HIGH FIDELITY's own J. Gordon Holt.

In summation, a superb release by a superb artist. Miss it at your peril. H.L.



Richard Dyer-Bennet, transmutationist.

GREGORIAN CHANT: *Solemn Intercessions and Adoration of the Cross from the Liturgy of Good Friday*

Choir of the Monks of Benedictine Abbey of St. Marrian (Beuron), Pater Dr. Maurus Pfaff, dir.

ARCHIVE ARC 3050. 12-in. \$5.98.

These are some of the chants that precede and follow the reading of the Passion in the liturgy of Good Friday. They begin with the responsory, *Tenebrae factae sunt*, and continue with the Solemn Intercessions, which are chanted by a single voice mostly on one tone but with the customary inflections at the beginning and end of each section. This is followed by the antiphon, *Ecce lignum crucis*, which is of special interest because it is sung three times, each time a tone higher. Also included are the Improperia, the first of which a choir singing in Greek is answered by another in Latin; the *Crux fidelis*, used as a refrain between the strophes of the hymn *Pange lingua*; and finally the antiphon *Crucem tuam*.

Father Pfaff's choir sings with its usual flexibility, and the reverberation that has sullied previous recordings of this group is not so pronounced here. It would have been helpful if the main divisions of this music had been marked off by bands. Archive supplies the complete texts with English translations. N.B.

DICK LEIBERT: *Leibert at Home*

Brahm: Limehouse Blues. Weill: Moritat, from The Three-Penny Opera. Leibert: Canary Caprice; Rosa Maria; The Mouse and the Pussy Cat; Jasmine; English Laven-

der; Waltz to a Princess. Auric: Theme from Moulin Rouge. Youmans: Halle-lujah. Spencer: Underneath the Stars. Rodgers: Lover.

Dick Leibert, organ.

WESTMINSTER WP 6029. 12-in. \$3.98.

Mr. Leibert at home is reduced to playing a Hammond instead of a Mighty Wurlitzer. The sound differs a little, but the wonderful style is still there. The organist has added some gadgets to his home instrument for special sound effects—to resemble a human whistler, a xylophone, etc.—and the electronic Hammond lends itself to highly rhythmic playing à la Ethel Smith. Outstanding is *Limehouse Blues*, all decked out in tricky, virtuosic accents and embellishments. In *Canary Caprice*, Mr. Leibert joins Brahms and Rachmaninoff, among others, in giving the famous A minor Caprice of Paganini a workout—the canary chirpings that go with it are said to be real. *The Mouse and the Pussy Cat* is based on another old friend, *In the Hall of the Mountain King*, from Grieg's *Peer Gynt* music. Leibert's nonadaptations are more conventional. Those in dance style are properly jaunty, those in sentimental mood properly schmalzy. R.E.

BOYD NEEL: *Light Music*

Sibelius: Romance in C, Op. 42. Grieg: Two Melodies, Op. 53. Ole Bull: Saeterjentens Sondag. Johann Agrell: Sinfonia in F. Arne: Air and Giga; Dances from Connus. Handel: Dream Music from Alcina; Overture to Faramondo.

Boyd Neel Orchestra, Boyd Neel, cond.
UNICORN UNLP 1038. 12-in. \$3.98.

"Light Music" can be a damning title. It implies the type of composition one might expect from a dinner concert or from one of those radio programs that offer "music to read by." It is particularly damning applied to the kind of works on this disc. Light in texture they may be; light in substance they certainly are not.

Side one of this collection is devoted to Scandinavian music, side two to music of English origin. The brooding Sibelius Romance is set forth with strong, clean lines and just the right degree of emotion. Of the two Grieg pieces, both transcriptions of earlier songs, I have a special personal attachment to the first, *Norsk*, with its gloriously melodic middle section. Here the conductor avoids an easy trap and presents the music without sentimentality. Only Ole Bull's *Saeterjentens Sondag* really belongs in the "light music" category.

The remainder of the music here is of eighteenth-century origin. Johann Agrell is a name new to me. Though he was born in Sweden and spent most of his musical life in Germany, his little three-movement Sinfonia has an almost Boccherinian quality. Coming between this and the Handel works, Thomas Arne's two compositions sound extremely simple and direct—even abrupt. By contrast, Handel's *Dream Music* emerges graceful and imaginative—vivid program music depicting pleasant and bad dreams. Hearing it reminds one of the need for an LP recording of an extensive suite of *Alcina*

Continued on page 78



WHAT? 3 OPERAS FOR TONIGHT?

Wagner's *Tristan* at Bayreuth! *Die Meistersinger* at Covent Garden! Weber's *Der Freischütz* at the Munich Opera House! Impossible? No, not quite. The magic of your phonograph can *in a single evening* bring you the vast enjoyment contained in these three operas. Tonight, at home, enjoy the *highlights* from these three operas, sung by Europe's greatest operatic stars, including Wolfgang Windgassen (the Met's new tenor), Rita Streich,

Annelies Kupper, Richard Holm, Kim Borg and many others—with superb orchestras and conductors of international importance—all in the new High Fidelity Decca Gold Label series, **Grand Opera Highlights**. Play any or all of these sparkling new albums...and Grand Opera in its most glorious tradition, is yours to enjoy... tonight!

GRAND OPERA HIGHLIGHTS... IN HIGH FIDELITY



Wagner: *Die Meistersinger* von Nürnberg; Highlights sung by Wolfgang Windgassen, Annelies Kupper, Richard Holm, Herta Töpper, Josef Herrmann. DL 9895



Carl Maria von Weber: *Der Freischütz*; Highlights sung by Anny Schlemm, Rita Streich, Wolfgang Windgassen, Hermann Uhde. DL 9896



Wagner: *Tristan und Isolde*; Highlights sung by Astrid Varnay, Margarete Klose, Wolfgang Windgassen, Kim Borg, Herta Töpper. DL 9897

Performances recorded in Europe by Deutsche Grammophon

DECCA  **RECORDS**
 ® GOLD LABEL... A NEW WORLD OF SOUND®

For your copy of the colorful new Decca catalog of popular and classical recordings, write Dept. HF, Decca Records, 50 W. 57th Street, New York 19, N. Y.



Boyd Neel: his artistry confirmed.

excerpts. The unfamiliar overture to one of Handel's last operas, *Faramondo*, with its grandly broad introduction, splendid fugue, and affecting air, is marked by exceptional virility.

Although there is no indication on the jacket or label, the performing group appears to be a Canadian edition of the Boyd Neel Orchestra. It matches in every way the cohesion, polish, and sonority of its older English counterpart, thereby attesting to the artistic stature of its founder-director. P.A.

DAVID OISTRAKH: *The Violinist-Composer*

Ysaÿe: *Elegiac Poem*, Op. 12. Wieniawski: *Etude in E*, Op. 18, No. 5; *Legende*, Op. 17. Sarasate: *Zortzico* (Spanish Dance). Kreisler: *La Gitana*. Vieuxtemps: *Two Romances*, Op. 7, Nos. 2 and 3. Paganini: *Variations on the G String* (on the *Prayer* from Rossini's *Mosé in Egitto*).

David Oistrakh, violin; Vladimir Yam-polsky, piano.
DECCA DL 9882. 12-in. \$3.98.

George Bernard Shaw once differentiated between those composers who wrote music for the violin and of the violin. The eight pieces in this collection belong to the latter category. Though every one of these violinist-composers created virtuoso music, there is none of it here; the accent is on the violin's tonal characteristics.

Oistrakh gets beneath the surface of this music and interprets it with greater understanding and intensity of feeling than he has done with many larger, more complex works. His double-stopping throughout the brilliant Wieniawski *Etude* and his octave passages in the Ysaÿe *Elegiac Poem* emerge with sparkling precision. Elsewhere he exploits with his suavest whipped-cream tone the rich romantic outpourings that characterize most of these miniatures. Especially is this true of the lyrical parts of the *Elegiac Poem*, the two Vieuxtemps *Romances*, and the Rossini-Paganini *Moses* fantasy, his performance of the latter being one of the most sonorous performances on the violin's lowest string that I have ever encountered.

As Soviet-made recordings go, this one passes muster very well; no rasp, no fog. If the piano has been relegated to the background, it is because, in this instance, it belongs there. P.A.

FELIX SLATKIN: *España*

Ravel: *Boléro*; *Alborada del Gracioso*. Rimsky-Korsakov: *Capriccio espagnol*, Op.

34. Albéniz (arr. Arbós): *Triana* (from *Iberia*).

Hollywood Bowl Symphony Orchestra, Felix Slatkin, cond.
CAPITOL P 8375. 12-in. \$3.98.

There are lots of *Boléros* in the catalogue, but no more than a couple that can rival this one. For one thing it respects the clearly expressed wishes of the composer in preserving correct tempos. Second, it is sympathetically played by a fine orchestra with first-desk men up to the solos and a percussionist who can stand the long haul. Third, the bright and spacious recording is first class.

In spite of occasional reverberation and orchestral voices seemingly misplaced, a set of fine performances. R.C.M.

SPOTLIGHT ON BRASS

Roger Voisin, Harold Meek, and Joseph Orsz.
VOX DL 300. 12-in. \$6.95.

According to R. D. Darrell's very readable accompanying booklet, this record of excerpts demonstrating twenty-six brass instruments is intended less for musical pleasure than for study. Certainly it provides a fine set of illustrations for any student of orchestration; and perhaps more important, it allows the ordinary listener to learn how to spot various members of the brass family by ear.

There are, of course, more brass instruments than are represented here, and perhaps longer selections from fewer instruments would have been desirable. Direct comparison between the sound of the instruments as they were known originally and as they are familiar to us today also would have been especially helpful. A choice had to be made, however, and so we have an African elephant horn sonorously blasted by a self-effacing virtuoso, a coach horn, and a medieval trumpeter among other interesting examples of obsolete brasses. Best of the historical material is the difficult solo from the Nocturne of Mendelssohn's *Midsummer Night's Dream Music* as it sounded on a natural (i.e. valveless) horn. (I'll take the modern one, thanks!) On the other hand, we aren't given a chance to hear the big F trumpet which composers from Beethoven through Franck regarded as standard. A terror to keep in balance in the ensemble, it produced tones which the smaller contemporary instruments demonstrated here cannot match in power and color.

The performances are marred enough to be really realistic. If an instrument has difficult or unreliable intonation, one senses it in the playing. If some of the notes in its scale are "bad," one hears their defects. This is all to the good. The recording, billed as "ultra high fidelity," conveys a remarkable feeling of the great resonant spaces of Symphony Hall, Boston. All in all, a useful disc, and a pleasant one, evoking renewed appreciation of this "Spotlight" series by Vox. R.C.M.

SPOTLIGHT ON KEYBOARD

Bruce Simmonds, Claire Coci, Martin Hoherman, Harold Thompson.
VOX DL 362. Two 12-in. \$12.95.

Anyone who has had any questions about

differences in sound among harpsichords, virginals, spinets, clavichords, and pianos of various periods will find most of them answered here. From the Belle Skinner collection of instruments in Holyoke, Massachusetts, are recorded two kinds each of virginals, spinet, and clavichord, five makes of harpsichord, and four sorts of piano. Each is heard as Bruce Simmonds plays on it a short composition of its own period. Every now and then a piece played on an old instrument is repeated on a modern piano to dramatize the contrast. There are also four types of organ — Italian Renaissance, reconstructed baroque, modern studio, and the gigantic instrument at West Point. And finally there is a miscellaneous group of instruments, some of which are apparently included here because they do not fit any better in the other albums of the "Spotlight" series. This group comprises the monochord (with keyboard), the hurdy-gurdy, the barrel-organ, the music box, the glaschord, the accordion, the celesta, and the zanza — the last a little bamboo affair from Africa which has all the sensuous appeal of a plucked rubber band.

The claviers on these discs — and it is unusual for a collection of old instruments to have so many that are in playable condition — seem to be in excellent shape, except for the Peres harpsichord, which to me sounded out of condition. A harpsichord by Andreas Ruckers and a Hoffman clavichord sounded particularly fine. It is too bad that the pianos do not include one of the Mozart period. Among the odds and ends, the monochord, hurdy-gurdy, and glaschord are out-of-tune curiosities, but the Hohner accordion and the Mustel celesta sounded splendid.

Indispensable to the proper use of these discs are the lively and informative notes by R. D. Darrell about both instruments and music. The recording itself is first-rate throughout; the instruments of the harpsichord family were purposely recorded louder than life and must therefore be played back with less volume than usual. Included in the album are two paper strips which quickly and easily locate any desired instrument on the disc. N.B.

ETTEL SUSSMAN: *French Operatic Airs from Lully to Rameau*

Desmarests: *Circé: Air de Circé*. Marin Marais: *Alcyone: Air d'Alcyone*. Des-touches: *Callirhoë: Monologue de Callir-boë*. Lully: *Amadis: Air d'Arcabonne*. Lully: *Armide: Air d'Armide*. Campra: *Alcine: Air de Ménélie*. Campra: *Les Ages: Air de Florise*. Campra: *Hésione: Air d'Hésione*. Colasse: *Enee at Lavinie: Prologue (La Félicité)*. Da la Guerre: *Céphale et Procris: Air de Procris*. Mouret: *Les Fêtes de Thalie: Air d'Isabelle*.

Ettel Sussman, soprano; Jean-Pierre Rampal, flute; Roger Albin, cello; Robert Veyron-Lacroix, harpsichord; L'Ensemble Orchestral de l'Oiseau-Lyre, Louis de Froment, cond.
OISEAU-LYRE OL 50117. 12-in. \$4.98.

Eleven arias from operas written during the period stretching elastically between the death of Lully and the first successes

Continued on page 80

FOLK MUSIC

by Howard LaFay

BELA BABAI: *Haunting Hungarian Melodies*

Bela Babai, violinist, and his gypsy orchestra.

PERIOD RL 1914. 12-in. \$4.98.

Abetted by velvety sound, Bela Babai's supple fiddle wrings every drop of Danubian emotion out of the tuneful and un-hackneyed melodies he has chosen. Babai commands all the technical glitter associated with gypsy violinists, but beneath the pyrotechnics is a faithful mirror of the music's mercurial moods—now wildly joyous, now steeped in gloom.

There is a peculiar nostalgia to the songs, evoking as they do a Hungary that—even though it existed best in the romantic imagination—can never be recreated.

BRITISH BALLADS

Vol. I - IV; *The English and Scottish Popular Ballads* ("The Child Collection")
Vol. V; *Great British Ballads Not Included in the Child Collection*

A. L. Lloyd, tenor; Ewan MacColl, baritone.

RIVERSIDE RLP 12-621/12-628. Vol. I - IV, Eight 12-in. \$9.96.

RIVERSIDE RLP 12-629. Vol. V, One 12-in. \$4.98.

Our present knowledge of folk ballads probably owes most to Francis James Child, a Harvard professor who, after years of study of original manuscripts in England and on the Continent, published, between 1882 and 1898, *The English and Scottish Popular Ballads*. Under the direction of Kenneth S. Goldstein, Riverside Records has collated some seventy-two of the better-known Child ballads (Child's total came to 305) in a set comprising four albums of two records each, along with a supplementary disc containing ten *Great British Ballads Not Included in the Child Collection*.

To support the avowed aim of making this material available primarily for educational purposes, the ballads are sung without instrumental accompaniment of any kind. It is a tribute to the high skill of the vocalists that even the skeptical listener soon accepts the lack of accompaniment; to the folklorist, of course, it is practically a prerequisite for authenticity. Monotony is avoided to some extent by an assiduous attempt to alternate the singers whenever possible. A degree of monotony is, however, inherent in such a collection; the wise listener will govern himself accordingly.

Ewan MacColl's handling of the Scottish ballads is admirable. His virile, craggy voice wears well; and his mastery of the tortuous Scots dialect endows the ballads with a realism that makes the versions of other, non-Scottish singers pallid by comparison. Once or twice, however, MacColl completely fails to establish the dominant mood of a particular song. He makes the

tragic *Lord Randal*, for example, sound almost exuberant.

The Englishman A. L. Lloyd has a less robust voice, and it is this relative lightness that makes his efforts, over the long pull, somewhat less impressive than his colleague's. Further, while both singers are no strangers to the fluffed note, Lloyd has a pronounced wobble as well.

Mr. Goldstein, who also supplies very informative notes along with the texts, has exercised commendable discretion in his selections. Virtually every one of the truly major works is included, and his omissions on the whole may be readily defended. It is, however, ironic that Child's own favorite ballad, *Childe Waters*, is omitted.

While there is some tape hiss and various forms of echo, the engineering is generally of a superior quality. On the whole, Riverside has well served both Child and Anglo-American culture.

BEN LUCIEN BURMAN: *Steamboat 'Round the Bend*

Songs and Stories of the Mississippi told by Ben Lucien Burman, accompanied by Eddie Manson, harmonica.

FOLKWAYS FP 74. 12-in. \$5.95.

Ben Lucien Burman, author of several books on the Mississippi, is certainly a more accomplished writer than a recitationist, but his gentle, nostalgic recounting of tales from the winding river—interspersed with ballads sung in a wobbly but pleasing voice—weaves a kind of charm all its own.

The tales and ballads are all purest Americana and Eddie Manson underlines them with a beautifully evocative harmonica accompaniment. Good sound, but Mr. Burman tends to crowd the mike when his stories develop excitement. Leisurely, off-beat, and thoroughly entertaining.

New Spring Releases from Unicorn . . . all with Full Money-Back Guarantee!

If you don't agree Unicorn records have the finest high fidelity sound available, just return with sales slip and get your money back!

MUSIC AT MIT SERIES

UNLP 1036 — Joseph Haydn Piano Sonatas. Ernst Levy, pianist. Recorded at Kresge Auditorium. M.I.T. Sonatas #51 (D Major), #32 (B Minor), #50 (C Major), #46 (A Flat Major).

BOYO NEEL SERIES

UNLP 1042 — Boyd Neel Conducts Mozart. The Boyd Neel Orchestra, Ltd. Eine Kleine Nachtmusik, K.525; Serenata Notturna, K.239; Divertimento No. 11, K.251.

UNLP 1044 — Boyd Neel Conducts Vaughan Williams. Dvorak. The Boyd Neel Orchestra, Ltd. Ralph Vaughan Williams: Fantasia on "Greensleeves", Fantasia on a Theme by Thomas Tallis. Antonin Dvorak: Serenade in E Major for String Orchestra, Op.22.

BERKSHIRE SERIES

UNLP 1028 — Bach — Hindemith — Dutilleul. J. S. Bach: Sonata in G Minor for Oboe and Harpsichord. Paul Hindemith: Sonata for English Horn and Piano. Henri Dutilleul: Sonata for Oboe and Piano. The Berkshire Woodwind Ensemble. Louis Speyer, director.

OTHER OUTSTANDING RELEASES

UNLP 1039 — Lukas Foss Conducts Bach. Brandenburg Concerto No. 5, Concerto for Piano in D Minor. Lukas Foss, piano with the Zimmler Sinfonietta.

UNLP 1045 — Music of Henry Cowell. Symphony No. 10. Hymn and Fuguing Tune No. 2 and 5. Ballad. Fiddler's Jig. Vienna Orchestral Society. F. Charles Adler, conducting.

You'll spot these new Unicorn Records in their outstanding "Woodland Portrait" jackets wherever fine records are sold.

All \$3.98 — All Recorded or Mastered by Peter Bartók!

2 NEW EXCITING SAMPLER RECORDS

MUSIC AT MIT SAMPLER

Complete Recording of the Beethoven Sonata #30 (Op. 109) with Ernst Levy, pianist. PLUS Selections from The Modern Age Of Brass and Handel Organ Concertos. Recorded at Kresge Auditorium and the new M.I.T. Chapel. Engineered by Peter Bartók. The records that have won rave reviews from all the leading critics.

12" L.P. UNSR-1 \$1.98

UNICORN SAMPLER

Samplings from thirteen composers represented in the Unicorn Catalog. Including Bartók, Ives, Stravinsky, Cowell, Handel, Vivaldi, Schubert, Palestrina.

12" L.P. UNSR-2 \$1.98

The Hi Fi Record to end them all!

THE AUTOMOBILE

The Sounds of 50 Years

Authentic Hi Fi Recording of the Stutz, Simplex, Stanley Steamer and dozens of other antique and sports cars both old and new. Colorful Picture-Album with print suitable for framing. Illustrated brochure with color photos of 12 antique and sports cars. A must for both Automobile and Hi-Fi Fans.

UDS-1 \$5.95

UNICORN

75 STATE STREET, BOSTON, MASS.



CONCORD RELEASE NO. 4

"THEY ALL DIE IN THIS ONE"

Famous operatic death scenes in a wonderful and unique collection! Cover by (who else?) Charles Addams. Sung with members of the Metropolitan Opera Association.

1. PONCHIELLI: Gioconda: Finale
2. REFICE: Cecelia: Morta
3. DONIZETTI: Lucia: Tu che a Dio
4. VERDI: Otello: Nium mi tema
5. PUCCINI: Butterfly: Tu, tu piccolo Iddio!
6. VERDI: Aida: O terra addio
7. BIZET: Carmen: C'est toi
8. VERDI: Rigoletto: Lassu in ciel

Albert DeCosta, Sandra Warfield, James McCracken, Frank Valentino, Valeria Ruggeri, Brenda Lewis, Mariquita Moll, Bruno Landi, Maria Leone, Franco Mieli, Adriana Ferrari. Concord Philharmonia conducted by Hans-Jurgen Walther.

Concord 3010—Long Play 12" Recording—\$3.98

BRAHMS: Hungarian Dances (Complete)

Wild as the wind . . . stirring as a gypsy's violin! All of the beautiful dances that first made Brahms famous . . . complete on one record. Victor Alessandri conducting the Oklahoma City Symphony Orchestra.

Concord 3011—Long Play 12" Recording—\$3.98

"TENOR SAX"

One of the most luscious, exciting records in the Jazz Idiom ever released! A "must" for every collector . . . created by six of the greatest tenor sax players of all time.

DON BYAS: September Song — They Say It's Wonderful

STAN GETZ: Don't Worry About Me — And The Angels Sing

COLEMAN HAWKINS: Old Man River — Wrap Your Troubles In Dreams

TED NASH: Over The Rainbow — Annie Laurie

CHARLIE VENTURA: Dark Eyes — Big Deal

BEN WEBSTER: Body and Soul — Honeysuckle Rose

Concord 3012—Long Play 12" Recording—\$3.98

"THE SPANISH HARPSICHORD"

Fernando Valenti plays a delightful program of music by Spanish classical composers.

- SOLER: Sonata in D Flat Major
Sonata in f sharp minor
Sonata in c minor
Sonata in D Flat Major
Sonata in F Sharp Major

GALLES: Sonata in f minor

ANGLES: Adagietto

RODRIGUEZ: Rondo in B Flat

FREIXANET: Sonata in A Major

ALBENIZ: Sonata in D Major

Fernando Valenti, harpsichord.

Concord 4004—Long Play 12" Recording—\$4.98

CONCORD RECORDS

... "The Sound Heard 'Round the World!"® Every CONCORD Record is wrapped three ways to protect it from dirt, dust and fingerprints . . . first in a polyethylene sleeve, second in an album container, third in an hermetically sealed plastic outer wrapper.

At your dealer or write:



CONCORD RECORD CORPORATION

Bureau 8, 519 S. Fifth Ave.,
Mt. Vernon, N. Y.

MURRAY LEHRER: *Freilach in Hi-Fi*, Vol. 2

Murray Lehrer and his ensemble.
PERIOD RL 1916. 12-in. \$4.98.

A rollicking, contagious type of dance music brought to perfection in the rented-hall wedding receptions of New York's lower East Side. In their second successful bout with the *genre*—at least on discs—Lehrer's forces burst with capability and enthusiasm. Sparkling engineering more than justifies the "Hi-Fi" of the title.

LOS GITANILLOS DE BRONCE: *Flamenco*

Los Gitanillos de Bronce, flamenco troupe.
MONTILLA FM 87. 12-in. \$4.98.

LOS BOCHEROS: *Folk Music From Spain*

Los Bocheros, vocal and instrumental quintet.

MONTILLA FM 86. 12-in. \$4.98.

Two more entries in the burgeoning recorded body of Spanish music. *Los Gitanillos* are a dynamic and talented quartet of flamenco singers and dancers, for whom one Aparicio provides a very capable contrapuntal guitar accompaniment. Very well engineered, the disc fits somewhere in the upper echelon of flamenco offerings. The uninitiated in particular should find the presentation rewarding, since *Los Gitanillos* have thoughtfully shaped a cross section of the idiom. Daniel Montorio rounds out the record by conducting an orchestra in a workmanlike *pasodoble* and *jota*.

Los Bocheros offer a different aspect of Spain; a five man choral and instrumental group, specializing in polished arrangements of regional ballads. On the whole, this is the kind of performance one is likely to hear in the better-kept cafés of provincial cities. Smooth performance and well recorded.

CLARA PETRAGLIA: *Songs From Brazil*

Clara Petraglia, soprano, accompanying herself on the guitar.

WESTMINSTER WP 6030. 12-in. \$3.98.

Bright, intimate sound frames Clara Petraglia's recital of a wide variety of Brazilian folk airs. In coloration, Miss Petraglia's voice bears a marked similarity to that of Susan Reed. Also like Miss Reed, the Brazilian is a consummate artist.

This disc, in fact, very probably represents the best collection of Brazilian folk song now in the catalogue. Thus, it is doubly regrettable that Westminster did not see fit to provide a single descriptive word on any of the songs. In short, first-rate singing, but you'll have to learn Portuguese if you want to know what it's about.

RIVERSIDE FOLK SONG SAMPLER

RIVERSIDE S-2. 12-in. \$1.98.

In making twenty top-flight selections from its catalogue available in this special bargain disc, Riverside provides an ideal opportunity to anyone who would like to: (1) sample the Riverside line; (2) provide himself with a compact, wide-ranging

anthology of folk ballads in English. The sound, like the content, is first-rate.

TORAIA ORCHESTRA OF ALGIERS: *Music of the Arab People*

Toraia Orchestra of Algiers with soloists.
ESOTERIC ES-547. 12-in. \$4.98.

Crystalline sound and vivid performances are the hallmark of this recording of the exotic polyrhythmic music of North Africa. The songs are presented in what seem to be café versions; in any case they are a sophisticated step removed from their Bedouin origins. It is this very polish, however, that makes them more readily acceptable to the casual western ear. The Ensemble's star dancing girl-vocalist, Anissa Toraia, has a smoldering, sensuous voice that makes short work of language barriers. One can find oneself speculating on whether Miss Toraia's physical charms equal her vocal vitality. . . .

Other Folk Music

Pete Seeger and his banjo breathe life into some twenty-five ballads connected with the American labor movement on Folkways FH 5251, titled *American Industrial Ballads*. The songs are not without interest, but generally they are of more sociological than musical import. The melancholy truth seems to be that American unionists, unlike their European counterparts, have failed to produce much of value in the way of working-class balladry.

Patrick O'Hagan, a gifted tenor, is beset by a grotesque organ accompaniment in an excellent collection of Irish songs on *Dear Little Shamrock* (London, LL 1524). While O'Hagan makes a valiant effort, no vocalist alive could surmount so ponderous a backdrop for such light-textured songs.

Folkways also offers an addition to the list of recordings of Israeli popular music. *Israel Dances* (FW 935) is the title of this ten-inch disc, and it features the Tzabar Group, singers and dancers from Israel now studying in the United States. Dov Seltzer directs them in authentic performances that are sometimes more excited than exciting.

In *Viennese Bonbons*, Vol. 2, Anton Karas of *Third Man* fame strums his zither in a breath-takingly hi-fi performance for Period (SPL 1918). Viennese songs of the Strauss-Lehar school form the bulk of his program and Karas skillfully milks them for every ounce of *gemütlichkeit*.

THE BEST OF JAZZ

by John S. Wilson

BROOKMEYER-SIMS QUINTET: *Whoeeee*

The King; Lullaby of the Leaves; I Can't Get Started with You; Snake Eyes; Morning Fun; Whoeeee; Someone to Watch Over Me; My Old Flame; Box Cars.

Bob Brookmeyer, valve trombone; Zoot Sims, tenor saxophone; Hank Jones, piano; Bill Crow, bass; Jo Jones, drums.
STORYVILLE 914. 12-in. 37 min. \$3.98.

On paper, this lines up as one of the

1 BRUTE FORCE STEELBANDS—The record which started a national trend. The 3 top bands of Antigua: mambos, sambas, rumbas, calypsos—& B.W.I. crickets. #1042 \$4.98



2 DANCE CALYPSO!—The real calypso. Recorded on-the-scene in Trinidad and Antigua. Undiluted. Terrific beat. #1180 \$4.98

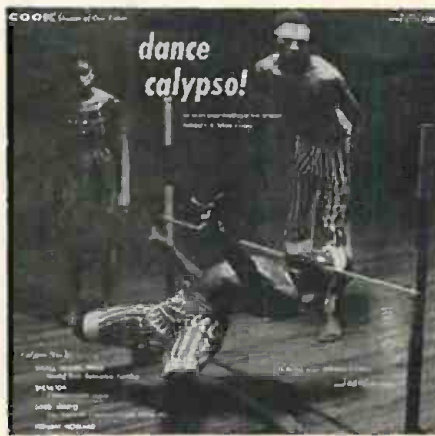

3 MUSIC TO AWAKEN THE BALLROOM BEAST—An on-the-scene recording of the mighty Brute Force Steelband playing calypsos, meringues, sambas, tangos, and pops #1048 \$4.98



LOOK what's Cookin'

4 THE CHROMATIC SCALE TEST RECORD—Only one using musical pitches instead of abstract frequencies. Tests entire range by ear alone. Only one using Fletcher-Munson curve. Series 60 \$4.98

THE SEVEN LAST WORDS (Dubois)—E. Reginald Foort, F.R.C.O. organist; Boston Chorale & soloists conducted by Willis Page. "Grandeur of Sound." *Sat. Rev.* #1094 \$4.98



6 MUSIC BOXES, CAROUSELS, & OLD HAND ORGAN—A fairyland fantasy of gay, nostalgic, and often lovely sounds of other times. #10120 \$4.98

THE COMPLEAT IN FIDELITYE—7 The ultimate high fidelity demonstration record: jets, trains, babies—something to frighten everyone #1044 \$4.98

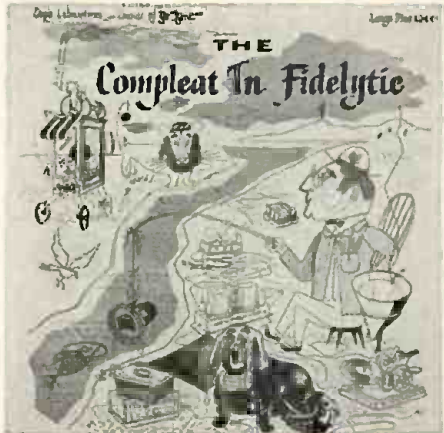

All records 12" LP \$4.98

At your dealer NOW
or direct from COOK



8 CAFE CONTINENTAL—Zither solos by Ruth Welcome. Dick Marta on the Hungarian cimbalon. Schrammelmusik by a Viennese quartet. Unique and incomparable. #10326 \$4.98

Cook Laboratories, Inc.
101 Second Street, Stamford, Conn.

Please send postpaid the items checked below. I enclose payment of \$4.98 for each selection.

1 2 3 4 5 6
7 8 9

Name _____

Address _____

City _____ State _____

COOK



9 INTERMISSION AT THE MOSQUE—Reginald Foort & gigantic Wurlitzer in the Mosque. Old chestnuts and bouncing balls... in overwhelming fidelity. #1059X \$4.98

of Rameau cannot escape monotony of effect if played in unbroken succession, but this record is a "must" for anyone fascinated by seventeenth- and eighteenth-century French opera. The informative notes tell us that "the record illustrates the attempt of younger composers to throw off" the all-pervading influence of the great Lully. This is not altogether easy to detect. Truth to tell, the two Lully arias, placed in the middle of the collection, sound "all of a piece" with what comes before and what goes afterwards. It is possible that a specialist in this music would find interesting differences; the layman will not.

The arias are sung with style but stridency, and with a lack of tonal variety, by Ertel Sussman, presumably a young French soprano. Mlle. Sussman knows what this music is all about, but her delivery is apt to be vehement, and her text overpronounced, as in the opening *Air de Circé* by Desmaret. Mlle. Sussman's smoothest work is found in the beautiful air from Campra's *Hésione*, which she sings well indeed.

An ensemble, featuring flute, cello, and harp, under Louis de Froment, supports the singer. Balance and reproduction are excellent. Recommended for students of operatic style, and for those who have a healthy curiosity. M. DE S.

More Briefly Noted

Devy Erlih: Violin Recital. London DTL 93106.

Violin works by Kreisler, Albéniz, and Falla smoothly performed. Also an admirable performance of the Ravel Sonata for Violin and Piano, with a less even rendition of the same composer's *Tzigane*.

Jean-Pierre Rampal: Baroque Flute Sonatas. Oiseau-Lyre OL 50120.

Nicely played and well-recorded flute sonatas by Locatelli, Tessarini, Marcello, and Bononcini—works quite typical of those any self-respecting eighteenth-century composer felt obligated to turn out.

The Renaissance Chorus. Esoteric ES 546.

The Renaissance Chorus seems to be a group of singers from the High School of Music and Art in New York City, and they acquit themselves admirably in a number of religious pieces, including Isaac's setting for the Proper of the Mass and a chromatic motet by Hassler. The interpretations of the director, Harold Brown, are open to question, but the sound of the chorus has been reproduced with clarity and transparency.

THE SPOKEN WORD

WALTER DE LA MARE: *A Conversation; 12 Poems; A Story, "The Princess"*

Walter de la Mare speaking and reading. CAEDMON TC 1046. 12-in. \$5.95.

I dreamed one day as the gray clouds gathered that I wandered over a rolling

green moor, and as I walked over the largest hillock I came upon a fairly large house. How many years it had nestled in that grove of trees I cannot say, but I suspect it had seen the best of the Jacobean era. Tired and in want of a glass of water, I came to the front door to be greeted by a spritely old man. "Come in," he invited me. "Do join us in a cup of tea." I went in and after tea had been poured, he said, "I hope that you will not mind if we continue with our work. You see the contemporary world has crept into our countryside, and this young man is recording, for eternity I suppose, the sounds that I make. I have just finished telling him about the trees around our house and about how many of them have been struck down by lightning; and now I shall read a story—*The Princess*." With that he settled back into the wings of his chair, nodded to the young man standing behind the dark Victorian sofa, and started. Into a land of fantasy mingled with reality we went as this gentle old man with a tired but cultivated voice read his story. When all was done and the tape was played back, I could only marvel at the exactness and clarity with which the sound of the human voice could be reproduced—and only sigh with regret that this man had not been recorded in his younger days when his voice was not tired and when there must have been a lilt to his speech as he read *The Veil*.

Then suddenly I realized that evening was gilding the moor, and I arose and took my leave. As I walked out into the evening I felt both elated and sad: 'Twas a rare privilege to hear such a man read his own works—a bit of another era and way of life re-created—and, I reflected, when this record appeared it would have the ring of authenticity. The poems would be heard as the author intended they should—the story would be repeated with all its subtle, imaginative nuances—a record to curl up with on a winter's afternoon before the fire. . . . and yet . . . why could this not have been made ten years before? The recording would not have been so perfect but the voice would have had clarity, resilience, and force—ah, well, we are lucky to have *this* I thought, as I walked up the steps to my own front door.

MIRIAM D. MANNING

J. FRANK DOBIE: *Stories of the Southwest*

Big-foot Wallace and the Hickory Nuts; the "Mezcla" Man; Sancho—the Long-borned Steer; Bears Are Intelligent People.

Read by J. Frank Dobie.

SPOKEN ARTS 722. 12-in. \$4.98.

Some people have what Mark Twain called a "constructive memory"—an irresistible talent for elaborating on a story. "Stretching the blanket," J. Frank Dobie calls it, a skill at which Dobie himself is no tenderfoot. Dobie's blankets usually are stretched out far enough to cover his whole state of Texas.

These four stories are an excellent introduction to Dobie and his famous stories of the Southwest. Although Dobie is a professor at Southwestern University, twenty-one years the editor of publications

for the Texas Folklore Society, and the author of twelve books on the Southwest, in telling these yarns, he sounds more like a Texas cowhand sitting around a Chisholm Trail campfire.

They are all tales for telling and not for reading, hence a perfect selection for Westminster's Spoken Arts series. However, they are a very special dish; and if you are the type who gets a little chilly around a fire, can't stand chigger bites, and tends to get a little disturbed about the sounds out there in the darkness—then you probably won't enjoy this record.

R.H.H.,JR.

EDGAR ALLEN POE: *Tales of Terror*

The Pit and the Pendulum; A Cask of Amontillado; The Fall of the House of Usher; The Tell-Tale Heart; The Masque of Red Death; The Strange Case of M. Valdemar.

Read by Nelson Olmsted.

VANGUARD VRS 9007. 12-in. \$4.98.

"SLEEP NO MORE": *Famous Ghost and Horror Stories*

Charles Dickens, *The Signal Man*; R. L. Stevenson, *Markheim*; Théophile Gautier, *The Mummy's Foot*; Ambrose Bierce, *An Occurrence at Owl Creek Bridge*; R. L. Stevenson, *The Body Snatchers*; Fitz-James O'Brien, *What Was It?*

Read by Nelson Olmsted.

VANGUARD VRS 9008. 12-in. \$4.98.

For those of you who prefer the traditional form of the horror story—that is, those of you whose spines are not all tingled out after reading the everyday horror stories of the atomic age in the evening newspapers—these records are highly recommended.

Nelson Olmsted is well known to devotees of radio and television dramas, particularly to followers of the *Big Show*, in which Olmsted played both the reporter and the menace, night after night, with equal skill. His voice has just the proper timbre and dignity for the characteristically formal language of Poe's traditional horror story, and his readings here are superb. In addition, the Vanguard engineers have created and reproduced the most chilling sound effects I have heard on a dramatic recording. The echoes of the Pit, the loathesome sound of the hungry rats, and the whirring swish of the approaching blade in the *Pit and the Pendulum* are still lurking uncomfortably in my mind.

The other anthology, a collection of classic stories, is equally spine chilling. One story in particular, *What Was It?* by Fitz-James O'Brien, deserves special comment. It is the story, set in New York City, of a man who is taking a nap one evening when suddenly something drops from the ceiling over his bed and attacks him. Only after a fierce struggle and with the help of friends who hear the commotion and come to his aid, does he overcome his attacker. When they turn on the lights, they find that the thing they have subdued and bound with a rope is nothing.

What was it? Don't ask me! I didn't stick around to find out! R.H.H.,JR.

Continued on page 82



MORTON GOULD IN HI FI

on **RCA VICTOR RECORDS** only **\$3.98** for each Long Play. On 45 EP's at New Low Prices*

Morton Gould has a unique facility for converting the ordinary to the unusual. And RCA Victor's special recording techniques add an extra dimension to high fidelity sound. The combination of the two has resulted in startling recorded performances that range from Rhapsody in Blue to Scheherazade. If you own *any* of Gould's RCA Victor albums, you know precisely what we mean when we say Gould is tops in hi-fi!

If you have yet to buy your first RCA Victor album by Morton Gould — make it his newest: "Brass and Percussion" — music by Sousa,

Goldman and Gould. You've never heard such clarity in brass ensemble tone, such jaunty brilliance in the woodwinds, and such definition and color in the sound of the tympani and the other percussion instruments.

- *1-RECORD ALBUM \$1.29
- 2-RECORD ALBUM \$2.49
- 3-RECORD ALBUM \$2.98

Nationally Advertised Prices



Leader in the High-Fidelity Record Field!
AUDIO FIDELITY

Guaranteed total frequency range recordings . . . the outstanding choice of Hi-Fi enthusiasts and manufacturers, alike!



THE DUKES OF DIXIELAND—The most exciting performance of authentic Dixieland ever recorded! . . . You Have to Hear It To Believe It! AFLP 1823



LEON BERRY takes you on a new and thrilling excursion into the World of Theatre Organ Music. AFLP 1828



PLAZA DE TOROS! La Fiesta Brava! Vol. 2—Music of the Bullfight Ring played by the Banda Taurina of Mexico. AFLP 1817



MARIMBA MAMBO Y CHA CHA CHA—Latin rhythms by Marimba Chiapas and Orchestra for your dancing pleasure. AFLP 1802



ACCORDION DE PARIS—The magic accordion of Jo Basile, his orchestra and melodies of love. AFLP 1815



CHA CHA CHA—Pulsating tropical magic played by Salamanca and his orchestra. Complete with illustrated dance instructions. AFLP 1813



PATACHOU—Incomparable, exciting Patachou sings for you . . . in French and English! Each a show-stopper . . . each bursting with verve, joie de vivre! AFLP 1814



FIESTA EN MEXICO—A rich, colorful variety of traditional music of Mexico played and sung by authentic Mariachi Musicians. AFLP 1816

12-inch LP (33 1/3rpm)—\$5.95 each

NATIONALLY DISTRIBUTED BY



DAUNTLESS INTERNATIONAL 750 TENTH AVENUE
 NEW YORK 19, N. Y.

J. B. PRIESTLEY: *Essays from "Delight"*

Thirteen essays, with prologue and epilogue written for the recording, read by the author. SPOKEN ARTS 716. 12-in. \$4.98.

Mr. Priestley here presents himself as a repentant curmudgeon, making amends for a lifetime of grumbling with a recital of some unalloyed delights. He does very well—so well, indeed, that I now can tally among my delights one he cannot with propriety claim. I mean, of course, this record.

Grumbling and laughter are means commonly used by deeply sensitive and clever people to make the world seem tolerable. Priestley is a master of both arts, which makes it no surprise whatever that the most affecting portions of this record partake of neither, but of pure wistfulness. Three of his chosen delights he invests especially with this quality. One is the remembered magical glitter of the illuminated fountains at the Bradford (Yorkshire) Exhibition in his boyhood, and this leads him into a quite unanswerable plea for more of the same. ("What is the use of living in a democracy if we want fountains and have no fountains?") Another is the gratitude of children for things new and wonderful, which he admits he withheld from his own parents out of an unaccountable stony contrariness, now sadly regretted. Most moving—to me, at least—is what he calls the delight that never was. It is a description of a place to live, at odds with all the demands of practical Laborite intellectuals (among whom Priestley always has been numbered). The place is not a sanitary, spoke-angled, greenbelt-tower development, but a little 1830 ducal city, graced with *gemütlichkeit* and lilacs, a small but perfect theater, an opera house, a concert hall, a superlative restaurant always thronged with friends, winding streets and pleasant lodgings for people bent on living unhurriedly, like philosophers or artists. Priestley paints it better than I do, though he could not long for it any more soulfully than I when I am through listening to him.

Indeed, he paints everything here vividly, taking a journalist's joy in the essay's freedom. In "Orchestral Conductors" he speaks of Nizich leading with a "tranced white passion," and of Beecham "duelling for Mozart with a glittering rapier." An orchestra tuning up he describes as "chaos caught at the supreme moment, immediately before creation."

However, it is his choice of delights that delights most. He loves to touch wood, and exults in blossoming trees. He recalls with wonder the joy of smelling an island, yet unseen, after weeks of salt Pacific seascape, and relives the splendid day when he first wore long trousers.

He exudes relief at the fact that grown-ups do not have school reports written about them (J.B. avoids exercise . . . does not cultivate a cheery attitude . . . should be sent to join the Sea Scouts during the holidays). And he chortles wickedly over the pleasure of lying in a hot bath, smoking a pipe, while other men rush to catch the 8:20 and, beyond the bathroom door,

delicate women perform Herculean household tasks.

Mr. Priestley reads his lines better than anyone else could, and the recording is just properly intimate. As I said, a delight.
J.M.C.

A ROUND OF POEMS

A selection of verse from *Invitation to Poetry*, read, with a commentary, by Lloyd Frankenberg.

COLUMBIA ML 5148. 12-in. \$3.98.

The editor of *Invitation to Poetry* (published, simultaneously with the release of this record, by Doubleday and Co., \$6.75) maintains that he prefers to consider his collection not an anthology, but a "round" of poems in which the hearer participates by listening. The "round" also suggests the circle of poetry, at which the selections here "take a roving look." The verse read represents no single period, no single technique, no all-inclusive theme, no general attitude. It is, in fact, a medley of selections ranging, chronologically, from a sixteenth-century ballad to Browning and, stylistically, from Longfellow to Donne. The intention, apparently, is to introduce the listener to the great range and variety of English poetry and thus to enable him to "make his own choices, explore his own tastes . . ."

This laudable aim is, unhappily, defeated, mainly because Mr. Frankenberg's powers of vocal interpretation are decidedly limited. His rendition of Matthew Arnold's *Dover Beach* does not sound much unlike a Keatsian sonnet; *Shall I compare thee to a summer's day* not vastly different from the Tennysonian excerpt, *Tears, Idle Tears*. The result is to leave the uninitiated listener, for whom the record seems designed, under the delusion that all English poetry, aside from its subject matter, is pretty much the same.

This surely is not anyone's intention, least of all Mr. Frankenberg's. In fact far and away the most interesting part of this record is the last band of the overside, on which the reader-editor offers a "round" of comments—specific critical observations on particular poems, both pertinent and illuminating, especially in connection with George Herbert's *Virtue* and Keats's *To Autumn*. However, to expect the listener to recall in detail Swinburne's *John Webster* at the moment when, some thirty minutes after its reading, the critic makes his annotations, seems to me to be unreasonable especially since no texts are provided.
J.G.

CARL SANDBURG

A selection from the poems of Carl Sandburg, read by the author.

DECCA DL 9039. 12-in. \$4.98.

Carl Sandburg may well be the most direct poetic descendant of Walt Whitman, sharing the earlier poet's perhaps too insistent zest for life, his perception of the breadth (moral as well as physical) of his country, and his all-encompassing embrace of all kinds and conditions of men. Like Whitman he also has a penchant for the catalogue of persons, places, and events—a device which does, on occasion, permit a cumulative sense of power and forward movement. And again like Whitman, he

sometimes falls into the didactic and plati-tudinous. One cannot quarrel with the nobility of the sentiments expressed; one can say that the manner of expression does not provoke the sense of revelation.

The poems on this disc are a representative selection, including *Grass*, an excerpt from *The Windy City*, *Cool Tombs*,



McKenna as Saint; Wager as Dauphin.

and *Tall Grass*. Side two is given over to *Prejudice* and *Proverbs*. They are sometimes chanted, sometimes crooned, sometimes intoned, and sometimes bellowed forth as by a street-corner preacher. This is an interesting and disturbing reading, for which reason prospective purchasers are advised to listen before buying. J.G.

SCANDINAVIA: A Portrayal in Sound

Jim Fassett, editor and narrator.

COLUMBIA ML 5147. 12-in. \$3.98.

Few records contain sounds more likely to stir the imagination than the voice and music of the Finnish bard who majestically chants the opening lines of the *Kalevala* on this disc. Indeed, the sound appeal of this collection of portraits is exceptionally high, for the Fassett touch assures a selection of items that are going to stick in the mind and demand rehearing. From Norwegian wolves through multi-lingual Stockholm guides, to the great bells and ivory organ of a Danish castle, these are sounds to set one packing his bags (if he can), or wishing he could (if he can't). An appealing and expert job. R.C.M.

BERNARD SHAW: *Saint Joan*

Siobhan McKenna, Saint Joan; Michael Wager, the Dauphin; Earl Montgomery, Chaplain De Stogumber; Earle Hyman, Dunois; Thayer David, Inquisitor; Bryant Haliday, the Earl of Warwick; Ian Keith, the Bishop of Beauvais; Frederick Tozere, the Archbishop of Rheims; Dennis Patrick, De Baudrivourt; *et al.*

RCA VICTOR LOC 6133. Three 12-in. \$14.94.

It is a pity that Shaw did not live to hear Siobhan McKenna's interpretation of his Saint. There have been Joans who have played the part for nobility, and others whose approach has been for sympathy. We have had deeply tragic versions, and some frankly melodramatic. But always they have been fundamentally lady-like. Miss McKenna, alone, brings out the peasant quality of Shaw's heroine, with an arrogant, rapturous simplicity that at times might almost be described as simple-minded. This is largely thanks to the

Irish dialect with which she invests her lines—a cadence that is too powerful for Cinnemara and too musical for Belfast, but, like Miss McKenna herself, is something between the two.

Furthermore this actress triumphantly rides over the difficulties of Shaw's dialogue by imprinting her thoroughly Irish interpretation on the part, not hesitating to alter a word here and a phrase there, whenever it comes naturally to her to do so. This is all very well in her own case, but the fine quality of this recording then goes on to emphasize a perfect Tower of Babel in the plethora of accents of the rest of the cast. We have some more authentic Irish, English, and American. But we also have some blatant imitations in all three fields, not only tasteless but sometimes positively confusing.

There are, however, some excellent supporting performances—Earl Montgomery as the English parson, De Stogumber; Bryant Haliday as an unusually smooth Warwick; and Michael Wager, who adds an intriguing stutter to his playing of the Dauphin. But basically, the play is Siobhan McKenna's; and without her contribution, this production could hardly be described as one of the outstanding presentations of *Saint Joan*. For one thing, it is peculiarly lacking in humor, due probably to pomposity in the playing of some of the supporting roles and to a certain absence of gusto in the direction. In addition the cutting has been carried out more with an eye to shortening some of the longer passages and focusing attention on Joan than with regard to intelligibility.

The technical quality of the recording is first rate, and the balance is admirably handled, particularly in the passage where the dialogue continues over the reading of the Act of Recantation. At the same time too many of the speeches appear to be projected towards the back of a non-existent auditorium, and are spoken with a deliberation and a theatrical emphasis which are fine for the stage, but which sometimes seem exaggerated when heard through the ear of the microphone.

DENIS JOHNSTON

THE SONG OF SONGS

A reading, in English and Hebrew, by Morris Carnovsky, Carol Veazie, Anne Meacham, and Henry Bate.

EXPERIENCES ANONYMES EA 0011. 12-in. \$5.95.

The Song of Songs, or *Song of Solomon* as it is entitled in the Authorized Version of the Bible, is a love poem about a Shulammitte girl who, because of her remarkable beauty, had been brought to the palace of King Solomon in Jerusalem. It is in the form of a dialogue which, tradition has supposed, took place between Solomon and this maiden. In modern times, however, the theory has been brought forward that there are three persons involved: Solomon; the Shulammitess; and also her true lover, a shepherd boy of her own country, to whom she is passionately attached. According to this interpretation she implores Solomon to release her so that she may return to him. Her request is granted;

Continued on page 86

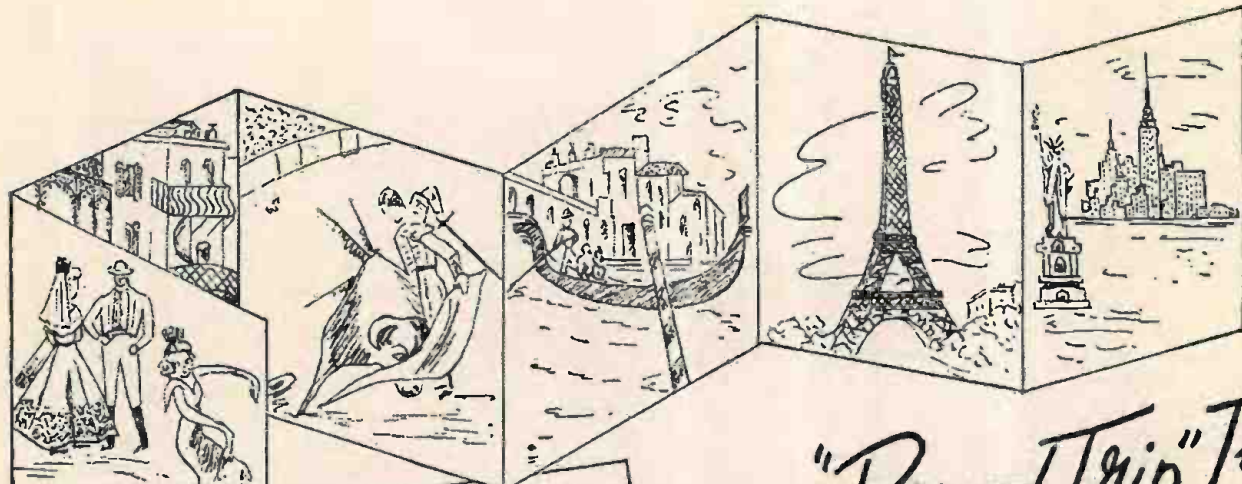

Your "Round Trip" Ticket

TO HIGH FIDELITY LISTENING PLEASURE

VIA **AUDIO FIDELITY RECORDS**

Take a Trip in Sound — and right from your favorite easy chair! AUDIO FIDELITY brings all the excitement and color of many countries right into your living room on their super-brilliant, guaranteed total frequency range recordings. Not just hi-fi records . . . but each a new listening thrill!

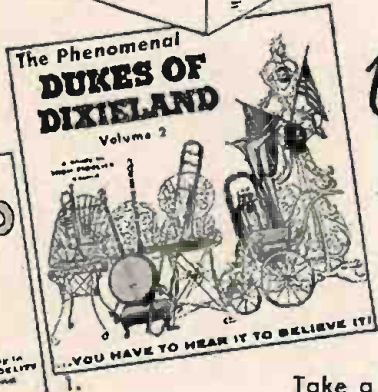
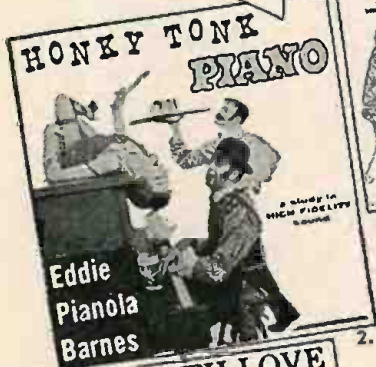

1. THE phenomenal DUKES OF DIXIELAND — Vol. 2. Hot trumpets . . . sweet trumpets . . . crazy clarinets . . . a real-gone tubo and a wild banjo make this the swingiest, low-down Dixie ever recorded! Spontaneity Supreme! **AFLP 1840**

2. HONKY TONK PIANO. The roaring 20's in brilliant Hi-Fil It's Eddie "Pianola" Barnes at the 88's. Sharps and flats go flying as he plays old-time favorites: My Sister Kate, I Ain't Got Nobody, etc. **AFLP 1827**

3. ROME WITH LOVE. Come wander down Piazza de Spagna and Via Margutta to Trevi Fountain accompanied by enchanting melodies of Rome . . . of Italy . . . played by Jo Basile and his accordion. **AFLP 1822**

4. FIESTA EN ESPANA. Rafael Malero, Guitarist; Alberto Salicru, Dancer. Exciting hand-clapping, heel-tapping music full of fire, passion and desire. Authentic Flamenco, never before recorded, that expresses the heart and soul of the gypsy. **AFLP 1819**

5. TORERO! La Fiesta Brava! Vol. 3. Once again music by the Banda Taurina transports you to the bullfight arena to watch the duel with death! All new selections. Complete with 50-page book, El Toreo, in English. **AFLP 1818**

6. RENDEZVOUS A PARIS. A dimly lit bistro . . . a long, soft sigh — and the singing accordion of Jo Basile create the mysterious enchantment of a Rendezvous in Paris. **AFLP 1821**

7. CHA CHA CHA. Tarrid rhythms, vibrantly alive with the mystery of exotic Latin nights . . . the lure of the exciting tropics. Pulsating Latin magic played by Pedro Garcia and his Del Prado Orchestra. **AFLP 1810**

8. BAWDY SONGS and BACKROOM BALLADS Vol. 3. Gather 'round you lovers of lusty lore . . . Oscar Brand has done it again! A complete new album of spicy musical folklore. **AFLP 1824**

each 12-inch LP (33 1/3 rpm)—\$5.95



WRITE FOR FREE CATALOG



NATIONALLY DISTRIBUTED BY **DAUNTLESS INTERNATIONAL**

750 TENTH AVENUE
NEW YORK 19, N. Y.

HIGH FIDELITY MAGAZINE

THE MUSIC BETWEEN

by Murray Schumach

Conquistadors in Puffed Sleeves

MILLIONS of residents north of the Rio Grande, possessed of South American feet and North American ears, have created quite a problem for record makers. Are the discs to be sold for foot or ear-appeal? Or is a compromise best? Anyone who discovers the right answer—if there is one—will have found more gold than Cortes and Pizarro combined. For the market for Latin rhythms in this country is already enormous and growing briskly. With the exception of the Negro influence in jazz, no musical strain has been as important in the pop record field as the Latin beat. Through rumba, bolero, conga, samba, mambo, cha-cha-cha, and now merengue, the rattle of gourds has grown loud in the land.

Though no one can gauge, with certainty, the future of Latin music, its popularity has been durable enough to justify a pretty positive prognosis. As early as 1916, according to Arthur Murray's experts, there were rumba contests in New York City—not to mention the tango fever before that. The sturdiness of Latin music kept it alive during the Charleston-fevered Twenties and the Swing-powered Thirties. By the Forties the Latin beach-head had become a full-scale invasion. As might be expected, however, the expansion of Latin pop music has been uneven. In the South, for example, square dancing is holding its own despite the Latin trend. And in the Midwest, the polka still has a strong appeal. But in the hotels and night clubs of major cities, and at big resorts, the dance floor without Latin numbers is as passé as the gavotte.

But increasingly, as with all pop music, the appeal is moving away from the feet, to the ears. This may be blamed on records: people are listening sitting down. Violins are being added to Latin music and brass is becoming softer. Smoothness is increasingly evident in the arrangements. One of the leading spokesmen for this trend—Johannie Camacho, international music director for RCA Victor—thinks Calypso will be "the perfect stepping stone" between Latin and North American tastes. With Calypso, he believes, almost any Latin rhythm can be used and, much more important, the record industry may finally lure into the Latin fold American teen-agers, a group that has not been particularly enthusiastic about Latin rhythms.

Perhaps because I'm prejudiced in favor of preserving something of the primitive Latin styles, I prefer those recent records that present the music intact with rattles. This bias applies equally to discs I've heard on Columbia, RCA Victor, Audio Fidelity, and Montilla labels.

Of the recent Columbia output, my favorite was *Vaya* (CL 827), with Joe Loco and his orchestra. This record seems to be equally seductive to ear or foot. Mr. Loco's piano playing is rhythmic; and his orchestrations, particularly when they juxtapose piano and drum, are beautifully balanced, with no attempt to overpower percussion with chords. Perhaps Mr. Loco's

secret is that he was a professional dancer before he became a band leader.

In Tito Puente, RCA Victor has a match for Mr. Loco. Mr. Puente's *Let's Cha-Cha* (LPM 1392) insinuates a fluid melodic line into his strong beat, the result of not being ashamed to use strings and not mistaking noise for passion. His brass is clean, strong, fine in tonal quality—and never hysterical.

I don't think anyone will be surprised that Xavier Cugat is still turning out good Latin records. For Columbia he has done two I like especially. They are *Merengue by Cugat* (CL 732) and *Cha-Cha-Cha* (CL 718). My only reservation is that I could do with a little less suggestion of the posh New York hotel and a little more of the West Indies thatched hut. But Mr. Cugat is still as expert in the living room as in the ballroom.

Audio Fidelity has a good contender in this field in Pedro Garcia, whose *Cha-Cha-Cha* (AFLP 1810) features fine arrangements that bring the equator right home, musically-speaking, to our northern latitudes. Moreover, the recorded sound on this disc is really hi-fi—big, bright, brisk, intimate. Finally, in the category of records that I think find a happy compromise, is Montilla's *Rapsodia de Cuba* (FM 80), with the Orquesta de Camara, conducted by Felix Guerrero, in sound vibrant without being blatant.

For those who like extremes in Latin music, I have two suggestions. *Piasta en Mexico* (Audio Fidelity AFLP 1816) with the Miguel Dias band using hard brass, strumming guitars, and chorus, is for those who like their Latin music straight. At the other end is *Standards in the Latin Manner*, with Edmundo Ros and his orchestra, (London, LL 1466). This one makes a jungle seem a hothouse plant.

Before I leave the subject of Latin music, I'd like to touch on recordings of Latin musical comedies made by Montilla. They are *El Cafetal* (FM 77); *El Aguila de Fuego* (FM 71); and *Maria la O* (FM 73). To me they demonstrate, for all their melodic qualities, how far the rest of the world is behind the United States in the field of musicals. By contrast, *Candide* (Columbia CL 5180), which I thought generally dull, seems almost good. But compared with good American musicals, Leonard Bernstein's score is poor imitation Kurt Weill, or Arthur Sullivan—or even Leonard Bernstein (for the force of this, go back to the opening number, "Christopher Street," in *Wonderful Town*: you'll find nothing like this in *Candide*). Irra Petina has done nobly in squeezing from her songs the little humor they have,

Stritch (Dolphin 3) and Portia Nelson (Dolphin 4). The others—Julie Wilson, Hermione Gingold, and Greta Keller—despite formidable reputations, can't project their special talents to the ear alone. Miss Stritch, an intuitive rhythm singer, takes off with a brassy, chesty, shouting voice that is just right for her humorous approach. She knows, as do few pop singers, the art of setting up a song in introductory verse and then cutting loose in hard contrast in the chorus. She is at her best in Rodgers and Hart tunes.

Miss Nelson's is a fine musical comedy voice, whose sustained notes and artistic shading are as pleasurable as her complete command of tone and lyrics. With the exciting background music of the Norman Paris Trio, she captures for the home the sophisticated supper club touch of songs by Gershwin (*By Strauss*); Rodgers (*Nobody's Heart*); Arlen (*Out of this World*); and Porter (*It's All Right with Me*).

RCA Victor carries night club work one step further by recording Tony Martin in a night club with an audience. Called *A Night at the Copacabana* (LPM 1357), this record makes good use of Mr. Martin's gracious manner as well as his pleasing voice. A top-flight crooner, he knows when to hug the melody (*Autumn Leaves*), and when to apply his casual charm to the lyrics (*Love and Marriage*). He lacks the fire of Sinatra, but when he uses tricks, such as the sort of sob in *Arrivederci Roma*, he is, much to my surprise, effective. One advantage of night club talent on records—no distractions by drunks who think they combine the wit of Fred Allen and Voltaire.

Dinah Shore's latest record, *Bouquet of Blues* (RCA Victor LPM 1214) is, perhaps because it uses three orchestras, somewhat disconcerting. When Miss Shore sings *I Got It Bad and That Ain't Good*, or *Warm-Hearted Woman*, her lucid style makes for good listening. But when the orchestration gets in her way in *Blues of the Night*, or when she is upstaged by whistling in *Lonesome Gal*, the competition is too much for her.

Generally, I am bored by a Hammond organ. But Hal Shuts, in *Organ and Firelight* (Columbia CL 906) considers this organ a musical instrument, not a gadget designed to grab attention for a commercial. I particularly liked his *I'll Remember April* and *I Could Have Danced All Night*.

Ironically, the best record I've heard this month is by a woman who, though she could easily be a fine jazz or pop singer, has avoided both fields. Mahalia Jackson has been called the nation's best gospel singer. Barring Marian Anderson, she is the best I've ever heard. In *Bless This House* (Columbia CL 899), Miss Jackson pours deeply-moving fervor into fourteen songs which include *Sometimes I Feel Like a Motherless Child*, *God Knows the Reason Why*, *Just a Little While to Stay Here*, and *Down by the Riverside*. All I can say is bless Miss Jackson.

PERIODICALLY, recording companies play a long shot by banking on an entertainer whose talents have gained notice primarily through a revue or night club. One of the most ambitious ventures of this sort has been undertaken by Dolphin. The best of the recent crop are records by Elaine

Continued from page 83

and one may feel this is one of Solomon's few really good and truly wise acts.

As might be expected, some passages of the poem are beautiful and picturesque, some gross and sensual, and some so obscure as to defy all attempts at rational interpretation. Such a variety of material,

one would think, would be quite difficult to read aloud. This feat Morris Carnovsky and Carol Veazie have achieved, and achieved well, in an interpretation that conveys the dignity essential to all true poetry. They have also made what is indeed a bold departure from convention in reading the poem simultaneously in English and Hebrew. One would think

that this would be impossible to listen to. It is not easy, but it is worth attempting; and it is greatly facilitated by having a copy of the text before one. Certain passages are read, not only by Carnovsky and Carol Veazie reading the English and Hebrew in unison, but with Anne Meacham and Henry Bates joining in. It is a little hard to see the purpose of this latter scheme, unless it is that the director wished to treat these passages as if they were less personal than the others and like parts taken by a Greek chorus. On the other side of the record, the Hebrew alone is read by Morris Carnovsky. Even for those whose knowledge of Hebrew is slight, there is real value in the reading of the original so beautifully rendered. The voice is deep and strong, and every syllable and sound is carefully distinct—in reading Hebrew an amazing accomplishment.

We do not nowadays read the *Song of Songs* as an allegory of Solomon's search for wisdom, nor yet of the Church as the Bride of Christ. But as the love lyric which it certainly was intended to be, it has genuine poetic interest.

WALTER B. WRIGHT, S.T.B.

Dialing Your Discs

All LP discs are recorded with treble boost and bass cut, the amount of which often varies from one manufacturer to another. To play a disc, the bass below a certain turnover frequency must be boosted, and the treble must be rolled off a certain number of decibels at 10,000 cycles. Recommended control settings to accomplish this are listed for each manufacturer. Equalizer control panel markings correspond to the following values in the table below: ROLL-OFF—10.5: LON, FFRR. 12: AES, RCA, Old RCA. 13.7: RIAA, RCA, New RCA, New AES, NARTB, ORTHOphonic. 16: NAB, LP, COL, COL LP, ORTHOacoustic. TURNOVER—400: AES, RCA. 500C: LP, COL, COL LP, Mod NAB, LON, FFRR. 500R. RIAA, ORTHOphonic, NARTB, New AES. 500: NAB. 630: BRS. 800: Old RCA.

All records produced under the following labels are recorded with the industry-standard RIAA curve (500R turnover; 13.7 rolloff): Angel; †Atlantic Bethlehem; Classic Editions; Clef; Composers Recordings; EMS; Epic; McIntosh; MGM; Montilla; New Jazz; Norgtan; Prestige; Romany; Savoy; Walden. Labels that have used other recording curves are listed below.

RECORD LABEL	NEW		OLD
	Turnover	Rolloff	Record No. or Date: Turnover, Rolloff
Allied	500	16	
Amer. Rec. Soc.	400	12	
Arizona	500R	13.7	To 1955: 400, 12.7
Audio Fidelity	500R	13.7	No. 901-903: 500, 16
Audophile	500	12	
Bach Guild	500R	13.7	No. 501-529: 500, 16
*Bartok	500R	13.7	No. 901-905, 308, 310, 311: 500R, 13.7 No. 906-920, 301-304, 309: 630, 16
Blue Note Jazz	500R	13.7	To 1955: 400, 12
Boston	500C	16	
*Caedmon	500R	13.7	No. 1001-1022: 630, 16
Canyon	500R	13.7	To No. C6160: 400, 12
Capitol	500R	13.7	To 1955: 400, 12.7
Capitol-Cetra	500R	13.7	To 1955: 400, 12.7
Cetra-Soria	500C	16	
Colosseum	500R	13.7	To January 1954: 500, 16
*Columbia	500R	13.7	To 1955: 500C, 16
Concert Hall	500R	10.5	To 1954: 500C, 16
*Contemporary	500R	13.7	No. 3501, 2501, 2502, 2505, 2507, 2001, 2002: 400, 12. No. 2504: 500, 16
†Cook (SOOT)	500	12-15	
Coral	500	16	
Decca	500R	13.7	To November 1955: 500, 16
Elektra	500R	13.7	No. 2-15, 18-20, 23-26: 630, 16. No. 17 22: 400, 12. No. 16, 21, 23, 24: 500R, 13.7
Esoteric	500R	13.7	No. ES 500, 517, EST 5, 6: 400, 12
Folkways	500R	13.7	To 1955: 500C, 16
*Good-Time Jazz	500R	13.7	No. 1, 5-8: 500, 16. No. 3, 9-19: 400, 12
Haydn Society	500C	16	
HMV	500R	16	
Kapp	500R	13.7	No. 100-103, 1000-1001: 500, 16
Kendall	500	16	
*London, Lon. Int.	500R	13.7	To No. 846: 500C, 10.5
Lyrichord	500	16	
*Mercury	500R	13.7	To October 1954: 400, 12
Nocturne	500R	13.7	No. LP 1-3, 5, XPI-10: 400, 12
Oceanic	500C	16	
*L'Oiseau-Lyre	500R	13.7	To 1954: 500C, 10.5
*Overtone	500R	13.7	No. 1-3: 500, 16
Oxford	500C	16	
Pacific Jazz	500R	13.7	No. 1-13: 400, 12
Philharmonia	400	12	
†Polymusic	500	16	
RCA Victor	500R	13.7	To September 1952: 500 or 800, 12
Remington	500	16	
Riverside	500R	13.7	To 1955: 400, 12
Tempo	500	16	
Transradio	500C	16	
Urania	500R	13.7	No. 7059, 224, 7066, 7063, 7065, 603, 7069: 400, 12. Others: 500C, 16
Vanguard	500R	13.7	No. 411-442, 6000-6018, 7001-7011, 5001- 8004: 500, 16
Vox	500R	13.7	500, 16 unless otherwise specified.
*Westminster	500R	13.7	To October 1955: 500C, 16; or if AES specified: 400, 12

*Currently re-recording old masters for RIAA curve.

†Binaural records produced on this label have no treble boost on the inside band, which should be played without any rolloff.

ADLAI STEVENSON: A Recorded Portrait

Adlai Stevenson, in conversation with Arnold Michaelis.

AMI AMI 101. 12-in. \$4.98.
(If not available at your record store, write: Arnold Michaelis, Inc., 320 West 76th St., New York 23, N.Y.)

To judge from the late, lamented unpleasantness (for the losers) of Nov. 6, 1956, there are still twenty-five million people in this country who think the wrong man is President of the United States. This record, then, should have a large potential market—for a great many of those twenty-five million people were on the losing side more because of their admiration and respect for Adlai Stevenson than for their knowledge of the Democratic platform.

This record should not be dismissed as an outdated campaign gimmick; it is an authentic political document of particular value to students of contemporary society, the first of a long series in which Michaelis hopes to paint informal recorded portraits of the men and women who are making history by their influence on events.

The conversation took place on June 19, 1956 in the study of Adlai Stevenson's Illinois farm. It is enlivened at regular intervals by sounds from an open window—crickets, birds, and passing aircraft. From the conversation emerges an image of Adlai Stevenson only partially visible on the rostrum or the rear platform of a train. The humanity and intelligence reflected in his public speeches are revealed in the kind of relaxed conversation that might have taken place in anybody's living room last night, provided, of course, that some one had first prepared a notebook of "leading" remarks to keep the conversation moving.

These "stimulants," provided in this case by Mr. Michaelis, often can be irritating. But even the annoying ones serve the purpose. Stevenson always picks up the cue—and in a voice, rare in American politics, of sanity, reason, and humor. R.H.H., JR.

most stimulating of today's small groups. It lives up to this promise in performance, and the only surprise is the way in which the steadily developing Bob Brookmeyer stands out even in such distinguished company. The life that he breathes into slow ballads (*Lullaby of the Leaves* and *I Can't Get Started*) is nothing short of amazing, and he develops his lines with real imagination. Then, turning to the uptempo *The King*, he wades in with force and dexterity that are constant delights. Hank Jones, sparking a fine rhythm section, throws off several driving solos en route. Low man on this lofty totem pole is Zoot Sims, who plays with his expected strength and fluidity on fast numbers, but bogs down on ballads. He also makes the frightful mistake of singing, revealing a voice that sounds like Tex Beneke under a veil of Wheateana.

PETE FOUNTAIN: *New Orleans to Los Angeles*

Farewell Blues; At the Jazz Band Ball; March of the Bob Cats; Jazz Me Blues: Al Hirt, trumpet; Abe Lincoln, trombone; Eddie Miller, tenor saxophone; Pete Fountain, clarinet; Stan Wrightsman, piano; Morty Corb, bass; Ray Bauduc, drums.

Cherry; Struttin with Some Barbecue; Home; Song of the Wanderer: Fountain, clarinet, tenor saxophone; Roy Zimmerman, piano; Phil Darois, bass; Johnny Edwards, drums.

SOUTHLAND 215. 12-in. 26 min. \$3.98.

Dixieland has rarely been treated with such a combination of polish and exuberance as it is by the larger group on this disc. Hard as it may be to imagine an original stylist in this minutely explored field, trombonist Abe Lincoln appears to be precisely that. His exhilarating attack has brightened several Columbia (Rampart Street Ramblers) and Capitol discs, but he has rarely approached the joyous, unquenchable roar with which he takes off on these four numbers. He has that same brashness that marks Wild Bill Davison's corner work, though he rarely lapses into the balancing wistfulness that Davison employs.

At the other extreme is Pete Fountain, a clarinetist in the liquid, mellow New Orleans tradition and, one may safely say, the best of his kind since the late Irving Fazola. Filling in the middle area are Eddie Miller's vivaciously velvet tenor saxophone and a probing but relatively restricted trumpet played by Al Hirt. It's a stimulating blend all the way through. The Quartet selections were previously issued on a ten-inch LP and are devoted almost completely to Fountain's flowing clarinet and tenor saxophone.

GLEN GRAY: *Casa Loma in Hi-Fi*

No Name Jive; Memories of You; White Jazz; I Cried for You; Come and Get It; Sunrise Serenade; Maniac's Ball; Casa Loma Stomp; Just an Old Manuscript; Sleepy Time Gal; Dance of the Lame Duck; For You; Black Jazz; Smoke Rings.

Conrad Gozzo, Mannie Klein, Shorry She-rock, trumpets; Joe Howard, Walter Benson, Si Zentner, trombones; Murray McEachern, trombone, alto saxophone; Gus Bivona, clarinet, tenor saxophone; Babe

Russin, tenor saxophone; Skeets Herfurt, Ted Nash, alto saxophones; Chuck Gentry, baritone saxophone; Ray Sherman, piano; George Van Eps, guitar; Mike Rubin, bass; Nick Fatool, drums.

CAPITOL W 747. 12-in. 47 min. \$4.98.

The jazz elements in these re-creations of the Casa Loma band's book lie in those riff-ridden instrumentals that Gene Gifford wrote (*Casa Loma Stomp, White Jazz, Black Jazz, Maniac's Ball, etc.*). These are the numbers which made the Casa Lomans a pioneer swing band before they turned, first, sweet with Kenny Sargent and, finally, sour with boredom. Only one veteran of the old band (McEachern) is among the West Coast studio men brought together for this session (Sargent appears as vocalist on two numbers). In spite of

this, Gray has managed to draw from them a sound and an attack that are remarkably close to the originals. Even such characteristic aspects of the old band as tenor saxophonist Pat Davis' harried efforts to play hot and drummer Tony Briglia's florid cymbal whacking are suggested by Babe Russin and Nick Fatool, each of whom normally plays quite differently. But this is a band of uniformly high quality such as Gray never had the good fortune to front in the old days. It brings a long gone era of jazz brightly to life. The best of the sweet side of the Casa Lomans is also represented by the band's theme, *Smoke Rings*, and by Sargent's singing of *For You and I Cried for You* (which opens with one of those wonderfully sonorous trombone choir passages that Gifford liked to write). It has been proved time and

VANGUARD
 RECORDINGS FOR THE CONNOISSEUR

UNCOMMON HI-FI ADVENTURES

*in the fine art of popular music . . .
with an assist from the great composers*

<p style="text-align: center;">German University Songs</p>  <p style="font-size: small;">of Wenzling, Wining and other Irreverent Pastimes. Erich Kunz, baritone with Male Chorus and Orchestra. VRS-477</p> <p style="font-size: x-small;"><i>"Rousing, ribald and thoroughly splendid."</i> — Playboy</p>	<p style="text-align: center;">Gottschalk: The Banjo</p>  <p style="font-size: small;">and other Creole Ballads, Cuban Dances, Negro Songs and Caprices. Eugene List, piano. VRS-485</p> <p style="font-size: x-small;"><i>"Delightful, nostalgic and utterly absorbing."</i> — N.Y. Times</p>
<p style="text-align: center;">The Wraggle Taggle Gypsies</p>  <p style="font-size: small;">Alfred Deller, counter-tenor, with lute and recorders. VRS-1001</p> <p style="font-size: x-small;"><i>A haunting anthology of English folk song.</i></p>	<p style="text-align: center;">Brahms: 21 Hungarian Dances For Orchestra</p>  <p style="font-size: small;">Mario Rossi, conductor. VRS-473</p> <p style="font-size: x-small;"><i>"Delicious is the word for the suavity, fleetness and humor which Rossi brings to these works."</i> — Boston Globe</p>
<p style="text-align: center;">Weill: The Three Penny Opera</p>  <p style="font-size: small;">Complete in German, with Liane, Roswaenge and Vienna State Opera cast. VRS-9002</p> <p style="font-size: x-small;"><i>"An authentic performance such as this gives the opera the aspect of a classic."</i> — N.Y. Herald-Tribune</p>	<p style="text-align: center;">Dvorak: Slavonic Dances</p>  <p style="font-size: small;">Op. 46 and 72 (Complete) Mario Rossi, conductor. VRS-495</p> <p style="font-size: x-small;"><i>Dvorak matches Brahms with an all-time best seller of his own.</i></p>
<p style="text-align: center;">Songs I Taught My Mother</p>  <p style="font-size: small;">Charlotte Rae, vocalist. VRS-9004</p> <p style="font-size: x-small;"><i>"Charlotte Rae is a gifted singing comedienne of a very special sort."</i> — The New Yorker</p>	<p style="text-align: center;">A Night At The Apollo</p>  <p style="font-size: small;">VRS-9006 Complete show of music and comedy at Harlem's famed variety theatre.</p> <p style="font-size: x-small;"><i>"It takes the listener right into the 125th Street emporium and leaves him or her breathless with laughter."</i> — Pittsburgh Courier</p>

All 12" long-playing records, each \$4.98

Send for complete catalog to VANGUARD RECORDING SOCIETY, INC., 256 West 55th Street, New York.



a
salute
to

HI-FI-MANSHIP

Most people who buy records are not hi-fi fans. Nice people, too. But Vox considers that each record it produces will be heard by a true-blue hi-fi type of guy. You're our man... as these unusual high fidelity recordings clearly demonstrate.

The delight of sound!

SUITE MUSIC BY BIZET

(L'ARLESIENNE SUITES NOS. 1 & 2
— CARMEN SUITE)

Bamberg Symphony—Marcel Couraud,
conductorPL 10.230

The imagery of sound!

MOODS-IMPRESSIONS-FANTASIES

FEATURING STANLEY BLACK'S
"PERCUSSION FANTASY"

New Concert Orchestra—Nat Nyll, conductor
VX 25.270

The vitality of sound!

TCHAIKOVSKY:

ROMEO AND JULIET OVERTURE FANTASY
1812 OVERTURE, OPUS 49
CAPRICCIO ITALIEN, OPUS 45
MARCHE SLAVE, OPUS 31

Vienna State Philharmonia—Jonel Perlea,
conductorPL 8700

The story of sound!

THIS IS HIGH FIDELITY

(A Guide to Sound Listening)

The amazing facts about hi-fi... the greatest record of its kind. Demonstrations! Illustrations! Diagrams! Written and produced by Tyler Turner. Deluxe AlbumDL 130

FOR SOUND REASONS



again that it takes a lot more than old arrangements to re-create some of the great band performances of the past. In this case, Gray has recaptured both the spirit and the sound. The recording is excellent.

BILL HITZ AND HIS ORCHESTRA: *Music for This Swingin' Age*

Strike Up the Band; In a Sentimental Mood; Something Blue; Sampan; Matinee; But Not for Me; Stompin' at the Savoy; You Don't Know What Love Is; Open House; Diga Diga Doo; Status Quo; Fair and Warmer.

Conrad Gozzo, Mickey Mangano, Ray Linn, trumpets; Milt Bernhart, Dick Nash, trombones; Bill Hitz, clarinet; Russ Cheevers, Buddy Collette, Bill Ulyate, Chuck Gentry, saxophones; Gerald Wiggins, piano; Curtis Counce, bass; Larry Bunker, drums.
DECCA 8392. 12-in. 40 min. \$3.98.

For those who like big swinging bands, but who have been wary of them in recent years, this disc should be of special interest. Although it carries Hitz's name, it is essentially the product of Spud Murphy. Murphy, a noted arranger for Benny Goodman and Mal Hallett in the Swing Era, recently moved onto the modern jazz scene with a system he devised himself—a twelve-tone system of equal intervals. Hitz is a student of Murphy's. Between them, they have written all the arrangements, using Murphy's system, and four of the most successful selections are originals by Murphy.

Happily, they have not been carried away by fascination with their new toy. These are all soundly based, swinging big band performances in which the new musical ideas provide a fresh flavor without getting in the way of the swinging feeling. It is neat, unpretentious, and stimulating work, always melodic and harmonically rich and attractive.

Hitz, a clarinetist hitherto unknown in jazz (he has been a sideman in name dance bands), is skillful and controlled in the cool Buddy De Franco manner. He shares the solo burden with Buddy Collette, who is consistently polished in both his alto and tenor saxophone work. The band, made up of top West Coast studio men, digs into the arrangements cleanly and with commendable flair.

BUDDY RICH AND HIS ORCHESTRA: *"This One's for Basie"*

Blue and Sentimental; Down for Double; Jump for Me; Blues for Basie; Jumpin' at the Woodside; Ain't It the Truth; Shorty George; 9:20 Special.

Conrad Gozzo, Pete Candoli, Harry Edison, trumpets; Frank Rosolino, trombone; Bob Enevoldsen, valve trombone, tenor saxophone; Bob Cooper, tenor saxophone; Buddy Collette, tenor and baritone saxophones, flute; Jimmy Rowles, piano; Joe Mondragon, bass; Bill Pitman, guitar; Buddy Rich, drums.

NORGRAN MG N-1086. 12-in. 41 min. \$3.98.

The nostalgic urge to form groups which sound like the old Basie band seems to be stronger among men who never played for Basie than in the Count himself. Buddy Rich has, in this fancy, come closest

of any to picking up the true Basie feeling even though his band, on paper, is not especially Basie-oriented. Harry Edison, a proper Basieite, is on hand and so is Jimmy Rowles, who has frequently played the Basie role at the piano; and there are the tunes from the old Basie book. But although Frank Rosolino, Bob Enevoldsen, Bob Cooper, Buddy Collette, and Rich himself are all products of other influences and even though they remain essentially themselves in these performances, they still manage to fit into the over-all Basie framework that has been skillfully provided by arranger Marty Paich. The Basie crispness is here, the brass tight and precise, the reeds hoarse but soft. Rich gets in the way with drum solos on a few occasions—*Jumpin' at the Woodside* suffers the most—and his lack of sensitivity is not very helpful in some other instances but, his lapses aside, these are sterling big band works in one of the finest jazz traditions.

TONY SCOTT: *The Touch of Tony Scott*

Aeolian Drinking Song; Deep Purple; Round About Midnight; Vanilla Frosting on a Beef Pie: Tony Scott, clarinet; Bill Evans, piano; Leslie Grinage, bass; Leonard McBrowne, drums.

The Jitterbug Waltz; My Old Flame; Walkin' on Air: Scott; Joe Wilder, John Carisi, trumpets; Jimmy Cleveland, Urbie Green, trombones; Danny Bank, baritone saxophone; Evans, piano; Barry Galbraith, guitar; Milt Hinton, bass; Osie Johnson, drums.

Rock Me But Don't Roll Me; The Moon Walks; You're Driving Me Crazy; Poinciana; Yesterdays: Scott; Wilder, Jimmy Maxwell, Jimmy Nottingham, Idrees Suliman, trumpets; Cleveland, Green, Bart Varsalona, Rex Peer, trombones; James Bufington, David Amram, French horns; Sam Marowitz, Gigi Gryce, Zoot Sims, Seldon Powell, Bank, saxophones; Janet Putnam, harp; Evans, piano; Mundell Lowe, guitar; Hinton, bass; Johnson, drums.

RCA VICTOR LPM 1353. 12-in. 41 min. \$3.98.

Presumably this presentation of Tony Scott with three different groups was supposed to be marked by variety. "Scarred" might be a better verb and "mish-mash" a more apt noun, but still and all it is a disc that demands attention. Most of its attraction is Scott himself, who has reached that vaunted position of being interesting no matter how dreadful his surroundings. He is one of the three most individual jazz musicians playing today (Dizzy Gillespie and Erroll Garner being the other two) and almost everything he plays has a good measure of validity. He is, furthermore, a consistently exciting jazzman. His *Aeolian Drinking Song* is a blazing virtuoso performance; on *Round About Midnight* he is darkly, starkly moody, and throughout the disc his carefully formed lines ride lightly in and out of arrangements that are not otherwise enticing. He is ably supported by pianist Bill Evans whose charging style catches fire on the few occasions when he is given a chance to be heard.

Far and away the best of these numbers

are those played by Scott's quartet. Here he is least hindered by pretentious arrangements. The so-called Tenet is less consistent, although John Carisi's *Walkin' on Air* lives up to its title at times. The big band writing is almost uniformly soggy, saved from complete turgidity by Scott's sometimes valiant solos. This big group has practically no feeling of swing and only Eddie Sauter's *The Moon Walks* is an adequately realized performance. But despite this, there is enough good Scott on this disc to justify its existence.

PAUL WHITEMAN: Fiftieth Anniversary

When Day Is Done; Limehouse Blues; Ramona; It Happened in Monterey; Rhapsody in Blue (Eugene Weed); *My Romance* (Tommy Dorsey); *The Night Is Young and You're So Beautiful* (Tommy Dorsey); *It's the Dreamer in Me* (Jimmy Dorsey); *Basin Street Blues* (Jack Teagarden); *Lazy River* (Teagarden); *Lover* (Teagarden); *Jeepers Creepers* (Teagarden and Johnny Mercer); *Christmas Night in Harlem* (Teagarden and Mercer); *Washboard Blues* (Hoagy Carmichael); *How High the Moon* (Joe Venuti); *Autumn Leaves* (Venuti); *Mississippi Mud* (The Rhythm Boys).

GRAND AWARD 33-901. Two 12-in. 76 min. \$9.95.

The Whiteman formula still works. Back in the late 1920s and early 1930s, he always had such topnotch jazz musicians as Bix Beiderbecke and Jack Teagarden in his orchestra to cut through the heavy syrup of his arrangements. In fact, practically the only reason that the Whiteman performances of those days are still remembered is because of the work of these jazzmen. In this album, marking Whiteman's fifty years in music, it happens again—jazzman Jack Teagarden makes it much, much more than just a nostalgic collection of Popsiana in hi-fi. He appears in five numbers, singing with a zest that has never been caught on discs before (*Basin Street Blues* and *Lazy River* by himself, *Christmas Night in Harlem* and *Jeepers Creepers* with Johnny Mercer), and playing his trombone (on all these plus *Lover*) in his most exhilarating form. Like all the contributions made by the Whiteman alumni to this set (except that of the Rhythm Boys), Teagarden's recordings are new and, as noted, high in fi. The Rhythm Boys bit is a long, somewhat forced excerpt from a broadcast of ten years ago. The album also includes new recordings of several old Whiteman arrangements and still another *Rhapsody in Blue*, which is not improved by Whiteman's efforts to invest it with the ricky-tick conception of jazz which he (and presumably Gershwin) held in 1924 when he introduced it at Aeolian Hall.

Other March Jazz

How Wide? Dave Garroway has lent his name to a mélange called *The Wide, Wide World of Jazz* (VICTOR LPM 1325. 12-in. 38 min. \$3.98), which runs a breathless gamut from 49th Street to 50th Street on Sixth Avenue. Garroway's is a twilight world populated by Peanuts Hucko's Good-

man-like swing band, pianist Barbara Carroll, singers Lee Wiley and Helen Ward, and a stolid Dixieland band led by Deane Kincaide. It is only a pale little sliver of the jazz globe. Ted Heath came all the way from England to play at Carnegie Hall last spring and the disc memento of that performance, *Ted Heath at Carnegie Hall* (London LL 1566. 12-in. 37 min. \$3.98), is also lacking in vitamins, although the sheen is glossier than that developed by Garroway's friends. George Chisholm, an English trombonist who stayed at home, does jazz more justice with a slightly modern small group which swings in genteel style through *Chis* (London LL 1491. 12-in. 39 min. \$3.98).

The wideness of the world of jazz is suggested more accurately as one moves on. *Rhythm Was His Business* (Victor LPM

1301. 12-in. 35 min. \$3.98), are updated versions of numbers associated with Jimmie Lunceford's sophisticated two-beat band by George Williams' orchestra. The ensemble kick is fine. The inappropriate soloists are disappointing. The raucous, carnival style two-beat of *Al Hirt and His New Orleans All Stars* (Southland 211. 12-in. 36 min. \$3.98) is in sharp contrast to the slick, Bob-Crosby-descended, Hollywood version of the same thing on *Jerry Colonna Plays Trombone Along the Dixieland Hi-Fi Way* (Liberty SL 9004. 12-in. 39 min. \$3.98). *Jazz at Cal Tech* (Pacific Jazz 1219. 12-in. 47 min. \$4.98) is a sample of the boneless type of modern jazz favored by Bud Shank's *Quartet Gil's Guests* (Prestige 7063. 12-in. 35 min. \$4.98) on which Gil Melle's Quartet, augmented by such visitors as Art Farmer,

HI-FI 'Round the World

*The Music Halls of Paris—
The Fever and Excitement*

Ca C'est Paris!

Souvenirs of Paris after dark by Aimable's torrid jazz combo. Grand Prix winner 1956.

12" London International TW8V-91159—\$4.98



*Modern Italy—
Gay and Romantic*

A Festival of Italian Song

The complete San Remo Festival, 1956. Twenty hit songs. More than 60 minutes of hi-fi listening.

12" Durium TDU 97001—\$4.98



*Exotic Brazil—
A Hi-Fi Impression*

Four Stops in BRAZIL

Sixteen captivating dance selections authentically performed by four tropical rhythm groups.

12" Decca/et-Thomson-DTL-93103—\$3.98



LONDON INTERNATIONAL, INC. 539 W. 25 St., New York 1, N. Y.

MUSIC MEANS MORE WITH MERCURY LIVING PRESENCE



Paul Paray • Photo: Spina

The important thing is what you hear!

Living Presence brings you music the way it should be heard, with startling clarity, perfect definition and full dynamic range—a unique tonal quality and fidelity to the original performance possible only with Mercury's renowned single microphone recording technique. Play the Paray MASS (MG 50128) or any Living Presence record...discover for yourself what Mercury means to good listening!

- A: PARAY Mass Commemorating the 500th Anniversary of the Death of Joan of Arc. Frances Yeend, soprano; Frances Bible, mezzo-soprano; David Lloyd, tenor; Yi-Kwei-Sze, bass. Detroit Symphony and Rackham Symphony Choir, Paul Paray conducting. MG50128 •
- B: LISZT Piano Concerto No. 1 in E-flat; GRIEG Piano Concerto in A Minor. Richard Farrell, piano. Halle Orchestra, George Weldon conducting. MG50126 •
- C: CHOPIN Les Sylphides; DUKAS La Peri. Halle Orchestra, George Weldon conducting. MG50117 •
- D: FREDERICK FENNELL conducts the MUSIC OF LEROY ANDERSON. Eastman-Rochester "POPS" Orchestra, Frederick Fennell conducting. MG50130 •
- E: VIENNESE NIGHT AT THE "PROMS" The Gypsy Baron Overture; Die Fledermaus Overture; Tales of the Vienna Woods; Blue Danube Waltz; Pizzicato Polka; Perpetual Motion; Annen Polka; Radetzky March. Halle Orchestra, Sir John Barbirolli conducting. MG50124

HIGH FIDELITY
OLYMPIAN
LIVING PRESENCE



Hal McKusick, Don Butterfield, and Kenny Dorham, gives determined readings of several of Melle's experimental compositions. The brightest moments occur when Melle is grunting Mulliganesquely on his baritone saxophone and Don Butterfield lumbers gracefully through some swinging passages for solo tuba.

Razaf: Even Madagascar and a lyric writer infringe on this month's jazz domain. Lyrics usually enter jazz only through the grace of some singer's treatment of them; but if there is any such thing as a writer of jazz lyrics, it must be Andy Razaf, a son of the late Grand Duke of Madagascar, who has contributed the words to an impressive number of jazz tunes. His *Ain't Misbehavin'*, *Memories of You*, *Honeysuckle Rose*, *Stompin' at the Savoy*, and *S'posin'* are sung with husky affection by Maxine Sullivan and played with a bright, Kirbyish bounce by a little band headed by Charlie Shavers on *Maxine Sullivan, Vol. II* (Period SPL 1207. 12-in. 40 min. \$4.98). One may cringe at finding that the words of *Ain't Misbehavin'* have been modernized to acknowledge the replacement of radio by television, but this is more than balanced by the discovery of an almost completely unknown set of lyrics written by Razaf to commemorate the all-Negro town of Mound Bayou, Mississippi. For this Leonard Feather has supplied a comfortably functional musical setting.

Solo Stuff: Thad Jones, a seasoned member of Count Basie's trumpeter section, steps out on his own with the backing of five other unrelated Joneses (Jimmy, Eddie, Jo, Reunald, and Quincy) on *The Jones Boys* (Period SPL 1210. 12-in. 43 min. \$4.98), playing several controlled and neatly organized solos at medium to fast gaits but wavering dolefully through a slow ballad. *Two Trumpets* (Prestige 7062. 12-in. 42 min. \$4.98) is an out-and-out blowing session on which Art Farmer and Donald Byrd go their separate ways at great and tedious length. Don Elliott's trumpeter is prominent through most of *The Bob Corwin Quartet* (Riverside 12-220. 12-in. 42 min. \$4.98). The two most rewarding selections are those on which Elliott retires and pianist Corwin works out some pleasantly melodic ideas on his own. Pete Jolly, a West Coast pianist, is back at his glib keyboard skee-daddling on *When Lights Are Low* (Victor LPM 1367. 12-in. 46 min. \$3.98) with more change of pace than he has shown before and for the first time a suggestion of emotion.

Solo reeds are represented by an alto saxophonist, Ernie Henry, who plays a forceful version of the flat-toned, neo-Parker style of alto on *Presenting Ernie Henry* (Riverside 12-222. 12-in. 38 min. \$4.98) and by the industrious Buddy De Franco whose clarinet is as cold, precise, and uninvolved as ever on *The Buddy De Franco Wailers* (Norgran 1085. 12-in. 44 min. \$3.98). Finally, there is a roundup of soloists on *Rhythm Plus One* (Epic LN 3297. 12-in. 40 min. \$3.98), with Conte Candoli, trumpet, Jimmy Cleveland, trombone, Seldon Powell, tenor saxophone, and Gene Quill, alto saxophone, each featured on three selections. The saxophonists walk off with the honors quite handily as both Powell and Quill give evidence of a continued broadening of their talents.



César Franck on Microgroove

by Paul Affelder

"OH, IT SOUNDED WELL, just as I thought it would." This was the famous remark made by César Franck upon his return home after the unsuccessful première of his Symphony in D minor. One is led to wonder what would be his comment today when, perusing a long-playing record catalogue, he would find thirteen different recorded versions of that same Symphony, not to mention ten of the Violin Sonata, seven of the *Variations symphoniques*, six of the *Prélude, Choral, et Fugue* for piano, and five of the *Pièce héroïque* for organ. No doubt he would be completely overwhelmed by such lasting public attention to his music; no doubt, too, he would be completely satisfied with even the poorest of these disc presentations.

For, when it came to performances of his own compositions, Franck was too easily satisfied. Perhaps he was so grateful that they were being performed at all that he lost all critical perspective; or perhaps, ignoring what actually entered his ears, he heard the music in his mind only as he wanted it to sound.

If we were to believe one of Franck's earliest and most-quoted biographers, his disciple Vincent d'Indy, we would have what seems to be the generally accepted impression of the man: a seraphic, retiring, unappreciated, misunderstood mystic, whose entire existence was spent in the organ loft at Sainte-Clotilde or in his organ classes at the Paris Conservatoire, a man adored—even idolized—by his pupils and almost completely ignored or opposed by the rest of the musical world. A highly romantic picture by a musician with a highly charged sense of the poetic, but somewhat less than accurate.

Let us examine a few of the facts. While still in his early teens and under the complete domination of his father, Franck began his career as a concert pianist, composer, and teacher. Although he earned a small success in the concert field and fairly confounded the examiners at the Conservatoire with his sight-reading ability at the piano and his intricate improvisations on the organ, for some years he composed nothing of lasting value, unless we give consideration to the prophetic Trio No. 1, in F sharp, Op. 1, which dates from his nineteenth year. At twenty-five he broke with his family and married; thereafter he was obliged for some time to eke out an existence as piano accompanist, organist, and teacher. All the while he was writing new music, but even he was seldom satisfied with it. Not even his appointment, in 1858, as organist at Sainte-Clotilde brought forth any new music of significance, although four years later he was able to produce his *Six Pièces* for organ. Once again, ten years passed without any memorable contributions from his pen.

Finally, in 1872, at the age of fifty, when he was made professor of organ at the Conservatoire, Franck found himself. Encouraged by his pupils—who, indeed, did revere him—and by performances of his works by the newly formed Société Nationale de Musique, he began to write in a genuinely creative

style. Nearly all of his really worthwhile music was created during the last nineteen years of his life. Small wonder, then, that recognition came late. But recognition *did* come. The musical press almost always had been kind to him; now the public, too, began to awaken to the new beauties in his compositions. What hostility he encountered emanated mostly from the more reactionary members of the Conservatoire faculty and—strange as it may seem—from his own wife and sons. The professors resented the fact that he spent most of the time in his organ classes teaching improvisation and composition, while his family kept urging him to turn out music that was less adventurous and more readily salable.

We must not discount the influence upon Franck's music of his years as a church organist. The so-called mystical characteristics of that music derived not so much from religious fervor as from his close and constant association with the instrument itself. The chief Franckian hallmarks—intricate counterpoint, chromatic harmonies, constant modulation, and a quasi-improvisational style—all had their source directly in the organ loft at Sainte-Clotilde. So did the ethereal quality of his music. Three other distinguishing qualities apparently defy explanation. The first is the tendency of his themes to hover around one central note. The second is his inclination to write, for the most part, only one example of each type of work—one symphony, one string quartet, one violin sonata, and so on. The third is his surprising failure to create any significant music for the church. Finally, mention must be made of his preoccupation with the cyclical form, which recurs repeatedly in his compositions. He was not the originator of this practice of binding a work together by using a central theme or group of themes in more than one movement—examples of cyclical form can be found as far back as Beethoven—but he was the first to build whole compositions around it.

Nor can Franck's importance as a teacher be minimized either. During the last period of his life, he gathered about him at the Conservatoire a devout and closely knit coterie of disciples—men like Vincent d'Indy, Ernest Chausson, Henri Duparc, Guy Ropartz, Gabriel Pierné, and Guillaume Lekeu—who not only rallied to their master's support during his lifetime but carried on the letter and spirit of his style in their own compositions.

In many discographies mention has to be made of the omission of certain key works from the recorded repertoire or of inadequate performances of those which are represented by only one or two versions. Franck has not been thus neglected, or at least not badly. With the exception of his choral works—especially the early *Ruth* and *Mass for Three Voices* and the later *Les Béatitudes*, all of which have been subjected to some justified criticism—practically every Franck work of value has been recorded more than once, and in performances that would satisfy ears more fastidious than those of their composer.

**Walco
PRODUCTS**

Just for
the Record



**WALCO
STATI-CLEAN
ANTI-STATIC
RECORD SPRAY**

STOPS STATIC DUST. Walco Stati-Clean is your best defense against dust—major cause of record and needle wear. Stati-Clean spray cleans the disc surface, stops static electricity that attracts dust. Handling and "dusting" no longer builds up static. Stati-Clean improves fidelity, eliminates static "crackle." Lasts dozens of plays, no need to reapply each time. Tested safe—thousands sold. Complete with special applicator cloth.

**WALCO
DISCOVERS
PROTECTIVE SLEEVES
FOR RECORDS**

Walco DISCOVERS—now with the new contoured bottom—are the perfect answer to record protection. You slide your records into DISCOVERS, then into the original jacket. No more scratches, moisture or finger marks from handling. DISCOVERS seal out dust, protect against extremes of temperature, accidental spillage of liquids. They keep the sound safe and sound! Packaged 12 12-in. sleeves or 15 10-in. sleeves.

**WALCO
REPLACEMENT
NEEDLES
FOR LONGER RECORD LIFE**

Osmium and sapphire-tipped styli are rated only about 20 to 60 hours of play, after which they develop chisel-edged flats. These flats shear highs from your records, ruin groove walls. Periodic needle replacement is an absolute necessity for the serious music lover. You replace with the finest when you replace with Walco needles (and the superb Walco Diamond)—first choice of major cartridge manufacturers.

AT LEADING MUSIC DEALERS EVERYWHERE

Send For Free Sample Discover and Strobe Disc To Test Your Turntable Accuracy

Walco

Trade Name of Electrovox Co., Inc.
60-H Franklin St., East Orange, N. J.

ORCHESTRAL WORKS

SYMPHONY IN D MINOR (13 Editions)

This music not only has great intrinsic interest as a representation of Franck's own compositional style, with its colorful modulations and fine exploitation of cyclical form; it also suggests his extraordinary influence on his followers, especially Chausson, whose Symphony in B flat could, in many respects, be listened to as a Symphony No. 2 by Franck. Probably very few admirers of Franck do not already own at least one recording of his symphony; but for those who do not have it or wish a new version, there is a wide field of choice.

Paray captures first place by virtue of his dynamic and always fresh approach to an overworked score. No mawkish sentimentality here; drama is paramount. Though the reproduction becomes raspy and a bit distorted in achieving the big climaxes, this performance is still likely to hold up best. The Ormandy disc is notable for polished orchestral playing and naturalness of sound, kept at a level that never distorts the heavier passages and that suggests the auditory perspective of the ideal concert-hall seat. The interpretation itself is traditional and in good taste.

Vitality, flexibility, and the sense of forward movement—without loss of emotion or poetic feeling—are the characteristics of both Monteux performances. Neither recording is outstanding, but the newer Victor disc is the better balanced. Cluytens, who enjoys distortionless reproduction, gives a mellower over-all picture than his competitors. Leinsdorf's is a firm, sensible, yet amply warm reading, recorded in a reasonably wide-range, distortion-free manner. Since the Robin Hood Dell Orchestra is the Philadelphia Orchestra in summer dress, the playing is exceptionally fine. Against such polished playing the Hague Philharmonic cannot compete, yet Van Otterloo's interpretation is clean and often dramatically tense, if a trifle broad in portions of the first movement.

Other versions require careful weighing of merits and demerits. Westminster provides Rodzinski with the clearest, most realistic sound of all, but the interpretation is unduly calculated and is further marred by some highly individual liberties in tempo and phrasing. Very much the same may be said of Cantelli, with recording second only to Westminster's and a note-perfect reading. The first two movements are colorless; the exuberance of the Finale is finely tempered by some softly molded phrase lines. Munch is in a hurry throughout, running phrases together in his haste; while Golschmann ranges from routine to stodgy. The worst distortion in Mitropoulos' old disc is not, surprisingly enough, in the reproduction but in the interpretation, especially in the first movement, where it is almost impossible to differentiate between the *lento* and the *allegro non troppo*. Superior sound is completely wasted on Furtwängler; the music is almost unrecognizable.

—Paul Paray, Detroit Symphony, MERCURY MG 50023. \$3.98.

—Eugene Ormandy, Philadelphia Orchestra. COLUMBIA ML 4939. \$3.98.

—Pierre Monteux, San Francisco Symphony. RCA VICTOR LM 1065. \$3.98.

—André Cluytens, Orchestre National de la Radiodiffusion Française. ANGEL 35029. \$4.98 (or \$3.48).

—Erich Leinsdorf, Robin Hood Dell Orchestra. RCA VICTOR LBC 1001. \$2.98.

—Willem van Otterloo, Hague Philharmonic. EPIC LC 3019. \$3.98.

—Artur Rodzinski, Vienna Staatsoper. WESTMINSTER WN 18291 (with *Le Chasseur maudit*). \$3.98.

—Monteux, San Francisco Symphony. RCA CAMDEN CAL 107. \$1.98.

—Guido Cantelli, NBC Symphony. RCA VICTOR LM 1852. \$3.98.

—Charles Munch, Conservatoire Orchestra (Paris). LONDON LL 464 (with *Variations symphoniques*). \$3.98.

—Vladimir Golschmann, St. Louis Symphony. CAPITOL P 8221. \$3.98.

—Dimitri Mitropoulos, Minneapolis Symphony. COLUMBIA-ENTRE RL 3006. \$1.98.

—Wilhelm Furtwängler, Vienna Philharmonic. LONDON LL 967. \$3.98.

LE CHASSEUR MAUDIT (4 Editions)

Franck's second symphonic poem, *The Accursed Huntsman*, composed in 1882, is one of his most dramatic, if not profound, scores. Based on a ballad by Gottfried Bürger, it is a fairly literal depiction of a huntsman who dares to follow the hounds on Sunday, for which sacrilegious act he is condemned forever to be hunted by the demons of hell.

Both the Beecham and the Rodzinski versions deserve high praise for the clarity of their interpretations—the former for its animated treatment of the opening, its general forcefulness, and its atmosphere of the supernatural, the latter for the realism of the recorded sound. More speed but less impact emerges from Cluytens, whose orchestra isn't as scrupulous as its competitors; the horns, in particular, play with too much vibrato, the characteristically French-sounding trumpets cut through the ensemble with excessive brassiness, and the chimes are disconcertingly flat in pitch. The hunt never gets very far with Goehr, whose perfunctory reading of the score is cramped further by limited sonics.

—Sir Thomas Beecham, Royal Philharmonic. COLUMBIA ML 4454 (with Rimsky-Korsakov: *Le Coq d'or, Suite*). \$3.98.



Paul Paray

HIGH FIDELITY MAGAZINE

—Rodzinski, Vienna Staatsoper. WESTMINSTER WN 18291 (with Symphony in D minor). \$3.98.

—Cluytens, Conservatoire Orchestra (Paris). ANGEL 35232 (with *Psyché*; *Rédemption*). \$4.98 (or \$3.48).

—Walter Goehr, Netherlands Philharmonic. CONCERT HALL CHS 1243 (with *Les Eolides*; *Psyché*). \$3.98.

LBS DJINNS (1 Edition)

The supernatural dominates all four of Franck's symphonic poems. Inspired by a Victor Hugo poem about oriental spirits, the music here remains pure Franck, except where a little Liszt creeps into a few of the passages for piano. A spiritual ancestor of the *Variations symphoniques* and d'Indy's *Symphonie sur un chant montagnard français*, Op. 25, *Les Djinns* uses the piano as an integral part of the orchestra. If it lacks the musical strength of *Le Chasseur maudit* and *Les Eolides*, it is still a pleasant work too seldom heard.

Sensitivity and fluency mark the solo pianism of Annie d'Arco and the direction of George Sebastian, who, by design or coincidence, leads the same orchestra that gave the piece its première in 1885. Reproduction is bright, with more emphasis on highs than lows.

—Annie d'Arco, piano; George Sebastian, L'Association des Concerts Colonne, URANIA URLP 7099 (with Saint-Saëns: *Le Carnaval des animaux*). \$3.98.

LES EOLIDES (1 Edition)

The earliest of Franck's symphonic poems and one of his most beautiful orchestral creations, *Les Eolides* embodies a foretaste of *Psyché*; in fact, two of its themes are quoted in the later work. Unfortunately neither the interpretation nor the sonics on this disc do justice to the music. Even though the sound is brighter than in the other two compositions on the record, Goehr's reading, while maintaining the requisite zephyrlike lightness and transparency, is slow and prosaic.

—Goehr, Netherlands Philharmonic. CONCERT HALL CHS 1243 (with *Le Chasseur maudit*; *Psyché*). \$3.98.

PSYCHE (1 Edition)

Idyllic love between a mortal and a god—love found, love lost, love regained—is the subject of this surpassingly beautiful lyrical composition. Since three of its sections enlist the services of a chorus, they are usually omitted in concert performances. The purely instrumental four-movement suite that remains is exquisite in itself, but the choral parts add unity to the work—in particular rendering more effective the exultant *Psyché et Eros* as it evolves from the preceding vocal passages.

Listening to Van Otterloo's highly idiomatic performance and the singer's beautiful enunciation, one would think the work was being presented by French rather than Dutch artists. To these desiderata is added excellent, carefully balanced sound.

—Van Otterloo, Netherlands Chamber Choir, Hague Philharmonic. EPIC LC 3146. \$3.98.

PSYCHE, CONCERT SUITE (4 Complete Editions)

1. *Sommeil de Psyché* (2 additional editions)

2. *Psyché enlevée par les zephyrs* (2 additional editions)

3. *Le jardin d'Eros*.

4. *Psyché et Eros* (3 additional editions)

In his presentation of the four-movement concert suite, Van Beinum, another Dutchman with a French touch, delivers a performance marked by noble breadth and ethereal loveliness in the first, second, and fourth movements and added dramatic impact in the third. The range of tone and volume is wide, and the strings have a particular luster. Cluytens, as is his wont, is less forthright in approach, one reason, perhaps, being that the Conservatoire Orchestra (Paris) enforces caution, since it lacks the virtuosity of the Concertgebouw. Some may prefer André's faster pace, with the accent on the music's dramatic features; but this treatment imparts earthiness to a score notably unearthly. Goehr's slow, tepid interpretation binds him even closer to the ground.

Had his version included the third movement, Paray could well have shared top honors with Van Beinum. More than any other, his disc preserves the music's inherent delicacy and transparency. Jochum is apathetic throughout, while the focus of sound is entirely on the middle register. As might be expected, Toscanini's is a most expressive account of No. 4, with a broad but properly incisive climax and immaculate orchestral execution, pushed somewhat into the distance, however, by the microphone placement.

—Eduard van Beinum, Concertgebouw (Amsterdam). LONDON LD 9081. 10-in. \$2.98.

—The same. LONDON LL 852/3 (with Bruckner: Symphony No. 7, in E). Two 12-in. \$7.96.

—Cluytens, Conservatoire Orchestra (Paris). ANGEL 35232 (with *Le Chasseur maudit*; *Rédemption*). \$4.98 (or \$3.48).

—Franz André, Orchestra Symphonique de la Radiodiffusion Belge. TELEFUNKEN LGX 66024 (with De Greef: *Four Old Flemish Folk Songs*). \$4.98.

—The same. TELEFUNKEN LGX 66028 (with Saint-Saëns: *Le Carnaval des animaux*). \$4.98.

—Goehr, Netherlands Philharmonic. CONCERT HALL CHS 1243 (with *Le Chasseur maudit*; *Les Eolides*). \$3.98.

Nos. 1, 2, and 4 only:

—Paray, Detroit Symphony. MERCURY MG 50029 (with Fauré: *Pavane*; Ravel: *La Valse*). \$3.98.

—Ludwig Georg Jochum, Linz Bruckner Symphony. URANIA URLP 7024 (with Berlioz: *Les Francs-Juges*, Overture, Op. 3). \$3.98.

No. 4 only:

—Arturo Toscanini, NBC Symphony. RCA VICTOR LM 1838 (with Mussorgsky-Ravel: *Pictures at an Exhibition*). \$3.98.

REDEMPTION (3 Editions)

Rédemption, completed in 1874, is an early oratorio in three parts—two choral sections separated by a symphonic interlude. Only the latter seems to attain performance, and its dull, warmed-over Wagnerian pomposity makes one wonder why even it does. All three readings are about on a

THE REAL STUFF!

THE SPICIER PARIS HAUNTS where tourists go, and the more genuine quarters where Frenchmen go, have now been captured in pure melody by famed French conductor-composer André Colbert. It's the loveliest album of Parisian listening-music to come your way in a month of Tuesdays.

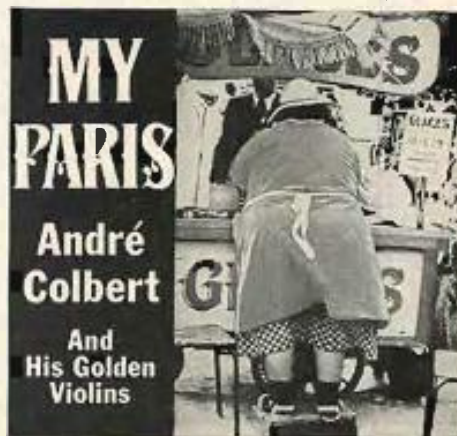

"My Paris" (10057) was brought from France by CAPITOL OF THE WORLD with two kinds of people in mind. First, for those who know Paris (and wouldn't consider a musical portrait by an outsider). Second, for the Yank who can make the trip only in his fancy—which, if less satisfactory, is also less expensive.

In either case, here is the real stuff, the real music of Paris—romantic melody that can never be copied.

"THE MUSIC OF HUNGARY" (10085) reflects a bittersweet blend of melancholy and high spirits. It is moody, gay, unrestrained. Recorded during the past decade by two of Hungary's most popular singers, it tells of love and sadness against a background of artful gypsy violins. Unforgettable.

Other CAPITOL OF THE WORLD albums include:
ARGENTINE YANOGS—No. 10053
ROMANCE IN ROME—Dino Olivieri—No. 10029
MY LONDON—Ray Martin—No. 10056



par—expressive with well-built climaxes. If Fournet gains a slight advantage, it is principally because the Lamoureux is a better-sounding orchestra than that of the Conservatoire, boasting richer strings and firmer brasses. Epic also has provided a broader tonal spectrum and greater hall resonance; by contrast, the Conservatoire forces, especially on the Urania disc, appear to be playing in an absorbent studio. —Jean Fournet, *Concerts Lamoureux*. EPIC LC 3067 (with Chausson: *Symphony in B flat*, Op. 20). \$3.98.
 —Cluytens, Conservatoire Orchestra (Paris). ANGEL 35232 (with *Le Chasseur maudit; Psyché*). \$4.98 (or \$3.48).
 —George Sebastian, Conservatoire Orchestra (Paris). URANIA URLP 7061 (with Berlioz: *La Damnation de Faust*, Three Excerpts; *Marche funèbre pour la dernière scène d'Hamlet*). \$3.98.

VARIATIONS SYMPHONIQUES (7 Editions)

Franck's only work for solo instrument and orchestra presents an old form—theme and variations—in an interesting new guise. A more accurately descriptive title would be Introduction, Variations, and Finale, the variations amounting to little more than an interlude between two more imposing sections—which, incidentally, hardly concern themselves with the main theme at all.

All seven disc versions of this popular composition are of such high quality that evaluating them in order of relative merit is a highly personal matter. Six months hence I might argue even with my own choices. Giesecking's interpretation earns my respect for its expressiveness and flexibility, its well-planned peaks and valleys. The variations, played very slowly, take

on great dignity; and the finale, begun in this same leisurely tempo, develops gradually and naturally out of the preceding material. The recording isn't new, but it is reasonably faithful. Ciccolini, whose piano almost outbalances the orchestra, takes a similar interpretative attitude, though he fails to build up sufficient momentum in the finale. An outstanding feature of Badura-Skoda's disc is the realistic sound; others are the fine proportion, careful shading, and inner strength of his reading, culminating in an exuberant finale.

Casadesus's is a dynamic performance, one that moves constantly forward. Unhappily the reproduction is outdated. Eileen Joyce, too, suffers from low-grade sound, several abrupt phrases betraying the fact that her recording was resuscitated from 78-rpm discs carelessly spliced. These technical defects are not sufficient, however, to detract entirely from the value of her unhurried, almost introspective, treatment of the score. Bruchollerie also has an interesting approach, though neither I nor her conductor (to judge from his phrasing) can altogether agree with her deliberate avoidance of legato. Doyen offers a workmanlike rendition, slightly hard-textured in recording, needing more subtlety and poetic insight than it receives.

—Walter Giesecking; Herbert von Karajan, Philharmonia Orchestra. COLUMBIA ML 4536 (with Mozart: *Concerto No. 23*, in A, K. 488). \$3.98.

—The same. COLUMBIA ML 4885 (with Grieg: *Concerto in A minor*, Op. 16). \$3.98.

—Aldo Ciccolini; Cluytens, Conservatoire Orchestra (Paris). ANGEL 35104 (with d'Indy: *Symphonie sur un chant montagnard français*). \$4.98 (or \$3.48).

—Paul Badura-Skoda; Rodzinski, Philharmonic Symphony of London. WESTMINSTER W-LAB 7030 (with Rimsky-Korsakov: *Concerto for Piano and Orchestra*). \$7.50.

—Robert Casadesus; George Weldon, Philharmonia Orchestra. COLUMBIA ML 4298 (with d'Indy: *Symphonie sur un chant montagnard français*). \$3.98.

—Eileen Joyce; Munch, Conservatoire Orchestra (Paris). LONDON LL 464 (with *Symphony in D minor*). \$3.98.

—Monique de la Bruchollerie; Jonel Perlea, Colonne Orchestra. VOX PL 9750 (with Rachmaninoff: *Rhapsody on a Theme of Paganini*). \$4.98.

—Jean Doyen; Fournet, Lamoureux Orchestra. EPIC LC 3057 (with Fauré: *Ballade; Saint-Saëns: Concerto No. 5*, in F, Op. 103). \$3.98.

EPIC

in cooperation with the
FROMM MUSIC FOUNDATION
 announces the first four releases in its new
TWENTIETH CENTURY COMPOSERS SERIES



Leon Kirchner: *Trio for Violin, Cello and Piano; Sonata Concertante for Violin and Piano*. Nathan Rubin and Eudice Shapiro, violins, George Neikrug, cello, Leon Kirchner, piano. (LC 3306)



Wilhelm Killmayer: *Missa Brevis for Mixed Chorus A Cappella*. Lou Harrison: *Mass for Mixed Chorus, Trumpet, Harp and Strings*. N.Y. Concert Choir and Orch., M. Hillis, Director. (LC 3307)



Benjamin Lees: *String Quartet No. 1*. William Denny: *String Quartet No. 2*. Juilliard String Quartet. (LC 3325)



Jerome Rosen: *String Quartet No. 1*. Ilhan Usmanbas: *String Quartet (1947)*. New Music String Quartet. (LC 3333)

First recordings by top-ranking artists. All works have received the FROMM MUSIC FOUNDATION award.

A PRODUCT OF CBS



CHAMBER MUSIC

QUINTET FOR PIANO AND STRINGS, IN F MINOR (2 Editions)

Composed in 1879, the Quintet is the first of the big Franckian works to employ cyclical form, one or two central themes recurring in a dominant position through the three movements. The first and third of these movements are dramatic, the second quieter-flowing and contemplative.

These characteristics are preserved much more faithfully by the Chigis than by their American colleagues, whose constant concern over achieving equitable balance inhibits their playing and puts the stamp of excess gentility upon their interpreta-

tion. Sonically, both recordings provide intimacy together with sufficient resonance; but again London is superior in offering brighter highs, fuller bass, and a better facsimile of the piano tone which, on the Capitol disc, takes on occasional hardness. —Chigi Quintet. LONDON LI 201. \$3.98. —Victor Aller, piano; Hollywood String Quartet. CAPITOL P 8220. \$3.98.

QUARTET IN D (4 Editions)

If the Quintet heralded the decade of Franck's major works in cyclical form, the Quartet, dating from 1889, brought this period to a close. Like the Symphony, written only a year earlier, it fully develops a central idea, at the close of its last movement summing up all the principal themes that have appeared in the entire work. But where the Symphony restates these themes singly, the Quartet combines two or three of them in an awesome display of the composer's mastery as a contrapuntist.

But there is much more interest in this music than mere thematic contortion and contrapuntal interlacing; there is unashamed romanticism in the first and third movements, bewitching mystery in the Scherzo, and ferocious drive in the Finale. The Parrenins, an excellent, warm-toned group, are more romantically inclined and more meticulous in their phrasing than the Loewenguths, who concentrate on dramatic intensity and technical precision, although not at the sacrifice of inner glow. Since the efforts of both ensembles have been faithfully transmitted to microgroove through close-to but uncramped microphoning, the preference for one or the other is a matter of personal taste. I lean very slightly toward the Parrenins who, I feel, come closer to the spirit of the work. The Pascals capture this spirit, too, but they are neither the technical nor tonal equals of the other three quartets; furthermore, faulty ensemble or studio placement gives undue prominence to the two middle voices. Technically clean and tonally opulent, the WQXR Quartet emerges as the most polished of the lot; what it lacks in its headlong dash through the four movements is refinement, subtlety, and a convincing point of view.

—Parrenin Quartet. WESTMINSTER WN 18136. \$3.98.

—Loewenguth Quartet. EPIC LC 3227. \$3.98.

—Pascal Quartet. CONCERT HALL CHS 1182. \$3.98.

—WQXR Quartet. POLYMUSIC PRLP 1010. \$5.95.

TRIO NO. 1, IN F SHARP, OP. 1, NO. 1 (1 Edition)

Franck was only nineteen and still a student when he wrote this, the first of four trios and his first published work. The miracle of Beethoven's Opus 1 Trios is not repeated here. Much of the writing is awkwardly choppy; whole sections are hermetically sealed off, without any bridge passages to connect them to each other. There is constant experimentation with the different sounds three instruments are capable of producing. Some of these experiments come off successfully, especially one in the first movement that provides

a startling augury of sounds to be recreated thirty-eight years later in the Quintet; others remain pedestrian exercises. Most important of the experiments is the young composer's first trial flight in the direction of cyclical form. The two dominant themes may lack impressiveness and the use to which they are put may seem naive, yet the germ of the idea is here. A mature craftsman in his fifties and sixties could be expected to do more with it than a lad of nineteen.

The members of the Trio di Bolzano are obviously sincere in their devotion to this early score and extremely careful in their treatment of it. One must regret, however, the harshness of the violinist's tone, a defect which may be due partly to the reproduction, otherwise satisfactory.

—Trio di Bolzano. VOX PL 8950 (with Chausson: Trio in G minor). \$4.98.

SONATA FOR VIOLIN AND PIANO IN A (10 Editions)

Cyclical form takes on a different aspect every time Franck uses it. In the Violin Sonata the treatment is cumulative, each succeeding movement picking up themes from its predecessors. The Sonata encompasses a wide range of moods, as well. Its opening movement is placid, the second turbulent, the third improvisatory, and the fourth is a rondo whose principal subject takes the unexpected form of a canon.

Fuchs's and Balsam's approach to the Sonata is intense and dramatic. Bobesco and Genty, a velvety and expressive duo,

NEW RELEASES

"L'Arlésienne—Complete Recording" (Daudet-Bizet)



Chorus and
Orchestra of the Paris Opera
Conductor: Albert Wolff
Members of the Comedie-Francaise
Director: Max de Rieux

Rose Mamal Mary Marquet
La Renaude Berthe Bovy
Balthazar Maurice Chambreuil
Frédéri Hubert Noël
Francet Mamal Pierre Larquey
Patron Marc Fernand Sardou
Mitifo Robert Vidalin
L'Innocent Jacques Bernand
Vivette Bernadette Lange

Free French-English translation
with profuse analytical material.
XLL-1489/90 \$9.96

"Mantovani Plays Music from the Ballet"

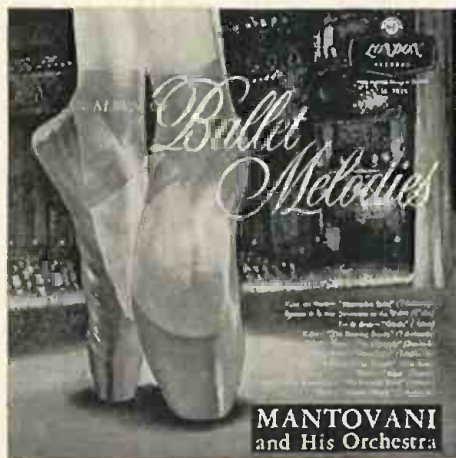

Waltz of the Flowers from The Nutcracker, *Tchaikovsky*; Invitation to the Waltz, *Weber-Berlioz*; Pas de Deux from *Giselle*, *Adam*; Waltz from The Sleeping Beauty, *Tchaikovsky*; Finale from Dance of the Hours, *Ponchielli*; Waltz from Swan Lake, *Tchaikovsky*; The Swan from Carnival of the Animals, *Saint-Saens*; Waltz from Faust, *Gounod*; Dance of the Comedians from Bartered Bride, *Smetana*; Waltz from Eugen Onegin, *Tchaikovsky*.

Mantovani and His Orchestra
LL-1525 \$3.98

LONDON
RECORDS

539 W. 25th St., New York 1, N. Y.





GIROLAMO FRESCOBALDI

(1583-1643)

PARTITAS • CANZONI
GAILLARDS • CORRENTI
PAUL WOLFE, harpsichord

EA-0022 Price \$5.95

LAS CANTIGAS DE SANTA MARIA
DEL REY ALFONSO EL SABIO
(Music of the Middle Ages;
Volume III—The Thirteenth Century)

RUSSELL OBERLIN, countertenor
JOSEPH IODONE, lute

EA-0023 Price \$5.95

FOR COMPLETE CATALOG WRITE:
EXPERIENCES ANONYMES
20 East 11th Street, New York 3



OVERTURES FROM SPAIN FM. 88

MONTILLA
presents

A NEW SOUND FROM SPAIN

10 INSTRUMENTAL SELECTIONS
written by Spain's greatest composers.

JOSE LUIS LLORET

conducting the
ORQUESTA de CAMARA de MADRID

Recorded in Spain with all its splendor on a
MONTILLA HI FI RECORDING
ON SALE AT ALL LEADING RECORD SHOPS
Write to Dept. F-3 for complete new catalog

131 East 23rd Street, New York 10, N. Y.



prefer to revel in the work's tonal wonders. Francescatti and Casadesus play with real authority, but their recording is dated; its limited range takes all the glitter out of the piano tone. Oistrakh and Oborin make another fine pair of collaborators, producing a solid, powerful performance. Presumably, the Vanguard and Colosseum discs were processed from the same Soviet tapes. Though the former is decidedly superior, with higher level, better focus, less distortion, and none of the latter's surface noise, the hardness of the violin tone and hollowness of the piano, plus some annoying pre-echo, force me to give these artists a lower rating than they would otherwise receive.

In both the Renardy-List and Oistrakh-Yampolsky versions, the violinist appears the stronger, the pianist taking a subsidiary role. List, however, is inclined to assert himself more forcefully than Yampolsky, who as a companion to Oistrakh, is no match for the more interesting Oborin. Renardy's assured attack is well proportioned, if occasionally lacking in softness. Oistrakh, recorded this time in Stockholm, has a chance to show off his tonal suavity. No one, though, is as suave as Heifetz and Rubinstein. Slick might be the better word to describe their reading, which glides along so smoothly that it frequently glosses over the surface without searching beneath it. The Kitain brothers are very uneven; no two successive measures are in the same tempo, the violinist's bowing is jerky and his intonation poor, while the pianist strikes many wrong notes.

Rose and Hambro merit special consideration. It is not an uncommon practice to transpose the violin part down an octave to suit the cello, which sounds equally at home and just as appropriate. Especially is this true of the present performance, a carefully planned and executed interpretation, both tasteful and eloquent, and one of the most naturally recorded of all.

—Joseph Fuchs, violin; Artur Balsam, piano. DECCA DL 9716 (with Fauré: Sonata No. 1, in A, Op. 13). \$3.98.

—Lola Bobesco, violin; Jacques Genty, piano. LONDON LS 326. 10-in. \$2.98.

—Zino Francescatti, violin; Robert Casadesus, piano. COLUMBIA ML 4178 (with Debussy: Sonata No. 3, in G minor). \$3.98.

—David Oistrakh, violin; Lev Oborin, piano. VANGUARD VRS 6019 (with Prokofiev: Sonata No. 1, in F minor). \$4.98.

—Ossy Renardy, violin; Eugene List, piano. REMINGTON R 199-148 (with Ravel: Sonata). \$3.98.

—David Oistrakh, violin; Vladimir Yampolsky, piano. ANGEL 35163 (with Szymanowski: Sonata in D minor). \$4.98 (or \$3.48).

—Jascha Heifetz, violin; Artur Rubinstein, piano. RCA VICTOR LCT 1122 (with R. Strauss: Sonata in E flat, Op. 18). \$3.98.

—David Oistrakh, violin; Oborin, piano. COLOSSEUM CRLP 151 (with Schubert: Sonata No. 13, in A, Op. 120). \$3.98.

—Roberto Kitain, violin; Anatole Kitain, piano. M-G-M E 3103 (with Brahms: Sonata No. 3, in D minor, Op. 108). \$3.98.

Version for cello and piano:

—Leonard Rose, cello; Leonid Hambro, piano. COLUMBIA ML 4652 (with Grieg: Sonata in A minor, Op. 36). \$3.98.

ORGAN

POSTHUMOUS PIECES (1 Edition)

Although the organ was Franck's chosen instrument, the number of works he created for it is not much larger than that he wrote for other instruments. What these compositions reveal most fully is Franck's amazing skill at improvisation. For his fellow organists who possessed neither this skill nor the instrument on which to exercise it, he composed two collections of short pieces for harmonium or pedal organ, to be used in daily church services. The first of these collections—the one recorded here—comprises thirty miscellaneous works, composed between 1858 and 1863 and published after his death as *Pièces Posthumes Pour Harmonium ou Orgue à Pédales pour l'Office Ordinaire*. The music is usually uncomplicated and often very short, sometimes only a few measures in length. In some of the more extended pieces the influence of Bach is stronger than that of Franck, whose unique musical voice had not developed. The disc represents some of the composer's earliest work. The second collection, also published posthumously under the title of *L'Organiste*, was to have consisted of ninety-one versets to be incorporated in performances of the Magnificat, with seven different settings for each of the thirteen keys from C to C; actually Franck had completed only fifty-nine when he died.

Watters has recorded both collections to make his survey of the master's organ works complete, but Classic has not yet released *L'Organiste*. In playing the *Pièces Posthumes*—incorrectly labeled *L'Organiste*, Book 2—he remembers that the music was written primarily for harmonium, and therefore employs mostly reed stops, using the pedals sparingly, only to supply a little body where it is needed.

—Clarence Watters. CLASSIC CE 1017. Two 12-in. \$9.96.

SIX PIECES, OPP. 16-21 (1 Complete Edition)

Franck's most important organ compositions were concentrated in three groups, produced at fairly long intervals: the *Six Pièces* of 1862, the *Trois Pièces* of 1878, and the *Trois Chorals* of 1890. Written when he was already forty, the *Six Pièces* are actually the earliest of his significant works to maintain a foothold in the ever-changing active repertoire. They comprise the short, reposeful, and rather uninteresting *Fantasia* in C, Op. 16; the *Grande pièce symphonique*, Op. 17, a veritable three-movement symphony for organ, the themes of whose first two movements are recapitulated in the third; the *Prélude, Fugue, et Variation*, Op. 18, featuring one of Franck's simplest, most ingratiating, long-spun melodies repeated, after a fugal interlude, with a running counterpoint; the *Pastorale*, Op. 19, an idyl; the *Prière*, Op. 20, another weak link in this series; and the bravura, almost completely un-Franckian *Final* in B flat, Op. 21, strong, brilliant, and obviously influenced by the Bach toccatas.

To expect one organist to make the most of all six of these divergent pieces is almost unreasonable. Watters makes a noble attempt, but he is not always successful. Since the relative merits of the

different recordings vary from piece to piece, and since no two discs contain all of the same works, it is advisable to consider separately each of the component parts of the *Six Pièces*, as follows:

1. *Fantasia in C, Op. 16* (1 edition)

Watters matches the mood of the music by playing and registering it in a quiet fashion. The level of recorded sound is also low.

—Watters. CLASSIC CE 1014 (with *Grande pièce symphonique; Prélude, Fugue, et Variation; Pastorale; Prière; and Final* in B flat). Two 12-in. \$9.96.

2. *Grande pièce symphonique, Op. 17* (4 editions)

A feeling of authenticity attaches to Langlais' recording, because it was made on Franck's own organ at Sainte-Clotilde. His performance is rather animated, his full registration calculated to produce a dramatic effect, especially in his broad treatment of the main theme when it returns in the major mode in the Finale. The church is reverberant, but this is no great deterrent to the well-balanced reproduction. A little more bass would have helped both this record and the one by Nies-Berger. The latter, a less exciting account, also has less variety of tone color and a lighter, less imposing Finale which, though easier on the recording engineers, is not as interesting to the listener. One has to be his own engineer in order to play the Watters disc. In the first two movements the level is extremely low, requiring a boost of the volume control. Everything is saved up for the Finale, at which point the dial must be reset. Where the Langlais and Nies-Berger discs were short on bass, this one gives too much prominence to the pedal stops for optimum balance. Distorted sound is the only factor that keeps Fox out of first place. In the acoustically more absorbent John Hays Hammond Museum at Gloucester, Massachusetts, he can step up the tempos without fear of blurring, make frequent shifts of stops without awkwardness, and, on the whole, present a lively, imaginative performance.

—Jean Langlais. LONDON DTL 93071 (with *Prière; Final* in B flat). \$3.98.

—Edouard Nies-Berger. CONCERT HALL CHS 1145 (with Liszt: *Variations on "Weinen, Klagen"*). \$3.98.

—Watters. CLASSIC CE 1014 (with *Fantasia in C; Prélude, Fugue, et Variation; Pastorale; Prière; Final* in B flat). Two 12-in. \$9.96.

—Virgil Fox. RCA VICTOR LM 1917 (with Reubke: *Sonata on the 94th Psalm*). \$3.98.

3. *Prélude, Fugue, et Variation, Op. 18* (5 editions)

Volume and tonal ranges are much improved when Watters reaches this work. Both he and White preserve the music's mood and wonderful long melodic lines by resisting the temptation to make constant shifts of registration. The latter has also been accorded first-rate reproduction, though without as full a bass as that provided for Watters. Biggs and Ellsasser break up the phrases with constant changes of stops. Ellsasser, the worse of the two offenders, also makes numerous retards at the ends of phrases. Using the composer's own transcription for piano, Lev plays with such musicianship that she almost

succeeds in creating the same introspective impression that is forthcoming from the organ; still, one misses the magic and mystery of the quiet reed stops.

—Watters. CLASSIC CE 1014 (with *Fantasia in C; Grande pièce symphonique; Pastorale; Prière; Final* in B flat). Two 12-in. \$9.96.

—Ernest White. DISCURIOSITIES BCL 7280 (with *Trois Chorals*). \$5.95.

—E. Power Biggs. COLUMBIA ML 4329 (with *Pièce héroïque; Poulenc: Concerto in G minor*). \$3.98.

—Richard Ellsasser. M-G-M E 3279 (with *Pastorale; Final* in B flat; *Pièce héroïque*). \$3.98.

Version for Piano:

—Ray Lev. CONCERT HALL CHC 55

(with *Prélude, Choral, et Fugue*). \$3.98.

4. *Pastorale, Op. 19* (3 editions)

Again, Watters' calm reserve, delicacy, and good taste make his the preferred version. Courboin, who also is subdued and reflective, would run him a close second were his recording more faithful; as it is, this is one of the more successful results of dubbing from old 78-rpm discs. Ellsasser's performance does less injustice to the music here than in the *Prélude, Fugue, et Variation, Op. 18*, but he is still too much interested in the virtuosic possibilities of his instrument.

—Watters. CLASSIC CE 1014 (with *Fantasia in C; Grande pièce symphonique; Prélude, Fugue, et Variation; Prière; Final* in B flat). Two 12-in. \$9.96.

12 EXCITING NEW RELEASES IN ...

Here are a few outstanding
NEW additions to our
Stereophonic Catalogue:

CLASSICAL

MOZART: Missa Brevis in F, Livingston 713 BN. Monaural version: AUD 7-9 D (includes contents of 714 BN).

A Concert by the Oberlin College Choir, Livingston 714 BN. Monaural version: AUD 7-9 D (includes contents of 713 BN).

The Music of the Bach Family—Volume I, Boston BO 7-6 BN. Monaural version: BO 7-8 D (includes contents of BO 7-7 BN).

The Music of the Bach Family—Volume II, Boston BO 7-7 BN. Monaural version: BO 7-8 D (includes contents of BO 7-6 BN).

HANDEL: Excerpts from "The Messiah," Boston BO 7-9 BN. Monaural version: BO 5-9 D.

Johann Harris Plays the Works of Claude Debussy, Connorsseur 116 BN. Monaural version: D 5-116 D.

Music Written for the Harp—Nicanor Zabaleta, Esoterie ES 7-10 BN. Monaural version: ES 5-10 D.

POPULAR AND JAZZ

Lenny Herman—A Musical Trip Around the World, Liv-

ingston 1093 BN. Monaural version: T 7-1095 D (includes contents of 1094 BN).

Lenny Herman—Hit Tunes Through the Years, Livingston 1094 BN. Monaural version: T 7-1095 D (includes contents of 1093 BN).

The Gin Bottle Seven Play Again, Empirical EM 7-6 BN. Monaural version: EM 5-6 D.

Bob Mielke and His Bear Gats, Empirical EM 7-7 BN. Monaural version: EM 5-7 D.

Send for our complete catalogue describing these and all other releases in detail. Request also, if necessary, the name of your nearest Livingston dealer.

STEREOPHONIC

Yours to choose and enjoy—from
Bach to "Pops"—all
quality-guaranteed by such
famous independent labels as:

**AUDIOSPHERE • BOSTON • ATLANTIC
EMPIRICAL • ESOTERIC • LIVINGSTON**

All LIVINGSTON tapes are splice-free, fully guaranteed. Packaged in attractive individual boxes, immediately identifiable and with complete program annotation.

STEREO: Stacked or Staggered (1200', 7" reels) \$11.95
MONAURAL (5" reels) \$6.95 (7" reels) \$11.95

Announcing the new thrilling
STEREO SHOWCASE BY LIVINGSTON
LS 5-38N

... containing highlights from all types of music in Livingston's Stereo Catalogue with outstanding stereo effects. 5" STEREO \$6.95

LIVINGSTON

LIVINGSTON AUDIO PRODUCTS CORP. Livingston, N.J.

Record Market

the newest and finest FOLK SAMPLER

comes from ELEKTRA—featuring eighteen complete selections from the extensive ELEKTRA catalog. Folk music from England, Spain, Ireland, France, The United States, Zululand, Mexico, Haiti, Italy, Nova Scotia and Israel performed by these outstanding ELEKTRA artists: Josh White, Susan Reed, Jean Leon Destine, Gordon Heath, Lee Payant, Theodore Bikel, Suzanne Robert, Los Gitanillos de Cadiz, Cynthia Gooding, Clarence Cooper, Jean Ritchie, Oscar Brand and Ed McCurdy.

a 12" High Fidelity Long Playing Record with full notes and complete texts only \$2.00 from your ELEKTRA dealer or postpaid from

ELEKTRA RECORDS

361 Bleecker St., New York City



**AT LAST—
REPLACEMENT
JACKETS FOR
LP RECORDS!**

**strate
jackets®**

Now for the first time, you can replace your torn and frayed record jackets with STRATEJACKETS—standard size jackets for 12" records, embossed in handsome leathertex finish. Each package contains 10 jackets, plus 10 contour-bottom Polyethylene bags, plus gold leaf transfer paper for inscribing music titles in gold.

EXTRA! With orders of 2 or more packages, we'll include 15 extra Polyethylene bags FREE.

Only \$3.49 per package, prepaid. Colors: red, blue, green, brown, maroon, tan, ivory. Check or money order to:

STRATEJACKETS, INC.

107-11 Continental Ave., Forest Hills, N. Y.

If you own
OVER 25
long-playing
RECORDS

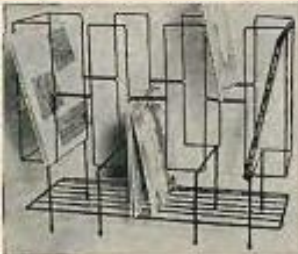

Surely you will want one of our Wrought Iron Cabinets that make record storage so pleasant and convenient! Ten compartments, each holding 20 albums, enable you to file over 200 records into every musical category. Sturdy, 25"X22"X10". Please remit \$9.95; shipping w/ 10 lbs., fully-assembled, exp. chgs. collect; with our famous AIR MAIL MONEY BACK **\$9.95** GUARANTEE!

© LESLIE CREATIONS • Dept. 209F • Lafayette Hill, Pa.

TAPE SPLICER

**CARBOLLOY CUTTER
AUTOMATIC**

**HEAVY DUTY
FAST**



F. REITER Co

3340 Bonnie Hill Drive
HOLLYWOOD 28, CALIF.

—Charles Courboin. RCA CAMDEN CAL 285 (with *Pièce héroïque*; excerpt from Choral No. 1; Choral No. 3). \$1.98.

—Ellsasser. M-G-M E 3279 (with *Prélude, Fugue, et Variation; Final* in B flat; *Pièce héroïque*). \$3.98.

5. *Prière*, Op. 20 (2 editions)

Watters does little to make this rather dull work interesting. Langlais tries to, using bright stops and a rather fast tempo to bring out the melodic line with clarity and to convey some sense of vitality.

—Langlais. LONDON DTL 93071 (with *Grande pièce symphonique; Final* in B flat). \$3.98.

—Watters. CLASSIC CE 1014 (with *Fantasia* in C; *Grande pièce symphonique; Prélude, Fugue, et Variation; Pastorale; Final* in B flat). Two 12-in. \$9.96.

—The same. CLASSIC CE 1007 (with *Trois Chorals*). \$4.98.

6. *Final* in B flat, Op. 21 (3 editions)

Except for a few cadenzalike passages at the end, which are taken at such a clip that they become meaningless, Ellsasser gives a brilliant performance of this unabashed showpiece. Langlais, hampered by church echo, of necessity adopts slower tempos; he is not required to play with so much legato, however, nor to color the tone with so many reeds. Nevertheless, the full, undistorted reproduction here makes his version preferable to the simpler, stronger one by Watters, which is marred by distorted highs in the heavier passages.

—Ellsasser. M-G-M E 3279 (with *Prélude, Fugue, et Variation; Pastorale; Pièce héroïque*). \$3.98.

—Langlais. LONDON DTL 93071 (with *Grande pièce symphonique; Prière*). \$3.98.

—Watters. CLASSIC CE 1014 (with *Fantasia* in C; *Grande pièce symphonique; Prélude, Fugue, et Variation; Pastorale; Prière*). Two 12-in. \$9.96.

ANDANTINO IN G MINOR (1 Edition)

Originally included with the manuscript of the *Six Pièces*, the Andantino was withheld from publication by its composer until 1889. It is a disarming little walking tune with practically no chromaticism, quite Slavic and decidedly atypical Franck. To me, it strongly resembles Stravinsky's *Russian Maiden's Song*. Watters evidently takes a similar attitude. He treats it gently, like a fragile little folk song; it comes off very effectively.

—Watters. CLASSIC CE 1015 (with *Trois Pièces*). \$4.98.

TROIS PIÈCES (1 Complete Edition)

1. *Fantasia* in A.
2. *Cantabile* in B.
3. *Pièce héroïque*, in B minor (4 additional editions)

Composed in 1878 especially for the dedication of a new organ in the Trocadero in Paris, the *Trois Pièces* are conceived along much grander lines than the *Six Pièces*, which had appeared sixteen years earlier. The *Fantasia* in this group lives up to its name much more closely than does its counterpart of 1862. Thematically, it is related, in a way, to the *Pièce héroïque*, the latter surely Franck's best-known composition for organ. Sandwiched between these two tonal pillars and forming a neat contrast is the *Cantabile*, as its title implies lyrical and relatively uncomplicated, yet more interesting than some of the lesser of the *Six Pièces*.

Watter's account of the first two pieces is well planned, never fussy, always clearly stated and fully reproduced. When it comes to the *Pièce héroïque*, he runs into stiff competition. Without much change of coloration, Biggs interprets it in the heroic manner. So does Ellsasser, though he chooses a wide variety of registration, not inappropriate here. The only blemish is some strangely disjointed phrasing near the end. Briskly paced, Watters' version loses much of the music's grandeur in being played too softly except for the final peroration. Asma's, the broadest of the five performances, becomes ponderous at times; there is also considerable reverberation and a certain breathiness of tone, possibly a characteristic of the baroque organ in the Old Church at Amsterdam. Courboin is brilliant but rhythmically uneven, and the dubbed 78-rpm recording, acceptable in the *Pastorale*, shows its age when called upon for bigger waves of sound.

—Watters. CLASSIC CE 1015 (with *Andantino* in G minor). \$4.98.

No. 3 only:

—Biggs. COLUMBIA ML 4329 (with *Prélude, Fugue, et Variation; Poulenc: Concerto* in G minor). \$3.98.

—Ellsasser. M-G-M E 3279 (with *Prélude, Fugue, et Variation; Pastorale; Final* in B flat). \$3.98.

—Feike Asma. EPIC LC 3051 (with *Trois Chorals*). \$3.98.

—Courboin. RCA CAMDEN CAL 285 (with *Pastorale*; excerpt from Choral No. 1 and Choral No. 3). \$1.98.

TROIS CHORALS (3 Complete Editions)

- No. 1, in E (1 partial additional edition)
- No. 2, in B minor
- No. 3, in A minor (1 additional edition)

As Brahms was to do less than seven years later, Franck sang his swan song in the form of chorale variations for organ. But whereas Brahms—and before him, Bach, Pachelbel, and many others—based his preludes and variations upon familiar chorale melodies, Franck developed original melodies along very free lines. Nor are there necessarily any religious implications in the music, though nobility is its dominant characteristic. In many passages—especially in the first two Chorals—the composer shows his own deeply spiritual feeling; in the opening and closing pages

GIBSON GIRL TAPE SPLICERS

splices in a wink!

NO SCISSORS!
NO RAZOR BLADES!

Original hole tape made and fused to the edges.
At Your Dealers

ROBINS INDUSTRIES CORP.



AUTOMATIC CHANGER NEEDLE BRUSH

KLeeNeedLE

KLeeNeedLE automatically keeps record changer needles clean. It is designed to remove the familiar "dust-blob" from under the needle point. At Your Dealer

ROBINS INDUSTRIES CORP., Bayshore 61, N. Y.



of the third Choral he is brilliantly secular. Of considerable interest also are the basic theme of the Choral No. 2, more than reminiscent of Bach's Passacaglia and Fugue in C minor, S. 582, and the middle section, recalling the *Pièce héroïque* and the Symphony. Surely nowhere but in these, his last and most intricate works, do we get as vivid a picture of Franck as a mystic.

Watters gives a distinct outline to the variations in the Choral No. 1, provides a steady forward flow for No. 2, and re-creates in No. 3 the necessary bravura qualities. Everything has life and zest in his interpretation. Although I find most of these same attributes in White's performance (which, unlike Watters', benefits from superior, distortion-free reproduction), I also feel that serious lack of balance results from his overbrilliant registration. Feike Asma is hopelessly handicapped by the Amsterdam organ on which he plays, an instrument perhaps perfect for Sweelinck or Bach but completely unsuited for Franck. Presenting only the opening portion of No. 1, Courboin injects a note of mystery with his quiet, lyrical handling of No. 3. Again, however, dated 78-rpm recording, distorted throughout the entire range, reduces the value of this disc.

—Watters. CLASSIC CE 1007 (with *Prière*). \$4.98.

—Ernest White. DISCURIOSITIES BCL 7280 (with *Prélude, Fugue, et Variation*). \$5.95.

—Asma. EPIC LC 3051 (with *Pièce héroïque*). \$3.98.

Excerpt from No. 1 and No. 3 only:

—Courboin. RCA CAMDEN CAL 285 (with Pastoral; *Pièce héroïque*). \$1.98.

PIANO WORKS

PRELUDE, CHORAL, ET FUGUE (6 Editions)

In his youth, Franck composed numerous works for piano, but among his mature creations there stand only the *Prélude, Choral, et Fugue* of 1884 and the *Prélude, Aria, et Final* of 1887. In many ways, these two works sound as if they had been written with the organ rather than the piano in mind. This is true more of the *Prélude, Choral, et Fugue*, wherein Franck sought to translate into his own musical language three of the forms so much loved by Bach. Here, as in the Quartet, he proves that he has learned much from the Leipzig cantor. This is especially apparent in the Fugue, where there are some remarkable contrapuntal passages in which the subject appears in augmentation, diminution, and interweaving with the Choral melody.

It is gratifying to find all six recorded interpretations very acceptable. The differences between them are slight, with Rubinstein's performance and recording being just a shade superior to the others. His playing is clear, flexible, along grand lines, and exciting, particularly as he builds the Choral to a climax. Demus is broad and noble, lyrical yet always distinct. Lev's is a similar approach, except that she takes the Fugue faster. Katchen is more impulsive, with interesting results, but at the sacrifice of some of the architectural grandeur and lyrical beauty attained by Rubinstein. Malcuzyński and Chailley-Richez lack the strength and conviction of the others.

—Rubinstein. RCA VICTOR LM 1822 (with Schumann: *Carnaval*, Op. 9). \$3.98.

—Joerg Demus. WESTMINSTER WL 5163, soon to be reissued in the WN 18000 series (with *Prélude, Aria, et Final*). \$3.98.

—Lev. CONCERT HALL CHC 55 (with *Prélude, Fugue, et Variation*). \$3.98.

—Julius Karchen. LONDON LL 823 (with Schumann: *Etudes symphoniques*, Op. 13). \$3.98.

—Witold Malcuzyński. COLUMBIA ENTRE RL 3031 (with Chopin: *Sonata No. 2, in B flat minor*, Op. 35). \$1.98.

—C. Chailley-Richez. LONDON TW 91145 (with Chailley: *Missa Solemnis*). \$4.98.

PRELUDE, ARIA, ET FINAL (4 Edition)

Franck's last composition for the piano is somewhat more in the style and spirit of the instrument than its organlike predecessor, the *Prélude, Choral, et Fugue*. It could be compared, in fact, to a three-movement sonata—or rather, a one-movement sonata in three thematically related sections. In contrast to the Franckian spirituality of the *Prelude and Aria*, the *Final*, in its forcefulness and driving momentum, recalls the bravura of the *Final* from the *Six Pièces* for organ. Demus presents the first two sections in the same clear-headed, stately, big-toned fashion that characterized his performance of the *Prélude, Choral, et Fugue*. His conception of the *Final*, also on a big scale, is admirably animated.

—Demus. WESTMINSTER WL 5163, soon to be reissued in the WN 18000 series (with *Prélude, Choral, et Fugue*). \$3.98.

1955

High Fidelity

RECORD REVIEW INDEX

A complete index to all classical, semiclassical, jazz, and spoken word record reviews which appeared in HIGH FIDELITY Magazine in 1955.

Arranged alphabetically by composer or by collection-title, with the issue and page on which you will find the review you wish.

ONLY 50¢ EACH

1954 INDEX also available at 50¢ per copy.

HIGH FIDELITY Magazine
Dept. R24, Publishing House
Great Barrington, Mass.

Enclosed find Please send me

..... copies of the 1954 Index

..... copies of the 1955 Index

Name

Address

No C.O.D.s or charge orders please.

STATIC masters
Instantly!

Remove static electricity and static-attracted dust and lint from your treasured high fidelity records. Protect their pure sound and increase their length of life. Greatly improve the reproduction on your "collector's items." Use the efficient atomic tool of our atomic age.

STATICMASTERS only \$14.95. Available at your Hi-Fi shop, music store, or order direct. Sent postpaid—cash with order.

NUCLEAR PRODUCTS CO. • 10173 E. Rush St. • El Monte 1, Calif.

SURE
IT'S STEREO,
BUT...

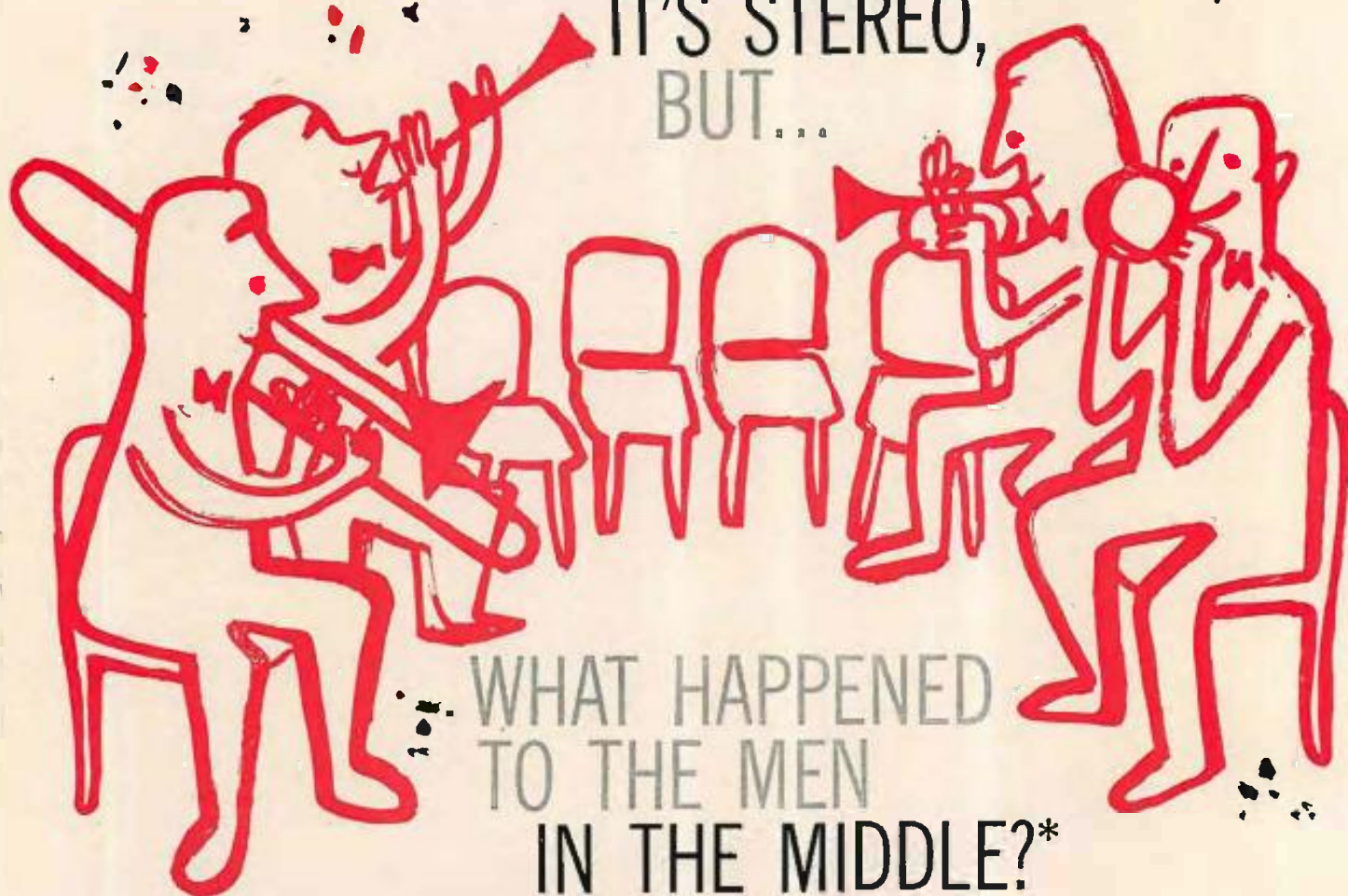

WHAT HAPPENED
TO THE MEN
IN THE MIDDLE?*

Everybody knows that stereophonic tape recordings offer the very best in high fidelity music reproduction. Yet all too often, stereo is left and right only, and the music which should be heard from the *middle* is only vaguely defined or missing altogether.

To hear *true* stereo reproduction, you must hear middle as well as left and right. Only two loudspeakers are required to accomplish this, and the recordings are still two-channeled, but the original recordings must be made to the exacting technical and engineering standards necessary to produce full stereophonic sound.

STEREOPHONY INCORPORATED is proud to introduce a new and exciting series of true stereophonic tape recordings—recordings of such realism and dynamics that it's like discovering stereo all over again when you hear them for the first time. Every detail of sound from left, middle, and right is completely and faithfully reproduced, exactly as it was heard in the live session.

You'll want to hear the results for yourself. Your favorite local high fidelity or music dealer now has **STEREOPHONY INCORPORATED** recordings and he will be happy to demonstrate them to you. Look for the distinctive package shown below and let it be your guide to the finest in stereophonic music on tape.

What Happened to the Men in the Middle?* Why, they went to make recordings with **STEREOPHONY INCORPORATED! And to prove to you how successful they were, we've prepared a special Sampler tape made up of selections from each of our releases. The sound is fabulous—and so's the price—30 full minutes of stereo for only \$4.95! Ask your dealer for **STEREOPHONY INCORPORATED SAMPLER VOLUME I** or write directly for your copy.

A free catalog listing of all tapes now available in both stacked and staggered head placement is waiting for you. Simply write . . .



STEREOPHONY INCORPORATED

DISTRIBUTED BY **emc** RECORDINGS CORPORATION • 806 E. SEVENTH STREET • ST. PAUL 6, MINN.

Export: EMEC Corp., Plainview, Long Island, New York



the Tape Deck

by R. D. Darrell

Note: As usual, all tapes reviewed are 7.5 ips and—unless specifically noted as stereo—are 2-track single-channel recordings. The symbol • • prefixed to a review indicates stereo tapes. If a date in parenthesis is appended to the review, it refers to the issue of HIGH FIDELITY in which the corresponding disc review appeared.

BACH: *Chorale Fughettas (3), Chorale Preludes (3), and Variations (3)*

Finn Viderø, organ.

BERKSHIRE BH 1019. 7-in. \$6.95.

Announced as Vol. I of a series of Bach organ tapes, this reel offers a wealth of mostly less familiar works originally released in differently arranged couplings on Haydn Society LPs HSL 3063 and HSL 94. The three chorale preludes (*Herzlich tut*, S. 727, *Liebster Jesu*, S. 706, and *Wer nun der lieben Gott*, S. 690) are old friends; but the little *fughettas* (*Christum wir sollen loben schon*, S. 696, *Gottes Sohn*, S. 703, and *Herr Christ*, S. 698) are likely to be new to all save Bach specialists; while the large-scale variations (*on Sei gegrüßet*, S. 768, *Vom Himmel hoch*, S. 769, and *O Gott, du frommer Gott*, S. 767), although occasionally recorded, are still far from adequately known and appreciated. These last three works are particularly valuable for their documentary evidence of Bach's own expressive and technical development: one of them, S. 767, was written when he was only seventeen; while another, S. 769, a set of incredibly complex canonic variations, dates from near the end of his life and sums up his polyphonic art and philosophy with a mastery comparable only to that displayed in the considerably better-known *Art of Fugue*.

I can't think of any organist capable of providing warmer or more endearing introductions both to these monumental contrapuntal structures and their companion jeweled miniatures. For Viderø is at once a purist and a romanticist in the finest sense of each term: insisting on authentic baroque qualities in his choice of instrument (that of the Sorø monastery church, Denmark) and registrations, yet always playing with infectious interpretative fervor as well as lucidity. The recordings themselves date back several years, but they still sound beautifully pure, and this admirable tape edition earns additional praise for its inclusion of Viderø's own concisely informative notes on the music, Sorø organ, and the present registration details—a *lagniappe* as yet seldom encountered even in much more expensive tape releases. (Nov.-Dec. 1953 and Sept. 1954)

• • BACH: *Tocatta and Fugue, in D minor, S. 565; Passacaglia and Fugue, in C minor, S. 582*

Carl Weinrich, organ.

SONOTAPE SWB 8001. 7-in. \$9.95.

Here familiar aspects of Bach are given an approach wherein ingratiating warmth and coloring are subordinated to a maximum of clarity, momentum, and dramatic weight. By this time both Weinrich's precision and the distinctively strong timbre contrasts of the Varfrukyrka organ of Skänninge, Sweden, are well known to many home listeners through earlier representations on Westminster LPs W-LAB 7023, W-LAB 7047, and more recently XWN 18260. (The *Tocatta in D minor*, S. 565 also has been issued before in the single-channel Sonotape SW 1011, reviewed here, June 1956.) In stereo, Weinrich's performances achieve even more strikingly sharp-focused sonic definition, particularly notable in some of the faster pedal passages, which were not entirely unblurred before, and in the trills toward the end of the *Passacaglia*, which surely have never been as cleanly articulated in any single-channel reproduction. There is also, of course, markedly enhanced sonic spaciousness and sense of power. Yet while such expansions are unquestionable advantages, it is surprising how slightly they alter the over-all effect of these performances. Given a choice, I'd naturally prefer hearing them in stereo, but I can't honestly claim that I'd be conscious of any serious deprivation if I were restricted to the single-channel versions only. (May and Nov. 1956)

• • BEETHOVEN: *Symphony No. 9, in D minor, Op. 125 ("Choral")*

Corry Bijster (s), Elisabeth Pritchard (c), David Garen (t), Leonardo Wolofsky (bs); Netherlands Philharmonic Chorus and Orchestra, Walter Goehr, cond.

CONCERT HALL CHT/BN 5. Two 7-in. \$23.90.

The first stereo Ninth is an unexpected and disheartening disappointment—a labored and coarse misrepresentation, my reaction to which might best be summed up by Pepys's criticism of one Pastor Mills's "unnecessary" sermon upon Original Sin: "neither understood by himself nor the people . . ."

The basic shortcomings of this performance (the same as that released on LPs in the Musical Masterpiece Society's MMS 2034) were judiciously specified in C. G. Burke's discographic "reconsideration" of the Beethoven symphonies (Jan. 1957). More pertinent here, perhaps, is the strange fact that even such recalcitrant material, although treated here with little technical imagination, still dimly but significantly foreshadows stereo's eventual success with the choral finale. Even in this generally prosaic and awkwardly mannered performance there are exciting moments when the infinite tonal "vistas" Beethoven sure-

ly had in mind momentarily unfold, but they are tantalizingly few. Even in listening to a far more professionally polished (if still well short of top-notch) performance in a single-channel recording—such as the current Phonotapes-Sonore single-reel edition (PM 150, 7-in., \$8.95) of Horenstein's reading with the Vienna *Singverein der Gesellschaft der Musikfreunde* and Pro Musica Orchestra (soloists: Lipp, Hoengen, Patzak, and Wiener), previously available on Vox PL 10,000 or DL 282—I find that even in the best of the orchestral passages, as well as throughout those for voices, I am invariably conscious that something essential is missing. Someday (I still maintain) that something will be thrillingly experienced via stereo reproduction in our own homes; until that happy day arrives, I'm now resigned to hearing the best of the Beethoven Ninth recordings with restless unsatisfaction.

• • CHOPIN: *"Autumn Leaves" (Homage to Pavlova, Vol. 1)*

Philharmonia Orchestra (London), Efreim Kurtz, cond.

HMV SBT 1250. 7-in. (£2. 7. 6. in England).

Through the co-operation of Mr. A. E. Foster, I am indebted to the Magnetic Recording Company, 528 Central Ave., Newark, N. J., for the opportunity of hearing a second example of British achievements in "stereosonic" recording. My first encounter (with Malko's *Nutcracker* Suite, October 1956 Tape Deck) impressed me by the carefulness with which the overseas engineers subordinated technique to musicianship, and I was further awed by a demonstration presented in conjunction with a paper on EMI stereo theory and practice at last fall's Audio Engineering Society Convention. But while the present tape is every bit as fine technically, it proves anew that the finest skill and taste in the world can't give musical substance to salon materials. Chopin's *Nocturnes* (Op. 15, No. 2 and Op. 27, No. 2), *Revolutionary Etude*, and *Fantaisie Impromptu* have considerable validity as piano pieces, but very little in these anonymous, excessively sentimental orchestrations. Kurtz plays them graciously and the reproduced sound is sheer sensuous enchantment, but except perhaps as a background for actual dancing, few listeners can surrender happily or for long to such tonal drugging.

DEBUSSY: *Prélude à l'après-midi d'un faune*—See Ravel: *Boléro*.

GERSHWIN: *Rhapsody in Blue*—See Ravel: *Boléro*.

Continued on next page

ON RECORDS!

ON TAPES!

PHONOTAPES LANGUAGE SERIES

SPEAK AND READ

FRENCH

Armand and Louise Bègué

A New Concept in
LANGUAGE STUDY

For the first time a language study course divided into 3 distinct sections—sold separately or complete. Study the part which suits your learning needs!

Part 1: BASIC & INTERMEDIATE
(Beginning & Refresher)

Correct pronunciation and intonation taught from the first lesson. Grammatical essentials explained. 176 page illustrated book.

3-12" lp records PHONODISCS 2001-A\$20.85*
or 3 tapes 3¾ speed PHONOTAPES 2001-A \$23.85*
or 3 tapes 7½ speed PHONOTAPES 2001-A \$29.85*

Part 2: CONVERSATIONAL
(Refresher & Advanced)

Simulated conversations on everyday topics designed to provide fluency in speaking. Illustrated book.

2-12" lp records PHONODISCS 2001-B\$19.90*
or 2 tapes 3¾ speed PHONOTAPES 2001-B \$15.90*
or 2 tapes 7½ speed PHONOTAPES 2001-B \$19.90*

Part 3: LITERATURE
(Advanced)

Poetry and prose passages selected from the works of 20 major writers. 17th, 18th, 19th Centuries. Illustrated book. 2001-C ..Prices same as Part 2.
*book included

This unique course will enable you to learn or practice French at any level. For home or school use.

Available now at leading record and book stores. Write for FREE descriptive booklet. Dept. F-1.

PHONOTAPES INC.
248 West 49th St., N. Y. 19, N. Y.

TAPE DECK

Continued from preceding page

• • HANDEL: *Water Music* (complete)

Frankfurt Opera Orchestra, Carl Bamberger, cond.
CONCERT HALL CHT/BN 14. 7-in. \$17.90.

Someone at Concert Hall has had a happy inspiration in recognizing stereo sound's special benefits for "open air" music—and the present reel proves it to be one of the most triumphal in the course of recent recording history. To hear the *Water Music* as it must have sounded from the decks of one of the boats in George I's festival Thames flotilla is probably an impossible dream to realize today; but the next best thing is surely to hear the work in stereo, where it becomes almost as magically air-borne and breezy as it must have been originally.

To compare the deservedly outstanding LP version, that by Lehmann on Archive ARC 3010, the latter has a somewhat more polished orchestra (although the proportion of strings is unduly heavy to my taste) and he commands a wider range of dynamic contrasts; but all the merits of his fine reading tend to pale after one has heard the incomparably airier and more buoyant sound of the stereo edition. And for a wonder this is not only pure joy to one's ears, but delight to one's soul as well, for Bamberger plays with superb zest, jauntily pompous courtliness, and heart-warming lyricism. If I ever hope to impress any friend with the quintessence of stereo attractions, or the indescribable piquancy of Handel's music at its best, I now know I need only play the electrifyingly brisk first *Bourrée* and *Hornpipe* here. The price tag is a stiff one, even in these inflationary days, and perhaps dubiously justified even by the necessity of using an 1,800-foot length of 1-mil tape to get the whole suite on a single 7-inch reel. But the musical and aural pleasures to be derived from that reel are literally priceless.

• • RAVEL: *Boléro*

†Debussy: *Prélude à l'après-midi d'un faune*

Boston Symphony Orchestra. Charles Munch, cond.
RCA VICTOR CCS 21. 7-in. \$10.95.

• • RAVEL: *Boléro*

†Gershwin: *Rhapsody in Blue*

Netherlands Philharmonic Orchestra (Ravel); Philippe Entremont, piano, and Concert Hall Symphony Orchestra (Gershwin); Walter Goehr, cond.
CONCERT HALL CHT/BN 7. 7-in. \$11.95.

Since Ravel's self-styled "piece lasting seventeen minutes and consisting wholly of orchestral tissue without music" is a rare, if not unique, work in that it exhausts itself and its listeners completely on its first hearing, that initial encounter should have a maximum of sensorial impact, or one will wonder forever after what all the shouting was about. The proper medium is of course a live performance, but failing that, stereo does Ravel's *jeu d'esprit* in-

initely more justice than any single-channel recording. Goehr's is the steadier reading here, but his players aren't skilled enough to make the most of the coloristic potentialities of their parts, and the vital side-drum *ostinato* is dull toned here in comparison with Munch's sizzlingly crisp snare drum. Elsewhere, too, the Bostonians provide marvels of kaleidoscopic tonal colorings, which—in the pellucid clarity of stereo sound—cleanly delineate every intricate detail of this superingenious score. But Munch's own tempo is nervously unsteady at times in a way that the composer certainly never would have approved, and even at its best this (or any tape) would seem a mighty heavy expenditure for a short-term investment. (Oct. 1956)

To me, each of these tapes justifies itself far better in its companion piece. Munch's Debussy *Prélude*, while perhaps unduly languorous and overexpressive, is ideally shaped for stereo, and here for once in home reproduction, it truly floats and shimmers iridescently. And if the Entremont-Goehr *Rhapsody* is a more literal than idiomatic reading, it is nevertheless admirably straightforward, graceful, and unmannered.

SCHUMANN: *Carnaval, Op. 9; Papillons, Op. 2*

Guomar Novaes, piano.

PHONOTAPES-SONORE PM 152. 7-in. \$8.95.

The previous Phonotapes transfers of Guomar Novaes's Vox LPs have been so uniformly effective that the series now is extended to include two of her earlier Schumann recordings (originally issued separately as PL 6710 and PL 6900 of 1951; later coupled on PL 7830). The piano tone here inevitably lacks something of its finest later bloom, but otherwise the recordings show few signs of their age, while the readings themselves are the finest vintage Novaes. (Schuman Discography, Sept. 1956)

• • TCHAIKOVSKY: *Quartet No. 1, in D, Op. 11*

Curtis String Quartet.

SONOTAPE SWB 8014. 7-in. \$9.95.

Apart from a couple of Concertapes (reviewed here, Sept. and Oct. 1956) and a few other releases under the same label which I haven't yet heard, true chamber music—that for string quartet in particular—seemingly has been deliberately avoided by stereo-tape manufacturers up to now. Yet stereo can add something valuable even here, as demonstrated in the present marked spacing-out of usually sonically huddled players and the quite startlingly realistic specific location effect of, say, cello *pizzicati* or certain viola inner-voice phrases. But do such phenomena really add notably or necessarily to one's enjoyment of a quartet performance? For myself, I'll grant the justness of the first adjective but not that of the second. Yet I might well be less grudging if the present performance had been more than only a reasonably competent, sometimes overlax, reading of agreeable but hardly inspired music.

Continued on page 106

HIGH FIDELITY MAGAZINE



STEREO RECORDING!

*you can have it
now with
viking*

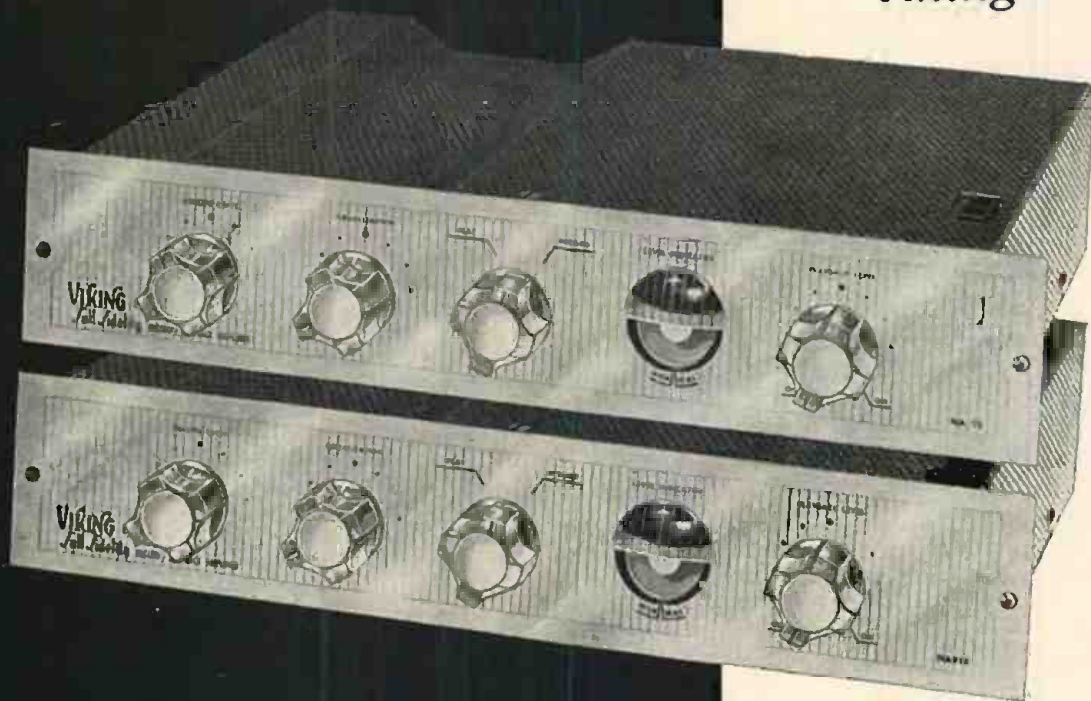

SOME OF THE BEST THINGS COME IN PAIRS

A pair of matching RP61 and RP61S Record/Playback Preamplifiers for *stereo recording* as well as playback of stereo tapes — plus conventional erase-record operation.

A pair of in-line heads on the Viking "SR" Tape deck for *stereo realism*, plus the conventional erase and record/playback heads.

Viking tape system components and recorders are sold through dealers. Further technical information may be obtained by writing directly to Viking of Minneapolis.

ALL VIKING DECKS

frequency response: 30 to 14,000 cps plus, at 7½ ips. 40 to 7,000 cps plus, at 3½ ips.

signal-to-noise: 50 db or better.

flutter: 0.2 percent average.

long term speed regulation: 1/5 of 1.0 percent.

capstan drive: belt driven from full floated motor platform.

capstan flywheel: 1½ lb.

tape speed: 7½ ips (3½ ips available by changing belt to smaller groove on motor pulley).

maximum reel size: 7".

motor: 4-pole, 60-cycle, (50-cycle motors available at \$2.00 additional charge.)

supply reel brake: mechanically actuated. Felt pad braking surface. Adjustable.

take-up reel brake: mechanically actuated. No adjustment required. Cork pad braking surface.

record/playback head characteristics: track width .090 inch. Gap width .00015 inch. Impedance 2000 ohms at 1000 cycles. Double coil hum bucking winding. Mu-metal shielded. Output 2.5 mv.

recommended bias current: .8 ma. at 68 kc.

erase head characteristics: track width .125 inch, double gap (each .005 inch); inductance 53 mh. at 1 kc, erase 60 db at 68 kc.

RP61 SERIES PREAMPLIFIERS

frequency response, playback: 30 to 14,000 cps ± 2 db.

frequency response, record-playback cycle: 30 to 12,000 cps ± 2 db.

distortion (tapes recorded 12 db below saturation) less than 2% within specified frequency range.

internal signal-to-noise ratio: 60 db minimum all units.

equalizations: modified NARTB

output: 1 volt, high impedance.



Viking OF MINNEAPOLIS

9600 Aldrich Avenue South, Minneapolis 20, Minnesota

EXPORT DIVISION: 23 Warren Street, New York City 7, New York
Cable: SIMONTRICE, NEW YORK (All Codes)

PENTRON

Emperor High Fidelity TAPE RECORDER



**NEW...
3 SPEAKER SYSTEM
with SEPARATE
ROVING SPEAKER**

Brilliant stereophonic sound presence exclusive with the Emperor. Two matched speakers in blonde oak or mahogany cabinet plus third "roving" tweeter in its own separate matching baffle. High fidelity at its fabulous best.

ONLY PENTRON OFFERS THESE PROFESSIONAL FEATURES at LOW COST

- 10 watt push-pull amplifier
- VU recording meter
- Automatic index counter
- Response: 40-12000 cps
- Unimagic single lever control
- Both 7½" and 3¼" tape speeds

Emperor IN PORTABLE CASE

Select the Emperor in a handsome portable case if you desire.

Highest quality, low cost.



Name _____
 Address _____
 City, State _____

PENTRON 786 S. Tripp Ave.
 Chicago 24, Illinois
 in Canada: Atlas Radio Ltd., Toronto

TAPE DECK

Continued from page 104

• • TCHAIKOVSKY: *Romeo and Juliet*

Boston Symphony Orchestra, Charles Munch, cond.
RCA VICTOR BCS 22, 7-in. \$8.95.

According to your personal Tchaikovskian predilections, Munch's reading (originally in the omnibus "Tone Poem" album, LM 6129; more recently coupled with *Franческа da Rimini* alone as LM 2043) is over-emotional or "dramatic and robust." For myself, forever under the spell of Koussevitzky's interpretation, this one just never seems to penetrate the heart of the music. But my sense of un- rather than dissatisfaction applies to the conductor's conception only and not to the performance—one which reveals the Boston orchestra (the string choir in particular) in its richest and most silken sonorities. Apart from a somewhat blurred and "thuddy" bass drum, every detail of the playing here has been caught to perfection in the spacious aural splendors and remarkable ethereal tonal delicacy reproducible only in stereo sound at its best. A sheer delight to one's ears, this tape also is an invaluable reminder of Tchaikovsky's seldom fully appreciated genius as a master of the art of timbre invention and weaving. (LM 6129, Oct. 1956)

REEL MUSIC NOTES

BEL CANTO: This enterprising young west-coast firm simultaneously bursts into stereo and widens the scope of its activities, both to include light classic as well as pops materials and to augment the products of local studios with European recordings—all as demonstrated in a stereo sampler of eight excerpts from its current releases. Most of these are brief and some are faded out rather disconcertingly, but they are happily free from any vocal announcement or blurb. The recordings are impressively brilliant, if sometimes in the unduly sharp-focus microphoning favored in Hollywood; and the stereo balancing is well handled too, except perhaps in the first movie-organ selection where antiphonal chimes peel forth with such "presence" that an unprepared listener is likely to be startled tight out of his skin. But exaggerated as the effect may be, it's sensational enough to overwhelm even the most blasé hi-fi fan (• • ST DX, 7-in., \$3.95). Among the regular releases, the first I tried (my appetite whetted by the earlier Bel Canto single-channel *In Old Bavaria*) was "Razberry" Reynolds's All-Star Band in *Polka Party in Stereo*, which proved to be even lustier than the demonstration-tape sample. The recording (in the Capitol Tower studios in Hollywood) makes the most of every oom-pah, cowbell, and drum-rim strick rattle, and while the stereo effect itself may be somewhat overaccentuated, it does wonders to invest the lively playing itself with the infectious jollity of an open-air old-style country dance festival. (• • ST 7, 7-in., \$7.95)

BERKSHIRE: Defying the current trend toward samplers which present more-or-

less complete excerpts and refrain from verbal announcements and sales pitches, the *Berkshire Highlights* Vol. 2 crowds in a hoarse m.c. on top of fragments from no less than twelve tapes—the complete Berkshire second release list drawn from Haydn Society and Urania sources. Musically these are more interesting than the first list of over two years ago; technically they are considerably better, though still uneven; but in such short, usually faded-off snatches, the present samplings are strictly appetizers (H 2, 5-in., \$1.50). Berkshire does itself far more credit with its special release of *The First Christmas in Carols* by the Societas Musica Choir (un-accompanied) under J. E. Hansen, first released on microgroove (HS 150) several years ago, but for the most part ignored in the press. It's quite immaterial that the holiday season has been long over now when these words appear in print: this heart-warming, honest music and the endearing simplicity of the singing make this a year-round listening delight. (BHX 1, 7-in., \$7.95)

CONCERT HALL: The time may be soon coming when the race course for popular symphonic war horses will be dominated by stereo recordings, for, as the present release by the Utrecht Symphony under Paul Huppers effectively demonstrates, even completely routine orchestral run-throughs of works like Smerana's *Moldau* and Borodin's *Prince Igor* dances sound infinitely better than they actually are in the broad concert-hall sonorities of the twin-channel medium. As score readings, these versions are markedly inferior to dozens on LP, but few if any of the latter are aurally as ingratiating. (• • CHT/BN 10, 7-in., \$11.95)

JAZZTAPE: Pending receipt of new releases under this label, I've gone back to two previously overlooked *Jazz Lab* items: Vol. 1 by a Frank Constock combo and Vol. 2 by the Bob Enevoldsen Quintet. The former is hardly jazz at all and experimental only in the hard-pressing efforts of its leader-composer to imitate Sauter-Finegan and Raymond Scott formulae. However, it alternates schmaltz with sprightliness, doesn't take its pseudo-exoticisms too seriously, features some jauntily lyrical flute playing, and is very brightly recorded. The latter reel, after a rather frankly lumbering start, strikes deeper into authentic jazz domains and, while it isn't as openly recorded, achieves at its best (as in *Topsy*) a genuine buoyancy. An eccentric double-bass solo, against *sottovoce* "whisk" drumming and accordion chord-"breathing," strikes me as particularly ingenious, but surely the piece in which this appears is entitled *Loaded with Bass* and not "Brass" as the contents list has it. (JT 4004 and 4011, 5-in., \$6.95 each; or boxed in DS 7, \$12.95)

LIVINGSTON: *Josh White Comes A-Visiting*, unlike the other (all single-channel) recordings I have heard of this half-folk, half-café entertainer, is both more informally relaxed and less insistent on maintaining a spotlight on Josh himself. The materials here are mostly homespun

Continued on page 108

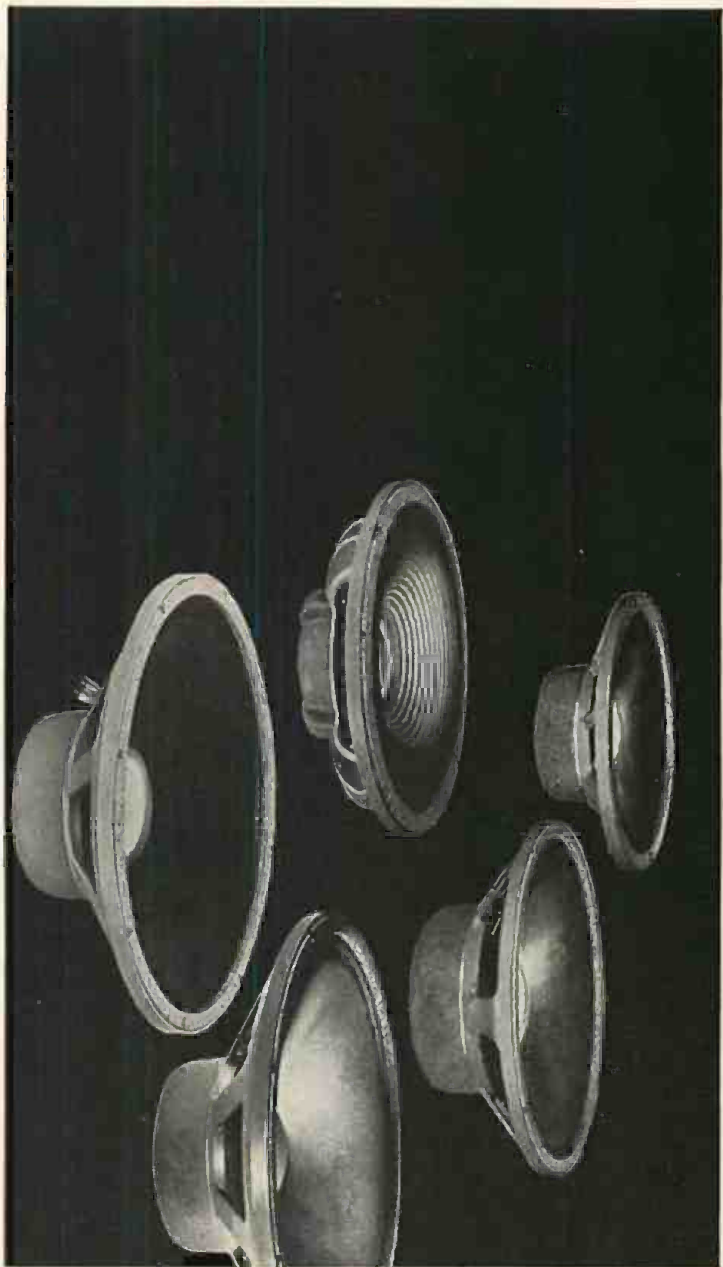

ALL THAT IT TAKES TO MAKE A SPEAKER GREAT

A great loudspeaker preserves the essence of high fidelity. This essence is the accurate reproduction of complex sound waves of varying magnitudes without distortion. What you hear is lifelike reproduction. It is achieved by thorough acoustical research and engineering, excellent basic design, precision manufacture and assembly, meticulous attention to detail.

JBL Signature Loudspeakers are built around the four-inch voice coil. The coil is made of wire ribbon wound on its narrower edge. Frames are rigid castings. Magnetic circuitry is designed to make maximum use of magnet materials, to eschew superfluous metal, and to avoid stray magnetic fields.

Added to these more obvious differences in JBL Signature Speaker construction are the constant refining of each minute detail, the unflagging, meticulous care with which the precision parts are assembled. These are details you cannot see, but they are most important to what you hear.

These are the reasons why JBL Signature Loudspeakers are the most efficient to be found anywhere. These are the reasons why JBL Signature Speakers cover the audio spectrum with such outstanding smoothness...why they make of "every note a perfect quote." Excellent design, painstaking care — these are what it takes to make a speaker great. There is no short cut.

For free catalog and technical bulletins describing JBL Signature Loudspeakers, write to James B. Lansing Sound, Inc. 2439 Fletcher Drive, Los Angeles 39, California.

"JBL" means JAMES B. LANSING SOUND, INC.

The brand-new second volume in the indispensable record guide series



**HIGH FIDELITY
Record
Annual:
1956**

Edited by Roland Gelatt

Here is the new volume in the planned series of *High Fidelity Record Annuals* which will keep you fully informed about the thousands of long-playing records released each year.

- Contains classical, semiclassical, and spoken word record reviews which appeared in HIGH FIDELITY Magazine from July 1955 through June 1956, assembled for greatest convenience.
- Covers both the performances of artists and the quality of the recordings.
- Organized for easy reference. Composers' names are arranged alphabetically. Performers' names are indexed.

An invaluable shopping aid. More information about more records for less money than in any other record review collection.

Only \$4.50

If you missed the 1955 Annual it is still available at \$4.95.

HIGH FIDELITY Magazine
The Publishing House
Great Barrington, Mass.

Enclosed please find \$..... for which please send me postpaid:

HIGH FIDELITY RECORD ANNUAL 1956
..... copies @ \$4.50 each

HIGH FIDELITY RECORD ANNUAL 1955
..... copies @ \$4.95 each

(No C.O.D.s or charge orders, please.)

Foreign orders sent at buyer's risk. Add 55c per book for postage on foreign orders except Canadian.

NAME

ADDRESS

TAPE DECK

Continued from page 106

and sometimes popularized reworkings of authentic folk stuff; but at their best (as in the extremely catchy *When the Dark Clouds Roll Away* and *Come Along, Charlie*), they have an unpretentious charm which is deftly underlined by the spontaneity of the little group of participating singers and the *solito voce* organ accompaniments by S. Benskin. As seems *de rigueur* with Josh, he and his guitar are extremely closely miked, as also is, less happily, Al Hall on an overponderous double bass. The stereo separation of the ensemble is somewhat excessive too, yet the over-all effect is admirably intimate and disarming—more so, I dare say, than it was in the LP version, Period SPL 1115, May 1956. (• • T 1085 BN, 7-in., \$11.95)

OMEGATAPE: The latest sampler from the West Coast firm, which also represents the Alphatape and Jazztape labels, is the most ambitious yet: entitled *Music for High Fidelity Shows* and illustrating some eighteen different reels (most of which have been reviewed lately in these pages) by surprisingly substantial excerpts framed by portentous opening and closing announcements. Omegatape's recent technical advances are excellently exemplified, as is the impressive diversity of its repertory; but the rapid alternation of, say, a Bach *Brandenburg* Concerto bit and Frank Comstock's *Frantica* makes for a schizophrenic frenzy only too characteristic of the audio shows this sampler evokes (D 8, 7-in., \$5.95). The same company's first *Stereo Demo*, however, is more consistently light in musical content (except for a bit of Antheil's *Ballet mécanique*) and its sales pitch is made more palatable by Tom Mercein's ingratiating manner. Best of all, there are some fine examples of impressive stereo technology made available at a price few stereo novices can resist. (STD 6, 5-in., \$4.00)

SONOTAPE: How Glère must have chortled when he combined the rigidly orthodox Soviet "line" (c. 1927) of *The Red Poppy* ballet's story with every decadent-capitalistic musical and scoring cliché he could recall or anticipate. Yet in the present performance of a concert suite by the Vienna State Opera Orchestra (available earlier on Westminster LPs in WAL 210; more recently in XWN 2212 or separately as W-LAB 7001), I can't detect the slightest indication that Hermann Scherchen ever has his tongue in his cheek in these perfectly serious and indeed almost loving readings. Only the engineers may have been a bit ironical in endowing his playing with such massive weight and glittering brilliance. But nothing anyone can do ever can make the first five movements sound any less like travesties of film-and-broadcast pseudo-exotic sound effects: only in the rambunctious *Sailor's Dance* does the music suddenly come to triumphant life. (SW 1026, 7-in., \$7.95)

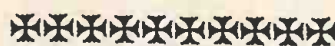

**Emotion
and
Meaning
in Music**



324 PAGES
104 MUSICAL SAMPLES

"The book is 'Emotion and Meaning in Music' by Leonard B. Meyer and after reading it I am convinced that it is by far the most important work on musical aesthetics that I have ever encountered . . . it explains for the first time, and in a thorough going and precise way, just how music is related to human experience . . . The realm of thinking about music will, I feel, never be quite the same again." *THE NEW YORKER*

No musical library is complete without a copy of this unusual book. Conclusions drawn apply not only to Western music, but Oriental, primitive and folk music as well.



UNIVERSITY OF CHICAGO PRESS

5750 Ellis Ave.

Chicago 37

**Now! New RCA Victor
superstrength, extra-long
play Hi-Fi "Mylar"* tape!**



Plays 50% longer! Not 1200 feet, but 1800 feet on a 7" reel! Extra-thin—superstrong! Costs \$7.50 per 7-inch reel. Also available: new RCA Victor acetate tape with full frequency performance—at a special low price! And RCA Victor acetate tape with full High Fidelity response. The same tape used for professional recordings—\$3.50 for 7-inch reel.

*"Mylar" is a registered DuPont trademark for its polyester film. Nationally advertised list prices shown, subject to change.

RCA VICTOR
RADIO CORPORATION OF AMERICA
CAMDEN 8, NEW JERSEY

HIGH FIDELITY MAGAZINE

Let's Get Down To Earth About Electrostatics

FEW developments in the audio field have created such a whirlwind of fantastic claims, sarcastic denunciation, and fanciful daydreaming as the electrostatic loudspeaker. We doubt that any product has ever created so many self-appointed experts in so short a time. The electrostatic has been alternately praised on the one hand as tolling the doom of the dynamic loudspeaker, and on the other hand wishfully dismissed as a "romantic" concept of speaker design "which has been thoroughly disproven". Neither statement is accurate. While we firmly believe that eventually all quality systems will include an electrostatic high and mid-frequency reproducer, it appears at this juncture that the low end can best be reproduced with cone designs. Manifestly, the head-in-the-sand ostrich approach which tries to dismiss the electrostatic with a wish, is proclaimed either out of abysmal ignorance or malice.

The development of electrostatic loudspeakers has progressed to the point where they can no longer be referred to as identical, any more than all dynamic designs can be so classified. In some respects, there is an even wider divergence of design between the various electrostatics than exists in their dynamic counterparts. No informed individual would attempt to evaluate a \$300 multi-driver speaker on the same performance basis as a \$2.00 replacement cone. Neither should the inexpensive single-ended electrostatics be compared with the precision-built push-pull designs.

The electrostatic is in the ascendancy not because it is now simpler and more inexpensive to build, but rather because the basic principle, long recognized as superior to dynamic designs for reproduction of the upper octaves has been made practical for the first time by the utilization of new materials, techniques and theories previously overlooked. Adherence to rigid production tolerances and test procedures virtually assures that the JansZen will never become a mass-produced item. Its relatively high cost directly reflects the uncompromising design and construction for which it is justly famous.

Since efficiency, per se, is no real criterion of loudspeaker performance, we have made no attempt to

emphasize this factor in our electrostatic design. In fact, the last thing we would want to do would be to match the raucous output of loudspeakers designed for theater use, whose outrageous invasion of one's sensibilities creates the effect of a brass band in the bathroom. We take strong exception to the thinking of some theater sound purveyors who prefer to base their high-powered efficiency claims on a single frequency or narrow band where conversion of electrical energy into acoustical energy is highest, even though claimed response is far in excess of these limits. With a given power amplifier, the maximum acoustic power output of the JansZen is higher than that of any other loudspeaker at the higher frequencies. Over the entire frequency range it is a suitable match for the very finest low frequency systems.

While high frequencies are by nature directional, the exclusive JansZen array results in uniform high frequency distribution throughout the room, without the use of any baffles, gratings, etc. imposed between you and the music. The result is a broad sound source with none of the resonances and reflections common to mechanical systems.

We categorically state that the JansZen has the finest transient response, and will provide the smoothest, most extended frequency response available in any high frequency loudspeaker, with absolutely no trace of any inherent noise.

In the light of the above facts, we hope when you are planning your "ultimate system" that you will give serious thought to the inclusion of an electrostatic, preferably a JansZen.

JansZen

Electrostatic

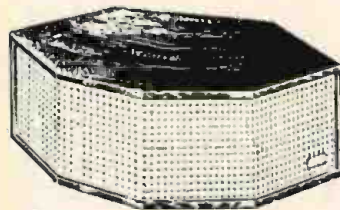

Send for complete literature on the JansZen 1-30 Electrostatic as well as the name of your nearest dealer!

PRODUCT OF

NESHAMINY ELECTRONIC CORP. NESHAMINY, PA.
Export Div.: 25 Warren St., New York 7, N. Y. Cable: Simontrice, N. Y.



AT CONVENTIONS

IN BOMBERS



**University achievements
... as the largest supplier
of loudspeakers to the
military and industry...
WHAT IT MEANS TO YOU**



IN MINES

IN SUBMARINES

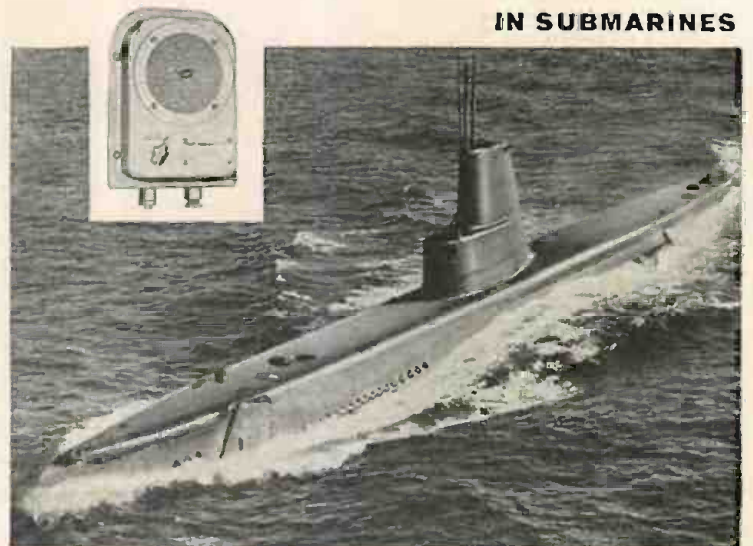

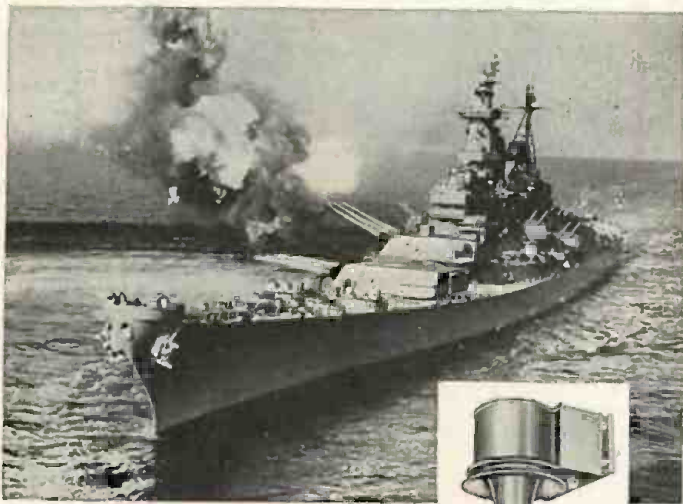

ON NAVAL VESSELS

... it means that mere claims count very little in the *making* of quality speakers. Achievements mean everything! University achievements speak for themselves.

... it means that the high precision techniques and specialized engineering skill acquired in meeting the exacting requirements of military and industrial reproducers are applied to the design and production of high-fidelity speakers.

... it means that University's meticulous system of quality control guarantees that all speakers of a given type be identical in every minute detail. A speaker is rejected at the slightest variation from rigid specifications.

... it means that the immense resources of the University organization make it possible to offer the highest quality speaker possessing unique and exclusive University features ... at the lowest possible price.

... more than all this, it means that the integrity of University, into which the U. S. government and the greatest industrial names have put their confidence, is your guarantee of a superior product.

Yes, University sounds better, because it is better.



IN TANKS

These self-contained units are just a few of a very complete selection of quality wide-range and thru-axial speakers and components to meet every size and budget requirement



Model 315

A 15" 3-way Super-Diffaxial speaker. Employs the deluxe multi-sectional "Diffusicone" element and 6 1/2 lbs. of Alnico 5 magnet. Response to beyond audibility. Exceptional power capacity of 50 watts. 8-16 ohms. \$132.00 User net.



Model 6303

A 15" 3-way Diffaxial speaker. Employs the deluxe multi-sectional "Diffusicone" element and extra heavy 2 lbs. of Alnico 5 Gold Dot magnet. Response to beyond audibility. 30 watt power handling capacity. 8-16 ohms. \$80.10 User net.



Diffusicone -15

A 15" 2-way Diffaxial speaker. Employs the deluxe multi-sectional "Diffusicone" element and heavy 24 oz. all-Alnico 5 Magnet. 30 watt power handling capacity. 8-16 ohms. \$45.00 User net.



Model 312

A 12" 3-way Super-Diffaxial speaker. Employs deluxe multi-sectional "Diffusicone" element and extra heavy woofer Alnico 5 Gold Dot magnet. Handles 25 watts. 8-16 ohms. \$64.50 User net.



Diffusicone -12

A 12" 2-way Diffaxial speaker. Employs deluxe multi-sectional "Diffusicone" element and extra heavy 24 oz. all-Alnico 5 magnet. Unusual 30 watt power handling capacity. 8-16 ohms. \$33.00 User net.

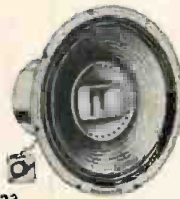

Model UXC-123

A 12" 3-way Diffaxial speaker. Employs the standard uni-sectional "Diffusicone" element. Response encompasses full musical reproduction range. Handles 25 watts. 8-16 ohms. \$59.50 User net.



Model UXC-122

A 12" 2-way Diffaxial speaker. Standard uni-sectional "Diffusicone" element. Super-sensitive Alnico 5 magnet of shallow design for application flexibility. 25 watt capacity, takes those heavy transients with ease. 8-16 ohms. \$29.75 User net.



Model 308

An 8" 3-way Diffaxial speaker. Employs the deluxe multi-sectional "Diffusicone" element and is the only small integrated 3-way speaker on the market. Performance is unbelievable for its size. Handles 25 watts. 8-16 ohms. \$37.50 User net.



Diffusicone -8

An 8" 2-way Diffaxial speaker. Employs deluxe multi-sectional "Diffusicone" element. Exceptional sensitivity and 25 watt power capacity makes this an outstanding performer for its size. 8-16 ohms. \$23.50 User net.

UNIVERSITY LOUDSPEAKERS, Inc., 80 So. Kensico Ave., White Plains, N. Y.



LISTEN... *University sounds better*



these
are the
features

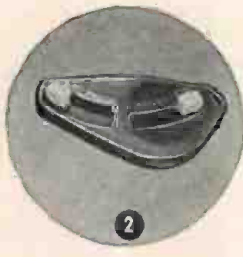
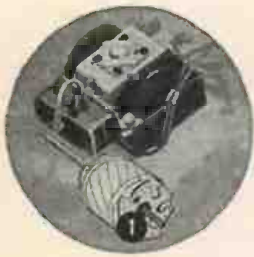

that have
made it

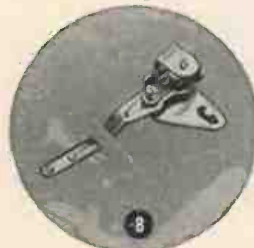
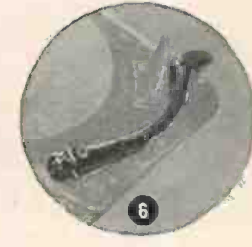
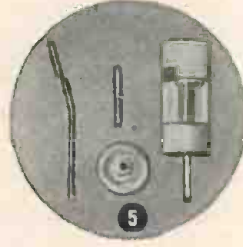

...and
kept it

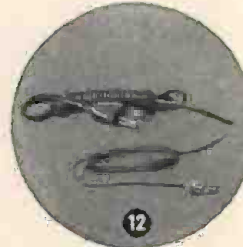
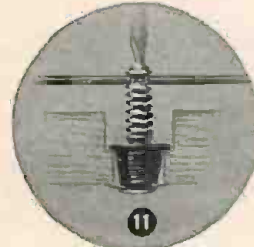

The
WORLD'S
FINEST!

1. 4-POLE SHADED "INDUCTION SURGE" MOTOR gives this changer constant speed with minimum vibration. Will not cause hum even with sensitive pickups. The rotor is dynamically balanced!

2. FULL MANUAL POSITION: Just touch the switch and tone arm is freed for manual play. Returns automatically to its rest at end of record.

3. ADVANCED GARRARD PUSHER PLATFORM: After twenty years still the only device insuring positive, gentle handling of all records, any diameter, thickness or condition of center hole.

4. PERFECTED TRUE-TURRET DRIVE operates directly off motor without belts. Combined with an oversized "soft tread" idler wheel, it gives you unflinching speed without wows or flutter.

5. INTERCHANGEABLE SPINDLES (Manual and Automatic) insert easily, remove instantly. Note that the Garrard one-piece spindle has no moving parts to nick or enlarge center holes.

6. EXCLUSIVE TRUE-TANGENT TONE ARM OF ALUMINUM plays better, provides rigidity, low mass and lightness... It has the easiest stylus pressure adjustment on any changer.

7. HEAVY STEEL PRECISION TURNTABLE with genuine rubber traction mat. A full inch high! Eliminates magnetic hum by strengthening motor shielding. Turns on silent, free-wheeling ball-bearing mount.

8. EXCLUSIVE SENSIMATIC TRIP MECHANISM gives you sure operation even with tone arm set at lowest tracking pressures. Automatic stop after last record.

9. INTERCHANGEABLE PLUG-IN HEADS accommodate your personal choice of high fidelity pickups, fit all cartridges... magnetic, crystal or ceramic; turnover, twist or simple plug-in types.

10. REINFORCED AUTOMATIC MUTING SWITCH eliminates sound through speaker during record change cycle. Also, a special condenser-resistor network eliminates shut-off noise.

Model **RC 88** *Triumph II*

GARRARD

De Luxe Auto-Manual Record Changer



11. STEEL MONO-BUILT UNIT PLATE keeps changer permanently in line. Exclusive snap-mount springs permit you to mount changer instantly, level it from top with screwdriver.

12. CHANGER COMES READY FOR PLUG IN to any system of high fidelity components. Supplied with full 5 ft. U.L.-approved electrical line cord, and pick-up cable terminating in standard jack.

\$54.50 net
less cartridge



301 Turntable \$89.00



RC 98 Super Changer \$67.50



RC 121 Mixer Changer \$42.50



Model T Manual Player \$32.50

Now there's a GARRARD for every high fidelity system!

Quality-endorsed product of the B.I.C. Group

MAIL THIS COUPON for illustrated B.I.C. High Fidelity Plan Book.

Garrard Sales Corp., Dept. GC-27
Port Washington, N. Y.

Send B.I.C. High Fidelity Plan Book.

Name.....

Address.....

City.....Zone.....State.....

TESTED IN THE HOME



Equipment reports appearing in this section are prepared by members of HIGH FIDELITY's staff, on the basis of actual use in conjunction with a home music system, and the resulting subjective evaluations of equipment are expressed as the opinions of the reviewer only. Reports are usually restricted to items of general interest, and no attempt is made to report on items that are obviously not designed primarily for high-fidelity applications. Each report is sent to the manufacturer before publication; he is free to correct the specifications paragraph, to add a comment at the end of the report, or to request that it be deferred (pending changes in his product), or not be published. He may not, however, change the report. Failure of a new product to appear in TITH may mean either that it has not been submitted for review, or that it was submitted and was found to be unsatisfactory. These reports may not be quoted or reproduced, in part or in whole, for any purpose whatsoever, without written permission from the publisher.

Dual Micro Pianissimo Record Cleaner

DESCRIPTION (furnished by manufacturer): a foam-plastic record cleaner, for 7- to 12-in. discs. Price: \$2.95. **DISTRIBUTOR:** United Audio Products, 202-4 East 19th St., New York 3, N. Y.

The Micro Pianissimo record cleaner is a 13½-inch long plastic strip, hinged at the middle and with two layers of fine foam plastic attached to its inner (when folded) sur-

times, and should be washed frequently with soap and water, because while the plastic cleaning pads are very soft when moist, any accumulation of dust on them will have an abrasive action on the grooves.

I have found that LP discs can be effectively cleaned by a moistened pad of folded cheesecloth, but I must say that the Dual Micro Pianissimo does an equally thorough job. It's an ingenious idea, and it works well. — J.G.H.



The Micro cleans both disc sides at once.

faces. At the ends of the hinged sections there are a short spindle of the same size as a standard record center, and a similarly-sized hole that this fits through when the strips are folded.

To use the cleaner, water is sprinkled onto the plastic pads and gently spread with the finger, and then the cleaner's spindle is inserted through the center of the disc to be cleaned. The other section folds over the other side of the disc, and then the disc is rotated while the cleaner is gently squeezed against the record surfaces. The result is a firm but gentle wiping action that precisely follows the direction of the record grooves.

I was at first inclined to be dubious about this gadget. When dry, the foam plastic seemed far too coarse to be safely used on soft vinyl record grooves. The plastic is, however, quite soft when moistened, and several weeks' use on LP discs has proven the Pianissimo to be highly effective in removing every visible trace of dust. Apparently my suspicions about groove damage were unwarranted. The Pianissimo should, though, be kept scrupulously clean at all

Sherwood S-2000 FM-AM Tuner

SPECIFICATIONS (furnished by manufacturer): a basic AM-FM tuner. **FM SECTION**—Frequency response: ±0.5 db, 20 to 20,000 cycles. Distortion: below 1.5% IM @ 100% modulation. Sensitivity: 1.2 uv for 20 db quieting. Selectivity: 6 db bandwidth, 200 kc. Hum and noise: 60 db below 100% modulation. Frequency drift: ±2 kc with AFC, ±15 kc without AFC. Discriminator: 400 kc, peak to peak. Tuning range: 87.5 to 108.5 mc. AFC correction: 16 db. **AM SECTION**—Frequency response: broad band, +0, -6 db, 20 to 7,000 cycles. Sensitivity: 2 uv @ 60% modulation for 0.5 volts out, 6 db signal/noise ratio. Selectivity: broad, 14 kc 6 db bandwidth; narrow, 5 kc 6 db bandwidth. Tuning range: 530 to 1650 kc. Inputs: 300-ohm FM antenna, AM Ferrite loopstick, AM external antenna, Ground. Tubes: 2—6BA6, 6BE6, 12AT7, 6AB4, 6CN7, 6BSB, 3—6AU6, 6AL5, 6X5—GT. Dimensions: 14 in. wide by 4 high by 10½ deep, over-all. Price:



The S-2000 has AFC, flywheel tuning.

\$139.50 to \$149.50, depending on case. **MANUFACTURER:** Sherwood Electronic Laboratories, Inc., 2802 W. Cullom Ave., Chicago 18, Ill.

This is a matching unit to the Sherwood S-1000 20-watt complete amplifier. The two comprise the heart of a fine high-fidelity system, which can be completed by the addition

Continued on next page

TESTED IN THE HOME

Continued from preceding page

of a phono unit and a loudspeaker system (preferably a Sherwood, we are advised).

The FM section of the tuner has very high sensitivity and wide frequency response. AFC action is particularly pleasant; it is not variable but simply switches in or out. It seems to work better than average insofar as effectiveness on medium-strength stations is concerned, as it is not readily pulled away by adjacent-channel stations of greater signal strength. Quieting is uniform over the entire FM band, being perhaps a hair better at the low-frequency end than at the high end. There is an FM multiplex output provided (in addition to the main output) which may be used with the proper accessory equipment, and the main output is at low impedance from a cathode follower. Output level is controlled by a potentiometer on the rear apron of the chassis; no front-of-tuner volume control is provided. (We approve of this simplification.) Tuning is sharp, and strong stations can be successfully kept out of the way of much weaker ones on adjacent channels.

The AM section has good frequency response, switchable from wide to narrow band, for full-frequency response on local stations, or restricted response and high selectivity for long-distance reception. A built-in ferrite rod antenna is provided, and while this will no doubt be adequate in primary service areas, only three stations in our remote location could drown out the local AM interference noises. The ferrite rod can be turned through a quarter circle; so it can be oriented to help reduce interference and increase signal strength.

Four screw terminals are provided for external AM and FM antennas. The terminals are very close to the chassis, so care should be exercised not to short out an antenna wire when making the connections.

The dial is clear and easy to read. The FM range from 88 to 108 megacycles occupies $4\frac{1}{8}$ in., and even though a logging scale is not included, the AM kilocycles scale is subdivided so finely that it can be used for this purpose. Tuning must be by ear or by AFC; no tuning indicator is included in the S-2000.

The control at the left is the function switch, for OFF, FM, or AM. The switch slightly below it is the AM wide-narrow control. The knob to the right is for tuning (flywheel type) and the switch below selects FM AFC ON-OFF.

Nice job all around! — C.F.

MANUFACTURER'S COMMENT: Since the above test on our Model S-2000, we have announced an increase in its FM sensitivity to 0.95 uv for 20 db quieting (1.8 uv for 30 db quieting). Field tests have shown dependable FM reception at 100 miles, useful reception to 125 miles, depending on antenna and terrain. We believe that the benefits of FM are now within the reach of many thousands of additional listeners.

Cabinart Record Storage Bins

With high-fidelity amplifiers, turntables, and speaker systems getting more and more attractive in appearance, the problem of where to put the equipment is becoming less perplexing than the problem of where to put the records we play on the equipment.

Record cabinets sold in hardware and department stores are usually so bedecked with irregular storage bins, record player compartments, and chrome-handled sliding doors that it is sometimes difficult to buy one designed for record storage and nothing else.

The Cabinart Division of G & H Wood Products* has offered a solution to the record storage problem with its

ACC-22 storage bins, which are devoted entirely to what they are made for: record storage. They are sturdily constructed of $\frac{3}{4}$ -inch birch plywood, and measure $23\frac{1}{2}$ in. wide by $14\frac{1}{2}$ high by $14\frac{1}{8}$ deep. Available finishes are blonde, walnut, and mahogany, and the price is \$18. The five vertical dividers (which keep the discs from leaning over against the end of the bin) are finished in ebony black, and four padded feet are mounted on the bottom of the bin so it can be placed on a finished surface or piled on top of other bins without marring their surfaces with scratches.

The unit we received for inspection was finished with a high gloss, and was very nicely put together. Its interior was, however, still coated with a film of furniture polish

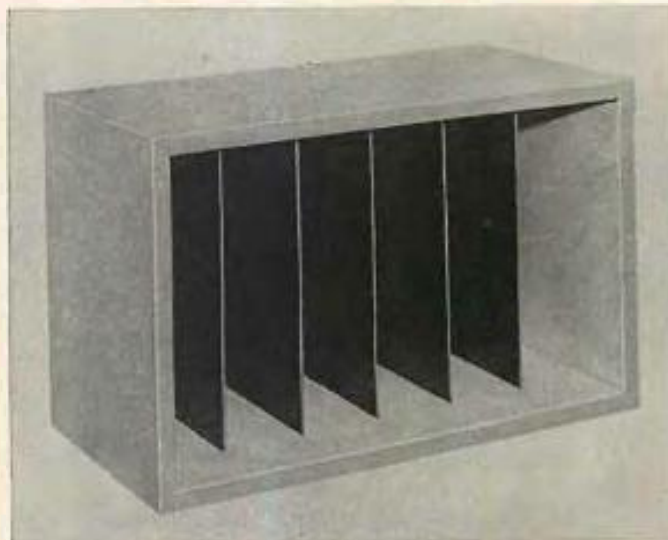

Cabinart's blonde finish record cabinet.

which had to be carefully wiped off to prevent staining the record jackets.

These storage bins are just the thing for a rapidly expanding record library, since they can grow with the collection. — J.G.H.

Bib Tape Splicer

DESCRIPTION: a small semi-automatic magnetic tape splicing jig. **Dimensions:** $1\frac{1}{2}$ in. wide by $4\frac{1}{2}$ long by $\frac{7}{8}$ high, over-all. Splicer detached from base: $\frac{1}{2}$ in. wide by $4\frac{1}{2}$ long by $\frac{5}{8}$ high. **Price:** \$3.95. **DISTRIBUTOR:** Ercona Corporation, 551 Fifth Ave., New York 17, N. Y.

Anyone who has tried splicing recording tape by hand knows the value of a well-designed, easy-to-use splicing jig. Such a device can contribute much to non-sticky, noise-free splices, and can materially reduce the time and tedium involved in editing tape or joining broken tape ends.

The Bib splicer, manufactured by Industrial Engineering, Ltd. of England, is a long channeled block with two hinged clamps attached to its center, and a 45-degree cut and 90-degree cut set into the middle of the channeled block to serve as cutting guides. To use the splicer, the two lengths of tape to be edited together are laid in the channel with their marked spots over the cutting guide, then the clamps are brought down to hold the tape in place. The clamps are lightly spring-loaded, and a small strip of cork on their underside holds the tape firmly in the channels. Then the tape is cut across the guide slot with a razor blade, the loose end of tape that lies on top is removed, and a strip of splicing tape laid across the tape ends and pressed in place. The edges of the splice are trimmed by running the cutting

*99 N. 11th St., Brooklyn 11, N. Y.

Continued on page 116

a winning pair...

Matched for Perfection!



Handmade wood cabinets available at a slight extra charge, in mahogany, walnut or blonde when table-top installation is desired. Separate power unit available for special applications at slight extra cost. See your dealer for Gray tone arms, pre-amplifiers, amplifiers, turntables, and the "Concert Duet"—Gray's complete Home Music High Fidelity System. Stop in and see your nearest Gray authorized High Fidelity Dealer for a real listening thrill!

Here's a winning combination for the High Fidelity perfectionist—the New Gray Audio Control System (Preamplifier-Equalizer) Model AM-3 and the famous Gray 50 Watt Power Amplifier.

Although designed principally for the fortunate owners of a Gray 50 Watt Power Amplifier, the Gray Audio Control System can be successfully used with any of the power amplifiers now on the market AND with ALL magnetic or ceramic pickup cartridges.

Includes many **exclusive** engineering features such as complete record equalization controls, multi-input selector and superb transient performance, in addition to the finest of electrical components for long trouble-free life. Eye appeal styling, as modern as tomorrow!

Write TODAY for complete technical literature on both the power amplifier and preamplifier—

GRAY RESEARCH & DEVELOPMENT CO., INC.
Manchester, Connecticut

Subsidiary of The Gray Manufacturing Company

EXPORT DIVISION: Racke International Corp., 13 E. 40th St., New York 16, N. Y.
Cables: ARLAB

TESTED IN THE HOME

Continued from page 114

blade along two parallel slots cut into the edges of the channel, and the splice is completed.

As might be expected from the simplicity of this device, it works quite well, producing splices that are sufficiently precise for all but professional applications. As is true of nearly all inexpensive splicers, the Bib requires some care on the part of the operator to produce splices straight and close enough to prevent the tape from twisting or sticking between layers, but with practice you can make this a real time-saver.

The Bib comes mounted on a small wooden base which can

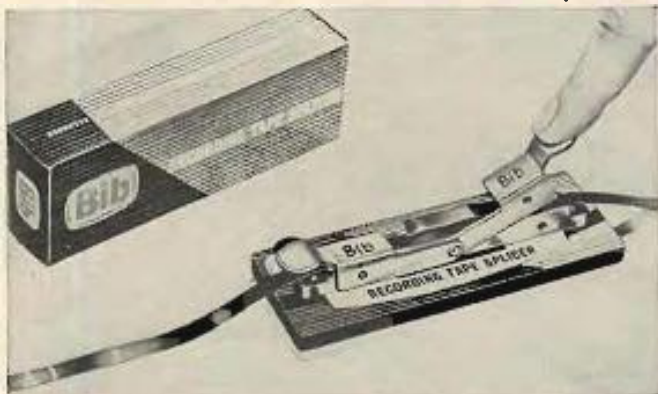

The Bib splicer clamps tape, guides cutter.

be removed, if desired, so that the splicer can be screwed directly onto the head assembly or top panel of the tape recorder. — J.G.H.

MANUFACTURER'S COMMENT: It has been our experience that the Bib will produce splices that are sufficiently precise for professional applications. The user has the choice of either a diagonal splice or, for editing down to a syllable, a vertical splice. All Ferrograph tape recorders and tape decks are pre-drilled to mount the Bib splicer.

Gellar Plastic Equipment Covers

September's "Noted With Interest" column mentioned a gentleman by name Marvin Gellar,* who had informed us he would be willing to supplement his production of custom-made auto seat covers with made-to-order plastic covers for phono turntables and record changers. We can point with some pride to the fact that, since that NWI item appeared, Mr. Gellar has gone into "full-scale production" of his custom covers.

Made of heavy (16-gauge) clear vinyl plastic, the covers are cut to any dimensions specified (within reason, anyway), and sell for \$2.95 (plus 25¢ for postage) in sizes up to 21 inches long. Larger sizes cost \$3.50, plus the 25¢.

We received one 22 inches long by 19 wide by 10 high, made for the Gray turntable unit, and have been using it for the past few weeks. Since it was mailed folded in a flat package, it was several days before the folds worked out of the vinyl and it became easily manageable. It now conforms quite well to the rectangular shape of the turntable assembly, and when in place settles lightly onto the top of the arm and turntable.

As might be expected, it does an excellent job of keeping dust from settling onto the table and arm while the system is not in use. This helps materially to prevent the underside of a disc placed on the turntable from becoming fouled from a dusty table mat, and it also protects the entire motor board from the airborne grime that normally dulls its appearance between dustings.

There isn't much that can be said about anything as simple

* 118 Main Street, Poughkeepsie, N. Y.

as this, except that it does what it is supposed to do, and at a very reasonable price at that. — J.G.H.

MANUFACTURER'S COMMENT: At present, these plastic covers are available only through the mail. Besides manufacturing turntable covers, we also custom make similar covers for other hi-fi components, such as amplifiers, tuners, and tape recorders. The plastic material is highly polished to give a clear, transparent finish, and it is fully guaranteed against cracking and discoloration.

Old Colony Record Filing System

DESCRIPTION (furnished by manufacturer): a record filing kit consisting of a special adjustable rubber stamp and adhesive label. Prices: stamp and 300 labels, \$10.00; stamp only, \$6.50; additional labels, \$1.50 per hundred. **MANUFACTURER:** Old Colony Sound Lab., Box 585, Millis, Mass.

When the first long-playing records appeared on the scene they were hailed as the solution to many of 78's knottiest problems, including that of storage. Discophiles who for years had been accumulating towering shelves of heavy gold-lettered albums began to envision their entire collections as reduced to a small record cabinet full of LPs.

But LPs brought with them their own unique storage problem, that of content-coupling being one. The availability of 45 to 60 minutes of playing time implied a commercial obligation to utilize that time, and since much of the musical repertoire consists of works lasting 10 to 20 minutes, it became necessary to couple different works on a single disc. Hence the record collector who used to arrange his albums alphabetically by composer and title was faced with a baffling question. Should he file a disc of *French Keyboard Music* under Ravel: *Miroirs*, Debussy: *Reflets dans l'Eau*, or Satie: *Mouvements Perpetuels*? Or should they all go into *Miscellany*, under *F* for French?

The problem remains, although many collectors with an orderly bent have managed to devise their own filing systems which, by careful cross-indexing and a card file or record catalogue, enable them to find practically any work in their collections on reasonably short notice. The essential weakness of most such filing systems, though, is that they depend upon the labeling on the record jackets. And if a conventional shelf arrangement is used to store the discs, new acquisitions tend to "fatten" the collection from the middle toward the ends, making it necessary from time to time to shift whole groups of discs from one shelf to the next.

The Old Colony record filing system provides what appears to be by far the best solution to date. It consists of



An Old Colony record filing label.

a specially-made band-type adjustable rubber stamp and 300 gummed labels (see illustration), which allow the record collector to compile his own filing system without the necessity for observing a record's serial number or contents. Thus, regardless of how many compositions are contained on one disc, it is represented in the collection by a single file number, and has but one assigned place on the shelf where it belongs.

The Old Colony system is used with a set of file cards, listing all compositions in the entire collection under as

Continued on page 118

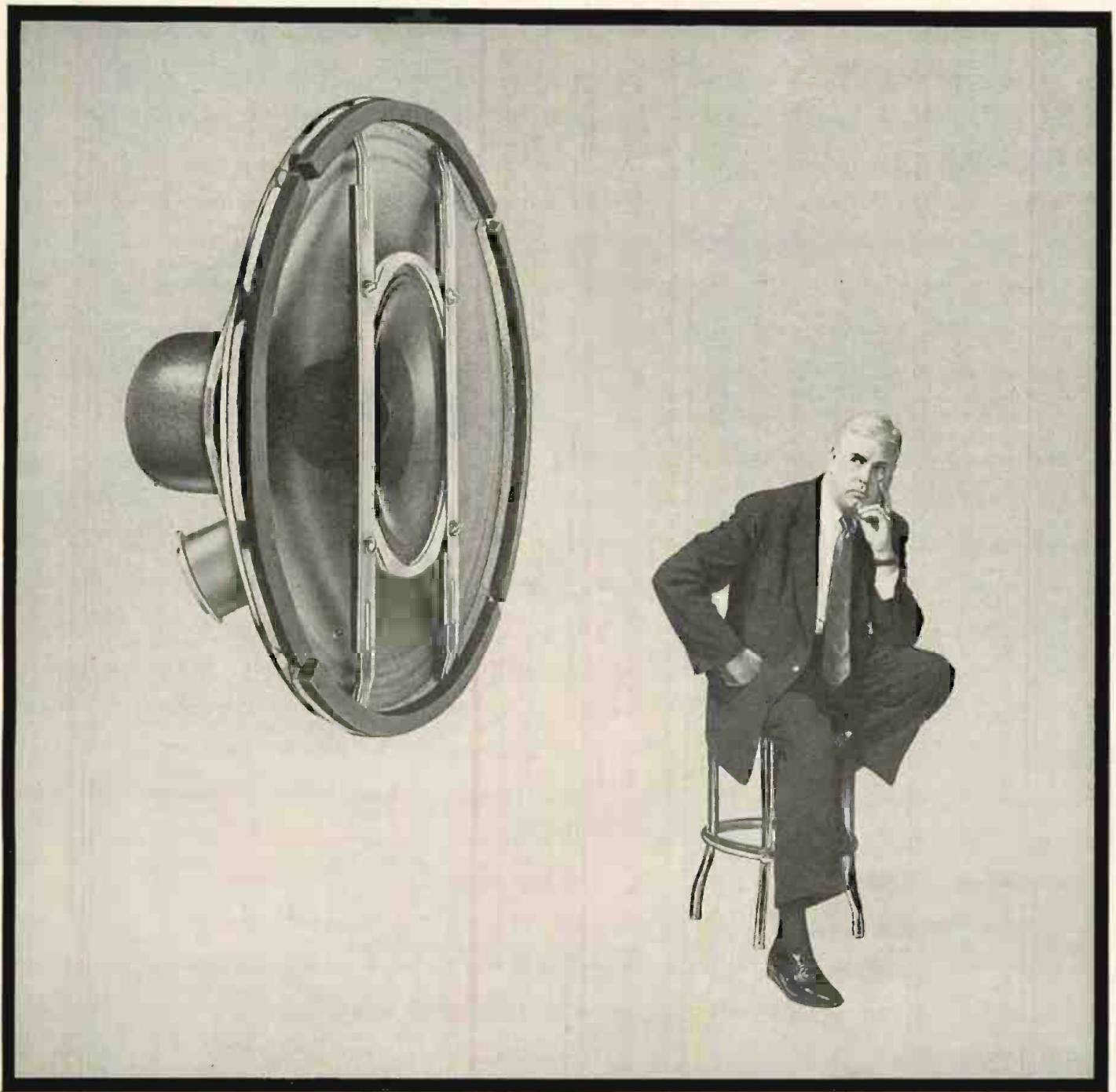

NEW SONOTONE CA-12 12" CO-AXIAL LOUDSPEAKER

The price will be music to your ears, too!

40-14,000 cycles—elliptical cone tweeter—complete dividing network. And the price... \$19.50. That's right, \$19.50. Yet it out-performs speakers selling at three times the price. Interested? Listen to the CA-12 and be convinced.

Ask your dealer for a demonstration, or send your name and address for full details.

Electronic Applications Division



SONOTONE® CORPORATION
ELMSFORD, N. Y.

NAME _____

ADDRESS _____

CITY _____ ZONE _____ STATE _____

LH-37

TESTED IN THE HOME

Continued from page 116

many categories as are deemed necessary. For instance, the files could be set up according to composer only, or could also include references by type of material (symphonies, concertos, bird calls). Each cross reference refers back to the same catalogue number, by which the record then may be located.

The labeling stamp has five adjustable bands, and its characters are oriented to be read vertically, from top to bottom, rather than horizontally. You need not twist your neck; the gummed labels, when stamped with the proper catalogue numbers, are attached around the spines of the envelopes. Thus, when the records are lined up in their shelves, their catalogue numbers are visible and easily read. The first two bands on the stamp are initials from A to K (excluding I), and the other three are numbered from 0 to 9.

Probably the simplest of Old Colony's suggested filing systems is that in which all discs are placed in their shelves without order or categorization, and are then assigned catalogue numbers in ascending order from one end of the shelves to the other. Since the file cards are the key to locating a disc, its actual location in the shelves doesn't matter. The outstanding advantage of this uncategorized system is that new records may simply be added to the end of the collection, enabling it to grow without expanding from the middle. Then as the collection outgrows its shelf space, it can expand into a new shelf without having to be redistributed.

Several other operating systems are also suggested in the very complete instructions supplied with the file kit, and the rubber stamp provides enough variations so that users with other ideas about filing or categorizing can follow their own inclinations.

As a useful addendum, space is also provided on the gummed labels for equalization data.

The convenience of the Old Colony record filing system to the user is likely to increase arithmetically as the size of his record collection increases; so the larger the collection, the better this investment will be. — J.G.H.

MANUFACTURER'S COMMENT: We only wish to add that the labels used are of the pressure-sensitive type, and will adhere to any surface or any type of record sleeve. The adhesive is permanent, and will not deteriorate or dry out.

Connoisseur Mark II Pickup

SPECIFICATIONS (furnished by manufacturer): a moving-iron magnetic pickup and arm. Frequency response: ± 2 db, 20 to 20,000 cycles on LP discs. Output: 15 millivolts from LP discs; 25 millivolts from 78 rpm discs. Tracking force: 4 to 6 grams on microgrooves; 7 to 8 grams on standard grooves. Stylus mass: 4 to 5 milligrams. Lateral compliance: 3.5×10^{-6} cm/dyne. Coil impedance: 400 ohms. Interchangeable plug-in heads for microgroove and standard groove. Tracking error: 2.5 degrees. Dimensions: 11 in. long, over-all; $8\frac{1}{2}$ in. from center of base to stylus; height adjustable from $1\frac{1}{2}$ to $2\frac{1}{2}$ in. Adjustable counterweight at rear of arm. Prices: Arm and Cartridge: \$49.50; Cartridge only, diamond stylus: \$33.00; cartridge only, sapphire stylus: \$17.50. **DISTRIBUTOR:** Ercona Corporation, 551 Fifth Ave., New York 17, N. Y.

Phono pickup design has come a long way since the days when a 1-oz. monster was considered "featherweight," and 5-gram pickups were reported with some disbelief as being used in laboratories as proof that 5-gram pickups were impractical. Now cartridges that will track LP discs at 6 grams are the rule rather than the exception, and several have appeared which, like the Connoisseur, will track cleanly at even less force.

The predecessor of Connoisseur's Mark II (which was presumably called the Mark I) was introduced in Great Britain several years ago, and used a somewhat larger arm than the present model. The arm sent to us is shorter than

the original one, and incorporates a single vertical needle bearing in place of the cone-face bearings of the earlier model.

The heavy rear-hanging counterweight on the Mark II is free to slide for some distance along the end of the tubular arm, and a set screw holds it in place at the desired position to give the proper stylus force when the microgroove head is plugged in. When that is replaced by the standard-groove head, a lead weight in the head automatically increases the stylus force to the optimum value for 78s.

The arm is quite simple to install, requiring only a single $1\frac{1}{4}$ -in. hole for the arm base, and five $3/32$ -in. holes for the fixing screws to hold the base and the arm rest. Arm height is adjustable over a sufficiently wide range to permit use with any turntable of standard height, and it should be set so that it is as close as possible to horizontal when playing a disc. To assure freedom of movement, the flexible



Connoisseur's Mark II lightweight pickup.

cable should be pulled out and bent to form a loop of about $1\frac{1}{2}$ -in. diameter at the point where it enters the top of the arm base.

The cartridge's 15 millivolt output from LPs happens to be about optimum for use straight into most American preamps, without the addition of a step-up transformer or an attenuator network. The manufacturer's instructions I received were, however, quite vague about the cartridge's recommended resistive load, preferring to let this be determined by "personal tastes and variation in the equipment being used." This is, I feel, an unnecessarily cautious approach to a matter which has such a direct bearing upon a pickup's performance, and since the Connoisseur, loaded with 47,000 ohms, tests and sounds about as linear as any cartridge of this type I have encountered, I feel that A. R. Sugden and Company (manufacturer of Connoisseur equipment) might have mentioned this fact in their instructions.

Another highly desirable characteristic of the Connoisseur is its vertical compliance, which results in reduced record wear and really remarkable lack of needle talk. Low needle talk is important not simply as a sign of low groove abrasion, but also when a pickup is to be used uncabineted in the same room as the loudspeaker. A cartridge with high needle talk will under similar conditions introduce what sounds much like groove distortion and can easily be mistaken for fuzziness coming from the loudspeaker.

I was also a little surprised to find that the Mark II's specifications did not list compliance figures, since the cartridge's compliance is certainly nothing to be ashamed of. Some buyers must depend entirely upon specifications rather than listening tests as a means of choosing components, and while a listening test would sell the Connoisseur without any trouble, the literature is not as compelling as it could be.

The Mark II is a beautiful performer. It handles high-level recorded passages with an effortless ease that can do justice to the finest associated equipment, and which also may help cover up the shortcomings of less pretentious systems. Its linearity and low distortion tend to minimize surface noise and blemishes, and its ability to ride high-amplitude low-frequency signals is surpassed by few other cartridges. It does, however, have a tendency to "bounce" from side to side (without skipping grooves, though,) when

Continued on page 122

STEREO-FANTASY

The NEW BOZAK B-304

adds the Ultimate Ingredient
of Realism . . .

Spatial Perception

This binaural speaker system in a single enclosure is a distinctively original Bozak concept. With two-channel stereo program material, it re-creates an unbroken front of living sound with the sense of breadth, depth and direction vividly perceptible over a wide angular listening area — retaining throughout virtually the entire room the sense of perspective and homogeneity of the sound that is the essence of the ultimate in realism. The Bozak B-304 literally transforms your living room into the pit of a concert hall — every instrument in its proper location on the stage and without the "hole in the center" that is felt so commonly with separate-enclosure stereo sound.



This is a luxury speaker system. It is expensive, and should be used only with two identical amplifying channels of the highest quality and minimum of 30 Watts power which, by their nature, are also costly. With wide-range, low-distortion two-channel discs, tape, or AM/FM broadcasts, the *Stereo-Fantasy* offers a listening experience approached by no other loudspeakers for the vital immediacy of its sound.

Superb cabinet work in a choice of two designs: The *Provincial* (above) in Fruitwood; and the *Contemporary* (left) in Walnut or Mahogany.

All Bozak Products are Designed and Built
by the R. T. Bozak Manufacturing Company

The Very Best in Sound

BOZAK

EXPORTS: ELECTRONICS MANUFACTURERS' EXPORT CO. • PLAINVIEW • N. Y.

THE R. T. BOZAK SALES COMPANY • BOX 966 • DARIEN • CONN.

MARCH 1957

119

Bogen



THE BOGEN MODEL DO70 HIGH

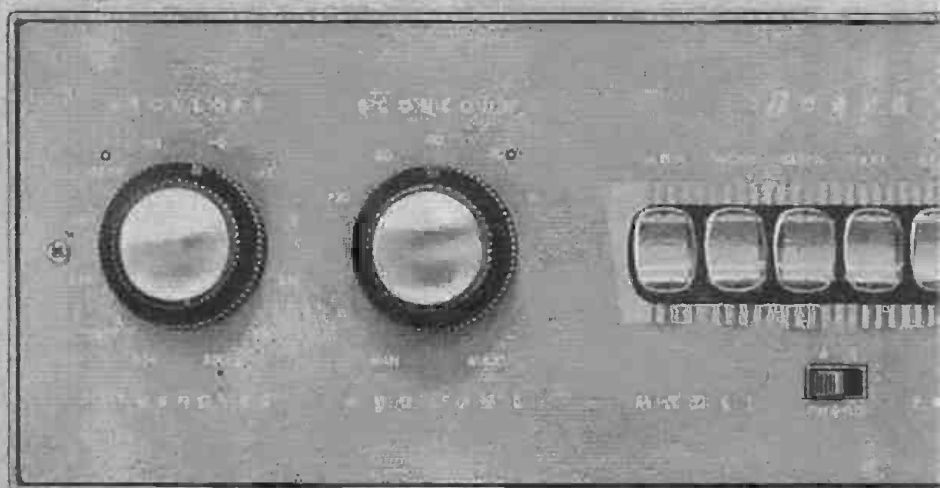

PR100A AUDIO CONTROL AN

If you are ready to own the optimum in high fidelity, get to know these two components. They are the standard against which others must be measured. The remarkable engineering specifications only hint at the flawless sound they produce together.

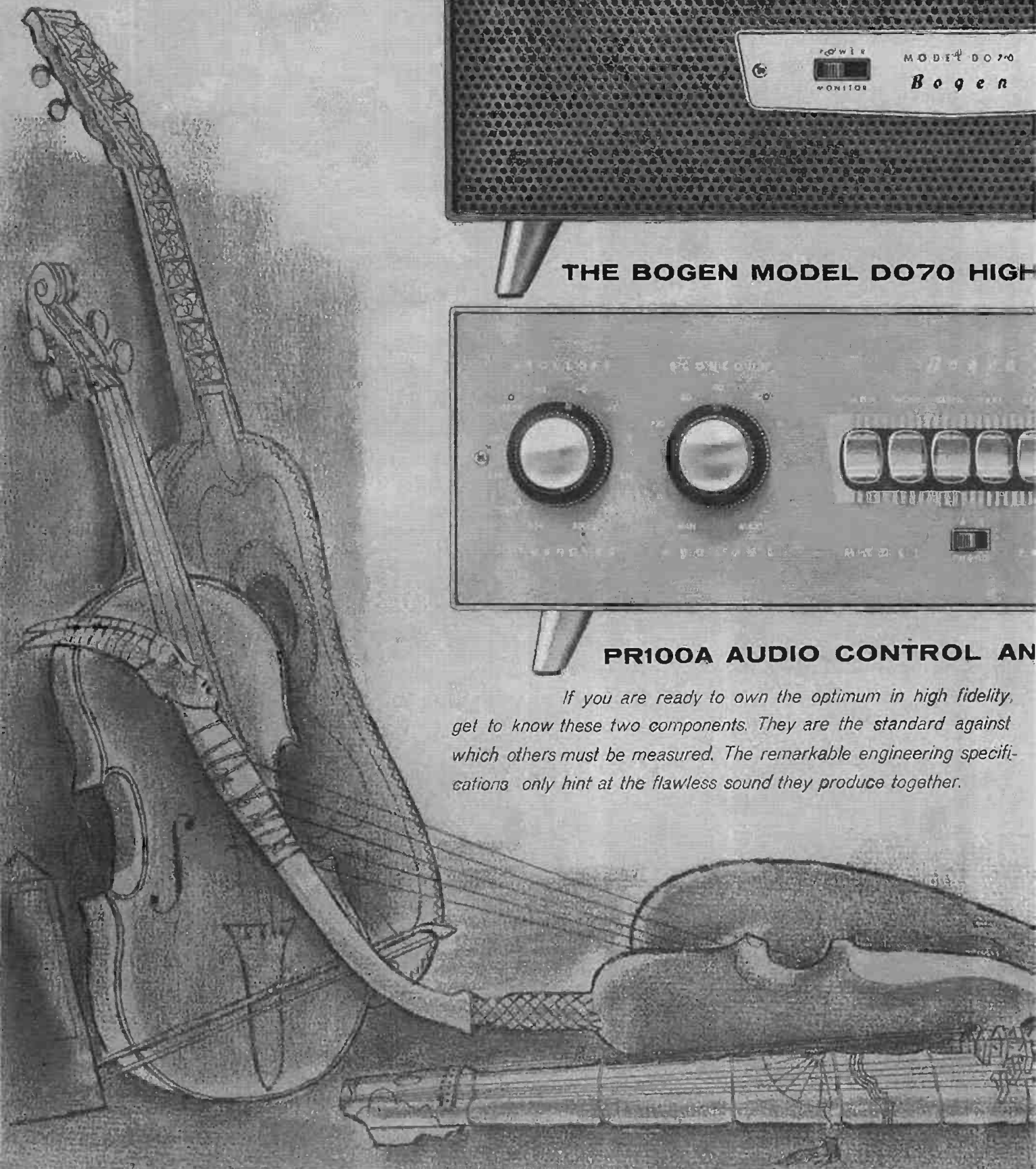

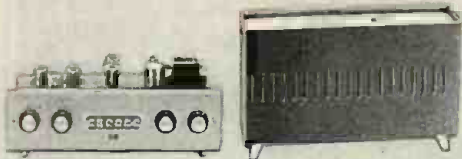

because it sounds better...



POWER AMPLIFIER

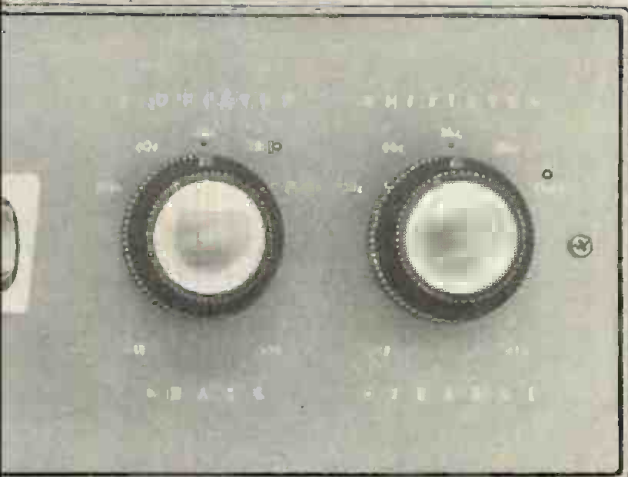

PREAMPLIFIER

THE D070—POWER OUTPUT: 70 WATTS; TONE BURST PEAK POWER: 300 WATTS; DISTORTION: 10% AT 80 WATTS 0.5%, AT 70 WATTS: 0.125%, AT 10 WATTS; FREQUENCY RESPONSE: 5 TO 100,000 CPS, WITHIN 0.5 DB; SENSITIVITY: 1 VOLT INPUT FOR 70 WATTS; GAIN: 76 DB; HUM AND NOISE: 100 DB BELOW RATED OUTPUT; DAMPING FACTOR: VARIABLE FROM 10.1 THROUGH 00 TO -1.5. BUILT IN 2 POS SPEAKER-SELECTOR SWITCH WITH BLONDE-OR MAHOGANY FINISHED METAL ENCLOSURE: \$129.50.

THE PR100A — DISTORTION: VIRTUALLY UNMEASURABLE; FREQUENCY RESPONSE: 10 TO 130,000 CYCLES ±0.5 DB; 10 FRONT PANEL CONTROLS: HIGH FREQUENCY ROLL-OFF (6 POSITIONS); LOW FREQUENCY TURNOVER (6 POSITIONS); PHONO SELECTOR (12 POSITIONS); BASS, TREBLE, LO FILTER (5 POSITIONS); HIGH FILTER (5 POSITIONS); VOLUME, LOUDNESS CONTOUR SELECTOR (5 POSITIONS); INPUT SELECTOR (6 PUSH-BUTTON SWITCHES); POWER OFF, MON, PHONO, RADIO, TAPE, AUX; 4 CHASSIS CONTROLS: LEVEL ADJUST FOR PHONO B INPUTS, TAPE INPUT, TUNER INPUT, AUX INPUT, EXCLUSIVE "TAPE-MONITOR" PERMITS MONITORING RECORDED SIGNAL WHILE RECORDING. CHASSIS: \$109.00, BLONDE OR MAHOGANY-FINISHED ENCLOSURE: \$7.50.

Bogen
HIGH FIDELITY

A UNITEDINNOVATIONS CORPORATION AFFILIATE

what the 'sound men' say...

"I get lots of calls for Bogen equipment here at Newark's in Chicago. I like Bogen's broad line, especially the moderately priced DB115 amplifier and its companion R620 tuner. They make a fine pair for those beginning in hi-fi.

"I have also found that the audio quality of Bogen's premium line of amplifiers, tuners, receivers, and turntables satisfies the most discriminating listener. The fact that Bogen equipment can fill most every hi-fi need both in price and features, has sold me on Bogen."

Richard B. Roetter, Newark Electric Company, Chicago, Illinois. (Dick is widely known among Chicago-area audiophiles as one of the mid-West's leading hi-fi consultants.)



Send 25¢ for new 56-page "Understanding High Fidelity".
David Bogen Co., Inc., Box 500, Paramus, N. J.

TESTED IN THE HOME

Continued from page 118

playing an eccentrically warped LP or an off-center 78. This odd phenomenon probably has something to do with the arm resonance, which occurs at a little above 20 cycles.

Watch the stylus force on the Mark II, as delivered. For some reason or other, the unit I tested was set for 2½-grams force instead of the 6 it was supposed to be. The fact that it took several loud recordings before I was aware of anything amiss is a tribute to the Mark II's remarkable tracking ability, but it doesn't pay to use a cartridge at less than its recommended force. I found 4 grams to be optimum. The stylus on this pickup is, by the way, replaceable by the user, which is a significant convenience feature.

The Connoisseur Mark II can be recommended for use in a system of the very highest quality. — J.G.H.

MANUFACTURER'S COMMENT: The Connoisseur's instructions show a schematic diagram which suggests the use of a 10,000-ohm load resistor, although the 47,000 ohms used for these tests would cause only a 1 db rise in response at 15,000 cycles. Only at loads below 10,000 ohms does the response begin to fall off significantly, being about 6 db down at 15,000 cycles with a 3,000-ohm load. It is for this reason that we suggest the proper load resistor as being a matter of taste.

Above the 10,000-ohm value, the load resistor is not critical since the Connoisseur's stylus resonance on vinylite occurs around 20,000 cycles. Thus it does not depend for its smoothness upon being heavily electrically damped.

The compliance specification has been added to current Connoisseur specification sheets, and is as stated in the Specifications section of this report.

We have intentionally designed the cartridge so that it can be used only with the Connoisseur arm, which is light enough so that its mass does not impede the motion of the pickup on warped or off-center records.

The counterweight on the arm should be fitted tight against the back of the arm base moulding to give the 6 gram tracking force, although rough handling in transit will occasionally shift its position. This is easily corrected by loosening its set screw and sliding it forward.

Rogers Symphony Corner Horn Speaker System

SPECIFICATIONS (furnished by manufacturer): a full-range single-way rear-horn-loaded speaker system. Driver: 8-in. wide-range speaker. Frequency response: ± 6 db from below 50 to over 15,000 cycles. Impedance: 15 ohms. Power capacity: 15 watts continuous, 20 watts program. Efficiency: 12%. Dimensions: 34 in. high by 32 wide by 25¼ deep. Price: \$149.50, in a choice of 12 custom decorator finishes. **MANUFACTURER:** Ercona Corp., 551 Fifth Ave., New York 17, N. Y.

This is one of the most deceptive-looking items I have tested for some time, appearing at first glance to be just another small two-way corner horn system with an 8-inch speaker aimed vertically from the top, instead of from the front, as is more usual.

However, the interior of the enclosure below the 8-inch speaker is occupied only by the ducts and panels comprising a rear-loading horn, which opens into the room in the usual manner through large apertures on either side of the enclosure.

Mounted directly above the speaker (inside the metal grille) is an inverted wooden cone, which serves to reflect our into the room highs which would normally head straight for the ceiling. This gives full 360-degree high-frequency dispersion, and does away with the on-axis off-axis beam effect that is a characteristic of many conventional speakers.

Like most corner horns, the Symphony works best in a 90-degree corner, which can provide something like an airtight fit between the edges of the system's top panel and the room walls. When used in a corner that fits it, its performance is notable. Considering the difficulty of obtaining



The Rogers corner horn speaker system.

deep bass from so compact a horn as this, the Symphony's low-range reproduction comes as a surprise. In the small room in which it was tested, its bass was quite linear to a little above 80 cycles, tapering off discreetly from there to its cutoff at about 50 cycles. This figure would probably be bettered in a larger room. No doubling was audible below cutoff, and this low distortion probably accounts to some extent for the Symphony's unusually pleasant bass definition on reproduced music.

Sweeping an oscillator through its upper range, the Symphony gives indications of being extremely smooth to about 2,000 cycles, where it rises slightly to a mild, broad peak centered at 4,000 cycles and then slopes off again at 6,000 cycles. From there on it continues out smoothly to around 10,000 cycles, where its output is almost as great as at 7,000. Beyond 10,000 its output begins to drop and is practically out by 16,000 cycles. This would be considered very good high-frequency performance for a multi-way speaker system; for a single wide-range speaker, it is outstanding.

On music, the Symphony system exhibits little of the brightness that I had expected in view of its broad 3,000-cycle peak; its "neutrality" of sound is very refreshing to these presence-fatigued ears. The Symphony's high-frequency range is, in fact, one of the smoothest and cleanest I have heard for some time, and its upper range is quite as good as the earlier oscillator tests suggested it might be.

Its over-all sound is clean and nicely balanced, with only the diminishing low-bass response to remind one that, after all, this is only an 8-inch speaker in a small horn enclosure. As for the enclosure itself, it is rigidly constructed, and contributes very little of the annoying "horn sound" that some designs have introduced into the lower middle range.

The Symphony won't take the place of the multi-way systems, but its smoothness and ability to reproduce accurately musical timbres put it into the top bracket of its price class.

— J.G.H.

MANUFACTURER'S COMMENT: We mildly object to your reference, "only an 8-in. speaker," since the speaker in question will, in this enclosure, out-perform many 10, 12, and 15-inch units in the lower and middle frequency ranges. In very few cases will multi-way

Continued on page 124

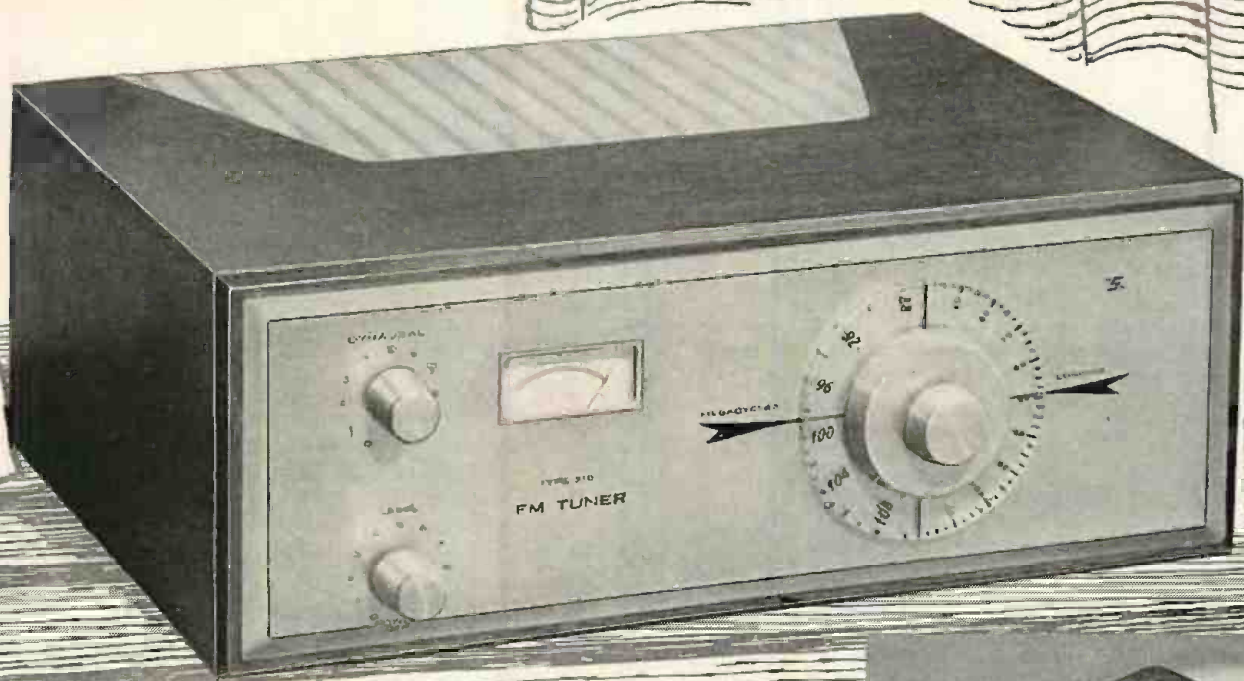

H. H. Scott Model 310-B FM Tuner 13½ x 5 x 9½ \$159.95 Other H. H. Scott tuners from \$119.95 (Mahogany Case \$19.95) All tuners meet FCC radiation specifications. All prices slightly higher west of rockies.

**Exclusive wide band design . . .
new silver sensitive front end . . .**

Most Sensitive . . . Most Selective FM Tuner Available Anywhere!

Wide-Band Design Makes Tuning Drift Free. Once you select a station, the 310 always stays tuned perfectly. As one 310 owner put it: "I tuned my 310 to WXHR, Boston, left it there for several weeks, simply turning it on and off each day. The 310 didn't drift off station once". With wide-band, troublesome AFC is eliminated, weak and strong signals tune alike!

Wide-Band Design Virtually eliminates cross-modulation and co-channel interference. With conventional tuners

you often pick up a strong local station at more than one place on the dial, seriously interfering with stations you want to receive. The 310 completely eliminates this . . . lets you enjoy stations you could not receive before.

Wide-Band Design gives you greater selectivity than is possible with any other tuner. The low capture ratio (2½db) inherent in wide-band circuitry plus 3 IF stages makes this possible. Now you can separate stations so close together ordinary tuners pass them right by.

Here are other important features:

- Planetary drive tuning with edge lighted dial that provides both quick and vernier tuning
- Dynoural Interstation, Noise Suppressor eliminates annoying FM "roar" between stations
- Illuminated Signal Strength and Tuning Meter for accurate station setting on weak signals
- Sensitivity 2 microvolts on 300 ohm antenna terminals for 20 db of quieting (equivalent to 1 microvolt with matched 75 ohm antenna)
- Logging Scale
- Separate tape recorder and multiplex outputs
- 2½ db capture ratio permits virtually noise free reception of stations only slightly stronger than interference on the same channel
- Easily panel mounted, matches all H. H. Scott amplifiers.



Silver Sensitive Front End Makes Distant Stations Sound Close By!

H. H. Scott never compromises on design. The front end pictured above is a good example. Only H. H. Scott, of all manufacturers, heavily silver-plates their cascade RF section to obtain both maximum sensitivity and most reliable performance. Sensitivity 2 microvolts for 20 db of quieting on 300 ohm antenna terminals (1 microvolt with matched 75 ohm antenna). You'll get perfect reception of stations whose signals are too weak for tuners of conventional design.

Write for Complete Technical Specifications

WHAT LEADING AUTHORITIES SAY ABOUT H. H. SCOTT COMPONENTS

" . . . any true high fidelity system . . . should include dynamic noise suppression when the ultimate in record reproduction is required."

Harold Weiler, Author
HIGH FIDELITY SIMPLIFIED

" . . . the 310-A seems as close to perfection as is practical at this time."

Tested in the Home Report
HIGH FIDELITY Magazine

" . . . it is the selectivity of the new Scott, its competence in choosing among the many the one station wanted, that has excited the greatest admiration for that unit."

SATURDAY REVIEW
Home Book, 2nd Edition



**FREE! Send for H. H. Scott's
Informative Photo-Catalog Today!**

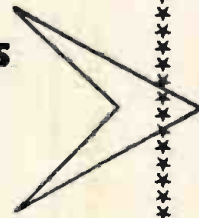

H. H. Scott, Inc.
385 Putnam Avenue, Cambridge, Mass.

Rush me your new catalog HF-3 showing the complete H. H. Scott line for 1957, including question and answer selection explaining hi-fi.

Name _____

Address _____

City _____ State _____

Export Dept.: Telesco International Corp.
36 West 40th Street, New York 18, N.Y.

TESTED IN THE HOME

Continued from page 122

systems provide sweeter high-end reproduction; nevertheless, an alternate model is in preparation, employing a 10-in. speaker to attain linear response to 60 or 65 cycles, with cut-off in the 35-40-cycle range. A slight penalty will be exacted to achieve this, amounting to a loss of about 1,000 cycles of range at the extreme high end. The lover of good music will thus be able to choose according to his individual preferences. The compact and highly styled enclosure will have the same dimensions for either speaker.

Bard Ortho-Sonic V/4 Arm

SPECIFICATIONS (furnished by manufacturer): a radial tone arm suitable for use with records of any size. Has provisions for leveling, height adjustment, and stylus force adjustment. Accepts any standard cartridge. Tracking error: zero, when properly installed. Price: \$35.95; also available for 16-in. transcriptions, \$44.50. Binaural model, \$59.50. **MANUFACTURER:** Ortho-Sonic Instruments, Inc., 66 Mechanic St., New Rochelle, N. Y.

A radial pickup arm—one in which the cartridge stylus traverses a straight line from the outer edge of the record to the center—is an ideal that designers and manufacturers have been trying to put into practical form for many years. Any arm that swings over the record from a vertical pivot at one end necessarily introduces some tracking error: that is, the cartridge is held perfectly tangent to the record grooves at one or two positions only. At all other positions, a lateral angle exists between the groove and cartridge that is known as tracking error. It is undesirable, because it can increase distortion and reduce high-frequency tracing ability, and even the best professional arms of the conventional type introduce it to some degree. This error is eliminated by the use of a radial arm.

The main difficulty in developing a practical radial arm, in which the cartridge must move sideways along a slide or track, has been in getting low enough friction in the lateral bearing system to permit low stylus forces. There is no leverage to help turn the bearing, as there is in a long standard arm. And because the lateral motion is extremely slow, the cartridge's momentum cannot help it to get over rough places; accordingly the bearing system must be very smooth as well. To make such a precise and delicate bearing system, and at the same time make it rugged and inexpensive, requires considerable ingenuity.

In the V/4, the cartridge is carried in a short arm or trolley suspended at its approximate midpoint from a yoke. At the top of the yoke are arranged four ball-bearing wheels which travel on a stainless-steel rod; the rod is held within a housing trapezoidal cross section that extends from the edge of the turntable inward toward its center. The housing can be rotated slightly on its horizontal axis, and when this is done its back apron pushes down on the rear of the cartridge carrier arm—thus lifting the stylus off the record. The whole arm can be turned on its base and swung out of the way while you change records; pushed back, it snaps into correct playing position. Then you push the carriage toward the outside of the record until the stylus is suspended over the run-in groove, tilt down the housing, and the stylus drops gently into the groove. If you want to interrupt play for some reason (such as answering the telephone) tilt the housing up—the carriage doesn't move laterally—and when you're ready to continue listening tilt the housing down again. Ordinarily you'll hit the groove where you left off. You never have to touch the cartridge carrier when beginning or ending play, so there's no reason for ever scratching a record because of careless set-down or pick-up.

The arm has several other design features that merit the adjective "ingenious." Take, for instance, the method for mounting cartridges. The carrier arm is channel-shaped, and

on one side of the channel is a leaf-spring that is pushed inward by a threaded screw whose knurled head protrudes outside the channel. To install a cartridge, insert it in the channel, tighten the side screw, and that's it! Contact to the cartridge terminals is made by two flat metal discs mounted side-by-side in the channel on two spring-loaded plungers; the pickup leads are connected to the other ends of the plungers. For adjustment of stylus force there is a weight fitted to a long screw on the back of the cartridge. Turning the screw inward increases stylus force; turning it outward decreases the force, as it counterbalances more of the cartridge weight.

Only one fairly small hole in the turntable base is needed to mount the arm. Because horizontal leveling of the housing (with its bearing rod) is of the utmost importance, leveling has been made particularly easy—two small set-screws, threaded through opposite sides of the arm base, bear in mutual opposition against a metal sole-plate under the base. Their relative settings determine the angle of the base (and housing) with respect to the mounting board.

At either end of the bearing rod are tight-fitting rubber bumpers that you adjust to limit the carriage travel. Normally you'd set one to stop the stylus over the run-in groove for a 12-inch record, and the other to prevent the stylus from hitting the turntable center pin. Finally, there is a cuing or indexing scale on the front of the housing, and a rigid



The Ortho-Sonic radial pickup arm.

arm attached to the carriage that holds a magnifying lens in front of this scale; with it, you can return to any given place on a record with high accuracy.

How does it work out? Very well indeed, although I could not obtain perfect tracking at a stylus force lower than 5 grams. It is possible, of course, that by more precise adjustment of the leveling screws this could have been lowered, but I was quite careful in this regard. Stylus force under 5 grams is, however, specified for only a very few cartridges.

The instructions are complete and clear, and the V/4's construction appears to be very good. For those who can use it to advantage, the V/4 arm offers a wealth of convenience features and the virtual elimination of tracking error.

—R.A.

MANUFACTURER'S COMMENT: The average stylus force gauge will not give accurate readings with a radial pickup arm unless used with extreme care. This is because it is difficult to avoid side pressure on the cartridge when measurements are made, so the reading will often reflect a combination of vertical stylus force and the lateral motion-starting force. With highly compliant cartridges, most records will track successfully with as little as 2 or 3 grams force. The question of stylus force, however, is of less importance with a radial arm than with a conventionally-pivoted arm, because of the former's lack of centripetal force. Because there is no need for arm length or offset angle in a radial arm, it eliminates the force which tends to throw the stylus toward the inner wall of the groove, so the stylus normally rides in the groove center. Thus, a cartridge can be used at a lower force than would otherwise be required to hold it centered in the groove.

how will
you have your



HIGH FIDELITY

...components or consoles?

Pilot offers you the same
superb quality in both

People show two preferences in high fidelity. Some select individual components which they install and connect themselves—while others prefer self-contained consoles that need only be plugged in and played.

If you are among those who enjoy the 'doing' as much as the listening, you will find no finer components than the tuners and amplifiers offered by Pilot. Or, if you favor the easy, 'plug-in-and-use' convenience of a console, you will find an exciting message in the story of Pilot Component-Consoles.



Pilot High Fidelity COMPONENTS



Pilot High Fidelity COMPONENT-CONSOLES

Today's Pilot Tuners and Amplifiers are the most advanced in circuit design and engineering. They cover all design types to permit the greatest flexibility in planning a system: tuners with built-in phono and tape preamps, for use with basic power amplifiers; and basic tuners for use with preamp-equipped amplifiers. The choice of combination is one of personal preference.

Pilot Tuners and Amplifiers are also the most modern in styling and appearance. They are housed in attractive metal enclosures, finished in brushed brass, and trimmed in contrasting burgundy. Pilot high fidelity components make handsome matched pairs when used on tables and open shelves.

Pilot high fidelity components are easily interconnected, and can be used with all makes of record changers, turntables, tape recorders, and speaker systems. All Pilot Tuners feature the new Beacon Tuning Indicator for easy, accurate station selection. This insures the precise tuning necessary for distortion-free FM reception.

Cathode follower circuits are included to permit the use of long amplifier connecting cables without degrading frequency response. The preamps provide equalization for tape heads as well as tape recorders and records. There are separate bass and treble controls, and separate loudness and volume controls. Hum-free DC voltage is used on the preamp tube heaters. Every essential quality feature has been included to assure flawless high fidelity performance.

Pilot Tuners are priced from \$79.50 to \$189.50 Amplifiers from \$49.50 to \$165.00.

You can now enjoy the proven, superior performance of high fidelity components without having to assemble, connect, and install your own system. For, with a Pilot Component-Console, you have a custom made component system, installed in a handsome cabinet. And you can identify each of the components—the Pilot Tuner, Pilot Amplifier, Garrard Changer, Magnetic Cartridge, 3-Way Speaker System—components you would select, or be advised to select if you were planning your own installation.

But the performance of the finest components can be impaired through the use of cabinets with internal resonances and wall vibration. Pilot therefore turned its top engineering skill to the task of designing a cabinet with the necessary sturdiness and rigidity to permit all of the components to be operated in a single console.

Even the speaker system is completely closed off in a heavy-walled, acoustically-padded infinite baffle. And inside this enclosure there are four loudspeakers to cover the entire audible frequency range: a 12" woofer; a 6" mid-range reproducer in its own vented, acoustically insulated baffle; and two 3" tweeters.

Pilot has achieved a wonderful, new approach to high fidelity for the home—by combining component quality with console convenience—superb high fidelity performance in a single cabinet.

ENSEMBLE 1035 FM-AM Radio-Phonograph (illustrated) in cordovan mahogany \$415; in cherry or blond mahogany \$425. Other models from \$178 to \$605.

Select the PILOT Dealer nearest you for a thrilling high fidelity demonstration

For complete literature, write to Dept. LC-2



RADIO CORP. Long Island City 1, N. Y.



Prices slightly higher west of Rockies



STRAIGHT TALK
FROM ELECTRONICS . . .
ABOUT LOUDSPEAKERS

A question often asked us is, "I know you have the finest speakers, but isn't there a moderately priced speaker that is listenable?"

Naturally we are always looking for newer and better answers. Highly recommended is the new WIGO Coaxial loudspeaker.

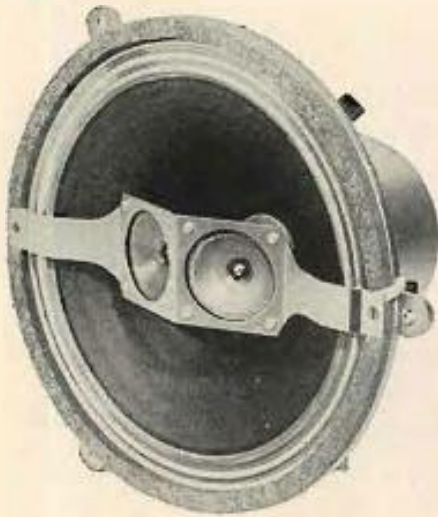

These are the reasons it sounds so well:

1. Very free, wide cloth suspension—ensuring linear motion and absence of "edge reflection".
2. Very light cone—ensuring good attack.
3. Coaxially mounted dual, direct radiator tweeters, which "roll-in" between 4 and 5 KC—giving a smooth "sparkle" without the obvious phase problems of mid-range crossover systems.

The WIGO thus produces a definite impression, of smooth, crisp sound. Scratch from records is quite low. Definition of orchestral choirs is good, and dynamic range is extraordinary for a speaker in this price class—it just won't "buzz" on loud sections. Recommended baffle is infinite or friction loaded Helmholtz. The WIGO woofer-midrange speaker (\$59.50) can be used for further expansion. A brochure is available.

The WIGO Coaxial **\$79.50**

Highly recommended by

ELECTRONICS

CITY LINE CENTER, PHILA., 31, PA.

PRIMA DONNAS

Continued from page 45

who was an unforgettable Senta when I sang my first *Dutchman* this summer at Bayreuth; Ljuba Welitch, who was Tatiana when I sang my first *Eugen Onegin* in Vienna. This opera, incidentally, after a long absence, will open the Met's next season, with Lucine Amara singing Tatiana to my Onegin.

And then there is, last but not least, Maria Meneghini Callas.

When I learned upon my arrival in New York, early this fall, that I would sing Scarpia to Callas' *Tosca*, I must admit I had a few forebodings. So much had been printed about this "stormy" star that I was prepared for almost anything. ("Look, she can't do more than actually kill you in the second act," my wife Nora said to me calmly. "What are you worried about?")

The first rehearsal assured me. Here was a trouper, a fanatic worker, a stickler for detail. Remembering my first season at the Met, and the forlornness one can feel, I crossed the stage before curtain time and, knocking at Mme. Callas' dressing room, said a quick "in bocca di lupo" (the Italian version of "good luck" or "Hals und Beinbruch"). Miss Callas took my hand in both of hers and seemed deeply moved. She later told me that this insignificant courtesy had meant a great deal to her.

Callas and I also sang a scene from the second act of *Tosca* on the first Metropolitan Opera broadcast of the Ed Sullivan Show. Again, she was a most co-operative colleague. At one point, during dress rehearsal, after she had "murdered" me, I fell too close to the desk and she couldn't pass to cross the stage and pick up the two candelabra which *Tosca* places next to the dead Scarpia. Callas laughingly stopped and announced to the director, "There just are too many legs around here." We all had a good laugh; I fell thereafter so that she and her long train could pass, and that was that. Yet, the day after the broadcast many newspapers reported that Mme. Callas and I had had a tiff during our rehearsal. I tried to tell my friends this was just not so. But, I finally gave up. For I realized that Callas, the prima donna reincarnate, fires not only the imagination of her audiences but also of the press. They want her to be "tempestuous" and "fiery," and that is the way it is going to be. And I believe this is a good thing. It brings back a long lost atmosphere of operatic excitement. There is nothing that can fire operagoers—and send them to opera box offices—so surely as the desire to see a genuine member of that sublime species, the prima donna.

The tragic fact, our doctors tell us, is that every third cancer death is a needless death... twice as many could be saved.

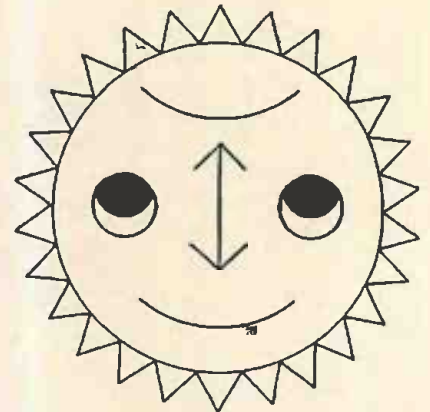

LET'S LOOK AT THE BRIGHTER SIDE

Many thousands of Americans are cured of cancer every year. More and more people are going to their doctors *in time*... To learn how to head off cancer, call the American Cancer Society or write to "Cancer" in care of your local Post Office.

American Cancer Society 

pfK
pre-finished Kits

PFK-120/150 PFK-500 PFK-300

designed by Paul Klipsch

Now you need only a screw-driver to put together a furniture-finished Klipsch speaker enclosure, indistinguishable from factory-assembled Rebel 3, 4 or 5. Also available as conventional, unfinished kits.

cabinart '57

Write for Complete Catalog!
 36 pages . . . 16 other hi-fi kits . . . 79 equipment cabinets . . . 4 matched speaker systems . . . 20 hi-fi accessories.

'57

Cabinart
 99 North 11th Street
 Brooklyn 11, N. Y.
 largest manufacturer of cabinets and kits for hi-fi
 a division of G & H Wood Products Co., Inc.



When the thrill of novel sound wears off, and you yearn for music superbly reproduced...



the BEETHOVEN by AMI

The very essence of high fidelity . . . and the *one* professional sound system that adapts custom components, acoustic-engineered enclosures, and precision calibrated controls to your ear . . . your recordings . . . the individual acoustical requirements of your home.

The Beethoven, shown with the AMI Mark VII Record Storage Console, is one of the new AMI Mark Series instruments included in a selection of six precision high fidelity AM-FM phonograph-tuner sound systems. Three are fully integrated, three are available with separate wall or corner horn enclosures and remote control consoles.

Audition an AMI sound system today. You'll be convinced there's nothing better in sound and luxurious cabinetry. Write us for the name of your nearest dealer.

EXCLUSIVE THREE-CHANNEL FRONT-LOADED EXPONENTIAL HORN SYSTEM: Below 45 cps to 16,000 cps flat with usable response in excess of those frequencies. Exceptional transient response. Three-way frequency dividing network with cross-over at 550 cps and 4,000 cps. High output 22 watt amplifier with preamp. 20 to 20,000 \pm 1.5 db. Less than 2% IM distortion (60 cps and 7,000 cps; 4:1 ratio signal). Precision calibrated bass and treble tone controls for definite stops in cut and boost; separate continuously variable volume control; professional three-step loudness control; 12 db/octave high frequency roll-off control (scratch filter) with 3-6-10 "KC" and "Flat" positions. Other input selector positions: "Mike," "Tuner," "Tape," and "TV." AM-FM tuner with AFC; 4-speed precision intermix changer of advanced design; G-E variable reluctance cartridge with 1 mil diamond and 3 mil sapphire styli.

...the Precision  Instruments of High Fidelity

1500 Union Avenue, S. E.
Grand Rapids 2, Michigan

Engineers, Designers and Manufacturers of
Professional and Commercial Sound Systems Since 1909



only LAFAYETTE can do it! OUR DIRECT IMPORTATIONS

YOU SAVE IMPORTERS PROFIT!

SAVE 33 1/2-50%

PROFESSIONAL TRANSCRIPTION TURNTABLE AND VISCOUS-DAMPED TONE ARM THE FINEST TRANSCRIPTION TURNTABLE AND TONE ARM FOR THE PROFESSIONAL USER AND THE AUDIOPHILE



PK-100A TRANSCRIPTION TURNTABLE
New 3-speed instrument with built-in stroboscope and viewer for exact speed determination, and magnetic brake for instantaneous speed variation. Precision engineered to meet professional standards for wow, rumble and flutter content. Heavy 12" cast aluminum rim-driven turntable. Variable speed control permits adjustment of each speed within $\pm 7\%$ using efficient frictionless magnetic brake. Heavy-duty constant speed 4-pole induction motor freely suspended and isolated by shock-mountings to eliminate vibration transfer. R-C filter network suppresses "pop" in speaker. Truly a delight for the connoisseur. Size: $13\frac{1}{2}$ " x 14 " and requires $2\frac{3}{4}$ " clearance above and $3\frac{3}{4}$ " below motorboard. For 110-120V and 60/50 cycle AC. Power consumption 12 watts. Handsome hammertone gray finish. Shpg. wt., 20 lbs. Net 49.50

PK-90 VISCOUS-DAMPED TONE ARM
This transcription arm assures dependable and stable operation, utilizing the "floating action" principle of "viscous-damping." The arm is supported at a single point by a pivot and jewel bearing having negligible friction. Damping is accomplished by a silicone fluid occupying the gap between a ball and socket. This damping control permits high compliance and negligible tracking error, and prevents damage to either record or stylus should the tone arm be accidentally dropped. Low frequency resonance, skidding and groove-jumping are likewise minimized. The tone arm accepts all records up to 16 " and accommodates virtually all hi-fi cartridges by means of precisely engineered adapters which simplify installation and provide proper stylus pressure. This tone arm is a quality companion to the PK-100 with matching finish. Shpg. wt., $2\frac{1}{2}$ lbs. Net 15.95

COMBINATION DEAL
72.50

PK-100-A

New!



HIGH FREQUENCY TWEETER WITH ACOUSTIC LENS DIRECT IMPORTATION MAKES THIS PRICE POSSIBLE!

- FREQUENCY RESPONSE FROM 2000 CPS TO BEYOND AUDIBILITY
- LOUVERED ACOUSTIC LENS FOR UNIFORM SOUND DISPERSION
- HANDLES 25 WATTS OF POWER
- PRICED EXCEPTIONALLY LOW

14.95

New high frequency tweeter featuring a louvered acoustic lens for uniform sound dispersion and capable of handling up to 25 watts of distortion-free power. The directional tendency of high frequency notes is overcome by the natural wide dispersion angle of the short horn and the acoustic lens which disperses and radiates the high notes smoothly throughout the entire listening area. The lens is detachable for panel mounting, with a separate base for the tweeter furnished for external mounting where desired. Aluminum voice coil has 16 ohms impedance. Size: $4\frac{1}{4}$ " long x 3 " diameter, lens extends $2\frac{1}{2}$ ". Requires a crossover network, preferably one with a level control, such as the LN-2. With full instructions. Shpg. wt., 5 lbs.

HW-7

Net 14.95

METAL-CASED CONE TYPE HI-FI TWEETER

FREQUENCY RESPONSE 2000-16,000 CPS • HANDLES 20 WATTS OF POWER

Highest quality cone type high frequency tweeter having a range from 2000 to 16,000 cycles. Especially efficient at higher end of audio spectrum where other cone type tweeters tend to lose clarity and volume. Entirely closed in a metal case with a base so that it can stand by itself or be mounted on a flat surface with mounting bracket supplied. Rated to handle 20 watts of power. A crossover network is required; the Lafayette LN-2 is ideal. Voice coil impedance 8-16 ohms. Size: $3\frac{1}{2}$ " x $2\frac{3}{8}$ " x 3 " Diam. Shpg. wt., 3 lbs. Net 5.95

5.95 Net



HK-3

Net 5.95



CROSSOVER NETWORK

CAPACITIVE INDUCTIVE NETWORK WITH CROSSOVER AT 2000 CPS • BUILT-IN LEVEL BRILLIANCE CONTROL

The frequencies above 2000 cycles are channeled to the high frequency tweeter by means of the high-Q inductance and capacitance comprising this efficient crossover network. The highs and lows are brought into acoustic balance by means of a continuously variable level-brilliance control. Control has a $2\frac{1}{2}$ " ft. long cable for remote mounting. Network matches 8-16 ohm speakers with insertion loss reduced to a minimum. Enclosed in metal case $6\frac{1}{2}$ " L x $2\frac{3}{8}$ " H x $2\frac{3}{8}$ " D. With full instructions. Shpg. wt., 5 lbs. Net 8.75

8.75

Net 8.75

NEW!



IMPORTED 12" HI-FI COAX. SPEAKER

- FREQUENCY RANGE 30-15000 CPS
- HANDLES 20 WATTS OF POWER
- COMPLETE WITH LEVEL CONTROL
- POWERFUL TSK-5 MAGNETS
- SPECIAL SHEEPSKIN-EDGED CONE

A Lafayette exclusive import and exceptional value. Consists of a 12" woofer, coaxially mounted $2\frac{1}{2}$ " tweeter and a built-in crossover network. The specially processed fibre cone has a sheepskin edge to suppress unwanted nodal vibrations and insure beautiful tone quality. Highly efficient TSK-5 magnets. Level control provides variation to 6 db cut. Maximum input 20 watts, impedance 8 ohms. Rugged all-metal frame. If made in this country, would cost at least \$49.50. Shpg. wt., 11 lbs.

Reg. Price 44.50
Net 29.50

SK-58 Net 29.50
SK-80. 15" Wt., 21 lbs. Net 42.50

3 WAY CROSSOVER NETWORK

Carefully designed and engineered to Lafayette's own specifications. Insertion loss is well below the acceptable minimum. Crossover is at 850 and 5000 cycles. Permits full enjoyment of any 3 way system. Properly balances woofer, mid range speaker and tweeter inputs. Complete with 2 continuously valuable "presence" and "brilliance" controls for tonal adjustment and full instructions. $6\frac{1}{2}$ " L x $3\frac{3}{8}$ " H x $2\frac{3}{8}$ " W. Shpg. wt., 7 lbs. Net 14.95



LN-3

3 WAY HI-FI SPEAKER SYSTEM



SK-74

55.50

HW-7

SK-67

- 15" Woofer with 31.5 oz Magnet
- 8" Mid-range speaker
- Acoustical Lens Tweeter
- 3-Way Crossover Network

A complete 3-way system capable of performance heretofore found only in systems at many times this price. The components were specially selected by Lafayette sound engineers to offer the maximum in audio fidelity at the lowest price possible. Includes continuously variable presence and brilliance controls. Offers superb reproduction across the entire audio spectrum. Shpg. wt., 26 lbs. SY93 Net 55.50

Lafayette Radio
DEPT WC 165-08 Liberty Ave.
JAMAICA 33, N. Y.

NAME _____
ADDRESS _____
CITY _____
ZONE _____
STATE _____

SEND FREE LAFAYETTE CATALOG

CUT OUT AND MAIL TODAY!



Lafayette Radio

100 SIXTH AVE., NEW YORK, N. Y.
BOSTON, MASS., 110 Federal St.
PLAINFIELD, N. J., 139 West 2nd St.
NEWARK, N. J., 24 Central Ave.
BRONX, N. Y., 542 E. Fordham Rd.

music listener's bookshop



Save yourself time and trouble by ordering your books directly from us. Just fill in the coupon below and mail it to us with your remittance.

MAINTAINING HI-FI EQUIPMENT

By JOSEPH MARSHALL

A much needed book on the specialized approach necessary to service high-fidelity equipment. The author discusses not only electronic faults, but the mechanical and acoustical defects which cause a hi-fi system to function less than perfectly. Hard cover, \$5.00 232 Soft, \$2.90 233

Still available — HIGH FIDELITY'S

RECORD REVIEW INDEX 1954 — 50c each

RECORD REVIEW INDEX 1955 — 50c each

The 1956 RECORD REVIEW INDEX is expected to be ready by the middle or end of April. If you would like the 1956 Index mailed to you as soon as copies are available, please send us your order together with 50c for each copy you order.

HIGH FIDELITY CIRCUIT DESIGN

By CROWHURST & COOPER

Two of England's top high-fidelity writers give complete information on high-quality audio circuit design procedures. The authors discuss circuit components, derive design formulas, describe testing methods and test equipment, and give examples of "how-to" design data for the improvement of existing audio systems. Numerous diagrams and charts. \$5.95 218

TAPE RECORDERS & TAPE RECORDING

By HAROLD D. WEILER

This book supplies the amateur and semiprofessional tape recordist with sound, practical, and factual information about all aspects of tape recording — microphones and their placement for both indoor and outdoor recording, room acoustics, sound effects, recording from discs and off-the-air, maintenance, etc. Paper, \$2.95 225 Cloth, \$3.95 243

HIGH FIDELITY RECORD ANNUAL: 1956

Edited by ROLAND GELATT

The second volume in the planned series of *High Fidelity Record Annuals*. Included in this new collection are reviews of classical and semi-classical music and the spoken word which appeared in HIGH FIDELITY Magazine from July 1955 through June 1956. Comparisons with recordings of previous years are emphasized. A performer index is included. \$4.50 237
HIGH FIDELITY RECORD ANNUAL: 1955 \$4.95 201

Winthrop Sargeant in *THE NEW YORKER* says of

EMOTION AND MEANING IN MUSIC

by LEONARD B. MEYER

"I am convinced that it is by far the most important work on musical aesthetics that I have encountered. . . . The vast importance of Mr. Meyer's book to my mind, is that it explains for the first time, and in a thoroughgoing and precise way, just how music is related to human experience. To the critic it offers tools of increased variety and sharpness, to the composer a badly needed clear statement of his purposes, and to the listener an explanation of why music affects him as it does. . . . Mr. Meyer, using, among other things, the resources of modern psychology, has succeeded where many a famous predecessor has failed." \$5.75 244

HIGH FIDELITY A Practical Guide

By CHARLES FOWLER, Publisher, HIGH FIDELITY Magazine

Here is the practical, expert advice needed by everyone who has, or expects to have, a high-fidelity system. Starting with an introduction to sound, the author then describes the various links in the hi-fi chain, explaining their features and specifications so as to provide the most helpful criteria for evaluating, and for selecting and matching components. \$4.95 234

HI-FI YEAR BOOK

Edited by MILES HENSLOW

The first complete, authoritative handbook about hi-fi in England. Not only the basic concepts of high-fidelity sound reproduction but complete descriptions of all major British hi-fi components.

Percy Wilson in *The Gramophone* says: "I know of no other book like it, or one that is so full of up-to-date and highly informative technical matter." \$2.25 238

THE FORMS OF MUSIC

By SIR DONALD FRANCIS TOVEY

Written by one of the most literate and profound of modern interpreters of music — its theory and history, these essays are all drawn from those articles on music which Tovey prepared for the *Encyclopaedia Britannica*. There are in all twenty-eight articles on different kinds and elements of music — arias, chamber music, concertos, harmony, masses, sonatas, symphonies, etc. Paper, \$1.35 239

Book Department
HIGH FIDELITY Magazine
Great Barrington, Mass.

I enclose \$..... for which please send me, postpaid, the books indicated by the circled numbers below. (No C.O.D.'s or charge orders, please.) Foreign orders sent at buyer's risk. Add 55c per book for postage on foreign orders except Canadian.

Index 1954	<input type="checkbox"/>	Index 1955	<input type="checkbox"/>	Index 1956	<input type="checkbox"/>
Binder 6b \$2.95 each					

234	237	201	234
238	238	218	237
239	239	225	238
243	243	232	239
244	244	233	243

NAME

ADDRESS

**Quiet
Undisturbed
LISTENING**
with the **GENERAL
HIGH FIDELITY PHONE**

- ★ Comfortable soft rubber cups
- ★ Light in weight — less than one pound
- ★ Hermetically closed construction
- ★ No annoying 'peaks'

For the finest in true, full range audio realism, order a set of General Hi-Fi Head Phones... the choice of top TV engineers... now at leading Hi Fi centers for the ultimate in listening enjoyment.

Monaural \$25 Binaural \$30
Order your set today from your dealer or buy direct



GENERAL PHONES CORPORATION
5711 HOWE STREET • PITTSBURGH 32, PA.



TREAT for RECORDS

Treat your records to the amazing ESL electrodynamic cartridge. By greatly prolonging the life of valuable records and styli, the ESL can save many times its own cost.

Treat your ears to the ESL—the pickup rated tops by the authoritative Audio League. Impartial Audio League tests show that the ESL is unsurpassed in smoothness, clarity, and naturalness of reproduction.*

Join the musicians, engineers, and music lovers who have switched to the world's most advanced cartridge. Write for details, and buy the ESL at your audio dealer's.



FOR LISTENING AT ITS BEST

Electro-Sonic Laboratories, Inc.

Dept. H • 35-54 Thirty-sixth Street • Long Island City 6, N.Y.

Soloist Series from \$14.95 • Concert Series \$35.95 • Professional Series arm and cartridge \$106.50

* Authorized quotation No. 63. Please consult The Audio League Report, Vol. 1, No. 6-7 (March-April 1955) for the complete technical report and listening evaluation of the ESL. Subscription: 12 issues, \$4, from P. O. Box 265, Mt. Vernon, N. Y.

INFIDELICAL SPOUSE

Continued from page 50

purely cathartic. Read it and weep, ye hi-fi husbands, but let your tears be the true tragic tears—resulting not alone from the weight of recollected woe but also from the somber joy of looking truth (however harsh, however unchangeable) squarely in the face.

ARTURO TOSCANINI

Continued from page 40

up to 1936. His final eighteen years as director of the National Broadcasting Company's Orchestra are a firm, imperishable part of the musical experience of almost all adults now living, whether they are in their twenties or their sixties. The man's life really dominated our lives, and those of our parents, in music.

What did he have and what did he do? Does anybody know? It is possible to enumerate the extramusical, or indeed extranormal, faculties, such as memory. Amongst these must come precision, which is not a normal faculty and not always a musical one. But if this beloved Maestro had been merely a freak of memory and precision, we could not weep as we do in our hearts for his absence. There was another magic in his soul. He had the capacity to give forth—and *through others*, which is so difficult—an intention from on high. This "on high" came to him from the perusal of a printed or manuscript score. It was, as he would have said—"the intention of the composer." However, how did he know the intention of the composer? He could read the notes and the markings. How did that tell him how to do what he did with the *Missa Solemnis*?

The temptation comes to me to quote Giacomo Puccini, who felt to the full what he owed to Toscanini and who once said: "Toscanini conducts an opera not as the score requires, but as the composer imagined it, even though his hand may have failed him in the moment when he had to put upon paper that which he had so clearly conceived."

During the thirty-odd years when it was my reward to hear Toscanini's work, I always felt that his wizardry had two aspects or functions, one for masterpieces and the other for work of lesser fiber. Giving their full due to the masterpieces, he made us feel that we had never heard them before or anything remotely like them. Giving more than their due to lesser works, extracting from them more than was written down (doing just what Puccini said), he made us feel, for a few moments, exalted unreasonably. What orchestral wonders he did with those Respighi tone poems, for instance! He always had

the knack of making minor composers sound like major ones, and of making major composers sound like what they really are, the voice of God.

It would be idle to regret such a gift for re-creation if we had no evidence of it; sadder, really, than last year's roses. However, at the stage to which we have now come, the evidence exists. Toscanini had a phenomenal adaptation to our contemporary machinery and monumentally availed himself of its devices. There is something he powerfully perpetuates. It may not be all he had to give. I think not. But what it does give is rare and permanent. At the very end of this immense career he was thoughtful, obedient, almost humble, when it came to the wishes or opinions of the sound engineers in a studio: he entrusted the future to them, and he was right. When we who think back in awe upon his *Fidelio* or his *Falstaff*, his *Seventh Symphony* or his *Eroica*, are no longer here to quibble over a phrase or a note, the little discs and tapes will take care of the matter. The future will have a standard.

RECORDING OF SPACE

Continued from page 42

two-channel, two-microphone recording could not have achieved the sound on this tape. When I was in Richmond, Virginia, with Dick Leibert, recording the wonderful Wurlitzer pipe organ installed in the Byrd Theatre, we found that it was necessary to rig some eleven microphones through the roof of the hall, using 3,500 feet of microphone cable and three 6-channel mixers to record adequately the many sources of sound. Dick was playing from a console in the orchestra pit, but there were three enormous rooms of pipes at the top of the proscenium arch above the stage, as well as a piano and xylophone in a box to the left of the hall, and a marimba and harp in a box to the right. In the album *Leibert Takes Richmond*, selections of which are on this demonstration tape, we hear the acoustical properties of the hall and we have the additional advantage of being able to "locate" various rooms and boxes from which the pipes of the organ speak. There is also a great spatial feeling not possible from a monaural recording.

One critic has remarked that solo instruments do not gain from stereophonic recording. It is true that some of the advantages of stereo are in effect to a lesser degree in the case of instruments of small volume, such as the guitar, because the air space and reverberation of the recording studio are less affected by the smaller amount of sound. But there are still other advantages, and

Continued on next page

COLBERT ELECTRONIC 3-CHANNEL FREQUENCY DIVIDER

As appears in
TESTED IN THE HOME
November 1956 issue

Over-all output is excellently clean; cut-off rates are 6 to 9 db per octave; levels change somewhat with adjustment of crossover controls; hum and noise are not audible — which is quite an accomplishment for an electronic crossover. Just prove it can be done if enough attention is paid to design and manufacture. All in all, highly commendable. If anyone doubts the value of an electronic frequency divider, this should convince them. — C.F.

MODEL 3-CFD \$154.50

Decorator style case in blonde or mahogany formica finish... **\$15**

Slightly higher in west and deep south

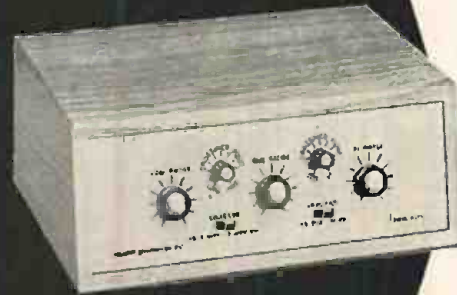

For full specifications see your dealer or write

colbert

LABORATORY, INC.
160-09A Hillside Avenue
Jamaica 32, New York



colbert

LABORATORY, INC.

SPECIFICATION SUMMARY

- Eliminates speaker impedance and efficiency mismatches
- Eliminates resonant filters (fixed crossover networks)
- Three-channel operation results in lowest over-all distortion
- Affords optimum damping of individual loudspeakers
- Features variable cross-over controls for low, mid and high ranges
- Provides individual level controls for each sound channel
- Designed for use on two or three way systems
- Eliminates distortion due to higher frequency harmonics
- For use with regular or electrostatic loudspeakers, or combinations
- Includes high quality 10 watt ultralinear amplifier of great stability

marantz

write for literature

...the ultimate goal
of the
critical listener

Audio Console

preamplifier with cabinet \$168*

Power Amplifier

\$198*

**slightly higher west of the Mississippi*

marantz company

44-15 Vernon Boulevard, Long Island City 1, N. Y.

announcing
the second
and larger

LONDON AUDIO FAIR 1957



WALDORF HOTEL
ALDWYCH, LONDON W. C. 2

friday through monday
april 12, 13, 14 and 15, 1957
11 a.m. to 9 p.m.

All the leading British manufacturers of high fidelity equipment will exhibit, and some international companies are also expected to participate.

American high fidelity enthusiasts and representatives of American manufacturers — planning to be abroad — are invited to attend.

For further details, write to:
AUDIO FAIRS LTD.
42 Manchester St., London W.1

RECORDING OF SPACE

Continued from preceding page

provided the size of the instrument is not distorted by faulty mike placement, two-channel is always superior to monaural. This is certainly true of the piano (although it is very difficult to record well in stereophonic sound), as here there is the advantage of the additional octave on the low end which stereo provides and which gives the listener a solid foundation in piano reproduction never before heard. There is a comparison of monaural and stereo piano recording on the demonstration tape which should answer the critic's questioning the purpose behind recording a piano in stereo.

One of my main ambitions was always to record Stravinsky's *L'histoire du soldat* in a performance clear of mistakes, with all the rhythmic changes intact, and with a perfect balance of the seven-piece orchestra. Stravinsky here has used violin, bass, clarinet, bassoon, trumpet, trombone, and percussion — instruments which differ widely in the volume of sound they are able to produce. In monaural audition, there are many times when the poor bassoon disappears completely, even when he has an important voice. Recording this piece stereophonically was one of the most nerve-racking, frustrating (but eventually rewarding) experiences I ever have had. When the proper balance was

achieved, there was a clarity — due to the fact that the artists could be kept separate in recording as well as in the eventual playback — which at last let all the instruments of this remarkable score articulate their own voices when necessary and blend as an ensemble as well. Recording the Tchaikovsky String Quartet also was very revealing, as it was at last possible to depict in sound exactly what a string quartet is, a combination of four different string instruments. No danger here of mistaking the violin for the viola, or the viola for the cello, either in solo passages or when all four instruments are playing together.

Much has been said about stereo and about ways of recording stereophonically, but after two years of trial and error and admittedly making a great many takes which I consider not usable, I feel I am entitled to add the following observation. Some recording engineers now recording stereophonically have dropped their monaural recording altogether, and are producing monaural records and tapes from stereophonic tapes, muting the channels together very much in the same way as several microphones may be. It is my opinion that for perfect balance, stereophonic recordings must be done stereophonically, with no secondary purpose in mind. Of the result, no channel should be a suitable sound for monaural reproduction, nor

WE ENGINEERED THE BEST—THEN IMPROVED IT

We just weren't satisfied with the best when we engineered the Tannoy Variluctance Pickup Cartridge. Our design engineers went to work right away and perfected the "Complidex", a brand new stylus assembly that gives increased magnetic efficiency within the gap plus improved mechanical efficiency of the cantilever by utilizing two separate metals in place of the conventional homogeneous material. Yet another development gives correctly graded damping without disturbing the optimum vertical-lateral ratio of compliance.

Like their predecessors, the new "Complidex" Styli—with either sapphires or diamonds—allow instantaneous replacement without tools.

The new "Complidex" Styli can be used to convert the original (Mark I) cartridge to Mark II specification.



TANNOY MARK II 'VARILUCTANCE' PICKUP CARTRIDGE SPECIFICATION

Each cartridge hand-made and laboratory tested
Frequency response within 2dB to 16,000 Kcs.
No resonant peaks
No undamped resonances in sub-supersonic range
Simple turn-over mechanism
Stylus assemblies completely independent
Instantaneous replacement of styli without use of tools
Optimum lateral to vertical compliance ratio
Very low effective dynamic mass
Output: 20 mV at 12 cm per second
Termination load: 50,000 ohms
Tracking weight: 6 grams for all discs
Available with either diamond or sapphire styli

TANNOY

Tannoy (America) Ltd.,
38 Pearl Street, New York 4,
N.Y., U.S.A.
Tannoy (Canada) Ltd.,
36 Wellington Street East,
Toronto 1, Ontario, Canada.

should any combination of the channels be suitable for monaural reproduction either. Proper microphone placements for monaural reproduction should be continued by the manufacturers of long-playing records. The inverse is also true: if a really fine monaural sound is achieved from either one or more tracks of a stereophonic tape, then the stereo recording itself will not be of the highest possible quality.

Mr. Crowhurst in a recent article on stereo for HIGH FIDELITY states that he "cannot help wondering whether there may not be a simpler method of achieving stereophonic realism" than the use of what he calls "... various tricks in recording." He then admits that if the illusion is satisfactory and gives us a better listening experience, it becomes valid. But one-channel or twenty-channel, *all*, save live performance, is illusion, and the artist and engineers must work with illusion as best they can.

It must be noted that there is unfortunately no established, foolproof stereophonic microphone setup for any given hall or any given instrument or groups of instruments. And here is stereo's only similarity to monaural recording: in the reproduction of good music, music is *still* the occasion and the occasion is still a question of taste. There is no absolute scientific rule or chart of diagrams or equations, whatever our advances in

multi-channel sound processing, which can satisfy the musical needs of the artist performing or the listener listening.

ROTARY SINGING COACH

Continued from page 47

The singer should not hope to be, nor want to be, a carbon copy of the recording artist. When he listens to recordings he must keep his own artistic wits about him. He must discern between good taste and bad. He may learn much from what his fellow singer has done, but he must not lose his own artistic identity by taking on the auditory image of the other. And this is not a fantastic possibility, even granting the inherent individuality of voices. Remember the Italian tenor who displayed the canned-Caruso sound.

It is his case which brings up a final and vital risk. Recordings are not recommended for study if the singer is mainly interested in vocal technique. There are too many unknown quantities between the lip of the recording artist and the ear of the phonograph listener, high fidelity or no. A good voice teacher, tireless practice, and critical listening to recognized artists *in actuality, on the stage*, are the best answers to his needs.

MF MADISON FIELDING *means...* MAXIMUM FIDELITY

MAXIMUM FIDELITY • The most advanced circuits... new transistor designs... incorporated into distinctive hi-fi instruments that are unsurpassed in appearance and lasting performance.



MADISON FIELDING FM TUNER • Series FM-15 with MICRO-BEAM TUNING

Exclusive Micro-Beam—newest system of positive dynamic tuning. Sensitivity: better than 0.9 microvolts for 20 db of quieting... insures exceptional performance... reception range increased to over 150 miles. Stability: less than 20 kc drift from cold start—professional laboratory standards! Shielded front-end eliminates spurious radiation well within FCC regulations. 12" x 3 3/4" x 6 1/2".

ONLY \$79.95

MADISON FIELDING Integrated Amplifier • Series A-15 with EXCLUSIVE All-Transistor Preamplifier

All-Transistor front-end guarantees zero hum and no microphonics. Frequency Response within .5 db, 20 to 20,000 cycles. 16 watts (32-watt peaks) of clean audio power at the speaker terminals. Seven Input Facilities. Loudness-Resistance Control and sharp cut-off Rumble Filter. Control layout on front panel designed for real operating ease. 14 1/2" x 3 3/4" x 7".

ONLY \$89.95

Better Sound with your Present Tape Recorder... Phonograph... PA System!

MADISON FIELDING All-Transistor Matching Amplifier • Series 30

Perfect for phono use—matches low-level, low-impedance cartridges to any preamp. Also permits use of high quality, low impedance mikes with any tape recorder (even a home machine). Hi-Fi or PA system—dispenses with low-fi crystal microphones. Micamp improves overall frequency response, reduces distortion, eliminates hum pickup—even with 1500-foot cable. More than 30 db gain. Battery powered; cell lasts over a year in normal operation.

ONLY \$11.25 with battery



MF MADISON FIELDING CORPORATION

Creators of Distinctive Audio Instruments

873 MADISON STREET • BROOKLYN 21, N. Y.

ASTOUNDING PERFORMANCE

FROM

20 to 20,000 CYCLES
WITH

GOODMANS

AXIOM 80

free suspension

LOUDSPEAKERS

and ARU

friction loaded ENCLOSURES

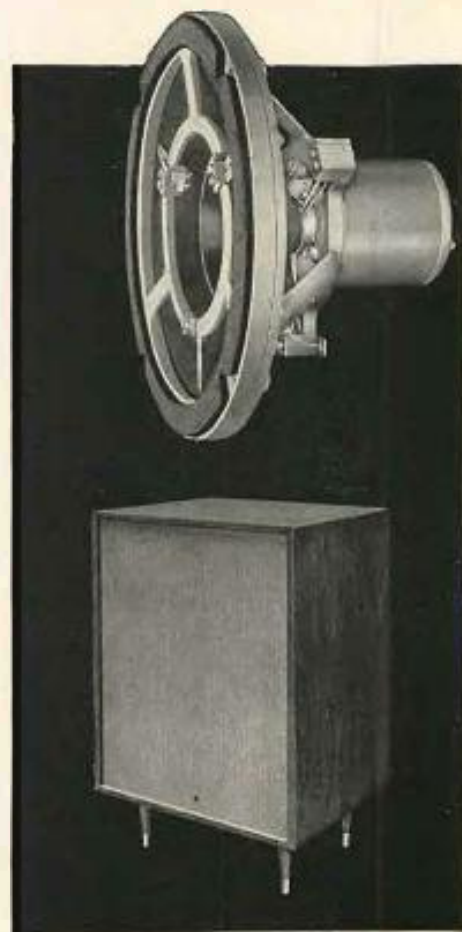

ROCKBAR CORPORATION Dept. ZC-2
650 Halstead Avenue, Mamaroneck, N.Y.
In Canada: A. C. Simmonds and Sons, Ltd.
Toronto, Ontario

Please send me complete details on
Goodmans Axiom 80 speakers and
ARU Enclosure Kits.

Name.....

Address.....

City.....Zone.....State.....

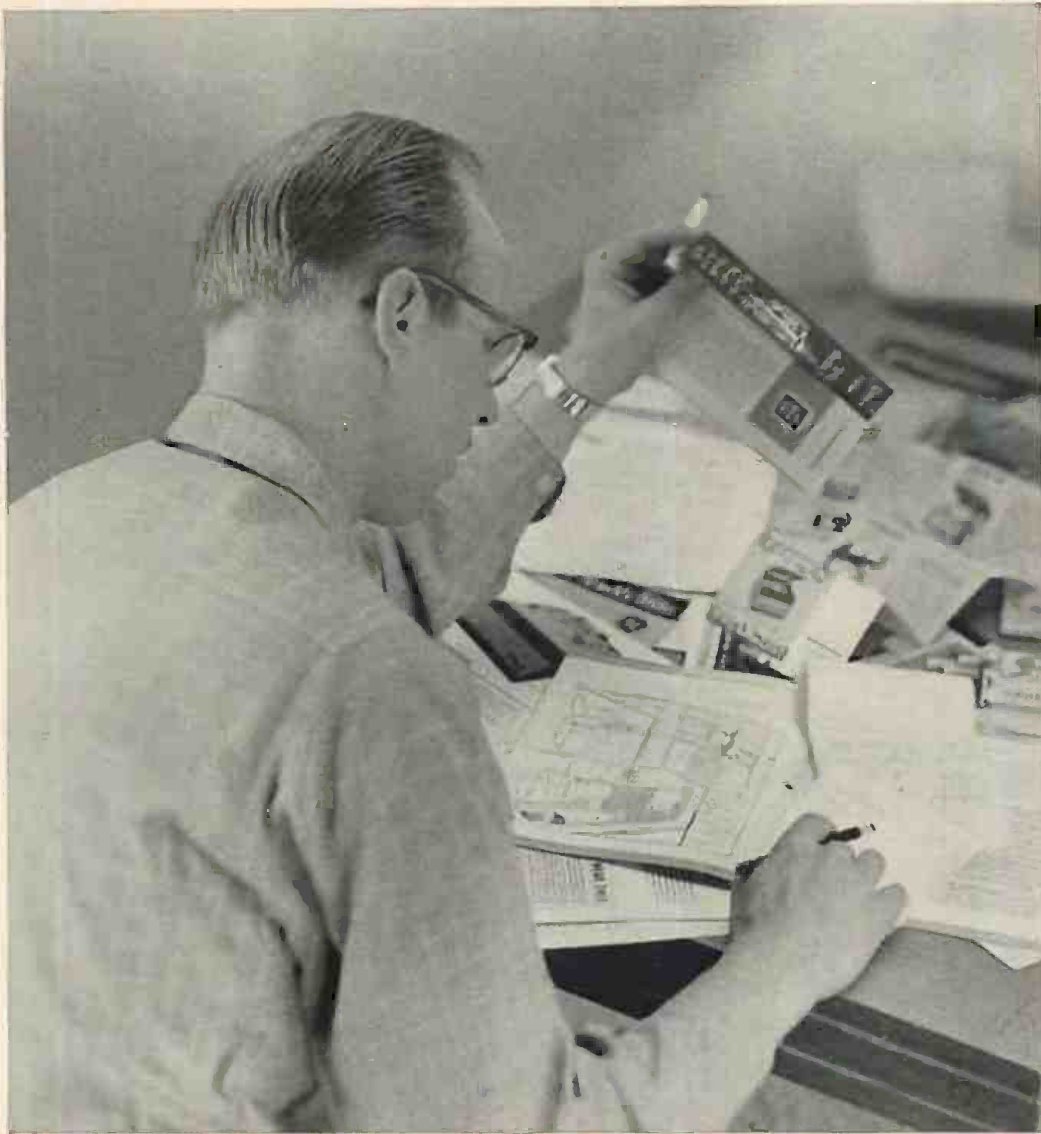

**TYPICAL
MATCHED
COMPONENTS**



SR-405 Radio Receiver, blending, in one chassis, an AM-FM tuner, a preamplifier, a record equalizer, tone controls and 12 superb watts of audio power. Microphone, Television, Crystal Phono, Magnetic Phono and Magnetic Recorder inputs. Size 8" x 13" x 12", Ideal for converting a cherished old cabinet. \$235.00



RF-471 Speaker. 12" coaxial speaker with exclusive Carpinchoe leather suspension of tweeter. Frequency response 30 to 15,000 cps; handles 32 watts of program material. \$49.95

...how do you match your components?

**IT can BE DONE, YOU KNOW,
WITH one BRAND NAME ON EVERY UNIT**

We're not going to tell you that selecting Stromberg-Carlson "Custom Four Hundred"[®] components is the *only* way to achieve a perfectly matched system. But we do insist it's the *easiest* and *surest*.

Every one of our 17 basic units is designed by one corps of engineers, produced in one factory, tested by one group of quality control specialists.

These men work as close to each other as you and your audiophile neighbor—and behind them is a 63-year tradition of quality in Sound.

Want proof? Just visit your Stromberg-Carlson dealer. Start with any component and know that, when you add more units of this brand, your whole system will be in perfect balance.



PR-456 Changer. The famous British Garrard, now 4-speed. Automatic stop, rubber-matted turntable; pickup muting switch; diamond stylus. \$80.00

"There is nothing finer than a Stromberg-Carlson"



STROMBERG-CARLSON COMPANY

A DIVISION OF GENERAL DYNAMICS CORPORATION

1719 University Avenue, Rochester 3, New York



AUDIO FORUM

SIR:
I have been considering installing a stereo system and am now intrigued with what bi-amplification has to offer.

Can the two be combined feasibly? If so, could you provide me with a schematic of the connections? I would want to use a record player, radio tuner (possibly AM-FM stereo), and monaural tape, as well as stereo tape.

J. C. Graf
Tampa, Fla.

Below is a schematic diagram showing how you may connect two amplifiers and two multi-way speakers for stereo-bi-amplifier use.

The diagram shows two identical amplifiers and speaker systems, but different units may be used with the addition of a level-set control (as shown) in the channel having the highest efficiency. Channel 1 is used for both stereo and monaural sources; channel 2 is for stereo only. An external control unit with volume and balancing controls feeds the inputs to this system.

The amplifier output taps are shown connected for use with 16-ohm speakers.

connected to a common ground by means of their shielded interconnecting cables.

SIR:
Every tape recorder I have used puts an annoying click on the tape when switched in or out of the Record mode. This is extremely discouraging, as it puts into a tape the one thing I am trying to get away from in records — clicks and pops.

In most cases, one can let the recorder run to the end of its reel after the end of a recording, but this cannot be done in the middle of a tape, when starting a new selection. What can you suggest as a remedy for this trouble?

George W. Miller
San Antonio, Texas

Nearly all nonprofessional tape recorders (and some professional ones) leave clicks on the tape at the beginning or end of a recording, except where there are special mechanical provisions to prevent this. For instance, some recorders have a "pause" switch which enables the tape to be held stationary after it

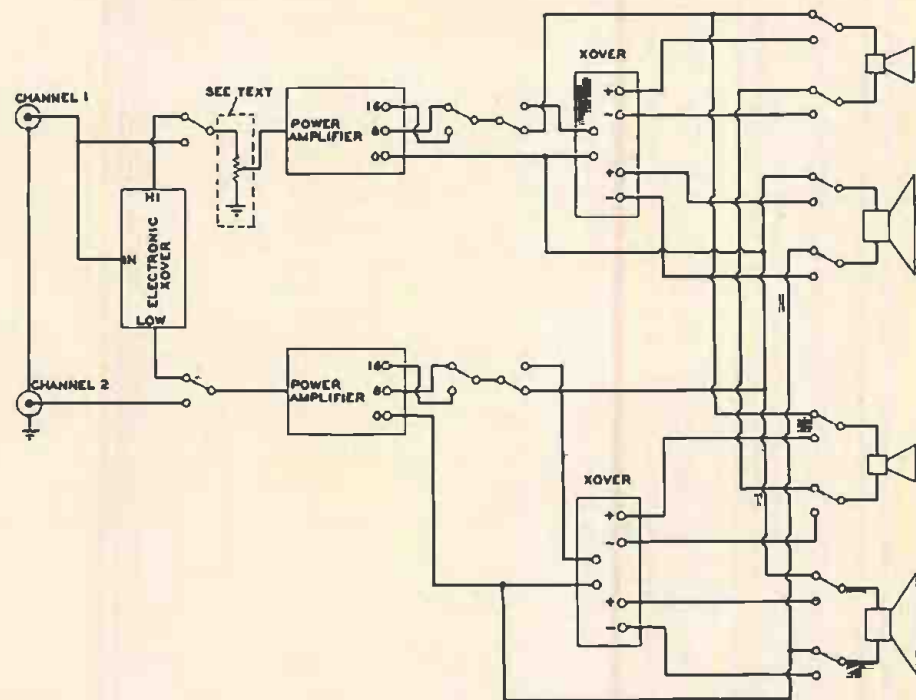

If 8-ohm speakers are used, the connections will be to the 8- and 4-ohm taps, rather than to the 16- and 8-ohm ones.

Switches are shown in the Bi-amplify position, and all amplifier chassis are

is started in the Record mode. This allows you to move back to precede a previous click, so that this is removed when the unit starts recording.

Continued on next page

Hold it
for a second!

That ad on the opposite page makes sense, doesn't it? As Stromberg-Carlson suggests, you'd probably like to hear for yourself.

QUESTION IS,
where? Well...
We are
New York area
headquarters

for the "VALUATOR" matched Hi-Fi system shown and for all Stromberg-Carlson "Custom Four Hundred"® audio components.

Reliability!

AIREX' experience in audio is almost as old as radio itself. And service is our creed. Soundproof studios for private audition . . . nothing sold but brand-new, factory-fresh merchandise . . . complete mail order service, with prepaid shipments, 20% deposit, balance C.O.D. . . . special appointments gladly arranged. Write for free catalog.

AIREX RADIO CORP.

64 CORTLANDT ST. • NEW YORK 7, N. Y.

Phone CO 7-2137

AR-2

The AR-1 acoustic suspension* speaker system is now widely recognized as reproducing the cleanest, most extended, and most uniform bass at the present state of the art. It is employed as a reference testing standard, as a broadcast and recording studio monitor, as an acoustical laboratory test instrument, and in thousands of music lovers' homes.

The AR-2, our second model, is a two-way speaker system (10 in. acoustic suspension woofer and newly developed tweeter assembly), in a cabinet slightly smaller than that of the AR-1—13½"x24"x11¾". It is suitable for use with any high quality amplifier which supplies 10 or more clean watts over the entire audio range.

AR-2

The price of the AR-2 in hardwood veneer is \$96.00, compared to the AR-1's \$185.00. Nevertheless we invite you to judge it directly, at your sound dealer's, against conventional bass-reflex or horn systems. The design sacrifices in the AR-2, comparatively small, have mainly to do with giving up some of the AR-1's performance in the nether low-frequency regions, performance which is most costly to come by. The AR-2 can radiate a clean, relatively full signal at 30 cycles.

The AR-2 speaker was designed as the standard for medium-cost high fidelity systems. Our tests have shown it to be so far ahead of its price class that we think it will come to be regarded as such a standard within its first year.

AR-2

Literature, including complete performance specifications, available on request from:
ACOUSTIC RESEARCH, INC.
24 Thorndike St., Cambridge 41, Mass.

* Pat. pending and coprs., Acoustic Research, Inc.

AUDIO FORUM

Continued from preceding page

The easiest (and least costly) way to eliminate these clicks is to edit them out of the tape (as long as there is no program on the reverse track).

SIR:

I have a custom-built crystal FM tuner which gives me wonderful reproduction. However, I get interference every time a car goes by outside. Is there anything I can do to eliminate this?

Leo H. Berman
South Norwalk, Conn.

First, try increasing the height of your antenna mast. If this does not eliminate most of the automobile interference, you should replace your antenna lead-in cable with a 72-ohm coaxial lead in, and use couplers where needed to match the lead-in to the antenna and tuner.

SIR:

When I touch the pickup arm on my record changer the hum level increases tremendously. I have also noticed that when the arm is placed away from the amplifier the hum decreases considerably. Except for the hum the system is working perfectly.

Could it be that my cartridge is picking up hum from the magnetic field radiated by my amplifier's power transformer?

Paul Singer
Brooklyn, N. Y.

Two things might account for the rise in hum level that occurs when you touch the arm of your phono unit. First, it is possible, although not too probable, that the leads coming from your player have been reversed so that the shield is acting as the signal carrier and the inner conductor is grounded. If this is not the case, then you can probably eliminate that source of hum by connecting a wire between the metal case of your cartridge and the shield of its output lead. Also, check to make sure that there is a ground connection between the metal parts of the changer and the chassis of your amplifier.

As for the hum picked up from your amplifier, this is undoubtedly coming from its power transformer. The amplifier should be located at least 3 ft. away from the phono, for minimum hum from this source.

SIR:

In the November issue, Roy Allison discussed bi-amplification at some length, but he did not solve my problem. I

the cartridge that scores **100%**

The Recoton-Goldring cartridge was acclaimed the best by a national independent research organization, because it passed all tests with flying colors!



- Performance uniformly excellent.
- Cantilever - stylus - armature construction capable of rougher treatment than most moving-coil mechanisms.
- Will fit just about any American-made arm.
- Smooth and free of strain even on heavily recorded passages.

Recoton - Goldring

**New MODEL "555 SDM"
MU-METAL SHIELDED
MAGNETIC TURNOVER CARTRIDGE**

At leading hi-fi distributors write for descriptive literature to:

RECOTON CORPORATION, 52-35 Barnett Ave., Long Island City 4, N. Y.
Manufacturers of World-Famous Phonograph Stylus.

In Canada: Quality Record, Ltd., Toronto

have two complete single-chassis amplifiers, and a three-way speaker system. How can I use these two units for a bi-amplifier system?

Mr. Allison's diagrams indicate that the electronic crossover must be between the preamp and the two power amplifiers, and mine can't be separated.

John R. Chapin
Springfield, Ill.

It would take a great deal of modification of both your amplifiers before you could use them in a bi-amplifier system, so we would advise against trying it.

Generally speaking, bi-amplification is usually the last step in the development of a system, and is added only when the rest of the components have been improved to a point where further improvement by conventional means becomes difficult.

SIR:

The instructions supplied with my stylus-force gauge say to set it on top of the turntable, place the pickup on the gauge, and adjust the arm for the correct force at that height. However, I find that when I place the gauge on the motor board, and check the force with the cartridge itself at turntable height, I get a lower reading.

Which is correct? Should I set the stylus force as recommended, at a height

of about an inch above the turntable, or set it for the correct value at turntable height?

Donald Ritchie
St. Louis, Mo.

If you use your changer primarily as a single-play device rather than with a stack of discs on it, the stylus force should be set at turntable height. Otherwise, it should be set to give correct force with the equivalent of four or five records on the turntable, which will put the stylus about 3/4 to 1 in. above the turntable surface.

SIR:

I am planning to buy an 8-in. Wharfedale speaker, but I notice that its impedance is rated at 10 ohms.

My amplifier has outlets for 4, 8, and 16 ohms; how can I correct this mismatch? It is my impression that feeding a speaker of 10 ohms impedance from an 8-ohm tap would introduce a good deal of distortion.

Joseph S. Handler
New York, N. Y.

The 8-ohm tap on your amplifier will correctly match your 10-ohm speaker.

You should remember that a speaker's impedance is rated at one certain fre-

Continued on page 139

COMING to your city HIGH FIDELITY MUSIC SHOWS

See and hear the latest in HIGH FIDELITY from leading high fidelity manufacturers . . .

Don't miss these public showings of Hi-Fi Equipment . . . from the most economical units for the budget-minded to spectacular home music theatres . . . compare and enjoy them all. Components and complete systems will be displayed.

THREE DAYS OF CONTINUOUS DEMONSTRATIONS 1 P.M. to 10 P.M.

Pittsburgh	March 8, 9, 10	Penn-Sheraton Hotel
Baltimore	March 29, 30, 31	Lord Baltimore Hotel
Philadelphia	April 5, 6, 7	Benjamin Franklin Hotel
Seattle	August 23, 24, 25	To be announced
Portland, Ore.	September 6, 7, 8	To be announced
Cincinnati	September 20, 21, 22	Sheraton-Gibson Hotel
Miami	October 18, 19, 20	McAllister Hotel
St. Louis	November 22, 23, 24	Statler Hotel

Rigo Enterprises, Inc. 500 North Dearborn Street, Chicago 10, Illinois

NEW



GRANCO

HIGH FIDELITY
FM-AM TUNER

JUST PLUG IT IN . . .

to phonograph,

hi-fi system,

tape recorder

or TV set

for the best in

FM-AM

radio listening!



A new adventure in sound from leading sound specialists . . . a most versatile FM-AM tuner of fine quality, designed to provide the best static-free FM as well as AM radio reception by simply "plugging it in" . . . yet, in the Granco tradition of producing much more for much less, priced lower than any other available tuner.

More than just a component, this elegantly styled tuner easily connects to any instrument with an amplifier and speaker and affords complete radio listening pleasure . . . FM and AM.

- Exceptional sensitivity and selectivity insure superlative FM and AM reception
- 6 tubes plus selenium rectifier
- Famous Granco coaxial tuner for smooth, sharp, no-interference, drift-free tuning
- Straight A. C. chassis
- A complete package — built-in antennas eliminate installation
- Compact decorator cabinet fits handsomely into any decor

T-270 FM-AM TUNER only \$54⁹⁵*

TECHNICAL FEATURES

2.5 volts maximum audio output — tuning knob and OFF-AM-FM phono switch knob
 FM Section: 5 microvolts sensitivity for 20 db. quieting — 88-108 mc. frequency range — 20-15,000 cycles flat audio frequency response — 220 kc. at 3 db. down selectivity — 1.0% total harmonic distortion for 2.5 volts RMS output — built-in antenna. AM Section: 20 microvolts sensitivity per meter (on loop stick) — 535-1650 kc. frequency range — 8 kc. selectivity at 2 times down — 2.5% total harmonic distortion at 1 volt RMS output — built-in antenna.

FM means GRANCO



Write for complete specifications and FREE BOOKLET "Granco NEW SOUND Radio with FM".

*Price slightly higher South and West

GRANCO
PRODUCTS, INC.

36-07 20TH AVE. • LONG ISLAND CITY 5, N. Y.
— the leader in FM and UHF

PROFESSIONAL DIRECTORY

• CALIFORNIA •

EVERYTHING IN HI-FI SOUND EQUIPMENT

FEATURING  WORLD'S FINEST TAPE RECORDERS

SANTA MONICA SOUND
12436 Santa Monica Blvd.
West Los Angeles 25 GRanite 8-2834

the finest in Hi-Fi
featuring *ElectroVoice*®

HIGH FIDELITY COMPONENTS



820 W. Olympic Blvd. • L.A. 15, Calif. • RI 7-8271

Since 1944

 **HOLLYWOOD ELECTRONICS**
HI-FI COMPONENTS EXCLUSIVELY
featuring *ElectroVoice*®

7460 MELROSE AVENUE
Los Angeles 46, Calif. • WE 3-8208

send for famous Bulletin G
it's free!

HIGH-FIDELITY HOUSE

Most complete stock of Audio components in the West

Phone: RYan 1-8171
536 S. Fair Oaks, Pasadena 1, Calif.

• ILLINOIS •

CABINET MAKERS



WE SPECIALIZE IN THE DESIGN AND CONSTRUCTION OF FINER FURNITURE FOR HI-FIDELITY

CONTEMPORARY AMERICAN FURNITURE CO.
728 S. LA SALLE ST., CHICAGO
WEbur 9-3666

ALLIED HI-FI STORES

ALLIED RADIO CORP.
100 N. Western Ave., Chicago 80, Ill.

EVERGREEN ALLIED HIGH FIDELITY, INC.
2025 W. 95th St., Chicago 43, Ill.

VOICE AND VISION, INC.
921 N. Rush St., Chicago 11, Ill.

ALLIED HIGH FIDELITY STORES, INC.
602 Davis St., Evanston, Ill.

WEST SUBURBAN ALLIED HIGH FIDELITY, INC.
7055 W. North Ave., Oak Park, Ill.

• MINNESOTA •

STYLI INSPECTION MICROSCOPES

G55MS 1 \$25.00 G55 MS 2 \$12.50

See "Tith" report, and ad, High Fidelity Magazine for October 1956

THE GENERAL SCIENCE SERVICE CO.
P.O. Box 8423
St. Louis Park Station
Minneapolis, 16, Minnesota

• NEBRASKA •

In Omaha . . . it's the "House of Hi-Fi"

✓ Fine High Fidelity Components
✓ Custom Installation Guidance
✓ Personalized Recording Service

"House of Hi-Fi"
4628 Dodge Street
Omaha, Nebraska
Phone GLendale 4434

OR STOP AT WORLD RADIO LABORATORIES
33rd & BROADWAY COUNCIL BLUFFS, IOWA

• NEW YORK •

Real HI-FI

QUALITY BUILT SYSTEMS by network engineers to professional broadcast standards — NONE FINER! Service laboratory, too, Fred Kamiel in charge. FREE CONSULTATION. Open Daily to 9 P.M.

Hi-Fi HQ
150 E. 46 St., N.Y.C., PL 5-2650

• OHIO •

IN CINCINNATI AND THE TRI-STATE AREA

- * COMPETENT ENGINEERING
- * COMPONENTS AT NET PRICES
- * SERVICE ON ALL HI-FI COMPONENTS

Customcrafters, Inc.

2259 Gilbert Ave., CA 1-3153 - Cincinnati 6, Ohio
"A Component or a Complete System"

• PENNSYLVANIA •

in the PHILADELPHIA area

YOUR COMPLETE SUPPLIER is

 **Radio Electric**
SERVICE CO. OF PENNA., INC.

HIGH FIDELITY & COMMERCIAL SOUND STUDIO
709 Arch St., Philadelphia 6, Pa.
Phone: LOmbard 3-7390

DELAWARE VALLEY HDQTRS. HI-FIDELITY COMPONENTS CONSOLES

FOR 

See & hear all models from \$169.50 to \$1050, or build them yourself with famous Pilot components.

Large Record stock • Terms • Trade-ins • Unlimited parking. Open Mon. • Wed. • & Fri. eves. • Free catalog. We ship anywhere U.S.A.

SHRYOCK HI-FIDELITY CO. EST. 1922
BONWIT-TELLER BLDG. Midway 7-1920
Opp. Wanamaker's, WYNNWOOD, PA. (Phila. Suburb)

• CANADA •

IN MONTREAL . . . IT'S

PECK'S

FOR HIGH FIDELITY

All the better high fidelity components at net prices. Also a wide selection of Equipment Cabinets and Speaker Enclosures.

TREVOR PECK CO. LIMITED
1498 Sherbrooke St. West, Montreal, Que.

CANADA'S FIRST HIGH-FIDELITY RADIO, PHONOGRAPH, RECORD AND TELEVISION CENTRE

Stromberg-Carlson "Custom 400"
Brociner — Freed-Eisemann — Bogen
Fisher Radio — Concertone Tape Recorder
All Makes of High Fidelity Records

Custom Sound and Vision Ltd.
390 EGLINTON WEST TORONTO, ONT.
Phone HUdson 9-2117

• GREAT BRITAIN •

HI-FI 

FROM BRITAIN

We stock the finest British Hi-Fi equipment available, and export it to all parts of the world. The cost of this precision built equipment will amaze you. Send for our Special Export Catalogue.

CLASSIC
ELECTRICAL CO. LTD.
352-364 Lower Addiscombe Rd., Croydon, Surrey, England

MUSICRAFT

Can supply all the leading British Hi-Fi Products

Agents for the amazing Spectone Stereophonic Reproducers

Trade supplied

20/22, High Street, Southall, Middx., England
13 King Street, Richmond, Surrey, England

CHANGE OF ADDRESS

If you plan to move soon, please notify us six weeks in advance. Give old address as well as new, clipping stencil imprint from wrapper of last copy received.

help your HEART FUND  help your heart

TRADER'S MARKETPLACE

Here's the place to buy, swap, or sell audio equipment. Rates are only 35¢ a word (no charge for name and address) and your advertisement will reach more than 75,000 music listeners. Remittance must accompany copy and insertion instructions.

TAPE RECORDERS, tapes, hi-fi components at WHOLESALE prices! FREE catalog. Clarston, 215 E. 88 St., New York City 28.

TEST YOUR RECORDER'S PERFORMANCE. Excerpt Dubbings D-110 Test Tape \$98*. Blank recording tape 3" reel: 3 reels \$1.00*. Free catalog. *Add postage. Amertest Products Corp., 1280-B Sheridan Ave., Dept. HF6, New York 56, N. Y.

\$200. MONTHLY POSSIBLE, sewing babywear! No house selling! Send stamped, addressed envelope. Babygay, Warsaw 106, Indiana.

LEARN WHILE ASLEEP with your recorder. Amazing book gives full instructions. \$2.00. Guaranteed. Research Association, Box 610, Omaha.

ALL HIGH-FIDELITY COMPONENTS in stock. Complete hi-fi package units at discount prices. Send your list for prompt quotations. Stan-Burn Radio & Electronics Co., 558 Coney Island Ave., Brooklyn 18, N. Y.

FOR SALE: PICKERING 190D Pickup Arm (\$20.00) and Model 260 D.D. dual Cartridge (\$35.00) Guaranteed excellent condition. S. Newburn, 240 Melbourne Ave., Town of Mount Royal, Quebec, Canada.

ANNUAL INVENTORY SALE. All Equipment Brand New Unless Otherwise Stated. Many one of a kind. Shipped Railway Express collect, inspection privileges.

Garrard 301, demo, perfect, \$72.00. Wharfedale W15CS Woofer, demo, perfect, \$55.00. Wharfedale W12/CS Woofer, \$35.00. Leak Arm and Cartridge, \$42.00. Thorens E52PA Turntable, \$40.00. Pickering Isophone, Model 581, \$165.00. Magnacord "Citation" Tape Recorder, demo, perfect, \$199.00. Ampex 600, demo, perfect, \$389.00. Viking "Pro" Recorder, Model FF75Pro, demo, perfect, \$135.00. Viking RP61 Record/Playback Amplifier, \$55.00. Viking PB60 Preamplifier, \$26.00. Ampex 612 player, demo, perfect, \$275.00. Jensen Imperial Enclosure Kit, completed, \$60.00. Jensen KT 32. 3-Way speaker system, Demo, perfect, \$115.00. Tannoy Autograph 30 watt amplifier, demo, perfect, \$95.00. Tannoy Autograph Preamplifier, demo, perfect, \$99.00. Tannoy GRF Speaker System, demo, perfect, \$395.00. Wharfedale 3-Way X-Over, \$26.00. Hartley Single Baffle, demo, perfect, \$28.00. Fairchild 281-A Arm, \$27.00 Cambridge Electronics Company, 530 Westcott Street, Syracuse, N. Y.

NOW OPEN! New Jersey's newest and finest audiophile center, "HI-FI HAVEN" (formerly Monmouth Music House). Complete demonstration facilities featuring the "AudioVac", free parking, courteous attention and professional advice, service laboratory on premises, trade-ins accepted, full line of components, kits, and packaged systems, competitive prices. Exceptional values during opening weeks. Unique mail order service available, write for information. Hi-Fi Haven, 28 Easton Ave, New Brunswick, N. J. CHarter 9-5130.

6 ELEMENT BROAD BAND FM antennas. All seamless aluminum, \$10.95 ppd. Wholesale Supply Co., Lunenburg, Mass.

HIGH FIDELITY, Nos. 1-49, \$25 plus postage. John W. Curry, 1653 Wyatt Pkway., Lexington, Ky.

HIGH FIDELITY SPEAKERS REPAIRED. Amprite Speaker Service, 70 Vesey St., N. Y. C. 7. BA7-2580.

DYNAKIT, CUSTOM WIRED TO ORDER \$80. A. Clarke, 1070 Fox St., Bronx 59, N. Y.

FREE MONTHLY hi-fi bulletin. Write for quotation on any components. Sound Reproduction, Inc., 34 New St., Newark, N. J. Mitchell 2-6816.

SELL Harman-Kardon A-400 (Counterpoint) FM Tuner. Excellent. \$70.00. Gilbert Lancaster, Jr., R.F.D. 3, Keyser, W. Va.

AUDIO FORUM

Continued from page 137

quency (usually 400 cycles), and that its impedance is likely to vary widely over its frequency range. Speaker impedance ratings are considered nominal rather than exact values.

SIR:

I have a number of LP discs that are so warped they scrape on the bottom of my pickup arm, and I was wondering if you knew of any way these could be straightened.

I've tried leaving them for days at a time with flat, heavy weights on them, but as soon as the weights are removed the discs spring back to their original warped shape.

Any suggestions will be appreciated, particularly if they solve my problem.

Frank R. Flaberty
Minneapolis, Minn.

The flat weights are the answer, but for them to do any good, each disc should first be warmed over a stove burner until it begins to sag under its own weight or until it is too hot to hold. Then it should be placed between two prewarmed 14-in. square sheets of glass, with the weights (books, or perhaps a discarded power amplifier) on top of the sandwich. Leave the record compressed overnight or until completely cooled, and then transfer it to the record shelf for another few days before playing it.

If the warp returns, it will be the result of an internal stress in the disc itself, so it should be returned to the dealer or factory for replacement.

SIR:

I have a Garrard model RC-80 changer which I converted to a manual player. It worked very satisfactorily for more than two years, but recently it has developed a hum which starts as soon as the motor is turned on, and becomes louder as the arm approaches the center of the record.

I have tried shielding and grounding the motor, arm, and equipment, but to no avail. I am quite sure that the hum does not come from the associated equipment.

Can you suggest what might be the matter?

Claude Parisot
Port-Au-Prince, Haiti

Since the hum varies in volume as the pickup moves across the turntable, its origin is obviously inductive interference into the cartridge from the phono motor or a nearby power transformer. This trouble could be caused by a de-

Continued on next page

VALUE SENSATION!

BIG 20 WATT FAMOUS MAKE



HIGH FIDELITY AUDIO POWER AMPLIFIER

Response 20 to 40,000 cps. Peak output 40 watts. Low distortion. Adaptable to any custom installation and may be used with any preamp or tuner preamp.

Regular Price \$99.50 Net. **\$39⁹⁵**
YOURS FOR LESS THAN KIT PRICE.
COMPLETE, READY TO WORK only



Beautiful NATURAL REDWOOD SPEAKER CABINET FOR 12" SPEAKERS

Attractive enclosure in handsome California Redwood, smartly styled to complement any decor. Acoustically balanced and expertly built. Provides clean smooth bass, ideal middle range and clear treble. Sanded smooth finish. Use as is or finish to taste. Comes complete with Redwood legs, 23 3/8" W, 11 1/2" D, 16 1/8" H; 28 3/8" H with legs. **NOW ONLY \$18⁹⁵**



UTAH Special High Fidelity 12" Loudspeakers Only \$6⁹⁵

Amazing high sensitivity and clear tone. Has special CURVELINEAR molded cone with 8 ohm voice coil impedance; 6.8 Alnico V magnet; extremely small voice coil gap. Handles 12 watts. Response is flat and smooth from 40 to 12,000 cps, only -5 db at 15,000.

FREE! SONOTAPE CATALOG

Latest Catalog listing the finest pre-recorded Monaural and Binaural Tapes made from authentic Westminster Hi-Fi masters. Send for your FREE copy and order your favorite music-on-tape at Terminal's low prices. Prompt shipments from our own complete library.

Prices do not include shipping costs.

Write for our attractive prices on other Hi-Fi components of your choice at b-i-g savings!

Phone: WOrth 4-3311

Terminal
RADIO CORP.
85 Cortlandt St. • New York 7, N. Y.

HAVE LESS RUMBLE FLUTTER WOW FOR HALF THE PRICE*



GET A BELT DRIVEN

Professional
JUNIOR
TURNTABLE

Write for complete details and name of dealer nearest you.

COMPONENTS
CORPORATION

DENVILLE, NEW JERSEY
Department J.

\$39.50*

AUDIO FORUM

Continued from preceding page

fective motor or a partially open-circuited pickup cartridge, but before you suspect those, you should first check to see whether your amplifier has not been moved closer to the turntable assembly than it originally was. If the amplifier's power transformer is not the source of the interference, and if the pickup cartridge is the same one you were using two years ago, then you probably have a defective drive motor on the RC-80, or a defective cartridge.

SIR:

For quite some time now I have been considering building an amplifier kit. This amplifier would be used for electrifying a guitar. I am assuming that I can operate this instrument mike directly through the magnetic pickup input on the amplifier. Would you please advise me whether or not I have made a correct assumption?

I also have another question concerning this prospective system. It will be necessary that I operate two instruments and one microphone at the same time. How could I connect these three sources to the amplifier since it has but one preamp input? It would be necessary to have a separate gain control for each of these mikes, so that the volume of

any one could be controlled independently of the others.

T. G. Hirschinger
Quincy, Ill.

A standard unequalized microphone input will be required for your electric guitar, as well as for any other instruments that use contact microphones.

For the system you have in mind, you would require an amplifier having three independently variable microphone inputs, and as far as we know there are no such amplifiers available in kit form. Your needs would best be served by any one of the better-quality public address amplifiers, equipped with a three-channel microphone-input mixer.

SIR:

I own a very sensitive FM tuner, but I would like to extend its range of coverage as much as possible.

What type of FM antenna would give me the best long-distance reception?

Roy H. Berger
Albany, N. Y.

Probably the best antenna for long-distance FM reception would be a wide-band FM Yagi, mounted on a rotator atop a high mast. Additional sensitivity at a certain frequency can be obtained by purchasing an antenna cut specifically to that frequency, but this causes sensitivity loss over the rest of the band.

NOW! HI-FI (FM) IN YOUR CAR!

Only **BLUE SPOT** offers all these features!

Concert Hall Sound under bridges, through short tunnels, next to high power lines, even in lightning storms!
Constructed to outlast your car.

Coaxial Speakers, 6" x 9", full-range tone control, built-in rear speaker plugs, separate amplifier, 6 to 12 volt convertibility.

Compact design fits most American and foreign cars. Service throughout the U. S.



**BLUE SPOT
Köln Mark I**

Selectomagic Tuner—the first FM "one touch" signal seeker in a car radio.

FM—3 microvolts for 20 DB quieting; AM, 3 microvolts. Response 40-16,000 c. p. s.—image rejection 25 DB.

HI-FI—15 tuned circuits FM and AM.

BLUE SPOT Frankfurt Mark I

FM—plus Hi-Fi, AM and Pushbutton Selectometer. De luxe, yet economy-priced version of the Köln Mark I.

BLUE SPOT Hamburg

Luxury AM car radio—economically priced. Magnificent sound, pushbutton station selector, ruggedly engineered.

AMERICAN ELITE, INC.

7 Park Avenue, New York 16, N. Y.

Importers of Telefunken and Audio Elite home Hi-Fi Sound Systems, Tubes, Components, Microphones... and Blue Spot car radios.

Write Dept. A for free pamphlet and information.

Stacking two or four antennas will further increase pickup.

SIR:

I own a Concertone 20/20 tape recorder, single track, 7½ and 15 ips speeds, and as far as I'm concerned the thing produces far too much hiss.

The recording heads are spotlessly clean and not magnetized. I have had this trouble with my recorder ever since I bought it, and have had it serviced twice. The noise was reduced, but not enough.

I'd like to get the hiss down some more, and would like to know if it would materially improve things were I to substitute special-purpose audio tubes for the ones already in the recorder?

Frank J. Hatzelboffer
Bronx, N. Y.

Your proposed tube substitutions might reduce hum very slightly, but they would not be likely to change the recorder's hiss level.

We would be inclined to suspect that your trouble is not in the tape recorder, but is rather a reflection of troubles elsewhere in your system. A high hiss level from tape often indicates either accentuated high-frequency response in the loudspeaker, or higher-than-normal distortion in the control unit or power amplifier.

If your amplifying equipment is satisfactory, then you should investigate the possibility of a defective, misadjusted, or substandard speaker. Setting a coaxial speaker's tweeter level control too high will invariably cause this trouble.

SIR:

When playing records (all kinds, old and new), I notice a peculiar sort of sound during relatively quiet passages. I hear it coming only from the tweeters and midrange speaker, and the best way I can describe it is as a "midrange rumble." I have tried to eliminate it by playing the system at lower volume, using a rubber pad on the turntable, and tracking at a heavier stylus force, but nothing helps. The sound is even easier to hear if I turn the bass control off.

Any suggestions?

Martin Tytun
Bronx, N. Y.

Two things might be causing the high-pitched "rumble" you are getting from your system.

First, it is possible (but not too probable) that your preamplifier is marginally unstable at the low-frequency end and tends to oscillate when "triggered" by turntable rumble. Have the preamp checked for this at a qualified high-fidelity service agency, and if found to

Continued on next page

You can have the finest sound reproduction throughout all frequency ranges without distortion

You will hear a remarkable difference in the clarity of Norelco *Full Response Speakers. In a single speaker, twin-cones reproduce low frequencies, middle range, as well as the higher frequencies extending beyond the audible range—without distortion.



WHY ARE NORELCO FRS SPEAKERS SO EXCEPTIONAL?

They have incorporated a number of technical refinements which are evident the moment you listen. The air gap has been made long so that the coil is completely enclosed in an even magnetic field at all times. A copper ring has been fitted into the deep air gap to keep the voice coil impedance constant over the whole frequency range; this avoids incorrect matching. High flux densities are obtained through the use of "Ticonal" magnet steel.

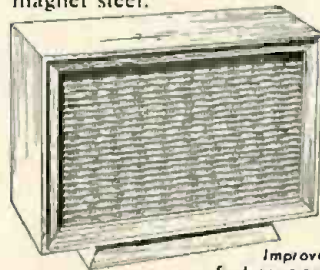

Norelco FRS Improved Bass Reflex Enclosures are available in three sizes; FRS Enclosures I, II and III. Priced from \$33.75 to \$119.95.

Norelco speaker-matched enclosures are scientifically designed acoustical boxes which enhance the exceptional tone qualities of FRS speakers; bringing out their true performance values.

Norelco FRS Speaker Enclosures are available in three sizes to match the characteristics of the speaker in use. Supplied in either mahogany or blond, these enclosures incorporate a removable base permitting the enclosures to be placed horizontally or vertically to suit any room arrangement or decor.

ADD TO... and improve any sound system with *Norelco*®

*FULL RESPONSE SPEAKERS



Write today to Dept. K2 for brochures and prices of these unique speakers.
NORTH AMERICAN PHILIPS CO., INC.
100 E. 42nd St., New York 17, N.Y.

2
MINIATURE WIDE-RANGE HIGH-FIDELITY SPEAKERS

TYPE K
S. G. Brown
DYNAMIC HEADPHONES

This professional headset is designed to reproduce the full orchestral range from 50 to over 10,000 cycles. Connects to any sound system, amplifier, radio, phonograph, tape recorder. Suitable for audiometers. Excellent for audio-visual instruction.

At your local electronic or high-fidelity distributor

- Moving Coil motor assemblies
- Bakelized conical diaphragm
- Flux Density—6,000 lines
- 2 standard impedances—52 & 600 ohms
- Available with Binaural wiring

52 ohms.....\$28.95
600 ohms..... 34.50

BRITISH INDUSTRIES CORPORATION
PORT WASHINGTON, N. Y.

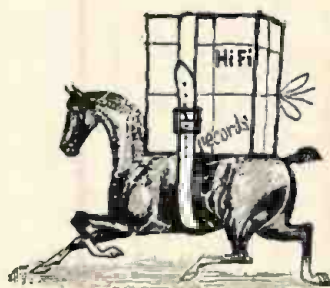

cheaper and quicker direct from Britain

You can save yourself time and money by ordering your Hi-Fi equipment direct from London.

Every day at Imhofs equipment and records are carefully examined and tested before packing for despatch to addresses all over the world. Imhofs good name gained in more than 100 years of fair trading is your guarantee of first class service.

Write today for our comprehensive catalogue which lists details of the best Hi-Fi equipment of all makes.

IMHOFS

Europe's HiFi Centre

Alfred Imhof Limited
established 1845
112-116 New Oxford Street
London WC1, England

DYNAKIT

MARK II

50 WATT POWER AMPLIFIER KIT*



A premium kit for the audio perfectionist, the Dynakit sounds better because it is designed for outstanding transient response and stability, for high power at low distortion, and for complete and accurate reproducibility. The improvement over conventional circuits is immediately apparent to the discriminating listener. The Dynakit combines unequalled quality with economy and simplicity. It features the finest of parts, like the superb Dynaco A-430 output transformer. At the same time construction is greatly simplified by the Dynaco pre-assembled printed circuit unit which includes the major portion of the wiring.



This printed circuit assembly guarantees that the Dynakit's outstanding specifications will be met by every constructor. The Dynakit can be wired in less than three hours, and its low price means that everybody can now afford to have the best

Specifications:

Power Output: 50 watts continuous rating, 100 watts peak. **Distortion:** under 1% at 50 watts, less than 1% harmonic distortion at any frequency 20 cps to 20 kc within 1 db of maximum. **Response:** Plus or minus .5 db 6 cps to 60 kc. Plus or minus .1 db 20 cps to 20 kc. **Square Wave Response:** Essentially undistorted 20 cps to 20 kc. **Sensitivity:** 1.5 volts in for 50 watts out. **Damping Factor:** 15. **Output Impedances:** 8 and 16 ohms. **Tubes:** 6CA7/EL34 (2) (6550's can also be used) 6AN8, 5U4GB. **Size:** 9" x 9" x 6 3/4" high.

Dynakit Mark II

\$69⁷⁵

Slightly higher in West

Complete including

- Punched Chassis
- Protective Cover
- Transformers
- Tubes and all parts
- Factory Wired Printed Circuit Assembly
- Complete step-by-step construction data and pictorial diagrams.

Available through leading Audio and Electronic Parts Distributors

* Pat. Pending

DYNA COMPANY

DEPT. HF, 5142 MASTER ST.
PHILADELPHIA 31, PA.

AUDIO FORUM

Continued from preceding page

be defective, have it repaired or replace it with one having better low-frequency stability.

Second, and most likely, the slight inherent vibration of your turntable may coincidentally occur at the same frequency as a mechanical resonance in the pickup arm. Another turntable or arm should eliminate the noise.

SIR:

Recently I have noticed that, on certain recordings, an echo or "ghost" precedes loudly recorded sounds. Can you tell me what might be the cause of this?

Donald Bencker

Green Cove Springs, Fla.

"Echoes" preceding and following loudly recorded passages on records may be caused by spillage of the sound from the loud groove into the grooves adjacent to it.

Most LP records are originally recorded on magnetic tape, which is then rerecorded onto the discs. If a sound is very loudly recorded on tape, the intense magnetization at that point will sometimes tend to "print" through onto the magnetic coating of the tape layers lying next to it on the reel. The result is a faint echo preceding and following the loud sound.

A similar effect can result from cutting a disc at too high a volume level or from spacing the grooves too closely. In this case, the side-to-side motion of the cutting stylus impresses some of its vibration through the groove wall into the sides of the adjacent grooves.

Pre-echo is more noticeable than post-echo, because the latter is generally drowned out by the natural reverberation in the sound on the disc.

SIR:

I own a medium-priced tape recorder unit, but I recently listened to a stereophonic tape played back on a converted recorder. The effect is tremendous.

Is it possible for me to convert my machine for a stacked-head stereophonic playback and still retain the monaural record-play functions?

Louis Ferendo

North Bergen, N. J.

Modifying tape recorders for stereophonic tape playback is a job that should be tackled with considerable care, unless you can work from instructions directly pertaining to your equipment.

If the manufacturer of a stereo playback head or of your tape recorder is willing to supply you with such instructions, then you might undertake the job. Otherwise, you would do better to consider buying a stereo player.

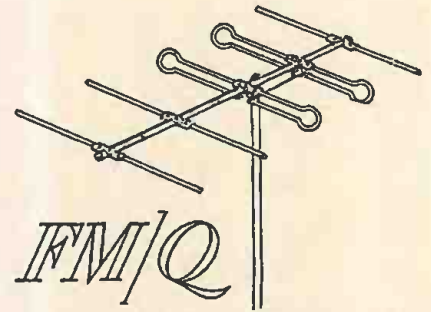

FM/Q

ANTENNAE

"Indisputably the finest available"

L. F. B. Carini, Ph.D.
Noted F.M. Authority

Both for optimum sensitivity and quality of construction, the FM/Q Antennae offer truly outstanding performance that is unsurpassed by any other.

Don't limit your tuner's sensitivity by using an inefficient antenna. Listen to the many other Good Music Stations on the air and enjoy the full capabilities now dormant in your FM tuner. Obtain increased signal strength and the long distance reception that only an "FM/Q" System can provide.

For advice and information write our consulting correspondent who will be happy to advise you regarding the solution of your particular problem. Send twenty-five cents for our valuable book, entitled "All About FM Antennae and Their Installation," which also includes a complete Directory of All FM Broadcast Stations.

APPARATUS DEVELOPMENT COMPANY, INC.

WETHERSFIELD 9, CONNECTICUT

in a

pushbutton world...

this is your Hi-Fi Life!

MIRACORD XA-100

"2-in-1" Fully Automatic Pushbutton Changer and Manual Player with the exclusive "Magic Wand" Spindle.

Enjoy endless hours of delightful music at the touch of a fingertip... so automatic you need never touch the tone arm. Has every advance feature you want.

Complete, Ready to Use \$67.50 less cartridge

FAR AHEAD > THE FINEST BY FAR

At All Hi-Fi Dealers

Write for Complete Brochure

AUDIOGERSH CORPORATION

514 Broadway, New York 12, N.Y.

New STRIKINGLY DIFFERENT
..the "Cathay"

a piece of fine furniture for your components



Beautifully finished on four sides, the "CATHAY" may be used as a divider or anywhere in the room. Its reed-paneled door slides to the left to expose the component knobs. Compartment at left accommodates any changer or turntable. In mellow walnut, satin black, mahogany, blond korina and sandy oak. 44"x23 1/2"x24"H. Net \$119.00

CONCERT CABINETRY'S
POPULAR RACK 55

Std (unfinished) model \$39.50
Furniture finished mod. \$54.50
Soft plastic cover \$4.95

High Fidelity Magazine says:
"fine product"

*See TITH report in the
November 1956 issue



E. and R. SCHELLER
1630 West Granville Ave.
CHICAGO 26, ILLINOIS



An Instrument
for Music Lovers!

BOHN Phonograph-Radios have been created for those who demand the finest performance from both AM-FM radio and today's Hi-Fi records. Powerful Professional Components are featured. Yet these sets are among the most compact High Fidelity Instruments made: The End Table unit is only 25" high! A superb Bohn Loudspeaker System in separate cabinet completes the set. Five finishes available.

BOHN Phonograph-Radio — \$1290
(other models: \$1075 to \$2000)
Expertly Crated, Shipment Worldwide
Ask Your Dealer or Write:

TRUE HIGH FIDELITY

MUSIC SYSTEMS COMPANY
550 Fifth Ave., New York

ADVERTISING
INDEX

AMI Incorporated	127
Acoustic Research, Inc.	136
Airex Radio Corp.	135
Allied Radio Corp.	9, 138
Altec Lansing Corp.	21, 23
American Cancer Society	126
American Elite, Inc.	140
Angel Records	Indexed on 60
Apparatus Development Co., Inc.	142
Audak Company	144
Audio Devices, Inc.	Inside Front Cover
Audio Fair, Ltd.	132
Audio Fidelity Records	Indexed on 60
Audiogersh Corp.	142
Bell Sound Systems, Inc.	30
Bogen, David, Co. Inc.	120, 121
Bohn Music Systems Co.	143
Book-of-the-Month Club, Inc.	7
Bozak, R. T., Co.	119
British Industries Corp.	112, 141
Cabinart	126
Capitol Records	Indexed on 60
Classic Electrical Co.	138
Colbert Laboratory, Inc.	131
Collaro	54
Columbia LP Record Club, Inc.	5
Columbia Records	Indexed on 60
Components Corporation	140
Concord Record Corp.	Indexed on 60
Connoisseur	8
Conrac, Inc.	52, 53
Contemporary American Furniture	138
Cook Laboratories	Indexed on 60
Customcrafters	138
Custom Sound & Vision, Ltd.	138
Dauntless International	Indexed on 60
Decca Records, Inc.	Indexed on 60
Diamond Stylus Co.	144
Duotone Company, Inc.	143
Dyna Company	142
EMC Recordings Corp.	102
Electro-Sonic Laboratories, Inc.	130
Electro-Voice, Inc.	Inside Back Cover, 28, 29
Elektra Records	Indexed on 60
Epica Records	Indexed on 60
Ercona Corp.	8
Experiences Anonymes	Indexed on 60
Fairchild Recording & Eqpt. Corp.	51
Ferrograph	8
Fisher Radio Corp.	11, 12, 13, 14, 15, 16, 17
Fleerwood Television (Conrac, Inc.)	52, 53
Garrard Sales Corp.	112
General Phones Corp.	130
General Science Service Co.	138
Goodman's Loudspeakers	133
Granco Products, Inc.	137
Gray Research and Development Co.	115
Grommes	27
Harman-Kardon, Inc.	56
Heart Fund	138
Heath Co.	33, 34, 35
Hi-Fi Headquarters	138
High Fidelity House	138
High Fidelity Record Annual	108
Hollywood Electronics	138
Holt Radio	144
House of Hi-Fi	138
Imhof, Alfred, Ltd.	141
JansZen	109
Jensen Mfg. Co.	1

Continued on next page

Introducing



**DUOTONE
FIDELITY
FOCUS**
Loudspeakers

New Engineering Technique Assures You—
Bell-Clear Highs; Vibrant-Undistorted Lows.

DUOTONE—For a quarter of a century, leader in the high fidelity industry, presents for the first time, DFF, DUOTONE FIDELITY FOCUS LOUDSPEAKERS. A new high in manufacturing standards and procedures assures you of a superb quality seldom found in most other loudspeakers. Rigid specifications adhered to and exacting field trials were made before this fine line was presented to the public. It was only the results of these exhaustive tests that assured us of a product worthy of the HI-FI enthusiasts interests. Whether you choose a coaxial speaker such as the Royal or Medallion, or a woofer-tweeter combination like the Supreme and the Duchess, you will be more than satisfied with the excellent response these speakers afford. Stop into your HI-FI dealer's showroom and ask to hear them. Your reward will be the self-satisfaction of hearing excellent high fidelity sound reproduction. There's a DUOTONE FIDELITY FOCUS LOUDSPEAKER to match your system and they are priced to \$53.97.

Write today for our FREE new booklet, "An Objective Study of Loudspeakers". It's designed to help you choose and install your speaker system.

12 in. Coaxial
Cat. No. 12CX-62
35 to 18,000
cps.
Power: 25 watts
Imp: 8 Ω



The ROYAL

12 in. Coaxial
Cat. No. 12CX-60
35 to 18,000
cps.
Power: 15 watts
Imp: 8 Ω



The MEDALLION

8 in. Coaxial
Cat. No. 8CX-50
50 to 20,000
cps.
Power: 10 watts
Imp: 8 Ω



The MARQUIS

8 in. Coaxial
Cat. No. 8CX-70
75 to 19,000
cps.
Power: 6 watts
Imp: 8 Ω



The VISCOUNT

4 in. Tweeter
Cat. No. 4-TX
1000 cycles to
beyond aud.
Power: 5 watts
Imp: 8 Ω



The DUKE

7 in. Tweeter
Cat. No. 7-TX
350 cycles to
beyond aud.
Power: 10 watts
Imp: 8 Ω



The DUCHESS



AUDAX TONE ARM NOW IN KIT FORM

Anyone can assemble it in about 10 minutes — and save 50%! Exactly duplicates Audax "Compass-Pivoted" transcription arm long recognized as top "blue chip". "Selector-Index" permits instant adjustment for any stylus pressure. Newly-designed cartridge housing permits all-important stylus-to-groove alignment at a glance. Accommodates ANY make cartridge.

KT-12 \$14.55 NET
factory-assembled
\$24.00 NET.

KT-16 \$17.55 NET
factory-assembled
\$30.00 NET



Read CONSUMER REPORTS,
January 1957 issue, Page 25.

LISTENING QUALITY IS EVERYTHING!

Impartial Lab reports on the new Audax Hi-Q7 magnetic cartridge:

A leading recording studio: "Because readings showed an amazing total lack of distortion, check-tests were repeated 3 times"

Consumer sheet: "Good frequency and transient response. Practically no high frequency distortion. Low inter-modulation distortion."



Listening quality is everything — and Audax Hi-Q7 has it to a degree not equalled by any other pickup. But — HEAR it yourself . . . there is no other way! Net \$47.70, with one Chromatic Diamond and a Sapphire . . . Other models as low as \$20.70 Net.



STYLUS-BALANCE

"This really works . . ." (Audio Magazine) Stop deformation of record grooves! Only Audax Stylus-Balance can give you the all-important certainty of correct stylus pressure — ALWAYS. Precision-calibrated like a pharmacist's balance. Works with any arm and cartridge. Gold Finish. Net \$4.80.

LISTENING QUALITY CUTTERS

Flat to 14,000 cps. Distortion 0.6% at 1000 cps. Fully modulates groove with input of about 16 db with 220 lines. Z's up to 500 ohms. Two models:

H-5 Net \$111.00
H-4 Net \$75.00

Any above item, when shipped from New York, add 40c.

AUDAX COMPANY

500-5th Ave., New York 36, N.Y. Attn. Mr. H.

- Send FREE latest catalog & name of nearest dealer.
- Send FREE \$1.00, 22-page "ELECTRONIC PHONO FACTS" by pioneer Maximilian Weil. I enclose 25c for handling & postage.

Name _____
Address _____
City _____ Zone _____ State _____

Continued from preceding page

Karlson Associates Inc. 31
Kelly 8
Kierulff Sound Corp. 138
Kingdom Products, Ltd. 6
Klipsch & Associates 26

Lafayette Radio 128
Lansing, James B., Sound, Inc. 107
Lectronics 126
Leslie Creations Indexed on 60
Livingston Electronic Corp. Indexed on 60
London Audio Fair 132
London International Indexed on 60
London Records Indexed on 60
Lorenz 6

Madison Fielding Corp. 133
Marantz Company 131
McIntosh Laboratory, Inc. 18, 19
Mercury Record Corp. Indexed on 60
Metzner Engineering Corp. 22
Montilla Records Indexed on 60
Music Listener's Bookshop 129
Musicraft 138

Neshaminy Electric Corp. 109
Newcomb Audio Products Co. 36
North American Philips Co., Inc. 141
Nuclear Products Co. Indexed on 60

Peck, Trevor, Co., Ltd. 138
Pentron Corp. 106
Phonotapes, Inc. 104
Pickering & Co., Inc. 2
Pilot Radio Corp. 125
Precision Electronics, Inc. 27
Professional Directory 138

RCA Victor 108
RCA Victor Division Indexed on 60
Radio Electric Service Co. 138
Record Market Indexed on 60
Record Review Index Indexed on 60
Recoton Corp. 136
Reeves Soundcraft Corp. 24
Reiter, F. Co. Indexed on 60
Rek-O-Kut Co. 10
Replica Records Indexed on 60
Rigo Enterprises, Inc. 137
Robins Industries Corp. Indexed on 60
Rockbar Corp. 54, 133

Santa Monica Sound 138
Sargent-Rayment Co. 4
Scheller, E. & R. 143
Scott, Herman Hosmer, Inc. 223
Sherwood Electronic Laboratories, Inc. 20
Shryock Company 138
Shure Brothers, Inc. 32
Sonotone Corp. 117
Stephens TRU-SONIC INC. Back Cover
Stereo by Holt 144
Stereophony Inc. 102
Stratejackets Indexed on 60
Stromberg-Carlson 134

Tannoy, Ltd. 132
Terminal Radio Corp. 139
Trader's Marketplace 139

Unicorn Records Indexed on 60
University Loudspeakers, Inc. 110, 111
University of Chicago Press 108

Vanguard Recording Society, Inc. Indexed on 60
Viking of Minneapolis 105
Vox Productions, Inc. Indexed on 60

Walco (Electrovox Co., Inc.) Indexed on 60
Westminster Recording Co. Indexed on 60
World Radio Lab. 138

FOR A SOUND
INVESTMENT ...
USE A QUALITY CRAFTED
DIAMOND STYLUS

only \$10

Our skilled diamond craftsmen convert your present needle to a genuine, unconditionally guaranteed diamond needle! Send or bring your replaceable needle, check or money order for \$10. Specify either 33 or 78 rpm. If desired, new shaft supplied, \$2.75 additional.



DIAMOND STYLUS CO.

Dept. HM
31 WEST 47 STREET
N. Y. 36, N. Y.



ADD HOLT STEREO!

Guaranteed to improve any Hi Fi or money back.

Works from monaural source, (radio, ordinary single track records and tape.)

See "Tested in the Home" report in the Nov. 1956 issue of High Fidelity magazine.

Order yours today or send for folder. \$62.00 prepaid in U.S.

STEREO by HOLT

4712 W. Magnolia Blvd.
Burbank, California.

Note: Due to the demand for this unit sales will be restricted to the United States until further notice.

There is a difference in *High-Fidelity* speakers

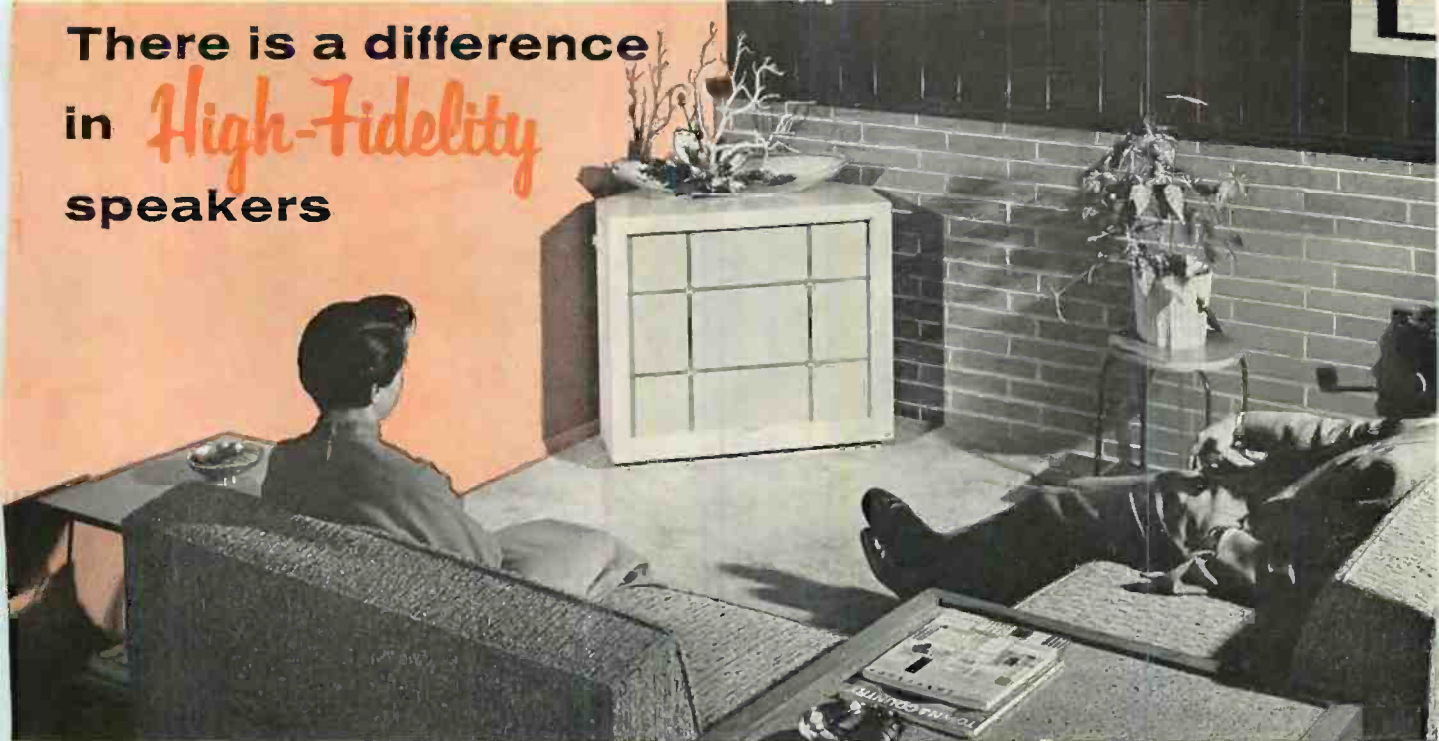

Hear the wonderful, wonderful difference! In the REGENCY SPEAKER SYSTEMS

The first ripple of the scintillating treble, the textured impact of the sonorous bass . . . and you know that this is high fidelity with a real and vital difference. You close your eyes and you are there! Sheer magic? No, you're hearing Electro-Voice . . . the ultimate in hi-fi realism.

Electro-Voice speaker superiority is only a part of the wonderful difference E-V brings to high fidelity. Balanced speaker components matched to the superlative REGENCY enclosure are the secret of E-V's marvelous range, realism and cleanliness of reproduction. By using the walls or the corner of the room as an extension of its folded horn, the REGENCY provides you with one entire octave more bass than ordinary bass-reflex enclosures.

Hear it First...Then Decide!



Don't spend a cent until you hear the difference between a single speaker and a multi-speaker system. Unique E-V *Systems Selector* lets you hear *in advance* how each added speaker component enhances the illusion of musical reality. Dial it yourself at your E-V hi-fi dealer!

Electro-Voice, manufacturer of the most complete high-fidelity product family—speakers, speaker enclosures, speaker systems, amplifiers, preamps, tuners, phono cartridges, do-it-yourself enclosure kits and microphones. Available everywhere.

See your *Electro-Voice Hi-Fi Dealer Today!*
Write for Catalog No. 113-F73.

Electro-Voice

ELECTRO-VOICE, INC.
BUCHANAN, MICHIGAN

• Canada:
• E-V of Canada, Ltd.,
• 73 Crockford Boulevard
• Scarborough, Ontario
• Export:
• 13 East 40th Street,
• New York 16, U. S. A.
• Cables: ARLAB

Electro-Voice®

Electro-Voice Speaker Building Block Plan High Fidelity That Goes Hand-In-Hand With Your Budget!

FIRST STEP

Buy the E-V Model SP15 15-in. Radax Coaxial Loudspeaker (1) and the REGENCY Enclosure (2). You get response from 30 to 13,000 cps. You pay: only \$85.00 Net for the speaker and \$127.50 Net for the enclosure in Mahogany. Blonde, Net \$137.00. Walnut, Net . . . \$143.85.

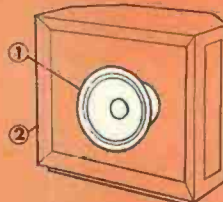

SECOND STEP

Whenever your budget permits, expand into a separate two-way system. Additional silky highs? Add Speaker Building Block 2 . . . T35 Super-Sonax VHF Driver (3), X36 Crossover Network (4), and A137 Level Control with wiring harness (5). It costs you only \$46.50 Net.

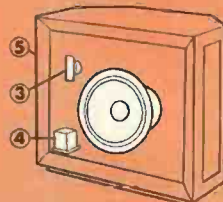

OR, maybe you prefer smoother, richer mid-range response. Then add Speaker Building Block 4 . . . T25A HF Driver (6) with 8HD Diffraction Horn (7), X8 1/2-section Crossover Network (8), and A137 Level Control with wiring harness (9). Only \$112.00 Net for Building Block 4.

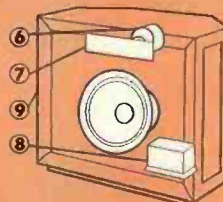

THIRD STEP

Add the Speaker Building Block that you didn't select in Step Two. You now have a deluxe E-V separate 3-way system . . . and without obsoleting any components. Your total cost, spread over any period of time you wish, is \$371.00 Net.

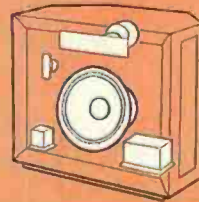

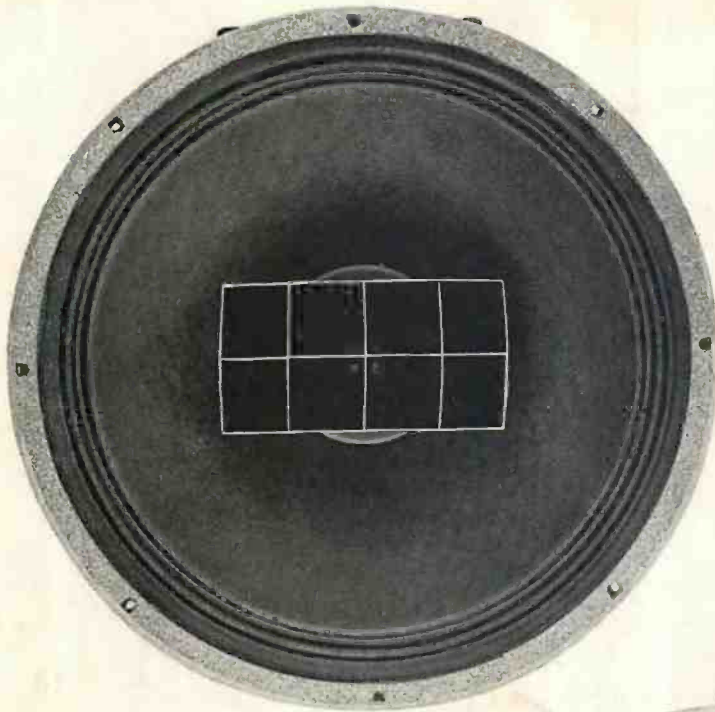

The Stephens Tru-Sonic Coaxial Speaker 206AXA is a combination of a tru-woofer and a tru-exponential, multi-cellular horn designed to provide a coverage of the audio range beyond the limits of human hearing, 20 to 20,000 cps. This unit combines two matched voice coils, a 15" cone and a multi-cellular horn for the wide angle dispersement of highs. A rich, natural blending of all the high and low frequencies... a perfect balance of the full audio spectrum.

superlative performance

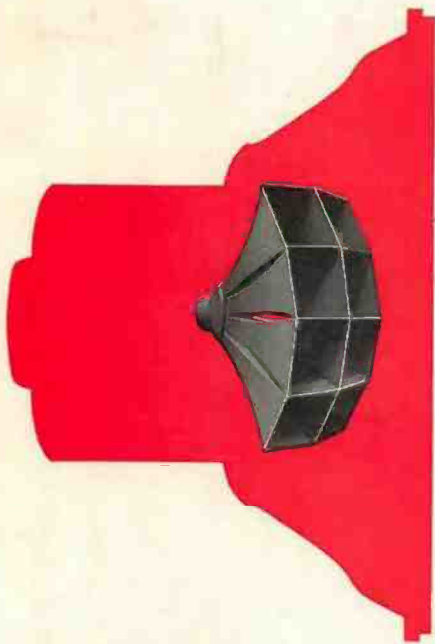
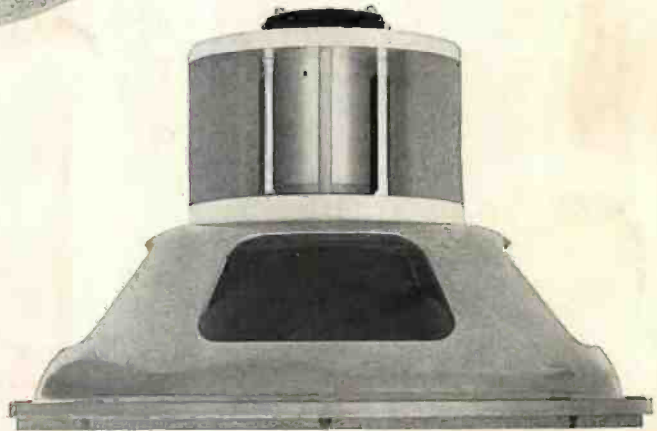

two-voice coil 15" coaxial speaker 206AXA

STEPHENS TRU-SONIC INC.

8538 Warner Drive, Culver City, California

Cable address: "Morhanex" Export address: 458 Broadway, New York 13, N.Y.

2