



HENSCHEL 1881-1884



GERICKE 1884-1889
1898-1906



NIKISCH 1889-1893



MUNCH 1949



PAUR 1893-1898



MUCK 1906-1908
1912-1918



FIEDLER 1908-1912



RABAUD 1918-1919



MONTEUX 1919-1924



KOUSSEVITZKY 1924-1949

the magazine for music listeners

High Fidelity

60 CENTS

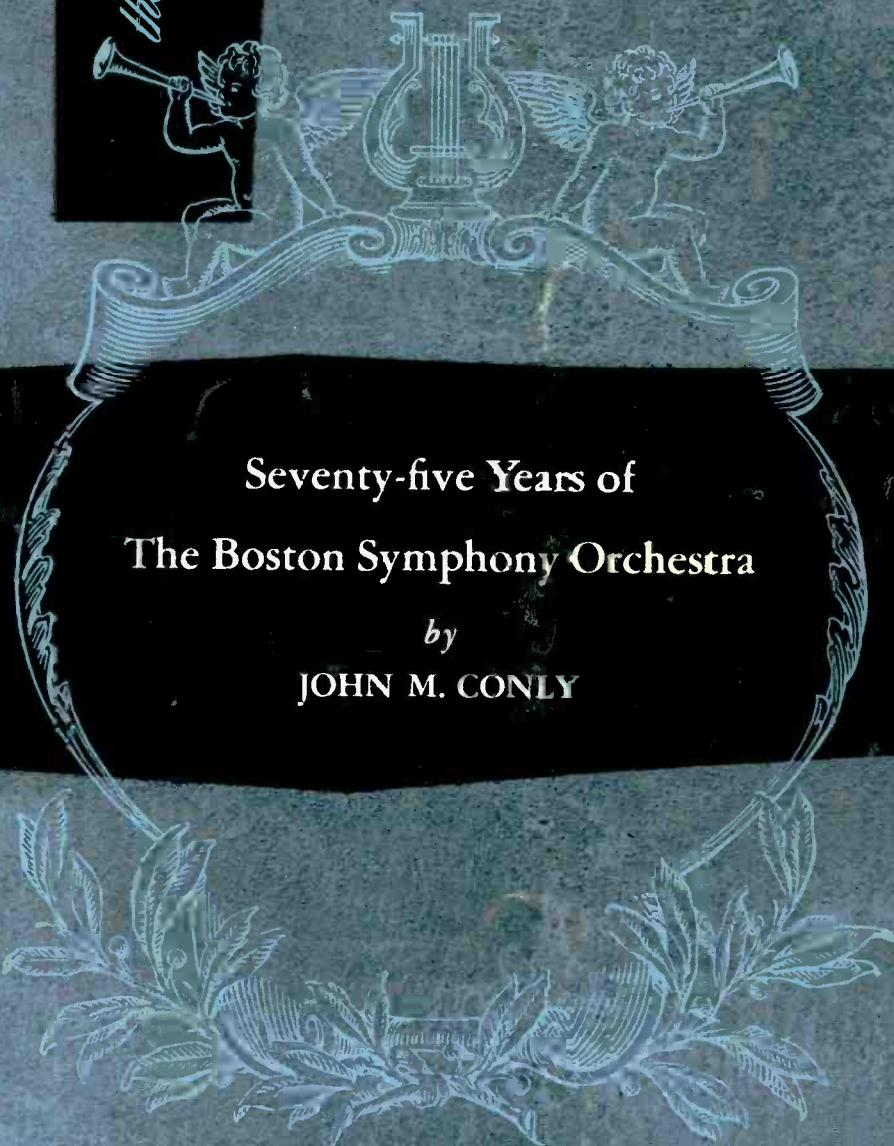

Seventy-five Years of
The Boston Symphony Orchestra
by
JOHN M. CONLY

FEBRUARY

Roy Lindstrom

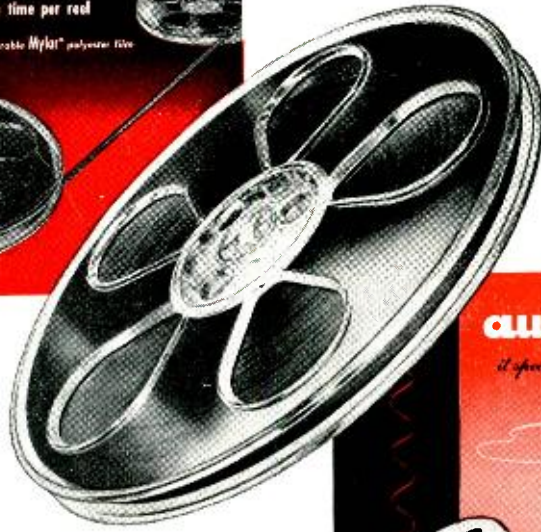

how to select the

audiotape

best suited to your needs

Standard Plastic-Base Audiotape meets all the requirements of the professional or home recordist to excellent advantage, providing unsurpassed recording quality at minimum cost. It has consistently set the highest performance standards in radio stations, sound studios and record manufacturing companies throughout the world. The standard 1½-mil cellulose acetate base has ample strength for trouble-free operation under all normal operating conditions.

LR Audiotape offers two important advantages which, for many applications, more than outweigh the slight additional cost per foot. First, it gives 50% more uninterrupted playing time on a standard reel. Second, its 1-mil Mylar* base is actually stronger at high humidity than the standard plastic base—and has *far greater* strength than long playing tape on a 1-mil acetate base.

Standard Audiotape on 1½-mil "Mylar" is a premium-quality professional tape that provides the utmost in mechanical

strength and immunity to temperature and humidity. Like all "Mylar" Audiotape, it will not dry out or embrittle with age.

Super-Thin Audiotape, on ½-mil "Mylar," doubles the footage obtainable on a standard reel. Its use, however, is limited to special applications where greatly increased playing time justifies a sacrifice of mechanical strength and some increase in print-through.

Regardless of the base material, there is only *one* Audiotape quality—the finest obtainable. All tapes are precision coated with the same carefully formulated oxide and meet the same exacting professional standards of performance. Every day, more and more professional and home recordists are finding that Audiotape gives the most *faithful* reproduction of the original live sound throughout the entire audio frequency range. For truly fine recording and reproduction, insist on Audiotape — IT SPEAKS FOR ITSELF!

RELATIVE STRENGTH OF TAPE BASE MATERIALS (at 75°F)

■ 50% Humidity
■ 90% Humidity

Yield Strength

5.0 lb.
3.0 lb.

Breaking Strength

5.5 lb.
4.1 lb.

AUDIOTAPE, STANDARD PLASTIC BASE

4.2 lb.
4.1 lb.

7.6 lb.
7.6 lb.

LR AUDIOTAPE, 1-MIL "MYLAR"

6.3 lb.
6.3 lb.

14.5 lb.
14.5 lb.

AUDIOTAPE, STANDARD 1½-MIL "MYLAR"

2.0 lb.
2.0 lb.

2.9 lb.
2.9 lb.

SUPER-THIN AUDIOTAPE, ½-MIL "MYLAR"

*Trademark, Du Pont polyester film

AUDIO DEVICES, Inc.

444 MADISON AVE., NEW YORK 22, N. Y.
IN HOLLYWOOD: 1006 N. Fairfax Ave. • IN CHICAGO: 6571 N. Olmsted Ave.
Export Dept.: 13 East 40th St., New York 16, N. Y., Cables "ARLAB"

High Fidelity

THE MAGAZINE FOR MUSIC LISTENERS

This Issue. On the twelfth day of Christmas, as the song says, our true loves, the record companies, had sent us such an incredible profusion of disks for review that something drastic had to be done, if December-January releases were not to be cropping up in July reviews. Further, most of the records were good and many of them important. Thus, after much thumping, shaking and nodding of heads, it was decided to put off until March the Prokofiev discography originally scheduled for this month, and in its stead to cover as fully as possible the midwinter flood from the diskeries. This is only the second time since Vol. I, No. 1, that HIGH FIDELITY has come out without a discography or part of one, and may be the last.

As alert readers will note, Editor John Conly's disquisition on the Hub City's great musical organization is titled on the cover: "Seventy-five Years of the Boston Symphony Orchestra," and on the title-page, more piquantly, "A Subway Stop Named Symphony." Mr. Conly explains that the second title was suggested to him, after the cover had gone to press, by Doriot Anthony Dwyer, the BSO's charming first flutist, and that he liked it so well he used it anyway.

By coincidence, we seem — with C. G. Burke's piece on record-treatment — to be starting a series on disk ailments. In hand we have two more, each covering a different aspect, by James G. Deane and Fritz A. Kuttner. You'll be reading them.

CHARLES FOWLER, *Publisher*

JOHN M. CONLY, *Editor*

ROY H. HOOPES, JR., *Managing Editor*

J. GORDON HOLT, *Assistant Editor*

ROY LINDSTROM, *Art Director*

Editorial Assistants

MIRIAM D. MANNING; JOAN GRIFFITHS

ROLAND GELATT, *New York Editor*

Contributing Editors

C. G. BURKE

JAMES HINTON, JR.

CORA R. HOOPES

ROBERT CHARLES MARSH

WARREN B. SYER, *Business Manager*

SEAVER B. BUCK, JR., *Circulation Director*

Branch Offices (Advertising only): New York: Room 600, 6 East 39th Street. Telephone: Murray Hill 5-6332. Fred C. Michalove, Eastern Manager.-Chicago: John R. Rutherford and Associates, 230 East Ohio St., Chicago, Ill. Telephone: Whitehall 4-6715.-Los Angeles: 1052 West 6th Street. Telephone: Madison 6-1371. Edward Brand, West Coast Manager.

Volume 6 Number 2

February 1956

The Listener's Bookshelf, by R. D. Darrell	4
AUTHORitatively Speaking	16
Letters	21
Swap-a-Record	32
Noted With Interest	38
As the Editors See It	53
A Subway Stop Named Symphony, by John M. Conly	54
<i>Seventy-five years of the Boston Symphony Orchestra.</i>	
On Modifying the Senescence and Mortality of Disks, by C. G. Burke	58
<i>Many are the hazards that beset your record collection.</i>	
What Goes into Your Tutti, by Edgar Villchur	61
<i>Analyzing the tones of an orchestra's instruments.</i>	
A Half-Century Without Vitamins, by Harold C. Schonberg	64
<i>An interview with Artur Rubinstein, pianist extraordinary.</i>	
Music Makers, by Roland Gelatt	69
Record Section	73-109
<i>Records in Review; Dialing Your Disks; Building Your Record Library.</i>	
Tested in the Home	111
<i>Sherwood Forester Speaker System; Browning L-500 SW Tuner; Electro-Voice Patrician IV; Recoton-Goldring 500 Cartridge; Pentron Emperor Tape Recorder; Jensen TV Duette; Shure Music Lover's Cartridge; Scott 311-A Tuner; Crescent 501 Record Changer; Walco Replacement Stylis; Sherwood S-1000 Amplifier; Jensen Coaxial Speakers.</i>	
Audio Forum	133
Trader's Marketplace	135
Professional Directory	136
Advertising Index	139

High Fidelity Magazine is published monthly by Audiocom, Inc., at Great Barrington, Mass. Telephone: Great Barrington 1300. Editorial, publication, and circulation offices at: The Publishing House, Great Barrington, Mass. Subscriptions: \$6.00 per year in the United States and Canada. Single copies: 60 cents each. Editorial contributions will be welcomed by the editor. Payment for articles accepted will be arranged prior to publication. Unsolicited manuscripts should be accompanied by return postage. Entered as second-class matter April 27, 1951 at the post office at Great Barrington, Mass., under the act of March 3, 1879. Additional entry at the post office, Pittsfield, Mass. Member Audit Bureau of Circulation. Printed in the U. S. A. by the Ben Franklin Press, Pittsfield, Mass. Copyright 1956 by Audiocom, Inc. The cover design and contents of High Fidelity magazine are fully protected by copyrights and must not be reproduced in any manner.

For Every Listener's Bookshelf

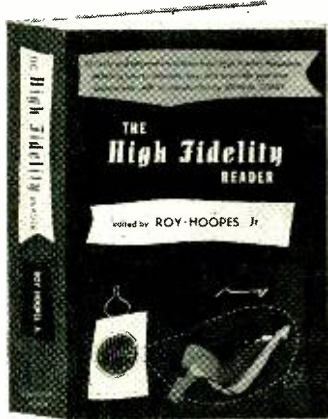

FOR the past four years the most literate and informative writing on the subject of sound reproduction has appeared in *High Fidelity* Magazine. Now, for those of you who might have missed some of *High Fidelity's* articles and for those of you who have requested that they be preserved in permanent form, *High Fidelity's* Managing Editor, Roy H. Hoopes, Jr., has selected 26 of them for inclusion in a HIGH FIDELITY READER. The introduction was written by John M. Conly.

ALTHOUGH the READER is not intended as a "layman's guide" to high fidelity, it tells you everything you need to know, and perhaps a little more, for achieving good sound reproduction.

INCLUDED in the READER are articles by:

- | | |
|------------------|----------------------|
| Roy F. Allison | Richard W. Lawton |
| Peter Bartók | Theodore Lindenbergl |
| John W. Campbell | Thomas Lucci |
| L. F. B. Carini | Joseph Marshall |
| Abraham Cohen | Gilbert Plass |
| Emory Cook | R. S. Rummell |
| Eleanor Edwards | Paul Sampson |
| Charles Fowler | David Sarser |
| Irving M. Fried | Glen Southworth |
| Chuck Gerhardt | Fernando Valenti |
| Gus Jose | Edward T. Wallace |
| F. A. Kuttner | Harry L. Wynn |

ONLY \$3.50

HIGH FIDELITY MAGAZINE
Publishing House
Great Barrington, Mass.

Enclosed lease find \$.....

Please send me copies of
THE HIGH FIDELITY READER

NAME

ADDRESS

.....

.....

NO C.O.D.'s please

(PUBLISHED BY HANOVER HOUSE)



LISTENER'S

by R. D. Darrell

BOOKSHELF

THERE are bleak days when I sourly question the Onwards-and-Upwards-with-the-Arts role customarily assumed by book and record reviewers and generally accepted—or at least seldom protested—by most of their readers. It's the critic's obvious duty, as well as a pleasurable function, to encourage others to share his own most precious discoveries. But, since all that glistens in the realm of art is by no means genuine gold, isn't it his equally obvious duty to warn others of the counterfeits and costume-jewelry he encounters far more frequently than authentic treasures? I realize that so-called "destructive" criticism is apt to be resented, since few eager prospectors enjoy learning that the shining nuggets they have laboriously unearthed are actually nothing but iron pyrites. But our faith in the ultimate rewards of aesthetic adventuring must be shallow indeed if it is so naïvely optimistic as to believe that every discovery will be a bonanza. Surely one of the hallmarks of maturity in artistic experience is coming to terms with the bitter truth expressed long ago in the verses of the Elizabethan madrigal:

*More geese than swans now live,
More fools than wise!*

In the particular area of books on music, many ordinary readers may be taken in by specious aids to "appreciation," romantically over-blown biographies, and unverified hack reference compilations, but ordinarily they are spared the less innocuous examples of bad thinking and writing—such as may be found in most guides to "better" singing and piano-playing. And this is a pity in some ways, since one hardly can measure the greatness of the finest books on music and musicians until one is equipped with a full-length yardstick or is familiar with a full-frequency value spectrum which is properly balanced at the low as well as at the high end.

Anyway, there's a certain wry

pleasure in turning for a change from partial or complete music-book successes to some of the current failures. Indeed the most preposterous of these have a horrid fascination all their own. If I can't recommend, for example, Arthur M. Abell's *Talks With the Great Composers* (Philosophical Library, \$2.75) on any grounds whatever of merit, I can hope that it will be read more widely than it deserves—simply as testimony to the fantastic lengths and depths to which some writers and publishers can go. There is comparable nonsense appearing elsewhere—especially in the fields of bogus religiosity and mysticism and on such subjects as flying saucers, psychic phenomena, organic gardening, and the like—but this is the most odoriferous slice of musical cheese I have sniffed in years.

It is also the most thoroughly aged, for Mr. Abell's revelations on the workings of musical inspiration (which for him involve a process of "contacting the Universal Vibrating Cosmic Energy") have been fermenting since the 1890s. Most of his book is devoted to a blow-by-blow description of his conversations with Brahms and Joachim, but Abell pads it out by "disclosures" from Richard Strauss, Humperdinck, Puccini, Bruch (who speaks at second hand for Wagner), and Grieg. Why have such world-shaking pronouncements been withheld so long? Well, it seems that Brahms and some of the others enjoined Abell from publishing their "secrets" for fifty years following their own deaths. One can hardly blame them for making this proviso; what surprises me is that they didn't insist on at least a hundred—or a thousand—years.

I have no legitimate reason to doubt that Abell conscientiously reports what was said—or at least what his credulous mind thought it heard—at these conferences, but neither can I doubt

Continued on page 6

FREE

YOUR CHOICE OF ANY ONE OF THESE MAGNIFICENT SETS OF THREE 12" COLUMBIA RECORDS

If you join the Columbia  Record Club now—and agree to accept as few as 4 selections during the coming 12 months

3-RECORD
SET #1

Treasury of Great Classics

Eugene Ormandy conducting The Philadelphia Orchestra

TCHAIKOVSKY

Symphony No. 6 "Pathétique"

Sir Thomas Beecham, Bart., conducting
the Royal Philharmonic Orchestra

BEETHOVEN SYMPHONY NO. 8

SCHUBERT SYMPHONY NO. 8 "Unfinished"

Bruno Walter Conducting the Philharmonic-
Symphony Orchestra of New York

BRAHMS Variations on a Theme by Haydn —Academic Festival Overture

WAGNER Siegfried Idyll SMETANA The Moldau



3-RECORD
SET #3

TREASURY OF GREAT MOOD MUSIC

STRAUSS WALTZES by

ANDRE KOSTELANETZ

Andre Kostelanetz and his
Orchestra play ten waltzes.

IN THE DANCING MOOD

LES BROWN ☆ ERROLL GARNER

HARRY JAMES ☆ LES ELGART

PERCY FAITH ☆ SAMMY KAYE

America's most popular orches-
tras play your favorite music for
dancing. 12 numbers in all.

AMONG MY SOUVENIRS

PAUL WESTON and his Orchestra

Dreamy arrangements of *Embraceable You*, *Pen-
nies From Heaven*, *I'll See You Again*, and more.

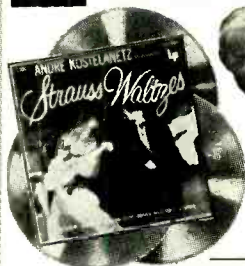

3-RECORD
SET #2

JAZZ HALL OF FAME

BRUBECK JAZZ GOES TO COLLEGE

Jazz At Columbia — Swing

- ☆ Benny Goodman ☆ Harry James
- ☆ Gene Krupa ☆ Duke Ellington
- ☆ Charlie Barnet ☆ Buck Clayton
- ☆ Count Basie ☆ Lionel Hampton

Jazz At Columbia — Collector's Items

- ☆ Bix Beiderbecke ☆ Louis Armstrong ☆ Bessie Smith
- ☆ Red McKenzie ☆ Eddie Condon ☆ Wally Rose ☆ Billie Holiday
- ☆ Bunk Johnson ☆ Pete Johnson
- ☆ Jimmy Lunceford ☆ Teddy Wilson

These 3 records are a jazz library
in themselves — presenting jazz
greats of every period and style.



3-RECORD
SET #4

BROADWAY HALL OF FAME

THE PAJAMA GAME

(Original Broadway Cast Recording)

Starring John Raitt, Janis
Paige, Carol Haney, Eddie
Foy Jr. — singing all the
tunes from this musical.

SONGS TO REMEMBER

DOROTHY KIRSTEN

Percy Faith, Russell
Case and Orchestras
join Miss Kirsten in
15 songs.

BEWITCHED



MORTON GOULD

11 songs arranged and conducted by
Morton Gould. Includes *September
Song*, *So In Love*, *Where or When*.



Now You Can Build a Fine Library of the World's Greatest Music at Tremendous Savings!

Yes! You may have, FREE, any one of these valuable record sets, each containing *three* magnificent 12" Columbia  records!

We make this unique offer to introduce you to the money-saving program of the Columbia  Record Club... a program that selects for you each month the greatest works in every field of music — performed by the world's finest artists and reproduced with the astonishing brilliance for which Columbia  records are famous!

HOW THE CLUB OPERATES

To enjoy the benefits of the Club's program—and to receive your 3-record set *free*—fill in and mail the coupon, indicating the Club division that best suits your musical taste: 1. Classical; 2. Jazz; 3. Listening and Dancing; 4. Broadway, Movies, Television and Musical Comedies.

Each month you will receive free the informative Club Magazine which describes the current selections in all four divisions. You may accept or reject the monthly selection for your division. You may also take records from other divisions, or you may tell us to send you NO record in any month.



Your only obligation as a member is to accept as few as four selections from the almost 100 that will be offered to you during the next 12 months, and you may cancel your membership at any time thereafter. The records you want are mailed to your home and billed to you at the low price of only \$3.98 plus a small mailing charge.

FREE BONUS RECORDS GIVEN REGULARLY

The 3 records sent to you now represent an "advance" of the Club's bonus system—given to you at once. After you have fulfilled your membership obligation by purchasing four records, you will receive an *additional free Bonus record of your choice for every two additional Club selections you accept*. These 12" Columbia  Bonus records are pressed *exclusively* for Club members in limited editions, not available elsewhere at any price!

CHOOSE YOUR 3-RECORD SET NOW

Indicate which 3-record set you want free, and the division you prefer. Then mail the coupon at once. You *must* be delighted with membership or you may cancel without obligation by returning the free set within 10 days.

MAIL THIS COUPON NOW!

COLUMBIA  RECORD CLUB, Dept. 291

165 West 46th Street, New York 36, N. Y.

Please send me as my FREE gift the 3-Record Set checked here:

- Set #1. GREAT CLASSICS Set #3. GREAT MOOD MUSIC
 Set #2. JAZZ Set #4. BROADWAY HALL OF FAME

and enroll me in the following Division of the Club:

- (Check one box only)
 Classical Jazz Listening and Dancing
 Broadway, Movies, Television and Musical Comedies

Each month you will send me the Columbia  Record Club Magazine which describes the records offered in all four Club divisions. I have the privilege of accepting the monthly selection in the division checked above, or any other selection described, or none at all. My only obligation is to accept a minimum of four records in the next twelve months at the regular list price plus a small mailing charge. After accepting four records, I will receive a free Bonus record for every two additional records I purchase. If not delighted with my membership, I may cancel within 10 days by returning all records.

Name.....
(Please print)

Address.....

City.....Zone.....State.....
CANADA: Prices slightly higher. 11-13 Soho St., Toronto 2B

If you wish to have this membership credited to an established Columbia Records dealer, authorized to accept subscriptions, please fill in the following information:

Dealer's name.....

Dealer's address.....

COLUMBIA  RECORD CLUB 165 West 46th St.
New York 36, N. Y.

© "Columbia",  Marcas Reg.  T.M.

WGMS

the Good Music Station

presents

A Glorious Hi-Fi Weekend in Washington

THE WASHINGTON HIGH FIDELITY MUSIC SHOW

FRIDAY, SATURDAY, SUNDAY
MARCH 2nd, 3rd and 4th

ON TWO FLOORS OF
ONE OF AMERICA'S GREAT HOTELS



The SHOREHAM

EXHIBITORS:

For information on the Show that "handled publicity most skillfully" (according to High Fidelity Magazine) write, wire or call M. Robert Rogers, President, WGMS, Washington 4, D. C. EXecutive 3-8676.

BOOKSHELF

Continued from page 4

that any skillful ouija-board operator might well have elicited much the same mystical farrago from the "spirit world." Whether poor Brahms, Joachim, *et al.*, are now revolving furiously or gratefully in their graves, I can't say. But they're certainly revolving.

Murkiness, Frou-Frou, Opera-Plots

Ascending from such abysmal depths, I feel almost comfortable when I reach such ledges of simple obfuscation and inanity as, respectively, *Ernest Chausson* by Jean-Pierre Barricelli and Leo Weinstein (Univ. of Oklahoma Press, \$4.00) and *Opera Stars in the Sun* by Mary Jane Matz (Farrar, Straus & Cudahy, \$3.95).

Despite a lack of outstanding stature, Chausson well deserves to be better known to American listeners; and, apart from some highly unidiomatic translations from his letters and *critiques*, the first part of this recent study is a useful and reasonably straightforward account of the French romantic composer's (unfortunately very prosaic) life. But the second half, purportedly concerned with analyses of the works, promptly gets tangled up in the thickets of a private language which is as hifalutin' as it is essentially meaningless. The authors profess to be impressed by Chausson's "unwillingness to transcribe *intentionally* the palpitations of the heart or the pulsations of an inspired soul." Unhappily, they themselves have no such inhibition.

Mrs. Matz's book, subtitled "Intimate glimpses of Metropolitan personalities," makes no such fancy-writing pretensions, but its gushy woman's-page journalism is no easier to take. Perhaps the more naïve of opera fans may be willing to interrupt their queue-standing and autograph-collecting long enough to read about some hundred stars' favorite hobbies and foods, but I can't imagine who else would want to. If you ever feel the urge, however, while listening to some Met singer's records, to share his or her favorite (non-musical) fare, you'll be glad to know that you now can do so — thanks to the convenient "culinary index" to the some ninety recipes with which these pages are appetizingly garnished.

Continued on page 9

BOOKSHELF

Continued from page 6

Several other recent opera books at least succeed in arousing neither ridicule nor ire; and if indeed they fail to rouse any definite reactions whatever, that possibly can be chalked up to my complete disinterest in the conventional re-telling of opera "stories" and singers' careers. I had hitherto deliberately avoided the immensely popular Milton Cross story-book (of 1947), so I am mildly surprised (or perhaps disappointed) that its current revision, **New Complete Stories of the Great Operas** (Doubleday, \$3.95), is neither as pretentious nor as dubious as I was prepared for. The plots are described somewhat clumsily, to be sure, but reasonably matter-of-factly — and certainly in immense detail: Cross takes some 642 firmly packed pages to run through 76 works from *L'Africaine* to *Die Zauberflöte*. The remaining few pages — on "How to enjoy an opera," a brief history of opera, and a discussion of opera ballets — are more questionable, but at least there's a fair three-page briefly annotated bibliography and an excellent twenty-page detailed index, which includes main arias and characters cited as well as titles and composers.

Nevertheless, it seems to me that the main usefulness of such a plot-book is captured about as well in the far smaller, cheaper, and more convenient paperback, **Stories of the Famous Operas** by Harold Vincent Milligan (New American Library "Signet," 50¢) — a revised edition, now covering some 57 operas in 320 pages, of the original "Perma-book" published by Doubleday in 1950. Milligan goes into less plot detail than Cross and he indexes titles only, but at least he arranges his works in alphabetical order by composer rather than title and his narrative style is much smoother.

Another popular opera-story specialist, Gladys Davidson, turns currently from plots to protagonists in **A Treasury of Opera Biography** (Citadel, \$4.00): a collection of biographical sketches of some 119 stars of the present and past which I daresay will appeal to some fans. Everything smacking of criticism or controversy is, however, so carefully skirted that most of the sketches approximate polite blurbs, and the inclusion of so many younger

Continued on page 11

ALLIED recommends *Pilot*

IMMEDIATE DELIVERY FROM STOCK
on all PILOT HI-FI equipment

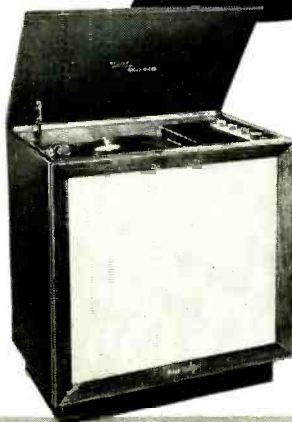

HERE'S TRUE HI-FI COMPLETE IN A CONSOLE

Pilot "Ensemble" Features Matched Components

MODEL PT-1030. New deluxe console phonograph featuring perfectly matched true Hi-Fi components. Value-packed instrument contains Pilot AA-903 Williamson-type 10-watt amplifier; Garrard RC-80 "Triumph" 3-speed changer; G. E. triple-play magnetic cartridge with sapphire styli; large, carefully designed speaker enclosure with 4 hi-fi speakers (12" woofer for deep, impressive bass, mid-range speaker and 2 tweeters); 3-way dual-control presence network for fine acoustical balance. Beautiful cabinet on "ready-roll" casters. 28 $\frac{3}{4}$ " high x 25 $\frac{3}{4}$ " wide x 16 $\frac{1}{2}$ " deep. Shpg. wt., 115 lbs. **\$289.50**

94 RZ 389. Mahogany. Net. **\$289.50**
94 RZ 390. Limed Oak. Net. **\$299.50**

Pilot HF-56 AM-FM Tuner, Preamp, 35-Watt Amplifier Combination

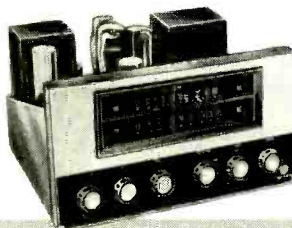

Three components in a single chassis—sensitive FM-AM tuner, versatile preamp-equalizer and Williamson-type 35-watt hi-fi amplifier. Features: dual-cascade limiter-discriminator circuit, tuned RF amplifier, AFC, flywheel tuning, built-in antennas, loudness control, full record compensation, separate bass and treble tone controls, tape output, etc. Removable gold and maroon front panel. 7 $\frac{1}{2}$ " x 14 $\frac{1}{4}$ " x 12". Shpg. wt., 31 lbs.

94 SZ 378. Net. **\$209.50**

Popular-Priced Pilot Amplifier and FM Tuner

MODEL AA-903 AMPLIFIER. Famous low-cost Williamson-type 10-watt hi-fi amplifier. Includes preamp and 4-position record compensator, with 1 magnetic phono and 3 high-impedance inputs. Response, ± 1 db, 15-40,000 cps at rated output. Separate bass and treble controls; rumble filter; hum balance control. Attractive gold-finished chassis, 12" x 7" x 8 $\frac{3}{4}$ " deep. Shpg. wt., 15 lbs.

98 SX 662. AA-903 Amplifier (less cabinet). **\$69.50**
Net.

94 SX 379. Metal cabinet for above. Net. **\$4.95**

MODEL FM-607A FM BASIC TUNER. Moderately priced, yet deluxe in features and performance. Features AFC (with "defeat" for tuning weak station adjacent to strong one); built-in antenna; tuned RF stage; temperature compensated oscillator; sensitivity, 3.5 uv for 20 db of quieting. Attractive chassis and front panel; 6 $\frac{7}{8}$ " x 10 $\frac{1}{2}$ " x 7 $\frac{1}{4}$ ". Shpg. wt., 10 lbs.

98 SX 697. FM-607A FM Tuner (less cabinet). Net. **\$69.50**

94 SX 382. Metal cabinet for above. Net. **\$4.95**

All prices net, F.O.B. Chicago

WE STOCK ALL PILOT EQUIPMENT • EASY-PAY TERMS AVAILABLE



ALLIED 100-PAGE HI-FI CATALOG

FREE

Send for this invaluable guide to a complete, easy understanding of Hi-Fi, plus the world's largest selection of quality music systems and components, **FREE** — write for it today.

ALLIED RADIO

America's  Hi-Fi Center

ALLIED RADIO, Dept. 49-B-6
100 N. Western Ave., Chicago 80, Ill.

Ship the following Pilot Hi-Fi Equipment: _____

Check _____ Money Order _____ for \$ _____ enclosed.

Send me your free 100-page Hi-Fi catalog.

Name _____

Address _____

City _____ Zone _____ State _____



THE
Stan White 4-D

We're Sorry . . . it would have been interesting. Of all the fine speaker systems in the field, none came forward to accept our challenge to compete with the 4-D at the Chicago and New York Hi-Fi Shows. Now . . . you be the judge . . . see, hear and compare.

The 4-D is audio reproduction developed to its highest degree of excellence. A six way system providing new 4 dimensional sound with power and clarity you must hear to believe.

If you missed this amazing performance at the Hi-Fi Show, hear it now at your Stan White High Fidelity Distributor. You'll agree . . . the MIRACLE OF MULTI-FLARE 4-D will outperform any system at any price.

Wait for
 THE **Mach 1**[®]
 A radically different loud speaker

- New Magnet Structure
- Designed with the aid of wind tunnel data at . . .

Mach 1

4-D Cabinets are finished in formica to any formica sample furnished
 Size: 67 x 40 x 24 inches. Net.....1500.00

If the 4-D, designed for large rooms, is too much speaker for you, see and hear the other outstanding systems in the Stan White line for the one to meet all of your requirements. And be sure of this—each one, from LeSabre at \$69.50 to the Millennium at \$1000.00 features the exclusive MIRACLE OF MULTI-FLARE—and each is the most outstanding performer in its price class.

LeSabre	69.50	Hi-Fi	339.50
Opus I.....	99.50	Millennium	1000.00
Esquire	199.50	4-D	1500.00

Stan White

For literature and location of exclusive Stan White Distributor in your area, write:
 Dept. F-1, 725 S. LaSalle St., Chicago 5, Illinois
 A Division of Eddie Bracken Enterprises

BOOKSHELF

Continued from page 9

British singers is of dubious value to most American readers.

Coda, In More Cheerful Vein

But even in my bleakest moods, depressed by my current explorations of the lower depths and pedestrian plains of musical literature, I hate to maintain even a single "Bookshelf" column on such a negative note. And I hesitate too from encouraging, even negatively, any potential music-book reader to let any month pass by without at least *wanting* to know some new work of genuine interest and solid worth. After all, there always have been "more geese than swans" among books as well as people: the truly miraculous thing is that no matter how fast the geese multiply or how harshly they gabble, the swans always survive.

And, *mirabile dictu*, one of these is to be found this month in (of all places) the opera-book lists—and moreover in the usually hodge-podge yearbook category, which I discussed, none too favorably, some months ago. But the (British) *Opera Annual*, 1955-6, edited by Harold Rosenthal (John Calder, London; 21 shillings) is as notable outside as it is within these categories.

Although its surveys of the opera season in Europe, Soviet Russia, and the United States (including a piece by our own James Hinton, Jr., on Menotti's *Saint of Bleeker Street*) are unusually competent, the book's prime distinction lies in its extensive Mozart Bicentennial sections, its handsome printing and format, including no less than forty pages of photographs and nine pages of color illustrations. The authoritative nature of the Mozart essays is accurately indicated by the names of such contributors as Edward Dent, Vittorio Gui, Karl Böhm, *et al.*, including (in the invaluable notes on "Singing in Mozart's Operas") Brownlee, Novotna, Kern, Ivogün, Hüni-Mihacsek, Hellensgruber, Steuart Wilson, and Patzak! And for good measure there is an illuminating discussion of the complete Mozart opera recordings by Andrew Porter. (The U.S.A. price is not stated on the book jacket, but I assume that—like its highly praised predecessor, *Opera Annual*

Continued on next page

Hit the Top in Listening Pleasure

**NOW—Make YOUR system
best the easy way!**

Stop wading through tons of material to get information you want. Stop calling every friend and hi-fi fan you know every time you have a question. Stop investing hours and hours of time trying to puzzle out a difficult problem. Here, for the first time in ONE series of beautifully bound Library books is all the Hi-Fi and Audio info' you've chased all over town, read dozens of magazines to get.



The Gernsback Audio and High-Fidelity Library brings the top Audio Engineers and Technicians right into your own home . . . men who can tell you just what's right or wrong with any Hi-Fi system . . . men who can give you all the inside tips on tape recording — turntables — pickups — amplifiers — speakers — enclosures. Now you will know how audio circuits work, how to use them properly, how to tell which parts work best in which systems . . . how to build, repair and maintain *any* system. At last you will have complete diagrams—the latest tips, the inside dope—in 9 handsomely bound books. You will have at YOUR fingertips the FIRST and ONLY COMPLETE library of practical, detailed Audio and Hi-Fi know-how ever published!

**The First Book Is
Ready Now!**

BASIC AUDIO COURSE, by Donald Carl Hoefler, well-known RCA recording engineer, gives you all the lowdown on what audio systems must do—covers such vital subjects as audio-frequency amplifiers, principles of audio-amplifier design, push-pull amplification, inverse feedback, volume compression, power supplies for audio

amplifiers. This important basic book tells you about the Forms of Sound, The Characteristics of Music, the Physics of Music and so much more it's impossible to list the topics.

Then . . . the additional books you may get include: High Quality Audio; Maintaining High Fidelity Equipment; The Golden Ear; Audio Hints; Constructing Audio Amplifiers; The Audio Designer's Guide Book; Loudspeakers and Speaker Systems; Loudspeaker Enclosures.

And You Can Save 25%

If you buy each of these 9 books individually as they are published, you will pay \$5.00 each . . . but by becoming a member of the GERNSBACK AUDIO AND HIGH-FIDELITY LIBRARY PLAN YOU SAVE 25%.

How The Library Plan Works

- 1) You will receive the very latest book by mail every three months as it comes off the press. Examine it IN YOUR OWN HOME FOR 10 FULL DAYS AT OUR RISK! If you don't like it, return it.
- 2) You only have to take four of the nine Audio and Hi-Fi books to get one at the special low member's price of only \$3.75 per copy—you can save \$11.25 on the whole library!

Fill Out No-Risk Coupon Today!

All you have to do is fill out this coupon and mail it today. Just check the box that suits you best. Don't delay! Get your copy of BASIC AUDIO COURSE for a FREE home examination now!

NO-RISK COUPON

GERNSBACK LIBRARY, INC.

Dept. 101, 25 West Broadway, New York 7, N. Y.

Enroll me now as a member of the GERNSBACK AUDIO AND HIGH-FIDELITY LIBRARY. Send me postpaid, for free examination, the deluxe, hard cover edition of BASIC AUDIO COURSE. If satisfied I agree to remit the special member's price of \$3.75 and will take at least 3 more books as published.

I want to know more about the GERNSBACK AUDIO AND HIGH-FIDELITY LIBRARY. Send full information.

NAME _____
Please Print

STREET _____

CITY _____ STATE _____

Years Ahead in Engineering . . .

unmatched for
performance
regardless of
PRICE!

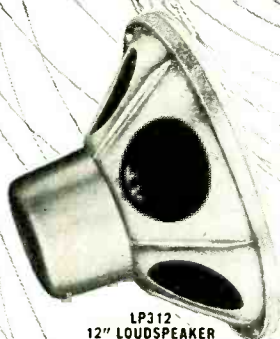

LP312
12" LOUDSPEAKER



TB-1



TB-2

TB-1 & TB-2
Coaxial and Diaxial
TWEETER ASSEMBLIES
Fits across any
12" speaker.

Your Sound System GROWS UP... Never Grows Old

WITH



World Famous Quality

SPEAKERS • TWEETERS • COMPONENTS



LP208
8" LOUDSPEAKER



LP65 HORN
TYPE TWEETER



HP-1
HIGH PASS FILTER

Lorenz craftsmanship and know-how enables you to plan your present and future sound systems! Designed for expansion—to GROW UP with your requirements or you can expand and improve your present system at little cost. There's no limit to your music enjoyment!

LISTEN TO LORENZ . . . you'll understand why Lorenz Speakers are the choice of sound engineers and high fidelity enthusiasts—acknowledged favorites for their crisp, clean tonal qualities that add the miracle of life to the magic of music reproduction. Three generations of Lorenz research and technical mastery guarantee Lorenz quality—performance.

Lorenz Quality Speakers and Components
are surprisingly low in cost.

Exclusive U.S. Distributors

See and Hear them at your high fidelity dealer. Write for Catalog

KINGDOM

PRODUCTS, Ltd.

23 Park Place, New York 7, N. Y.
Worth 4-8585

BOOKSHELF

Continued from preceding page

1954-5 — it may be had for \$4.50, plus 15¢ postage, from The Central Book Co., 261 Broadway, New York City 7. It would still be a bargain at double that price.)

And there is still another really worthwhile value this month: Robert Magidoff's *Yehudi Menuhin* (Doubleday, \$4.50) — a fascinating study which is infinitely more substantial as well as more provocative than the usual biography written during a musician's own lifetime. Whatever one may think of Menuhin the violinist, no one can read this sympathetic yet by no means uncritical account without a new respect for the awesome problems of infant prodigies in general and a vastly enhanced respect for one of the most sensitive and serious musical personalities of our day. It's an absorbing story, written with exceptional skill, insight, and good taste, and it is augmented by one of the finest (unannotated) discographies I've ever seen in print — one which includes not merely all Menuhin's recordings, under both American and British order-numbers, but also exact recording dates for every entry.

Back to School

At least once (and sometimes often) in every serious audio amateur's life there comes a dire moment when he realizes bleakly that he doesn't *really* know what he's talking about when he glibly pronounces such shibboleths as "output impedance," "feedback," "cathode-follower," "intermodulation distortion," and the like. He may be able to use the terms themselves familiarly and even correctly enough, but when he is pressed by a curious friend to explain them, he becomes suddenly disillusioned about the true depth of his apparently "expert" technical knowledge. And he resolves then and there to plug the gaps in his theoretical education by a thorough study (or review) of electronic principles. Perhaps his resolution is strong enough to stimulate his signing-up for a "radio" course in some nearby vocational school, or even with one of the many institutes which offer correspondence courses; but more often (if he doesn't lazily postpone any direct action), he falls back on the purchase of a textbook or two and

Continued on page 14

INSTALLATION SIMPLIFIED

*that's the story
behind the
2 new series
of the ...*

Collaro

RC-54

*Automatic Intermix
RECORD CHANGER*



Three Speeds: 33 1/3, 45 and 78 rpm

More people can now enjoy the reliable quality and performance of the Collaro RC-54—because something has been done about the installation problem.

The two new RC-54 series have power and sound leads wired and soldered in position.

Both are supplied with Automatic 45 rpm Spindle Adapters and both offer a choice of pickup cartridges: either the G.E. dual-sapphire magnetic or Collaro Studio O dual-sapphire crystal.

The 'C' Series are supplied with *pre-cut, unfinished mounting boards*, suitable for easy installation into record cabinets and consoles—without the need for intricate carpentry.

The 'M' and 'B' Series are supplied with *hardwood bases* instead of mounting boards

—'M' for mahogany and 'B' for blond. These require no carpentry whatever. They can be fitted into most cabinets, or placed on open shelves, tables or any other convenient surface.

With woodworking, wiring and soldering eliminated—it takes no time at all to install an RC-54. And of this you can be sure . . . there is no finer record changer than Collaro.



Priced from **\$56.00**

Sold by Leading
Sound Dealers



Write for complete specifications to Dept. CB-2

ROCKBAR CORPORATION • 215 East 37th Street, New York 16, N. Y.



Made in England



'Highest performance possible'

► America's authoritative testing organization devoted exclusively to high fidelity equipment is The Audio League. Here are excerpts from *The Audio League Report** on the PRECEDENT tuner:

"Unquestionably the most sensitive FM receiver on the market. Its stability and ease of tuning are outstanding. The limiting characteristic is fantastically good. The PRECEDENT is foremost in capture ratio, and possibly in stability and low distortion. It is built and designed for long and trouble-free life. It is beautiful.

"If money is no object, one can have an FM receiver capable of the highest performance possible at the present state of the art, and not likely to be obsoleted or significantly improved upon."

► Detailed information on this superlative instrument is available without cost.

RADIO ENGINEERING LABORATORIES • INC.
36-40 Thirty-seventh Street • Long Island City 1, N. Y.

*AUTHORIZED QUOTATION NO. 14. THE READER SHOULD CONSULT VOL. 1, NO. 9, (OCT. 1945) OF THE AUDIO LEAGUE REPORT, PLEASANTVILLE, N. Y., FOR THE COMPLETE TECHNICAL AND SUBJECTIVE REPORT.

BOOKSHELF

Continued from page 12

makes a more-or-less effective attempt at self-education.

For many years two of the most popular sources of such home training in electronics have been the preliminary chapters in the RCA *Receiving-Tube Handbook* and the ARRL *Radio Amateur's Handbook*, both of which are carried in current editions by every radio/audio "parts" dealer. Both of these are excellent as far as they go, but generally the novice needs still easier, more detailed, preliminary instruction, and most advanced students will want far more extensive information. This wartime "speed-up" device has been adapted for home readers in a five-volume *Basic Electronics* by Van Valkenburgh, Nooger & Neville, Inc. (Rider, \$2.00 per paperback volume; \$9.00 the set), but this "course" is both so primerish in content and so excessively crude in its appeal to the reader's "intelligence," that it will have (I hope!) only negative attractions for any HIGH FIDELITY subscriber. In any case, however, only the first two slim volumes here (*Introductions to Electronics, Tubes, and Amplifiers*) have any particular audio pertinence; the others are concerned almost exclusively with radio and video matters. There are many fine, good, reliable electronics textbooks, but some of those most widely known and used today are far from up-to-date either in specific contents or in materials-presentation style and organization. To the everlasting credit of the United States Navy, it developed, during the late war, some excellent adult instructional techniques. Chief Naval Radio Technician Henry V. Hickey's and Lt. William M. Vallines's *Elements of Electronics* (McGraw Hill, \$5.00) admirably exempli-



fies the straight-forwardness, thoroughness, and authority of the best modern technical pedagogy.

No textbook of this kind can be evaluated properly until one has tested it by extensive use—either as a student or teacher, but even in cursory examination this strikes me as far superior and far more satisfactory to

Continued on page 16



GARRARD

World's Finest

now presents its new
MODEL 301
"the Professional"
transcription turntable

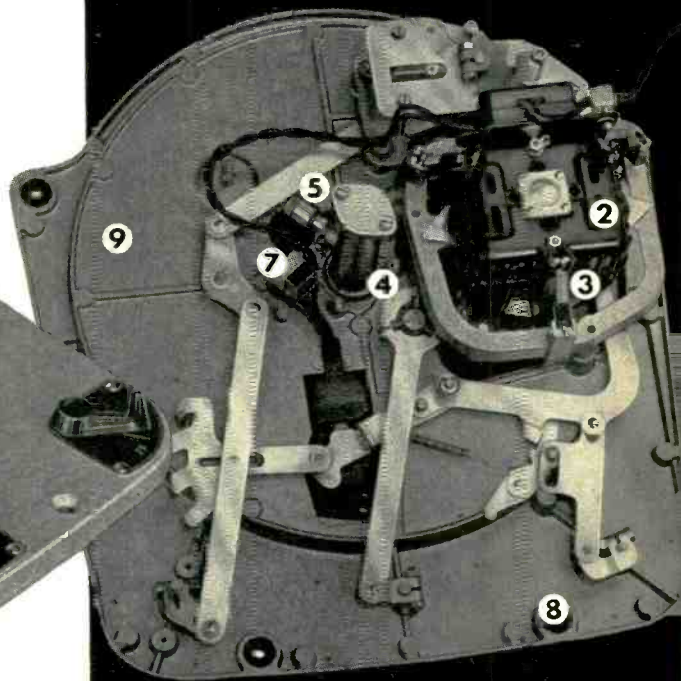

MODEL 301
Transcription Turntable **\$8900** net

WHY RECOMMENDED: This machine has been designed to provide the professional user and quality enthusiast with a unit supreme in its class... truly the world's finest transcription turntable for use in the home!

FEATURES:

1 TURNTABLE: 12" diameter... 7 1/2 lb. cast aluminum... dynamically balanced, and precision-machined. Permanently "true" center boring fitted with phosphor bronze bushing.

2 NEW HEAVY-DUTY MOTOR: 4-pole shaded design, specifically engineered for this unit. Entirely Garrard-built heavy die-cast housing. Dynamically balanced armature. Rotor set into permanently accurate, self-centering, self-lubricating phosphor bronze bushings.

3 FREE-FLOATING ISOLATED MOTOR MOUNT: A newly developed GARRARD principle, whereby the entire motor is suspended in air by two sets of counterbalancing tension springs. This unique mounting eliminates even the barest possibility of vibration being transferred to the unit plate.

4 NOISELESS MAIN SPINDLE: Rotates on single, specially designed frictionless semi-elliptical bearing of phosphor bronze which eliminates noise and rumble and is simple and inexpensive to check and replace.

5 BUILT-IN PRESSURE LUBRICATING SYSTEM: Oversized grease-housing permanently mounted on main spindle to insure continuous, proper lubrication at all times. Knurled knob, easily accessible from top of unit for turning, forces additional lubricant into spindle, when required.

6 VARIABLE SPEED CONTROL: Simple, footpedal eddy current brake permits instantaneous variation of all 3 speeds. Positive action at all times through permanent magnet, which interacts with revolving metal disc. No friction, no loss of efficiency.

SPEED SAFETY LOCK: Makes it mandatory to shut unit off before switching speeds. An important safety device, preventing jamming of idlers and operating mechanism.

SPECIFICATIONS: Voltage: Dual range, 100 to 130 and 200 to 250 volts. 50 cycle pully available. Wow: Less than 0.2%. Flutter: Less than 0.05%. (Gausson-Kalee Wow and Flutter Meter Type 564) 3000 cycle constant frequency records at 33 1/3, 45 and 78 rpm. Rumble: Virtually non-existent. Cabinet space required: 16" back-to-front x 13 3/4" wide x 2 1/2" above (excluding pickup) and 3 1/2" below top of motorboard. Weight: Net 16 lbs., Gross 20 lbs.

7 RESISTOR-CONDENSOR NETWORK: Eliminates shutoff noise, which is normally induced through pickup to loud-speaker.

PERFECTED TURRET-DRIVE MECHANISM: Large, true pulleys actuate oversized live rubber inter-wheel, which is mounted on ball bearings and retracts upon shutoff.

SHUTOFF BRAKE: Stops free turntable revolutions when unit is switched off.

8 EXCLUSIVE MOUNTING-SUSPENSION SYSTEM: Permits unit to be mounted firmly to motorboard in fixed relationship to tone arm. Entire motorboard (including turntable and tone arm) is then spring-suspended on base. Special conical Garrard springs and other hardware provided.

9 HEAVY UNIT PLATE: Entirely die-cast and aluminum.

INDIVIDUAL INSPECTION REPORT and owner's manual: Great attention has been given to quality control details appreciated by the connoisseur; including the most exhaustive performance test-procedure ever devised by a gramophone manufacturer. Accurate measurements of speed, wow, flutter, rumble, flash and insulation are contained in an individual inspection card, enclosed with each Garrard Turntable and referring to that turntable only. Also furnished are a comprehensive 24 page book-bound owner's manual and a permanent, heavy-duty stroboscope.



Typical installation in case with a popular tone arm.



- A quality-endorsed product of the British Industries Group:
- GARRARD Record Players
 - WHARFEDALE Loudspeakers
 - RIVER EDGE Cabinets
 - MULTICORE Solders
 - LEAK AMPLIFIERS
 - R-J Enclosures
 - GENALEX Tubes

Write for illustrated
B.I.C. High Fidelity Plan Book . . .

British Industries Corp., Dept. GB-26
Port Washington, New York
Please send B.I.C.
High Fidelity Plan Book.

Name _____
Street _____
City _____ Zone _____ State _____



about which pickup is best. The Audio League,* America's authoritative consumer research organization devoted exclusively to high fidelity equipment, tested virtually every American and imported pickup. The verdict:

The ESL Professional and Concert series are by far the finest phonograph reproducing instruments. The smoothness and clarity of these cartridges are unique. Even persons who had never previously been exposed to high fidelity reproduction were struck by the superior definition of the ESL.

Join the musicians, engincers, and music lovers who have switched to this sensational new electrodynamic cartridge. Write for details.

*P. O. Box 55, Pleasantville, N. Y.

ESL

FOR LISTENING AT ITS BEST
Electro-Sonic Laboratories, Inc.
 35-54 Thirty-sixth Street • Long Island City 6, N. Y.

Soloist Series from \$14.95 • Concert Series \$35.95 • Professional Series arm and cartridge \$106.50

Listen and you shall hear...

Yes . . . when you listen to your favorite symphony or soloist on the revolutionary, new Sound Sales Phase Inverter Speaker unit, you'll thrill to the smooth, clean treble, and be amazed at the firm, clear bass you'll hear ALL the music!

Introducing a new era in Hi-Fi sound reproduction, this attractive unit out-performs enclosures two and three times its size! Measuring only 29" x 18" x 14", it supplies the answer to your speaker problems, where space is at a premium.

MADE IN ENGLAND

This compact unit combines a 12" dual suspension speaker with an acoustically matched resonant enclosure, to act as a true phase inverter. Rated at below 30 cps and above 13,000 cps frequency response, it has a power capacity of better than 12 watts, with minimum distortion. In standard walnut veneer, other finishes on special order.

SOUND SALES PHASE INVERTER SPEAKER & ENCLOSURE UNIT

Audiophile net **\$99.50** Speaker only **\$59.50**

AVAILABLE AT LEADING HI-FI MUSIC CENTERS

ERCONA CORPORATION (Electronic Division)
 551 Fifth Avenue, Dept. H-2, New York 17, N. Y.

BOOKSHELF

Continued from page 14

work with than any of the texts which I dutifully dog-eared in my own apprentice days. I recommend it heartily, both as an authoritative basic training course and as a valuable reference-addition to any serious audiophile's library.

And for many practical audiophile purposes, I recommend even more highly the smaller **Basic Vacuum Tubes and Their Uses** by John F. Rider and Henry Jacobwitz (Rider, \$4.50). For though this little book is confined to tube operation and circuitry alone, it is a superbly simple yet illuminating introduction to their theoretical understanding and practicable exploitation. Like Harold D. Weiler's *High Fidelity Simplified* (Rider, 1952), the Rider-Jacobwitz book is one of those miracles of attractive, stimulating exposition which seem as if they should have been as easy to prepare as they are to read and study That the former ease is wholly deceptive is testified to by the rarity with which such miracles appear. For the genuineness of the latter ease, make your own test!

AUTHORitatively Speaking

Edgar Villchur, whose tonal analysis of "What Goes Into Your Tutti" begins on page 61, is president of Acoustical Research, Inc., a position and an organization, he says, that sound more impressive than they are in fact. Acoustical Research's main stock in trade is the AR-1 acoustic-suspension speaker system, invented by none other than Edgar Villchur. He is also an instructor in the Division of General Education at New York University, where he teaches a course in high fidelity sound reproduction. Some readers will remember a series of articles on musical instruments he wrote a couple of years ago for *Audio* magazine. He lives in Woodstock, N. Y., halfway up the Hudson River, and since the AR factory is in Cambridge, Mass., and NYU in New York City, he has a triangular commuting schedule which would drive a lesser man mad. Villchur not only thrives on it, he has time to learn tenor parts and sing in the Woodstock Choral Group.

Fearful lest the highly sympathetic tone of his article, "A Subway Stop Named Symphony," give readers a false impression, John Conly submits the following statement: "I am not now, and never have been a Bostonian. I was born, as it happens, in Brooklyn — not to be confused with Brookline."

LETTERS



SIR:

I read with great interest Ralph Ellison's essay on living with music in your December issue. He is a gifted writer who does credit to his publishing house.

It is with sadness that I beg to point to an error in the preface of this worthy piece. We do not now, nor have we ever published the works of Ralph Ellison. Alas, I must report that he is published by our good neighbor up the street—Random House.

Sherman P. Laire

Harcourt, Brace and Co.

SIR:

Having been a hi-fi fan for quite sometime—I started collecting LPs around 1950—I have a bone to pick with hi-fi fanciers. I own several recordings of the Boston Symphony Orchestra. I am sorry to see Serge Koussevitsky laid by the wayside in this modern age of screeching "treble" and "dance hall" bass. Since most of the Koussevitsky recordings on LP were made from 78 rpm pressings, he didn't live long enough to be called a hi-fi conductor. Today he is strictly passé with record purchasers who are looking for sounds, not pure music. Many of his LPs are still preferred over new original LP recordings: his recordings of Sibelius' Symphony No. 2, Copland's *Appalachian Spring*, Shostakovich's Ninth, Prokofiev's *Peter and the Wolf*, Rachmaninoff's *Isle of the Dead*, and many others.

I say, long live the greatest of the lo-fi conductors.

Morton Fader

West Chester, Pa.

SIR:

I know just how Mr. Clancey feels ("Letters," November 1955). I am a great admirer of tenor Jussi Bjoerling, but I never have an opportunity to hear him on radio or TV.

Continued on next page

Klipschorn

CORNER HORN LOUDSPEAKER SYSTEM

The ultimate in FIDELITY
of music reproduction

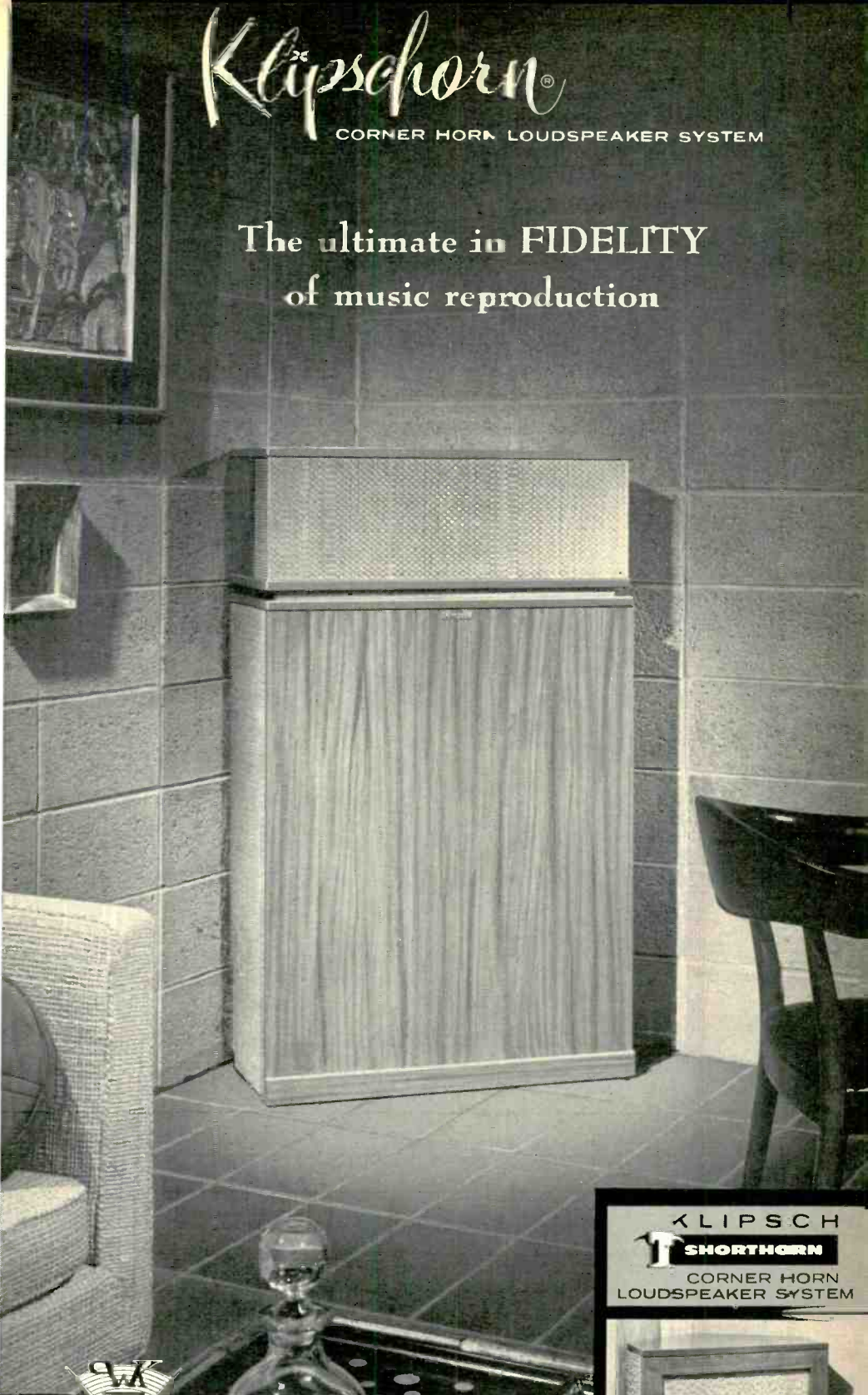

KLIPSCH
SHORTHORN
CORNER HORN
LOUDSPEAKER SYSTEM

For low or medium budget sound systems the Shorthorn corner horn with Klipsch ortho 3-way drive system approaches the Klipschorn system in performance. Available as shown, with or without drivers or in utility model or unassembled kit form.

Both the Klipschorn and Shorthorn systems are fabricated under personal supervision of their designer, Paul W. Klipsch. Write for the latest literature and prices on Klipsch loudspeaker systems.

KLIPSCH AND ASSOCIATES
HOPE, ARKANSAS

TELEPHONES:

PROspect 7-3393

PROspect 7-4533

PROspect 7-5573

PROspect 7-5511

LETTERS

Continued from preceding page

I have no intention of starting a fan club, but Mr. Clancey's idea of sending post cards to Voice of Firestone, Telephone Hour, etc., is a good one and worth trying.

"In unity there is strength." My Weede-Bjoerling cards are in the mail already.

Leon P. Guzowski
Buffalo, N. Y.

SIR:

November's page 55 has a misprint. The Bruckner Overture (with the Seventh; Epic SC 6006) is the already recorded one in G minor, not another "similar effort," in D minor, as the review might lead one to think.

The long-play premiere of this overture on SPA stresses Bruckner's Mozartean leanings, and is the best recording soundwise. It could unhesitatingly be recommended if only it were available on a single disk (it is coupled with the Loewe revision of the Bruckner Ninth which will always be open to debate).

Since SPA has already tormented Mahler lovers by similarly charging the toll of a longer work in making available their unique Mahler Tenth as done with the full blessings of Mahler's widow, why can't they now seek a happy remedy to both coupling gripes?

A single record could start with the Mahler Adagio, and turn over for the Scherzo, and then conclude (band two, side B) with the Bruckner Overture. (If SPA is opposed to the idea of selling records in mass quantities, then they should surrender their masters to some other firm not in business for health reasons alone.)

E. R. Petrich
Seattle, Wash.

SIR:

Well, what am I supposed to do?

I've just finished reading "From Bach to Brubeck and Back" (November 1955). I am a poor little confused young man. I don't know beans about music, and certainly I could not refute the older man's arguments. I am trying to grasp ahold and get a lot of this cloudiness out of my mind when I try to understand music. And along comes this old man and tells me that Brubeck does nothing but pound the piano and Desmond has a lousy sound.

HIGH FIDELITY MAGAZINE



"Breathtaking!" — EDWARD
TATNALL
CANBY

THE FISHER

Master Audio Control

SERIES 80-C

"**S**TARTLINGLY DIFFERENT," says Edward Tatnall Canby, *Audio Magazine*. "Has everything, at a very reasonable price for top-quality hi-fi equipment. The easiest to read and operate I've ever seen. The specs on performance are breathtaking and the over-all quality of its electrical operation is pretty closely comparable to that of a professional broadcast console control board. This is the current standard for really hi-fi operation of controls in the home. Hum, distortion, *et al* are so low as to be inaudible and mostly unmeasurable in the lab. And all this, mind you, in the middle price range."

Chassis Only, \$99.50 • Mahogany or Blonde Cabinet, \$9.95

Remarkable Features of THE FISHER 80-C

- Professional, lever-type equalization for all current recording characteristics. • Seven inputs, including two Phono, Mic and Tape. • Two cathode-follower outputs. • Complete mixing and fading on two, three, four or five channels. • Bass and Treble Tone Controls of the variable-crossover feedback type. • Accurately calibrated Loudness Balance Control. • Self-powered. • Magnetically shielded and potted transformer. • DC on all filaments; achieves hum level that is inaudible under any conditions. • Inherent hum: non-measurable. (On Phono, 72 db below output on 10 mv input signal; better than 85 db below 2v output on high-level channels.) • IM and harmonic distortion: non-measurable. • Frequency response: uniform, 10 to 100,000 cycles. • Separate equalization and amplification directly from tape playback head. • Four dual-purpose tubes, all shielded and shock-mounted. • Separate, high-gain microphone preamplifier. • Push-Button Channel-Selectors with individual indicator lights and simultaneous AC On-Off switching on two channels (for tuner, TV, etc.) • Master Volume Control plus 5 independent Level Controls on front panel. • 11 Controls plus 5 push-buttons. • Three auxiliary AC receptacles. SIZE: Chassis, 12 $\frac{1}{4}$ " x 7 $\frac{3}{4}$ " x 4 $\frac{1}{4}$ " high. In cabinet, 13-11/16" x 8" x 5 $\frac{1}{4}$ " high. Shipping weight, 10 pounds.

Prices Slightly Higher West of the Rockies

WRITE TODAY FOR COMPLETE SPECIFICATIONS

FISHER RADIO CORP. • 21-25 44th DRIVE • L. I. CITY 1, N. Y.

I guess he is right. I'm young and impressionable, true. I like the Brubeck sound. I enjoy the moods he creates in my mind. Oh, sure, the impressions Beethoven arouses in my mind when I play Egmont Overture, or Overture from Egmont or whatever it is (I don't read labels much, I guess) are much more grand in scope, and I'd never even attempt to compare Brubeck with him. But everything doesn't have to be a masterpiece, does it? I am definitely pepped up when I play Brubeck. I'm a cartoonist and I can really get the work out when Brubeck is coming through my speaker. But I put Beethoven on, or Berlioz, and man, my production goes way down. I keep finding myself sitting in my butterfly chair listening closely to what they put into the piece. And you can just imagine how much time I lose when I play something the length of *Symphonie Fantastique* or *Daphnis and Chloe*.

So please don't print any more articles telling me that Brubeck pounds and Desmond irritates. I'm too susceptible. I get dissatisfied too easily. How do you think I ever got into hi-fi?

Please leave Brubeck alone. Leave Chet Baker alone. Pick on Benny Goodman if you like, for I don't like him. And go ahead and tell me how beautiful and wonderful and tremendous Bach is. And Beethoven. And Mendelssohn. And Berlioz.

I'm susceptible. I'll love it.

Jerry Young
Granite City, Ill.

SIR:

About five or six years ago a friend gave us an album of children's records which were thoroughly enjoyed by our two little girls. When our little boy came along in 1952, one of the records was left out of the album and somehow or other was broken. The girls missed the album terribly and at the time tried, to no avail, to replace the record but no one in Portland had even heard of the series. Now our three-year-old boy dearly loves the two remaining records and plays them constantly, apparently not realizing that he doesn't hear the complete album. Record three/four is the one we are in need of . . .

The name of the album is King Thrushbeard (Adopted from Grimms' Fairy Tales). The records were made by Bel-Tone Recording Corporation —

Continued on next page



AN EXCEPTIONAL, NEW THIRTY-WATT AMPLIFIER • HANDLES SIXTY-WATT PEAKS!

Top Quality! Low Cost!

THE 
FISHER

30-Watt Amplifier

MODEL 80-AZ

ANOTHER FISHER FIRST — our great new 30-watt amplifier with *A PowerScope*, a Peak Power Indicator calibrated in watts to show instantly the peak load on your speaker system. The new FISHER 80-AZ Amplifier is the first with a positive indicator to prevent voice coil damage. The Model 80-AZ is magnificent in appearance and quality.

Incomparable Features of THE FISHER Model 80-AZ

- High output — less than 0.5% distortion at 30 watts; less than 0.05% at 10 watts. Handles 60-watt peaks. ■ Intermodulation distortion less than 0.5% at 25 watts and 0.2% at 10 watts. ■ Uniform response 10 to 50,000 cycles; within 0.1 db from 20 to 20,000 cycles. ■ Power output is constant within 1 db at 30 watts, from 15 to 35,000 cycles. ■ Hum and noise level better than 96 db below full output! ■ Three separate feedback loops for lowest distortion and superior transient response. ■ Unique cathode feedback circuit for triode performance with the efficiency of tetrodes. ■ Output transformer has interleaved windings and a grain-oriented steel core. ■ Three Controls: *PowerScope*, *Z-Matic* and *Input Level*. ■ Handsome, brushed-brass control panel (with sufficient cable for built-in installations.) ■ Tube Complement: 1—12AT7, 1—12AU7A, 2—EL-37, 1—5V4-G, 1—*PowerScope* Indicator, 1—Regulator. ■ 8- and 16-ohm outputs. ■ Size: 15½ x 4¼ x 6¾" high. WEIGHT: 22 lbs.

Price Only \$99.50

Price Slightly Higher West of the Rockies

WRITE TODAY FOR COMPLETE SPECIFICATIONS

FISHER RADIO CORP., 21-25 44th DRIVE • L. I. CITY 1 • N. Y.

50-Watt, All-Triode!

THE LABORATORY STANDARD

FISHER

AMPLIFIER MODEL 50-AZ

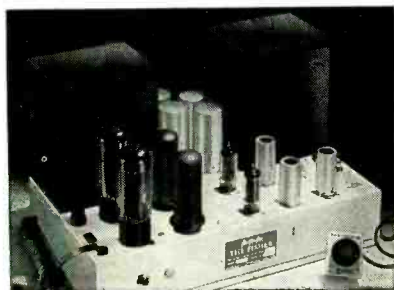

■ "Of the very best!"—*High Fidelity Magazine*. Will handle 100 watts peak. World's finest all-triode amplifier. Uniform response within 1 db from 5 to 100,000 cycles. Less than 1% distortion at 50 watts. Hum and noise content 96 db below full output—virtually non-measurable! Oversize components and quality workmanship in every detail. Includes FISHER Z-MATIC, at no additional cost. **\$159.50**

FINE ACCESSORIES



MIXER-FADER • Model 50-M

NEW! Electronic mixing or fading of any two signal sources (such as microphone, phono, radio, etc.) No insertion loss. Extremely low hum and noise level. High impedance input; cathode follower output. 12AX7 tube. Self-powered. Beautiful plastic cabinet. **Only \$19.95**



PREAMPLIFIER-EQUALIZER • 50-PR-C WITH VOLUME CONTROL

Professional phono equalization. Separate switches for HF roll-off and LF turn-over; 16 combinations of phono equalization. Handles any magnetic cartridge. Extremely low hum. Uniform response, 20 to 20,000 cycles. Two triode stages. Fully shielded. Self-powered.

New, Low Price \$19.95

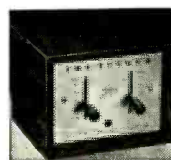

HI-LO FILTER SYSTEM • Model 50-F

Electronic, sharp cut-off filter system for suppression of turntable rumble, record scratch and high frequency distortion—with *absolute minimum* loss of tonal range. Independent switches for high and low frequency cut-off. Use with any high-fidelity system.

New, Low Price \$24.95



PREAMPLIFIER • Model PR-6

A self-powered unit of excellent quality, yet moderate cost. Can be used with any low-level magnetic cartridge, microphone, or for tape playback. Two triode stages. High gain. Exclusive feedback circuit permits long output leads. Fully shielded. Uniform response, 20 to 20,000 cycles. *The best unit of its type available.*

Only \$10.95

Prices Slightly Higher West of the Rockies

WRITE TODAY FOR COMPLETE SPECIFICATIONS

FISHER RADIO CORP. • 21-25 44th DRIVE • L. I. CITY 1, N. Y.

LETTERS

Continued from preceding page

no city or state mentioned. The dramatization and direction of production were by Ted B. Sills, narration by Uncle Bob (Robert Bailey), musical score by Raymond Sanns, orchestration by H. B. Gilbert, and sound effects by Alfred Span. I do hope that with this information you will be able to help me secure another record or album.

Mrs. John Loback
2447 N. E. Dunckley
Portland 12, Ore.

SIR:

The recent output of Paganini recordings has given me much pleasure. I have always considered Paganini as a Beethoven, for both men were great pioneers in their own way. The use of his melodies and techniques by other great musicians is an example of his creative genius. There is a distinct sadness about the situation, for not one of the recent recordings of the D major represents the complete score. That is one thing you failed to mention in your recent reports of these recordings. (There is altogether too much writing done without much being said in these reports) . . . The Epic production has a beautiful jacket and some of the most interesting anecdotes I have seen on a jacket. The pictures also give it a special class of its own. The recording, however, is a bit different. The D major is cut (as usual) and the fine performance by Mr. Grumiaux (D minor) is marred by a tubbiness that just about forces the orchestra out of the background.

Not enough can be said about the Angel recording. It is a terrific production and no recording I have heard can compare to the performances of soloist and orchestra. Yet all efforts are in vain, for this version is also cut. I have heard the cut version so often that I am beginning to wonder if Paganini really wrote it that way. (The older Franciscatti version—a best-seller—is also a cut version.)

I have not heard the recording by Ricci (London); but I am not too hopeful, for Mr. Ricci has done quite a bit of cutting in his previous works.

I guess I'll have to stick with the Menuhin-Monteux recording on the old 78 rpm disks. It is the only complete recording of the D major and thank goodness that we still have a few musicians that play music as written. I have tried for quite some time

trans-
uhin
N. Y.
help in
trying
broken
bert Im-
Fischer
written
in record
it all hope
want the
Fischer re-
the record
DM-494; Schu-
us; Edwin Fischer. The
at is broken is 16241 — A &
and on records in automatic se-
quence the sides would be two and
eleven. On 16241A (2) is Impromptu
in C minor, Part 2, Op. 90, No. 1.
On side 16241B (11) is Impromptu in
B-flat major, Part 1, Op. 142, No. 3.
I hope that properly identifies the
record.

If you know of anyone who would be willing to have a 78 cut of the record, and mailed to Old Bob, or in any way help him in his plight it would be greatly appreciated.

In case anyone finds it possible to act upon this request, he should write to: Mr. Robert G. Jordan, 619 Brummel, Evanston, Ill.

John W. Johnstone, Jr.
Evanston, Ill.

SIR:

... Mr. Henry Pleasants has guts and is trying to say something that has needed saying since *L'Enfance du Christ*. However... the first part of his article, full of those naïve quotes, is embarrassing. His conclusions are in the right direction, but painfully wide of the mark.

Why all the confusion over a definition of jazz? There is a definition of jazz, of course, one that will satisfy everybody and hold water as a critical yardstick. It has been known to people capable of reasoning for a long time. It can clear up the confusion Mr. Pleasants has manufactured for his article (by giving equal credence to all opinion) without difficulty. If the triple-thinkers can't give it to Mr.

Continued on next page



MODEL 80-T • MOST ADVANCED PROFESSIONAL TUNER WITH COMPLETE AUDIO CONTROL

Outperforms Them All!

THE SERIES 80

FISHER FM-AM TUNERS

Here are America's *only* FM-AM Tuners with TWO meters for micro-accurate tuning — just *one* of their many unique features. Says a FISHER dealer: "I set up a FISHER Series 80 for home demonstration against all performers. No other dealer was willing to submit a competitive tuner for direct comparison to the FISHER. Thanks for a fine product!" — *Unsolicited testimonial from A. W. Finley, Dayton Sound Associates.*

Outstanding Features of THE FISHER Series 80 Tuners

- The 80-T features *extreme sensitivity* (1.5 mv for 20 db of quieting.) ■ *Separate* FM and AM front ends, completely shielded and shock-mounted. ■ *Separate* tuning meters for FM and AM ■ 72-ohm, plus *exclusive*, balanced 300-ohm antenna inputs for increased signal-to-noise ratio. ■ AM selectivity adjustable; AM sensitivity better than 1 microvolt. ■ *Inherent hum non-measurable.* ■ Distortion below 0.03% or 1 volt output. ■ 4 inputs, including separate *tape playback* preamp-equalizer.
- Six record equalization choices. ■ Two cathode follower outputs. ■ 16 tubes. (80-R; 13 tubes.) ■ 8 controls including Bass, Treble, Volume, Function, Equalization, Tuning, Loudness Balance, AFC. ■ Self powered. ■ Magnificent appearance and workmanship. ■ CHASSIS SIZE: 12 3/4" wide, 8 1/2" deep less knobs, 6" high (80-R; 4" high.) ■ NOTE: Model 80-R is identical to the above, but is designed for use with an external audio control such as THE FISHER Series 80-C.

MODEL 80-R • FOR USE WITH EXTERNAL AUDIO CONTROL



MODEL 80-T

\$199⁵⁰

MODEL 80-R

\$169⁵⁰

MAHOGANY OR BLONDE
CABINET: \$179⁵⁰

Write For FULL Details

FISHER RADIO CORP.

21-25 44th DRIVE
LONG ISLAND CITY 1, N.Y.



AM Quality Leader!

THE FISHER AM TUNER

MODEL AM-80

SHORTLY after the appearance of the famous FISHER FM-80 Tuner, we received many requests for an *AM* counterpart of the same blue-ribbon breed. The AM-80 was engineered in response to those requests and we are proud of it — as its owners will be. In areas beyond the service of FM stations, users of the AM-80 will discover with delight that it has the pulling power of a professional communications receiver, bringing *enjoyable* reception of ordinarily elusive, distant stations. The AM-80 offers broad-tuning for *high fidelity* AM reception, as well as medium and sharp tuning for suppression of interference where it exists; and it is a perfect companion for the FM-80. The specifications below speak for themselves.

Outstanding Features of THE FISHER AM-80

- Features a relative-sensitivity tuning meter for micro-accurate station selection ■ Sensitivity: better than *one microvolt!* ■ Three-gang variable condenser.
- One tuned RF and two IF stages. ■ *Three-position*, adjustable band-width.
- Frequency response (broad position) ■ —3 db at 8 Kc. Audio section: uniform response, 20 to 20,000 cycles. ■ Built-in 10 Kc whistle filter. ■ Dual antenna inputs. Loop antenna supplied. ■ Three high-impedance inputs.
- Cathode-follower output permits leads up to 200 feet. ■ Completely shielded and shock-mounted construction, including bottom plate. ■ Flywheel tuning.
- Slide-rule tuning dial with logging scale. ■ Beautiful, brushed-brass control panel. ■ Four controls: Power/Sensitivity, Function, Tuning, Output Level Control. ■ Tube Complement: Total of Eight. 3—6BJ6, 1—6BE6, 1—6AL5, 2—6C4, 1—6X4. SIZE: 12¼" wide, 4" high, 8¼" deep, including knobs.

Price Only \$139.50

Mahogany or Blonde Cabinet: **\$14.95**

Price Slightly Higher West of the Rockies

WRITE TODAY FOR COMPLETE SPECIFICATIONS

FISHER RADIO CORP. · 21-25 44th DRIVE · L. I. CITY 1, N. Y.

Comments

Pleasants, I
Jazz is a fcs
urban kind of a
larging urban kind
born out of those
such things are wh.
presses. It is music n.
the musical tools availab.
itinerant musicians on the
moment as they perform
itinerant musician can be a
traveling by Stratocruiser, or
belly traveling by Red Ball
express. It is a short-term, imp
vised musical outcry. It is a people
music. Its beginnings were among
the lowly of our economic life, but it
continues to be the darling of the short
of cash and the people who habitually
feel more than they think. What is
demanded of it is the release of ex-
citement, the purging of the emotions

There is real jazz and phony jazz,
just as there is real folk music and
phony folk music . . . The real jazz-
men sing with their instruments from
the heart in whatever language they
can muster, new or old, to anybody
who will listen. The beat may be
savage, the horn guttural in vulgar
and bitter disillusionment, the saxo-
phone may wail in unmistakable sor-
row (or . . . joy) but the result is some-
thing not interchangeable and not
often forgettable. The phony jazz-
men are the slick musical entertainers
who listen to the real jazzmen talk
and then go home and practice until
they can approximate the sounds
they've heard . . . in order to cash in
on the desire of this citified age for a
folklore of its own. No one who has
heard and understood the original out-
cry can mistake the counterfeit emo-
tion for the real thing. Whatever its
virtues as entertainment, a musical
enterprise like the Benny Goodman
band or the Glenn Miller band cannot
be called jazz — and the above will
tell Mr. Pleasants why it can't. It is
no good to simply decide to reduce all
barriers and simply judge it as music.
This would be the ruin of the Glenn
Miller kind of thing — Miller has to
be judged on performance. It is the
jazzmen who get judged on the basis
of the goodness or not-so-goodness
of their music.

Jazz is not an art, and can never be
art. It is, however, the *material* of art.

Art implies selection, refinement, distillation, a realization crystallized by a genius welding the new raw clay over the old bones in a way to satisfy for all time. We want nothing changed in our masterpieces. Jazz . . . should be an outcry — of joy, of anger, of sorrow, of something felt and experienced (intellectually as well as otherwise), or even a soft, gentle gasp of delight and wonder, or a fluid kind of contemplation of a wisdom gently said — but some kind of raw statement, uttered at the moment of discovery. A great deal of fine artistry can be gotten out of this stuff. All that is necessary is that serious composing artists know and respect the real jazz, and that the real jazzmen respect the composer's enterprise in using their raw material as legitimate and desirable when sincere. Gershwin and Bernstein make music out of jazz, and acknowledge their debt. The jazzmen need not be affronted, nor the classical critics feel cheated . . .

Ray Ellsworth
New York, N. Y.

SIR:

I was interested in Mr. Saroyan's comments ["Living With Music," September 1955] about printed programs and chronological presentation of composer's work. I thought perhaps he, and your readers, might be interested in what we have accomplished here in the Midwest, where such things are little practiced and less appreciated.

Our program "Symphonic Minutes" started out seven years ago as a once-a-week spot for nothing. Interest developed, along with sponsors, and now the show is a daily fifty-five minute feature of a local independent station, WMRP (1510 kc.).

Among other features has been the chronological order Mr. Saroyan desires. Insofar as recordings available to us have permitted, we have had weeks-long series of such composers as Sibelius, Mahler, Bruckner, Nielsen, Delius, Dvorak, and quite a few others; chronological presentation of the symphonies of the above (sans Delius), as well as Beethoven, Schubert, Brahms, Mendelssohn, Franz Berwald, Vaughan Williams, Elgar, and Kallinikov, to name only those whose total output of symphonies has been recorded . . .

Vocal music hasn't suffered, either,

Continued on page 29



AMERICA'S TOP FM TUNER IN SENSITIVITY, APPEARANCE AND WORKMANSHIP

150,000 Witnesses

HAVE VERIFIED THE FM-80'S SUPERIORITY!

THE FISHER

FM TUNER MODEL FM-80

World's Best by LAB Standards

THOSE who attended the Audio Fairs in New York, Chicago, Los Angeles, Washington, Boston and Philadelphia found that *only* Fisher Radio Corporation had set up a battery of regular production tuners so that you, the consumer, might operate them as you saw fit, in an obviously radio-difficult location, and with only the most elementary of antennas taped to the wall. More than 150,000 people made these tests, and were astonished to find FM stations coming in perfectly from 'impossible' distances. This Missouri-show-me style test has settled once and for all the question as to who makes the best tuners in America. To those who did not attend the Audio Fairs, we say: Try it before you buy it! **Chassis Only, \$139.50**

Mahogany or Blonde Cabinet, \$14.95

Outstanding Features of THE FISHER FM-80

- TWO meters. One to indicate sensitivity, one to indicate center-of-channel for micro-accurate tuning. ■ Armstrong system, with two IF stages, dual limiters and a cascode RF stage. ■ Full limiting even on signals as weak as one microvolt. ■ Dual antenna inputs: 72 ohms and 300 ohms balanced (*exclusive!*) ■ Sensitivity: 1½ microvolts for 20 db of quieting on 72-ohm input; 3 microvolts for 20 db of quieting on 300-ohm input. ■ Chassis completely shielded and shock-mounted, including tuning condenser, to eliminate microphonics, and noise from otherwise accumulated dust. ■ Three controls — Variable AFC/Line-Switch, Sensitivity, and Station Selector PLUS an exclusive Output Level Control. ■ Two bridged outputs — low-impedance, cathode-follower type, permitting output leads up to 200 feet. ■ 11 tubes. ■ Dipole antenna supplied. Beautiful, brushed-brass front panel. ■ Self-powered. ■ WEIGHT: 15 pounds. CHASSIS SIZE: 12¾" wide, 4" high, 8¼" deep including control knobs.

Price Slightly Higher West of the Rockies

WRITE TODAY FOR COMPLETE SPECIFICATIONS

FISHER RADIO CORP. • 21-25 44th DRIVE • L. I. CITY 1, N. Y.

Discs made from "SCOTCH"^{REG. U.S. PAT. OFF. BRAND} Magnetic Tape masters earn Capitol's Full Dimensional Sound Seal!



Capitol Record's Full Dimensional Sound Review Committee. Left to right: Francis Scott; Roy Du Nann, Supervising Recording Engineer; Ed Uecke, Chief Electronics Engineer; Bill Miller and Bob Myers of the Capitol Artists and Repertoire Department.

You can thank the critical judgment of the five men pictured above for the wonderful tone and fidelity of the Capitol records you buy. They have the responsibility of listening to *every* Capitol Classical LP master recording before it is released to the public . . . appraising each disc's dynamic range, performance, background noise—in fact, judging it on *eight* critical points. Only the recordings which meet all of this Committee's rigid standards receive Capitol Record's famous gold stamp-of-quality . . . the Full Dimensional Sound Seal.

Capitol Record's Full Dimensional Sound Review Committee is *unique* in the recording field. But the mag-

netic tape the company uses for its original recordings is the same favored by *all* leading record firms—"SCOTCH" Magnetic Recording Tape. Only "SCOTCH" Brand makes its own magnetic coatings. This means *all* magnetic particles are alive, active—ready to record even the faintest sound with perfect fidelity. No wonder it's the largest-selling magnetic tape *in the world!*

^{REG. U.S. PAT. OFF.}
"SCOTCH" Magnetic Tape
BRAND

The term "SCOTCH" and the plaid design are registered trademarks for Magnetic Tape made in U.S.A. by MINNESOTA MINING AND MFG. CO., St. Paul 6, Minn. Export Sales Office: 99 Park Avenue, New York 16, N.Y. © 3M Co., 1956.

LETTERS

Continued from page 27

with a complete opera every two weeks, if possible, and outstanding singers, played a disk a day or so until their electrical recordings are fully aired . . .

Vocal music in the form of lieder hasn't been slighted. On successive days, all the six volumes of the Wolf sets on HMV were played, and other lieder collections of like value (Husch's Schubert cycles and Kilpenin songs, for example) were broadcast.

Another scheme just getting into tentative script form is the performance, numerically, of the first hundred Victor albums of classics. What a galaxy of musicians! Kreisler, Backhaus, de Greef, Isolde Menges, Granforte, Pertile, Giannini, Rachmaninoff, Toscanini, Coppola, Coates, Blech, Melchior, Mengelberg, just to name a few, and many in their best form.

Up until lately, when printing costs got the better of us, we printed daily programs that were distributed through the libraries and schools. We hope to do it again soon.

This letter may seem unduly proud, but we are proud, and we feel the justification is in the number of listeners we attract and hold here.

Soon our station goes on 500 watts; not much, but enough more to take us out of our town and send the program to the nearby cities such as Lansing, Detroit, Ann Arbor, etc.

"Symphonic Minutes" is on from 12:05 till 1:00 P.M., Monday through Friday.

Barton Wimble
Flint, Mich.

SIR:

There are now at least half-a-dozen of these subscription-type record issuing outfits in operation. Their practice is, as you know, to issue, on an average, one item every month. To control production they send to each of their members an advance notice which describes the forthcoming release and a reply card upon which the member may indicate his rejection of the offering. I am a member of a number of these groups and from time to time receive records from all of them. Not only do I receive records which I have desired, but I often receive records I had notified these organizations *not* to

Continued on next page

BROCINER

PRINTED CIRCUIT AUDIO AMPLIFIERS

HIGH FIDELITY Magazine says

"top quality"

Mark 30C Audio Control Center

"... distortion has been reduced almost to the vanishing point... Strictly a top-quality control unit worthy of the very finest associated equipment, and well suited to the needs of the high fidelity perfectionist." —HIGH FIDELITY Magazine



Feedback type preamplifier with extreme flexibility of control and input-output facilities, functionally designed for ease and simplicity of operation. Separate Turnover and Roll-off controls. Exact compensation for all recording curves, rigidly controlled in production. Feedback-type bass and treble controls. Rumble filter and loudness compensation front-panel controlled. Facilities for two phono inputs. Adjustable pickup load. Tape output jack. I.M. distortion virtually unmeasurable. Extremely low hum and noise level. Highly styled, legible front panel: maroon and gold cabinet. For use as remote control unit—self adjusting feature for cabinet installation. Size: 3½" x 10¾" x 6". **\$88.50**

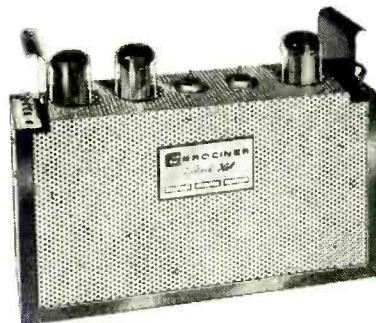

Mark 30A Power Amplifier

30 watts of low-distortion power in a compact, attractively styled, easy-to-install package. Long life assured by novel chassis design providing perfect ventilation of components. I.M. distortion below 1% at 30 watts; ¼% at 20 watts; 1/10% at 10 watts. 43 db. multiple-loop negative feedback. Wide-band phase compensation assures absolutely stable operation with all types of speakers. Perfect freedom from transient oscillation and fast recovery time result in audibly cleaner performance. Genuine, licensed Ultra-Linear Circuit. Size 3½" x 12" x 9". **\$98.25**

Mark 10 Integrated Amplifier and Control Center

"ASTONISHED ME."

—B. H. Haggin, "The Nation"

A complete, truly high fidelity amplifier at a moderate price. Features flexibility with simplicity of control. Accurate record compensation, adjustable for all recording curves. For all high quality phonograph pickups. Bass and treble controls. Rumble filter. Loudness-compensated volume control. Tape output jack. 20 db. feedback. 10 watts at less than 1% distortion. Attractive maroon and gold finish. Compact: 4½" x 11" x 8". **\$75.00**



Available at better high-fidelity distributors. (Prices slightly higher west of Rockies). Literature on request.



BROCINER
ELECTRONICS CORPORATION

Dept. HF2
344 E. 32nd St.
New York 16, N. Y.



New "Convertible" 20-watt Amplifier and Pre-Amp with controls, in one versatile unit, only \$99⁹⁵

The new General Electric Convertible is a dual-chassis design. In a single, amazingly flexible and low cost unit there's a powerful amplifier, with 20 watts of undistorted output—plus a pre-amp with seven panel-mounted controls. It gives you sound as it was meant to be heard.

There's New Installation Flexibility, too!
With General Electric's dual-chassis

design, the amplifier and pre-amp may be mounted independently in built-in systems. Or, as one complete unit, the handsome Convertible may be placed on a bookshelf or table.

Write today for new hi-fi ideas and the name of your dealer. *General Electric Company, Special Products Department, Section R5426, Electronics Park, Syracuse, New York.*

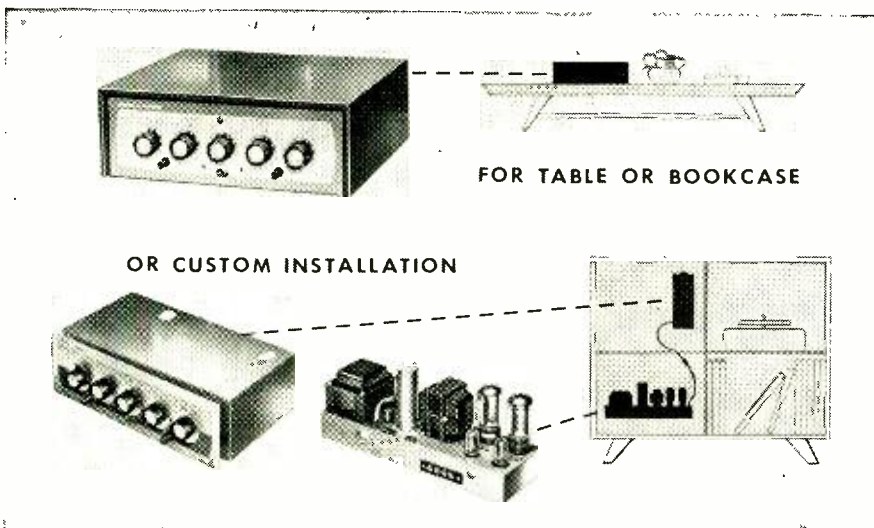

Progress Is Our Most Important Product

GENERAL  ELECTRIC

LETTERS

Continued from preceding page

send. Whenever this occurs, or when defective or damaged records require correspondence, the ensuing exchanges are likely to drag out for as long as five months. In fact, quite often there is no response at all until one is driven to recourse to aspersions on the probity and intelligence of the outfit addressed. I should like to suggest, through the medium of your columns, therefore, that other members of these groups adopt my present practice of sending their rejection cards or notices, and other correspondence, to them by certified mail. The little extra cost can obviate endless annoyance.

Al Franck
Mincola, N. Y.

SIR:

When my husband and I were engaged, he sent me a home recording of the then popular song "Symphony"—you know, "da-da-dee-dee-you are my symphony."

Now, eight years, \$400, seven speakers and two amplifiers later, I realize what a great compliment it was. So I wrote some new lyrics to it, especially for him:

"Symphony, symphony 'hi-fi'
Get that low and high,
How do you start?
Friends walk in and debates begin
'Hear that violin and this bass part.'
Symphony—fidelity.
Then we buy, and it's clear to me,
We've got a symphony,
High fidelity."

Seriously, although the technical aspects still elude me, I've got the bug even to the extent of reading HIGH FIDELITY Magazine!

We feel very fortunate, too, that at last St. Louis has a station putting out the highest quality ever heard in the city—KCFM, at 93.7 megs, with 21,500 watts of power. It's been a struggle for Commercial Electronics and Harry Eidelman to get it underway, but they've done a wonderful job.

Programming includes a program called "High Fidelity Magazine of the Air" with items and articles of unusual interest to hi-fi fans from your magazine. This certainly gives prestige to your publication, and sparks many a discussion at our house.

Hi-fi has opened a new world of enjoyment for us, for which we are grateful.

Esther L. McGowan
Imperial, Mo.



The Ampex 612-f Stereophonic Tape Phonograph and 620-f Amplifier-Speakers

the last word in living room listening...

AMPEX STEREOPHONIC SOUND

Once you've heard the Ampex 612 stereophonic tape phonograph system, you'll never be satisfied with less. It's the latest and the finest in listening pleasure, makes previous high fidelity seem old fashioned. The startling realism and magnificent quality of the 612 system brings a new panorama of sound into your living room—new heights in listening enjoyment that only a superb tape machine can achieve.

Not only does the 612 system capture all the depth and clarity of stereophonic sound, but its small size is really unique. Even the most critical audiophile is astonished that such big, clean

sound can come from such compact equipment. Complete with tape phonograph and two amplifier-speakers, it covers only four square feet of wall space for convenient placement in any living room.

With true Ampex quality, the Model 612 plays full-track, half-track or two track stereophonic tapes. Both the tape phonograph and the amplifier-speakers are available in handsome hardwood cabinets with either blonde or brunette finish. See and hear them today. Special stereophonic demonstrations are being featured this month at your Ampex Dealer's. Ask about the Ampex Time Pay Plan.

AMPEX
CORPORATION

Dealers in principal cities (see your local Telephone Directory under "Recording Equipment")
Canadian Distribution by Ampex American, 70 Grenville, Toronto, Ontario.

SIGNATURE OF PERFECTION IN SOUND

934 Charter Street, Redwood City, California.

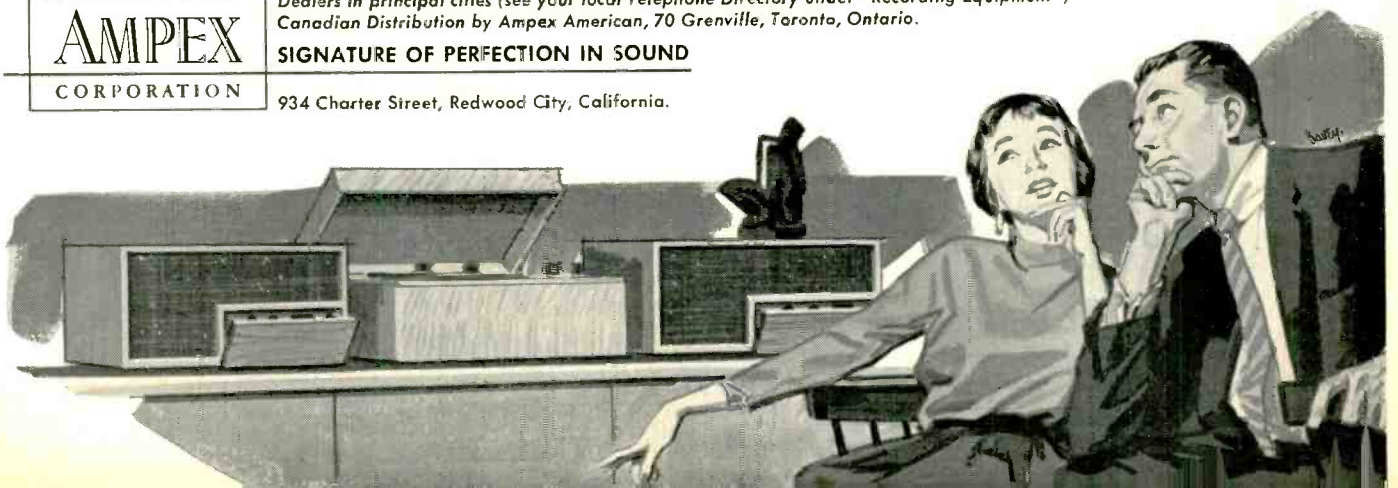

AN IMPORTANT MESSAGE TO THOSE WHO OWN A RECORD CHANGER... OR INTEND TO BUY ONE

**let's separate fact from fancy . . .
on the subject of rumble and wow!**

We are astonished by the growing defiance of fact inherent in claims made for some record changers. . . namely, that they have **NO RUMBLE OR WOW!** Such patently inaccurate statements may only serve to confuse you . . . and most certainly cannot aid in your selection of equipment.

Let's get the facts right. All record changers . . . and turntables too . . . **HAVE SOME RUMBLE AND WOW CONTENT.** At best, the absence of noise is an ideal to tempt new achievements towards perfection. The important question is . . . **HOW MUCH RUMBLE AND WOW IS PRESENT?** Among changers, the differences are at least great enough to spell listening pleasure or total dissatisfaction.

The quietest record changer made today is the Thorens Concert CD-43. In fact, it performs as well as many fine turntables. Its noise ratio is -48 db below program level and for this reason we believe it rightly deserves its reputation as the **"ONLY TRULY HIGH FIDELITY RECORD CHANGER."**

How does this vast difference come about? The answer lies in Thorens' use of a big, powerful Swiss-precision direct-drive motor with a separate gear for each standard speed. Rubber belts, pulleys and other elements common to rim or friction drive units are not present to cause undesirable noise or speed variation. The huge cast-iron frame and mechanical filter further act to reduce rumble content, and a flyball governor on the electronically-balanced main shaft provides freedom from undesirable wow.

ARE CONVENIENCE FEATURES IMPORTANT?—Indeed they are . . . and it was Thorens of Switzerland who originated many of the now well-known functional advantages. No other changer has Thorens' simple three-speed selector with integral fine tuner for exact pitch adjustment . . . and you can intermix automatically, 10" and 12" records — with special switch for 7". The fine tone-arm has adjustments for tracking weight and cartridge alignment. Pause and reject controls, manual-play switch, muting condenser . . . all these and more, are found in the Thorens.

A majority of Thorens Changers are bought as a replacement. Why not choose wisely the first time . . . ask your dealer to demonstrate a **THORENS CD-43 Record Changer.**

Also manual and automatic players, and turntables.



**CD-43
price \$93.75 net**



The following are lists of records for trade: if any records listed here interest you, write directly to the person offering them and give him your trade list. The records listed below are stated to be in good condition; however, we cannot be held responsible for any records obtained through this column.

Lists submitted for publication in this column must be limited to ten records for trade and ten which are wanted. Composer, title, performers, recording company, record number and speed must be supplied by the trader. Only 33 $\frac{1}{3}$ and 78 rpm records will be listed.

Otto Flakowski, 831 Wolfram St., Chicago 14, Ill., has a collection of eight hundred 78-rpm records of which he will swap forty (albums included) for one LP, preferably to someone in the Chicago area. Interested persons should write for complete list.

* * *

Gerald E. Hochman, 54th USAF Dispensary, Greater Pittsburgh Airport, Coraopolis, Pa., would like to trade the following LPs for progressive jazz, Broadway shows, or classical records:

Gilbert & Sullivan: *The Mikado*. D'Oyly Carte Opera Company. VICTOR LCT 6009, two 12-in.

Borodin: *Poloversian Dances*; Ippolitoff-Ivanoff: *Caucasian Sketches*, Op. 10; Enesco: *Roumanian Rhapsody No. 1* in A major, Op. 11. Wallenstein, Los Angeles Philharmonic Orch. DECCA DL 9727, 12-in.

Drums of the Caribbean. AUDIO FIDELITY AFLP 902, 12-in.

* * *

William D. Gaboriault, 18 Oaklawn Manor Dr., Apt. 3, Cranston, R. I., offers the following 78 rpm records for trade:

Gaubert: *Les Chants de la Mer*. Gaubert. Paris Symphony. COLUMBIA X109, 2 records.

Requiem Mass—Gregorian. Pius X School Choir. VICTOR M 177.

Gabrieli: *Processional and Ceremonial Music*. Biggs, Harvard and Radcliffe Choirs. VICTOR DM 928.

Boyce: *Symphonies (complete)*. New York Sinfonietta. TIMELY 1-K ("Original recording, long a collectors' item.")

In exchange for the above records, Mr. Gaboriault is interested in obtaining the following William Lekeu 78-rpm disks: *Adagio for Strings*, Op. 3. Boyd Neel. English DECCA D-X 236/7; *Quartet in B minor*. Polydor PD-516555/7; *Sonata in G*. H. & Y. Menuhin. HMV DB-3492/5.

* * *

Joseph Gale, Assistant Editor, N. J. Music and Arts, 415 Westminster Ave., Elizabeth, N. J., urgently wants the London complete

Continued on page 34



FAIRCHILD

Model 411

"Turromatic" TURNTABLE
New—A Turntable for the home, built to Fairchild professional standards! Vibrationless operation, absence of reproduced noise, complete acoustical silence. Continuous Belt Drive, Exclusive Idler Pressure Release, Turret Control and many other features. \$99.50

Model 280

TRANSCRIPTION ARM

The arm that satisfies every requirement of "professional" reproduction with exclusive features never available in popularly-priced transcription arms: perfect tracking of all records, quick cartridge change, no open circuit hum when changing cartridges, etc. Arm drop limit adjustment prevents stylus damage. *Model 280A* (recordings up to 12"). \$33.95

220 Type CARTRIDGE

Latest refinement in the cartridge design Fairchild has supplied to the Recording & Broadcasting industries for over 20 years. Linear response and freedom from resonant peaks provide unbelievably accurate reproduction of the most delicate tones as well as massive full orchestra sounds.

Frequency response: ± 2 db, 20 to 17,000 cps.

Model 220A — for microgroove (LP) records. \$37.50

Model 240

PREAMPLIFIER-EQUALIZER

Sets new standards with its flawless performance, flexibility, beauty of appearance and craftsmanship. "Balanced-Bar" Tone Control is easiest of all to see and use. Cascade input circuit, gives highest gain with least noise. One-knob equalizer gives exactly correct equalization quickly and automatically. \$98.95

Model 275 65 Watt POWER AMPLIFIER

Designed to be the ultimate in power amplifiers! True concert hall realism achieved under the most difficult circumstances because of its tremendous power response (full output available from below 20 to above 20,000 cps. at .5% THD). Variable damping control adapts it to any quality speaker system. \$213.00

Stan White **HI-FI**

Rich, spacious, effortless realism from a complex multi-horn system with four separate drivers. Components: 2 woofers driving a 14 ft. equivalent bass horn, 1 mid-range 30 watt horn driver, 1 high frequency 5 watt horn driver. Peak power handling capacity: 60 watts. *Model 4330* \$339.50

ASCO ... sound consultants

to the great names in music,
creates a perfect installation
for celebrated Metropolitan
Opera Star

Renata Tebaldi



... and it takes the
push-button selection of
 Asco's "Audiomat" to
 choose the fine components
 that will reproduce the
 superb sound of Mme. Tebaldi's
 London fir recordings ... as
they are meant to be heard

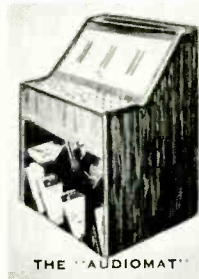

THE "AUDIOMAT"

Speaker by *Stan White*

Components by

FAIRCHILD

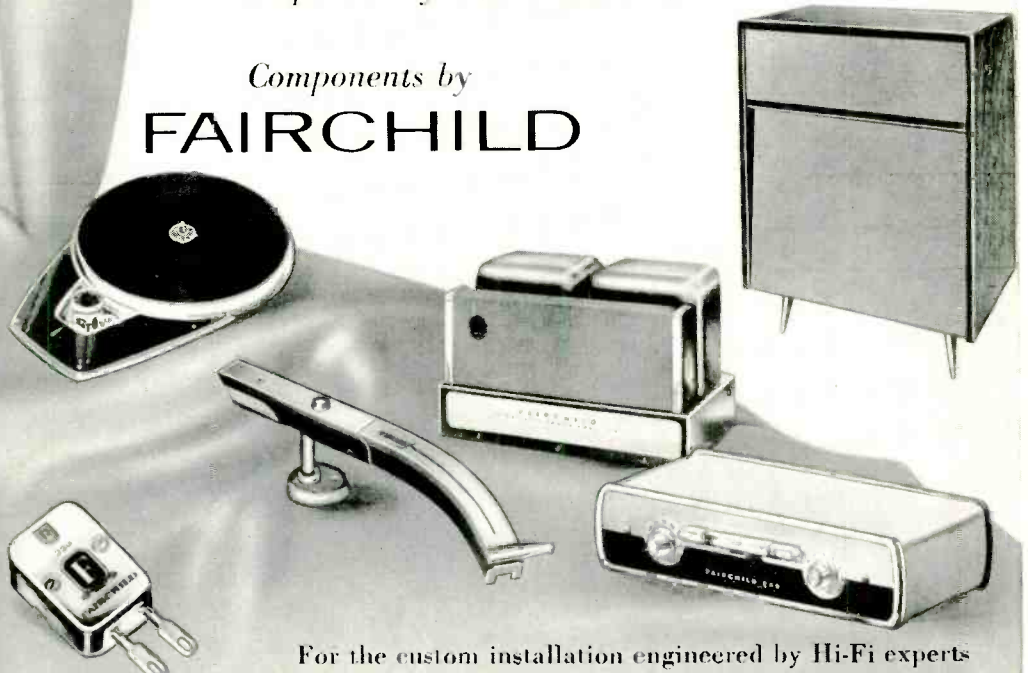

For the custom installation engineered by Hi-Fi experts
 who know how and care enough to do the job right,
 regardless of budget ... who else but

ASCO Sound Corp.
 115 West 46th St., N.Y.C.
 Judson 2-1750

3rd FLOOR

Please send me an illustrated brochure on ASCO Custom Installations to Fit Every Budget.

Name _____
 Address _____
 City _____ Zone _____ State _____

No matter where...

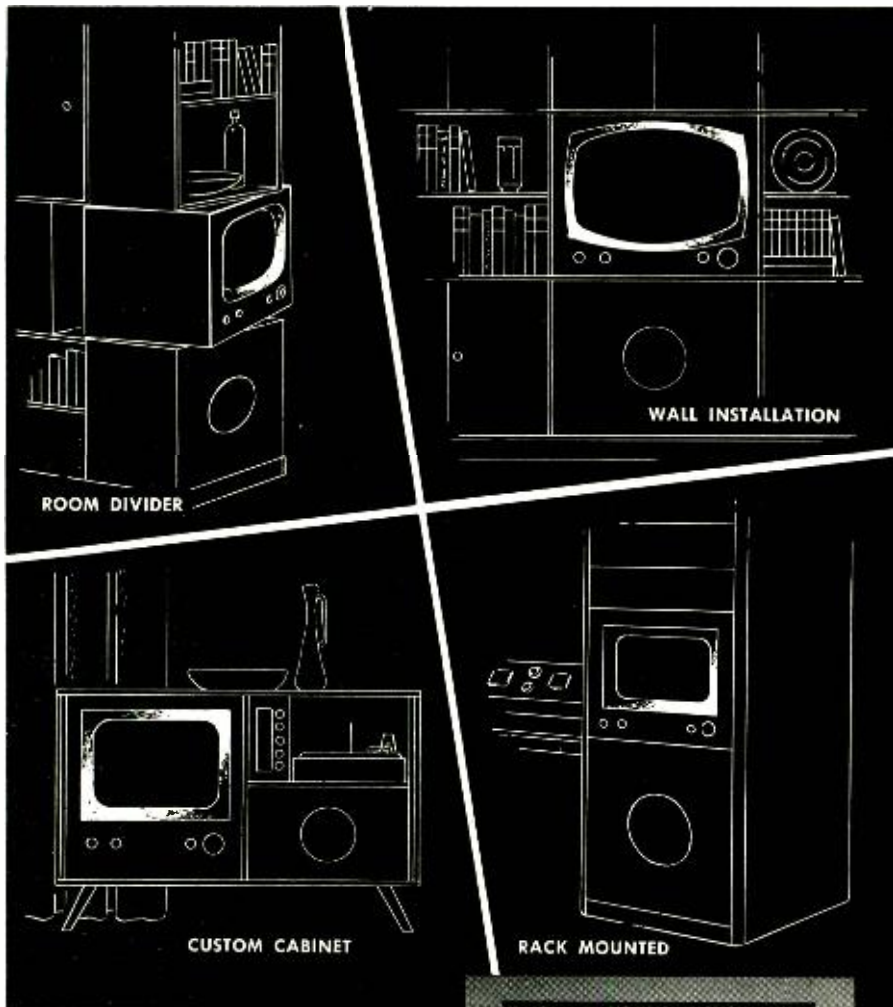

The very best in
Custom Television
by **TECH-MASTER**

FOUND IN THE FINEST INTERIORS



As the custom installation signifies the ultimate in well-chosen decor . . . so the name Tech-Master stands for the utmost in Custom Television. The reputation established with the manufacture of the renowned Model 630 chassis is further enhanced by the outstanding Tech-Master Audiophile and Sound Theatre.

Only Tech-Master has these outstanding plus features: • World-famous 3 tube synchro-lok picture circuit for constant picture stability. • 30 tubes fully used. • "Full Frame Mounting" . . . just a simple cutout is required for installation. • High fidelity picture as well as exceptional audio reproduction.



See your Custom hi-fi dealer today . . . or write
TECH-MASTER CORPORATION
75 FRONT STREET, BROOKLYN, NEW YORK

SWAP-A-RECORD

Continued from page 32

Parsifal and Lekeu's Quartet in B minor, on POLYDOR 516555/7.

In exchange Mr. Gale is prepared to offer six new LPs of the donor's choice for each selection—a dozen in all—from a collection of more than 2,000 LPs.

* * * *

Harold L. Dvorin, 10138 S. Hoxie Ave., Chicago 17, Ill., wants the following:

Hindemith: *Der Harmonie der Welt*. DECCA DL 9765.

Hindemith: *Concert Music*; Mathis der Maler. COLUMBIA ML 4816.

Bartók: *Two Rhapsodies*; *Two Images*. BARTOK 307.

Stravinsky: *Danses Concertantes*, etc. CONCERT HALL 1129.

Mr. Dvorin offers for trade the following:
Stravinsky: *Petrouchka*. Ansermet, Suisse Romande Orch. LONDON LL-130, 12-in.
B. Wagenaar: *Symphony No. 4*. Haeffner, ARS Orch. ARS 21, 10-in.

D. Moore: *Symphony in A*; R. Thompson: *Symphony No. 2*. Dixon, ARS Orch. ARS 45.

Copland: *Music for the Theatre*; Moross: *Frankie and Johnnie*. Hendl, ARS Orch. ARS 12.

Rachmaninoff: *Concerto No. 3*. Rachmaninoff, Ormandy, Philadelphia Orch. VICTOR DM 710.

Beethoven: *Symphony No. 5*. N. del Mar, London Symphony Orch. MAR. 81.

* * * *

Russell W. Brickell, 137 Grove St., McCloud, Cal., has the following for trade:

Brahms: *Serenade No. 2 in A*, Op. 16. Swoboda, Concert Hall Symphony Orch. CONCERT HALL E-3.

Honegger: *Concerto da Camera*. Nicolet, Parolari, Winterthur Symphony Orch.; Barraud: *Sonatine for Violin and Piano*.

Reyes, Menasee. CONCERT HALL E-17.

Buxtehude: *Three Cantatas for Solo Voice, String, and Organ*. Vonlanthen, Meili, Reichel. CONCERT HALL E-5.

Mozart: *Serenade No. 7*, in D. Rybar, Busch, Winterthur Symphony Orch. CONCERT HALL E-1.

Schubert: *Symphony No. 6*, in C major. Desarzens, Winterthur Symphony Orch. CONCERT HALL E-14.

The Student Prince; *The Chocolate Soldier* (excerpts). Stevens, Eddy. COLUMBIA ML 4060.

Wagner: *Die Götterdämmerung*; *Siegfried's Rhine Journey*; *Siegfried's Funeral Music*. Stokowski, Philharmonic Symphony Orch. of N. Y. COLUMBIA ML 4273.

Brahms: *Symphony No. 1 in C minor*. Rodzinski, Philharmonic Symphony Orch. of N. Y. COLUMBIA ML 4016.

Rimsky-Korsakoff: *Scheherazade*. Ormandy, Philadelphia Orch. COLUMBIA ML 4089.

Shostakovich: *Symphony No. 1 in F major*, Op. 10. Rodzinski, The Cleveland Orch. COLUMBIA ML 4101.

Continued on page 36

ORGANIZING THE CONTROLS

....the key to high fidelity



Every control on a well designed, honestly considered high fidelity instrument has a specific useful function, related to each of the other controls.

Operation of the Prelude, Harman-Kardon's new 10 watt printed circuit amplifier, illustrates this point well. With the *function selector*, choose the type of program material you plan to listen to (tuner, phono, tape or T.V.). Select the correct record equalization settings for the particular record to be played, using the separate *low frequency turnover* and *high frequency roll-off controls*. To minimize turntable rumble operate the *rumble filter* slide switch. With the *loudness contour selector* in the uncompensated position, turn the *loudness control* to a reasonably high level. This permits you to make the remaining adjustments while listening at your own maximum efficiency.

Adjust the separate *bass* and *treble tone controls* to correct for the characteristics of your loudspeaker and for the acoustic characteristics of the room. Choose settings which, in your total system, create the proper sense of aural balance. Now reduce the loudness setting to a level, lower than the normal listening level in your room. Note that the full bodied, lifelike quality you experienced at high listening level has disappeared. This is typical of human hearing since it loses sensitivity to very low and very high pitched notes as the sound level is reduced. With all other controls unchanged, switch quickly through the four positions of the loudness contour control until you find the one which most nearly duplicates the full bodied sound you enjoyed at high level.

Turn the loudness control up to the level at which you wish to listen. The controls are now properly organized and your system should perform at its very best!

ADDITIONAL FEATURES: Turnover Selector Switch includes position which provides correct preamplifier equalization for tape playback head (requires *no* extra tape preamplifier) — Tape Output, unaffected by tone controls, available to drive tape recording head — Safety Interlock Power Cord disconnects power when cage is removed — Printed circuit throughout, employs dip soldered copper-clad laminated phenolic plastic board, easily available for service — Output level: 10 watts at 3% IM. Peak Power: 15 watts — Frequency Response ± 1 db 20-20,000 c.p.s. Hum: Min. Volume Hum: 80 db below 10 watts. Aux and Tuner Hum: 60 db below 10 watts. Phono Hum: 50 db below 10 watts — Rumble Filter: 6 db per octave cut below 50 cycles — Turnover Control: Tape, RIAA AES, LP — Tube Complement: 2-12AX7, 2-6V6CT, 1-5Y3CT — Dimensions: 12 $\frac{5}{8}$ " wide x 4 $\frac{1}{8}$ " high x 6 $\frac{5}{8}$ " deep — Finish: Control Panel: Brushed Copper; Cage and Knobs: Matte Black.

\$55⁰⁰

*Slightly
higher
in the
west*

WRITE FOR FREE COLORFULLY ILLUSTRATED CATALOG A-13

harman kardon

INCORPORATED

520 Main St. Westbury, L. I., N. Y.

NOW HEAR THIS

for
improved high fidelity

GOODMANS LOUDSPEAKERS

in the New
'Friction-Loaded'
AXIOM Enclosures

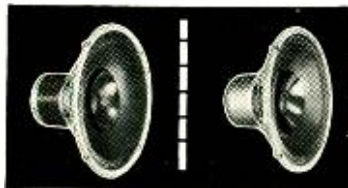

Axiom 22 Mk II Axiom 150 Mk II

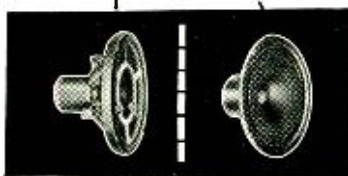

Axiom 80 Axielle

Complete do-it-yourself construction
details — available on request

Mail this Coupon... Today

ROCKBAR CORPORATION Dept. NB-2
215 East 37th St., New York 16, N. Y.

Please send me:

- Complete information about GOODMANS High Fidelity Loudspeakers.
- Complete details about the new 'friction-loaded' AXIOM Enclosures.

NAME.....

ADDRESS.....

CITY.....ZONE.....STATE.....

SWAP-A-RECORD

Continued from page 34

Mr. Brickell would like to obtain any of the following:

Bartók: Suite from the Miraculous Mandarin. MERCURY MG 50038.

Bartók: Concerto for Orchestra. MERCURY MG 50033.

Fauré: Sonata No. 1 in A, Op. 13. WESTMINSTER 5156.

MacDowell: Concerto No. 1, in A minor, Op. 15. WESTMINSTER 5190.

* * * *

Miss Jacqueline Crawford, 115 W. 6th St., Lansdale, Pa., wants to trade the following LPs for chamber, folk, jazz, Bach, Bartok, Segovia, Gieseking, and Ferrier recordings: Virgil Thomson: The River; Billings-Luening: Tune on a Hymn. ARS 8, 12-in. Haieff: Concerto for Piano and Orchestra; Ward: Symphony No. 1. ARS 9. Copland: Music for the Theatre; Moross: Frankie & Johnny. ARS 12, 12-in.

Bergsma: String Quartet No. 2; Shepherd: Triptych for Soprano and String Quartet. ARS 18, 12-in.

Bloch: Trois Poèmes Juifs; Herbert: Concerto for Cello and Orchestra. ARS 24, 12-in.

Carter: Sonata for Piano; Sonata for Cello and Piano. ARS 25, 12-in.

Randall Thompson: Symphony No. 2; Moore: Symphony in A. ARS 45, 12-in.

Piston: Symphony No. 2. ARS 1, 10-in. Hanson: Symphony No. 4. ARS 6, 10-in.

Griffes: Poem for Flute and Orchestra; Foote: Suite in E major, Op. 63. ARS 22, 10-in.

* * * *

Richard Brumer, 2150 Wallace Ave., New York 62, N. Y., wants to trade the following LPs and is particularly interested in obtaining in exchange any of the Beethoven concertos, and symphonies 6, 7, and 9:

Beethoven: Wind Trio in C major. Kamesch, Kautsky, Hadamovsky. WESTMINSTER WL 5262, 12-in.

Beethoven: Trio in B-flat major. Fournier, Janigro, Badura-Skoda. WESTMINSTER WL 5131, 12-in.

Martini: Concerto Grosso. Vienna Symphony Orch. WESTMINSTER WL 50-4.

Mozart: Divertimento in E-flat major. Pougnet, Riddle, Pini. WESTMINSTER WL 5191, 12-in.

Mozart: Divertimento No. 17, in D major. Vienna Konzerthaus Quartet, Hermann, H. & O. Berger. WESTMINSTER WL 5276, 12-in.

Brahms: Trio in E-flat major. Barylli, Koch, Holletschek. WESTMINSTER WL 5146, 12-in.

Schubert: Trio No. 1 in B-flat. Fournier, Janigro, Badura-Skoda. WESTMINSTER WL 5188, 12-in.

Schumann: Kreisleriana. Demus. WESTMINSTER WL 5142, 12-in.

Beethoven: String Trio in E-flat major. Pougnet, Riddle, Pini. WESTMINSTER WL 5226, 12-in.

Beethoven: String Trio in C minor. Pougnet, Riddle, Pini. WESTMINSTER WL 5219, 12-in.

The
Microphone
makes the
difference...

between an ordinary
performance and a
truly fine distortion-
free recording.

Your tape recording or PA
equipment can reproduce a
much wider range of voice
or music—if you use these

SHURE microphones!



"SONODYNE" Model 51

A dynamic semi-directional microphone with excellent response to 10,000 cps. Widely used by performers, bands and recording artists. Ideal as a moderate-cost replacement for conventional tape recorder and PA microphones. Multi-impedance switch gives you the versatility of three microphones in one. Supplied with 15' microphone cable. Rich satin chrome finish. List price \$49.50.



"MONOPLEX" Model 737A

The only uni-directional crystal microphone made! Super-cardioid polar pattern reduces pickup of background noises and reverberation by 73% to provide clear noise-free recordings. Frequency response to 10,000 cps. Has moisture-proofed "Metal Seal" crystal and internal sponge-rubber floating mount for long operating life. 15' cable, satin chrome finish. List price \$46.00.



The Mark of Quality

SHURE BROTHERS, INC.

225 West Huron Street, Chicago 10, Illinois

HIGH FIDELITY MAGAZINE

AS MODERN AS

Strawinsky

AS BEAUTIFUL AS

Schubert

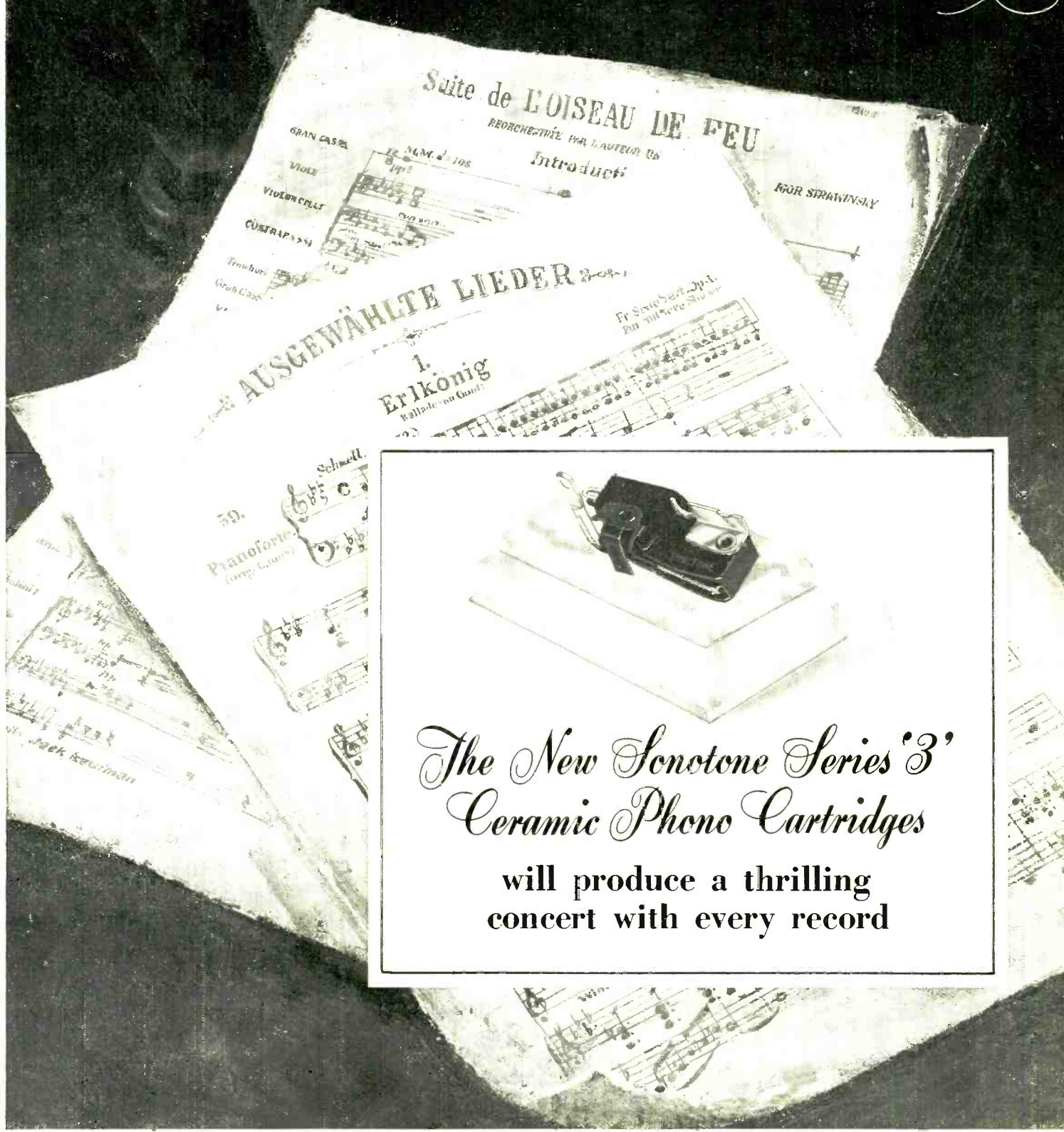

The New Sonotone Series '3'
Ceramic Phono Cartridges

will produce a thrilling
concert with every record

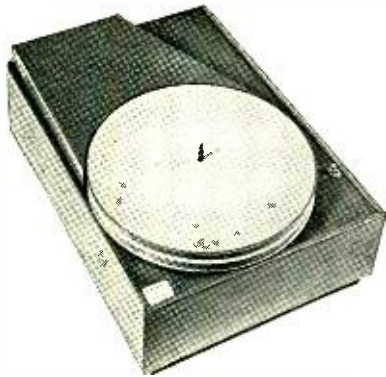

UNEXCELLED LISTENING QUALITY



UNEXCELLED HI-FI CENTER!

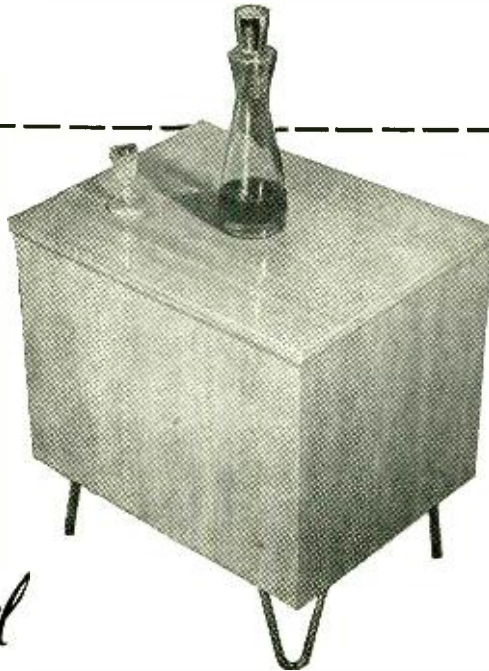

Now enjoy the COMPONENTS



TURNTABLE IN THE NEW COMPONENTS

Pro-Ette MASTER CONTROL CABINET!

Audio engineers and armchair engineers agree: The Components *Professional* Turntable provides the finest listening quality in hi-fi today. Rumble down 70 db or better . . . wow and flutter 0.05% or less . . . 3-speed accuracy at least 0.25% . . . no other turntable matches this performance! And now you can enjoy the ultimate in listening convenience

with the new Components *Pro-Ette* Master Control Cabinet. Besides providing ideal mounting for the *Professional* turntable, the *Pro-Ette* is designed to accept most tuners, pre-amps and amplifiers — on any and all sides. Special rail and accessory hangers make it easy. Available in blonde or mahogany, or unfinished.

See the *Professional* and the *Pro-Ette* at your hi-fi dealer's!

NEW! "QUIET PLEASE" RUMBLE TEST RECORD!

Measure your turntable for rumble with this unique quiet groove disc made possible by Components spectacular new Hydrofeed recording process. Only 89¢ at dealer's or \$1.00 post paid from Components Corporation.

NEW! 4-SPEED MODEL of "PROFESSIONAL" TURNTABLE

The three standard speeds, plus the increasingly popular 16 $\frac{3}{4}$ rpm. These new recordings provide up to 1½ hours or more of playing per side. Same speed as used in new automobile record players. Costs only slightly more than standard Components 3-speed *Professional* turntable.

FOR FURTHER INFORMATION WRITE DEPT. II

COMPONENTS
CORPORATION

DENVILLE



NEW JERSEY

Wide, Wide, Hi-Fi World

With apologies for slightly modifying the title of a well-known television program, we note with interest that high fidelity is a world-wide phenomenon. From Johannesburg, South Africa, we have received Vol. I, No. 8 of *Hi-Fi News*, the Journal of the High Fidelity Society of South Africa . . . and from several thousand miles the other direction, we have received the bulletin of the Society of Music Enthusiasts in Toronto, Canada. Though literally a world apart, both groups are very active, with regular meetings, excellent guest speakers, demonstrations, and of course, highly active open-discussion periods.

According to A. S. Brown, editor of the South African *Hi Fi News*, his group was founded in September 1954. Twelve people attended the first meeting; Johannesburg now has a paid membership of 155 and there are groups in Durban (70 members) and in Pretoria.

In Toronto, the SME group continues to make excellent progress. Membership is well over the hundred-mark, and attendance at meetings averages nearly 200. The Society's activities helped make possible the first Toronto Audio Fair; the second one will have taken place by the time you get this issue of HIGH FIDELITY.

Maybe we should say: small, small, hi-fi world.

Swap Stamps?

We received a card from Dr. George Wentz, Jr., Box 26, 417 N. Comanche, San Marcos, Texas, saying, "Stamp dealer will swap fine U. S. & Foreign stamps. Want an REL Precedent tuner (or equal), professional tape recorder, and other hi-fi items."

Dr. Wentz added a note, "Please post this on your bulletin board, or give to some interested person." Well,

Continued on page 40

never before
such a Magnificent tape recorder

... moderately priced



THE NEW

Citation

by MAGNECORD...the choice of professionals

Magnecord is proud to introduce the Citation, the finest portable tape recorder in the moderate-priced field. The Citation is as modern and handsome in design as it is rich and clear in faithful reproduction. Paneled in satin gold and ivory, cased in handsome tan cowhide, it quietly blends into any decor.

Most important, the Citation makes it possible for you to afford professional levels of full-frequency and high fidelity. It incorporates many features usually found only in higher priced tape recorders for professional use.

Before you decide, see the Citation. To be truly convinced, hear the Citation.

For the name of the Magnecord dealer nearest you, who will assist you . . . please consult the "RECORDERS" listing in the classified section of your telephone book. Ask him for your copy of "207 Ways To Use A Tape Recorder" — a new booklet outlining valuable uses for a tape recorder in today's modern living.

IDEAL FOR

— musical arts profession, the educator, schools, homes, offices, stores, institutions, business and industry.

with these outstanding SPECIFICATIONS

Portable unit in case
Built-in amplifier and speaker
Illuminated VU meter
Signal-to-noise ratio:
45 db., half track
Flutter: .3%
Frequency response:
3¾" ±2 db., 50-5000 cps
7½" ±2 db., 50-10,000 cps
(also available with hysteresis synchronous motor)

magnecord, inc.
the finest name in tape recording

1101 SOUTH KILBOURN AVENUE • CHICAGO 24, ILL.



MUSIC LISTENER'S BOOKSHOP

A TIME-SAVING SERVICE TO OUR READERS. WE ATTEMPT TO SEND YOU THE BOOKS YOU ORDER BY RETURN MAIL. Just send the coupon with your remittance.

BEST SELLERS

The New **HIGH FIDELITY HANDBOOK:** Irving Greene and James Radcliffe. 250 illustrations, diagrams and plans. A complete practical guide for the purchase, assembly, installation, maintenance, and enjoyment of high fidelity music systems.

No. 200.....\$4.95

THE HIGH FIDELITY READER: edited by Roy H. Hoopes, Jr. Introduction by John M. Conly. An anthology of outstanding articles originally appearing in **HIGH FIDELITY** Magazine covering various aspects of the high fidelity phenomenon. Among the contributors are Charles Fowler, Roy Allison, Fernando Valenti, Peter Bartok, Emory Cook, and David Sarser.

No. 155.....\$3.50

HIGH FIDELITY RECORD ANNUAL—A first volume of record reviews—classical music and the spoken word—from **HIGH FIDELITY** Magazine. Edited by Roland Gelatt.

No. 201.....\$4.95

BINDERS FOR HIGH FIDELITY Magazine: Red Leatherette, gold stamped on front and backbone. Each binder holds 6 issues. Binders are now in stock for Volumes 3, 5a, and 5b.
Binders\$2.75 each

MUSIC LOVERS' ENCYCLOPEDIA: compiled by Rupert Hughes; newly revised and edited by Deems Taylor and Russell Kerr. 930 pages. Contains a series of essays contributed by eminent authorities on such subjects as: acoustics, counterpoint, the conductor and his art, harmony, jazz, orchestration, recorded music, etc. Extremely valuable reference work; compact and easy to use.

No. 152.....\$3.50

RECORD INDEX - 1954: Complete alphabetical listings by composer or collection-title of all the classical and semi-classical, jazz and spoken word record reviews contained in **HIGH FIDELITY** Magazine in 1954. Discographies included. 50c each.

HOME MUSIC SYSTEMS (Revised Edition); Edward Tatnall Canby. 302 pages, illustrated. This popular guide to high fidelity has been completely revised. **Home Music Systems** explains the operation of a radio-phonograph, where to buy the separate parts, and how to house them. One chapter is devoted to suggested combinations of equipment.

No. 151.....\$3.95

THE FABULOUS PHONOGRAPH: Roland Gelatt. A history of the phonograph tracing its progress from Thomas Edison's curious tin-foil apparatus to the astounding high fidelity sound systems of today. As one of this country's outstanding music critics, Roland Gelatt has a keen appreciation of the phonograph's importance. As a sensitive social historian, he has a discerning eye for the flavorful fact, or the pungent quotation that sets a scene and illuminates an era.

No. 154.....\$4.95

NOTED WITH INTEREST

Continued from page 38

this column is sort of our Bulletin Board . . . and we wouldn't be surprised if there were several interested persons among our readers. Who knows?

C. D-J., M.D.

Which simply means that in Atlantic City, N. J., there is an active physician (that's the M.D. part) who is also an active classical disk-jockey, and has been for the past six years. It started back in 1949, when one of Dr. Victor Ruby's patients—the program director of Atlantic City's WMID—mentioned that the station needed a man to present classical music. Dr. Ruby volunteered . . . and is now beginning the seventh year of his Sunday Concert Hall. The program hasn't missed a Sunday yet, and three years ago Dr. Ruby started another program over the same station. This, too, is still going strong. On the air, Dr. Ruby uses the pseudonym Victor Travis.

In November of last year, Dr. Ruby was called in on another emergency operation: to write a music column for the *Atlantic City Press* while the regular columnist was on vacation. Dr. Ruby did a fine job; wish we had room to quote at length from the column because he gave his answer to a question which is so often asked of enthusiastic music lovers: "Why do you spend so much time promoting phonograph records?" This is a particularly pertinent question for Dr. Ruby, because medicine is his vocation; music—and promoting phonograph records—strictly an avocation. The essence of Dr. Ruby's answer is contained, we think, in the following paragraphs:

"The age of superspecialization in which man now lives seems to restrict him more and more to a small field of activity and knowledge. It is a pity that so many go through life missing many of the pleasures that are all about them. The wondrous beauties of nature, of art, of music are within the reach of almost everyone. In many cases all that is needed is a key to open a seemingly impregnable door . . .

"In the specific case of music, phonograph records can be such a key. For as wonderful as live performances

Continued on page 42

Book Department
HIGH FIDELITY Magazine
Great Barrington, Mass.

I enclose \$..... for which please send me, postpaid, the books indicated by the circled numbers below. (No C.O.D.'s or charge orders, please.)

Foreign orders sent at buyer's risk. Add 55c for postage on foreign orders.

151 152 154 155 200 201

Binders: 3, 5a, 5b. Record Index 1954

NAME

ADDRESS

CITY ZONE STATE

by
h. h. Scott

The Greatest Amplifier Buy You Have Ever Seen

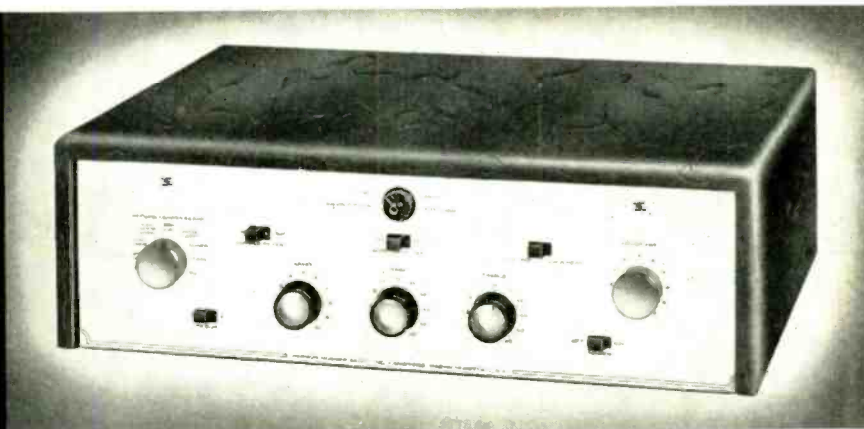

99-B Transcription Amplifier \$99.95*

Imagine! 22 watts – complete controls – only \$99.95

- The famous "99", a complete amplifier, now with twice the power — a brilliant 22 watts.
- Complete equalizer-preamplifier with five-position record compensator. Equalizes virtually all records.
- New adjustable rumble filter and record scratch filter reduce record noise and rumble.
- Two magnetic inputs, switched on panel, allow use of both changer and turntable.

- Special provisions for playback of pre-recorded tape through your 99-B.
- Continuously variable LOUDNESS compensation, with volume-loudness switch, gives perfect tonal balance at all listening levels.

TECHNICAL SPECIFICATIONS

Input selector switch for two magnetic pickups, crystal or constant amplitude pickup, three high-level inputs, and NARTB tape playback — frequency response flat from 20 cps to 30 kc — hum better than 80 db below maximum output — harmonic distortion less than 0.8% — first-order difference-tone intermodulation less than 0.3% — class A circuits throughout — easy panel mounting — beautiful accessory case \$9.95*
*Slightly higher west of Rockies.



210-D Dynaural Laboratory Amplifier, \$169.95*

by
h. h. Scott

Most Complete Amplifier Made Full 30 Watts

Includes famous DNS — makes worn records sound new again

- Complete professional equalizer-preamplifier with magnificent new 30-watt power amplifier.
- Amazing, patented DNS (dynamic noise suppressor) eliminates record noise and rumble, but *without* losing audible music as fixed filters do.
- Seven-position record compensator exactly equalizes practically any record made.
- Unique features for tape-recording, with three special inputs for recording and monitoring.

- Special provision for playback of pre-recorded tape through your 210-D.
- Continuously variable speaker damping control.

TECHNICAL SPECIFICATIONS

Input selector for 3 high-level inputs, 2 low-level phono (magnetic), and one high-level phono (constant amplitude) — NARTB tape playback curve — frequency response flat from 19 cps to 35,000 cps — adjustable record-distortion filter — harmonic distortion less than 0.5% — first-order difference-tone intermodulation less than 0.25% — beautiful accessory case \$9.95*
*Slightly higher west of Rockies.

Write for FREE BOOKLET
HF 256 giving complete details
on entire H. H. Scott line.

h. h. Scott

385 PUTNAM AVE. • CAMBRIDGE 39, MASS.

TEMPO SERIES

HI-FI SPEAKERS by OXFORD

For the Finest in
Sound Reproduction

Every home and institutional Hi-Fi Installation should have an Oxford "TEMPO" Speaker. Engineered for optimum performance at minimum cost, OXFORD HI-FI SPEAKERS have a flat response throughout the audible range and are capable of handling the range of power inputs necessary for finest high fidelity reproduction.

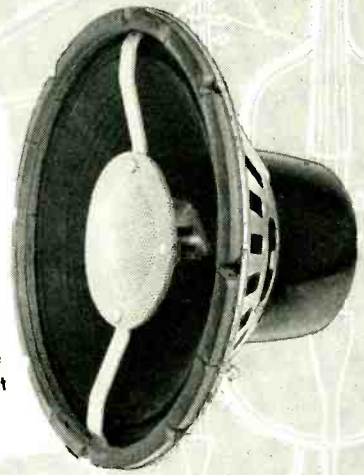

Write for free illustrated literature!

OXFORD ELECTRIC CORPORATION

Distributor Sales Division: 556 West Monroe Street, Chicago 6, Illinois
Export: Roburn Agencies, New York City In Canada: Atlas Radio Corp., Ltd., Toronto

Hi Fi SOUND REPRODUCING EQUIPMENT

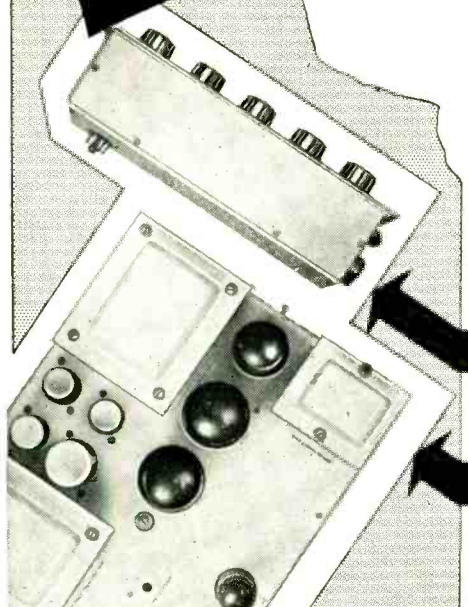

A top-grade High Fidelity Amplifier and Remote Control Unit from the world-famous Pye Research Laboratories in Cambridge, England. Smooth, highly flexible controls and facilities for record player, tape recorder, microphone and radio tuner inputs. Frequency response substantially flat from 2 to 160,000 c.p.s. Infinite damping factor. Intermodulation distortion under 1% at output of 25 watts.

Proctor
REMOTE CONTROL UNIT. HF25A

Provost
POWER AMPLIFIER. HF25

PYE LTD., CAMBRIDGE, ENGLAND

DISTRIBUTORS
U.S.A. ▶ BRITISH RADIO ELECTRONICS
1833 JEFFERSON PLACE, N.W. WASHINGTON 6 D.C.
CANADA ▶ PYE CANADA LTD. AJAX, ONTARIO

NOTED WITH INTEREST

Continued from page 40

are, the limitations imposed on the average man by his way of life do not allow him to attend enough live concerts really to get to know music in the fullest sense. Most people do not reside in the large metropolitan centers where good live performances can be heard daily. And even those who do, in most instances, cannot or do not take advantage of their situation because of other commitments . . .

"That is why, in this writer's opinion, the development of the phonograph record is one of the momentous events in the history of music."

Call to Photographers

Last summer, we sent questionnaires to many of our readers to help us understand their interests and give them more of the type of information they wanted. Among many other things, we discovered what we have suspected for some time: that photography runs a close second to music in terms of hobby interest. Of our readers, 66.5% said music was their hobby; 47.8% listed photography.

We were discussing this phenomenon with some friends of ours who are associated with the Nikon Camera Company which, as 47.8% of you know, manufactures a definitely hi-fi miniature camera. During the conversation, we got to wondering about many things . . . such as how many of the non-photographers in HIGH FIDELITY's readership might be on the verge of becoming seriously interested in photography as a hobby, and whether or not the interest in quality in musical and sound reproduction matters would also apply to other products, such as cameras.

The upshot of the whole discussion was that Nikon decided to test HIGH FIDELITY as an advertising medium . . . and probably many of you noticed their advertisement in our January issue. Now we are all watching with considerable interest to see what happens. If our survey results hold up, Nikon should be pleasantly surprised.

Time for Hi-Fi

Hard on the announcement by Ampex that a time payment plan had been worked out with dealers to facilitate

Continued on page 44

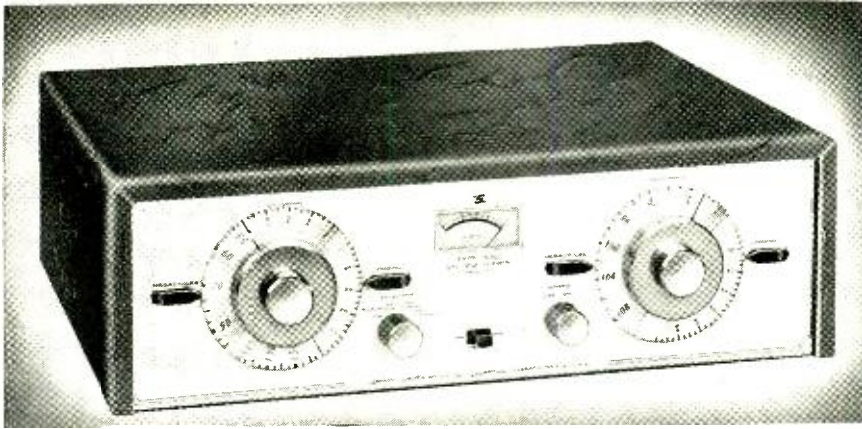

330 AM-FM (Binaural) Tuner, \$169.95*

Sensational New Advance in AM-FM Tuners

by
h.h. Scott

ONLY really wide-range AM, plus super-selective FM

- Now you can receive the full 10 kc frequency range broadcast by the better AM stations. Entirely new IF and detector circuits make this possible for the first time.
- New AM detector insures distortionless reception even if stations modulate to 100%. Conventional detectors give distorted AM above moderate modulation percentages.
- Three-position IF-bandwidth switch for perfect AM reception under any signal conditions.

- New wide-band FM design gives super-selectivity to let you separate stations so close together you would ordinarily pass right over them.
- Wide-band design insures drift-free reception.

TECHNICAL SPECIFICATIONS

FM Section: 3 mv. sensitivity for 20 db quieting — 2-megacycle wideband detector — 80 db rejection of spurious cross-modulation response by strong local signals — automatic gain control — equipped for multiplex. AM Section: 1 mv. sensitivity — 10 kc whistle filter — extended frequency response to 10 kc — ferriloopstick antenna — output jacks for binaural — beautiful accessory case \$9.95*
*Slightly higher west of Rockies.

by
h.h. Scott

Sensational FM Performance at a Best-buy Price

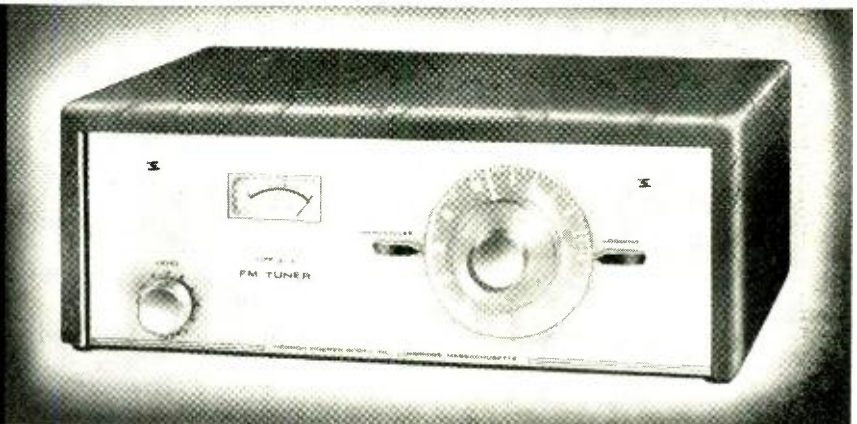

The 310 FM Tuner, \$99.95*

There are NO weak stations with this new tuner

- Terrific 3-microvolt sensitivity makes distant stations sound as clear and strong as those nearby.
- New wide-band FM design gives super-selectivity, to separate stations so close together you would ordinarily pass right over them.
- Wide-band circuitry insures rock-steady, drift-free reception, so you never need readjust tuning.
- Automatic gain control always keeps tuner perfectly adjusted, no matter how the signal varies.

TECHNICAL SPECIFICATIONS

2-megacycle wideband detector — 2 stages of full limiting — 80 db rejection of spurious response from cross modulation by strong local signals — low-impedance output — equipped for multiplex — beautiful accessory case \$9.95*
*Slightly higher west of Rockies

310 FM BROADCAST MONITOR TUNER

For perfectionists and connoisseurs, H. H. Scott offers the 310 FM tuner. High Fidelity Magazine says: The 310 "... is a tuner that seems as close to perfection as is practical at this time." Price, including case \$149.95 East Coast; \$157.45 West Coast.

PIONEERS IN SOUND

Recognition of leadership includes: First-choice rating of amplifiers in the SATURDAY REVIEW HOME BOOK; amplifier ratings as "finest on the market" by Harold Weiler, author of HIGH FIDELITY SIMPLIFIED; Medal of Merit at International Sight and Sound Exposition.

h.h. Scott

385 PUTNAM AVE. • CAMBRIDGE 39, MASS.

Export department: TELESCO INTERNATIONAL CORP., 270 Park Avenue, New York 17, N. Y.

How To Select A *FINE* High Fidelity Loudspeaker

Let Your Ear Decide, Not Your Eye!



Standards for use as a yardstick are still nonexistent. Printed claims and specifications in the loud speaker field are more often based on wishful thinking rather than the objective findings of the laboratory. Racon, the oldest loudspeaker manufacturer in the United States with the newest in fine high fidelity loudspeakers, has just one suggestion to offer—insist on a direct "A-B" listening test with a Racon loudspeaker and any seemingly similar one. You will be pleasantly surprised at not only the better performance but the price savings which average 10-35%, depending on model.

NEW DESIGN

These radically new "HI-C" (high compliance) loudspeakers employ a new principle of cone suspension (patent applied for) which results in large motion, lowered resonant frequency and for the first time introduces pneumatic damping for a smoother response characteristic. Ask your sound dealer to put these speakers through their paces. Closely observe the clean, uniform cone movement, right down to four cycles, a test which proved the eye opener at the recent N. Y. Audio Fair. Available in three fifteen inch models: tri-axial, dual cone and woofer. Model 15HTX tri-axial illustrated.

Write For Free Literature

Performance Data
15-HTX—15" TRI-AXIAL

RESPONSE: 20-20,000 cps.
POWER: 25 watts
IMP.: 8 ohms
RES. FREQ.: 24 cps.
FLUX: 14,500 gauss.
CROSSOVER: 2000 and 5000 cps
WEIGHT: 23 lbs.

PRICE: \$109.50
audiophile net

ACOUSTICAL  EXCELLENCE

Racon Electric Co., Inc.
1261 Broadway, New York 1, N. Y.

IN CANADA: DOMINION SOUND EQUIPMENTS LTD.
Branches in all principal cities.

NOTED WITH INTEREST

Continued from page 42

your purchase of Ampex equipment comes the announcement from Heath that *its* equipment may now be purchased on a 10% down, 12 months to pay program. Aside from routine credit clearing, the only provision is that you must buy equipment having a cash price of \$90.00 or more.

TITH Staff Portrait

Although all TITH reports carry the initials of the staff member responsible for the opinions expressed, their faces are seldom seen in print. Maybe they're shy, retiring scientists; maybe they would prefer not to be recognized in a dark alley at night.



Recently, a manufacturer sent us a photograph for publicity purposes; it was immediately pounced upon by some of the TITH people and proclaimed to represent a manufacturer's idea of two TITH'ers examining his equipment.

Back Copy Dept.

WANTED: No. 4, as usual; by Howard Wood, 652-A Natoma St., San Francisco, Calif.

Nos. 26 and 28; by Tom Hammeral, 857 McKinley Ave., Akron 6, Ohio.

Nos. 3, 4, 5, 6, and 7; by Carl Bauman, Box 375, Hiram, Ohio.

Nos. 1 through 20; by R. H. Smart, 8 Marlborough St., Brighton, South Australia. Since Mr. Smart cannot get dollars in Australia, he will swap books about Australia, or what have you.

No. 13; by W. L. Kennedy, 321 Vine St., W. Lafayette, Ind.

FOR SALE: Nos. 1 through 35; by R. W. Rhodes, 103 Del Ray Ave., Chattanooga 5, Tenn.; first offer over \$15.00, shipment in any manner at buyer's expense.

Nos. 1 to present issue, except No. 4; by Robert M. Grubbs, 2539 Broad-

Continued on page 46



MUSCLES DON'T MAKE MUSIC

Great music, superbly rendered, draws life and warm beauty from the teamwork of the true artist's heart and hands. Precise coordination of mind and body — not muscular power — is the secret of artistic accomplishment.



Great performance is faithfully recreated in the full brilliance of original rendition by electronic teamwork in high fidelity sound systems.

components are tailored to true balance, to inter-relationship and interaction as precise and coordinated as the fingers and feelings of the musical artist. Only through such thorough integration can you be assured the utmost in listening pleasure.

for the best in home hi-fi, look to Newcomb

Ask your dealer to demonstrate the new Compact Series of amplifiers and tuners

NEWCOMB

the Sound of Quality Since 1937

NEWCOMB, Dept. W-1
6824 Lexington Ave., Hollywood 38, Calif.

Enclosed is 25c for booklet "Hi-Fi Is for Everybody."

Send name nearest Newcomb dealer and details on Newcomb Compact.

name _____
address _____
city _____ state _____

One of a series on what makes one magnetic recording tape better than another

**Let's look at
Soundcraft PLUS 50**

50% Extra Playing Time



Full Depth Oxide Coating

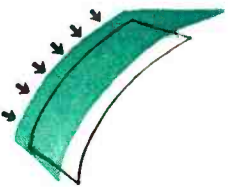

Lubricated Both Sides...

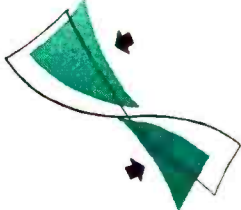

Extra Strength
Mylar* Base



Micro-Polished®

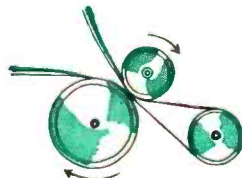

**YET
COSTS
NO
MORE**

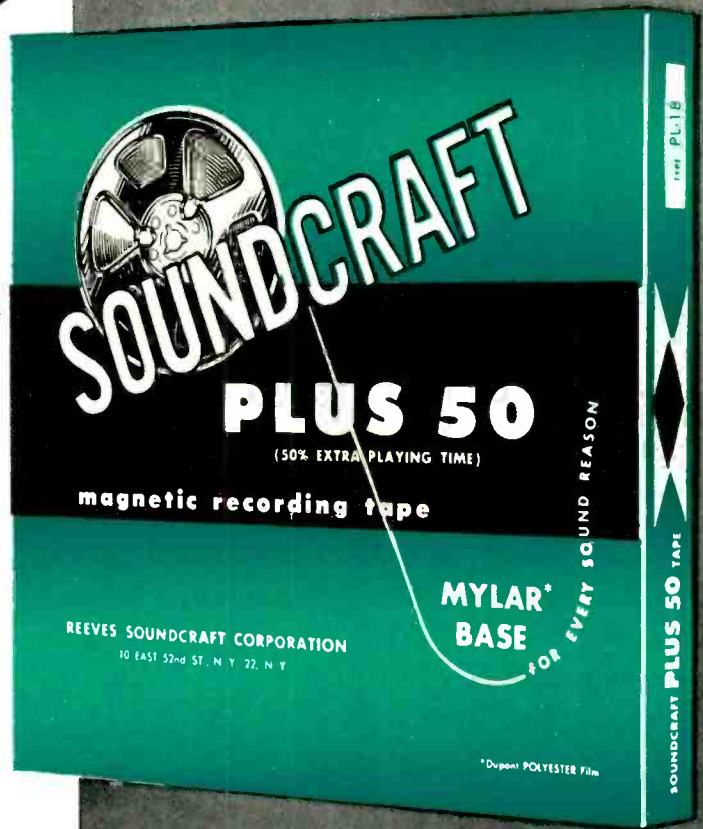

The tape that has EVERYTHING!

PLUS 50 Magnetic Recording Tape—newest in the famous Soundcraft line—brings you a combination of superior qualities that no other tape possesses. Qualities that let you capture and hear the true sense of violin strings, all the brilliance of brass, the color of wood winds... that faithfully record the human voice

in all of its varied subtleties.

Plus 50's uniform output, inherently low signal-to-noise ratio, its 50% extra playing time, added strength and flexibility... its dimensional stability in any climate. These are the special qualities that make it the choice of professionals and amateurs, alike, wherever tape perfection is required.

And Soundcraft Plus 50 adds this special bonus: Its "Mylar" base assures virtually a lifetime of smooth, trouble-free service at no more cost per foot than other quality tapes. Like all Soundcraft products, Plus 50 is engineered and made by tape recording specialists. Get some Soundcraft Plus 50 Tape at your dealer's today.

FOR EVERY SOUND REASON

REEVES SOUNDSCRAFT CORP.

Dept. F-2, 10 East 52nd Street, New York 22, N. Y.

*Trade-Mark for DuPont Polyester Film

Acousti-Magic



New standards of excellence
in kit cabinetry

NO RISK HOME TRIAL

It's true—a speaker enclosure you may test in your own home with your own equipment—and in money saving KIT form!

SUPERIOR PERFORMANCE

Acousti-Magic incorporates a highly refined, TUNABLE labyrinth design which allows installation of any speaker with space for future expansion to a multiple system. Using only an average \$50. speaker, Acousti-Magic will faithfully reproduce the tremendous pedal tones of the mighty organ. Correct acoustical loading enables you to FEEL fundamental bass to 30 cycles and below.

SUPERIOR KIT DESIGN

Acousti-Magic is prefabricated entirely of 3/4" plywood. Professional lock-mitre joints join the furniture plywood exterior panels—but you use NO CLAMPS or NAILS in the assembly. EXCLUSIVE Acousti-Magic construction with MACHINE SCREWS allows effortless assembly with only a screwdriver in 2-4 hours. Over one hundred pounds of the very finest materials.

SUPERIOR STYLING

Acousti-Magic gives you styling and quality to complement the finest home. The EXCLUSIVE CONVERTI-BASE gives you highboy or lowboy styling in an instant—and either way you will see nothing but furniture. There are no gimmicks—you don't paint it, you don't cover it—it's all genuine furniture plywood—more of it than any other kit speaker enclosure.

ACT NOW—MAIL THIS COUPON!

Order Acousti-Magic in either hardwood Mahogany or Oak. When you receive your kit, assemble it without glue and test it for two weeks. It must give complete satisfaction—sound and sight! If not, disassemble it and return it for a full refund.

For 12" or 15" Speakers & Multiple Systems

Acoustical Development Corporation
Box 572, Hempstead, N. Y.

I Prefer Acousti-Magic
in OAK \$64.75 in MAHOGANY \$59.75

My speaker system is Speaker Size
Send Illustrated Brochure

Name
Address
City

NOTED WITH INTEREST

Continued from page 44

way, Indianapolis 5, Ind.; \$15.00 plus postage.

Complete set through 1954 for \$20; or complete set through 1955 for \$25; by Dr. V. Arnett, 172 East 54 St., New York 22, N. Y.

Nos. 1 through 36; by Dr. A. E. Cronkite, 14 S. W. 11th Ave., Fort Lauderdale, Fla.; highest bid.

Nos. 1 through 36; by A. Z. Skelding, 162 Hamilton Rd., Hempstead, L. I., New York; \$10 if picked up, \$15 shipped.

Complete through May 1955; by Dr. A. Ettinger, 137 Academy St., Poughkeepsie, N. Y.; any reasonable offer.

Complete set except May and December 1954; by James P. O'Neill, 117 North Rosborough Ave., Ventor, N. J.; \$20 plus postage.

Nos. 1, 2, 4, 5, 7, 8, 13, 14, 15, 17, 18, 19, 20, 26, 28, 31, and 32; by M. E. Boyd, 903 Salmon Drive, Dallas 8, Texas; 50¢ each.

Nos. 2, 3, 5, 6, 7, and 8; by W. L. Kennedy, 321 Vine St., W. Lafayette, Ind.; highest bidder.

Alta Fidelidad, S. A.

Slow, but sure, describes the beginning of hi-fi in Colombia, South America. And we have it straight from the hi-fi pioneer down in Barranquilla. Carlos Granados who runs the Casa de los Discos there started trying to interest local music lovers in hi-fi back in 1951 by importing and displaying such items as Stephens speakers and enclosures, Brook amplifiers, Garrard changers and GE cartridges. Residents listened but apparently weren't convinced right off that a system such as Sr. Granados was playing was any better than what they were used to. Besides, no cabinet! . . . the same old story.

But Sr. Granados didn't give up. He decided that rather than let all this equipment rot in his store he'd give it away. So he sought out some of the better record collectors and music lovers in the area, offered to install systems in their homes, and expected nothing more in return than that they would listen at least one hour each day for a couple of weeks. Results? Sr. Granados says: "The first impression on most of them was that the music didn't sound right—the highs were

Continued on page 50

Have you
got the

'B-T Blues?'

If you're a high-fidelity fan,
then you undoubtedly suffer
from the B-T Blues.

You want to hear a record as it was originally recorded . . . so you set the equalization control on your amplifier to the curve at which the record was made . . . and then you're stuck! The record doesn't sound quite right to you, because the acoustics of your room are different from those of the studio, or perhaps your individual taste requires a little less highs—or a little more lows.

Now you have to adjust the bass and treble controls to get the kind of reproduction you want, and, because they're not calibrated, you have to readjust them every time you play the same record — that's the B-T Blues.

The new Munston "10," with 'Dynamic B-T' (Bass-Treble), does away with the B-T Blues! Dynamic B-T gives you separate turnover and rolloff settings distinctly marked on the bass and treble controls, respectively, for all of the latest equalization curves. Both controls are also completely calibrated through their entire range, so that if it is necessary to adjust the controls after the equalization setting has been made, it is a simple matter to note on the record the exact setting of the controls which pleases you best, for future reference.

munston
10-WATT AMPLIFIER
WITH BUILT-IN PREAMP

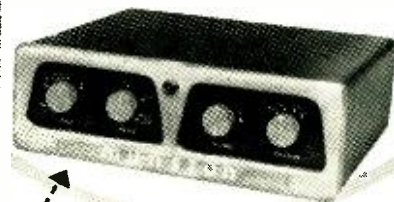

See the new Munston "10" at your
local Hi-Fi dealer's, or write for
complete information.

MUNSTON MANUFACTURING, INC.
Beech Street, Islip, L.I., N.Y.

.... yours to control with

Fleetwood models now on display at your dealers'. Ask for a free demonstration soon. Notice the superb picture quality, audio outputs for playing through a hi fi system, and, of course, the fact that Fleetwood receivers are designed to install anywhere you want them — in the wall, bookcase, room divider, or specially built cabinet. Get your copy of the free booklet, "A Fleeting Glance at Fleetwood" for installation ideas. At your dealers' or write to the manufacturer.



Fleetwood

Manufactured by **CONRAC, INC.**
Department A • Glendora, California

Export Division: Frazar & Hansen, Ltd., 301 Clay Street, San Francisco 11, Calif., U.S.A.

Conrac is the Canadian name for Fleetwood television.

MISSOURI

DAVID BEATTY CUSTOM HI-FI & TV
1616 W. 43rd (Westport Rd.),
Kansas City 11
Phone: JEFFerson 1-3110

THE HIGH FIDELITY SHOWROOM
6383 Clayton Rd., St. Louis 17
Phone: PArkview 1-6500

NEW JERSEY

THE JABBERWOCK
104 Somerset St., New Brunswick
Phone: CHarter 9-1900

JOHN J. CASEY CO.
205 W. Englewood Ave.,
W. Englewood Phone: TE. 6-7761

NEW MEXICO

THE HI-FI HOUSE
SOUND ENGINEERING & EQUIPMENT CO.
3011 Monte Vista, NE, Albuquerque
Phone: 5-1695

NEW YORK

BUFFALO AUDIO CENTER
161 Genesee St., Buffalo 3
Phone: MOhawk 1368

NEWMARK & LEWIS, INC.
THE HOUSE OF HI FI
43 Main St., Hempstead, L. I.
Phone: IVanhoe 1-6890

THE AUDIO EXCHANGE, INC.
159-19 Hillside Ave., Jamaica 32
Phone: OLYmpia 8-0445

HOUSE OF HI-FI
605 Plandome Rd., Manhasset, L. I.
Phone: MA. 7-1376

HARVEY RADIO CO., INC.
103 W. 43rd St., New York 36
1123 6th Ave., New York 36
Phone: JUdson 2-1500

LAFAYETTE RADIO CORP.
100 Sixth Ave., New York
Phone: REctor 2-8600

NEW YORK (continued)

SUTTON AUDIO SYSTEMS
970 First Ave., New York 22
Phone: PL. 3-7224

TERMINAL RADIO CORP.
85 Cortlandt St., New York 7
Phone: WOrth 4-3311

JERRY FINK CO.
644 Clinton Ave. S., Rochester 20
Phone: BRowning 3503

OHIO

AUDIO CRAFT CO.
2915 Prospect Ave., Cleveland 15
Phone: CHerry 1-5560

PIONEER ELECTRONIC SUPPLY CO.
2115 Prospect, Cleveland 15
Phone: SU. 1-9410

RICHARD J. SAUER
CUSTOM ELECTRONICS, INC.
1000 S. Main St., Dayton 9
Phone: ADams 3158

CUSTOM CLASSICS
13421 Euclid Ave., E. Cleveland 12
Phone: GL. 1-0256

COUNTERPOINT
20971 Westgate (Westgate Shopping
Center) Fairview Park 26
Phone: ED. 1-6448

R. S. T. LABS
14511 Granger Rd., Maple Heights
Phone: MOntrorse 2-3213

OKLAHOMA

CUSTOM-CRAFT ELECTRONICS
1314 S. Peoria, Tulsa
Phone: LUther 5-5148

OREGON

OTT'S RADIO, TV & HI FI
3760 S.E. Hawthorne Blvd., Portland
Phone: FIlmore 5341

PENNSYLVANIA

AUDIO LABORATORIES, INC.
808 Mohican St., Bethlehem
Phone: UNiversity 7-3909

DANBY RADIO CORP.
19 So. 21st St., Philadelphia 3
Phone: RIttenhouse 6-5686

TEN CATE ASSOCIATES
6128 Morton St., Philadelphia 44
Phone: GERMantown 8-5448

CONCERTO ROOM, INC.
642 Grant St., Pittsburgh 19
Phone: ATLantic 1-2312 & 1-2313

SOUTH CAROLINA

HI-FI SOUND & RECORDS
621-23 Harden St., Columbia
Phone: 6-3538

TENNESSEE

BLUFF CITY DISTRIBUTING CO.
234 East St., Memphis 2
Phone: BRoadway 6-4501

TEXAS

TOWN NORTH MUSIC CORP.
5328 W. Lovers Lane at Inwood Rd.,
Dallas 9 Phone: ELMhurst 6477

CLIFFORD HERRING SOUND EQUIP. CO.
W. Lancaster at Burnet Sts.,
Fort Worth 3 Phone: FO. 4877

TRUETT KIMZEY COMPANY
3515 W. Vickery, Fort Worth 7
Phone: FAnnin 6145

GULF COAST ELECTRONICS
1110 Winbern St., Houston 4
Phone: JUstin 1551

WRYE CO., LTD.
2410 W. Alabama, Houston 6
Phone: JA. 3-7874

VIRGINIA

AUDIO CONSULTANTS, INC.
76 N. Glebe Rd., Arlington 3
Phone: JACKson 5-3355

ADWESTCRAFT
1107 Mulberry Rd., Martinsville
Phone: 6294

WASHINGTON

OLYMPIC ENGINEERING CO.
2008 Westlake Ave., Seattle 1
Phone: ELiot 4650

UNIVERSITY HI-FI SHOP
4111 University Way, Seattle 5
Phone: ME. 6000

WISCONSIN

THE AUDIO SHACK
1208 Milwaukee Ave., Janesville
Phone: PLeasant 4-7657

THE HI-FI CENTER, INC.
2630 N. Downer Ave., Milwaukee 1
Phone: WOODruff 4-3344

CANADA

AVENUE RADIO & TELEVISION, INC.
4114 St. Catherine St., W., Montreal
Phone: GLEnview 4236

PAYETTE RADIO LIMITED
730 St. James St., W., Montreal 3
Phone: UN. 6-6681

ALPHA ARACON RADIO CO., LTD.
29 Adelaide St., W. Toronto 1

HAWAII

JOHN J. HARDING CO., LTD.
1471 Kapiolani Blvd., Honolulu 12
Phone: 991481 - 991593

your Fleetwood® dealer or write: Conrac, Inc., Glendora, Cal

Rauland

"GOLDEN SERIES"
HIGH FIDELITY
The Very Best for Less!

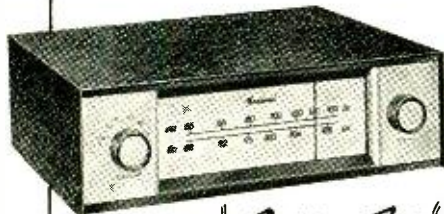

HF155 "Golden Gate"
FM-AM HI-FI TUNER

Here is quality FM (response ± 0.5 db, 20 to 20,000 cps) and improved AM, both most perfectly realized for finest reception in a unit only 4" high—at a very reasonable price. Outstanding features: Sensitivity, FM—3 microvolts for 20 db of quieting; AM—5 microvolts for 1.5 volts output; separate RF stage on FM and AM; discriminator with dual limiters; cathode follower with 2 outputs; AFC; flywheel tuning, FM di-pole antenna, etc.

NEW! HI-FI SOUND FOR TV!



Now, make your TV sound "come alive". Just plug the new RAULAND TV55 Tuner into the unit above and enjoy TV sound through your hi-fi system. Exclusive with RAULAND. See it—hear it soon.



1520 "Golden Crest"
20-WATT HI-FI AMPLIFIER

Designed for those who appreciate the finest in Hi-Fi reproduction—the very best for less. Features: Full 20 watts output; response, ± 0.5 db, 20 to 40,000 cps; 6 response curves (compensation for all record types); 5 inputs for complete hi-fi versatility; separate bass, treble controls; contour and volume controls; variable damping control; rumble filter, plus many other deluxe features. In compact cabinet, 4" high.

HANDSOME "SPACE-SAVER" DESIGN

RAULAND matching "Space-Saver" units are decorator-styled in smart charcoal black with marbled gold finish, control panels in soft brushed brass. No cabinets required—fit beautifully anywhere. (Extension shafts available for behind-panel mount.)



Hear these RAULAND Hi-Fi units at your dealer's, or write for full details

RAULAND-BORG CORPORATION
3515 W. Addison St., Dept. F, Chicago 18, Ill.

NOTED WITH INTEREST

Continued from page 46

too squeaky and the lows unnatural or too loud. But after a few tries, those that didn't have tin ears began making comparisons with their own phonographs and noticed the big difference." The rest of the story is old soap: it's



been full speed ahead (aided, Sr. Granados says, by *Life's* Spanish Edition which carried the "fabulous write-up" on high fidelity) ever since.

Pictured here is the interior of La Casa de los Discos where hi-fi started in Barranquilla, Colombia, S. A.

Defining Hi-Fi

Altec-Lansing has laid down five rules-of-thumb to help determine what is, and what is not, hi-fi. Says Altec: (1) separate speaker cabinet; (2) three record crossover selections; (3) separate bass and treble controls; (4) genuine two-way speaker (i.e., uses dividing network); and (5) at least two cubic-feet for a speaker cabinet.

High-Power FM

If you live within an 80- to 100-mile radius of Urbana, Illinois, you have probably discovered by now the very strong signal down at 90.9 on your FM dial. This is the University of Illinois' station WILL, which increased power December 1st from 60 to a whopping 300 kilowatts. This makes it one of the three most powerful FM stations in the country, according to a recent release.

If you want a program guide, drop a card to Pat Jordan, Station WILL, Urbana, Ill.

How Tape Is Made

Speaking of tape, did you ever wonder how it's made? If so, Orradio Industries have the answer in a new, illustrated folder. Write them for it. — Dept. 8, Opelika, Ala.

CRITICS ACCLAIM BEAM STENTORIAN EXTENDED RANGE LOUDSPEAKERS!

"... without doubt (Beam Stentorian HF 1012 is) the most remarkable \$16. speaker we have ever heard."
— TITH, High Fidelity Magazine, Sept. 1955



This review by one of America's leading high fidelity authorities is typical of the unparalleled praise given throughout the world to British-made Beam *Stentorian Speakers. The reason: Beam Stentorians provide quality, design and performance and finish far in excess of other units of comparable size—regardless of price class!

Superbly smooth response, patented cambric cones with lower bass resonance, more uniform output, variable impedance (4-8-15 ohms), die cast frames are a few of the features that make Beam Stentorians the most praiseworthy speakers in America today. Hear them at your audio dealer's soon! Use them singly or in banks as extended range, mid range or woofer units.

MODEL HF 1012-U (Universal) 10" diameter; composite cambric cone; Response, 30-14,000 cps; Bass Resonance, 35 cps; Power Rating, 10 watts; 2 lb. Alcomax 3 magnet, 12,000 gauss; 1" dia. voice coil, optional variable impedance 4,8,15 ohms; Die-cast frame.\$16.95

MODEL HF 912-U (Universal) 9" dia.; composite cambric cone; Response, 40-13,000 cps; Bass Resonance, 45 cps; Power Rating, 7 watts; 2 lb. Alcomax 3 magnet, 12,000 gauss; 1" diameter voice coil, variable impedance 4,8,15 ohms; Die-cast frame.\$13.95

MODEL 812-U (Universal) 8" diameter; composite cambric cone; Response, 50-12,000 cps; Bass Resonance, 65 cps; Power Rating, 5 watts; 2 lb. Alcomax 3 magnet, 12,000 gauss; 1" diameter voice coil, variable impedance 4,8,15 ohms; Die-cast frame.\$12.95

Whitehall Bookshelf Enclosure complete with 812U Fitted\$37.00 unfinished wood.

ABOVE MODELS WITH SINGLE IMPEDANCE 15 OHM VOICE COILS, \$1.00 LESS

MODEL 812U IS SUITABLE FOR AUTO INSTALLATION

STENTORIAN T-10 TWEETER — Response, 2,000-16,000 cps; 1" diameter aluminum voice coil, 15 ohms; Power Rating, 5 watts; 2 lb. 8 oz. Alcomax 3 magnet, 14,000 gauss.\$19.95

STENTORIAN CX 3000 CROSSOVER — Half pi matching network for 15 ohm tweeters and woofers. Input impedance, 15 ohms. Crossover at 3,000 cps.\$9.25

H.F. 1214 — New super 12" extended range speaker 25-14,000 cps; also ideal as wide range or woofer unit; die-cast frame, 5 1/2 lb. magnet, 39 cps resonance, 15 ohms, 15 watts.\$49.50

STENTORIAN T-12 Super Tweeter — \$58.50 | **1814 Super Woofer** 1801A — \$179.00

For Literature and Detailed Specifications, write:
BEAM INSTRUMENTS CORPORATION
350 FIFTH AVENUE, NEW YORK, N. Y.

In Canada: Cossor Ltd., 8230 Mayrand St., Montreal 9, P.Q.
Charter Member: Institute of High Fidelity Manufacturers, Inc.

*T/M Whiteley Electrical Radio Company
World famous speaker makers for 30 years.

AS THE EDITORS SEE IT

FOR OTHER FOLK, the poet may have had it right when he said that the saddest words of all were these: it might have been. But for seasoned devotees of high fidelity, four other words would have to be substituted: *it used to be*.

Perhaps these are the saddest words because they are also the fondest. I am a record reviewer — for another magazine — and in consequence I have a record collection larger and more heterogeneous than most (though it is small and narrow beside some I know of). Lately a colleague has kindly applied himself to organizing this collection, heretofore in disarray, and in so doing has confronted me with various aspects of my past. There seem to be, in my possession, certain elderly recordings that I might reasonably be expected to dispense with. But I feel a reluctance (an in-variable reluctance) to do so.

This has nothing to do with musical values. There is no suggestion that I should give up my Schnabel Beethoven sonatas, or my Supervia *Carmen* arias, or my Schumann-Heinck *Traum durch die Dämmerung*.

In question, rather, are some early LPs of no great distinction now, and a few 78s which overlapped the micro-groove era. Their hold on me, and my attachment to them, derives almost wholly from their significance in my arduous progress toward perfect musical delectation in the living room — which I seem to be as far from as I ever was.

Take the Beethoven Seventh Symphony conducted on British Decca 78s by Anatole Fistoulari. I still think this was a noteworthy recording, in its day, but that is not why I have clung to it, even when something more nearly definitive, and higher in fi, came along. Rather, this was the set which involved me in my last great test with my imported 78-rpm record changer. The latter treasure I had acquired two years earlier. The salesman told me it was the utmost, and I stubbornly believed him for many months, despite the discovery that the machine had a pot-metal frame, which began to warp almost at once, and that its variable speed was altogether too variable, changing with each additional record. In part out of affection for this monster, I resisted LP when it arrived. Fistoulari's Seventh was the last recording I bought before yielding, and, in a feverish effort to prove my hopeless thesis, I completely dismantled the changer, to check its every ailing part. Finally reassembled, by dawn's early light, it lurched and lagged just as it had before. When the sun rose, it shone on an imported record changer in our ashcan. I had become a three-speed man.

And here is Stravinsky's own performance of the *Sacre du Printemps*. Alfred Frankenstein says it's still the best reading, and maybe it is. But no one now would think of it as a hi-fi marvel. Yet it was, so to speak, the capstone of my first complete high fidelity system: A variable reluctance cartridge, with needle-talk audible across

the room. A full fifteen-watt amplifier, with two stages of treble cut-off — no other tone controls. A fifteen-inch speaker, with an aluminum dome in the center. None of my acquaintances had anything remotely like it. The neighborhood got pretty sick of *Le Sacre du Printemps*. But it still can give me a fleeting touch of that wonderful time. (I wonder what it really *did* sound like.)

Next, Fritz Heitmann playing the organ works from Bach's *Clavierübung*, on Capitol-Telefunken — and my voluminous correspondence with the amiable Jensen executive who had unwarily reported on bass-reflex theory in the Radio Yearbook. Midnight sawing and cursing in the apartment kitchen, and the sliding port-panel that wouldn't slide, and the final thunderous triumph.

Haydn's *Military* Symphony by Scherchen, and the anguished realization that my single-voice-coil speaker couldn't bring the triangles out properly. The new two-way loudspeaker, far beyond the means of any young newspaper reporter in his right mind. The raucous racket that came forth when it was hitched to the poor public-address amplifier. The desperate raid on the savings account, and the mighty, twenty-watt THING that wouldn't pass square waves but would pass Haydn's triangles. The neighborhood got pretty sick of the *Military* Symphony.

Gilbert and Sullivan's *Trial by Jury*, and the Mystery of the Bodiless Basso, which initiated a long preoccupation with equalization. Festoons of little resistors strung between pintip plugs and sockets, and the ritual of substituting one array for another when a Columbia or a Westminster followed a London or an RCA Victor, always accompanied by an enormous throbbing jar because I had forgotten to turn the volume down first. But how impressive to visiting neophytes, and how delightfully and completely *mine!* Essentially, of course, the new, expensive control-unit, with sixteen equalization-settings etched into its brushed gold scutcheon, is the same thing, only much better — but somehow there is less thrill in the listening.

Varèse's *Ionization*. The irresistible need for a corner-horn enclosure, and the immovable obstacle of the cornerless apartment. The move, at long last, to a house. The corner horn sounds fine. On the other hand, it does *not* have, anywhere in its bland facade, a handmade sliding panel that won't slide, and you can miss these things.

And then, there are the records whose past associations are their own — they were so thrillingly vivid once. On 78s, the Bach Concerto for Violin and Oboe by Danish HMV, and the Deutsche Grammophon *Freischütz*. On LP, the early Handel Concerti Grossi, by London, and the Haydn *Bear* Symphony by Haydn Society. It should be occasion for joy, of course, that almost any new recording now is their sonic equal. But, for that very reason, I don't play the old favorites readily these days. I'd rather remember them.

J. M. C.



A Subway Stop Named Symphony

by JOHN M. CONLY

IN THE COLUMBIA ENCYCLOPEDIA, that inviting trove of tastefully assorted facts, various great American cities are described in brief, apparently by people who live (or have lived) in them. Though fond and proud, most of these descriptions share a certain sameness. New York, Chicago, San Francisco, St. Louis — all are portrayed as vital foci of great transportation networks, worldwide commercial activity, lively cultural and educational interest, and rich recreational traffic. But there is one passage in one description that has no counterpart in any other.

"The *spiritual mantle* of Boston," the writer says, "spreads over many nearby cities and towns."

The italics are mine. Possibly no other American city, through whatever spokesman, could advert to its spiritual mantle without seeming a little ridiculous, but Boston can. It has one. The mantle may be too tenuous now, and it may spread too far, to suit old Bostonians, and some new Bostonians may think it figmentary. It has not saved the city from shabbiness and congestion. But it is there, and under its spread have grown, and still grow, many unique and treasurable things. Not the least of these is the Boston Symphony Orchestra, which will be seventy-five years old this season.

The Orchestra exists in two sets of dimensions. Seen from outside Boston it towers imposingly, as one of the very greatest instruments of artistic utterance ever developed by any civilization on earth. This is no extreme statement. Symphonic music is one of the highest points, if not *the* highest, achieved by Western culture in all its attempts at expression. And never has anyone been more ardently, constantly, and intelligently devoted to making symphonic music than this band of 104 people.

By contrast, from certain viewpoints *within* the city, the Orchestra is seen simply as a Boston institution, worthily

comparable to the Common, the codfish business, the Public Garden, and possibly the illuminated weather-indicator on the Hancock building. Along with this goes a bland air of proprietorship toward the Orchestra, especially noticeable among elder concert subscribers. These things infuriate certain other Bostonians, who know and esteem the Orchestra in its larger, outer-world aspect. But — and this is more important — they don't infuriate the members of the Orchestra. Indeed, quite the contrary.

Here is the way it is put by Harry Dickson of the first violins, who also has served, with distinction, as substitute-conductor of the Boston "Pops": "The Symphony musician in Boston has a unique position. People introduce you quite proudly as a member of the Boston Symphony Orchestra, even people who never attend a concert. It's considered a high honor."

Therein may be a clue to the connection — and there is one — between the Orchestra's excellence and its Boston origin and nurture. In Boston it is still felt important to be part of something; it lends to a man's stature. And, of course, an orchestral musician, to be any good, must have that very same feeling. Otherwise his job can be dullness itself, and his performance of it lifeless.

The Boston Symphony Orchestra was founded in 1881 by Major Henry Lee Higginson, a remarkable man. Destined by background for banking, he conceived in his youth a passionate fondness for music, and went to Vienna to study the piano. While there he incurred an arm injury, which ended his piano-playing. He returned to America and (after time out to fight in the Civil War) to banking. He applied himself to such effect that, at forty-seven, he was able to make his devoir to music by starting and financing an orchestra. He paid its deficits every year thereafter (save one, when his brother did) until the year before his death in 1919. Apparently this was pure devotion, to music and to Boston's people; he never bid for acclaim. Willing to accept Back Bay gentry's



extra cash, he always put a portion of the season tickets up for sale at auction (a pair once brought \$1120, base-price being \$12 each); the rest were sold at the box office at very low prices. The latter drew speculators, of course: in 1888, a line of men and boys began waiting for the \$7.50 season tickets *five days* before the box office opened, sleeping, by night, with their heads on each other's shoulders. (Since its inception, the Boston Symphony Orchestra seldom has had any trouble filling a hall.) Music lovers balanced the benefits and abuses, and did not blame Major Higginson.

In another way, too, he welded the community to the Orchestra. He hired conductors, gave them a free hand, and stood by them staunchly while they wooed and won — or lost — Boston's favor, and while they themselves assayed Boston. On this basis, conductors came and went. Among them were Georg (later Sir George) Henschel, who drew fire for his attachment to the pernicious modernism of Brahms and Wagner; Wilhelm Gericke; Artur Nikisch; Emil Paur, Max Fiedler, and Karl Muck. It was up to the conductor to sell his interpretations and innovations, up to the audience to accept or reject his wares. The management — Major Higginson — merely judged the outcome. In nearly forty years of this *laissez-faire* procedure, Boston acquitted itself surprisingly well, its only tragic botch being the short-sighted failure to hold Nikisch against the lure of Budapest. A listenership developed that was truly interested and judicious, though it bore one odd imprint of Major Higginson's musical judgment: in taste, it could have passed for a German audience, never having heard a conductor who wasn't German, or music not cast in the German mold. But this was to change, and promptly.

Along with Major Higginson's resignation — whereafter the Orchestra formally became a corporation — came World War I. Conductor Karl Muck was interned as an enemy alien, and all German instrumentalists not yet naturalized were forced to quit the Orchestra. They left important seats empty, and the new trustees went talent-hunting. The visiting Frenchman Henri Rabaud became director, and other Frenchmen began to appear in the empty seats. Louis Speyer, who has been the English horn player for thirty-seven years, can remember this, and for good reason.

"The funny thing," he says, "is that I came to this country to stay three weeks, playing in the band of the Garde Republicaine, for a French fund drive. We were a success, so we stayed all summer. In Boston, Judge Frederick Cabot [then president of the trustees] heard us, and offered me a contract. Some others of us, too, were signed up, I think six or seven, though I am the only one still here. And so my three weeks became thirty-seven years, and now I am a Bostonian, though not a very proper Bostonian."

This process (which could be described as raiding, but no one minded, in the flush of Allied victory) finally netted about thirty-five French musicians, Speyer recalls, and distinctly changed the character of the Orchestra. It was further altered by French conductors, for after a year of Rabaud came Pierre Monteux, and by yet another factor — the hungry arrival on the scene of the newly formed

American Federation of Musicians. Major Higginson had spurned the advances of the earlier Protective Union of Musicians, but the AFM was something quite different. The BSO management finally repelled its attack, but at the cost of thirty-one musicians, mostly string players. When, by 1921, Monteux had filled the gaps in the ranks with his own choices (including Richard Burgin, concertmaster then and now, and certainly one of any conductor's most felicitous finds), Boston had almost a whole new Symphony.

And the new Symphony had a new repertoire. It had to have. The classical masters, up to and including Brahms, could be forgiven for being German, but Wagner and Strauss could not. Monteux knew what to do about this, and was happy to do it. He was, after all, the man who had caused a riot in Paris with the first performance there of *Le Sacre du Printemps*. He brought forth Ravel, Musorgsky and Stravinsky, and sought nearer home, too. As Louis Speyer says: "People do not remember, but



WARREN B. SYER

Man with a priestly function: musical director Charles Munch.

Monteux, as well as Koussevitzky, played much American music."

But a certain special flair was needed to abate the distrust with which Boston (being full of Bostonians) still received its new fare and its new Symphony. The man with the flair was found. Boston had bungled its chance at Nikisch. It made no such mistake with Serge Koussevitzky. It entangled him fondly and held him for twenty-five years, from 1924 to 1949, when he retired, to die two years later. It was during this period that the Orchestra acquired its enormous outside prestige, and against no mean competition. It was a day of great splendor for American orchestras. Stokowski headed the Philadelphia; Toscanini was still with the New York Philharmonic-Symphony. The latter dominated radio, the former was pre-eminent in recording. The Boston broadcast and recorded, too, but more sparingly. The very fact that it was not



WILL RAPPORT

SYMPHONY'S LUGGAGE. *These scale-model miniatures represent the packing-cases and wardrobe trunks the BSO must take on every tour — 88 pieces, occupying 1985.7 cubic feet, and weighing 8 tons. The replicas are an aid in load planning; actual pieces are color-coded to guide freight crews.*

overavailable, so to speak, may have enhanced its appeal. People strove for tickets to its concerts, in Boston and on its extensive tours, and it came to be characterized as the Orchestra that made the *most beautiful* music in the world.

However, its repertoire continued to be made in and for Boston. Paradoxically, this had a liberalizing effect. America-at-large just had discovered symphonic music, and its taste was a beginner's taste — Beethoven, Brahms, Tchaikovsky. Most other orchestras were influenced by this, but Koussevitzky kept on averaging three new works every two programs (fewer on tours, but simply because new works often required extra instruments, expensive to transport). He was giving the Boston listeners something they still have, which is valuable and rare. Thomas D. Perry, Jr., the Orchestra's present manager, describes it: "Though Bostonian, and some of them elderly, they have no misgivings about their ability to like new things. . . . They've had twenty-five years of musical adventure with Serge Koussevitzky, and it's made them about as open-minded as an audience can be." Enduring evidence of this lies in the fact that for a full half-century the Boston Symphony Orchestra has regularly and effortlessly sold out, in advance, its season concert series tickets. There has been, on the part of the buyers, no cautious inclination to hold back and shop later, concert by concert. Critics elsewhere have deprecated this by referring to "that most solemn of Back Bay rituals — 'Symphony'."* But if it is a ritual, it would seem to derive from a very vital rite, easy to describe but hard to perform without some thousands of trained participants — namely, the knowledgeable enjoyment of music.

Of course, the rite needs the right man to preside over it. The man who does this now is Charles Munch, the Orchestra's musical director since 1949, and it is interesting to note that he once described his job as that of a priest.†

*This and most other historical references throughout this article are drawn from *The Boston Symphony Orchestra — 1881-1931*, by M. A. DeWolfe Howe, revised and extended in collaboration with John N. Burk (Houghton Mifflin, Boston, 1931).

†In *I Am A Conductor*. Oxford University Press. New York, 1955.

In more mundane terms, he describes his greatest responsibility as keeping the programs and performances good enough to deserve well of the people of Boston. He likes to deserve well of record buyers and radio listeners, too, but adheres to the opinion that what is good enough for Boston is good enough for anyone, including RCA Victor and NBC. The latter do not take this amiss. (It is true that the BSO has been somewhat neglected on records in the microgroove era, but this can be accounted for by RCA Victor's desire to make the most of the last active years of Arturo Toscanini and the NBC Symphony. The BSO being a spirited outfit, it did not spurn some flirtatious advances, in early 1955, from London-Decca, and this may have helped hasten a handsome new Victor contract, signed last summer. Its results will be a new flow of Boston recordings, covering a broad repertory, made desirable by the rapid technical obsolescence of older records these days. Already in evidence are a magnificent *Daphnis and Chloë*, a splendid Tchaikovsky *Pathétique* conducted by Monteux, and, to launch the seventy-fifth anniversary season, a pairing of the Beethoven Fifth and Schubert *Unfinished*.)

The Bostonian orientation of the Orchestra seems to sit well with its personnel. They are conscious of their standing in the wide world of music (a lot of them are engaged in extracurricular musical undertakings), but they do not let this lessen their appreciation of a gracious way of living, which is what membership in the BSO amounts to.

"This is not a job," says violinist Harry Dickson. "It's more like belonging to a family. Even socially we are closely knit. There is less jealousy than anywhere else I've ever worked, and everyone appreciates everyone."

"The high morale and spirit of the players," answers young Noah Bielski, latest addition to the violins, when asked what lured him away from higher pay in New York TV and radio work, "and the wonderful, almost unbelievable support by the people of Boston." As an afterthought (he is something of a sound-enthusiast), he adds a credit for the acoustical magnificence of three-tiered, richly gilded, fifty-five-year-old Symphony Hall. Musicians like to hear themselves, just as writers love to dwell on their words in print, and as aircraft designers revel in test-flights.

It was something just outside Symphony Hall that specially appealed to Doriot Anthony Dwyer, youthful first flute of the Orchestra, daughter of a flutist-mother,

Thomas D. Perry, Jr.

Gail Rector



pupil of Georges Barrère and William Kincaid, and one of the few women ever to play in the Boston Symphony Orchestra. "What surprised me most, when I came here," she says, "was that they have a subway stop named Symphony."

Leonard Burkat, Munch's imperturbable young secretary-assistant, holds the theory that BSO players fit their milieu so happily (as they seem to, in a degree that makes an observer think at first there must be something phony about it) because the jobs themselves, long established and multiplicate, have the power now to attract, unerringly, the right people. "Either that," he offers, "or the character of the people alters to fit, just as seems to happen to new recruits in a baseball club." Certain it is that new recruits in the Orchestra very soon exude an air of belonging, and even refer unself-consciously to the Orchestra as "Symphony," as older Bostonians do. ("I hear Heifetz is coming to town. I wonder if he will appear with Symphony.")

Whichever of the two Burkat theories is correct, the man who keys its operation is Rosario Mazzeo, who has played bass clarinet in the Orchestra since 1932 and has been personnel manager as well since 1942. These are two man-sized jobs, which makes it all the more astounding that Mazzeo is also a noted bird-watcher and photographer, a director of the Massachusetts Audubon Society, a skilled mountain-climber, and president of the Cambridge Society for Early Music. It is Mazzeo who has seen the BSO assume its latest national complexion. First German, then French, it is now American. This is partly the doing of the American Federation of Musicians, which the BSO finally joined in 1942, and which restricts recruitment to musicians who are, or are becoming, citizens of the United States or Canada. But, as Mazzeo adds, it would have happened anyway, since American musical training is now the equal of any in the world. Many foreign musicians, of course, apply for BSO jobs. "Every day I have letters from Europe," says Mazzeo. "We can't negotiate with them, of course, but we can and do pass them on to the union."

As might be imagined, there is nothing hasty about the way the Boston Symphony Orchestra takes on a new member. Mazzeo has his own ways of keeping track of musicians throughout the country who seem likely candidates. Usually they themselves initiate a correspondence, at some point in their passage through lesser jobs. This is all very informal, until a vacancy occurs in the BSO. Then the

most promising applicants are notified, assembled, and auditioned (from behind a curtain) by a jury which always includes Mazzeo, Richard Burgin, and the principal of the section with the vacancy. The jury selects from four to seven fortunates for the next stage of elimination — another audition, this time attended by Charles Munch. He may also interview them personally, make them play as he conducts, make them sight-read. The lucky winner usually is in a state of near-prostration by the time he is selected, but none ever complains. He has come into what Henry B. Cabot, president of Symphony's trustees, calls "the most attractive musical job in America."

No one in the Boston Symphony Orchestra makes less than \$7,000 a year at regular orchestral work, according to Mazzeo, and the most important members make substantially more — how much more is necessarily secret. The work week is not a tough one, averaging slightly over four concerts (not counting rehearsals) as against, say, about five at the New York Philharmonic-Symphony. The work year varies, among the personnel, from thirty-seven to forty-six weeks. When the regular thirty-week winter season ends in April, the seats are hurriedly cleared from Symphony Hall's parquet to make room for refreshment tables, and Arthur Fiedler begins conducting nine weeks of the famous "Pops" concerts, begun in 1885, under Fiedler's direction since 1930. (The Boston Pops Tour Orchestra, which Fiedler takes afield in early spring, is a separate group, not staffed by BSO personnel.) After the Pops come three weeks of open-air, free, Esplanade Concerts on the Charles Embankment, supported by voluntary contributions (some from business firms) and also led by Fiedler. Thereafter comes Tanglewood (the summer Berkshire Music Festival), which occupies most of the Orchestra six weeks. There has been, some summers, an overlap between the Esplanade (first half of the week) and early Tanglewood (latter half) concerts, forcing some of the personnel to traverse weekly the abominable route between Boston and the Berkshire Hills, and making them ardent rooters for the Massachusetts East-West Thruway slowly approaching completion. Most of the first-chair players take vacations during the Pops-Esplanade period. The entire schedule gives the BSO the longest active season of any American orchestra. In 1956 it will be even longer, since when Tanglewood is over, the Orchestra will leave on its second European tour (the first was in 1952), to play in Edinburgh, *Continued on page 128*

Richard Burgin



Rosario Mazzeo



Doriot Anthony Dwyer



Louis Speyer



PHOTOGRAPHS BY WARREN B. SYER



by C. G. Burke

This article is adapted from an essay to be published this month as part of a new McGraw-Hill HIGH FIDELITY anthology, Building Your Record Library.

On Modifying the Senescence and Mortality of Disks

WHEN MOTIONLESS glossy as a seal, and while revolving iridescent as a starling with the spring sun on his back, the round wafer of vinyl whose single spiraling groove on each of its sides imprisons masterpieces has the beauty of immaculacy in fact, and of Olympus in anticipation. The polished skin contains a miracle delicately incised, and the concealed miracle, not the skin, is what we choose when we buy a record.

Unfortunately, with a skin as thin as this and as frail, indented permanently by a fingernail, scarred for life by a slap from the edge of a piece of paper, ulcerated by a drop of diluted alcohol, the latent life beneath, the miracle of the music microscopically incised, makes a pained and painful outcry when the skin is hurt. The most trifling indentation on the surface of a record can be heard as a little mutter in the loudspeaker, and a superficial scratch from the fingernail or from the stylus when the pickup is carelessly handled can produce a hundred percussive clicks in rhythmic competition with the music being played.

The bravely-labeled, darkly-shining, iridescent phonograph record, so vulnerable to skin afflictions, is an expedient, like the shift of gears in an automobile, tolerated until something better is contrived, because it works in spite of its impropriety. The disk, with an effective circumference constantly shrinking in play, its spiral twisting in an inexorably-continued reduction of lineal speed, results from a compromise with physics, and is retained in commerce because it is cheap and easy to multiply.

Bad in principle, the disk is deficient in operation. Its sliver-thinness invites warping. The spindle-hole, which must be in the exact center if fluctuations of speed and consequently of pitch are to be prevented, very seldom is near enough to the center to obviate a to-and-fro movement of the pickup arm. The vinyl or similar material, soft and elastic to reduce the hiss of friction, is intolerant of heat, easily marred by mishandling, and shares with its shellacked predecessor susceptibility inflicted by the reproducing stylus. It has one physical advantage that the shellacs tragically had not: it is hard to break, and to shatter or fracture or crack a vinyl disk one has to try.

It sometimes seems a wonder that we tolerate disks

at all. Stylus-friction in their grooves generates electrical charges that attract and grimly hold particles of dust, lint, and soot difficult to dislodge once they have found rest; and the point of a sensitive pickup jostling these invaders sends unwanted impulses to the amplifier, whence they are translated by the speaker as alien noises. Furthermore, such particles, when they are hard or sharp, mar the soft walls of the grooves under the grinding pressure of the stylus. In the grooves they will stay and will become embedded with repeated grinding unless they are promptly removed. But since we do not throw away disks like a discus, whatever the provocation, but condone and ever cherish their blundering fragility for the sake of the wonderful drug they contain, we may as well make the best of them and keep the drug undiluted.

The disk after all is still expensive, and we are all reluctant to obtain little when we spend much. Having spent our dollars for a certain quantity of music printed in a disk, we wish the expenditure for the music to be final. If the record still faithfully fulfills its musical duty after two hundred playings we may regard the music it has brought us as cheap indeed.

Records are capable of playing two hundred times without serious inadequacy at the 200th, but twenty times is a more frequent span for a record's life in customary use. Everyone can obtain the longer duration if he observes a certain procedure and enforces certain prohibitions. The following conditions and measures are proper to extend the musical life of discal phonograph records:

Association exclusively with instruments mechanically accurate and correctly adjusted. The turntable employed should revolve in a plane which reveals to the eye no deviation from the horizontal. The stylus should be made of diamond. The arm or crane should be as light as possible consistent with adequate length and freedom from excessive resonance. The force of the stylus in rest on the record should be maintained at as low a point as can be contrived without detracting from the quality of reproduction.

Most arms have provision for the adjustment of stylus-force, and there are a number with all the required features. At least five companies make solid and accurate turntables. It is imperative to use diamond styli because

every other known material wears out far too quickly, and wear of a stylus — a broadening of its point, the creation of a flattened facet with a pair of sharp edges — accelerates the abrasion produced in the groove of a record, an abrasion that in turn accelerates the wear of the stylus. The results of wear are a steady deterioration of sound, especially of high-frequency sound, and a corresponding increase of unwanted noise. It is a truer economy to use precise and durable equipment than to replace one's records. The optimum stylus-force varies somewhat according to the type of pickup used, but in general a force of from three to four grams is enough for good reproduction, and the Weathers pickup properly mounted betrays no detrimental effects when used at a force as low as a gram and a half.

Currency has been given to a belief that abrasion of stylus and record increases rapidly both above and below some generally unstated optimum point. Through the microscope this increase may be observed at stylus-forces above six grams, but the microscope in the examinations of the writer does not confirm the belief that reduction of force below six grams is invidious. Most of the difficulty encountered when a very low stylus-force is used results from improper mounting of the turntable or arm. These must be insulated — by springs, rubber cushions or suspension — against external vibration, or the stylus will be jarred from the groove. Similarly, the turntable must be level and the arm free of effective vertical and lateral resistance if the stylus is to trace the groove with a maximum of efficiency and a minimum of damage.

Care in handling. Neither the hand nor any part of the hand should come in contact with the engraved part of a record's surface. If this injunction is disregarded a thin film of oil will mark the point of touch, and frequent touches will make the film a thick one. Records are invariably supplied with protective jackets, generally poorly designed for their purpose.* Good or bad, a protective cover of some kind must be used, since the soft vinyl will be dented by slight contact with a hard surface.

Veteran collectors have learned to handle records automatically with an instinctive solicitude for their frailty. Pressure is brought against the edges of the stiff jackets to force the open ends to gape, permitting the delicate contents to slip out without damaging the recorded surfaces. The slipping record is stopped by the palm of the hand beneath its rim, the middle finger against its lower label, and thus it is carried for placement on the turntable. The playing grooves are not touched, and after repetition the manual operation becomes spontaneous reaction. In turning a record to play the reverse of the side exposed on the turntable, the disk should be lifted by the index fingers at oppo-

*The best containers for long-playing records at this moment are Epic's inner cardboard envelope fitted into an external somewhat softer cardboard jacket, a convenient, simple, dustproof and durable arrangement; and Angel's double envelope of which the inner has a wooden rod as backbone. It may be remarked that most of the other "protective" inner envelopes, of cellophane, pliable glass, tissue-paper, glassine, etc., are nuisances obviously designed by people who never play records. When a record, after an effort, is extricated from one of these diaphanous chemises, it is resistant to reinsertion and the chemise itself prefers to crumple and tear rather than be slid back into the outer jacket.



site points of its edge and flipped over by action of the middle fingers serving also as point of pivot with the indices.

If the record is dirty — and after it has been housed in any large American city it will be — it should be cleaned, lest the superficial dirt, particularly soot, be ground into the groove. When it is returned to its jacket it should be handled in the same manner as that of its removal, the fingers aloof from the engraved surfaces. Finally, it is prudent that a naked record never come into contact with another, or with anything but its cover, the mat on top of the turntable, and the stylus after that has been gently lowered to play.

Exclusion of childhood. As long as the national sentiment is pleased to believe that juvenile harm is harmless, a neutralized zone at least ten feet from records and phonograph should be established in every music room; and tomorrow's citizens, if they wish to listen, can be chained at the prudent boundary.

Periodical examination of arm and stylus. Any stylus operating in friction against a record will be worn in the process. This includes styli of diamond: no material is immune to wear. A one-mil diamond point of careful manufacture can be relied on for from six to eight hundred hours of use under good conditions, and a greater longevity is frequently attained. It is wise to have a stylus scrutinized microscopically every hundred hours after it has been in use three hundred hours, since abrasion injurious to records but not yet apparent to the ear may be revealed by the microscope. Similarly the stylus-force should be measured frequently and adjustment made on the pickup arm when necessary.

Storage of disks. All plastic and shellacked disks, having large areas in proportion to their thickness, are subject to warpage. The larger the area, the more apparent the warpage. Fortunately warpage can be controlled by proper regular storage, and cured by an easy corrective measure. Pressure will control it, and controlled weight will cure it. This does not mean that records should be stored in vertical stacks. Vinyl is too soft to endure the weight of a considerable stack without damage to the disks near the bottom, particularly when temperatures are high. Instead records should be aligned side by side on horizontal shelves. They should be retained in their envelopes and kept snug against each other — snug, but not tight enough to make withdrawal of an envelope difficult. Partitions distributed about eight inches apart will keep the sidewise pressure of the records within safe and manageable limits. Arranged like this, rectified by each other, disks will be constrained against warping.

Care must be taken to place the shelves away from any considerable source of heat including rays of sunlight. Ten and twelve-inch disks ought not to be intermingled.

Badly warped records can be straightened by the following method: place the disk to be treated, in its jacket, between two pieces of

glass at least one foot square, and with the lower square resting on a smooth flat surface and the upper square occupied by a rather heavy object of fair dimensions — the Columbia Encyclopedia, say — allow the sandwich to stay undisturbed for a few days. The warp will be ironed out by this therapy.

Cleanliness. Disks may be cleaned of most of their superficial dirt by the application of slightly dampened cheesecloth, gently glided over the surface circularly with the grooves, from the circumference inward. This operation will clean a record temporarily without harm if the circular motion is truly gentle, and will also prevent the generation of superficial electricity during a playing immediately following the cleaning.

The electricity generated by the stylus in contact with the revolving plastic groove is one of the major minor irritants of long-playing reproduction. The charge has considerable attractive force, and gathers to the record's surface particles of matter floating in the air. Its pull garners lint, dust, tobacco ash, traces of paper, soot, powder, and most especially dog and cat hairs. All this refuse, adhering as if glued to a surface so slick that it would seem nothing could stick there, becomes a continuous obstacle to the pickup stylus which in bumping into the soot, etc. relays the little shocks to be magnified by the amplifier and speaker into vivid snaps, clicks, clucks, and popples. These exacerbating intrusions continue until the record ceases to give music, but so pertinacious is the static attraction that microscopic culprits remain in adherence after the turntable has been halted. They can be ejected only by action taken to neutralize the charge.

Other action can quickly become amusing and then infuriating. A brush will remove those deleterious particles (although most brushes will scratch records and should not be used). An artist's broad brush with bristles of the finest red sable, soft as a fledgling's belly and expensive as platinum, flicked lightly over a disk will not harm it and will otherwise produce the same effect as any other brush. The sweeping motion generates electricity as abundantly as thick soles in a thick carpet; and as all the unwanted

trucks is evicted from the observe of the record it comes speedily to rest with a deep new accumulation on the reverse. The reverse then being brushed, the obverse welcomes home its old and new guests with greater magnetism than before; and the process can be repeated indefinitely, making one side momentarily immaculate, the other furry with microscopic matter. One can sense in the air near the record a tingle, as of imminent lightning.

A number of liquids and emulsions are compounded to neutralize static electricity in disks. Most of them are quite efficient in this primary task. Records anointed with at least three of these preparations retain an immunity to the generation of new charges for an extended period, in one case for eighteen or twenty months. Unfortunately all those put under close examination had an additional property less engaging: they clogged up pickups with sticky iotas of their own substance, eventually restricting response. As a whole the static with its concomitant noises seems preferable to a pickup that stammers. Some fluids which do not bedeck the stylus with gum put a visible film upon the disk; and five of the five preparations tried by the writer did one or the other.

A tiny device known as the Mercury "Dis-Charger" — not made by the manufacturer of the celebrated "Olympian" series of records —, a small tube containing a radioactive element, can effectively protect disks against accumulations of static for an indefinite period. This instrument, of negligible weight and not much more than half an inch long, is designed to be hooked or otherwise attached to the tip of the arm carrying the cartridge. In that position, it ionizes the atmosphere in its immediate vicinity while the disk revolves beneath the stylus. The little thing works: it neutralizes the electric charge, and the record does not attract new bits of dirt to make new noises. The effect is not lasting until the record has been subjected to the treatment two or three times, but the little tube retains most of its power for years.

One can find written in the lore of the phonograph objections to the use of a brush or cloth of any kind on vinyl surfaces. These objections are not inclusively valid. A soft brush of the kind mentioned above, and possibly of other, less expensive kinds, and a dampened soft cheesecloth, tenderly applied, will not be injurious to records unless one tries to make them so.

The foregoing parade of facts and counsel contains no information absolutely new, but none either that is not verified by experience. Many of the procedures recommended are adopted by neophytes in record-collecting without any advice at all, and many people, indifferent to the finer qualities and the poorer qualities of reproduction, will find here much ado about nothing important.

But others need help, if only as a corrective to bad advice. The phonograph is easy to play, but like all mechanisms its parts and accessories need care. Most people have not the good fortune to be able to replace a worn record by a maiden. They want the Beethoven Quartet, the Mozart opera, the Strauss tone-poem, as alive at the fiftieth playing as at the first. Possibly these notes will occasionally help that to happen.

JACKETS BY RODRIGUES

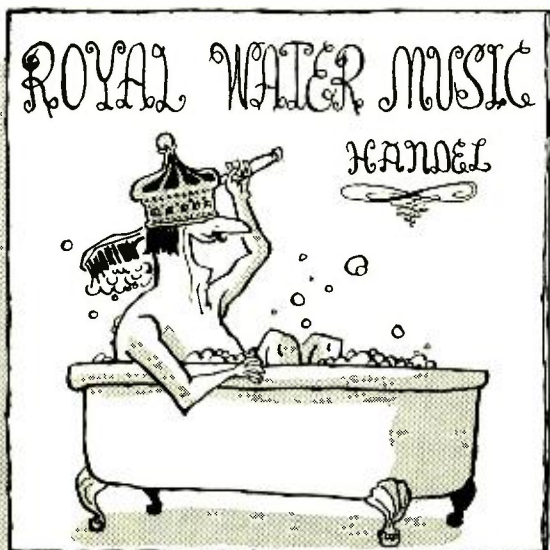

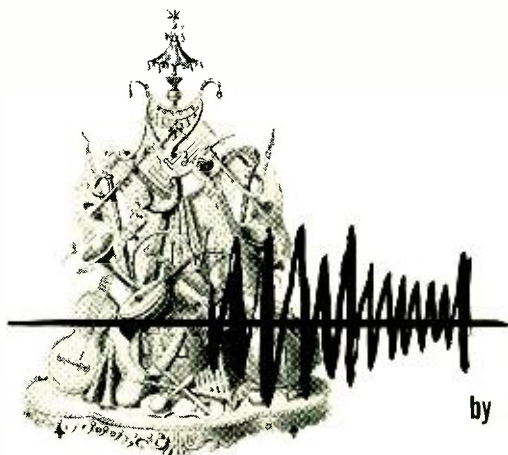

BETTMANN ARCHIVE

What Goes Into Your Tutti

by EDGAR VILLCHUR

The author heads a loudspeaker firm named Acoustic Research, Inc. — very appropriately, since obviously much (lower case) acoustic research went into this article on how various musical instruments' tones are formed.

THE MOURNFUL sound of the oboe, the twang of the guitar, and the blare of the trumpet would seem to have little in common with one another. But the formation of the characteristic timbre of various musical instruments (and of the human voice mechanism), while employing different physical elements, is almost invariably the same in basic method.

This method of tone production may be analyzed into three stages, of which the player has normally only a dim awareness. The first is the creation of some sort of vibration as a primary tone; the second is the shaping of the tone color by mechanical or acoustical resonators; and the third step consists of a build-up of volume through increasing the efficiency of radiation into the surrounding air.

The vibrations of the reed in a clarinet mouthpiece, or of the swirling air currents at the embouchure of a flute, divorced from the air columns which they engage, are examples of primary tones. The sandpaper-like stimulation of violin strings by the rosin-coated bow is another. In each of these cases, a steady mechanical or pneumatic force is broken up and converted into an oscillatory one, and the fundamental frequency of vibration, a characteristic that we perceive as pitch, is flexible enough to be able to accommodate itself to control by the resonators. The primary tone also includes a diffuse spectrum of overtones, or higher frequency components sounded simultaneously with the fundamental, whose formless distribution is of a type associated more with noise than with musical sound. Strange as it may seem, the stimuli from which the final tone colors are derived are themselves rough and unmusical in character.

Sound may be represented graphically by plotting the course of the vibration on a horizontal time axis. The resultant diagram predicts the quality of the sound and is called the wave form, although the graph represents an abstract concept rather than visual reality. Primary tones usually have a jagged, saw-toothed wave form, a shape that implies a sprawling supply of discordant overtones and which does not represent musically pleasing tone color. A buzz-saw, in fact, produces a similar type of sound.

This noise-like, unmusical primary tone turns out to be just what is needed. It is the energizing well from which the resonators — strings, air columns, and the instrument

bodies themselves — draw their sustenance. Since the resonators can only be activated at or near their natural frequencies, and since it is impossible to provide independent stimuli for each of the resonant modes of the instrument, the wave form of the initial vibration must contain all of the fundamental and harmonic frequencies (integral multiples of the fundamental frequency) corresponding to the instrument's various resonances. The resonators lock the uncertain fundamental frequency of the primary tone to the desired note; they also select and emphasize certain of the overtones to give the sound its characteristic timbre.

Once the resonating elements of the instrument have been energized the frequency and harmonic structure of the tone is formed. The subjective terms used to describe musical timbre such as *nasal*, *brilliant*, or *metallic* correspond to a cold, objective wave form analysis concerning the distribution and relative intensity of the different overtones, the intensity of the fundamental, and the attack and decay characteristics of the sound.

The primary tone is thus swamped by the resonators, but there is a residue of bow scrapes, blowing noises, and strike tones. The first two are almost but not entirely eliminated by expert musicians, and are more prominent when less accomplished players perform. A small amount of this inharmonic noise is often considered to have other than nuisance value, since it may give the listener a more poignant awareness of the physical medium, like the edges of brush strokes in a water-color painting. Inharmonic effects are purposely introduced into the orchestra by instruments such as the bass drum, the cymbal, and the triangle, in whose vibrations so many harmonically unrelated frequency components are present at the same time that no definite sensation of pitch is created.

The third element of musical instrument design, that of providing sufficient coupling between the vibrating elements of the instrument and the air, involves increasing the effective radiating area of the instrument. A small vibrating source like a stretched string needs a better bite of the acoustic medium than it can get directly — since the amount of sound energy radiated is dependent on how much air can be moved. The coupler may be mechanical, like the soundboard of a piano stimulated into vibration by the strings

connected to it, or it may be an acoustical device like a horn, in which vibrations at the narrow throat are tightly engaged to all of the air at the wide mouth. The coupling device is passive; additional energy is not introduced, but more efficient use is made of the energy that is already there.

MEMBERS of the viol group — the violin, viola, violoncello, and double bass — are essentially the same except for size and frequency range. In all of these instruments the primary stimulating tone is provided by the friction between strings and the roughened surface of the hair bow.

The moving bow displaces the string laterally, until the elastic restoring force of the stretched gut becomes greater than its frictional coupling with the bow. At this moment the bow releases its hold and allows the string to spring back. Momentum carries the string beyond its former rest position, displacing it in the opposite direction. When the combined effect of the increasing lateral tension and decreasing momentum becomes less than the force of friction, the bow grabs again, carrying the string on another forward journey. The operation is like that of a high-speed ratchet mechanism with an imperfect forward grip, and just as unmusical. But the initial saw-toothed vibration is applied to an exceptionally rich multi-resonant system.

The stretched gut string is an ancient musical device, with a natural frequency of vibration determined by its length, mass, and elasticity. It can be tuned by varying the tension at its supports or by changing the length of string left free to vibrate, and it resonates at many different harmonics in addition to its fundamental. The existence of these harmonic resonances results from the fact that the string is able to vibrate as if it were clamped in the middle — in thirds, fourths, fifths, and so forth — at the same time that it vibrates from its end supports. The primary tone thus simultaneously energizes both the fundamental and an extended series of harmonic vibrations.

The properties of a stretched string do not, however, completely explain the tonal splendor of a well-played violin or cello. A string borrowed from a Stradivari violin may produce strident sound in a cheap instrument. The belly and back of the viol body break up into complex patterns of resonant vibration which emphasize certain of the string harmonics and attenuate others, while the imprisoned air and *f*-holes form a relatively low-pitched acoustical resonator. Although this resonator, like an empty jug, is of the Helmholtz type, without overtones, the resonance is not a sharply tuned one and it reinforces a broad band of lower frequencies. The vibrational response of the whole instrument to stimulation at different frequencies is the main point of difference between a good viol instrument and a poor one.

There is one resonant mode of the viol-type instrument that may be a source of annoyance rather than musical pleasure. The lowest frequency resonance of the body can

produce violent vibration and a rough, howling sound referred to as the "wolf note." This defect is especially prevalent in cellos and is sometimes present in otherwise excellent instruments. The designs of the violin, viola, and cello have not been changed from those left in the seventeenth century by Antonio Stradivari, who made about 1,100 instruments, some six hundred of which are extant; but the wolf problem has never been completely solved. Countermeasures include the use of damping elements at strategic points on the body in order to subdue the violence of vibration, and, when the wolf resonance is a sharp one, adjustment of the body to make the wolf note fall in between notes of the scale.

The viol body resonators serve double duty as acoustic coupling devices. The lower the frequency range of the instrument, the greater is the required size of these couplers, since the radiation of sound in the bass region involves moving large quantities of air. The lowest frequency produced by the double bass, approximately forty-one cycles per second, is little more than one fifth of the corresponding frequency extreme on the violin, and the lower pitched instrument requires much larger radiating surfaces.

Wind instruments of the reedless category — the flute, piccolo, recorder, and the flue pipes of the organ — derive their primary tones from a stream of air directed against a hard lip. This airstream may be introduced in a direction across the resonating air column, as in the first two instruments mentioned, or in line with it, as in the last two. In either case, eddies of air are formed, alternately on each side of the lip, and these flip back and forth at a frequency determined by the velocity of the airstream and the thickness of the lip. Each flip imparts a shock to the imprisoned column of air, and the nature of this primary "edge" tone conforms to that of our classic model; it readily shifts its fundamental frequency to get into step with the resonance of the air column, and it contains a full spectrum of overtones.

Edge tones are common natural phenomena. The whistle of the wind across the branches of trees and the singing of telephone wires are examples; the wails associated with the rise and fall of pitch are caused by an increase or decrease of wind velocity. The miniature whirlwinds formed at the lip of an organ pipe have actually been photographed by the physicist Carrière, who used smoke to make the motion of the air visible.

Air columns, like strings, have both fundamental and harmonic resonances whose frequencies are inversely proportional to length, with the difference that the air column vibrates longitudinally instead of transversely. The pitch of a reedless woodwind is not determined exclusively by the characteristics of the air column, however, but can be influenced by the natural frequency of the edge tone. The flutist is able to humor the exact frequency of his notes by controlling his breath against the edge of the blow hole, and "overblowing" can raise the natural edge tone frequency to such an extent that it



may mesh with a harmonic of the air column instead of the fundamental. It is this last facility that makes the three-octave range of the flute possible. The independent edge tone frequency of an organ pipe is also important; unless it is close to the resonant frequency of the air column, too much time will be required for the necessary excitation energy to build up, and the pipe will not speak promptly. One of the tasks involved in voicing flue organ pipes is the correct adjustment of edge tones.

A PECULIAR problem is created in organs whose pipes are distributed in different parts of an unevenly heated building — some of the pipes are liable to go out of tune on a cold day. The resonant frequency of a column of air is directly proportional to the velocity of sound in the confined medium, and this velocity varies with temperature. A drop of 20° Fahrenheit will lower the pitch by about half a semitone.

The organ has separate pipes for different notes, whereas the flute resonates the same air column at different frequencies. This is done by changing the effective length of the column through a system of holes, providing acoustical short circuits at predetermined points along the resonating path. The edge tone for all notes must be formed at the same lip, and the playing of musical passages with "flutelike" purity of tone calls for considerable skill on the part of the player. The tone of a woodwind is partly determined by the material of the pipe, which vibrates sympathetically with the pulsations of air within it. Instruments made of hard woods, silver, and even gold or platinum have been used in the search for satisfying tonal quality.

Reed woodwinds like the oboe and clarinet, and brass instruments like the trumpet, tuba, and trombone also make use of the air column as a multi-harmonic resonator, but the primary stimulation is produced differently. The player blows directly into the column, and the steady pressure of his breath is periodically throttled, in the one case by a reed or set of reeds, and in the case of brass instruments by the vibration of his own lips. The air column thus receives a succession of sharp, saw-toothed puffs, and responds in the same way as it does to the edge tone, locking the fundamental frequency of reed- or lip-vibration and selectively emphasizing harmonic overtones. The sound is almost always coupled to the outer air through a flared opening. The timbres created are so distinctive that the adjectives "reedy" and "brassy" have become general terms in the descriptive vocabulary of musical sound.

The conversion of the steady air stream to a pulsating one depends on the fact that a current of air flowing between flexible elements will cause the internal pressure to drop and the passages to close. This restricts the air-flow, raises the pressure again, forces the wall elements to spring open once more, and the cycle of events starts all over. This effect takes place between double reeds in the oboe and bassoon, between a single reed and mouthpiece in the clarinet and saxophone, and directly between the musician's lips in brass instruments.

The primary reed vibration is much louder than the flute's edge tone, and it is capable of producing very unlively quacking noises when unskilled players allow the reeds to escape from the dominance of the air column. The combination of reeds and air column, properly coupled, is capable of haunting musical effects. Reed woodwinds have an important position in musical literature, and the organ includes reed-actuated as well as flue pipes for tonal variety. Older organs used reeds which cut off the air flow sharply, stimulating the higher harmonic orders of the air column and creating a fiery tone. Later a smoother cutoff and softer tone were favored, but there has been a recent revival of interest in the earlier design.

BRASS instruments consist of a long, coiled pipe (an uncoiled tuba is about eighteen feet long), generally of progressively increasing diameter; a cup-shaped mouthpiece; and, except in bugle-type instruments, facilities for changing the effective length of the air column by means of valves or sliding pipe sections. The player matches the primary vibration of his lips to different resonant harmonics of the column — the fundamental is not generally a useful resonance — by controlling lip tension. (If you are interested, the second harmonic has a frequency ratio to the fundamental of two to one, and the resonant frequency jumps an octave; the third harmonic has a frequency ratio to the second of three to two, and the pitch interval is a fifth. The higher the harmonic order, the smaller the geometric ratio to the preceding harmonic and the smaller the corresponding pitch interval.)

The flared shape is used in brass instruments for efficient coupling between the source of sound energy and the air. Any one cross-section of the horn is only slightly different in area from the cross-section immediately adjacent, and each layer of air is therefore coupled to its entire adjacent layer. The result is that the player's lips are tightly engaged to all the air in the horn, effectively increasing the small radiating area of the mouthpiece to approximately that of the large opening.

Stretched strings act as resonating elements in struck instruments like the piano and clavichord and in plucked instruments like the guitar, harp, and harpsichord. The initial stimulus may still be considered a primary tone, but one whose duration is only a fraction of a cycle-period.

The piano has a separate set of strings for each note, which are sounded by a felted hammer. When a key is depressed, the string damper is removed; and the appropriate hammer is launched towards its string like a projectile from a sling. By the time the key has reached its bed the launching device has lost all contact with the hammer, leaving it free at the point of striking and allowing it to rebound immediately. The hammer remains poised a short distance from the string until the key is released, at which time the damper is re-applied to the string unless the sustaining pedal is down.

It should be clear from the above action that the pianist, unlike the players of viol instruments or woodwinds, has no control over the tone of a single note other than determining when, how hard, and for how *Continued on page 125*

Artur Rubinstein looks back upon . . .

A Half-Century Without Vitamins

by HAROLD C. SCHONBERG

ARTUR RUBINSTEIN, a man who gives the impression of bounding around the room when he is merely sitting on a couch, has probably given more concerts, covered more ground, lived more lustily, and made more money from records than any pianist active today. He looks back, rather fondly, on a splendidly misspent youth and looks with equal fondness to the future, wherein he expects — among other things — to record what Chopin he has not recorded (which is very little), the major works of Schumann, a large grouping of concerted works, and other music he admires.

He came to records late in his life. Josef Hofmann, for instance, made some tests for Edison in 1888. Wilhelm Backhaus has many acoustic disks to his credit, and Percy Grainger's career on records goes back to 1915 or thereabouts. Gieseking recorded for Brunswick (or, rather, performances of his were released on the Brunswick label, in this country around 1923), and both Novaes and Cortot were represented by Victors of 1920 vintage. Rubinstein could have recorded in America in 1919. At that time he came here for a tour and made friends with a lady very much admired in operatic circles. It was her first trip to America. She spoke no English, and everybody came to Rubinstein (a man who has eight or nine languages fluently at his disposal) for their dealings with the diva. He arranged an audition for her with Gatti-Casazza, and the lady was subsequently engaged by the Metropolitan Opera. Then a Victor man came around. "If you persuade her to record for us," he whispered in the pianist's ear, "I'll let you make five records." Rubinstein was insulted. He refused to be bribed. Besides, he had no liking for the twanging banjo sound that passed in those days for piano reproduction.

He did make some piano rolls. "Such fakes!" he says. "You play a horrible, smeared scale, like so." And he lets his fingers scabble on his knee. "You are mortified and ashamed. They tell you not to worry. They take little papers and they cover up the holes. They move the holes up a little. Such a wonderful scale now!"

About ten years after attempted bribery and piano rolls, Rubinstein was in London, where he met the famed HMV impresario Fred Gaisberg ("that wonderful fellow"). Rubinstein admits that he wonders why Gaisberg was interested in him: "I was very low in British critical opinion at that time." But Rubinstein's public, though not too large, consisted of artists, society people, and connois-



DRAWING BY HAROLD SCHONBERG

seurs, and Gaisberg was impressed. "You must make records, you must make records," he insisted. Rubinstein didn't want to make records. He was still thinking of the phonograph in terms of banjo sound. Gaisberg, one day, inveigled him into the HMV studios at Hayes, Middlesex. This was around 1928 or 1929 — Rubinstein is uncertain of the year. Gaisberg persuaded him to try something, and Rubinstein selected Chopin's *Barcarolle*, which was played right back to him from the wax. "I was amazed, I had tears in my eyes. My God! It sounded

like a piano." He went back next day and recorded the *Barcarolle* officially. Thus it all started.

At that time, Rubinstein had been playing in public some thirty years. Like nearly all great pianists he had been a child prodigy (no relation to Russia's great Anton Rubinstein). He gives his birth date as January 28, 1889. Some of the older encyclopedias put that date back a few years. Born in Lodz, Poland, he was the youngest of seven children. Joseph Joachim, the greatest classical violinist of the century, interested himself in the child and helped pay for his studies on the condition that his parents not exploit little Artur as a prodigy. In Berlin he studied under Heinrich Barth (piano) and Max Bruch (composition), among others. At eleven he made his debut in Mozart's A major Concerto (K. 488). He has retained his liking for the work; has recorded it twice. As a youngster he was known as a Mozart player, something he definitely is not known as today. "In those days," he says, "I played Mozart so clear, so simple! Now I find him hard to play. The difficulty is to keep from making him too big."

Like many young men of artistic bent, Rubinstein found himself in Paris after his physical and artistic adolescence. He flung himself into the modern school. In 1904 he began playing Debussy and was hissed for his trouble. Throughout the next two decades he interested himself in composers like Prokofiev, Scriabin, Szymanowski, Ravel, Dukas, and Villa-Lobos, to his great artistic satisfaction and to the distress of his finances. He came to America in 1906 — fifty years ago — making his debut with the Philadelphia Orchestra under Fritz Scheel. He made a big success with everybody but the critics, who scornfully looked on him as a mere virtuoso. "I played two encores at my debut in Philadelphia," he recalls. "The audience wanted them and I played them. I did not know I was breaking a custom. Scheel was very mad at me. I was so scared."

During those years Rubinstein scarcely set the world on fire. He admits that he was often technically sloppy in his youth. The Slavs and the Latin countries adored him, technical sloppiness and all. As he figures it out, he was taken to the bosom of the Slavs because they were conditioned to wrong notes. Anton Rubinstein, their idol, had demonstrated to them that delivery and interpretation were more important than a few missed notes squirming on the platform. In that respect, Artur was a real descendant of Anton. And the Latin nations loved him because he had temperament. But the English and Americans! "Ah," says Rubinstein, sorrowfully, "that was a different story. They liked exact playing. They paid for their concert and felt they were entitled to all the notes. Since sometimes I played only thirty per cent of the notes, they felt cheated. The critics found me out."

Rubinstein in those years was unperturbed. "To hell with the German pianists and their exact fingers. Temperament! I was spoiled, I admit it. But as I never have played in Germany since 1914, I at least escaped their criticism." Rubinstein made a vow in 1914, after seeing some of the atrocities in Belgium, that he never would play in Germany. He never has since. His dislike for many Germans, especially Nazi-tainted Germans, has not simmered down. In 1949 he was one of a group of prominent musicians who protested the proposed engagement of Furtwängler with the Chicago Symphony. He claims that there are only two places on the globe he has not visited in the last forty years: Tibet, because it is too high, and Germany, because it is too low.

Anyway, Rubinstein admits, he was occupied with too many things to waste much time practicing the piano. "I adored books, pictures" — his homes in New York and Paris are embellished with Vuillards, Rouaults, and other such little *objets d'art* — "wine, women. I couldn't sit eight, ten hours a day at the piano. When I had to play I would give the music a quick look. I lived for every second. Do you know the preciousness of one second of your life? That's gone for good. You cannot recapture it." (In an interview with a reporter from the *New York Evening Post* in 1939 he gave the following advice to humanity: "What good are vitamins? Eat a lobster, eat a pound of caviar. If you are in love with a beautiful blonde with an empty face and no brain at all, don't be afraid. Marry her!") One time in Cuba he stayed on for an extra week to study the cigar business; he is a connoisseur of tobacco. The natural concomitant was that he didn't waste any time practicing scales. "Take Godowsky. I was awed. It would take me five hundred years to get that kind of mechanism. But what did it get him? He was an unhappy, compulsive man, miserable away from the keyboard. Did he enjoy life? That made me think a bit. A pianist isn't a steel factory, like Pittsburgh." To this day Rubinstein doesn't spend more than three hours a day at the keyboard. "It's useless. The brain doesn't work after that."

He feels that, the way he operates, he can make music a new experience every time he approaches it. "Like marriage." It was his marriage in 1932 that "reformed" him. "I became conscious that my wife and child" —

he now has four children — "might suffer for my sins. And I didn't want people telling my child, after I died, 'What a pianist your father *might* have been!' I started to restudy, to work hard, to apply myself. It showed immediately."

Rubinstein returned to America in 1937 and created a furor that shows no signs of abating. His success came as no great surprise to the record-buying public. His HMV performance of the Tchaikovsky B-flat minor Concerto had been released here in July 1933,* and his performances of the complete Chopin scherzos, nocturnes, and polonaises were released soon after by Victor. (His prewar version of the mazurkas, a phonographic landmark, had to wait until 1940 for domestic release.) Rubinstein admits that these records did his cause no harm in America. Pianists resident here, great ones like Josef Lhevinne, "made tremendous verbal propaganda" about Rubinstein's Chopin and Tchaikovsky. With Rubinstein's American reputation firmly fixed after his triumphant return in 1937, he became a frequent visitor to the Victor studios.

"I adore making records" he says. "It thrills me. I have a feeling of perpetuation." He is nervous in the studio, just as he is nervous before a concert. The nervousness ceases when he sits down to play. "There are two kinds of shakes. One kind is necessary to get you into the blessed state of nervous preparation. You can't become inspired without it. Once on stage I am completely relieved." The other kind of shakes? "The paralyzing kind. If you have that, the only advice I can give is don't play in public."

In the recording studio he is the admiration of all the Victor officials and engineers. "He has everything under control, always," says one recording director. "And when he hears the playback he plays the performance over,

*The Tchaikovsky set, one of Victor's all-time best sellers, had been preceded in America by Victor album M-80, the Brahms Piano Concerto No. 2, released here in July 1930. This was the first example of Rubinstein's playing on the Victor label. He was under contract to HMV until 1938. In 1940 he entered into a contract with Victor. The first all-American Rubinstein album was M-858, Beethoven's *Les Adieux* Sonata, which he recorded on Dec. 31, 1940 in New York and which was released in January 1942.



"He is a natural pianist, with the hand of a natural pianist."

without ever touching the piano. While he is actually recording, he is strictly business. I don't see many of the gestures in the studio that he uses in the concert hall. I'd say it's the 'B' version of his concert act. He's a lot of fun to work with. Talk, talk, talk. But he works hard too. He won't stop until he gets the effect he wants. He has tremendous energy and, believe me, he is never temperamental."

ALAN KAYES, of the RCA Victor staff, calls Rubinstein the soul of courtesy and co-operation. "In the recording studio he works with less inhibition than nearly any artist I have known. Nothing bothers him. I remember a session in the mid-West in 1947. Rubinstein was staying at a hotel where an alumni gathering was going on. *Nobody* got any sleep that night. What a racket! Then the next day there was some sort of air show. Planes kept sweeping in every twelve minutes during the recording session, and every twelve minutes we had to stop. Rubinstein was absolutely unruffled. I was amazed." George Marek, manager of RCA Victor's Record Albums Department, calls Rubinstein a dream to work with and plans to record him heavily in the near future. Rubinstein is playing a concerto series this month in New York — seventeen works for piano and orchestra in five concerts — and RCA is going to put some of those works on LP. Several solo disks will also be forthcoming — one devoted to Spanish piano music, one to Liszt (the *Funérailles*, two *Hungarian Rhapsodies*, and shorter pieces), and one to the Chopin impromptus.

Rubinstein wants very much to finish off his recordings of all the major Chopin works. He already has recorded on LP all the concertos, scherzos, nocturnes, polonaises, preludes, mazurkas, and waltzes. Which leaves the B minor Sonata (he has recorded the B-flat minor), the études, ballades, and a handful of miscellaneous works. He also is eying Schumann intently. "Now I am bound to dig deep into Schumann." He also would like to do some chamber music, including the three Brahms piano quartets, Schubert's E-flat Trio, and the Fauré Piano Quartet in G minor.

Of the many recordings to his credit he likes best his fairly recent version of the Chopin E minor Concerto, with Wallenstein and the Los Angeles Philharmonic. For this he admits satisfaction: "It sounds right to me." Of his prewar recordings, he is proudest of the three-volume set of mazurkas, but considers his re-recording on LP superior interpretatively. He thinks Chopin is one of the most difficult composers to play, but nowhere near as hard as Beethoven or Schubert, and he cites the fugue of the *Hammerklavier* as perhaps the most difficult thing in the repertoire.

"Because," he explains, "the approach is unpianistic. Your unpianistic composers like Beethoven and Schubert are the hardest to play because they ask for things that the accomplished pianist-composer would not dream of demanding. Take the accompaniment to Schubert's *Erlking*. Your right wrist can drop off. When Liszt arranged it he split those repeated patterns between the two hands, so

that the wrist could have a chance to relax. Liszt himself was a great pianist and knew how to space his writing no matter how busy the hands are. Bach is very difficult. Mozart is very difficult. In Mozart everything has to be exact, more than in any composer."

It is difficult to conceive of anything Rubinstein cannot play. Of all living pianists he probably is the most versatile. From Beethoven onward, the world of piano literature is his. He is today's unparalleled Chopinist. His Beethoven is glittering and exciting: witness his fiery new recording of the *Appassionata*. (He has never recorded a late Beethoven sonata.) He is at home with Schumann, Liszt, Brahms, the Spanish composers, the French impressionists, modernists like Stravinsky, Prokofiev, and Szymanowski. His technique, when he wants it to be, is transcendent. He is a natural pianist, with the hand of a natural pianist. He has a broad palm, spatulate fingers, a thumb that can bend far below the right angle granted to ordinary mortals, a little finger almost as long as his middle one, and a mighty stretch that can encompass C to G of the octave above (a twelfth). His tone is his competitors' despair; nobody today can coax a more virile, resonant, and colorful sound from the piano. Rubinstein's tone recalls Rachmaninoff's in its singing intensity, and perhaps Rubinstein patterned it after his great colleague. "I always envied Rachmaninoff his tone," he is frank to admit. But the pianist Rubinstein admired more than any other was Busoni, and that despite the fact that Busoni and he had little in common musically or interpretatively. "I wouldn't want to play the way he did and yet it was magical. Such incredible personality!"

THAT word "personality" means a good deal to Rubinstein. He once was talking about his younger colleagues, and after paying tribute to their skill he threw up his hands. "They come out on the stage like soda jerks," he complained. Nobody has ever accused Rubinstein of coming out like a soda jerk. When he approaches the piano it is a genuine Event. He is the boss, the sagem, the grand duke, the magician. He puts on a show, some of it calculated, some of it part of his very being. His talons rise high in the air and his fuzzy crown of hair bristles as his head rears back. His nose points for the stratosphere like the prow of a jet going upstairs. After five minutes the audience is his. Even when he plays badly — and one sometimes wishes that his three-hour practice sessions had been extended a little more; say three and a half hours — his grand manner has a habit of overpowering anything so silly as rational listening. Not long ago he played the Saint-Saëns G minor Concerto with the New York Philharmonic Symphony, and one had the uneasy feeling that he was making it up as he went along, that he hadn't looked at the music for a generation or so. Which may well have been the case, but somehow it didn't much matter. One bemused critic was overheard mumbling something about the missing notes. "But," he finished, "wasn't it a *beautiful* performance?"

When Rubinstein is in top form he is excelled by no living pianist. He has enough *Continued on page 126*



music makers

by ROLAND GELATT

WHATEVER DAVID OISTRAKH'S views may be on the one-party system, he does not seem to favor monolithic doctrine in his recording commitments. Abroad, this violinist has made records for EMI in England and Sweden, for Deutsche Grammophon in Germany, for Chant du Monde in France,



Oistrakh watches Munch's baton . . .

and for the State Music Trust in Soviet Russia. Here, during the course of a six-week visit, he made records for RCA Victor in Boston and for Columbia in Philadelphia and New York. Perhaps a philosophy of "share the wealth" underlies this phonographic promiscuity. At all events, it has enabled Mr. Oistrakh to be heard on records with a variety of orchestras and conductors.

"Is it really true," he asked incredulously, "that Jascha Heifetz is not permitted to record with the Philadelphia Orchestra and the New York Philharmonic?" Dorle Soria, to whom the question was addressed, acknowledged that this was so. Mr. Oistrakh shook his head. "Poor Heifetz" was all he said, leaving unspoken his evident disapproval of this seeming lack of liberty. For a moment, Mrs. Soria thought she ought to explain the advantages of exclusive recording contracts; but time was short, more pressing business needed to be discussed, and she decided to let Mr. Oistrakh draw whatever conclusions he wanted.

The first Oistrakh recording date in America took place in Boston on

December 9, when he and accompanist Vladimir Yampolsky taped sonatas of Prokofiev, Leclair, and Locatelli. Victor put the record on sale a week later. In the meantime, Oistrakh had been at work again in Symphony Hall, recording on December 14 with the Boston Symphony. There was time on this occasion for only half an LP to be made: the Chausson *Poème* and Saint-Saëns *Introduction and Rondo Capriccioso*. At that, it took four hours before these two pieces were done to Munch's and Oistrakh's satisfaction.

On Saturday, December 24, while the rest of us were engaged in last-minute shopping and Christmas-tree decoration, Oistrakh and Columbia's engineers went to Philadelphia for what proved to be a surprisingly fruitful recording session. The schedule called for two concertos: Mendelssohn's in E minor and Mozart's in



. . . shares potables with Ormandy . . .

D major (No. 4). No one could know how long the session might run, but it looked to be a lengthy one, for the violinist had not played either of the concertos before with Ormandy and the Philadelphians. However, as sometimes but seldom happens at recording sessions, things went smoothly and quickly. By four o'clock in the afternoon, the two concertos had been disposed of, and Oistrakh asked "What next?"

At this point another violinist entered the picture: Isaac Stern, who had been in Philadelphia that week as

soloist with the orchestra and had stayed over to attend the Oistrakh recording session. Stern and Oistrakh had met in Europe several years before and were renewing acquaintanceship in the United States. They had even talked of making a record together, and at 4:00 P. M. on Christmas Eve the opportunity for an Oistrakh-Stern collaboration had arrived. The two violinists declared themselves willing; Columbia's David Oppenheim was willing; Ormandy was willing; and certainly the men of the orchestra (who make about \$19.30 an hour at recording sessions) were willing.

The piece chosen was not Bach's Double Concerto, which Oistrakh intends to record someday with his son, but a Double Concerto in A minor by Vivaldi. This too was recorded without any difficulties. Only two complete takes were necessary, though the work had not been rehearsed or even played before by the orchestra. After the Vivaldi, Oistrakh was still asking "What next?" Whereupon the Philadelphia Orchestra's music librarian produced some more scores and Oistrakh went to work on the Bach E major Violin Concerto. At 8:45, after four concertos and no dinner, the Soviet violinist decided to call it a day.

The next week he was in New York to give the first American performance of Dmitri Shostakovich's new Violin Concerto, Op. 99, with Mitropoulos and the Philharmonic-Symphony. This



. . . trades sour looks with Mitropoulos.

too he recorded — on the morning of Monday, January 2. David Oppenheim, remembering the speedy achievements in Philadelphia, anticipated a short session lasting no more than two hours. It was not to be. Despite a week's previous preparation, there were still many rough spots in the performance of this difficult concerto. The second movement, a scherzo, was taped fourteen times before it received the *nihil obstat* of Oistrakh and Mitropoulos, and the other three movements also had their stumbling places. Indeed, the work was just barely finished in time to clear Carnegie Hall for the "Telephone Hour" rehearsal.

Four days later, Columbia's LP of the Shostakovich Violin Concerto was pressed and ready for distribution. Mr. Oistrakh was able to take a copy of it with him when he left for home on January 7. Only one person took a rather jaundiced view of this production feat, and that was a gentleman by the name of Igor Stravinsky, who has been waiting more than a year for Columbia to issue one of his own recordings. O! most wicked speed, to post with such dexterity to another's score.

THE SHOSTAKOVICH Concerto got a generally bad press in New York and David Oistrakh a uniformly rapturous one. I hope I am not being merely ornery in suggesting that the new piece of music may have been underrated and the violinist overrated. About Oistrakh I am reminded of the story told by Moriz Rosenthal, one of Liszt's most celebrated pupils and a great Chopin specialist, concerning his first encounter with Paderewski. For years and years Rosenthal had been hearing people rave about Paderewski's piano recitals. According to reports, no one had ever played with such scintillating technique, such singing tone, such flaming passion. Rosenthal's curiosity was definitely aroused, and finally he chanced to be in London one day when Paderewski was giving a recital. Needless to say, he went. After the concert his friends wanted to know what Rosenthal thought of the other artist. "Magnificent tone!" he exclaimed. "Impeccable virtuosity! Gripping interpretations! But" — and here Rosenthal's eyes betrayed just the slightest twinkle — "he's no Paderewski."

For me, the visitor from Soviet Russia was a first-class violinist, but

he was no Oistrakh. The build-up had been too spectacular. We had been led to expect a performer with the technical abandon of Heifetz, the tonal charm of Kreisler, and the musical subtlety and imagination of Szigeti: in short, a violinist the like of which the world has never seen. Oistrakh, in fact, turned out to be an exceedingly competent musician, technically gifted, artistically sober, but in no way the superior of several violinists now resident in the United States.

The truth of the matter is that we have almost an oversupply of talented violinists in this country. When an Oistrakh visits us, he is only one among many. Certain parts of the repertoire, notably the twentieth-century Russian school and the eighteenth-century Franco-Italian school, suit his detached and understated style of playing better than others; but not once on the three occasions I heard him (at his debut recital in Carnegie Hall and as soloist with the Philadelphia Orchestra and New York Philharmonic-Symphony) was I overwhelmed by his interpretative powers. His playing was always accomplished, always in good taste, and usually rather dull. But this, I should warn, is definitely a minority view.

IN CONNECTION with the seventy-fifth anniversary of the Boston Symphony, RCA Victor has issued a record entitled *A Musical History of the Boston Symphony and Boston Pops*. It costs 98¢ and is in the nature of a "sampler" LP. Obviously, RCA published it with the idea of promoting new recordings made in Boston and not with the intent of educating the American public. To this, I suppose, one can hardly object. But there is that word "history" in the title — "a branch of knowledge," says Webster, "that records and explains past events" — and as history RCA's *History* shows some limitations.

The malefactions begin on the jacket, where it is stated that the "Boston Symphony's career on records dates back to 1916, when its first discs were made for the Victor Talking Machine Company." In the spoken narration by Milton Cross, however, the listener is told that the "first experimental recording of the voice of a great orchestra" was made in September 1917. "Which of these two statements accords with the facts?" the listener might ask, and the answer would have to be "Neither." The first Boston Symphony recordings were made in

October 1917 and they were not the first such to be undertaken by "a great orchestra"; the Berlin Philharmonic, under Nikisch, had been in HMV's recording studio four years earlier.

Dates are pesky things. Later in the narration we are told that "the great tenor Ferruccio Giannini . . . made the first operatic recording produced by the Victor Talking Machine Company in 1899." Inasmuch as the Victor Talking Machine Company did not exist in 1899 (it was formed in 1901), this statement cannot be entirely valid. Giannini's first operatic disks were made for the Berliner Gramophone Company, not in 1899 but in 1897, and no one (probably not even Giannini himself) would ever have described him as "a great tenor."

As for Koussevitzky's "recording of the billionth Victor record" in 1946, the unwary listener might conceivably conclude that 999,999,999 different Victor recordings had preceded this particular one of Sousa's *Stars and Stripes* in the company's history, whereas of course the *Stars and Stripes* was recorded in honor of Victor's billionth pressing — which is quite a different thing. And what kind of history is it to state that an already published LP of Schubert's *Unfinished* was "recorded on the occasion of the seventy-fifth birthday of the orchestra" when that birthday won't take place until October 22, 1956?

When a record company delves into history, it ought to get the facts straight. This "musical history" might have been a fascinating and instructive record. What RCA has produced is, alas, neither.

LEST I FINISH on a captious note, let me hasten to add that the Boston Symphony itself never sounded better than it did in mid-January under the guest conductorship of Ernest Ansermet. Bartok's *Music for Strings, Percussion, and Celesta*, precise in execution and lyrical in mood, was the *pièce de résistance* of a program that included a cogent, powerful *Jupiter* Symphony and a finely controlled *Bolero*.

Before the concert, M. Ansermet told me about some of his forthcoming disks and about the binaural system that Decca-London now employs at all his recording sessions. He is usually not given to speaking in superlatives, but he used them copiously in describing the sound of these binaural recordings. When, oh when, shall we get to hear them?

Records in Review

Reviewed by PAUL AFFELDER NATHAN BRODER C. G. BURKE
 RAY ERICSON ALFRED FRANKENSTEIN ROLAND GELATT
 JAMES HINTON, JR. JOHN F. INDCOX ROBERT KOTLOWITZ
 JOHN S. WILSON

Classical Music, listed by composer	73	Dialing Your Disks	98
Advertising Index	74	Folk Music	100
Building Your Record Library	85	Music Between	103
Recitals and Miscellany	94	The Best of Jazz	107

CLASSICAL

AUBER

Overtures: Le Domino Noir; Le Cheval de Bronze; Fra Diavolo; Le Muette de Portici

†Saint-Saëns: *Samson et Dalila: Bacchanale*

†Thomas: *Raymond: Overture*

Orchestre des Concerts Lamoureux. Jean Fournet, cond.

EPIC LC 3174. 12-in. \$3.98.

This disk might be described as a French pop concert. Fournet's readings are clear and forthright, but his Auber lacks the real excitement stirred up by Albert Wolff in his recent London recordings, and there are some strange excesses of tempo, both slow and fast, in the Thomas overture. Reproduction is extremely clean and wide-range. P. A.

BACH, JOHANN SEBASTIAN

Chaconne (arr. Busoni); Partita No. 1, in B-flat; Jesu, Joy of Man's Desiring (arr. Hess); Sheep May Safely Graze (arr. Petri); Adagio, from organ Toccata in C (arr. Hess)

Anatole Kitain, playing "The Siena Piano-forte."

ESOTERIC ESP 3001. 12-in. \$5.95.

The lutelike and harplike sounds produced by the "Siena Piano-forte," a reconstructed early nineteenth-century instrument, are attractive and well reproduced on this record. If you do not have an ingrained distaste for the type of transcriptions offered here, as this reviewer does, you may find this disk appealing. The sounds are engaging in themselves, but the connection with Bach is rather remote. N. B.

BACH

Concertos for Harpsichord and Orchestra: No. 1, in D minor, BWV 1052; No. 2, in E, BWV 1053.

Helma Elsner, harpsichord; Pro Musica Orchestra (Stuttgart), Rolf Reinhardt, cond. VOX PL 9510. 12-in. \$4.98.

The D minor is one of Bach's finest harpsichord concertos, with a vigorous and passionate first movement, a brooding Adagio, and a lively finale. The E major is less interesting but still well worth an occasional hearing. Both works are given full-blooded performance here. The soloist has a hearty style and her instrument (a Neupert) makes lovely sounds. In the first movement of the D minor it is sometimes swamped by the strings when it is playing important material, but this imbalance clears up later in the same movement and does not reappear. The orchestral basses occasionally have a rather gruff, indeterminate sound. Whether this is a fault of the players or of the otherwise excellent recording, I cannot say. In any case, it is not consequential enough to prevent this disk from offering serious competition to its only available rival employing the harpsichord — the Haydn Society version with Viderø as soloist. N. B.

BACH: Organ Works — See page 76.

BACH

Prelude and Fugue in E minor (BWV 533); Fantasia in G major (BWV 572); Passacaglia and Fugue in C minor (BWV 582)

Anton Nowakowski, organ.

TELEFUNKEN LGM 65030. 10-in. \$2.98.

Nowakowski favors heavy registrations, so that the lines are sometimes unclear and occasionally are really blurred, as in the last

variation of the Passacaglia. Otherwise he plays straightforwardly and with skill. The coupling he employs in the opening of the Passacaglia gives it an eerie sound; as the piece proceeds he changes registration with every variation, and one finds one's attention drawn to the resources of the instrument (the organ of the Cloister Church at Sorø, Denmark) rather than to the music. N. B.

BACH

Six Organ Sonatas. BWV 525-530

Fernando Germani, organ.

RCA VICTOR LHMV 601. Two 12-in. \$9.98.

These sonatas, says Schweitzer, are "the Gradus ad Parnassum for every organist. Whoever has studied them thoroughly will encounter no further difficulties in either ancient or modern organ literature, having already met and conquered them all in these sonatas." But they are, of course, far more than mere exercises for hands and feet. For here again one may enjoy the inexhaustible inventiveness of Bach's mind as he creates six different works each of which deals with only three voices — usually two lively ones on top and a slower one for harmonic underpinning. While they may not have the emotional power of the chorale preludes and the greatest of the preludes and fugues, their variety and superb construction make them very good listening indeed.

Germani plays them well, and his instrument is clearly recorded. While he usually keeps the three voices distinct — an indispensable requisite for this music — there are times, as in the first two movements of No. 2 or the last of No. 4, when the middle voice is not clear enough. This is probably the fault of the registration chosen in those movements, but it is doubtless the instrument that must be blamed for the indistinct rumbles sometimes emitted by the pedal. N. B.

BARANOVICH*The Gingerbread Heart*†Lhotka: *The Devil in the Village*

Belgrade Philharmonic Orchestra, Kreshmir Baranovich, cond. Orchestra of the Zagreb National Opera, Fran Lhotka, cond.
LONDON LL 1235. 12-in. \$3.98.

These two little suites from ballets by contemporary Yugoslav composers are sprightly and energetic and tuneful, with a good share of what it used to be fashionably cliché to call "motor impulse." The one is mildly Stravinskian (*Petrouchka*), the other more in the nineteenth-century tradition, *Walpurgisnacht* included. Well enough made, they are not works of serious pretensions or very rememberable ideas, but they may hold some passing interest for musicians who wonder what contemporary composition is like in Yugoslavia. J. H., Jr.

BARTOK

Divertimento for String Orchestra — See Müller: *Sinfonia*.

BARTOK

Music for Strings, Percussion, and Celesta
†Kodály: *Háry János, Suite*

London Philharmonic Orchestra, Georg Solti, cond.
LONDON LL 1230. 12-in. \$3.98.

This is the sixth recording of each of these works to be released on LP. It would take many hours to assess it in detail against its competition, but it makes a very favorable impression so far as the Bartók is concerned. The Kodály is extremely full-bodied and rich in sound, but by virtue of that very fact much of the lightness and nimbleness of this comic score is missing. A. F.

BEETHOVEN: *Lieder von Gellert, Op. 48* — See Schubert: *Schwanengesang*.

BEETHOVEN

Sonatas for Cello and Piano, Nos. 1-5
Variations for Cello and Piano: on Handel's "See, the conquering hero comes," G. 157; on Mozart's "Bei Männern," G. 157; on "Ein Mädchen oder Weibchen," Op. 66

Gregor Piatigorsky, cello; Cutner Solomon (in the Sonatas), Lukas Foss (in the Variations), piano.
RCA VICTOR LM 6120. Three 12-in. \$11.98.

Here in one album is Beethoven's music for piano and cello. The sonatas have not hitherto been neglected on records, the aggregate of performances reaching twenty-nine with this edition's increment of five. The three sets of variations have been relatively disdained, though all exist in satisfactory versions. This is the only disk in the catalogue to offer all three on a single side, or indeed on a single record, a forerunner that did this having been taken out of circulation.

The variations occupy Side 6, the reverse of the First Sonata. They are attractive enough, in the crisp, sprightly way Mr. Foss hits the piano against the very dark background of the cello, to give this edition of the sonatas and variations a certain ad-

vantage against the other versions of the sonatas. It may also be true that the sonatas too, in the Solomon-Piatigorsky playing and the consistently good sonics accorded to it, present a somewhat higher average of merit than the average of any other set. The Bogin-Starker and Serkin-Casals editions are hurt by some reticence of the piano, whereas the new offering and the Zecchi-Janigro records are admirable in a union of players which permits no undue deference to either. In any comparison the Schnabel-Fournier disk of Sonatas No. 3, 4, and 5 — old but entirely acceptable in sound — invariably claims affectionate attention (Victor LCT 1124).

Mr. Piatigorsky certainly sounds the gravest quality, the deepest black, of the living cellists who have acquired fame. When this fine linearity is associated with the ebullient animation of the Solomon suppleness, there is a piquancy of opposites married — of giddiness and severity in impatient agreement, of the saraband and the mambo fused. Stimulating. On the major matters of shape and pace there is no conflict. C. G. B.

BEETHOVEN

Sonatas for Cello and Piano: No. 2, in G minor, Op. 5, No. 2; No. 3, in A, Op. 69

Maurice Gendron, cello; Jean Françaix, piano.
LONDON DTL 93036. 12-in. \$4.98.

No. 3 deviates from its expected course into determined delicacy in the first movement and into sport a little breathless in the finale. The concept belittles it, but the playing of the concept is assured. No. 2, music less often played, has not had to suffer a re-examination and is stylized in a less brilliant but more current manner. The very distinct sound of the latter is enormous and dry, with a minimum of environmental influence,

interesting and excellent of the type. No. 3 has conventionally accurate sound. C. G. B.

BEETHOVEN

Sonatas for Piano: No. 4, in E-flat, Op. 7; No. 28, in A, Op. 101

Kurt Appelbaum, piano.
WESTMINSTER 18056. 12-in. \$4.98 (or \$3.98).

Early in 1962, Mr. Appelbaum — continuing an unimpetuous rate of production — will have completed his recording of the thirty-two sonatas of Beethoven. The fourteen vouchsafed have been worth a wait. All are characterized by the basic virtues of clarity and strength, for this is a composer's pianist to whom the most flashing devices of the keyboard are distasteful unless they are relevant. The musical design remains consistently more apparent than the runs and arpeggios which embellish it. This finality and preservation of pattern can be particularly admired in Op. 101, never more transparent; while the thicker but more facile thought of the earlier sonata has a rather matter-of-fact statement neither improper nor displeasing. The piano sound is invulnerable to honest objection in both sonatas. C. G. B.

BEETHOVEN

Sonatas for Piano: No. 8, in C minor ("Pathétique"), Op. 13; No. 23, in F minor ("Appassionata"), Op. 57

Artur Rabinstein, piano.
RCA VICTOR LM 1908. 12-in. \$3.98.

Both sonatas exist in old recordings on separate disks of this pianist, and the *Pathétique* has earned warranted admiration for the way in which an immaculacy of pianism is used to promote sentiment without trespass out of pattern. The present record follows that design but is immensely more effective in the most lifelike piano sound that Victor has ever pressed into a disk.

The *Appassionata* thunders an even more compelling facsimile of the grand piano in breadth and depth. It is hard, however, not to regret the absence of dishevelment from the supernatural poise of the performance. A feeling of security emanates from these heroics so glossy, whereas other pianists (including a number with less commanding skill) blunder into an impotence of apposite danger. Nevertheless, grand pianistics, superb recording, and the best *Pathétique* engraved. C. G. B.

BEETHOVEN

Sonatas for Piano: No. 17, in D minor ("The Tempest"), Op. 31, No. 2; No. 21, in C ("Waldstein"), Op. 53

Jacob Lateiner, piano.
WESTMINSTER 18086. 12-in. \$4.98 (or \$3.98).

This *Waldstein*, admirable in nimble manipulation and in the subtle mutations of its themes, is corroboration of the talent of a young pianist obviously destined to become a great interpreter of Beethoven. That the writer prefers several versions of less episodic appeal and more gradual dramatic development means no more than that concepts differ. In the D minor Sonata, however, a certain constraint may be the inevitable lot of listeners hearing contrivances — the protracted pause, the barely audible pianissimo — more distracting than il-

ADVERTISING INDEX

Acta Corp.	104
Angel Records	72
Audiophile Records, Inc.	103
Capitol Records	89
Chambers Radio Corp.	108
Columbia Records	87
Dauntless International	97
Decca Records, Inc.	95, 99
Duchin, Maurice, Creations Inc.	101
Elektra Records	108
Epic Records	102
Leslie Creations	108
Lippincott, J. B., Co.	77
London International, Inc.	102
London Records	91
Music Box	109
Nuclear Products Co.	107
Perspective Records	108
RCA Victor Division	93
Record Market	108
Record Review Index	106
Robins Industries Corp.	108
Sonotape Corp.	109
Unicorn Records	104
Vanguard Recording Corp.	104
Vox Productions, Inc.	100
Walco (Electrovox Co., Inc.)	105
Westminster Recording Co.	107
Williams Co.	108

luminating. In both, the calm naturalness of the piano sound risks being overlooked among more excitable records, like Miss Katharine Cornell in a group of starlets.
C. G. B.

BEETHOVEN

Symphony No. 1, in C, Op. 21
Great Fugue, in B-flat, Op. 133

Orchestra of the Vienna Staatsoper (in the Symphony), English Baroque Orchestra (in the Fugue), Hermann Scherchen, cond.
WESTMINSTER 18034. 12-in. \$4.98 (or \$3.98).

A good tape has endless fecundity. The inviting, unruffled performance of the First Symphony is that which appeared in 1952 as fourth side to Dr. Scherchen's version of the Ninth. It seemed then the most desirable record of No. 1, and seems better now in a somewhat brighter transference from the tape. Its merits entitle it to pre-eminence with a not dissimilar Karajan interpretation (Angel 35097) and a brash, impatient excursion on Epic 3095 by the Englishman John Pritchard supported by the hottest, most definite sound in the nineteen recordings.

Dr. Scherchen is probably the ideal conductor for an expanded projection of the *Grosse Fuge*, which was the original, shelved finale of the Thirteenth Quartet, but in this opinion the record attains incomplete success. The grief is one of those trifles which loom large because of their position — in this case the failure of the first violins, carrying the transfigured fugal subject, to dominate during the twenty-odd bars of the crescendo that closes the work. A trifle, surely; but those violins have to establish thapsodic triumph as the only valid conclusion to the wonderful, uncouth paean. Here it is rather a conjecture than an establishment. Everything preceding is drawn with remarkable fineness and clarity, the four voices in fact more distinct than they are in the usual performance with only one man to a voice.
C. G. B.

BEETHOVEN

Symphony No. 5, in C minor, Op. 67
†Schubert: *Symphony No. 8, in B minor*
("Unfinished")

Boston Symphony Orchestra, Charles Munch, cond.
RCA VICTOR LM 1923. 12-in. \$3.98.

There is a rich, somber glory in the *Unfinished* Symphony, as the conductor has prepared the orchestra and the engineers have engraved it, that will keep the appeal of this disk green until the next era of the phonograph. Close, powerful timpani, black satin basses, and beautifully organized trombones and horns work a dark tapestry of subtle tints sumptuously correct for the grave movement allowed by the conductor. Not one of the fierce performances (Leinsdorf, Toscanini), and not one of the long-extended, melting exhalations (Jochum, Lehmann) either, but something between, immensely satisfying in conjunction with the appropriateness of the coloration. This department, examining hastily notes on twenty-three versions, would not say that any exists capable of giving a balanced musical experience equal to that conveyed by the newest.

Beethoven's Fifth, in spite of orchestral

splendor and sound of good clean force, is not, on the obverse, of the same imperial kidney. It does not give out conviction, and this may be attributed to *laissez-faire* in the strong accents of the first two movements. And then there is the matter of the repeat of the Exposition in the first movement, essential in this short allegro for the stability of the whole and invariably taken in public performance. Dr. Munch, no doubt at the solicitation of the engineers (the side lasts nearly thirty-two minutes without the repeat) cuts it, thus aligning himself with Prof. Hans Wolf and Prof. Dr. Willis Page in a lonely élite of conductors for LP willing to consider the repeat expendable.
C. G. B.

BEETHOVEN

Symphony No. 7, in A, Op. 92

Wunderkind Among the Goldberg's



Young Glenn Gould communes with Bach, then dances it off during playback.

A REMARKABLE performance by a young Canadian pianist whose name and deeds were hitherto unknown to this reviewer. According to the jacket notes, he hails from Toronto and is in his early twenties. The *Goldberg Variations*, it is perhaps superfluous to say, are no easy nut for a performer to crack. They demand far more than is usually supplied in the way of musical insight, historical knowledge, and fleet-fingered technique. These thirty different elaborations of a profusely ornamented theme are extremely varied, each one having a character of its own. Pianists are usually liable to succumb to the temptation to color them in a way that is possible only on a piano; and they are seldom comfortable with the ornaments. Gould, however, realizes that this is harpsichord music *par excellence*. While he gives each variation its own character, he does not superimpose any pianistic "effects" within the course of a variation.

He has apparently had the good sense to use the excellent edition published by Ralph Kirkpatrick. Although he does not observe every embellishment indicated there, those he does play are exe-

cuted correctly and — what is even more important — so naturally and easily as to leave no doubt that the embellishment in question is an integral part of the music. Everything is beautifully phrased and even the most contrapuntal sections are cleanly and clearly articulated. There is little or no pedal, and consequently no smear. The tempos chosen for some of the variations — such as Nos. 23 and 29 — might strike one as being a little too fast, but Gould plays them with such virtuosity that they are almost convincing. Similarly, Variation 25 might seem a bit slow; the line tends to sag in one or two spots; but there is no denying the deep feeling that Gould sustains throughout this section.

Taken as a whole, this is an extraordinary performance that leaves one eager to hear what else this very gifted player can do.

NATHAN BRODER

BACH: *Goldberg Variations*

Glenn Gould, piano.
COLUMBIA ML 5060. 12-in. \$3.98.

richness of the Philadelphia phalanx serves to fulfill the music and not to distract from it; and the individual strokes not found in the score are few, tasteful, and beneficent. It is a manly and compelling performance, decidedly the best that the present writer has ever heard; and few music-lovers, even those most distressed by the standard Stokowski image, will deny that it is good.

But the sound was too old to resurrect properly, and the LP is atrocious in its multitude of bad noises, impossible to hear without wincing. It is the most eloquent interpretation in the least bearable sonics. Those who can stomach it do not need high fidelity.

In making the disk available Camden has recognized an obligation and given a service. Sunken treasure naturally gathers barnacles. But students can divine a wonderful Seventh under this distortion, and perhaps Dr. Stokowski can be induced to

imitate exactly the best thing he ever did.
C. G. B.

BERLIOZ

Les Nuits d'Été, Op. 7
†Debussy: *La Damoiselle élue*

Victoria de los Angeles, soprano; Boston Symphony Orchestra, Charles Munch, cond.; with Carol Smith, contralto, and the Radcliffe Choral Society (in the Debussy).
RCA VICTOR LM 1907. 12-in. \$3.98.

Victoria de los Angeles has a beauty and purity of voice, plus a sincerity of purpose and sensitivity of interpretative style, that make her performances of almost everything irresistible. Doubtless there will be people who may prefer Berlioz's lyrical song cycle in the more excitingly sung interpretations by Eleanor Steber or Suzanne Danco. By the same token, Debussy's ethereal little cantata may be preferred by some in its fine performance by Bidú

Sayao. Yet I doubt that many will want to pass up this more serenely interpreted disk by the Spanish soprano, who has been excellently supported by Munch, the Bostonians, and the Radcliffe students, with a deep-voiced assist from Carol Smith and superbly balanced sound from the recording engineers.
P. A.

BELLMAN

Nine Songs — See Dowland: *Seven Songs*.

BERLIOZ: *Roméo et Juliette*; *Romeo Alone*; *Grand Fête at Capulet's House*; *Love Scene* — See Chausson: *Poème, Op. 25*.

BOCCHERINI

Quartets: in B-flat, Op. 1, No. 2; in E-flat, Op. 40, No. 2; in E-flat, Op. 58, No. 2; in B minor, Op. 58, No. 4

New Music Quartet.

COLUMBIA ML 5047. 12-in. \$3.98.

When volume is restrained the string quartet as such is as convincingly true as anything in the Columbia catalogue. A strong output from the strong recording brings an acoustic re-enforcement bigger than truth and falsifies the objective raciness of interpretations gauged to the captivating emptiness of music made to please knowing tastes — for there is no more meaning here than there is in a cold brook or the practiced tremor of a pleading underlip. Partial sonata-form bending to the nature of the phrases, airy harmonies, more repetition than exploitation: the foam of the wave that carried Beethoven. Not much in words but seductive in sound, and warmly recommended. The appetite is best whetted with the first movement of Op. 40, No. 2.
C. G. B.

BOCCHERINI

Quintet for Flute and Strings, in E-flat
Sonata for Cello and Piano, in A
Trios for Two Violins and Cello, Op. 35:
No. 1, in F; No. 2, in G

Richard Adeney, flute, and members of London Baroque Ensemble (in the Quintet); Antonio Janigro, cello, and Eugenio Bagnoli, piano (in the Sonata); Walter Schneiderhan, Gustav Swoboda, violins, and Senta Benesch, cello (in the Trios).
WESTMINSTER 18050. 12-in. \$4.98 (or \$3.98).

The covering title is "Chamber Music of Boccherini, Volume I." The record is a redistribution along rational lines of performances that formerly occupied parts of four different disks. In their first guise all received tender comment here, corroborated by a hearing of the new version, improved by a clearer bite in the strings as sounded along the RIAA curve. Gentle, intimate music, played as if for simple diversion, and recommended for the second time. The little quintet is probably the best appetizer.
C. G. B.

BOWLES

A Picnic Cantata

Martha Flowers and Gloria Davy, sopranos; Mareda Gaither, mezzo-soprano; Gloria Wynder, contralto; Alfred Howard, percussion; Gold and Fizdale, pianos.

†Poulenc: *Sonata for Two Pianos*

Gold and Fizdale, pianos.
COLUMBIA ML 5068. 12-in. \$3.98.

Bach on Ancient Organ Pipes

HERE IS A TREASURY of the greatest music ever written for the organ. In other fields — choral music, chamber music, clavier music — Bach was a culmination but not an end. As the eye scans these mountain ranges, the summit created by Bach is followed by other peaks, some not as high, others even higher. But in the range of organ music, from the towering mountain of Bach there is a sharp descent to a flat plain broken only by an occasional hill. Despite all sorts of technical improvements and changes in the instrument, no one in the last two centuries has found anything essential and new to say with it that was not said or implied by the *Allwater* of organ composers. There is hardly another area of musical creation where one man's pre-eminence has remained unchallenged for so long.

Practically all of Bach's important organ works may be found here. Present are the six sonatas (on ARC 3013-14); the magnificent preludes and toccatas and fantasies with their fugues (ARC 3015-20); the great Passacaglia and other large miscellaneous pieces (ARC 3021); the complete Part III of the *Clavier-Uebung* (ARC 3022-24), in which the four *Duetti* are played on a harpsichord; the entire *Orgelbüchlein* (ARC 3025-26); the eighteen chorales "of various kinds" and the six "Schübler" chorales (ARC 3027-29); and three extended individual works (ARC 3030). Lacking are the Eight Little Preludes and Fugues, the six Concertos after various masters, some trios and miscellaneous chorale preludes, and a number of early or doubtful works.

Walcha has long been admired as a performer of Bach. He is here his usual steady, dependable self. His playing is sensitive and intelligent, his registrations varied and tasteful, his technique big enough to encompass the manifold problems of this music with apparent ease — as in the moving setting of *An Wasserflüssen Babylon* with two parts in the pedal (BWV 563b), to name only one example. There are times, in some of the toccatas and fantasies, when a little more fire and abandon would have been welcome, but even here Walcha's steadiness wears well and seldom descends to mere placidity.



Helmut Walcha

The recordings were made from 1947 to 1952 on one or the other of two instruments: the organ built at the end of the seventeenth century by Arp Schnitger for a church in Hamburg and now in the north German village of Cappel, and the smaller of the two organs at St. Jakobi in Lübeck. These seem to be ideal instruments for Bach. Each of the stops has an attractive character of its own. They permit a sharp differentiation of the voices in a transparent texture, and even in the powerful passages of the more monumental preludes the sound remains clear.

It is difficult to single out any of these disks for special recommendation. It seems pretty safe to say that no matter which one you may start with — whether it contains some of the grand preludes and fugues or a group of the miraculous little chorale preludes — you are not likely to remain satisfied with only that one.

NATHAN BRODER

BACH: *Organ Works*

Helmut Walcha, organ.
ARCHIVE ARC 3013-30. Eighteen 12-in.
\$5.98 each.

Four girls pack up a lunch on a Sunday, drive out to a park, eat their hot dogs and pie, loll around reading the paper, and drive home again well pleased with their day's doings. The heroines of James Schuyler's poem bear no names, but one of them must surely have been called Gertrude and another Alice B. Paul Bowles's musical setting is a kind of cross between *Les Noces* and *Four Saints in Three Acts*. The singers belong to the scoop-and-wobble school, but they join in the fun and games with great gusto, and the general results are altogether delightful.

The Poulenc sonata is a new work in the light, gracious, tuneful style of which that composer is past master. A. F.

BRAHMS

Symphony No. 1, in C minor, Op. 68

Hague Philharmonic Orchestra, Willem van Otterloo, cond.
EPIC LC 3155. 12-in. \$3.98.

This is not a conventional version, and the bald contrasts of massive blocks and tenuous mortar realizing the architecture of the first movement, very deliberate, will evoke a ruminated approval rather than a quick enthusiasm. Driving the contrasts deeply, the conductor makes the *poco allegretto* a diffident wisp, not unappealing, to be crushed by the rolling chorale of the finale. Interesting and very well recorded, with the proviso that volume should be high, and higher for the second side than the first, the level having dropped from one to the other. C. G. B.

BRAHMS

Symphony No. 4, in E minor, Op. 98

Detroit Symphony Orchestra. Paul Paray, cond.
MERCURY 50057. 12-in. \$4.98.

The French conductor's records with this orchestra for this company are now a dozen. He has chosen music he can play and has had good luck in the recording. He has strong convictions, which do not always convince. (Beethoven's *Pastoral* Symphony, in a lively canter as he reins it, will certainly seem hopelessly wrong if it does not seem a dazzle of right.) The aggressiveness of concept in the Brahms Fourth is asserted by a square-cut, heavily accented delivery of the two terminal movements, massive blocks in forceful motion; and revealed by brilliant sonics in which the orchestra sounds as if in tiered formation, nothing panoramic about its straightforward thrust into the ear. This is not balance as we recognize it but it is perhaps better, in a splendor of brass and full identity of the woods beyond a concert-hall experience of the throttled instrumentation of the music. It is the most startling version, and perhaps also the best. C. G. B.

BRUCKNER

Symphony No. 4, in E-flat ("Romantic") †Wagner: *Siegfried Idyll*

Vienna Philharmonic Orchestra, Hans Knappertsbusch, cond.
LONDON LL 1250/51. Two 12-in. \$7.96.

For some years now, I have been waiting for the recorded version of Bruckner's Fourth Symphony. Up to now, it was a tossup between Abendroth on Urania and Van Otterloo on Epic, both of whom employed the

composer's original version of the score. Now along comes Knappertsbusch, not with *the* recording but with the best so far. There is less heaviness, more flexibility and true Viennese spirit in his reading than in any of the others. My only quarrel is with the rather fast tempos in portions of the finale; elsewhere everything seems just right. Purists among the Brucknerites, however, may be dissatisfied because Knappertsbusch uses the disputed, somewhat curtailed, and reorchestrated edition of Ferdinand Loewe — at least, that is what it sounds like, though the liner notes impart no information in this connection. In two pressings I heard, the wind instruments come through at times with a distorted warble; the sound is not too bad, however, to mar an otherwise admirable set.

Whereas Knappertsbusch keeps things moving so nicely in the symphony, he practically falls asleep in the *Siegfried Idyll*, which is given a dreamy, uninspired reading. P. A.

CAIX D'HERVELOIS

Two Suites — See Marais: *Five French Dances*.

CHABRIER

Joyeuse marche — See Saint-Saëns: *Danse macabre*.

CHAUSSON

Poème, Op. 25

†Saint-Saëns: *Introduction and Rondo Capriccioso, Op. 28*

†Berlioz: *Roméo et Juliette: Romeo Alone; Grand Fête at Capulet's House; Love Scene*

David Oistrakh, violin (in the Chausson and Saint-Saëns); Boston Symphony Orchestra, Charles Munch, cond.
RCA VICTOR LM 1988. 12-in. \$3.98.

David Oistrakh's first American recording with orchestra may be put down as a smooth-running effort, if not an overwhelming musical experience. The Chausson *Poème* moves along with greater evenness and forward motion than in any recorded version I know, and the Saint-Saëns *Introduction and Rondo Capriccioso* is flawlessly played. What both lack, however, is needful subtlety of nuance and depth of feeling on the part of the soloist. Though pure technique and silken tone contribute enormously, they aren't everything. Victor has not heightened the attractiveness of this record by filling the reverse side with excerpts from Berlioz' *Roméo et Juliette* already represented in the catalogue as part of the complete version and as a contributory side to a *Romeo and Juliet* sampler. If it was impossible for Oistrakh to record something for the other side, Victor might at least have given us a new recording by the orchestra. There must be *something* in the "icebox."

Needless to say, Munch and his men do a fine job, and the reproduction is excellent — always a welcome quality in an Oistrakh disk. P. A.

CHOPIN

Mazurkas and Polonaises

Mazurkas: No. 32, in C-sharp minor, Op. 50, No. 3; No. 20 in D-flat, Op. 30, No. 3; No. 7, in F minor, Op. 7, No. 3; No. 15, in C. Op. 24, No. 2; No. 47, in A minor, Op. 68, No. 2; No. 27, in E minor, Op. 41,

Here's the book you've
been asking for . . .

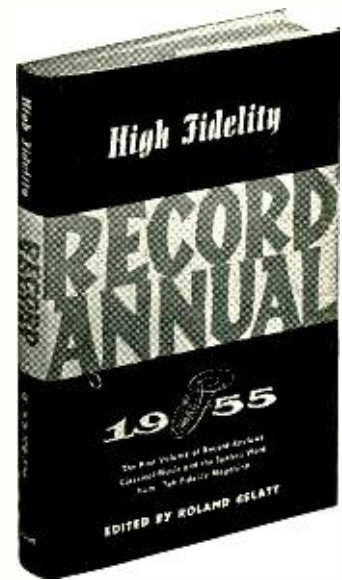

the High Fidelity

RECORD ANNUAL 1955

edited by Roland Gelatt

● Don't fail to get the first volume (containing *High Fidelity* record reviews from July 1954 through July 1955) in what is planned as a permanent and continuing series — the only one which will keep you up-to-date with the thousands of long-playing records released every year.

● These are the reviews that one reader called "marvels of literacy" — delightfully readable as well as fair and accurate audio and musical criticism.

● Edited by Roland Gelatt, the reviews have been entirely rearranged and organized for easy reference. In permanent form they will be a treasured addition to your library as well as an invaluable shopping guide.

Composers (from Albeniz to Zeller) are arranged alphabetically; performers are indexed.

● More information about more records for less money than in any other record review collection — only \$4.95.

Published by J. B. Lippincott.

**SEND FOR YOUR COPY
NOW**

HIGH FIDELITY Magazine
The Publishing House
Great Barrington, Mass.

Please send me, by return mail, a copy of *The HIGH FIDELITY RECORD ANNUAL—1955*. \$4.95 enclosed
Sorry, no C.O.D.s

NAME ..
ADDRESS ..

No. 2; No. 41, in C-sharp minor, Op. 63, No. 3; No. 17, in B-flat minor, Op. 24, No. 4. Polonaises: No. 4, in C minor, Op. 40, No. 2; No. 5, in F-sharp minor, Op. 44; No. 6, in A-flat, Op. 53

Witold Malcuzyński, piano.

ANGEL 35284. 12-in. \$4.98 (or \$3.48).

Mr. Malcuzyński favors a great deal of rubato in the mazurkas. In most cases the effect is intensely interesting; in some cases too much rubato actually changes a 3/4 rhythm to a 2/4 rhythm. The fingerwork is clean and strong; the tone is never ugly and is exceedingly lovely in soft passages. All in all, Malcuzyński makes little tone-poems of the mazurkas, whereas Novaeas and Rubinstein keep them more direct and dancelike. The playing of the polonaises is more strict rhythmically, equally virile and strong. Malcuzyński brings out inner voices but is not always careful about sounding all the notes in a chord — a minor defect. The recorded tone sometimes gets weak at the top of the piano. R. E.

CHOPIN

Nocturnes, Nos. 1-20

Jan Smeterlin, piano.

EPIC SC 6007. Two 12-in. \$9.96.

Mr. Smeterlin has a fair reputation in this country as a Chopin interpreter, and his over-all performances of the lacy, light-in-mood nocturnes have an attractively unsentimental clarity, with enough shading to make them interesting. But he is ill at ease in the nocturnes that are artfully simple, dramatic, or heavily somber. His playing takes on a kind of neuroticism, almost as if he were not fully in control of the music. There are punched bass tones, fading inner voices, stresses on weak tones (and the reverse), rushings into new phrases. Nocturne No. 4, in F, for example, lacks the *tranquillo* quality, as marked; No. 13, in C minor, misses its essential sweep and breadth. Others — Nos. 12, in G; 16, in E-flat; 19, in E minor — come off quite well. The tone is clean but rather dry, and it does not flow freely from one note to the next as it must in these works. R. E.

CHOPIN

Sonata in B-flat minor, Op. 35

†Shostakovich: *Preludes and Fugues, Op. 87: No. 24, in D minor; No. 1, in C; No. 5, in D*

Emil Gilels, piano.

ANGEL 35308. 12-in. \$4.98 (or \$3.48).

This is the Soviet pianist's first American recording, made in New York on October 19 and 20, 1955. The works played here also formed part of his New York recital in Carnegie Hall on October 11. The recorded performance of the Chopin sonata (the one with the Funeral March) is more poetic and less driven than the performance in Carnegie Hall, but it embodies the same large-scale approach to the work. The playing is often exciting in detail, with technical brilliances in the scherzo and in the murmurous finale, and an exquisite tone in the middle section of the Funeral March; but it is the sense of sweeping line, of unity, of a constant movement forward that distinguishes Mr. Gilels' playing. If the level of penetrating ideas about the music is uneven — there could be more variety in color,

and persuasive work in the Ives tradition — the tradition of the hymn and fuguing tune, the folk-song andante, and the jig-scherzo. The *Fiddler's Jig* is a trifle. Schoenberg's *Begleitmusik*, or *Accompaniment to a Film Scene*, is a kind of sinfonietta (not, apparently, composed for any specific motion picture) dealing with "Threatening Danger," "Fear," and "Catastrophe." The music is rather mild in view of its subtitles, but it provides an easy approach to the twelve-tone idiom. The performances are good, the sound mediocre, but no other recordings of these interesting things are likely to appear for a long time. A. F.

Shostakovich went to Leipzig in 1950 to attend a celebration of the tricentennial of Bach's birth. This experience may have inspired him to compose the Twenty-four Preludes and Fugues, Op. 87, which were completed in August 1952 and given their first performance that fall by the composer. Critical reaction in Russia was mixed; New York critics dismissed the three excerpts Mr. Gilels plays here as trivial. This seems

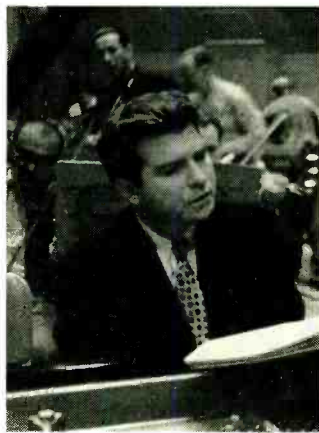

Emil Gilels

a harsh judgment on pieces that are conservative and not world-shaking but are decidedly listenable and well-made. The big double fugue in D minor and the quiet, poignant prelude in C are fine compositions. I, for one, hope Mr. Gilels will record more of them.

The piano tone is excellent but smacks a little of the studio in the way it clings to itself instead of projecting straight out. R. E.

COUPERIN

Messe solennelle (For Use in Parish Churches)

Gaston Litaize, organ.

LONDON DTL 93039. 12-in. \$4.98.

This is the more elaborate of two organ Masses that Couperin wrote at the age of twenty-one. It consists of a series of couplets or *versets*, mostly designed to be interpolated among the sung portions of the service. The music is rather uneven in quality, but at its best it is of an astonishing richness for so young a composer. Much of it is contemplative in character, but there are also couplets that are active and vigorous and others that are majestic. In some sections the melody seems to wander a bit, others are tightly constructed. The disk is especially welcome because it represents a little-known aspect of this master's output. The organ of St. Merry in Paris sounds better here than under the hands of Marie-Claire Alain in her Bach recordings. Even the high reeds are less shrill, perhaps because they are seldom employed at full volume. N. B.

COWELL

Symphony No. 10; Fiddler's Jig

†Schoenberg: *Begleitmusik, Op. 34*

Vienna Orchestral Society, F. Charles Adler, cond.

UNICORN 1008. 12-in. \$3.98.

Cowell's symphony is a relaxed, mellow,

and persuasive work in the Ives tradition — the tradition of the hymn and fuguing tune, the folk-song andante, and the jig-scherzo. The *Fiddler's Jig* is a trifle. Schoenberg's *Begleitmusik*, or *Accompaniment to a Film Scene*, is a kind of sinfonietta (not, apparently, composed for any specific motion picture) dealing with "Threatening Danger," "Fear," and "Catastrophe." The music is rather mild in view of its subtitles, but it provides an easy approach to the twelve-tone idiom. The performances are good, the sound mediocre, but no other recordings of these interesting things are likely to appear for a long time. A. F.

DEBUSSY

La Damoiselle élue — See Berlioz: *Les Nuits d'Été*.

DEBUSSY

Petite Suite (trans. Büsser) — See Roussel: *Bacchus et Ariane*.

DEBUSSY

Quartet in G minor

†Ravel: *Quartet in F*

Curtis String Quartet.

WESTMINSTER 18049. 12-in. \$4.98 (or \$3.98).

Brusque, heavy-footed, and rather acidulous-sounding performances of two works that demand finesse, understatement, and suavity in their execution. The same coupling can be heard more advantageously in recordings by the Budapest String Quartet (Columbia) or the Stuyvesant String Quartet (Philharmonia). R. G.

DOWLAND

Seven Songs (arr. Dorumsgaard)

†Bellman: *Nine Songs* (arr. Dorumsgaard)

Richard Lewis, tenor (in the Dowland); Aksel Schiøtz, baritone (in the Bellman); Jacqueline Bonneau, piano.

LONDON TW 91067. 12-in. \$4.98.

Carl Michael Bellman, one of Sweden's great poets, set some of his verses to music, either borrowed or invented by himself. The present group of his songs are from a cycle that appeared in 1791. They are simple and charming. In style they remind one sometimes of Haydn, sometimes even of Schubert. One or two are declamatory and the rest are melodious. I cannot tell you what most of them are about because they are sung in Swedish, no translations are supplied, and my knowledge of the language is practically restricted to "Skoal!" Nor can I judge the extent of Dørumsgaard's contribution. Nevertheless, in Schiøtz's smooth and effortless performance they are delightful.

The Dowland songs are all on a very high level, and they are pleasantly sung, but the accompaniments have been rather heavily elaborated by Dørumsgaard and bear little resemblance to the originals. N. B.

DUKAS

The Sorcerer's Apprentice — See Saint-Saëns: *Danse macabre*.

DURANTE

Divertimento in F minor — See Pergolesi: *Concertino in G*.

ELGAR

Three Bavarian Dances, Op. 27; Chanson de Nuit, Chanson de Matin, Op. 15

London Philharmonic Orchestra, Sir Adrian Boult, cond.
LONDON LD 9193. 10-in. \$2.98.

If Elgar's reputation were based solely on works of this stamp, he would be classed as one with Hamish MacCunn and Edward German. They are light, tuneful, expertly orchestrated pieces, and would sound very engaging at a Prom concert on a soft mid-summer night in London. For that matter, they sound engaging here; the playing and recording is first-rate. R. G.

FAURÉ

Pelléas et Mélisande, Suite, Op. 80 — See Roussel: *Bacchus et Ariane*.

FRANCK

Grande pièce symphonique — See Reubke: *Sonata for Organ*.

FRANCK

Three Chorals; Prelude, Fugue, and Variation

Ernest White, organ (Möller organ at the Church of St. Mary the Virgin, New York City).
DISCURIOSITIES BCL 7280. 12-in. \$5.95.

The first and third Chorals are fantasia-like in their treatment; the middle one takes the form of a chaconne or passacaglia on a theme not unlike that used by Bach in his Passacaglia and Fugue in C minor. White plays these works with taste, though there are moments when more interpretative excitement would have been welcome. His registration is always varied sufficiently to hold the listener's interest, and he never interrupts a musical idea by choppy phrasing or shifts of stops. The organ tone, while well reproduced, with not too much reverberation, is a bit weak in the bass. Competing versions of these works are not at hand for comparison, but the present disk should do very nicely for those who want this lovely music in their libraries. P. A.

FREDERICK THE GREAT

Sonatas for Flute and Harpsichord: No. 2, in C minor; No. 5, in A
†Quantz: *Sonatas for Flute and Harpsichord: No. 2, in B-flat; No. 4, in D; No. 5, in E minor*

John Wummer, flute; Fernando Valenti, harpsichord.
WESTMINSTER 18070. 12-in. \$4.98 (or \$3.98).

The royal sonatas are neatly put together out of rather undistinguished materials. One wonders how much their smooth construction owes to Quantz, the king's teacher and author of a great treatise on flute playing and performance in general. Quantz's own sonatas are much more interesting, melodically, rhythmically, and contrapuntally. Wummer plays all of these works with his customary skill and fine tone, enhanced — as always with this artist — by a complete absence of breath noises. A few whiffs of pre-echo on the Quantz side. N. B.

GEMINIANI

Concerti Grossi, Op. 3 (Complete)

English Baroque Orchestra, Hermann Scherchen, cond.

WESTMINSTER 18002. 12-in. \$4.98 (or \$3.98).

In the reference books Geminiani is usually characterized as lacking in individuality and important chiefly because of his treatise on violin playing, one of the earliest of that kind. It is perfectly true that these concerti grossi are not in a class with those of Bach and Handel, nor are they equal to the best of Vivaldi. But to ignore them entirely would be to miss some lovely music, dignified but not dry, melodious, and skillfully put together. I found them all attractive, and was especially impressed by the grave and poetic second slow sections of Nos. 2 and 3, the fine fugue of No. 3, the charming gigue in No. 4, and the expressive sequences in the last section of No. 6. Scherchen performs them with precision, warmth, and vitality. N. B.

GERSHWIN

An American in Paris; Porgy and Bess, Symphonic Suite (arr. Robert Russell Bennett)

Philharmonia Orchestra of Hamburg, Hans-Jurgen Walther, cond.
M-G-M E 3253. 12-in. \$3.98.

Nothing delights this reviewer more than to discover a recording that he fears will be hopeless turning out in fact to be not only acceptable but positively good. This German version of Gershwin's *An American in Paris* is a case in point. Expecting a heavy-handed, *echt Deutsch* treatment, I was treated instead to a spirited and rhythmically secure performance that bounced along with enough Franco-American *esprit* to rank it with many performances by American orchestras, under American conductors, now to be found on records. Walther occasionally lingers over small

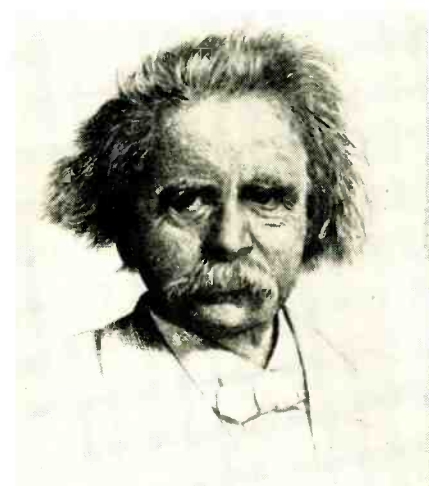

Edvard Grieg

interior details a trifle too affectionately, but otherwise the work is altogether firmly and skillfully managed. Not quite so successful is the handling of the music from *Porgy and Bess*, which has a tendency to sound slightly confused in tempo, and has something less than ideal clarity of instrumental voices. Even so, this is far from a negligible version.

M-G-M's sound is extremely good, and a word should be added about the interesting

liner notes concerning this recording and its part in the renaissance of West Germany's interest in the music of Gershwin.

J. F. I.

GERSHWIN

Rhapsody in Blue; Concerto for Piano and Orchestra, in F

Julius Katchen, piano; orchestra, Mantovani, cond.
LONDON LL 1262. 12-in. \$3.98.

Rhapsody in Blue; Concerto for Piano and Orchestra, in F; An American in Paris; Suite from Porgy and Bess (arr. Morton Gould); *Preludes for Piano; Piano solo from Porgy and Bess*

Morton Gould, piano; orchestra, Morton Gould, cond.
RCA VICTOR LM 6033. Two 12-in. \$7.98.

Whoever had the idea of turning over these two popular Gershwin scores to the hands of Mantovani should be made to listen to the result of his brainwave for a week, with no possible chance to escape. That should "larn" him. Two more precious performances cannot be imagined, for in addition to tampering with the score of the *Rhapsody*, the conductor has redistributed the orchestral parts — and you know where — with results that can easily be imagined. The phrases are grotesquely distorted, and the whole performance sounds as if it were regulated by traffic lights, being strictly of the stop-and-go order. Katchen has little option but to go along with this rhythmically distorted affair, though his own performance, technically efficient, is not above some reproach where matters of phrasing are concerned. London, of course, has lavished beautiful sound on this absurd concoction.

In the curiously titled RCA Victor album *The Serious Gershwin*, which does not include either the *Cuban Overture* or the *Second Rhapsody*, but does include the Gould-arranged suite from *Porgy and Bess*, we are also offered performances of the *Rhapsody* and the Piano Concerto — with Gould as conductor and pianist. These are considerably more valid realizations, even though they expose the pianistic limitations of Gould as a Gershwin exponent. Both orchestral scores go much better. The *American in Paris* and the *Porgy and Bess* Suite, have good momentum and rhythmic security. Clean, but extremely shallow sound is not much help here. J. F. I.

GRIEG

Music for String Orchestra

From Holberg's Time, Op. 40; Two Lyric Pieces, Op. 68, Nos. 4 and 5; Two Elegiac Melodies, Op. 34; Two Melodies After Original Songs, Op. 53; Two Norwegian Melodies, Op. 63.

Arthur Winograd String Orchestra, Arthur Winograd, cond.
M-G-M E 3221. 12-in. \$3.98.

This happily inspired disk contains all of the enchantingly beautiful music that Edvard Grieg wrote for string orchestra. Despite the fact that these tuneful, hauntingly harmonized, often folklike pieces are eminently suited to the medium of the string orchestra, they are all reworked Grieg, inasmuch as the composer transcribed them either from songs or piano com-

positions. No matter; they are among the loveliest creations in the entire string repertoire.

Arthur Winograd's readings are careful, perhaps a bit reserved, but in the best taste. The playing too is fine, but as usual M-G-M's studio sound is too cramped for a group of this size. P. A.

GRIFFES

Roman Sketches; Three Tone Pictures; Fantasy Pieces

Lenore Engdahl, piano.
M-G-M E 3225. 12-in. \$3.98.

The fastidious, lyrical impressionism of Griffes is matched here by a performance of marvelous sensitivity, penetration, and technical resourcefulness. The titles of the pieces amply characterize the music, much of which is well known. First of the *Roman Sketches* is the famous *White Peacock*; then come *Nightfall*, *Clouds*, and *The Fountain of the Acqua Paola*. The *Three Tone Pictures* are *The Lake at Evening*, *The Vale of Dreams*, and *The Night Winds*. The three *Fantasy Pieces* are called *Barcarolle*, *Notturmo*, and *Scherzo*. A better

interpretation than Miss Engdahl's is difficult to imagine. So is a recording of the piano with a finer scale of nuance. A. F.

HARRIS

Fantasy for Piano and Orchestra

Johana Harris, piano; M-G-M Symphony Orchestra, Izler Solomon, cond.

Abraham Lincoln Walks at Midnight

Nell Tangeman, mezzo-soprano; Johana Harris, piano; Samuel Thaviu, violin; Theo Salzman, cello.

M-G-M E 3210. 12-in. \$3.98.

The *Fantasy* is a beautifully written piece. It is based on folk themes, which Harris does not always handle well but which he handles superbly in this instance. Excellent, big, and important as the *Fantasy* unquestionably is, it is surpassed by the "cantata of lamentation" on the other side. This work, a setting of Vachel Lindsay's poem of the same title, embodies the same marvelous length of line that is to be found in Harris' famous Third Symphony, but treated much more lyrically and quietly as befits the ensemble and the subject. Wonderful singing and playing and a fine regis-

tration on the disks, but the absence of Lindsay's text from the sleeve is highly regrettable. A. F.

HAYDN

Concertos for Clavier and Orchestra, in D; in G; in F

Concertino for Clavier and Orchestra, in C

Robert Veyron-Lacroix, harpsichord; Vienna Staatsoper Orchestra, Milan Horvat, cond.
WESTMINSTER 18042. 12-in. \$4.98 (or \$3.98).

The D major Concerto is of course the "Op. 21," all dash and confidence, the one that works overtime in public concert as the single Haydn representative of the form. The work in G has been recorded to less advantage by the Haydn Society. The F major Concerto is not the same as the F major Concerto on Period 556. This and the effervescent Concertino are new to records.

All four have the dart and color of a rainbow trout but are less useful. They decorate existence now even more than they did when their type was a true reflection of an aspect of an era. If a shrewd and disgusting editor had called them, respec-

The Fourth Modern Messiah Comes from Boston

BOSTON, a city of many singularities, some of which her people are willing to recount, was a center of true intellectual and cultural drive until about 1910. This often took crazy directions, but was vital for two centuries and a half. Among her great pre-Curley institutions are the Library, the Museum, the Symphony, and the Handel and Haydn Society.

Founded in 1815, a few months after the most respectable rascals of Massachusetts had seen their treason — which for the rest of their lives they tried to have called by a softer name — aborted by Jackson at New Orleans and by the Treaty of Ghent, this choral Society has managed to maintain itself until now in the forefront of musical organizations in its city and state, hand-in-hand with the Symphony latterly, in spite of intermittent frustrations and vicissitudes. It is as much a Boston institution as the Common, and is praised by thousands who have never heard its work.

Its first concert was devoted to Handel, to Haydn, and to George I. Webb. In its third year the Society gave the first complete *Messiah* heard in the United States. *Messiah*, *Elijah*, and *The Creation* have been its staples ever since. This is the way of venerable choral societies.

In view of the multitude of competing editions, and the magnificence of several, the project of recording a new *Messiah* — whose first appeal one is bound to suspect must be parochial, whatever its merit — demanded pride, confidence, and courage. However, those qualities are common to good forgers and poor poets. Let's listen to the records.

The Unicorn edition frankly admits the omission of a dozen numbers from the oratorio, a practice commonplace in public performance and in all the recorded editions except three, although the excisions are not identical with those in any other recorded version. The scoring is an adaptation



LENSCRAFT PHOTOS: INC.

Adele Addison: "... prettiest moments."

of Franz's adaptation, with a discreet and occasional interpolation of winds not prescribed in the original. A harpsichord, indispensable for proper performance, and the organ, helpful to any performance, are both used. Overwhelmingly the orchestral body is of strings, which is what Handel established for *Messiah*. No other edition employs exactly the scoring here, the greatest similarity being in the London version conducted by Sir Adrian Boult, a more massive production.

Credit for the orchestral playing on these disks is given to the Zimmler Sinfonietta, an expert splinter of the Boston Symphony Orchestra. Here we have something heart-warming, in the nature of a barn-raising, for the deep ruddy velvet of the strings here is beyond the capacity of a reduced group like the Zimmlers to produce without help. It

looks very much as if a substantial group of friendly neighbors, luckily carrying viols, happened into the recording sessions, stayed to lend a hand, and somehow blundered into a glossy perfection of tone and a remarkable unity of spirit and enunciation. No other recorded *Messiah* matches this orchestral uncton.

The soloists are competent singers, with the prettiest moments coming from the soprano, and the well-trained chorus is flexible beyond the demands of the conductor. Not that the conducting is of the hangdog sort we have to submit to in most of our churches. It is admirably lyrical and not wanting in tempest, but has a contentment in tempos and dynamics obtained static for the variable requirements of the husky, holy melodrama. A Godly subject is usually deadly to conductors, who have discovered that pursed lips and a steady beat give less offense than rapture. In Mr. Stone's behalf let it be insisted that he has infused an extraordinary quota of feeling into a *Messiah* re-created in a region where rapture has always been proscribed.

Pure, sweet, trouble-free sound has been given to the performance, reverberant without excess, and particularly kind to the long lyrical line. Volume is low in the grooves and will have to be augmented above the usual degree.

In sum, a good *Messiah*, galvanic for Boston. Let us not, however, condone the excising because the residue is good. No matter what is removed from this oratorio, it is no less wonderful than what remains.

C. G. BURKE

HANDEL: *Messiah*

Adele Addison (s), Lorna Sydney (a), David Lloyd (t), Donald Gramm (bs); Chorus of the Handel and Haydn Society (Boston) and Zimmler Sinfonietta, Thompson Stone, cond.

UNICORN UNS 1. Three 12-in. \$11.98. It

tively, "Soda-Jerk," "Thruway," "Stripper," and "Vegas," redolent of contemporary pep, Messrs. Westminster would have been engulfed by encomiums and buried in gold. There is still time for an editor to do that. The only time that Haydn made *Life* was in an account of the decapitation of his cadaver.

Lacking the shrewd educative editor, we shall have to accept the four lovely designs as designs only. They are earnestly recommended to everyone wary of "significance." Played with a calculated delay of brilliance until the time for it, solidly registered without strain, conductor and soloist in accord and the harpsichord with a minimum of metal, the four delectations find in this disk a home of refined and subtle pleasure, fit for homes where refinement is a pleasure.

C. G. B.

HAYDN

Smaller Pieces for Clavier

Andante varié in F minor; Arietta and Variations, in A; Arietta and Variations, in E-flat; Capriccio in G; Fantasy in C; Theme and Variations, in C.

Nadia Reisenberg, piano.
WESTMINSTER 18057. 12-in. \$4.98 (or \$3.98).

All are new to LP except the F minor *Andante* and Variations. The others have been excluded hitherto presumably in deference to the traditions of public performance. They do not roll enough thunder to make a big hall gape. But they are packed with fancy and invention allied to taste, and strew bright patterns in resourceful alterations lively with unexpected notions.

No other Haydn record of the solo piano strikes the memory as comparable to this one in the precise mirroring of small piano-sound, or in the unruffled, obstinate refinement of the feathered filigrees whirled into a classic geometry by Miss Reisenberg. Why have we had no other Haydn from her, and why no Mozart?

Unluckily a fly is in the unguent. The record is long—fifty-six minutes—and the groove is fine, its walls thin. Sonic seepage, pre-echo and echo, is constantly audible. It is a concurrence mocking the delicacy of the playing, and it may be fatal to the pleasure of many listeners. Many who can close their ears to the intrusion will hear a great record.

C. G. B.

JANACEK

Concertino for Piano, Horn, Clarinet, Bassoon, Two Violins, and Viola *Mladi (Youth Suite)*

Rudolf Firkusny, piano; Mason Jones, horn; Anthony Gigliotti, clarinet; Sol Schoenbach, bassoon; Jacob Krachmalnick and David Madison, violins; Samuel Lifschey, viola (in the *Concertino*). Philadelphia Woodwind Quintet and Leon Lester, bass clarinet (in *Mladi*).

COLUMBIA ML 4995. 12-in. \$4.98.

As I reported in the March 1955 issue, the *Concertino* by the late Czech composer Leos Janáček, written when he was seventy-one, is full of youthful vitality, with many highly original but palatable rhythmic and melodic ideas that remind one by their strength and folkishness of Bartók. Firkusny and six members of the Philadelphia Orchestra give a remarkably polished in-



JAMES ABRESCH

Nadia Reisenberg: a revelation in Haydn.

terpretation of this attractive work, though they may lack just a bit of the fire to be found in the earlier recording by Franz Holetschek and the Barylli Ensemble for Westminster.

What makes the present disk more desirable—to me, at least—is the music of matching interest on the other side. Again, don't let the word "youth" fool you; *Mladi* was written only one year before the *Concertino* and is marked by many of the same fine qualities as the latter. The crystal-clear reproduction affords an opportunity to hear the polished Philadelphia woodwinds in all their tonal beauty. The Westminster disk contains, instead, two more serious works for violin and piano—the *Dumka* and *Sonata*—both played by Walter Barylli and Holetschek. Actually, you won't go wrong with either record, as each offers the chance to hear worth-while music by a neglected master.

P. A.

JONGEN

Concerto for Piano and Orchestra, Op. 127

Edvardo del Pueyo, piano; Orchestre National de Belgique, Fernand Quinet, cond.
LONDON W 91081. 10-in. \$2.98.

The spirit of César Franck must hang over the town of his birth, Liège, Belgium. Joseph Jongen (1873-1953), another native of Liège, not only studied in Belgium but spent nearly all his life there; and the Franck-Chausson style is very predominant in this, his only piano concerto. The work is well put together, with a nice balance between the purely musical and the purely display elements. It is also very pleasant to hear once or twice, but is neither very profound nor very strong on originality. The performance seems adequate, though its limited tonal range suggests that it is not very new.

P. A.

KODALY

Húry János, Suite—See Bartók: *Music for Strings, Percussion, and Celesta.*

LALO

Namouna: Ballet Suites Nos. 1 and 2

London Philharmonic Orchestra, Jean Martinon, cond.

LONDON LL 1268. 12-in. \$3.98.

When Edouard Lalo's ballet *Namouna* had its Paris premiere in 1882, it was said that the musicians could not play it and the dancers were unable to perform to it. This sounds like another example of Parisian critical politics—which it was—for the music is certainly not difficult to comprehend, nor could it have been at that time, and most of the movements in the two suites that Lalo made from the score are very balletic in character and rhythm. Nothing very great here, to be sure, but some entertaining, above-average ballet music, expertly performed by a man who has a flair for such things.

P. A.

LALO

Symphonie espagnole, Op. 21

David Oistrakh, violin; Philharmonia Orchestra, Jean Martinon, cond.

ANGEL 35205. 12-in. \$4.98 (or \$3.48).

Oistrakh's account of the *Symphonie espagnole* is smooth-textured and very clean, but it sometimes lacks the necessary Spanish fire and rhythmic kick. Its main virtue is that it includes all five movements, whereas other versions—Menuhin's excepted—omit the third movement. This makes Oistrakh's recording run to two full sides. If you want the work complete, this is an eminently acceptable version.

P. A.

LASSUS

Missa Puisque j'ay perdu—See Palestrina: *Missa Veni Sponsa Christi.*

LHOTKA

The Devil in the Village—See Baranovich: *The Gingerbread Heart.*

LISZT

Hungarian Rhapsodies, Nos. 3, 4, and 6

Philharmonic Symphony Orchestra of London, Hermann Scherchen, cond.
WESTMINSTER W-LAB 7007. 12-in. \$7.50.

This is the second of Westminster's Laboratory Series disks to be devoted to a group of Liszt's *Hungarian Rhapsodies* presented in the composer's rarely heard original orchestration. In this respect, it is interesting to hear the dulcimerlike Hungarian cimbalom in the Rhapsody No. 4. Scherchen avoids all mannerisms in interpreting this music. His straightforward treatment is always clear; and though it may occasionally lack excitement, it is never dull or routine. The record's outstanding feature, however, is the definition of its sound, which is clean, extremely faithful, yet not too brilliant for complete naturalness. To one pair of ears, this is the most successful of the Laboratory Series thus far, even if the Sixth Rhapsody is split between record sides.

P. A.

MALIPIERO

Quartet No. 4

†Prokofiev: *Quartet No. 2, in F, Op. 92*

Quartetto Italiano.

ANGEL 35296. 12-in. \$4.98 (or \$3.48).

Malipiero is quoted on the jacket of this recording as saying that his Fourth Quartet is an interlude in the sequence of his seven works for four strings. Its mood is quieter

and more nostalgic than that of the others, but it is an equally masterly expression of the same distinguished, aristocratic style. It recalls the Italian madrigalists of the sixteenth century, brings in touches of folk song and folk dance as it proceeds along its copiously inventive way, and is, in general, as felicitous and beautiful a quartet as the modern literature affords. Its performance by the Quartetto Italiano is completely authoritative and the recording is excellent.

The performance of the Prokofiev work, based on Caucasian folk themes, lays special emphasis on the exoticism and pungent color of the music somewhat to the neglect of its strength. A. F.

MARAIS

Five French Dances; Suite in D minor
†Caix d'Hervelois: *Two Suites*

Paul Doktor, viola; Fernando Valenti, harpsichord.

WESTMINSTER 18088. 12-in. \$4.98 (or \$3.98).

Of the French dances by Marin Marais, three are particularly attractive — the charmingly melodious *L'Agréable*; *Le Matelotte*, which manages to be jaunty in a melancholy sort of way; and the cheerful *La Basque*. His Suite includes a fine set of variations on *La Follia*, followed by a gay little movement tantalizingly called *L'Américaine*. One wonders what Marais had in mind in choosing that title (this music was written around 1700). The two suites by Louis de Caix d'Hervelois are noteworthy for the songlike character of some of the melodies, such as that of the little set of variations that begins the Suite in A major. All of these pieces, which were written for the gamba, are nicely played by the able Doktor on a viola and discreetly accompanied by the dependable Valenti. N. B.

MONIUSZKO

Halka (in Polish)

Antonina Kawecka (s), Halka; Felicia Kurowiak (s), Zofia; Waclaw Dominiacki (t), Jontek; Juliusz Bienkowski (t), a Peasant; Marian Woznicko (b), Janusz; Antoni Farulewski (b), the Bagpiper; Edmund Kossowski (bs), Stolnik; Josef Michalla (bs), Dziemba. Chorus and Orchestra of the Polish National Theater (Poznan), Walerian Bierdiayew, cond.

COLOSSEUM CRLP 188-189P. Two 12-in. \$7.96.

Halka (in Russian)

Natalia Sokolova (s), Halka; Irena Maslennikova (s), Zofia; Georgi Nelepp (t), Jontek; Jan Dolgy (t), a Peasant; Pavel Lisitsian (b), Janusz; Grigori Korotkov (b), the Bagpiper; Mikhail Soloviev (bs), Stolnik; Stanislaw Krasovski (bs), Dziemba. Chorus and Orchestra of the Bolshoi Theater (Moscow), Kiril Kondrashin, cond.

COLOSSEUM CRLP 188-89. Two 12-in. \$7.96.

The old order changes, and in these LP days the hearable operatic repertoire still continues to expand—in all directions. Now it is apparently Poland's turn for attention, at least insofar as there is a turn, operatically speaking, for Poland to have. Time was when to have heard Stanislaw

Moniuszko's *Halka*, or even three notes from it, was a real distinction in this country. But now two full-length recorded performances of the opera are to be had, both issued by Colosseum, one taped in Poland, the other in Russia.

It is difficult for a non-Slav to evaluate the relative artistic merits of the two. Both performances, though they differ somewhat in choice of tempos and in other matters



of style, have the solid ring that comes of routinizing in established conventions; neither is well enough engineered for recorded quality *per se* to make much difference. By rule of thumb, the Polish performance *ought* to be the authoritative one, even though the Moscow cast average out somewhat better vocally. And, though it may be blind prejudice that makes it seem so, it is the Polish performance that has, in the long run, the better feel musically and more real dramatic conviction.

Halka, which had its premiere in 1847, is — like most East European operas of its time — a blend of the academic usages of the early nineteenth century and deeply felt national colorations. In the course of growing up musically, Moniuszko acquired a sound Berlin-made technique, along with a vast admiration for Cherubini and a contempt for what he regarded as the insincerity of Meyerbeer. Hans von Bülow was not far wrong about the notes in it when he described *Halka* as being a French opera written with a German *Kapellmeister* technique. But it is something rather more than that, too. For Moniuszko was basically both a nonurban Pole and an honest man, and there is about *Halka* a kind of passionate, peasantlike sincerity that goes far to show why his admirers call him "the Polish Verdi."

The story is simple — so simple, in fact, that when the music does not carry it in terms of emotional reactions it seems a little dragged-out in the telling. *Halka* is a peasant girl who has had a baby by her feudal overlord, Janusz, and is so naïvely in love that she cannot quite comprehend why he fails to marry her (the charming album notes explain that in those times such a marriage was a "physical impossibility"). Jontek, a young peasant boy who loves her, tries to explain the facts of life, but she will not understand and keeps embarrassing everyone, particularly Janusz, by singing insanely allegorical songs about her betrayal. She is, in fact, the maddest of all operatic heroines; she has only a few lucid bars during the whole opera, which ends with her drowning herself in the Vistula just as Janusz and his noble bride come out of the church to the strains of what the notes describe as a "semi-gay" wedding chorus.

As said before, the casts of both sets know their business, and though the engineering of neither version is any better than the depressing average of all save a few exceptional Soviet-area recordings, it ought to be possible to endure the lumpy bass and splintery highs and general whangy distortion in the interests of hearing a work that has as much merit as *Halka* does. All told, the Polish sound, while not good, seems easier to compensate to a listenable point; but that too may be a subjective and hence variable matter. The opening ensemble is as good a place as any for prospective buyers to check characteristics. Text in translation, with (in the Polish set) a copy of the text as sung. J. H., JR.

MONTEVERDI and MARENZIO

Madrigals on Texts from "Il Pastor Fido"

The Golden Age Singers, Margaret Field-Hyde, dir.

WESTMINSTER WLE 105. 12-in. \$5.75.

Il Pastor Fido, a tragicomic pastoral play by Battista Guarini, was first published in 1590. It became enormously popular, and its vogue did not end until late in the eighteenth century. Many composers, including Schütz and Carissimi, set various of its lines to music, and Vivaldi published a collection of sonatas called *Il Pastor Fido*. It was a very interesting idea on Westminster's part to present six passages from the play as set to madrigals by Claudio Monteverdi on one side, and the same six as set to madrigals by Luca Marenzio on the other. It gives us a good opportunity to compare the styles of two of the great masters of the form at the end of its development in Italy.

Marenzio is the older of the two, and his music is more elegant, the polyphony more finely wrought, the expressiveness a little impersonal though at the same time intense, as in *Cruda Amarilli*. Monteverdi's music is more passionate, his bass line tends to be more a harmonic support than an independent voice, and his expressiveness is more direct, more "modern," as in the moving *Ab dolente partita* or the chromatic *O Mirtillo*. The five singers, including the director as first soprano, perform with excellent ensemble, good intonation, clear enunciation, and attractive tone. Highly recommended. N. B.

MOZART

Divertimento No. 15, in B-flat, K. 287

Six from the Vienna Octet.

LONDON LL 1239. 12-in. \$3.98.

This is one of three Mozart divertimentos scored for two violins, viola, two horns, and bass. The strings are often multiplied with good effect, and the bass is almost invariably taken by cello and bass viol. Not in this record. The cello is not used, and the omission makes surprisingly little difference in the apparent texture.

Another surprise is the absence of multiple rivalry in the recording of one of the best and best known of all the divertimentos. The only other version is an excellent one on Vanguard 444, in which the strings are increased to the proportions of a small orchestra. This writer in general favors the multiplication of strings for this type of

divertimento, and particularly for No. 15, half of whose six movements are built like a miniature violin concerto.

The general favor does not hold here against the flexibility, the tonal ripeness, the bland friendliness of the expert group known as the Vienna Octet, whose three or four annual records continue to show unassailable musical sense and sensitivity more and more clearly with a steady improvement in the reproduction granted to them. Horns, violins, and double bass are not easily captured, but this disk presents the hard combination in a kind of washed juiciness, like melted fudge, and nearly as sweet. A hint of wire in the principal violin is easily eliminated by the tone controls, after which the instrument contributes a smooth blandishment, especially in the fourth and sixth movements. The player is the Vienna Philharmonic concertmaster, Willi Boskovsky, who has participated in hundreds of recordings but seldom as advantageously as here. C. G. B.

MOZART

Divertimentos: in E-flat, K. 166; in B-flat, K. 186; in B-flat, K. 240; in E-flat, K. 289

Wind Sextet from the Vienna Philharmonic Orchestra.

WESTMINSTER 18011. 12-in. \$4.98 (or \$3.98).

This kind of music is one of Westminster's specialties, and no one does it better. Luscious playing; limpid, exultant, exact, unmanacled reproduction. A great unimportant disk that every lover of superb trifles should own and every manufacturer should study. C. G. B.

MOZART

Don Giovanni

Matia Curtis Verna (s), Donna Anna; Carla Gavazzi (s), Donna Elvira; Elda Ribetti (s), Zerlina; Cesare Valletti (t), Don Ottavio; Giuseppe Taddei (b), Don Giovanni; Italo Tajo (bs), Leporello; Vito Susca (bs), Masetto; Antonio Zerbini (bs), Commendatore. Cetra Chorus and Symphony Orchestra of Radiotelevisione Italiana (Turin), Max Rudolf, cond.

CETRA C 1253. Three 12-in. \$14.94.

If ever one were to hear a completely satisfactory performance of *Don Giovanni*, no further proof would be needed that one's time had come and passage into the next world had been accomplished. The best that can be said for this fifth integral recording is that it has some points of superiority over the other four. By this time, indeed, enough distinguished individual characterizations have been assembled in the various sets to make a fine composite performance, but this kind of juggling went out with the coming of LP.

Max Rudolf, the Cetra conductor, has done nothing finer, certainly, on records. His conception of the score is clean and straightforward, less polished and imaginative — less romantic, if you will — than that of Krips, more poised than Swarowsky's, better rehearsed than Moralt's. Only occasionally I would take exception to his tempos, and complaints on this score are counterbalanced by the enjoyment of hearing so clearly so much orchestral detail. If there remains the memory of Fritz Busch,

it is really only a memory now, for the old Glyndebourne recording shows its years, especially as Victor's transfer to LP was something less than a perfect job. Sonically, the new set is good, the balance certainly equal to the best of its rivals. It should be noted that in this performance the piano is used to accompany the recitatives, whereas the harpsichord is favored by London, Epic, and the Haydn Society.

To my mind Giuseppe Taddei is easily the best of the five singers who have recorded the title role so far. To begin with, the voice is right — a real baritone with smooth, elegant tone, and brilliance when needed in the upper register. He produces more beautiful sounds than John Brownlee, his nearest rival; and he possesses an even greater ability to act with his voice. The *Serenata* is sung in a *mezza voce* that must be the despair of all heavier-voiced Dons, and in "*Finch'han del vino*" he is able at least to suggest articulation of the slurred eighth notes, which most singers simply disregard. His part in "*La ci darem la mano*" is as polished as any since Scotti's; his *secco* recitative is a delight throughout. And for once the voices of Don Giovanni, Leporello, the Commendatore, and Masetto are all quite distinct and properly contrasted.

I would place Italo Tajo's Leporello next to Corena's in the London set. He, like Taddei, is a singer of imagination (sometimes it almost seems too much) and he also does a good deal by vocal coloring. But it is less of a voice than Corena's, and his work is more contrived. Cesare Valletti sounds more imposing at first than he does in the vast reaches of the Metropolitan. He is good in the recitatives but seems overawed by his two big arias. His "*Dalla sua pace*" is easily outdone by Dermota in the London set, even more so by Simoneau in the Epic; and "*Il mio tesoro*" sounds, unfortunately, just like the taxing thing it is. Still, his intentions are good. Susca is a properly crusty Masetto; Zerbini's Commendatore has dignity and the unearthly quality it needs in the later scenes. I like the impression of stage distance as he breaks in upon Don Giovanni's laugh in the cemetery scene.

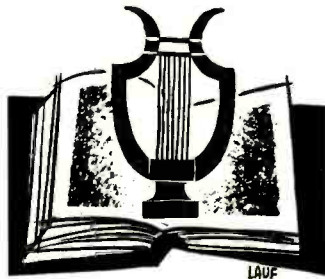

The real weaknesses of the set are on the distaff side. Neither Maria Curtis Verna nor Carla Gavazzi is happily cast, a fact that becomes painfully evident in their big arias. That they have fine natural voices is obvious enough, but more than that is needed for this music. Verna's unsteadiness mars the first scene, but even more the great outburst of "*Or sai chi l'onore*." Her "*Non mi dir*" may be called, at best, a noble attempt. I was reminded of Ernest Newman's complaint about the second part of this aria, where he quotes Berlioz's condemnation of it as "indecent buffoonery." According to Newman,

it is "difficult to understand why the singer should suddenly cease to be the sympathetic and noble Donna Anna and become transformed into a mere Madame This or Madame That, angling for applause." But given such a performance as we can hear on the antique Lilli Lehmann record, I find the argument refuted. As for Verna, she plainly has too much on her hands even to think of angling for applause. But then, Donna Anna is not one of the happily realized roles in any of the sets.

Gavazzi is even more unsatisfactory. Her singing is at best not near, and she meets her Waterloo in the tremendous "*Mi tradi*." It is all she can do to get through the number at all, and near the end she follows a custom more familiar in Rossini or Verdi of taking time out to prepare for the final windup. Needless to say, with these two voices in the cast, the big ensembles are bound to suffer.

The Zerlina of Elda Ribetti is very much better, though hardly as fresh and winning as that of Hilde Gueden in the London recording. Both her arias are nicely sung (though the first part of "*Batti, batti*" seems fast and the last part slow) and she joins very nicely with Taddei in "*La ci darem la mano*."

To sum up: the one great virtue of this performance is its central character; with Victor's Busch set disqualified by old recording, the best sum of unequal parts seems to me to be London's Krips.

PHILIP L. MILLER

MOZART

Mass in C minor (Unfinished), K. 427

Teresa Stich-Randall (s), Hilde Rössl-Majdan (ms), Waldemar Kmentt (t), Walter Raninger (b); Vienna Chamber Choir and Vienna Symphony Orchestra, Rudolf Moralt, cond.

EPIC LC 3177. Two 12-in. \$7.96.

We do not know why Mozart left this Mass unfinished. He had nine years to live after commencing it, but the Credo was never finished and the Agnus Dei never started. In this incomplete form it is often performed, and has been recorded by the Haydn Society, without giving musical affront; but people accustomed to the liturgical formality of the Solemn Mass may well feel distress at a partial statement. In the first year of the present century Georg Aloys Schmitt brought forth a version completed by himself, which used sections of earlier Mozart church music in the empty places in the Gloria, with the Agnus Dei sung to the music of the Kyrie of this same C minor Mass. About four decades later, Bernhard Paumgartner modified the Schmitt procedure by an edition which filled the Gloria with music entirely from one earlier Mass, that in C, K. 262. The Agnus Dei-Kyrie device of Schmitt was retained. It is this Paumgartner edition that Epic has recorded.

Success in performance of the Mass must always depend in disproportionate measure on the quality of the solo sopranos, the tenor and bass being allotted nothing very extensive. No doubt that an infirm *Et Incarnatus Est*, a precarious rocket-flight for high soprano, will infect the memory of what follows, and that a clumsy *Laudamus Te*, early in the work, will have a discomfiting effect beyond its own duration. Fortunately, both recorded performances are

honors, however, to the Epic ladies. They are invulnerable in this respect, with the remarkable readiness to evince the best that we have been able to infer from their many previous records. Miss Stich-Randall is in process of becoming a great singer, and her deeper-toned colleague is endowed with a flexibility of voice and style which has made her almost indispensable in a bewildering contradiction of musical roles.

The solo sopranos prevail for Epic, and so does the chorus, more responsive and more apparent. Contrarily, the orchestra is weak in utterance and dissipated in the comparative prominence given to the chorus, while the older performance had the instrumentalists in the spotlight—too much, compared to the chorus—clarifying the unusual color written into this Mass. Sonics play no great part in determining

value, Epic's being smoother but blunter, both showing unbalance. As a whole, Epic's is more desirable, meaning soprano plain and soprano mezzo. It ought to be, after five years. And if one wants Mozart pure—
C. G. B.

MOZART

Quartets: No. 19, in C, K. 465; No. 21, in D, K. 575

Amadeus Quartet.

RCA VICTOR LHMV 32. 12-in. \$4.98.

Disdaining the authorization of incipient romantic license in these scores, the Amadeus nevertheless attain pre-eminence through the fine interadjustment of their four voices. This transcends the mere balance we all hope for in quartets: it is an illumination of the beautifully mannered polyphony too often blurred or swollen in performance.

No. 19, the thornier fruit, is laudable if one does not regret a feeling of restraint, a fear of total immersion, that withholds the players from the deeper plunge and the longer curve. The registration of both is suavely competent.
C. G. B.

MOZART

Quartets: No. 20, in D, K. 499; No. 21, in D, K. 575

Barcher Quartet.

Vox PL 8730. 12-in. \$4.98.

Lofty exhibitions of classic playing at its best, superb in articulation, explicit in shape, and aloof in sentiment, push this disk into prominence in spite of some sonic complications. If the sound as such is liked, K. 499, in the healthy expression here of music needing directness and strength to point its own half-sick sunniness, ought to be the preferred edition. The classicism of the later work in this performance is laudable but a bit chilling.

The sound is very powerful. It needs careful reduction to whatever the optimum point may prove to be on hearers' phonographs. This will erase a certain adenoidal quality in the violins, but will tend to separate them from the deeper strings. No doubt this results from a vaulted environment, which to many people is desirable. It is excellent sound for those who like the type.
C. G. B.

MOZART

Serenade No. 9, in D ("Post-Horn"), K. 320

Barylli Quartet with String Bass and eleven players (wind and timpani) from the Vienna Philharmonic Orchestra.

WESTMINSTER 18033. 12-in. \$4.98, (or \$3.98).

Two other versions expand the string body, and there is the obvious advantage in that of providing bulk to counter the imposing cluster of wind instruments. Given that advantage, those honorable versions are nevertheless in no position to dispute leadership with the discerning love and studied craft of the Barylli group.

Great music need not be translated out of music into some other kind of significance. The *Post-Horn* Serenade is great music for the ears but is not history or tragedy or a documentary something. It veers here and there close to burlesque, restrained by the surest musical instinct that ever was from a definite trespass. The pomposity of all those wind instruments is invariably relieved by a delicate rejoinder just before we are ready to laugh; and as we smile instead, a curtain of reflective loveliness rebukes the smile and makes us think that we are thinking.

This record is splendid, one of the most successful presentations of this kind of music with an assortment of dominant winds. In spite of the individuality of the colors, a mellow fusion has been achieved by the joint effort of players and engineers, and no record comes to mind with brass and wood spreading a more even glow. This gives a nourished finality to the harmonies, and a dark background against which the instruments in solo excursion are brightened. The phrases are fully enunciated and the tempos nervous although slower than usual

Continued on page 86

Mozart's Final Four, Chicago Style

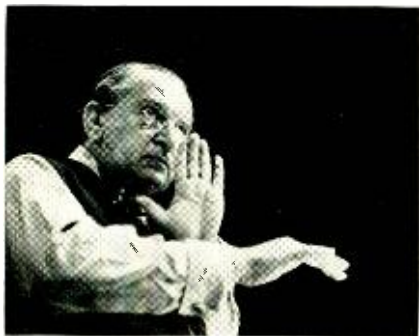

Fritz Reiner

THE KNOWING KIND of music-lover anticipates the records of this conductor as the knowing rabbit anticipates the first tender succulent shoots of spring lettuce. The conductor—an orchestral jeweler at home in a company that includes names like Rodzinski, Beecham, Stokowski, Karajan, Ormandy, and Szell—one of the ablest men living as translator of the inclusive repertory, worldly, experienced in the best company and the best traditions, innocent of eccentricity, and a perspicacious, painstaking student of scores, was the inexorable choice of RCA Victor to inject some splendor into her rather bleak catalogue of Mozart symphonies. It must be known to her that Dr. Reiner's obvious talents have always been seconded by first-class contemporaneous engineering—perhaps because he has insisted on it—and that he has been associated with a lower percentage of really poor records than any other conductor who has made enough records to count. In entrusting the last three symphonies and—skipping the *Prague* and No. 37, which was written by Michael Haydn—the spectacular invention called the *Linz* to the newly blossoming orchestra from Chicago and her redoubtable chief from Hungary, Victor had secure title to confidence in the results.

Which are decidedly good, and in final summary disappointing. Probably disappointment is inevitable when a revelation is expected. Perhaps it is asking too much to anticipate a clean sweep of all the opposition (an aggregate of fifty-one versions) in

these four symphonies. Or in any four symphonies.

Where these records are at their best is precisely where fine editions already abound: in the *Linz* Symphony, with five other admirable versions, and in the G minor, with seven. The *Linz* has its most effervescent performance here, no doubt of it; darting brightly and quickly without the drag of a good bass, and helped by the cleanest sound; but the greater sentimentality of Bruno Walter and the steadier strength of Sir Thomas Beecham, both muscled in the low instruments and just as valid as effervescence, seem preferable to this writer (Columbia SL 224; Columbia ML 5001). The G minor is brilliantly defined and nervously apprehensive in the purest and richest recording of the four symphonies. It may have an appeal as great as any other version's, but it is noncommittal when compared to the dramatic fever of the Leinsdorf record (Columbia RL 3070) or the studied *malaise* of the Furtwängler (RCA Victor LHMV 1010). Let's call the Reiner record one of the three best and regret that it did not overwhelm us.

The *Jupiter* is underrecorded, has a superb minuet and a stunning finale under Dr. Reiner's stick, and fails the fluency demanded in the *andante cantabile*, played slow and sounding sticky. No. 39 has *andante con moto* trouble, slapped out fast and literal not to a listener's unqualified delight; but the rest is beautifully drawn, and a resurgence of power in the bass is not unwelcome.

Reproduction as a whole is less seizing than in recent Reiner records, but the Mozart orchestra is not one to startle in phonographic terms. The echo is a little overlong in the four symphonies; and the *Jupiter*, besides having the weakest sound instead of the strongest, is acrid, though not deplorably, in the violins and high woods.

C. G. BURKE

MOZART: *Symphonies: No. 36, in C ("Linz"), K. 425; No. 39, in E-flat, K. 543; No. 40, in G minor, K. 550; No. 41, in C ("Jupiter"), K. 551.*

Chicago Symphony Orchestra, Fritz Reiner, cond.

RCA VICTOR LM 6035. Two 12-in. \$7.98.

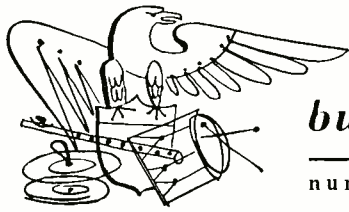

building your record library

number twenty-nine

FRED GRUNFELD CHOOSES A
SHELF OF BASIC AMERICANA



SERIOUS MUSIC in America is usually regarded as an onward and upward affair, showing steady improvement over the better part of two centuries. The small colonial acorns are supposed to have reached something like fulfillment in the Copland oaks and the adjacent stand of Piston hickory and pale-white Thomson birches. But this is a misleading picture. Only the quantity of American music can be charted as one continuously rising curve. Qualitatively we have had music of native worth at every stage of our history. All that has happened with the passing of time is that the juices have swapped around some—as with Huck Finn's favorite Missouri victuals—and our music has taken on a more distinct flavor of its own.

A shelf of Americana should properly begin with Indians; any number of fine ethnic recordings do justice to various aspects of the red man's art. One notable collection is Folkways' *American Indian Music of the Southwest* (P 420).

Some of the earliest European settlers produced music that those who stayed behind would consider worth listening to. Among the Moravian brethren of Bethlehem, Pennsylvania, and Salem, North Carolina, a musical missionary, Johann Friederich Peter (1746-1813), composed six delightful string quintets in the Southern settlement during the 1780's. The First and Sixth of the set are creditably recorded by the Moravian Quintet in the New Records Series on the instrumental music of colonial America (2013).

The suite that Richard Bales arranged from *Music of the American Revolution* brings together five works that George Washington heard, including two by Francis Hopkinson (1737-1791), a signer of the Declaration and the first man to serve as Secretary of the Navy. All of this is listenable and evocative, but the major attraction of this record is the overside, *Symphony No. 3*, by Charles Ives (1874-1954), the founding father of modernism in America. Bales leads the National Gallery Orchestra in smooth performances and sound adequate for the purpose (WCFM 1).

Had there been a Mozart in Hopkinson's generation or even a Czerny in the next, Stephen Foster (1826-1864) might have become America's Schubert; he had the melodic gift but lacked the training and tradition to make the most of it. Yet *De Camptown Races* and *Oh Susanna* were to a burgeoning America of the 1840s and 1850s what *Heidenröslein* and *Die Forelle* were to the sleepy Austria of the 1820s. There are no really satisfactory issues of the Foster songs. The most acceptable collection is the Roger Wagner Chorale's (Capitol P 8267).

Edward MacDowell (1861-1908) was caught up in the turn-of-the-century preoccupations with historical tableaux and pretty scenery. Still his music has far more strength, fundamentally, than that of the dandified professors who replaced him. MacDowell's *Indian Suite* is now a period piece, but Howard Hanson and the Eastman-Rochester Symphony bring life and a taut power to the score, and the sonics are impressive (Mercury 40009).

Some of the squareness and the manliness goes out of American music in the works of Charles Tomlinson Griffes (1884-1920), the Impressionist-on-Hudson who spent the best years of his life teaching in a boys' school in Tarrytown, New York, and creating strange, exotic visions—*The Pleasure Dome of Kubla Khan*, that miracle of rare device (a sunny pleasure dome with caves of ice); *The White Peacock*, a bird of the inner eye; and Japanese and Scottish songs. Leonid Hambro performs Griffes's parti-colored *Piano Sonata* and the finely wrought *Roman Sketches* with a fluid sense of line, contour, and shading; the piano sound is exceptionally clear (Walden 100).

Charles Ives, patriarch and rebel, the homespun genius whose thoughts dwelled not on the faraway places but on the transcendental philosophy of Emerson and on the nature of the Yankee universe—this rocky New Englander with his strange

notions of harmony and dissonance occupies the loftiest peak in our native musical topography. That he is mentioned here twice is justly his due as the most stouthearted composer of the age. Vladimir Cherniavsky conducts a chamber orchestra in a superb collection of his smaller pieces, all written before World War I—*Hallowe'en*, *Central Park in the Dark*, *Over the Pavements* (all part of Balanchine's *Ivesiana* ballet). On the second side Elliot Magaziner and Frank Glazer give a fine fiddling performance of the Second Sonata and of the Largo for violin, piano, and clarinet, with David Weber. (Polymusic 1001).

"Do you think any of my music will live?" George Gershwin often and anxiously asked his friends. The sages along Tin Pan Alley had a saying: "George's tunes will live just as long as George is alive to play them." That compliment to his eloquence at the keyboard was hardly calculated to reassure Gershwin the composer. Hearing him play his own Broadway songs, one can easily see why his presence seemed essential to success. He had rhythm, and under his hands a simple tune like "Do Do Do," or "Clap Yo' Hands" were in truth the Katherine minuets and contredanses of our country and century. Nine of these memorable Gotham *Liebeslieder* of the mid-twenties are collected on one ten-inch disk; all have Gershwin at the piano, and several are done together with Fred and Adele Astaire. The sound, of course, is somewhat the worse for wear, but the spirit remains intact and that is more than warrant for its welcome (Heritage 0073). Gershwin's own recording of the *Rhapsody in Blue* (cut to fit on two sides of the original 78 disk), with Paul Whiteman conducting the orchestra, is a raggle-taggle document of enormous historic worth and capable of generating large amounts of nostalgia. No other edition can hold a candle to it. The reissue also offers *An American in Paris* in the performance led by Nathaniel Shilkret and supervised by the composer (RCA Victor LPT 29). Gershwin's songs have also endured even when George was no longer there to play them; we can take it for granted, I'm sure, that *Porgy and Bess* is with us to stay as the strongest and most stageworthy of American operas, notwithstanding Virgil Thomson's assertion that it is "crooked folklore and halfway opera." The production for records organized by Goddard Lieberson and conducted by Lehman Engel, with Lawrence Winters, Camilla Williams, Inez Matthews, Warren Coleman, and Avon Long, is both musically and technically a phonographic masterpiece (Columbia SL 162, three 12-in.).

If Thomson himself is to appear on the Americana shelf, he would be best represented with a halfway opera of his own, *Four Saints in Three Acts*. Parts of the Gertrude Stein libretto—"Pigeons on the grass alas and a magpie in the sky," for example—have already been assimilated into the quasi folklore of the intellectuals. Thomson does an authoritative job conducting the work in a 1947 recording (reissued as RCA Victor LCT 1139). Aaron Copland also fares best in a Victor Treasury release, a coupling of *El Salón México* and *Appalachian Spring*, played by the Boston Symphony under Serge Koussevitzky, the conductor who put Copland on the map (RCA Victor LCT 1134). Leonard Bernstein's *Jeremiah Symphony*, abounding in the passionate earnestness of youth, has only a handful of rivals among native symphonies. In one of the Camden bargain records, Bernstein conducts the work with the St. Louis Symphony and Nan Merriman as soloist, together with the dances from *On the Town*, some of the sprightliest music ever written for the lyric theater, and the repetitive ballet *Facsimile* (Camden CAL 196).

Though not as facile as these gentlemen, Wallingford Riegger—now over seventy—has more to say and more incisive ways of expressing himself. His *Symphony No. 3* of the 1940s brandishes a hard fist and brews extraordinary sonorities. Howard Hanson and the Eastman-Rochester provide an energetic performance; the overside offers a reading by Dimitri Mitropoulos and the New York Philharmonic-Symphony of Peter Mennin's pleasant Third Symphony (Columbia ML 4902).



Rachmaninoff: a fine set of *The Bells*.

for the most part, in this most careful calculation. Nothing is casual in a performance of plotted relationships of force and timing; and this studied respect produces an effect of memorable holiday where other performances state an evanescent gaiety lovely but renewable.

Sound as such is dramatically real and detailed, intimate, for the proximity of sixteen players; but the pair of violins will give metal except on the best or worst reproducers. C. G. B.

MUELLER

Sinfonia for Strings and Flute

†Bartók: *Divertimento for String Orchestra*

Zurich Chamber Orchestra, Edmond de Stautz, cond.; André Jaunet, flute.
LONDON LL 1183. 12-in. \$3.98.

Paul Müller of Switzerland is a fairly obscure composer, but his *Sinfonia for Strings and Flute* stands up extremely well alongside the great and famous *Divertimento* of Bartók with which it is coupled. This Swiss work is in the neo-baroque style, with a magnificent adagio and outside movements of extraordinary ingenuity and interest. The Bartók is one of that master's most powerful creations, and De Stautz gives it an altogether masterly performance. The recorded sound of the strings is, to be sure, a little harsh, but this is in character with the music. All in all, a most attractive disk. A. F.

PALESTRINA

Magnificat; Stabat Mater; Mass, "Assumpta est Maria"

Dessoff Choirs, Paul Boepple, cond.
CONCERT HALL CHS 1231. 12-in. \$4.98.

The Mass, based on one of Palestrina's own motets, is among the loveliest of his many works in that form. The other two compositions (the *Magnificat* is the one for eight-part chorus) are also very fine. Unfortunately, the firm, nicely modulated tone of the large chorus is often slightly veiled by a thin film of noise — possibly tape hiss; and there is some distortion in loud passages. Worth having until a better recording of this music comes along. N. B.

PALESTRINA

Missa Veni Sponsa Christi

†Lassus: *Missa Puisque j'ay perdu*

Vienna Kammerchor, Hans Gillesberger, cond.

UNICORN UNLP 1013. 12-in. \$3.98.

Fine, representative Masses by two great masters. The Palestrina is quite typical of its composer in its lovely lines that flow along in transparent polyphony without ever coming to a full stop within a musical paragraph. Here is "endless" melody in every one of the four parts. Lassus, as was to be expected, favors more contrast. He juxtaposes more chordal writing against his polyphonic passages and employs complete cadences in the course of a movement. Both men, like other composers of their time and later, take special pains to write particularly beautiful settings of the *Benedictus*. The performances are cool but spirited, not emasculated. The tone of the *a cappella* chorus is pleasant (though it could have been recorded a bit more clearly). Except for one or two uncertain attacks in the Palestrina, the singers stay well on pitch. The Lassus seems to have been recorded on a lower dynamic level. N. B.

PERGOLESI

Concertino in G

†Durante: *Divertimento in F minor*

†Vivaldi: *Concerto for Two Cellos and Orchestra, in G minor* (Pincherle 411)

Orchestre de Chambre Gérard Cartigny, Gérard Cartigny, cond.
LONDON DTL 93044. 12-in. \$4.98.

All three compositions are for strings. Whether the *Concertino* was actually written by Pergolesi is doubtful; in any case it is an agreeable work, mostly late baroque in style but with elements of the rococo in the first Allegro. There is a lyric slow movement, in which a solo cello is prominent, and a sprightly, contrapuntal final gigue. A stronger impression is left by the Durante, whose pithy and individual quality raises it above the level of the conventional orchestral concerto of its time. No continuo instrument is employed here in any of these works. Performance is satisfactory on the whole, but the Vivaldi has more brightness and transparency in the version by the Virtuosi di Roma on Decca DL 9684. N. B.

POULENC

Sonata for Two Pianos — See Bowles: *A Picnic Cantata*.

PROKOFIEV

The Prodigal Son

New York City Ballet Orchestra, Leon Barzin, cond.
VOX PL 9310. 12-in. \$4.98.

A somewhat anemic performance and recording of an exciting, at times profound, score that deserves much better treatment from all concerned. A. F.

PROKOFIEV

Quartet No. 2 — See Malipiero: *Quartet No. 4*.

QUANTZ

Sonatas for Flute and Harpsichord — See Frederick the Great: *Sonatas for Flute and Harpsichord*.

RACHMANINOFF

The Bells; The Isle of the Dead

Frances Yeend, soprano; David Lloyd, tenor; Mack Harrell, baritone; Temple University Choir, Elaine Brown, director; Philadelphia Orchestra, Eugene Ormandy, cond.
COLUMBIA ML 5043. 12-in. \$3.98.

At the time this recording of *The Bells* was made in 1954, I heard the same forces perform the work in Carnegie Hall. It seemed then about as good an interpretation as this music was ever likely to get. It had the benefit of the Philadelphia Orchestra's tonal splendor; the clean, agile singing of the Temple University chorus; and the superb artistry of the three soloists. Hearing the performance again on records, it still seems incomparable. Although there is some loss of impact in the recorded choral sound, there is a compensating gain in the greater prominence accorded the solo parts. Miss Yeend's voice is at its vibrant best, and she proves on this occasion how musically she can sing in congenial material. Mr. Lloyd's and Mr. Harrell's voices, which seemed rather light in the concert hall, project beautifully on the recording, and their diction and phrasing are a constant joy. Eugene Ormandy is thoroughly at home with the lush, brilliant score; he allows it a full quota of color and drama. If the work is still not to a listener's taste after hearing this version, it never will be. No text is provided for this sung-in-English version of *The Bells*. Where the soloists are concerned this does not matter; it does for the choral portions.

For all its sumptuous sound, the performance of *The Isle of the Dead* is less praiseworthy. Mr. Ormandy exaggerates all the little crescendos and decrescendos to the point where the waters around the isle begin to sound like surging waves rather than quietly lapping currents. R. E.

RACHMANINOFF

Sonata for Piano, No. 1, in D minor, Op. 28

Warren Perry Thew, piano.
M-G-M B 3247. 12-in. \$3.98.

Originally issued on a Rachmaninoff Society disk (RS 6), this performance is now reissued by M-G-M. The sonata is moody and too long for its slight material, but it has some moments characteristic of Rachmaninoff's more inspired style, and Mr. Thew plays very skillfully indeed. The piano tone has more ping and brightness than in the original pressing. The latter coupled with the sonata, as the M-G-M release does not, a brief curiosity: Rachmaninoff himself accompanying Nadejda Plevitskaya in his setting of a Russian folk song, *Powder and Paint*. R. E.

RASSE

Concerto for Violin and Orchestra, in C

Robert Hosselet, violin; Orchestre National de Belgique, René Defossez, cond.
LONDON INTERNATIONAL W 91063. 10-in. \$2.98.

This attractive but not too important concerto by the Belgian composer François Rasse (1873-) reveals a work of pleasingly melodic, late-romantic characteristics, mostly derived from Chausson, Saint-Saëns, and Glazunov. The recorded sound is a bit conservative by contemporary standards.

P. A.

Continued on page 88

ML 5077

COLUMBIA MASTERWORKS

SHOSTAKOVITCH VIOLIN CONCERTO

Op. 99 (First recording)

A HIGH FIDELITY
RECORDING

Lp

DAVID OISTRAKH

PHILHARMONIC-SYMPHONY ORCHESTRA OF NEW YORK,

DIMITRI MITROPOULOS



OISTRAKH-SHOSTAKOVITCH **PREMIERE!**

Columbia Records presents the first recorded performance of Shostakovich's great new violin concerto with David Oistrakh, for whom the piece was expressly written; the Philharmonic-Symphony Orchestra of New York is conducted by Dimitri Mitropoulos, who introduced the composer's Tenth Symphony on Columbia last year.

Other new Columbia "Lp" Masterworks Records available now:

Starring Richard Tucker: One of the fabulous tenor voices of our time in an outstanding collection of French and Italian arias. ML 5062

Bach: New, high-fidelity versions of the famous Philadelphia Orchestra Bach transcriptions. Eugene Ormandy conducts. ML 5065

Kostelanetz Plays "Tosca": The Maestro's latest "opera-for-orchestra"—a brilliant reading of Puccini's violent, tempestuous score. CL 767

Brahms: "Double" Concerto in A Minor for Violin, 'Cello and Orchestra. Isaac Stern and Leonard Rose are soloists with Bruno Walter and the Philharmonic-Symphony Orchestra of New York. ML 5076

Bach: *Little Organ Book*. E. Power Biggs plays the 45 Choral Preludes that make up this work. Album includes special 28-page booklet with notes by Mr. Biggs. SL-227 (2—12" records)

COLUMBIA  RECORDS

© "Columbia" ® "Masterworks" ® T. M.

RAVEL

Piano Music (Complete)

Vlado Perlemuter, piano; Concerts Colonne Orchestra, Jascha Horenstein, cond. (in the two concertos).

VOX DL 153. Three 12-in. \$19.50.

Perlemuter plays certain quietly wistful pages — like the opening of the Sonatine — extremely well, but that is the best one can say for this pretentious release. No one would ever gather from these disks that Ravel was the supreme master of the musical raised eyebrow; Perlemuter just plods dutifully through the music, missing not only its irony but its effervescence and its subtle understatement as well. The pianist is not helped by a recording which manages the rather extraordinary feat of sounding both tubby and tinny at the same time. A. F.

RAVEL: *Quartet in F* — See Debussy: *Quartet in G-minor*.

REUBKE

Sonata for Organ on the 94th Psalm

†Franck: *Grande pièce symphonique*

Virgil Fox, organ (recorded at the John Hays Hammond Museum, Gloucester, Mass.).

RCA VICTOR LM 1917. 12-in. \$3.98.

Virgil Fox's recording of the Reubke Sonata is the best now available. He quite literally pulls out all the stops in an effort to squeeze the full drama out of a highly dramatic work, and being an imaginative colorist he arrives at an appropriate and interesting reading of the music. RCA Victor has given the performance immaculate engineering, from the wispiest to the most thunderous tones.

Mr. Fox's lively version of the Franck piece cannot obscure its *longueurs*, and the work is better served by the more stylistically correct, if also more placid, performance by Clarence Watters for Classic. R. E.

RIMSKY-KORSAKOV

Scheherazade

Vienna Staatsoper Orchestra, Michael Gielen, cond.

GRAND AWARD 33-302. 12-in. \$2.98.

There are already nineteen recorded versions available of this marvelous score, most of which offer considerably more acceptable performances of the work than this roughly played, poorly recorded, and generally pedestrian effort. At the low price of \$2.98 it may seem a good buy, but for an additional cent the excellent Westminster version (WL 5234), superb in sound and boasting a stunning performance by the same (?) orchestra under Quadri, is obtainable. The back of the record sleeve contains an imposing list of credits and some high-sounding claims for the recording; however, the latter are not substantiated by this release. J. F. I.

ROUSSEL

Bacchus et Ariane, Suites Nos. 1 and 2, Op. 43

†Fauré: *Pelléas et Mélisande, Suite, Op. 80*
†Debussy: *Petite Suite* (trans. Henri Büsser)

Orchestre des Concerts Lamoureux (Paris), Jean Martinon, cond. (in the Roussel); Jean Fournet, cond. (in the Fauré and Debussy). EPIC LC 3165. 12-in. \$3.98.

Epic has been responsible for issuing some superior records of French orchestral music, of which the present disk is a prime example. This is the first time that both suites of excerpts from Albert Roussel's exciting and colorful ballet *Bacchus et Ariane* have been recorded together. One is often reminded of Ravel's *Daphnis et Chloé* in listening to this wonderful score, which is performed with clarity, breadth, and drama by Martinon. Fournet's reading of the Debussy *Petite Suite* is the best I've heard on disks, and his *Pelléas et Mélisande* is surely the equal of any of the other five extant LP versions. P. A.

SAINT-SAENS

*Danse macabre, Op. 40**Samson et Dalila: Bacchanale*

†Dukas: *The Sorcerer's Apprentice*

†Chabrier: *Joyeuse marche*

Philharmonic Symphony Orchestra of London, Argeo Quadri, cond.

WESTMINSTER W-LAB 7009. 12-in. \$7.50.

Clarity of recorded sound seems to be the prime purpose of this disk; and clarity it certainly achieves, though sometimes at the expense of musical values. The two outstanding numbers are the *Joyeuse marche* and *Bacchanale* from *Samson et Dalila*, both of which incorporate clarity with plenty of excitement. *The Sorcerer's Apprentice* is on the routine side; for a supposedly mint-perfect "laboratory" issue, it had an annoying swish most of the way through my re-



Quadri: "clarity and . . . excitement"

view copy. The *Danse macabre* is taken at a ridiculously slow tempo and thereby loses all its drama, though every note on every instrument comes through perfectly. P. A.

SAINT-SAENS

Introduction and Rondo Capriccioso, Op. 28 — See Chausson: *Poème*.

SAINT-SAENS

Samson et Dalila: Bacchanale — See Auber: *Overtures*.

SCARLATTI

Sonatas, Vol. X

Fernando Valenti, harpsichord.
WESTMINSTER 18068. 12-in. \$4.98 (or \$3.98).

Westminster's noble project of recording all the sonatas of Scarlatti proceeds steadily. Each new volume only increases one's amazement at the inexhaustible fecundity of that master's mind. No two sonatas are ever alike, and Scarlatti is always finding new ways to exploit the capacities of the harpsichord. But much more important than the instrumental effects are the musical values

of these pieces. They are extraordinary little tone-pictures, some of them gentle and songlike, others gay and carefree, still others passionate and powerful.

Perhaps the most remarkable of the sonatas in this album is the brilliant one in G major, Longo 349. But each of the others has its own particular charm: the percentage of duds in Scarlatti's keyboard works is very low. Valenti, as usual, plays with vigor and drive, with understanding, and with impeccable technique. There are times when one finds oneself wishing that this artist made more use of the delicate qualities of his instrument. And either it was too late for him to adopt Kirkpatrick's pairwise arrangement of the sonatas or he doesn't agree with it. These, however, in view of Valenti's achievement, are relatively minor blemishes, if they are indeed blemishes at all and not matters of taste. N. B.

SCHMIDT

Symphony No. 4, in C

Vienna Symphony Orchestra, Rudolf Moralt, cond.

EPIC LC 3164. 12-in. \$3.98.

When Anton Bruckner died in 1896, the gold-winged baroque angels with whom he held daily conversation went down the block and took up their abode with a young man, recently arrived in Vienna, named Franz Schmidt. Such, at least, is the impression one gathers from Schmidt's Fourth Symphony, though this work was not written until 1934, five years before its composer's death. Only Bruckner's legitimate heir could have written this intensely visionary, grandly scaled, brass-colored piece, and only one who was truly his inheritor could have improved on the old master's formula as Schmidt does here. Although the work is Brucknerian in spirit and timbre, its structure is considerably more sophisticated than that of the older composer, and it sustains its slow-paced length with unflagging interest. The performance is excellent, the recording a bit coarse-grained but serviceable. A. F.

SCHOENBERG

Begleitmusik, Op. 34 — See Cowell: *Symphony No. 10*.

SCHUBERT

Lieder

An die Musik; Fischerweise; Geistertanz; Im Abendrot; (Die) Liebe hat gelogen; Nacht und Träume; Rastlose Liebe; Schlummerlied ("Es mahnt der Wald"); Seligkeit; (Der) Tod und das Mädchen; (Dem) Unendlichen; Wanderers Nachtlied; Wehmut; Widerschein; Wiegenlied ("Schlafe, schlafe")

Lucrezia West, mezzo-soprano; Leo Taubmann, piano.
WESTMINSTER 18090. 12-in. \$4.98 (or \$3.98).

Cursory research indicates that four of these songs had not previously found place on an American LP. About 450 of Schubert's 600-odd songs remain to be recorded, and the participants in the fifteen on this disk are to be thanked for not making the existing ruts deeper, with the venial exception of three, beautifully presented.

Continued on page 90

*"Lizzie Borden took an axe,
And gave her mother forty whacks,
And when she saw what she had done,
She gave her father forty-one."*

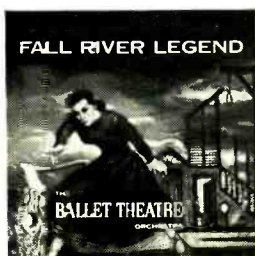
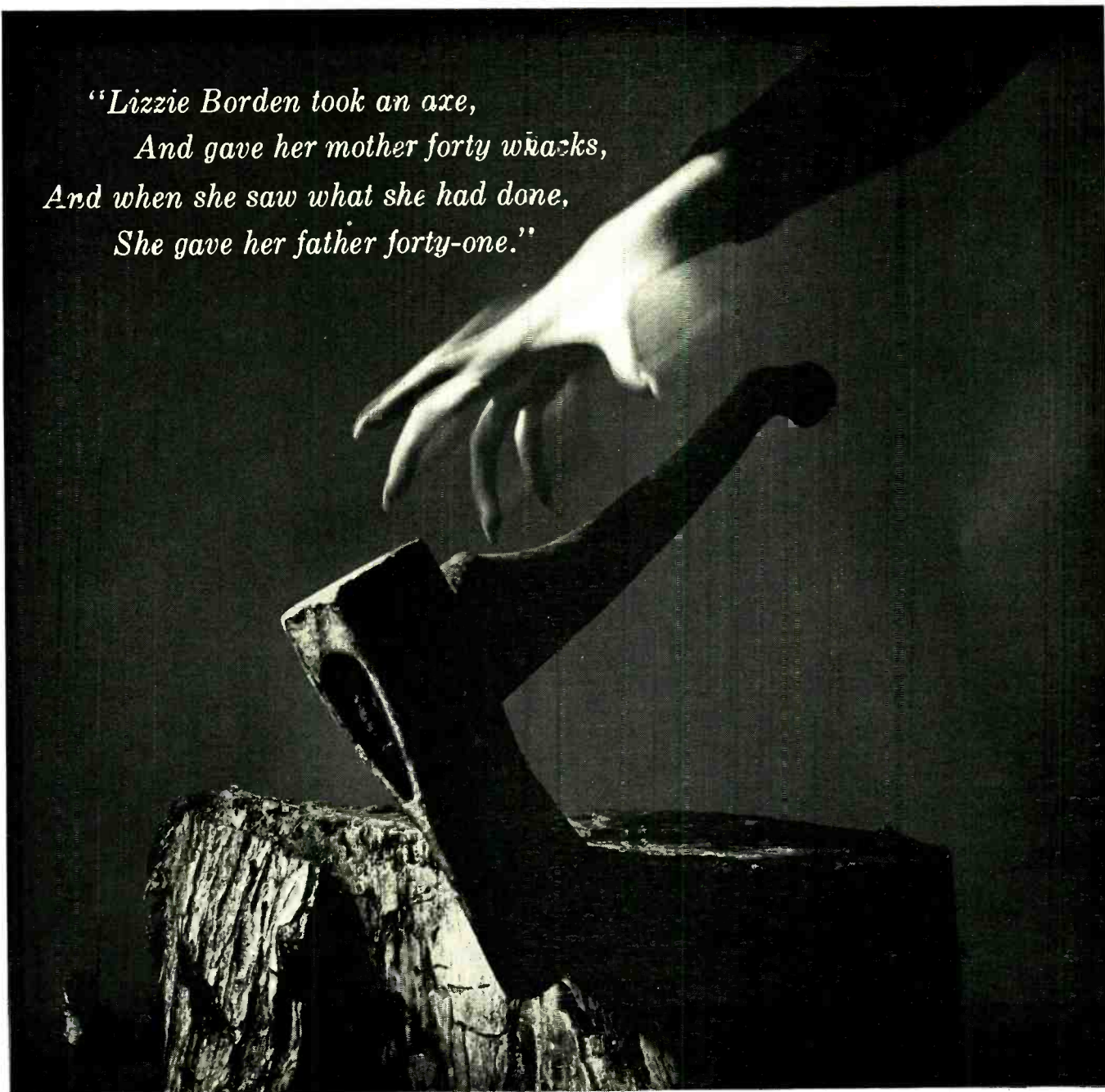

2nd side: premiere high-fidelity performance of Leonard Bernstein's ballet score, FACSIMILE.

From the notorious double-axe murder of Lizzie Borden's parents in 1892 has come a familiar folk-rhyme . . . and a fabulous ballet, *Fall River Legend*.

Produced by the famed Ballet Theatre, it spotlighted the extraordinary talents of choreographer Agnes De Mille and composer Morton Gould.

Now performed some 70 times a season by Ballet Theatre, its enormous popularity is a feather in each of their respective caps. But the outstanding score deserves wider currency. A simple ballet score leans and depends upon the

dancers for interpretation. *Fall River Legend* could stand by itself—and has—in a concert hall.

That's why Capitol Records has recorded this American Classic in flawless "Full Dimensional Sound." It is powerful, dramatic music and Joseph Levine, conducting the Ballet Theatre Orchestra, plays it with the deftness and comprehension that come only from long familiarity.

If your collection includes a *single piece* of provocative and meaningful modern music, this album should join it.

Capitol's "Full Dimensional Sound" symbol denotes an exceptional performance, flawlessly recorded. It is the purest high fidelity achieved by the recorder's art.



In solo or in chorus, Negro altos and mezzos seem to have fruitier voices than their white cousins. Perhaps that is inherently physiological, but more likely it is (in the case of mezzos) the natural result of song generally confined to the less artificial and stringent reaches of the feminine throat. By whatever cause, Miss West has a natural delivery of ripe tones a little too sweet to be called dusky, and a musical taste that permits her to sing unawed and unpretending an array of songs both simple and devious in which she invariably seems an ordained mouthpiece. Disarming art highly recommended here, especially in the untroublesome and pearly sound managed for the singer and pianist by the engineers.

C. G. B.

SCHUBERT

Schwanengesang

†Beethoven: *Lieder von Gellert, Op. 48*

Inez Matthews, mezzo-soprano; Lowell Farr, piano.

PERIOD 717. 12-in. \$4.98.

This voice, softly gleaming like waxed and weathered paneling, adorned by a short-phased vibrato so adept as to seem intrinsic, has found in the temperamental discrepancies of Schubert's last fourteen songs and in the masculine worship of Beethoven's rheism a double opportunity to make its opulence properly felt. In fact, the dark throb in the music written to Gellert's words as Miss Matthews sings it underlines the communication of a conviction beyond the reach of most instruments less artful. And even if in certain of the Schubert songs — of which no fewer than ten are dogmatically masculine declarations, with a man as protagonist — we demur at an unsexing of their quality, we do not cavil at the singing as such. *Kriegers Abnung, Am Meer, and Der Doppelgänger* are moving and beautiful although misdirected. *Ständchen* would not suffer with more leisure, and *Der Atlas* is still impossible for a soprano. The others incur no major objection, except from those to whom a lovely voice is in impropriety in the later Schubert.

The accompaniments are generally adequate, and the recording — lasting more than an hour for the two sets of songs — is of obvious merit. Soprano and pianist both embrace the intensities from whisper to alarum, and the engineers deliver the sweep without blur or explosion. German text and English translation are furnished.

C. G. B.

SCHUBERT

Symphony No. 8, in B minor ("Unfinished")

—See Beethoven: *Symphony No. 5.*

SCHUMANN

Album für die Jugend, Op. 68 (excerpts)

—See Tchaikovsky: *Children's Album.*

SHOSTAKOVICH

Preludes and Fugues — See Chopin: *Sonata in B-flat minor, Op. 35*

SIBELIUS

Symphony No. 6, in D minor, Op. 104
Pelléas et Mélisande Suite, Op. 46 (four movements only)

London Symphony Orchestra, Anthony Collins, cond.

LONDON LL 1277. 12-in. \$3.98.

In my Sibelius discography [HIGH FIDELITY, November 1955] I noted that Sixten Ehrling's was the only extant recorded version of the Sixth Symphony and that it would do until something better came along. That "something better" has now come along, and with it Anthony Collins has completed his Sibelius cycle. His reading of the Sixth Symphony is a model of clarity, proportion, and Nordic spirit; and, like most of his other disks in this series, it has been admirably recorded.

Since the fourth movement of the symphony has been placed on the second side — Mercury got Ehrling's all on one side — there isn't too much space left; consequently, only four of the nine movements of the *Pelléas et Mélisande* Suite are included — No. 2 (*Mélisande*), which is played far too rapidly, and No. 7 (*Mélisande at the Spinning-Wheel*), No. 8 (*Entr'acte*), and No. 9 (*The Death of Mélisande*), all of which are performed with fine sensitivity. Still, for a nearly complete suite, the best disk remains the Blomstedt recording on Urania. P. A.

STRAUSS, JOHANN

Die Fledermaus (excerpts)

Uta Graf (s), Rosalinda; Hedda Heusser (s), Adele; Rita Pich (s), Ida; Nata Tuscher (ms), Orlofsky; Johannes Bartsch (t), Eisenstein; Albert Kunz (t), Alfred; Richard Miller (b), Falke; Mathias Schmid (b), Frank. Radio Zurich Chorus and Orchestra, Walter Goehr, cond.

MUSICAL MASTERPIECE SOCIETY M 2022-OP 3. 12-in. \$2.75.

With the complete Angel and London performances of *Fledermaus* sounding in the ears, it is not easy to work up enthusiasm for any recorded version of lesser stature; yet under these very special circumstances,



Lucrezia West: ripe tones for Schubert.

the Musical Masterpiece Society abbreviated performance stands up remarkably well. Uta Graf has a good deal of voice and flair, the rest of the cast make their points with good average style and vocal abilities, and Walter Goehr conducts an energetic and well-controlled ensemble. Although the spoken lines are not in question in a one-disk truncation, a great deal of the musical score has been retained — enough to make this really more a shortened full performance than just the "excerpts" the jacket

claims. Text of the inclusions in German (and in *very* small type) can be found on the jacket. Sound: sometimes coarse-grained, but full and clear. J. H., JR.

STRAVINSKY

Petrouchka

Philharmonic-Symphony Orchestra of London, Hermann Scherchen, cond.

WESTMINSTER W-LAB 7011. 12-in. \$7.50.

From the point of view of sheer sound, this is far and away the best of the eleven *Petrouchkas* now available on LP; the performance, too, is very good, though at times one feels as if the instruments were more intent on having their pictures taken than on contributing to the effects Stravinsky intended. The record is accompanied with a slightly weird pamphlet by C. G. McProud, which contains much information (not completely accurate) about the trumpet, horn, and trombone, and a fantastic analysis of Stravinsky's score wherein rhythmic and instrumental changes are pointed out in a detailed, split-second timetable. A. F.

SULLIVAN

The Tempest: Incidental music *Henry VIII: Incidental music*

Vienna Orchestral Society, F. Charles Adler, cond.; Patricia Brinton, soprano.

UNICORN UNLP 1014. 12-in. \$3.98.

The incidental music to *The Tempest*, Sir Arthur Sullivan's earliest known score, was written in Leipzig around 1860 and was first heard in London in 1862. It immediately established Sullivan's reputation. English critics, rather hopefully, hailed him as another Purcell or at least an English Mendelssohn. Such hopes were, of course, never fulfilled, and whatever genius Sullivan had remained dormant until awakened by the lyrics of William Schwenk Gilbert, almost ten years later. Why such expectations should have been aroused by this work is rather difficult to fathom. It is a good serviceable score, well organized and pleasantly melodic, but it lacks what Mendelssohn brought to Shakespeare's *Midsummer Night's Dream*, the element of magic, the ability to create and sustain a mood, particularly one of fantasy. It is quite conceivable that it sounds and plays well in the theater, though I have never heard of its being so used in the past thirty years.

The three short excerpts of incidental music to *Henry VIII* came some eighteen years later and betray the composer's affiliation with the Savoy operas. The March might easily come from *Iolanthe*, while the "Graceful Dance" and "Water Music" belong to the tea-lounge or concert-in-the-park program.

Adler does everything possible to infuse some life into these scores; quite successfully, I should say, for the orchestral work is first-rate. The soloist does not sound completely at home in the *Tempest* songs, however. Her voice is basically a good one, but is used here with too much caution and restraint. At the top and the bottom, Unicorn's recording is excellent; but the middles have a tendency to flatten out, and the overall sound has a hollow, empty-hall ring to it.

J. F. I.

Continued on page 92

XLLA 37



VERDI La FORZA del DESTINO

Complete Recording

CAST

DON ALVARO
LEONORA
DON CARLO
PADRE GUARDIANO
FRA MELITONE
PREZIOSILLA
TRABUCCO
CALATRAVA
CURRA
ALCADE
CHIRUGO

MARIO DEL MONACO
RENATA TEBALDI
ETTORE BASTIANINI
CESARE SIEPI
FERNANDO CORENA
GIULIETTA SIMIONATO
PIERO DI PALMA
SILVIO MAIONICA
GABRIELLA CARTURAN
EZIO GIORDANO
ERAZIO CODA

CHORUS AND ORCHESTRA
OF L'ACCADEMIA
DI SANTA CECILIA, ROME
(Chorusmaster: Bonaventura Somma)

Conductor: FRANCESCO MOLINARI-PRADELLI

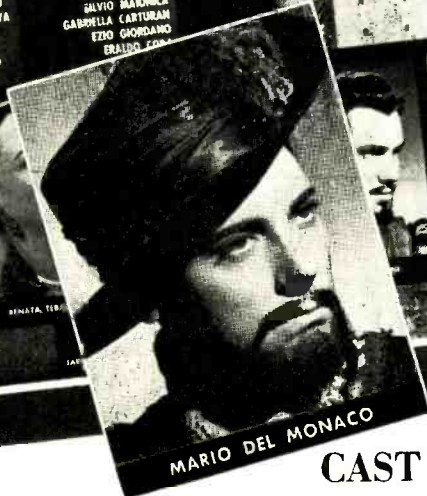

MARIO DEL MONACO



RENATA TEBALDI

CAST

Don Alvaro
Leonora
Don Carlo
Padre Guardiano
Fra Melitone

MARIO DEL MONACO
RENATA TEBALDI
ETTORE BASTIANINI
CESARE SIEPI
FERNANDO CORENA
Chirugo

Preziosilla
Trabucco
Calatrava
Curra
Alcade

Eraldo Coda

GIULIETTA SIMIONATO
PIERO DI PALMA
Silvio Maionica
Gabriella Carturan
Ezio Giordano

CHORUS AND ORCHESTRA OF L'ACCADEMIA DI SANTA CECILIA, ROME
(Chorus Master: Bonaventura Somma)

Conductor: FRANCESCO MOLINARI-PRADELLI

XLLA-37

4-12" records

\$19.92

"When it comes to the cast, too, there is much talent to admire: take the lesser parts first. This Preziosilla is much more the right thing . . . and so is the Melitone which Corena relishes . . . Siepi as Padre Guardiano is very magnificent indeed . . . Mario del Monaco . . . does magnificent things—the terrific B in the battle scene and the sheer animal thrill of his acuti. He sings with great generosity . . . words as ever are very clear—for instance the cry of "Un reprob" in the last heart searching trio. The baritone is new to me, and a mighty voice it seems to be. And Leonora? Tebaldi never lets you down. In sum, then, a superb recording and a true account of a grand work."

Philip Hope-Wallace; *The Gramophone*, December 1955



LONDON
RECORDS

SURINACH

Ritmo Jondo; Tientos; Tres Cantos Berberes

Chamber ensembles, the composer conducting.

M-G-M E 3268. 12-in. \$3.98.

Three aspects of Spanish folk music as handled by an extremely adroit, original, and learned composer, Carlos Surinach. *Ritmo Jondo*, the longest of the three works, is a ballet score in Flamenco style for eighteen instrumentalists and three hand-clappers. It has all the usual folk elements — immense rhythmic propulsion, overwhelming animal lustiness, and a barbed, fierce edge — all reinforced, made sharper, spicier, and more incandescent by virtue of the purity and simplicity with which these elements are handled. *Tientos (Essays)*, for English horn, harp, and timpani, and the *Tres Cantos Berberes (Three Berber Songs)*, for flute, oboe, clarinet, viola, cello, and harp, turn to other aspects of Spanish folk music. They are more primitive and more Oriental in source and feeling. Surinach's clean, open, aerated sonority is perfect for recording. Engineering and performances are both magnificent. A. F.

SWEELINCK

Harpsichord Music

Fantasia chromatica; Toccata (New ed., No. 24); Toccata (No. 23); *Fantasia in Echo Style* (No. 14); Variations on: *Von der Fortuna werd' ich getrieben*; *Mein junges Leben hat ein' End*; *Est-ce Mars*; *Balletto del Granduca*.

Helma Elsner, harpsichord.

VOX PL 9270. 12-in. \$4.98.

This Dutch master was one of the links between the Renaissance and the Baroque. His keyboard music is one of the bases upon which was established the great line of German organ and clavier music that culminated in Bach. Outstanding among the fantasias and toccatas here is the *Chromatic Fantasy*, a big work with a fugue like structure. Of the variations, those on the descending scale-line of *Mein junges Leben* are probably the most interesting. This will not, perhaps, be found to be very endearing music, but it has a healthy solidity and vigor, especially in the variations. Miss Elsner plays it well and with a considerable variety of registration. N. B.

TCHAIKOVSKY

Children's Album, Op. 39; The Seasons, Op. 37a (excerpts)

†Schumann: *Album für die Jugend, Op. 68 (excerpts)*

Ania Dorfmann, piano.

RCA VICTOR LM 1856. 12-in. \$3.98.

Easy but musically secure pieces like the two *Albums*, not made for public performance but for intimate association with hearers of the most malleable age and condition, create a multitude of varying standards, in accordance usually with the strength or durability of the earliest impressions. To at least one very immature and incompetent pianist Schumann's *Wild Horseman* was a fascination of pure terror, and the obsequies for Tchaikovsky's doll were more poignant by far than the grief

impatiently accorded the shadowy demise of an overkind, ancient aunt. But Miss Dorfmann does not give this drama to these little dramas, and on reflection it must be admitted that there is no reason for her to do so. *She* was not frightened by that wild ride.

Let it only be said then that these interpretations are propelled by an airy, spotless



Ania Dorfmann: unfrighting gallop.

technique of pianism above their requirements, with the piano sounding appropriately crisp, not to say a little brittle.

C. G. B.

TCHAIKOVSKY

Quartet No. 2, in F major, Op. 22

Armenian State String Quartet.

ANGEL 35238. 12-in. \$4.98 (or \$3.48).

The second of Tchaikovsky's three quartets was written in the early weeks of January 1874. Its composition gave him little trouble; and, like other works that sprang effortlessly from his mind, he considered it one of his finest scores. Few people today share his enthusiasm for a work so somber in character, so uneven in structure, in which the few moments of genuine inspiration are overpowered by pages of indifferent and repetitive writing. The two inner movements are the most attractive, with the Andante holding some fine stretches of emotional music. But this is hardly enough to sustain a score that is generally arid and uninteresting. In this performance, the first to reach us on LP, the Armenian players prove themselves to be a well-integrated, musical group, playing with balanced assurance and polish. The recording is from a London session of December 1954, and the sound is well up to Angel's very best. J. F. I.

TCHAIKOVSKY

Sleeping Beauty, Op. 66

Royal Opera House Orchestra (Covent Garden), Robert Irving, cond.

RCA VICTOR LM 6034. Two 12-in. \$7.98.

A few months ago we had a "complete" *Sleeping Beauty* from Mercury that was really complete, in that it used the whole score as originally written by Tchaikovsky. This new version, also labeled "complete," is so only in that it accords with those portions of the score currently used in the Sadler's Wells Ballet production. However, what has been omitted is music of little

consequence, either in musical or dramatic value, a statement that also applies to the Fistoulari version on London LL 636/37, with which this new edition comes into direct competition.

As Sadler's Wells' *chef d'orchestre*, Robert Irving works closely with the orchestra of Covent Garden, but on this occasion something appears to have happened to the rapport between orchestra and conductor. The performance could not justifiably be called poor, but it certainly lacks life, lift, crispness, and definition. The direction at times verges on the perfunctory and would surely not pass muster in actual performance. The tempos are danceable enough, it is true, but the perspective of the theater, which was so noticeable and impressive in Irving's *Swan Lake*, is noticeably absent. But then he had at his disposal the Philharmonia, a far superior orchestra. The engineers have supplied acceptable but not very plump sound. A rehearing of the Fistoulari effort reinforces the opinion that it remains one of the best ballet recordings available, not only for the sumptuous London sound, but for the beauty of the orchestral performance. J. F. I.

THOMAS

Raymond: Overture — See Auber: *Overtures*.

VERDI

La Forza del Destino (excerpts)

Act I: *Me pellegrina e orfano* (Leonora).

Act II: *Son giunta! . . . Madre, pietosa Vergine: La Vergine degli Angeli* (Leonora; chorus). Act III: *La vita è inferno . . . O tu che in seno agli angeli* (Alvaro); *Solenne in quest' ora* (Alvaro, Carlo) . . . *Morir! tremenda cosa! . . . Urna fatale . . . E s'altra prova rinvenir potessi?* (Carlo; Surgeon). Act IV: *Invano Alvaro* (Carlo, Alvaro); *Pace, pace* (Leonora); *Finale* (Leonora, Alvaro, Carlo, Padre Guardiano).

Zinka Milanov (s), Leonora; Jan Peerce (t), Alvaro; Leonard Warren (b), Carlo; Raymond Keast (b), Surgeon; Nicola Moscona (bs), Padre Guardiano. Robert Shaw Chorale and RCA Victor Orchestra, Renato Cellini and Jonel Perlea, conds. RCA VICTOR LM 1916. 12-in. \$3.98.

What RCA Victor has done here is to pick up Leonora's great scenes from Zinka Milanov's 1954 recording, entitled *Milanov Sings*, and build a set of excerpts around them — with quite variable artistic results. Her singing in the earlier recording, and in the duplicated bands here, is of a seamless resplendence as impressive as it is unlikely-seeming; a Milanov performance without a few loose vocal ends simply does not have a homey sound. The Act I aria, sung with a more familiar if less purely beautiful quality, is added in the highlights reshuffle; but the duet between Leonora and the Padre (which, after all, does hold the emotional and musical climax of Act II) is cut out, leaving the lovely surrounding sections still lovely but juxtaposed in a way that kills dramatic sense. The magnificent finale of the work is also a new Milanov record, of course; her fine "Pace,

Continued on page 94

Only at Your Record Dealer!

New! RCA Victor albums... only

\$3.98*
for each 12" Long Play
\$1.49 for each 45 EP

Popular and Classical recordings in "New Orthophonic" High Fidelity Sound



LONG PLAY \$3.93; 45 EP's \$1.49



LONG PLAY \$3.98; 45 EP's \$1.49



LONG PLAY (3 RECORDS) \$11.98



LONG PLAY \$3.98; 45 EP \$2.98



12" \$3.98 — EP \$2.98 & \$1.49



LONG PLAY \$3.98



LONG PLAY (3 RECORDS) \$11.98



LONG PLAY \$4.98; 45 EP \$4.98



LONG PLAY \$3.98; 45 EP's \$2.98



LONG PLAY \$3.98 — EP's \$2.98



LONG PLAY \$3.98; 45 EP's \$1.49



LONG PLAY \$3.98

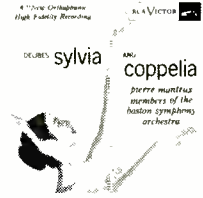

LONG PLAY \$3.93



12" \$3.98 — EP \$2.98 & \$1.49



LONG PLAY \$3.98; 45 EP's \$2.98



LONG PLAY \$3.98; 45 EP's \$2.98

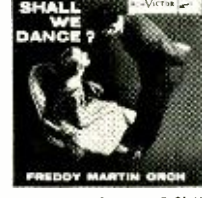

LONG PLAY \$3.98; 45 EP \$1.49



LONG PLAY \$3.98; 45 EP \$3.98



LONG PLAY \$3.98



LONG PLAY (2 RECORDS) \$7.98



LONG PLAY \$3.98



LONG PLAY \$3.98 — EP's \$2.98



LONG PLAY \$3.98; 45 EP \$3.98



LONG PLAY \$3.98 — EP's \$2.98

"Meet the Girls"—an exciting album series you can sample right at home



12" \$3.98 — EP \$2.98 & \$1.49



12" \$3.98 — EP \$2.98 & \$1.49



12" \$3.98 — EP \$2.98 & \$1.49



12" \$3.98 — EP \$2.98 & \$1.49



12" \$3.98 — EP \$2.98 & \$1.49



12" \$3.98 — EP \$2.98 & \$1.49



12" \$3.98 — EP \$2.98 & \$1.49



12" \$3.98 — EP \$2.98 & \$1.49



12" \$3.98 — EP \$2.98 & \$1.49



Worth \$1.49...
Only 25¢. Send coupon for "Meet the Girls" Showcase Record. I enclose 25¢ in coin to cover handling and mailing charges.

Print clearly. Coupon is your mailing label.
TO: RCA VICTOR, DEPT. HF,
401 N. BROAD ST.,
PHILADELPHIA 8, PENNSYLVANIA

Please send me RCA Victor's "Meet the Girls" Showcase Record. I enclose 25¢ in coin to cover handling and mailing charges.

NAME _____

ADDRESS _____

CITY _____ ZONE _____ STATE _____

Mail Today — Offer Expires April 1, 1956



*Original Cast Albums \$4.98
Nationally Advertised Prices

pace" is held over. The contributions of Jan Peerce and Leonard Warren, with Jonel Perlea conducting, are thus the principal additions, and owners of the *Milanov Sings* disk can decide for themselves whether the new attractions are sufficient to warrant so much duplication.

As sound artistically as usual, Mr. Peerce is far from being the owner of a voice big and dramatic enough to do Alvaro in the opera house; and though the engineers can ease him of some strain in a recording, they cannot make the quality either good or right. As for Mr. Warren, he is a full-scale Carlo-type baritone in any context, and he sings with fine tone; but he gives an essentially dull, complacent reading of a part that is nothing if not made vividly dramatic. The conducting is competent, the quality of sound good. No texts, but notes. J. H., JR.

VILLA-LOBOS

The Baby's Family

José Echaniz, piano.
WESTMINSTER 18065. 12-in. \$4.98 (or \$3.98).

Villa-Lobos' baby actually has two families, one composed of eight dolls and one of nine toy animals. The doll set was written in 1918, is well known, and has been recorded several times. The animal set was produced three years later, is little known, and has never been recorded before. This is odd, for the animal series is incomparably the finer; indeed, under the spell of Echaniz' superb performance and Westminster's excellent recording, one feels this to be one of Villa-Lobos' most important works. It is the kind of thing that led a Parisian critic to call Villa-Lobos an intelligent, inquiring savage inventing the art of music as he goes along. A good many years have passed since 1921, but Villa-Lobos has never surpassed these sketches so far as harmonic pungency, electrifying rhythm, and folkloric freshness are concerned. So, at least, it seems when Echaniz plays them. The Cuban pianist suggests, among other things, that these toys are, like the katchina dolls of the Southwest or the clay dolls of some Mexican Indians, the descendants of ancient gods, and that something of their hypnotic, supernatural power for good or evil lingers in the Brazilian composer's ostensible pictures of the child world. A. F.

VIVALDI

Concerto for Two Cellos and Orchestra, in G minor — See Pergolesi: *Concertino in G*.

WAGNER

Siegfried Idyll — See Bruckner: *Symphony No. 4*.

RECITALS AND MISCELLANY

GINA BACHAUER

Piano Recital

Chopin: *Trois Ecosaisies*. Liszt: *Paganini Etude No. 2*, in E-flat. Debussy: *Suite*,

Pour le piano; Bruyères; La Fille aux cheveux de lin. Ravel: *Gaspard de la Nuit*.

Gina Bachauer, piano.
RCA VICTOR LHMV 31. 12-in. \$4.98.

The deservedly admired Greek pianist is primarily a colorist with a formidable technique. With exceptional delicacy of touch, she produces a shimmering, glistening tone; and her facility helps her breeze through even that most difficult of piano pieces. Ravel's *Gaspard de la Nuit*, with the utmost poise. The music here is ideally suited to her talents; as a matter of fact, she has made something of a specialty of the Ravel work and of Liszt's music.

Like Gieseking, Miss Bachauer seems to evoke music from the keys rather than to strike the keys themselves, and her Debussy comes close in quality to Gieseking's, though lacking some of the latter's vigor and orchestration. In the Ravel she cannot match Gieseking's *Ondine* (neither can Casadesu) but is otherwise the peer of both artists in this softer-textured interpretation. The *Ecosaisies* have a darting birdlike quality; the *Barcarolle* is well-proportioned and lovely, with its continuously singing tone and lightness.

In one of those strange errors recording companies sometimes make, Miss Bachauer is listed on the jacket, in the notes by Alfred Frankenstein, and on the record label as playing Debussy's *Danses de Delphes*, but the Liszt étude turns up in its place. It adds variety to the repertoire and is superbly played. R. E.

SIR THOMAS BEECHAM

"Sir Thomas"

Méhul: Overtures to: *Timoléon; Le Trésor supposé; Le Jeune Henri*. Boccherini: Overture in D. Grétry: Pantomime from *Zémire et Azor*. Beethoven: *Coriolan* Overture, Op. 62. Brahms: *Tragic* Overture, Op. 81.

Royal Philharmonic Orchestra, Sir Thomas Beecham, cond.

COLUMBIA ML 5029. 12-in. \$3.98.

The record, affectionately given the generic title *Sir Thomas*, as one would commemorate lovingly the fierce and familiar complex bee who stings but makes honey, is assured of an enthusiastic welcome from all those admirers of the conductor who admire most his address in music more like the first five pieces above than the last two. (His *Coriolan* is a fast one, and the excellent *Tragic* Overture in his playing is not salient in the light of the brilliant competition from three other specialists.)

But the delicate little Pantomime by Grétry is a misty plaint of scented charm as it emerges from the fastidious instrumental adjustments of the conducting baronet; and the positive shaping of the Méhul tunes, which are certitude itself, out of a hand-wrought orchestral texture of gleaming precision, is one of the few recent examples of the special Beecham talent for jewel-like music. Two of the Méhul overtures have never been recorded before, nor has the lively Boccherini Overture (Italian symphony).

Proficient registration, although not of the same type for all these works, with the unusual feature of heavy bass combined with distinct articulation. Orchestral quality of first order. C. G. B.

FOUR CONCERTOS FOR TRUMPET, WOODWINDS, AND STRINGS

Torelli: Trumpet Concerto in D; Vivaldi: Concerto in G minor (Pincherle 383); Locatelli: Concerto No. 2, from *L'Arte del Violino*, Op. 3; *Il Pianto d'Arianna*.

Maurice André, trumpet (in the Torelli); Huguette Fernandez, violin (in the Locatelli); J.-M. Leclair Instrumental Ensemble, Jean-François Paillard, cond.

HAYDN SOCIETY HSL 147. 12-in. \$5.95.

Somebody goofed when the title for this disk was selected. Only the Torelli is a trumpet concerto, and only the Vivaldi employs woodwinds. A violin is the solo instrument in the two Locatelli pieces, and the Vivaldi is a concerto grosso.

This is an engrossing and varied group. The Torelli shows how a clever composer could maintain interest even within the severe technical limitations that hampered the trumpet of that time. The Vivaldi, written for the Dresden orchestra, is a fine, full-blooded work ranking with that master's best. The selection from Locatelli's Op. 3 reveals the violin concerto well on its way to its classic form. Melodically and harmonically the work is unusually expressive, and there are considerable technical demands on the soloist, which Miss Fernandez meets with the required bravura. *The Plaint of Ariadne*, which is the last work in Locatelli's Op. 7, is one of those programmatic instrumental pieces that were not as uncommon in the Baroque period as may be supposed. It is a fascinating attempt to express in orchestral terms the grief of the abandoned heroine, though one needs the Ariadne's thread of the annotations to follow it in detail. Generally good performance and recording. N. B.

ORAZIO FRUGONI

Spanish Piano Music

Albéniz: *Prelude, Sous le Palmier, Córdoba, Seguidillas*, Op. 232, Nos. 1, 3, 4, 5; *Malagueña*; Tango in D. Granados: *Allegro de Concierto; Andaluza (Playera)*. Turina: *Exaltation*. Falla: *Andaluza; Ritual Five Dance*.

Orazio Frugoni, piano.
VOX PL 9420. 12-in. \$4.98.

Mr. Frugoni's somewhat hard and brittle style of playing proves effective in the shifting, subtle rhythms of these Spanish works. Most of the items are thrice familiar. A real rarity is Granados' *Allegro de Concierto*, a student work somewhat naively Chopinesque, but not without charm and a light Spanish flavor. Bright, clean-cut sound. The record liner does not list the works played; they are described in notes, but not in the order in which they are played, which makes it necessary to look at the disk label constantly to see what the music is. A minor point, surely, but an irritating one. R. E.

COR DE GROOT

Piano Music from Spain

Albéniz: *Sevilla; Cadiz; Castilla; Malagueña*, Op. 165, No. 3; *Rumores de la Caleta*. Falla: *Spanish Dance No. 1* (from *La Vida Breve*); *El Paño Moruno; Cancion; Pièces espagnoles*;

Ritual Fire Dance (from *El Amor Brujo*).
Mompou: *Gitano*; *Prélude*; *L'Homme de l'Aristo*.

Cor de Groot, piano.
EPIC LC 3175. 12-in. \$3.98.

Competent performances of fairly standard items. The Dutch pianist brings a conventional, Chopinesque, but attractive lyricism to phrases that Spanish pianists treat with greater rhythmic crackle and bite. *El Paño Moruno* and *Cancion*, from Falla's *Seven Popular Spanish Songs*, were arranged for piano solo by the composer's pupil Ernesto Halfter; with the last two Mompou pieces, they represent the nearest things to novelties here. Incidental intelligence: Like many of his recording colleagues in Europe, Mr. De Groot will come to this country next season for his first American tour. R. E.

GIOVANNI MARTINELLI
Sings by Request

Giovanni Martinelli, tenor.
RCA CAMDEN CAL 274. 12-in. \$1.98.

The choice of repertoire in this Martinelli reissue was made largely by readers of this magazine who sent their suggestions to RCA in response to an item in "Music-Makers" (June 1955). This LP and another Martinelli reissue ("Giovanni Martinelli in Opera and Song," RCA CAMDEN CAL 283) will be the subject of an essay-review by Desmond Shawe-Taylor in a forthcoming issue. Meanwhile, those who helped compile this "By Request" collection will want to know of the disk's release. R. G.

MODERN AMERICAN COMPOSERS,
VOL. 1

Soloists and chamber ensemble of the New Symphony Orchestra, Camarata, cond.
LONDON LI 1213. 12-in. \$3.98.

For an English orchestra to start a modern American series under an English label may be news of a sort, even if nothing much can be said in favor of the works chosen for the first record in the group. Robert McBride's *Pumpkin Eaters Little Fugue* and *Workout for Small Orchestra* are light and trivial, while Ulysses Kay's *Round Dance and Polka* is one of the least distinguished works of a gifted man; all these, however, are Beethoven compared to the overblown television commercials by one Walter Mourant on the other side. To provide as many of the grisly details as are necessary, these compositions are entitled *In the Valley of the Moon*, *Air and Scherzo*, and *Sleepy Hollow Suite*. Performance and recording are as good as the music deserves. A. F.

ERICA MORINI
Violin Recital

Erica Morini, violin; Leon Pommers, piano.
WESTMINSTER 18087. 12-in. \$4.98 (or \$3.98).

This is a collection of typical encore pieces — and even some of these are old-fashioned for such purposes — but no matter what Erica Morini does, she does with care and impeccable artistic taste. Certainly, there is much love lavished on the performances on this disk, and the violinist's warm, smooth tone, as well as that of her expert accompanist, has been most faithfully preserved on exceptionally quiet record surfaces. P. A.

"Show off" that new phonograph with these new DECCA ALBUMS!

... here are eight wonderful ways to do it.



String Enchantment: Alfred Newman & Orch.; "Nocturne," "Waltz," "Molly On The Shore," others. (DL 8194, ED-769)



Woman Of Paris: Introducing Miss Vicki Benét; "Pigalle," "The Heart of Paris," "C'est La Vie," etc. (DL 8233, ED-782)

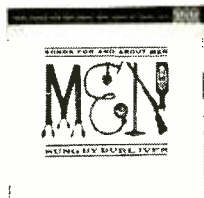

Men: Songs For and About Men; Burl Ives; "John Henry," others. (DL 8125, ED 2235-6-7)



***The Hi-Fi Nightingale:** Caterina Valente; "This Must Be Wrong," "The Way You Love Me," etc. (DL 8203, ED-771)



The Golden Moment: Camarata & Orch.; "Che Gelida Manina," "Flower Song," others. (DL 8206)



The Moment of Truth: Impressions of the Bull Ring. Recorded in Spain. (DL 9806)



Andrés Segovia: Masters of the Guitar; Compositions of Francisco Tarrega & Fernando Sor. (DL 9794)



Genius At Work: The Conley Graves Trio; "Prelude II - Fugue," "Laura," others. (DL 8220, ED 2316-7-8)



"DL" indicates 33 1/2 Long Playing Records
"ED" indicates 45 RPM Extended Play Recordings



*Recorded in Europe by Deutsche Grammophon Gesellschaft - Polydor Series.

DECCA® RECORDS

a New World of Sound

"You Can Hear The Difference!"

MORMON TABERNACLE CHOIR
Concert of Sacred Music

Cyril Jenkins: *Light in Darkness; Lead, Kindly Light; Weep You No More, Sad Fountains; Fierce Raged the Tempest.* Liszt: *Ave Verum.* Brahms: *Sapphic Ode; How Lovely Is Thy Dwelling Place* (from *A German Requiem*). Elgar: *As Torrents in Summer.* Purcell: *Nymphs and Shepherds; Thy Work Is a Lantern.* Dett: *Listen to the Lambs.*

Mormon Tabernacle Choir of Salt Lake City, J. Spencer Cornwall, cond. Alexander Schreiner and Frank W. Asper, organists. COLUMBIA ML 5048. 12-in. \$3.98.

The Mormon Tabernacle Choir, widely known for its nationwide Sunday morning broadcasts, which date from 1929, commands admiration for its massive, homogeneous tone, excellent diction, and straightforward interpretations. The music on this disk is generally disappointing. The title notwithstanding, the selections are not all sacred—three works are very definitely secular—and the four long original pieces by Cyril Jenkins, a Welsh-born composer, have as their only major merit great technical skill in choral writing; otherwise they are pretentious, melodically commonplace, sentimental if sincere. The works by Elgar and Dett, and the chorus from the Brahms *Requiem*, provide the most satisfactory listening. Resonant, clear sound for the choir and for the organ as long as it is dealing with nonpolyphonic music. R. E.

DAVID OISTRAKH
Violin Recital

Prokofiev: Sonata for Violin and Piano, No. 1, in F minor, Op. 80. Leclair: Sonata for Violin and Piano, No. 3, in D. Locatelli: Sonata for Violin and Piano, in F minor ("Au Tombeau") (arr. Ysaye).

David Oistrakh, violin; Vladimir Yampolsky, piano. RCA VICTOR LM 1987. 12-in. \$3.98.

RCA Victor stole the march on its competitors by making the first domestic recordings of this season's two Russian musical visitors, Emil Gilels and David Oistrakh. In so doing, it has managed to turn out two of the best disks that either of these artists has ever made anywhere. One of Oistrakh's failings often has been his inability to get beneath the surface of a composition, but here he does some wonderfully expressive things with these three fine sonatas. Outstanding is his treatment of the slow movements, as well as his smoothly integrated double-stopping in the Leclair. The high quality of the reproduction not only reveals the beautiful Oistrakh tone in all its true light but also finally does complete justice to the work of his long-time collaborator, Vladimir Yampolsky. P. A.

ORIGINAL DON COSSACK CHORUS
Favorite Encores

Original Don Cossack Chorus; Serge Jaroff, cond. CONCERT HALL CHS 1230. 10-in. \$3.98.

This is strictly for admirers of the Don Cossacks. They give here a familiar exhibition of their throbbing low bass tones and high wiry ones, their sudden alternations of fortissimos and pianissimos. R. E.

LEONARD PENNARIO
Concertos Under the Stars

Liszt: *Liebstraum.* Bath: *Cornish Rhapsody.* Addinsell: *Warsaw Concerto.* Beethoven: Adagio sostenuto from Sonata in C-sharp minor (*Moonlight*), Op. 27, No. 2. Wildman: *Swedish Rhapsody.* Rachmaninoff: Prelude in C-sharp minor, Op. 3, No. 2. Litloff: Scherzo from *Concerto Symphonique.*

Leonard Pennario, piano; Hollywood Bowl Symphony, Carmen Dragon, cond. CAPITOL P 8326. 12-in. \$4.98.

Leonard Pennario lavishes his lithe, virile pianism and outstanding technical skill on an odd mixture here. The three rhapsodies (the *Warsaw* and *Cornish* being of film origin, the *Swedish* of comparable style) probably never had it so good. The Beethoven, Liszt, and Rachmaninoff works are played against an orchestral background conceived by the conductor. There remains only one unadulterated piece of any interest: the fragment by Henry Litloff, a well-known nineteenth-century pianist and founder of the music editions that bear his name. His Scherzo is typical in its bustling, sporty gaiety, fast and unrelenting for the soloist, splashily effective. Mr. Pennario gives it the works, in a very engaging way. The orchestral performances are properly lush, but not indecently so, and the sound is genuinely full-dimensional. R. E.



Pennario mixes a Hollywood potpourri.

CARLOS SALZEDO
Harp Recital

Handel-Salzedo: *The Harmonious Blacksmith.* Corelli-Salzedo: Giga, from Sonata in A for Violin and Continuo, Op. 5, No. 9. Massenet-Salzedo: *Menuet d'Amour.* Salzedo: *Scintillation; Ballade; Petite Valse; La Désirade; Traipsin' thru Arkansasaw.*

Carlos Salzedo, harp. MERCURY MG 80003. 12-in. \$3.98.

Mr. Salzedo can make his harp sound like almost anything he wants it to, and he gives the instrument a workout on this disk, which is entitled *Scintillation—The Harp in High Fidelity*. In the title piece he produces some thrumming, throbbing masses of tone in rhumba rhythm that are quite fascinating. He can also play music as music, too, as he does in the Handel, Corelli, and Massenet items (the last based on a duet from the opera *Thérèse*), but for

comparable works one turns with relief to the fastidious, less flamboyant art of Nicanor Zabaleta, who records for Esoteric. Mr. Salzedo is most entertaining and rewarding in his own harp exercises, which might conceivably appeal to lovers of "Music Between." The sound is almost too good—every tone emerges a little larger than life. R. E.

PAUL SCHOEFFLER
Opera Arias

Wagner: *Die Walküre*: Act III: from *Leb wohl* (Wotan) through *Magic Fire Music.* Parsifal: Act I: from *Mein Sohn Amfortas* (Tituel) through *Nein! Lass' ihn unentbült!* (Amfortas). Verdi: *Simon Boccanegra*: Act III: *M'ardon le tempia* (*Boccanegra*). *I Vespri Siciliani*: Act II: *O tu Palermo.* Meyerbeer: *L'Africaine*: Act II: *Figlia dei Re* (Nelusco). Wagner: *Die Meistersinger*: Act II: *Was duftet doch der Flieder* (Sachs).

Paul Schoeffler, baritone; Vienna State Opera Orchestra, Felix Prohaska, cond. VANGUARD VRS 469. 12-in. \$4.98.

Already long established in Germany and Austria, and particularly in Vienna, Paul Schoeffler first came to this country and to the Metropolitan in 1950. He was then fifty-three—not ancient, as baritone years are reckoned, but well beyond the full glow of youth, with a voice beginning to pass its peak and a figure beginning to thicken about the middle. He was received with politeness rather than enthusiasm, but in the intervening five years politeness has ripened into deep respect, respect into warm acceptance; for he has always been an artist—not great, set against the highest standards, but thorough and usually satisfying. As heard at the Metropolitan—and, well-reproduced, in this Vanguard miscellany—the voice is not characteristically very rich or very responsive to expressive nuances of color. It is a reliable voice, firm and of good size; dry, but strong and unproblematic. Here it sounds to best advantage in the Wagner excerpts—which, except for the *Parsifal*, have been recorded before by Mr. Schoeffler, singing neither notably better nor less well, for London and Remington. In the Verdi and Meyerbeer excerpts, all sung in rather unflowing Italian, the musical intentions are good, the results somewhat vitiated by the essential unmallemability of the voice.

Reproduction of the voice is quite good; the balances, with the orchestra pushed back in perspective, and rather gently conducted in any case, are debatable but at least consistent. No texts, rather unhelpful notes. J. H., Jr.

SIENA PIANOFORTE
Recital by Marisa Regules

Turina: *Danzas gitanas.* Albéniz: *Leyenda* (*Prelude*); *Cordoba*; *Seguidillas.* Villa-Lobos: *The Baby's Family*, Book I. Mompou: *Scènes d'enfants.*

Marisa Regules, piano. ESOTERIC ESP 3002. 12-in. \$5.95.

The "Siena piano," resembling in some degree many instruments with plucked strings, is a congenial medium for the performance of Spanish music. It bestows valuable

Continued on page 98

HERE IT IS... BY REPLICA

THE MOST SENSATIONAL HI-FI PIPE ORGAN RECORD EVER!
"The BEAST in the BASEMENT"
 & Leon Berry

Record Sensation of the
 Hi-Fi Shows!
"FABULOUS EDDIE"

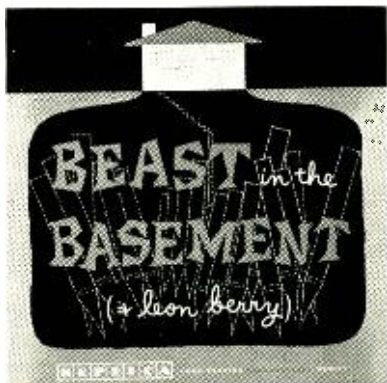

*New Adventures
 In Sound*

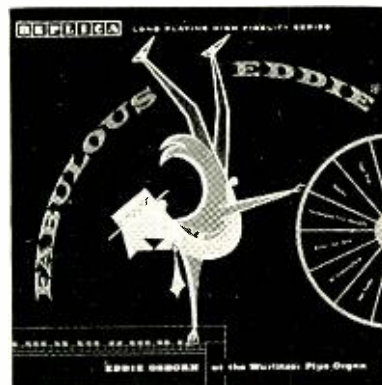

This is the record that everyone has been waiting for. Leon Berry removed from a theatre and installed in the basement of his house in the suburbs of Chicago, a complete Mighty Wurlitzer Pipe Organ, including console, hundreds of pipes of every dimension and size, glockenspiels, drums, klaxons and all. This is a huge 2 manual instrument which pours forth, within the confines of the basement, sounds which literally rock the house. Recording-wise it represents a miracle in engineering technique. Here is more of the great organ music that has made Replica and Leon Berry a favorite of the Hi-Fi fans and audio shows.

Featuring EDDIE OSBORN and his rollicking rhythm at the console of the great Wurlitzer theater pipe organ. Here is the latest **Balanced Audio Range** recording by REPLICA, full of big sound, subtle tonal colorations and a sparkling mixture of polyphonic effects unique on a unit pipe organ. Here is lively entertainment superbly captured by REPLICA in the full audio spectrum of 16 to 25,000 CPS—a musical delight for the audiophile and a challenge in reproduction for any high fidelity sound system!

Replica 33 X 509 12-inch \$5.95

Replica 33 X 511 12-inch \$5.95

Other High-Fidelity Record Sensations by Replica

- GLOCKENSPIELS, TRAPS and PLENTY of PIPES. The hit of the Hi-Fi Shows. Leon Berry at the Chicago Hub Rink, Organist. Replica 501 10-in. LP \$4.00
- GLOCKENSPIELS, TRAPS and PLENTY of PIPES. Vol. 2. Leon Berry, Organist. Replica 503 10-in. LP \$4.00
- GLOCKENSPIELS, TRAPS and PLENTY of PIPES. Vol. 3. Leon Berry, Organist. Replica 505 10-in. LP \$4.00
- GLOCKENSPIELS, TRAPS and PLENTY of PIPES. Vol. 4. Leon Berry, Organist. Replica 507 10-in. LP \$4.00
- THE LATIN SET. Bill Knaus plays Latin American favorites. Replica 500 10-in. LP \$4.00
- HAL PEARL AT THE ARAGON PIPE ORGAN. Wurlitzer Pipe Organ. Replica 502 10-in. LP \$4.00
- ORGAN ECHOES. Kay McAbee at the Mighty Wurlitzer Pipe Organ. Replica 506 10-in. LP \$4.00
- MATINEE. The organ mastery of Arsene Siegel in his first recording for Replica, played on the great Oriental Theater organ. Replica 513 12-in. LP \$5.95
- AL MELGARD AT THE CHICAGO STADIUM PIPE ORGAN, World's largest Pipe Organ. Replica 504 12-inch LP \$5.95
- AL MELGARD AT THE CHICAGO STADIUM PIPE ORGAN. Vol. 2. Replica 510 12-inch LP \$5.95
- BILL KNAUS PLAYS "SWELL" TO "GREAT". A High Fidelity treat. Replica 508 10-inch LP \$4.00
- MEMORIES OF OLD VIENNA. Tyrolean Trio with Rudy Waack and his Zither. Replica 200 10-inch LP \$4.00
- JOHNNY HAMLIN QUINTET. Fresh new sound in Jazz plus drum breaks. Replica 1000 10-inch LP \$4.00
- HELEN'S HOLIDAY. Helen Westbrook at the magnificent four-manual Wurlitzer organ in Chicago's Oriental Theater. Replica 512 10-inch LP \$4.00

IF YOU ARE SEEKING A STARTLING, NEW HIGH FIDELITY EXPERIENCE — THIS IS IT!

UNUSUAL RECORDINGS

for the Discriminating **Hi-Fi** Record Collector



AUDIO FIDELITY RECORDS presents

THE BRAVE BULLS

La Fiesta Brava
 Music of the Bullfight Ring

Featuring the "BANDA TAURINA" of the Plaza Mexico, world's largest bullfight arena. A Hi-Fi presentation of the complete musical background of an afternoon at the bull-fights including the traditional Pasodobles, the fanfares, etc.

Complete with book of 24 full-color illustrations from famous Bullfight Posters with full explanation in English and Spanish of an afternoon at the bullfights.

RECORDED IN MEXICO
 A Study in HI-FIDELITY Sound
 Audio Fidelity AFLP 1801 12-inch \$5.95

MARIMBA MAMBO y CHA-CHA-CHA

Thrill to the greatest and the latest dance rhythms with a 6 man Marimba with Orchestra.

A Study in HI-FIDELITY Sound
 HI-Fi Fans... This is a Total Frequency Range Recording
 Audio Fidelity AFLP 1802 12-inch \$5.95

TALBOT BROTHERS CALYPSO

Bermuda's greatest tourist attraction in new high fidelity recordings.

VOL. 2 AFLP 903	10-inch	\$4.00
VOL. 3 AFLP 1807	12-inch	\$5.95

BAWDY SONGS and BACKROOM BALLADS

To those of you of good appetite and strong stomach, here is your dish! Here are the rollicking songs and ballads of tough, hard-living and hard-drinking men and their wholesome, winsome wenches, Oscar Brand, folk singer.

VOL. 1 AFLP 906	10-inch	\$4.00
VOL. 2 AFLP 1806	12-inch	\$5.95

These records are available at your favorite Audio or Record Shop

WRITE FOR FREE CATALOGS

DAUNTLESS INTERNATIONAL

750 TENTH AVE. NEW YORK 19, N.Y.

Dialing Your Disks

All LP disks are recorded with treble boost and bass cut, the amount of which often varies from one manufacturer to another. To play a disk, the bass below a certain turnover frequency must be boosted, and the treble must be rolled off a certain number of decibels at 10,000 cycles. Recommended control settings to accomplish this are listed for each manufacturer. Equalizer control panel markings correspond to the

following values in the table below. ROLL-OFF — 10.5: LON, FFRR. 12: AES, RCA, Old RCA. 13.7: RIAA, RCA, New RCA, New AES, NARTB, ORTHOPHONIC. 16: NAB, LP, COL, COL LP, ORTHOCoustic. TURNOVER — 400: AES, RCA. 500C: LP, COL, COL LP, Mod NAB, LON, FFRR. 500R: RIAA, ORTHOPHONIC, NARTB, New AES. 500: NAB. 630: BRS. 800: Old RCA.

RECORD LABEL	NEW		OLD
	Turnover	Rolloff	Record No. or Date: Turnover, Rolloff
Allied	500	16	
Amer. Rec. Soc.	400	12	
Angel	500R	13.7	
Arizona	500R	13.7	To 1955: 400, 12.7
†Atlantic	500R	13.7	
Audiophile	500	12	
Bach Guild	500R	13.7	No. 501-529: 500, 16
*Bartok	500R	13.7	No. 901-905, 308, 310, 311: 500R, 13.7 No. 906-920, 301-304, 309: 630, 16
Bethlehem	500R	13.7	
Blue Note Jazz	500R	13.7	To 1955: 400, 12
Boston	500C	16	
*Caedmon	500R	13.7	No. 1001-1022: 630, 16
Canyon	500R	13.7	To No. C6160: 400, 12
Capitol	500R	13.7	To 1955: 400, 12.7
Capitol-Cetra	500R	13.7	To 1955: 400, 12.7
Cetra-Soria	500C	16	
Classic Editions	500R	13.7	
Colosseum	500R	13.7	To January 1954: 500, 16
*Columbia	500R	13.7	To 1955: 500C, 16.
Concert Hall	500R	10.5	To 1954: 500C, 16.
*Contemporary	500R	13.7	No. 3501, 2501, 2502, 2505, 2507, 2001, 2002: 400, 12. No. 2504: 500, 16
†Cook (SOOT)	500	12-15	
Coral	500	16	
Decca	500R	13.7	To November 1955: 500, 16
Elektra	500R	13.7	No. 2-15, 18-20, 24-26: 630, 16. No. 17, 22-400, 12. No. 16, 21, 23, 24: 500R, 13.7
EMS	500R	13.7	
Epic	500R	13.7	
Esoteric	500R	13.7	No. ES 500, 517, EST 5, 6: 400, 12
Folkways	500R	13.7	To 1955: 500C, 16
*Good-Time Jazz	500R	13.7	No. 1, 5-8: 500, 16. No. 3, 9-19: 400, 12
Haydn Society	500C	16	
HMV	500R	16	
Kapp	500R	13.7	No. 100-103, 1000-1001: 800, 16
Kendall	500	16	
*London, Lon. Int.	500R	13.7	To No. 846: 500C, 10.5
Lyrichord	500	16	
McIntosh	500R	13.7	
*Mercury	500R	13.7	To October 1954: 400, 12
MGM	500R	13.7	
Montilla	500R	13.7	
New Jazz	500R	13.7	
Nocturne	500R	13.7	No. LP 1-3, 5, XP1-10: 400, 12
Oceanic	500C	16	
*L'Oiseau-Lyre	500R	13.7	To 1954: 500C, 10.5
*Overtone	500R	13.7	No. 1-3: 500, 16
Oxford	500C	16	
Pacific Jazz	500R	13.7	No. 1-13: 400, 12
Philharmonia	400	12	
†Polymusic	500	16	
Prestige	500R	13.7	
RCA Victor	500R	13.7	To September 1952: 500 or 800, 12
Remington	500	16	
Riverside	500R	13.7	To 1955: 400, 12
Romany	500R	13.7	
Savoy	500R	13.7	
Tempo	500	16	
Transradio	500C	16	
Urania	500R	13.7	No. 7059, 224, 7066, 7063, 7065, 603, 7069: 400, 12. Others: 500C, 16
Vanguard	500R	13.7	No. 411-442, 6000-6018, 7001-7011, 8001-8004: 500, 16
Vox	500R	13.7	500, 16 unless otherwise specified.
Walden	500R	13.7	
*Westminster	500R	13.7	To October 1955: 500C, 16; or if AES specified: 400, 12

*Currently re-recording old masters for RIAA curve.

†Binaural records produced on this label have no treble boost on the inside band, which should be played without any rolloff.

clarity and transparency, with different tonal effects provided by different registers, though the color variations are not as wide within one register as they are on a modern piano — or even on a guitar. After a while, however, I found the Siena piano's constant twang and its thumping bass tiresome and even painful to the ear. Miss Regules, an Argentinian pianist, plays with clean, rhythmic forcefulness, and the Spanish-Brazilian repertoire is decidedly attractive and not too hackneyed. R. E.

CESARE SIEPI *Opera Arias*

Verdi: *Don Carlo: Ella giammai m'amo. Nabucco: Tu sul labbro. Ernani: Infelice! e tu credevi. Simon Boccanegra: Il lacerato spirito.* Gomes: *Salvator Rosa: Di sposo di padre le gioie serene.* Meyerbeer: *Les Huguenots: Seigneur, rempart et seul soutien; Piff. Paff. Robert le Diable: Nonnes qui reposez.* Halévy: *La Juive: Si la rigueur.*

Cesare Siepi, bass; Orchestra of the Accademia di Santa Cecilia (Rome), Alberto Erede, cond.

LONDON LI. 1240. 12-in. \$3.98.

This is a re-release of performances recently issued, and reviewed, on two ten-inch disks (LD 9168 and LD 9169). Cesare Siepi is in characteristically warm, mellow voice and sings with good control, but gets above the level of rich-sounding concert readings and onto the level of notable dramatic art only in the more familiar Verdi excerpts. Still, the Meyerbeer and Gomes and Halévy repertoire heard here is not easy to come by on LP at all, much less in performances of such vocal richness, so well recorded. There is no really significant difference between the technical qualities of the

Dialing Your Disks Clarification

Apparently the new "Dialing Your Disks" chart (on this page) has been both a boon and a source of confusion to HIGH FIDELITY readers. So in answer to those few bewildered readers who haven't yet queried us about this, and who have been unable to glean the information from the note at the top of the chart, a few words of explanation.

In the bass turnover column, 500 stands for straight 500-cycle turnover, with linear bass boost down to 30 cycles.

500C stands for 500-cycle turnover with bass boost continuing down to 100 cycles and leveling out below that. This is the old Columbia LP bass curve, also referred to as 500-modified.

500R, if you haven't guessed it already, stands for 500-cycle turnover with the RIAA characteristic; that is, with bass boost continuing down to 50 cycles and leveling out below that.

High-frequency rolloff values in the chart represent the number of decibels attenuation at 10,000 cycles. Record equalizers are marked either as shown on the chart, or as the letter abbreviations shown in the note above the "Dialing Your Disks" columns.

twelve-inch and the two ten-inch records, but a considerable difference in price.

J. H., JR.

SWEDISH CONTEMPORARY MUSIC

Larsson: Concerto for Violin and Orchestra. Blomdahl: *Pastoral Suite*. Fernström: Concertino for Flute, Women's Chorus, and Orchestra.

André Gertler, violin; Erik Holmstedt, flute; Stockholm Radio Chorus and Orchestra, Sten Frykberg, cond.

LONDON TW 91091. 12-in. \$4.98.

By far the best of the three works in this anthology of modern Swedish music is the *Pastoral Suite* by Karl-Birger Blomdahl, which — despite its title — is a big, finely resonant piece full of highly original harmonic and coloristic ideas. It is for strings alone. The Concertino by John Fernström is a light, entertaining affair full of Oriental effects; unfortunately, the notes do not contain the slightest indication of what its text is all about. The Violin Concerto by Lars-Erik Larsson is a somewhat academic composition, though pleasantly melodious, and is beautifully played by Gertler, for whom it was written. The recordings are excellent. A. F.

SWISS CHAMBER MUSIC

Regamey: String Quartet No. 1. Honegger: *Petite Suite*; *Danse de la Chèvre*. Moeschinger: Sonata for Violin and Piano, No. 1.

Winterthur String Quartet; George Aurele Nicolet, flute; Hansheinz Schneeberger, violin; Pierre Souverain, piano.

LONDON LL 893. 12-in. \$3.98.

An interesting if not overwhelming anthology of modern Swiss chamber music. Constantin Regamey seems to be one of the neo-Bartókians who are now catching up with Bartók's early style. His quartet is a vigorous, grandly scaled, and brilliant affair, with a rather wonderful slow movement. The other big work on the disk, the sonata by Albert Moeschinger, is more conservative in idiom, though the annotator's insistence upon parallels with the Franck sonata is surely exaggerated. Schneeberger and Souverain give the piece the full peaches-and-cream treatment, ably assisted by London's recording engineers. The two Honegger pieces that complete the collection are trifles, but delectable ones. The *Petite Suite* is a trio for flute, violin, and piano which was written for children and produces a maximum of tuneful effect with a minimum of technical demands. The *Danse de la Chèvre* is a virtuoso study for flute alone; it is marvelously well played by Nicolet. A. F.

TREASURY OF FAVORITE SYMPHONIES

Beethoven: Symphony No. 8, in F, Op. 93. Mendelssohn: Symphony No. 4, in A ("Italian"), Op. 90. Schubert: Symphony No. 8, in B minor ("Unfinished"). Brahms: Symphony No. 1, in C minor, Op. 68. Dvorak: Symphony No. 5, in E minor ("From the New World"), Op. 95. Franck: Symphony in D minor. Mozart: Symphony No. 41, in C ("Jupiter"), K. 551. Tchaikovsky: Symphony No. 6, in B minor ("Patbétique"), Op. 74.

Various orchestras and conductors.

RCA CAMDEN CFL 104. Six 12-in. \$10.98.

Recent announcements that Camden planned to discontinue using orchestral pseudonyms appear to have been slightly premature; for in this new album of eight symphonies we still have to cope with our old friends "Warwick," "Centennial," *et al.*, though for some mysterious reason Monteux and the San Francisco Orchestra (once known as "Wide World") have managed to emerge from behind the veil. Others most likely will follow, though whether they do or not will make little difference to the knowledgeable listener anxious to acquire these performances of the pre-high-fidelity era.

Time may have dealt rather harshly with the sound of some of these recordings, but even this has been partially remedied by Camden's engineers in a sort of updating process. The most successful renovation is

accorded Stokowski's *New World*, though the Monteux version of the Franck Symphony in D minor is almost as good. The latter, in fact, is as good a performance of this popular work as one can now find in the catalogue. The brilliance of the Koussevitzky *Italian* has been a byword in the record world for almost two decades, and it is still an exciting and wonderfully played performance. Stokowski offers a fine-sounding *Patbétique*, which is slightly spoiled by his overdramatization of the music. A genial and altogether acceptable *Jupiter* comes from Vienna, directed by Bruno Walter, but plagued with some slight hall-echo. Less inviting are Stokowski's bloated Brahms; the wonderfully played but overenergetic Beethoven Eighth, by Koussevitzky and the Boston Symphony,

Music in the Great European Tradition

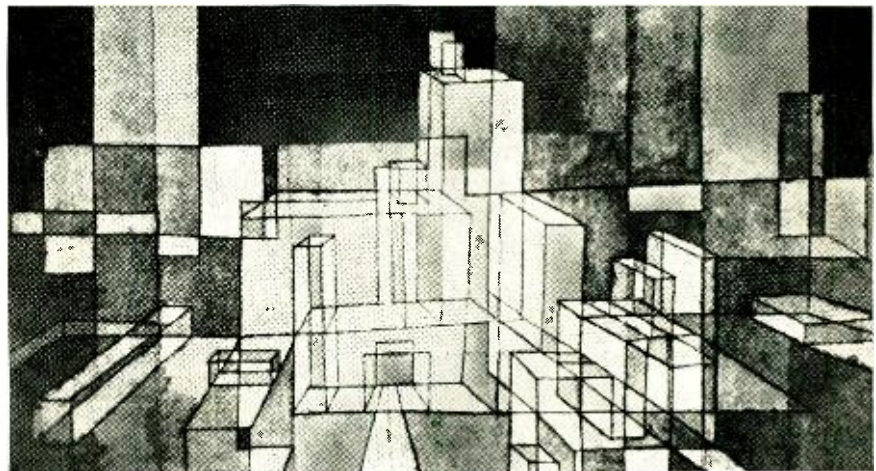

Detail from a painting by Paul Klee

"B" is for BARTÓK, too!

Bach, Beethoven and Brahms are acknowledged masters of music in the great European tradition. Now, Decca proudly presents the major solo piano repertory of **Béla Bartók**, a modern master in that same great musical tradition. Newly recorded in flawless high fidelity, these definitive piano works have been authentically and sensitively performed by **Andor Foldes**, considered by many to be the foremost interpreter of Bartók's music. Here are four

superb volumes, each impeccably recorded in Europe by the famous *Deutsche Grammophon Gesellschaft*:

VOLUME I: From "Mikrokosmos," "For Children," Sonatina. (DL 9801)

VOLUME II: From "For Children,"—6 Rumanian Folk Dances—Fantasy II—7 Sketches, Op. 9—Improvisations. (DL 9802)

VOLUME III: Hungarian Peasant Songs—Sonata for Piano (1926)—3 Rondos—Rumanian Carols—Suite. (DL 9803)

VOLUME IV: Out Doors—10 Easy Pieces—Allegro Barbaro—9 Little Pieces—3 Burlesques, Op. 8c. (DL 9804)

TWO MORE EXCITING EXAMPLES OF DECCA'S *New World of Sound!*

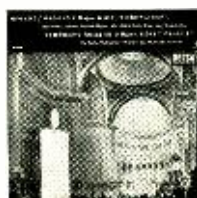

MOZART: Mass in C Minor, K. 317 ("Coronation"). Soloists: Stader, Wagner, Krebs, Greindl; Choir of St. Hedwig's Cathedral, Berlin. Symphony No. 38 in D Major, K. 504 ("Prague"). Berlin Phil. Orch., Igor Markevitch, Conductor. Recorded in Europe by Deutsche Grammophon Gesellschaft. (DL 9805)



MOZART: The Abduction From The Seraglio. The N. Y. Times says: "... remarkably fine both as recorded sound and as a musical performance... under Mr. Fricssay's direction." Soloists: Stader, Greindl, Streich, Häfliger, others; RIAS Symphony Orch., Chorus. Recorded in Europe by Deutsche Grammophon Gesellschaft. (DX-133)

DECCA® Gold Label RECORDS

a *New World of Sound*



and a Schubert *Unfinished*, from the same orchestra and conductor, which lacks grace and is light in sound.

In general, this collection can be recommended to all, except those primarily interested in hi-fi. The six records, with explanatory booklet, are presented in a box album; each symphony is available singly on individual records, the numbers of which may be found in the LP catalogue. J. F. I.

WHITTEMORE AND LOWE

Dances for Two Pianos

Strauss, Johann, Jr.: *Waltz Fantasy*. Bach: Siciliano, from Sonata for Flute and Clavier in E-flat. Reger: *Valse d'Amour*, from *Eine kleine Ballet Suite*. Dvorak: *Slavonic Dances*, Nos. 1, 6, 8, and 10. Copland: *Celebration Dance*, from *Billy the Kid*.

Lecuona: *Malagueña*. Brahms: *Waltzes in E, B minor, and A-flat*, from Op. 39. Gluck: *Mélodie*, from *Orfeo ed Euridice*. Schubert: *Valses nobles*. Satie: *Gymnopédie No. 2*. Gould: *Guaracha*. Shaw, Clifford: *Third Street Rhumba*.

Arthur Whittemore and Jack Lowe, two pianos.

RCA VICTOR LM 1926. 12-in. \$3.98.

Attractively efficient performances of pleasant music that could have been assembled under any other name just as easily. Try playing the Reger waltz for a musician friend to see if he can guess the composer's name. My belief is that he won't—it's such an unlikely work to come from this composer's pen. R. E.

FOLK MUSIC

by Howard LaFay

BAWDY SONGS AND BACKROOM BALLADS

Roll Your Leg Over; No Hips At All; One-Eyed Reilly; Blow The Candle Out; Sam Hall; The Chandler's Wife; Her Name Was Lil; Bell Bottom Trousers; The Sergeant; Old Joe Clark; Around Her Neck She Wore a Yellow Ribbon; Our Goodman; Rollin' Down the Mountain.

Oscar Brand, folk singer.

AUDIO FIDELITY AFLP 906. 10-in. \$4.00.

A conventional gambit in reviewing such records is an arch warning that "this is not for sensitive ears." Well, with all archness omitted, this is *not* for sensitive ears. Mr. Brand, a balladeer well-represented on LP, has elected to sing these bawdy songs sans the customary clean-up—save where the bluntest Anglo-Saxonisms require euphemism.

Brand's interpretations are uneven. Where he maintains a straightforward naïveté—as in the delightfully ribald *Chandler's Wife*—he is at his entertaining best; but often he seems to be straining for "apt" vocal characterizations, most of which don't quite come off. However, his percentage of hits outweighs the misses. He is aided throughout by clean, natural reproduction.

FATHER SYDNEY MacEWAN

Scotch And Irish Songs

The Dashing White Sergeant; Galway Bay; The Meeting of the Waters; See Amid the Winter Snow; Mowing the Barley; Lewis Bridal Song; The Rowan Tree; Come to the Manger; The Lark in the Clear Air; Kelly, the Boy from Killann

COLUMBIA ML 5067. 12-inch. \$3.98.

Some dozen years ago, Sydney MacEwan, an accomplished young Scotch-Irish tenor, smashed all box office records on a concert tour of Australia. Shortly thereafter he astonished the musical world by abandoning his singing career to enter a Roman Catholic seminary. Now, as a parish priest in the Scotch village of Lochgilphead, he still makes an occasional concert tour (including one to the U.S. last season) or an occasional record—the proceeds going to charity.

Father MacEwan's voice retains the clarity and flexibility that distinguished his earlier professional appearances. However, his concertized versions of these songs are marked by excessive smoothness and a consequent loss of vitality. While the orchestral accompaniment is less than inspired, excellent engineering enhances Father MacEwan's performance.

FRANKIE AND JOHNNY

And Other Folk Song Favorites

Frankie and Johnny; My Bonny Lad; Widdicombe Fair; Red Rosy Bush; Richard of Taunton

Let your hi-fi set flex its muscles with these...

modern works

...and **VOX'**
dynamic sound!

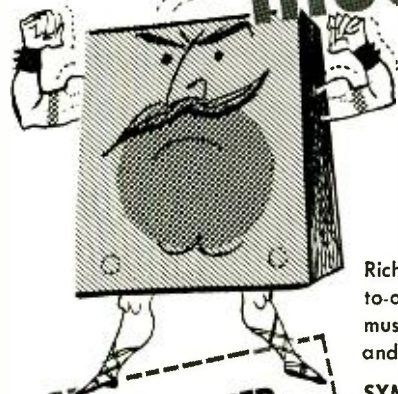

Rich in color and excitement—these pieces are made-to-order for the hi-fi fan. No la-dee-dah stuff here, but music with dimension, performed by artists who respect and understand the "moderns"...and recorded by VOX.

- BRUCKNER**
- R. STRAUSS**
- STRAVINSKY**
- JANAČEK**
- BARTÓK**

SYMPHONY NO. 8 IN C MINOR (Version of 1890)
Jascha Horenstein conducting the Pro Musica Symphony, Vienna2-12" **PL 9682**

METAMORPHOSES
FOUR LAST SONGS
Christel Goltz, soprano—Pro Musica Orchestra, Vienna—Bamberg Symphony—Heinrich Hollreiser, conductor **PL 9400**

VIOLIN CONCERTO IN D MAJOR
CARD GAME (Jeu De Cartes)
DUO CONCERTANT
Ivry Gitlis, violin—Charlotte Zelka, piano—Concerts Colonne Orchestra—Bamberg Symphony—Harold Byrns & Heinrich Hollreiser, conductors.....**PL 9410**

SINFONIETTA
TARAS BULBA, Rhapsody for Orchestra
Jascha Horenstein conducting the Pro Musica Symphony, Vienna**PL 9710**

SONATA FOR 2 PIANOS AND PERCUSSION
MUSIC FOR STRINGS, PERCUSSION AND CELESTE
Alfred Brendel, Charlotte Zelka, pianos—Pro Musica Chamber Orchestra, Stuttgart—Rolf Reinhardt, conductor **PL 9600**

for sound reasons



Ultra High Fidelity

236 West 55th Street, New York 19, N. Y.

Dean; Who Killed Cock Robin; The Bold Fisherman; Red River Shore; The Praties They Grow Small; 'Twas in the Broad Atlantic.

Sung by Ed McCurdy.
BY-LINE BL-1. 10-in. \$3.85.

Another sterling folk song sampler by the ubiquitous Ed McCurdy who switches labels as often as France switches governments. This time he is featured on the initial release of a brand new company, By-Line. As is his wont, McCurdy gets maximum mileage from his somewhat gritty voice, neatly adapting it to the varying humors of the songs he has chosen. The end product is a well-conceived, well-executed, well-engineered disk.

HAUL ON THE BOWLIN'
(And Other Shanties and Foc'sle Songs)
Vol. I

Haul on the Bowlin'; Row, Bullies, Row; The Coast of Peru; The Black Ball Line; The Ship in Distress; The Gauger; Blow The Man Down; Do Me Ama; Santa Anna; The Flying Cloud; A Hunderd Years Ago.

Sung by A. L. Lloyd and Ewan MacColl.
Accompanied by Alf Edwards, concertina.
STINSON SLP 80. 10-in. \$3.00.

OFF TO SEA ONCE MORE
(And Other Foc'sle Songs and Shanties)
Vol. II

Blood Red Roses; Van Dieman's Land; The Greenland Whale Fishery; Paddy Doyle; Johnny Todd; Lord Franklin; Reuben Ranzo; The Cruel Ship's Captain; Handsome Cabin Boy; Sally Racket; The Dreadnaught; Off To Sea Once More; Stormalong.

Sung by A. L. Lloyd and Ewan MacColl.
Accompanied by Alf Edwards, concertina.
STINSON SLP 81. 10-in. \$3.00.

A vocal recreation of a bygone age of seafaring — a harder, more boisterous, more dangerous age — that boasts some remarkably salty singing by A. L. Lloyd, who was recently sought out by John Huston to fill the role of the Shantyman in his newly filmed version of *Moby Dick*. Lloyd's partner, Ewan MacColl, also pulls a strong vocal halliard.

The shanties and ballads, all possessed of a rich nostalgia, date from the waning days of sail and the first grinding decades of steam. Since the disks originated in England, it is hardly surprising that the material is culled almost exclusively from British sources.

The occasional concertina accompaniments suggest the atmosphere of the foc'sle, as does the monumentally disorganized choral background. The sound is marred by some fuzziness and a variance in dynamic levels between bands; none of it, however, is fatal to enjoyment.

Anyone who prefers songs of the sea without the customary latterday sugar-coating will do well to investigate these records.

THE JEWISH YOUNG FOLKSINGERS

Oy A Liebe; Rozbinkes Mit Mandlen; In A Shtetl; S'Falt A Shnei; Dire Gelt; La Carmagnole; En Mi Viejo San Juan; Didn't My Lord Deliver Daniel; Frankie Slide; Hava Na Gila.

Robert DeCormier, Musical Director.
STINSON SLP 67. 10-in. \$3.00.

Under the direction of Robert DeCormier, these New York amateurs sing with the finesse of professionals. The Yiddish folk songs on this release are the most effective, notably the very fine arrangement of *Rozbinkes Mit Mandlen* (Raisins and Almonds). The rather thick, undefined reproduction does not show the singers to best advantage.

LAS MUSAS LATINAS

Zarzuela by Manuel Penella with Luisa de Cordoba and Mimi Aznar.

Orquesta de Camara de Madrid, Enrique Navarro, cond.
MONTILLA FM 61. 12-in. \$4.98.

A one act zarzuela literally bursting with melody and recorded in crystalline fidelity. The plot is fragile, concerning three penniless artists — one French, one Italian, one Spanish — who, after imbibing freely, are individually inspired by the Muses of their respective countries. In the course of these events, a bit of good-natured and very tuneful fun is poked at the musical clichés of all three nations. Enrique Navarro conducts his forces with verve and the singing is of a superior order.

MATADOR
Spanish Bull Ring Marches and Pasodobles

Marcha Granadera; Isha; Legionarios y Regulares; La Perfecta Casada; Dem; Viva la Jota; España Cañi; Puñao de Rosas; Pepita Creus; Flores de España; Ecos Españoles; Brisas del Ebro.

Spanish Air Force Military Band, Madrid.
Commander Manuel G. de Arriba, cond.
DECCA DL 9792. 12-in. \$4.98.

Music of the bull ring skillfully played and recorded with lucidity. Although *Matador's* engineering lacks the super-brilliance of Audio Fidelity's *The Brave Bulls* (AFLP 1801), the sure, intelligent conducting of Commander Arriba imparts a musical fluency not found in the competition. You will never hear marches and pasodobles played this well at a *corrida*, which is perhaps all the more reason to esteem this disk.

NANIGO (The Soul of Afro-Cuban Music)

Oggere; Lacho; Facundo; Chivo Que Rompe Tambo; La Cumparsa; Mi Ochun, Ecue; Macongo; Ya Negro Murio; Negra Triste.

Interpreted by Ruth Fernandez, with Obdulio Morales and his Native Cuban Orchestra and Chorus.
MONTILLA FM 54. 12-in. \$4.98.

An exploration of the Afro-Cuban idiom by Ruth Fernandez, a memorable performer on Montilla's version of *Cecilia Valdes*. While Miss Fernandez' contralto is at its rich best, her choice of songs is not unexceptionable. Too many of the folk themes have been musically masticated by a motley array of Latino songsmiths, with unhappy results. Miss Fernandez is well-supported by the accompaniment of Obdulio Morales, and Montilla provides satisfactory sound.

There are notes in Spanish and English, but the songs receive only a vague sentence or two by way of explanation. If you *no entiende español*, you may have to enroll with Berlitz to find out what Miss Fernandez is singing about.

A Hit In Any Room
DUCHIN'S Exciting
Record Cabinet
Protects & Catalogs
200 Records!

Top value, only
\$10.⁹⁸ Freight Prepaid

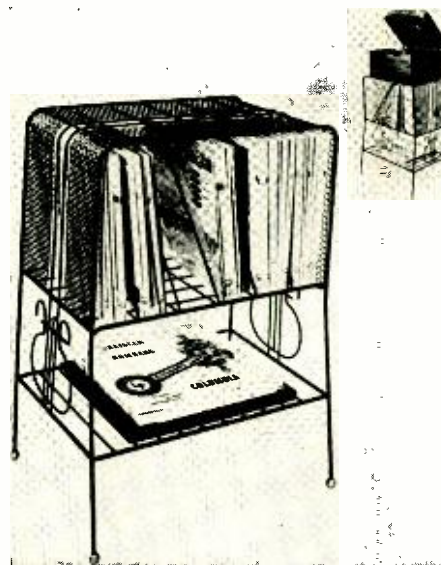

Check off these terrific features

- **FASHIONABLE . . .**
Perforated black wrought iron sparked with gleaming brass, superbly crafted and constructed.
- **PRACTICAL . . .**
Divided shelf neatly catalogs every size record and album, protects valuable records. Holds full size radio-phonograph too.
- **VERSATILE . . .**
Ideal for rumpus room, patio, den, living room.
29"x20"x13"

Send check or money order to:

Maurice Duchin Creations, Inc.
Dept. H2, 230 Fifth Avenue
New York 1, New York

FROM EVERY ANGLE  **DUCHIN'S WROUGHT IRON IS BEST!**

EPIC RECORDS

bring you a
world of music



From Cleveland...
first performances
on Epic
by one of
America's greatest
orchestras!

In just 38 years the Cleveland Orchestra has come into being and developed into one of the finest orchestras in the world. For the past 10 years this development has been under the baton of George Szell who conducts these first releases for Epic:

Beethoven: Symphony No. 5 in C Minor;
Schubert: Symphony No. 8 in D Minor ("Unfinished"). Hear both these most popular symphonies recorded in Epic's unique Radial Sound. LC 3195

Haydn: Symphony No. 88 ("Paris") in G Major; Symphony No. 104 in D Major ("London"). Precision playing by the fabulous Cleveland strings. LC 3196

Deluxe package
with illustrated brochure.

Each 12" Long Playing Record... \$3.98

The Cleveland Orchestra is now heard exclusively on Epic.

THE NEW LABEL OF GREATNESS



A PRODUCT OF CBS

© "Epic"

OHIO VALLEY BALLADS

Bruce Buckley, with guitar

The Rowan County Crew; Pearl Bryan; Sidney Allen: Sam Bass; Lula Viers; The Rarden Wreck of 1893; John Henry; Molly Bonder

FOLKWAYS FP 23-2. 10 inch.

Bruce Buckley, a graduate student at Indiana University, has a bland, pleasing baritone and a highly developed ability to shape his style to the demands of the individual song. The ballads he has chosen — all indigenous to the sprawling Ohio River Valley — are strongly colloquial in flavor, although most hark back to Anglo-Irish-Scotch antecedents. The majority of Buckley's versions are new to the record catalogue. Many of them, such as *Sidney Allen, The Rowan County Crew*, etc., afford fascinating glimpses into the violent backwaters of American history. Outstanding sonics and detailed notes round out a distinctly superior release.

WATERS OF TYNE

English North Country Songs and Ballads

Waters of Tyne; Billy Boy; Colliers' Rant; Keel Row; Lambton Worm; When This Old Hat Was New; Geordie Hinny; Cusbie Butterfield; Willow Tree; Blaydon Races; Ca' Hawkie; Maa Bonny Lad; Heb You Seen Wor Jimmy; Banks of the Dee.

Sung by Paul Clayton.

STINSON SLP 70. 10-in. \$3.00.

Paul Clayton's selections are representative both of the older folk and newer music hall

traditions that have shaped the musical life of the Tyneside. Clayton collected these songs himself on a swing through the British Isles; this close tie between singer and song breeds an expressive interpretation. Despite a certain harshness of texture, the sound is satisfactory.

SEVEN TELEFUNKEN RELEASES OF GERMAN MUSIC

The 85 selections contained on these seven releases provide a substantial run-down of German traditional music. However, most of the songs receive the kind of over-orchestrated treatment that polishes away virtually every trace of folk origin. The engineers contribute an unadorned, unembellished, well-balanced naturalness of reproduction.

Telefunken calls these 10 inch disks *Medium Play* and they aren't kidding: playing time averages a mere 15 to 20 minutes per record. As a result, the selections tend to be fragmentary — sometimes to the point of near obliteration. The album notes, which incline toward the lyrical, are singularly uninformative and unhelpful. No texts; no translations.

Evaluations of the individual records follow:

MIT KLINGENDEM SPIEL (With Ringing Sound)

Musikkorps Der Schutzpolizei, Berlin.
Obermusikmeister Heinz Winkel, Dir.
TM 68012. 10-in. \$2.98.

Bar none, this is the best brass band sound on records, with the oompah of the tubas and the tinkle of the glockenspiel perfectly

THE CRITICS CHOICE

<p>"truly inspiring" <small>Review of Recorded Music</small></p>	<p>"sheer delight" <small>The Gramophone</small></p>	<p>"one of the great things on records" <small>High Fidelity</small></p>
<p>"the counter-tenor artistry of Alfred Deller" Purcell: COME YE SONS OF ART Alfred Deller, John Whitworth, counter-tenors; Margaret Ritchie, soprano; Bruce Boyce, baritone; St. Anthony Singers and L'Ensemble Orchestral de L'Oiseau-Lyre conducted by Anthony Lewis. <small>L'Oiseau-Lyre—10" DL 53004—\$2.98</small></p>	<p>Rodrigo: CONCERTO FOR GUITAR AND ORCHESTRA <small>("Concierto de Aranjuez") (with Narcisco Yepes, guitar)</small> Falla: NIGHTS IN THE GARDENS OF SPAIN <small>(with Gonzalo Soriano, piano) Madrid Chamber Orchestra (augmented), conducted by Ataulfo Argenta. <small>London International—12" TW 91019—\$4.98</small></small></p>	<p>ORIGINAL CAST PRODUCTION Weill: THE THREE PENNY OPERA <small>(DREIGROSCHENOPER) Original cast production of 1929. Featuring Lotte Lenya, Erika Helmke, Kurt Geron, Erick Ponto, Willy Trenck-Trebitsch and Lewis-Ruth band conducted by Theo Mackeben. <small>Telefunken—10" LGM 65028—\$2.98</small></small></p>

LONDON INTERNATIONAL, INC. 539 WEST 25th STREET, NEW YORK 1, N. Y.

projected and flawlessly reproduced. Obermusikmeister Winkel's direction of these swinging march tunes is firm and competent, but the performance of the Berlin Schutzpolizei Band transcends mere competence. This is without question the best of the batch.

O DU WUNDERSCHONER DEUTSCHER RHEIN (Songs of the Rhineland)

Benno Kusche; Kurt Adolf Thelen, vocalists. Orchestra and Chorus. Willy Mattes, cond. TM 68022. 10-in. \$2.98.

Catchy, evocative melodies full of the sunny side of the German character. Very fine vocal work by Kusche and Thelen, but the orchestral accompaniments occasionally smack of over-saccharine "arrangements."

UBER DER HEIDE (Over the Heath) LIEDER DER HEIMAT (Songs of the Homeland)

Benno Kusche; Renate Holm, vocalists. Choruses and Orchestra. Hansgeorg Otto, dir. TM 68030. 10-in. \$2.98.

Again Benno Kusche turns in some fine vocal work as does Renate Holm. This time the orchestral support is unimpeachable. Unfortunately, excessive fragmentation tells here to a greater extent than in the other disks. The majority of the songs are nostalgic, but it is impossible to establish a mood in the minute or so allotted to each selection.

RUND UM'S HOFBRAUHAUS (Round the Hofbrauhaus)

Various Performers. TM 68032. 10-in. \$2.98.

A sprawling mélange of Bavarian melodies, the best being a delightfully beery rendition of the rollicking *In Munchen stehts a Hofbrauhaus*. Elsewhere, Rudi Knabl and his folk musicians perform well, as does the yodeler Anni Fahrnberger. However — and this is a large however — the labels, at least on my copy, are reversed, the Side 1 label being affixed to Side 2 and vice-versa. Combined with the unhelpful notes and German titling that is not unambiguous, the consequent confusion approaches the traumatic.

WENN DIE GLASER KLINGEN (When the Glasses Clink)

Studentenchor Und Grosses Unterhaltungs-Orchester. Hans Mielenz, cond. Georg Lohmann, bass solo. TM 68038. 10-in. \$2.98.

Thoroughly beguiling drinking songs in the best *Weinstube* tradition. Georg Lohmann's otherwise rich bass develops a wobble once in a while, but the chorus performs with distinction.

WAS STUDENTEN SINGEN (Student Songs)

Willy Langel, tenor; Karl Golgowsky, baritone. Studentenchor. Grosses Begleitorchester. Hans Mielenz, dir. TM 68040. 10-in. \$2.98.

Sturdy, full-throated singing by the unidentified student chorus, plus some solid efforts

by the soloists. The University ambiance is enhanced by a slight lack of choral precision that is most student-like, although shockingly un-Teutonic. Strangely, the disk does not contain that loveliest of student songs *Ich habe mein Herz in Heidelberg Verloren*.

BEKANNT UND BELIEBT (Songs Known and Loved)

Renate Holm and Benno Kusche vocalists. Fred Weyrich and Chorus. Hermann Hagedest and his Orchestra. TM 68041. 10-in. \$2.98.

These are mostly "pops" songs of the more genteel type, with a strong international salon flavor; they are not distinctively German, they just happen to be sung in German. The orchestra performs with the sheen of a good dance band. Renate Holm and Benno Kusche do a polished job on the vocals.

THE MUSIC BETWEEN

THE SONGS OF ADLER AND ROSS

Various singers and orchestras. EPIC LN 1122. 10-in. \$1.98.

Six tunes from *The Pajama Game* and *Damn Yankees*, served up by Dolores Hawkins and the Mello-Larks, among others. The company does its work in competent and conventional pop fashion, but the inclusion

of only six tunes in the album leaves a considerable amount of unused record space. R. K.

HAROLD ARLEN AND COLE PORTER

Composers at Play

Arlen: *Let's Fall in Love; As Long as I Live; Ill Wind; This Is Only the Beginning; Happy As the Day Is Long; Stormy Weather.*

Porter: *Anything Goes; Two Little Babes in the Wood; The Cocotte; I'm a Gigolo; Be Like the Bluebird; Thank You So Much Mrs. Lounsbrough Goodbye.*

"X" LVA 1003. 12-in. \$3.98.

ALAN JAY LERNER

Performs His Own Songs

Almost Like Being in Love; Love Song; A Jug of Wine; Economics; There But For You, Go I; Love of My Life; Here I'll Stay; Wanderin' Star; Green Up Time; Progress; Susan's Dream; Heather on the Hill; I Talk to the Trees; Mr. Right.

HERITAGE 0600. 12-in. \$4.98.

Cole Porter's voice is sharp and tiny, and its accents are Ivy League *cum* gin-and-vermouth. In a quiet way, the voice is almost perfect for these songs that he recorded, with his own piano accompaniments, back in the Thirties. The composer is most interesting, however, for his tempo ideas; he sings an *Anything Goes* that is a good deal slower than what we're used to. His other five choices are less well-known, but at least two of them — *Two Little Babes in the Wood* and *The Cocotte* — are bound to delight you with their matchless

Response to recent Audiophile ad:

Gentlemen:

We can't figure out what you are selling* but it must be overpriced** if you can afford to run that kind of an ad. Anyway, send us a descriptive booklet, if it's free.

Very dubiously yours,

(Name sent upon receipt of a \$3.00 bill)

*We're not selling anything really — we're trying to sell records.

If is.*

***At least most people think so.

But there's one thing about Audiophile Records: — they are truthfully and candidly represented and nearly all who hear them recognize their uniquely good quality of sound.

Join our list of confused customers — write us and we will be glad to send you a free booklet. Very few dealers would have Audiophile Records in their store — so we will be glad to ship from the laboratory if your dealer is the proud type.

AUDIOPHILE RECORDS INC.
High Quality Recordings
 SAUKVILLE, WISCONSIN

NEW FROM UNICORN!

MUSIC TO SHAKESPEARE'S TEMPEST

Sir Arthur Sullivan



F. Charles Adler conducting
Vienna Orchestral Society

Here is Sullivan at his best . . . as a "boy wonder" composer. For while in his 'teens, the composer produced this remarkable accompaniment, no mean task for a grown-up. For those who prefer the schmaltz Sullivan, Henry VIII is recommended.

UNLP 1014 12" LP \$3.98

SYMPHONY IN C MAJOR, Op. 16, No. 3

Luigi Boccherini



F. Charles Adler conducting
Vienna Orchestral Society

. . . form and substance are stated so plainly as to make any extended analysis unnecessary."
JULES WOLFFERS

UNLP 1017 12" LP \$3.98

Ask your dealer to order from
QUARTO, 53 State St., Boston 9, Mass.

UNICORN RECORDS
75 State St. Boston 9, Mass.

VANGUARD
recordings for the connoisseur

HI-FI SHOWPIECES

MARIO ROSSI
conducts
BRAHMS: HUNGARIAN DANCES
for Orchestra (complete)
Vienna State Opera Orchestra VRS-473

One of the
Greatest Recordings of our time!

Prokofiev: ALEXANDER NEVSKY
Mario Rossi, conductor Ana Maria Iriarte, soprano
Chorus & Orchestra of the Vienna State Opera VRS-451
"An absolutely astonishing recording . . . Percussion is tremendous . . . Dynamic range is among the greatest on records."
RADIO AND TELEVISION NEWS
Elizabethan Music in Definitive Performances
the english madrigal school
ALFRED DELLER, director Vol. I
The Deller Consort, BG-553
"A distinguished musician in a distinguished repertoire.—PAUL HUME, WASHINGTON POST
Previously released:
Elizabethan and Jacobean Music BG-539
Music of Henry Purcell BG-547
Tallis: Lamentations of Jeremiah BG-551
All 12" long playing \$4.98
send for complete catalog
VANGUARD RECORDING SOCIETY INC.
236 W. 53rd Street, New York 19, N. Y.

lyrics. Harold Arlen's songs, which Arlen himself sings on the other side of the record, are a little more rich-blooded. Their beautiful melodies are no match for the composer's voice — even as it was in 1933-34, when the recordings were made. Arlen the song writer wins hands down.

Alan Jay Lerner is another story. A writer of warm, often subtle lyrics, he can also sing with a voice that is sure and expressive. He is given first-rate co-operation by Kaye Ballard and Billy Taylor, and together they happily run through the best portions of *Love Life*, *Brigadoon*, and a few other scores. R. K.

BROADWAY GOES HOLLYWOOD

Oh! What A Beautiful Mornin'; People Will Say We're in Love; I Love Paris; Stranger in Paradise; Hey There; I'll Know; Hello, Young Lovers; We Kiss in a Shadow; A Wonderful Guy; Younger Than Springtime; Old Devil Moon; I Get a Kick Out of You.

Jack Pleis, his piano, orchestra, and chorus. DECCA DL 8167. 12-in. \$3.98.

Fairly standard approaches to melodies that were part of some of Broadway's biggest musical comedy hits. As often as not, Mr. Pleis's chorus gets in the way of the tunes with its lugubrious keening, but the vigor of the melodies themselves is usually sufficient to get everybody out of serious trouble. R. K.

MAURICE CHEVALIER

Rendez-vous à Paris, No. 3

Viens dans mon hélicoptère; Deux amoureux sur un banc; Mon p'tit moustique; Loin du pays; La chanson des lilas; C'est l'amour, mais oui; Un gentleman; Rendez-vous à Paris; Chapeau de paille.

Maurice Chevalier, with the orchestras of Fred Freed, George Ghestem, and Paul Durand. LONDON WB 91080. 10-in. \$2.98.

Chevalier's happy knack of quickly establishing a friendly rapport with his audience is the most engaging thing about this informal session of Parisian songs. He permits us to share in his affection for the famous straw hat and to feel and understand his chagrin at discovering that, on Broadway, electric signs that start with "Chev" do not end in the expected "alier" but in "rolet." And when he invites us to a rendezvous in Paris, we feel like making a beeline to the nearest air line. This perennially youthful artist is in exceptionally good voice on this record. J. F. I.

FRANK CRUMMIT

The Gay Caballero

A Gay Caballero; I Learned About Women from Her; Little Brown Jug; Frankie and Johnny; My Grandfather's Clock; Down by the Railroad Track; Abdul Abdulbul Amir; The Grandson of Abdul; Minnie Skavinsky Skavar; Roll Them Roly Boly Eyes; How Come You Do Me Like You Do; Would You Like To Take a Walk (with Julia Sanderson).

Frank Crummit. "X" LVA 1005. 12-in. \$3.98.

BING CROSBY

Young Bing Crosby

I'm Coming Virginia; Ol' Man River; Wrap

Your Troubles in Dreams; The Little Things in Life; I'm Gonna Get You; Thanks to You; Ho Hum!; One More Time; Fool Me Some More; It Must Be True; That's Grandma; Them There Eyes.

Bing Crosby. "X" LVA 1000. 12-in. \$3.98.

RUSS COLUMBO

Love Songs

Call Me Darling; Sweet and Lovely; Just Friends; Where the Blue of the Night (Meets the Cold of the Day); You Try Somebody Else; You're My Everything; All of Me; Time on My Hands; Save the Last Dance for Me; Living in Dreams; Auf Wiedersehen, My Dear; Paradise.

Russ Columbo. "X" LVA 1002. 12-in. \$3.98.

GENE AUSTIN

All-Time Favorites

I've Got a Feeling I'm Falling; My Melancholy Baby; St. James Infirmary; When Your Lover Has Gone; If I Could Be With You (One Hour Tonight); St. Louis Blues; Ain't Misbehavin'; After You've Gone; Mood Indigo; Please Don't Talk About Me When I'm Gone; How Am I to Know?; All I Do Is Dream of You.

Gene Austin. "X" LVA 1007. 12-in. \$3.98.

Most of these recordings date from the late Twenties and early Thirties, and they serve as perfect examples of what popular singing in this country was like at the time. It seems immediately apparent, listening to Columbo and the young Crosby, that vocalists cared a good deal less for their material. Columbo, in particular, is frankly corny and sounds unaware of what he is singing. Crosby crooned, and that was an end in itself. On the other hand, Gene Austin had a voice, placed high and sweet, and with it he managed an appearance of sincerity that was downright endearing, if we can believe our eyes and ears today. Frank Crummit, of course, was the perennial college boy, singing engaging limericks without a worry in the world. There hasn't been anyone like him since his death. Generally speaking, this is fascinating period-stuff and it's immeasurably helped by the improved sound. R. K.

LENNY DEE

Deelirious

DECCA DL 8165. 12-in. \$3.98.

More hopped-up organ solos from a gentleman who has become enormously popular in his chosen field. Slick stuff, and tricky too. R. K.

FAMOUS GIPSY MELODIES

Kocze Antal and his Gypsy Orchestra. LONDON LD 9190/91. Two 10-in. \$2.98 each.

Another round with Kocze Antal, in which he displays his usual gifts — all authentic, mostly tearful, and well recorded. R. K.

ELLA FITZGERALD

Sweet and Hot

Thanks for the Memory; It Might As Well Be

Spring; You'll Never Know; I Can't Get Started; Moanin' Low; Taking a Chance on Love; That Old Black Magic; Old Devil Moon; Lover, Come Back To Me; Between the Devil and the Deep Blue Sea; You'll Have To Swing It.

Ella Fitzgerald.
DECCA DL 8155. 12-in. \$3.98.

A practical lesson on how a great jazz singer can command a fantastic variety of voices and inflections and use them all with astonishing skill. There's very nearly a different Ella for each of these dozen tunes. Any way she chooses to present herself, she winds up a truly remarkable woman.
R. K.

THE MUSIC OF RUDOLF FRIML

Nathaniel Shilkret and his orchestra, with soloists and chorus.
RCA CAMDEN CAL 252. 12-in. \$1.98.

Mainly because they came quite late in Friml's career as an active composer, and then achieved such enormous popularity, the scores for *Rose Marie* and *The Vagabond King* have had a tendency to obscure the beauty of his earlier contributions to the Broadway stage. More's the pity, for *The Firefly*, *High Jinks*, and *Katinka* contain, among them, some of the most tuneful and musicianly operetta music ever written. Camden has thoughtfully restored them to the catalogue in this reissue of sides made in the Thirties. Admittedly, the sound is anything but hi-fi, but this should not deter anyone interested in the music, particularly when it is as well presented and sung as it is here.
J. F. I.

GYPSY MELODIES

Edi Csoka and his Gypsy Orchestra.
VANGUARD VRS 7035. 10-in. \$3.95.

One of the virtuosos of the gypsy fiddle hard at work again here, showing off once more his intense affinity for his particular brand of folk music.
R. K.

HOLIDAY IN NEW YORK

Rod Gregory, piano; Frank Carroll, bass; Bob Rosten, drums.
GRAND AWARD 33-317. 12-in. \$2.98.

Professional cocktail-lounge playing at its deftest, with the trio collaborating on some of the nicest songs we have around. Rod Gregory, at the piano, can hold his own neatly with his competitors in the field, and he and his teammates help to bring a pleasant feeling of *elan* and even eagerness to their work.
R. K.

GORDON JENKINS *Heartbeats*

Gordon Jenkins and his Orchestra.
DECCA DL 8116. 12-in. \$3.98.

Mood music that sticks to tradition like pudding to the ribs. Quiet, monotonous, and nearly perfect for an undemanding conversation.
R. K.

AL JOLSON AND EDDIE CANTOR *The Immortals*

Rock-a-Bye Your Baby With a Dixie Melody;

April Showers; Hallelujah, I'm a Bum; If You Knew Susie; Margie; What a Perfect Combination.

EPIC LN 1128. 10-in. \$1.98.

Immortality, even in the record business, was surely never so unjustly earned. If Jolson's schmaltzy singing and Cantor's exuberant pipings are to be considered sufficient qualifications for election, they had better make way for Milton Berle and Jerry Lewis, who are both certainly as well qualified. The record is strictly for the singers' fans.
J. F. I.

WAYNE KING *Waltz Dreams*

Wayne King and His Orchestra.
DECCA DL 8145. 12-in. \$3.98.

A dozen popular waltzes played by the waltz king and his entourage in imperishable fashion. For Wayne King royalists only.
R. K.

MARCHES AND POLKAS

Various bands.
TELEFUNKEN TM 68033. 10-in. \$2.98.

Several Teutonic musical organizations, including Berlin's police band, in a grabbag of polkas and marches. The results, as you'd expect, are literally bands and bands of wonderfully resounding oom-pahs, blown with little delicacy but great spirit.
R. K.

ETHEL MERMAN AND GERTRUDE NIESEN *On Stage*

I Gotta Right to Sing the Blues; How Deep Is the Ocean; I'll Follow You; Satan's Lil' Lamb; Smoke Gets in Your Eyes; Harlem on My Mind; Jealousy; Supper Time; When Love Beckoned (on 52nd Street); Katie Went to Haiti.

Ethel Merman and Gertrude Niesen.
"X" LVA 1004. 12-in. \$3.98.

ETHEL WATERS

Frankie and Johnny; Georgia on My Mind; Jeepers Creepers; They Say; Lonesome Walls; Stop Myself from Worrying Over You; Down in My Soul; If You Ever Change Your Mind; Y'Had it Comin' to You; Old Man Harlem; Bread and Gravy; What Goes Up Must Come Down.

"X" LVA 1009. 12-in. \$3.98.

Another trip down yesteryear's well-worn paths, this time with three ladies whose careers are still going strong. The Merman of the early Thirties, at least on the four songs she sings here, was a more "interpretative" worker than she is today; she went in for octave-zooming, while singing sadder ballads than she became accustomed to later. Gertrude Niesen sounds much the same; her special gifts have always been the ability to color her voice with varying metallic intensities plus the faintly humorous trick of rolling her r's dramatically on occasion.

Ethel Waters, on the other hand, has no special gifts. All she can do is sing, and a joy it is to hear her. Then, just as now, she sometimes seemed to stop over a word in the lyrics, as though she were tasting it, and the effect is somehow almost always exactly right.
R. K.

**BETTER SOUND...
LONGER RECORD LIFE**

Begin
HERE



the new
Walco

**RECORD
ACCESSORY
BAR**

Put it on your PX counter!

This all-in-one record accessory counter display has everything your customer needs to improve the sound... extend the life of his records. Famous Walco Stati-Clean, anti-static record spray and Discovers, plastic protective sleeves for records—plus two entirely new Walco products that are absolute "musts" for every serious record collector: the Walco Balanced Sound Kit, for turntable and tone arm accuracy and Disclean, the soft-as-sable Walco record brush that's *unconditionally guaranteed* not to scratch delicate record surfaces.



WALCO STATI-CLEAN

An anti-static record spray; eliminates destructive dust. Less than a penny per disc.

WALCO *Balanced Sound Kit*

Accurate turntable level; precision stylus pressure gauge.



WALCO DISCLEAN

Camel's hair record brush; clips to tone arm brushing away dust ahead of the needle.

WALCO DISCOVERS

Plastic protective record sleeves; protect against dust, moisture, fingerprints.



Help your PX to a big share of the fast-moving accessory market with a Walco Record Accessory Bar. Write Walco today for complete details.

Walco PRODUCTS, INC. Dept. PX
60 Franklin Street, East Orange, N. J.

FEBRUARY 1956

105

Lee Lorenz, trumpet; Roz Rudd, trombone; Pete Williams, clarinet and soprano saxo-

manner — rhythmically swinging and somewhat cool on the solos. It's an in-and-out

FEBRUARY 1956

107

HELEN MORGAN AND FANNIE BRICE

Miss Sanders also respects her melodies and the words that frame them. Her accom-

Record Market

Send For Our **free!**
WONDER VALUE CATALOG
OF LONG PLAYING
CLASSICAL RECORDS
One Of The Largest Selections
In The Whole Country
Write Dept. H

CHAMBERS RADIO CORP.
97 Chambers St., New York 7, N. Y.

LP INDEX TABS

The ideal filing system for your LP collection. Names of the 100 most recorded composers printed on sturdy index tabs to be attached to your LP sleeves or cardboard dividers. Also many miscellaneous categories, and a generous supply of blank tabs. \$1.00 postpaid from Perspective Records, 550 Fifth Avenue, New York 36, N. Y.

LP RECORDS ARE DUST AND STATIC FREE

with the **STATI-MUTE**

- Clips On
- Negligible Weight
- Lasts Indefinitely

The American Record Guide Recommends the Stati-Mute:

"Used it successfully for months . . . preferable to liquid applications . . . no usual ball of dust . . ."—Aug. 1955 issue.

WILLIAMS CO.
BOX 348
WHITE PLAINS, N. Y.

\$2.95

Postpaid

GIBSON GIRL TAPE SPLICERS

splices in a wink!
NO SCISSORS!
NO RAZOR BLADES!

Disposal cuts tape ends
and forms splice edges.



ROBINS INDUSTRIES CORP.

Model TS-4 \$8.50 List
Model TS-4DLX (illus.) \$11.50 List

Heavy Duty Models for Industrial Use
and Special Purpose Tapes

TS-250 for 1/4" Tape	— \$55.00 Net
TS-500 for 1/2" Tape	— \$55.00 Net
TS-625 for 3/4" Tape	— \$55.00 Net
TS-750 for 7/8" Tape	— \$55.00 Net
TS-1000 for 1" Tape	— \$55.00 Net

At your dealer or write to us for information.

collection but it is definitely in when Peanuts Hucko is to the fore with his free-wheeling Goodman-like clarinet which he alternates with surprisingly modern (and surprisingly good) tenor saxophone. There are also several helpful appearances by Eddie Costa on xylophone and piano and by all three of the guitarists.

BUD FREEMAN

Newport News; At Sundown; Exactly Like You; Let's Do It; But Not for Me.

Ruby Braff, trumpet; Bud Freeman, tenor saxophone; Ken Kersey, piano; Al Hall, bass; George Wettling, drums.

Stop, Look and Listen; Hanid; Dave's Blues; I Remember You; Perdido; You Took Advantage of Me.

Freeman; Wettling, Dave Bowman, piano.
BETHLEHEM BCP 29. 12-in. 37 min. \$4.85.

The native styles of that group of jazz musicians who came out of Chicago in the Twenties was designed for use in a crowd. As a consequence they may be heard in gaggles, swarms, prides or herds but rarely in trios and it's just as well. Bud Freeman's trio selections on this disk indicate why. Even with as sterling a threesome as Freeman, Dave Bowman, and George Wettling, there isn't much substance to this trio work. It's a thin, watery mixture which drains readily off the ribs. The larger group, however, is a delightfully meaty project. Truth to tell, Freeman is far from being a major contributor to this meatiness. That is done primarily by Ruby Braff, in brilliant form, and secondarily by Ken Kersey, a moving

and free fingered pianist. Freeman doesn't really assert himself until the fourth number on the side, *Let's Do It*, a fine instance of his rolling, whirligig style. But he is at his best on *But Not for Me*, a slow ballad performance which exhibits a different, more fertile Freeman, playing in a guttily tender manner, abetted by magnificent muted accompaniment by Braff.

THE HARRIS-LEIGH BAROQUE BAND AND BRASS CHOIR
Jazz 1755

High Street Steps; Miss Pope of Drury Lane; Blue Bell and Crown; Royal Horse Guard Blue; Cool, Easy and Serene; Soho Square; Rambler; Whitefriars; Love in a Village; Mr. Diggs; Lady Louisa; Savoy Stairs.

Bob Montesi, John Bello, trumpet; Billy Byers, Sonny Russo, trombone; Dan Cowen, french horn; Tom Parshley, flute; Joe Soldo, clarinet; Leon Cohen, oboe; Mitch Leigh, bassoon; Art Harris, harpsichord-piano; Doc Goldberg, bass; Jim Chapin, drums.
KAPP KL 1011. 12-in. 32 min. \$3.98.

This interpretation of the eighteenth century in jazz terms is fun all the way through. But it's more than a mere novelty because Art Harris and Mitch Leigh have concocted several pieces which have lasting validity as jazz (count *Mr. Diggs*, *Lady Louisa*, and *Savoy Stairs* among them), they have brought together an excellent group for these performances, and they have provided a showcase for Bob Montesi, a trumpet player whose bright, clean, brassy tone is ideally suited to the caper at hand and who also proves to have a strong, driving jazz sense. There is a fine mixture of material — swinging uptempo affairs, ballad types played with lilting beauty, mood pieces, and a few excursions that are scarcely jazz at all: a delicate and briefly satirical minuet, *Blue Bell and Crown*, and a blowsily merry report on *Love in a Village*. The recording is unusually good.

COLEMAN HAWKINS
The Hawk Talks

Lucky Duck; Spellbound; I Can't Get Started; Lonely Wine; Ruby; Trust in Me; If I Could Be With You; The Song from Moulin Rouge; Midnight Sun; Amber; Lost in a Fog; Carioca.

DECCA DL 8127. 12-in. 35 min. \$3.98.

Hawkins is one of the great, consistent figures of jazz who has been largely overlooked in recent years in the rush to record tenor saxophonists whose playing would benefit immeasurably by some study of Hawkins' use of the instrument. A man of dramatic concepts and a rich, virile tone, Hawkins has moved with the times without deviating in the slightest from the basic principles of the jazz tenor saxophone which he established thirty years ago. The performances on this disk can scarcely be called superior Hawkins. But at least they are Hawkins and the failings are rarely his fault. On several numbers he is encased in syrupy strings, on two he is whined at by a steel guitar (it's catching — Hawkins whines back), and all but the first and last selections are in that slow tempo that is considered suitable for "moods." (Why don't we ever get "Mood Music for People with Terrible

FOLK MUSIC SAMPLER!



ELEKTRA Issues a special High Fidelity 10" Long Playing record featuring selections from twelve of our folk releases.

Each Folk Music Sampler is pressed on pure vinyl, triple inspected and carefully packaged in a dust-free plastic envelope, which in turn is protected by a hard jacket.

This unique Elektra release is specially priced at \$2.00 (postpaid) and is available only from:

ELEKTRA RECORDS
361 Bleeker St., N. Y. C., N. Y.

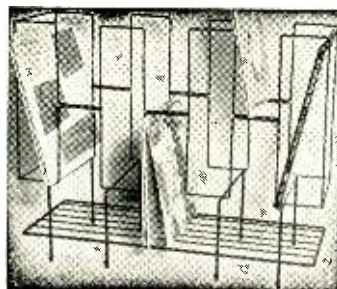

★
YOUR MUSIC GIFT!
★

This is one of the nicest record stands we have seen, for every lover of recorded music. The perfect gift for you or your musical friends! 10 handy compartments hold 200 long-playing records of either size, also 78 rpm albums. Sturdy black wrought iron with rubber tips. 25" x 22" x 10". Shipped completely assembled, express collect. You can't possibly buy one in stores as they're sold only by mail with our MONEY BACK GUARANTEE. Please remit with order. **\$9.95**

LESLIE CREATIONS • Box 9516 • Dept. 209 • Phila. 49, Pa.

Tempers'?) The result is that Hawkins works under wraps most of the way but his is a fighting instinct and he constantly breaks through tempo and background to play with that stirring and imaginative virility which has always been characteristic of him.

THE MODERN JAZZ QUARTET *Concorde*

Ralph's New Blues; All of You; I'll Remember April; Gershwin Medley (Soon; For You, For Me, Forevermore; Love Walked In; Our Love Is Here to Stay); Softly As in the Morning Sunrise; Concorde.

Milt Jackson, vibes; John Lewis, piano; Percy Heath, bass; Connie Kay, drums.
PRESTIGE 7005. 12-in. 36 min. \$4.98.

The two LPs by the Modern Jazz Quartet which preceded this one have contained some suggestion of the merit of this group, but this disk reveals them as they really are: a great beacon of warmth in a sea of cool jazz. For all the monkish solemnity with which they sometimes approach their work, the Quartet is essentially a direct and swinging group as almost every selection on this disk demonstrates. Vibist Milt Jackson has developed steadily and now has the combination of strength, delicacy, and taste required to hold up his important end of the foursome. The rhythm section seems more aptly balanced since Connie Kay has taken over the drums. And John Lewis, the mind behind all this, continues to be an amazingly rational and unpretentious pianist whose playing is utterly jazz even while part of his thinking is firmly rooted in the classics (there is a fine sample of his surprisingly low down piano behind Jackson's solo on *Softly As in a Morning Sunrise*). Except for *I'll Remember April*, these are all mature, reasoned, and delightfully rhythmic performances. *I'll Remember April* misses only because Kay turns to that bane of modern drumming, the persistent riding cymbal, which is blessedly absent from the other selections.

DJANGO REINHARDT *Django's Guitar*

You Rascal You; Improvisation No. 3; Blues Clair; Tea for Two; Bouncin' Around; Sweet Georgia Brown; Naguine; I'll See You in My Dreams; Echoes of Spain.

ANGEL ANG 60011. 10-in. 29 min. \$2.98.

The master of the jazz guitar is heard on this disk in an unaccustomed setting. Instead of the quintet or sextet with which he usually worked, he is accompanied here by one or two other musicians at most and, on three occasions, plays unaccompanied. This serves a dual purpose: there is, obviously, more Reinhardt per selection than in the sextet numbers and he is faced with challenges which didn't necessarily crop up when he worked with larger groups. The challenge, for instance, of achieving a jazz performance on an unaccompanied instrument is one that he meets brilliantly and variously. On *Naguine* he develops a melodic line which is inherently swinging, while on *Tea for Two* he makes silence swing, using the breaks between phrases to provide a compelling sense of rhythmic movement. The other selections are well chosen ex-

amples of his direct and imaginative playing and the disarmingly easy, relaxed manner in which it is done. These selections were recorded at various times between 1937 and 1949 and the surfaces vary in quality.

THE JOHNNY SMITH QUARTET

Django; Wait 'Till You See Her; 0500 Blues; More Bass; Un Poco Loco; Easy Living; Old Girl; Little Girl Blue; Tired Blood; Spring Is Here.

Johnny Smith, guitar; Bob Pancoast, piano; George Roumanis, bass; Mousie Alexander, drums.

ROOST 2203. 12-in. 35 min. \$3.98.

The recent recorded work of Johnny Smith has concentrated on his finicky picking at pallid ballads, a medium of expression which is not to be discounted completely but which gets awfully tiresome in unrelieved doses.

There are samples of this side of Smith in this new collection (*Wait 'Till You See Her, Little Girl Blue*) but it is presented in perspective along with Smith's abilities as a brightly swinging guitarist, as shown on *Tired Blood, 0500 Blues, Old Girl* and *Un Poco Loco*. For further variety, there is evidence that Smith's approach to a ballad can be lively and imaginative (*Easy Living*). He also undertakes an interesting *tour de force* on John Lewis' *Django*, playing both the piano and vibes parts, and while the Smith Quartet can't measure up to the Modern Jazz Quartet on its own material, this performance is a provocative variant on the original one. This is one of the more adventurous disks issued by a modern guitarist.

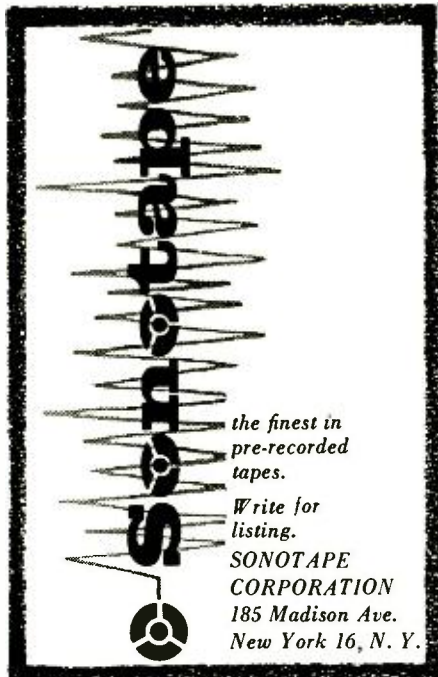

the finest in
pre-recorded
tapes.
Write for
listing.
SONOTAPE
CORPORATION
185 Madison Ave.
New York 16, N. Y.

EVERY DAY

EVERY WEEK

EVERY MONTH

more and more discriminating music listeners, owners of high fidelity equipment, looking for perfect copies of Long Playing Records, are discovering the outstanding personal mail order record service of

THE MUSIC BOX

A unique mail order service which guarantees that:

- ★ Every record mailed is a brand new, factory fresh, unplayed copy.
- ★ Every record mailed is most carefully inspected for visible imperfections. Every possible flaw is carefully spot checked, on the finest equipment, and records that do not conform to our rigid standards are rejected.
- ★ Every record is dusted, cleaned and enclosed in a polyethylene envelope, to protect it from possible dust damage, while in transit.
- ★ Every record is carefully packed, to reach you in absolutely perfect condition.
- ★ Every order over \$6.00 is mailed POSTAGE FREE anywhere in the U. S. A. On orders of less than \$6.00, please add 40¢ to cover mailing charges.
- ★ Our service is fast, prompt and courteous.
- ★ All records are sold at the manufacturer's suggested list price only.
- ★ We can supply you with any LP, on any label, IF it is currently available.
- ★ THE MUSIC BOX is devoted to mail orders exclusively. The general public do not have any access to our stock, which is handled only by two people.
- ★ When ordering, simply list the records needed, plus your check or money order to cover their cost. To avoid delay, list substitutes, since we will never make substitutions, without your written permission. Sorry . . . no C. O. D.'s.

★

The Music Box

MAIN STREET
GREAT BARRINGTON, MASS.



Meet WILLIAM H. THOMAS, Audio Pioneer

The control of sound, its attenuation, reproduction and distribution, has been the primary field of activity during the last two decades for physicist Bill Thomas. He is President of James B. Lansing Sound, Inc., manufacturer of loudspeaker equipment acclaimed by Life magazine as the finest obtainable. He has led the development of the acoustical lens for audio use in theater, military and high fidelity applications. In addition to manufacturing Jim Lansing Signature Speakers, Mr. Thomas is a principal in the only companies in the West successfully engaged in the field of industrial noise control. His pioneering research and development in this area for twenty years is directly responsible for recent design, manufacture and installation of jet engine silencing equipment and instrumentation.

"In developing and testing Jim Lansing Signature Speakers," says Bill Thomas, "we find Berlant-Concertone Tape Recorders most useful. The versatility and professional reliability of this equipment helps us maintain the traditional high quality of Signature Speakers."

If you are ready for a professional quality tape recorder, visit your Berlant-Concertone distributor for a personal demonstration. See and hear why these recorders are the personal choice of leading audio manufacturers, and now the first choice of audiophiles too, according to a recent survey. The Concertone is priced from \$445. The Berlant with hysteresis synchronous motor is specifically designed for broadcast and studio use. Both recorders available as complete sound systems for portable use. For detailed literature, write Department 4-F.

The Signature Model 375 High Frequency Driver is shown here with horn and acoustical lens. Designed by Bill Thomas, this unit is the secret of the success of The Hartsfield.



Berlant  Concertone

Audio Division of American Electronics, Inc.
655 West Washington Blvd., Los Angeles 15, Calif.
For industrial requirements consult Recordata Division



Berlant-Concertone . . . personal choice of leading audio manufacturers.

TESTED IN THE HOME



Equipment reports appearing in this section are prepared by members of HIGH FIDELITY's staff, on the basis of actual use in conjunction with a home music system, and the resulting subjective evaluations of equipment are expressed as the opinions of the reviewer only. Reports are usually restricted to items of general interest, and no attempt is made to report on items that are obviously not designed primarily for high fidelity applications. Each report is sent to the manufacturer before publication; he is free to correct the specifications paragraph, to add a comment at the end of the report, or to request that it be deferred (pending changes in his product) or not be published. He may not, however, change the report. Failure of a new product to appear in TITH may mean either that it has not been submitted for review, or that it was submitted and was found to be unsatisfactory. These reports may not be quoted or reproduced, in part or in whole, for any purpose whatsoever, without written permission from the publisher.

Sherwood Forester Speaker System

SPECIFICATIONS (furnished by manufacturer): a three-speaker system featuring low distortion and ample power-handling capacity. Uses a 12-in. woofer, 8-in. mid-range unit, and 5-in. tweeter with brilliance level control. **Crossover frequencies:** 300 and 5,000 cps: 12 db/octave dividing network. **Impedance:** 16 ohms. **Power capability:** 30 watts continuous program input. **Frequency response:** 42-13,500 cps at -5 db. **Intermodulation distortion:** less than 0.6% at 10 watts (meas. at any frequency from 55-500 cps mixed 4:1 with any frequency from 2kc.-20kc.) **Shipping weight:** 85 lb. **Dimensions:** 35½ in. high, 25¾ wide, and 14¾ deep. **Finishes:** contemporary blond or mahogany, or French provincial. Also available as a kit. **Prices:** \$129.00 to \$189.00. **MANUFACTURER:** Sherwood Electronic Laboratories, Inc., 2802 West Cullom Ave., Chicago 18, Ill.

Considering the price and size of this unit, two features are outstanding: weight and performance! It looks like a unit which could be shoved around with one finger; it cannot. It is solid — apparently throughout. Tapping the various panels produces a

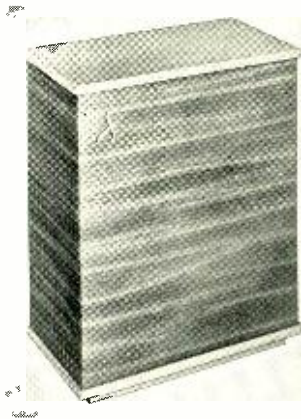

The Forester: an outstanding performer.

pleasingly dead sound. And the performance is smooth and well-balanced. Highs are not excessive, even with the level control on the tweeter wide open. Bass holds up well to about 45 cycles; below that, a considerable amount of bass boost can be added by a tone control before distortion sets in.

Design of the unit is unusual. A 12-in. woofer feeds into a horn, said to be 5½ ft. long, which exhausts to the rear of the enclosure. The 8-in. mid-range unit and the

5-in. tweeter both face forward. This arrangement gives the illusion of good projection and presence and minimizes the very slight coloration caused by the horn. The horn-sound is further hidden by the fact that the crossover frequency — 300 cps — is relatively low for a three-way system. I believe this aspect of design is a definite advantage, and contributes materially to the smoothness of response throughout the audible range.

Correct location of the speaker was found to be not only important but almost critical. Because the woofer sound comes out at the rear of the enclosure, the cabinet should not be plastered against a wall. Corner positioning, pulled out about 6-in., seemed to give best results.

All in all, a very nice job, and one that is easy to listen to for long periods of time at a stretch. — C. F.

MANUFACTURER'S COMMENT: Since the Forester horn cabinet makes use of the walls of the room in forming its mouth extension, we are advising in our instructions to locate the rear side 4 to 12 inches from a corner or the shortest wall of the room.

Other tests we have made show that low intermodulation distortion is greatly responsible for the reactions of "smoothness" and "easy to listen to for long periods" mentioned above. In the Forester system, the low level of intermodulation distortion is due to the 300 cps, 12 db/octave electrical filter and careful acoustical separation of the component speakers.

The cone-type mid-range and tweeter speakers comprise an excellent acoustical balance for the horn-type woofer, and thus eliminate any need for a mid-range level control.

Browning L-500 SW Tuner

SPECIFICATIONS (furnished by manufacturer): a compact AM broadcast band and short-wave tuner covering from 550 to 1650 kilocycles and from 6 to 18 megacycles (49 to 17 meters). Incorporates automatic gain control, variable bandwidth IF, 10 kc. whistle filter, built-in ferrite antenna, tape recorder as well as standard output. **Controls:** on-off and volume; tuning; selector switch (AM broad, AM sharp, short-wave). **Dimensions:** 9 by 4 7/8 by 8 inches. **Weight:** 8 lb. **Prices:** L-500 (chassis only) \$87.50; blonde or mahogany cabinet, \$12.00 extra. **MANUFACTURER:** Browning Laboratories, Inc., 750 Main St., Winchester, Mass.

There are many areas in this country where FM reception is not available at all or not sufficiently active to warrant the purchase of an FM or FM-AM tuner. Then the need is for a good AM tuner. If you can

get one with short-wave bands besides, you'll have an extra feature and probably some extra enjoyment, because short-wave reception opens up many areas of exploration.

The Browning L-500 is an excellent AM broadcast band tuner. Sensitivity is fine; it includes broad as well as sharp IF tuning; it incorporates that essential accessory to broadband IF, a whistle filter. It has a built-in antenna which performs well indeed. It has a minimum number of controls, and is

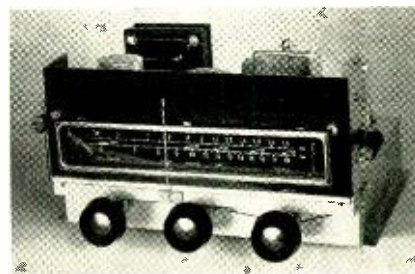

The L-500 provides broad AM coverage.

designed to connect directly to a hi-fi amplifier or control unit.

The added feature of short-wave coverage opens, as I said, a good many doors. The short-wave bands are lots of fun. Since I feel that most readers of HIGH FIDELITY would be interested in using SW only for reception of broadcasts (on 49, 31, 25, and 17 meters) I would be much more enthusiastic about this unit if bandspread could have been provided. As it is, the five bands are compressed into less than a quarter-inch of dial scale each. Tuning is difficult, but practice helps, and there is some tendency to drift during early warm-up.

Whether these criticisms of the SW arrangement are significant or not depends on what you intend to do with the short-wave section. If you just want to have some fun, you'll have it with the L-500. It's sensitive — hot — and covers enough of the spectrum so you can explore widely.

As far as the AM broadcast section is concerned, that's fine. Compactness, excellent sensitivity and good fidelity are at-

Continued on next page

Continued from preceding page

tractive features, as is the price. The tape output, by the way, is parallel to the main output: both are therefore affected by the volume control. — C. F.

MANUFACTURER'S COMMENT: Besides adding shortwave to the high fidelity system, the L-500 is now extensively used in conjunction with an FM tuner to receive binaural broadcasts. It is the twin in price and appearance of the FM-only L-300 reviewed in this column a few months ago.

Electro-Voice Patrician IV

SPECIFICATIONS (furnished by manufacturer): a 4-way speaker-system in a very large housing whose lower two-thirds contains a Klipsch-type folded corner horn. **Frequency response:** 25 cycles to well beyond audibility. **Power capacity:** 40 watts program material, 75 watts peak. **Impedance:** 16 ohms. **Components:** 18WK low-frequency driver; two 8288F mid-range drivers with A8419 lignocphenolic horns; T25A high-frequency driver with 6HD diffraction horn; T35 very-high-frequency driver and diffraction horn, and X2635 4-way crossover network. Individual level controls for mid-range, high frequency, and very-high-frequency drivers. **Dimensions:** 62-in. high by 39 wide by 29 1/8 deep. **Weight:** 317 lbs. **Price:** complete system in ma-

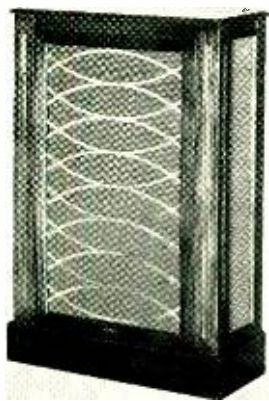

The E-V Patrician: durable and versatile.

hogany or blonde Korina, \$772.50. Interior working parts available also, as model 103C-115 Patrician Utility System, \$528.00. — Also available, model 115 Klipsch-type horn, \$180.00. Model 115 horn also available knocked down for home construction as model KD-1 pre-cut construction kit, \$99.00. All components may be purchased separately, or together (without bass horn) as 103C package, total price \$348.00. **MANUFACTURER:** Electro-Voice, Inc., Buchanan, Mich.

This examination was undertaken at the request of the writer, an admirer of certain principles of the Patrician's design.

The fourth model is similar to its predecessors in fundamentals but differs from them in details. The Klipsch-type folded corner horn has been increased in capacity by one-sixth, with a fortification of the lower octaves noticeable at once. In this large chamber the imprisoned air, displaced by the pumping action of the diaphragm of the 18-inch, specially-designed woofer, is forced through tapered channels over an angular route until it is pushed out through a vertical sluice in the rear. Thence it is guided in two columns to freedom through vertical sluices in either side. The walls of the room, if the instrument is in a corner, then provide an additional prolongation of the pathlengths of the horn and resultant low bass-fundamentals. If not in a corner — the reproducer being designed for placement

anywhere allowed by space — some of its potential low bass will be inaudible.

But many people do not like, or think that they do not like, the oblique delivery of a bass that does not slap them frontally from a hole in the facade, that glides pervasively along the walls and floor. Yet this is the way that bass normally behaves: it is sinuous and follows a contour, while the higher frequencies are missiles which bounce sharply away from an obstruction. Everything has been permitted in the reproduction of sound, and it is certainly permissible for people to prefer a direct to a sidelong delivery of bass. Those who do may as well discontinue reading this account now. In the opinion here, the indirect low bass, when produced by a horn of the Klipsch type from the cone of a matching woofer, has a minimum of complications and a remarkable semblance of smoothness. To the ear alone its transient sonance is immaculate, and below 30 cps — as low as one

Dept. of Fuller Explanation

We have had several letters taking us to task for our TITH report on the Staticmaster System (December High Fidelity). No objections to what we said about the Staticmaster, but our remarks about chemical sprays and such sounded inconsistent with previous TITH reports* on these products. On rereading the paragraphs under fire, we realize we should have been more specific.

Let's make the point clear: used correctly (according to manufacturer's instructions) the chemical products fill a very definite need, and our opinion of them remains as stated in various TITH reports which have appeared in earlier issues. Used incorrectly, some may tend to accumulate unduly on record surfaces, and this extra accumulation will come off on the stylus. It is harmless; you simply need to clean the stylus from time to time. In very bad cases, enough excess chemical may collect, particularly on styli of lightweight cartridges, to make the stylus ride up a bit. If this occurs, the spray is being incorrectly used . . . and that means: spraying is being done too often, or too heavily, or is not being wiped after application, as recommended by some spray manufacturers.

Everybody understand now?

*"Quiet," June 1955, "Kleen-Disk," April 1955, "Stati-Clean," May 1954.

need go in music — the response is still clean although beginning to weaken.

It is in the range from about 150 to 700 cps — that ambiguous section where bass is becoming pale and treble has not yet acquired color — that owners of previous Patricians will hear the most striking improvement. The reproduction allotted by the crossover network to the range 200 to 600 cycles, formerly to a 12-in. cone-speaker and now to a pair of compression drivers fitted to wood-and-plastic megaphones, has lost a certain dryness and become alive. (This is a change that can be effected at no great cost, but with considerable physical

difficulty, in view of the construction of the Patrician, by people who possess an earlier model.)

The two drivers, and their associated horns, designed to reproduce the frequencies 600 to 3,500 and 3,500 to 20,000 cycles respectively, have not been changed essentially. The crossover is half-section, attenuating the frequencies beyond the critical points at the rate of 12 db per octave.

The four upper-frequency horns (two in cyclic duplication) deliver their sound forward through ornamental cloth above the panel concealing the bass horn. They accomplish enough dispersion for this not to be a problem, but since they are at some distance from the controlling bass, the listener must be at a minimum of fifteen feet from the Patrician if he is to hear a properly-blended sound, and five or ten feet more is beneficial. (Enticing photographs printed to promote the sale of the instrument include a rapt young lady placed where she can fondle it; and those who dare not do this wonder if she was deaf *a priori* or *a posteriori*.)

Three separate controls provide individual attenuation, continuously from full output to silence, for the upper-frequency drivers. These are a necessity in multi-way systems, but it ought to be understood that their function is *not* the compensation of recording curves, an obligation reserved for a control unit, but the adaption of the multi-way system to the acoustics peculiar to the place where it will be used. The upper-frequency units in the Patrician, wide open, give an output larger than life, and in most circumstances will have to be partially closed by the controls. Granted that some people like the effect of nearness or presence produced by an exaggeration of the frequencies an octave or two above middle C on the piano; others will wish the entire output to be as even as can be arranged. Experimentation and manipulation will accomplish a smoothness over the entire range, in any anticipated environment. The best judge of the proper setting of these controls is of course the aural bias of the owner. Once set, it is wise to leave them in the position



chosen until the instrument is moved to another location or a change of amplifier or pickup is made. The flexibility offered by these controls makes available in effect a speaker-system for every taste, including some not likely ever to be encountered.

But the appeal of the Patrician is to an elevated musical taste. With its elements in balance, actuated by record, pickup and amplifier of equivalent high quality, it is capable of a musical utterance superior to anything the majority of people have ever heard in reproduction.

To this writer, the sonic spectrum as divided and then blended by the Patrician is delivered in a discrimination of orchestral timbre, without unwanted stresses or harsh undertones, not surpassed by anything in his experience. The enveloping bass, solid but fluent, gives a structural strength to

Continued on page 114



How Hi is Fi?

Let Moussorgsky's spirits of darkness twirl out of your custom Bogen hi-fi for the first time, and you'll at last understand what happens on Bald Mountain every Saint John's Night. In the very midst of a Black Mass in your own living room, you'll quite likely rise, join the assembly of witches, and ask the first dance with Satan's uncomely sister.

New Bogen R660 FM-AM Tuner. New styling, new design. Response, 15-15000 cps \pm 0.5 db; superb selectivity! FM sensitivity, 2.5 mv @ 70 ohm output. Features: new calibrated "Zero-In" Tuning Meter;

Illuminated Dial Pointer; striking gold-finish cage. R660 chassis, \$119.50. Metal enclosure, \$7.00. FM tuner only (FM50), \$79.50.

New Bogen DB130 35W Amplifier. Descended from famous Bogen DB20 (the "Champ"). Response, 15-30000 cps \pm 0.5 db; distortion within 0.5% @ 35 watts. Features: built-in Speaker Selector Switch; visual indicator on Variable Damping Control; Tape Monitor; Two 3-Position Filter Switches; Separate LCS Control; 7-Position Record Equalizer. DB130 Chassis, \$115.00. Enclosure, \$7.50.

For a rare experience in listening, hear these two perfectly matched Bogen units at your favorite hi-fi Sound Salon now.

Don't miss the third edition of Bogen's popular booklet, "Understanding High Fidelity". Get this 56 page "easy-to-understand" illustrated primer on hi-fi—while it lasts. Send only 25c to Dept. WB, David Bogen Company, Inc., 29 Ninth Avenue, New York 14, N. Y.

Bogen
HIGH FIDELITY
Because It Sounds Better

TESTED IN THE HOME

Continued from page 112

the emission of any music, without calling separate attention to bass as an aggressive element. The instrument is enormous, heavy, and very expensive. It can roar with the mightiest; but it is even more impressive when it is gentle.

Durability? Well, one Patrician or another, in heavy employment here for four years, subjected to the attack of fifty- and seventy-watt amplifiers, has suffered injury in only one part, a driver not used in the two latest models.

Versatility? With certain tumultuous orchestral records any speaker or speaker-system can be imposing, even when it is bad. This instrument, whose balanced proclamation of the full orchestra is so certain on the details within the whole, presents chamber music with a startling sense of exact proximity and the piano with the tapering retention of its bass that makes hearers tingle.

Is this an encomium? Hardly; — there are imperfections in the Patrician as there are in all reproducers. But relatively they are neither many nor flagrant. At any rate it is the preferred reproducer of this writer. — C. G. B.

MANUFACTURER'S COMMENT: Electro-Voice is grateful for acknowledgement of its Patrician design effort, and is exceedingly happy with what it considers acclaim.

Recoton-Goldring 500 Cartridge

SPECIFICATIONS (furnished by manufacturer): triple-play variable-reluctance phono pickup cartridge. **Compliance:** 4 times 10^{-6} centimeters per dyne. **Moving mass:** 3.5 milligrams effective. **Response:** virtually flat from 20 to 16,000 cps (33 1/3 rpm). **Stylus force:** 6 to 7 grams normal; 3 to 4 grams in transcription arm. **Recommended load:** 47,000 ohms. **Output:** 10 millivolts. **Styli:** independently driven and independently replaceable. **Prices:** model 500-SS (two sapphire styli), \$9.90; model 500-SD (sapphire 3-mil and diamond 1-mil styli), \$23.40; model 500-DD (two diamond styli), \$36.90. **MANUFACTURER:** Recoton Corp., 52-35 Barnett Ave., Long Island City 4, N. Y.

The Recoton-Goldring model 500 magnetic cartridge was developed in England and is being made there. When it was first released (about a year ago) it was received with unstinted praise by English technical writers and reviewers. It is now readily available in this country, and we have been looking forward to an opportunity to work with it. We should say that it merits high praise indeed, although possibly not the unqualified panegyrics bestowed on home grounds.

Operating on the same variable-reluctance principle as the GE, Audak, and Pickering cartridges, the 500 has two sets of pole-pieces on opposite sides of the turnover cartridge. The two styli, completely independent, are of the cantilever type and are set in rubber-like blocks that provide restoring force and resonance damping. Styli are individually replaceable by the user; replacement styli are supplied with new mounting blocks attached. Both micro-groove and standard styli are available in sapphire or diamond.

Each stylus and its cantilever supporting arm are minute in dimensions, so that the moving mass is effectively very low. Com-

pliance — both lateral and vertical — is relatively quite high. These factors result in low minimum tracking force, wide frequency range, and low stylus and record wear. According to work-bench checks on our sample cartridge, frequency response of the 500 was quite even from 20 to 3,000

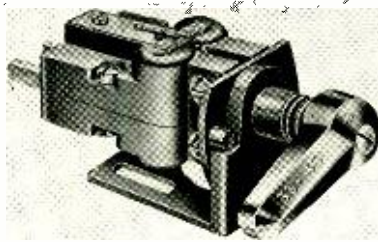

Styli in the Recoton-Goldring are separate and easily replaceable.

cycles, rising slowly to a 4-db peak at 12,000 cycles, after which it dropped quite rapidly. Now, a 4-db peak is really mild compared to some cartridges, particularly since the rise is slow. It can be compensated for easily and precisely by turning down the treble control slightly. Such performance is excellent; it is exceeded only by a very few units, all of which are much higher in price.

Output voltage of the 500, while lower than other variable-reluctance types, is adequate to drive all modern preamplifiers without a step-up transformer. Hum level is extraordinarily low, possibly because of a push-pull coil arrangement and mu-metal shielding. Recommended termination is 47,000 ohms. As with all VR cartridges, this is quite critical; a higher value increases the high-frequency peak, and a lower value produces rolloff. Length of the shielded cable to the preamplifier must be kept to a minimum also.

The cantilever-stylus-armature construction is inherently capable of more rough treatment than most moving-coil mechanisms, so this cartridge can probably be used in changers without trouble. All you have to do is keep the stylus centered between the pole pieces. As a further protection against damage, a downward force of 10 grams or more will push the stylus upward, and the protector plate will then absorb any more force. When the force is subsequently decreased below 10 grams the stylus will spring back into operating position. A nice feature. The cartridge will fit just about any American-made arm; it is fairly short and has standard 1/2-inch mounting centers. But the styli are farther back on the cartridge body than they are in domestic cartridges, so you have to push the cartridge fully forward on its slotted mount or — if this is impossible with your arm — decrease the distance from the arm pivot to the turntable center slightly to obtain optimal tracking.

Listening quality is very good, smooth and free of strain even on heavily-recorded passages. Without treble tone-control cut, the sound is bright, although not with the ragged brilliance caused by sharply-peaked response. With a slight treble cut the balance is just about right, and only on direct comparison is detected the lack of a

fleeting shimmer that is given by further extension of the range.

With two sapphire styli the Recoton-Goldring costs less than \$10; with sapphire stylus for 78s and diamond microgroove stylus, less than \$24. You can get cartridges that are better in very subtle ways, but you have to pay substantially more for them. In terms of what you receive per dollar spent, the 500 is a noteworthy bargain. — R. A.

Pentron Emperor Recorder Model HF-400

SPECIFICATIONS (furnished by manufacturer): a two-speed single-case portable tape recorder. **Speeds:** 3.75 and 7.5 ips, selected by panel knob. **Frequency response:** 40 to 12,000 cycles at 7.5 ips, 40 to 6,000 cycles at 3.75 ips. **Record-playback head:** half track (full track on special order). **Flutter:** less than 0.3% at 7.5 ips. **Signal-to-noise ratio:** 50 db. **Rewind and fast-forward time:** 70 seconds for 1,200 feet. **Record level indicator:** illuminated VU meter. **Power output:** 10 watts. **Inputs:** two, for Microphone and Radio. **Controls:** single lever for Play/Record, Fast Forward, and Rewind; interlocked Record button; speed change (3.75 and 7.5); volume and amplifier AC power; tone and motor AC power. **Outputs:** two, to Speaker and external Amplifier. **Microphone:** Shure "Rex" crystal. **Tubes:** 5879, 6SL7, 6V6, 12AU7, 2-6AQ5, 6X6GT. **Weight:** 33 lbs. **Dimensions:** 18 1/8 in. wide by 17 3/4 deep by 10 3/4 high. **Price:** \$249.50; \$259.50 with full-track heads. **MANUFACTURER:** The Pentron Corporation, 777 South Tripp Ave., Chicago 24, Ill.

Not very long ago there were only two kinds of tape recorder available, and a purchaser had to make up his mind to get either a lo-fi model or a professional unit. There was practically no middle-of-the-road, and the idea that not all high fidelity enthusiasts were enthusiastic enough to spend \$1,000 for a tape recorder had not yet achieved wide recognition.

But repeated efforts to produce professional-quality recorders at moderate prices showed that it simply could not be done, without at least some sacrifices. The very nature of the tape recording medium demands extreme precision in every phase of the mechanical and electrical design, and precision manufacturing costs money. So in tape recorders, as in many other things, a buyer still must be willing to pay premium prices for premium quality. Today, there is a tremendously wide selection of recorders



to choose from, and a prospective buyer can acquire a toy or a recording studio, or anything in between, depending on how much he is willing to pay.

The Pentron HF-400 falls pretty well into the middle category; it bears all the design earmarks of a unit intended to meet nearly everyone's requirements. For the strictly amateur recordist, it offers convenience and simplicity in a single self-contained package, and for the more ambitious user it provides facilities for easy connection into a high fidelity system, plus one or two professional features.

The HF-400 is one of the few non-professional recorders that is equipped with a

Continued on page 116

We beg your pardon!

A short time ago we announced the creation of a new series of Altec Lansing loudspeakers, representing an entirely new concept in loudspeaker design. The use of multiple concentric compliances permitted stepped sections of the cone to radiate different frequencies, thus achieving a smoother, more extended frequency range than that previously attainable from a single cone loudspeaker. We announced that the guaranteed frequency range extended to 13,000 cycles.

This is no longer true. And because it is not true we do beg your pardon. Because of improved production techniques and production controls we are pleased to announce that the 408A 8" *biflex* speaker now has a guaranteed range from 60 to 16,000 cycles, the 412A 12" speaker from 40 to 15,000 cycles and the 415A 15" speaker from 30 to 14,000 cycles. These ranges, measured in Altec's anechoic chamber, are guaranteed by the manufacturer.

We suggest that you hear these remarkable speakers at your earliest opportunity. Ask your Altec dealer for a demonstration of their range and fidelity today.



408A
8", 15 watts, 60-16,000 cycles, \$24.00

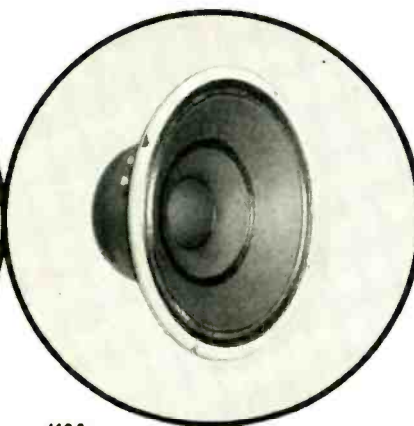

412A
12", 20 watts, 40-15,000 cycles, \$45.00

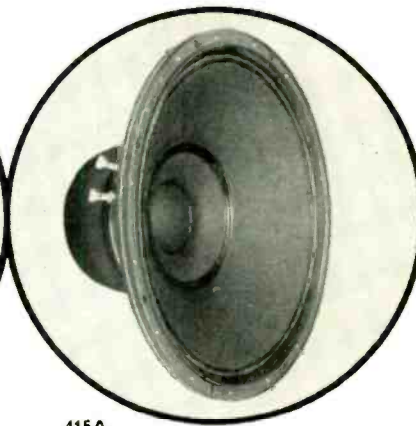

415A
15", 25 watts, 30 to 14,000 cycles, \$60.00

ALTEC FIDELITY IS HIGHEST FIDELITY

reproducers • loudspeakers



amplifiers • preamplifiers • tuners • enclosures

Dept. 2-H
9356 Santa Monica Blvd., Beverly Hills, Calif.
161 Sixth Avenue, New York 13, N. Y.

TESTED IN THE HOME

Continued from page 114

VU meter for record level indications. Unlike the usual "magic eye" or neon flasher indicators, a VU meter shows the presence of low-level sounds going onto the tape, besides giving a very accurate indication of normal or overload levels. A little above the mid-position on the meter scale there is a zero mark that indicates the maximum permissible record level, and above this point the scale is marked in red as a grim reminder that that way lies overload. This is a nice feature, and it works very well on the HF-400. This recorder, however, seems to have quite an amount of overload latitude, and even on some occasions when the needle pinned at the top of the scale there was very little audible increase in distortion. Pinning of the meter, though, is neither recommended nor necessary, since the background hiss level on the HF-400 is low enough that the slight additional signal



The HF-400 features a VU level meter.

volume gained by driving it into overload will do nothing more than magnetize the record head.

A second feature that I have yet to see on a professional recorder, and which might be an asset to some of them, is a revolution counter. This isn't a new idea for home machines, but it is a welcome convenience whenever it appears on one. The counter, which registers rotation of the supply reel, proved to be remarkably accurate, and I found it quite easy to pick out a sentence or musical phrase from almost any place in the tape, simply by noting the counter indication at that spot and then rewinding to it from the end of the reel.

Using the recorder by itself, with its separate roving tweeter attached, my first impression was of disbelief. The machine put out sound at least three times as big as the case it is housed in, with a crispness and clarity that surprised me! Nothing really massive, and by no means as good as what might be expected from a large speaker system, but with a spaciousness and body that belied the size of the speakers used in it.

Sound from commercial recorded tapes was far better than that from a phonograph of comparable size, and the low end was quite evident even if somewhat ill-defined. Playback of tapes recorded on the HF-400, however, exhibited a slightly less satisfactory bottom and a little weaker high end.

When the External Amplifier output was connected through a six foot shielded cable into the rest of my system, however, the extreme highs virtually gave up. Reducing

the cable length to two feet brought an immediate improvement, but there was still an audible loss in the cable. The External Amplifier connection on the HF-400 is, apparently, of very high impedance, so the cable should be kept as short as possible.

Results of tests through the large system, which is notorious for showing up any flaws that exist in equipment, were a little less impressive than I had hoped. The low end was not very much better than before; my ear would estimate that not much below 70 cycles was coming through. Also, while the flutter was extremely low, and well below the rated 0.3 per cent maximum, wow was audible on sustained notes. On A-B tests, the balance between the original and the HF-400 recording was very nearly identical, although the tape showed some evidence of harmonic distortion.

Hum was somewhat of a problem through the large system, but this is one of the most difficult things to lick in moderate-priced tape recorders, and only in the most expensive units is it ever really reduced to inaudibility.

Summing up, the HF-400 by itself seems to be a very good portable machine, albeit a little on the weighty side. (Some other manufacturers have blithely labeled units threetimes the weight of this one "portable.") Used as a self-contained unit for general-purpose music recording, and for reproduction of commercial recorded tapes, it will probably suit the needs of most recordists. It is much better than most medium-priced recorders. — J. G. H.

MANUFACTURER'S COMMENT: By introducing the Pentron Emperor, we believe we are fulfilling the needs of many who desire a high-quality dependable recorder at reasonable cost. This judgement has been confirmed at the recent high fidelity shows, where several thousand people were polled regarding the Emperor model. We received nothing but compliments, and the general feeling is that we have every desirable feature incorporated in this Pentron. Aside from the sound, which amazed everyone, we received most compliments on the VU meter, 10-watt push-pull amplifier, the automatic index counter, and our instantaneous braking system. Incidentally, Pentron does not take issue with any of the statements made in this review, for we recognize the wisdom of a fair impartial examination of recording equipment. As a representation of one viewpoint on Pentron equipment we can only agree that this review is a valuable contribution to the understanding and appreciation of our recording equipment.

Jensen TV Duette

SPECIFICATIONS (furnished by manufacturer): A wide-range, compact speaker system designed for use primarily with TV sets to improve sound reproduction. Two models, each in blonde and mahogany finishes, are available. The DU-400 employs a special 6 x 9-in. woofer plus a 3-in. cone tweeter; the DU-500 has the same woofer but uses a horn-type tweeter. Size: either model, 24 in. wide, 22 in. deep, 8 1/4 in. high. Legs (detachable) increase height above floor to 17 1/2 in. The DU-500 in blonde oak is equipped with brass hairpin legs; the mahogany finished DU-500 and both models of the DU-400 are provided with wood legs. Selector switch: both models are equipped with a selector switch which permits using 1) original TV speaker; 2) Duette; or 3) output from external amplifier. Prices: DU-400, either finish, \$49.50; DU-500 in mahogany, \$82.50; in blonde oak, \$85.50. **MANUFACTURER:** Jensen Mfg. Co., 6601 S. Laramie, Chicago 38, Ill.

For the man with a regular television set, this is one of the niftiest ideas that have come along in quite a while. Jensen redesigned the shape of its well-known Duette (described in the TITH section some months ago) into a sort of low end-table. You can use it as such or, as shown in the illustration, put a standard television on it. The sound

will be much better than that from most TV speakers, many of which are aimed off to one side instead of toward the front.

The small switch on the front of the grille serves a double purpose. In one position,



Low-fi TV speakers can be replaced by the wide-range Jensen TV Duette.

it enables you to feed TV sound through the regular TV set speaker. Turned to the right, it connects the Duette — and the comparison is startling. Turned to the left, it connects the Duette speakers to an external screw-terminal block on the back of the Duette, so that this system may be used as a speaker for a phonograph, radio set, or what have you.

Connections are very simple to make, and the instruction book is completely clear. You connect two of the three wires from the Duette to the TV set speaker's terminals, disconnect one of the old wires to the speaker and connect it to the third wire in the Duette cable. That's all.

Sound is clear and wide range. Bass is entirely adequate, though no one should expect organ pedal notes out of a speaker this size. However, as with the standard Duettes, the bass can be boosted, via tone

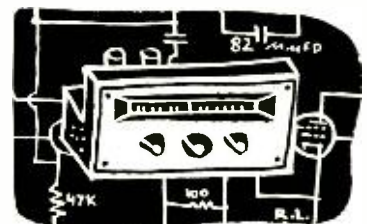

control adjustment, surprisingly far without getting into trouble.

We hope Jensen will sell a few million of these — and in so doing, introduce TV viewers to the pleasures of hi-fi sound. — C. F.

Shure Music Lover's Cartridge

SPECIFICATIONS (furnished by manufacturer): model ML44 is a dual-stylus Ceramic phono cartridge that can be used with any type of phono input circuit. Compliance: 1.5 x 10⁻⁶ centimeters per dyne. Response: 30 to 15,000 cycles. Output: 0.4 volt without conversion network; 25 millivolts with network. Load impedance: 22,000 ohms to 1 meg-ohm. Tracking force: 5 to 8 grams. Prices (list): ML44(ss), two sapphire styli, \$13.95; ML44(ds),

Continued on page 118

"BUILD-IT-YOURSELF" AND ENJOY

high fidelity at its finest



IN KIT FORM



1 Heathkit FM TUNER KIT

Features brand new circuit and physical design. Matches WA-P2 Preamplifier. Modern tube line-up provides better than 10 uv. sensitivity for 20 db of quieting. Built-in power supply.

Incorporates automatic gain control—highly stabilized oscillator—illuminated tuning dial—pre-aligned IF and ratio transformers and front end tuning unit. Uses 6BQ7A Cascade RF stage, 6U8 oscillator—mixer, two 6CB6 IF amplifiers, 6AL5 ratio detector, 6C4 audio amplifier, and 6X4 rectifier

MODEL FM-3
\$24.50
Shpg. Wt. 7 Lbs.

Heathkits®

2 Heathkit 25-Watt HIGH FIDELITY AMPLIFIER KIT

Features a new-design Peerless output transformer and KT66 output tubes. Frequency response within ± 1 db from 5 cps to 160 Kc at 1 watt. Harmonic distortion only 1% at 25 watts, 20-20,000 cps. IM distortion only 1% at 20 watts, 4, 8, or 16 ohms output. Hum and noise, 99 db below rated output. Uses 2-12AU7's, 2-KT66's and 5R4GY. Attractive physical appearance harmonizes with WA-P2 Preamplifier. Kit combinations:

W-5M AMPLIFIER KIT: Consists of main amplifier and power supply, all on one chassis. Shpg. Wt. 31 Lbs. Express only.

\$59.75

W-5 COMBINATION AMPLIFIER KIT: Consists of W-5M amplifier kit plus Heathkit Model WA-P2 Preamplifier kit. Shpg. wt. 38 Lbs. Express only.

\$79.50

3 Heathkit HIGH FIDELITY PREAMPLIFIER KIT

Designed specifically for use with the Williamson Type Amplifiers, the WA-P2 features 5 separate switch-selected input channels, each with its own input control—full record equalization with turnover and rolloff controls—separate bass and treble tone controls—and many other desirable features. Frequency response is within ± 1 db from 25 to 30,000 cps. Beautiful satin-gold finish. Power requirements from the Heathkit Williamson Type Amplifier.

MODEL WA-P2
\$19.75
Shpg. Wt. 7 Lbs.

4 Heathkit Williamson Type HIGH FIDELITY AMPLIFIER KIT

This amplifier employs the famous Acrosound TO-300 "Ultra Linear" output transformer, and has a frequency response within ± 1 db from 6 cps to 150 Kc at 1 watt. Harmonic distortion only 1% at 21 watts. IM distortion at 20 watts only 1.3%. Power output 20 watts, 4, 8, or 16 ohms output. Hum and noise, 88 db below 20 watts. Uses 2-6SN7's, 2-5881's and 5V4G. Kit combinations:

W-3M AMPLIFIER KIT: Consists of main amplifier and power supply for separate chassis construction. Shpg. Wt. 29 lbs. Express only.

\$49.75

W-3 COMBINATION AMPLIFIER KIT: Consists of W-3M amplifier kit plus Heathkit Model WA-P2 Preamplifier kit. Shpg. Wt. 37 lbs. Express only.

\$69.50

5 Heathkit Williamson Type HIGH FIDELITY AMPLIFIER KIT

This is the lowest price Williamson type amplifier ever offered in kit form, and yet it retains all the usual Williamson features. Employs Chicago output transformer. Frequency response, within ± 1 db from 10 cps to 100 Kc at 1 watt. Harmonic distortion only 1.5% at 20 watts. IM distortion at rated output 2.7%. Power output 20 watts, 4, 8, or 16 ohms output. Hum and noise, 95 db below 20 watts, uses 2-6SN7's, 2-5881's, and 5V4G. An exceptional dollar value by any standard. Kit combinations:

W-4AM AMPLIFIER KIT: Consists of main amplifier and power supply for single chassis construction. Shpg. Wt. 28 lbs. Express only.

\$39.75

W-4A COMBINATION AMPLIFIER KIT: Consists of W-4AM amplifier kit plus Heathkit Model WA-P2 Preamplifier kit. Shpg. Wt. 35 lbs. Express only.

\$59.50

6 Heathkit 20-Watt HIGH FIDELITY AMPLIFIER KIT

This model represents the least expensive route to high fidelity performance. Frequency response is ± 1 db from 20-20,000 cps. Features full 20 watt output using push-pull 6L6's and has separate bass and treble tone controls. Preamplifier and main amplifier on same chassis. Four switch-selected inputs, and separate bass and treble tone controls provided. Employs miniature tube types for low hum and noise. Excellent for home or PA applications.

MODEL A-9B
\$35.50
Shpg. Wt. 23 Lbs.

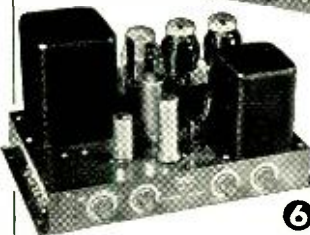

The World's Finest Electronic Equipment in Kit Form

New Heathkits are easy to build..

Heathkit construction manuals are full of big, clear pictorial diagrams that show the placement of each lead and part in the circuit. In addition, the step-by-step procedure describes each phase of the construction very carefully, and supplies all the information you need to assemble the kit properly. Includes information on resistor color-codes, tips on soldering, and information on the tools you need. Even a beginner can build high quality Heathkits and enjoy their wonderful performance.

HEATH COMPANY

A Subsidiary of Daystrom Inc.

**BENTON HARBOR 8,
MICHIGAN**

TESTED IN THE HOME

Continued from page 116

diamond microgroove stylus and sapphire 78 stylus, \$38.95; ML44(dd), two diamond styli, \$57.90. MANUFACTURER: Shure Brothers, Inc., 225 West Huron Street, Chicago 10, Ill.

One of the major advantages of the new hi-fi ceramic cartridges, and one that is an important selling point, is that they combine high output with a frequency characteristic that is inherently a close approximation to flat from a normal record. Accordingly, you can connect one directly to a high-

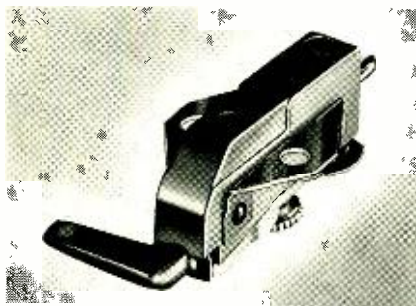

The Shure Music Lover's cartridge.

level input circuit on a preamplifier or amplifier. This is a genuine advantage, if you're only trying to obtain an inexpensive improvement in sound from a conventional phonograph by replacing the minimum-quality crystal or ceramic cartridge normally supplied with it.

But high fidelity amplifying systems are just about universally supplied with input circuits for magnetic cartridges, and the variable equalization controls are ordinarily effective only on these phono inputs. Admittedly, magnetic cartridge preamp circuits add to the cost, and are superfluous if a ceramic cartridge is used. Also, some of the new ceramics and crystals (among them the Shure ML44) are legitimately entitled to the high fidelity label. The fact remains that a variable phono equalizer is still required to get the most from records, and on most amplifiers you won't get variable equalization if you plug a ceramic cartridge into a high-level input. It's pretty difficult to talk the owner of such an amplifier into using a ceramic cartridge when, for the same price or a little more, he can buy a magnetic cartridge and take advantage of his equalizer knobs. Even if ceramic cartridges were markedly better than magnetics, then, there would be serious sales resistance.

Shure has solved this problem neatly and efficiently by including, at no extra cost, a "magnetic" adapter network with each cartridge. This converts the output of the ML44 to a constant-velocity characteristic, the same as that of a magnetic cartridge, and at the same time reduces the output so that it is equivalent to a magnetic. Using the adapter you can plug directly into a magnetic input circuit; without the adaptor you can use a high-level input or drive an amplifier directly. The adapter has clip-on connections and fits easily into a cartridge shell along with the cartridge.

This cartridge has a replaceable stylus assembly on which two completely separate

stylus arms are mounted side-by-side, with one stylus for microgroove records and one for 78s. You rotate the changeover lever as in conventional cartridges, but neither the cartridge nor the styli turn with it; instead, one stylus arm is lifted from the cartridge drive lever and the other is deposited in its place by an ingenious lateral-shift mechanism. Rugged and seemingly fool-proof, this system permits easy stylus replacement and retains the good features of fixed-stylus design.

Compliance is high enough and tracking force low enough to compare well with average magnetics. With a 50,000-ohm termination and 5 db tone-control boost at 20 cycles, workbench checks showed the response to be flat within ± 2 db from 20 to 9,000 cycles, with rolloff beyond that. Compared to most ceramics there was a notable absence of peaks and dips. Sound was eminently acceptable, smooth and not at all harsh from overbrightness: well-balanced. — R. A.

MANUFACTURER'S COMMENT: Many magnetic cartridges, as well as the Shure ML44 ceramic cartridge, are capable of superlative performance; however, the ML44 has certain advantages for the average high fidelity enthusiast, as follows:

1) The ML44 is not affected by the hum field from the changer motor, or the power transformer in the nearby amplifier, or fluorescent lamp ballasts. Placement of the system components is less critical.

2) The ML44 does not exhibit magnetic attraction to steel turntables; the needle force remains the same for the first and tenth record in a record changer stack.

3) The relatively high output of the ML44, even when the magnetic input adapter is used, can be instrumental in diminishing the effect of filament hum and tube noise by several db.

4) The ML44 is not affected by any reasonable lateral drag exhibited by some pickup arms and record changers.

In other words, while the ML44 achieves a performance equal to that of better magnetic pickups it does so in a simpler and more reliable manner than do most magnetic pickups.

Scott 311-A Tuner

SPECIFICATIONS (furnished by manufacturer): a compact, FM-only tuner of advanced design featuring high sensitivity and selectivity. **Sensitivity:** 3 microvolts required for 20 db of quieting. **Dimensions:** including cabinet, 13 in. wide by 4 7/8" high by 10 1/2" deep. **Detector band width:** 2 mc. **Outputs:** two, both low impedance, for connection to tape recorder, and to a power amplifier or preamp-control unit. **Price:** \$99.95; case \$9.95 extra. **MANUFACTURER:** H. H. Scott, Inc., 385 Putnam Ave. Cambridge 39, Mass.

The first thing that strikes you about this tuner is its sleek appearance; next, you'll notice the tuning knob. It is a tuning dial, as opposed to the usual knob and tuning scale. It appears to be a single knob but is actually two concentric knobs. The larger one is attached directly to the dial scale. The left-hand half of the circle is calibrated in megacycles; the right-hand half is divided into 40 marked and equally-spaced units. This side you use for precise logging of the stations.

The small knob is geared to the larger one, to provide fine tuning. The ratio is 5 to 1 and this "low gear" tuning feature is definitely needed; stations can be tuned in and out with a 5° wiggle of the smaller knob. A pilot light is behind the clear-plastic dial, so that the etched figures of the tuning scale are illuminated from behind. Two markers at the left and right edges of the dial are calibration points.

The small knob at the left of the panel is a combined on-off switch and volume control. (It's marked LEVEL, and it serves the

function of a volume control.)

The 311-A includes a signal strength meter of excellent sensitivity. You tune for maximum deflection; the scale is logarithmic and reads from 0 to 10. With an 8-element Yagi aimed at one of the strong stations around here, the meter read 8.5 to 9.0. Rotating the antenna away from the station dropped the meter reading to 0.5 but the station was still audible and limiting was good. On very weak stations, which nevertheless were strong enough to limit, the meter just wiggled a bit at the bottom end of its scale; its deflection would not be

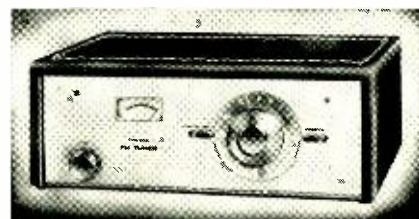

The Scott 311-A: high selectivity and sensitivity over the entire FM band.

sufficient on such stations to permit orienting the antenna for optimum reception. To make the meter serve such a wide range of signal strengths, a sensitivity switch would be required, on this as on other tuners.

The sensitivity on this unit is excellent; I wonder a bit what the effective advantage is of Scott's 310, which costs \$50 more, so far as sensitivity is concerned. As has been pointed out in this magazine before, today's best FM tuners have what seems to be maximum usable sensitivity; I suppose a microvolt more — which the 310 boasts — might make a worthwhile difference in some cases, but personally I think I'd rather spend the difference for an extra stack on the antenna. Will Scott please clarify this point in the "Manufacturer's Comment" section?

This tuner was found to be exceptional in its ability to keep strong stations out of the hair of weak ones on adjacent channels. In tuning, it was noted that stations come in very suddenly, hang on a second as the dial is rotated, and then drop out abruptly. This is in contrast to the more usual slow appearance and disappearance. The result is that there is a minimum of slop-over from a strong station and therefore you can pull in weak ones which, in crowded-channel



areas, would be interfered with if not entirely eliminated by lesser tuners.

No comments on fidelity: it was excellent, as it should be. Drift: not observable after first five minutes or so. AFC is not provided.

The automatic gain control is unusually effective in the 311. Once you set the level control to the desired loudness level, you can tune up and down the band without readjusting it, almost regardless of signal strength.

All around, and price duly considered, a

Continued on page 120

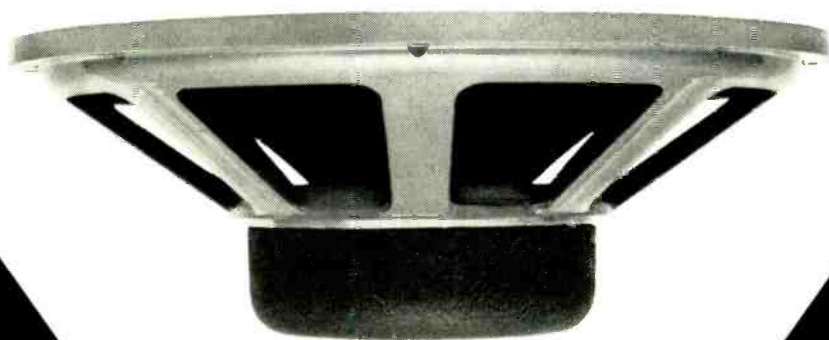

the best extended range speakers made *bear the name*

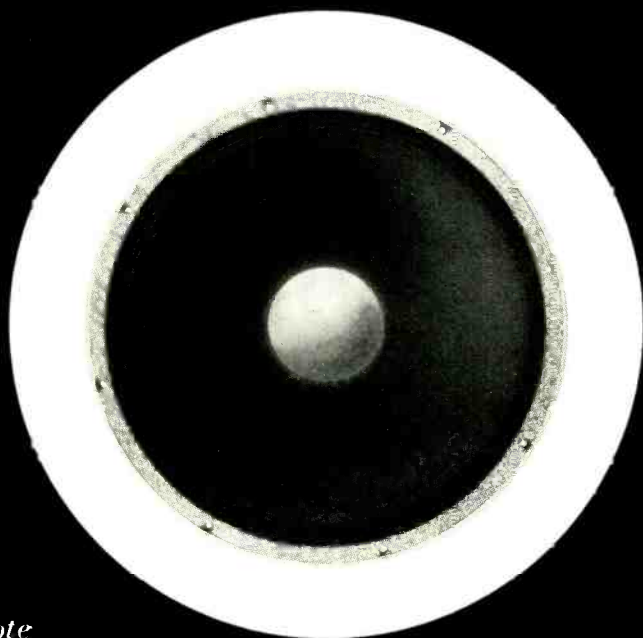

every note a perfect quote

JIM LANSING

Signature



They are the best because they are made right. All of the requirements for making a perfect extended range cone-type loudspeaker are known to many people. But only in Jim Lansing Signature Speakers are all of the requirements for perfection met. Doing all things exactly right produces Signature Sound — honest bass, precision mid-range, smooth treble, superlative transients.

It is reassuring to find that this is what a growing number of people want. They tell us that most of our customers have owned other speakers. After prolonged comparison, they switch to Signature Speakers as a permanent investment in perfect listening.

TESTED IN THE HOME

Continued from page 118

mighty slick piece of equipment. — C. F.

MANUFACTURER'S COMMENT: The 310-A is the best tuner we know how to produce, regardless of price. It was designed particularly for monitoring and rebroadcasting applications, and is actually considerably better than is needed for the average home application. The 311-A, on the other hand, represents the best tuner we can produce to sell under \$100. Actually, this unit turned out somewhat better than we expected . . . the result of a very fortunate choice of design parameters. Comparing the 310 and the 311, the 310 has about 50% more sensitivity and an interstation noise suppressor (squelch circuit). It is also a little more selective, but the 311 is so good that it is difficult to notice this difference.

Crescent 501 Record Changer

SPECIFICATIONS (furnished by manufacturer): a record changer that will intermix 7, 10, and 12-inch records of the same speed in any sequence. Equipped with turnover ceramic cartridge. **Turntable:** 9 in. diameter; rubber mat; rim drive. **Motor:** 2-pole shaded-pole type; can be replaced with 4-pole motor. **Dimensions:** 13 in. by 11 $\frac{1}{4}$; 5 $\frac{11}{16}$ in. required above mounting board and 2 $\frac{7}{16}$ below. **Price:** \$46.00, list. **MANUFACTURER:** Crescent Industries, Inc., Home Instrument Division, 5900 Touhy Ave., Chicago 31, Ill.

Performance of the Crescent 501 we worked with was substantially better than that of most inexpensive changers. Controls are simple and seemingly foolproof; there are only two, and they are mounted concentrically. Operation was quiet, and the change mechanism seemed unlikely to damage records. The turntable is fitted with a smooth rubber mat instead of the usual cork composition or flocking—which makes it easier to keep records (particularly LPs) clean, since the mat can be wiped off easily.

Speed selection is accomplished with a rotary switch that has positions marked N, 33 $\frac{1}{3}$, 45, and 78. The N position disengages the rubber idler from the drive pulley. Since the pulley is of quite small diameter, it would be easy for rumble-causing depressions to form in the rubber idler if it were not disengaged when the changer was



The Crescent 501 automatically plays a stack of intermixed record sizes.

turned off. Although the changer switches itself off after playing the last record in a stack, this control is not switched automatically to the N position; it must be done manually. Seems to us that, under the circumstances, it would have been safer if the changer didn't switch itself off. Inside the speed control is mounted an on-off-reject knob that is standard in operation.

Records of any standard size (7, 10, and

12-in.) can be intermixed in a stack and the arm will come down automatically at the right diameter for each. A good turnover cartridge (Sonotone Titone) is supplied; this requires a large value of terminating resistance for full bass response, and if the input resistor on the amplifier to be used with the Crescent is less than 1 megohm it is worth while replacing it. It is worth while replacing the styli, too, with sapphires or diamonds, for those supplied are of the precious-metal type.

A two-pole motor is furnished on the 501; this is adequately shock-mounted and



gives reasonably smooth drive. But it cannot be used with a magnetic cartridge because the hum pickup would be excessive. The literature supplied with the changer states that four-pole motors are available for field replacement.

Generally, we should say that the Crescent would be ideal for modernization of aged radio-phonographs or as part of a secondary hi-fi system. Provided proper styli are used in the cartridge this changer won't butcher good records as some low-cost units will, and sound from the cartridge is quite acceptable. Another model, the 505, is identical except that it has a good looking metal base and sells for \$50.00, list. — R. A.

Walco Replacement Stylus

Some time ago, Walco asked if we would do a TITH report on one of their replacement styli. As you know, they make replacements for practically every cartridge which has a replaceable stylus. Most of these are crystals and ceramics; a few magnetics have replaceable stylus assemblies.

Please note that there is a difference between retipping and replacing. Companies which retip diamond (or sapphire) styli use the same shank and/or assembly which you send them. Walco makes available complete replacements. The diamond or sapphire itself is, in such cases, only part of the problem. A major part is the damping blocks and the assembly itself; this must exactly match that of the original manufacturer or response will be altered. Use of inadequate damping material might, for example, result in peaked response.

Frankly, none of the HIGH FIDELITY staff has laboratory equipment of a quality to test thoroughly anything as hard to measure as a stylus. However, Walco sent us a replacement for a G-E cartridge, so we listened to the original and to the replacement; we ran a frequency response test on both, and we watched distortion on an oscilloscope. None of the three tests revealed any difference observable either by ear or by instrument. If anything, the replacement stylus had slightly better low frequency response below 100 cycles than the original, and also above 10,000 cycles. The latter

was probably due to the fact that the Walco stylus was new and unworn, whereas the original one had been used quite a bit.

Which is about all we can say . . . and which is probably enough. What more does one need to know other than that a replacement is actually a replacement and not a substitute? — C. F.

MANUFACTURER'S COMMENT: The best possible guarantee of good-as-new performance from a replacement part is to obtain the identical part used in the original equipment. This is particularly true of phonograph needles, where manufacturing tolerances are held to within plus or minus .0001-in. It may be of interest to readers to know that Walco originated the present-day jewel-tipped phonograph needle and is the world's largest supplier of styli to the biggest phonograph and cartridge manufacturers in the industry. More often than not, the needle that comes installed in a cartridge was made by Walco, which means that a Walco replacement needle is generally the exact replacement part. We do not recommend retipping old needles, as the metal and spring assemblies in most styli can become fatigued after countless millions of vibrations, and a new needle tip in an old shank is still apt to be an old needle with attendant frequency loss distortion.

Sherwood S-1000 Amplifier

SPECIFICATIONS (furnished by manufacturer): a preamplifier-control unit and power amplifier, combined in one small, attractive cabinet. **Power output:** 20 watts continuous, 40 watts peak. **Intermodulation distortion:** 2% at 20 watts, 60 and 7,000 cps mixed 4:1. **Output taps:** 4, 8, and 16 ohms. **Power response:** 20 to 30,000 cps \pm 1 db at 20 watts. **Frequency response:** 7 to 100,000 cps \pm 1 db at $\frac{1}{2}$ watt. **Controls:** bass (+16 to -19 db, 40 cps); treble (+20 to -20 db, 15,000 cps); equalization: (LP, RIAA, London, and European); rumble filter; variable damping factor; scratch filter. All input jacks and speaker output terminals are conveniently accessible from the rear. **Dimensions:** 14 in. long by 10 $\frac{1}{2}$ deep by 4 high. **Weight:** 20 lb. **Price:** \$99.50 in black and gold cabinet; \$104.50 in gold-tooled leatherette. **MANUFACTURER:** Sherwood Electronic Laboratories, 2802 West Cullom Ave., Chicago 18, Ill.

This amplifier deserves three significant compliments: the sound from it is undistorted; it has a multitude of features; and for this combination, the price is excellent.

First: the sound is nice and clean; nothing special about it, and you don't want anything special. Tone control range is more than adequate; equalization matches well. The sound wears well; ample power is available.

Second: the features; there are many, so let's be as brief as possible. A rumble filter



The Sherwood S-1000: 20 watts output.

is controlled by a slide switch toward the left of the front panel. Workbench tests showed it produced 1.1 db cut at 200 cps, 12.5 at 30, and 19 db at 20 cps. A scratch filter (also slide-switch operated) cuts equally sharply beginning at about 4,000 cps. Tone control ranges meet manufacturer's specifications above, and response is flat in their "flat" positions. The tone controls are calibrated on the front panel to indicate

Continued on page 122

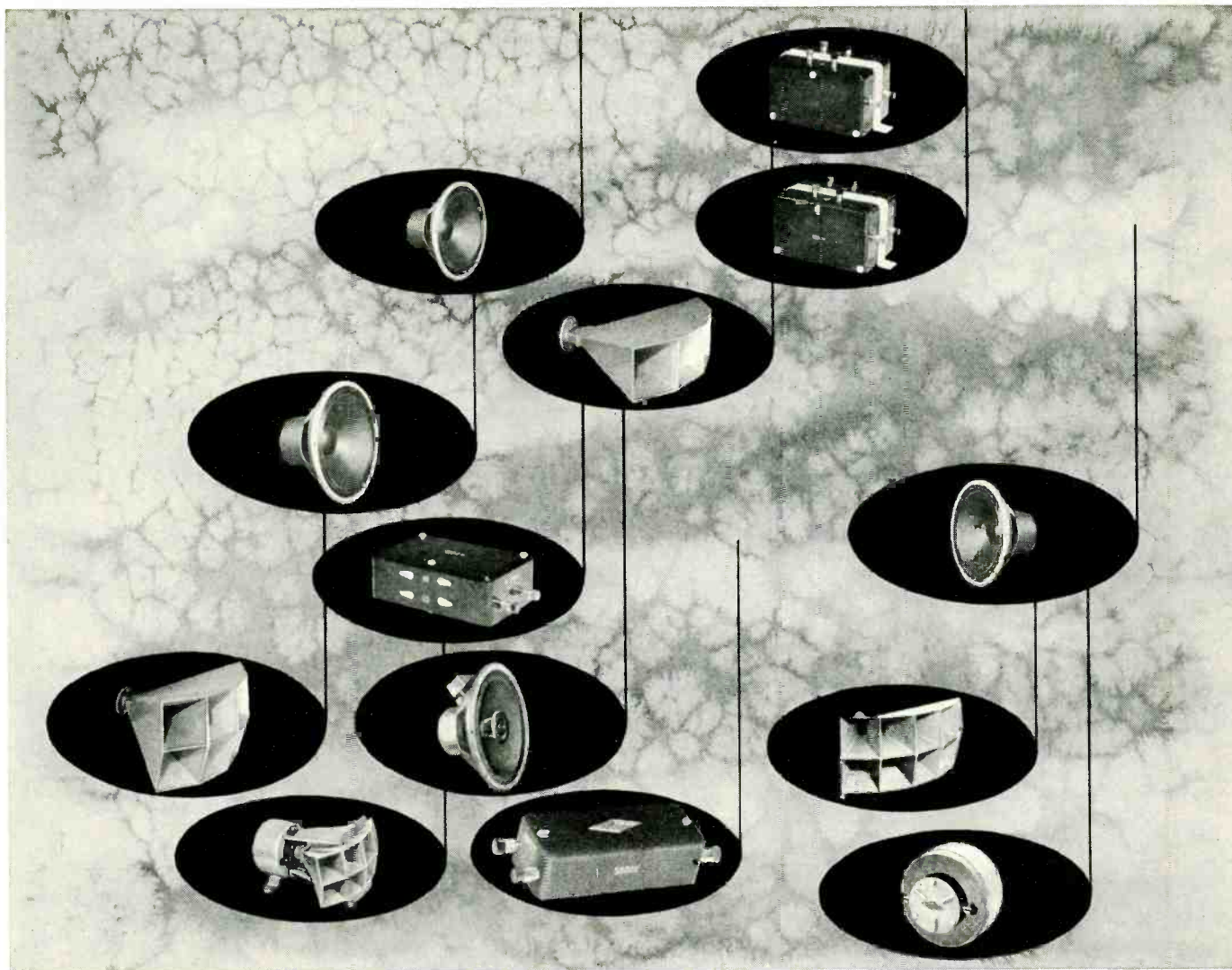

symphony in sound

Sound by Stephens is always noteworthy when selecting the finest in superlative speaker systems. Designed, constructed, and tested by the pioneer sound engineers in high fidelity equipment, the name Stephens stands for true fidelity with music listeners

the world over. Each pictured note represents quality speakers and components that will insure the listener a true symphony in sound.

Stephens Tru-Sonic speaker systems are scientifically developed to reproduce brilliant, artistic sound reproduction without fidelity loss or distortion. From the designer's table to your home or

business, Stephens speaker systems will provide flawless and trouble free operation throughout the years.

Consult your Stephens dealer as to a recommended Tru-Sonic speaker system for your particular needs.

For name of dealer nearest you, write:



Stephens



STEPHENS MANUFACTURING CORPORATION
8538 WARNER DRIVE / CULVER CITY, CALIFORNIA

CABLE ADDRESS "MORHANEX" EXPORT ADDRESS 458 BROADWAY, NEW YORK 13, NEW YORK

TESTED IN THE HOME

Continued from page 120

a amount of boost or droop; the indication is approximate.

Equalization (four positions) is accomplished by push buttons, and will be correct for phono cartridges requiring a 47,000-ohm load. Constant-amplitude type pickups can be connected to the phono input jack and correct equalization secured provided a single wire inside the chassis is cut. There is a back-of-chassis level control for the phono channel; levels for the other three channels should be set at the equipment connected to these channels (as FM tuner or tape recorder) to secure proper operation of the loudness control.

The loudness control is unusual; it gives flat response at about its one o'clock position. Turning it to the left reduces the volume and brings in the loudness contour; to the right of one o'clock, the control operates as an uncompensated volume control. The thinking behind this arrangement is worthwhile. Sherwood figured that most people played their music at a reasonably loud level most of the time and that this condition should be achieved with the knob in its zero (one o'clock) position, and that then there should be no compensation. However, there are times when some people may want it really loud; then the control has some reserve beyond its flat position. Good idea! Incidentally, the loudness feature can be switched out completely by the front-panel control at the extreme right, which also serves as an on-off switch.

There is a tape output connection, appearing at low impedance. It is affected only by the scratch filter, and then only when the selector switch is turned to phono. Tone and volume controls do not affect the tape output. This output is disconnected when the selector control is turned to TAPE, but not, of course, when the selector is in any one of the three other high level positions or in PHONO.

We played around a bit with the damping factor control, but because our speaker system is relatively good, could hear no substantial change. Normal damping factor is +7. Available also are +2 and -2.

One word of warning: the unit runs hot. Give it plenty of ventilation.

So, all in all, a fine unit. Well-designed, lots of features (which means plenty of flexibility) and good performance. Certainly one of the best of its type. — C. F.

MANUFACTURER'S COMMENT: Although the S-1000 has versatility with its many features, a great portion of the time that went into its design was spent in obtaining the utmost simplicity of operation. It was felt that an amplifier's controls should be flexible enough to meet any situation, but at the same time they should not be confusing to the newcomer to high fidelity. The convenience of the push-button record equalizers, for example, appeals to the most untrained housewife. In addition, should the user forget to press one of these buttons to select proper equalization, the phono preamplifier will automatically be compensated for the most-used RIAA curve. This ease of operation is typical throughout the S-1000 amplifier.

Jensen Coaxial Speakers

SPECIFICATIONS (furnished by manufacturer): Models H-530, H-520, and H-222 are 15, 15, and 12-inch (respectively) true coaxial speakers. Each has a highly-efficient woofer cone crossing over at 2,000 cycles to compression driver, loaded by a 6-

section Hypex-formula high-frequency horn. LC crossover networks are used, and each speaker has high-frequency balance control on 36-inch cable. Impedance: 16 ohms. Power rating: 25 watts. Prices: H-222, \$54.50; H-520, \$79.50; H-530, \$129.50. **MANUFACTURER:** Jensen Mfg. Co., 6601 South Laramie Ave., Chicago 38, Ill.

Loudspeaker design is a tricky business, as any hi-fi initiate knows. It is a field in which the most respected experts may (and often do) hold diametrically opposing views on any aspect you may bring up. For instance — you may decide that it's best to cover the entire audio range with a single voice-coil driver, which can be made to drive a single cone or two cones with a mechanical crossover; the latter is often represented as a coaxial speaker, but it isn't, strictly speaking. Or you may prefer to divide the range between two or more individual units: mount them concentrically, and you have a true coaxial or triaxial speaker; you may alternatively keep them physically separate and baffle them individually. Again, you may decide to design a mechanical-crossover (twin-cone) unit combined with an individual high-frequency unit, and come up with a pseudo-triaxial speaker. All variants



The H-222 has a 60-cycle resonance.

have their boosters. Most users believe that a coaxial speaker is likely to be better than a single-cone unit, and that a true coaxial is better than a mechanical-crossover design. Some prefer a separate two-way system to a coaxial, and some the other way around — but there is no denying the coaxial's advantages in space economy and mounting ease.

No matter which method of fabrication is used, there are inevitable compromises that must be made. To obtain a woofer that will reproduce the lowest audible frequencies without distortion, it must have a low resonance frequency; if it has, it cannot be very efficient over the upper bass range, and it is likely to be limited in power-handling ability. You can have high efficiency and extreme ruggedness, then, or fully extended low-frequency response — but not all three. You have another dilemma, too, in the lower treble range. Here you can keep the response fairly level to satisfy the audio perfectionists and those who like seats well back in the concert hall (relatively minor groups, we are told), or you can let the response rise in this "presence" range and please what is probably the majority of listeners.

Jensen, long a leader in the speaker business, has aimed for the average hi-fi enthusiast with this "H" series. They are all true coaxials, consisting of cone woofers with compression-type high-frequency units

mounted concentrically, and thus have the advantages of two-way systems but are easy to install and baffle. All have audibly rising response in the range from about 2,000 to 5,000 or 6,000 cycles, and accordingly achieve a remarkable projection of sound, as well as a brilliance that row M listeners may



Jensen model H-520 15-inch coaxial.

not care for on a long-time basis. Brilliance can, of course, be adjusted to some extent by the high-frequency balance control supplied with each speaker, but the characteristic sound remains.

The woofer resonance frequency of the H-222 was, according to our checks, about 60 cycles. This is about average for a 12-inch quality speaker. It was 60 cycles for the H-520 also, and this is slightly high for a 15-incher. Both speakers can obviously take hard usage; they aren't at all delicate, as many speakers are. They have fairly heavy magnets and are quite efficient, which indicates good transient response and means that they can be driven for all normal applications with amplifiers of moderate power. Bass response in a bass-reflex cabinet was



The deluxe model H-530 with crossover.

audibly flat to about 55 cycles with the H-222, slightly lower for the H-520.

The H-530 is the deluxe, heavy-duty version of the H-520. It has a much heavier magnet, and a cast-metal high-frequency horn rather than the molded plastic horn in the two less-expensive models. Bass resonance was somewhat higher, and efficiency substantially higher. All models are well worth careful listening and serious consideration if you're planning to get a dependable, well-built speaker system in the medium-price range. — R. A.

MANUFACTURER'S COMMENT: The H-530 has a flatter response in the high-frequency range. There is no prominence in the presence range, due to the deluxe tweeter used.

How good
will your
new tape
recorder be?

One of the answers lies in the quality of the magnetic recording head—a basic and important part of all recorders. The better the head, the better the performance you can expect. A Shure magnetic recording head insures a unit constructed to close tolerances . . . precision specifications . . . optimum performance of your recorder.

An outstanding example is the "Micro-Gap," a new, high quality magnetic recording head specifically designed for use in professional studio and fine quality home tape recorders. It provides excellent response over an extremely wide frequency range . . . long operating life at maximum efficiency. For home recordings of professional stature, or for precision data recording equipment, the "Micro-Gap" cannot be excelled.

The "Micro-Gap" is the latest of the Shure family of fine-quality magnetic recording heads. When a tape recorder manufacturer announces a model equipped with any of them, you can be assured of the high quality of the tape recorder . . . for the choice of a Shure head is proof that the manufacturer is giving you the very best.

The Mark of Quality



**Pioneers in Magnetic Recording
Since 1939**

SHURE BROTHERS, Inc.
225 West Huron Street, Chicago 10, Illinois

YOUR TUTTI

Continued from page 63

long the key is depressed. This fact has been established experimentally by comparing the oscilloscope wave forms of single tones struck by recognized concert musicians with the wave forms of tones of equal amplitude produced by mechanical means. It is valid, however, to speak of a complete performance as having a "singing" or a "brittle" tone. Such musical effects are created by the phrasing and relative intensity and duration of the various notes, rather than by direct control of actual timbre.

The clavichord strikes its strings with a piece of brass called a tangent, giving the sound a more metallic timbre with a larger percentage of high-order overtones and a more pronounced strike tone than the piano has. The distinguishing feature of the clavichord is that the tangent marks off the length of string left free to vibrate at the same time that it strikes, and the key never loses control of the tangent. The player can thus introduce vibrato and nuances of pitch from the keyboard. This is not true of the similar sounding harpsichord, but the latter has special features of its own. "Stops" are provided, associated with each manual, that engage or delete different sets of resonating strings for the variation of timbre.

The human voice mechanism could be classified as a double-reed woodwind, without overstretching the point. A steady flow of air from the lungs is periodically throttled by the vocal cords to produce the familiar saw-toothed wave form, and the resonating cavities of the human pulmonary system pick off certain harmonics and form the overtone structure of the vocal tone. Muscular variation of the vocal cord tension controls pitch.

The crooner rejects the classical use of the body resonators and of the full singing voice, substituting a sort of moan that does not have the necessary volume for a public performance, but is of the proper strength to serve as the input stimulus for a public-address system. The microphone, electronic amplifier, and loudspeaker must be considered integral elements of the crooner's tonal apparatus. Without these the effect would be comparable to that of a piano without a soundboard. Whispers, sighs, and quiet

Continued on next page

LANGEVIN PRESENTS



**Designed
by COOK
for use at the
N.Y. Audio Fair**

Over 70 watts at extremely low distortion, the only truly class A high power unit in manufacture.* Bona fide 3-stage current/voltage feedback network dynamically adjusts response to any speaker, the closest approach to a feedback speaker ever achieved. With resistor load, response exceeds FCC f-m specs—8 and 16 ohm output.

Stable, conservatively rated at 50 watts; new, heavier 316B output coil. Design by Cook, built by Langevin for lifetime use.

*4-6550's; high tube capacity for Class A design costs us more, brings you unparalleled performance at this economical low price.

168.50 net (incl. tubes)

available only from

Langevin

*for years . . . makers of
premium broadcast equipment*

Mr. Al Schneider, Chief Engineer
Langevin Manufacturing Corp.
47-37 Austel Place
Long Island City 1, New York

- Please send complete information on the Cook-Langevin Ultimate.
- Ship the Cook-Langevin Ultimate as soon as available.
- \$25 dep. enclosed. Balance C.O.D., express.
- I enclose \$168.50. You pay express.

REALISM

Again the Audio Fairs confirmed that the experienced listener and music lover value, above all else in a music system,

REALISM

that effaces the presence of equipment and completely re-creates the music.

Time and again, visitors were heard to say: "The best sound is where they are using Bozaks."

Designed on proven, straightforward principles — built one-by-one with painstaking handcraft—tested ruthlessly and tested again —

properly mounted and powered, used with true wide-range, low-distortion program material,

BOZAK LOUDSPEAKERS

are The Purest Voice for a fine Music System.

More than that — the Bozaks are designed for **Systematic Growth**. Start modestly, if you wish, with a single B-207A; grow as you can, without discarding a single Bozak, into the unequalled realism of the B-310 — the Supreme Accomplishment in the Reproduction of Sound.

The R. T. BOZAK SALES Co.



BOX 966 • DARIEN • CONNECTICUT

YOUR TUTTI

Continued from preceding page

tones whose timbre and whose style of delivery are quite different from those of the full voice are magnified to concert hall volume, a feat that would have been impossible before the age of amplification. (Is this progress?)

Electronics has, as a matter of fact opened up a wealth of possibilities for the design of new musical instruments. These possibilities have in general been greeted with favor by the engineering fraternity and, as often as not, with horror by musical scholars. In any case it is unlikely that the old-fashioned acoustical devices described above — of wood, brass, and precious metals — will be rendered obsolete in anything like the near future.

WITHOUT VITAMINS

Continued from page 66

temperament to inflate a dirigible, but it is a temperament invariably under musical and intellectual control. He remains virtually the last survivor of the romantic school of pianists. Only Novaes, who has been before the public nearly fifty years, is active with him. (Backhaus, another grand veteran, is not one of the romantic pianists.) Rubinstein's playing more than that of any pianist expresses a *joie de vivre*, a healthy approach never touched by a neurotic quality. His musical conceptions are always eminently sane: no excessive rubato, no monkeying with tempos and rhythms, no yearning for the Infinite, no apparent inner struggles.

He is a civilized man. As he plays, so he is. He can even laugh at himself, the sign of a civilized man. He delights to tell the story of his great medical examination. Last year, at the height of the agitation about the effects of tobacco on the throat and lungs, he came down with a hoarse throat and immediately thought dire thoughts. Off he went to a prominent doctor in Los Angeles. This doctor, says Rubinstein, was a dour, grave man who seldom opened his mouth. He poked the pianist all over, took gallons of blood and volumes of X-rays. He inserted various instruments within the Rubinstein body, saying not a word, and soon the patient was near nervous collapse. "Come back

Continued on page 128

New PENTRON

Pacemaker

Tape Recorder

with

Unimagic

Control



— easier than pushing buttons

Pentron's new Unimagic feather-light selector lever does everything. The Pacemaker's 2 hi fi speakers, automatic index counter, instantaneous braking, brilliant functional styling, and other features add up to the recorder you've dreamed of . . . See it today!



PENTRON
PACEMAKER

\$199.95
list

others,
\$139.95 to
\$249.50

PENTRON

103-55

PENTRON CORPORATION

786 Tripp Ave., Chicago 24, Ill.
Canada: Atlas Radio, Ltd., Toronto

available at all fine HI-FI

Centers including:

NEW YORK CITY

Arrow Audio Center
ASCO Sound Corp.
Center Electronics
Electronic Workshop
Federated Electronic Sales
Goody Audio Center
Harvey Radio
Heins & Bolet
Hudson Radio & TV Corp.
48 W. 48 St. & 212 Fulton St.
Leonard Radio
Sun Radio & Electronics Co.
Terminal Radio Corp.
Thalia Hi-Fi Audio Center
Brooklyn High Fidelity Center

NEW YORK STATE

Audio Exchange, Jamaica
Westlab, Inc., Yonkers
Hi Fidelity Center, White Pls.
The Pine Shop, Glen Head
House of Hi-Fi, Manhasset
Island Radio, Hempstead

ALBANY, N. Y.

Commercial Sound Systems
Ostonside Inc.

ROCHESTER, N. Y.

Jerry Fink Co.
Craig Audio Laboratory
Audio Service, Binghamton
Buffalo Audio Center, Buffalo
House of Harmony,
Schenectady
Custom Music
E. Orange, N. J.

BOSTON, MASS.

DeMambo Radio Supply Co.
The Listening Post Inc.
A. Marks Company
Radio Shack Corp. (Also in
Providence, R. I.)
Lafayette Radio (Radio
Wire TV)
Lowe Associates, Brookline

PHILADELPHIA, PA.

Radio Electric Service Co.
Danby Radio Corp.
Electronics
Almo Radio Company

PITTSBURGH, PA.

Concerto Room, Inc.
Wolk's Hi-Fi Center
Grove Enterprises, Roslyn

BALTIMORE, MD.

Wholesale Radio Parts Co.
High Fidelity House
Radio Electric Ser. Co.
Wilmington, Del.

WASHINGTON, D. C.

Electronic Wholesalers, Inc.
Shrader Sound, Inc.
Custom Hi-Fi Radio & TV Co.
Hi Fidelity Wholesalers

CHICAGO, ILL.

Allied Radio Corp.
Newark Electric Co.
Voice & Vision Inc.
Electronic Expeditors
Universal Audio Equip.
Atronic Corporation
The New Sound, Champaign

CLEVELAND, OHIO

Counterpoint, Inc.
Audio Craft Co.
Custom Classics

DAYTON, OHIO

Dayton Sound Assoc.
Klopf's Piano Shop
The Camera Center, Canton
Customcrafters Audio, Cinn.
Anderson Hi Fi, Columbus

DETROIT, MICH.

K. L. A. Labs.
Audio House, Inc.
Pecar Electronics
Electronic Supply,
Battle Creek
McCallum & Dean,
Birmingham

Satterfield Electronics,
Madison, Wisc.

SOUTH BEND, IND.

Radio Distributing Co.
Al Smith's Hi Fi Studio
Hedstrom Hi Fi, Marion
Hedstrom Hi Fi, Muncie
Streight Radio & TV, Gary
The Golden Ear, Lafayette
Electronic Supply,
Kalamazoo
James Black & Sons,
Wheeling, W. Va.

ST. LOUIS, MISSOURI

Aeolian Company of Missouri
Commercial Electronics
High Fidelity Showroom
Newberry Radio Company
Don Cook's Electronic Equip.
Co., Independence
David Beatty Custom Hi-Fi,
K. C. 11
Garstang Company, Belle
Music, Unlimited, Denver, Col.
Wells Music, Denver, Col.
Mid State Dist., Des Moines, Ia.

HOUSTON, TEXAS

Wrye Company, Ltd.
Audio Center
Home Music Associates,
Dallas
High Fidelity Inc., Austin
Thompson Audio Center,
Beaumont
Audio Associates, Ft. Worth
Texas Sound Studios,
San Antonio
Custom Electronics,
New Orleans, La.
Audio Electronics, Tulsa, Okla.
Radio and Sound Clinic,
Oklahoma City

HOLLYWOOD, CALIF.

Hollywood Electronics
California Sound Products
Magnetic Recorders Co.
Weingarten Electronic Sales
Pacific Hi Fi House

LDS ANGELES, CALIF.

Crenshaw Hi Fi Center
Kieruff Sound Corp.
L. A. Portable Recording
Midway Electronic Supply Co.
Universal Radio Supply Co.

PASADENA, CALIF.

Audio Associates
Dow Radio, Inc.
High-Fidelity House

SAN DIEGO, CALIF.

Breier Sound Center
Shanks & Wright
Dackney Electronics,
Long Beach
Audio-Vision Co.,
Santa Barbara
Custom Music, Riverside
Hollywood Hi-Fi Shop,
San Bernardino
House of Sight & Sound,
Van Nuys
Audio Workshop, La Jolla
Hall's Hi-Fi, China Lake
Valley Electronic, Burbank

SAN FRANCISCO, CALIF.

Columbia Music Co.
The Hi Fi Shop
The Listening Post
San Francisco Radio &
Supply Co.
Zack Radio Supply Co.
Paramount Radio & Sound,
San Jose
Allied Radio, San Jose
Coast Electronic, Oakland
Thos. Tenney-Music,
Berkeley 5

SEATTLE, WASH.

Sound & High Fidelity Center
Olympic Engineering
C & G Radio Supply, Tacoma
Cecil Farnes Co., Salem

**A TURNTABLE FOR THE HOME, BUILT TO
FAIRCHILD'S STUDIO EQUIPMENT STANDARDS!**



FAIRCHILD

Turromatic TURNTABLE

Fairchild, now in its third decade of supplying equipment to meet the most exacting standards of recording and broadcasting studios throughout the world, presents for the first time a home turntable of compatible excellence.

You would naturally expect superlative performance in a table from Fairchild, and the new "411" gives it. Vibrationless operation makes possible utilization of the full dynamic range of modern LP recordings; its rumble content is actually lower than that of most records. The Turromatic's absence of reproduced noise is matched only by its complete acoustical silence — you will only know by the soft illumination that it is running! Flutter and wow are no longer a consideration, being completely imperceptible (typical measurements: less than 0.07% RMS at 78 and less than 0.1% at 33).

OTHER FEATURES:

All bearings poured babbitt precision rifle-drilled for highest polish. (Babbitt running on polished hardened steel is still the smoothest, most quiet, and most durable bearing devised.) Thrust bearing is ROTATING polished steel ball turning on nylon seat . . . self-adjusting, self-aligning, practically wear-free. Main bearing sealed to shaft—no one (including you!) can mar its mirror-like surface after assembly and final test.

Automatic Idler Pressure

Release—no flats on idlers ever!

Unless you remember to "turn the switch to the off position", most turntables (probably yours) will develop "flat" spots on the idler. This naturally results in greatly deteriorated performance. With the Fairchild Automatic Pressure Release such damage is impossible. Since pressure is applied to idlers only when motor current is on, you can safely shut off the "411" from any remote point — for example, at the main control or by clock switch for lazy listening.

Turret Control

The "411" takes full advantage of all the smooth performance inherent in silent, flexible, endless-belt drive. But also, step-pulley type idlers in an ingenious turret mounting provide:

1. Instantaneous, silent, fool-proof speed shift
2. Greatly increased driving surface for positive non-slip drive.

TWO STAGES of motor isolation from frame and turntable.

Polished aluminum turntable, non-magnetic. Heavy cast-iron flywheel for greatest stability and smoothness of motion.

Built-in "45" center raises or lowers quickly and easily.

Clearance provided for playing 16" transcriptions with appropriate arm.

PRICE: \$99.50 Audiophile Net

Canada: H. ROY GRAY LTD., Toronto 13
Export: CBS INTERNATIONAL, New York, N. Y.

FAIRCHILD Recording Equipment Co., Whitestone, N. Y.



Centralab's NEW Fastatch® Senior Compentrol® Kit

**PUTS MORE TWEET
IN YOUR TWEETER...**

**more woof
in your woofer**

How do you titillate your tympanum? With tones true but tempered? Or do you show no pity for the plaster and want 'em true but thunderous?

Either way, Centralab's new Fastatch Senior Compentrol Kit is for you. For, quick as a wink, you can assemble the ultimate in a compensated control, to improve the tonal performance of your hi-fi amplifier or pre-amplifier.

**You can get any shaft-length
you want. It's a SNAP to do it:**

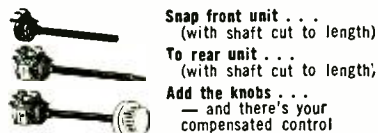

Snap front unit . . .
(with shaft cut to length)
To rear unit . . .
(with shaft cut to length,
Add the knobs . . .
— and there's your
compensated control

A special Printed Electronic Circuit*, pre-wired to the rear unit, automatically bolsters frequencies otherwise often lost. Two additional high-boost plates are included in the kit, in case your taste demands even further emphasis of the highs.

If you like to tinker, ask your Centralab distributor for a Centralab C2-200 kit. If you're not a do-it-yourselfer, ask your service man to install a Fastatch Senior Compentrol for you.

*Trademark



C2-200 Kit
\$4.75
suggested net price

Send for Compentrol
booklet. Write
Centralab, Dept. 928B
Milwaukee 1, Wis.

Centralab

8-2655

WITHOUT VITAMINS

Continued from page 126

tomorrow," said the doctor finally, and Rubinstein tottered home. He looked at his will to make sure it was in order, and gave himself up to his particular gods. Back he went the next morning, determined to be brave, come what might. "Tell me, doctor," he said. "Tell me the worst. I am prepared. Is it cancer?" The doctor looked at him. "Mr. Rubinstein," he said, "the only trouble I can see is that you talk too much."

Only once, according to his friends, has Rubinstein been held speechless, and that notable event occurred within the bosom of his family. He had returned from a concert tour, had burst into the house, and had been embraced by his five-year-old Eva. "Daddy," she said, "play me some music." Rubinstein was touched and deeply moved. He sat down at the piano, vowing to himself that he would play for her as he had never played for a mortal. He brought his hands up high. "No, daddy," Eva said before he could bring them down. "Not the piano. The phonograph."

SYMPHONY

Continued from page 57

Dublin, and perhaps Soviet Russia, depending on prevalent temperatures in the Cold War. Human interest note: sixty orchestra wives hope to make the European trip.

During its regular September-April Season, the BSO always has toured assiduously, and still does. A week per month, on the average, is spent on the Eastern Seaboard outside Boston, and annually at least one wider sweep, through the South or the Great Lakes area, is made. Assistant manager Gail Rector handles tour arrangements, while his opposite number, assistant manager Norman Shirk, attempts to rent Symphony Hall, in the Orchestra's absence, to lecture-groups, conventions, and the like. The transportation of equipment is in the hands of Harvey Genereux, property man, who rides the same train with the instruments and music. There have been few foul-ups, though on the 1952 European tour a truck containing the music got stuck at the end of the annual Bordeaux-to-Paris bicycle race, ar-

Continued on page 130

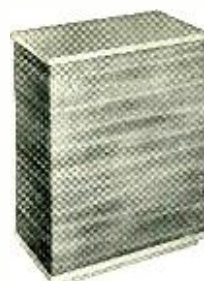

**build
your own
FORESTER
3-way
Low Distortion
SPEAKER
SYSTEM**

for as little as \$129.00

. . . with 1M distortion below that of systems costing more than \$350.00. Intermodulation distortion or "blurring" of the most-listened-to middle and high frequencies is prevented by complete electrical and acoustical isolation of each speaker. This results in less than 0.5% 1M distortion to provide exceptionally clean middle tones and clear highs with no harshness.

The Forester system contains 3 low distortion speakers. (A) a 12" woofer, 30-300 cps, with a 1 lb. magnet; (B) an 8" mid-range unit, 300-5000 cps, with a 14.6 oz. magnet and (C) a 5" tweeter, 5000-18,000 cps with a 2.15 oz. magnet and lightweight, spiderless cone. These three speakers are controlled by a 6-element, 300:5000 cps, 12 db/octave crossover network. The entire cabinet measures 32" high, 25" wide, 14½" deep.

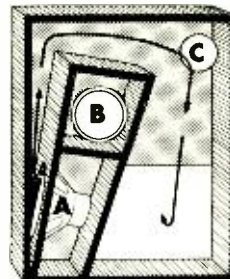

Front View

COMPLETE SYSTEMS

SF1	Spkrs., network, cabinet drawings...	\$ 79.50
SF1/SFK	Spkrs., network, cabinet kit.	\$129.00
SF1/SFP	Spkrs., network and assembled ¾" unfinished plywood cabinet.	\$154.00
SF1C	Spkrs., network, in finished bleached mahogany cabinet (illustrated)	\$189.00

MODERNIZATION SYSTEMS

For use with your present 12" speaker, instead of the Sherwood Woofer.

SF2	Same as SF1, less 12" woofer.	\$ 49.50
SF2/SFK	Same as SF1/SFK, less 12" woofer. . .	\$ 99.00
SF2/SFP	Same as SF1/SFP, less 12" woofer. . .	\$124.00

CROSSOVER NETWORKS (16 ohms)

For your own speaker system.

SFX35	300/5000 cps, 12 db/octave.	\$ 19.50
SX2	200 cps, 12 db/octave.	\$ 26.00
SX55	500/5000 cps, 12 db/octave.	\$ 18.50
SX6	600 cps, 12 db/octave.	\$ 16.90
SX8	800 cps, 12 db/octave.	\$ 15.50
SX36	3500 cps, 12 db/octave.	\$ 6.50

See the Forester Speaker System at your hi-fi dealer or write for free descriptive catalog. Construction manual also available at 50¢.

Other Sherwood products include:
Low Distortion Amplifiers from \$99.50
and FM-AM Tuners from \$139.50

Sherwood
ELECTRONIC LABORATORIES, INC.

Dept. 2H • 2802 W. Cullom Ave.
Chicago 18, Illinois

Harvey HARVEY

The House of Audio

THE
New

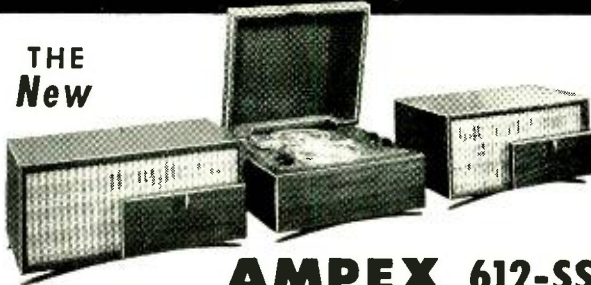

AMPEX 612-SS STEREOPHONIC SOUND SYSTEM

First true dual-channel stereophonic tape system designed specifically for the home, the 612-SS combines the new Ampex 612 stereophonic tape phonograph (playback only) with two complete and independent Ampex 620 amplifier-speaker systems for unrivaled reproduction of stereophonic tapes. The space effects made possible by Ampex stereophonic sound cannot be duplicated on single-channel systems in any price range. The 612 will also play the conventional half-track and full-track tapes with customary Ampex playback quality. Tape speed is 7 1/2 in. per sec.; frequency response extends from 40 to 15,000 cycles. Standard 7-in. RMA reels. Complete with custom-designed cabinets, as Model 612-SSF. **\$69900**

Also available in a completely portable system, with Samsonite cases, as Model 612-SSP **\$694.00**



THE New DYNAKIT Mark II 50-WATT Amplifier Kit

Here is something altogether new — a no-compromise "dream" amplifier in easy-to-build kit form at a popular price! The DYNAKIT Mark II employs a special new circuit in conjunction with a newly developed transformer of unique construction. Its beautiful simplicity — it has only three tubes plus rectifier and includes printed circuitry — makes it easy for the home constructor to reproduce the impressive performance characteristics of its laboratory prototype with only three tools: soldering iron, pliers and screw driver.

Rated power output is 50 watts (continuous); intermodulation distortion is less than 1% at rated power; harmonic distortion is less than 1% at any frequency from 20 to 20,000 cycles within 1 db of rated power. Frequency response is within ±.5 db from 6 to 60,000 cycles; ±.1 db from 20 to 20,000 cycles. Square wave response is essentially undistorted from 20 to 20,000 cycles. Output stage has the new 6CA7's in push-pull; output impedance is 8 or 16 ohms.

Complete, with tubes, output transformer and instructions **\$6975**

THE Stan White MODEL 4330 THE 'HI-FI'

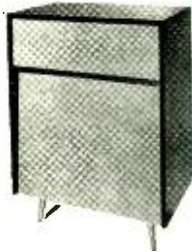

Complex multi-flare horn system with four separate driver units. Bass horn (30-150 cps) has equivalent axial length of 14 feet. Mouth area is 7 square feet, and is substantially increased with proper room placement. Lower mid-frequencies are handled by two 8" speakers (150-600 cps) located on each side of the cabinet, with a phase shift network between speakers for three-dimensional effect. Higher mid-frequencies (600-3000 cps) are handled by a multi-flare horn with an equivalent axial length of 6 feet. High frequencies (3000-18,000 cps) are handled by a multi-flare horn with an equivalent length of 4 feet. Frequency response is substantially flat from 30 to 18,000 cps. Power handling capacity is 60 watts. Available in four finishes — mahogany, blonde, walnut, and ebony, with three coats of lacquer, hand rubbed. **\$33950**

Other units in stock priced from \$49.50 to \$1,500.

Everything worthwhile in high-fidelity equipment is IN STOCK at Harvey's — our demonstration facilities are second to none! Orders shipped same day received.

TIME-PAYMENT PLAN AVAILABLE • TRADE-INS ACCEPTED

Prices are net, F.O.B. N.Y.C. — subject to change without notice.



at 1123 Avenue of the Americas (6th Ave.)

Nothing has been spared to make this new extension of HARVEY's, which adjoins the old store, a hi-fi shopper's paradise. Devoted exclusively to high fidelity, it has more display area... more demonstration facilities... more conveniences of every sort for hi-fi lovers.

THE NEW PAMPHONIC Sr. SPEAKER SYSTEM

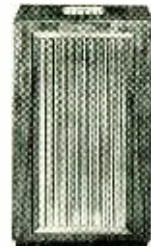

Embodying several new and unconventional design features, the Pamphonic Sr. Reproducer is a de luxe two-way speaker system with 1500-cycle crossover in an exceptionally rigid enclosure. The treble unit is a special elliptical cone speaker with aluminum voice coil; the woofer is a 15-in. unit with a flux density of 16,000 gauss. The cabinet, constructed of one-inch wood and internally braced, employs a tuned vertical bass-reflex chamber for exceptionally smooth low-frequency response and has the treble speaker oriented for rear-wall reflection to assure unusually wide and even high-frequency dispersion. The speaker units, dividing network and enclosure were conceived from the ground up to function as an integrated system, rather than just a woofer and a tweeter in an all-purpose cabinet. Together they cover the entire audible range of frequencies and are capable of handling power levels in excess of 15 watts.

Available in mahogany or walnut finish **\$29500**

PRINTED-CIRCUIT — MINIATURIZED 'Preamp with Presence'

— as described by C. G. McProud in *May, Audio Engineering*. 3 equalization choices, presence control, volume and loudness controls, and Bendall-type bass and treble controls.

Basic kit containing the 1.0 henry encapsulated choke, the printed circuit panel completely drilled, and the 4 metal chassis parts **\$750**

The complete kit of parts, including the basic kit and all other parts and tubes as specified by author. **\$3550**

The New FAIRCHILD 220XP PHONO CARTRIDGE with elliptical microgroove stylus

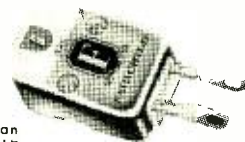

A stylus with an elliptical cross section can follow the violent zig-zags of the modern LP record groove with considerably greater accuracy than one with a circular cross section. The new Fairchild 220XP cartridge features for the first time an elliptical diamond stylus in the 1-mil microgroove size for matchless tracking on LP's. Combined with the additional new Fairchild features of reduced dynamic mass, increased compliance and toroidal damping, the new stylus design enables the 220XP cartridge to deliver a completely distortionless replica of the signal recorded in the groove, so that for the first time the music can be heard as it was actually recorded. **\$6000**

ESTABLISHED 1927
HARVEY RADIO COMPANY, INC.
103 W. 43rd Street, New York 36 • JU 2-1500

The **FIRST** really
STATIC-FREE, DUST-FREE
NOISE-FREE CARTRIDGE

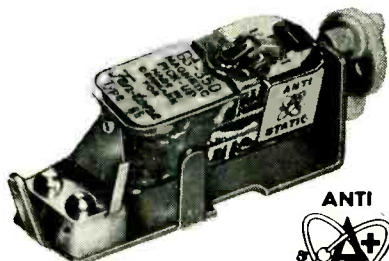

Fen-tone



DO scientists have brought you new magic — the B&O A+ professional anti-static cartridges for ABSOLUTE FIDELITY. (Pat. Pending).
 Now you can enjoy static-free, dust-free, noise-free reproduction, longer lasting records and prolonged stylus life with a brilliance never before dreamed of!

Audiophile Net:

Dual Sapphire.....	\$ 9.78
Single Sapphire.....	\$ 9.30
Single Diamond.....	\$21.30
Micro Diamond St. Sapphire.....	\$21.78



Fen-tone



P-12 A+ — the only anti-static crystal cartridge — it out-performs all other ceramic and crystal cartridges — no matter what the price.

Audiophile Net:

P-12/RS A+ (Dual Sapphire)	\$ 7.25
P-12/RG A+ (Micro Diamond St. Sapphire)	\$21.75



FREE! 1956 *Fen-tone* Catalog. The above are only samples of the many terrific values in the new 1956 Fen-Tone Hi-Fi catalog including mikes, tape decks, cartridges, record changers, silent listening devices, etc.

FENTON COMPANY
 15 Moore Street, New York 4, N. Y.

Sold through better
 Audio Distributors.
 See yours today!

West of Rockies,
 prices slightly higher.

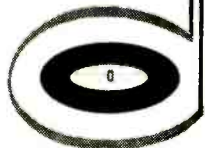

See us at the Los Angeles Hi-Fi Music Show, Room 456

SYMPHONY

Continued from page 128

rived in Paris a day late, and almost caused a cancellation. The musicians themselves travel however they want to. Rector's office makes reservations for them on request.

This volume of music-making provides good livings for the Orchestra's members, but not for the Orchestra itself.

Thomas D. Perry, Jr., the manager, sums the situation up in two sentences: "To mount a Boston Symphony Orchestra concert costs \$8,500. Selling one out, ordinarily, brings in \$7,100." Multiply that by about 220, the number of concerts given in a year, and the operating deficit is the result. This is made up partly by income on endowments, partly by contributions, and partly, says Perry, "by God, I guess." Tanglewood loses money,



even though over 100,000 people usually pay admission fees, because the vast, handsomely landscaped estate, with its enormous music shed and numerous buildings, must be maintained during forty-six weeks of idleness a year.

Perry, a Hoosier of Bostonian family, was propelled into his job, he says, because he is a music-lover without talent (though he sang in the Bach B minor Mass chorus once at Tanglewood, under Koussevitzky). The problem of the BSO, or of any other great symphony orchestra, as he sees it, is this: "We're a public service institution. Our duty is to give music to people who need music, of whom there are more and more, and to keep it good. What confuses some people is that we sell out, we're a 'hit show,' and thus they think we should make money. But we cannot raise prices and still serve our whole public. And, if it comes to that, Harvard always has a full enrollment, and no one criticizes Harvard for not showing a profit."

After the retirement of Major Higginson, the financial strong man of the BSO was trustee-treasurer Ernest B. Dane. Henry Cabor says he can remember Dane's contributing, one year, more than \$100,000, out of his own pocket. But with Dane's retirement, this ceased. The Orchestra cannot depend now on enormous personal donations. This is, says Mr.

Exciting High Fidelity Firsts!

In these superb matched instruments—enjoy the foremost advances in High-Fidelity—startling realism—lowest distortion—precision craftsmanship—gleaming polished chromium chassis.

INTERELECTRONICS

Coronation 400
40 WATT
AMPLIFIER



\$109⁵⁰

Greatest amplifier buy today! COMPLETELY NEW, NON-RINGING NEGATIVE FEEDBACK CIRCUITRY—over 50 DB feedback. CUSTOM CRAFTED—sealed transformers, encapsulated networks, finest molded components on Bakelite terminal board. DISTORTION-FREE—less than 0.05% at 30 watts. POWER RESPONSE ±0.1 DB 16 to 35,000 cycles at 30 watts. Surpasses FCC requirements for FM broadcasting. 5 to 200,000 cycle response. 40 WATT WIDE-RANGE OUTPUT TRANSFORMER, sealed multiple section windings, thin strip core. FOOL-PROOF DAMPING CONTROL for startling speaker performance. BUILT-IN POWER for preamplifiers and newest electrostatic tweeters.

INTERELECTRONICS

Coronation 85
CONSOLETTA PREAMPLIFIER-EQUALIZER



\$79⁵⁰

Incomparable companion to the "CORONATION 400". EXCLUSIVE NEGATIVE FEEDBACK CIRCUITRY. Over 50 DB—virtually eliminates distortion. Surpasses FCC requirements for FM Broadcasting. 5 to 200,000 cycle response. CUSTOM CRAFTED—polished chromium chassis, satin gold front panel. Encapsulated precision networks, molded components on Bakelite panel. LOUDNESS CONTROL, continuously variable. FIVE INPUT SELECTIONS, 16 PRECISION PLAYBACK CURVES. FULL 20 DB DISTORTION-FREE Bass and Treble compensation. Phenomenal lowest noise Z-729 input tube HUM IN-AUDIBLE with all controls on full. Highest gain. Built-in power for motion picture photocells, FM phono cartridges, condenser microphones. Ultra compact, easy front mounting.

Now at your local dealer!
 Write Dept. H for literature

INTERELECTRONICS
 2432 Grand Concourse
 New York 58, New York

Cabot, as it should be, but there should be other sources.

One of the sources, Mr. Cabot himself and his fellow-trustees began tapping in 1934, when they founded the Friends of the Boston Symphony Orchestra. The function of the Friends is simply to help support the Orchestra through contributions (which ranged this year from \$1 to \$15,000), in return for which they receive nothing but a free tea in the springtime — and music for Boston. The Friends came through with \$155,000 in 1954-55, which left, still, a deficit of nearly \$100,000.

Cabot, whose family is the one cited in a famous verse which also mentions the Lowells and the Deity, explains his exertions for the Orchestra by saying: "It's exciting, it's very good fun, and it's a privilege, even in the lowly job of raising money." And he has a very clear idea of where the money should and could come from. The present-day equivalents of yesterday's princely patrons and Major Higginsons, he points out, are the city's businesses. For the nonce, they are not behaving with princely enough generosity to suit him, and he is a trifle peeved with them. They would realize

what the Orchestra meant to the city soon enough if they lost it, he says, but without such drastic stimulus they are hard to move. Detroit and Pittsburgh businesses have done much better, he points out, though — comfortably? — New York and Philadelphia are as bad as Boston.

So far, although individual Friends number 4,000, business Friends number only 90. Actively engaged in trying to raise this quota, acting on leads from Trustees and other advisers, is Carlos Pinfield, who probably typifies what BSO performers feel toward the BSO. Last May, after forty-three years' service in the first violins, he retired. The Orchestra has one of the best retirement policies in the world of music — or of business, for that matter. The retired member receives a pension keyed, in effect, to the cost of living — half what he would receive were he still actively in his job. So Mr. Pinfield could have relaxed and enjoyed himself. Instead of which he returned, only a few weeks after his retirement, with the suggestion that he go back to work, this time without pay, soliciting contributions from Boston businesses. He is still at it, and

Continued on next page

AR-1

PRESS COMMENT

"Atlantic"

"The AR-1W woofer gives the cleanest bass response I ever have heard."

AUDIO (Edward Tatnall Canby)

"... the highs impressed me immediately as very lovely, smooth, unprepossessing, musical (for music) and unusually natural. No super-hi-fi screech and scratch... As to the lows... I was no end impressed, from the first time I ran my finger over a pickup stylus and got that hearty, wall-shaking thump that betokens real bottom bass to the time when I had played records and tapes on the speaker for some months on end."

THE NATION (B. H. Haggin)

"... achieves the seemingly impossible; a real and clearly defined bass in a cabinet only 14 by 11 3/8 by 25 inches in size."

RADIO - ELECTRONICS (J. M. Krech)

"... reproduced the full range of bass, even the pedal tones of the organ, cleanly and spectacularly... shook the concrete reinforced floors of the Hotel New Yorker..."

The Saturday Review (R. S. Lanier)

"... goes down into the low, low bass with exemplary smoothness and low distortion. It is startling to hear the fundamentals of low organ notes come out, pure and undefiled, from a box that is two feet long and about a foot high."

High Fidelity (Roy Allison)

"... a woofer that works exceptionally well because of its small size, not in spite of it... I have heard clean extended bass like this only from enclosures that were at least six or seven times its size."

THE AUDIO LEAGUE REPORT

(Oct., '55) Pleasantville, N. Y.

"Speaker systems that will develop much less than 30% distortion at 30 cycles are few and far between. Our standard reference speaker system,* the best we've ever seen, has about 5% distortion at 30 cycles."

*The AR-1

The AR-1 speaker system, in mahogany or birch, is \$185. Suggested driving power, at least 30 watts. Literature on request from Dept. H.

ACOUSTIC RESEARCH, INC.

23 Mt. Auburn St., Cambridge 38, Mass.

Are all diamond needles really alike?

Don't be misled. There's a tremendous difference in diamond needles. Just because it's a diamond doesn't mean you get protection for your records. Real protection depends on radius control polishing of the diamond.

That's why Duotone puts the polisher's certification and picture right in the needle package. So you can be sure of a tip polished to the highest degree for absolute concentricity.

15,000 rotations in polishing, never less, for the Duotone diamond! Because even the slightest microscopic burr will feather-cut the delicate groove on your records.

Don't be misled by the easy term "diamond." Look for the picture of the man who did the polishing in every Duotone Diamond Needle Package. His picture tells you you are getting the protection of a perfectly polished diamond for your records. The Duotone Company, Keyport, N. J., Manufacturer and Supplier. Exp. Div., Ad Auriema, Inc., New York.

Frame design after an original in the Metropolitan Museum

the famous
Ferrograph
HIGH FIDELITY
Portable Tape Recorder

Series 3A/N
audiophile.net **\$37950**

professional quality at nominal cost

The world-famous FERROGRAPH magnetic tape recorder, designed and developed primarily for professional use, has been re-styled for YOU — the discriminating audiophile, the progressive educator, the efficient businessman, the music lover.

Standard equipment with the British Broadcasting Corporation, it is a byword with cultural, educational and scientific users throughout Europe. The FERROGRAPH is unconditionally guaranteed to meet the most critical performance requirements.

Two models of this versatile dual-speed, dual track recorder are now available in LIMITED QUANTITIES, with tape speeds of 3¾" and 7½" or 7½" and 15" per second. Both models feature the employment of a synchronous hysteresis capstan motor providing unparalleled long-term speed stability, thus avoiding pitch errors on playback.



FERROGRAPH RECORDERS AND TAPE DECKS also available for custom installation or rack mounting to meet your special requirements. Custom Model 3A/DT (illus.) with tape speeds of 7½ and 15"/sec.



Write for performance specifications and the name of the franchised dealer in your area.

ERCONA CORPORATION
(Electronic Division)
551 Fifth Ave., Dept. H.2, New York, N. Y.

SYMPHONY

Continued from preceding page

increasingly successful. "It's a new idea to Boston businessmen," he says, "and they want some answers. And they deserve them. That's my job. It's the toughest one I can think of, but I asked for it."

Despite its omnipresent deficit, the Orchestra has proceeded confidently about its business of providing more and better music, in all ways. To mark its seventy-fifth anniversary, it commissioned (together with the Koussevitzky Music Foundation of the Library of Congress, on a half-and-half basis) fifteen new works by composers all over the world, with grants of \$2,000 per work. Among the composers are Schuman, Milhaud, Ibert, Petrossi, Barber, Bernstein, Copland, Hanson, Martinu, Piston, Sessions, and Villa-Lobos.

And it has not abandoned such traditions as the "Friday rush" for 251 seats at sixty cents each, in which process each buyer (to prevent resale) must come into the hall and eat his lunch at the cafeteria.

It is tenacious of its personality, which is hard to describe but easy to recognize, by ear and otherwise. In-



deed, it is so distinct that composer-critic Virgil Thomson was able, fourteen years before the fact, to pick Charles Munch, then in Paris, as a man who certainly would some day lead the BSO. Thomson cannot completely define his conviction; the critical quality in his analysis would seem to be "elegance." His hunch is that the succession next will descend on Herbert von Karajan. But no one need feel hurried: at sixty-four, Munch seems good for most of another pair of decades.

As for the Boston Symphony Orchestra, it seems certainly good for another seventy-five years, at the very least.

First things last!

We freely confess that when we began planning the Tannoy high-fidelity Domestic Sound System, we did not contemplate designing and manufacturing our own phono-cartridge. After all, there were several excellent cartridges already on the market.

We changed our minds when the first power amplifiers and 'Autograph' pre-amplifiers began to emerge from the assembly lines. It was evident that the almost uncanny faithfulness of the amplifying chain, ending with the now world-famous Dual Concentric Speaker, justified the use of a cartridge of more than ordinary 'freedom'.

Our engineers therefore set about the task of designing a cartridge which was free to extract and pass on, *everything* from the recorded groove without any spurious effects or blanketing resonances. The result is the Tannoy Variluctance Cartridge... a precision transducer which would be completely wasted on any but the very finest of high-fidelity reproducing equipment.

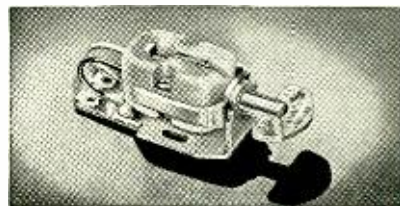

TECHNICAL SPECIFICATION

Every cartridge hand-made and laboratory tested. Upper frequency limit > 16,000 cps.

No resonant peaks.

No undamped resonances in sub-supersonic range. Simple turn-over mechanism.

Stylus assemblies completely independent.

Instantaneous replacement of styli without use of tools.

Optimum lateral to vertical compliance ratio.

Very low effective dynamic mass.

Output: 20 mV at 12 cm per second.

Termination load: 50,000 ohms.

Tracking weight: 6 grams for all discs.

TANNOY VARILUCTANCE
Phono-Cartridge

TANNOY (Canada) LTD. TANNOY (America)
36 Wellington St., East 38 Pearl St.
Toronto 1, Ont., Canada New York, N. Y.

AUDIO FORUM



SIR:

I would like to suggest the following idea for anyone having trouble getting his spouse to allow a large enclosure in the living room.

This baffle gives excellent results, and can be hidden in a corner behind the other furniture. The sound is directed toward the corner and ceiling, before bouncing back into the room. The bass response is the best I have heard, and if there is a loss of highs,

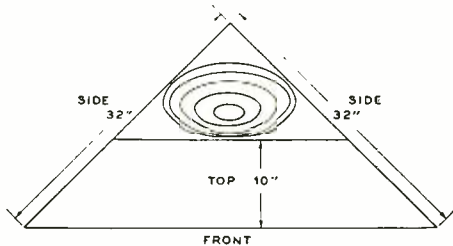
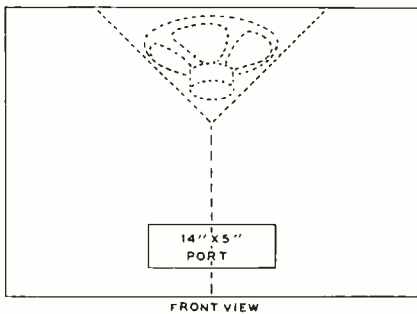
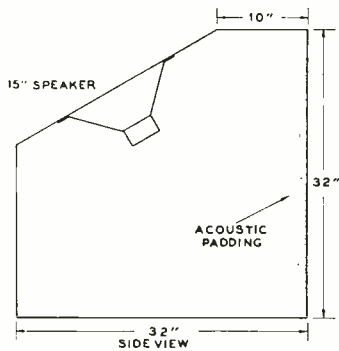

the effect is mellowing and pleasant. The cabinet is made of $\frac{3}{4}$ inch plywood, braced, and screwed and glued together.

Leon Miller
1942 East Walnut Lane
Philadelphia 38, Pa.

True, there will be a loss of highs from an arrangement like this, but as Mr. Miller suggests, this may be a definite advantage when using certain

"bright" speakers in a relatively live listening room.

The port dimensions given will probably require modification to suit the speaker that will be used. It is also suggested that a little more acoustic lining be used than that shown in the diagrams. All the internal surfaces of the enclosure should be padded.

SIR:

About a year ago, I built a six-foot air coupler cabinet for a 12-inch speaker. The room in which the cabinet is placed was once our garage. It has cement-block walls, a concrete floor, and a plastered ceiling. The only window is a very small one located next to the ceiling. The chairs and davenport are made of woven cane with soft seats. There is a fiber rug on the floor, but there are no drapes or anything else of soft material. By the above description of this, is it the best room for the speaker?

Since there is little soft material in the room, would drapes help? If so, where should they be placed?

Preston K. Hayes
524 S. Allen Street
State College, Pa.

Your listening room, as you described it, would be about as far from ideal as it is possible to get. A listening room should have as much thick absorbing materials lining its surfaces as is needed to reduce the sound of a hand clap to a dull smack. If a single hand clap shows any tendency to echo at a particular pitch, or to produce any trace of a buzzing sound, the room needs acoustic treatment.

You should start by putting a heavy carpet on the floor, from wall to wall, with Ozite underlining beneath it. Then hang folded velour drapes along both walls that are adjacent to the speaker. Any further treatment that is needed may be supplied by overstuffed furniture in the room.

SIR:

Will you continue to cater to the man with the 20,000 cps audio system and

Continued on next page

Sign of the Best! . . .

STROMBERG-CARLSON
Custom 400
SPECIALIST

your "one-stop" source
of Hi-Fi supply

 Your Stromberg-Carlson dealer is an expert—fully equipped, ready to demonstrate, suggest and install the exact components you need for a Hi-Fi outfit perfectly fitting your needs. And not the least sign of his dependability is the fact that he sells "Custom 400" equipment—backed by his own guarantee and that of a brand which has been famous in Sound for over sixty years!

Send the coupon below for free literature and the address of your nearest dealer—where you can make one stop and get the best!

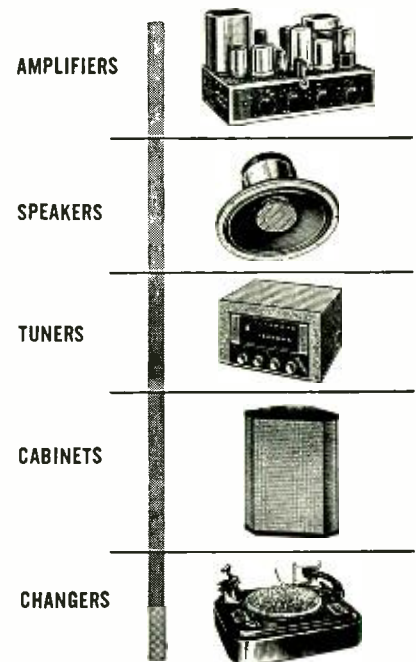

STROMBERG-CARLSON

A Division of General Dynamics Corporation

Special Products Division

1219 Clifford Avenue Rochester 21, N. Y.

Please send me your Hi-Fi literature and the name of my nearest dealer.

NAME.....

ADDRESS.....

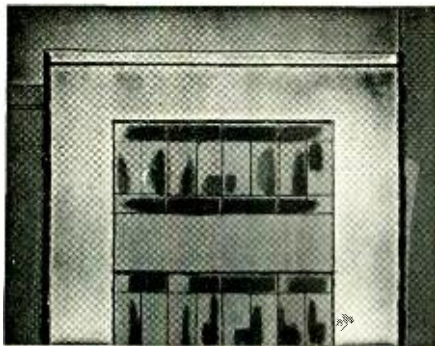

MusiCraft



real
high fidelity
music
made easy —

You no longer need to understand the complications of high fidelity sound systems to have the very finest music in your home. MusiCraft experts will recommend the best combination of components in your price range and demonstrate them in an atmosphere like that of your own living room.

We will handle all or any part of a high fidelity installation . . . from supplying a single component to designing special cabinet work or built-in construction detail. We are also prepared to work with your architect or interior decorator.

MusiCraft

48 East Oak

Chicago 11 • DElaware 7-4150

COMPONENTS AND COMPLETE INSTALLATIONS
IN ALL PRICE RANGES

AUDIO FORUM

Continued from preceding page

10,000 cps ears? Do you still go along with the character who has an oscilloscope tied to his system and who says with pride "Look at that fidelity!"

Us general publicans have made the big discovery; that a clean 8-to-9,000-cycle high and 70-to-80-cycle low response will satisfy those who like *music*, whether they are listeners or performers. This is not meant to include key-janglers, sound effects listeners, or the cat who digs three hours of the Flying Dutchman just to hear the fine reproduction of the splash when Senta jumps into the sea.

If this sounds a little extreme, make this simple test: invite a real musician to your home — one who makes a living at it. Put on any record of the instrument he plays, and ask him to fiddle with the tone controls until it sounds right to him. Then take a look at what he has done. In nine cases out of ten he has cut down most of the highs.

Who says that music can't be taped at $3\frac{3}{4}$ ips? I have a recorder that by actual measurement gives me from 80 to 8,500 cps, give or take 3 db. I have had musicians from the St. Louis Symphony Orchestra record on this machine using a good mike, and have heard them comment that "That's the way it sounds to me." I have had sound engineers from both of the city's hi-fi stations make the same statement — "If I didn't see it ($3\frac{3}{4}$ ips tape) I wouldn't believe it!" One accused me of using a souped-up model, which I wasn't.

The reason for this letter is to ask why people don't know about this. You devote a long article to clean crescendos — can the average music lover tell the difference between a clean and a dirty one? And how is he to find out whether he can or not?

On the strength of what they have heard in my home, over fifty record collectors in this city have abandoned records entirely in favor of tape. The tapes are made from borrowed records, as well as from two FM stations that broadcast good music. None of these people will ever own a record again. Why doesn't everyone know about this? Anyone who thinks that the difference between the 15,000-cycle top of a good record and the 8,500-cycle top of my recorder is detectable

Continued on next page

Keep Your Records Young!

No more brushing, spraying or wiping records

Use the new

DIS-CHARGER



Now 100% better than ever!

Imitated but not duplicated.

This tiny plastic device contains a radioactive material which constantly ionizes the air in its vicinity, drawing off the static electricity generated by your records.

Static electricity causes records to attract and hold dust. Use of the Disc-Charger* eliminates the static electricity and allows the stylus to pick up the dust and clean the record in a few plays. Records now no longer attract dust and stay clean and noise free.

$\frac{1}{2}$ gram — clips to any pickup arm. See your local distributor. **\$4.50** or shipped postpaid, only . . . Each

MERCURY SCIENTIFIC PRODUCTS CORP.

1725 W. 7th ST.

LOS ANGELES 17, CALIF.

*Pat. App. For

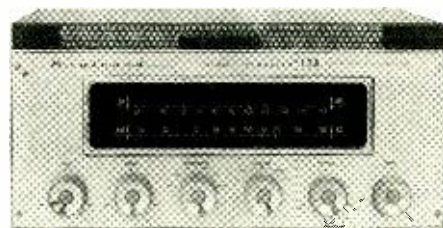
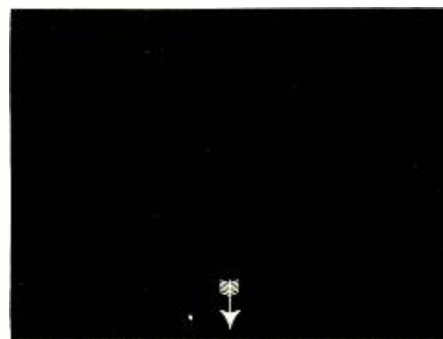

BRAINARD TUNER-AMPLIFIER

Every feature the experts specify, plus the exclusive Brainard Acoustic Balance Control. For complete specifications write to Engineering Department for Catalog H-2.

ELECTRONICS

Brainard

8586 Santa Monica Blvd./Los Angeles 46, California

HIGH FIDELITY MAGAZINE

TRADER'S MARKETPLACE

TAPE RECORDERS, professional quality. Transport, \$175; heads, \$75; amplifier, \$150. Write for specifications. E. J. Lesher, 2730 Heatherway, Ann Arbor, Mich.

FRAZIER-MAY SPEAKER SPECIAL. Blonde Dutchess 8-50, \$115. Special 8-50 Utility Model, \$110. Blonde Dutchess 8-58 (Improved tweeter), \$145. Some with slight surface blemishes. Write for details. Paul A. Schulz, 6630 Del Norte, Dallas, Texas.

RECORD COLLECTORS—Put your name on my list of Rare record catalogs, old phonograph material! George Moran, Lodi, Wisconsin.

6 ELEMENT BROAD BAND FM antennas. All seamless aluminum, \$10.95 ppd. Wholesale Supply Co., Lunenburg, Mass.

KARLSON 15-in. enclosure, custom finished in beautiful knotty pine—worth \$150.00. Sell \$80.00. F.O.B. Windsor. Kendall Jones, Windsor, N. Y.

BOZAK SPEAKER 207A—LIKE NEW. F. E. MARTIN, 200 FIFTH AVENUE, NEW YORK, N. Y.

HI-FI ENTHUSIASTS! Get our terrific low prices before buying any HI-FI, TAPE RECORDER and ELECTRONIC equipment. Rush your list for our low prompt quotations. No obligations. Stan-Burn Radio & Electronic Co., 558-H Coney Island Ave., Brooklyn 18, N. Y.

RECORDS FROM YOUR TAPES—Ideal gifts, perfect money-makers! Hi-Fi reproduction all speeds, any quantity. Musical groups, weddings, speeches, etc. Write for free folder and prices, Recorded Publications Labs., 1560-1572 Pierce Ave., Camden 5, New Jersey.

BERLANT "Concertone" Model 1601 stereo-binaural two channel tape recorder. 7.5-15 ips. Stacked heads. New October '54. Cost \$495, asking \$325. Russell Cowles, 2318 Park Avenue, Minneapolis 4, Minn.

INVENTORY SALE—latest models, leading makes—guaranteed brand new. Send us your list of wanted equipment for price quotations. Monmouth Music House, Box 432, Freehold, N. J.

"THE FABULOUS PHONOGRAPH"

by Roland Gelatt

For the first time—the complete story of the phonograph its invention and development. As one of this country's outstanding music critics, the author has a keen appreciation of the phonograph's aesthetic role—and as a historian he traces the phonograph's development from Thomas Edison's curious tin-foil apparatus to the astounding high fidelity sound systems of today.

Roland Gelatt, New York editor of HIGH FIDELITY Magazine, put years of research into the making of this sensitive authoritative book.

Published by J. B. Lippincott

Send \$4.98 for your copy TODAY.

HIGH FIDELITY Magazine
The Publishing House,
Great Barrington, Mass.

Please send me, by return mail, a copy of "The Fabulous Phonograph." \$4.95 enclosed sorry, no C.O.D.'S.

NAME
ADDRESS

AUDIO FORUM

Continued from preceding page

without an "a-b" comparison is vastly mistaken. You have to listen and listen carefully. And furthermore, in most cases an unbiased audience asked to choose between a recording and a tape without knowing which they are listening to will as likely choose one as the other, and will even more often be unable to detect any difference at all.

And to compare an 8,500-cycle-response with a record that has been played a half dozen times or so; well, there is no comparison!

John Goldston

4421 Westminster Place
St. Louis 8, Mo.

We're afraid you are greatly over-estimating this deception that is being perpetrated upon the high fidelity enthusiast and music lover.

It is quite true that, to a music-lover, the key-janglers, the oscilloscope-watchers, and the noise-record enthusiasts may seem like a thoroughly demented bunch, but you can't criticize

Apologia—

In the December Audio Forum's reply to a radio interference problem from Jorge A. Rodin, M.D., it was suggested that he put a small capacitor of 100 to 500 microfarads value across his pickup cartridge. Anyone who tried this may have wondered why his system ceased to work, but we can explain it on the basis of a typographical error.

The values given should, of course, have been identified as *micro-microfarads*. Our apologies to those readers who were misled.

someone for wanting perfection. Even if his entire spare time is devoted to testing or demonstrating his system, he is still, we would guess, ultimately after the same thing that the musician is supposedly after . . . true high fidelity.

But it is equally evident that, to a listener whose ears are good up to 10 or 11,000 cycles (you'd be surprised how many are), there is a noticeable difference between a clean 8,000-cycle response and a clean 15,000-cycle response, on really good equipment.

Continued on page 137

Grommes

BEST BUY IN HI-FI

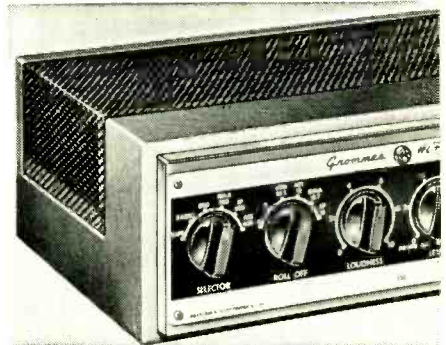

55-C "FLAT SIX" AMPLIFIER

Grommes high-fidelity amplifier. Output: 12 watts. IM distortion less than 1%. Response ± 0.5 DB, 15 to 30,000 CPS. Built-in pre-amplifier with separate roll-off and turnover controls. Loudness control. Calibrated bass and treble controls. Feedback throughout; 4 loops used. \$79.50 net.

Division of Precision Electronics

GROMMES FREE! NEW 1956 CATALOG
9101-HF King Ave. Franklin Park, Ill.

QUALITY SPEAKERS

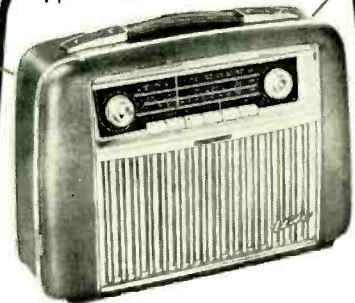

TELEFUNKEN ELITE FM PORTABLE HI-FI SYSTEM

FM, Standard and Short Wave broadcasts . . . plug-in for phono, tape recorder and additional external speaker.

Elite
TELEFUNKEN
HIGH FIDELITY
SYSTEMS

Imported by

AMERICAN Dept. 35
ELITE, INC. 7 Park Avenue
N. Y. 16, N. Y.

Write for details

PROFESSIONAL DIRECTORY

• CALIFORNIA •

HIGH-FIDELITY HOUSE

Most complete stock of Audio components in the West

Phone: RYan 1-8171

536 S. Fair Oaks, Pasadena 1, Calif.

• MASSACHUSETTS •

NEW ENGLANDERS

Your search for a *complete* Custom High Fidelity music system will end with *one* visit to

THE LISTENING POST

161 Newbury Street, Boston
COpley 7-7530

First in Boston to serve the High Fidelity field exclusively.

• PENNSYLVANIA •

DELAWARE VALLEY HDQTRS. FOR RCA HI-FIDELITY

Sets • Components • Color TV Radio • Victrolas • Tape Recorders Records • Cabinets • Kits • Compare all leading makes • Terms • Trade-Ins. • Unlimited Parking. *Mon., Wed., Fri. eves. FREE catalog.*

SHRYOCK HI-FIDELITY CO. EST. 1922
RADIO & TV
BONWIT-TELLER BLDG. Midway 2-1920
WYNNEWOOD, PA. (Philadelphia Suburb)

• NEW JERSEY •

EVERYTHING IN HI-FI SOUND EQUIPMENT

FEATURING  WORLD'S FINEST TAPE RECORDERS

SANTA MONICA SOUND

12436 Santa Monica Blvd.
West Los Angeles 25 GRanite 8-2834

CREATIVE AUDIO

- * Quality Components
- * Custom Cabinetry
- * Professional Installation

Special demonstration facilities. One-year warranty and service on all installations. Open evenings until 10.

214 Glenwood Ave. E. Orange, N. J.
Studio 207 OR 6-5229

in the PHILADELPHIA area

YOUR COMPLETE SUPPLIER is



HIGH FIDELITY & COMMERCIAL SOUND STUDIO

709 Arch St., Philadelphia 6, Pa.
Phone: LOmbard 3-7390

• NEW YORK •

the finest in Hi-Fi
featuring *ElectroVoice*

HIGH FIDELITY COMPONENTS



820 W. Olympic Blvd. • L.A. 15, Calif. • RI 7-0271

AIREX RADIO CORP.

"The Electronics Supermarket"

171 Washington St., N.Y.C. 7 CO 7-5218

SEND FOR OUR FREE HI-FI CATALOG

Includes a full line of hi-fi equipment. Send us your requirements.

In PITTSBURGH and the TRI-STATE AREA

Everything in Hi-Fi

WOLK'S HIGH FIDELITY CENTER
right next to Wolk's Kamera Exchange

306 Diamond Street Pittsburgh (22), Pa.
Express 1-0220

• CANADA •

Since 1944

 **HOLLYWOOD ELECTRONICS**
HI-FI COMPONENTS EXCLUSIVELY
featuring *ElectroVoice*

7460 MELROSE AVENUE
Los Angeles 46, Calif. • WE 3-8208

No lemons here!

CRAIG AUDIO LAB

thoroughly bench tests all units before selling. Lowest net prices. We pay shipping within U.S.A.

12 Vine St. Rochester 7, N. Y.
"a stylus to a Klipschorn"

CANADA'S FIRST HIGH-FIDELITY RADIO, PHONOGRAPH, RECORD AND TELEVISION CENTRE

Stromberg-Carlson "Custom 400" Brociner — Freed-Eisemann — Bogen Fisher Radio — Concertone Tape Recorder All Makes of High Fidelity Records

Custom Sound and Vision Ltd.
390 EGLINTON WEST TORONTO, ONT.
Phone HUdson 9-2117

• ILLINOIS •

CABINET MAKERS

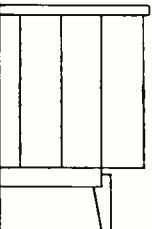

WE SPECIALIZE IN THE DESIGN AND CONSTRUCTION OF FINER FURNITURE FOR HI-FIDELITY

CONTEMPORARY AMERICAN FURNITURE CO.
725 S. LA SALLE ST., CHICAGO
WEbster 9-2888

DON'T EXPERIMENT . . .

CONSULT A SPECIALIST IN **TRUE HIGH FIDELITY**

NEW YORK CITY AREA

Specialist in the best in sound.

BOHN MUSIC SYSTEMS CO.
PL 7-8569 550 Fifth Ave., N. Y. 36

IN CANADA —

There's one place where you can find — and hear — all your high-fidelity equipment needs. We carry a complete stock . . . come in, or write in, for a chat, a look, and a listen.

ELECTRO-VOICE SOUND SYSTEMS

141 Dundas St., West, TORONTO

• OHIO •

EVERYTHING IN HIGH FIDELITY

3 ALLIED HIGH FIDELITY STUDIOS

100 N. Western Ave., Chicago 80, Ill.
HAymarket 1-6800

 2025 W. 95th St., Chicago 43, Ill.
BEverly 8-1067

602 Davis St., Evanston, Ill.
DAvis 8-8822 • SHeldrake 3-6233

IN **CINCINNATI** AND THE **TRI-STATE AREA**

- * COMPETENT ENGINEERING
- * COMPONENTS AT NET PRICES
- * SERVICE ON ALL HI-FI COMPONENTS

Customcrafters, Inc.

2259 Gilbert Ave., CA 1-3153 - Cincinnati 2, Ohio
"A Component or a Complete System"

• GREAT BRITAIN •

BRITISH HI-FI

The widest selection of all top makes of British High Fidelity reproducing equipment available. We ship to any part of the world. Send for Special Export Catalogue.

CLASSIC

ELECTRICAL CO. LTD.
352-364 LOWER ADDISCOMBE ROAD,
CROYDON, SURREY, ENGLAND

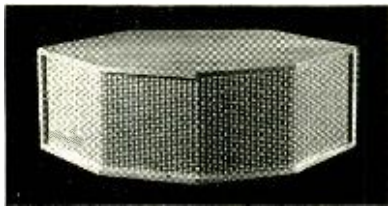

The
**first successful
 electrostatic speaker**

*500 cycles to beyond
 the limit of audibility*

literature on request

JansZen Laboratory inc.

69 Harvey St., Cambridge, Mass.

Phone UNiversity 4-2247

See What's New in
High Fidelity



FREE!

Send for
NEWARK'S 1956 CATALOG

and see the newest developments in
 tuners, amplifiers, tape recorders,
 record changers and speakers. 260
 pages of everything you need in High
 Fidelity, Radio, TV and Electronics.

NEWARK
 ELECTRIC COMPANY

Dept. H-1 223 W. Madison, Chicago 6, Ill.

WEST COAST BRANCH

4736 W. Century Blvd., Inglewood, Calif.

AUDIO FORUM

Continued from page 135

Most of the criticism that musicians direct at high fidelity in general is based on unfamiliarity with it. They listen to a record played on a peaky pickup, feeding through a distorting amplifier, and coming out of a speaker with its high end souped-up with violent peaks, and their first impulse is bound to be to cut down the treble.

It is a known fact that distortion becomes increasingly unpleasant to the ear as the frequency range is extended upward, so where such distortion exists there is bound to be a preference for limited-range response. On the other hand, a speaker that really lets you have it in the "presence range" and then falls off above that is bound to show little or no difference between a really wide-range signal and one that is limited to 8,000 cycles.

We think you will find that your musician friends are directing their criticisms at medium fidelity rather than at high fidelity. A truly smooth, low-distortion, wide-range system has never been criticised by a musician or a music-lover, because it produces a very accurate replica of the real thing, and they certainly have no objections to that. But if you restrict the range of such a system, the immediate reaction is that it becomes dull and lifeless.

You can undoubtedly justify mediocre reproducing equipment on the grounds that it costs less than the finest systems, and for those who can't hear the difference it is plainly a waste of money to buy the best. But the argument that a compromise system is just as good as a top-quality one is, to someone who can hear the difference, simply not valid.

SIR:

I have made a somewhat perplexing discovery, and wonder if there is any significance or explanation.

I am using a GE cartridge and a diamond needle, and I have discovered that as time passes and my needle becomes worn, there is a definite increase in needle talk. When I replace my old needle with a new diamond, the needle talk becomes negligible. As I do not have access to a microscope I cannot tell whether the needle shows wear, but I can tell that both needles

Continued on next page

**NOW ULTIMATE PERFECTION
 IN TONE ARM PERFORMANCE**

Ortho-sonic V/4

TRACKS COURSE OF ORIGINAL RECORDING STYLUS

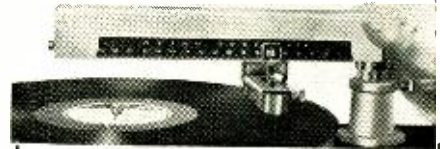

**VITAL ENGINEERING
 PRINCIPLE SOLVED!**

FLAWLESS REPRODUCTION ATTAINED.
 Stylus moves in straight line from edge to center as in original recording.

INSPIRED DESIGN: Increases record life . . . fits smallest cabinet . . . plays all size records . . . **no scratching possible** . . . all popular cartridges fit.

Never before in the history of Hi-Fi development has the introduction of a single component created such wide interest, laboratory and editorial endorsement. Get ORTHO-SONIC V/4 with its 10 incomparable features which eclipse conventional tone arms. **ONLY \$44.50.**

AT BETTER HI-FI DEALERS EVERYWHERE

Write For Illustrated Literature

ORTHO-SONIC INSTRUMENTS, Inc.
 66C Mechanic Street, New Rochelle, N. Y.

**ORDER NOW!
 LOWEST PRICES!**

**DIAMOND
 NEEDLES \$10***

*Our skilled diamond craftsmen convert your present needle to a genuine, unconditionally guaranteed diamond-tipped needle! Send or bring your replaceable needle, check or money order for \$10. Specify either 33 or 78 rpm. If desired, new shaft supplied, \$2.75 additional.



DIAMOND STYLUS CO.

DEPT. HFM
 31 WEST 47 STREET
 N. Y. 36, N. Y.

Listening quality is everything!

Impartial Lab reports on the new Audax Hi-Q7 magnetic cartridge:

A leading recording studio: "Because readings showed an amazing total lack of distortion, check-tests were repeated 3 times."

Consumer sheet:

"Good frequency and transient response. Practically no high frequency distortion. Low intermodulation distortion."

Ideal as these reports are, they belong in the Lab. Listening quality is everything—and the new Audax Hi-Q7 has it to a degree not equalled by any other pickup. *But — HEAR it yourself . . . there is no other way!*



NEW COMPASS-PIVOTED ARM

Universally acknowledged as the most efficient arm—barring none. No restraint. No frontal oscillations. No springs. No fatigue. Highest tracing efficiency. *Equipped for stylus-pressure adjustment . . .* (New adapter makes this superb Audax arm usable with practically all cartridges.)



STYLUS-BALANCE

"the most accurate gauge available for home use . . ." (HIGH FIDELITY Magazine)

With the scales and gauges available heretofore, it has been impossible to check stylus-pressure closer than 2 or 3 grams—that is 50% off-correct. This means deformation of groove-walls, echoes, ghosts and other distortion. Stroboscope-like, STYLUS-BALANCE accurately indicates correctness or incorrectness of stylus-pressure. Precision-calibrated like a pharmacist's balance. Works with any arm or cartridge. Gold Finish. **Net \$4.80** (add 25¢ if shipped from N. Y.)

FREE copy of \$1.00, 22-page, 1956 reference guide, "ELECTRONIC PHONO FACTS" — by Maximilian Weil — at your dealer, or write us.

AUDAK COMPANY

500 Fifth Ave., dept. H, New York 36
Fine audio-electronic apparatus over 30 years

AUDIO FORUM

Continued from preceding page

have been at least eight months old, and am sure they have had more than 1,000 hours' use.

I wonder if anyone on your staff or amongst your correspondents has encountered similar conditions, and I would appreciate your opinion about this matter.

Mary Jane McCloskey
740 ½ E. 14th Apt. 5
Eugene, Ore.

Needle talk is the result of the stylus making poor contact with the groove, and may be expected to increase as the stylus or damping material deteriorates.

Your diamond stylus should be replaced after about 800 plays, since by the time it starts to rattle around in the groove it will have already started to damage the record.

SIR:

I am planning to put together a high fidelity radio, phonograph, and tape recorder installation in my house.

There is one special requirement. I am wondering whether I could successfully use the amplifier as a hearing-aid, by installing a microphone and a set of headphones, and wiring the living room for two or three headphone connections.

What type of microphone and head set would you suggest for this service? Any help would be appreciated.

L. H. Nielsen
26 Broadway
New York 4, N. Y.

If your phono preamplifier unit is equipped to take a microphone input, you could easily undertake to use the system as a hearing-aid.

Plug any high-impedance microphone into the receptacle provided, and use any number of earphones connected across the amplifier's 16-ohm speaker terminals. While using the hearing-aid, you will have to cut out the speaker system to prevent feedback into the microphone, so a double-pole double-throw switch should be connected between the speaker and the amplifier in such a way that when the switch shuts off the speaker, it replaces it with a 25-watt resistor of the same impedance as the speaker.

The headphones should be rated at 600 ohms or more, to prevent additional loading of the amplifier.

When it sounds like this ↓



... instead of this ↓



IT'S TIME FOR

University

The ULTIMATE in Loudspeakers and Systems

Send for Free brochure giving complete details to Desk A6
UNIVERSITY LOUDSPEAKERS, INC., WHITE PLAINS, N. Y.

Do YOU Like To Waste Money?

Can You AFFORD To Throw Money Away??

If not, *there are some things you should know* before buying any piece of high fidelity equipment, regardless of where you plan to purchase.

After three years in the audio field, during which time we have become one of the largest distributors of components in the nation, High-Fidelity House has published Bulletin G.

This bulletin contains some startling information, much of which has never before been put into print. It can help you to prevent costly mistakes and you will find it most fascinating reading. We suggest you write for your copy at once. Bulletin G is absolutely free.

HIGH-FIDELITY HOUSE

Dept. H602

536 South Fair Oaks, Pasadena, California