

Stereo Review

NOVEMBER 1990 ● \$2.50

INCORPORATING HIGH FIDELITY

THREE TOP AUDIO/VIDEO RECEIVERS

SOUND SEPARATES

CAR STEREO OPTIONS FOR 1991

**TEST REPORTS: YAMAHA CD CHANGER,
CARVER TUNER/PREAMP, JBL SPEAKERS,
VELODYNE SUBWOOFER, AND MORE**



06276



PHILIPS
FB1000.
THE
SPEAKER
YOU CAN'T
HEAR.

Philips introduces a four-way loudspeaker system designed to achieve the audiophile's ultimate goal—optimum transparency, with virtually no coloration from the speakers themselves. All you hear is the music. Exactly as recorded.

Years of innovation in speaker technology at Philips have made this breakthrough possible. Our patented Isophase planar ribbon drivers provide exceptionally accurate, low-distortion musical reproduction. Philips' approach to speaker design combines the most advanced proprietary computer techniques with expert listening tests to achieve optimum acoustic tuning. The result is a speaker system that produces what may be the purest, most accurate sound to date.

With the introduction of the FB1000, Philips has created a Reference Series addition to a speaker line destined to set new standards throughout the world. To experience them for yourself, call for your nearest Philips audio dealer at 1-800-223-7772.

WORLD-CLASS TECHNOLOGY. EUROPEAN EXCELLENCE.

© 1990 Philips Consumer Electronics Company, A Division of North American Philips Corporation



PHILIPS

by Rebecca Day and
William Livingstone

MUSIC NOTES

A court in Las Vegas has ruled that the British rock band Judas Priest cannot be held responsible for the deaths of two young men who committed suicide after listening to the heavy-metal group's recording "Stained Class."

... Another heavy-metal group, Deep Purple, which holds the world's record for the loudest concert ever played and has sold more than seventy million albums, is now making its debut on RCA. The band's first studio album in three years, the new release is called "Slaves and Masters." ... Noted Liverpudlian Paul McCartney is collaborating with composer/conductor Carl Davis (known for his scores for silent-film classics) on an orchestral work to be performed next year at celebrations of the 150th anniversary of the Liverpool Philharmonic.

GEORGIA HIGH TECH

Denon Digital Industries, of Madison, Georgia (the U.S. disc-manufacturing arm of Denon's parent company, Nippon Columbia), has provided a \$100,000 research grant to the Georgia Institute of Technology toward the formation of the Telecommunications-Multimedia Initiative. The Initiative is part of a research center at Georgia Tech that will specialize in interactive multimedia technology. Included are such areas as digital signal processing and compression methods, digital data transmission, and copyright/intellectual-property management systems.

AUDIOPHILE REISSUES

Among the LP records most sought by collectors are those in the Mercury Living Presence series recorded with minimal miking on 35mm film during the 1950's and 1960's, featuring such artists as cellist Janos Starker, pianist Byron Janis, and the Detroit Symphony, the Minneapolis Symphony, and the

Eastman-Rochester Orchestra conducted by Paul Paray, Antal Dorati, and Frederick Fennell. Philips has just begun rereleasing the series on midprice compact discs that were meticulously remastered under the supervision of the original producer, Wilma Cozart Fine. The first ten CD's with the artists named above are in stores now.

NIPPER LIVES!

For the first time Nipper, the internationally recognized canine mascot of the RCA brand, will appear live in TV broadcast commercials. Famous for listening to his master's voice on an old phonograph horn, the dog and his junior partner, a little Nipper, will perform this fall in ads for RCA home-theater color tv's and 8mm compact camcorders manufactured and marketed by Thomson Consumer Electronics.

ON THE ROAD

Ninety-six Linear Power Model 5002 power amplifiers are used in the new Carlos Moseley Music Pavilion, a mobile sound system that will travel with the New York Philharmonic Orchestra and the Metropolitan Opera to twenty-four concert sites in the New York City area next spring.

RECORD STORE DIRECTORY

A directory of a thousand specialized record stores carrying used or rare LP's and CD's or special-interest recordings and memorabilia has been compiled by Keith Wharton and is now available by mail order. Eliminating major chains that just stock best sellers, the directory concentrates on stores that specialize in such things as imports, jazz, opera, Elvis memorabilia, bluegrass, laserdiscs, or American Indian recordings. Geographical listings describe the stores in detail, and they are also broken down by format and music category. To order send \$14.95 plus \$2 for postage and handling to Directory of Record and CD Retailers, Power Communication Group, P.O. Box 786, Wharton, NJ 07885. For

credit-card charges to Visa or MasterCard call 1-800-331-6572.

Q-ING UP

PolyGram is the first company to announce plans to release records using QSound mixing technology. According to PolyGram, it will release twenty titles in the next fifteen months using the technology, which is said to deliver three-dimensional audio on conventional two-channel stereo equipment. QSound, which made its television debut in a Coca-Cola commercial aired during the Super Bowl last January, is added during the postproduction phase of recording. Its inventors describe QSound as a phase-shift process that can produce clear, localized sound images between, around, above, and below a pair of speakers without requiring listeners to sit in a strictly defined position.



BROADWAY SHOWS

Although British composers may be dominating Broadway these days, the American musical is not dead. Scheduled fall openings on Broadway include *Shogun*, with music by Paul Chihara, and a new show about the assassination of American presidents (of all things!) by the veteran composer Stephen Sondheim. ... With sales of two million copies, RCA's recording of *Fiddler on the Roof* with the original Broadway cast from 1964 has been certified double Platinum by the RIAA. A new production of *Fiddler* starring Topol is scheduled to open in New York in November.



*W***HAT IT'S LIKE TO WATCH A WESTERN
WITH SANSUI'S NEW SURROUND SOUND AV RECEIVER.**

You won't just watch movies, you'll experience them. That's because the engineers at Sansui have made Dolby Pro-Logic™ Surround Sound an integral part of their new RZ-9500AV receiver. The RZ-9500AV separates the soundtrack into five distinct channels to create sound so real, so astonishingly lifelike, you'll swear you're part of the action. In fact, when the movie's over, don't be surprised if you find hoofprints in your carpet. The Sansui RZ-9500AV receiver. Sight and sound made better.



SANSUI
ENGINEERED TO
FIT YOUR LIFE.

THE SANSUI RZ-9500AV RECEIVER. FIVE AMPS. FRONT, REAR, CENTER. DOLBY PRO-LOGIC. MEMORY LEARNING REMOTE
©1990 Sansui USA Inc., P.O. Box 625, Lyndhurst, NJ 07071 (800) 524-2351 Dolby Surround is a trademark of Dolby Laboratories Licensing Corp.

CIRCLE NO. 99 ON READER SERVICE CARD

Stereo Review

Incorporating High Fidelity®

BULLETIN	1	TECHNICAL TALK	43
LETTERS	8	POPULAR MUSIC	139
NEW PRODUCTS	15	CLASSICAL MUSIC	158
AUDIO Q&A	32	RECORD MAKERS	182
SIGNALS	36	THE HIGH END	184

EQUIPMENT

CAR STEREO		29
Philips DC794 cassette receiver	<i>by Ken C. Pohlmann</i>	
HIRSCH-HOUCK LABS EQUIPMENT TEST REPORTS		47
Yamaha CDC-805 Compact Disc Player, page 47		
JBL XPL140 Speaker System, page 52		
Carver CT-6 Tuner/Preamplifier, page 58		
Velodyne Servo 1200 Powered Subwoofer, page 61		
Phase Technology PC8.5 Speaker System, page 68		
THREE TOP AUDIO/VIDEO RECEIVERS		74
Evaluating the state of the art	<i>by Craig Stark</i>	
SOUND SEPARATES		81
Components for flexibility	<i>by Michael Smolen</i>	
SYSTEMS		86
Do-it-yourself audio	<i>by Rebecca Day</i>	
LOADED		88
Automakers turn up the volume	<i>by Bob Ankosko</i>	
YOU CAN TAKE IT WITH YOU		98
Carrying cases to keep recordings safe and organized		
DISASTER (ALMOST)		101
A fire in the listening room	<i>by Gary Burton</i>	
THE BASICS: ROAD AND TRACK		107
Stereo at home away from home	<i>by Ian G. Masters</i>	



PAGE 74

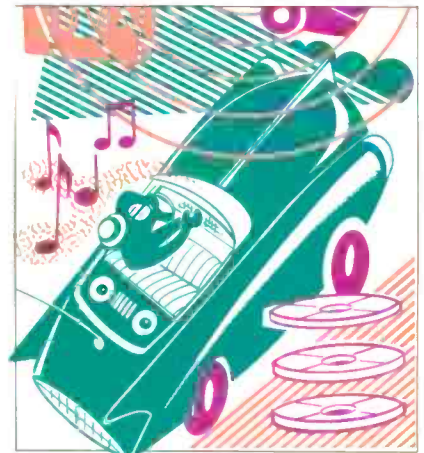

PAGE 107



MUSIC

MIRELLA FRENI		94
"When singing becomes a strain, then I will stop"	<i>by William Livingstone</i>	
BEST RECORDINGS OF THE MONTH		131
Carlene Carter, Ives's Symphony No. 2, Hothouse Flowers, and Mahler's Symphony No. 1		

Cover: The Yamaha CX-2000 preamplifier (see page 81).
Design by Sue Llewellyn, photo by Michael Mazzeo.

COPYRIGHT © 1990 BY DIAMANDIS COMMUNICATIONS INC. All rights reserved. Stereo Review, November 1990, Volume 55, Number 11. Stereo Review (ISSN 0039-1220) is published monthly by Diamandis Communications Inc. at 1633 Broadway, New York, NY 10019; telephone (212) 767-6000. Also publishers of Car Stereo Review, Stereo Buyers' Guide, Compact Disc Buyers' Guide, and Video Buyers' Guide. One-year subscription rate for the United States and its possessions, \$13.94; Canada, \$18.94; all other countries, \$21.94; cash orders only, payable in U.S. currency. Second-class postage paid at New York, NY 10001, and at additional mailing offices. Printed in the U.S.A. Authorized as second-class mail by the Post Office Department, Ottawa, Canada, and for payment of postage in cash. POSTMASTER/SUBSCRIPTION SERVICE: Please send change-of-address forms and all subscription correspondence to Stereo Review, P.O. Box 55627, Boulder, CO 80322-5627. Please allow at least eight weeks for the change of address to become effective. Include both your old and your new address, enclosing, if possible, an address label from a recent issue. If you have a subscription problem, write to the above address or call (800) 876-9011. PERMISSIONS: Material in this publication may not be reproduced in any form without permission. Requests for permission should be directed to: The Editor, Stereo Review, Diamandis Communications Inc., 1633 Broadway, New York, NY 10019. EDITORIAL CONTRIBUTIONS must be accompanied by return postage and will be handled with reasonable care, but the publisher assumes no responsibility for return or safety of unsolicited art, photos, or manuscripts.



HAVE YOU EVER HEARD A SAX ON THE VERGE OF A MELTDOWN?

Have you ever heard sparks fly off the bow of a violin? A brass cymbal shudder with anticipation? Or guitar strings cry out for mercy?

There is so much more in music than most speakers reveal. So much more detail and life.

If you have never heard music with this kind of intimacy before (save for actually hearing it live), we invite you to discover the Infinity Reference Series. A family of speakers created from scratch to reveal all the delicious details of music you've been missing.

Their drivers - hardly off-the-shelf technology - are unlike any you've ever seen or heard: radical new IMG™ (injection-molded polypropylene/graphite) cones that define the lower and middle frequencies with unparalleled linearity and transient response. And our new EMIT-R™, a round-aperture electromagnetic induction tweeter which can deftly reproduce the outermost edges of the harmonic spectrum to achieve ultimate musicality.



Reference Series woofers and midranges feature inverted dust caps which minimize flexing where the voice coil meets the cone. The result: less distortion and improved musicality.

Their elegant cabinetry was sculpted by Infinity's unique understanding of the behavior of sound waves and their impact on the integrity of the sonic image.

Little wonder, you don't just hear a sax on a Reference Series speaker, but all the velvety, throaty, brassy textures enveloping each note. The way the artist performed it. The way the artist intended for you to hear it.

Your entire music collection becomes an invitation to hear all the hidden treasures that have, up to now, gone unnoticed.

For an enthralling preview of the endless rapture to come, visit your Infinity dealer and ask to hear your favorite disc or tape on a new Infinity Reference Series speaker.

And fall passionately in love with your music all over again.

 **Infinity**
We get you back to what it's
all about. Music.





A little Venturi makes a sizeable impression.

Introducing remarkable room-filling sound and Venturi high efficiency in bookshelf size.

The V62 packs a powerful, front-firing "venturi" venting system for greatly enhanced sound pressure and bass output. With the very same quality components and design integrity of Venturi mini towers.

All of which delivers sound performance that clearly rises above in comparisons.

To judge the size of its value yourself, just listen to a little Venturi.

Call us or write:

B-I-C America
895-E, Hampshire Road
Stow, Ohio 44224
Phone: (216) 928-2011



Venturi
Speaker Systems by **B I C** America™

A Complete Sound Deserves A Complete System

HEADLINER™ Classic Audio Accessories



HEADLINER audio accessories add more than elegance to your sound system. They add organization. Use them to customize storage needs, hold cases while music is in play and keep favorite selections close at hand. Only the new HEADLINER series offers all aluminum stands and organizers for CDs, LPs, video/audio cassettes, laser discs and remote control units. Model sizes vary to hold two, six or thirty cases at a time. Available in five rich color treatments.

Allen Products Company 279 South Beverly Drive Suite 1188A Beverly Hills, CA 90212

For more information call toll-free: (800) 729-1251

CIRCLE NO. 50 ON READER SERVICE CARD

Stereo Review

LOUISE BOUNDAS
Editor in Chief

MICHAEL SMOLEN
Executive Editor

SUE LLEWELLYN
Art Director

CHRISTIE BARTER WILLIAM WOLFE
Music Editor Technical Editor

DAVID STEIN
Managing Editor

REBECCA DAY, WILLIAM GOLDMAN

ROBERT ANKOSKO
Senior Editors

MINDY BALL
Associate Art Director

ARINDA J. SEGARRA
MARYANN SALTZER

Assistant Editors

BARBARA AIKEN, ROCCO MATTERA
Editorial Assistants

MICHAEL RIGGS
WILLIAM LIVINGSTONE
Editors at Large

Contributing Editors: Robert Ackart, Chris Albertson, Richard Freed, Phyl Garland, David Hall, Ron Givens, Bryan Harrell (Tokyo), Roy Hemming, Julian Hirsch, Ralph Hodges, Stoddard Lincoln, Ian Masters, Louis Meredith, Alanna Nash, Mark Peel, Henry Pleasants (London), Ken Pohlmann, Parke Puterbaugh, Charles Rodrigues, Eric Salzman, Steve Simels, Craig Stark, David Patrick Stearns

WINSTON A. JOHNSON
Vice President and Publisher

ADVERTISING

Advertising Director: Nick Matarazzo

National Manager: Charles L. P. Watson
(212) 767-6038

Account Manager: Sharon Dube
(212) 767-6037

Corporate Account Manager: Tom McMahon
(212) 767-6025

Assistant to the Publisher: Nadine L. Goody
Classified Advertising: (800) 445-6066

Midwestern Managers: Arnold S. Hoffman,
Jeffrey M. Plaster, (708) 679-1100

Western Managers: Robert Meth,
Paula Mayeri, (213) 739-5130

Tokyo Office: Iwai Trading Co., Ltd.
603 Ginza Sky Heights Building, 18-13,
Ginza 7-Chome, Chuo-Ku, Tokyo, Japan 104
Japan Representative: J. S. Yagi, (03) 545-3908

Production Director: Patti Burns
Production Manager: Michele Lee
Business Services Director: Greg Roperti
Newsstand Sales Director: Margaret Hamilton



STEREO REVIEW is published by Diamandis Communications Inc., a subsidiary of Hachette Publications, Inc.

President & CEO: Peter G. Diamandis
Executive Vice President: Robert F. Spillane
Senior Vice President, Finance, & CFO: Arthur Sukel
Senior Vice President, Manufacturing & Distribution: Murray Romer
Senior Vice President, Operations & Administration: Robert J. Granata
Vice President, Controller: David Pecker
Vice President, General Counsel: Catherine Flickinger
Vice President, Circulation, Leon Rosenfield
Vice President, Communications, Phyllis Crawley Gates
Vice President, Marketing, Anthony F. Incalcaterra
Vice President, Research, Bruce Gershfield

PICTURE THIS ON YOUR TV.

OVER 35 TITLES
INCLUDING:

OPERA

The Barber of Seville*
La Bohème*
Carmen †
Cavalleria Rusticana*
Die Fledermaus*
Madama Butterfly*
The Magic Flute*
Otello*
I Pagliacci*
Rigolero*
Tosca*

Featuring: Carreras, Domingo,
Freni, Levine, Milnes, Mitchell,
Pavarotti, Ramey, Solti, Von
Stade, Stratas and many others.

CELEBRATIONS

Bernstein in Berlin*
"Ode to Freedom"
Beethoven Symphony No. 9*
Carreras, Domingo, Pavarotti,
Mehta in Concert

SOLOISTS/RECITALS

Ivo Pogorelich Piano Recital*
Arthur Rubinstein in Concert*
Horowitz Plays Mozart
(CAMI VIDEO)

DOCUMENTARIES

Leonard Bernstein
West Side Story
with Te Kanawa, Troyanos,
Horne and Carreras*
Karajan In Salzburg
with Norman, Battle, Ramey
and the Vienna Philharmonic
(CAMI VIDEO)
Jessye Norman Sings Carmen
(CAMI VIDEO)

ORCHESTRAL PERFORMANCES

Beethoven Symphonies Nos.
4 & 7 with Carlos Kleiber
and the Concertgebouw*
Mahler Symphony No. 2,
"Resurrection" with Leonard
Bernstein and the London
Symphony*
Vivakli's "The Four Seasons"
with I Musici

VOCAL

An Evening with Kiri Te Kanawa
Homage to Sevilla with
Plácido Domingo

BALLET

Giselle
Featuring Carla Fracci and
Ivan Nagy*
Swan Lake
Featuring Margot Fonteyn
and Rudolf Nureyev*

COMING SOON:

"The Ring" (Book 2/Chereau
Production)
Bejart: Art of the
20th Century Ballet
Herold/Hartel: La Fille Mal
Gardée
Pavarotti & Levine
in Recital at the Met
Lohengrin

The Flying Dutchman and
many other exciting titles.

* PRODUCTION BY UNITEL
† METROPOLITAN OPERA
PRODUCTION
© UNITEL
© 1990 PHILIPS CLASSICS
CAROLIN PHOTO: WENNIG-KLEITZ
METROPOLITAN OPERA



YOUR VCR WILL
NEVER BE THE SAME.



You'll find the most helpful shopping information in the 120 page Crutchfield catalog.

FREE Stereo Catalog

Refer to the Crutchfield catalog before buying your next car stereo, home stereo, or video product:

- 120 pages of helpful articles, consumer tips, charts, and installation guides.
- Color photos, complete descriptions and technical specifications on hundreds of the finest brand name products.

You get more value shopping at Crutchfield:

- Toll-free product advice, ordering, and customer service.
- 24 hour shipping.
- Absolute satisfaction guaranteed.
- Full 30-day return privileges.
- Discount prices on Sony, Pioneer, JVC, Jensen, Proton, Advent, Clarion, Kenwood, AR, Infinity, Bose, and many more!

Call or send this coupon now for your FREE Catalog

800-336-5566

Be sure to mention *Stereo Review* when calling

Name _____

Address _____ Apt. # _____

City _____ State _____ Zip _____

Optional - Are you in the market for:

- PC products fax/copiers
 security products

CRUTCHFIELD

1 Crutchfield Park, Dept. SR, Charlottesville, VA 22906

LETTERS

Sony DAT Deck

In the September test report on the Sony DTC-75ES digital audio tape deck Craig Stark is guilty of one glaring omission: He does not mention that the deck has no microphone inputs.

I recently looked at this machine at our local audio store. I entered the store with checkbook in hand, but the lack of microphone inputs stopped me dead. The next to last paragraph in Mr. Stark's review [about the pleasures of live recording] reflects my sentiments exactly. Why has Sony chosen to downplay the possibilities opened up by DAT for live recording by not including microphone inputs? I realize that one could go through a mixer, but I prefer to do my taping direct from the microphones.

RAYMOND A. BRUBACHER
 Olney, MD

CD Deterioration?

The September letter from Fred McCieniian about compact disc deterioration prompted me to examine my own collection. I have a number of Telarc CD's dating back to 1983-1985, and since the labels are not completely opaque I can hold them up to the light and get a view of the condition of the aluminum layer. All the oldest ones show numerous holes where the light comes through at full brightness, some as large as the head of a pin. On one there are so many it looks as if something had been splashed across a portion of the disc. Several show marks that look like water marks.

My collection is well taken care of, never exposed to extremes of temperature or other abuse. There is no sign of label damage, no cracking or peeling, on any of these discs. I only clean a disc if it really needs it, and then only manually using a soft cotton swab and 99 percent isopropyl alcohol, as advised by Telarc, and never on the label side.

Strangely, though some of the holes appear to be more than large enough to produce audible effects, all of these discs play flawlessly, both on my new Sony ES machine and on my old first-generation player, one of the first available in the U.S. This old player was always touchy about handling flawed discs, so it appears that the visible damage to the aluminum layer may not represent a problem—at least not yet. The question is how much further this kind of deterioration will go and what ultimate effect it will have.

ROY W. HOGUE
 Newbury Park, CA

You're seeing what are known in the trade as "pinholes," which are created during disc manufacture; they are not the result of later deterioration. Some discs have more

pinholes than others. Although a disc with a lot of them may look disturbingly flawed, these tiny imperfections in the reflective layer are easily overcome by the player's error correction and therefore have no effect on sound quality.

Multiroom Installations

I read with interest Julian Hirsch's September column on "Multiroom Installations" because I recently researched the available equipment and its capabilities for my residential installation. I concluded that for any installation catering to more than one user, so-called multiroom systems are not cost effective or flexible enough.

The person who wants to distribute the same music source to multiple rooms can run speaker wires to extension speakers and install local volume controls, as Mr. Hirsch described. Recent products such as wireless UHF-transmitter/infrared-repeater systems (about \$150) allow you to change the program source, operate auxiliary equipment (CD, tape, etc.), and adjust volume without hard-wired remote infrared eyes or remote-control equipment. This type of system can take advantage of existing stereo components and, except for the UHF transmitter, requires no new "multiroom" technology. The problem is that when one person establishes or changes the music type and source, all other persons/rooms are locked into the same choice. This is not particularly useful if you have a Mozart/Mötley Crüe dichotomy in your house.

Multizone systems such as the one based on the Luxman TP-117 preamplifier address part of the problem, but at a fairly high cost (\$1,200 plus the cost of remote eyes, hard wiring, and repeaters). But what happens if, for example, two people want to use the CD player to listen to two different artists? At this point, with a Luxman, Bose, Bang & Olufsen, or any other multiroom system, you will need to buy an extra CD player (or tape player, tuner, etc.). A further complication occurs if a family member wants to hook up his TV or video source to the audio system. Few, if any, of the multiroom systems on the market will allow you to do this from a remote location without the need for additional amplifiers or other equipment. Given these rather typical needs and constraints in a multiuser environment, you would be better off purchasing separate source components for each room or each user.

A parallel example is found in the computer industry. Up until a decade ago, the high cost of large central processor units and auxiliary equipment dictated the establishment of centralized computer facilities. Remote users had to



Sound that astonishes the ear...

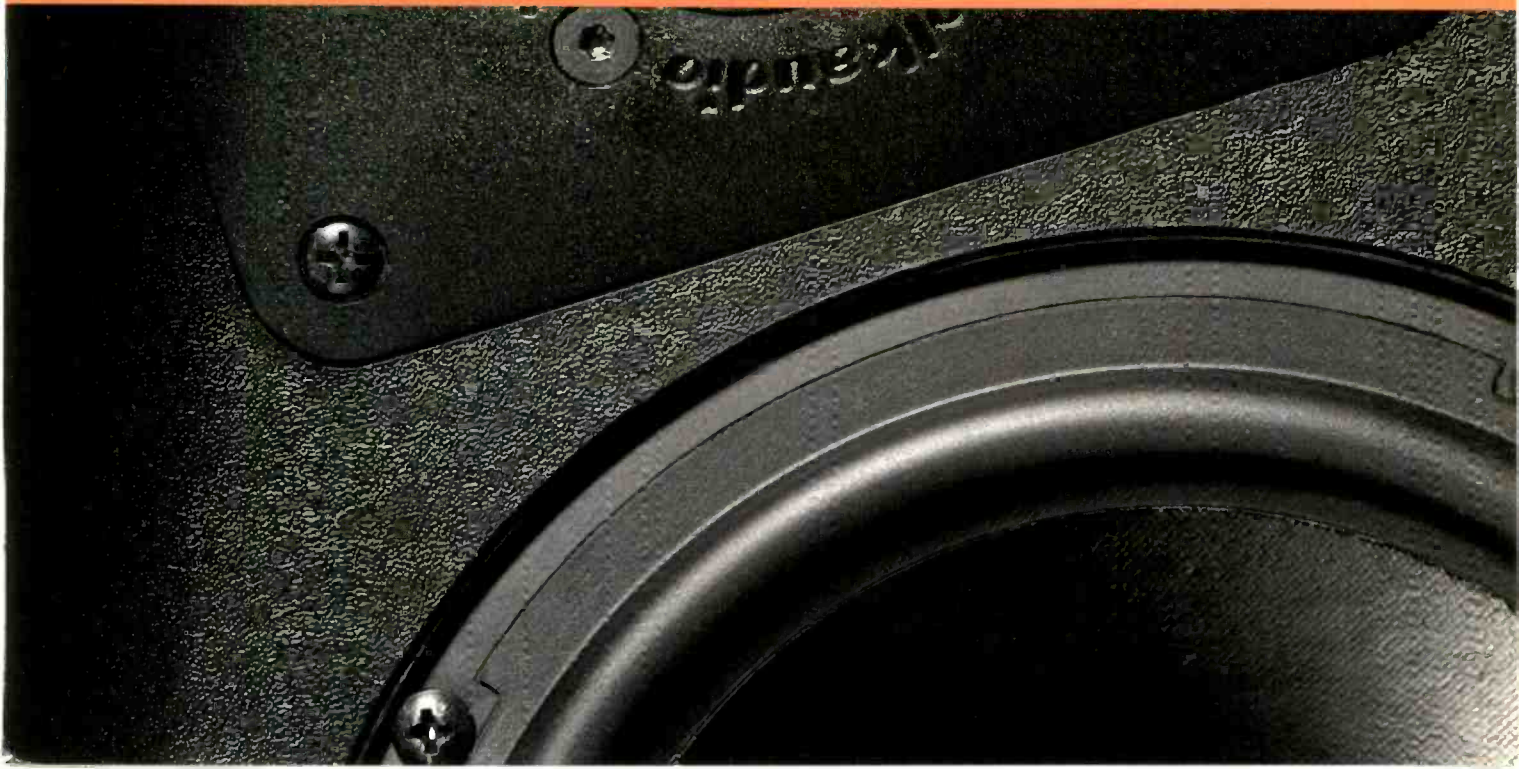

Today's Generation Of Music Lovers

Years ago, it didn't matter what speakers looked like as long as they sounded good. Admittedly, some of the best sounding speakers did not always blend perfectly into everyone's decor.

Today, those of us who consider music an important part of our life and who demand the highest performance possible from our stereo components prefer that our loudspeakers reflect our lifestyle by complementing our taste in home furnishings.

The new RTA 15TL, representing over 18 years of Polk's research and development, is already setting new standards of sonic excellence. And its elegant cabinet is a beautiful visual addition to any environment or listening room.



By using a rare ULV Magnetic Fluid to cool a tweeter's voice coil, both performance and reliability are vastly increased.

Low Viscosity Magnetic Fluid, nearly as thin as water, to cool the SL 3000's voice coil, power handling capacity would increase. Indeed, the SL 3000 tweeter can significantly exceed normal listening levels without loss of performance or reliability.

The Clear Imaging of Polk's Line Source Array

By arranging its four 6 1/2" drivers in a vertical line source along with the SL 3000 tweeter, superior imaging and midrange purity is achieved. This line source technology is the same advanced principal used in Polk's flagship "Signature Reference Series."

By clearly focusing midrange frequencies and avoiding floor and ceiling reflections, Polk's Line Source delivers a wide open, natural sound without tonal coloration. Consequently, the RTA 15TL performs superbly in a wide variety of room sizes and placements.

...from speakers that seduce the

It All Begins With The Remarkable SL 3000 Trilaminare Tweeter

Working with the Johns Hopkins University Center for Non-Destructive Testing, Polk engineers utilized Laser Interferometry to test tweeter designs and materials. They found that ultimately, by vapor-depositing stainless steel and aluminum to a polyamide dome surface, an



extended, very flat frequency response, out to 26 kHz, was achieved.

Polk also discovered that by using a rare Ultra

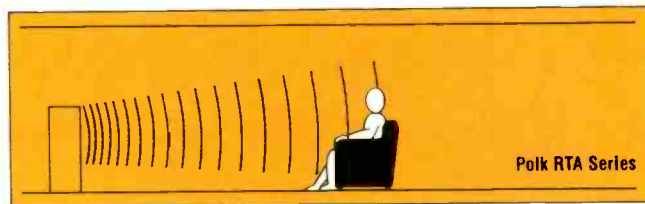

Polk's Line Source Technology reduces floor and ceiling reflections by focusing the vertical dispersion of midrange frequencies.

Controlling Diffraction To Create A Lifelike Stage

The grille of the RTA 15TL has been specially designed to eliminate mid and high frequency diffraction and to actually enhance dispersion. In fact, the RTA 15TL sounds better with the grille on than off.

And to eliminate any possibility of phase anomalies and other colorations, Polk developed a unique "diffraction spoiler" which dramatically improves audible frequency response and imaging.

By controlling diffraction, "smearing" of the sonic image and "peaky" characteristics are eliminated.

Polk Bass: Deep, Powerful & Tight

Two independently tuned, 10 inch bass radiators, one facing front, one facing rear, deliver the impressive bass for which Polk is known. These two radiators move a significant amount of air and at the same time produce a more accurate reproduction of an instrument's timbre and transience than a single conventional woofer. This configuration provides the tight, well defined bass normally associated with small systems combined with the deep, powerful performance found in large systems.

eye.

Listen To The Next Generation Of Loudspeakers

The new RTA 15TL is both a sonic and aesthetic breakthrough. It is also priced to create a new standard in value. Ask for a demonstration at your authorized Polk dealer. You'll hear the detail, depth and excitement of a live performance.

You'll hear...and see... the next generation of loudspeakers.

polk audio

The Speaker Specialist®

5601 Metro Drive, Baltimore, MD 21215 (301)358-3600

CIRCLE NO. 90 ON READER SERVICE CARD



The RTA 15TL is available in natural oak, natural walnut and black oak wood veneer finishes.

Where to buy Polk Speakers? For your nearest dealer, see page 175.

LETTERS

"timeshare" off the main system. Since the advent of inexpensive and powerful micro-sized computers, printers, and storage units, the most cost-effective and flexible approach is to locate that equipment either on the user's desk or as near it as possible and to eliminate the costly interconnecting cables, interfaces, and big mainframes.

I believe the same principle applies to audio/video installations. Audio/video equipment is simultaneously becoming less costly and smaller while its capabilities and performance improve. As with computers, this cost/size/performance trend allows us to have high-quality "personal" stereo systems and "personal" TV's so that we can enjoy our

favorite recordings or programs without imposing those choices on others.

I suppose there are some consumers whose very specialized needs require multiroom systems. I doubt, however, that these systems have any practical application for those of us who don't live in multiroom homes by ourselves.

STUART D. LUM
San Francisco, CA

Julian Hirsch replies: Your points are well taken. Today's multiroom systems are most likely to appeal to people who prefer not to have their rooms' decor "marred" by visible hi-fi components and the wires and cables associated with them. It is possible to assemble separate systems for each room or zone of equal or better quality than that of most of the multiroom systems on the market for no more money—and frequently much less. Although I have no doubt that future multiroom systems will allow greater independence in the program distribution to different zones, this seems likely to be even more costly.

Environmental Awareness

In the August "Bulletin," you note that MB Quart Electronics has discontinued using Brazilian rain-forest wood for its speaker enclosures. The company deserves recognition for choosing to stop using mahogany and associated woods. Unfortunately, however, August "New Products" includes an item on a Museatex Audio speaker shown in its "high-gloss mahogany" finish.

CHARLES J. UNGS
New Hampton, IA

Hard-to-Find Basics

In the pamphlet "The Basic Repertory on Compact Disc," Richard Freed recommends several recordings by Carlos Paita on the Lodia label. I have searched and searched for that label and have not been able to find it sold anywhere. Where might I find these recordings?

GARY ECKHARDT
Cedar Hill, TX

Lodia recordings are distributed in the U.S. by Allegro Imports in Portland, Oregon; call 1-800-288-2007 to order directly. You can also order these or any other recordings listed in the Schwann catalogs from Bose Express Music; call 1-800-233-6357.

Addendum

The speaker stands shown on page 80 in September in the special test report on the Bose Lifestyle Music System should have been identified as Model S-5 stands made by StudioTech, 201 E. Sandpoint, Suite 450, Santa Ana, CA 92707; (714) 540-4947. We regret the omission. □

IN LIFE WE HOPE TO FIND TRUE LOVE AND TRUE SOUND. PHASE LINEAR GRAPHITE GUARANTEES YOU ONE OF THEM.

PLC2525 Component System



PLS1200 12" Subwoofer

PL3690 6" x 9" 3-Way Speaker

Phase Linear® speakers use graphite in a special, patent-pending process developed here in the U.S. by our acoustical engineers.

It adds a faster 'attack' time. An exciting liveliness to the music. With less coloration, less distortion. And one of the highest peak and RMS

power ratings of any speaker available.

With Phase Linear speakers, your car will be flooded with a new, true sound. Will you also find true love? Hey, we only deal with the sound part.



For free information and the name of your nearest dealer, call 1-800-28-GRAPHITE.

phase linear

THE TRUE SOUND OF GRAPHITE™

© 1990 Phase Linear®
is a registered trademark
of International Jensen, Inc.

Anyway you look at it, or listen to it.

Proton's 600 Series Stands Apart.

Sculpted for dramatic impact, and designed for ease of use Proton's 600 Series components fit elegantly into any environment. Seldom used controls are concealed, yet revealed at the touch of a button. Cables, hidden by rear panel covers, disappear into the pedestal of this sleek, free-standing unit.

And naturally, the sound is pure Proton. With high performance technologies like Dynamic Power on Demand™ (DPD), the new Schottz II tuner circuitry and the exclusive Aphex® Aural Exciter™, 600 Series components provide absolute clarity and realistic reproduction for incomparable listening pleasure.

The series includes the AM-656 Integrated Amplifier, the AT-670 Tuner, the AV-646 AM/FM Receiver, the AD-630 Auto Reverse Cassette Deck, the AC-620 Compact Disc Player and the matching AB-600 pedestal. Each component can be controlled with the versatile AH-681 remote, which also controls select Proton video products.

Proton's new 600 Series. A rewarding investment for the discerning listener. From every point of view.



For Product Information



Call 1-800-888-8237

For a free brochure and the Proton retailer nearest you, call (800) 772-0172. In California, (800) 428-1006. Or write to 5630 Cerritos Ave., Cypress, CA. 90630.

PROTON[®]
CLEARLY THE BEST

Aphex and Aural Exciter are trademarks of Aphex Systems Ltd.
600 Series industrial design—Reinhold Weiss Design, Inc., Chicago
CIRCLE NO. 93 ON READER SERVICE CARD

Read your lips.

One sip will

tell it all.

And that's a

promise

not subject

to change.

SMIRNOFF® VODKA 40 & 50% Alc. by Vol., distilled from premium grain. © 1990 Ste. Pierre Smirnoff FLS (Division of Heublein, Inc.) Hartford, CT—Made in U.S.A.

NEW PRODUCTS

SOUNDCRAFTSMEN

The Soundcraftsmen Pro-PT Five-R Preceiver is a combination preamplifier and tuner. Features include feather-touch digital C-MOS (complementary metal-oxide semiconductor) switching; field-effect transistors in the preamplifier; CD/DAT, phono, and audio/video inputs; two tape loops with cross dubbing; and a Spectral Gradient circuit to remove high-frequency harshness from

some CD's. There are two pairs of line outputs for surround-sound or subwoofer/satellite speaker systems. The tuner has sixteen presets and automatic scan. The remote control provides volume adjustment, preset and input selection, muting, and power switching. Price: \$599. Soundcraftsmen, Dept. SR, 2200 S. Ritchey, Santa Ana, CA 92705. *Circle 120 on reader service card*



TDL ELECTRONICS

Despite its small size, the TDL Studio 0.5 transmission-line speaker is said to have a frequency range of 30 to 20,000 Hz. Its long-throw woofer has a 5¼-inch doped-polypropylene cone with a phase plug, a Kapton former, and a vented pole magnet in a cast-alloy chassis. The 1-inch magnesium-alloy suspended-dome tweeter takes over above 3,000 Hz. Nominal impedance is 6 ohms, and sensitivity is rated as 84 dB. The Studio 0.5 can be biwired or biamplified. Dimensions are 26 x 7¼ x 12 inches. The optional spiked stands add 1½ inches to the height. Vinyl finish is simulated black ash. Price: \$995 a pair; stands \$173 a pair. TDL Electronics, Dept. SR, 652 Glenbrook Rd., Stamford, CT 06906. *Circle 123 on reader service card*

THAT'S AMERICA

The Audition Series Type IV and Type II (not shown) audio cassettes from That's America use Prestxide, an extremely fine particle formulation designed to maintain frequency response in high-speed dubbing. Prestxide is said to preserve high frequencies, from 4,000 to 12,500 Hz, while improving low-frequency resolution. The Audition Series features a specially made friction sheet for smooth rotation of tape and hubs to provide stability in portable and car tape players. Prices: Type IV, \$4.38, \$4.93, and \$5.37 in 60-, 90-, and 100-minute lengths; Type II, \$2.91, \$3.15, and \$3.57 in 60, 90, and 100 minutes. That's America, Dept. SR, 1983 Marcus Ave., Suite 201, Lake Success, NY 11042. *Circle 121 on reader service card*



PIONEER

Pioneer's Premier DEH-80 is the first high-power, in-dash car CD player/receiver to have a detachable face. The removable control panel is lightweight and small enough to slip into a coat pocket, and when it is out a blank backing plate shows in the dash. The player has a three-beam laser pickup, a four-times-oversampling digital filter, and a "double floating" suspension system for accurate tracking. Operating features include random play, track scan and search, last-position memory, and repeat. The AM/FM tuner features Pioneer's Supertuner III technology and twenty-four presets. Rated output is 25 watts into two channels. Price: \$540. Pioneer Electronics, Dept. SR, 2265 E. 220th St., P.O. Box 1720, Long Beach, CA 90801-1720. *Circle 122 on reader service card*



NEW PRODUCTS



REALISTIC

The Realistic MD-1000 is Radio Shack's first combination CD/laserdisc player. It plays 8- and 12-inch videodiscs, CD's, CD-V's, and 3-inch CD singles. The audio portion uses a four-times-oversampling digital filter and a 16-bit digital-to-analog converter. Signal-to-noise ratio is rated as 92 dB for audio and 47 dB for

video. The MD-1000 has programming, intro-scan, random-play, repeat, and still-frame functions and a headphone jack with volume control. It comes with a remote control. Price: \$499.95. Radio Shack, Dept. SR, 1700 One Tandy Center, Fort Worth, TX 76102.

Circle 124 on reader service card



KOSS

The Koss Pro/4XL Stereophone uses titanium-coated diaphragms that are said to enhance detail and clarity in the middle to high frequencies. According to Koss, the Pro/XL's copper-clad aluminum voice coil reduces moving mass for improved high-frequency response and lower distortion, and the circumaural earcushion creates a tight seal for extended bass response and isolation from outside noise. The headband is adjustable, and the earcups pivot for comfort. Frequency response is rated as 10 to 25,000 Hz. The Pro/4XL carries Koss's lifetime warranty. Price: \$129.99. Koss Corp., Dept. SR, 4129 N. Port Washington Ave., Milwaukee, WI 53212.

Circle 125 on reader service card

ACOUSTIC RESEARCH

Previously sold only in Europe, the Acoustic Research IMS 660 three-piece speaker system is now available in the U.S. Dual 6-inch drivers operate in a push-pull configuration in the bass module, and each acoustic-suspension satellite houses a 4-inch woofer and 3/4-inch tweeter. Overall frequency response is rated as 55 to 25,000 Hz - 3 dB. Nominal impedance is 4 ohms. Power handling is rated as 75 watts and sensitivity as 85 dB. The subwoofer's dimensions are 8 1/2 x 12 x 1 inches; the satellites are each 7 3/4 x 4 3/4 x 4 3/4 inches. All three pieces have a scratch-resistant, textured black finish. Price: \$500. Acoustic Research, Dept. SR, 330 Turnpike St., Canton, MA 02021.

Circle 126 on reader service card

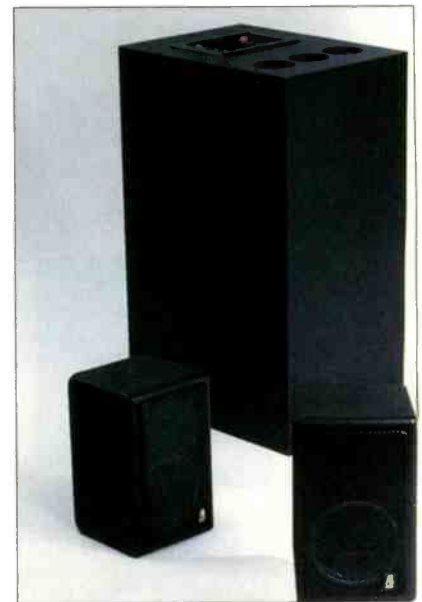

NUMARK

Numark's dual-transport CD6020 CD player enables users to load and program two CD's for uninterrupted listening. Each transport has an independent digital readout, start-stop buttons, skip and search controls, and memory functions. Users can program as many as eight tracks per disc in any order. An Integrate feature enables tracks on different discs to follow each other with no pause in between. The rack-mountable player uses an eight-times-oversampling, 18-bit digital filter. Price: \$1,995. Numark Electronics, Dept. SR, 503 Newfield Ave., Edison, NJ 08818.

Circle 127 on reader service card



PROFESSIONAL POWER CONTROL

One of the few things that audio experts will usually agree upon, is that most of the World's Finest Power Amps are MADE IN THE U.S. But there are very few amp manufacturers who make amps reliable and powerful enough for sound reinforcement AND good-sounding enough to be exciting for hifi use. Soundcraftsmen has done it! Here's what db Magazine (The Recording Studio Magazine) had to say about one of our amps:

"...extensive listening to the Soundcraftsmen revealed that this amplifier would be as 'at home' in the most discriminating audiophile's listening room as it would in a demanding sound reinforcement environment."



PRO-PT 5R
Pre-ceiver



WHY BUY HIGH POWER? SIMPLE...BECAUSE IT MAKES QUALITY SPEAKERS COME ALIVE. As a reader of this magazine, you're more aware of fine audio than the average listener. You know that most of the better brands of speakers are a bit lower in efficiency than average. If you don't have enough power, the music sounds lifeless and constricted. In his lab, the engineer who designs high-quality speakers typically uses a MINIMUM of 200 watts of power per channel. He gets wonderful dynamic range. But when someone spends the money for quality speakers and then buys a receiver, that speaker's dynamic excitement, and much of the musicality, is lost. **QUALITY SPEAKERS SOUND BETTER WITH HIGH POWER!**

We created the Pro-PT 5R (pictured here), so that you have "user friendly" access to our High-Power Professional Amps. (They're usually hooked up to mega-button professional sound consoles.) The PT 5R is a remote controlled Preamp/Tuner that has all the features you'd expect from a receiver, plus you have access to REAL POWER! When you visit one of our dealers (listed below) you'll recognize the Soundcraftsmen products easily. Our products look like serious, professional gear...because that's exactly what they are. With Soundcraftsmen, there's no fake frills, just smooth, continuous, clean, musical POWER.

FOR A DEMONSTRATION, VISIT NEAREST DEALER LISTED BELOW

However, many additional Dealers - too numerous to list here - are located throughout the U.S. with many models on display. If no dealer is shown near you, or you encounter any difficulty please phone us at 714/556-6191, ask for our "Dealer Locator Operator" | ARKANSAS Jonesboro THE SOUND CENTER | NO. CALIFORNIA Berkeley UNGLE RALPH'S AUDIO Chico G&G STEREO Sacramento TURNTABLES UNLIMITED | SO. CALIFORNIA Cerritos FEDCO Costa Mesa ATLANTIC STEREO, FEDCO Glendale CAPTAIN VIDEO Hollywood AUDIO-VIDEO SOLUTIONS Los Angeles FEDCO Montebello AUDIO-VIDEO SOLUTIONS, SML, INC. Monterey Park AUDIO VIDEO INTERIOR DESIGN Newport Beach ATLANTIC STEREO Ontario FEDCO Orange FIDELITY SOUND Pasadena FEDCO San Bernardino FEDCO San Diego FEDCO Santa Ana FIDELITY SOUND Van Nuys FEDCO Whittier HI FI HAVEN | CONNECTICUT Greenwich FAIRFIELD AUDIO VIDEO New Haven AUDIO ETC | FLORIDA Fort Lauderdale SPEAKER WAREHOUSE Hialeah SPEAKER WAREHOUSE Hollywood SPEAKER WAREHOUSE Miami, South AUDIO PLUS, ELECTRO SOUND, PARS ELECTRONICS Orlando SOUND EFFECTS West Palm Beach SOUND SHACK | GEORGIA Atlanta ATLANTA SOUND WORKS | HAWAII Hilo YAFL SO T.V. APPLICATION Honolulu BOSE ENTERTAINMENT CENTER, VIDEO LIFE | IDAHO Idaho Falls PHASE 4 STEREO | ILLINOIS Burbank POLK BROS. CHICAGO MARTROY ELECTRONICS, MIDWEST STEREO, MUSICRAFT, POLK BROTHERS Cottage Grove, POLK BROS. Elgin, POLK BROS. Evergreen Park MUSICRAFT Gurnee OPUS EQUIPMENT Homewood MUSICRAFT Melrose Park, POLK BROS. Jacksonville FRONT ROW RECORDS Morton Grove MUSICRAFT Naperville, POLK BROS. Oak Park MUSICRAFT Palatine MUSICRAFT Peoria ELECTRONICS DIVERSIFIED Springfield REEL TO REAL DESIGNS Villa Park MUSICRAFT INDIANA Michigan City AUDIO CONNECTION New Haven HJS SOUND West Lafayette VON'S ELECTRONICS | KANSAS Overland Park AUDIO ELECTRONICS | KENTUCKY Louisville HI-FIDELITY, INC. | LOUISIANA New Orleans TULANE PRO AUDIO | MAINE Ellsworth Falls ELLSWORTH AUDIO | MARYLAND Frederick THE ELECTRONIC SHOP Gaithersburg AUDIO BUYS | MASSACHUSETTS Boston HIGH STYLUS Fall River IMAGES SIGHT & SOUND Littleton E.E.B. ENT./RADIO SHACK | MISSOURI Independence INDEPENDENCE AUDIO | MISSISSIPPI Tupelo MAP ELECTRONICS | NEW JERSEY THE WIZ STORES Bourdubrook PRANZATELLI'S STEREO Kinnelon SOUND CITY Newark MEG RADIO CORP. New Brunswick BARRACKS TRADING POST Trenton BARRACKS TRADING POST Wildwood SEASHORE STEREO | NEW YORK THE WIZ STORES Bronx VICMARR STEREO Brooklyn CENTRAL AUDIO, MAGNA ELECTRONICS Glen Cove ISLAND AUDIO New York City STEREO PLAZA, VICMARR STEREO, CANAL HI FI, U.S.A. ELECTRONICS Syracuse SUPERIOR SOUND | NORTH CAROLINA Charlotte SOUND AUDIO Raleigh CREATIVE ACOUSTICS Shelby SOUND ADVICE Wilmington JUST CD'S | OHIO Cleveland DESERT-AUDIO Columbus AUDIO EXCHANGE Defiance ZELLER'S SOUND STORE Lima HART AUDIO Wooster S&W TELEVISION | OKLAHOMA Oklahoma City JOHNSON TV & SOUND | PENNSYLVANIA Erie HOUSE OF RECORDS McKeesport HI FI CENTER, THE RECORD WAREHOUSE Philadelphia SOUND SERVICE Reading, Shillington PHOENIX HI FI Stroudsburg, Wilkes-Barre & W. Hazleton STROUD'S Pittsburgh AUDIO JUNCTION Willow Grove SOUNDEX PUERTO RICO Sanurce R.F. ELECTRONICS | SOUTH CAROLINA Greenville DON JONES STEREO | TEXAS Arlington SOUND IDEA Austin MUSICAL DIFFERENCE Dallas/Catrolton VERY SERIOUS TOYS El Paso CASA SONIDO Lake Jackson RCS Laredo JETT SALES Mesquite VIDEO ACCESSORIES PLUS Midland FOLGERS San Antonio THE SOUND IDEA | VIRGIN ISLANDS St. Thomas, U.S. and British Virgin Islands ELECTRONICS UNLIMITED | VIRGINIA Great Falls STARSHIP AUDIO | WASHINGTON Longview LOOKOUT ELECTRONICS Yakima STEREO FIRST BY BEMIS | WISCONSIN Appleton AMERICAN TV Glendale SOUNDSTAGE Madison AMERICAN TV Manitowoc M & A ELECTRONICS Monroe FUZZY'S AUDIO Waukesha AMERICAN TV



PCR800
Power Amp



PRO-PA 2X200
Power Amp



PRO-POWER FOUR
Power Amp

FREE! SYSTEM ANALYSIS KIT ON COMPACT DISC OR LP

Using only your ears and this Soundcraftsmen test kit, you can plot the frequency response of your system in your own listening room! FOR YOUR FREE TEST KIT: 1. Contact us (see below). 2. Fill out the Card we send and have an Authorized Dealer stamp it. 3. Return the Card to us. To receive a 16-page Color Brochure and the "\$19.00 Value Analysis Kit" Card, Call, Write, Fax or use the Reader Service Card.

Soundcraftsmen

2200 S. RITCHEY, SANTA ANA, CA 92705 PHONE 714-556-6191 FAX 714-662-0750
CIRCLE NO. 108 ON READER SERVICE CARD

Made
in the
U.S.A.

Learn to play Bach

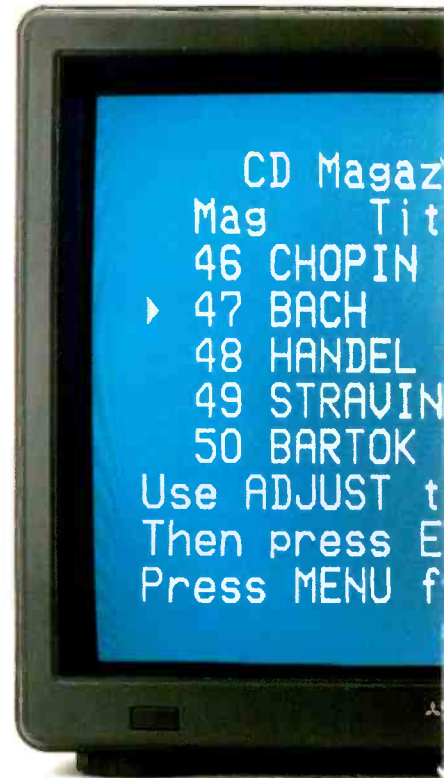
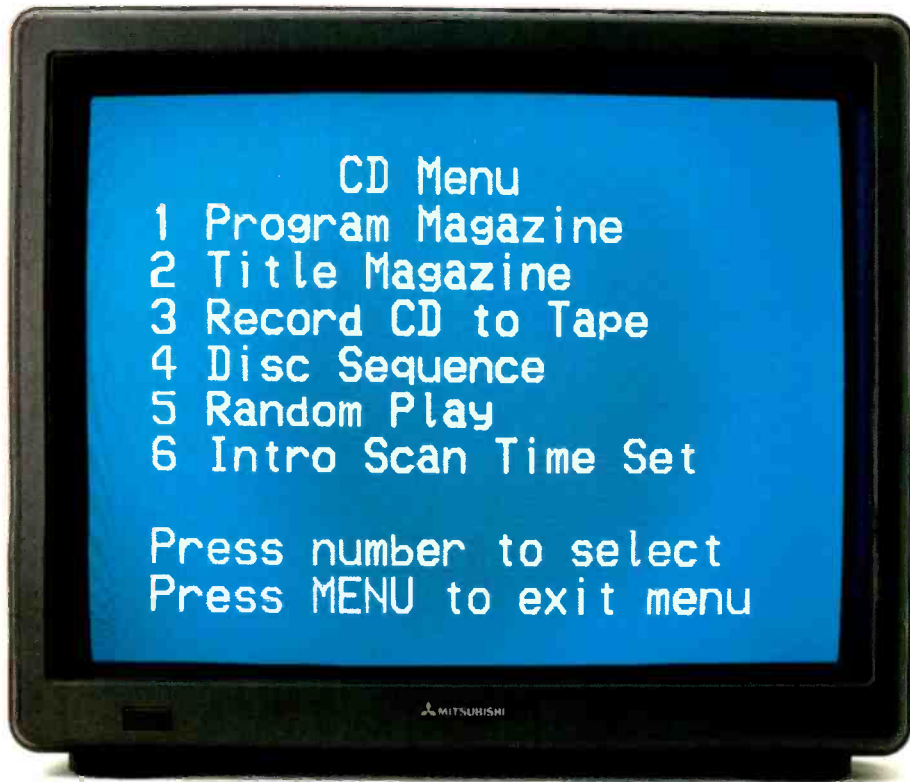

It may have taken a musical genius to write the *Tocatta and Fugue in D Minor*, but it shouldn't take a technical genius to play it.

Or at least, that's the thinking behind the Mitsubishi M-C6010, the world's first CD changer with on-screen commands.

The way we see it, you shouldn't have to spend the best years of your life figuring out how to work your audio equipment. So we've put the directions right on the TV screen in

front of you, in the form of menus that lead you through every function, step by step. And confirm what you're doing while you're doing it. There are menus that cover all the usual functions, like programming discs and recording them to tape.

And then there are menus for things that aren't usual at all. For instance, imagine being able to customize your CD library according



The M-C6010 CD changer.



The M-R8010 Home Theater receiver.

in three easy steps.



to category. You name each magazine, and the next time you insert it into the changer, your title — “Sixties Classics” or “Elevator Greats” — will appear on the screen. Or if you feel like browsing, you can call up the names of every magazine in your library with a quick flick of the remote control.

As a piece of video equipment, our CD changer is pretty impressive. But we could hardly expect you to buy it on looks alone, so we gave it all the technology any right-minded audiophile would insist on. Dual 18-bit linear D/A converters. 8-times oversampling during the filtering process. And digital de-emphasis, a special circuit for accurate playback of the

high frequencies present on compact discs.

Of course, the best way to get the most out of all this technology is to make it part of a Mitsubishi Home Theater System, so your audio and video components can work together as a cohesive unit. Everything in the system — from our big screen TVs and VCRs to our CD changer and Home Theater receiver — operates the same way and can be controlled by a single learning remote.

With all of this in mind, picking out your next CD changer should be as easy as playing “Chopsticks.”

 **MITSUBISHI**
TECHNICALLY, ANYTHING IS POSSIBLE®

NEW PRODUCTS



TERK TECHNOLOGIES

Terk Technologies' Ampstands combine integrated amplifiers with speaker stands for use with a Master Controller (not shown) in Terk's Leapfrog wireless multiroom audio system. Encoded stereo audio signals are sent from a master controller through a home's AC wiring to Ampstands in a remote room. The Ampstands decode the signals and drive a pair of ordinary speakers. They can also drive headphones, and separate inputs and outputs enable them to operate inde-

pendently of the main system. An infra-red sensor allows the main system's remote control to operate from the remote location. Ampstands are available in 30- and 60-watt-per-channel versions. Price: \$450 a pair for the 30-watt version, \$550 a pair for the 60-watt set. There are two Master Controller models, the MC 1000 (\$180) and the MC 4000 (\$260). Terk Technologies, Dept. SR, 233-8 Robbins Lane, Syosset, NY 11791.

Circle 128 on reader service card

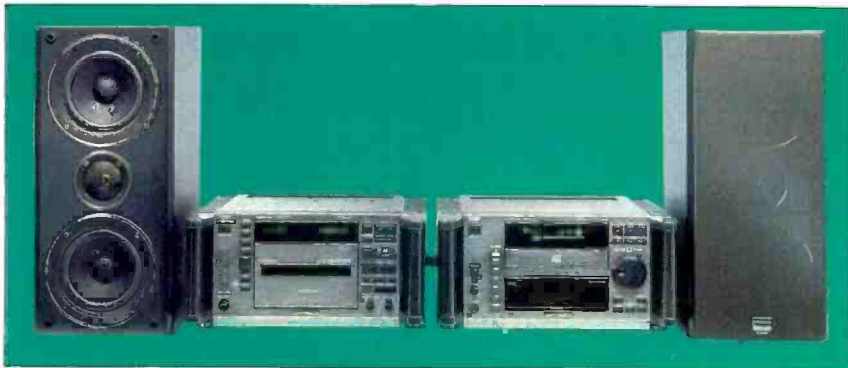

OPTONICA

The Optonica CD-U10 from Sharp is a bookshelf-size stereo system equipped for four-channel surround sound with the addition of rear speakers. One chassis includes an AM/FM tuner and an auto-reverse dual cassette deck. The other chassis holds the amplifier section and a quadruple-oversampling CD player with dual digital-to-analog converters. The front-channel amplifier is rated for 22 watts per channel rms into 6 ohms, and the rear-channel amp is rated for 3 watts per channel into 8 ohms. There are seven

selectable ambience modes as well as decoding for Dolby Surround and a bass-extension circuit. The built-in timer can also be used as an alarm clock or tape counter. The shielded two-way 6-ohm speakers each have two 4 $\frac{3}{4}$ -inch woofers and a 2-inch tweeter. Their dimensions are 7 $\frac{1}{2}$ x 16 $\frac{5}{16}$ x 13 $\frac{1}{16}$ inches, and frequency response is rated as 40 to 20,000 Hz. Price: \$1,500. Sharp Electronics, Dept. SR, Sharp Plaza, Mahwah, NJ 07430.

Circle 129 on reader service card

RADIO PARTNERS

The Radio Partners Custom Earset consists of two Sony MDR 414 earbud headphones molded into vinyl earpieces custom fitted to impressions of a user's ears so as to direct sound into the ears instead of allowing as much as 30 percent of it to escape. The earpieces won't fall out, the company says, during running or exercising. They are available in red, yellow, blue, or clear. Price: \$69, including an ear-impression kit and a mailer. Radio Partners, 132 W. 21st St., New York, NY 10011.

Circle 130 on reader service card



MAGNAVOX

The Model MRB200 receiver is part of the new Magnavox line of audio/video components. The amplifier section is rated to deliver 100 watts rms per channel into 8 ohms from 20 to 20,000 Hz with no more than 0.09 percent total harmonic distortion. Features include a five-band equalizer with tone defeat, matrix surround sound, direct-access tuning, a motorized volume control, and inputs for phono, CD, monitor, tape, and two VCR's. It comes with a thirty-six-button remote control that can also control Magnavox TV sets. Magnavox, Dept. SR, One Philips Dr., P.O. Box 14810, Knoxville, TN 37914.

Circle 131 on reader service card



Pioneer introduces Home Theater without the usual paperwork.



 **PIONEER**[®]
The Art of Entertainment

Home Theater for the '90s



Who can forget their first glimpse of a sizzling red sports car flashing down the highway? Or the experience of a full-blown surround sound system in their favorite movie palace? Road rockets that top \$100,000 are truly for the lucky few. Fortunately, the dramatic impact of a roaring Star Wars spaceship can be enjoyed by almost every enthusiast in their very own cutting-edge home theater—without having to break the bank, tap into a home equity loan or get an advanced degree in electrical engineering. Let Pioneer show you the way...

Some think if they turn up the volume on their old 19-inch TV sets, they can re-create the incredible experience of a Steven Spielberg or George Lucas epic. That's truly science fiction. The reality is even better. The Home Theater components of 1990

can magically transport you light years ahead of your current equipment's capabilities—and at a reasonable price. Many people have the mistaken impression that they have to toss out all of their equipment and spend \$50,000 for a great home theater experience. However, all that is really required is a love of music, movies and

concerts. A few key components will do the rest.

Affordable Family Entertainment

Pioneer's goal is a simple one—to maximize your audio/video experience within the confines of your budget. Pioneer wants to rock your walls, shake your chandeliers

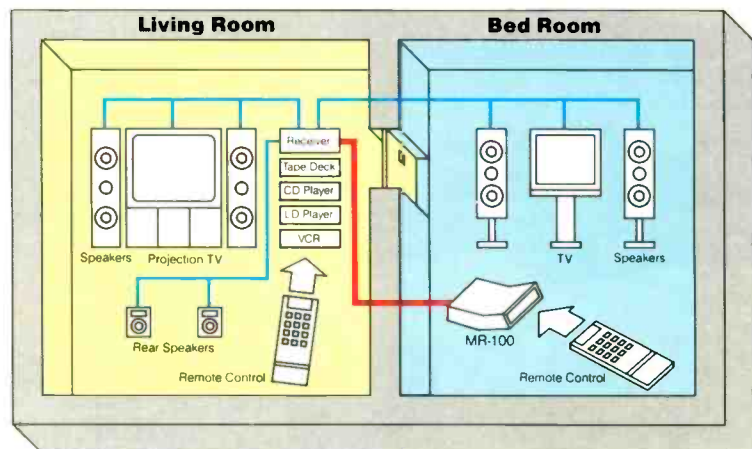

High-powered multi-room home entertainment from Pioneer.

(without bothering the neighbors!) and deliver a Home Theater experience that will keep you and your family riveted with outstanding entertainment. Although Pioneer equipment is eminently suited for the media rooms of the rich and famous and is used by custom installers everywhere, the company knows most consumers can't spend lavishly on a \$10,000 CD player or mono block amplifiers.

"For a relatively small investment, families can get close to experiencing a Madonna concert or a Hollywood blockbuster in their homes," said Mike Fidler, Pioneer's senior vice president of home entertainment. "Today's affordable technology can re-create those experiences in your living room," Mr. Fidler added. "Millions can now enjoy movies with Dolby Surround soundtracks, superior Laser Disc video quality, dramatic big screen TV performance and crystal clear digital sound."

Best In Sight And Sound

Although price increases have impacted many products, quality home entertainment equipment continues to be a Best Buy. Pioneer now has a combination CD-Laser Disc player priced under \$500 (the CLD-980). This new model is really two super-charged components in one as it can play 3- or 5-inch compact discs as well as 8- and 12-inch Laser Discs. The ubiquitous VCR still has its place in a Home Theater sys-



Pioneer CLD-980

tem, especially for taping TV shows. But with over 5,000 laser titles now available, LD's unsurpassed picture and sound quality, and the popularity of the compact disc, the '90s are quickly becoming the Decade of the Disc.

Pioneer, an unquestioned leader in projection television, continues to improve home video quality. The latest models offer brightness and resolution levels that were unheard of just a few years ago. Images are much more life-like, with radiant colors that put ordinary TV sets to shame. Complementing excellent picture performance are advances that make the 40-, 45- and 50-inch PTVs truly state of the art. And anyone cramped for space will be impressed with how much quality Pioneer engineers designed into TVs with attractive cabinets that take up very little floor space.

Power At Your Fingertips

Although audio and video components are key concerns, the heart of the new Home Theater of the '90s is the A/V receiver. A/V receivers not only tie your entire collection of compo-

nents into one powerful command center, they have built-in decoders so you can experience Dolby Surround sound effects at home. Simply add a pair of speakers in the back of the room, connect them to the VSX-9700S, play a Laser Disc, and you and your family will be approaching Home Entertainment Heaven. And with its multi-room capability, superb A/V quality can be enjoyed throughout the house.

"All of this technology is easy to use, cutting edge and affordable," remarked Mr. Fidler. "And you can upgrade step-by-step, using components that are part of your current system." Pioneer has introduced a Home Theater without the usual paperwork. Get ready to experience the best in sight and sound in your own livingroom.

Pioneer SD-P4543K



AV Receivers

A/V receivers have come a long way. From low-powered components with a few sets of audio and video inputs, 1990 models can control the most advanced home theater systems—or the most basic. Not only can they accommodate almost any equipment config-

Dolby Stereo has been thrilling moviegoers for over 15 years. With the Dolby system, four channels of sound are compressed onto a film soundtrack—front left/right, center and surround. In order to re-create the dramatic impact of the flashing "Top

ceiling while the spoken word comes from the TV screen. In fact, Pioneer was the first company to design advanced Dolby Pro Logic circuitry into their A/V receivers (the VSX-9300S) in 1988. Today, Pioneer is a leader in the field and has four



Pioneer VSX-9700S

uration with power to spare—TVs, VCRs, tape decks, CD/Laser Disc players—advanced receivers offer multi-room, multi-source capability so you can control your system anywhere in the house. And to transport you and your family to different worlds (thanks to Hollywood hits), top A/V receivers incorporate Dolby Surround decoders and amplifiers.

"In order to truly bring the movie theater experience home, a receiver with built-in Dolby Surround is an absolute must," said Mike Fidler. "Almost every top Hollywood film has a Dolby Stereo soundtrack. The sound effects can come to life in your livingroom simply by using an A/V receiver and two pairs of speakers."

Gun" F-14s at the home in the early '80s, you needed a separate Dolby Stereo decoder/amplifier that was more suited for a rocket scientist than a movie lover. Manufacturers such as Pioneer then designed powerful receivers that incorporated Dolby Stereo decoders and enough amplification to power all of the speakers required for a top-notch home theater.

Hollywood's Finest

The first A/V receivers with Dolby used the passive matrix system that created a "phantom" center dialog channel. With an active matrix system—Dolby Pro Logic—the sound effects are more accurately placed in your livingroom. Rumbling boulders and roaring jets soar across the

A/V receivers with Dolby Pro Logic and four with Dolby Surround at prices that fit every budget and system.

To see what the new generation of receivers can do, look at the new VSX-9700S. It delivers 125 watts to the front channels, 40 watts to the rear speakers and 40 to the center dialog channel. Simply hook up the speakers and you're ready to sit back and enjoy the best Hollywood has to offer.

Pioneer A/V receivers also bring multi-room capability to your home theater system. By adding optional MR-100 or MR-101 remote control adaptors, you'll be able to listen to the FM tuner, play a cassette or watch a movie in rooms other than your media center. The only limit is your imagination.

CD/CDV/LD Players

\$100,000 sports cars need supercharged engines... the Home Theaters of the '90s are no different. Just as you wouldn't put a four cylinder engine into a Ferrari (12 is more like it), hooking poor quality video and audio

combination player is the hottest component in consumer electronics.

"In one supercharged

You can now buy a CD/LD player for just a bit more than a quality CD player. Pioneer's new CLD-980 (\$500 list) not only can play any size disc, it has audio and video per-



Pioneer CLD-3080

sources to high-powered receivers and big-screen televisions makes even less sense. Today—and for years to come—CD digital audio is the standard for superior sound. And for the ultimate in quality video, the Laser Disc player simply has no equal.

Combine CD and Laser Disc capability in a single component, and you'll understand why the

machine, you can play any size disc—ranging from 3-inch CD singles, to 5-inch CDs, up to 12-inch laser discs with the latest Hollywood favorites," said Mike Fidler.

Pioneer has almost single-handedly kept the 10-year-old laser video format alive under the onslaught of the VCR revolution. And while the VCR has its place in a home theater for taping TV shows, many consumers now know that the Laser Disc delivers a picture 60 percent better than VHS. Combine this excellent picture with digital sound and you'll understand why operas and rock concerts are among the most popular Laser Discs sold today. Laser enthusiasts have over 5,000 titles to choose from—many at \$24.98 suggested retail.

formance that was wishful thinking a few years ago.

Moving up in price improves audio and video parameters while increasing programming flexibility. Pioneer's new CLD-2080 (\$850) and CLD-3080 (\$1,400) take convenience a step further by automatically playing both sides of a disc. The CLD-3080 even incorporates pro-level Digital Time Base Corrector circuits to eliminate jitter. And by using a 20-bit digital filter with 8x oversampling, its digital audio quality matches the world-class picture.

Today—and for years to come—there is no debate: The combination CD/Laser Disc player is the centerpiece for the High Quality Home Theater of the '90s.



Projection TVs

Impact. It can be the crashing sound of a sonic boom or the overwhelming images projected in a movie theater. Pioneer big-screen projection TVs are on the cutting edge of video and audio quality for today's home theaters—like yours. Any thoughts of holding out until High Definition TV (HDTV) reaches stores later in the decade will vanish once you see Pioneer's latest 40-, 45- or 50-inch monitor/receivers in action.

Two key criteria for top-quality rear projection sets are brightness and resolution. When a TV picture gets larger, it tends to dim, making the brightness level (measured in foot lamberts) critical for optimum viewing under different light conditions. The higher the rating, the better. Resolution determines the amount of detail you will see on a single scanning line (measured in horizontal and vertical lines). Again, the higher the number, the finer the picture you will see. For example, the new 1990 Pioneer 40-inch projection

monitor receiver (SD-P404K) has a brightness rating of 550 foot lamberts and horizontal resolution of 720 lines. Resolution jumps to 750 lines with the 45-inch SD-P454-K which has a 460 foot-lambert brightness level. The top-of-the-line SD-P5047-Q—with an impressive 50-inch screen—has a brightness rating of 400 foot lamberts and super-sharp horizontal resolution of

800 lines. These specifications equal a picture that comes close to the goal of true-to-life video in your home, making the investment in a Pioneer projection TV pay off in years of state-of-the-art viewing.

While maximum A/V quality and conveniences were key Pioneer projection TV goals, so were cabinet design and overall size. Not everyone has an infinite amount of space for a rear projection TV and their growing home theater. For these consumers, Pioneer introduced the Slim Design Cabinet concept. This attractive shape (in black or oak) is less than 30 inches deep—even with our largest 50-inch set.

The impact of Pioneer big-screen TVs is dramatic. It is the difference between the *best* and second place... a difference you will see every time you turn on your set.



Pioneer SD-P5047-Q

Pioneer SD-P4543K



Speakers

Pioneer *knows* speakers. As one of the world's largest and oldest manufacturers of loudspeakers, Pioneer understands just how important this often overlooked component can be to your growing home theater system.

"Upgrading your system with a new TV, combination player and an advanced A/V receiver is terrific," remarked Mike Fidler. "Not spending the same amount of attention to your speakers—whether you use two, five, or more—is like listening to a concert with ear muffs on."

Pioneer has won plaudits for its world-class TAD (Technical Audio Devices) studio monitor speakers. That same professional engineering know-how can be enjoyed in your home with the internationally-designed and American-built S-T series. The highly efficient loudspeaker systems of the S-T500, S-T300 and S-T100 can reproduce a wide frequency range, from booming basses to the highest highs. The latest advances in space-age driver materials, cabinet design and crossover technology combine to produce loudspeakers that deliver exceptionally accurate response. Our least expensive S-T edition (S-T100) has a frequency response of 30-40,000 Hz—and can fit almost anywhere.



Dolby Stereo is actually four channels of information encoded onto a film soundtrack (front left and right, dialog or center, surround). While the S-T Series are

As if five speakers weren't enough, some Home Theater enthusiasts want to add more booming bass to the experience. For them, nothing less than a powered subwoofer that shakes the floor will do.

Pioneer S-T500



Pioneer CS-X5Q



excellent building blocks for a home theater system, additional *smaller* speakers are required for the full Dolby Surround effect. With the decoding and amplification provided by a Dolby Surround A/V receiver, a pair of our CS-X5Q speakers will be more than adequate for the rear channels. If you decide to buy an A/V receiver with Dolby Pro Logic, another CS-X5Q would be appropriate as well for the center or dialog channel.

Pioneer S-W1000



The Pioneer S-W1000 will make you feel as though boulders were rumbling through your livingroom, chasing after you and Indiana Jones!

Pioneer has the speakers you need, with superior sonic quality and prices that won't break the bank.

All Together Now

As we stated at the outset, turning your living room into a sophisticated Home Theater does not require a degree in electrical engineering or a magic touch on Wall Street. You can build your system component by component at the pace and price of your choosing. And although you can continue to use some of your old equipment—even from different makers—after a quick walk through your dealer's showroom to see real-life demonstrations of what we've just described, you'll only need to know one brand when you shop—Pioneer.

Pioneer is a leader in those key components required to dramatically alter the way you watch movies and listen to music. And Pioneer is *the* name to know with combination compact disc and Laser Disc players. Pioneer has maintained its high quality standards while lowering the cost for the high-powered machines. For a price just a bit more than a quality CD

player, you now can get a component that delivers superb digital sound *and* laser video—the best prerecorded video medium available.

Performance Leaders

Once you've added a high-powered source component, upgrading your playback equipment can be next. Pioneer 1990 Slim Design cabinets let almost everyone enjoy a big-screen TV in their home—no matter how limited their space. Picture quality and brightness levels are dazzling. Add advanced audio capabilities, built-in amplification, and extensive hook-up capability and you'll understand why Pioneer is the performance leader in big-screen projection monitor receivers.

Pioneer also leads the way in variety, technology and price with the heart of the new Home Theater—the A/V receiver. Pioneer was the first to incorporate Dolby Pro Logic into this key component and now has a full lineup of

A/V receivers with Dolby decoding capability—including our top-of-the-line VSX-D1S with built-in Dolby Pro Logic *and* Digital Signal Processing, another industry first. Couple all of these advanced and reasonably priced components with cutting edge loudspeaker systems and you'll be able to surround yourself with vivid sound. In fact, Pioneer is one of the oldest and largest manufacturers of speakers in the world. Add optional multi-room, multi-source capability and you'll know why Pioneer and Home Theater are now synonymous.

You don't have to change your financial lifestyle to have a Pioneer Home Theater but there is no doubt you and your family will be changed. Movies enjoyed in your living room will look and sound as good as they do at your favorite cinema. And music will feel like you're front row center at a jamming concert. That's why it can be said: Pioneer is The Art of Entertainment.



The Art of Entertainment

PIONEER ELECTRONICS (USA) INC.
P.O. Box 1540, Long Beach, California 90801

"Dolby," "Dolby Surround" and "Pro-Logic" are trademarks of Dolby Laboratories Licensing Corporation

"Non-Switching" is a trademark of Pioneer Electronic Corporation.

Chick Corea Electric Band · Belinda Carlisle · La Bohème
Aerosmith—Things that go Pump · Jody Watley
© Pioneer Artists. All Rights Reserved

The Enforcer: ©1950 Republic Pictures Corporation. All rights reserved. **Night of the Demons**: ©1987 Halloween Partners, Ltd. All rights reserved.
It's A Wonderful Life: ©Republic Pictures Corporation. **Driving Miss Daisy**: ©1990 Warner Home Video Inc. **Superman Movie**: ©1990 Warner Home Video Inc.
Born on the 4th of July: ©1989 Universal City Studios, Inc. All rights reserved. **Field of Dreams**: ©1989 Universal City Studios, Inc. All rights reserved.
Little Mermaid: ©The Walt Disney Company.

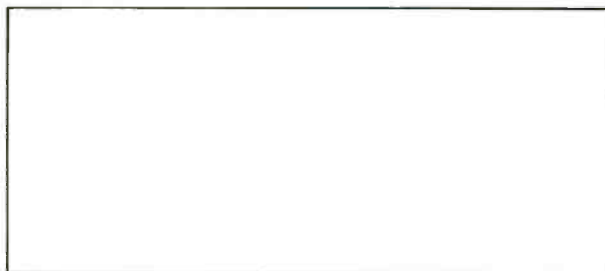

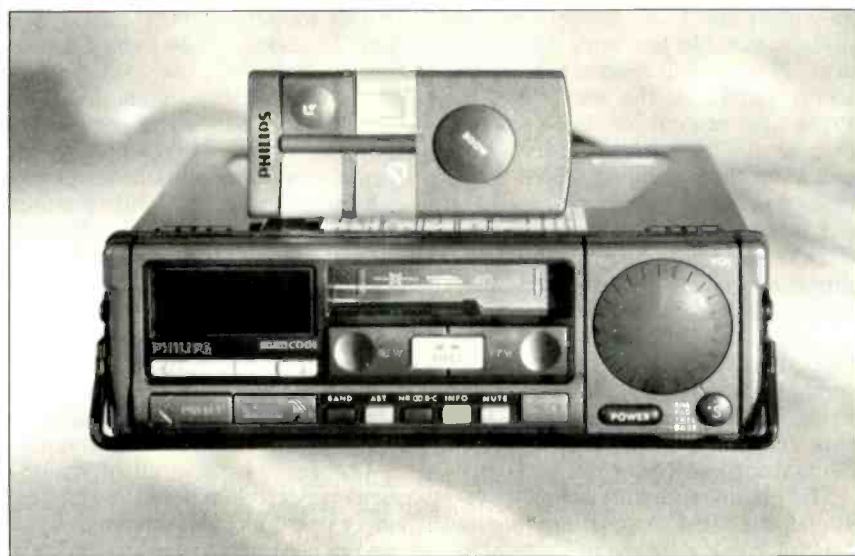

PHILIPS DC794 CASSETTE RECEIVER

by Ken C. Pohlmann, Hammer Laboratories

THE Philips DC794 is a cassette receiver head unit, a product category that's the bread and butter of the car audio industry. One look at its front panel, however, tells you that this isn't your typical head unit. Its styling is strictly European, and it comes with features and accessories not found on any other cassette receiver.

There is a power button to turn the unit on and off (unusual in a head unit), yet it is the large rotary volume control that catches your eye first. It's a continuous control without end stops; its setting is relative instead of absolute. That's because the knob also serves as controller for four other functions beside volume: balance, fader, treble, and bass. To change the function, you hit the select (S) button, then spin the rotary controller. The LCD readout uses abbreviations such as BA (bass) and FA (fader) to show which function is selected as well as numerals to show settings. The selector knob automatically reverts to a volume control after a few seconds. A minor irritation: After you change the control function, it takes a second or two before the setting comes up on the

display, which makes settings difficult to check. This control method takes a little getting used to, but it's still pretty nifty.

To the left, a pair of search buttons are used to scan (up or down) through a band and find stations. The search occurs on three sensitivity levels. The tuner looks for strong stations first, then steps up to higher sensitivities to find weaker stations. Pressing the buttons simultaneously engages the manual tuning mode, and you can step through a band in 50-kHz steps for FM and 1-kHz steps in AM. The small FM steps (half the size of those used by most tuners) allow for more precise tuning, but you pay the price in slower tuning speed, even when the buttons are held down for continuous scanning.

Three large buttons just below the cassette loading slot control tape functions; they are not operable in the tuner mode. A row of smaller buttons provides a variety of functions. The band button switches the tuner between FM, LW (long-wave), MW (medium-wave), and SW (short-wave). Only the FM and MW (AM) bands are useful in the States; you'll have to wait until you're motoring through Europe to try the others.

Unlike models that use a bank of preset buttons, the DC794 has only two, which step up or down between the presets. You can store eight FM and eight AM frequencies.

The AST button provides an auto-store function. Hold it down, and the tuner automatically finds the eight strongest stations in the band and locks them into eight AST presets. If an AST preset duplicates another preset station, you can find a new AST preset by stepping to the unwanted preset and holding the AST button; a new station is entered.

A DOLBY button is used to select Dolby B, Dolby C, or no noise reduction. An INFO button allows travelers in Austria, Germany, and Switzerland to hear traffic information (another good reason to take your car with you next time you go to Europe). A MUTE button attenuates the audio output when you're answering important phone calls or explaining things to state troopers. Finally, the MODE button is used to switch between tuner and autoreverse tape playback. The LCD window gives comprehensive status information, and controls are back-lit for easy night visibility.

Buried deep inside the DC794 is a security-code circuit. A unique factory code number is contained in every unit's memory. Once it is activated, each time an incorrect code number is entered, the wait until a new code can be tried is doubled from 1 minute to 2, from 2 to 4, and so on up to 32 minutes.

The DC794 slips into a mounting sleeve that attaches to the dashboard. Three mounting jacks and two antenna jacks connect it to the sleeve, and it is easily removable for security. The unit also comes with hardware for permanent dashboard mounting with the handle removed. In this case, a pair of wire handles are used to extract it for servicing, and a second front bezel is provided. Alternatively, the sleeve can be omitted entirely.

The DC794 contains a diversity-tuning circuit to help compensate for reception problems. It uses two antennas to derive four input tuning signals. A sensor automatically (and inaudibly) switches between the four input signals to maintain the highest possible reception quality.

DAVID KELLEY

CAR STEREO

Although the diversity system works with any types of antennas, in most cases the standard car antenna is used along with the Ea6701 active aerial supplied with the DC794.

Installation

Installation of the DC794 proceeded without incident. As with most removable head units, it was easy to position the mounting sleeve in the dashboard, bend a few tabs, and secure the rear mounting bolt. Electrical installation was similarly typical. Philips provides separate jacks and sockets for all types of wiring harnesses. Depending on your chosen configuration, either two or four speakers can be connected. For our test, we installed the unit in its removable chassis and connected it to outboard Eclipse power amplifiers, which in turn were connected to four Nakamichi speakers.

Although a line output is buried alongside the connectors on the rear of the head unit, Philips does not supply a connector for it. To use our external power amplifiers we had to solder pigtailed to these pins and terminate them in phono jacks. A connector or, better yet, attached phono jacks would have been nice. There is also no line input provided, but a variety of supplied hardware pieces do ease installation and permit extensive customization.

Road Tests

On the road, I required a few minutes to acclimate myself to the European ways of the DC794, but I soon found the controls easy to use. In particular, I liked the big rotary volume knob; it spins easily with one finger, allowing quick volume changes. It's slightly harder to adjust balance, fader, treble, and bass, but I rarely change those parameters anyway once they're set. I do have a minor ergonomic complaint: The removable handle protrudes from the front panel even in its rest position, making it somewhat awkward to use the lowest row of buttons, especially the select button.

On the way to my tuner torture site, I tried a few cassette tapes. I was immediately won over by the DC794's automatic equalization setting. That's one of my least favorite chores (narrowly edged out by lawn

mowing), and I was happy to have the machine do the work for me. I also liked the music-search function and in particular the way it works: Press the rewind or fast-forward buttons once for music search and twice for fast winding. That sure beats a separate button.

I was also satisfied with the tape deck's sound quality. Wow-and-flutter as well as noise seemed minimal, but I was able to detect frequency-response differences between tape directions. I played with the wired remote control but soon laid it aside. Although many people like this convenience feature, I prefer using front-panel controls.

Our tuner tests start on Key Biscayne and wind through downtown Miami. Weak stations can be hard to receive, and strong stations with their nearby antenna masts can overload a tuner's front end. The potential for multipath is rampant. I felt the DC794 did a reasonable job of coping with these adversities. Reception of strong stations was very good, and there was no hint of overload. Fidelity was generally good, and multipath was under control

thanks to the diversity tuning system. It seemed, however, that the tuner's sensitivity was on the low side—weak stations sometimes had a hard time cutting through. This may have been aggravated by extreme weather conditions (a typically bombastic South Florida thunderstorm). The various tuner features such as AST worked flawlessly, and I regretted not having the opportunity to try some of the Europe-only features. Specifically, when I got caught in an accident-related traffic jam on the drive home, I wished I were on the Autobahn and able to use the traffic-information channel.

The DC794 offers all of the features expected from a high-end head unit as well as such advanced technology as diversity tuning and conveniences like remote control. And its extensive collection of installation hardware insures that it can be completely integrated with your car and optimized for it. In short, although it was designed for European roadways, this unit seems very much at home on American thoroughfares.

Circle 139 on reader service card

LABORATORY MEASUREMENTS

Tuner Section (all figures for FM only except frequency response)

Usable sensitivity (mono, 75-ohm input): 23.1 dBf

50-dB quieting sensitivity (75-ohm input): mono, 30.2 dBf

Harmonic distortion (THD + noise at 65 dBf): mono, 1.68%; stereo, 1.70%

Signal-to-noise ratio (65 dBf): mono, 44.5 dB; stereo, 43.6 dB

Channel separation (1,000 Hz, 65 dBf): 19.5 dB

AM rejection: (65 dBf): 57.1 dB

Capture ratio (65 dBf): 2.9 dB

Selectivity: adjacent-channel, 13.7 dB; alternate-channel, 72.3 dB

Image rejection: 75.0 dB

Frequency response (referred to 1,000 Hz): FM, 30 to 15,000 Hz +0.0, -2.6 dB; AM, 30 to 3,000 Hz +1.7, -11.9 dB

Maximum output voltage (100% modulation): 1.6 volts

Tape Section (standard IEC test tapes)

Frequency response (31.5 to 18,000 Hz, 70- μ s EQ): forward, +6.0, -6.2 dB; reverse, +1.3, -5.3 dB

Frequency response (31.5 to 18,000 Hz, 120- μ s EQ): forward, +1.7, -5.4 dB; reverse, +0.7, -6.1 dB

Signal-to-noise ratio (A-weighted, 250-nwb/m level, 315 Hz, decibels):

	70 μ s	120 μ s
Dolby B	52.5	51.5
Dolby C	53.3	53.5
No NR	49.3	50.2

Flutter: J1S-weighted rms, 0.09%; IEC/DIN-weighted peak, 0.20%

Speed accuracy: -1.3%

Crosstalk (1,000 Hz): 44.5 dB

Channel separation (1,000 Hz): 39.2 dB

Fast-forward/rewind time (C-60): 105 seconds

Amplifier Section

Signal-to-noise ratio (A-weighted, referred to 1 watt): 65.4 dB

Harmonic distortion (THD + N) at 1 watt into 4 ohms: 0.88%

Damping factor: 20

Power output at clipping (four channels): 1.5 watts per channel into 8 ohms, 2.8 watts per channel into 4 ohms

Tone-control range: 100 Hz, +12.9, -11.1 dB; 10,000 Hz, \pm 9.9 dB

WHAT SETS OUR CAR CD APART FROM THE COMPETITION.



ACTUALLY, OUR TOUGHEST COMPETITION DOESN'T COME FROM ANOTHER COMPANY. IT COMES FROM THE ENTERPRISING YOUNG MEN YOU SEE PICTURED HERE. BUT AFTER WATCHING THESE GUYS DEFACE AND MAKE OFF WITH CAR STEREOS FOR SO MANY YEARS, PIONEER DEvised A BRILLIANT IDEA. INTRODUCING DETACHABLE FACE SECURITY™ AND IT COMES IN THE INCOMPARABLE FORM OF CAR CD. THE FACE AND ACCOMPANYING CARRYING CASE ARE COMPACT, FITTING EASILY IN YOUR POCKET. AND THE SYSTEM FEATURES BUILT-IN HIGH POWER. AS WELL AS SUPERTUNER® III™ FOR EXCEPTIONALLY CLEAR FM RECEPTION. SO BEFORE THE COMPETITION RIPS YOUR FACE OFF, GIVE US A CALL. AT 1-800-421-1404. AND THEN RIP IT OFF YOURSELF.

 **PIONEER**
The Art of Entertainment

CAMBRIDGE
SOUNDWORKS



"Henry Kloss brought Dolby sound, CrO cassette tape, and large-screen projection television into living rooms, and made the dominant speaker systems of three decades. Now he's at it again at Cambridge SoundWorks, selling direct to the public."

Inc. Magazine

FREE Audio Catalog

At Cambridge SoundWorks we manufacture speakers and music systems designed by Henry Kloss (founder of AR, KLH & Advent), and we sell them from our factory in Newton, Mass. We also sell carefully selected audio components from brands like Philips, Pioneer and Denon. Because we sell factory-direct, you can save hundreds of dollars on components and systems. We sell nothing but "the good stuff." Our knowledgeable audio experts will help you make the right choices, without being pushy. And you can call toll-free for advice, to order or for "hook-up help" 365 days a year. This is the simplest way to get the right deal on stereo components...and there's no risk.

- Call toll-free for factory-direct savings.
- UPS delivers right to your front door.
- Audio Experts will answer all your questions, before and after you buy.
- 30-day money-back guarantee.

To get the right deal on the right stereo, mail the coupon or call

1-800-AKA-HIFI

24 hours a day, 365 days a year (1-800-252-4434)

Name

Address

City

State Zip

**CAMBRIDGE
SOUNDWORKS**

154 California St., Suite 102N, Newton MA 02158
* In Canada call 1-800-525-4434. Fax: 617-332-9229
Outside U.S. or Canada 617-332-5936

AR & Advent are trademarks of International Jensen, Inc. AR & Advent are not associated with Cambridge SoundWorks.

CIRCLE NO. 118 ON READER SERVICE CARD

AUDIO Q&A

by Ian G. Masters



Encoded Surround

Q In July, you said that Dolby Surround recordings were specially encoded, but I understood that the surround channel merely extracts the electrical difference between the left and right channels—the out-of-phase material—and that the center channel is simply the combination of left and right. So wouldn't any stereo recording work in a surround system?

PAUL GANI
Baltimore, MD

A Yes it would, to some degree. Every stereo recording contains some out-of-phase material (live recordings are loaded with it), which decodes very well, and solo instruments or voices do tend to come out of the center-channel speaker. But these effects are accidental and vary from recording to recording. A Dolby Surround encoded recording, on the other hand, contains ambience material and center-channel material (most of the dialogue, for example) that has been added intentionally in amounts designed to produce a particular effect. The technique is common in video soundtracks and is beginning to show up on audio-only recordings as well.

By the way, thinking of the center and surround channels as simple sum and difference signals doesn't convey the precision of the technique. For example, with proper decoding the center-channel signal consists only of information that has the same phase and amplitude in the two encoded stereo channels. Ideally, all of this information is reproduced through the center channel and none of it through the left and right channels.

Subwoofer Hookup

Q I am adding a powered subwoofer to my system, but because my main amplifier doesn't have preamp outputs, I'm not sure where to pick up the signal. There are unused tape outputs on my surround decoder and equalizer, but I can't select those without losing the effects of the components containing them. What should I do?

PETER DEBRUSK
North Grafton, MA

A You'll probably find that you can indeed drive your subwoofers from one of the unused tape outputs, because they feed a signal whether or not the corresponding input is selected. It's probably not a good idea to do this, however, as such a feed would precede the volume control of the main amplifier, and you would thus have to adjust the subwoofer independently every time you wanted to change level.

Your best bet would be to feed the subwoofer's amplifier from the speaker outputs of the main amplifier (the Speaker B terminals, if provided, might be useful for this). The signal should be padded down by means of an inexpensive volume control so that the subwoofer amplifier's inputs won't be overloaded. Once that is done, you can set the level of the second amp to balance the overall sound and then forget it.

Ground Loops

Q Both my preamplifier and power amplifier have three-prong grounded AC plugs, and this has resulted in hum that I can only get rid of by using "cheater" plugs on both components to break the ground connection. Is there a better way?

WAYNE G. NIELSON
Hutchinson, MN

A I would think almost anything would be better than the risk of getting zapped by 110 volts of the power company's finest. Rather than cut the connections from the individual components to "house" ground, I would be inclined to break the ground link between the components. That can be accomplished by carefully cutting through the shielding at one end of the patch cables connecting the components—but leave it intact at the other end or the shielding won't work.

Because you've had to defeat the ground connections of both your preamplifier and power amplifier, however, I suspect that the problem doesn't really occur between them but elsewhere in the system. You can find out by setting up just the preamp and amp with nothing else connected (except speakers) but without the cheater cords. If there is no hum, the problem is elsewhere.

All this Jazz



ANY 8 CDs FOR ONLY 1¢

with membership in the Club. See details below.

PLUS A CHANCE TO GET ONE MORE CD—FREE!



Spyro Gyra—Fast Forward (GRP) 407-817



Stanley Jordan—Cornucopia (Blue Note) 387-142



Wynton Marsalis—The Resolution Of Romance (Warner Bros.) 389-932

CLASSICAL SOUNDS

Vladimir Horowitz—The Last Recording (Sony Classical) 405-985

Best Of The Canadian Brass (CBS) 401-596

Murray Perahia, Piano—Chopin: Piano Concertos Nos. 1 & 2 (Israel Phil./Zubin Mehta Conductor) (SOCL) 403-337

Roger Norrington—Early Romantic Overtures (London Classical Players) (Angel) 406-090

The Boston Pops Orchestra—Music Of The Night Pops On Broadway (John Williams, Conductor) (SOCL) 405-993

Yo-Yo Ma—Great Cello Concertos (CBS Master) 401-604/391-607

Isaac Stern-Humoresque—Favorite Violin Encores (CBS Master) 405-720

Dvorak: Violin Concerto; Romance; Carnival Over Midori; Mehta, NY Phil. (CBS Master) 386-573

Zubin Mehta, Cond.—New Year's Concert 1990 (Weiner Philharmoniker) (SOCL) 407-189

Kathleen Battle—Handel: Arias Academy Of St. Martin In-The-Fields (Neville Marriner) (Angel) 407-155

Jay Hoggard—Overview (Muse) 408-211

Dave Valentin & Herbie Mann—Two Amigos (GRP) 408-096

Tom Scott—Them Changes (GRP) 408-088

Larry Carlton—Collection (GRP) 407-825

Courtney Pine—The Vision's Tale (ANTI) 407-494

Don Grusin—Raven (GRP) 407-452

Jack DeJohnette—Parallel Realities (MCA) 407-270

Charles Mingus—Epitaph (Columbia) 406-660/396-663

McCoy Tyner—Things Ain't What They Used To Be (Blue Note) 406-462

Randy Brecker—Toe To Toe (MCA) 406-355

Dave Sanborn—Close Up (Warner Bros.) 370-304

Bobby McFerrin—Simple Pleasures (EMI) 369-306

Basia—Time And Tide (Epic) 368-043

Lee Ritenour—Stolen Moments (GRP) 406-280

The Rippingtons—Moonlighting (GRP) 406-272

Film & The B.B.'s—New Pants (Warner Bros.) 406-017

Patti Austin—Love Is Gonna Getcha (GRP) 405-951

John Scofield—Time On My Hands (Blue Note) 405-928

Najee—Tokyo Blue (EMI America) 405-910

The Gary Burton Quartet—Reunion (GRP) 405-118

Joey DeFrancesco—Where Were You? (Columbia) 404-939

Rich Margitza—Color (Blue Note) 404-764

Charnett Moffett—Beauty Within (Blue Note) 404-756

Oscar Peterson—The Trio (Pablo) 367-268

The Manhattan Transfer—Brasil (Atlantic) 363-648

Duke Ellington Orch.—Digital Duke (GRP) 357-350

Michel Petrucciani—Music (Blue Note) 404-624

Chick Corea Electric Band—Inside Out (GRP) 404-574

George Howard—Personal (MCA) 404-558

Dianne Reeves—Never Too Far (EMI) 404-517

Frank Morgan—Mood Indigo (ANTI) 404-152

Mike Stern—Jigsaw (Atlantic Jazz) 403-493

Eddie Gomez—Street Smart (Columbia) 403-360

Stanley Clarke/George Duke—3 (Epic) 403-352

George Benson—The Best Of George Benson (CBS Associated) 403-246

Dave Grusin—The Fabulous Baker Boys (Soundtrack) (GRP) 402-958

Randy Crawford—Rich And Poor (Warner Bros.) 401-950

Dizzy Gillespie—The Symphony Sessions (August 25, 1989) (Pro Jazz) 401-943

Dave Brubeck—Waiting For Spring (GRP) 401-901

Basia—London Warsaw (New York) (Epic) 401-752

Kenny G Live (Arista) 401-505

Happy Anniversary, Charlie Brown—Various Artists (GRP) 400-846

Strait No Chaser—Music from the Motion Picture (Columbia) 400-614

Dave Grusin—Migration (GRP) 400-044

Chuck Mangione—The Best Of Chuck Mangione (A&M) 340-547

Brandford Marsalis—Trio Jeepy (Columbia) 381-830

Miles Davis—Amandia (Warner Bros.) 381-756

Michel Camilo—On Fire (Epic) 389-999

Earl Klugh—Solo Guitar (Warner Bros.) 389-932

Nancy Wilson—Lady With A Song (Columbia) 389-692

Quincy Jones—Back On The Block (Qwest/Warner Bros.) 389-577

Lou Rawls—At Last (Blue Note) 387-589

Victor Bailey—Bottom's Up (Atlantic Jazz) 387-464

Freddie Hubbard—Times are Changing (Blue Note) 387-449

Stanley Turrentine—La Place (Blue Note) 387-159

Harry Connick, Jr. When Harry Met Sally—Music From The Motion Picture (Columbia) 386-821

George Benson—Tenderly (Warner Bros.) 384-214

Dr. John—In A Sentimental Mood (Warner Bros.) 384-040

Diane Schuur—Collection (GRP) 383-919

Pat Metheny Group—Letter From Home (Geffen) 383-901

Jean Luc Ponty—Storytelling (Columbia) 383-521

Grover Washington, Jr.—Time Out Of Mind (Columbia) 383-539

Steps Ahead—N.Y.C. (Intuition) 381-681

Kirk Whalum—The Promise (Columbia) 380-436

Hiroshima—East (Epic) 379-321

Dave Grusin Collection (GRP) 378-398

Joe Sample—Spellbound (Warner Bros.) 378-224

Al Jarreau—Heart's Horizon (Reprise) 376-186

Bird—Original Motion Picture Soundtrack (Columbia) 373-332

Bob James—Ivory Coast (Warner Bros.) 372-789

Take 6 (Reprise) 372-680

LEGENDARY JAZZ PERFORMANCES

Chet Baker—Let's Get Lost, The Best Of Chet Baker Sings (CAPJ) 407-486



Charlie Parker—Bird/The Savoy Recordings, Vol. 1 (Savoy Jazz) 383-950

The Dave Brubeck Quartet—Time Out (CL Jazz Masterpieces) 353-060

Benny Goodman—Sextet-Slipped Disc 1945-46 (CL Jazz Masterpieces) 377-531

Billie Holiday—Lady In Satin (CL Jazz Masterpieces) 353-151

The Best Of Chess Jazz—Various Artists (Chess) 363-937

Charles Mingus—Mingus Ah Um (CL Jazz Masterpieces) 354-795

Great Moments In Jazz—Various Artists (Atlantic) 376-582/396-580

Ray Charles and Betty Carter (Dunhill CD Classics) 376-293

Ornette Coleman—The Shape of Jazz to Come (Atlantic) 371-641

Duke Ellington Orch. & Count Basie Orch.—First Time The Count Meets The Duke (CL Jazz Masterpieces) 353-078

Louis Armstrong And His All-Stars—Satch Plays (Fats) (CL Jazz Masterpieces) 353-169



Miles Davis—Kind of Blue (CL Jazz Masterpieces) 353-045

Thelonious Monk—The Genius Of Modern Music (Blue Note) 407-445

Nat King Cole—Nat King Cole And The King Cole Trio (Savoy Jazz) 400-648

John Coltrane—Giant Steps (Atlantic) 371-591

HERE'S HOW TO GET YOUR 8 CDs FOR 1¢...

- Just mail the coupon and we'll send you 8 CDs, together with a bill for 1¢, plus shipping and handling.
- You agree to buy just six more selections in the next three years, at regular Club prices (currently \$12.98 to \$15.98, plus shipping and handling)—and you may cancel membership at any time after doing so.
- Free Music Magazine sent every four weeks (up to 13 times a year), describing the Regular Selection for your listening interest, plus hundreds of alternates. And Special Selection mailings up to six times a year (total of up to 19 buying opportunities).
- Buy only what you want! If you want the Regular or Special Selection, do nothing—it will be sent automatically. If you'd prefer an alternate selection, or none at all, just mail the response card always provided by the date specified.

- You always have 10 days to decide; if not, you may return the Selection at our expense.
- Half-Price Bonus Plan. If you continue your membership after fulfilling your obligation, you'll be eligible for our money-saving bonus plan. It lets you buy one CD at half-price for each CD you buy at regular Club price.
- 10-Day Free Trial. We'll send details of the Club's operation with your introductory package. If not satisfied, return everything within 10 days with no further obligation.
- Extra Bonus Offer: you may take one additional CD right now at the super-low price of only \$6.95—and you are then entitled to take an extra CD as a bonus FREE! And you'll receive your discounted CD and your bonus CD with your 8 introductory selections—a total of 10 CDs in all!

COLUMBIA HOUSE, 1400 N. Fruitridge Ave., P.O. Box 1129, Terre Haute, Indiana 47811-1129

252/F90

Please accept my membership application under the terms outlined in this advertisement. Send me the 8 Compact Discs listed here and bill me 1¢ plus shipping and handling for all eight. I agree to buy six more selections at regular Club prices in the coming three years—and may cancel my membership at any time after doing so.

SEND ME THESE 8 CDs FOR 1¢ (write in numbers below):

My main musical interest is (check one): (But I may always choose from any category)

- Jazz
Wynton Marsalis, Spyro Gyra
- Soft Rock
Michael Bolton, Fleetwood Mac
- Classical
Vladimir Horowitz, Kathleen Battle

Mr. _____
Mrs. _____
Miss _____
First/Last Name Initial Last Name

Address _____ Apt. _____

City _____

State _____ Zip _____

Do you have a VCR? (04) Yes No **VRK/F6**
Do you have a credit card? (03) Yes No **VAL/S9**

Extra Bonus Offer: also send me this CD for which I will be billed an additional \$6.95.

...and I'm entitled to this extra CD FREE!

Selections with two numbers contain 2 CDs and count as 2—so write in both numbers. © 1990 CBS Records Inc.

COLUMBIA HOUSE: Terre Haute, IN 47811

Note: we reserve the right to reject any application or cancel any membership. These offers not available in APO, Ft. Alaska, Hawaii, Puerto Rico, write for details of alternative offer. Canadian residents serviced from Toronto. Applicable sales tax added to all orders.

Signal Cleaners

Q I am interested in finding ways to clean up old records for transferring to tape, and I have considered trying to find an old click-and-pop machine or an Autocorrelator. Are such devices very effective?

GEORGE BOWRON
Ashcroft, British Columbia

A They can be useful, but neither is a cure-all. The SAE 5000A, the Burwen (later KLH) TNE-7000, and the Garrard MRM-101, all introduced in the 1970's, were the only consumer click-and-pop suppressors ever sold. They worked by detecting the sharp transients characteristic of physical clicks on vinyl records and trying to cancel them out.

Very loud pops were eliminated, but lower-level noises often remained; if the machines were adjusted to deal with lesser clicks, they usually started to remove bits of music as well. The machines were most useful with records that were basically clean but had a small number of very bad scratches.

The Autocorrelator, developed by Bob Carver while he was at Phase Linear, was a very sophisticated device that was effective at removing high-frequency noise from tapes and records. It was very level-dependent, however, so it had to be set carefully for every selection (and sometimes even reset during a selection). If you were willing to go to the trouble of constantly adjusting the Autocorrelator—which was not unreasonable for dubbing a record onto tape but irksome as a regular listening routine—it worked very well. It also contained a fairly effective low-frequency processor to remove hum and an expander to increase the dynamic range of compressed recordings.

These devices turn up in classified ads from time to time. They might be worth seeking out, but only if you have a large amount of material to dub, and much of that in bad shape.

Repairing Eight-Tracks

Q I have a large number of eight-track cartridges that I would like to listen to from time to time, but many of them are wearing out. In some cases, the foam pressure pads have dried out and no longer keep the tape firmly in contact with the playback head. In others, the splice has stretched, allowing sticky adhesive to foul the pinch-roller and capstan. Many of these tapes are irreplaceable. Is there anything I can do to make them playable?

JAMES F. ECKERT
DeRidder, LA

A Fixing the splices is relatively easy; a quarter-inch-tape editing kit will enable you to cut out the damaged part of the tape and replace it with a clean splice. Don't worry about losing music—most commercially recorded tapes fade out a few seconds before the splice and fade back in a few seconds after it. If the adhesive from the old splice has fouled the adjacent layers of tape, you may want to try to clean up the mess with a bit of isopropyl alcohol, but if the glue has dried or it doesn't disrupt the sound, I wouldn't bother.

The pressure pads present more of a problem. You may be able to slide a small piece of felt between the tape and the pad, securing it to the sides of the cartridge with a bit of adhesive tape. This might let you get one or two plays out of each cartridge, but it's not a long-term solution, so I suggest that you dub them to cassettes for preservation. □

THIS MAN JUST GOT THE REPAIR BILL FOR HIS CD PLAYER.

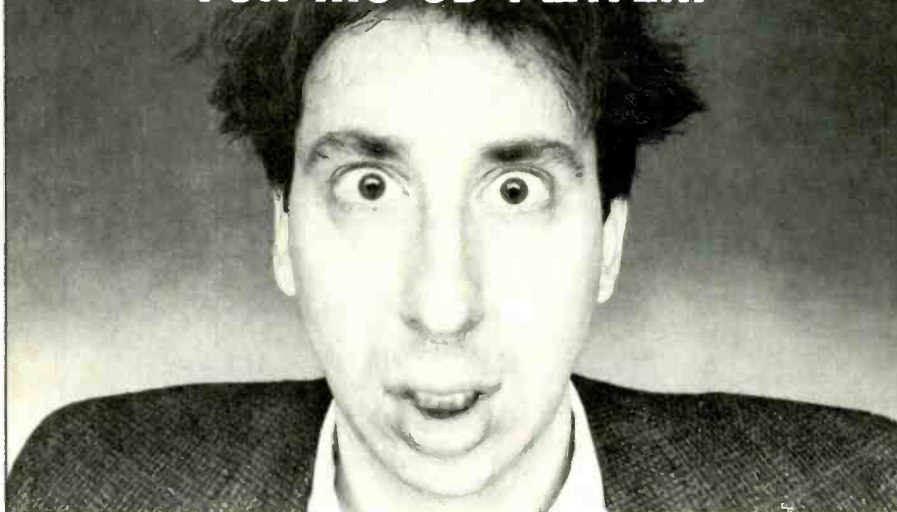

Unfortunately, a large percentage of audio and video components do have problems. In fact, one of the manufacturers featured in this magazine has a CD player breakdown rate of almost 30% after one year.

Luckily, there's an easy and affordable way to protect yourself against unexpected repair bills. A ComponentGuard Extended Warranty.



ComponentGuard offers complete parts and labor protection for up to 5 years on over 120 different kinds of products.

So, don't suffer from costly unexpected repair bills on your components. Get a ComponentGuard Extended Warranty with your next purchase—and get a piece of mind guarantee at the same time.

DON'T FORGET YOUR WARRANTY!
COMPONENTGUARD™

100 Summit Lake, Valhalla, N.Y. 10595 1-800-421-9820

Noted audio critics agree about the new PS•3 Speaker System:



The PS•3 Micro Monitor™ System is finished in genuine oak veneer. Each Point Source™ satellite is less than 7½ inches high, about 5 inches wide and 4¾ inches deep, to fit anywhere while delivering superb stereo imaging. The nationally advertised price of the complete system is just \$599.95, a remarkable value.

“The speakers that have caught my ear in the past few months have been small and remarkably compact.

...you can hear the bass evenly throughout the room regardless of where you put the woofer.

The sound was lively, full of punch and power, and extremely true on the nuances...”

— **Howard Blumenthal,**
HI-TECH HOME

“Imaging was well focused. The PS•3 also sounded startling for its diminutive size, with lots of presence and warm, rich bass.”

— **CD Review**

“...the PS•3 satellites sound smooth and natural. They do their job with clarity...”

The woofer continues the smooth work...

...impressive imaging. All the instruments and voices seem to be in just the right place.

If the PS•3 speakers were sold like magic elixirs, I would have bought a case!”

— **Rich Warren,**
Chicago Tribune



“...any listener would assume that another, larger system was playing. The sound in our listening room was smooth and well balanced...”

— **Julian Hirsch,**
Stereo Review

Don't choose any speaker system without first hearing and seeing the new PS•3. Visit a Design Acoustics dealer near you. Write today for dealer list, full reviews, and color brochure.

DA DESIGN ACOUSTICS
An Audio-Technica Company
1225 Commerce Drive, Slow, OH 44224 • (216) 686-2600

Dial 1-800-933-9022
for dealer names, full reviews,
color brochure and details on a
no-obligation home trial.

by Ken C. Pohlmann



PASS THE POPCORN

WHEN I was a kid, there were exactly two places where you could get really great popcorn: the county fair and movie theaters. Since the fair came around only once a year, that meant a lot of trips to the cinema. Today, everything's changed. Now I can get really tasty popcorn any time I want—for example, while I'm writing magazine articles—through the miracle of microwave. Buttered, light, nacho, cheddar, salt-free, caramel, gourmet, you name it—thanks to Orville Redenbacher and friends, I don't have to go to the movies any more.

Unless, of course, I want to hear really great sound. A first-class movie-theater sound system is much better than most home audio/video systems, and a THX-certified theater is unbeatable. Back in 1980, frustrated by poor theater sound, George Lucas resolved to establish a sound-system standard for movie theaters that would enable them to convey a filmmaker's aural intentions fully. Implementation of the idea fell to Lucasfilm's corporate technical director, Tomlinson Holman, who developed the THX Sound System (named after Holman himself and Lucas's first feature

film, *THX 1138*). The system complements Dolby Stereo playback equipment by specifying the types of power amplifiers, loudspeakers, and room acoustics a theater needs to create a high-fidelity sound system as well as a standard playback environment.

To obtain THX certification, a theater must use THX-licensed contractors to do the installation (which includes equalization to a specified response curve) and test its performance. Lucasfilm even requires that THX theaters be retested twice a year to insure compliance with the specifications. THX systems are installed in more than five hundred theaters around the world.

Now, however, you don't have to go to a theater to hear THX sound. Lucasfilm has developed standards for Home THX components that can emulate the sound of a theater THX system in your living room. Technics, Lexicon, and Snell Acoustics are the first licensees for the technology and are introducing products that carry the THX trademark.

For example, Technics offers a complete Home THX system, including a control center, three power amplifiers, three front speakers (left, center, and right), two surround speakers, and a subwoofer. A variety of program sources could be employed, but aficionados will surely want to have a laserdisc/CD combi-player in the rack as well as a Super VHS Hi-Fi VCR. Per Lucasfilm specifications, the Technics SH-TX100 THX controller uses a Dolby Pro Logic surround decoder to extract the four channels of audio encoded in Dolby Stereo film soundtracks. In addition, the unit uses digital signal processing (with 1-bit MASH circuitry) to derive two decorrelated surround channels from the Dolby decoder's mono surround output according to a technique prescribed by Lucasfilm for Home THX. An adjustable digital delay helps establish the size of the recreated acoustic space, and a surround timbre equalizer matches sound from the rear speakers with that from the front channels.

A THX system strives to achieve highly intelligible dialogue, accurate spectral balance, good stereo and dialogue localization, and extended

low-bass response. (In addition to reproducing motion-picture sound accurately, a Home THX system is a high-quality music-reproduction system.) In fact, one thing that particularly sets Home THX apart is its low-bass response. If you're accustomed to hearing movies through your TV's 3½-inch speakers, or even average hi-fi speakers, you'll be surprised to discover a whole new world of bass and sub-bass material in film soundtracks. Films like *Die Hard* have extensive low-frequency audio content throughout most of their running time. You can create a quake zone with a 100-foot radius by simply nudging your subwoofer's level control. (That can be a real problem for your neighbors if you live in an apartment, especially if you like to watch *Die Hard* often and late at night.)

Although Home THX is impressive in itself, perhaps its greatest

Home THX components can now emulate the great sound of a theater THX system in your living room.

significance is as a harbinger of things to come. Motion-picture companies are finding the home market increasingly profitable. With growing interest in home media installations and the availability of reproduction systems such as Home THX, it seems inevitable that more and more attention will be paid to home movie-viewers. Perhaps we're not far from the time when motion-picture studios will simultaneously release first-run movies to theaters and directly to consumers. By that time, a compact disc format holding 2 hours of digital audio and video should be off the drawing board. That way you could stop by your neighborhood record/video store to buy the latest music *and* motion-picture releases to enjoy in your home media room.

We'll count down the years until that becomes a reality, but I'll bet it happens before the twenty-first century rolls around. Meanwhile, turn up that THX-certified subwoofer a little. And pass the popcorn. □

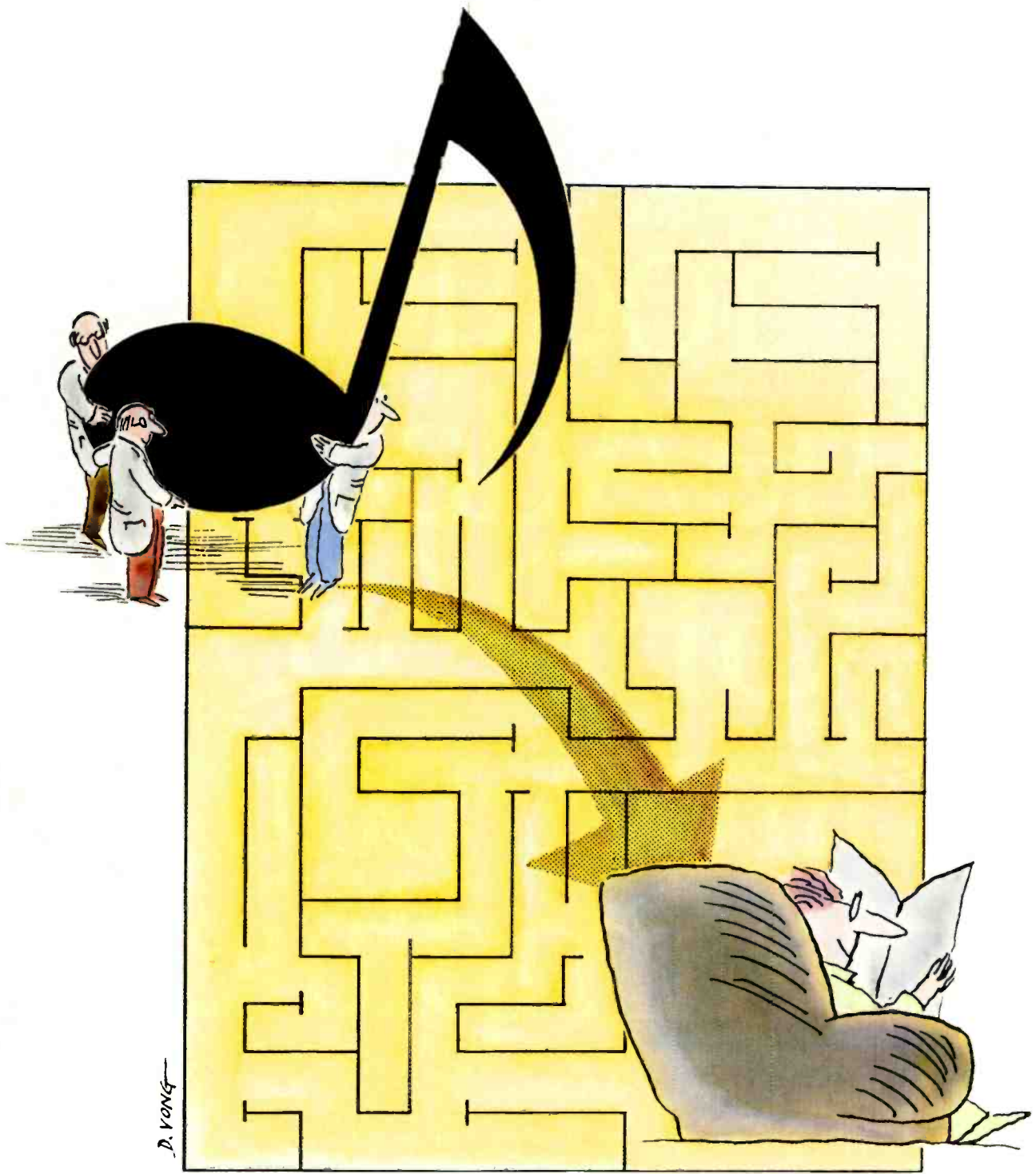

In search of sonic perfection,
Adcom has taken the path of least resistance.

Introducing
the Adcom
GFP-565
direct-path
preamplifier.

Precision 1% tolerance Roederstein metal-film resistors and polycarbonate-film capacitors - For infinitesimally low distortion and long-term stability.

Buffered tape outputs - To prevent any degradation of source signals by tape recorders connected to the recording circuit.

Low-impedance RIAA network with Roederstein capacitors - For minimal noise and distortion; purest sound with highest RIAA accuracy.

Low ESR bypass capacitors - Insure purest DC to each stage and eliminates "crosstalk."

All gold-plated input and output jacks - Eliminates corrosion; direct mounting avoids unreliable wiring, hum and noise.

Direct, on-chassis switching - Switches audio signals close to their input source eliminating long signal traces and wires.

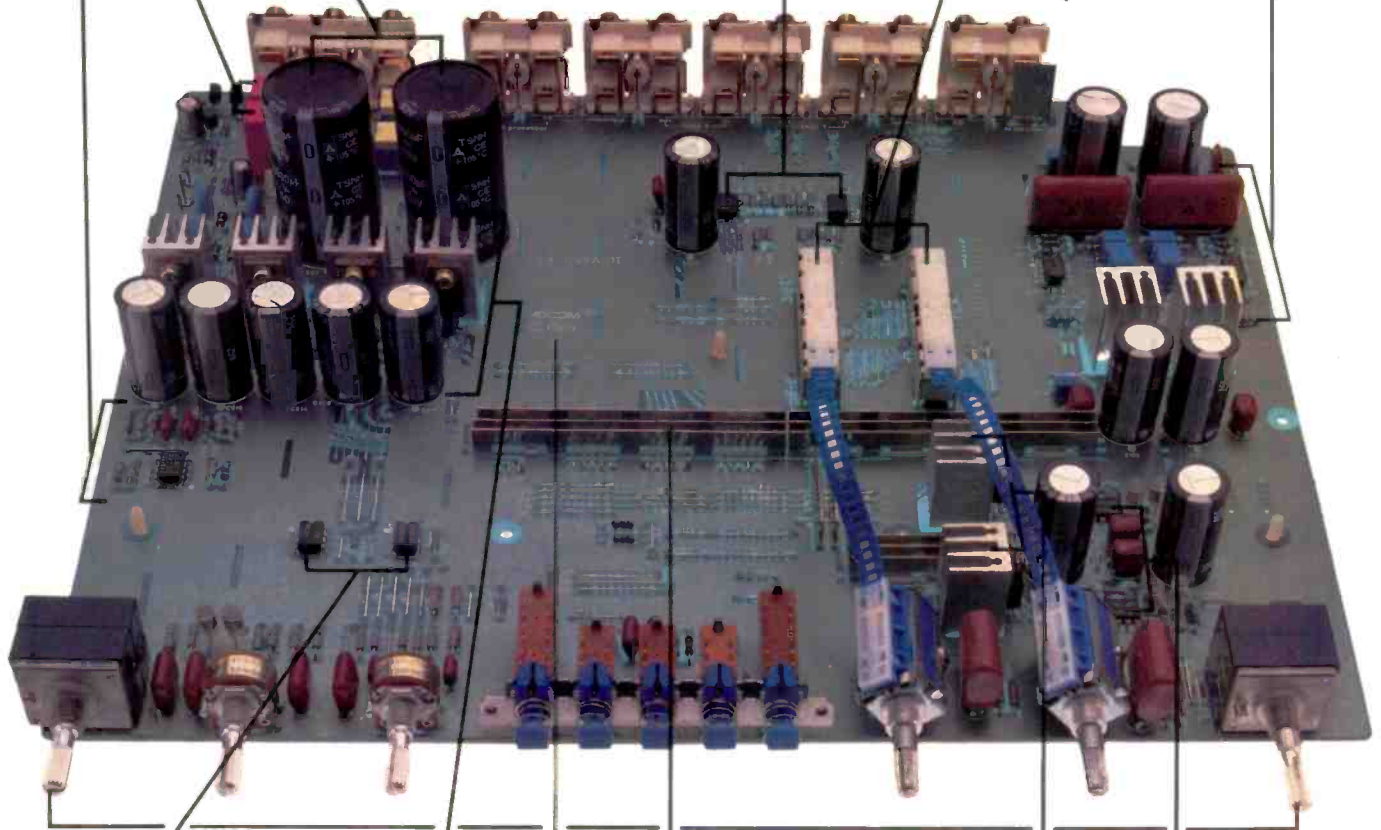

Separate and switchable tone-control amplifiers - Assures superior signal fidelity and maintains symmetry.

High-current, low-impedance regulated power supply - Uses programmable regulators and low ESR capacitors; avoids voltage drops and current losses.

High-grade potentiometers - For long-term accuracy and ideal channel balance.

Massive bus-bars - Carry DC to each stage without power loss; keeps source impedance low and current capability high.

High-speed linear gain amplifiers - The "heart" of the Adcom preamp, individually selected for low noise and DC offset. Assure peak performance (with no sonic deterioration) over a long period of time.

Glass epoxy board, copper-plated on both sides - Provides a shield/ground plane to block hum and interference.

High current output buffers - For superior dynamic performance and total isolation of circuits.



Audio designers have long known that the fewer circuits and electronic components a musical signal encounters on its way to your loudspeaker system, the greater its musical purity will be when it gets there. Ideally, if a signal could travel directly from its source (CD, tape, record or FM broadcast) through your preamplifier and your power amplifier without the need for amplification or tonal adjustment, it would sound exactly as it did when it was recorded. Now, through obsessive attention to detail and design ingenuity, Adcom creates the GFP-565—the world's first affordably priced preamplifier that boasts direct, linear gain path circuitry.

Direct Gain Path: Pure And Simple

From input to output, Adcom has made every effort to make the signal path as direct, pure and simple as possible. Starting by gold plating all input and output jacks, and then directly mounting all jacks, switches, potentiometers and other laboratory grade components on a double copper-plated, glass epoxy printed circuit board, signal losses and noise are greatly reduced.

Through a uniquely innovative approach which minimizes the number of components and wiring harnesses, waveform distortion is reduced while dynamic contrasts are preserved. All of this translates into superior, more lifelike sound.

Design Ingenuity You Can Hear

Having earned a reputation for providing high performance at reasonable cost with its power amplifiers, preamp/tuners and CD player, Adcom designers set out to establish a new reference standard in value among the very best preamplifiers on the market. In every area of design, a no-compromise approach was taken with respect to quality of components and construction. Its performance-to-cost

relationship marks a significant breakthrough into a whole new category of audiophile-grade components: super performance that doesn't cost a king's ransom.

All stages operate in pure Class-A mode. To prevent interaction and maintain absolute signal integrity, each stage is buffered and has its own individually bypassed source of power. This resolute design approach achieves complete decoupling between all stages for extraordinarily low distortion.

A high-current, very low impedance, regulated DC power supply delivers an abundance of reserve current for musical peaks with instantaneous recovery. To keep power supply source-impedances low, heavy bus-bars feed power to each individual stage rather than the usually thin "hook-up" wiring.

Direct coupling, which does not use capacitors in the signal path, eliminates the "veiling" of low-level detail and extends frequency response. To reduce the loading effects of connecting cables and associated equipment, an extraordinarily low impedance was developed for the outputs.

This combination of Class-A operation, linear gain path, very low-impedance power supply, direct coupling, buffered stages and low output impedance all add up to a preamp capable of maintaining absolute signal integrity with full dynamics.

Even the tape outputs are buffered to prevent the impedance of a tape recorder from loading down or otherwise distorting the signal through "diode" effects. Precision 1% Roederstein metal-film resistors and metallized-film capacitors are used throughout.

Perhaps most impressive of all is the application of Adcom's proprietary linear-gain amplifier circuits, which undergo a relentless testing and quality control procedure. Less than 6% of manufactured devices meet Adcom's stringent quality acceptance specifications. As an end result, every Adcom preamplifier produced not only sounds as good as its designers intended, but maintains its uniform standard of excellence.



These high-speed, state-of-the-art linear amplifiers are specially selected for the lowest DC offset voltage and lowest noise of any comparable components currently available. The virtual elimination of DC offset allows the GFP-565 to be direct-coupled, providing superior frequency response from 5 Hz to almost 100,000 Hz! Noise is astonishingly low, with a typical noise floor, even in phono, comparable only to the finest digital studio equipment.

Three Sets Of Outputs For The Perfect Balance Of Performance And Flexibility

Traditionally, audiophiles have had to choose between two opposing preamplifier designs. One offered the flexibility of tone, balance and input controls but with some inherent signal degradation; and the other, more purist approach, offered little more than an on/off switch and volume control. The GFP-565 resolves this dilemma and satisfies the needs of not only the most demanding perfectionists, but all other music lovers as well.

You can choose one or more of three sets of outputs: 1) **BYPASS**: direct-coupled output before tone controls, filters, etc. This provides the musical signal its most straightforward and direct path to your power amplifier while retaining control of volume and balance. 2) **LAB**: direct-coupled output with no output-coupling capacitors in the signal path. This mode provides in addition to volume and balance, switchable tone controls, filter, loudness contour and mono modes. 3) **NORMAL**: identical to LAB output but utilizing the highest quality metallized polycarbonate output-coupling capacitors for operation with amplifiers requiring the extra protection of low-frequency bandwidth limiting. Bi-amplified and tri-amplified systems are easily accommodated with this remarkably flexible arrangement.

Convenience Made Simple

At first glance, the minimalist style of the GFP-565 is deceptive in its simplicity. However, it is this carefully considered lack of complexity which makes the GFP-565 so convenient and user friendly. It will cosmetically and electronically match the rest of your Adcom components whether you're buying them now, or adding to an Adcom system you've started a couple of years ago.

Without unnecessary complications, you may listen to one input (phono, CD, tape, VCR) while recording from another. And for total system integration and control, there are five high level inputs (tuner, CD, tape 1, tape 2, video/aux) as well as a phono input with enough gain for any high-output moving-coil, moving-magnet, or induced-magnet cartridge.

A highly sophisticated loudness contour helps augment the bass range to compensate for perceived aural reduction of these frequencies at low listening levels, while maintaining musical integrity as the volume level is increased. And, when needed, separate bass, treble and hi-filter functions can be activated to provide adjustment for the often less than perfect characteristics of loudspeakers, program material and room acoustics.

To take advantage of today's new signal processors, a separate front panel switch allows processor in/out operation while leaving both tape circuits free for tape deck use. If you have an equalizer or surround-sound processor, for example, you can switch it into the sound path only when appropriate to the program.

And for optimum performance with today's superior headphones with impedances of 100 to 2000 ohms, a separate, high quality headphone amplifier has been incorporated into the GFP-565.

(over please)

Why Is Adcom Clearly Superior To Other Brands?



GFP-565/GFA-535 (60 watts/ch)*



GFP-565/GFA-545 (100 watts/ch)*



GFP-565/GFA-555 (200 watts/ch)*

Adcom stereo components have repeatedly won critical acclaim for offering audibly superior performance even when compared to components costing two and three times more. Indeed, Adcom's reputation has been built by offering exceptional quality at realistic, uninflated prices. How can this achievement of creating so much consumer value, year after year, be possible?

To begin with, Adcom has clearly identified its need to lead the market rather than follow it, concentrating on the development of a small number of highly innovative products, easily differentiated from the vast array of equipment generally offered. By choice, Adcom is not part of a larger multi-national conglomerate, nor does Adcom set out to produce redundant models for every taste and pocketbook.

Adcom's designers are free to imaginatively explore new and exciting ways of bringing great sound into the homes of more and more people, unrestricted by any rigid bureaucracy.

Adcom's philosophy that a well-engineered product should remain viable for years to come is common among premium priced manufacturers, yet rare among those companies making affordable components.

While other manufacturers were promoting their third and fourth generation of CD players with "features" which added little or no benefit in terms of musical enjoyment, Adcom painstakingly went about developing the one model which became the critically acclaimed GCD-575. Its Class-A analog circuitry is still unrivalled for sonic perfection.

Specifications

Output Impedance
Main Out: 100 ohms
Tape Out: 475 ohms
Output Level (Rated)
Main Out: 2.0 V
Output Level (Maximum)
Main Out: 10.0 V
Frequency Response (± 0.5 dB)
High Level: 5 Hz - 90 kHz
Phono: 5 Hz - 70 kHz
THD + Noise (@ Rated Output, 20 Hz - 20 kHz)
High Level: 0.0025%
Phono: 0.009%
IMD (SMPTE, @ Rated Output)
High Level: 0.0025%
Phono: 0.0025%
Signal-to-Noise (@ Rated Output, "A" Weighted)
High Level: >100 dB
Phono: >95 dB
Input Impedance
High Level: 22 kohms
Phono: 47 kohms
Input Sensitivity (@ Rated Output)
High Level: 205 mV
Phono: 23 mV
RIAA Accuracy (20 Hz - 20 kHz): ± 0.1 dB
Tape Output THD + Noise (@ 2.0 V, 20 Hz - 20 kHz): 0.003%
Tape Output IMD (SMPTE) @ 2.0 V: 0.002%
Tone Controls
Bass (20 Hz): ± 10 dB
Treble (20 kHz): ± 9 dB
Loudness (Volume Control @ 9:00 o'clock)
100 Hz: +5 dB
20 Hz: +10 dB
Crosstalk (1 kHz): -105 dB
Separation (1 kHz, @ Rated Output): >75 dB
Hi Filter (20 kHz): -2.7 dB

General

Power: 120 VAC/50-60 Hz (available in other voltages on special order)
Power Consumption: 10 watts
Chassis Dimensions: 17" (432 mm) \times 11 3/8" (289 mm) \times 3" (76 mm)
Maximum Dimensions: 17" (432 mm) \times 12 9/16" (319 mm) \times 3 1/4" (83 mm)
Weight: 11 lbs. (5 kg)
Weight, Packed: 14 lbs. (6.4 kg)

Adcom components also available with optional white front panel.

Specifications subject to change without prior notice.

Adcom has also been extremely selective in choosing its dealer network, limiting it to include only the nation's best, most professional audio retail organizations. By relying on the knowledgeable, intelligent presentation of its product and the enormous benefits of positive word-of-mouth advertising from enthusiastic music lovers, Adcom can optimize its marketing expenditures. These savings are important in keeping costs down to the end user of Adcom products.

Listen To The Difference

You are cordially invited to audition the new GFP-565 direct-path preamplifier at your Authorized Adcom Dealer. Don't hesitate to compare it to the most expensive preamp on your dealer's shelves. You'll echo the words of one perfectionist critic who, hearing the GFP-565 through a pair of GFA-565 amplifiers for the first time, said, "I've never heard my speakers 'sing' like this!"

In their search for the optimum preamplifier concept, Adcom took the path of least resistance. Why not do the same? Of course, you could spend more . . . but should you? Consider the new Adcom GFP-565. It's your best choice in preamplifiers. Pure and simple.

**Power output, watts/channel, continuous both channels driven into 8 ohms, 20 Hz - 20 kHz < 0.09% THD.*

ADCOM[®]
details you can hear

11 Elkins Road, East Brunswick, NJ 08816
 U.S.A. (201) 390-1130
 Distributed in Canada by PRO ACOUSTICS INC.
 Pointe Claire, Quebec H9R 4X5

by Julian Hirsch



FM TUNER SPECIFICATIONS

LAST month I discussed in general terms the significance of objective and subjective measurements of high-fidelity audio components. This month I will deal specifically with the standardized tests applied to FM tuners.

Typically, a manufacturer's specifications for an FM tuner (or the tuner portion of a receiver) refer to characteristics such as *usable sensitivity*, *50-dB quieting sensitivity*, *alternate-channel selectivity*, *image rejection*, *frequency response*, and *capture ratio*. The average audio consumer has at best a hazy idea of the significance of these parameters.

These and other rigorously defined parameters help to determine a tuner's overall performance potential. Like many measurements of other audio products, tuner specs do not necessarily correlate with a tuner's listening qualities, although as a group they can generally define its strengths and weaknesses.

In this country, the accepted standard for FM tuner measurement was issued in 1975 by the Institute of High Fidelity (IHF) and adopted by the Electronic Industries Association (EIA) and the Institute of Elec-

trical and Electronic Engineers (IEEE). It is currently known as IEEE Standard 185-1975. The standard was adopted by U.S. manufacturers within a few years and more slowly by most of the Japanese companies. It is rarely used by European manufacturers, who follow the German DIN standard. Product specifications following one of these systems cannot be translated into the other because of their almost totally different test conditions.

The IEEE standard defines some twenty-four different tests for monophonic tuners plus ten more for stereo tuners. Most of these tests relate to factors that do not directly affect ordinary operation in a home environment. Those of most concern to hi-fi users deal with a tuner's sensitivity, noise, distortion, and interference-susceptibility characteristics.

A major departure of the 1975 standard from previous practice was the use of decibels referred to 1 femtowatt, or 10^{-15} watt (dbf), to replace the microvolt (μV) as a unit of signal level. The microvolt sensitivity rating of a tuner depends on the impedance of its antenna input circuit. A 75-ohm input, widely used these days, gives half the microvolt rating of a 300-ohm input for the identical tuner. The likelihood of confusion, to say nothing of misleading claims, makes the microvolt an undesirable reference unit.

The dbf rating is a measure of the actual signal power (as opposed to voltage) available to the tuner's circuits. A 0-dbf sensitivity is equivalent to 0.55 microvolt across a 300-ohm antenna input, at a 300-ohm impedance level, from a generator connected through a standard

matching network. Very few tuners attain a sensitivity of 10 dbf, and 12 to 15 dbf is typical of today's tuners.

The sensitivity we are discussing here is "usable sensitivity," which has little relation to the weak-signal performance of a tuner. It is actually a measurement of the level of input signal, modulated 100 percent (mono) at 1,000 Hz, that produces a 30-dB ratio of the 1,000-Hz component of the tuner's output to the total harmonic distortion plus noise (THD + N) in its output.

This ratio corresponds to 3.2 percent THD + N in the output, which may or may not be listenable. If the THD + N is mostly distortion, the signal may be acceptable under some circumstances, but if it is largely noise (hiss), the sound is likely to be too noisy for enjoyment. And in any case, we are considering mono listening only. In stereo, no useful reception will be obtained from a signal whose usable sensitivity (which I prefer to think of as *unusable* sensitivity) is at this level. Nonetheless, this measurement does provide some idea of the *relative* sensitivities of different tuners.

Measurement of the *50-dB quieting sensitivity* applies to both mono and stereo operation and is far more meaningful. It is performed much like the usable-sensitivity test except that we measure only the *noise* in the tuner's output, again as a function of input level referred to the audio output from a signal modulated 100 percent at 1,000 Hz. A -50-dB noise level, while by no means fully quiet, does permit reasonably satisfactory listening to most broadcasts. Most tuners have a fairly steep quieting curve, so that the 50-dB sensitivity (in mono) is frequently only a little greater than the usable sensitivity reading. For stereo reception, which is inherently noisier, 50-dB quieting requires about 20 dB greater signal input.

Tuner distortion decreases as input level increases. Although it is common to measure distortion over a wide range of input levels, it is usually specified as the THD + N for a 65-dbf input. Most tuners achieve their ultimate quieting by that level, but those that show a further reduction of noise at higher inputs may be specified at 85 dbf (9,700 μV).

Tested This Month

YAMAHA CDC-805
COMPACT DISC PLAYER

JBL XPL140
SPEAKER SYSTEM

CARVER CT-6
TUNER/PREAMPLIFIER

VELODYNE SERVO 1200
POWERED SUBWOOFER

PHASE TECHNOLOGY PC8.5
SPEAKER SYSTEM

Stereo channel separation is measured by modulating only one channel of the signal generator and measuring the output in both channels as a function of frequency. The difference between the two, in decibels, is the *channel separation* (sometimes called *crosstalk*). Although this may vary a bit with signal strength, it is normally specified only at 65 dBf.

Two parameters that have much to do with a tuner's ability to receive

Tuner specifications do not necessarily correlate with a tuner's listening qualities, but as a group they can generally define its strengths and weaknesses.

programs under difficult conditions are its *capture ratio* and *AM rejection*. In theory, a unique advantage of FM broadcasting is that a receiver will respond only to the strongest of several signals on the same frequency, without interference from the others. It is this "capture effect" that enables FM stations separated by only 100 miles or so to use the same frequency without interference.

Unfortunately, theory and practice do not always agree 100 percent. As anyone living between two stations using the same channel knows, it may be impossible to enjoy interference-free reception from either one if their signals are nearly the same strength. Capture ratio is a measure of a tuner's ability to reject all but the strongest signal on the same channel. Expressed in decibels, it roughly indicates the ratio of the two signal levels when the program from the stronger signal is 30 dB louder than that from the weaker signal. The smaller the capture ratio, the better, and most tuners have readings between 1.5 and 3 dB.

The AM rejection is an indicator of an FM tuner's ability to reject amplitude modulation (ideally, it should not respond at all to AM). With 100 percent frequency modulation at 1,000 Hz and 30 percent amplitude modulation at 400 Hz applied simultaneously to the signal generator, the ratio of the levels of the two frequen-

cies is measured in the tuner's audio output. A high number is desirable. Some tuners, especially in car radios, have very poor AM rejection, sometimes as low as 40 dB, but better ones may measure 75 dB or higher.

There are other measurements involving the interference susceptibility of a tuner. *Selectivity*, or the ability to reject a strong signal on a different frequency from the desired signal, can be very important in a populous urban area, but it's of no importance whatever in rural areas served by only one or two FM stations. Selectivity is specified both for *alternate-channel* spacings (400 kHz) and *adjacent-channel* spacings (200 kHz). In any given area, no adjacent-channel frequency assignments are made, but there are some locations where adjacent-channel stations can be received from different directions. Most tuners have rather poor adjacent-channel selectivity (5 to 10 dB are common readings), but alternate-channel measurements can be as low as 50 dB or as high as 100 dB (60 to 70 dB is typical).

Image rejection can be important in some areas, especially near an airport or under the approach path to a busy airport. A superheterodyne-type receiver, which includes all FM tuners, can respond to two frequen-

cies simultaneously under some conditions. The "image frequency" response of an FM tuner is 21.4 MHz higher than its tuned frequency, lying in the very busy band devoted to air-to-ground communications. If your tuner's image rejection is poor—less than 40 dB or so—you may find your favorite FM station "captured" temporarily by a passing airplane. Image rejection is usually in the 50- to 70-dB range but can be as high as 100 dB in some tuners.

As you can see, these key parameters can define quite well an FM tuner's overall quality and suitability for use in a given location. Still, only a few of them have much to do with its sound per se. When you read test results or a manufacturer's specifications, look for the ones that matter most in your own installation. In many cases, a relatively inexpensive tuner will do as good a job for you as the most advanced model you can buy. By the same token, it is possible that *no* tuner made will be able to deliver what you are looking for. Minor differences in measurements between tuners are usually meaningless in practical terms. A difference of 1 or 2 dB in sensitivity or noise level is unlikely to be detectable. In marginal-reception cases, a good outside antenna is far more important. □



"Those Gregorian chants sound absolutely divine on that speaker, Father McKeon, and I say that as an agnostic!"

The ultimate in sound...
The ultimate in savings...

8 COMPACT DISCS FOR THE PRICE OF 1

WITH NOTHING MORE TO BUY...EVER!

Bruce Hornsby: A Night On The Town 63689

The Jeff Healey Band: Hell To Pay 00544

Madonna: I'm Breathless 00572

Sinead O'Connor: I Do Not Want What I Haven't Got 33512

Alannah Myles (Atlantic) 30045

Eric Clapton: Journeyman (Warner Bros.) 53940

Milli Vanilli: Girl You Know It's True (Arista) 01048



Paula Abdul: Shut Up And Dance (Virgin) 80326

The Harper Brothers: Remembrance (Verve) 14896

Kenny G: Live (Arista) 64505

Peter Murphy: Deep (RCA) 44638

Carly Simon: My Romance (Arista) 24824

Wilson Phillips (SBK) 00726

Guns N' Roses: Appetite For Destruction (Geffen) 70348

The Black Crowes: Shake Your Money-maker (Geffen) 52142

Janet Jackson's Rhythm Nation (A&M) 72386

The Who: Who's Better, Who's Best (MCA) 00790

Don Henley: The End Of The Innocence (Geffen) 01064

Eagles: Greatest Hits, Vol. 1 (1971-75) (Asylum) 23481

Quincy Jones: Back On The Block (Warner Bros.) 64116

Horowitz At Home (DG) 25211

The Moody Blues: Greatest Hits (Threshold) 34284

Whitesnake: Slip Of The Tongue (Geffen) 01147

The Dizzy Gillespie Symphony Sessions (Pro Jazz) 44022

Duran Duran: Decade (Capitol) 73573

The Best Of Steely Dan: Decade (MCA) 54135

Bon Jovi: New Jersey (Mercury) 00516

Faith No More: The Real Thing (Reprise) 63719

Cher: Heart Of Stone (Geffen) 42874

Tom Petty: Full Moon Fever (MCA) 33911

The Traveling Wilburys: Volume One (Warner Bros.) 00711

Roy Orbison: Black And White Night (Virgin) 64495

Jeff Lynne: Armchair Theatre (Reprise) 00803

Lisa Stansfield: Affection (Arista) 34198

Bell Biv DeVoe: Polson (MCA) 01029

Jazz CD Sampler (PolyGram) 73406

The B-52's: Cosmic Thing (Reprise) 14742

J.R. Baker: Everybody's Favorite Synthesizer Pieces (Newport Classic) 44611

Linda Ronstadt: Cry Like A Rainstorm, Howl Like The Wind (Elektra) 52221



Heart: Brigade (Capitol) 64305

Bobby Brown: Dance!...ya know it! (MCA) 73660

Supertramp: Classics (14 Greatest Hits) (A&M) 04891

Kentucky Headhunters: Pickin' On Nashville (Mercury) 24740

Marcus Roberts: Deep In The Shed (Novus) 73646

20 Great Love Songs Of The '50s & '60s, Vol. 1 (Laurie) 20768

Barry Manilow: Live On Broadway (Arista) 24805

Sofli: Tchaikovsky, 1812 Overture (London) 25179

Richard Marx: Repeat Offender (EMI) 01118

Kitaro: Kojiki (Geffen) 43758

Clint Black: Killin' Time (RCA) 01112

Johnny Gill (Motown) 00738

Roy Hargrove: Diamond In The Rough (Novus) 14893

Skid Row (Atlantic) 10138

Najee: Tokyo Blue (EMI) 44482

Little Caesar (DGC) 83514

Michael McDonald: Take It To Heart (MCA) 00573

Pat Metheny: Question & Answer (Geffen) 73522

Fine Young Cannibals: The Raw And The Cooked (I.R.S.) 01068

Pavarotti: Volare (London) 25102

Randy Travis: No Holdin' Back (Warner Bros.) 34766

Def Leppard: Pyromania (Mercury) 70402

The Smithereens 11 (Capitol) 10619

Pretty Woman/Sound-track (EMI) 34631

Restless Heart: Fast Movin' Train (RCA) 10802

Bonnie Raitt: Nick Of Time (Capitol) 54410

Chicago: Greatest Hits 1982-89 (Reprise) 63363

George Gershwin Plays Rhapsody In Blue (Pro Arte) 44635

Michael Penn: March (RCA) 83798

Best Of Dire Straits: Money For Nothing (Warner Bros.) 00713

The Church: Gold Afternoon Fix (Arista) 71667

Depeche Mode: Violator (Sire) 73408

The Judds: Love Can Build A Bridge (RCA) 30298

Robert Plant: Manic Nirvana (Es Paranza) 54122

Slaughter: Stuck To Ya (Chrysalis) 42308

Lynyrd Skynyrd: Skynyrd's Inneryds (Hits) (MCA) 01150

The Cure: Disintegration (Elektra) 01109

Peter Gabriel: Passion (Geffen) 63668

Frank Sinatra: Capitol Collector's Series (Capitol) 64362

Rod Stewart: Greatest Hits (Warner Bros.) 33779



M.C. Hammer: Please Hammer Don't Hurt 'Em (Capitol) 34791

Simon & Garfunkel: Concert In Central Park (Warner Bros.) 44006

Aerosmith: Pump (Geffen) 63678

Led Zeppelin IV (Runes) (Atlantic) 12014

Hank Williams, Jr.: Lone Wolf (Warner Bros.) 64311

John Hiatt: Stolen Moments (A&M) 44540

Keith Sweat: I'll Give All My Love To You (Elektra) 51603

Diana Ross & The Supremes: 20 Greatest Hits (Motown) 63867

Styx: Classics (14 Greatest Hits) (A&M) 14822

13 Jazz Classics (Compose) 10460

Dionne Warwick: Greatest Hits (Arista) 00667

Fleetwood Mac: Behind The Mask (Warner Bros.) 43766

Jimi Hendrix: Electric Ladyland (Reprise) 23362

The Beach Boys: Made In U.S.A. (25 hits) (Capitol) 64143

Soul II Soul: Keep On Movin' (Virgin) 14823

Lita Ford: Stiletto (RCA) 63893

START WITH 4 COMPACT DISCS NOW!

Yes, start with any 4 compact discs shown here! You need buy just 1 more hit at regular Club prices (usually \$14.98—\$15.98), and take up to one full year to do it. Then choose another CD free. In addition, as a member in good standing you can get 2 more selections Free after completing your first year of membership. That's 8 CDs for the price of 1 *with nothing more to buy... ever!* (A shipping and handling charge is added to each shipment.)

HOW THE CLUB OPERATES

You select from hundreds of exciting CDs described in the Club's magazine and mailed to you approximately every three weeks (19 times a year). Each issue highlights a Featured Selection in your preferred music category, plus alternate selections. If you'd like the Featured Selection do nothing. It will be sent to you automatically. If you'd prefer an alternate selection, or none at all, just return the card enclosed with each issue of your magazine, by the date specified on the card. You will have at least 10 days to decide or you may return your Featured Selection at our expense. Cancel your membership at any time after completing your enrollment agreement, simply by writing to us, or remain and take advantage of bonus savings.

FREE 10-DAY TRIAL

Listen to your 4 introductory selections for a full 10 days. If not satisfied, return them with no further obligation. You send no money now, so complete the coupon and mail it today.

SAVE 50% INSTANT HALF-PRICE BONUS PLAN
You get 50%-off bonus savings with every CD you buy at regular Club prices...right with your very first purchase...unlike other clubs that first make you buy 4, 6 or more.

START SAVING NOW—MAIL TODAY!

Mail to: BMG Compact Disc Club
P.O. Box 91412/Indianapolis, IN 46291

YES, please accept my membership in the BMG Compact Disc Club and send my first four selections, as I have indicated here, under the terms of this offer. I need buy just one more CD at regular Club prices during the next year —after which I can choose another CD FREE! In addition, as a member in good standing I can get 2 more selections FREE after completing my first year of membership. That's 8 CDs for the price of one...*with nothing more to buy, ever!* (A shipping/handling charge is added to each shipment.)

RUSH ME THESE 4 CDs NOW (Indicate by number):

I am most interested in the musical category checked here—but I am always free to choose from any (check one only):

1 EASY LISTENING (Instrumentals/Vocal Moods)
2 COUNTRY 3 HARD ROCK
4 POP/SOFT ROCK 5 CLASSICAL

MR MRS MISS

First Name _____ Initial _____ Last Name _____ (PLEASE PRINT)

Address _____ Apt. _____

City _____ State _____ Zip _____

Telephone (Area code) _____

Signature _____

We reserve the right to request additional information or reject any application. Limited to new members, continental USA only. One membership per family. Local taxes, if any, will be added.

ZLU33 CZ

How to make an Onkyo receiver as good as its competition.

Eliminate room-to-room remote capability

Remove high capacity Onkyo transformer

Substitute smaller, less efficient heat sink

Replace metal with cheap plastic

If we wanted to make an Onkyo receiver as good as our competition, it wouldn't be too hard.

First, we'd remove our proprietary heavy duty transformer, replacing it with a commonly used smaller version. Unfortunately, this means less current capability, resulting in compromised low impedance performance and compressed musical dynamics. Sonic anemia.

Next, we'd substitute a much lighter, cheaper heat sink. Of course, this greatly increases the chance of thermal overload when the music's cooking, but since we'd already be using a low capacity transformer, the music would only be half baked anyway.

Room-to-room remote capability would have to be

sacrificed. After all, if we're not concerned with performance, why should we bother with convenience?

As a finishing touch, faceplates & chassis would be plastic instead of metal. True, that wouldn't give us the same structural integrity. But we'd be cutting so many other corners you'd probably never notice the difference.

Now, we could do all these things to an Onkyo receiver. But then we wouldn't have a component as extraordinary as our new TX-866, with 185 watts per channel of dynamic power, plus the ultimate in room-to-room musical control.

At Onkyo, all our receivers are built to be better. And, that's a difference you can hear—and see.



ONKYO®

200 Williams Drive, Ramsey, N.J. 07446 201-825-7950

CIRCLE NO. 47 ON READER SERVICE CARD



YAMAHA CDC-805 COMPACT DISC CHANGER

Julian Hirsch, Hirsch-Houck Laboratories

THE Yamaha CDC-805 CD changer can play as many as five discs automatically in addition to operating as a conventional single-disc player. Its carousel-type disc-changing system uses a rotating tray that extends across most of the panel width. Pressing the open/close button on the panel causes the tray to slide forward, revealing numbered disc wells for five CD's (either 5- or 3-inch diameter). A single disc is normally placed in Position 1; others can be added as desired for multidisc operation. A second touch on the button returns the disc tray to its playing position. Yamaha's carousel system, which the company calls PlayX-change, enables the user to remove or change any nonplaying discs while one is being played.

The disc tray is at the top of the front panel, above the display window and two rows of small buttons. The display shows the disc numbers (1 through 5), the current track number, and its elapsed playing time in minutes and seconds. Other status information appears in the window as required. The level at the CDC-805's line and headphone outputs is

electronically variable, controlled by a rocker switch on the panel.

The standard CD-player operating controls, located at the right side of the panel, include play, pause, stop, track skip, fast scan (search) in either direction, random-play, and repeat. The lower row of buttons below the disc tray gives direct access to any of the discs for single-play operation as well as direct access to any track up to No. 99.

The CDC-805 has an unusual feature (for a CD player) identified as a Digital Equalizer. In addition to the normal FLAT response, four other frequency-response characteristics—identified as CLASSIC, VOCAL, JAZZ, and ROCK—can be selected by pressing the appropriate buttons.

The CDC-805 can be programmed to play the tracks of the designated disc in any order or to play as many as forty tracks selected from any of the five discs in its disc tray. A Program File can store track selections for as many as a hundred discs as well as selected equalization characteristics.

A novel Relay Play feature enables two CDC-805's to be linked for a total playback capacity of ten

discs. The two can be programmed to play discs alternately or to play all the discs in one machine before going to the other. The audio output of the second player is connected to input jacks on the first so that the amplifier/speaker system can treat the linked players as a single unit.

The infrared remote control supplied with the CDC-805 duplicates every control on the main unit except its power switch. It also adds a few functions not found on the player itself, such as an index button that replaces the playing-time indication in the display with the current index number (where applicable). In the index-display mode, the track-selector buttons also serve as direct-access index selectors, a rare feature in CD players. A feature unique to this remote control is a duplicate set of disc-selector buttons that affect only the slave player in relay operation.

Yamaha's specifications for the CDC-805 include a frequency response of 20 to 20,000 Hz ± 0.5 dB, de-emphasis equalization accurate within ± 0.5 dB, and channel separation greater than 85 dB at 1,000 Hz. Total harmonic distortion plus noise (THD + N) is rated as less than 0.0035 percent at 1,000 Hz, signal-to-noise ratio (S/N) as 105 dB, and dynamic range as more than 95 dB.

The CDC-805 measures 17 $\frac{1}{8}$ inches wide, 14 $\frac{3}{4}$ inches deep, and 4 $\frac{1}{4}$ inches high, and it weighs 13 pounds, 10 ounces. Our test sample came with Yamaha's attractive tita-

TEST REPORTS

niium-gray finish, but the player is also available in black. Price: \$499. Yamaha Electronics, Dept. SR, 6722 Orangethorpe Ave., Buena Park, CA 90620.

Lab Tests

The Yamaha CDC-805's output voltage from a 0-dB, 1,000-Hz test track was 2.07 volts, close to the standard 2-volt CD-player output. Its frequency response was very flat, well within ± 0.1 dB from 15 to 15,000 Hz and down 0.5 dB at 20,000 Hz. De-emphasis response error was between +0.25 and -0.12 dB from 1,000 to 16,000 Hz.

Channel separation was 95 dB at 100 Hz, 91 dB at 1,000 Hz, and 69 dB at 20,000 Hz. At 1,000 Hz the playback THD + N was -88 to -90 dB (0.003 to 0.004 percent) relative to full output (0 dB), depending on signal level. At a 0-dB recorded level, the distortion was -86 to -88 dB (0.004 to 0.005 percent) from 20 to 1,000 Hz, rising to a maximum of -75 dB (0.018 percent) at 10,000 Hz.

The maximum interchannel phase shift measured 2.6 degrees above 16,000 Hz.

Although the manual doesn't mention it, the CDC-805 uses a 1-bit pulse-width-modulation (PWM) digital-to-analog (D/A) conversion system that includes the MASH noise-shaping circuit. As a result, low-level linearity of its D/A converters was very good, with errors typically less than 0.5 dB from -60 to -90 dB. The noise spectrum (with de-emphasis) of an unmodulated (zero-level) test track was between -120 and -130 dB from 30 to 20,000 Hz. Dynamic range (EIAJ) was 94.2 dB, and quantization noise was -88.5 dB. The A-weighted broad-band noise level was -104.6 dB.

We also measured the frequency response of the CDC-805's Digital Equalizer circuit. The VOCAL response was peaked about 4 dB at 500 Hz and 2 dB at 4,000 Hz, relative to the 1,000-Hz level. The CLASSIC response had a broad 3-dB plateau from 50 to 100 Hz and another from

5,000 to 10,000 Hz. The JAZZ and ROCK settings produced similar characteristics, with a 5-dB boost at 100 and 10,000 Hz.

The CDC-805 was fairly good in its resistance to impacts: A moderate slap on the sides or top could induce a momentary skip or drop-out. Defect tracking was adequate but hardly outstanding: The player tracked 750-micrometer interruptions successfully, but a 1,000-micrometer interruption caused it to jump to an earlier track. Cueing time between Tracks 1 and 15 of the Philips TS4 test disc was 2.9 seconds. Cueing time increased to about 10 seconds when a disc change was involved. The headphone volume was very good.

Comments

The Yamaha CDC-805 proved to be a very good CD player in almost every respect. Defect-tracking ability and impact resistance were its weakest points, though few users would ever detect any shortcomings in practice. Its sound was excellent, and mechanical noise was virtually inaudible even while it was changing discs.

The instruction manual is well illustrated and generally thorough, and the operation of the player is logical. We would not expect a user to encounter any difficulty operating this versatile player, although some of its special features are not mentioned in the manual or not emphasized enough to make one aware of their significance.

The Digital Equalizer did create the sort of sound that would seem compatible with the several types of program material indicated, and the amount of equalization was modest and never overbearing. Nevertheless, we question the desirability of including this feature in a CD player. It is more appropriate to a preamplifier or control amplifier.

All in all, Yamaha has created a very nice response to the need for longer uninterrupted playing time from CD's with no sacrifice of performance or ease of use. The CDC-805 offers a fine combination of utility, versatility, and quality in a very handsome package at a moderate price.

Circle 140 on reader service card

FEATURES

- 1-bit D/A conversion with MASH noise shaping
- Plays one to five discs automatically (either 5- or 3-inch size)
- Display of disc, track, and index numbers, elapsed time in track, status of operating modes
- Discs can be loaded into or removed from carousel without interrupting play
- Relay Play enables two players to be coupled for ten-disc capacity
- Programmable to play as many as forty tracks from one or more discs in any order
- Equalization presets for four different types of music as well as flat response
- Program File to store track selections and equalization settings for as many as a hundred discs (with an average of ten selections each)
- Repeat and random play
- Direct track and index access
- Headphone jack
- Volume control for headphone and analog line outputs
- Optical digital outputs
- Infrared remote control duplicates all front-panel controls except power switch; compatible with other Yamaha RS series system remote controls
- Player can be operated from remote control of any other Yamaha RS component

LABORATORY MEASUREMENTS

Maximum output level: 2.07 volts

Total harmonic distortion at 1,000

Hz: 0.004% at 0 dB, 0.0039% at -20 dB, 0.0035% at -70 dB

Signal-to-noise ratio (A-weighted): 104.6 dB

Dynamic range: 94.2 dB

Channel separation: 69 dB at 20,000 Hz, 91 dB at 1,000 Hz, 95 dB at 100 Hz

Maximum interchannel phase shift: 2.7 degrees at 17,000 Hz

Frequency response: +0, -0.5 dB from 20 to 20,000 Hz

Low-level linearity error: +0.38 dB at -60 dB, +0.18 dB at -70 dB, -0.7 dB at -80 dB, +0.4 dB at -90 dB

Speed error: -0.0012%

Slewing time: 2.9 seconds

Impact resistance: top and sides, B+

Defect tracking: tracked 750-micrometer defects on Pierre Verany #2 test disc

Only Sony records the music,



mixes the music,



masters the music



and creates the Compact Discs themselves.



So why play around with anyone else?

You don't have to be a digital audio expert to pick the right CD changer. You just have to know who the expert is. Sony. In the studio, Sony digital recorders capture all the energy and emotion of the music. Then Sony professional expertise takes the music every

step of the way home. So to recapture that same energy and emotion, listen to the Sony CDP-C705 Carousel Changer.

Marvel at its 5-disc convenience. Thrill to its sound. And discover you get more out of the music from the people who put more into it.



SONY

THE LEADER IN DIGITAL AUDIO™

The Audio Ana

If you ask five different audiophiles which is the best high bias audio cassette to record music on, you're likely to get five different opinions. But if you ask the Audio Precision Analyzer™ you'll get a definitive answer, right there in living color: TDK SA-X.

The Audio Precision Analyzer is one of the most sophisticated pieces of laboratory equipment of its kind. It's used by audio engineers to evaluate an audio cassette's performance in a variety of areas. Two of the most critical of these areas are MOL (Maximum Output Level) and bias noise, which together are used to measure what is known as *dynamic range*.

MOL is indicated by the curve at the top of

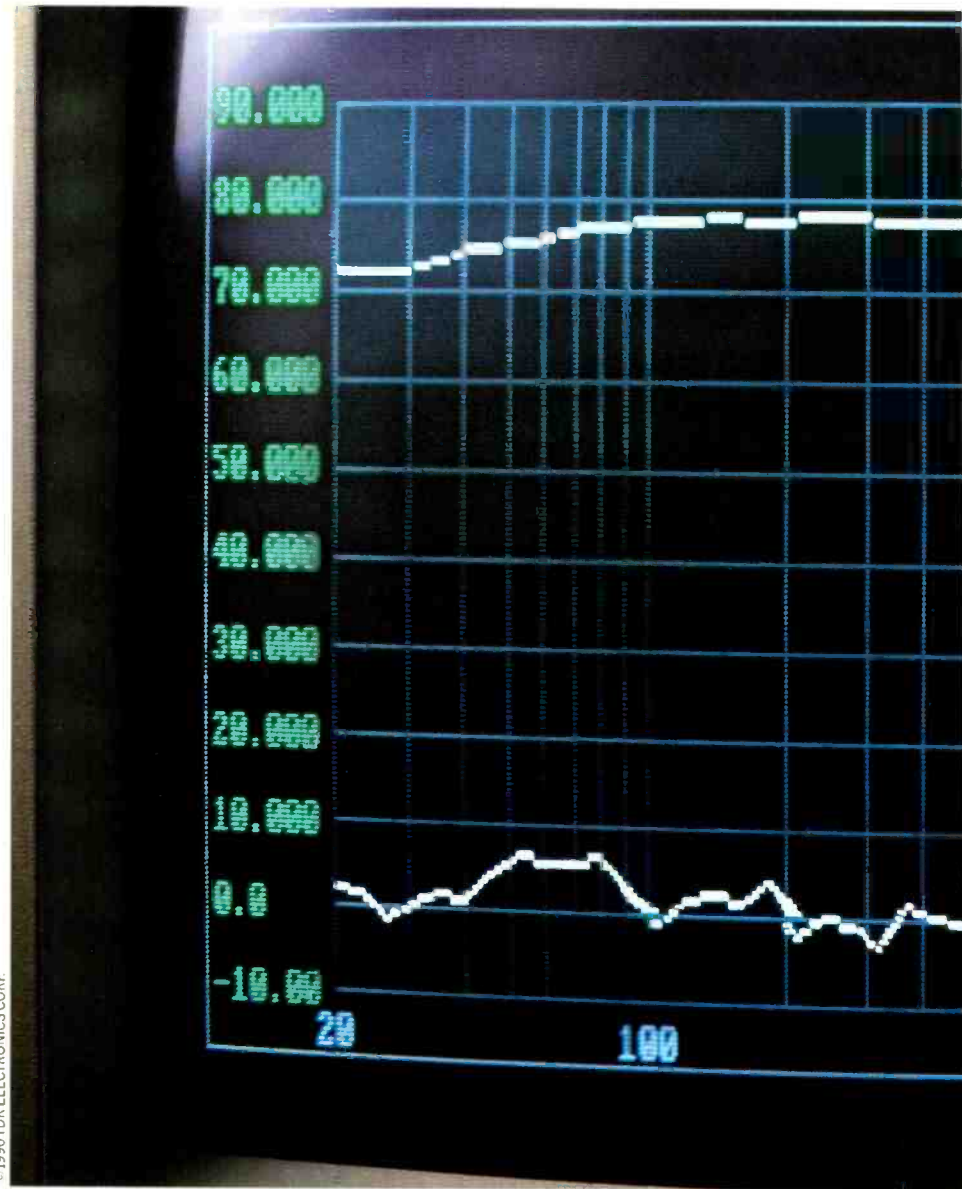

© 1990 TDK ELECTRONICS CORP.

TDK SA-X's DYNAMIC RANGE, THE WIDEST OF ANY HIGH BIAS the analyzer's monitor; bias noise is indicated by the curve at the bottom. The vertical distance between any two points on these curves is the measure of an audio cassette's dynamic range at that particular frequency.* The greater the distance, the greater the dynamic range. And the greater

lyzer Never Lies.

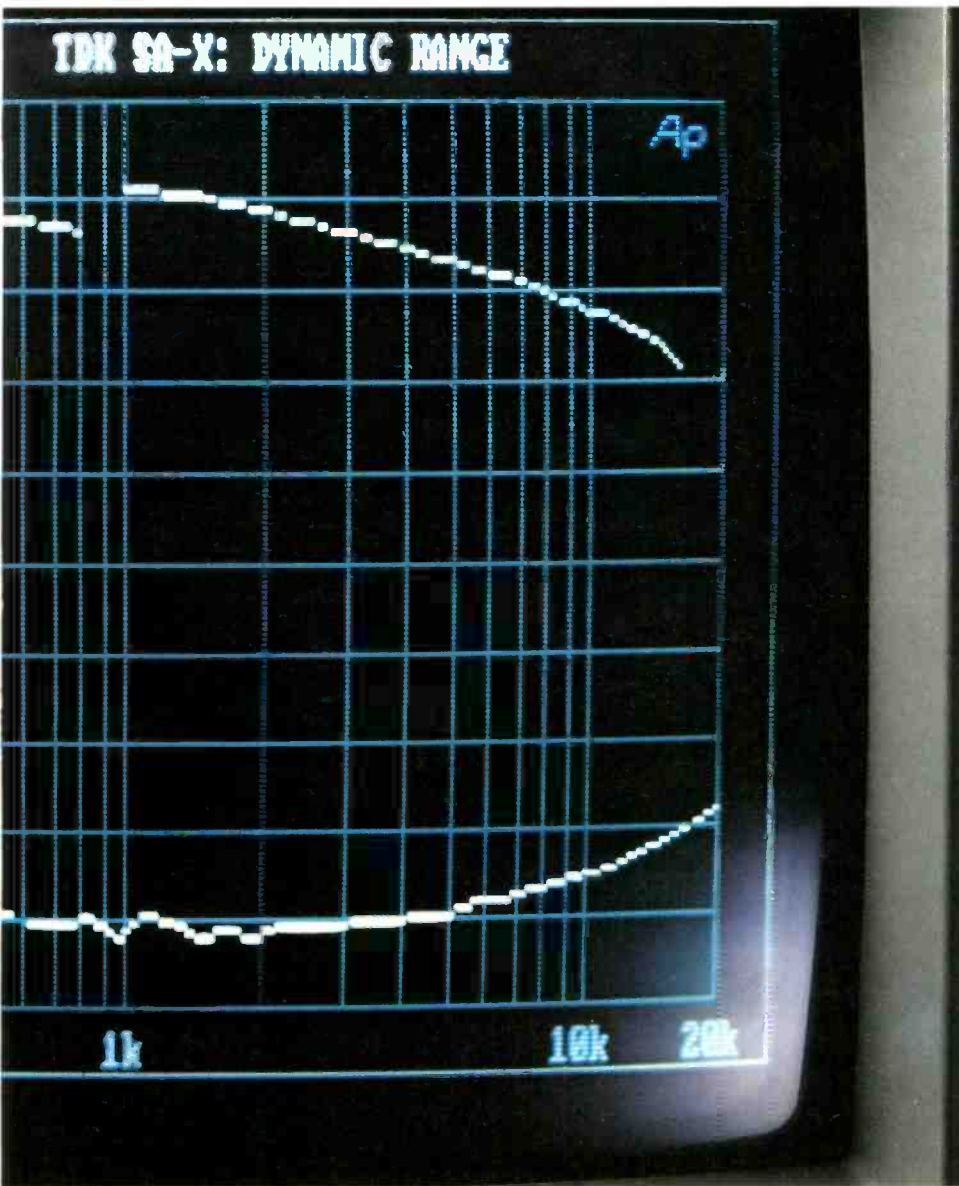

What the analyzer told *Audio*—in no uncertain terms—was TDK SA-X's dynamic range was the widest of all Type II audio cassettes tested. Which makes it the best tape you can use to capture the fortissimos, pianissimos, and transients of today's music sources.

So if you want the most faithful sound reproduction you can get from a high bias tape, look at what the Audio Precision Analyzer is telling you. And listen to TDK.

*Vertical Scale normalized to 0 dB for illustration purposes.

TAPE, IS SHOWN HERE ON AN AUDIO PRECISION ANALYZER.

the dynamic range, the more sound the cassette can faithfully reproduce.

When *Audio* magazine conducted an exhaustive test of 88 blank audio

cassettes (the results of which were published in the March 1990 issue), it utilized an Audio Precision Analyzer to evaluate dynamic range.



As Serious As You Can Get.



JBL XPL140 SPEAKER SYSTEM

Julian Hirsch, Hirsch-Houck Laboratories

THE JBL XPL140, a moderate-size floor-standing three-way speaker system, is unusual in its use of titanium-dome drivers for the mid-frequency and treble ranges. Its 1-inch tweeter operates above 4,000 Hz, where there is a crossover from the 3-inch dome midrange driver. The 8-inch woofer, which operates below 900 Hz, is in a vented enclosure whose port is on the rear of the cabinet.

The upper half of the speaker cab-

inet's front panel, containing the midrange and high-frequency drivers, is stepped back to place the effective locations of the three drivers in the same plane, thereby preserving the time alignment of their respective contributions to the total sound output. The stepped portion of the panel is covered by a resilient rubber-like foam material to minimize diffraction and consequent response irregularities. A removable gray cloth grille normally covers the entire panel.

Set into the rear of the cabinet below the woofer port are two pairs of gold-plated multiway binding posts, normally joined by gold-plated jumpers, that are spaced to accept dual banana plugs. Removing the jumpers permits biwiring or biamplification, with the low and high frequencies carried by separate cables from a single amplifier or from separate amplifiers. Near the terminals is a small switch that can drop the tweeter output by 2 dB from its nominally flat setting.

The system's specifications include a frequency response of 50 to 21,000 Hz ± 2 dB and a usable response of 35 to 25,000 Hz at the -6-dB points. Its rated sensitivity is 88 dB sound-pressure level (SPL) at 1 meter with a 2.83-volt driving signal, and the nominal impedance is 6 ohms. The system is rated to handle 125 watts continuously or 500 watts on program peaks.

The cabinet of the XPL140 stands 30½ inches high and has a tapered cross section. It measures 12 inches deep, 13¼ inches wide at the front, and 11 inches wide at the rear. The cabinet is available in a number of wood-veneer finishes as well as a high-gloss lacquer finish. Each speaker weighs about 50 pounds.

JBL's detailed installation instructions state that stereo imaging is often improved by tilting the speaker slightly backward to optimize the drivers' phase alignment relative to the listener's ear. For this purpose, removable adjustable feet are provided for installation under the front of the cabinet. Price: \$1,998. JBL, Dept. SR, 240 Crossways Park West, Woodbury, NY 11797.

Lab Tests

We installed the JBL XPL140 speakers as recommended, about 7 feet apart, 2 feet from the wall behind them, and 4 feet from side walls, angled slightly inward and tilted back on their adjustable feet. The maximum tilt was slight, perhaps 5 degrees.

The close-miked woofer response, combined with the port output, was flat within ± 1.5 dB from 25 to 240 Hz. It dropped off smoothly at higher frequencies to about -11 dB at 900 Hz referred to the maximum output at 100 Hz.

The first CD Carousel with Denon sound quality.



The sound quality and performance features that have made Denon Single-play CD players widely regarded as the best sounding have now been incorporated in Denon's first Carousel CD player.

The 5-disc DCM-350 features the same 8X oversampling, 20-bit digital filter and dual Super Linear Converters found in Denon's top-rated models. Denon's dedication to performance means that each Super Linear Converter is hand-tuned for lowest noise and best linearity. This advanced digital signal processing and conversion system fully resolves musical detail and

accurately reproduces all the liveliness and air of the original recording.

In multi-disc players, the transport is an important key to performance. The superior transport technology which has made Denon famous in both CD and turntable categories is found in the DCM-350. Its integrated laser transport and disc carousel not only provides outstanding acoustic and mechanical isolation, it also allows uninterrupted play while two of the five discs are changed.

If the essence of a CD changer is convenience, the DCM-350 covers this base in

spades. It offers a 32 track memory plus programmable, disc sequential and full random play modes; all terrific features in a multi-disc machine. Plus, there is a full-function remote control with direct track selection from the remote's keypad. Recognizing that the DCM-350 will find its way into many of the most sophisticated systems, Denon has even provided a coaxial digital output.

Carousel CD changers have been out for a while now. But the DCM-350 is the first to carry the Denon name. Which again proves Denon's belief that being best is more important than being first.



Enter the Denon 80th Birthday Sweepstakes. Win a trip to Japan or over 40 terrific hi-fi prizes. Look for displays and entry boxes at participating record, tape and audio retailers.

For complete details (and entry blank) write to "Denon's 80th Birthday Sweepstakes," P.O. Box 118, Hollywood, CA 90078. No purchase necessary. Must be 18 years of age or older to enter.



Japan Airlines

Denon America Inc., 222 New Road, Parsippany, NJ 07054 (201) 575-7810

DENON
The first name in digital audio.

CIRCLE NO. 27 ON READER SERVICE CARD

The averaged room response of the two speakers showed a slightly elevated but relatively uniform bass section, with a middle- and high-frequency response within ± 3 dB from 300 to 20,000 Hz. The separate woofer response curve overlapped the room curve for more than two octaves, from 200 to 900 Hz. The resulting composite frequency response was ± 5.5 dB from 20 to 20,000 Hz. The tweeter-level switch had a very subtle effect on the sound of the system, slightly reducing the output above 6,000 Hz (about 1 dB at 10,000 Hz and a maximum of 2 dB at 20,000 Hz).

Quasi-anechoic FFT response measurements confirmed the essential characteristics of the room-response curve. A dip at about 4,000 Hz appeared to be a tweeter crossover effect, and the woofer response, which was strong and fairly uniform up to 250 or 300 Hz, sloped down at higher frequencies. The result was an overall frequency response whose lower end was about 5 dB higher on average than the middle and higher frequencies. Minor irregularities in the midrange and treble response were caused in part by normal measurement artifacts in a live room and in part by the inherent response of the speaker system.

The system's horizontal dispersion was fair. The response curves

on-axis and at 45 degrees off the speaker's axis diverged by about 6 dB at 7,000 Hz and by at least 20 dB at 15,000 Hz. The tweeter's response on the forward axis was down only 6 dB at 22,000 Hz, however. Probably in part thanks to the antidiffraction treatment of the speaker board, the group-delay variation was only ± 0.2 millisecond from 1,500 to 22,000 Hz and about ± 0.05 millisecond from 5,000 to 22,000 Hz.

The minimum system impedance was 4.2 ohms at 120 and 8,000 Hz, and it reached a maximum of 20 ohms at 57 Hz, 17 ohms at 750 Hz, and 9.5 ohms at 4,500 Hz. Sensitivity was better than rated, measuring 90.5 dB SPL at 1 meter with 2.83 volts of pink-noise input. The woofer's total harmonic distortion (THD) plus noise at a drive level equivalent to a 90-dB SPL (2.66 volts) was about 0.2 percent from 120 to 300 Hz, rising at lower frequencies to 1 percent at 75 Hz, 4 percent at 40 Hz, and 10 percent at 20 Hz.

In our power-handling tests, using a single-cycle-burst test signal, the woofer cone rattled at 610 watts into its 4.5-ohm impedance at 100 Hz. At higher frequencies the driving amplifier clipped, at levels ranging from 500 to more than 1,200 watts, before the speaker gave evidence of serious overload.

Comments

Our test samples of the JBL XPL140 had a mirror-like black-lacquer finish that would do justice to a fine piano. When we unpacked the speakers, we noted that white gloves were supplied in the interest of preserving their superb finish during the unpacking and setup process. Another nice touch was the inclusion of a special plastic socket wrench for loosening and tightening the binding-post connectors.

Although we have commented in the past on the relatively poor correlation between the measured frequency response of loudspeakers and the way they sound in actual use, the JBL XPL140 was one of the exceptions that (perhaps) proves the rule. It had a somewhat warm, soft quality that seemed consistent with the shape of its frequency-response curve in our measurements. Unlike many other speakers about which the same could be said, however, the XPL140 was essentially free of the tubbiness and muddy quality that often come with an emphasized bass response. Though it did not have the kind of floor-shaking, ear-popping bass that comes from a huge subwoofer, its low end was more than one expects to hear from a single 8-inch cone in a cabinet of modest size.

The middle and high frequencies sounded smooth (much smoother than the response curves might suggest) but without the "sizzle" that is often characteristic of metal-diaphragm drivers. Overall, the JBL XPL140 was a very smooth, easy-sounding, yet wide-range speaker with a well-balanced musical quality. Its imaging was good, too, though not as striking as that of some other speakers we have heard.

In many respects, the XPL140 seems to bridge the performance and size gap between high-quality smaller speakers (usually based on a 6-inch woofer) and larger, three-way floor-standing systems with 10-inch or larger woofers and correspondingly large (and heavy) cabinets. Its size and weight are manageable, its sound is excellent, and it makes a truly handsome piece of furniture.

Circle 141 on reader service card



"Okay! Who the hell took my Swiss Army knife!!!"



PHILIPS LHH500. A QUIET REVOLUTION IN CD TECHNOLOGY.

Philips, the inventor of CD technology, introduces the next generation in digital audio sound. The LHH500, Philips' most recent Reference Series CD player, delivers audio quality that truly transcends the digital domain.

This superb musicality is attributable to Philips Bitstream PDM (Pulse Density Modulation) D/A Conversion technology. With 1-bit, 256 times oversampling, Bitstream PDM D/A Conversion technology greatly enhances low-level linearity. Quiet passages are reproduced with previously unattainable accuracy. Overall performance achieves a level of depth, warmth and ambience traditionally associated with the best in analog reproduction.

The LHH500 is only the second compact-disc player offered to consumers that bears the professional LHH designation. This heritage of broadcast-quality CD and mastering playback equipment is evident in its uncompromising sound reproduction. To experience this unequalled performance firsthand, call 1-800-223-7772 for your nearest Philips audio specialist.

WORLD-CLASS TECHNOLOGY. EUROPEAN EXCELLENCE.

© 1990 Philips Consumer Electronics Company, A Division of North American Philips Corporation



PHILIPS

Presenting the Limited Edition Bose® 901®

A Very Limited Edition.

Elegance and Performance for a select few.

The 901 Concerto system. Inspired by one of the great symbols of live music — the concert grand piano. Witness the elegant look of black lacquer — hand polished to a deep, ultra-gloss sheen. Its visual richness affirms that you are only satisfied with the best from Bose. The Concerto is a limited edition of the legendary Bose 901 Series VI Direct/Reflecting speaker — the most critically acclaimed loudspeaker in the world. As our flagship product, it sets the standard for musical realism, dynamic range and bass reproduction.

Destined to become a collector's item.

To commemorate this rare offering, you'll receive a beveled jade lead crystal plaque, along with a parchment certificate of ownership and a special CD developed specifically for demonstrating the benefits of 901 speaker technology.



Act now.

To avoid disappointment, we encourage you to place your order early. Because when the Concerto systems are gone, they're gone forever.

The system price of \$2,200.00 includes custom high-gloss black pedestals and 901 Series VI active equalizer.

Concerto System

Hailed by the Critics:

"The Bose 901, fortified against the rigors of the digital age, still makes the listening room seem to expand."

"It is apparent from the first note why so many listeners are captivated by this speaker."

Hans Fantel,
The New York Times, 1990

"...I must say that I have never heard a speaker system in my own home which could surpass, or even equal, the Bose 901 for overall 'realism' of sound."

Julian Hirsch, Stereo Review, 1968

"...it has a total sound that soars, with a brilliance that defies description."

Modern Hi-Fi & Music, 1977

"If music is important in your life, sooner or later you will own a Bose system."

The 901 Concerto system is available through select participating dealers and directly from Bose.

To order or obtain further information, please call:

1-800-444-BOSE

Between 8:30AM and 9PM(ET)

CIRCLE NO. 24 ON READER SERVICE CARD

BOSE
Better sound through research.



JOCK P. LEUNG

CARVER CT-6 TUNER/PREAMPLIFIER

Julian Hirsch, Hirsch-Houck Laboratories

THE current Carver line of audio components includes several compact, low-profile units that provide excellent performance in minimal space. One of these is the new CT-6 tuner/preamplifier, which is about as compact as such a product can possibly be without sacrificing functionality. Its chassis measures 17 inches wide, 13 inches deep, and only 1 7/8 inches high. It weighs only 8 3/4 pounds.

The CT-6 has inputs for a moving-magnet phono cartridge, four high-level inputs, and two tape-recorder loops with monitoring and dubbing provisions. It also incorporates the proprietary Carver Sonic Hologram Generator, a circuit designed to cancel interaural crosstalk, which extends the stereo sound stage beyond the area defined by the speakers. To obtain the full effect of Sonic Holography, the positions of the speakers and listener must be adjusted to a close tolerance, but the result can be very impressive. (The circuit can be switched off when desired.)

The CT-6 contains a digital-synthesis AM/FM tuner with twenty sta-

tion presets. It has both manual tuning and preset scan or auto scan (which finds the next receivable station in the band), and there is a stereo/mono switch. In addition, the CT-6 incorporates Carver's exclusive Asymmetrical Charge-Coupled FM Detector (ACCD). This switchable circuit can strikingly improve the reception of a weak stereo signal plagued by multipath distortion by replacing the stereo difference component (L - R) with a low-noise substitute derived from the quieter mono sum (L + R) signal. The result is a signal having most of the essential content of the original stereo broadcast but with less noise and distortion.

Because of its small size, rather than merely styling considerations, most of the CT-6's controls are small, round, momentary-contact pushbuttons, clearly marked and well spaced. Many of them form a row across the bottom of the panel.

In this row are the ten preset selectors and the tuner mode selectors. Each preset button can select two memorized channels. For instance,

a momentary touch on button 4/14 calls up preset No. 4; holding it in for about 2 seconds selects preset No. 14. The display window shows the current tuner frequency, and preset channel number if applicable, in large numerals. Three red lights to its left indicate relative signal strength. Red LED's show the status of the operating features.

Other buttons to the right of the display select the program source and switch the Sonic Holography circuit on and off. The loudness-compensation button is one of three mechanically latching controls. The others, at the far left of the preset buttons, switch the tape-monitoring circuits on and off and select between the two tape sources.

The CT-6 does have a few control knobs, though only the volume control is large enough to be perceived immediately as a knob (it also carries a green LED position indicator). Three small center-detented knobs adjust balance, bass, and treble, and another switches the tape-recording outputs to the selected source or interconnects the two tape decks for dubbing in either direction. A large, square momentary-contact power button and a headphone jack complete the front-panel controls.

The rear of the CT-6 is populated by eighteen phono jacks for the various inputs and outputs. There are binding posts for the supplied wire-

MAGNATUDE.

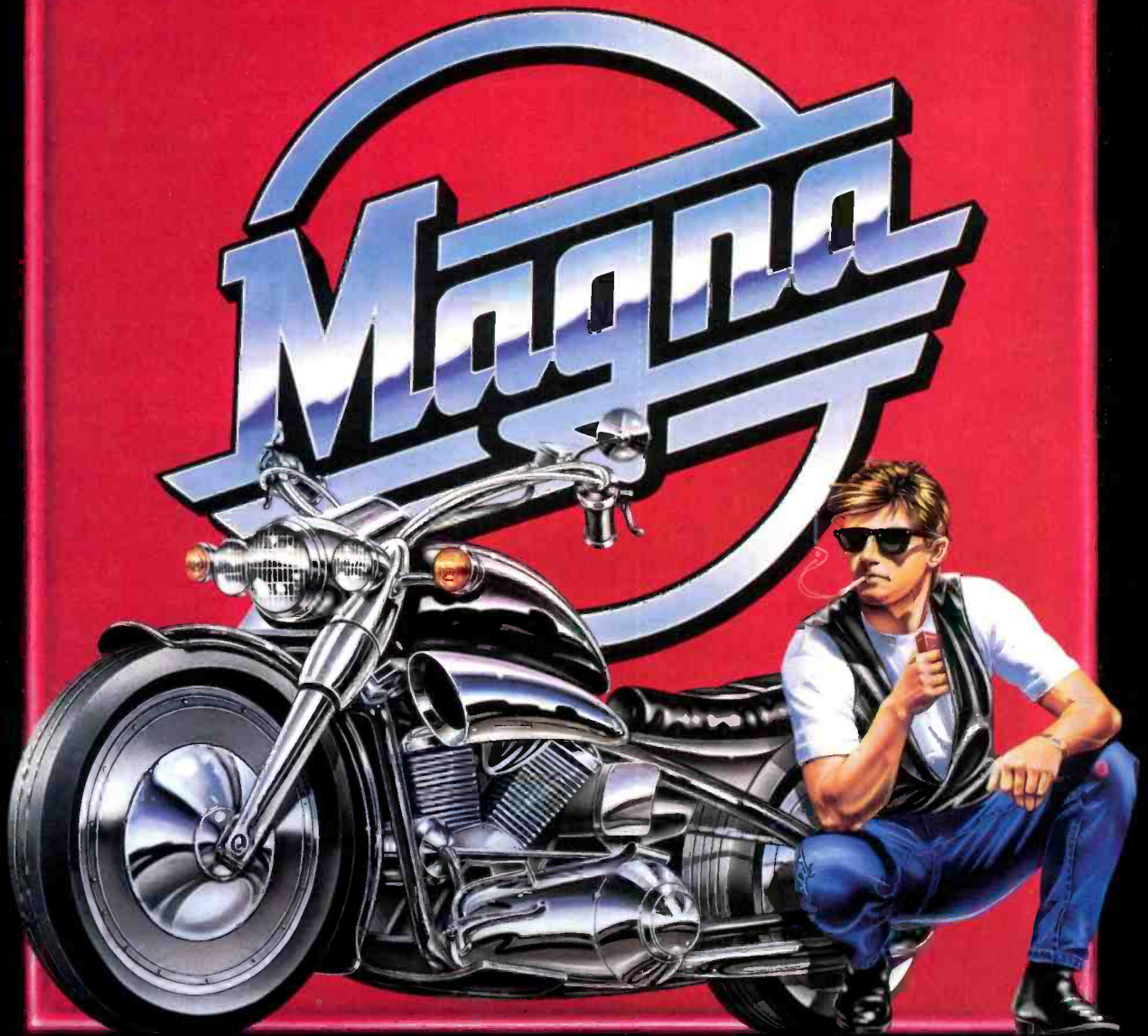

15 mg. "tar", 1.0 mg. nicotine av. per cigarette by FTC method.

Magna

© 1990 F.J. REYNOLDS TOBACCO CO.

SURGEON GENERAL'S WARNING: Smoking By Pregnant Women May Result in Fetal Injury, Premature Birth, And Low Birth Weight.

loop AM antenna and a coaxial 75-ohm FM antenna jack. Two of the four AC outlets are switched.

The CT-6 is furnished with a compact infrared remote control that duplicates almost every front-panel function, including a pair of UP/DOWN buttons that operate the volume control by means of a small electric motor. Although the tape-monitoring and record-selection functions cannot be operated from the remote, it has a mute button (not present on the front panel) that drops the audio level by 20 dB, changing the color of the indicator in the volume-control knob from green to red. The remote control also has several

buttons dedicated to controlling the primary functions of several current Carver CD players. Price: \$550. Carver, Dept. SR, 20121 48th Ave. W., Lynnwood, WA 98036.

Lab Tests

The frequency response of the Carver CT-6's preamplifier section (through the CD input) was flat within +0, -0.5 dB from 20 to 10,000 Hz and down 1.1 dB at 20,000 Hz. The tone controls had a maximum range of +11, -12 dB at 20 Hz, and +9, -11.5 dB at 20,000 Hz. The bass control's turnover frequency varied from below 100 Hz to about 400 Hz, and the treble control's response

curves were hinged at about 3,000 Hz. At its extreme counter-clockwise setting the bass control also reduced the overall level by 2 dB, but otherwise the controls had no effect on frequencies beyond their designed ranges of operation.

The RIAA phono-equalization error was ± 0.4 dB from 20 to 2,500 Hz and down 1.5 at 20,000 Hz. The loudness compensation boosted both low and high frequencies slightly at most usable settings, by a maximum of about 7 dB at 20 Hz and 2 dB at 20,000 Hz.

The input sensitivity for a 0.5-volt reference output at 1,000 Hz was 136 millivolts (mV) for the CD input and 2.2 mV for the phono input. The A-weighted signal-to-noise ratio (S/N) was 94.5 dB for CD and 69.7 dB for phono. The clipping-level output of the preamplifier into an EIA standard load of 10,000 ohms and 1,000 picofarads (pF) was 3.85 volts. The phono preamplifier overloaded at inputs between 136 and 142 mV over the range of 20 to 20,000 Hz. Its input termination was 47,000 ohms in parallel with 114 pF.

The 1,000-Hz total harmonic distortion plus noise (THD + N) was between 0.04 and 0.05 percent from an output of 2 volts to the clipping point. A spectrum analysis of the distortion at a 1-volt output showed several low-level harmonics, corresponding to a THD of -84 dB, or 0.006 percent.

The FM tuner had a usable sensitivity of 12.8 dBf in mono and, unlike most other tuners, had no stereo threshold. Stereo signals were received with full separation down to the lowest measurable levels, with a usable sensitivity in stereo of 18 dBf. The 50-dB quieting sensitivity was 25.5 dBf for mono, 38 dBf for stereo.

The S/N at 65 dBf was 79 dB in mono and 72 dB in stereo, with corresponding distortion readings of 0.1 and 0.062 percent. Stereo channel separation was between 40 and 45 dB from 30 to 10,000 Hz, falling to 36 dB at 15,000 Hz.

The capture ratio was 2.2 dB, and AM rejection was 67 dB. Image rejection was a rather low 45 dB, but selectivity was good, measuring 66 dB for alternate-channel spacing and 12 dB for adjacent-channel spacing. The 19,000-Hz pilot-carrier leakage

FEATURES

- | | |
|---|---|
| <ul style="list-style-type: none"> <input type="checkbox"/> Compact, low-profile chassis <input type="checkbox"/> Digital-synthesis AM/FM stereo tuner <input type="checkbox"/> Twenty station presets <input type="checkbox"/> Asymmetric Charge-Coupled Detector circuit to reduce noise and distortion on weak stereo FM signals <input type="checkbox"/> Manual, auto-scan, or preset-scan tuning <input type="checkbox"/> 75-ohm coaxial FM antenna input <input type="checkbox"/> Detachable loop AM antenna <input type="checkbox"/> Four high-level inputs, moving-magnet phono input | <ul style="list-style-type: none"> <input type="checkbox"/> Two tape-recording/monitoring loops with dubbing in either direction <input type="checkbox"/> Sonic Holography <input type="checkbox"/> Bass and treble tone controls, balance control <input type="checkbox"/> Front-panel headphone jack <input type="checkbox"/> Volume knob motor-driven from remote control <input type="checkbox"/> Switchable loudness compensation <input type="checkbox"/> Four AC outlets, two switched <input type="checkbox"/> Wireless remote control (duplicates most front-panel functions) plus audio mute and basic controls for Carver CD players |
|---|---|

LABORATORY MEASUREMENTS

- | | |
|---|--|
| <ul style="list-style-type: none"> <input type="checkbox"/> Tuner Section (all figures for FM only except frequency response; measurements in microvolts, or μV, referred to 75-ohm input) Usable sensitivity: mono, 12.8 dBf (1.2 μV); stereo, 18 dBf (2.2 μV) 50-dB quieting sensitivity: mono, 25.5 dBf (5.2 μV); stereo, 38 dBf (21.8 μV) Signal-to-noise ratio at 65 dBf: mono, 79 dB; stereo, 72 dB Harmonic distortion (THD + N) at 65 dBf: mono, 0.1%; stereo, 0.062% Capture ratio at 65 dBf: 2.2 dB AM rejection: 67 dB Selectivity: alternate-channel, 66 dB; adjacent-channel, 12 dB Stereo threshold: see text Pilot and subcarrier leakage: 19 kHz, -67 dB; 38 kHz, -70 dB Hum: -71 dB Stereo channel separation at 100, 1,000, and 10,000 Hz: 45, 43.5, and 41 dB Frequency response: FM, +0.15, -1.1 dB from 30 to 15,000 Hz; AM, -2.5 dB at 20 Hz, -6 dB at 3,900 Hz | <ul style="list-style-type: none"> <input type="checkbox"/> Preamplifier Section 1,000-Hz output voltage at clipping: 3.85 volts 1,000-Hz distortion: 0.006% at 1-volt output, 0.04% at 2.5 volts Frequency response (high level): +0, -0.5 dB from 20 to 10,000 Hz, -1.2 dB at 20,000 Hz RIAA equalization error: ± 0.4 dB from 20 to 2,500 Hz, -1.5 dB at 20,000 Hz Sensitivity (for 0.5-volt output): CD, 136 mV; phono, 2.2 mV A-weighted noise (referred to a 0.5-volt output): CD, -94.5 dB; phono, -69.7 dB Phono-input overload: 136 to 142 mV from 20 to 20,000 Hz Phono-input impedance: 47,000 ohms in parallel with 114 pF Tone-control range: 100 Hz, +9, -9.5 dB; 10,000 Hz, +8, -9 dB Loudness-contour range: 50 Hz, +5 dB; 15,000 Hz, +2.5 dB |
|---|--|

was -67 dB, and the 38,000-Hz sub-carrier was at a low -70 -dB level. The FM frequency response was flat within ± 0.2 dB from 30 to 10,000 Hz and down 1.1 dB at 15,000 Hz. The AM frequency response was down 2.5 dB at 20 Hz and 6 dB at 3,900 Hz relative to the 1,000-Hz level.

Comments

Our tests and use of the Carver CT-6 showed it to be a very flexible component, qualified to be the control center of just about any music system, no matter how complex. In spite of its impressively compact dimensions, it incorporates a full array of standard features as well as some Carver innovations that were originally found only in the company's most expensive tuners and pre-amplifiers. Although Sonic Holography is not always suitable for use because its full benefits depend on the program material and can be experienced by only one or two people at a time, in our limited listening tests of the CT-6 the circuit appeared to function as claimed.

The tuner's ACCD circuit was effective in reducing noise and distortion on weak stereo signals. Although it might seem superficially similar to the channel-blending systems used in some other tuners for stereo noise reduction, it is considerably more complex and has the advantage of providing a higher degree of apparent stereo separation than other systems for a given amount of noise reduction.

Considering its compactness, the CT-6 was surprisingly easy to use. Its controls are more accessible and easier to identify than those of most current receivers. Having virtually all of the front-panel controls duplicated on the remote-control unit also simplifies operation. Moreover, the CT-6's instruction manual is one of the best I have yet seen for a component of this complexity. Its thirty pages are full of easily understood directions, illustrations, and hints for more effective use of the tuner/preamp.

To sum up, the Carver CT-6 is a somewhat unusual but highly effective core component for a music system—a modest midprice system, a high-price, super-power system, or anything between. □

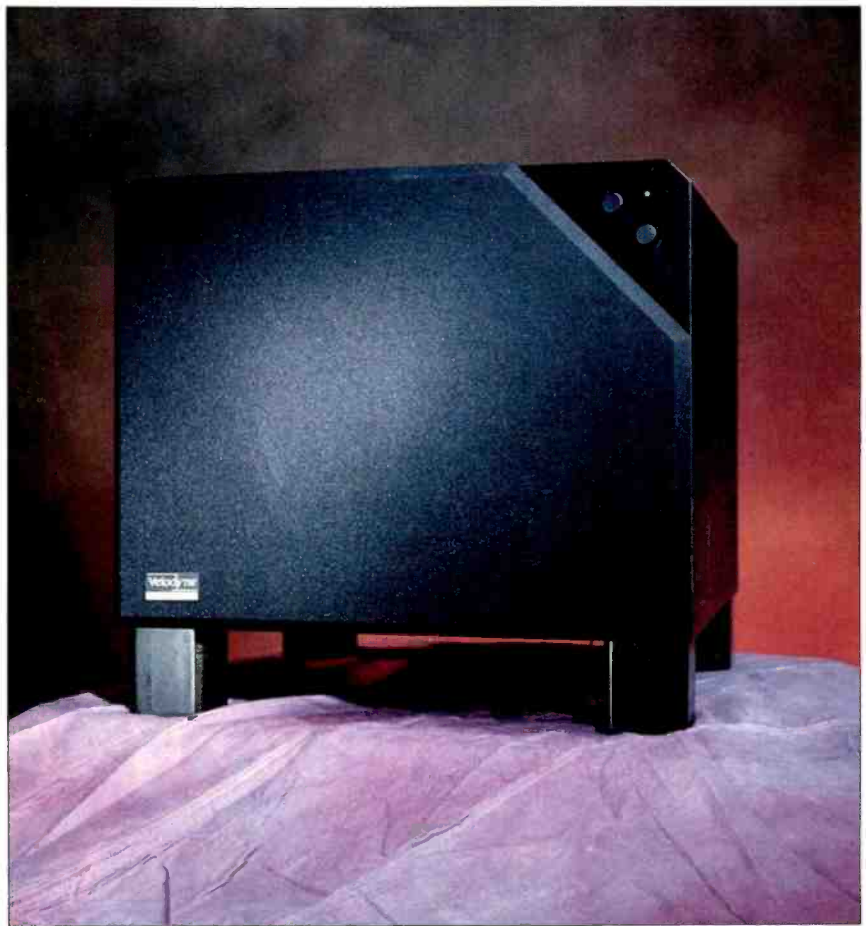

JOOK P. LEUNG

VELODYNE SERVO 1200 POWERED SUBWOOFER

Julian Hirsch, Hirsch-Houck Laboratories

A SUBWOOFER, as its name implies, is a bass speaker designed to operate below the normal frequency range of a typical woofer. Unfortunately, the term is widely misused to refer to the lowest-frequency driver in a system, regardless of its actual operating-frequency limits.

True subwoofers are usually additions to a system's main speakers, separate from them and often from a different manufacturer. Because of a subwoofer's low operating-frequency range, it can be located almost anywhere in a room (frequencies below 100 Hz are not normally localizable by ear). Although some people feel that better results are obtained

by using separate subwoofers for each channel, most subwoofers are designed to sum the low frequencies of the left and right channels and radiate them from a single enclosure.

Velodyne Acoustics, Inc. specializes in subwoofers, and the Servo 1200 is a recent addition to the low-price end of its line. The approximately cubical 60-pound box (18¼ inches square and 16¼ inches high, including its 3-inch feet) houses a 12-inch driver and a 100-watt amplifier. The bass driver is mounted on one side of the box, radiating outward in the conventional manner. The cabinet is finished in black woodgrain vinyl.

The driver has a 56-ounce magnet

At Altec Lansing, we think it's time you had a hand in what you hear. That's the idea behind the new Altec 511 Tower, the first loudspeaker that gives you total control of amplification, tonal balance and imaging for each midrange, tweeter, upper bass and woofer. The result is a sound system that lets you mold the music precisely to your taste, so everything from Mozart to Motown will sound exactly the way you want it.

Five years in the making, this towering achievement lets the discriminating audiophile choose between single, bi, tri or quad amplification and an impressive range of tonal balance levels, all through a simple control panel. So now, you can tell the philharmonic how to conduct itself.

The remarkable 511 Tower is one of twelve new Altec Lansing speakers, all designed to reproduce sound with unheard-of accuracy.

If the new 511 sounds good, call 1-800-Altec 88 for the dealer nearest you. Then take a pair home and tell them what you want to hear.



AN UNHEARD OF ADVANCE IN AUDIO TECHNOLOGY. SPEAKERS THAT LISTEN TO YOU.



**ALTEC
LANSING**

LOUDSPEAKERS FOR THE
WELL TRAINED EAR.

CIRCLE NO. 80 ON READER SERVICE CARD



TEST REPORTS

and a 2 $\frac{3}{8}$ -inch-diameter voice coil with a length of slightly more than 1 inch. A piezoelectric accelerometer mounted on the voice coil senses its motion and supplies a feedback signal to the driving amplifier. This servo action (also known as motional feedback) is said to reduce the acoustic distortion of the subwoofer system and flatten its response.

The Servo 1200 can be driven from an amplifier's normal speaker outputs or at line level from a preamplifier output. Its rated sensitivity is 1 volt at the speaker inputs or 100 millivolts (mv) at the line inputs, which have a nominal 10,000-ohm impedance. The Servo 1200 has a built-in gain-compression circuit that prevents amplifier clipping without affecting its normal operation. An extreme overload or a power-supply fault will automatically shut down the subwoofer's power supply for 5 seconds. A built-in passive, high-pass crossover network channels frequencies above 85 Hz (with a 6-dB-per-octave rolloff) to the satellite speakers (normally the system's regular stereo pair).

The Servo 1200 also has an adjustable active, low-pass crossover system that supplies low frequencies to its internal amplifier and driver. The crossover frequency is adjustable from 40 to 100 Hz, and its initial 6-dB-per-octave slope ultimately steepens to 24 dB per octave.

The back of the cabinet has spring-loaded input connectors for the normal speaker outputs of the system's amplifier and output connectors that deliver frequencies above 85 Hz to the satellite (main) speakers. There are also input and output phono jacks for line-level signals, with the outputs going to the satellites through an external power amplifier. The back panel also contains the knob to adjust the crossover frequency and the line cord. All of these are mounted on a metal plate that serves as a heat sink for the internal power amplifier.

The front of the cabinet has a removable cloth grille retained by plastic fittings, a pushbutton power switch and pilot light, and a knob that adjusts the subwoofer's level relative to the satellite speaker level. In normal use, the Servo 1200 can be left powered at all times. Price: \$895.

Velodyne Acoustics, Dept. SR, 1746 Junction Ave., San Jose, CA 95112.

Lab Tests

We measured the frequency response of the Velodyne Servo 1200 by driving its line inputs directly from the output of our Audio Precision System One. At the 100-Hz setting of the crossover control on the speaker, the close-miked frequency response reached a broad maximum in the 35- to 55-Hz range and was down 6 dB at 20 and 85 Hz. There was almost no difference in the response curve using the 80-Hz

The Velodyne Servo 1200 subwoofer should be able to add at least an octave of useful bass to most home speaker systems.

setting, but with a 60-Hz cutoff the response was down 4 dB at 20 Hz and 6 dB at 78 Hz. The 40-Hz setting produced a maximum response at 25 to 30 Hz, and the response was down 2 dB at 20 Hz and 6 dB at 65 Hz.

We measured the distortion in the acoustic output of the speaker with close microphone spacing, driving the speaker with a 50-Hz input that produced a 90-dB sound-pressure level (SPL) at 1 meter. The crossover control was set at 100 Hz. The high-resolution spectrum analysis in the Digital Domain mode of our System One showed a large number of low-level harmonics (up to the twentieth order) on a 1,000-Hz display width. When the eighteen harmonics whose level exceeded -90 dB were combined in an rms fashion, the equivalent total harmonic distortion (THD) was 0.425 percent.

A conventional measurement of THD plus noise versus frequency at the same input level showed a minimum distortion of just under 0.3 percent at 60 Hz and less than 0.5 percent from 45 to 100 Hz. A 1-percent distortion level was reached at 32 Hz and 2 percent at 25 Hz.

Comments

The measured performance of the Velodyne Servo 1200 indicated that it should be able to add at least an

octave of useful bass to most home speaker systems, including some fairly expensive ones.

We put it to the test, using it both with a pair of inexpensive mini-speakers, Triad System Fives, and a pair of high-quality compact speakers, Celestion SL-12i's. The Triad speakers, not surprisingly, demonstrated the capabilities of the Servo 1200 most dramatically. The combination produced floor-shaking bass that almost seemed out of keeping with the diminutive size of the satellites.

In a sense, however, the Celestion speakers seemed to benefit even more from the addition of the subwoofer. Despite having a combined volume less than that of the subwoofer, they are capable of delivering excellent sound unaided. Yet the addition of the Servo 1200 converted a very good-sounding system into an even better one.

The setup and adjustment of the Servo 1200 subwoofer is easy and takes only a few seconds. The setting of the crossover frequency is not critical, although I obtained the best results by setting it fairly low (60 Hz with the Celestions and 80 Hz with the Triads). The most important part of the process is setting the level of the subwoofer output, since too much bass, while it can generate some interesting effects, imparts an unnatural quality (especially to voices). The speaker has lots of reserve level-adjustment range, and I usually preferred to set the level at or just below the center of its range.

The Servo 1200 is one of the more affordable general-purpose powered subwoofers currently on the market. While it is not likely to see much use in low-price systems (where, ironically, its benefits are probably most needed), it would make a worthwhile improvement in almost any system. A full-range speaker system with the bass response of this unit would be very large and very expensive. There is probably no easier way to get a system with satisfying deep-bass performance that will fit into a modest-size room (and budget) than to combine a pair of good medium-price speakers with this subwoofer. Viewed in that light, it is a good value indeed.

Circle 142 on reader service card

COSMIC REALISM

Engineered for the sophisticated audio enthusiast.



cooustic
... a sound investment.

4260 Charter Street
Vernon, CA 90058-2596
(213) 582-2832

© Cooustic 1990

CIRCLE NO. 88 ON READER SERVICE CARD

THE 1990 INTERNATIONAL SUMMER CONSUMER ELECTRONICS SHOW

INNOVATIONS '90

SERIOUS

SOUND IMAGINATION

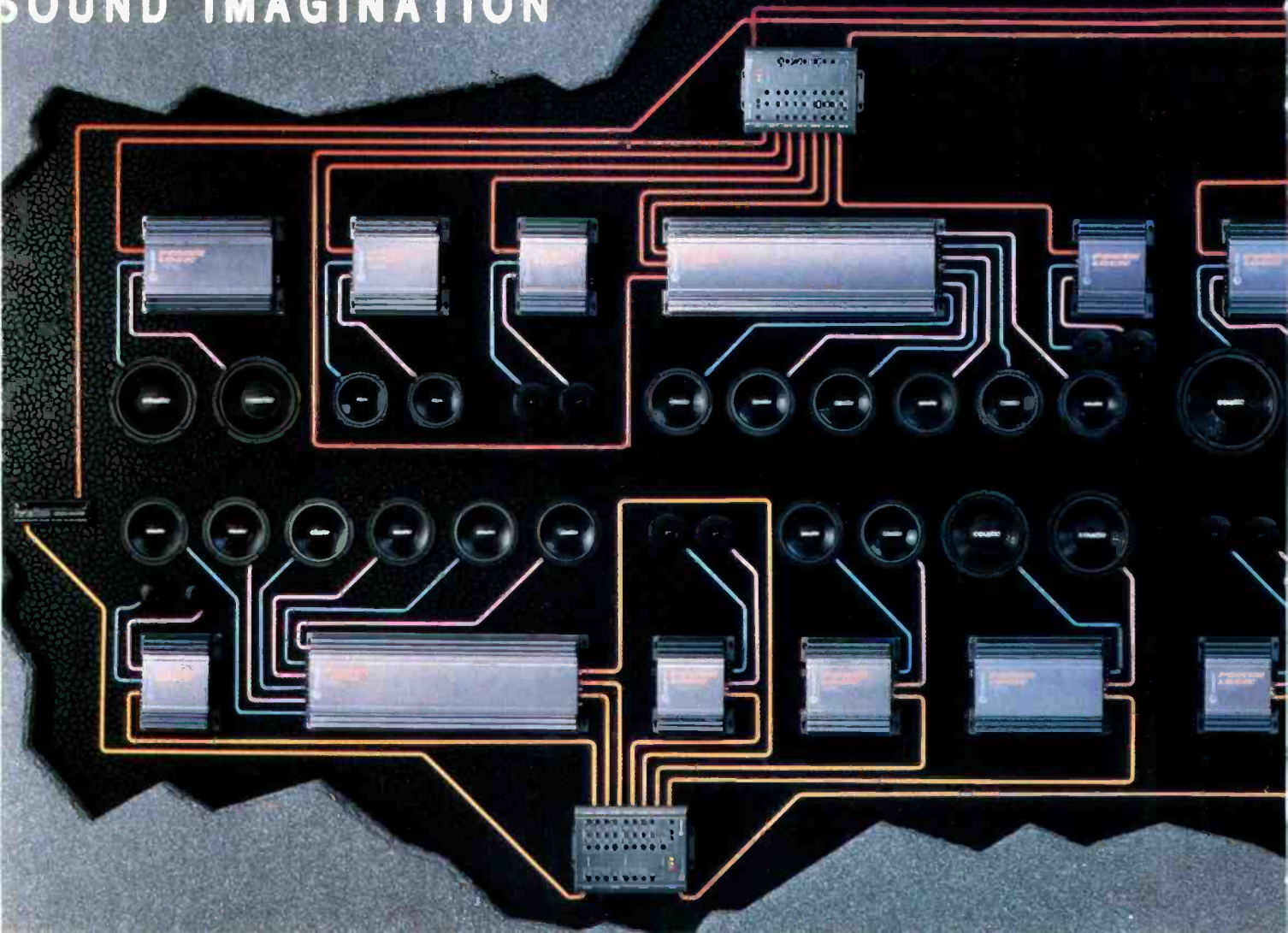

REALISM.



coustic

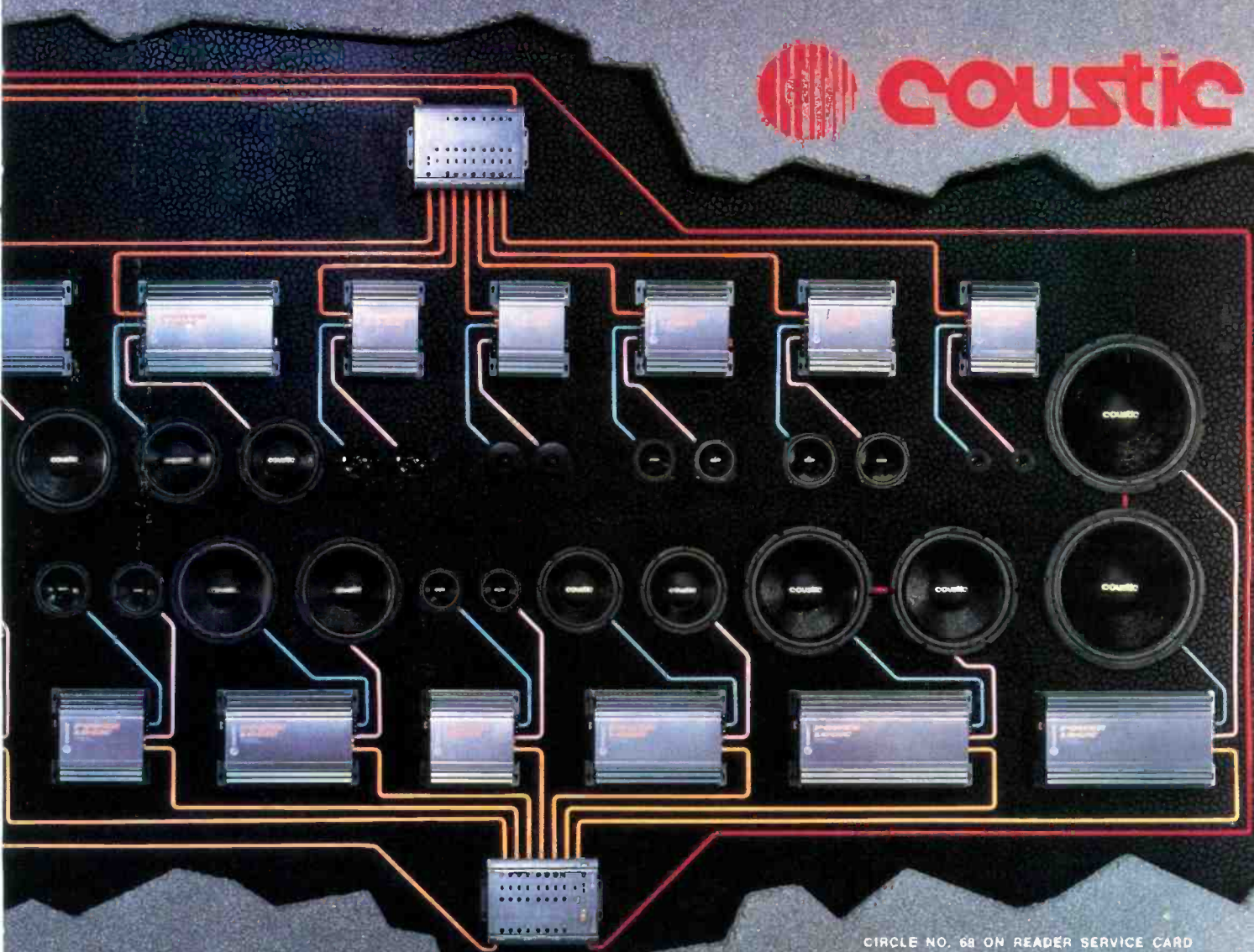

CIRCLE NO. 68 ON READER SERVICE CARD



PHASE TECHNOLOGY PC8.5 SPEAKER SYSTEM

Julian Hirsch, Hirsch-Houck Laboratories

PHASE TECHNOLOGY speakers come from a company that has manufactured speakers sold under many famous brand names for the past thirty-five years. The new three-way, floor-standing PC8.5 speaker system contains a number of unique or unusual design and construction features that yield performance beyond that of many competitively priced speakers.

Approximately halfway up the speaker panel is a 10-inch woofer that employs the RPF (rigid polymer foam) construction exclusive to Phase Technology products. The RPF process forms a cone-shaped radiator, which is driven by a voice coil at its apex. According to Phase Technology, an RPF driver is essentially free of the usual cone break-up effects at high frequencies. The solid, light, and rigid cone radiates from

its flat surface, which is conventionally supported by a plastic surround. The front of the white RPF cone is covered with a dark-gray foam plastic material.

In the PC8.5, the woofer operates in a sealed enclosure. At 350 Hz there is a crossover to a 5 1/4-inch RPF piston midrange driver, which is similar in design to the woofer and mounted above it on the centerline of the speaker panel.

The entire design of the PC8.5 reflects special care to minimize diffraction effects. These can occur in virtually every speaker system wherever a discontinuity exists in an acoustic path. Typical examples are the edges of a speaker mounting hole, a cabinet edge, a grille frame, etc. The result of diffraction is usually an irregularity in the speaker's frequency and phase response, usually in the upper-middle and high-frequency ranges.

Diffraction can be minimized either by altering the shape or dimensions of the responsible surface discontinuity or by isolating the driver's radiation from the discontinuity. In the PC8.5, both methods are used. The metal outer rings of the woofer and midrange driver baskets are screwed to the speaker panel and covered with rings of absorbent rubber, about 1/4 inch thick, whose outer surfaces lie in the plane of the panel. Although this is done for both drivers, it seems likely to be most useful for the midrange.

But it is the PC8.5's tweeter, in whose operating range (from 2,000 Hz upward) diffraction effects are likely to be most troublesome, that has received the most unusual corrective treatment. The tweeter itself is a fairly conventional 1-inch, soft-paper-dome radiator. (Phase Technology and its parent company, United Speaker Systems, hold the patent on this widely used tweeter design.) The tweeter dome is surrounded by a "Unicell Acoustic Treatment," a specially molded piece of dense plastic foam that extends into the mounting hole to a depth of about an inch and in front of the panel by about 3/8 inch. The foam section is 6 1/4 inches square and occupies a total volume of 40 cubic inches. When the speaker's removable grille is installed, its wooden

YOU CAN HEAR THE DIFFERENCE!

"It's amazing", most people say, "how much better my system sounds with AudioQuest® cables. I can't believe what I've been missing!"

AudioQuest makes a full line of cables; speaker, audio-interconnect, video, S-video, fiber-optic and installation cables. All are engineered to bring you maximum performance.

AudioQuest has spent 12 years continually improving and fine tuning its cable designs to reduce all types of cable-induced distortion — and, to do it cost-effectively. Many different constructions and grades of copper and silver are used depending on the budget.

AudioQuest *F-18* speaker cable is one of three very flat cables which use multiple-solid conductors. The sound is sweet and clean because strand interaction is eliminated, while skin-effect and resistance are kept to a minimum.



F-18*

AudioQuest *Indigo Hyperlitz*® speaker cable uses geometry similar to our most expensive cables, yet is very affordable. The spiraled solid conductors maintain an absolutely consistent position and are far enough apart to prevent magnetic interaction. The clarity, dynamics and sense of acoustic space are incredible.

AudioQuest *Lapis Hyperlitz*® interconnect cable uses a patented construction which eliminates strand interaction and minimizes distortion caused by insulating materials. Teflon insulation, FPC-6™ copper (99.99997% pure), and resistance-welded, direct-gold plated, FPC™ plugs make this cable sound incredible. The aural invisibility of this cable is something you will have to experience for yourself.

AudioQuest's absolute commitment to value doesn't mean that all AudioQuest products are inexpensive. It does mean that the expensive products are a very good value when used with better systems.

No matter what type of equipment you have, you can maximize your system's performance with AudioQuest cables! Contact your local AudioQuest dealer and listen for yourself. You can hear the difference!



Indigo Hyperlitz*

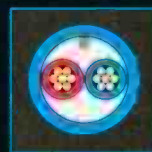

Lapis Hyperlitz*

*All diagrams are 1½ times actual size.

audioquest®

Tel: 714-498-2770 Fax: 714-498-5112
P. O. Box 3060, San Clemente, CA 92674 USA

CIRCLE NO. 37 ON READER SERVICE CARD

frame hugs the top and sides of the foam panel, extending a smooth surface out to the edges of the grille frame, which are rounded to make a smooth transition to the edges of the cabinet.

The function of the Unicell treatment, according to Phase Technology, is to "slow and gradually stop the sound waves before they can be diffracted by any surface or edge." If acoustic energy from the tweeter does not reach the grille or cabinet edge, there can be no diffraction-

The entire design of the Phase Technology PC8.5 speaker system reflects special care to minimize diffraction and the resulting irregularities in response.

caused response irregularity resulting from that edge.

The PC8.5's crossover network is a complex system, initially designed with theoretically ideal values and then optimized by trial and error for the cabinet and driver characteristics. The cabinet, externally conventional in appearance, is unusually sturdy. It is constructed of 1-inch particle board, extensively braced internally and stuffed with absorbent padding. The 2-inch-thick speaker panel is exceptionally rigid. The woofer and midrange/tweeter portions of the system are brought out to separate gold-plated binding posts, which can be joined for conventional installations or separated for biwired or biamplified operation.

The PC8.5 system's specifications include a frequency response of 35 to 20,000 Hz ± 2 dB, a sensitivity of 89 dB sound-pressure level (SPL) at 1 meter with a 2.83-volt input, and a 4-ohm nominal impedance. It is recommended for use with amplifiers rated to deliver from 25 to 120 watts per channel. Dimensions are 39½ x 13 x 11¼ inches, and weight is about 90 pounds. The cabinet is available finished in dark oak, walnut, or black. Price: \$1,200 a pair. Optional spiked feet are included. Phase Technology, Dept. SR, 6400 Youngerman Cir., Jacksonville, FL 32244.

Lab Tests

The averaged room response of the two speakers was unusually wide and uniform, even at low frequencies where room-boundary interaction is unavoidable. The *uncorrected* response curve was flat within ± 5 dB from 20 to 20,000 Hz.

The close-miked woofer response varied only ± 1.5 dB from 45 to 250 Hz, falling at 12 dB per octave above and below that range. When this was spliced to the averaged room curve, it produced a composite response that varied only ± 3.5 dB from 33 to 20,000 Hz. Other than a slight dip at 500 Hz probably caused by a room-boundary interaction, the response was extremely smooth, with a nearly linear downward slope of less than 7 dB from 65 to 20,000 Hz.

The manufacturer advises that the grilles should be left on the speakers since they form an integral part of the diffraction-control system. We were able to confirm this to our complete satisfaction. Removing the grille from a speaker produced a jog of about ± 3 dB in its frequency response in the vicinity of 3,000 Hz. Replacing the grille effectively eliminated this effect and restored the system's inherent smooth response. Our FFT analysis confirmed that this was purely a diffraction effect and not the result of a resonance of some sort, since it was present only during the test signal and was not sustained after it had ended.

The tweeter's response was possibly the smoothest and flattest we have measured from a speaker (very similar results were obtained with both swept-sine-wave and FFT measurements). Its variation of ± 0.4 dB from 2,800 to 11,000 Hz is more like that of an amplifier than of a speaker. From 11,000 to 20,000 Hz the response sloped off smoothly. The system's group delay (a measure of phase linearity) varied only about 0.1 millisecond overall from 4,000 to 26,000 Hz.

Another measurement that confirmed the superior performance of the PC8.5 was the "waterfall" plot, a 3-D display of thirty-two successive FFT response measurements at intervals of less than 0.1 millisecond. This plot reveals vividly the various resonances and sustained "ringing" frequencies (and their durations) in a speaker's output. Most speakers do not produce very gratifying results in this test, but the PC8.5 showed only a very low-level ringing at about 10,000 Hz, at a level of some -40 dB relative to the primary output, that lasted about 2 milliseconds.

The system's impedance was a minimum of 3.55 ohms at 200 Hz, and it varied between that value and 3.8 ohms over the 100- to 200-Hz range. The maximum impedance, at the bass resonance frequency of 39 Hz, was 17.5 ohms. There were smaller peaks of 8 ohms at 385 Hz and 4.9 ohms at 2,000 Hz. Although

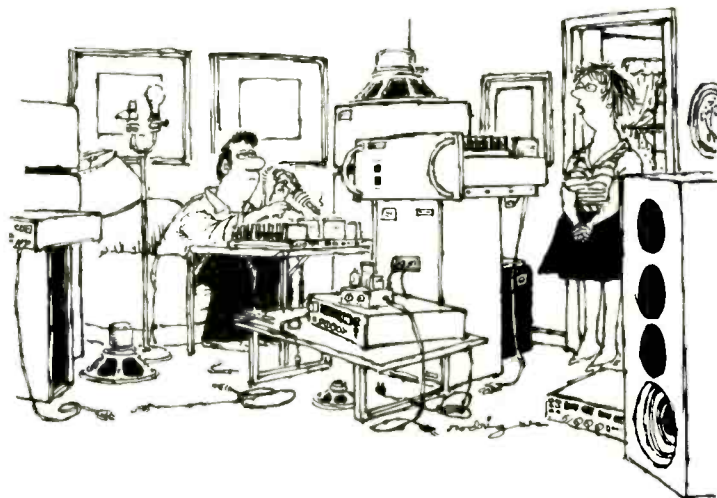

"Lester, I liked it better when you were just an anglo-ophile."



Marlboro



SURGEON GENERAL'S WARNING: Cigarette
Smoke Contains Carbon Monoxide.

17 mg "tar," 1.2 mg nicotine
av. per cigarette by FTC method.

© Philip Morris Inc. 1990

Definitive Technology Dealer List

AZ: Audio Video Emporium: Tucson • HI FI Sales: Mesa. **CA:** Absolute Audio: Orange • Audio Concepts: Long Beach, San Gabriel • Creative Stereo: Carpinteria, Santa Barbara, Santa Maria, Thousand Oaks, Ventura • Performance Audio: San Fran. • Shelley's Stereo: Canoga Pk., Santa Monica • Sound Co.: Escondido, San Diego • Sound Goods: Campbell, Mountain View • Systems Design: Redondo Beach. **CT:** Al Franklin's: Hartford • Robert's Music: New London. **DC:** Suburbs: Audio Associates. **EL:** Absolute Sound: Winter Pk. • Audio Center: Ft. Lauderdale • Audio Vision: Tampa • Sound Insight: Ft. Pierce. **IL:** Stereo Shoppe: Boise, Moscow. **IN:** Hi Fi Hutch: Chic., Villa Pk., Schaumburg, Naperville • Media Room: Morton Grove • Simply Stereo: Hoffman Estates, Orland Pk. • Sterling Elect.: Sterling. **IN:** Ovation Audio: Indianapolis & suburbs. **KS:** Audio Video Elect.: Overland Pk. • Primus Audio: Kansas City. **KY:** Ovation Audio: Lexington, Louisville. **MD:** Audio Assoc.: Laurel, Rockville • Soundcape: Bltrm. **MI:** Classic Stereo: Grand Rapids, Kalamazoo • Court St. Listening Room: Saginaw • Overture Audio: Ann Arbor. **MN:** Audio Perfection: Minneapolis. **NC:** Stereo Sound: Chapel Hill, Durham, Greensboro, Raleigh, Winston Salem. **NH:** Cuomo's: Salem. **NJ:** Woodbridge Stereo: Montclair, Princeton, West Caldwell, West Longbranch, Woodbridge. **NY:** Audio Breakthroughs: Manhasset • Avtronics: Hicksville • Clark Music: Albany, Syracuse • Electronic Wkehp: Manhattan • Hart Elect.: Vestal • Innovative Audio: Bklyn. • Listening Rm.: Scarsdale • Speaker Shop: Amherst, Buff. • Studio One: Jameswn. **OH:** Audio Craft: Akron, Cleveland suburbs, Findlay, Toledo. **PA:** GNT Stereo: Lancaster • Hart Elect.: Blakely, Kingston • Hi Fidelity House: State College • Listening Post: Pittsburgh & suburbs • Stereoland: Natrona Hts. • Studio One: Erie. **IN:** Hi Fi Buys: Music City, Nashville • Lindsay Ward: Knoxville. **TX:** Audio Tech: Temple, Waco • Bell Audio: Denton. **VI:** Broadway Music: Salt Lake City • Stokes Bros.: Logan. **VA:** Audio Assoc.: Arlington • Audiotronics: Roanoke • Digital Sound: Va. Beach. **WA:** Q.C. Stereo: Bellingham, Oak Harbor. **WVA:** Sound Post: Princeton. **Canada:** Advance Elect.: Winnipeg, Regina • Audio Ark: Edmonton • Audio Center: Montreal, Ottawa • Boutique of Sound: Calgary • CORA: Quebec City.

STEREO REVIEW PRESENTS

New for 1990

THE BASIC REPERTORY ON COMPACT DISC

A Critical Discography



In response to many readers' requests, the noted critic Richard Freed has chosen the best available CD recordings of the standard compositions in the classical orchestral repertory. More than 200 works from Bach to Wagner!

To receive your copy of this useful pamphlet, send a self-addressed business-size (#10) envelope, stamped with 45¢ postage, and a check or money order for \$3 (no cash, please) to The Basic Repertory, Stereo Review, P.O. Box 1125, New York, NY 10101-1125. Outside the United States, where you cannot buy American stamps, send the self-addressed envelope and \$4 (payable in U.S. funds) to the same address.

TEST REPORTS

at some frequencies the impedance was slightly lower than the rated 4 ohms, its phase angle remained within a range of ± 45 degrees, indicating that the PC8.5 should not present a difficult load to any amplifier designed to drive 4 ohms.

Sensitivity was 89.5 dB SPL at 1 meter with a 2.83-volt input of pink noise. The woofer's distortion at a drive level of 3 volts (equivalent to a 90-dB SPL in our sensitivity tests) was between 0.5 and 1 percent from

The PC8.5's frequency coverage was wide and well balanced, with no tendency toward brightness or dullness. In fact, it sounded truly "flat."

40 to 400 Hz, rising to 4 percent at 30 Hz and 8 percent at 20 Hz. The midrange driver's distortion was also very low, from 0.2 to 0.8 percent between 200 and 2,000 Hz.

The horizontal dispersion of the PC8.5 was only moderate over a 45-degree angle. There was about a 6-dB difference between the on-axis and off-axis response from 2,000 to 10,000 Hz and an increasing spread at higher frequencies. At 30 degrees off-axis, however, the response was very similar to the axial readings, typically within 2 or 3 dB up to at least 12,000 Hz.

Finally, we subjected the system to a single-cycle tone-burst test to establish how much short-term power it could handle at frequencies of 100, 1,000, and 10,000 Hz without obvious distortion or damage. At each frequency our Carver Mono-Block amplifier clipped before the speaker showed any signs of distress. The respective power outputs were 1,375 watts, 1,635 watts, and 1,255 watts into impedances of 3.7 to 4.6 ohms.

Comments

In our preliminary listening, before any measurements were made, it was apparent that the PC8.5 had a very smooth, easy sound quality, without roughness, shrillness, or any of the other problems that can

prevent a speaker from sounding "right." Its frequency coverage was wide and well balanced, with no tendency toward brightness or dullness. In fact, it sounded truly "flat," and the confirmation of its flat response in our measurements came as no great surprise.

The lower frequencies were reproduced solidly but without the "boom" in the upper bass that in so many loudspeakers impairs the natural reproduction of male speech. One of the most surprising and impressive features of the speaker's sound was the way that the lowest bass frequencies (when present in the program material) could be felt as well as heard, even at low volume. This effect, not unlike that of a good subwoofer, is quite rare in speakers of this size and price.

In other words, the PC8.5's frequency response (no matter how defined) was wide, uniform, and free from audible aberrations that could impair the natural quality of its sound. Our measurements demonstrated convincingly that it had the fundamental qualities of a full-range, smooth, well-dispersed response and low distortion.

Not only did the system sound superb with respect to these measurable qualities, but it created a spatial image that almost overshadowed its basic performance as a transducer. Listening with closed eyes to a good orchestral recording from a CD, we found the illusion of attending a live performance remarkably convincing. The sound image was usually only slightly wider than the speaker spacing, but its height and depth made it the next best thing to a genuine live listening experience.

The PC8.5's designers believe that its imaging quality is related to its exceptional response flatness and freedom from diffraction. Though I have no solid proof, I am inclined to agree. In many ways, the Phase Technology PC8.5 performs at a level that is rarely, if ever, found in conventional dynamic speaker systems, and certainly not at or near its price. It is a top value in today's market, and I suspect that it could give strong competition to some speakers selling for several times its price.

Circle 143 on reader service card

We're Handing You A Rare Opportunity.

One of "America's Ten Best Designs" among all products produced in the U.S.A. in 1988!

— Fortune Magazine

"Superb sound and virtual invisibility."

"Side by side with speakers costing three to five times as much, the AM-5 consistently produced the more exciting and listenable sound..."

— Stereo Review, Julian Hirsch



For details, and the name of a participating dealer, call
1-800-444-BOSE.

Call between 8:30 AM and 9 PM, Monday through Friday;
9 AM through 5 PM, Saturday and Sunday ET.
In Canada, call 1-800-465-BOSE.

CIRCLE NO. 24 ON READER SERVICE CARD

GIVE
us your old
speakers...

GET
at least \$100*
toward
breakthrough
Acoustimass[®]
speaker
technology!



Bose Acoustimass-SE5 styling alternative.

You'll get at least \$100 for your old speakers, regardless of condition, when you trade up to the revolutionary Bose[®] Acoustimass-5 speaker system! Limited time offer — act now!



• System consists of two cube arrays and an easily concealable Acoustimass bass module.



BONUS OFFERS!

- **Free compact disc!** Send a copy of your sales receipt to us at the address below, and we'll send you a free limited edition compact disc, and the chance for you and a friend to win a free system!***
- **Bose 101[®] speakers 1/2-price** when you buy a Bose Acoustimass-5 system and any surround sound receiver! (Bose 101 quantities limited.)

BOSE
Better sound through research.

*Amount determined by dealer. Offer valid Friday, October 26 through Monday, November 26, 1990 at participating dealers. Limit one trade per purchase. Offer applies to the Bose Acoustimass-5/SE5 Direct Reflecting[®] speaker systems only. CD requests must be received by Bose by December 21, 1990. © Copyright 1990 Bose Corporation. Attn: Trade-In Offer, The Mountain, Framingham, MA 01701-9168 USA. Covered by patent rights issued and/or pending. ***No purchase required. Limit one entry per person. For free entry form, call 1-800-444-BOSE.



TOP AUDIO/VIDEO RECEIVERS

Evaluating the state of the art in performance

and features Time was when "A/V equipment" meant public-address systems and elementary-school film projectors, equipment that was definitely not intended to meet the needs of high-fidelity music reproduction. No longer. While TV audio may still be little better than what a mass market demands, the hi-fi VCR's and laserdisc players used to reproduce today's movie sound are capable of sonic performance that approaches the CD in quality, and today's audio/video receivers have become the centerpieces of home theater systems from which no-compromise audio performance is expected. Are they up to the challenge?

To see—or, rather, hear—the state of the art in A/V receivers for ourselves, we selected three top models for testing: the JVC RX-1010VTN (\$1,500), the Pioneer VSX-9700S (\$1,050), and the Onkyo

By CRAIG STARK

DAVID A. WAGNER





PIONEER VSX-9700S AUDIO/VIDEO STEREO RECEIVER

TUNER

101.50 MHz
1ch FM
AUTO
TONE

SPLIT SCREEN
MIN ENHANCER
MAX ENHANCER
VCR1 REC ENHANCER
SURROUND
OFF STADIUM SIMULATED SURROUND DOLBY SURROUND PRO LOGIC
VCR1 REC SEL MODE
VCR NOISE FILTER SIMULATED STEREO DELAY TIME
VIDEO SIGNAL SELECTOR VIDEO ADAPTOR
VCR 1 VCR 2 VCR 3
TAPES 1/2 MONITOR
LINE CD TUNER PHONO
INPUT SELECTOR
VCR 3 VCR 2 VCR 1
BASS TREBLE
TV VIDEO
ACQUSTIC MEMORY SELECT

ONKYO AUDIO VIDEO CONTROL TUNER AMPLIFIER A1

POWER
STAND-BY/ON SPEAKERS
DN OFF
REAR CENTER
ON OFF
PHONES

REMOTE SENSOR
DOLBY SURROUND PRO LOGIC
DYNAMIC BASS EXPANDER
SIMULATED STEREO
DELAY TIME (mSEC)
15 20 30
SURROUND MODE
DOLBY HALL MATRIX
VCR-2 VCR-1 VDP-2 VDP-1
TAPES 2 MONITOR

REAR CENTER
PHONES
VCR 2/VIDEO CAM INPUT
VDP-1
L - AUDIO - R (MONO)
SURROUND MODE
DYNAMIC BASS EXPANDER
SIMULATED STEREO
DELAY TIME
CENTER MODE
CENTER OFF
PRESET 1/11 2/12 3/13 4/14 5/15 6/16 7/17 8/18

JVC RX-1010VTN (\$1,500)

THE Digital Acoustic Processor (DAP) in the JVC RX-1010VTN is an audiophile's delight. You can start with any one of seven acoustical environments, aptly labeled Symphony Hall, Recital Hall, Opera House, Church, Live Club, Stadium, and Movie Theater. To each of these you can apply five different size factors that affect the early-reflection intervals of the reverberant sound (from the rear speakers), and then you can apply any of five "liveness" factors, which govern how long the reverb takes to die away. (Acousticians call this factor the "reverberation time" of the room.) Then you can apply any one of

displayable names such as BLUES, JAZZ, and so on can be entered for the tonal contours created with the seven-band SEA graphic equalizer.

The Dolby Pro Logic circuitry permits selection of any of five initial delay times for the rear channels, and a test-tone switch is provided to make setup adjustments easy. The digital volume control adjusts in 2-dB steps down to -76 dB, and a mute switch is provided for fielding telephone calls and other interruptions.

The JVC RX-1010VTN can accommodate three video sources with either conventional pin jacks or the newer



three "wall" characteristics, which affect how the simulated room walls "soak up" high frequencies as the reverberant sound waves bounce between them. (I came to call the first setting of this parameter "dry wall.") Finally, the DAP treatment can also be mixed in various amounts with the direct sound from the main front speakers, though I found that this tended to muddy the stereo image. Fortunately, JVC's factory presets for the different room environments provided good, sonically believable starting points to which it was always possible to return.

The RX-1010VTN can memorize as many as forty AM and FM station frequencies, along with display names of up to five characters (the station call letters, for example). Similarly,

S-type connectors, and it supplies both S-video and composite TV monitor outputs. It is the only one of the three receivers tested that provides for a moving-coil phono cartridge as well as a moving-magnet one. Two three-head tape decks can be accommodated along with a DAT deck and a CD player. By using the Sound Selector switch you can record simulcasts, putting the FM sound onto the VCR tape, and you can dub audio or video sources to any appropriate recorder connected to the receiver.

The two pairs of main speaker connectors are dual banana jacks; the rear channels have push-in wire connectors. Both 75- and 300-ohm FM antennas can be accommodated, and an AM loop antenna is supplied.

TX-SV90PRO (\$1,200). Naturally, all three incorporate the Dolby Pro Logic circuitry needed to re-create the spatial effects encoded into Dolby Surround movies and broadcasts. All three incorporate powerful amplifiers (110 to 125 watts per channel) for the left and right front channels as well as smaller amplifiers (15 to 40 watts per channel) for a pair of rear "surround sound" speakers.

The Onkyo and Pioneer receivers also have a fifth power amplifier to handle the Dolby Surround center channel; the JVC has a center-channel preamplifier output to which the user can connect a separate power amplifier. Although a center channel is highly desirable for Dolby Surround reproduction, installing a fifth speaker is not always practical in home setups. Consequently, all of the units provide a "phantom center" setting that causes the Pro Logic decoder to revert to conventional two-channel stereo in the front.

For multiroom applications, all three receivers can handle two pairs of main speakers (switched or, impedance permitting, together), and all have wireless remote-control devices that can also be user-programmed to operate other components. And, of course, in addition to including FM and AM tuners, all provide connections not only for CD players, cassette decks, and turntables but also for digital audio tape decks, VCR's, laserdisc players, and TV monitors.

Though it lacks a powered center channel, the JVC RX-1010VTN is in many ways the most versatile of the three for music reproduction. Behind its innocent-looking pop-down front panel lie some sixty-seven separate pushbuttons for setting and storing a vast array of sonic parameters. Rated at 120 watts per channel (110 watts in four-channel mode) into 8 ohms from 20 to 20,000 Hz, with no more than 0.007 percent total harmonic distortion (THD), the RX-1010VTN replaces conventional bass and treble adjustments with a digitally controlled seven-band graphic equalizer. The user can create and store complex frequency-shaping curves (five factory-set curves are supplied). Moreover, any of the stored curves can be inverted at the touch of a button and fed to a tape deck, thus providing an additional form of record/playback equalization.

Besides providing a Dolby Pro Logic decoder with adjustable rear-channel delay, the JVC receiver's Digital Acoustic Processor (DAP) affords an enormous array of digital reverberation enhancements for regular stereo sources. The acoustic character, size, and even wall absorption characteristics of a simulated room are all separately selectable and storable for instant access.

So numerous are its computer-controlled adjustments, indeed, that JVC even provides a CompuLink Source Related Preset (CSR) button that stores (and displays) all the relevant settings used with a particular source. Each time you play your tuner, for example, a given set of room characteristics, volume and equalization settings, and so on instantly pops into place. An entirely different group of settings might be stored for when you use the TV set or CD player.

There's something almost sensual about the smooth-operating motorized volume control of the Pioneer VSX-9700S. Hard-core video enthusiasts, on the other hand, will probably appreciate more the Pioneer's video enhancer, with its split-screen viewer, which reduces the loss of image detail when you copy tapes. The VSX-9700S has the highest power of the three receivers. Its main channels are each rated at 125 watts into 8 ohms, from 20 to 20,000 Hz, with no more than 0.005 percent THD. Its rear- and center-channel amplifiers are specified at 40 watts per channel into 8 ohms, with distortion of 0.08 percent at 1,000 Hz. All five of its amplifiers have preamp-out/main-amp-in jacks for external-processor additions or substitutions. Bass and treble tone controls, left-right balance, and rear and center levels are all set in digital increments, and as many as five sets of tonal contours can be stored in memory.

THE Pioneer VSX-9700S provides three surround modes: Dolby Pro Logic; Stadium, which reproduces the kind of large, open stereo environment you might experience at a rock concert; and simulated surround, with digitally created acoustics more akin to the feel of a concert hall. Initial delays (the "first-bounce" sound in the reverberant



ONKYO TX-SV90PRO (\$1,200)

THE Onkyo TX-SV90PRO has a total of four video inputs, three of which are on the back panel and have S-video as well as the usual composite-video jacks. The fourth video input (composite only) and its corresponding stereo audio input jacks are at the lower left-hand corner of the front panel for easy attachment of a camcorder or other temporary source for viewing or dubbing. The TV-monitor output has both S-video and composite jacks.

In addition to a CD player and a turntable, the receiver will accommodate two audio tape decks, with monitoring during recording from the second. The TX-SV90PRO's tuner enables you to preset as many as twenty AM and FM stations in memory.

The bass, treble, and balance controls all use regular knobs, making it fast and easy to set them to an exact position. The main volume control is also analog; it is motor-driven from the remote control, but it can be turned manually as well. The remote control is used to set the relative balance (adjustable in six increments) between the main channels and the center and rear channels. Front-panel pushbuttons permit separate on/off switching of two pairs of main speakers, the surround speakers, and a center-channel speaker. Most of the secondary

controls, such as the tuner presets, are normally hidden on a panel that pivots out from the bottom of the faceplate.

Three surround modes are provided: Dolby Pro Logic, Hall, and Matrix. In our listening tests we were most impressed by the results in the Hall mode. A three-step initial delay (15, 20, or 30 milliseconds) can be applied in both the Dolby and Hall modes. A simulated-stereo switch is supplied for mono sources. Full video dubbing facilities are provided, including simulcast recording, and audio tapes can be dubbed from TAPE 1 to TAPE 2. The remote control has buttons to activate the test-tone sequence to set up the Dolby Surround system; it also has an audio-mute button.

The Onkyo TX-SV90PRO uses dual banana jacks for both sets of main speakers; center and rear speaker connections are made with the usual spring-loaded wire connectors. Preamp-out/main-in connections are provided for the left and right front channels, and preamp-out jacks are available on the rear panel for the center and rear channels. A separate rear-panel output is provided for connection of an outboard mono subwoofer channel. An AM loop antenna is supplied, and there are inputs for both 75-ohm (F-connector) and 300-ohm FM antennas.

PIONEER VSX-9700S (\$1,050)

CAPABLE of handling as many as three VCR's (two with S-video as well as composite-video connectors), a videodisc player, and a video monitor (both S-connector compatible), the Pioneer VSX-9700S puts more than average emphasis on the video side of the A/V equation. It even supplies a special noise filter to lower any audible tape hiss from VCR1 or VCR2.

High among the video attractions of the Pioneer VSX-9700S is its Video Enhancer, which lets you precompensate for the losses in image detail that will occur in the course of the normal copying process. When the Enhancer function is turned on a second control is activated that places a movable line (which is not recorded) on the screen, dividing it between enhanced and unenhanced portions. As you adjust the Enhancer control you can see and optimize the effect it will have on the copy.

But the VSX-9700S is not without its audio attractions. It is, by a small margin, the most powerful of the three receivers tested, and it provided very clean sound. The digital bass and treble controls provide four boost and four cut positions (together with a flat position), and as many as five composite frequency-modifying curves can be memorized for recall by letter. Thirty AM and FM stations

can be preset, and each frequency can be stored with a four-letter name display (the call letters or a tag such as NEWS). Connections are provided for the supplied AM loop antenna and for 75-ohm (F-connector) and 300-ohm FM antennas.

The Dolby Pro Logic circuit has three selectable initial delay times (15, 20, and 30 milliseconds), and front/back balance is adjustable in nine steps, which are neatly displayed on the front panel. The level of the center-channel signal, relative to the main stereo and rear signals, is adjustable in five steps, and there is a built-in calibration signal that rotates among the various channels until you achieve the desired balance. Full provision is made for simulcast recording and for creating a pseudo-stereo signal from mono sources. Two cassette decks can be accommodated (one shares the DAT switch position), and simultaneous record/playback comparisons can be made on TAPE 2.

Full preamp-outpower-amp-in connectors are provided for all five amplifiers in the Pioneer receiver. The two main sets of speakers use what look to be, but are not, dual banana jacks; they will accept only bare wires and are about as anomalous as cooked sushi. The rest of the speaker connectors are conventional spring-loaded push-in terminals.

field) can be set at 15, 20, or 30 milliseconds for any of the surround modes, and a simulated-stereo mode is provided for use with mono sound sources.

Also offering a motorized volume control and five amplifiers, the Onkyo TX-SV90PRO adds a convenient set of front-panel inputs labeled for a videodisc player or camcorder, though a VCR or any other video source delivering a composite-video signal could be attached here as well. Its main channels are rated at 110 watts per channel (100 watts in four-channel modes) into 8 ohms from 20 to 20,000 Hz with no more than 0.04 percent THD; the three additional amplifiers for the rear speakers and front center channel are rated at 30 watts into 8 ohms with a maximum of 0.08 percent THD at 1,000 Hz.

The TX-SV90PRO also offers three kinds of surround sound: Dolby Pro Logic, Hall (concert hall), and Matrix (a synthesized, full-surround treatment especially suited for music videos). The same three delay settings as on the Pioneer (15, 20, and 30 milliseconds) are available for tailoring the initial delay to suit the placement of the rear (or side) speakers in your listening room. As on the other receivers, the center-channel speaker output from the Onkyo can be switched three ways: WIDE, which sends a full-range signal to the center speaker; NORMAL, which splits low frequencies in the center channel between the left and right main speakers (useful when the center speaker must be small, with limited bass extension and power-handling ability); and PHANTOM, which divides all the center-channel information between the main stereo pair, for use in installations where a dedicated center speaker is impractical.

Unlike the Pioneer and JVC receivers, however, the Onkyo TX-SV90PRO incorporates conventional, nondigital bass, treble, and balance controls, though its rear- and center-channel levels must be raised and lowered (via the remote control) in fixed steps. In addition to the usual fixed loudness-compensation switch, the Onkyo TX-SV90PRO has a Dynamic Bass Expander switch that adds emphasis to low-frequency signals in proportion to their instantaneous level. A simulated-stereo option is also provided to enhance reproduction of mono sources.



In the Lab

The results of our lab tests of the three receivers are presented in the accompanying table. With a few exceptions, as noted below, our FM measurements confirmed the manufacturers' ratings, which represented very good, though not spectacular, tuner performance.

BOTH in mono and in stereo, the 50-dB quieting sensitivity of the JVC RX-1010VTN (12 and 35 dBf, respectively) made it the best choice for reception in very weak signal areas, though the other two receivers performed quite adequately in this respect. The Onkyo TX-SV90PRO's FM signal-to-noise ratio (S/N) at 65 dBf was not as outstanding as that of the other two receivers' tuner sections, but it nonetheless exceeded its specifications. The stereo THD of the Pioneer VSX-9700S's FM tuner measured a very poor 1.05 percent, but further examination showed that the apparent distortion products consisted very largely of inadequately suppressed 38-kHz stereo-subcarrier sidebands, which are well above the audible range.

The alternate-channel selectivity measurements on all three units promise excellent performance in crowded signal areas. Adjacent-channel selectivity, rarely a concern except when two distant metropolitan areas' broadcast signals overlap, was average. Though slightly short of the manufacturers' ratings, the stereo channel separation of all three units was impressive, and their FM frequency response left little to be desired. The AM frequency response was as narrow as we have come, ruefully, to expect.

During amplifier preconditioning and testing, the top of the JVC receiver became more than slightly warm, though not so hot as to activate its cooling fan. The other units became only moderately warm. All three rely on a free flow of air over their covers to carry away considerable heat, however, so their ventilation should not be obstructed in installation.

The Pioneer receiver's clipping-level power output was 144 watts into 8 ohms; the JVC and the Onkyo reached 120 and 115 watts, respectively. (The rear-channel amplifiers

LABORATORY MEASUREMENTS			
AMPLIFIER SECTION	JVC	ONKYO	PIONEER
Output power at clipping (1,000 Hz)			
main channels, 8 ohms	120 watts	115 watts	144 watts
main channels, 4 ohms	170 watts	192 watts	220/122 watts*
one main channel, 2 ohms	261 watts	247 watts	245/179 watts*
rear/center channels, 8 ohms	16.4 watts	40 watts	53 watts
Clipping headroom (relative to rated output)			
main channels	0 dB	0.2 dB	0.6 dB
rear/center channels	0.4 dB	1.25 dB	1.2 dB
Dynamic power output (main)			
8 ohms	196 watts	150 watts	189 watts
4 ohms	312 watts	253 watts	288/160 watts*
2 ohms	361 watts	361 watts	380/196 watts*
Dynamic headroom (main)	2.1 dB	1.3 dB	1.8 dB
Maximum full-power distortion (20 to 20,000 Hz into 8 ohms)	0.065% at 110 watts (20,000 Hz)	see text	0.018% at 125 watts (20,000 Hz)
Sensitivity (for 1 watt output into 8 ohms)			
CD	22 mV	15.3 mV	15 mV
phono	0.24/0.04 mv**	0.26 mV	0.25 mV
A-weighted noise (referred to a 1-watt output)			
CD	-83.8 dB	-75.9 dB	-79.5 dB
phono	-81.1/-69.1 dB**	-73 dB	-77.5 dB
Phono-input overload	102/16 mv**	120 to 128 mV	135 to 161 mV
Phono-input impedance (MM)	47,000 ohms/160 pF	47,000 ohms/63 pF	50,000 ohms/235 pF
RIAA equalization error (20 to 20,000 Hz)	±0.2 dB	+0.7, -0.1 dB	+0.6, -0.1 dB
Tone-control range	±10 dB at 63, 160, 400, 1,000, 2,500, 6,300, and 16,000 Hz	±11 dB at 20 and 20,000 Hz	±11 dB at 20 Hz, ±10 dB at 20,000 Hz
*Normal/low impedance setting			
**MM/MC inputs			
TUNER SECTION†	JVC	ONKYO	PIONEER
Usable sensitivity			
mono	9 dbf (1.6 μV)	13.5 dbf (2.6 μV)	13.6 dbf (2.6 μV)
stereo	25 dbf (9.8 μV)	18 dbf (4.4 μV)	25 dbf (9.8 μV)
50-dB quieting sensitivity			
mono	12 dbf (2.2 μV)	16 dbf (3.7 μV)	16 dbf (3.5 μV)
stereo	35 dbf (30 μV)	39 dbf (49 μV)	39 dbf (49 μV)
Signal-to-noise ratio at 65 dbf			
mono	80 dB	78 dB	80 dB
stereo	76 dB	73 dB	75 dB
Harmonic distortion (THD + noise at 65 dbf)			
mono	0.20%	0.14%	0.096%
stereo	0.185%	0.098%	1.05% (see text)
Capture ratio at 65 dbf	1.3 dB	1.8 dB	1.3 dB
AM rejection	80 dB	71 dB	65 dB
Selectivity			
alternate channel	73 dB	80 dB	71 dB
adjacent channel	7 dB	10 dB	8 dB
Stereo threshold	25 dbf	stays stereo	stays stereo
Pilot and subcarrier leakage			
19 kHz	-65 dB	< -85 dB	-58 dB
38 kHz	-78 dB	< -85 dB	-40 dB
Hum	-74 dB	-80 dB	-73 dB
Stereo channel separation			
100 Hz	35 dB	44 dB	42 dB
1,000 Hz	38 dB	42 dB	47 dB
10,000 Hz	33.5 dB	35 dB	43.5 dB
Frequency response			
FM, 30 to 15,000 Hz	+0.7, -1 dB	+1, -1.5 dB	+0.2, -1.2 dB
AM	+0.3, -6 dB from 90 to 2,500 Hz	+0.8, -6 dB from 90 to 2,400 Hz	+0.7, -6 dB from 80 to 2,100 Hz

†All figures for FM only except frequency response; measurements in microvolts, or μV, referred to 75-ohm input

of the three receivers clipped at 53, 16.4, and 40 watts, respectively.) With a 4-ohm load the Pioneer clipped at 200 watts when the impedance switch was in its normal 8-ohm position; at the low-impedance setting (which trades power for safety), it clipped at 122 watts. The 4-ohm clipping points for the JVC and the Onkyo were 170 and 192 watts, respectively.

With EIA standard measurement techniques, none of the three receivers quite met its FTC power specification, but the shortfall was relatively slight. The Pioneer VSX-9700S came the closest, registering 125 watts into 8 ohms with 0.006 percent THD at 1,000 Hz, but at that power level the distortion at the ends of the spectrum ran to 0.012 percent (20 Hz) and 0.018 percent (20,000 Hz), numerically well above the claimed 0.005 percent across the whole range. For the TX-SV90PRO Onkyo claimed 0.04 percent THD from 20 to 20,000 Hz at 110 watts, but at that distortion level its main amplifiers produced 106 to 108 watts across most of the audio spectrum and only 102 watts at 12,500 Hz. When we drove it to the specified 110 watts, the distortion climbed to 1.5 percent

The JVC receiver leans more to the audio side of the A/V equation than the Pioneer and Onkyo receivers.

at 20,000 Hz. With only two channels driven, the JVC RX-1010VTN is rated to deliver 120 watts into 8 ohms with a minuscule 0.007 percent THD across the full audio bandwidth. But in our tests it ran into clipping with a mid-band, 1,000-Hz tone at that level, and even at 110 watts (its rating for four-channel operation) the distortion reached 0.065 percent at 20,000 Hz. On the other hand, however, I suspect that no one could possibly hear any difference between the measured 110 watts output and the rated 120 watts (the difference is less than 0.4 dB) nor, in all probability, between 0.007 and 0.065 percent THD.

Both the Onkyo and the Pioneer units also carry dynamic power ratings, which are designed to reflect an amplifier's performance under conditions more representative of the

real demands of music and speech. In these measurements, the receivers did meet their specifications, the Onkyo producing 150, 253, and 361 watts into 8-, 4-, and 2-ohm loads, respectively, and the Pioneer producing 189, 288, and 380 watts into those loads. Although the JVC receiver's dynamic power output was not specified, we measured an impressive 196, 312, and 361 watts. As shown in the table, the JVC receiver produced the best signal-to-noise ratios, but those of the other receivers were very good. All three units showed excellent RIAA phono-equalization accuracy and more-than-adequate phono-overload margins. Frequency response, input sensitivity, and tone-control ranges were all as rated and quite normal.

Conclusions

In terms of basic performance, these three receivers were on approximately equal footing. We sometimes thought we heard very small sonic differences between them, but these appeared to depend on the particular loudspeakers being driven and were, in any case, exceedingly slight. Power differences between the receivers seldom

however, is its Digital Acoustic Processor, which is far more sophisticated in its action than the music-oriented surround options of the Onkyo and the Pioneer. We could not help being fascinated as we explored the seemingly endless possibilities of acoustic space and sonic coloration that it opened up. The DAP's digital capabilities make the delay-line ambience-enhancement units of a few years ago seem like toys.

With five channels of built-in amplification and more video inputs and features, the Onkyo TX-SV90PRO and Pioneer VSX-9700S will probably appeal more to those for whom Dolby Surround reproduction is the main priority. Both do an excellent job in that role. And though the center channel is really the *main* channel in Dolby Surround, usually carrying more sound energy than any of the others, the use of center-channel amplifiers having about 4½ dB lower maximum output than the left and right stereo amplifiers is probably a reasonable compromise for receivers that will spend much of their time playing ordinary music recordings.

The Onkyo and the Pioneer each have specific features that will appeal to some users more than others. We liked the Onkyo's mechanical volume, balance, and tone controls, and its front-panel video input is a real convenience if you need to hook up a camcorder once in a while. (We do think, however, that one of the S-video jacks should have been put up front, since recordings made with a camcorder are perhaps the most likely to benefit from this type of playback connection.) On the other hand, we missed the station-labeling feature of the tuners in the JVC and Pioneer receivers.

If you do a lot of video dubbing, you probably will like the Pioneer's Video Enhancer, and the noise filter for the audio outputs from VCR1 and VCR2 can be handy as well. Also useful, given the sonic vagaries of different video sources, is the VSX-9700S's ability to memorize a number of tone-control settings for instant recall.

Deciding between these three audio/video receivers boils down mostly to some questions of personal preference. Any of them, however, will do a very creditable job of reproducing both Dolby Surround and ordinary stereo music recordings. You're not likely to be disappointed. □

SOUND SEPARATES

by Michael Smolen

THERE'S AN OLD ADAGE ABOUT HI-FI EQUIPMENT: THE MORE you take out of one box, the better the system will sound. Putting components in separate boxes does have some electronic advantages in theory, such as better isolation of audio circuitry from noise sources like transformers. Given the general level of sophistication of today's audio gear, however, hearing differences between separates and the best receivers will push your listening skills to the limits.

Separates are undoubtedly more flexible, though. For instance, you can buy a preamplifier or integrated amp that has just the features and inputs you need, whether you're putting together a full-blown audio/video home theater or a simple music system. If you don't need a phono input, you don't have to pay for one, and if you want to use an outboard equalizer instead of tone controls, or no signal processing at all, there are separates to suit you. And if you need lots of power to drive inefficient speakers at high volume, it's much easier to get it with separates than with a receiver or even an integrated amplifier.

Moreover, separates give you more options for upgrading. For example, your checkbook may limit you now to hooking up a simple music system, but in a year or so you may intend to upgrade to a complete Dolby Pro Logic surround-sound setup. Adding audio and video processors, the requisite extra amplifiers and speakers, and video sources is easier when you have a separate preamp or integrated amp than it is with most receivers. Separates also let you upgrade one part of your system at a time, something you can't do if all the main functions are locked up in a receiver. And if your equipment ever needs repair, separates let you isolate the problem area.

The following pages show some of the power amplifiers, integrated amplifiers, preamplifiers, preamp/tuners, and tuners that you can find on dealer shelves today. All specifications and list prices are from the manufacturers.

SOUND SEPARATES

AudioSource's TNR One AM/FM tuner (top, \$229) has quartz-PLL digital tuning and twenty station presets; the PRE One preamplifier has six digitally switched inputs and features Bass EQ circuitry (\$249); and the AMP One, a 60-watt stereo power amplifier, features soft clipping and can be bridged to 170 watts in mono (\$299).



The Philips FA-50 integrated amplifier (\$399) offers 60 watts per channel and the company's proprietary linear-drive power supply, DC and short-circuit protection, and a Source-Direct mode that automatically uses the shortest possible signal path.



Accom's GTP-500 II (\$600) combines tuner and preamplifier functions in a single-chassis package. The preamp section features buffered switching devices, 1-percent-tolerance resistors, and multiroom control capabilities. The tuner has eight FM and eight AM presets. Most functions of the tuner/preamp can be operated from its remote control.



NAD's Model 2600A power amplifier (top) has 150 watts per channel, an exclusive Power Envelope design for long-term dynamic headroom, and a high-current output stage that can deliver up to 50 amperes. The Model

1700 preamplifier offers fourteen AM/FM presets, digital tuning with an analog control knob, semiparametric tone controls, two tape loops and an external-processor loop, and a wireless remote control. Price: \$799 each.



Technics packs 100 watts per channel, Class AA circuitry, and a digital processor with a four-times-oversampling digital filter and dual 18-bit digital-to-analog converters into its SU-V90D integrated amplifier (\$1,050).

Marantz's ST 54CG AM/FM stereo tuner (\$500) features quartz-locked digital tuning, switchable wide/narrow bandwidth, and sixteen FM and eight AM presets. The bandwidth can be set individually for each preset. The gold-finished tuner comes with rosewood side panels.



SOUND SEPARATES

Sansui's TU-X711 AM/FM tuner (\$500) uses a Super Linear Digital Decoder to remove interference from nearby stations without restricting bandwidth. It has thirty random-access presets with preset scan, and you can program two different stations for unattended timer-activated recording.



Yamaha's 2000 series of titanium-finish components includes the CX-2000 audio/video preamplifier (\$1,499) and the MX-2000 power amplifier (\$1,899). Both feature hand-selected, hand-matched components. The MX-2000 is rated at 260 watts per channel into 8 ohms and features Yamaha's proprietary Hyperbolic Conversion Amplification circuitry, said to eliminate signal degradation caused by switching and crossover distortion. The CX-2000 features a digital processor with an eight-times-oversampling, 18-bit digital filter and dual Hi-bit digital-to-analog converters.





JVC's FX-1010TN tuner (top, \$480) has a dual-gate MOSFET front end and presets for any combination of forty AM or FM stations. The AX-Z1010TN integrated amplifier (\$1,200), rated for 100 watts into 8 ohms, features JVC's K2 digital interface, with an eight-times-oversampling, 18-bit digital filter and four 18-bit digital-to-analog converters.



Denon's five-channel AVC-3000 integrated amp (\$1,000) features Dolby Pro Logic, complete A/V switching for up to eighteen sources, a sixty-two-key programmable remote control, and variable digital delay for both audio and video sources. The main channels have 80 watts each, and the three others are rated at 35 watts each.

Sony's TA-E1000ESD digital preamplifier (\$1,000) converts virtually all analog input signals into digital ones so that they can be processed in the digital domain before being converted back to analog and delivered to the power amplifier. Dolby Pro Logic and enough audio and video inputs/outputs for even the most sophisticated system complete the package.



SYSTEMS



by Rebecca Day



PHOTOS BY PETER MARGONELLI

*Do-it-yourself audio,
from a turntable and stand to
a three-way speaker system*

To James Spain there's no other way: If you want it done right, do it yourself. He built his bedroom furniture and his children's bunk beds in their home in Opelika, Alabama, and he's renovating the organ and sound system in his local church. He also built his turntable and speakers.

Intrigued by a *STEREO REVIEW* article years ago about how audiophiles often build amplifiers and speakers but not turntables, Spain took on the challenge. He bought an SME V tonearm, an Audio-Technica OC9 cartridge, and a VPI motor and platter, and then he crafted a 300-pound freestanding turntable assembly.

The stand's five legs are made of 2½-inch steel tubing. Four steel spikes serve as feet, and the fifth leg houses the AC line cord. Spain used alternate layers of ¼-inch steel plate and ¼-inch mirror-polished black acrylic for the main frame, which supports the motor and is secured to the stand with ⅜-inch bolts. Four neoprene dampers, covered by a sheet of polished brass, minimize vibration from the motor. Spain drilled holes in the steel-and-acrylic subchassis for the platter bearing and tonearm, which he says are coupled "quite effectively." Feet made by Sims Vibration Dynamics provide damping and suspension between the subchassis and main frame. He



also inserted RCA connectors and a binding post for the ground cable on the back of the frame.

To construct his 6-foot-tall, three-way, transmission-line speakers, Spain used pairs of Audio Concepts 8-inch woofers, 5-inch Focal midbass/midrange

drivers, and 1-inch Focal Kevlar dome tweeters—each in a separate subenclosure. He designed and built the active crossovers, which have transition points at 100 and 4,000 Hz. Biwired to a Quad Model 606 power amplifier—one run for the low frequencies and one for the highs—the speakers are housed in two cabinets, each made up of forty-eight pieces, with ¼-inch particleboard walls. The terminals are solid-copper Edison-Price Music Posts. The rest of Spain's store-bought equipment consists of a B&K Pro 5 preamplifier and a Magnavox CDB 472 compact disc player.

Spain, a machinist, likes the challenge of making something himself, and he likes to save money while he's at it. His turntable cost about \$4,250 to build, but it was a lot cheaper than the \$25,000 Goldmund Reference turntable that he modeled his turntable's base on. It was also more rewarding. "You can buy just about anything you want if you look for it," he said, "but somebody has to make it, and it might as well be me." □



Load

Sound-package options available to buyers of Mazda's MX-5 Miata (above)—a poor man's sports car that packs a 116-horsepower engine — include headrest-mounted speaker pairs, a cassette receiver with an integral security-code system, and an in-dash CD player.



AUTOMAKERS TURN UP THE VOLUME IN '91 MODEL YEAR

by Bob Ankosko

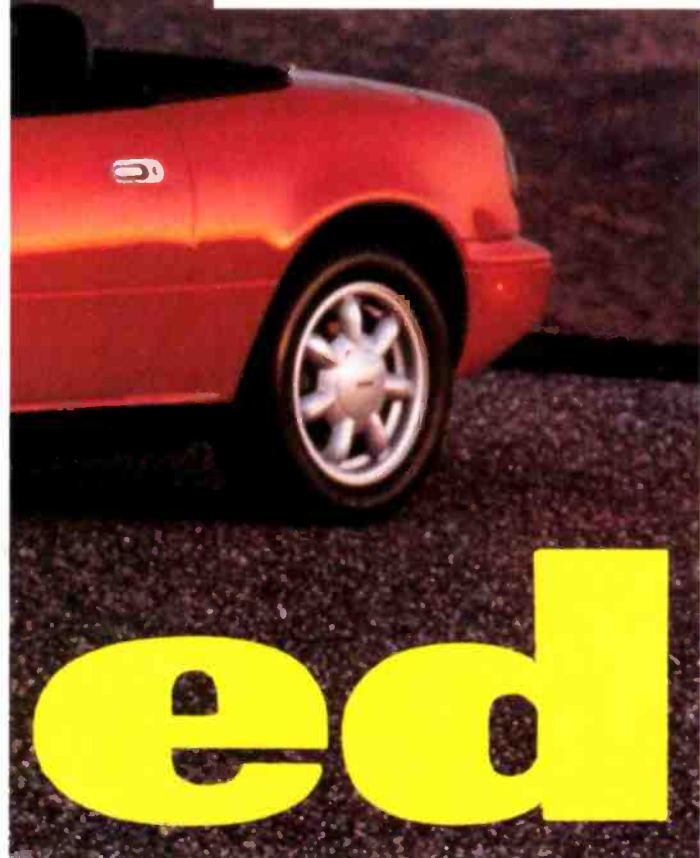

MANY people dread shopping for a new car. Let's-make-a-deal-today sales tactics, compromising on color because the one you want will take six weeks to deliver, haggling over option prices—it's just not much fun. There is, however, one part of it that music lovers will enjoy, and that's auditioning the sound systems. Wait a minute, it's not what you think. A cheesy radio and tin-can speaker aren't the only options any more. For the past three or four years most car makers have offered at least one respectable factory-installed sound system, and in some cases these systems are designed and built by such stalwart audio companies as Bose, Infinity, JBL, Jensen, and Nakamichi. Contrary to what you may have thought, walking into a new-car dealership and asking whether a single-play or multidisc CD option is available, or if the stereo package in question includes a subwoofer, won't cause the salesman to double over in laughter. The audio systems on tap for the 1991 model year present an impressive range and variety (prices are given where available).

Toyota's Lexus division showed its audiophile aspirations when it collaborated with Nakamichi to produce a \$1,000-plus high-end option for the 1990 Lexus LS400 luxury sedan. Highlights of that system, which carries over into 1991, include fixed parametric equalization tailored to the car's interior, a cassette tuner with twelve AM/FM presets and Dolby B noise reduction, 126 watts of continuous power with 0.1 percent distortion into 4 ohms, an 8-inch subwoofer mounted on the package tray, four door-mounted 4½-inch speakers, and a pair of tweeters. A six-disc Pioneer-built CD changer with random



Mitsubishi's sleek 3000GT VR-4 rolls off the assembly line with a 100-watt cassette-based system featuring six speakers, stereo AM reception, twelve AM/FM presets, and a loudness-compensation switch. A CD player is a \$600 option.

Loaded

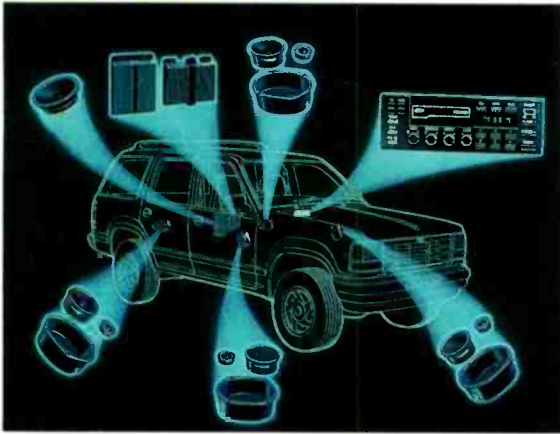

To help enliven off-road travels, the Ford/JBL sound package for the Explorer features 132 watts of power, four satellite speakers, and a 7-inch subwoofer; the basic option price is \$488. Other options include an in-dash CD player and a rear-mounted CD changer.



playback is offered as a \$900 option.

In 1991 Toyota vehicles, an improved high-end package, known as the Premium 3-in-1, is designed to keep Toyota customers away from aftermarket car stereo installers. Highlights include an integrated (double-DIN-size) cassette player/tuner/CD player that features CD random play, Dolby B and Dolby C noise reduction, separate bass, midrange, and treble controls, and five preset equalization curves. A four-amplifier version with four to eight speakers is offered as a \$700 to \$1,350 option in the Cressida, Supra, and 4Runner. Biamped versions with five or six amplifiers and seven to ten speakers are a \$1,000 to \$1,405 option in the Celica, MR2, Previa, and Land Cruiser.

Bose, the company whose pioneering efforts produced the automobile industry's first "high-end" factory sound option in 1982, for GM's Cadillac, is now supplying systems as standard or optional equipment on eleven GM vehicles as well as numerous other cars from Audi, Acura, and Nissan. Custom equalization is the hallmark of the Bose package: Each system is pre-

equalized at the factory to compensate for the unique acoustical characteristics of the vehicle's interior.

For 1991, the Delco/Bose Gold Series system—a high-power version of the original Cadillac system—is offered as standard equipment in the classy Cadillac Allante. The 200-watt package is built around an integrated Delco cassette tuner/CD player featuring a switchable compression circuit for enhanced CD playback, ten AM/FM presets, Dolby B noise reduction, and music search for both tape and CD. Four 4½-inch full-range speakers are deployed in ported enclosures, two in the doors and two in the quarter-panel area behind the seat. The compression switch reduces dynamic range by 50 percent, which helps keep the music audible when the Allante's top is down.

A similar, cassette-based Gold system is offered as a \$773 option on the Buick Park Avenue. The outfit features a unique control that automatically adjusts the volume according to engine speed, and it uses a pair of 6 x 9-inch speakers in the rear package shelf. A similar system offered for the Camaro is equipped

with a pair of 6½-inch rear speakers each housed in a 3½-cubic-foot ported enclosure that is said to enhance bass performance. A \$400 dealer-installed, in-dash CD player is also available for both cars.

A less powerful Delco/Bose Silver Series option is offered in Chevy's 1991 Caprice, which features a striking aerodynamic redesign. Highlights of the 80-watt system include a pair of door-mounted 3½-inch speakers and two 6 x 9-inch speakers mounted on the rear package shelf; option price is \$335.

The Acura/Bose system offered as standard equipment on the flashy new Acura NS-X sports car includes an Alpine-built cassette tuner with Dolby B and music search, a ported bass module with a 4½-inch driver, 4½-inch door-mounted speakers, and a 2½-inch midrange/tweeter between the driver and passenger seats to enhance ambience. A six-disc CD changer is available as a dealer-installed option (\$700 plus labor).

Achieving "concert-like sound" was the goal behind the Reference Standard system Infinity developed for Chrysler's 1991 luxury cars. Building on the earlier-generation



A six-speaker Acura/Bose system featuring a center "fill" speaker and a ported bass module is standard equipment on Acura's \$60,000 NSX roadster. A \$700 CD changer option is also available.



The 120-watt Chrysler/Infinity RS system offered as an \$810 option in the New Yorker Fifth Avenue sports ten speakers, a five-band graphic equalizer, and ambience-enhancing circuitry.

Loaded



Standard equipment on Sterling's Oxford Edition includes an eight-speaker, 80-watt Pioneer-built system.

Infinity I and II systems (currently offered on a number of Chrysler vehicles including the LeBaron, Plymouth Sundance, and Dodge Caravan), the 120-watt RS system comprises ten speakers, including two 3½-inch dash-mounted coaxials, a pair of 5¼-inch door-mounted woofers, and a pair of package-tray-mounted 6 x 9-inch woofers, each with a coaxially mounted 2½-inch midrange. Features include a graphic equalizer, stereo AM reception, Constant-Bass circuitry (said to provide steady bass output regardless of the fader setting), and an ambience-recovery/blend circuit. The RS system is standard in the Chrysler Imperial and an \$810 option for the New Yorker, Fifth Avenue, and Dodge Dynasty. But development

hasn't stopped there. Infinity is said to be planning to add a center channel in 1993.

In the mid-Eighties, Ford turned to JBL for help in designing a top-shelf autosound option for the 1986 Lincoln Continental. Since then, several incarnations of the Ford/JBL system have been made available to buyers of the Lincoln Town Car and Mark VII, the Mercury Cougar and Sable, and the Ford Taurus and Thunderbird. But the latest vehicle to feature a Ford/JBL system is the 1991 Explorer, a compact sport-utility vehicle. Similar to other Ford/JBL packages, the Explorer's system offers stereo AM reception, Dolby B and DNR noise reduction, custom pre-equalization, and 132 watts of power (with 0.08

percent distortion into 4 ohms). The speaker lineup includes four two-way satellite enclosures, each with a 4-inch midrange and 1-inch tweeter, and a 7-inch subwoofer housed in a sealed, 3½-cubic-foot enclosure. The option price is \$488. But that's not all. Once you select the JBL system, two CD upgrade options are available: a factory-installed CD tuner instead of the cassette tuner with switchable compression and shuffle play (\$295) or, if you want a three-source system, a dealer-installed ten-disc rear-mounted CD changer (between \$800 and \$900).

We've heard that BMW is planning an ultra-high-end system option for 1992, but in the meantime Bimmer buyers will have to settle for the pre-equalized 120-watt system of-



Polk's twelve-speaker, 160-watt H700 sound system is offered as part of a \$1,450 options package for Hyundai's Sonata V6.



ferred across the board as standard equipment. The system isn't too shabby, though, boasting a cassette tuner with eighteen AM/FM presets and ten speakers: a 6½-inch woofer in each footwell, two 3-inch mid-ranges in the dash, tweeter pairs in the front-door panels and rear package tray, and a pair of 6½-inch mid-bass drivers in the package tray. A trunk-mounted six-disc CD changer (made by either Pioneer or Alpine, depending on the vehicle) is available for \$780 on all models except the 850i coupe, which includes a changer as standard equipment. During the 1991 model year BMW is also phasing in a diversity-tuning antenna system, which should offer a significant improvement in reception over the standard antenna.

For the first time, Mercedes Benz is making a trunk-mounted ten-disc CD changer option available for all of its vehicles. The \$460 changer complements the 100-watt, ten-speaker system that's standard in the 300E and 300C models and optional in the 300E 2.6 and 300D 2.5 Turbo.

Following a successful launch in 1990, Polk's twelve-speaker H700 sound system is being offered as part of a \$1,450 options package for Hyundai's 1991 Sonata V6. Highlights include 160 watts of power, a cassette tuner with Dolby B and Dolby C, a CD player, and Polk's ambience-enhancing SDA Crossover Matrix. The front speaker complement teams a pair of dash-mounted 4-inch midranges with two ¾-inch dome tweeters mounted in the front-door panels. A 6½-inch woofer in the lower portion of each front door stabilizes the front stereo image. In the rear, a pair of 6½-inch coaxials mounted on the package shelf handles the SDA signal, while two 6½-inch woofers deliver bass from a ported enclosure beneath the package shelf.

Volvo's new Model 780 Coupe is equipped with a standard 200-watt Alpine system built around a cassette tuner and six-disc CD changer. Speakers include a pair of door-mounted 6½-inch coaxials and two 6 x 9-inch coaxials in the rear parcel shelf. The system features Dolby B, twenty-four AM/FM presets, and an integral security-code system.

Mazda has reserved its slickest sound package for the 1991 RX-7 convertible: Standard equipment includes an integrated AM/FM cassette/CD system, a diversity-tuning antenna system, 150 watts of power, Pio-



The \$335 Delco/Bose Silver Series sound-system option is one of many luxurious amenities offered in Chevy's all-new Caprice. Highlights include four speakers and 80 watts of power.



neer's Acoustic Equilibration ambience-enhancing processor, and eight speakers, including a woofer in each door and a pair of speakers in each headrest. Offering a neat twist of flexibility, there is a separate volume control for each headrest. A six-speaker system with a seven-band graphic equalizer is standard equipment on the GXL and Turbo models, and the CD player/processor combo replaces the equalizer as an option.

Mitsubishi's new 3000GT SL and VR-4 sports cars are rolling off the assembly line with a 100-watt cassette-based system featuring six speakers, Dolby B, stereo AM reception, twelve AM/FM station presets, a seven-band graphic equalizer, and a front-panel CD/auxiliary input. For an additional \$600, buyers can go all the way and order an in-dash CD player in place of the equalizer.

An 80-watt (maximum) Clarion-built AM/FM cassette receiver with a graphic equalizer and four speakers is available as standard equipment on the 1991 Subaru Legacy LS, LSi, and Sports Sedan and as an option on the L and L+ models. A CD player is an option for all models.

The 1991 Sterling 827Si, 827SLi, 827SL, and Oxford Edition are equipped with 80-watt (maximum)

Pioneer-built systems featuring a cassette receiver with twelve AM/FM presets, an integral security-code system, and eight speakers, including a two-way door system and a pair of 6½-inch coaxials in the rear package tray. A trunk-mounted six-disc CD changer is optional.

Jetsetters who are looking into the purchase of a 1991 Lamborghini Diablo—successor to the legendary Countach—may be pleased to know that this exotic vehicle leaves the factory with a 60-watt, four-speaker Alpine sound system. Highlights include the removable Model 7390 cassette tuner with Dolby B and Dolby C, two door-mounted 5¼-inch woofers, and a pair of silk-dome tweeters in the windshield's A-pillars. An optional upgrade adds a six-disc CD changer, 8-inch subwoofer, and 85 watts of power to the package.

So the next time you walk into a new-car showroom, don't forget to take along your favorite tapes and CD's. And remember to ask the right questions. For example, "How powerful is the sound system?" Or, "Is a subwoofer included as part of the upgrade package?" These questions are just as important as, "How fast does it go?" Then you'll be ready for a real test drive. □

MIRELLA FRENI

*"When singing
becomes a strain,
I will stop."*



by William Livingstone

ITALIAN operatic voices are often like flowers—beautiful but fragile. Easily damaged by overwork, the light soprano and tenor voices, in particular, tend to fade quickly. But in the lyric soprano Mirella Freni Italy has produced a hardy perennial, a singer who has managed to prolong the full bloom of her career into her middle fifties.

Last season at the Metropolitan Opera she caused a sensation with her performances as the headstrong young protagonist of Puccini's *Manon Lescaut*, and her busy schedule included a return to New York to open the new Met season in September in another Puccini role, Mimì in *La Bohème*. This year Miss Freni is celebrating the thirty-fifth anniversary of her first professional engagement and the twenty-fifth anniversary of her Metropolitan debut.

Interviewed in New York during her spring run in *Manon Lescaut*, she said she wasn't sure how she had kept her voice sounding so young and fresh. "I've always worked hard, but I've been careful in the technique of using my voice and careful in choosing repertory that was not too heavy for it. But I know other singers who have done the same with less fortunate results, so perhaps I owe a little bit to luck."

What critics notice is not her carefulness, but rather the seeming reckless abandon with which she sings and the increased intensity of her performances as she has matured. "Slowly everything came into balance—voice, breath, and support—and it has been a nice surprise to discover that I can comfortably sing a few roles that are more dramatic than anything I dreamed of when I was younger."

Among these somewhat heavier roles are the Tchaikovsky heroines, Tatiana in *Eugene Onegin* and Lisa in *Pique Dame*, which she sings in Russian. These astonishing additions to the repertory of a mature Italian soprano were among the results of some rather theatrical events in Miss Freni's private life.

From time to time she appeared in operas, such as Gounod's *Faust*, with the Bulgarian bass Nicolai Ghiaurov. Eventually, what had begun as a friendly professional rela-

tionship between them blossomed into romance. Both were married to other people, but patiently and quietly they obtained divorces (it takes five years in Italy), and they have been married now for about a decade. Trained in Leningrad, Ghiaurov was able to help her with the Russian style and language.

Now whenever possible they sing together. "We were both in Barcelona last November for *Eugene Onegin*, and we have sung *Don Carlos* together," Miss Freni said, "but we like to be in the same place even if we sing different works. This fall we are together at the Met where I sing in *La Bohème* and Nicolai is Sparafucile in *Rigoletto* and has some performances of *Boris Godunov*. Whenever we can, we arrange our schedules this way. We are not young people, and we have no time to wait to be together."

Mirella Freni was born February 27, 1935, in Modena, Italy, the same small city where Luciano Pavarotti was born. Her mother and Pavarotti's were friends and bought milk for their babies from the same wet nurse. Mirella sang as a child and began taking singing lessons in her early teens. In 1955, a few weeks short of her twentieth birthday, she made her debut with the local opera company as Micaëla in *Carmen*. In 1958 she won a singing contest that gave her an engagement as Mimì in *La Bohème* with the great tenor Giuseppe di Stefano. From then on she has worked exclusively in the operatic Big Time, starting with debuts at Glyndebourne (1960), Covent Gar-

den (1961), La Scala (1962), and the Metropolitan Opera (1965).

Today in private as well as on stage, Freni seems to have changed little since the early 1960's. She still has the ample dark-blond hair, the large expressive brown eyes, and the full sensuous mouth. Her figure is somewhat rounder and fuller, but you would never know to look at her that she is a grandmother.

"Although Micaëla in *Carmen* is a very young girl, I still enjoy singing that role, and I recently recorded it for the third time, but I am not asked for it so much any more. These days I am invited more often for *Adriana Lecouvreur*, *Eugene Onegin*, and *Manon Lescaut*, and I like these more dramatic roles, but I am still a lyric soprano and still sing lyric parts like Liù in *Turandot*."

HARMING, feminine, and vivacious, she chats amiably and frankly about her career. She has recorded *Madama Butterfly* quite successfully twice and has made a movie of it. Will she ever sing it on stage? "No, no, NO! It is really demanding, especially the second act. That would be okay on a day when I am in very good form, but singers are normal people, and we don't wake up every morning in top form. Forcing to sing *Butterfly* on a less than perfect day could damage my instrument."

In her early years at Glyndebourne, Miss Freni sang Zerlina in Mozart's *Don Giovanni* and Susanna in *The Marriage of Figaro*, and she looks forward to returning to the Met in February to sing Susanna again. Besides *Faust* and *Carmen*, the French operas she has sung often include Gounod's *Roméo et Juliette* and *Mireille* and Massenet's *Manon*. She finds the technique of singing in French the same as Italian, but says she has to work a little harder to project her voice in French because some of the consonants are difficult to sing.

"I prefer Puccini's *Manon Lescaut* to the Massenet opera," she commented. "Perhaps its power and passion appeal to me more because I am older, perhaps because of the things that life has given me."

Singing Russian with its many

Mirella Freni in Puccini's *Manon Lescaut*



MIRELLA FRENI

consonants is even more difficult than French, but in preparing the role of Tatiana she mastered it. "Although he is a little more classic, I think of Tchaikovsky as a Russian Puccini with his big, long phrases and all that passion. I like this kind of music, and finally singing Tatiana was the fulfillment of a dream. I had studied the role in Italian but never sung it. Maestro Bruno Bartoletti in Chicago urged me to take it up because he felt it was perfect for my voice and temperament, but it was hard for me to face singing a whole opera in Russian. Then in San Francisco I worked with a fantastic teacher, who found that I could sing Russian correctly while retaining the warmth of an Italian. Nicolai explained the meaning of certain words and helped with fine points of pronunciation."

Miss Freni has had considerable success in *Eugene Onegin* at Lyric Opera in Chicago, at the Metropolitan, and elsewhere. A video of a Chicago performance is available from Home Vision, and the Deutsche Grammophon recording of the opera she made with Thomas Allen in the title role and the Dresden State Orchestra conducted by James Levine was nominated for a Grammy Award this year. After *Tatiana*, *Pique Dame* was easier. She performed it at La Scala in June and in concert at Tanglewood in July.

MISS Freni speaks warmly of her colleagues, particularly conductors and especially Herbert von Karajan, who had a great influence on her career. It was Karajan who led her gently into some of the more dramatic roles in Verdi's operas, such as Elisabetta in *Don Carlos*, Desdemona in *Otello*, and even *Aida*.

"There was an incredible special feeling between us, a sort of mental telepathy," she said, "and I was very lucky to have this with Maestro Karajan. Last night, after I sang *Manon*, I came home and switched on the television, and there was *Madama Butterfly*, a movie with me conducted by Karajan! I had never seen it, and I stayed up watching it until four o'clock. It brought me many memories, and it was touching

after all these years to see how close we were musically in the phrasing. It was so sad when he died last year. I know he was old and not well, but he had loved me very much and cared for me like a child."

Other conductors with whom she has enjoyed a particularly fruitful artistic rapport include Carlos Kleiber, James Levine, and Giuseppe Sinopoli. "There is an incredible feeling that comes from working with great conductors who are sensitive to what a singer contributes and are responsive. For people who don't sing it is probably hard to understand the satisfaction of that kind of collaboration.

"Sometimes even with important conductors this special communication does not take place, and the results may be beautiful performances that lack something. But when the special artistic contact occurs between the conductor and the singer, it is so strong that you can feel it in the body, in the skin, and it generates a kind of electricity that fills the whole theater with magic."

She also speaks with appreciation of other singers. She and Renata Scottò, for example, have sung many of the same roles, but they are friends, not rivals. Tenors are often said to be more temperamental than prima donnas, but Miss Freni has sung with the leading ones, including José Carreras, Plácido Domingo, and Luciano Pavarotti, without problems.

"Luciano and I knew each other as children, and our friendship has survived as a very, very nice relationship. We are both very busy with our work, but we still speak often on the telephone. I am happy that he has had such a tremendous career, but back home in Modena we treat each other as though none of it ever happened, as though we were still students discussing what we are working on, speaking frankly about the good and the bad. Luciano has been a good colleague. The pressure to perform well sometimes makes an artist temperamental, but if he ever tried that with me, I would have to remind him that he owes me respect. After all, I am older than he is by nearly a year!"

Mirella Freni's long career has been documented in detail on record-

ings and video. For example, the Schwann catalog currently lists her in five versions of *La Bohème*, including her first from 1963, which is still available on Angel audio cassettes.

Videos on major labels show her work at La Scala, the Met, and elsewhere, and her lengthy discography includes many aria recitals and complete opera sets. And she is still recording—*Tosca* for DG, *Trovatore* for London, and so forth. She claims, however, that she rarely listens to her recordings. "I give them to my mother and my daughter, and I save copies at home still in cellophane. Perhaps I can listen to them when I retire."

HE is unsure how much longer she can be convincing on stage as a young woman giving her all for art and love, and it depends on how well her voice holds up. "When it becomes a strain, I will stop."

Some of her contemporaries remain on stage singing the roles of mothers, nurses, witches, or earth goddesses, but these are not in Miss Freni's plans. "At present I don't think so. After thirty-five years of career, what do I have to prove?"

"Some singers continue because they have no other life. My other life in Modena is very pleasant. Nicolai loves going there, and I have my family there—my mother, my uncle, my brother, two sisters, my daughter, and above all my two grandchildren. My grandchildren are my contact with the real world. I adore them, and they give me great happiness. It will be nice to see more of them when I stop singing."

When it is time to stop, both Ghiurov and Miss Freni would like to pass on their experience through teaching. She said, "I would like to put myself at the service of younger singers." When she talks of coaching or teaching, she does not speak of cultivating delicate hothouse flowers, but uses the terminology of athletics. "We singers are like boxers in that we have our own categories, and it's dangerous to go outside them. Instead of a few seasons as a heavyweight contender, I have been satisfied with a longer career as a world-champion welterweight." □

BUCK THE SYSTEM



Full rich flavor, not full price.

Available in Kings & Kings Lights.

Mfr. suggested retail price.

SURGEON GENERAL'S WARNING: Smoking By Pregnant Women May Result in Fetal Injury, Premature Birth, And Low Birth Weight.

© Philip Morris Inc. 1990

Kings Lights: 11 mg "tar," 0.7 mg nicotine — Kings: 14 mg "tar," 1.0 mg nicotine av. per cigarette by FTC method.



The Tape Mate C-11 vinyl carrying case from Tantrum Trading has a see-through window that makes locating a cassette easy. It holds eleven tapes and has a suggested retail price of \$6.99. Colors include black, white, red, and pink.



Lebo's Voyager bags are made of waterproof nylon. The Jumbo Voyager shown above (\$36.95) has removable dividers and two zippered side pockets for accessories. It holds forty-eight CD's and comes in red, black, blue, or gray.

YOU CAN TAKE IT WITH YOU

A disc or tape player is only as portable as the music you feed it. Spending almost as much time hunting for the next recording you want to hear as you will listening to it is not the idea. Fortunately, no matter what the size of your traveling library, there's a carrying case that will keep your recordings safe and organized. Here are some of our favorites.



Perfect for toting half a dozen CD's for a six-disc car changer, Bib's A-621 storage album has individual dust-free compartments. Its suggested retail price is \$12.95.

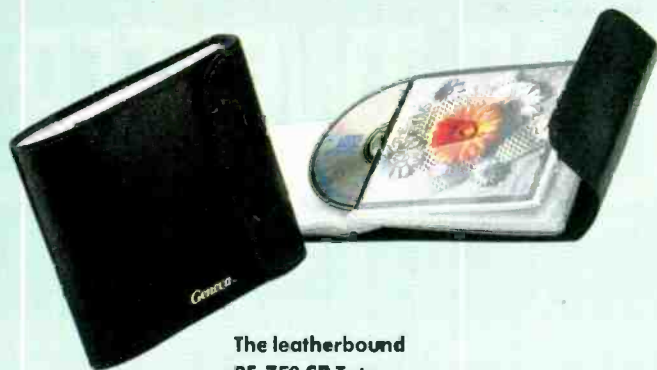

The leatherbound PF-750 CD Tote (\$29.95) from Geneva would make a good gift for an audiophile you're trying to impress. It holds ten discs in antistatic cloth inner sleeves that can be replaced when they become dirty.



Fool your boss with the tape case that's disguised as a briefcase. Leslie Dame's padded, vinyl-covered TA-630 (\$8.95) holds thirty tapes. Other models can hold sixty, twenty-four, or twelve cassettes.

Your portable CD player will be safe inside the Case Logic DM-1 (\$19.95). Its thick foam padding protects the player, and there is an extra pocket for accessories or CD's. The shoulder strap is adjustable.



The slim-line Klik!Case will appeal to the style-conscious buyer. It holds sixteen CD's in what is said to be less than half the space of comparable carriers. The weather-resistant case's list price is \$9.



If you can't be bothered with straps or handles, the Service Manufacturing Corp.'s FP-3 adjustable waist pack (\$10.95) is for you. Made of nylon, it has a quick-release buckle and is available in black, blue, and assorted neon colors.



THE MILLION DOLLAR TWEETER.

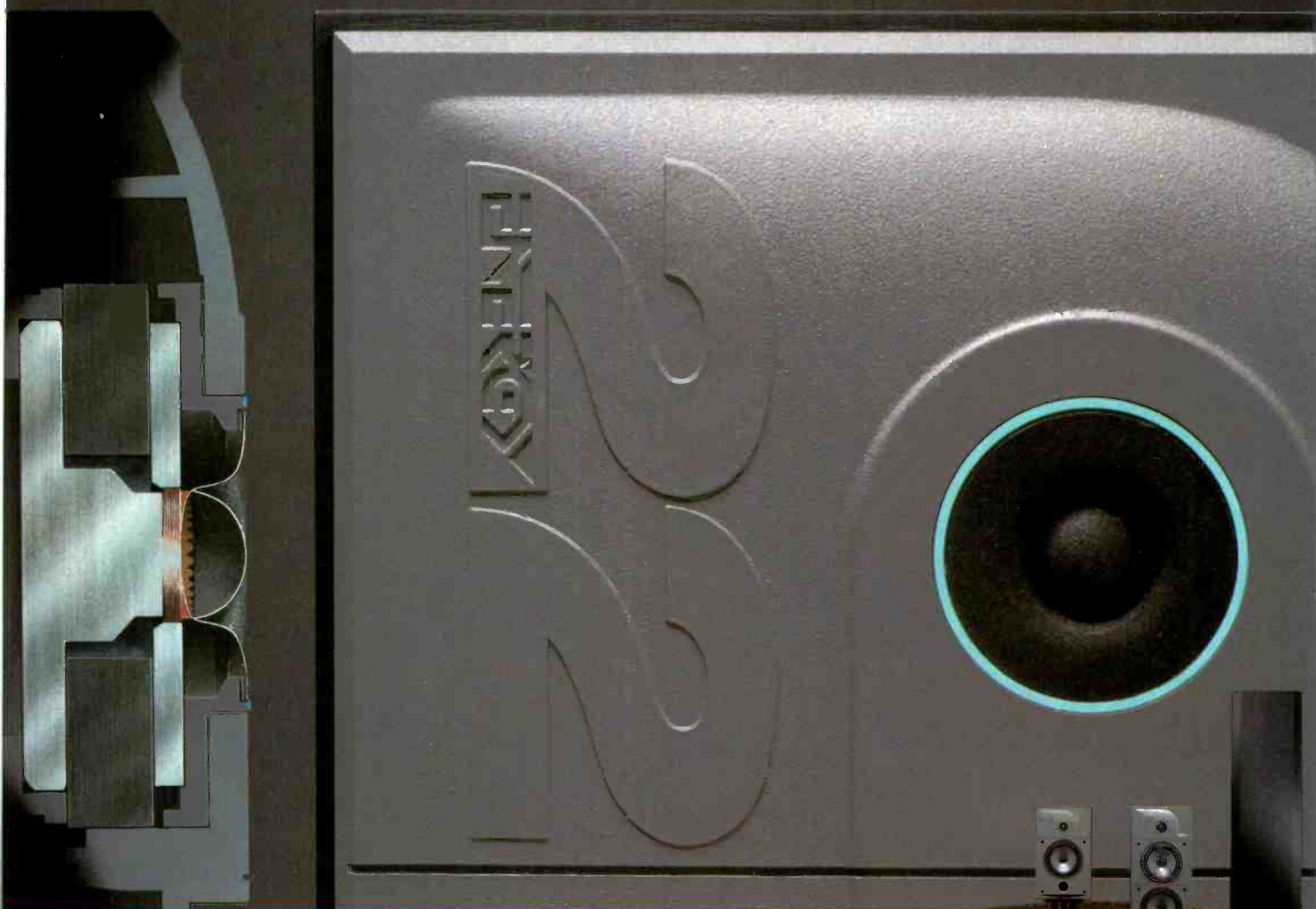

ENERGY loudspeakers have become the personal favorites of discriminating audiophiles the world over. **O**ur Dual Hyperdome™ tweeter is the key reason why ENERGY recreates the original performance with uncompromised accuracy. **W**ith more than \$1 million in development, it exhibits better dispersion than any other tweeter on the market today. **T**hat's also why our new ENERGY 22-Series incorporates the revolutionary SPHEREX™ baffle. **I**ts smooth, sculpted surface angles gracefully out of the

way of direct radiated sound. **D**iffraction is eliminated for superior soundstage and positional imaging. **S**imply put, the ENERGY 22-Series defines a new standard in sonic precision. **T**ake a test drive today. **Y**our ears will thank you.



ENERGY®

CIRCLE NO. 58 ON READER SERVICE CARD

©1990 ENERGY • 3641 McNicoll Ave. • Scarborough, Ontario, Canada M1X 1G5 • (416) 321-1800

DISASTER

(ALMOST)



I COULD see the flashing lights from four blocks away. When I got closer I could see the fire hoses running across the street and up my driveway. A fire had broken out in my garage apartment while I was in evening class. There was no structural damage to the building, but inside nothing was untouched.

After I rounded up my three safe and lucky cats, I began to wonder about my stereo equipment and music collection. Most of my equipment was fairly new. The Yamaha receiver and two BEC speakers in my bedroom were undamaged by the heat but covered with soot. The most expensive equipment had been in the room with the fire. The Technics turntable was dirty and wet and had a warped dust cover and melted patch cords, but it was repairable. Metal cases had saved my

BSR equalizer and Hafler DH-110 preamplifier and DH-500 power amplifier from being totaled. All three needed some repairs and a lot of cleaning.

The tape deck, CD player, and VCR were headed for the junk heap. Their plastic cases and controls had melted, and they looked like escapees from a Salvador Dali painting. (The Zenith TV set actually worked for several weeks before it shut down completely.)

The newest part of my system was a pair of three-month-old Polk Audio SDA-1C speakers. They looked bad, and repair seemed beyond reason, but not beyond hope. I was relieved to see that my 300 LP's, which sat on the floor across the room from where the fire had been, were not ruined—just dirty.

It didn't look like my CD's were as

by Gary Burton



lucky. The plastic cases were melted, and they were covered with soot. Replacing nearly 150 CD's was a more depressing thought than replacing equipment. My friend Terry, who was helping me in the rescue effort, said he thought that some of the CD's might still play once they were cleaned. I doubted it, but we loaded all of them onto my truck anyway.

I had been turned down for insurance because of the age and structural type of my home, so my only hope was to repair, rebuild, and replace things as best I could. In the days that followed, after I found a temporary place to live, I began to restore my equipment.

Using liberal doses of soap, water, contact cleaner, and rags, I cleaned the receiver and speakers that had been in my bedroom and the equalizer and turntable from the living room. All the patch cords and

some diodes in the equalizer had to be replaced. I set up this condensed system in the electronics shop where I work, turned on the power, put a record on the turntable, held my breath, and lowered the tone-arm. It sounded fine.



WHEN I started working on the Hafler amplifiers. The plastic buttons on the preamp had melted and frozen the controls. After bypassing the power switch and connecting the turntable to the power supply, I got good, clean music through the headphone output. To test the DH500 power amp, I removed the cover and applied power. The cooling fan had to be nudged to start running, but everything else looked fine, just dirty. When I connected it to the preamp and speakers, it put out the same clean sound it always had. I

called the people at the David Hafler Co., who were very helpful, and sent them an order for the fan, switches, and buttons that needed to be replaced. Things were beginning to look better.

Next I turned to the Polk speakers. From looking and listening I knew that the crossovers were good, some of the drivers were not, and the cabinets had to be rebuilt. When I phoned Polk Audio, their concern and advice went well beyond good customer relations. The technician I spoke with suggested that I find which drivers needed to be replaced and get an estimate for cabinet repair. Then he would give me a price on the replacement drivers and I could decide if it would be worth it to rebuild the speakers.

I examined each driver by hand, eye, and, especially, ear. Three of the midrange drivers, two of the tweeters, and both passive woofers

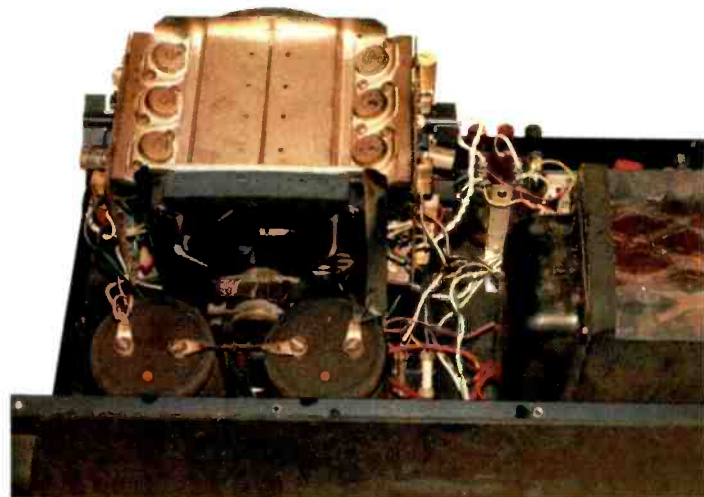
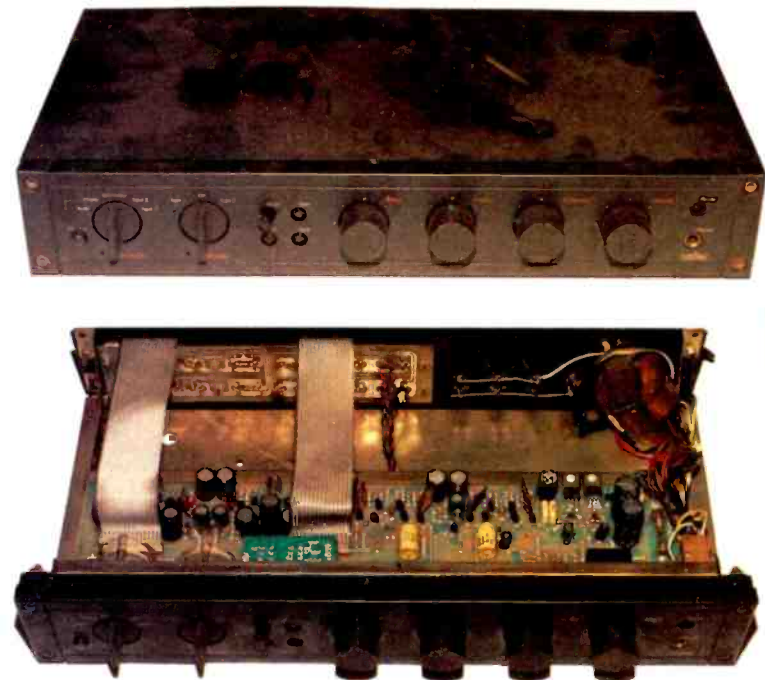

The worst damage from the fire was to the Zenith TV set, Denon CD player, and Technics tape deck (far left), all of which had to be junked. The Polk speakers were damaged but could be repaired (near left, after repair one speaker still shows water stains on the drivers that were not replaced). Despite intense heat, the Hafler DH-110 preamp (above, with and without its case) survived almost unscathed except for some melted plastic pushbuttons. The Hafler DH-500 power amp (right) only had to have its cooling fan replaced.

needed to be replaced. After testing the drivers I drew diagrams of both speakers. Then I removed each driver, marked them according to the diagrams, and put them into boxes labeled "left" and "right." I removed the wires and crossovers and put them into the appropriate boxes. Then I loaded the empty speaker cabinets into my truck and headed on out.

I went to the audio store where I had bought the speakers and got the names of several cabinet makers. Two places I went to weren't interested. One even said he could see no reason to put so much time and money into a stereo system. Finally, the owner of Sloan's Cabinet Shop looked them over and told me he could repair them by replacing everything except the front and back. He gave me an estimate of the cost, and I left the speakers there and returned to my shop.

When I called the technician at Polk, I told him which drivers needed to be replaced, and he gave me the best price he could. The cost of the drivers plus the cabinets added up to slightly less than half the cost of a new pair. It was worth it; I decided to repair them.

While I had been taking care of the speakers, Terry had been checking out the CD's. He had carefully opened some of the cases, which required prying and sometimes cutting, and had cleaned the discs with lens cleaner. They looked good, but I was still doubtful. I bought a used Sony Discman from a friend, and we tested the discs. To my amazement, every disc played fine. I didn't lose one of them.

All of the cases, however, had to be replaced. I ordered 136 CD jewel boxes from a local Radio Shack store. When the new cases arrived, Terry and I spent most of one day

transferring discs and labels from the damaged cases to the new ones.

BEFORE a month had passed, the parts for my amplifiers arrived and I had them operating like new. The drivers came in from Polk, and the cabinets were finished sometime later. With everything assembled, we had ourselves an excellent-sounding workshop for the next several weeks.

When the repairs on my house were finished I moved back in, equipment and all. That all happened a little more than a year ago. Since then I have upgraded my CD player to a Sony CDP-C7ESD and bought a budget tape deck, and I still spend too much money on compact discs. But I'm convinced more than ever now that they are a good investment. □

McIntosh[®]...

*handcrafted with pride
dedicated, highly*

In a world of mass produced merchandise McIntosh is a welcome relief. Since its beginning in 1949, all McIntosh instruments have been and still are hand made, one by one, with as much care and dedication as if each was the only one. Each McIntosh is handcrafted. There is no production rush at McIntosh, for handcrafting takes time. Handcrafting gives you more performance and more value. Note the precise placement of each part. This means longer trouble-free performance. As more parts go into a chassis, craftsmanship becomes more apparent. Each operator is highly trained. Trained in the McIntosh way, training is continuous. Each instrument is checked from one station to the next. Each instrument is checked again and again to give the best possible performance ensuring that your McIntosh instrument will continue to sound good year after year after year. If you were going to build stereo components, isn't this the way you would build them?

McIntosh instruments are made with the best materials. Before any particular individual

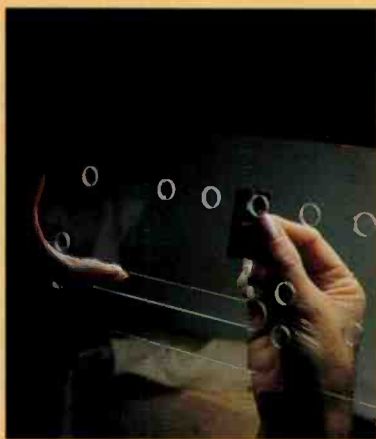

component part is chosen, it is checked, re-checked, tested and re-tested to make sure that you are getting the best. The manufacture, alignment and testing of all McIntosh instruments reflect this care. Try the controls on a McIntosh. Then you will know one of the reasons a foremost technical journal of sound reproduction said: "The McIntosh feel... is the most perfect we have experienced." At McIntosh, nothing is left to chance. Every part selected for use in a McIntosh must be top quality. As each assembly takes shape, it is inspected, tested and measured to exacting performance demands. Then each completed instrument passes hundreds of tests designed to prove it is a McIntosh.

No word describes how immaculate a front panel must be to pass the critical eye. It is checked for dust, fingerprints, smudges, or anything that is distracting. The front panel is checked and rechecked, just like everything in a McIntosh. After a final cleaning and visual inspection, the instrument is put into a plastic bag

in the United States by trained craftspeople.

to keep it spotless and is packed in a scientifically designed shipping carton to provide maximum protection from transportation influenced maladjustment or damage. All these things are done to protect your investment.

To handcraft a product, there can be no demanding production pressure. At McIntosh there is only a **demanding product quality pressure**. Each McIntosh instrument must have the same quality performance, reliability and long life demanded of the original laboratory designed and built sample. To assure that each instrument is an exact duplicate of the laboratory model each wire, each resistor, each capacitor, each solid state device is carefully wired into its specific place. Laboratory precision and care are built into each McIntosh instrument.

Each instrument is rigorously tested. Each test is designed to give you the best performance. So much testing makes sure each part, each circuit, each detail meets the McIntosh quality requirement. Every instrument must meet exacting critical,

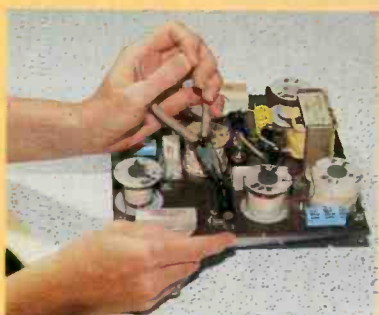
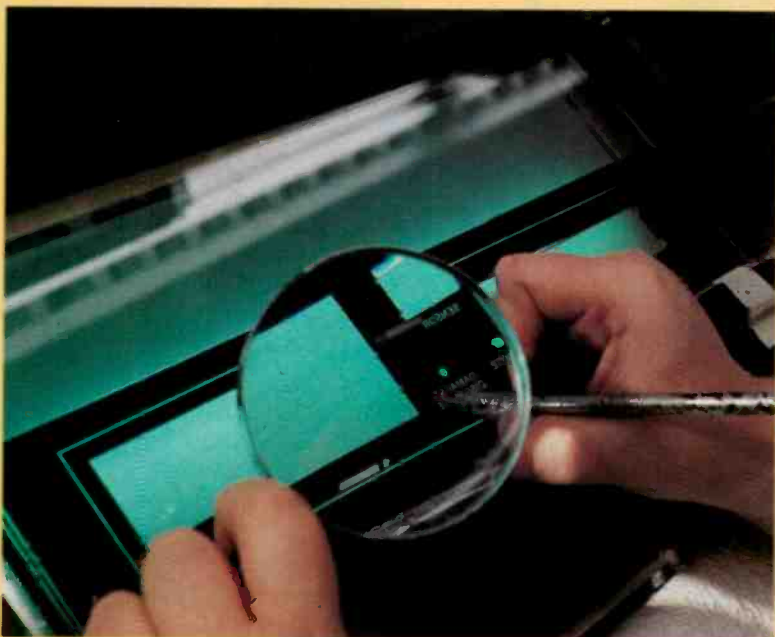

precision standards. At any point, if something does not meet its performance guarantee, all testing stops. The reason is found, corrective measures are taken and then the testing starts all over again. Testing, endless testing, is your assurance of highest quality performance and protection from failure; testing is one of the reasons McIntosh can give you a guarantee that your new McIntosh will meet or exceed its published performance limits.

At McIntosh, each of us is responsible for product quality. Each of us knows that one of the prices of leadership is **the constant struggle for superiority**. Each of us is dedicated to giving you the performance you expect and the value you deserve.

These are just some of the considerations that go into each McIntosh, your McIntosh.

For information on McIntosh products and product reviews, please send your name, address and phone number to:

McIntosh Laboratory Inc.
Department A100
PO Box 96 East Side Station
Binghamton, NY 13904-0096

ULTIMATE SATISFACTION

LUXMAN BRINGS THE SHUTTLE HOME



Created with Luxman Home Audio technology, the Alpine 5952S CD Shuttle for the car delivers a sound so pure ... so rich, even concert hall aficionados have applauded it. It's a sound that's hard to leave behind and now you don't have to.

With the Luxman DC-114 CD Shuttle you can take this incredible sound with you, from your car right into your living room. The DC-114 is the only Compact Disc changer in the world that's compatible with the Alpine 5952S CD Shuttle. Simply remove the six disc magazine from your car's audio system and plug it into your home system.

That's the type of convenience and

engineering know-how you can expect from Luxman, a recognized leader in sonic excellence for over 65 years. The DC-114 boasts a myriad of advanced features, including 8-fold oversampling digital

filter, 18 bit dual digital-to-analog converters, Luxman's patented Duo-Beta Circuitry to minimize the audible effects of negative feedback, and Star Circuit Topology to significantly reduce noise and distortion. And thanks to its rugged durability, it comes with our exclusive 5 Year Parts and Labor Warranty, the finest in the industry.

So bring the Shuttle home, and enjoy ultimate satisfaction ... from the ultimate in sound.

LUXMAN
5 YEAR
WARRANTY

LUXMAN

For Your Authorized Dealer, Call: 1-800-4-LUXMAN

CIRCLE NO. 52 ON READER SERVICE CARD

ROAD AND TRACK

Stereo at home
away from home—the
eleventh in a
series on
the basics of audio.

BY IAN G. MASTERS

NO picture of an Edwardian picnic would be complete without a wind-up Victrola in the background. Almost as soon as there was sound equipment for the home, there was an urge to take it outdoors, and the earliest equipment was not ill-suited for that. The first record players were totally mechanical, and early radios, although electric, ran on batteries. The problem with the early devices, however, was that they were bulky, and reducing them to a practical size usually meant serious compromises in performance.

Still, the desire for sound on the go has been a powerful one from the beginning. In the 1920's car radios became popular, powered by the automobile's battery and with the electronics stowed safely in the trunk. True portable radios—ones you could carry around—were another matter. Certainly there were radios with handles in the 1930's, but

they were definitely too heavy to carry for long because their vacuum tubes required so much power that large batteries had to be accommodated. Not until transistors began to replace tubes in the 1950's did true portability become possible. These solid-state devices were tiny, used little power, and produced almost no



heat, making them ideal for pocket-size radios.

Victrolas aside, audio outside the home was restricted to radio until recently. The 78-rpm shellac records followed by their vinyl counterparts were the chief audio storage medium for most of the past century, and they were notoriously unsuitable for anything but the most steady conditions. Only when magnetic tape became really popular did audio free itself from the home for good; the compact

disc has refined the possibilities even further.

Beyond AM Radio

The car radio relieved boredom, gave useful information, and created a captive audience for the radio stations. All of this was possible with fairly minimal performance, and that's what most early **autosound** equipment delivered. But when broadcast authorities decreed that all radios should include FM, and when listeners realized that the now-accessible FM stations were broadcasting in stereo, they demanded the extra channel, and **car stereo** was born.

At roughly the same time, **recorded tapes** became widely available, and players for them began to appear. Tape had been around for a couple of decades before it showed up in cars, but it was the packaging in **plastic containers** that could be shoved in a slot that made tape so popular. The first version to gain popularity on this continent was the **four-track cartridge**, an endless loop of tape containing two stereo pairs of recordings: a bit of metal leader tape triggered a mechanism that switched the playback heads from one program to another (often in mid-song), allowing hands-off reproduction of a whole album. Four-track cartridges were soon replaced by **eight-track cartridges**, which were physically similar but held twice as much material.

It was very difficult to record on an eight-track cartridge, and it was inconvenient to manipulate the tape during playback—there was no rewind, and only a limited sort of fast forward—but the format reigned supreme in North American vehicles during the first decade or so of

THE BASICS

the autosound boom. Eventually, it gave way to the **cassette**, which had long since been the standard elsewhere in the world. Exotic tape formulations and **Dolby noise reduction** had turned the cassette into a true high-fidelity medium, although such niceties were late to show up in cars. Still, there were lots of home cassette decks, so car stereo enthusiasts began to discover the joys of recording their own tapes for playing in the car.

The Electronic Heart

The central component in any autosound system is the **head unit**. In simple systems, this contains all the electronics and need only be hooked up to speakers elsewhere in the car; in more elaborate setups some of the electronics may be separate, the head unit being used as a control center.

Head units come in a number of physical formats, both **in-dash** and **under-dash**; the one to use in any situation will depend on the car itself. Many head units are designed for **three-hole** mounting, with a pair of knobs on either side and a central display area. Another popular style is the **European DIN mount**, in which the equipment fits a rectangular opening in the dash. Special requirements, such as the addition of extra components—an equalizer or external CD player, say—may make the use of **mini-chassis** equipment a reasonable choice.

If the head unit contains only AM and FM capability, plus amplification, it is simply a **car radio**; if there is no amplification, it's called a **tuner**. A head unit with tuner, amplifiers, and tape capability is called a **cassette receiver**, without the amps it's a **cassette tuner**, and similarly for a **CD receiver** and a **CD tuner**. Without the radio capability, but with or without amplification, these become cassette or CD **players**. Increasingly, users are choosing multidisc CD **changers**, usually mounted in the trunk and run by an up-front **CD controller**, which may also have the ability to play cassettes or CD's on its own.

Most head units provide a **preamp output** for feeding extra amplifiers, and some also include **line inputs** for extra signal sources. Almost all now

have at least a **fader** for controlling front-back balance in multispeaker systems. A few contain **equalizers** for shaping response to suit a car's acoustic properties, although these are more often found as separate components. In many cases, the equalizer is combined with an external amplifier, usually called a **booster amplifier** if it is meant to be fed from the built-in amplifier rather than the preamp outputs.

Separate amplifiers are often used where numerous speakers are placed about the car, sometimes **bridged to mono** to increase output. Since amplification tends to consume considerable power, some elaborate autosound systems include heavy-duty **alternators** and batteries to handle the load. Various



noise-suppression circuits are sometimes necessary as well to overcome electrical interference generated by the car itself.

The cassette player (or cassette tuner or cassette receiver) is almost universal in autosound systems today, and more and more of them are reaching the technical sophistication of their home-bound cousins. Noise reduction is becoming very common: usually **Dolby B**, fairly often **Dolby C**, and occasionally **dbx**. More modest units sometimes include **DNR**, a single-ended playback noise reducer that requires no pre-

encoding of the signal. In the noisy environment of a car, it is doubtful that the benefits of noise reduction will ever be very apparent, but inclusion of Dolby decoding makes for compatibility between home and car players.

Two features that are very useful, and almost universal in car tape players, are **autoreverse** play, which reduces the amount of tape fumbling, and **auto eject**, which disengages the cassette mechanism when the car's ignition is turned off to prevent flat spots from developing on the pinch-roller and increasing wow and flutter. Some players claim **metal-tape capability**, although any player that will play Type II tapes (**chrome** or chrome-equivalent) will handle metal ones (Type IV) as well.

Considerable effort has gone into improving the FM performance of car stereo tuners, which may be more susceptible to reception problems than home tuners. **Multipath distortion** and its most common mobile manifestation, **picket-fencing**, have been tamed in some advanced systems by means of **diversity tuning**, in which the signals from two (or more) **antennas** are constantly monitored and the better one is fed to the tuner. Input overload is sometimes dealt with by a **local/dx** switch, whose main function is to set the threshold level for automatic scanning of a radio band. The inherent noise of weak-signal reception is countered by **FM blend** (or **auto blend**), which reduces channel separation, and thus noise, at high frequencies.

Selecting the station you want to hear is often simplified by tuner **pre-sets**, which can range in number from a handful to dozens. Some tuners are able to **scan** the band as well, choosing the strongest stations. All tuners have AM capability, and a few are beginning to show up with the ability to receive stereo AM broadcasts.

Pumping Tunes

As with every sort of audio, car stereo **speakers** are critical for good sound. In the simplest systems, the sound is reproduced by a single pair of speakers mounted near the front seats (frequently in the doors) or by a similar pair in the rear deck. Often



OPTIMUS[®] LIVE IN CONCERT!SM

Introducing the performer that's blowing listeners away. It's the Optimus[®] CD-36, the first and only under-dash stereo compact disc system.

The CD-36 performs "solo" with its powerful 36-watt amplifier, or plugs in to play alongside your radio or cassette. Four-times oversampling gives you crystal-clear sound. The under-dash design saves you the hassles of in-dash or trunk mounting.

The Optimus brand is designed, crafted, and tested to the toughest quality standards in consumer electronics. It's technology that performs for you. Hear it today. Available at . . .

Radio Shack[®]
AMERICA'S TECHNOLOGY STORESM

THE BASICS

two pairs are used together, one in front and one in back, and most head units can control the balance between them by means of a fader. Such systems may use **full-range** speakers, either with single-cone drivers or with cones that have extra diaphragms, called **whizzers**, to help with the high frequencies. These are sometimes known as **dual-cone** speakers, but they should not be confused with true **two-way systems**, in which a high-frequency **tweeter** and a low-frequency **woofer** are fed separately through a **crossover network** (if a separate driver for the midrange is added, the system is **three-way**). Often the drivers in two-way systems are mounted together, with the tweeter in front of the woofer, so that they will fit together in a standard speaker cutout; such speaker systems are called **coaxial** (or **triaxial** if a midrange driver is included).

Individual speaker drivers may be placed separately around the car rather than in combined units, and this often requires **bi-amplification**, where tweeters and woofers are amplified separately, the signals being split by means of an **electronic crossover**. Systems with three separate drivers may require **tri-amplification**. And even if only full-range units are employed, extra amplifiers may be advisable for multiple speakers, as car speakers tend to have rather low nominal **impedances**—typically 4 ohms—and can be hard to drive. **Powered speakers**—with their own amplifiers built in—are often a solution to problem loads. Sometimes extra speakers used for the lowest bass octave, or **subwoofers**, are powered this way, although a conventional crossover is often used.

Speakers can be installed in several different ways. Often the most satisfactory method is to drop the speaker into a hole that lets its back wave vent into the trunk. Such **flush-mount** speakers are probably the most common type, and most cars have cutouts to accommodate them. In some cases, these cutouts are inadequate, and speakers with their own enclosures must be used. Such **surface-mount** systems are affixed to the car's interior by brackets. A larger variant is the **truck box**, for use in vehicles such as vans and

pickups that lack suitable surfaces for conventional mounting. Truck boxes may be full-range units or contain only woofers (some woofer-only units, depending on their shape, are called **bass tubes**), and they may or may not include their own amplifiers.

Car stereo systems often have features that have little to do with sound quality. Many feature some form of **security** arrangement to discourage thieves. Two popular security devices are the **pull-out chassis**, which lets you remove the head unit easily and take it with you or lock it in the trunk when you leave the car,

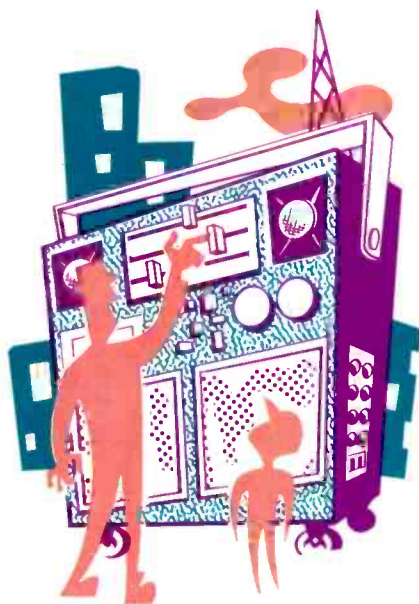

and the **security code**, which disables the equipment if it is ever stolen. Car audio components can also be used to control things like overall security systems and **power antennas**. A few even offer circuits that interrupt the audio when a cellular car telephone is in use.

Walkman and Boombox

While car stereo has grown enormously in popularity, the real portables have probably had a greater social impact. The small stuff goes by a number of names—**pocket stereo**, **personal portables**, and the like—but everybody really refers to them by the trade name of the first models to appear: the Sony **Walkman**. The Walkman was made possi-

ble by the development of very powerful magnetic materials, which enabled small headphones to deliver reasonable levels from amplifiers powered by tiny batteries. The first models were tape players only, and many still are, although some have added such goodies as noise reduction (usually Dolby B but occasionally more advanced circuits), auto-reverse, and metal equalization. A few offer recording capability as well, and more and more are throwing in FM radios for those times when you don't want to be carrying cassettes around while you jog.

The latest variety is the **compact disc portable**, which has the added attraction that it can be used with a home system as well. For that reason, most portables will accept **AC adaptors**, and these often double as battery chargers. Because such portables are often used outdoors, many are weatherproof to some degree, and several companies offer **add-on speakers**, usually powered, for those occasions when you want to share the music.

For such occasions, however, a larger portable is usually more satisfactory. These go by such names as **radiocassette players** or **system portables**, at least officially, but most people refer to them as **boomboxes**. The majority contain **dual cassette decks**, most with **high-speed dubbing** for copying tapes, and many top models now include a CD player as well, sometimes synchronized with the cassette decks for easier dubbing. Most have **line outputs** so the CD player can be used in a home system.

Although some boomboxes are small enough to carry around, many are very large indeed, and the manufacturers of the largest models don't even offer battery operation as a possibility. These megaboxes usually have **detachable speakers** and often some sort of **bass-enhancement** and **image-enhancement** circuitry (sometimes called **stereo wide**), which suggests that such equipment is really meant for use at home in spite of the handles . . . just like those "portables" back in the 1930's.

NEXT: Putting together the stereo system that's right for you.

LASER HOME THEATER



Step Inside The Media Room Of The '90s

by Bruce Apar

TUNE IN TO PERFECTION

OVER 80 PERFORMANCES INCLUDING:

OPERA
Ariadne auf Naxos
The Barber of Seville*
La Bohème*
Carmen*
Cavalleria Rusticana*
La Cenerentola*
Die Fledermaus*
Madama Butterfly*
The Magic Flute*
The Marriage of Figaro*
Otello*
I Paglicci*
Rigoletto*
Tosca*
Featuring: Carreras, Domingo, Norman, Freni, Levine, Milnes, Mitchell, Pavarotti, Ramey, Solti, Te Kanawa, Von Stade, Stratas and many others.

CELEBRATIONS
Bernstein in Berlin
"Ode to Freedom"
Beethoven Symphony No. 9*
Carreras, Domingo, Pavarotti, Mehta-In Concert

SOLOISTS/RECITALS
Ivo Pogorelich Piano Recital*
Arthur Rubinstein in Concert*
Horowitz Plays Mozart
(CAME VIDEO)

DOCUMENTARIES
Leonard Bernstein
West Side Story
with Te Kanawa, Troyanos, Horne and Carreras*
Karajan In Salzburg
with Norman, Battle, Ramey and the Vienna Philharmonie
(CAME VIDEO)
Jessye Norman Sings Carmen
(CAME VIDEO)

ORCHESTRAL PERFORMANCES
Beethoven Symphonies Nos. 4 & 7 with Carlos Kleiber and the Concertgebouw*
Mahler Symphony No. 2, "Resurrection" with Leonard Bernstein and the London Symphony*
Vivaldi's "The Four Seasons" with I Musici

VOCAL
An Evening with Kiri Te Kanawa
Homage a Sevilla with Plácido Domingo

BALLET
G sellé
Featuring Carla Fracci and Ivan Nagy*
Swan Lake
Featuring Margot Fonteyn and Rudolf Nureyev*

COMING SOON:
Bejart: Art of the 20th Century Ballet
Pavarotti & Levine in Recital at the Met
Lohengrin
Pavarotti/Sutherland-Metropolitan Opera Gala and many other exciting titles.

*PRODUCTION BY UNITEEL
†METROPOLITAN OPERA PRODUCTION
© UNITEEL
© 1990 POLYGRAM CLASSICS



LASER DISC



SOPHISTICATED LASER TECHNOLOGY AND FLAWLESS SOUND.

Enter The Laser Home Theater

"The same people willing to spend more for fully featured kitchen products in the 80s," says Martin Holleran of Thomson Consumer Electronics, "will be spending more to equip their homes with media rooms in the 90s."

Many of us, echoing Dorothy's revelation after her trip to Oz, are discovering "there's no place like home" for entertainment value and convenience.

Yet, for fully exciting the senses, there's no place like the modern movie theater and live performances. Home is where the hearth is, but not the panoramic view and "you are there" acoustics that dramatize stage and cinema presentations.

Enter the "home theater." What started out as a catchphrase is quickly moving from concept to total-system status.

The incomparable laserdisc is a key element of the home theater. "Laserdisc is not just another prerecorded software format," said Sony co-founder Akio Morita in his keynote speech at the Consumer Electronics Show earlier this year, "it is new entertainment. Videotape may have brought movies home, but laserdisc brings live performance to the living room." Hence, the Laser Home Theater.

Our theater's principal player is a combination compact disc (CD)/laser disc (LD) machine, or CD/LD combi-player.

For theater-like acoustics, Dolby Pro Logic surround sound also is a cornerstone component. Many A/V receivers and amps have it built-in, or a separate processor and amps can be added to the system. Other important pieces in the theater, according to a consumer survey by Mitsubishi, are big-screen TV and front and surround speakers. Tying it all together is a unified, or universal, remote keypad that puts total system control in the palm of your hand.

Knowing how to arrange the extra speakers and connect the equipment is critical to optimum performance. Fortunately, today's audio and video products are more sophisticated yet user-friendly than ever, with onscreen display the order of the day.

To further demystify matters, companies such as Atlantic Technology and Shure are packaging the requisite electronics and speakers in single-price home theater systems. And a name synonymous with state-of-the-art cinema, Lucasfilm, is certifying manufacturers like Technics, Snell and Lexicon to produce components with the same THX sound standard used in over 500 theaters worldwide.

The finishing touch for some is having the theater pieces installed by electronics design experts. Leading brands are beginning to offer products designed expressly for this purpose. Mitsubishi and Philips have wall-sized screens, and more wall-mounted speaker models are surfacing, from companies like a/d/s, Bang & Olufsen, Infinity and Sonance.

Help in finding a qualified designer/installer is made easier by contacting the Custom Electronics Design & Installation Association (CEDIA), 10400 Roberts Rd., Palos Hills, IL 60465; phone 1-800 CEDIA90 (inside Illinois, 708-598-7083).

Laser Home Theater guarantees

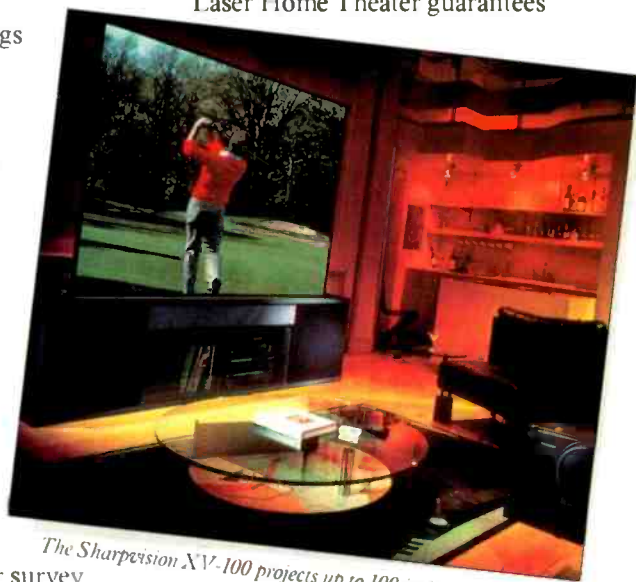

The Sharpvision XV-100 projects up to 100 inches diagonal.

you the best seats in the house to enjoy the very best picture and sound quality made for the home.

Curious to know more of what the "laser home theater" is all about? We prepared this special advertising supplement to help keep you current with the cutting edge of entertainment. Chances are, the more informed your buying decisions, the more value you'll get for the dollar.

Your Personal Guide To Laser Players

Certain features are common to the laser disc (LD) format. These include digital sound, forward/reverse variable-speed play and scan, still-frame, and random access search and display of individual selections indexed on the disc or by elapsed time. Use of features varies with players and discs. CLV discs contain up to 60 min. per side and may not offer still frame and variable speed on some players, while CAV discs have up to 30 min. per side with all special effects intact.

Many players have repeat modes, and on-screen status displays. Some offer random playback of selections on LDs as well as CDs. Except where noted, all models play all laser formats: 12-in. LD, 8-in. LD, 5-in. CDV (Video), 5-in. CD and 3-in. CD.



Pioneer LD-S2

Philips CDV 600



MODEL	PRICE	SPECIAL FEATURES
DENON L-2000	\$ 700	Full screen display; CD auto edit, S-video.
L-3000	\$1000	Same as 3000 plus Real 20-bit LAMBDA Super Linear Converter and zero-cross for improved digital audio; three-line comb filter for "incredibly sharp, clean and noise-free pictures;" motor-driven remote volume control.
MAGNAVOX CDV-305	\$ 549	Similar features to Philips CDV-400 (see below), CD auto edit, intro scan.
CDV-485	\$ 699	Same as above plus Favorite Track Selection (FTS) to program tracks on up to 226 CDs; 38-button remote.
MITSUBISHI M-V7010	\$1099	Plays both sides; intro scan, S-video, optical output.
PANASONIC LX-200	\$ 850	Plays both sides; onscreen display of volume; auto turnoff.
PRISM LX-1000	\$1400	Same as above plus MASH digital audio circuit for "pure digital audio"; programmed and random playback plus 7 mode repeat for CD and LD play; jog shuttle control on remote and panel; last memory function (records picture on LD when paused for easy start); digital effects on any disc include still w/sound and strobe, and point effects, S-video.
PHILIPS CDV-400	\$ 499	S-video; 42-button remote.
CDV-500	\$ 829	Same as 400 plus Bitstream technology w/ 256X oversampling for improved digital sound; 20-ch programming, FTS; intro scan; S-video.
CDV-600	\$1029	Same as 500 w/ 50-button jog shuttle remote; digital effects on any disc.
PIONEER CLD-980	\$ 500	Programming for up to 24 selections; intro scan.
CLD-1080	\$ 600	Same as 980 with CD synchro for 9 hrs of recording (with Pioneer cassette deck), CD auto edit; intro scan, seven-mode repeat or random play for LD and CD; remote power on/off.
CLD-2080	\$ 850	Same as 1080 plus plays both sides.
CLD-3080	\$1400	Same as 2080 with three-line comb filter for improved picture; digital effects on any disc; jog shuttle control on remote and panel; personalized file-name feature.
ELITE CLD-92	\$2000	Same as 3080 with 50dB signal-to-noise ratio; zero-cross distortion-free (ZDF) digital/analog converter for improved sound.
ELITE LD-52	\$3500	Plays 12- and 8-in. LDs only, winner of 1989 Japan Grand Prix; same features as CLD-92 plus "world's fastest" access time of two seconds; weighs 68 lbs; video signal-to-noise of 52dB highest available; digital circuits for "exceptional picture clarity."
PIONEER LASER ENTERTAINMENT CLD-V500	\$ 800	Karaoke player is combi-player with built-in amplification and microphone that allows customized sing-along with special LDs or normal CDs; library offers 75 English-language discs at \$25 each; 500 songs from past 40 years; "One-Touch Karaoke" removes vocals from any CD; vocals recorded for playback; echo control; replay control; 15-song selection keys.
CLD-V700	\$1100	Same as 500 with digital key controller for pitch control.
CLK-V900	\$1600	Same as 700 with 15 watts per channel stereo amplifier, multiplex balance control for lead vocal control; and "Once more" key replays five-second segments of song; audiocassette player included.
QUASAR LD9090	\$ 899.95	Plays both sides; programmed and random playback; S-video, optical output.
RCA LDR300	Price N/A	CD auto edit; VideoLink remote works with other RCA products and most VCRs; random playback of LD and CD, intro scan, six-mode repeat.
REALISTIC (RADIO SHACK) MD-1000	\$ 499.95	Intro scan.
SHARP MV-D2000	\$ 799.95	CD auto edit; 36-key remote; intro scan.
MV-D100	\$1499.95	Same as 2000 plus multiple-play of three 3- or 5-in. CDs; 20-step random access programming; last picture memory for easy re-start; S-video, optical output.
SONY MDP-333	\$ 650	Unicommander remote also operates Sony TVs; S-video; optical output.
YAMAHA CDV-1700	\$ 699	Remote volume control; 5-min. forward/reverse quick search for CLV; 38-key remote operates other Yamaha RS products; S-video, optical output.

Feature glossary: CD auto edit—times selections being dubbed to cassette so they remain intact; S-video—"Super" video output connects to S-compatible VCRs and TVs for optimum picture quality; intro scan—plays first few seconds of each selection in sequence as sampling device; optical output—direct-to-digital audio jack connects to compatible amplifiers/receivers or digital-to-analog converters for optimum sound reproduction; jog shuttle control—for more precise viewer manipulation of onscreen images.



Yamaha CDV-1700

LUCASFILM
THX
AUDIO

HOME THX AUDIO SYSTEM

Technics
The science of sound

LUCASFILM DEMANDED NOTHING LESS THAN 100% MOVIE SOUNDTRACK REPRODUCTION... THE THX SYSTEM DELIVERED IT

INFERIOR SOUND QUALITY IN THE MOVIE THEATER — A SOLUTION EXISTS

George Lucas, founder of Lucasfilm Ltd, is as devoted to quality sound as he is to quality visuals. Unfortunately, many cinemas are incapable of faithfully reproducing the film soundtracks which Lucas and other demanding filmmakers intended audiences to hear — the sound as it was originally recorded in the film studio. This was the reason Lucasfilm decided to develop its Theater THX sound system — a system which represents a significant improvement over conventional cinema sound systems.

Tomlinson Holman, Corporate Technical Director, lead the development of the system. Holman had several goals in mind when he started the project. He wanted to give movies clearer, more intelligible dialogue. He also looked for reproduction of a broader frequency spectrum — from ultra-low bass to top end treble. High on his list of priorities also was a superior dynamic range — from soft clear



whispers to loud undistorted booms. In addition, he wanted to achieve uniform sound coverage of the auditorium so that all of the audience could enjoy the same full and accurate sound experience.

All sound contained in a movie soundtrack — and that includes dialogue, music, and sound effects — is recorded by skilled sound engineers in a special studio called a dubbing stage. As they create their sound, they repeatedly listen to the results and adjust the sound elements until they obtain exactly the

desired effect. Thus, the dubbing stage serves as the reference standard for a film's soundtrack.

In 1980, Lucasfilm conducted a survey which compared the actual movie sound recording, as produced in the dubbing stage, with what was reproduced in the theaters. Their findings were disappointing, to say the least; movie soundtracks were often not being fully reproduced. Frustration with poor sound quality in the cinemas spurred Lucasfilm's research into a high grade reproduction system capable of delivering the sound which creators intended.

The THX Audio System was born out of extensive knowledge of acoustics, leading edge technology, and the use of precise measuring equipment. Armed with considerable experience and know-how, Holman and his team designed and built a film studio which achieved an ideal sound quality. State-of-the-art equipment was used to realize a wide frequency range, smooth response and natural spatialization.



Scoring Stage where background music is recorded



Foley Stage — where the astounding foley sound effects, such as the sound of footsteps, are created



ADR (Automated Dialogue Replacement) Facility — where dialogue is often recorded for feature films.



The dubbing stage. The reference for cinema sound reproduction.

PRECISE SONIC LOCALIZATION FOR UNBELIEVABLY LIFELIKE MOTION PICTURES

Dolby Stereo® is the reference standard used in the recording and playback of the audio signals for today's major movie soundtracks. The 4-channel capability of Dolby Stereo films allows three dimensional sound positioning. There are three front channels which are used primarily to handle dialogue, music, and effects. In addition, there is a rear surround channel which is primarily used for ambience and some special effects. The theater THX Audio System that Lucasfilm developed was designed to fully reproduce the superb effects of Dolby Stereo. It achieves natural sounding dialogue located at the speaking actor's position on the screen — regardless of one's seating position in the theater. Sonic imaging also matches on-screen movement. The sound of footsteps, for instance, follows the movement of an actor precisely. The strictest standards were set for the THX Audio System. All system equipment — including the sound processor, crossover networks, amplifiers, and speakers — as well as the acoustic characteristics of the cinema itself have to conform to exacting specifications. Tomlinson Holman's and George Lucas' dream, the theater THX Audio System, can now be heard in over 500 cinemas worldwide. Audience reaction to the system has been overwhelming. Lucasfilm has been applauded the world over for this accomplishment.

*See page 7

TOWARDS A THX SOUND SYSTEM FOR THE HOME

The cinema is not the only place movies are enjoyed these days. Video has become an extremely popular form of home entertainment. However, to reproduce the stunning quality of theater THX in a place the size of the average living room was a tall order indeed. Lucasfilm responded to the challenge by designing a THX system for home use. This system is based on the technology and experience developed during the evolution of the THX Audio System Program. The result: amazingly lifelike sound reproduction similar to that experienced by movie-goers in topclass cinemas — right in your own home. Dubbing stage sound quality is kept in pristine condition. Panasonic/Technics implemented Lucasfilm's Home THX Audio System with uncompromising design and state-of-the-art technology. This system will soon be available for the true AV enthusiast.

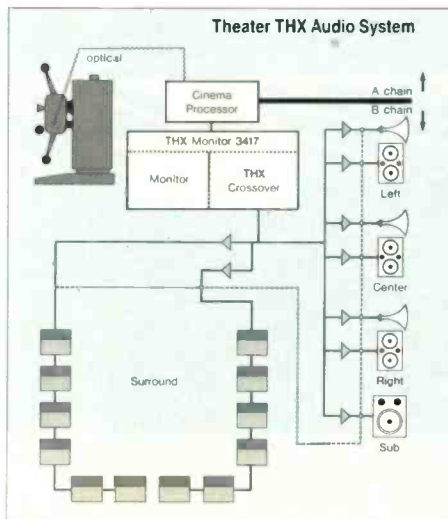

MAN BEHIND THE MAGIC — GEORGE LUCAS — AND THOSE THREE MAGIC LETTERS...THX

Some thought went into the actual naming of THX. These letters first appeared in a film title — THX 1138 — a movie which brought the producer George Lucas to public attention. Lucas made the original version of the film during his student years at USC. Its theme concerned a future totalitarian society. Cinematographic techniques Lucas used were considered extremely advanced for the period. In 1971, Francis Coppola was so impressed that he introduced Lucas to Warner Bros., who remade THX 1138 as a full length feature film. Robert Duvall played the lead character whose name was the same as the movie's title. Although the film met with little success at the box office, it did mark the beginning of Lucas' commercial film career. This career was to really take off when Lucas went on to direct "American Graffiti" and the legendary "Star Wars". Lucas continued to tie in the THX name in a light-hearted manner in his films. The license plate of the car driven by John in "American Graffiti" (played by Paul La Matte) was none other than THX-1138. Given this heritage, it's no surprise that Lucasfilm chose to apply the THX name to its revolutionary sound system. THX does, however, carry an additional meaning which is associated with its developer, Tomlinson Holman. It's an acronym for "Tomlinson Holman's eXperiment".

STATE-OF-THE-ART CINEMA SOUND FOR THE LIVING ROOM

Technics implemented Lucasfilm's Home THX Audio System utilizing a great deal of its own and Lucasfilm's leading-edge audio technology. Our aims — or should we say dreams — were the dreams of all genuine AV enthusiasts. To produce a sound approaching that experienced by

moviegoers in a top-class cinema. And to let you hear the full impact of today's movie soundtracks. We have realized these dreams in one sound system. Now you can hear, on laser disc or video tape, the full splendor of a movie soundtrack just as it was meant to be heard.

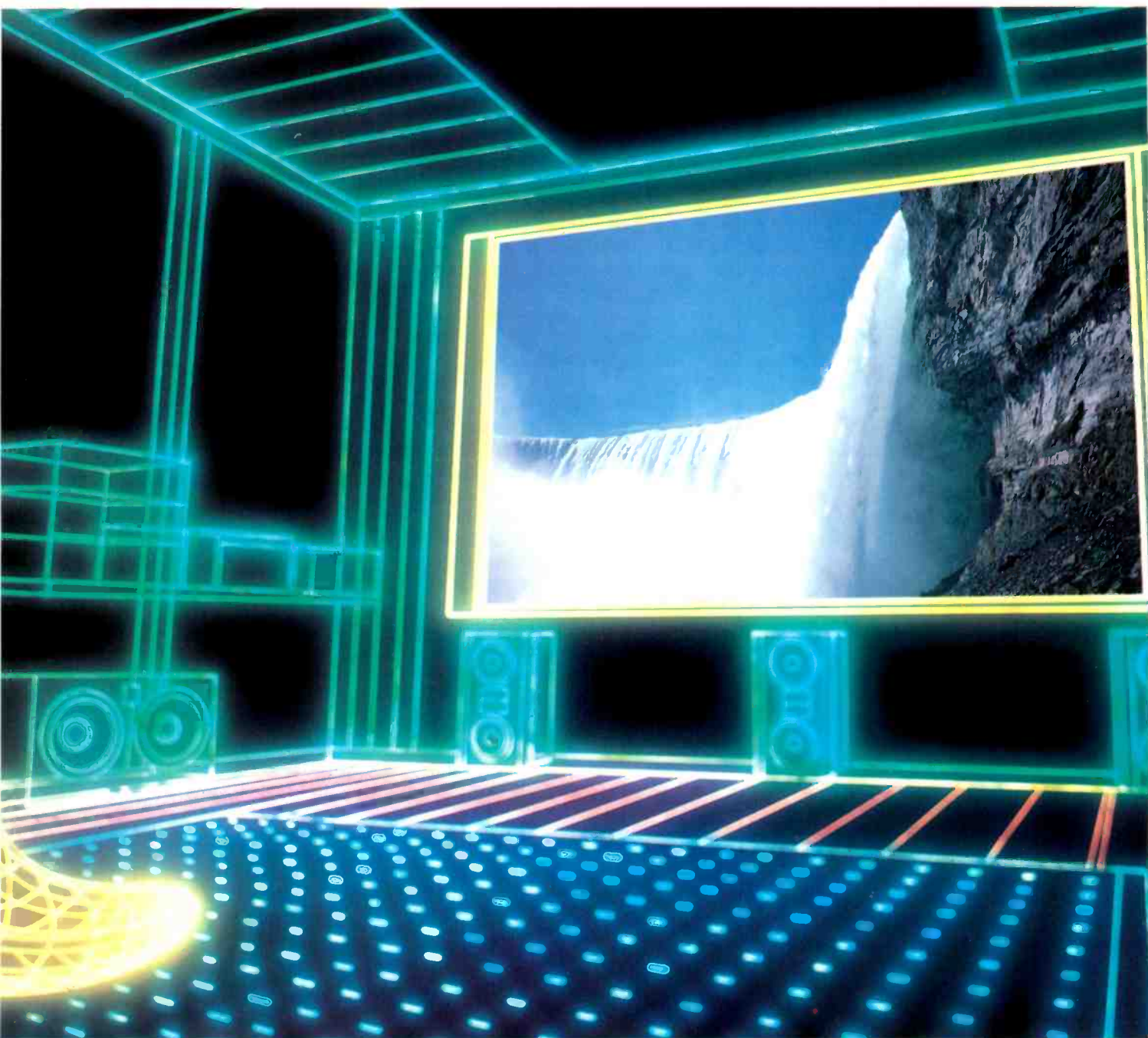



The Home THX Audio System was electrically and acoustically designed to meet the demanding reference standards obtained on a dubbing stage where the movie soundtrack is mixed. Here are just four important elements which contribute to the world-class sound of the THX system.

- (1) Outstanding frequency range and impressive balance over the range
- (2) Remarkable loudness and dynamic range capability at low distortion
- (3) Clear stereo spatialization including localization and envelopment
- (4) High dialogue intelligibility

At the heart of the system lies the THX Control Center (SH-TX100). There are three power amps (SE-TX100), three THX (left, right and center) front speakers (SB-TF100), two THX

surround speakers (SB-TS100)...plus a THX sub-woofer for dynamic low bass (SB-TW100). Combined they produce a lifelike sound close to that experienced by audiences in THX equipped theaters — right in your own home.

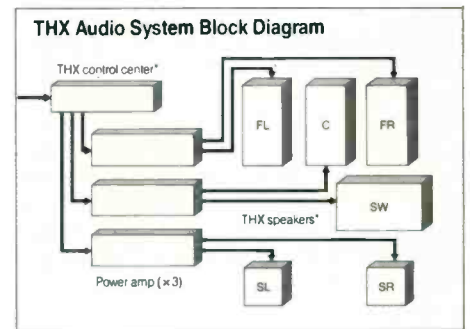

*Home THX licensed products



Home THX Audio System Controller*



Power Amplifier



Sub-Woofers System*



Front Speaker System*



Surround Speaker System*

*Home THX licensed products: Manufactured under license from LucasArts Entertainment Company. U.S. and foreign patents pending. Lucasfilm THX Audio and Home THX Cinema are trademarks of LucasArts Entertainment Company. Lucasfilm is a trademark of Lucasfilm Ltd.

Home THX Audio System

Home THX Audio System
Controller

SH-TX100



Advanced Control Circuitry Fully Delivers the Sound of Movies

This unit is the control center for the Home THX Audio System. It includes signal processing to recreate within the home listening room the sonic environment intended by a film's creators.

To assure consistent sound quality during the screening of movies in a theater, film sound is produced while carefully listening to the results in a special film sound recording studio (the dubbing stage). The dubbing stage has electrical and acoustical characteristics that satisfy the requisite standards for movie theaters. The Home THX Audio System makes it possible to reproduce, under the different acoustic conditions of the home listening room, nearly the same sound produced for movie theater use. To achieve this goal, the Home THX Controller incorporates a Dolby Pro Logic Surround decoder to correctly extract the four channels of sound encoded during the production of Dolby Stereo films. In addition the

controller processes the sound in several ways to assure accurate reproduction of all the subtly crafted sonic elements of a film soundtrack. The resulting sound is equivalent to that heard in the film sound recording studio.

There are several differences in tonal perception between large rooms, such as movie theaters, and small rooms, such as home AV rooms. Films are produced for large rooms, and therefore will sound unbalanced when played in small rooms. The Home THX controller includes re-equalizer circuitry to help correct the tonal errors, and reproduce the original film sound, as it was intended. It also contains advanced circuitry to create enhanced envelopment by the surround channel. New digital processing is used to produce naturally diffuse surround sound by de-correlating the monaural surround output of the Dolby Pro-Logic Surround decoder into two channels. For this digital signal processing and delay, Technics developed a special LSI.

Our MASH (multi-stage noise shaping) 1-bit DAC technology is used for digital-to-analog and analog-to-digital conversion. Furthermore, a surround timbre equalizer is employed to realize a smooth matching of sound quality between directional sound from the front speakers and the diffuse field produced by the surround speakers. This creates a uniform sound quality in the listening room.

Large Variety of Modes for Greater Freedom in Video Software Enjoyment

The SH-TX100 is equipped with an auto-balance function to bring out the full power of the system. Automatic correction is made for channel balance deviation that can occur during the process of producing video software. This helps ensure that the reference sonic standards are faithfully reproduced. The Academy filter lets you hear monaural soundtrack recordings of yesteryear as you might if you were in a cinema with today's state-of-the-



Home THX
Licensed Product

art audio equipment. The SH-TX100, of course, allows superb high-fidelity reproduction of normal music from sources such as CD, simply by using the Stereo mode. You can also enjoy the benefits of surround sound from mono or stereo non-encoded source by using the corresponding simulated surround function. Master volume and individual channel level controls are provided so that you can accurately set the balance of your system.

An adjustable delay line allows you to get the best perception of sound field separation when listening to film programs.

A built-in Test Signal allows you to accurately adjust the overall and relative levels of all the channels to achieve the best re-creation of film sound.

SH-TX100 Main Specifications

- Power consumption: 45 W
- Dimensions (W x H x D): 16-15/16" x 4-29/32" x 14-7/32" (430 x 125 x 361mm)
- Weight: 22.0 lb (10.0 kg)

irrespective of load fluctuations — with sufficient current supply to drive the speakers. To help minimize crosstalk between left and right channels, power amps for each channel are located separately in the proven Technics twin-mono construction. OFC (oxygen-free copper) windings are employed for the large capacity power transformers which are separated by the twin-mono construction for L/R channels. This arrangement is yet another example of the Technics research effort geared to higher sound quality. While this amp is not a Lucasfilm licensed product, it is offered for Home THX Audio use.

SE-TX100 Main Specifications

- Power consumption: 520 W, 620 VA
- Dimensions (W x H x D): 16-15/16" x 6-11/32" x 16-1/16" (430 x 161 x 408mm)
- Weight: 36.4 lb (166 kg)



100 W + 100 W Power Amplifier SE-TX100

The SE-TX100 is a high performance power amp that eschews excessive functions in favor of a simple design that's purpose-built for the Home THX Audio System. It delivers 100 W (20Hz 20kHz, 8 ohms, 0.005%

THD) of high power into each channel, and contains Technics Class AA circuitry in the advanced VC-4 amp configuration. It combines voltage control — which boosts input signals with enhanced fidelity

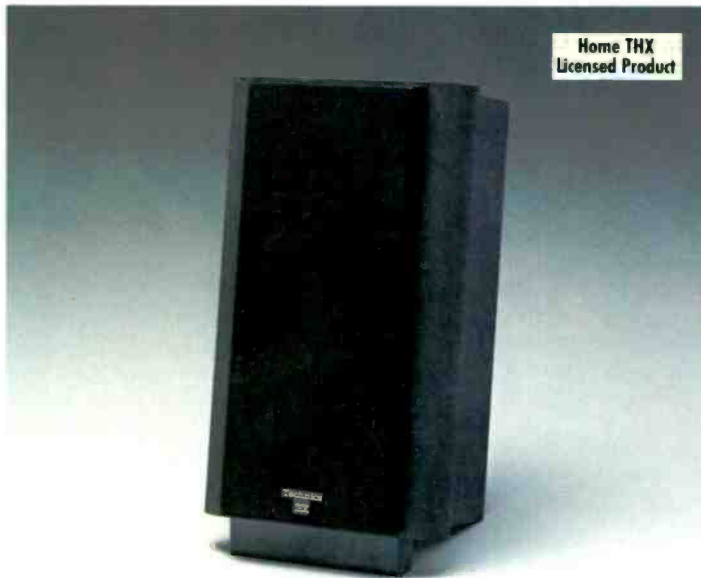

• Dimensions (W x H x D): 13-17/32" x 22-17/32" x 12-23/32" (344 x 572 x 323mm)
• Weight: 38.1 lb (17.3 kg)

Symmetrical Stack Speaker System for Front Channels —

SB-TF100

This two-way speaker system (for left, center and right channels) helps make soft, intricate dialogue intelligible, while having the capability of delivering the forceful impact of the loudest sound effects. Woofers are made of tough, lightweight mica-polypropylene formed into 7-1/8" (18 cm) cones. The dome shaped tweeters, meanwhile, use neodymium magnets of high coercivity. Woofer and tweeter pairs are stacked in a vertically symmetrical configuration. This setup achieves the wide horizontal dispersion and controlled vertical dispersion pattern that is

specified for the Home THX system. The effects of sound reflections from the floor and ceiling are minimized, and sonic imaging is improved. The speaker front is equipped with an acoustic wing — a device which lowers the effect of diffraction from the edge of the cabinet, thus smoothing the frequency response. The internal dividing network employs a top grade LC-OFC choke coil, high sound quality film capacitors and other select components. Extensive use of high density particle board and the cross-bridged construction of the cabinet itself assures high rigidity. Speakers incorporate magnetic shielding, a prerequisite for use in an AV system, and are matte finished. Extensive damping has been added to cut out spurious sound emanating from the surface of the speakers.



• Dimensions (W x H x D): 9-17/32" x 11-23/32" x 12" (240 x 298 x 305mm)
• Weight: 18.7 lb (8.5 kg)

Staggered Push-Pull System Surround Speakers for Natural Sound Orientation —

SB-TS100

These two-way surround speakers deliver a natural, diffuse sound field. The front and rear of the speaker cabinet are separate units driven in opposite phase, in the midrange and higher, while progressively more in phase at lower frequency. This assures playback over a wide range that extends way down to the bass

region of the spectrum, while giving a special di-pole sound dispersion pattern in the midrange and higher. This arrangement minimizes direct sound toward the listener while providing the desirable delocalization of surround sound. Each unit contains the same woofer and tweeter configuration as the front speakers (SB-TF100). The speakers have remarkable uniformity of timbre. In consideration of the problem of placement as surround sound speakers, means are provided for the attachment of accessory ceiling or wall mounts.

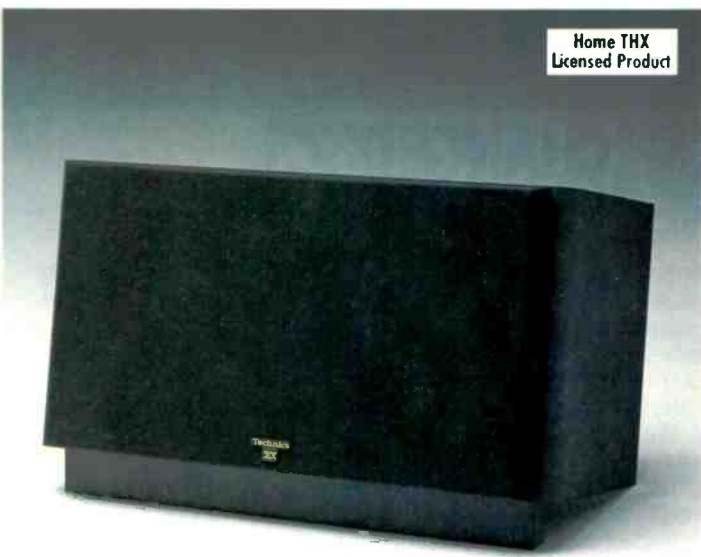

• Dimensions (W x H x D): 30-23/32" x 16-17/32" x 18-5/32" (780 x 420 x 461 mm)
• Weight: 82.7 lb (37.5 kg)

Earthshaking Low Bass 12" (30 cm) Twin Drive Sub Woofer —

SB-TW100

The SB-TW100 lets you hear superb low bass without taking up precious space. Woofer diaphragms — just 12" (30 cm) in diameter — are rigid, and provide optimal internal loss. Magnets for one unit weigh in at an incredibly heavy 4.4 lb (2 kg), and

deliver a powerful magnetic field. The magnetic circuit also features 4-layer, long-throw, highly heat resistant voice coils in this twin-drive system. The results of this setup are clear from the specs — 15% more efficiency than a diaphragm with a 15" (38 cm) diameter. High sound pressure level bass reproduction is assured. The cabinet is finished in matte paint to cut down surface glare. The units are tuned to maximize the effects of the system.

Home THX Audio System Component units

THX control center*	SH-TX100 x 1
Power amp*	SE-TX100 x 3
Front speaker*	SB-TF100 x 3
Sub-woofer speaker*	SB-TW100 x 1
Surround speakers*	SB-TS100 x 2

*Home THX licensed product

- THX, Home THX, Lucasfilm THX Audio and Home THX Cinema are trademarks of LucasArts Entertainment Co.
- "Dolby", the double-D symbol and Dolby Surround are registered trademarks of the Dolby Laboratories Licensing Corporation.
- Dolby Pro Logic is the trademark of Dolby Laboratories Licensing Corporation.
- Technics developed the world's first MASH type DAC and ADC. MASH technology was invented by NTT (LSI Labs). MASH is a trademark of NTT.



ANY CD CHANGER CAN CHANGE DISCS. THIS ONE WILL CHANGE THE WAY YOU HEAR MUSIC.

Technics introduces MASH* one-bit technology.

When you (and your friend) sit down to hear music, you want as much glorious sound with as little of anything else as possible.

Technics' MASH digital-to-analog converter system not only helps improve low-level reproduction during quiet passages, it also brings you more accurate reproduction of the harmonics in music

throughout the louder passages as well.

And because MASH delivers wider dynamic range, the expanded distance between the very quietest and loudest passages can give you more of the directness and dramatic impact of the original performance. With the virtual elimination of zero-cross distortion.

The net effect is that you're that much closer to the music. And that much further from distractions.

Of course, since all our CD changers play any combination of five

3-inch or 5-inch discs, they also bring you music for hours. Any way you like. Continuously. Only selected tracks. Random play from all discs. Or random only from selected tracks. All under the direct control of the wireless remote.

You can even – thanks to its top-loading design – change 4 discs while the fifth keeps playing. Because when you and a friend are having such a rich experience, who wants the music to stop.

Technics
The science of sound

*Technics developed the MASH one bit DAC. NTT (LSI Labs) invented MASH technology. NTT has applied for trademark registration for MASH.

CIRCLE NO. 181 ON READER SERVICE CARD

A Laserdisc Sampler

Collector's Editions

That's Entertainment Collector's Edition (MGM/UA), \$49.98

Widescreen sequences; CAV with original trailer & featurette

Alien & Aliens (CBS/Fox), \$99.98

Widescreen, digital surround

Taxi Driver (Criterion), \$99.95

Widescreen, second audio-track commentary by Martin Scorsese, supplementary section

Dark Crystal (HBO Video/Image), \$59.95

Widescreen, "Making of" featurette, digital surround

The Phantom of the Opera (Image), \$39.95

1925 silent version w/Lon Chaney

Herbert Von Karajan

The laser legacy of one of the great conductors of the 20th century is on Polygram Music Video (PMV) and Sony Classical labels.

Beethoven: Symphony No. 9, \$34.95 (PMV)

Berlin Philharmonic 1984 New Year's Eve Concert

J.S. Bach: Violin Concerto in E, "Magnificat," \$54.95 (Sony)

Berlin Philharmonic 1988 New Year's Eve Concert, Prokofiev "Classical Symphony"; Tchaikovsky Piano Concerto No. 1.

Yevgeny Kissin, piano, \$54.95 (Sony)



Breaking Down the Wall

Aptly described by Polygram Music Video (PMV) as "musical mega-theater," Roger Waters' "The Wall—Live in Berlin" concert before 320,000 people has never been shown in the U.S. Performers include Van Morrison, Sinead O'Connor and Albert Finney. The two-hour laserdisc, climaxed by the crashing of a 600-foot, 2500-brick styrofoam wall, includes interviews and behind-the-scenes footage. \$29.95.

- From Pioneer Artists, there's Madonna's "Blond Ambition" World Tour.
- Image/CBS Music Video offers The Who Live in "Tommy," Branford Marsalis's "Steep," and "Singin' & Swingin'" with Harry Connick, Jr.

Opera

Selections from PMV include Peter Sellars' complete Mozart Operas, "Met Opera Gala" and "Three Tenors Concert," with Jose Carreras, Placido Domingo and Luciano Pavarotti.

RCA Victor's Got CD Surrounded

Since "Star Wars" burst onto the screen in 1976 over 2500 video movies have been made in Dolby Stereo. Now, thanks to RCA Victor, CD movie music also can be enjoyed with the extra dimension of ambience that surround sound brings to the home theater. Among the 13 discs are "Mancini In Surround—Mostly Monsters, Murders & Mysteries," "Gone With The Wind," "Casablanca," "Lost Horizon," and "Classic Film Scores for Bette Davis." Except for the \$14.98 Mancini all are \$9.98.

Mail-Order Resources:

Laserdisc Fan Club, 1-800-322-2285
U.S. Video Source, 1-800-USA DISC
The Voyager Co. (Criterion), 213-451-1383

Hollywood At Home System Suggestions

The Bijou (\$5,000 to \$6,500)

You want to experience the thrill of surround sound and spring for a projection TV while still using your core hi-fi components. Here are suggestions for a mini-theater system . . .

Sony MDP-333 laser combi-player (\$650, pictured) comes with remote that operates Sony TVs; Philips WallVision



Proton SD-1000

systems (\$3000 to \$3700, pictured on cover) are 46-, 52- and 61-in. rear projection TVs that can be used standalone or wall-mounted, with Dolby Pro Logic Surround; or, RCA 52-in. rear projection TV P52150CP is top-of-line model (\$2799) with digi-

The Videplex (about \$15,000)

You want to skip what's playing at The Bijou and get on line for something more adventurous. Sounds like you're ready for an upgrade of most if not all your components. Step right up . . .

Panasonic Prism LX-1000 laser combi-player (\$1400) plays both disc sides, plus digital effects on any disc and jog shuttle remote control; or, Sharp MV-D100 (\$1500) is only combi-player that is also three-disc CD changer;

Pioneer Elite PRO-93 50-in. projection TV (\$4400, pictured) has three audio modes, digital effects and audio/



Pioneer Elite PRO-93

Video City Music Hall (about \$35,000)

You know the Star Wars trilogy backwards, ditto for Indiana Jones and the rest of Spielberg's films. You're state-of-the-art all the way, and money's no object. Welcome to home theater heaven . . .

Pioneer LD-S2 dedicated laser disc player (\$3500, no CD play) is a winner in every way, including the prestigious Japan Grand Prix Award of 1989;

Mitsubishi 120-in. diagonal, custom-installed rear projection TV (\$20,000)

has S-video and RGB inputs and everything else you'd expect for the price;

Technics Home THX Sound System (\$12,000) includes a THX

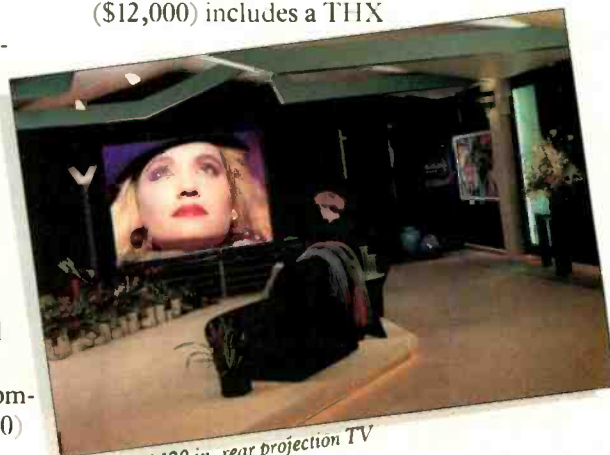

Mitsubishi 120 in. rear projection TV

tal stereo, surround sound and S-video input, viewable from any angle;

Proton SD-1000 Enhanced Surround-Sound Decoder (\$1200, pictured) with Aphex circuitry has three settings including Cinema and Music, and full remote; or, Denon AVC-3000 A/V Amplifier (\$1200) with Dolby Pro Logic & five channels of output for full front, surround and center/subwoofer channels;

Cambridge SoundWorks Ambiance bookshelf models (\$260) make fine rear speakers for surround setup, complemented by Yamaha NS-C70 center-channel speaker (\$119) and Bang & Olufsen Beovox Cona subwoofer (\$425);

or, Atlantic Technology Pattern Surround Home Theater (\$1500, pictured) is package system with Dolby Pro Logic decoder, five matched speakers, subwoofer, amps and cables, and remote control;

Philips "Smart One" universal remote (\$85) has "learn" feature to operate most audio and video brands.



Atlantic Technology Pattern system

video memory control; or, SharpVision XV-100 (\$4000, pictured on p. 3) is 31-lb. tabletop LCD projector with variable image up to 100-in. diagonal on any flat white surface;

Onkyo TX-SV90 PRO surround sound receiver (\$1100, pictured) has five amps including center-channel, Dolby Pro Logic and two other modes; or, Mitsubishi M-R8010 A/V receiver (\$1399) with Dolby Pro Logic, on-screen menu displays & universal remote;

Snell Multimedia Home THX Audio System (\$5000) has left, right and center speakers, two surround and two sub-

woofer speakers, all of which can be bought separately (\$500 for subwoofer, \$800 each for others); Available early 1991, Lexicon CP3 THX digital surround processor (\$2800) has output amps, 15 preset audio modes, onscreen pull-down menu and two remotes;

Proton UVA-2000 universal remote (\$140) operates most brands of A/V equipment.



Onkyo TX-SV90 PRO



Technics THX SH-TX100

controller (SH-TX100, pictured) with Dolby Pro Logic Surround, three stereo power amplifiers (SE-TX100), front, left, right and center speakers (SB-TF100), subwoofer (SB-TW100) and two surround speakers (SB-TS100);

Other speaker options include: a/d/s 750iL in-wall (\$1200 per pair) with

sonic isolation from wall and easy installation; Infinity Modulus compact speakers (\$1000 per pair) and 250-watt amplified subwoofer (\$2000) with control box; JBL ProPerformers Plus 4½-in. full-frequency loudspeakers and subwoofer (\$439);

Harman Kardon MasterWorks (\$119, pictured) 53-key universal remote with 4000 stored functions and 100 code formats easily operates any system without "learning" process.

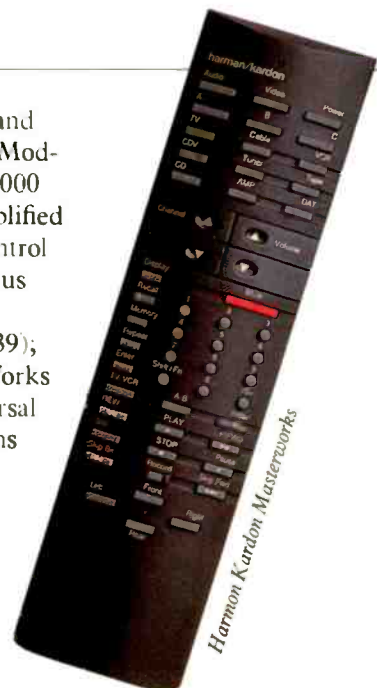

Harman Kardon Masterworks

Sound Ideas From Lucasfilm

Introduced by Lucasfilm in 1983 to faithfully reproduce the lifelike, three-dimensional images of Dolby Stereo (Surround) soundtracks, the THX Sound System is now offered.

Here are highlights of a recent chat with the corporate technical director of Lucasfilm Ltd., Tomlinson Holman, "the father of THX sound."

Q. How would you describe the difference someone hears in a THX home system?

A. THX takes care of the translation from a large theater space to a small one. THX came about in part when I listened to the laserdisc of "Return of the Jedi" and knew exactly what it was supposed to sound like because I was the sound engineer on the film. Attacking each of the problems is what resulted in THX and all its characteristics.

The laserdisc was too bright, the top end too sizzly. I brought it back to the studio and compared it with the original master. I found the laser was perfect. For the first time, we have a mass-distribution medium indistinguishable from the original.

My problem was the sound system at home had many differences from theaters, the most obvious being that home lacks a center channel. I experimented with two versus three channel listening. When you're looking at big, bright pictures, the center channel has a huge impact. It's not a THX invention, but we improved it. It stabilizes and solidifies the center of the stereo field so you can move around the room.

Other ingredients are screen sound localized with regard to the picture (like footsteps), and use of a narrow-directivity speaker to better hear dialogue in the presence of the soundtrack. There's also improved frequency range and tonal balance with low distortion.

Q. There's a lot of misconception about surround channels. What's your approach?

A. People expect a lot of information to pour forth from surround. We will tackle that with a demo disc to show there are occasional loud effects but

more common sounds are low-level ambience to pull you into the scene.

Some of the best examples of how surround should be used are in the jungle scene from "Apocalypse Now" where the tiger jumps out, and the fly by sequence in "Empire of the Sun." That's a marvelous case where the plane flies



overhead and is blown up as another plane comes from the center into the surround channel.

Q. Will we ever see the THX logo on movies like the Dolby logo?

A. THX is not an encoded format recorded on film like Dolby. Our role is promoting a higher level of standardization for playback of all film soundtracks, including Dolby.

Ultimately, my goal is to reduce the variation level among laserdiscs. The reference levels of tapes and discs are not consistent from the program sources.

Q. Is THX planning to certify home video equipment too?

A. My goal is to make more transparent channels for producers of materials. We've concentrated so far on audio because we knew a bunch of things were wrong that we could fix. I don't know if TV, which demands more work, will be in the form of high-def or something else. Right now, I'm all for big-screen projection TV. As untransparent compared with film as it is, it has much more impact than the small screen.

Laser Leads The Way... Into The '90s

At the Tech 2000 gallery of interactive media in Washington, D.C. visitors can touch a screen showing a vase from the J. Paul Getty Museum and read about its origins, or spin a trackball to fly above a videomap of Houston and choreograph a ballerina below, or view an ABC News Interactive program on Martin Luther King, Jr. that combines text, still photos and film footage of his historic speeches.

It's not done with smoke and mirrors, but with laserdiscs and video monitors. Despite the permanent exhibit's name, we won't have to wait nine years before using this flash-forward technology in our homes.

Those ready, willing and able to part with about \$2500 might only have to wait until mid-1991. That's when Philips plans to introduce its CD-I (for Interactive) system that will perform much the above plus play music CDs. "Disc-based multimedia," predicts Joe Rothstein, whose Capitol Disc Interactive joint venture with Philips donated equipment to Tech 2000, "will be the VCR of the '90s." He sees the price for the CD-I player dropping to below \$500 in three to five years. There's talk of an omni-player that will handle compact discs, laserdiscs and CD-I.

"Real people," notes Stan Cornyn of Warner New Media, "like computer programs that work like movies." A noted entertainment futurist, Cornyn heads a team developing programs for a \$1,600 interactive system due next year that combines 12-in. laserdiscs with CD-ROM. He says, "Within 18 months we'll be looking at computers you won't know as computers. They'll be able to control audio and graphics and subtext for movies, music and sports programs."

One example from Warner New Media is The Fleetwood Macro Album. The viewer can choose four different camera angles of the group in concert, visit backstage with the band, juxtapose

live and original studio versions of the same song, play along with onscreen sheet music and listen to lyrics and commentary in three languages.

As for CD-I, its capabilities are prodigious. A single 5-in. can hold 300,000 pages of text or 1000 floppy disks' storage or 7000 photographs or four different levels of audio, including 16 individual channels for over 18 hours of AM-quality information. The format can combine any of the above plus full-motion video.

In the CD-I program "A Visit to Sesame Street," kids can turn on a TV in The Count's castle to see early segments of the show in full-motion video. Sinatra fans can listen to him in digital sound, view rare family album photos and access a listing of all his TV and film roles. Weekend duffers can play a Palm Springs course while an ABC commentator and wise-guy caddy chatter away.

As Stan Cornyn says, "The software of the future is just starting."

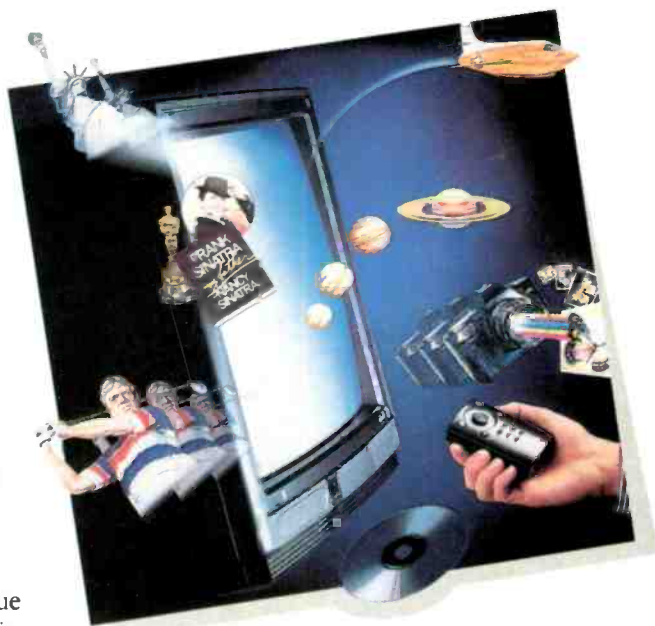

Bruce Apar is editor of Video Business, a weekly magazine of Capital Cities/ABC Publishing based in New York City.

This special advertising supplement was prepared independently without participation from the editorial staff of Stereo Review.

CONCERTS



Now Available On LaserDisc

BRING THE "BAND" INTO YOUR LIVING ROOM— WITH LaserDiscs

THE FINEST TECHNOLOGY...

The sound quality of a compact disc is superb, but why just listen to music when you can watch the performance on a video LaserDisc and experience:

- **SUPERB PICTURE CLARITY—**
Delivers 60% greater video resolution than VHS tape.
- **DIGITAL SOUNDTRACK—**
Offers the identical full-fidelity sound of a digital compact disc.
- **INSTANT RANDOM ACCESS—**
Allows push-button access to any scene within seconds.
- **LONG TERM RELIABILITY—**
Maintains the original quality even after thousands of plays.

THE FINEST SELECTION...

A wide selection of full-length concerts and music videos are now available on LaserDisc, featuring the top performers in the world:

- MICHAEL BOLTON • KATE BUSH
- PINK FLOYD • GLORIA ESTEFAN
- NEW KIDS ON THE BLOCK • BASIA
- THE BANGLES • GEORGE MICHAEL
- HARRY CONNICK, JR. • THE WHO
- BILLY JOEL • BRANFORD MARSALIS
- ROLLING STONES • ROSANNE CASH
- LUTHER VANDROSS • JULIO IGLESIAS
- AEROSMITH • JOHN HAMMOND
- MIDNIGHT OIL • MICHAEL JACKSON

image[®]
ENTERTAINMENT

"The Finest In LaserDiscs"™

© 1990 IMAGE ENTERTAINMENT, INC. ALL RIGHTS RESERVED. (A PUBLIC CORPORATION—SYMBOL "DISK")

CIRCLE NO. 100 ON READER SERVICE CARD

Visit Your Nearby LaserDisc Retailer Today



RX-1130 RECEIVER

125 watts per channel into 8 ohms from 20-20,000 Hz at no more than 0.015% THD
Low impedance drive capability provides 360 watts per channel into 2 ohms dynamic power
Additional amplifier section for two rear channels with rear channel level control
Five digital Surround Sound modes (Dolby,* Natural, Hall, Simulated Stereo, Live)
Computer Servo Lock tuning
MM/MC Phono Selector
Banana plug compatible speaker connection terminals
24-segment signal quality meter
Continuously variable loudness control
Learning-capable multi-function remote control
Eight audio inputs, three video inputs
Four audio outputs, three video outputs
S-VHS compatible
Separate front and rear pre-main coupling terminals
Eight-mode REC OUT selector
Continuously variable delay time control
CD Direct switch
Motor-driven volume control with LED indicator
Sleep timer
Center defeat bass/mid-range/treble tone controls
16-station random access preset tuning with multi-status memory
Absolute Linear Amplification (ALA) circuitry
Preset indicators with preset number and station frequency
Front panel headphone jack
Tone bypass switch
High-gain AM loop antenna
Manual or auto IF Mode selector (wide or narrow)
Auto search tuning
Manual up/down tuning

If any of these features compromised its sound, this is the first thing we'd remove: **YAMAHA®**

Stereo Review's critics choose the outstanding current releases

CARLENE CARTER UPDATES TRADITIONS

CARLENE CARTER, with her faultless hillbilly heritage—daughter of June Carter and Carl Smith, granddaughter of Mother Maybelle, and stepdaughter of Johnny Cash—had a lot to live up to when she walked into the recording studio in the late Seventies. Nonetheless, in three albums she carved out a discernible niche for herself as a progressive country-rocker. The last of those albums, "Musical Shapes," released in 1980, was hailed as one of the finest efforts of the post-rockabilly age. But then Carter called it quits for a while, keeping a low profile in England with husband Nick Lowe (they've since divorced) and watching another talented member of her extended family, singer Rosanne Cash, walk off with the accolades.

In her new comeback album, "I Fell in Love," produced by Howie Epstein (of Tom Petty's Heartbreakers) and laced with first-rate backing by some of the biggest names in country and rock, Carter returns to her strengths, walking a delicate line between the backwoods strains of her pedigree and the smart beat of contemporary country and neo-rockabilly. In the title song, for example, Albert Lee's stinging electric guitar propels a rocking shuffle set to lyrics that hark back to the rural experience but carry a distinctly modern attitude: "You burn me up like a chicken at a bar-be-que."

Throughout, Carter, who possesses a perfect and natural rockabilly vocal lilt, alternately delights, surprises, reaffirms her independent musical stance, and reworks her family's musical legacy with songs of integrity, heart, and style, much of it diverse and wide-ranging. *Come On Back*, for instance, is mostly Sixties-style pop, reminiscent in spots of the great girl-groups of the era; *One Love*



Carter: the Cowgirl Supreme

and *The Leavin' Side* evoke the rockabilly days of early Elvis and the young Brenda Lee; *Goodnight Dallas* mates progressive honky-tonk with mock yodeling, set to an Emmylou-like beat that's squeezed along by a zesty accordion; and a revival of A. P. Carter's *My Dixie Darlin'* finds guitarist James Burton picking sweetly in the straightforward folkish Carter Family style, with the singer infusing the vocal with modern gusto and emerging the Cowgirl Supreme.

The album's most affecting cut, however, is Carter's own *Me and the Wildwood Rose*, a memorable and soulful tribute to Mother Maybelle in which she again calls up the original acoustic-based Carter Family sound, playing the autoharp as her grandmother did and lamenting, "If I could change a thing in this world/I'd go back to the days of Grandma and her girls/Singing sweet and low/For me and the Wildwood Rose."

Few singer-songwriters have arrived at such a seamless fusion of styles. But then Carter has long lived in two worlds, that of her glittery-suited relatives and that of their modern, rocking counterparts, who put a new spin on the old sound. "I

Fell in Love" is a stunning salute to them both.

Alanna Nash

CARLENE CARTER: *I Fell in Love*. Carlene Carter (vocals, autoharp); Albert Lee (guitar); Benmont Tench (piano); Dave Edmunds, Levon Helm, June Carter Cash, Nicolette Larson (background vocals); other musicians. *I Fell in Love; Come On Back; The Sweetest Thing; My Dixie Darlin'; Goodnight Dallas; One Love; The Leavin' Side; Guardian Angel; Me and the Wildwood Rose; You Are the One; Easy from Now On*. REPRIS 26139-1, © 26139-4, © 26139-2 (38 min).

BERNSTEIN AND IVES AT THEIR BEST

CHARLES IVES wrote his Second Symphony shortly after the turn of the century, but it had to wait until 1951 to get its first performance—by Leonard Bernstein and the New York Philharmonic.

Why so long? Because it is one of Ives's ear-crunching, dissonant, he-did-it-years-before-Schoenberg-and-Stravinsky, way-ahead-of-his-



Bernstein: Ives with pride

time pieces? Not at all. Until the very last note, it is one of the most consonant and seemingly traditional pieces Ives ever wrote. And literally traditional, too. It quotes old hymns, some fine fiddle tunes, Stephen Foster, and college and sentimental songs, culminating in, of all things, *Columbia, the Gem of the Ocean*.

There is more. The piece is full of references to European as well as American music: Bach, Dvořák, Brahms, and even Wagner. A Bach fugue turns into *Camptown Races*; Brahms turns into *Pigtown Fling*—or is it the other way around? In a sense, Ives had to invent his own tradition. This wonderful amalgam of European symphonic tradition with olde Americana is the very subject of this amazingly successful symphony, a creative hodgepodge that never sounds like anything but a perfectly natural and ingratiating work of art.

The big brouhaha about Ives has always been about his more overtly experimental works, some of which accompany the new Bernstein–New York Philharmonic recording of the symphony, including the ever-intriguing *Central Park in the Dark* and *The Unanswered Question*. These pieces are Ives at his most cosmic. In the safer, more mystical *Central Park* of 1906, a cycle of dissonant, impressionistic string sounds evokes the mystery of the night, against which we hear the ragtime sounds of the city (this may be the first use of ragtime in a symphonic work). *The Unanswered Question* reverses the equation: The endless cycling of the music of the spheres is perfectly

harmonious, and it is the nagging questions humans pose that ring hollow and dissonant.

Although these works contain the most obviously delicious and modernistic ideas, it is beginning to look more and more as though Ives's real originality lay elsewhere: in his use of tradition, his ideas about music and society, his way of taking musical forms apart and putting them back together. This is all heady and very up-to-date stuff, and it is all very much present already in the *Second Symphony*.

Is Leonard Bernstein aware of all this? Of course he is. The CD comes with a classic and very perceptive Bernstein essay on the symphony. Even more important, it contains a classic and very perceptive, contemporary performance of this great “old” symphony. It swings, it croons, it laughs, it slyly comments, it pays homage and turns into a singalong, it jumps up and shouts, it thrills with pride, and cries and laughs uproariously. It is a completely self-sufficient work without one single self-sufficient note in it.

What fate more ironic and more fitting than Ives on Deutsche Grammophon? And in the hands of the conductor who, far and away, knows him best?

Eric Salzman

IVES: *Symphony No. 2; The Gong on the Hook and Ladder or Fireman's Parade on Main Street; Tone Roads No. 1; Hymn (Largo Cantabile); Hallowe'en; Central Park in the Dark; The Unanswered Question*. New York Philharmonic. Leonard Bernstein cond. DEUTSCHE GRAMMOPHON © 429 220-2 (68 min).

HOTHOUSE FLOWERS FINDS ITS WAY “HOME”

IRELAND has turned out an inordinate number of notable pop musicians in recent decades. Van Morrison. U2. Sinéad O'Connor. And now, Hothouse Flowers. “Home,” the second Hothouse Flowers album, is a bottomless work that marries traditional folk, knockabout rock, and feverish gospel in the service of a deep Celtic yearning for a rooted, meaningful existence in a tarnished world. The thematic key to the album can be found in *Give It Up*, a song that shudders with the kind of passionate sweat Bruce Springsteen used to wring out of himself when he was in touch with the street. In it, Liam Ó Maonlai sings, “It doesn't really matter if you're all/Jumbled up inside/As long as you know love is/Endless and the world is wide.” As the tune gathers steam, his voice is buoyed by the others in a potent demonstration of the community he urges as an answer to our despair.

“Home” was recorded in locations ranging from New Orleans to Dublin, with sessions nabbed on the road and on the run. In the CD version there's even a live track, a rousing fiddle breakdown titled *Dance to the Storm*, stuck on for good measure. Out of this whorl of activity and locales, the idea of home emerges as a sense of well-being that

Hothouse Flowers: Ó Bruonáin, Barnes, O'Toole, Ó Maonlai, Fehily



POLYGRAM

Fasten your seat belts



Buckle up and get ready to experience the sonic energy and pure power of Pyle PRO woofers.

Pyle engineers have reinvented the heart and soul of loudspeakers — our new woven fiber IronCloth voice coils make Pyle PRO woofers virtually indestructible. When combined with polymer laminate cones, vented pole pieces, massive motor structures and heavy duty housings, you get the most durable speakers available at any price.

Now you can dive to the deepest lows and accelerate to the highest peaks with new found confidence. You'll feel the power as your skin tingles, see the force as your car moves to the beat and hear sounds you've never heard before.

Break the sound barrier with Pyle car stereo speakers and electronics.



Powerful Enough To Be Pyle!

Dollar for dollar, the most dynamic speakers you can buy. Perfectly Pyle!

PYLE

For the name of the Pyle dealer nearest you write:
Pyle Industries, Inc. • Huntington, IN 46750

H A Harman International Company

CIRCLE NO. 94 ON READER SERVICE CARD

Don't T Friend Expens

Overwhelming envy could interfere with their listening pleasure when you play a few of your favorite tracks for them.

Your friends will remember the great sounding receivers we built back in the Sixties that reproduced the music of Clapton, Jimi Hendrix and The Doors. You can just imagine what our FM sounds like now with improvements such as balanced mixers and a MOSFET front end. A heavy duty power

supply, bypassable tone controls and a low noise motorized volume control help ensure the cleanest, most distortion free amplification whatever the signal source.

Because you demand that your receiver is your Audio/Video command center, we provide input jacks for CD, Phono, Video 1 and 2, Tape 1 and DAT/Tape 2. To enhance your home theater experience our engineers have added Dolby® Surround and a remote



control to harness all this power from the best seat in the house.

Yes, the RV-1340R does look expensive. That's because we haven't gone away from

ell Your s How ive It Is.



an all-aluminum cabinet or cheapened the faceplate with seldom used features, instead we neatly concealed them behind a smoothly articulated fold-down door.

Too much for your friends to believe? Well, we include a Certificate of Performance to verify that we test every unit to guarantee that they meet or exceed every specification.

So after you've installed your Sherwood RV-1340R, cranked up the volume, and impressed your most critical friends with your sound judgement, please don't tell them how expensive it is.

 **Sherwood®**
The Music Is Right On The Money

INTEL CORPORATION 14830 Alondra Blvd., La Mirada, CA 90638
CIRCLE NO. 103 ON READER SERVICE CARD

springs from many things: strong, committed love, an emotional and intellectual bond with the wisdom of the ages, a physical environment that's respected and well cared for, and much more. In its more sanguine moments, Hothouse Flowers reels almost giddily over the pleasures life has to offer. In *Shut Up and Listen*, Ó Maonlai sings, "... there's mountains to climb and/The sky if we are willing to aim high/We are just children at heart/If not in our minds/For the rest of our lives."

The music is a rich interweaving of electric rock and ethnic folk instruments. Hothouse Flowers is capable of serene impressionism (*Christchurch Bells*, *Eyes Wide Open*) as well as more rollicking and upbeat music (*Water*, *Hardstone City*). Bands committed to following their muse to the furthest reaches, regardless of fashion, are increasingly rare; bands that dig beneath the surface for lasting truths are rarer still. Therefore, the pleasures of "Home" are not to be missed or taken for granted. It is, quite simply, an uplifting piece of work. *Parke Puterbaugh*

HOTHOUSE FLOWERS: *Home*. Liam Ó Maonlai (vocals, keyboards, bodhran); Fiachna Ó Braonáin (guitar, bass, vocals); Peter O'Toole (bouzouki, mandolin, vocals); Leo Barnes (saxophones, organ, vocals); Jerry Fehily (drums, percussion, vocals); vocal and instrumental accompaniment. *Hardstone City: Give It Up; Christchurch Bells; Sweet Marie; Giving It All Away; Shut Up and Listen; I Can See Clearly Now; Movies; Eyes Wide Open; Water; Home; Trying to Get Through* (CD only); *Dance to the Storm* (CD only); *Seoladh na nGamhna*. LONDON © 828 197-4, © 828 197-2 (56 min).

DOHNÁNYI'S REFRESHING MAHLER FIRST

THOSE who have tired of the usual blockbuster approach to Mahler's First Symphony may find the antidote in the fascinating new recording by Christoph von Dohnányi and the Cleveland Orchestra. Clarity of line, dynamic refinement, and elicitation of the work's poetic element get top

priority in this performance, and for me the whole listening experience was remarkably refreshing.

The opening pages, which Dohnányi takes at a very measured pace, really suggest the sound of nature in its pre-dawn stillness that Mahler seems to have had in mind, and the ensuing music conveys the feeling of awakening from a dream. Only at the close of the movement does the workaday world come into being.

The following *Ländler* movement is performed in a straightforward, dancelike fashion, with no coyness whatever. The dynamic gradations of its central section are elegantly honed, with a lovely use of Mahlerian portamento in the strings. The famous funeral march based on *Frère Jacques* in the third movement reverts to the dreamlike quality of the opening, even in the country-

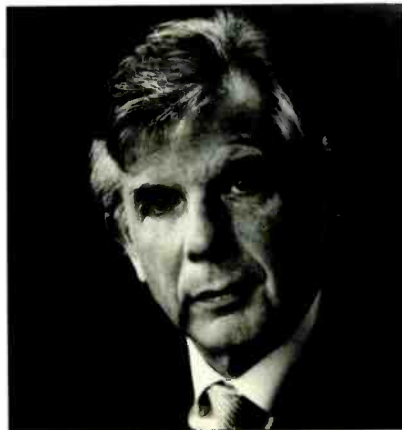

Dohnányi: Mahler with clarity

band episodes, which are not vulgarized but treated in a touchingly nostalgic fashion. The tympani at the beginning of the movement sound muffled, creating a wonderfully atmospheric effect. Even the finale makes no attempt to split the heavens open, and Dohnányi saves his big guns for the very last pages.

The recording itself is so clean and so beautifully shaded dynamically that you could almost copy out the score from hearing it. This may not be a Mahler First for everybody, but I found it elegantly poetic and singularly illuminating. *David Hall*

MAHLER: *Symphony No. 1, in D Major*. Cleveland Orchestra, Christoph von Dohnányi cond. LONDON © 425 718-4, © 425 718-2 (55 min).

NOW ON CD Compact Discs of previously released LP's

POPULAR

- **THE BEACH BOYS:** *Pet Sounds*. CAPITOL 48421-2. Critically acclaimed at the time (1966) as the group's (and Brian Wilson's) best work to date. *Surfin' Safari/Surfin' USA*. 93691-2. Their first two Capital releases, 1962-1963.
- **DUKE ELLINGTON:** *The Brunswick Era, Vol. 1*. MCA MCAD-42325. Early classics, recorded in New York between November 1926 and January 1929.
- **TOM LEHRER:** *An Evening Wasted*. REPRISE 6199-2. *Revisited*. 26203-2 (with two bonus tracks). *That Was the Year That Was*. 6179-2. Songs of high hilarity by a campus favorite of the late Fifties and early Sixties.
- **DEL SHANNON:** *Greatest Hits*. RHINO R2 70977. A compilation of twenty singles spanning the Sixties, beginning with Shannon's first big hit (and only Gold record), *Runaway* of 1961.
- **ART TATUM:** *The Complete Pablo Group Masterpieces*. PABLO 6PACD-4401-2 (six CD's). Recordings from the mid-Fifties, most of them from an eight-LP set titled "The Tatum Group Masterpieces," plus an album's worth of tracks issued since that boxed set and a few previously unreleased tracks.
- **THE WHO:** *Tommy*. MOBILE FIDELITY UDCC 533. The original, late-Sixties Polydor/Decca version of Pete Townshend's rock opera, on one CD.

CLASSICAL

- **BACH:** *Orchestral Suites Nos. 2 and 3; Fourteen Canons*. Marlboro Festival Orchestra; Casals. SONY SMK 45892. Released in observance of the fortieth anniversary, this past summer, of the Marlboro (Vermont) Music Festival, where cellist Pablo Casals taught, played, and conducted.
- **BEETHOVEN:** *Symphonies Nos. 1 and 6*. SONY SMK 45891. *Symphonies Nos. 7 and 8*. SMK 45893. Marlboro Festival Orchestra; Casals. Also celebrating the Festival's fortieth.
- **BRITTEN:** *Death in Venice*. Pears; Bedford. LONDON 425 669-2 (two CD's). *A Midsummer Night's Dream*. Pears, Deller; Britten. 425 663-2 (two CD's). *The Rape of Lucretia; Phaedra*. Baker, Pears; Britten, Bedford. 425 666-2 (two CD's). *The Turn of the Screw*. Pears; Britten. 425 672-2 (two CD's). The definitive recordings, dating from the late Sixties and early Seventies, of these twentieth-century masterpieces.
- **PUCCINI:** *Tosca*. Tebaldi; Molinari-Pradelli. LEGATO LCD-157-2 (two CD's). Recorded live at Covent Garden in 1955.

State Of The Art That Leaves Room For The Art.



Now it's perfect. The final touch. ■ High-fidelity, in-wall speakers from Sonance. They add a dimension throughout your home that enhances fine art, compliments decor and completes an environment that delights all your senses. ■ Music. ■ Music that is startlingly accurate. Rich. Dynamic. A total audio ambience produced by these compact but powerful speakers. ■ Sonance is the leader in Architectural Audio,[™] with the world's most complete, single-source line of speakers, switchers, wires, and accessories. ■ Learn how easy it is to fill your home with audio art while leaving room for your visual art. ■ Contact the Sonance dealer nearest you. Call 1-800-582-7777. Outside the U.S.A., 714-492-7777, in Canada 604-873-4475. Or, write: Sonance, 961 Calle Negocio, San Clemente, CA 92672. Fax: 1-714-361-5151.



T H E • L E A D E R • I N • A R C H I T E C T U R A L • A U D I O • [™]

CIRCLE NO. 59 ON READER SERVICE CARD

If You've Heard Live Music, This Receiver Will Sound Familiar.



There are those who will tell you audible differences among modern amplifiers are largely imagined. Not among them, however, is Steve Cullison, amplifier designer extraordinaire at Nakamichi's research and development center in California. His theory of **Harmonic Time Alignment (HTA)** in amplifier circuits sheds new light on age-old mysteries. And in Nakamichi's new Receiver 1, this theory has been proven in practice.

The HTA principle, simply stated, asserts that the *timing* of an amplifier's harmonic distortion components has more to do with its sound quality than perhaps any other single factor. When distortion components are phase shifted with respect to the main signal, even small amounts can destroy an amplifier's musicality.



Nakamichi engineer Steve Cullison, inventor of Harmonic Time Alignment (HTA) amplifier circuitry.

HTA explains why conventional specifications utterly fail to describe how an amplifier sounds... why many audiophiles still prefer tube electronics for the middle to high frequencies... and why solid state designs are nonetheless often preferred for low-frequency reproduction.

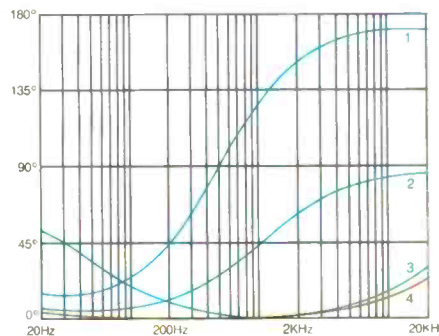

Computer analysis of Harmonic Time Alignment for four amplifier designs: 1) typical early solid-state, 2) typical recent solid-state, 3) typical tube, and 4) Nakamichi HTA.

In Nakamichi Receiver 1, every stage from preamp input to power output has been designed in accordance with HTA principle. The result is astonishing. There is no trace of harshness or graininess. Instrumental timbres are convincingly accurate. Presence and soundstage information are reproduced intact.

But the story doesn't end there. Receiver 1 is a full-featured control center around which you can build a complete, state-of-the-art audio/video system. You get a high-current, low-impedance HTA power amplifier stage rated at 80 watts per channel*; a superb quartz-locked PLL frequency-synthesis tuner section; 3 video inputs and 2 video outputs with high-quality buffer amplifiers; independent source selectors for listening and record outputs; Nakamichi's proven Multi-Regulated Power Supply and Isolated Ground circuitry; a precision motorized volume control; truly useful "Nakamichi-concept" tone controls; and much more.

Receiver 1 also comes with a wireless System Remote control that lets you operate the receiver plus compatible Nakamichi CD

players and cassette decks from your chair. Make that *chairs* in up to three additional rooms when you use Nakamichi's optional Multi-Room System Remote sensors.

Combined with Receiver 1's remote speaker A/B switching feature, it's almost like having another complete system in a different room.

If all this sounds too good to be true, ask your Nakamichi dealer to demonstrate Receiver 1. Compare it to other receivers for versatility, ease of use, and value. But for sound quality, compare it, as Nakamichi engineers do, only to the ultimate reference standard: live music. You'll be amazed by the resemblance.

Receiver 1 is one of three new Nakamichi receivers. Write or call for complete information on Nakamichi's new line of CD players, cassette decks, and receivers.

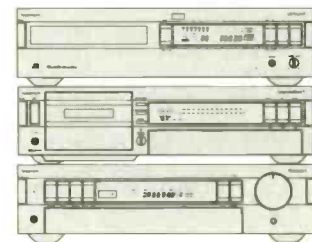

Nakamichi

Nakamichi America Corporation
19701 South Vermont Avenue
Torrance, CA 90502 (800) 421-2313
In California: (800) 223-1521
Nakamichi Canada: (800) 663-6358

*Continuous sine wave power output into 8 ohms, both channels driven, 20-20,000Hz, with no more than 0.1% THD

*Discs and tapes reviewed by
Chris Albertson, Phyl Garland,
Ron Givens, Roy Hemming,
Alanna Nash, Parke
Puterbaugh, Steve Simels*

ALIAS. Alias (vocals and instrumentals). *Say What I Wanna Say; Haunted Heart; Waiting for Love; The Power; Heroes; What to Do;* and five others. EMI 93908-1, © 93908-4, Ⓣ 93908-2 (48 min).

Performance: *AOR all the way*
Recording: *Good*

It is fitting that this band calls itself Alias since it could be Foreigner, Journey, Boston, Loverboy, or any number of exalted album-oriented rock outfits working under an assumed name. Alias has the FM-rock format down pat—keening, operatic vocals and high masculine harmonies; guitar-dominated might cut with a touch of synthesized sweetening; loud drums pounding out a steady beat so all the arena rats can pump their fists in the air. It's as formulaic as Oreos, but that's what the mainstream rock audience wants, and Alias delivers the goods. Call it lite metal or hard pop, this debut album is an amalgam of Seventies source material and Nineties haircuts and technology. It's no surprise that three former members of Heart are lurking herein, alongside two young guys late of a band called Sheriff. To a critic, it's all a little off-putting—melodies that sound like beer jingles, sensitive ballads added to broaden the demographic in a feminine direction, lyrics like "Hooray for the hero, the hero in all our hearts"—but "Alias" is so expertly assembled and so marketable that success is a foregone conclusion. *P.P.*

ASLEEP AT THE WHEEL: *Keepin' Me Up Nights.* Asleep at the Wheel (vocals and instrumentals); vocal and instrumental accompaniment. *Keepin' Me Up Nights; Boot Scootin' Boogie; Dance with Who Brung You; Quittin' Time; Eyes; Goin' Home;* and six others. ARISTA AL8-8550, Ⓣ AC8-8550, Ⓣ ARCD-8550 (41 min).

Performance: *Smart and swingy*
Recording: *Very good*

Twenty years after its inception on a farm near Paw Paw, West Virginia,

EXPLANATION OF SYMBOLS:

- = DIGITALLY RECORDED LP
- Ⓣ = TAPE CASSETTE
- Ⓣ = COMPACT DISC (TIMINGS ARE TO NEAREST MINUTE)

BOB MOULD

BOB MOULD'S outstanding first solo album, "Workbook," was meditative, largely acoustic, and cautiously optimistic—unlike the preceding avalanche of albums from his old band, Hüsker Dü. His new one, "Black Sheets of Rain," is a darker album that finds the electric guitar back in full force as well as the rage and discontent that made Hüsker Dü one of America's most popular alternative bands. The album neatly divides into halves, with one batch of songs railing about environmental woes while the others address a recently ended relationship. Don Henley utilized the same sort of political/personal dichotomy in "Building the Perfect Beast," and it works as an organizing principle for Mould as well. (No coincidence that Mould and Henley are two of our finest songwriters.)

The first half of "Black Sheets of Rain" contains the bleaker and more venomous material. Songs such as *Stand Guard, It's Too Late,* and *One Good Reason* attempt to do in song what writer Bill McKibben achieved in his book *The End of Nature*, depicting a world caught in an environmental gridlock. Blackened rain forests, skies full of fluorocarbons, poisoned fish, and toxins in the bloodstream are only a few of the images that run through these songs, which are rife with thick, plodding guitar work and agitated vocals. The title track depicts the crushing, abnormal heat of a summer day in a time of global warming: "Every morning, the sky it's on fire/And it's only 9 a.m. again." Mould expands on the

theme to convey his unease with the way modern life is organized around the narrow, binding horizons of labor and capital. Personally, he's feeling none too good about it: "It's the black sheets of rain/Following me again/Everywhere I go/Everywhere I've been."

Mould lifts the mantle of gloom somewhat in the second half of the album to sing about what sounds like a liberating personal catharsis. *The Last Night, Out of Your Life, Hear Me Calling,* and *Disappointed* work through the bitterness and heartache of a dying affair or friendship. Though the words excoriate the past (could he be singing about Hüsker Dü's troubled breakup and his old partner, drummer Grant Hart?), the music is pop-pish and uplifting, like early Who singles or Neil Young at his succinct, electric best. As he did in "Workbook," though, Mould closes "Black Sheets of Rain" with an air-clearing tirade. *Sacrifice/Let There Be Peace* is soured by gruff singing and creased with black, sludgy chords worthy of Metallica. When it subsides you feel as if Mould has worked through something difficult and come out on the other side, scarred but wiser.

Parke Puterbaugh

BOB MOULD: *Black Sheets of Rain.* Bob Mould (guitar, vocals); other musicians. *Black Sheets of Rain; Stand Guard; It's Too Late; One Good Reason; Stop Your Crying; Hanging Tree; The Last Night; Hear Me Calling; Out of Your Life; Disappointed; Sacrifice/Let There Be Peace.* VIRGIN 91395-1, © 91395-4, Ⓣ 91395-2 (56 min).



Asleep at the Wheel continues to turn out some of the most inventive and evocative music of the western-swing genre. Still led by the long-haired, lanky Ray Benson (who has survived the numerous personnel changes through the years), in "Keepin' Me Up Nights" the group mixes Texas dance-hall fare, boogie-woogie, ballad, jazz, rock, and r-&-b to move through a well-paced and sophisticated set. The album finds the band seeking mainstream acceptance without sacrificing its dignity or compromising its free-roaming style, and while it still suffers somewhat from the departure of singer/guitarist Leroy Preston, a founding member who wrote some of the

adult lyrical themes, and "maturity" is the watchword. The album zigs and zags autobiographically from the rough terrain of his days as an unrepentant rock-and-roller to the spiritual quest that constitutes his current mind set.

In a blindfold test, "Brent Bourgeois" could pass for the work of Utopia. Todd Rundgren's exercise in band democracy. Like Rundgren, Bourgeois elongates pop forms into rhythmically decentralized chants and swirling melodies. His voice recalls the boyish tenor of Utopia's Kasim Sulton yet also takes on a soulful, low-end vibrato. Starbursts of vocal harmony illuminate such songs as *Dare to Fall in Love*. Exotic touches

fle late last year, but it's simply too fine to let slip away. The recent release of "Any Kind of Lie" by his wife, Marti Jones, is a good excuse to slip in a reminder about "EEE," because the two albums complement each other nicely. Together, they constitute an ongoing dialogue between male and female points of view on the sometimes comical, often hurtful, and always confusing battleground of love and war between the sexes.

In "EEE," Dixon serves up tantalizing snatches of Sixties-style Top 40 and beach music while employing thoroughly modern approaches to the studio and pop-soul songcraft. The Uptown Horns provide soulful punch in John Hiatt's muscular *Love Gets Strange* and a propulsive stomper called *Roots of Truth*. Elsewhere, Dixon scuffs up the dB's' *Bad Reputation* and pulls off a snappy little barroom weeper, *Calling Out for Love at Crying Time*, co-written with Marshall Crenshaw. He also tackles Brenton Wood's beach classic *Gimme Little Sign*, sung as a duet with Jones, and James Carr's haunting *Dark End of the Street*. The best song, however, is Dixon's own *I Can Hear the River*, a grand, gospel-style number that ought to be covered by Aretha Franklin or Al Green. P.P.

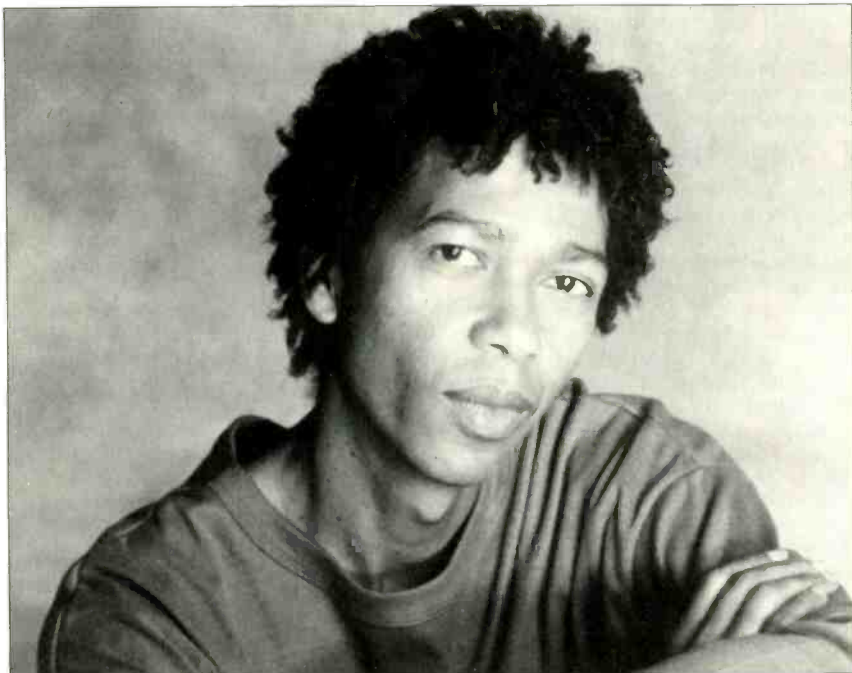

Djavan: the truth of an older heritage

band's more commercial tunes, the inclusion of such upbeat numbers as Preston's own *That's the Way Love Is* and the Ray Charles-like title tune almost makes up for the loss. George Strait may have made the western-swing revival cool, but Asleep at the Wheel keeps it honest as sagebrush and loose as tumbleweed. Superb musicianship, sparkling songs, and an all-out "fun" approach add up to an exemplary album of the kind of music sometimes referred to as "hillbilly's answer to jazz." A.N.

BRENT BOURGEOIS. Brent Bourgeois (vocals, drums, keyboards, bass, accordion, acoustic guitar); other musicians. *The Real Things; Compromise; Dare to Fall in Love; Can't Feel the Pain; Scene of the Crime; Wild Child*; and five others. CHARISMA/ATLANTIC 1-91364. © 4-91364. © 2-91364 (46 min).

Performance: *Intriguing*
Recording: *Very good*

Brent Bourgeois, late of the group Bourgeois-Tagg, has made an album based on

abound, from the Eastern modality of *My Little Island* to *A Long Way from Home*'s traditional Irish-folk styling. A lushly harmonized remake of the Zombies' *Time of the Season* will probably attract the most attention, yet "Brent Bourgeois" is best approached *in toto* as an extended meditation on morality and transcendence. P.P.

CARLENE CARTER: *I Fell in Love* (see *Best of the Month*, page 131)

DON DIXON: *EEE*. Don Dixon (vocals, guitar, keyboards, bass); other musicians. *Oh Cheap Chatter; Silent Screen; Love Gets Strange; I Can Hear the River; Dark End of the Street*; and seven others. ENIGMA © 73356-4, © 73356-2 (45 min).

Performance: *Soulful and assured*
Recording: *Very good*

Don Dixon is best known as a producer, but he is a commanding vocalist, musician, and songwriter as well. His fourth solo album, "EEE," got lost in the shuf-

Performance: *One of Brazil's best*
Recording: *Very good*

The two albums by Djavan previously released in the U.S. skillfully combined his awesome natural talents with state-of-the-art production techniques, earning him immediate acceptance by those more accustomed to the easy accessibility of North American pop than to the sweet subtlety of Brazilian song. For "Puzzle of Hearts," his third outing on Columbia, he returned to Brazil and has come up with an album that's much closer to his original style. While it retains the punch and directness of pop, it resonates with the rich rhythms and textures of his native land. The result is his most artistically satisfying effort since he emerged as a major figure in what is called World Music.

Like Milton Nascimento, the standard-bearer of the modern Brazilian sound, Djavan is a master singer, guitarist, and composer, though he has more of an affinity for lean, edgy pop rhythms. This characteristic is most apparent in the openers, *Corisco* and *Being Cool*, but most of the music here rings with the truth of an older heritage, as in *Amazon Farewell*, where pulsating percussion underscores his commentary on the burning of the Amazon rain forest. The brightest gem of all is the haunting title track, which Djavan sings twice, in both

The International Preview Society

Invites you to accept
The ultimate in sound...
The ultimate in savings...



3 COMPACT DISCS OR CASSETTES **\$1**
FOR JUST
With No Obligation To Buy Anything...Ever!

plus shipping and handling with Club membership

Horowitz At Home 25211

HOROWITZ AT HOME

Nadia Salerno-Sonnenberg: Mendelssohn, Violin Concerto # 31 (Paris) & # 32 - Vienna Philharmonic Orchestra led by James Levine. DG 25341

Le Mystere Des Voix Bulgares, Vol. II - Bulgarian Female Vocal Choir/Cellier. A Grammy Winner! "Spectacular" - *The New York Times* Nonesuch 54525

Norrington: Berlioz, Symphonie Fantastique - The London Classical Players. Angel 20760

Segovia Plays Bach - 3 Pieces For Lute, Siciliano, Gavotte en Rondeau, Chaconne, more. MCA 63600

Corelli, Concerti Grossi, Op. 6 - Tafelmusik. "Best Of 1989" - *New York Times*. DHM 73751

Gershwin, Overtures - John McGlinn conducts. Oh, Kay! Girl Crazy, more. Angel 70391

Simon Rattle: Stravinsky, The Firebird - Plus 4 Etudes, Scherzo à la Russe. City of Birmingham Symphony. "Brilliant" - *Stereo Review* Angel 93834

James Galway: Greatest Hits - Memory, Annie's Song, Greensleeves, more. RCA 73233

Ute Lemper Sings Kurt Weill - Mack The Knife, I'm A Stranger Here Myself, more. "One of Germany's most exciting stars." - *Gramophone* London 15163

Ravel, Piano Concertos - Argerich and Beroff, pianists. LSO/Abbado. "Exquisite" - *Stereo Review* (Best of the Month) DG 15462

Sound The Trumpet - English Ceremonial Music. Edward Carroll, trumpet; Purcell, and more. Newport 00990

Bartok, Concerto For Orchestra - Plus Dance Suite. Chicago Sym./Georg Solti. London 15177

Mozart, Overtures - Magic Flute, Marriage Of Figaro, Don Giovanni, Così fan tutte, more. Neville Marriner conducts. Angel 34267

Bali - Gamelan and Kecak recorded in Bali. Ritual songs, sacred music, etc. Nonesuch 44671

Bach, Violin Concertos - S. Accardo, violin, Chamber Orchestra Of Europe. "Warm." - *Gramophone* Philips 25162

On The Boardwalk - Paragon Ragtime Orchestra/Benjamin Chatterbox Rag, The Memphis Blues, more. Newport 24699

Itzhak Perlman: French Violin Showpieces - Havanalse, Tzigane, Carmen-Fantasy, more. New York Phil./Mehta. DG 15457

Mozart, Lodron Serenades - Camerata Bern. "Strongly recommended." - *Fanfare* Novalis 63642

Copland, Appalachian Spring (Complete) - Plus Cortege macabre; Letter From Home; John Henry. St. Louis Sym. Orch./Slatkin. Angel 54176

Pops In Space - The Boston Pops/Williams. Music from Star Wars, Superman, more. Philips 05392

Kronos Quartet: White Man Sleeps - Music of Ives, Volans, Hassell, Coleman, Johnston & Bartok. "Superb." - *Gramophone* Nonesuch 40256

Beethoven, Symphonies Nos. 1 & 6 (Pastorale) - London Clas. Players/Norrington. "Exhilarating." - *Stereo Review* Angel 60068

Chopin, Ballades, Barcarolle, more - Krystian Zimerman, piano. "[His] pianism is breathtaking." - *Ovation* (Recording Of Distinction) DG 15332

Michael Feinstein: Pure Gershwin - S' Wonderful, Embraceable You, many more. Elektra 54173

Rhythm Song - Evelyn Glennie, percussion. Flight of the Bumblebee, Maple Leaf Rag, Mexican Dances, more. RCA 24723

Respighi, Roman Tone Poems - Riccardo Muti conducts the Philadelphia Orch. Angel 34443

Jascha Heifetz: Debussy & Respighi Sonatas - with Artur Schnabel, piano. RCA 53802

Dvorak, Symphony No. 9 (From The New World) - Cleveland Orch./Dohnányi. London 15065

Mendelssohn, Piano Concertos Nos. 1 & 2 - Sergei Edelmann, piano. Bamberg Sym./Flor. "Exceptionally beautiful." - *Stereo Review* RCA 63909

J.S. Bach, Works For Organ, Vol. 1 - Ton Koopman, organ. "Wachet auf"; Toccata & Fugue in D Minor; etc. Novalis 01137

James Galway: The Enchanted Forest - Traditional Japanese music with synthesizer. RCA 44533

Mahler, Symphony No. 1 (Titan) - Sir Colin Davis leads the Bavarian Radio Orchestra. Novalis 73745

Kiri Sings Gershwin - Kiri te Kanawa, soprano. Somebody Loves Me, I Got Rhythm, more. McGlinn conducts. Angel 70258

Vivaldi, The Four Seasons - Simon Standage, violin. English Concert/Pinnock. Archiv 15356

Perlman: Brahms, Violin Concerto - Chicago Symphony Orchestra/Giulini. A Grammy Winner! Angel 63343

Classic Marches - Beethoven, Turkish March, Strauss, Radetzky March; 14 others. St. Louis/Slatkin. RCA 00996

Scarlatti, Sonatas - Anthony Newman, harpsichord. 23 Scarlatti favorites. Newport 64168

Mario Lanza: The Student Prince And The Desert Song - "Lovely." - *Fanfare* RCA 50269

Beethoven, Symphony No. 3 (Eroica) - Roger Norrington conducts the London Classical Players. Angel 70023

Simon Rattle: The Jazz Album - Rhapsody In Blue, La Création Loves Me, I Got Rhythm, more. Angel 72226

Heifetz: The Decca Masters, Vol 1 - Humoreske, Melodie in E-Flat, Clair de lune, Golliwog's Cake-walk, many more. RCA 00604

Fauré, Requiem; Pelléas et Melisande; Pavane - Kiri te Kanawa, soprano. Montreal Sym./Dutoit. London 15321

Ciburn: Liszt & Grieg Piano Concertos - The Philadelphia Orchestra/Ormandy. RCA 00606

SAVE 50% HALF-PRICE BONUS PLAN
Unlike other clubs, you get bonus certificates good for 50%-off Bonus Savings with every album you buy at regular prices, effective with your first full-price purchase!



This remarkable \$1 offer is being made to introduce you to an outstanding classical music membership—with never any obligation to buy.

You'll find hundreds of outstanding albums in each issue of the Society's magazine, which will be sent to you approximately every 4 weeks. That gives you 13 convenient, shop-at-home opportunities a year. But there is no obligation to accept any offering at any time.

You choose only the music you want!

If you'd like to accept the Main Selection, you need not do a thing. It will be sent automatically. If you'd prefer an alternate selection, or none at all, just mail back the Notification Card by the specified date. You'll always have at least 10 days to decide. But if you don't, you may return your Main Selection at our expense. You may cancel your membership

whenever you wish, simply by writing to us. Or, remain a member and take advantage of future money-saving bargains.

Substantial savings with our bonus plan.

For every regular purchase you do make, you'll receive bonus certificates good for 50%-off bonus savings. (Shipping/handling added to each shipment.)

3 Compact Discs or Cassettes for just \$1!

Begin your membership now by choosing any 3 albums shown here for just \$1 plus shipping and handling. Send no money now. We want you to judge for yourself before you decide to buy. If not delighted, return your selections at the end of 10 days without obligation.

The International Preview Society

P.O. Box 91406 • Indianapolis, IN 46291

YES! Please accept my membership in The International Preview Society and send me, for 10 days' FREE examination, the 3 selections I have indicated below, under the terms of this offer. I may return them after 10 days and owe nothing, or keep them and pay only \$1 (shipping and handling added to each shipment). I understand that I'm not obligated to buy anything...ever!

Please send all selections on } Compact Disc* Cassette

Write Selection Numbers Here:

Mr. Mrs. Miss First Name Initial Last Name (PLEASE PRINT)

Address _____ Apt. _____

City _____ State _____ Zip _____

Telephone (Area Code) _____

Signature _____

*Members who select CDs will be serviced by the BMG Compact Disc Club and will receive CD Discovery 18 times a year (approx. every 3 weeks). Full membership details will follow with the same 10-day, no-obligation, no minimum purchase privilege. Current BMG CD Club members not eligible for this offer. Limited to new members, continental U.S.A. only. One membership per family. We reserve the right to request additional information or reject any application. Local taxes, if any, will be added.

P22 (PJ)
ZLP22 (BF)

English and Portuguese. It's a beautiful song in any language. P.G.

HOTHOUSE FLOWERS: *Home* (see Best of the Month, page 132)

ETTA JAMES: *Stickin' to My Guns*. Etta James (vocals); vocal and instrumental accompaniment. *Whatever Gets You Through the Night*; *Love to Burn*; *The Blues Don't Care*; *Your Good Thing (Is About to End)*; *Get Funky*; and five others. ISLAND 842 926-1, © 842 926-4, © 842 926-2 (40 min).

Performance: *Vibrant*
Recording: *Excellent*

Etta James made a spectacular comeback two years ago with "Seven Year Lich." That album took exquisite advantage of her immense vocal talents (she can go from a whisper to a roar in nothing flat) in a variety of musical settings that were true to classic r-&-b as well as contemporary black music. In "Stickin' to My Guns," she offers a similar mix of tunes. Again there's an Otis Redding classic, *I've Got Dreams to Remember*, in which she nearly makes us forget the master. She's also got her share of sassy struts laced with nasty rockish guitar, such as Dobie Gray's *Love to Burn*. There's even a soul-rap hybrid, *Get Funky*, that combines James's bluesy exhortations with the easy patter of rapper Def Jef. This woman has been a blessing to pop music since she recorded *The Wallflower (Dance with Me Henry)* in 1954. Long may she thrive. R.G.

WAYLON JENNINGS: *The Eagle*. Waylon Jennings (vocals, guitar); vocal and instrumental accompaniment. *Workin' Cheap*; *What Bothers Me Most*; *The Eagle*; *Her Man*; *Wrong*; *Where Corn Don't Grow*; and four others. EPIC © ET 46104, © EK 46104 (31 min).

Performance: *Warm and fuzzy*
Recording: *Good*

Waylon Jennings has always been one of the great masquerade artists of country music, a big-hearted teddy bear posing as a rough-and-tumble outlaw. The evidence was clearly there—you just had to look beyond the scraggly beard and the menacing black hat and examine the lyrics of his songs. Jennings doesn't write much any more, but the songsmiths who service him know this about him and try to write material that shows off his dichotomy—hard on the outside, soft on the inside—with traditional themes such as the bittersweet romance of being the last of the cowboys or the conflict of the roustabout who aches for the comfort of the hearth but itches for the adventure of the road.

There are a number of such tunes in "The Eagle," such as Roger Murrah and Mark Allan's *Where Corn Don't Grow* and John Hadley and Kevin Welch's *Reno and Me*, a buddy song that turns into a kind of modern-day *Poncho and Lefty*. But while producers Richie Albright



Louie Louie: funk-pop original

(Waylon's old drummer) and Bob Montgomery get the persona right and keep the backing tracks lean and jangly. Jennings himself seems unusually low-key. With no blockbuster tunes, his mellow, bemused, and seemingly settled approach makes him come across more as an elder statesman of country music than as the vital trendsetter he once was. No longer a man out to change the world and vent his anger, he appears now to be a man who wants to sit on the porch and take things as they come. A.N.

LOUIE LOUIE: *The State I'm In*. Louie Louie (vocals, keyboards, keyboard and drum programming); Dizzy Gillespie (trumpet in *Sittin' in the Lap of Luxury*); vocal and instrumental accompaniment. *The State I'm In*; *Sittin' in the Lap of Luxury*; *I Wanna Get Back with You*; *Mata Hari*; *Penny Lady*; and six others. WTG/CBS N 45285, © NT 45285, © NK 45285 (45 min).

Performance: *Princely*
Recording: *Very good*

He calls himself Louie Louie, and it's his final word on the matter. By the age of twenty, he was living a double life—a neatly dressed, highly paid car salesman by day and the star of the L.A. dance clubs by night, outfitted in a zoot-suit that gave him his provocative street name. From his picture, he appears to be Hispanic, but his inspiration always came from blacks—Stevie Wonder, Gladys Knight, Chaka Khan and Rufus. And then, in 1981, he found himself in the third row of a Prince concert. The earth didn't so much *move* as shake all over and change inexorably for all time.

Whoever he is, Louie Louie has real talent, no matter how shameless a Prince clone he appears to be on first listen. In his WTG debut album, a racy collection of infectious, original dance-pop, he du-

plicates Prince's personal flamboyance, androgyny, and licentiousness as well as his funk-pop milieu, pumping a hot, heavily synthesized keyboard sound that also draws on drum programming, synth guitar, talkbox, and tangerine wah-wah.

The subject matter, too, is familiar: all manner of social no-nos, including the gigolo grind ("love power" by the hour) and lesbianism ("I caught you sneakin', freakin' with another girly girl"). But he drives through this volcano of sound with impassioned lead vocals that put Prince's wispy dronings to shame.

All the same, it is high praise to say that after a few spins through this album—produced by Bobby Colomby, former drummer for Blood, Sweat & Tears—Louie Louie's material doesn't come across so much as Prince posturing as an *extension* of the Prince sound, which, of course, started out as a tame imitation of Jimi Hendrix. The songs are enormously inventive, both lyrically and melodically, within their own confines. *Rodeo Clown*, for example, a tune about the kind of women who drive men to distraction (among other things), with its direct references both to the Carpenters and to Prince ("and then we popped in Purple Rain"), is one of the most creative and clever funk-humps in memory. And even Dizzy Gillespie sees fit to sit in on the swing-beat of *Sittin' in the Lap of Luxury*.

Louie Louie, then, is a fooler—an original in the guise of an imitation. No matter how you judge his taste factor, he's got something going on. Just what, exactly, is up to you. A.N.

JEFF LYNNE: *Armchair Theatre*. Jeff Lynne (vocals, guitars, keyboards, bass); other musicians. *Every Little Thing*; *Don't Let Go*; *Lift Me Up*; *Nobody Home*; *September Song*; *Now You're Gone*; and five others. REPRISE 26184-1, © 26184-4, © 26184-2 (37 min).

Performance: *Spotless pop*
Recording: *Airy*

Jeff Lynne has the touch. As the singer, guitarist, and leader of Electric Light Orchestra, he set symphonic pop to a danceable beat, generating hit albums and singles throughout the Seventies. Lately he's been on a roll again, producing and participating in albums by George Harrison, Tom Petty, and the Traveling Wilburys. In his first solo recording, "Armchair Theatre," Lynne employs a light touch, constructing musical castles in the sand out of elements both modern and old-fashioned. Whereas he always had to find a way to put ELO's seven musicians to use, alone he is free simply to strum an acoustic guitar, which he does in *Save Me Now*. Still, he seems to enjoy pumping up the arrangements with keyboards and countermelodies, as in the ELO-style *Every Little Thing*.

Lynne's inventive use of background vocals stands out in "Armchair The-



Definitive BP 10
Under \$550 each

“Definitive’s Revolutionary New Bipolar BP 10 Is a True Sonic Triumph!”

Definitive Technology’s BP 10 is a revolutionary new designer styled, audiophile engineered loudspeaker intended for musical reproduction and home theatre systems of the highest quality. It is a full-range bipolar (front and rear) radiating system which combines the lush spacious

soundstaging, life-like depth-of-field, razor-sharp resolution and pinpoint imaging of the finest dipolar panel loudspeakers with the extended bass response, high-efficiency, wide dynamic range and easy-to-position convenience of the best conventional box systems.

Experience this revolutionary sound!

Please see page 72 for dealer list.

Definitive Technology

11105 Valley Heights Drive • Baltimore Maryland 21117

Our YSFC11 Audio System is small enough to put just about anywhere in your home or office. But it has all the deep, powerful bass of an audio system three times its size. In fact, it has everything you'd find in a larger, more traditional audio system. AM/FM tuner, dual-well cassette deck, CD player, plenty of power and even a wireless remote control. But we've got to warn you. A bass response down to 40 Hz is bound to stir things up wherever you put it.

YAMAHA

Small enough to fit on your desk.
Enough bass to wake up your boss down the hall.



atre." Perhaps because his unaccompanied voice is more serviceable than strong, a veritable Greek chorus is always there to surround and embellish it. The harmony parts in *Now You're Gone* sound like the Beach Boys interpreting Indian vocal music. In *Nobody Home*, the vocals soar like a UFO lifting into the sky. They provide a heavenly cushion in *Don't Say Goodbye*, a ballad I could picture Elvis Presley cooing on bended knee to a girl in one of his movies.

Some might argue that while Lynne manufactures the tastiest ear candy around, there's little substance to it. The album's very title, calling to mind the term "armchair traveler," seems to imply that Lynne is more of a watcher than a doer, writing his billowy retro-pop from an uninvolved, secondhand perspective. His love of early rock balladeers such as Del Shannon is genuine, however, and his spotless, note-perfect arrangements reveal a heartfelt devotion to craft. Looking not at what he's doing but at how he's doing it, it's apparent that Jeff Lynne has got a rock-and-roll heart and the commitment of a true believer. P.P.

REBA McENTIRE: *Rumor Has It*. Reba McEntire (vocals); vocal and instrumental accompaniment. *Climb That Mountain High; Rumor Has It; Waitin' for the Deal; You Lie; Now You Tell Me; Fancy*; and four others. MCA ● MCA-6444. © MCAC-6444, © MCAD-6444 (39 min).

Performance: *Glorious*
Recording: *Very good*

By the time Reba McEntire switched producers from Jimmy Bowen to Tony Brown, she was in a fix—recording material that was both inappropriate for her milieu and unsuited to her voice, as well as undercutting the emotional power of her delivery with excessive vocal trills and flourishes, the equivalent of messing up a sleek evening dress with too many bows and lace. Worse, she was beginning to erode her reputation as a woman who had something to say and knew how to put it across.

For her new album, "Rumor Has It," Brown helped McEntire find a nearly perfect set of songs. These are tunes that show off all of her strengths and few of her faults—the trills are thankfully kept to a minimum—and convey a sense of character and dignity. *You Remember Me*, for example, puts the singer in the role of a woman confronting an old friend who now needs some basic human understanding—a friend who was also once her lover and later rejected her. It calls for a difficult piece of musical acting, and McEntire delivers it with understated compassion.

But many of these songs are also tunes that speak to other women—McEntire's primary fans—about the pain of failed relationships and of the struggle to hold things together. The best of these are *You Lie*, an exquisite ballad in which both the husband and the wife put off an



World's Largest Record Catalog

Now you can shop from home for any CD, Tape or Video from Bose Express Music, the first complete record store in a catalog.

We carry the complete catalog of all the major labels plus independents like Alligator, Rounder, Fantasy, Chandos, Telarc, Harmonia Mundi, Dorian, Reference and many more. All music videos are available as well.

Send \$6.00 (refundable on your first record order from the catalog) for a copy of our 240 page (45,000 titles) 1990 Catalog plus 1 year of Updates **FREE**, covering new releases and specials. Absolutely no obligation and no unrequested shipments.

Special Stereo Review Offer

You can order any title reviewed or advertised in this issue of *Stereo Review* from Bose Express Music, for our usual subscriber low price of only \$13.99/CD or \$7.99 LP/CA, when you subscribe.

Subscription / Mail Order Form

Start the Updates & send Catalog (\$6.00/yr.)
 Send me the attached list of recordings (include artist, title, & format — CD/CA/LP) Please include payment + \$3.65 for Shipping & Handling per order
 Check or Credit Card Visa MC AMEX

_____ EXP _____
Name _____
Address _____
City/State/Zip _____

CALL OR MAIL WITH PAYMENT TO:

Bose Express Music, 50 W 17th St., NYC, NY 10011

☎ 1-800-233-6357

SR-110



Cassette System Saver



Audio/Video Tape Erasers



Video Head Cleaners



Auto-Stop CD Cleaner



Leather CD Tote



Demagnetizers

Geneva's unique, iron-clad guarantee continues to underscore our commitment to quality and technological leadership. But now our assurance of positive protection extends beyond your valuable audio and video gear—to include the earth's ozone layer.

Best of all, the new generation Geneva products are not only ozone-safe—they reach a higher level of performance, as well. For example, Geneva Head Cleaners include new advanced technology polyester cleaning tape. Tape that reaches down into tiny recesses—pulls out particles of dust and dirt—and captures contaminants in microscopic pockets.

Our ozone-safe cleaning solution has twice the cutting power. And it's packaged in a pre-metered pump bottle that delivers precisely the right measure of solution.

And there's more. Much more.

From our new Audio Cassette System Saver to an Auto-Stop CD Cleaner. From Audio/Video Tape Erasers to Demagnetizers to our unique leather CD Tote.

In short, we're reaching new heights to help you care for your audio and video gear. And you can reach us, toll-free, at 1-800-328-6795 ext. 382 for the Geneva dealer nearest you. In Canada, call Optex Corporation, 1-416-449-6470.

Geneva

INTRODUCING VERY HIGH TECHNOLOGY.

They will hate you. Why? Because our little YSTC11 has all the deep, loud, powerful bass of an audio system over three times its size. It even has all the same features. AM/FM tuner, CD player, dual-well cassette player, plenty of power and even a wireless remote. But we've got to warn you. If you buy one, they may never let you borrow their lawn mower again.

YAMAHA

The YST-C11's bass response goes down to 40 Hz.
Better warn the neighbors.



imminent split, and *This Picture*, a sinewy piece of pop in which a woman hides all the photos of her beloved but still can't get him out of her mind. In both performances McEntire, virtually exploding with emotion, does a wonderful job of conveying the grief and craziness that come with the torment of doomed romance. And yet she never takes it so far as to be mawkish or phony, as she has a time or two before.

Although this set runs the gamut from ballad (*Falling Out of Love*), to bluesy pop (*That's All She Wrote*), to country-rock (*Waitin' for the Deal to Go Down*), and even swamp-rock (a remake of Bobbie Gentry's *Fancy*), hard-core traditionalists will find little to rejoice over except McEntire's consistent Okie drawl ("again" becomes "a-GAY-yun") and scrapper personality. But she shines so brilliantly—regaining her good judgment and take-charge attitude, and communicating with everything she has—that she is bound to win over her recent critics. "Rumor Has It" is a powerhouse recording that should put McEntire back on top where she belongs. **A.N.**

RIOT: *The Privilege of Power*. Riot (vocals and instrumentals); other musicians. *On Your Knees; Metal Soldiers; Runaway; Killer; Kiss of Death; Storming the Gates of Hell;* and five others. CBS ASSOCIATED Z 45132. © ZT 45132. © ZK 45132 (58 min).

Performance: *Metal and more*
Recording: *The louder the better*

Faster than the race cars at the Indy 500, Riot might just be the last word in speed metal. "The Privilege of Power" is a concept album of sorts about what's ailin' America, with media fascism placing high on the enemies list. The alleged concept, with TV sound bites linking the tracks, is undercut by an irrelevant, self-serving song about how the band can't wait to hit the stage (*Metal Soldiers*) and by too many numbers with the word "death" in them. Still, Riot's charge of the heavy brigade carries an undeniable, adrenalin-fueled power that packs a mighty wallop.

Standard metal conventions are observed, including a singer who aims for the stratosphere and maniacal exercises in fretboard gymnastics by guitarist Mark Reale, but Riot steps beyond the genre's noisy boundaries to find room for the Tower of Power horns and fusion guitarist James Blood Ulmer. The final stroke is a blistering cover of Al DiMeola's *Racing with the Devil on a Spanish Highway*. More than an interesting novelty, it's pretty exciting, and kudos to Riot for going for it. **P.P.**

SIDEWINDERS: *Auntie Ramos' Pool Hall*. Dave Slutes (vocals); Rich Hopkins (guitar); Mark Perrodin (bass); Bruce Halper (drums). *We Don't Do That Anymore; Sara's Not Sober; Get Out of That Town; 7 & 7 Is; Doesn't Anyone Believe; If I Can't Have You;*

CRYSTAL PERSUASION



#42 GP001 \$45.95
(\$3.00) Gift boxed

From the skilled craftsmen of Hofbauer in West Germany comes this beautiful crystal piano. Made of highly polished lead crystal with over 24% PbO it measures approximately 6" in length and 5" in height. A great collectible item for the discriminating Stereo Review reader.

To order, call our TOLL FREE lines. We accept Visa, MC, and AE or send a check plus shipping and handling to Stereo Review, P.O. Box 742, Holmes, PA 19043. ORDER TOLL FREE 800-345-8112.

THE SHOCKING TRUTH!

Speakers are the most important part of your stereo system. It is the speaker that turns amplifier signal into sound and so ultimately determines what you hear. If your speakers do not perform well, your stereo system will simply not sound like music.

The search for musically satisfying speakers, however, can lead to some very expensive products. And if you have already bought those high priced speakers, then you better not listen to Paradigms. But if you haven't, better not miss them. Why? Because from the time they were first introduced, Paradigm's sheer musical ability utterly amazed listeners.... but what caused even more amazement was the *unprecedented low price*.

The shocking truth is, you no longer have to amass a small fortune to buy speakers that will satisfy your love of music. Simply visit your authorized Paradigm dealer.... *and listen*.

The critics agree:

"... natural, open and clear...excellent depth... lots of hall sound... big, expansive soundstage... well defined... a rare achievement for any loudspeaker, but when price is taken into account the Paradigm's performance must be considered as nothing short of remarkable."

Sound & Vision Magazine

"... we can't think of another speaker at or below this price that manages to match the Paradigm's overall sense of balance and competence... exceptional value."

Hi Fi Heretic Magazine

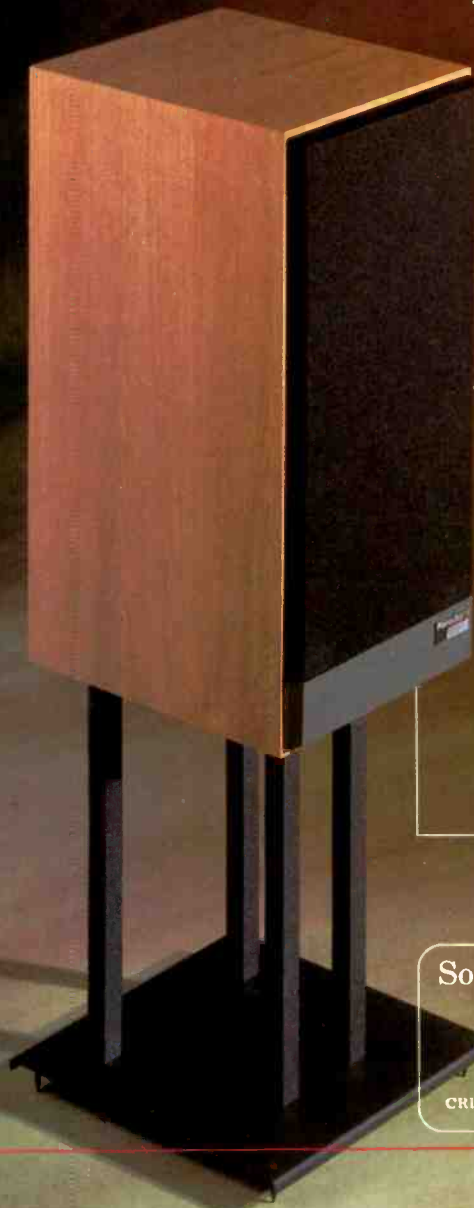

Paradigm[®]
music . . . above all.

In the U.S.: AudioStream, MPO Box 2410, Niagara Falls, New York 14302
In Canada: Paradigm Electronics Inc., 457 Fenmar Drive, Weston, Ontario M9L 2R6

CIRCLE NO. 97 ON READER SERVICE CARD

BLAUPUNKT'S TAMPA. THE HEAT IS ALWAYS ON.



At sundown, the gulf breezes cool down the city, but nothing cools down hot sounds from a Blaupunkt. And the hottest news is that you can own the Tampa SQR 29 FM/AM receiver for under \$250.00.

Blaupunkt's advanced tuner technology lets you program up to 15 presets (10 FM and 5 AM) and scan each station. FM frequency response is an incredible 35 to 15,000 Hz. And Blaupunkt's exclusive Optimum Reception Control ensures maximum listening fidelity.

The Tampa gives you an autoreverse cassette deck. The loudness button with separate bass and treble contour allows a fine tailoring of the sound.

You get a powerful 2 x 7.5 watt internal amplifier and a 4-speaker hookup. Plus a Flex Fader with true 4-Channel, RCA Preamp Output lets you add more power to the system.

What's more, when you head for the beach you can easily remove the Tampa from your car with the quick-release handle or leave it with the 4-Digit Security Code activated.

The Tampa's not the only Blaupunkt FM/AM receiver under \$300.00. Check out the Boston, Phoenix and Newport. Each becomes part of a system of incomparable sound fidelity when paired with Blaupunkt's BEA 108E Equalizer Amplifier and CB 4500 die-cast enclosed speakers, which are great for your car, home, boat or even portable sound system.

For a dealer near you, call 1-800-237-7999. Wherever you live, Blaupunkt generates the hottest sound under the sun.

BLAUPUNKT
Bosch Telecom
The difference is pronounced.™

and six others. MAMMOTH/RCA 2068-1-R, © 2068-4-R, © 2068-2-R (49 min).

Performance: *Hot as the sun*
Recording: *Good*

The Sidewinders come on like a garage band with a folk-rock chord book. Give the Byrds an amphetamine jolt in the direction of the Nineties, and you've got a rough idea of what the Sidewinders are up to in "Auntie Ramos' Pool Hall." The Tucson, Arizona, foursome revolves around core members Dave Slutes and Rich Hopkins, who wrote all the songs except the ferocious cover of Love's garage-rock anthem, *7 & 7 Is*. The Sidewinders have a knack for longish, soul-baring songs about growing up and getting older, faith or the lack of it, and the sun-baked inferno in which they live, which is metaphorically put to good use in songs like *Come On Like the Sun*. They also know the virtues of simplicity; witness *Blood on Our Hands*, a two-chord vamp that employs a nonmelodic chunka-chunka rhythm slashed out on guitar. *Doesn't Anyone Believe* is another charging folk-rocker cut from the same existential cloth as Blue Öyster Cult's (*Don't Fear*) *The Reaper*. *We Don't Do That Anymore* is worthy of Roger McGuinn and Company, with words and harmonies that trigger pangs of longing for lost, reckless youth.

"Auntie Ramos' Pool Hall" doesn't let up in intensity; the drums pound, the guitars churn, and the singer reaches for notes that mean something. What more could you ask for? P.P.

TEXAS TORNADOS. Texas Tornados (vocals and instrumentals); vocal and instrumental accompaniment. *Who Were You Thinkin' Of*; (*Hey Baby*) *Que Paso*; *Laredo Rose*; *A Man Can Cry*; *Soy de San Luis*; *Adios Mexico*; and four others. REPRISÉ 26251-1, © 26251-4. © 26251-2 (32 min).

Performance: *Ole!*
Recording: *Good*

Texas Tornados is the Tex-Mex equivalent of the Traveling Wilburys, bringing together Austin legend Doug Sahm (Sir Douglas Quintet), his keyboard pal Augie Meyers, country hitmaster Freddy Fender, and accordion player Flaco Jimenez, each of whom contributes a particular spice to a flavorful stew of danceable Texas border soul. From triplet-teamed, Fifties-style rock-and-roll (*A Man Can Cry*) to the proud but poignant bolero waltz of *She Never Spoke Spanish to Me*, Sahm and friends percolate through an energetic program, especially coming to life in such party vamps as (*Hey Baby*) *Que Paso*, where Meyers's sandpaper vocals make the band seem as if it could be the rough little combo in any loud, back-alley cantina, and *Who Were You Thinkin' Of*, a wonderful, witty treatise on sex. When Sahm sings, "Who were you thinking of/When we were making love last night?/There was a smile on your face/I ain't seen in some



The Sidewinders: garage-rock intensity

time," someone screams out. "Aw, squeeze it!" A command to accordionist Jimenez, or something raunchier? Either way, squeeze it, indeed. A.N.

THE TIME: *Pandemonium*. The Time (vocals and instrumentals). *Dreamland*; *Pandemonium*; *Sexy Socialites*; *Jerk Out*; *Yount*; *Blondie*; *Donald Trump* (*Black Version*); *It's Your World*; *My Summertime Thang*; *Chocolate*; and five others. PAISLEY PARK/REPRISÉ 27490-1, © 27490-4, © 27490-2 (60 min).

Performance: *Punk funk*
Recording: *Fair*

The Time's long-awaited reunion comes seven years after svengali/benefactor Prince jiggled with the band's original lineup and five years after their official split. Making up for lost Time, they've cut an album that runs for a full hour while contributing four additional songs to Prince's "Graffiti Bridge" soundtrack. The Time's chemistry results from the play of Morris Day's silly/horny persona against the stripped-down, nonsense punk funk of the band, yielding some seriously upbeat party-down grooves. When they're cooking, there isn't an idle pair of feet within earshot. *Pandemonium*, *It's Your World*, and *My Summertime Thang* seems like vintage Time: hot and cool, sweaty yet suavely composed.

The album is far from an unqualified triumph, however. Day's seductive raps are more condescending than amusing, and he is unctuously obnoxious in his ceaseless propositioning. His overheated pillow talk is so embarrassingly jejune that Barry White seems like Alfred Lord Tennyson in comparison. Compounding the jive factor, the tittering of some apparently smitten female airheads can be heard in several cuts. *Blondie* and *Chocolate* are nothing more than bath-room banter bordering on sexism, and *Jerk Out* and *Donald Trump* (*Black Version*) are worse, celebrating a vacant,

materialistic vision of the world that's centered around money, clothes, cars, credit cards, and the conspicuous bulge beneath Morris Day's overcoat. P.P.

RUBY TURNER: *Paradise*. Ruby Turner (vocals); vocal and instrumental accompaniment. *Paradise*; *It's Gonna Be Alright*; *It's a Cryin' Shame*; *Leaves in the Wind*; *There's No Better Love*; *Every Time I Breathe*; *Sexy*; and four others. RCA 1298-1-J, © 1298-4-J, © 1298-2-J (51 min).

Performance: *British soul*
Recording: *Satisfactory*

Though Ruby Turner was born in Jamaica and has spent most of her life in England, she has a fine enough feeling for modern American soul music to attract Stateside fans. In fact, the songs in "Paradise" are not noticeably different from much of what is produced over here these days, and Turner's singing is marked by an attractive, straight-ahead style devoid of pretension. She is particularly appealing when a trace of Jamaican flavor finds its way into the music, as in the reggae-laced *Leaves in the Wind*, or when some rhythmic Caribbean fire infuses the proceedings, as in the concluding *It's Gonna Be Alright* (*Brixton Bass Mix*). She is similarly effective in *Sexy*, which musically echoes the earthy style of the American soulsters Womack and Womack, with whom she has worked. I wish, though, that this record could have been a bit *more* different from other current offerings. What Turner needs is a stronger sense of exactly who she is and what she has to offer that others don't. With her background, varied experience, and solid singing talent, that shouldn't be too hard to do the next time around. P.G.

STEVE VAI: *Passion and Warfare*. Steve Vai (guitars, keyboards, bass); other musicians. *Liberty*; *Erotic Nightmares*;

"A True High-Fidelity System. Has No Equal For Its Combination Of Performance, Value, And Portability."

Julian Hirsch—Stereo Review

MODEL ELEVEN

BY HENRY KLOSS

Cambridge SoundWorks' Model Eleven is the world's first *transportable* full-range, high performance component system. It consists of a powerful 3-channel amplifier and two "satellite" mid/high-frequency speakers—all packed in a rugged "BassCase"™ that, when empty, serves as the system's subwoofer. Model Eleven's performance, when coupled with your portable CD or tape player,** rivals that of the most expensive component systems. And because we market it directly from our factory, it costs hundreds less than it would in stores.



Made In U.S.A.

- Fits under airline seats—23 lbs.
- Can be checked as luggage.
- Works on all electrical systems.
- Delivers the full range of music.
- Is backed by a unique 5-year warranty.

• Perfect for boating, camping & vacations anywhere in the world.

Save \$70
on Philips portable CD Player with purchase of Model Eleven

sound virtually identical to our acclaimed Ensemble® speaker system.

Model Eleven can be used virtually anywhere in the world—115- or 230-volt, 50 or 60 Hz AC or 12-volts DC. Because the entire system fits under an airline seat—or can be checked as baggage—you can take it just about anywhere. But Model Eleven's sound is so good, so "big," you may want to keep it home. It's an ideal second (or first) music system for a study, bedroom or kitchen. At \$749† we don't know of any combination of components near its price (transportable or not) that approaches its sound quality.



The drivers used in Model Eleven's two-way satellite speakers are no-compromise, high-performance components—just like you'd expect to find in the finest home speaker systems.

work *with* a room's acoustics for optimum performance. Remove the satellite speakers, amplifier and your portable CD player from BassCase. Place the satellites where they create a musical "stage" near ear level. Put the BassCase where it reinforces low frequency output—on the floor, even behind furniture. The result is musically accurate



Performance that rivals the best home component systems.

Until now portable music systems were, at best, a compromise. Even the most expensive ones lack the deep bass necessary for full, natural sound. But Model Eleven delivers the all-out performance previously found only in high quality home component systems. Its three speakers are designed to

Henry Kloss created the dominant speaker models of the '50s (AR), '60s (KLF) and '70s (Advent)—as well as our highly acclaimed Ensemble and Ambiance® speakers. While packing a stereo system into a suitcase before a vacation, he realized that an amplifier, a CD player and two small speakers take up the same space required for an acoustic suspension woofer to reproduce really deep bass. That was the inspiration for BassCase, Model Eleven's bass speaker enclosure which doubles as the entire system's carrying case.

"We Know Of No Small Speaker That Surpasses The Overall Sound Of Ambiance" —Stereo Review

Ambiance

BY HENRY KLOSS

Ambiance is an ultra-compact speaker that proves high performance, small size and low cost need not be mutually exclusive. Ambiance is ideal for bedrooms, dens, dorm rooms...or for use as an extension speaker or in surround sound systems. While no speaker of its size can provide the same low bass as our Ensemble and Model Eleven systems, Ambiance has more output in the

40Hz region than any "mini speaker" we've encountered. Stereo Review magazine described Ambiance as "...beautifully balanced, delivering a full-size sound image with not a hint of its origin in two small boxes... very few small speakers we have heard can match the overall sound of Ambiance, and we know of none that surpass it." Available in Nextel or primed for painting for \$109 each †, or in solid oak for \$129 each †—backed by our 30-day money-back guarantee—direct from Cambridge SoundWorks.



Made In U.S.A.

Avoid Price Increase
Order by Oct. 31, 1990

"Cambridge SoundWorks May Have The Best Value In The World. A Winner."

David Clark—Audio Magazine

Ensemble

BY HENRY KLOSS

Ensemble is a speaker system that can provide the sound once reserved for the best speakers under laboratory conditions. It virtually disappears in your room. And because we market it directly, it costs hundreds less than it would in stores.

Ensemble consists of four speaker units. Two compact low-frequency speakers reproduce the deep bass, while two small satellite units reproduce the rest of the music, making it possible to reproduce just the right amount of energy in each part of the musical range without turning your listening room into a stereo showroom.

Your listening room works *with* Ensemble, not *against* it.

No matter how well a speaker performs, at home the listening room takes over. If you put a conventional speaker where the room can help the low bass, it may hinder the upper ranges, or vice-versa. Ensemble, on the other hand, *takes advantage* of your room's acoustics. The ear can't tell where bass comes from, which is why Ensemble's bass units can be tucked out of the way—on the floor, atop bookshelves, or under furni-



\$50 Gift Certificate
with purchase of
Ensemble with
Black-laminate
woofers.

Made in U.S.A.

ture. The satellites can be hung directly on the wall, or placed on windowsills or shelves. No bulky speaker boxes dominate your living space, yet Ensemble reproduces the deep bass that *no* mini speakers can.



You can put Ensemble's low-frequency units exactly where they should go for superb bass. You can't do this with conventional speakers because you have to be concerned about the upper frequencies coming from the same enclosures as the low ones.

Not all the differences are as obvious as our *two* subwoofers.

Unlike seemingly similar systems, Ensemble uses premium quality components for maximum power handling, individual crossovers that allow several wiring options and cabinets ruggedly constructed for proper acoustic performance. We even gold-plate all the connectors to prevent corrosion.

Unlike satellite systems which use a single large subwoofer, Ensemble features separate compact bass units for each stereo channel. They fit more gracefully into your living environment, and help minimize the effects of the listening room's standing waves.

30-day money-back satisfaction guarantee.

At only \$499†—complete with all hardware and 100' of speaker cable,—Ensemble is *the* value on today's speaker market. *Esquire* magazine describes them by saying, "You get a month to play with the speakers before you either return them or keep them. But you'll keep them." *Stereo Review* said "It's hard to imagine going wrong with Ensemble." For literature, reviews or to order, write us at the address in the coupon, or call 1-800-AKA-HIFI.*

Try Model Eleven...
Or Ensemble...
Or Ambiance...
Risk Free For 30 Days
Call 1-800-AKA-HIFI*
(800-252-4434)

All Cambridge SoundWorks products are sold only factory direct. This allows you to save hundreds of dollars and audition our products the *right* way—in your home for 30 days, with no risk, no sales person hovering nearby.

Our toll-free number connects you to

a Cambridge SoundWorks audio expert. He or she will answer all your questions, send literature and reviews—or take your order (you can use Visa, MasterCard or American Express) and arrange shipment via UPS. Your Cambridge SoundWorks audio expert will continue as your personal contact with us.

*9 AM to midnight (ET), seven days a week.
In Canada, call 1-800-525-4434.
Fax: 617-332-9229.
Outside the U.S. or Canada, 617-332-5936.

FREE
Audio Catalog
Call 1-800-
252-4434

© 1990 Cambridge SoundWorks. *Ensemble is a registered trademark of Cambridge SoundWorks. "BassCast," Ambiance, Model Eleven and Cambridge SoundWorks are trademarks of Cambridge SoundWorks, Inc. Ensemble review quote reprinted with permission of Audio Magazine. © 1990 Diamond-Communications. AR & Advent are trademarks of International Jensen, Inc. AR & Advent are not associated with Cambridge SoundWorks.
*CD player not included in Model Eleven system.

CAMBRIDGE SOUNDWORKS

154 California St., Suite 102N, Newton, MA 02158

- Send more information and test reports.
- Send Ensemble (black-laminate woofers) \$599.†
- Send Ensemble (vinyl-clad woofers) \$499.†
- Send Model Eleven risk-free for 30 days, \$749.†
- Send _____ (qty.) Ambiance (Nextel), for \$109 ea.†
- Send _____ (qty.) Ambiance (Primed), for \$109 ea.†
- Send _____ (qty.) Ambiance (Oak), for \$129 ea.†

I'm paying by Check MC Visa AmEx

Acct. Number _____ Exp. _____

Signature _____

Name _____

Address _____

City _____ State _____ Zip _____

Phone (Area Code) _____ Number _____

FOR IMMEDIATE SERVICE: 1-800-AKA-HIFI.

MA re-sidents add 5% sales tax.

Utility bass cabinet version \$499. All prices plus freight. (Ensemble \$8-\$27, Model Eleven \$6-\$16, Ambiance \$4-\$12). Delivery time usually 2-7 days. We ship worldwide, including APO & FPO.

HOW MUCH SHOULD A GOOD AMPLIFIER COST?

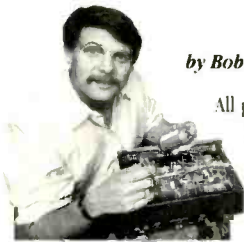

by Bob Carver, part 1 of 2

All power amplifiers with the same power output are neither created equal nor priced equally. Why? I and other members of the scientific audio community know that only four factors actually determine the sonic characteristics of an amplifier:

1. CURRENT OUTPUT
2. VOLTAGE OUTPUT
3. POWER OUTPUT
4. TRANSFER FUNCTION[†]

These factors transcend the longstanding debates over tubes vs. solid state, MOS-FETs vs. bi-polar, Class A vs. AB, silver Litz wiring vs. copper and so on forever. An amp can have any combination of these entertaining variables (plus special bricks stacked on top) and yes, sound wonderful...provided it ALSO has high simultaneous current and voltage, robust power output and the correct output impedance.

Unfortunately, maximizing simultaneous current and voltage output using traditional design approaches costs serious money and explains why price and sonic quality ARE often closely related.

But what if there was an affordable way around the economic constraints of conventional, inefficient power supplies? There is: My Magnetic Field power supply can deliver awesome simultaneous current and voltage into real-world speaker impedances without shocking your pocketbook. And it does it without gimmicks, mirrors, myths or mysticism. Simply put, a Magnetic Field power supply can "tap into" progressively more of each line voltage swing as power demand increases, making it far more efficient. How and why this works is explained in our new White Paper called "The Magnetic Field Story Parts I, II & III" available free by calling 1-800-443-CAVR.

Carver solid state power amplifiers have suggested retail prices of from \$399 to \$1000 (I also make a conventional-power-supply tube amplifier that costs \$20,000). Because of my patented power supply and Transfer Function Modification — and because the factors that these technologies address directly and profoundly determine sound quality — I honestly think that you needn't pay more to get superb audio amplification.

If you are intrigued by my assertion that science, not myths, determines the sound of an amplifier, I invite you to visit a Carver dealer soon and seriously evaluate my amplifier designs.

Bob Carver

Bob Carver

[†]...as determined by frequency response and output source impedance. This fourth quantifiable amplifier factor, transfer function, is totally independent of economic constraints — and is considerably less well understood than the first three. I'll address this subject next month. Or call toll-free for the complete story today.

CARVER

LYNNWOOD, WA U.S.A. 1-800-443-CAVR

Distributed in Canada by Evolution Audio Inc. 1-414-847-8888

The Animal; Answers; The Riddle; Ballerina 12/24; and seven others. RELATIVITY 88561-1037-1, © 88561-1037-4, © 88561-1037-2 (53 min).

Performance: *Six-string showcase*
Recording: *Very good*

"Passion and Warfare" is an orgy of harmonized, multitracked guitars that the next generation of string-benders will cramp their fingers trying to emulate. Long Island guitarist Steve Vai has played with Frank Zappa, David Lee Roth, and Whitesnake. From Zappa he's acquired an experimental bent and a yen for broken rhythms; from the heavy-metal bands, he gets full-throttle dynamics and a tendency to look at the world as a pitched battle between good and evil. Yet ultimately Vai is his own man. Too melodic for metal, less cynical than Zappa, he explodes all over "Passion and Warfare" like an action painter hurling colors at a canvas.

What makes this more than an exercise in stunt playing for guitar freaks only is the tug between two halves of Vai's split personality, the schooled virtuoso intent on execution and the creative kid wanting to express himself. Unlike, say, Jeff Beck's records, "Passion and Warfare" is not just screaming sirens and wolf whistles on the guitar. In *For the Love of God and Blue Powder*, for instance, Vai erupts with spine-tingling passion and spiritual yearning. Elsewhere, he takes off on blindfolded roller-coaster rides full of hairpin turns, sudden stops, and the feeling of flying at high speed. "Passion and Warfare" is, in Vai's own words, an adventure in metaphysics. P.P.

WAS (NOT WAS): *Are You Okay?* Was (Not Was) (vocals and instrumentals); other musicians. *Are You Okay?; Papa Was a Rollin' Stone; I Feel Better Than James Brown; How the Heart Behaves; Maria Novarro; I Blew Up the United States;* and six others. CHRYSALIS 21778-1, © 21778-4, © 21778-2 (45 min).

Performance: *Zany*
Recording: *Very good*

Who says you have to play it safe to succeed? Not Was (Not Was). Their bizarre blend of silky soul, nitro-funk, and wacked-out humor produced two major pop hits two years ago. *Spy in the House of Love* and *Walk the Dinosaur* from the "What Up, Dog?" album. They follow up here with more funk and games. A snappy retooling of the Temptations' goldie oldie *Papa Was a Rollin' Stone*, for example, uses rip-snorting rap interludes by guest narrator G Love E to give the tune a contemporary punch. Then there's *I Feel Better Than James Brown*, which interpolates dance-floor rhythms with Caribbean pizzazz while a narrator describes a surreal jag. He begins talking about domestic disarray and ends up at Mardi Gras with Fidel Castro. What does it all mean? Hard to say, especially when you're dancing so hard

that all the blood has rushed from your head.

Was (Not Was) used to go off the deep end like this all the time. In this album they seem more normal. On the simplest level, nearly all of these tunes are built upon irresistible rhythms, layered with unpredictable music bits, such as free-jazz saxophone or cocktail-lounge piano. On top of everything are the vocals, straight out of the glory days of Motown, courtesy of the group's two superb soul singers, Sweet Pea Atkinson and Sir Harry Bowens.

Then comes the strange part: the words. Often they're wildly out of sync with the way they're delivered. *I Blew Up the United States* sounds like a straightforward piece of r-&-b grit, but it's all about someone who has, literally, blown up the U.S. Until now, Was (Not Was) songs were either all straight or all twisted, but "Are You Okay?" is subversive. The nice sounds lure you into a weird alternative universe, but that's the point. The more you listen, the crazier it all gets. R.G.

BARBARA WEATHERS. Barbara Weathers (vocals); vocal and instrumental accompaniment. *Barbi Doll; Our Love Will Last Forever; My Only Love; Where Can You Run; The Master Key; Where Did Our Love Go;* and three others. REPRISE 26166-1. © 26166-4, © 26166-2 (39 min).

Performance: *Barbi can sing*
Recording: *Good*

From the pull-out art that accompanies Barbara Weathers's debut album, it's apparent that she's both lovely and sexy, but I have some problems with a woman who refers to herself (in the opening track) as a *Barbi Doll*. If you can get past that one, though, you'll find pleasure in her mixed bag of songs. Weathers has such fine pipes that even the mediocre items take on a sheen of class. She's at her best in midtempo dance tunes like *Our Love Will Last Forever* and *My Only Love* as well as in an updated version of the old Supremes classic *Where Did Our Love Go*, produced by Maurice White. An intriguing side of her personality is glimpsed in the closing selection, a haunting ballad called *Our Love Runs Deep*, which is marred by some distracting special effects. On the whole, a promising debut. P.G.

JANE WIEDLIN: *Tangled.* Jane Wiedlin (vocals); vocal and instrumental accompaniment. *Rain on Me; At the End of the Day; Guardian Angel; Tangled; World on Fire;* and five others. EMI 90741-1, © 90741-4, © 90741-2 (46 min).

Performance: *Air-popped*
Recording: *Very good*

Former Go-Go Jane Wiedlin will never be mistaken for an M.I.T. graduate — one title here. *Big Rocky Candy Mountain*, gives you an idea of the kind of substance that forms the foundation of her music. But she's onto something

"Gee, I hope those aren't Memorex headphones."



Memorex is a trademark of Memorex Corporation licensed to Memorex Products.

MEMOREX
Is It Live Or Is It Memorex?SM

CIRCLE NO. 194 ON READER SERVICE CARD

CHERYL WHEELER



KAREN MILLER/CYPRESS RECORDS

CHERYL WHEELER laughingly refers to herself as a "slash music" artist. Not the gory slash of chainsaw murder movies, nor the slash-kneed bluejeans of some of rock and country's more defiant performers. But "slash" as in folk/rock, country/pop, and singer/songwriter, all of which begin to describe Wheeler's personal and ingratiating brand of musical ruminations.

A familiar figure on the Newport folk scene, Wheeler has recorded two previous albums on the independent North Star label, and in her new one on Capitol, "Circles & Arrows," she again draws deeper from her folk roots than from any country or pop influence, even though it was recorded in Nashville and produced by Kyle Lehning (Randy Travis, Dan Seals).

The decision to sign Wheeler to a major label and release her album through its country division may stem from the success of folkies Mary Chapin Carpenter and Nanci Griffith, or from the fact that Lehning plucked Wheeler's song *Addicted* for Dan Seals to ride to No. 1 in 1988. Either way, both Lehning and Capitol should be commended for taking a risk with such thoughtful and satisfying music, especially when the singer looks as if she's already seen her thirty-fifth birthday—a minus in the view of most record-company executives.

Wheeler's strong suit is portraying the complexity of adult human relationships. Whether she's singing about the difficulty and dissolution of friendship and love (*Hard Line to Draw*, *Aces*, *Don't Wanna*)

or the desire to patch up a threadbare romance (*Miss You More Than I'm Mad*, *Moonlight and Roses*), she keeps a clear head, eschews easy endings, and tempers sentimental thoughts with the harsh morning light of reality. "Maybe love is not as gentle as my memory," she sings in the album's last song, *Arrow*. "Maybe time and wishful half-remembered fantasy/Are the greatest part."

Not entirely an armchair romantic, Wheeler also possesses an energetic sense of humor. In *Estate Sale*, for instance, she reflects on the fun of one of America's favorite pastimes, "going through dead people's houses." In a scene right out of *Zorba the Greek* (although without the ghouliness and with much more black humor), she recalls "shaving mugs 'n' winged eyeglasses/giant plastic pins/Linen suits and flowered dresses/I'm so glad we got in."

Wheeler, who warbles in a full, richly textured voice, is probably too real for country radio, but like Griffith and Carpenter, she makes a valuable contribution to Nashville's New Integrity. Honestly. *Alanna Nash*

CHERYL WHEELER: *Circles & Arrows*. Cheryl Wheeler (vocals); Jonathan Edwards, Vince Gill, Pam Tillis, Jonelle Mosser (background vocals); other vocal and instrumental accompaniment. *I Know This Town*; *Hard Line to Draw*; *Aces*; *Estate Sale*; *Don't Wanna*; *Northern Girl*; *Soon As I Find My Voice*; *Miss You More Than I'm Mad*; *Moonlight and Roses*; *When You're Gone*; *Arrow*. CAPITOL 92063-1, © 92063-4, © 92063-2 (39 min).

nonetheless. Practicing a guitar-based style of reworked Sixties pop-rock (her heroes are the Beatles, the Byrds, and Buffalo Springfield), Wiedlin really never gets more philosophical than the Dave Clark Five, whose bouncy music she emulates in *Tangled*. But while she presents her smallish, bimbo voice as a screen of simple insouciance, she does have a few pangs of social consciousness, evident in *Flowers on the Battlefield*, with its jangling, Byrds-like instrumental framework, and in *Paper Heart*, a moving appeal (co-written with Cyndi Lauper) to a friend who's rapidly succumbing to drug addiction.

Underlying all of this, however, is a sizable gift for pure, uncomplicated pop, music that's as cathartic and infectious as a baby's smile. Whether performing as a sexual tease in *At the End of the Day* ("Bet you're gonna want it/Bet you're gonna need my love, boy") or moving through the campy high energy of *World on Fire* ("I feel the flames of love/Climbing up my panty hose"), Wiedlin delivers a set of melodic, hook-laden dance tunes, done up here with unusual cohesiveness by the band-oriented ensemble of drummer Steve Ferrera, guitarist Tim Pierce, keyboardist Dave Stewart, and bassist Nik Kershaw. Notice the word "deep" never appears in this review, but then neither does "fluffy." *A.N.*

WINGER: *In the Heart of the Young*. Winger (vocals and instrumentals). *Can't Get Enough*; *Loosen Up*; *Miles Away*; *Easy Come Easy Go*; *Rainbow in the Rose*; and six others. ATLANTIC 82103-1, © 82103-4, © 82103-2 (47 min).

Performance: *Progressive frenzy*
Recording: *Excellent*

Lately, more and more young musicians are breaking into hard rock and metal bearing credentials from hallowed music schools like Berklee and Juilliard. As a result, the distance between Verdi and Van Halen is shrinking, and schooled virtuosity is becoming commonplace in the unlikelyst corners. Winger is a case in point. Leader and namesake Kip Winger studied for three years under a Juilliard instructor (plus a stint at the Joffrey Ballet School), and guitarist Reb Beach earned his calluses at Berklee. Drummer Rod Morgenstein comes to Winger after a long tenure with Southern progressive-rock instrumentalists the Dixie Dregs. This is no fly-by-night glam band; they wear the clothes and fluff the hair, but they can play.

Admittedly, the material here too often panders to the vacuous mentality of the suburban mall-prowler and lane changer, with titles like *Can't Get Enough*, *Loosen Up*, and *Little Dirty Blonde* speaking for themselves. Still, Winger lets its progressive chops and nobler ambitions out of the cage around the middle of the program. *Rainbow in the Rose*, *In the Day We'll Never See*, and *Under One Condition* are musically entrancing, featuring solid arrangements, deft meter changes, virtu-

osic tears on the fretboard, keyboard, and drumhead, and a fanciful turn of lyric or two. The rest of "In the Heart of the Young" is state-of-the-art car music, for whatever that's worth (millions and millions!). Still, those three songs and the group's undeniable chops point the way toward a brighter horizon for contemporary rock in general and Winger in particular. *P.P.*

JOHN ZORN: *Naked City*. John Zorn (alto saxophone); Bill Frisell (guitar); Wayne Horowitz (keyboards); Fred Frith (bass); Joey Baron (drums); Yamatsuka Eye (vocals). *Batman; The Sicilian Clan; You Will Be Shot; Latin Quarter; A Shot in the Dark; Reanimator*; and twenty others. NONESUCH 79238-1, © 79238-4, © 79238-2 (55 min).

Performance: *Wild*
Recording: *Good*

The cover is a black-and-white photo of a murder victim lying face down in a pool of blood on the sidewalk. It's not for the faint of heart, and neither is the music within John Zorn's "Naked City," a twenty-six-track salute to the exhilaration and danger of the urban environment. Zorn and his quintet dramatize the humor and horror of the mean streets by tossing feature-film and TV theme music, Lower East Side punk-jazz, serrated garage-rock jamming, and free-form noise into this hour-long blowout.

More playful than astringent, "Naked City" is surprisingly entertaining and accessible. Certainly the Zorn gang's versions of the *Batman* and James Bond themes are riproaring and hard-charging fun, featuring twangy surf guitar, cheesy Farfisa-like keyboards, Ventures-style bass, and Zorn's wailing alto-sax tantrums. The musicians perform a deconstructionist vivisection of Henry Mancini's *A Shot in the Dark*, but Ennio Moricone's moody *The Sicilian Clan* is given a straight-up, reverential reading.

The most amazing original compositions are *Latin Quarter* and *Saigon Pickup*, panoramic 4-minute symphonettes that evoke everything from r-&-b jukebox instrumentals to big-band waltzes and Blue Note jazz. Intense, concentrated bursts of noise turn up in nearly every song as unexpectedly as bombs or gunfire, but that's all part of life in the *Naked City*. Midway through the album, eight consecutive tracks with names like *Igneous Ejaculation* and *Blood Duster*, none longer than 38 seconds, launch a sonic assault on the senses that is nothing but pure aural TNT.

Most-valuable-player honors go to drummer Joey Baron, who powers the ensemble with explosive stickwork like a hybrid of Keith Moon and Elvin Jones. As for Zorn, his inspired mélange of the popular and the avant-garde calls to mind a collaboration between Ornette Coleman and Boots Randolph. "Naked City" looks dangerous from a distance, but it's more fun than a ride on the Coney Island roller coaster. *P.P.*

BRANFORD MARSALIS: *Crazy People Music*. Branford Marsalis (soprano and tenor saxophones); Kenny Kirkland (piano); Robert Hurst (bass); Jeff "Tain" Watts (drums). *Spartacus; The Dark Knight; Wolverine; Mr. Steepee*; and three others. COLUMBIA © CT 46072, © CK 46072 (65 min).

Performance: *Mo' better*
Recording: *Excellent*

MO' BETTER BLUES. Original motion-picture soundtrack. Branford Marsalis (soprano and tenor saxophones); Terence Blanchard (trumpet); Kenny Kirkland (piano); Robert Hurst (bass); Jeff "Tain" Watts (drums); Cynda Williams, Gangstarr (vocals); other musicians. *Harlem Blues; Say Hey; Again Never; Mo' Better Blues*; and four others. COLUMBIA © CT 46792, © CK 46792 (38 min).

Performance: *Very mixed*
Recording: *Okay*

"Crazy People Music" is Branford Marsalis's sixth jazz album as a leader in as many years, but he has also recorded a classical album, and he appears in numerous other releases, including the new *Mo' Better Blues* soundtrack. The two new albums feature the same Marsalis quartet, but the soundtrack is enhanced by the work of trumpeter Terence Blanchard—and diluted by other presences. *Mo' Better Blues* begins and ends with *Harlem Blues*, a composition credited to W. C. Handy with "original adaptation" by Raymond Jones. If Handy wrote this limp song, bananas are blue and pigs fly. It's simply awful, and having Cynda Williams sing its stupid lyrics in her limited, pedestrian pop voice only makes matters worse. Then

there is *Jazz Thing*, a rap novelty performed by a group called Gangstarr; writing credits go to the rappers and Marsalis, but I happen to have heard the late Eliot Horne's jazz rap song as, not so coincidentally, performed by Gangstarr, and it is uncomfortably similar. In between these atrocities lie some fine performances by Blanchard and the Marsalis group, but they only account for 17½ minutes of this skimpy 38-minute offering.

"Crazy People Music" is quite another matter. Here we have a solid 65 minutes of excellent hard bop—and sounds beyond that—played by a group that enjoys unusual rapport. If Branford Marsalis continues along this path, he will firmly establish himself in the upper echelon of jazz artists. Without question, "Crazy People Music" is much mo' better than the soundtrack. *C.A.*

JOHN PIZZARELLI: *My Blue Heaven*. John Pizzarelli (guitar, vocals); Clark Terry (trumpet, flugelhorn); Dave McKenna (piano); Bucky Pizzarelli (guitar); Milt Hinton (bass); Connie Kay (drums). *My Blue Heaven; I'm an Errand Boy for Rhythm; It Could Happen to You; Lady Be Good; The Touch of Your Lips; Can't Take You Nowhere; Take My Smile; That's What; and eight others.* CHESKY © JC38, © JD38 (60 min).

Performance: *Engaging swing*
Recording: *Excellent*

Guitarist Bucky Pizzarelli has provided lovers of tempered, straight-ahead jazz with many enjoyable moments. It must be a family trait, for "My Blue Heaven," an album by his son John, offers a wonderful hour crammed with superb, light-

John Pizzarelli: glorious, lighthearted jazz



ERNESTO BAZAN/CHESKY RECORDS

hearted jazz featuring his mellow vocals and feathery guitar work. The landscape for this somewhat nostalgic trek is provided by Bucky and an all-star foursome. The program is a splendid mix of standards and whimsical rarities, with a couple of originals thrown in for good measure, and young Pizzarelli handles them all with loving care. I particularly liked the two Nat King Cole tunes, *I'm an Errand Boy for Rhythm* and *That's What*, Dave Frishberg's *Can't Take You Nowhere* and *Zoot Walked In* (which incorporates Zoot Sims's own *Morning Fun*), and Slam Stewart's *Oh Me, Oh My, Oh Gosh*. The rest of the cuts are merely glorious. Seldom does one hear such rapport between six musicians: everybody performs flawlessly. C.A.

JOHN SCOFIELD: *Time on My Hands*. John Scofield (guitar); Joe Lovano (saxophones); Charlie Haden (bass); Jack DeJohnette (drums). *Wabash III*; *Since*



Nino Tempo: comeback

You Asked; *So Sue Me*; *Let's Say We Did*; *Flower Power*; *Stranger to the Light*; and two others (five others on CD). BLUE NOTE ● 92894-1, © 92894-4, © 92894-2 (63 min).

Performance: *Prime Scofield*
Recording: *Very good*

When guitarist John Scofield came onto the jazz scene in the early Seventies, his style had been shaped by influences ranging from the blues of Muddy Waters and Otis Rush to the jazz of Jim Hall and George Benson (who had yet to go pop). By 1982, when chief fusioner Miles Davis beckoned, Scofield had established himself firmly in jazz. The association with Davis undoubtedly heightened Scofield's visibility, but it did little for him artistically.

Throughout the Eighties, Scofield worked on his own and with various bands, straddling the fence between fusion and hard-core jazz of the bop variety. He is an effective exponent of fu-

sion, but he really shines when he focuses on bop, as he does in "Time on My Hands," a quartet date featuring excellent collaboration by saxophonist Joe Lovano and topnotch rhythm support from bassist Charlie Haden and drummer Jack DeJohnette. The program consists of eight disparate Scofield compositions (eleven on the CD) that display the many facets of his talent. To hear him zip through *Farmacology* and *Wabash III*, fuzz along a grainy *Fat Lips*, or gently nudge the melodies of *Be Hear Now* and *Since You Asked* is to experience the work of an inventive player in full control of his art. C.A.

MCCOY TYNER: *Things Ain't What They Used to Be*. McCoy Tyner (piano); George Adams (tenor saxophone); John Scofield (guitar). *The Greeting*; *Naima*; *I Mean You*; *Here's That Rainy Day*; *Things Ain't What They Used to Be*; *Joy Spring*; *What's New*; and three others (six others on CD). BLUE NOTE ● 93598-1, © 93598-4, © 93598-2 (63 min).

Performance: *The real McCoy*
Recording: *Excellent*

A long-time admirer of McCoy Tyner's work, I had grown somewhat disenchanted by the tedious torrents of tinkles that have characterized his style in recent years. Tyner's recent output is virtually tinkle free, however, and he is using his left hand as never before, superbly blending lessons learned from striders and strutters with more delicate, Tynesque things. Tyner is once again the extraordinary pianist who captured my imagination as a member of the Jazztet and totally won me over during his five years with John Coltrane. "Things Ain't What They Used to Be" is a follow-up to 1989's "Revelations," also on Blue Note. "Things" is Tyner's finest album in years, perhaps his best ever.

There are five duets—two with tenor saxophonist George Adams and three with guitarist John Scofield—all wonderful collaborations that bring out the best in both participants. Adams and Scofield have worked with Tyner before: Adams spent four years with Tyner's quintet, and Scofield toured Europe with a concert package that included the Tyner trio. I'd like to hear more duets with these partners, and it might not be a bad idea to get all three of them together. Indeed, things ain't what they used to be—they're better. C.A.

NINO TEMPO: *Tenor Saxophone*. Nino Tempo (tenor saxophone); John Tropea (guitar); Ron Carter (bass); Roberta Flack (vocals); other musicians. *Darn That Dream*; *This Masquerade*; *Love Will Find a Way*; *You Are So Beautiful*; *Anyone Who Had a Heart*; and five others. ATLANTIC © 82142-4, © 82142-2 (46 min).

Performance: *Tenor pleasantries*
Recording: *Quite good*

Atlantic Records founder Ahmet Ertegun first became aware of Nino Tempo

in 1961 when Tempo was auditioning a song for Bobby Darin. Ertegun signed Tempo and his sister, singer April Stevens, to an Atco recording contract, forming an association that lasted a couple of years and produced such chart climbers as *Whispering*, *Sweet and Lovely*, *Paradise*, and *Deep Purple*, a song that five years later gave its name to a very successful British rock group. Tempo and his sister went on to a smaller label and subsequently all but disappeared from the scene.

Last year, when Ertegun again heard Tempo play, the old enthusiasm returned, and, according to Tempo, Ertegun said, "Let's do a jazz album." The result is "Tenor Saxophone." Tempo certainly has a pleasant, full tone, and he knows how to maneuver through a ballad with ease, but something is missing. Mind you, most listeners will probably enjoy this set thoroughly, for it's filled to the brim with soothing, accessible music. I wish it could have been a bit meatier, though. There are soft-pop vocals by Rachele Cappelli and Roberta Flack, and Tempo hits a jazz groove when bassist Ron Carter joins him on a couple of tracks, but there are also some totally uninspired tracks like *Caught in the Rapture*. Tempo is a fine musician, but if he and Ertegun set out to make a real jazz album, this is not it. C.A.

TURTLE ISLAND STRING QUARTET: *Skylife*. Turtle Island String Quartet (instrumentals). *Skylife*; *Señor Mouse*; *You Noticed Too*; *Blues for Oaktown*; *Gettysburg*; *Dexteriors*; and five others. WINDHAM HILL © WT-0126, © WD-0126 (51 min).

Performance: *Imaginative*
Recording: *Excellent*

Violins were used in early ragtime music, and jazz has occasionally produced extraordinary soloists on that instrument. Still, you can almost count the important jazz violinists on the fingers of one hand: Eddie South, Joe Venuti, Stuff Smith, Stephane Grappelli, Svend Asmussen, and Jean-Luc Ponty. In recent years a few new violinists have cropped up, including David Balakrishnan and Darol Anger, who form half of the Turtle Island String Quartet. A few years back—before most people realized that the jazz Charlie Parker played with strings was as valid as the jazz he played without them—fans who accepted a single violin often considered two or more to be an infringement of jazz rules. Some of today's dedicated jazz fans, therefore, may find the music of the Turtle Islanders overly imbued with classical coloring, but the combination of two violins, a viola, and a cello—all acoustic—simply produces that kind of sound. It's a rich, wonderful sound that's quite ingratiating when projected with the rhythmic intensity and improvisational excitement generated by these four string players. "Skylife" is a superb album from any angle. C.A.

ORIGINAL MASTER RECORDING™

ULTRADISC



THE MOBILE FIDELITY FORMULA*
O·M·R + A/A/D + 24k Au =
The Ultimate Audio Experience

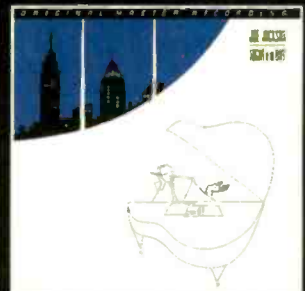
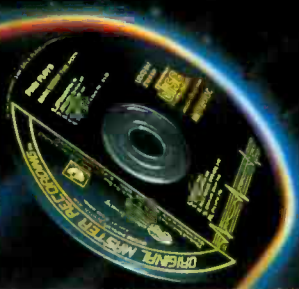

*(Original Master Recordings
+ Analog/Analog/Digital
proprietary transfer
technology + 24 karat gold
plated compact discs)

 mobile fidelity
sound lab
a division of MFSL, Inc.

For a complete free Original
Master Recordings catalog
and ULTRADISC technical
information, call toll free
800-423-5759.

*Discs and tapes reviewed by
Robert Ackart, Richard Freed,
David Hall, Eric Salzman,
and David Patrick Stearns*

BRUCKNER: *Symphony No. 8, in C Minor*. WAGNER: *Lohengrin, Preludes to Acts I and III; Parsifal, Preludes to Acts I and III*. Berlin Philharmonic Orchestra, Herbert von Karajan cond. EMI/ANGEL © CMS 63469 two CD's (121 min).

Performance: *First-rate*
Recording: *Very good for period*

BRUCKNER: *Symphony No. 8, in C Minor*. Bavarian Radio Symphony Orchestra, Rafael Kubelik cond. ORFEO © C 203 891 A (74 min).

Performance: *Dynamic*
Recording: *Good live broadcast*

BRUCKNER: *Symphony No. 8, in C Minor*. REGER: *Variations and Fugue on a Theme of Beethoven, Op. 86*. London Philharmonic Orchestra, Neeme Järvi cond. CHANDOS © ABTD 2023/4 two cassettes, © CHAN 8843/4 two CD's (107 min).

Performance: *Good*
Recording: *Symphony blurred*

BRUCKNER: *Symphony No. 8, in C Minor*. Hamburg NDR Symphony Orchestra, Günter Wand cond. RCA © 60364-4-RC two cassettes, © 60364-2-RC two CD's (86 min).

Performance: *Resplendent*
Recording: *Impressive*

Thirty years separate the first and last of these recordings of the Bruckner Eighth Symphony. The one by Herbert von Karajan, from 1957, is one of EMI's most successful early stereo efforts, and I assume that it was done with single-capsule sum-and-difference matrixed miking. The reading carries with it a bit more youthful impulse than Karajan's later, more sternly controlled versions for Deutsche Grammophon. It was hailed as a great reading at the time of its release, and it remains one. The Wagner filler performances, of 1975 vintage, are among the very best versions of these excerpts. The sound quality is fine by any standard, and the tape hiss is kept at a reasonable minimum.

Rafael Kubelik's Orfeo recording is one of a series of fourteen documentary

CD's commemorating the fortieth anniversary of the Bavarian Radio Symphony Orchestra. Spanning the period 1950-1987, they derive from mono concert broadcasts and were not originally intended for commercial release. Thus we find in this Bruckner Eighth more than the usual quota of audience noise as well as some horn bobbles early in the opening movement. The reading as a whole is highly dramatic and moves at a swifter than usual pace throughout, yet there is no sense of undue haste. The scherzo in particular has a windswept Alpine quality that I particularly appreciate.

One does not associate Neeme Järvi with the symphonies of Anton Bruckner, let alone with the cyclopean grandeurs of No. 8, but he comes through with a solid,

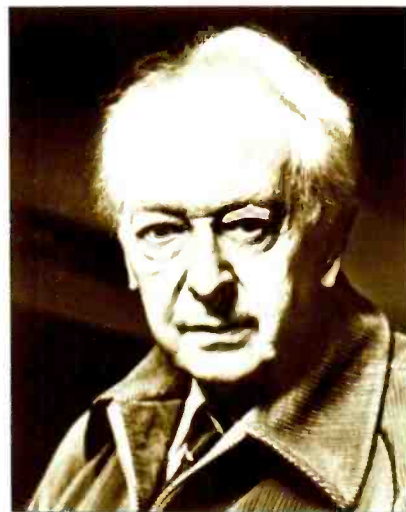

Günter Wand: intense Bruckner

forceful reading. Like Kubelik, he scores high in the scherzo. For a filler we get an installment in Järvi's survey of the orchestral works of Max Reger, the Variations and Fugue on a Theme of Beethoven. Originally a two-piano piece, it turns out to be a real charmer in its orchestral guise.

Though it offers the least in terms of performing time, Günter Wand's 1987 live performance of the Bruckner Eighth is a standout on every other count. This is Bruckner in the grandest manner, both intensely dramatic and profoundly spiritual. Though less granitic in its climactic moments than the two later Karajan interpretations, there is a sense of limitless power and energy in every measure. Like Karajan and Järvi, Wand uses the Haas edition.

Comparison of the sonics in Wand's recording, made in the Lübeck Cathedral, with Järvi's, from All Saints Church, Tooting, London, is instructive. Whereas the London church has a reverberant acoustic that tends to blur the musical texture at times, the Lübeck

Cathedral has a long decay time but little or no reverberation. The sound simply travels up to the vaulted ceiling and stays there, with a resultant impressive enhancement for Bruckner, whose late symphonies are indeed cathedrals of sound. *D.H.*

CAMPRA: *Tancredi*. François Le Roux (baritone), Tancredi; Daphné Evangelatos (contralto), Clorinde; Catherine Dubosc (soprano), Herminie; Pierre-Yves Le Maigat (tenor), Argant; Gregory Reinhard (bass), Ismenor; others. The Sixteen; La Grande Ecurie et la Chambre du Roy, Jean-Claude Malgoire cond. ERATO © 2292-45001-2 two CD's (122 min).

Performance: *Spirited*
Recording: *Live but good*

André Campra (1660-1774) has been the great mystery composer of the current French Baroque revival. Though his numerous operas dominated the Paris stage between Lully and Rameau, only his tantalizing Requiem, a few cantatas, and some operatic excerpts have been available on CD. After listening to this *Tancredi*, which appears to be the first complete recording of a Campra opera, I can understand why: Most of the first act and much of the second sound like routine Lully. As the opera progresses, however, it becomes a good deal more distinctive. The vocal lines more frequently emerge independently of the orchestral scoring, to great dramatic effect. Often, in fact, there are foretastes of Gluck, especially in the work's nobler moments.

The unusual vocal distribution specified by the composer turns out to be particularly inspired: The title role is sung by a baritone and that of the heroine, Clorinde, by a contralto. Thus, the weightier voices portray the more substantial characters. But while Campra's theatrical sense is just as evident elsewhere, it seems odd that two of the five acts end with a whimper instead of the expected bang. That may well be the fault of the edition used in this performance. It was customary in Baroque operas to have orchestral interludes between the acts (thus, "entr'actes"), but none is provided here.

Although Jean-Claude Malgoire has to be commended for his pioneering work in early music, his renditions are often so dreary that you wonder if he's really doing these Baroque composers any favor. Recorded live at the Aix-en-Provence Festival, *Tancredi* is far livelier than the conductor's usual studio efforts, though still fairly pedestrian and unimaginative. The singers deliver vivid portrayals, but there isn't as much really beautiful vocalism as this genteel music requires. So while this recording is es-

EXPLANATION OF SYMBOLS:

- = DIGITALLY RECORDED LP
- © = TAPE CASSETTE
- Ⓢ = COMPACT DISC (TIMINGS ARE TO NEAREST MINUTE)

KLAUS HENNEH/RCA VICTOR

sential for anyone seriously interested in French Baroque music, the less devoted might want to wait for one by someone like William Christie and his Arts Florissants. *D.P.S.*

CHOPIN: *Piano Sonata No. 2, in B-flat Minor, Op. 35. Nocturnes: F-sharp Major, Op. 15, No. 2; E Major, Op. 62, No. 2; C-sharp Minor, Op. posth.; C Minor, Op. 48, No. 1. Barcarolle in F-sharp Major, Op. 60; Scherzo in B-flat Minor, Op. 31.* Mikhail Pletnev (piano). VIRGIN © VC7 90738-2 (68 min).

Performance: *Mannered*
Recording: *Okay*

Mikhail Pletnev's Chopin recital is certainly provocative, but in a less positive sense than his earlier recordings of Rachmaninoff and Beethoven on the same label. You expect a certain degree of freedom in these works, but it ought to be in terms of flexibility and fluidity, of subtle shadings over a base of rhythmic steadiness. Pletnev's tempo for the famous Funeral March in the Sonata No. 2 is relatively brisk, and that is all to the good, but the conspicuous shifting of gears for the trio, taken at a much slower pace, is jarring. The same phenomenon mars the Op. 31 Scherzo, and in the Op. 60 Barcarolle, the exquisite middle section is drained of its momentum before Pletnev gives himself a shot of adrenalin and races off with the conclusion.

These abrupt changes of tempo and mood may be less obtrusive to some listeners than to others, as may the very deliberate pacing of the nocturnes or the excessive rubato here and there. There is no denying that there is an abundance of striking pianism in this CD, but it does tend to get in the music's way rather than make it more appealing. The sound itself is a little more reverberant than ideal, though it is otherwise quite good. *R.F.*

COPLAND: *The Tender Land.* Elisabeth Comeaux (soprano), Laurie; Janis Hardy (mezzo-soprano), Ma Moss; Maria Jette (soprano), Beth; LeRoy Lehr (bass), Grandpa Moss; Dan Dressen (tenor), Martin; James Bohn (baritone), Top; Vern Sutton (baritone), Mr. Splinters; others. Chorus and Orchestra of the Plymouth Music Series, Minnesota. Philip Brunelle cond. VIRGIN © 91113-4 two cassettes, © 91113-2 two CD's (107 min).

Performance: *Affecting*
Recording: *Good*

The Tender Land, written in the musical idiom of Copland's other celebrations of American life—*A Lincoln Portrait*, *Appalachian Spring*, *Billy the Kid*, and *Rodeo*—presents the story of a young farm girl who wants to experience life beyond the confines of her tranquil home

A DIAMOND JUBILEE

TWENTY-FIVE years ago the American composer David Diamond, who had been living in Italy for some time, returned home, occasioning numerous performances of his music in honor of his fiftieth birthday. Since that time, however, his music has rarely been performed. Now Delos has launched a welcome corrective, a survey of Diamond's orchestral works conducted by Gerard Schwarz. That the initial release—a well-filled disc comprising the Symphonies Nos. 2 and 4 and the Concerto for Small Orchestra—was timed to the composer's seventy-fifth birthday might in one sense be considered an embarrassment for our musical establishment, which has allowed such neglect of a major talent. But the overridingly positive note is that Diamond's Jubilee can be observed in a meaningful way, providing yet another boost to the national image in a year marked also by round-number anniversaries for such musical eminences as Aaron Copland (ninety) and William Schuman (eighty).

As it happens, all three of these composers achieved national eminence at about the same time (some fifty years ago) and through the same fiery champion, Serge Koussevitzky. No one needs to be reminded of the Schuman or Copland works that continue to exemplify the American character in music, but how does one explain our not being similarly aware of so stunning an American symphony as Diamond's Second?

In this case the term "American" is used in neither a delimiting sense nor a boastful one, but simply by way of characterizing music whose very individuality—its own personal form of restless vitality and romantic lyricism—stamps it, just as in Schuman's case, as music

only an American could have conceived, no matter how broad his training or experience. Diamond's Second is a *big* symphony, in its substance as well as its dimensions. Following its dramatic opening movement, marked *Adagio funebre*, and an almost demonically energetic scherzo is an extended slow movement in a generally confident vein that contrasts with the opening. The finale ties up all the threads of the preceding sections—ties them up, one might say, in a more or less Brucknerian manner, except that Bruckner seldom evinced such conciseness or anything resembling the wit that has as much a part in the affirmative impact of Diamond's score as the more dramatic gestures.

The Second is given a performance of great conviction and persuasiveness by Schwarz and his Seattle Symphony, and so is the far more succinct Fourth, the only one of Diamond's symphonies, I believe, to have been recorded before (by Leonard Bernstein, who conducted the Boston premiere in 1948). The two symphonies would have been very full value but it was an excellent idea to separate them on the disc with the still earlier and more concise Concerto for Small Orchestra. This work, whose two movements comprise a pair of preludes-and-fugues framed by a pair of fanfares, is performed by Schwarz and the New York Chamber Symphony. The sound is first-rate throughout the disc, and the annotation, with a biographical lapse or two, gives comprehensive background on the three works. *Richard Freed*

DIAMOND: *Symphony No. 2; Concerto for Small Orchestra; Symphony No. 4.* Seattle Symphony Orchestra, New York Chamber Symphony, Gerard Schwarz cond. DELOS © DE 3093 (73 min).

Composer David Diamond

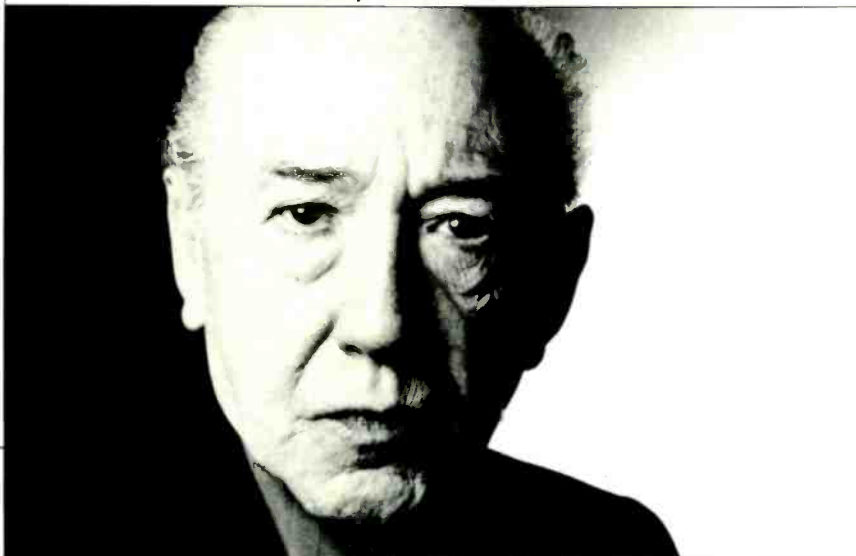



This Month's

Compact Disc Players



- Technics SL-P370 Remote CD Player**
 • New MASH digital/analog converter system for more accurate reproduction
 • 4 X oversampling • 18-bit digital filter • 20-track programming • Wireless remote
 Our Low Price **\$159⁹⁵** (TEC SLP370)
- Sharp DX-670
 • 20-track programmable, 2 X oversampling **\$99⁹⁵**
- Sharp DXR-770
 • 20-track programmable, remote **\$119⁹⁵**
- Technics SLP-170
 • 4 X oversampling, MASH system **\$139⁹⁵**
- JVC XLZ-431
 • 8 X oversampling, 20 bit, remote **CALL**
- Technics SL-PS50
 • MASH system, 4 X sampling, 4 D/A **\$249⁹⁵**
- Technics SL-PS70
 • MASH system, 8 D/A, remote **\$339⁹⁵**

CD Changers/Combos

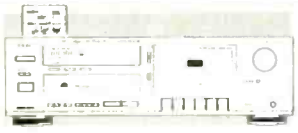

- Teac AD-3 CD/Cassette Combo**
 • CD features 16 bit, 4 X oversampling • Dual D/A converter • 3-way repeat • Cassette features auto-reverse, record/play • Dolby B • Dolby HX-Pro • Wireless remote
 Our Low Price **\$299⁹⁵** (TEA AD3)
- Technics SL-PC15
 • 5-disc rotary, 32-track programmable **\$189⁹⁵**
- Teac AD1
 • CD/Cassette combo, Dolby B **\$199⁹⁵**
- JVC XLR-302
 • 5-disc rotary, remote **CALL**
- Technics SL-PC25
 • 5-disc rotary, remote **\$219⁹⁵**
- Technics SL-PC33
 • 5-disc rotary, MASH, remote **\$249⁹⁵**
- Technics SL-PC45
 • 5-disc rotary, lap-load, remote **\$289⁹⁵**

Audio Systems



- Panasonic SC-CH9 Lifestyle Component Audio System**
 • 8.5" width • 20 watts/channel • Surround sound • 5-band EQ • 28 presets • CD player • Auto reverse dual Dolby B cassette deck • Magnetically shielded speakers • Remote
 Our Low Price **\$799⁹⁵** (PAN SCCH9)
- Panasonic SCT-090
 • Compact w/dual cassette, tuntable **\$149⁹⁵**
- Panasonic SCT-100
 • Compact w/dual cassette, tuntable **\$179⁹⁵**
- Panasonic SCR-500
 • 50 watts/channel, dual cassette, tuntable **\$379⁹⁵**
- Panasonic SCT-C300
 • With dual cassette, CD changer & remote **\$399⁹⁵**
- JVC MX1
 • Mini w/CD, dual cassette & unified remote **\$799⁹⁵**
- Technics SCS-310
 • 110 watts/channel, CD changer **CALL**

Compact Disc Specials

GRP Jazz

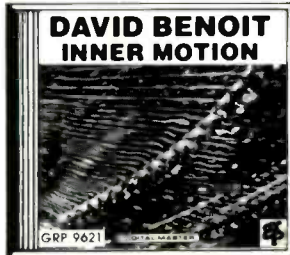

Your Choice **10⁹⁹ Per CD**

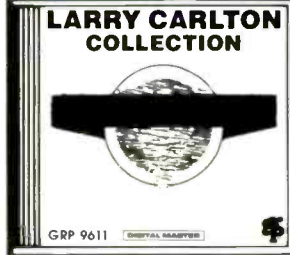

Also Available For **10.99 Per CD**

- David Benoit: Every Little Step Of The Way (GRP 9558)
- David Benoit: Urban Daydreams (GRP 9587)
- David Benoit: Waiting For Spring (GRP 9595)
- Chick Corea Electric Band: Inside Out (GRP 9601)
- Dave Grusin: Cinemagic (GRP 9547)
- Dave Grusin: Migration (GRP 9592)
- Dave Grusin And Lee Ritenour: Harlequin (GRP 9522)
- George Howard: Dancing In The Sun (GRP 9626)
- Steve Kahn: Public Access (GRP 9599)
- Glenn Miller Orchestra: In The Digital Mood (GRP 9502)
- New York Voices: New York Voices (GRP 9589)
- Nelson Rangel: Nelson Rangel (GRP 9624)
- The Rippingtons: Moonlighting (GRP 9605)
- Lee Ritenour: Festival (GRP 9570)
- Lee Ritenour: Stolen Moments (GRP 9615)
- Diane Schuur: Collection (GRP 9591)
- Tom Scott: Flashpoint (GRP 9571)
- Special EFX: Just Like Magic (GRP 9609)
- Dave Valentine: Two Amigos (GRP 9606)
- Yutaka: Brazasia (GRP 9616)

Teac Cassette Decks



- Teac V-480 IC-Logic Control Cassette Deck**
 • Dolby B & C noise reduction • Dolby HX-Pro headroom extension • Bias line tuning • Auto tape selector • Timer Rec Play • Headphone jack
 Our Low Price **\$99⁹⁵** (TEA V480)
- Teac V-250
 • Dolby B, 3 digit counter **\$64⁹⁵**
- Teac V-260HX
 • Dolby B, HX Pro **\$74⁹⁵**
- Teac V-285CHX
 • Dolby B/C, HX Pro **\$94⁹⁵**
- Teac R-455CHX
 • Auto reverse, Dolby B/C/HX Pro **\$139⁹⁵**
- Teac R-540
 • 2-motor, auto reverse, Dolby B/C/HX Pro **\$159⁹⁵**
- Teac V-970X
 • 3 head, dbx, Dolby B/C/HX Pro **\$469⁹⁵**

Double Cassette Decks



- Teac W-370C Double Cassette Deck**
 • Continuous play/pack • Dolby B & C noise reduction • Normal & high-speed dubbing • Bias line tuning • LED peak level meter • Auto-stop • Auto tape selector • Black
 Our Low Price **\$99⁹⁵** (TEA W370C)
- Teac W-450R
 • Dolby B/C/HX-Pro, auto reverse **\$169⁹⁵**
- Technics RS-TR165
 • Dolby B/C, deck #1 reverse **\$179⁹⁵**
- Teac W-550R
 • Auto reverse, Dolby B/C/HX-Pro **\$199⁹⁵**
- Technics RS-TR265
 • Dual reverse, Dolby B/C/HX Pro **\$209⁹⁵**
- JVC TDW-901
 • Auto reverse, Dolby B/C/HX Pro **CALL**
- Teac W-990RX
 • Auto reverse, Dolby B/C, dbx **\$479⁹⁵**

Home Speakers



- Technics SB-L40 2-Way Linear Phase Speakers**
 • Bass-reflex design • 10-inch cone type woofer • 2 1/8-inch cone-type tweeter for smooth response • Anti-resonant cabinet • 100-watts • Simulated wood-grain finish
 Our Low Price **\$99⁹⁵** Pair (TEC SBL40)
- Technics SB-L60
 • 3-way, 10" woofer **\$129⁹⁵** Pair
- Technics SB-L80
 • 3-way, 12" woofer **\$169⁹⁵** Pair
- ADC 3025
 • 3-piece system, bass w/mini speakers **\$299⁹⁵**
- Pinnacle PN8 + /Oak
 • 2-way, 8" woofer, dual/diioduct ports **\$349⁹⁵** Pair
- Bose AM5
 • Acoustimass 3-piece system **\$749⁹⁵**
- Bose 901 Classic
 • Direct/Reflecting system **\$1399** Pair

Turntables



- Scott PS-60C Semi-Automatic Turntable**
 • Belt drive • Pitch-control with strobe light • Auto-return and shut off • Damped cueing • Low mass straight P-mount tonearm • Shock absorbing feet • Includes cartridge
 Our Low Price **\$59⁹⁵** (SCT PS60C)
- Gemini XL-8D10
 • Belt drive, semi auto, pitch **\$89⁹⁵**
- Technics SL-BD22K
 • Semi auto, belt drive, pitch **\$94⁹⁵**
- Technics SL-QD33K
 • Quartz lock, fully auto **\$139⁹⁵**
- Dual CS-431
 • Belt drive, semi auto **\$149⁹⁵**
- Gemini XL-DD30
 • Direct drive, manual pitch **\$189⁹⁵**
- Gemini XL-1800Q
 • Manual direct drive, pitch, for disco **\$269⁹⁵**

Phono Cartridges



- Shure V-15 Type V-MR Deluxe Micro Ridge Phono Cartridge**
 • Micro ridge stylus tip • Excellent trackability • Dynamic stabilizer • Side-guard stylus protection • Duo-point alignment gauge • Top rated design
 Our Low Price **\$139⁹⁵** (SHU V15-VMR)
- Shure M-92E
 • Universal mount, elliptical **\$9⁹⁵**
- Stanton 500AL
 • Standard mount, disco/pro **\$19⁹⁵**
- Stanton 500ALDP
 • Standard, disco/pro w/extra stylus **\$26⁹⁵**
- Audio Technica AT-231LP
 • Universal mount, linear contact **\$44⁹⁵**
- Stanton 680EL
 • Standard, disco w/extra stylus **\$54⁹⁵**
- Stanton 680ELMP
 • Standard, DJ 2 pack **\$69⁹⁵**

Mini Speakers

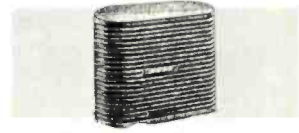

- Bose Acoustimass 3 Direct/Reflecting Speaker System**
 • Unique miniature wedge-shaped magnetically shielded cubes are coupled with an Acoustimass bass module producing life-like stereo sound
 Our Low Price **\$399⁹⁵** (BOS AM3)
- Memorex WM-200
 • Weathermate, indoor/outdoor **\$89⁹⁵** Pair
- Koss M80 Plus
 • 2-way, dual 4.5" woofers **\$119⁹⁵** Pair
- Audio Source LSIW/T
 • 2-way, 4" woofer **\$119⁹⁵** Pair
- Recoton W100
 • Cordless speakers w/12 watts built-in amp **\$149⁹⁵**
- Pinnacle PN5 + /Oak
 • 2-way, diioduct port for deep bass **\$149⁹⁵** Pair
- Bose RM2
 • Roomote powered speakers **\$299⁹⁵** Pair

CIRCLE NO. 39 ON READER SERVICE CARD



ORDER TOLL-FREE 24 HOURS A DAY 7 DAYS A WEEK 1-800-221-8180

Outside U.S.A. Call: 7-18-417-3737
 J&R Music World, Dept. SR1190, 59-50 Queens-Midtown Expressway, Maspeth, Queens, NY 11378





Super Specials!

Compact Disc Specials

Polygram Classics

LONDON

CARRERAS DOMINGO PAVAROTTI in concert MEHTA

POL 430 433 LONDON

Your Choice
12.99 Per CD

PHILIPS

POPS BY GEORGE
 John Williams
 Boston Pops Orchestra
 Misha Dichter
 Music of GERSHWIN

POL 426 404

PHILIPS

Also Available For 19.95 Per 2 CD Set
 Grand Opera On London
 •GIORDANO: Andrea Chenier -
 Tebaldi, Del Monaco

- DONIZETTI: Maria Stuarda - Sutherland, Pavarotti (POL 425-410)
- WAGNER: Flying Dutchman-Rysanek, London, Dorati Cond. (POL 417-319)
- MASSENET: Esclarmonde-Sutherland, Tourangeau (POL 425-651)
- VERDI: Un Ballo In Maschera - Bergonzi, Nilsson (POL 425-655)

- Best Sellers On Philips Digital Classics
 For 10.99 Per CD
- POPS A La RUSSE (POL 426-247)
 - TCHAIKOVSKY & VERDI ARIAS: Dmitri Hvorostovsky (POL 426-740)
 - DEBUSSY: Etudes-Mitsuko Uchida (POL 422-412)
 - RAVEL: Daphnis & Chloe - Halifm, Boston (POL 426-260)
 - VIVALDI: The Four Seasons, Op.8 plus Op. 8 Nos. 5 & 6 - 1 Musici (POL 426-847)

Stereo Receivers

Sherwood RA-1140
 Stereo Receiver with Surround Sound
 •25-watts/channel •Matrix surround sound
 •Video sound input •Digital readout •Quartz locked AM/FM tuner with 24 presets •LED power indicators •Headphone jack

Our Low Price **\$99.95** (SHE RA1140)

Scott RS-250
 •25 watts/channel, 16 presets \$89.95

Teac AG-55
 •55 watts/channel, 7 band EQ, remote . . . \$159.95

Technics SA-GX100
 •40 watts/channel, remote \$179.95

Teac AG-75
 •75 watts/channel, surround remote . . . \$199.95

Technics SA-GX300
 •60 watts/channel, EQ, A/V remote . . . \$229.95

JVC RX-703
 •100 watts/channel, surround, A/V remote CALL

Stereo Receivers

Technics SA-GX500
 Surround Sound Receiver
 •80-watts/channel •Dolby surround sound
 •widelog delay • Quartz tuning with 24 station presets • Parametric equalizer w/spectrum analyzer •48-key A/V remote control

Our Low Price **\$299.95** (TEC SAGX500)

Scott RS-300
 •30 watts/channel, surround \$119.95

Sherwood RA-1145R
 •50 watts/channel, surround \$159.95

Sherwood RA-1240R
 •70 watts/channel, surround \$199.95

Sherwood RA-1340R
 •100 watts/channel, EQ, surround . . . \$279.95

ADC 1320
 •25 watts/channel with 6-disc CD changer \$399.95

JVC 1440
 •60 watts/channel, 6+1 CD changer . . \$499.95

Electronic Antennas

Terk 9825 (pi2)
 Deluxe Gamma-Loop Indoor FM Antenna
 •Adjustable gain control • Scholtz 38dB high gain low noise amplifier • Omnidirectional or directional • Increases FM reception & sound quality • Black finish

Our Low Price **\$79.95** (TRK 9825)

Terk FM-2000
 •FM, passive, uni/omni directional . . . \$19.95

Parsec Wavecatcher
 •AM/FM passive, uni/omni \$24.95

Terk 9300
 •FM, active, uni/omni directional . . . \$29.95

Parsec Stealth
 •FM, active, up to 32dB gain \$39.95

Parsec LS-4
 •FM, active, Scholtz circuit \$49.95

Terk 9400
 •FM, wedge design, active, adj gain . . \$49.95

Equalizers

ADC SS-525X
 Computerized Graphic Equalizer
 •Custom tailor your sound the professional way • Automatic analyzer equalizes room for precise flat response • 12 bands/channel • Microphone • Pink noise • Wireless remote

Our Low Price **\$299.95** (ADC SS525X)

Teac EQ-A6
 •10 bands/channel, EQ record switch . . \$69.95

ADC SS-90
 •10 bands/channel, 12 dB boost/cut . . . \$84.95

Teac EQ-A22
 •10 bands/channel, analyzer display . . \$99.95

ADC SS-200
 •10 bands/channel, 15 dB boost/cut . . \$109.95

Technics SH-GE70
 •7 bands/channel, 12 memories \$149.95

ADC SS-310
 •10 bands/channel, pink noise \$159.95

DJ Equipment

Atus AM100
 Stereo Preamp/Mixer
 •Inputs for two turntables, two line level inputs
 •Mic input • Talkover mic switch • Monitor system for cueing • Master bass & treble controls • VU meters display output

Our Low Price **\$89.95** (ATU AM100)

Gemini FF1
 •FlashMaster, creates scratch effects . . \$69.95

Gemini MX-3300
 •Mixer, 3phono inputs \$139.95

Atus AM-300E
 •Mixer, 5-band EQ, echo, rock-mount . . \$199.95

Gemini MB-420
 •Disc speaker, 15" woofer \$199.95

Gemini MX-6500SE
 •Mixer w/sound effects, 7 band EQ . . \$249.95

Gemini PDM-5000
 •Mixer w/digital sampling \$449.95

Surround Sound

Audio Source SS-One
 Surround Sound Processor
 •Dolby surround processor with variable effects • 15 watts per channel rear amplifier
 •Time delay • LED level indicators • Synthesis & Matrix surround sound

Our Low Price **\$129.95** (ASO SS-ONE)

Technics SBS-25
 •Mini-speakers, ideal for surround . . . Pair \$79.95

Memorex DS-10
 •Surround amp w/Dolby surround . . . \$99.95

Technics SH-AV40
 •Processor w/Dolby surround \$169.95

Audio Source SS-Two
 •Dolby surround, wireless remote . . . \$199.95

Panasonic SY-DS1
 •Digital signal surround processor . . \$219.95

Bose VRM1
 •Video Roommate speakers, amplified Pair \$299.95

Audio Accessories

Audioquest Sorbothane CD Feet
 •An innovative approach to vibration control in CD players • Constructed of sorbothane which dampens resonances for greater definition • Set of 4

Our Low Price **\$22.95** (ADQ CD FEET)

Parsec Scratch Out
 •CD cleaner/repair kit \$9.95

Tweek
 •Contact enhancer for all connections . \$14.95

Audio Prism CD Spotlight
 •Marker to treat CDs \$14.95

Audioquest Feet
 •Sorbothane feet for components, 4-Pack \$34.95

Russound TMS-10
 •Tape switcher, 10-decks/2 processors . \$179.95

Niles SVC4
 •Speaker selector/volume, for 4 pairs . . \$249.95

Universal Remotes

Memorex CP8-Turbo
 Universal Remote Control
 •Single-handed operation of up to 8 separate audio & video components • Easy to program
 •LCD display with real-time clock • Stores up to 156 command codes

Our Low Price **\$119.95** (MEM CP8 TURBO)

Memorex CP4
 •For up to 4 audio/video components . . \$49.95

Memorex AV4
 •Preprogrammed remote, for 4 units . . \$49.95

One-For-All URC-4000
 •Preprogrammed, for 4 units \$69.95

One-For-All URC-5000
 •Preprogrammed, for 13 units \$89.95

Memorex AV8
 •Replaces up to 8 standard remotes . . \$89.95

JVC RMS1
 •Universal, screen menus for 11 units . . \$179.95

Blank Audio Tape

Sony SR-100
 Metal Cassette Tape
 •Sony brings metal tape and high quality housing to an affordable price • New 100 minute length is ideal for taping compact discs

Our Low Price **\$21.80** 10-Pack (SON SR100)

TDK MAXG-90
 •Deluxe metal cassette each \$11.40

Maxell MV90
 •Verdex audiophile metal cassette . . . each \$14.90

TDK SAX90
 •Metal tape 10-Pack \$19.90

Sony UX-Pro90
 •High bias cassette 10-Pack \$21.80

Maxell XLIIIS-90
 •High bias cassette 10-Pack \$22.90

Denon HD8-100
 •Deluxe high bias cassette 10-Pack \$27.90

FOR MORE PRODUCTS, SEE NEXT PAGE

TO ORDER BY MAIL:
 SEND MONEY ORDER, CERTIFIED OR CASHIER'S CHECK, MASTERCARD, VISA, AMERICAN EXPRESS or DISCOVER CARD (Include Interbank No expiration date and signature) TO: J&R MUSIC WORLD, DEPT. 58190, 59-59 QUEENS MIDDLETOWN EXPRESSWAY, MASPETH, QUEENS, NY 11378. Personal and business checks must clear our Authorization Center before processing. Shipping, Handling & Insurance Charge is 5% of Total Order with a \$4.95 minimum. (Canadian Orders Add 15% Shipping, with a \$9.95 minimum charge.) For shipments by air, please double these charges. \$25 MINIMUM ORDER. DO NOT SEND CASH. SORRY, NO C.O.D.'s. NEW YORK RESIDENTS PLEASE ADD SALES TAX. ALL MERCHANDISE SHIPPED BRAND NEW, FACTORY FRESH, AND 100% GUARANTEED. Copyright 1990 J&R Music World





VHS VCRs and Players



Samsung VR-3700
Slimline VHS Video Recorder
• 181-channel frequency synthesized tuner
• On-screen programming • 1-year/8-event programmable timer • Wireless remote control

Our Low Price **\$199⁹⁵** (SAM VR3700)

- Shintom VCR-550
• 14 day/6 event timer, remote **\$179⁹⁵**
- Samsung VP-2309
• VHS player only, 3-speed **\$179⁹⁵**
- Samsung VR-570
• 4 head, on screen, remote **\$249⁹⁵**
- Panasonic PV-2004
• On screen, 35-function remote **\$249⁹⁵**
- Panasonic PV-4010
• 4 head, on screen, remote **\$299⁹⁵**
- JVC HRD-660
• 4 head, digital tracking **CALL**

HiFi VCRs/LaserDisc Players



JVC HRS6600
Super-VHA Hi-Fi Video Recorder
• DA-4 heads • MIS decoder • Jog/shuttle control • 20-event LCD memory bank • Zero frame editing • On-screen menu • Next-function memory • 14 day/8-event

Our Low Price **\$749⁹⁵** (JVC HRS6600)

- General Electric VG-7685
• VHS hi-fi, on screen, remote **\$299⁹⁵**
- Pioneer LD-870
• Laser disc player, on screen **\$299⁹⁵**
- RCA VR-620HF
• VHS hi-fi, 4 head, 8 event/1-year **\$379⁹⁵**
- Panasonic PV-4060
• VHS hi-fi, 4 head **CALL**
- JVC HRD-850
• VHS hi-fi, digital quad picture-in-picture **CALL**
- Pioneer CLD-2080
• Laser/CD player, both side LP play **CALL**

Camcorders



Sony CCD-TR6
8mm "Handycam" Mini Camcorder
• 8.1 power zoom with macro focus • 4-Lux
• Variable high speed shutter • Auto-focus
• CCD image sensor with RGB color processing

CALL (SON CCDTR6)

- Sony CCD-F33
• 8mm 6:1 power zoom w/macro, 4-lux **CALL**
- JVC GR-60
• VHS-C, 8X, 2 speed zoom, dig superimpose **CALL**
- RCA CC-415
• 8.1 zoom, 2-lux, pro-edit **\$849⁹⁵**
- Sharp VLL-270
• VHS, 12:1 zoom, 6-lux **\$899⁹⁵**
- Panasonic PV-645
• 2-speed 12:1 power zoom, 5-lux **\$1099⁹⁵**
- Sony CCD-F55
• 8mm, 8:1 zoom, macro **CALL**

This Month's

VHS Video Movie Specials



699⁹⁵ Each

- New From Kultur - Jazz!
Alberta Hunter At The Smithsonian **24.95**
- Benny Carter w/Kenny Baron & George Duvivier **24.95**
- Art Farmer w/Fred Hirsch & Billy Hart **24.95**
- Mel Lewis w/Herbie Hancock & Bob Brookmeyer **24.95**

- Warner Bros.
Give You A Great Ensemble Bird **16.95**
- The Gig **16.95**
- Pete Kelly's Blues **16.95**
- Round Midnight **16.95**
- Straight No Chaser **69.95**
- Young Man With A Horn **16.95**

- New From Kino Video
Archie Shepp: I Am Jazz...It's My Life **24.95**
- Big Ben: Ben Webster In Europe **19.95**
- Mingus 1968 **24.95**
- Mystery, Mr. Ra (Sun Ra & Arkestra) **24.95**
- Stations Of The Elevated (Music Of Mingus) **19.95**
- Zydeco Gumbo (Clifton Chenier) **19.95**

- Ambient Music Video
See What You Hear
New From Todd Rundgren - Music & Ambient Visuals
Todd Rundgren: Groggazer **16.95**



169⁹⁵ Each

Television



Sony KV-13TR24
13-Inch Trinitron Monitor/Receiver
• 13" high-contrast mirrorblack picture tube
• Cable ready • A/V window on-screen
• Sleep timer • Jump-channel • Remote
• Choose black or white finish

Our Low Price **\$299⁹⁵** (SON KV13TR24 color)

- Samsung TC-3833T
• 13" color, on-screen, remote **\$199⁹⁵**
- Panasonic CTL-1942R
• 19" color, on-screen **\$259⁹⁵**
- NAD MR-13
• 13" stereo monitor, 440-line resolution **\$399⁹⁵**
- Sony KV-20TS30BK
• 20" stereo monitor, 5-video input **CALL**
- JVC AV-2760S
• 27" color monitor, 5-video **CALL**
- Sony KV-27TS20BK
• 27" stereo monitor, remote **CALL**

Portable Televisions



Sony FD-10A "Watchman"
2-Inch Portable B/W Television
• Unique flat easy-to-view high contrast picture tube
• Weighs less than one pound • Requires 4 "AA" batteries • Silver finish

Our Low Price **\$89⁹⁵** (SON FD10A-S)

- Samsung TB-0590
• 5" black & white with AM/FM **\$69⁹⁵**
- Sony FD-230
• 2.7" Watchman, black & white **\$99⁹⁵**
- Sony FD-500
• 4.5" Watchman, black & white, AM/FM **\$99⁹⁵**
- Sony FD-555
• 4.5" Watchman, b/w, AM/FM/cassette **\$149⁹⁵**
- Sony FDL-330S
• 2.7" color Watchman, tuner separates **CALL**
- Sony GV-200
• 8mm video Walkman w/4" color TV **CALL**

Video Accessories



Sima "Copy Kit"
Telecine Adaptor
• Transfer your slides and home movies to video tape
• Project on to high contrast optically flat mirror
• Tape the reflected image with your video camera

Our Low Price **\$34⁹⁵** (SMA SVC)

- Ambico V0617
• Imaget, photo to video transfer system **\$64⁹⁵**
- Ambico V0805
• All-day power bell **\$74⁹⁵**
- Sima SL3
• Camcorder light **\$79⁹⁵**
- Azden AVS-20
• Video switcher, mic mixing, 4 in/1 out **\$89⁹⁵**
- VideoLink Copycam+
• Camcorder enhancer w/color processor **\$99⁹⁵**
- Azden WMS-Pro
• Wireless mic for camcorders **\$149⁹⁵**

Video Accessories



Vidicraft Vidi-View
A/V Remote Transmitter
• Converts A/V & Ch-3 cable to signal to UHF
• Transmits up to 120 feet and converts it back to A/V or Ch-3
• View cable at one location & send your video to another

Our Low Price **\$129⁹⁵** (VID VIDI-VIEW)

- Vidicraft Soundsnighl
• Audio/video mixer w/mic **\$59⁹⁵**
- Unomat LX-775
• Camcorder halogen light **\$59⁹⁵**
- JVC JXS-100
• A/V switcher, 4 in/2 out **\$99⁹⁵**
- JVC CGV-60
• Character/filler generator **\$179⁹⁵**
- Azden VE-100
• Video editor, create up to 100 screens **\$329⁹⁵**
- Videonics Direct Editor+
• Video editor for all formats **CALL**

Blank Video Tape



Scotch T-160EG +
High Grade VHS Video Tape
• Famous Scotch tape dependability • EG + high grade video tape provides finer colors, detail and resolution • Great for all your recording needs

Our Low Price **\$399⁹⁵** 10-Pack (SCO T160EGH +)

- Scotch T120/3 PK
• 2 reg & 1 high grade VHS tape . . . 3-Pack **\$99⁹⁵**
- Maxell T120 Gold/3
• 2 gold & 1-VHS tape 3-Pack **\$109⁹⁵**
- Maxell T120EX
• Standard VHS tapes 10-Pack **\$289⁹⁵**
- TDK T120EHG
• Extra high grade VHS tape 10-Pack **\$359⁹⁵**
- TDK TC20EHG
• VHS C, extra high grade 10-Pack **\$359⁹⁵**
- Sony P-120
• 8mm metal video tape 10-Pack **\$519⁹⁵**

Headphones



Koss CD4
Lightweight Headphones
• Foam cushions for hear-through sound • 10 foot cord • Frequency response 15 - 20KHz
• 60 ohm impedance • Plug & adaptor are gold plated

Our Low Price **\$34⁹⁵** (KOS CD4)

- Sony MDR-006L
• Lightweight, for portables **\$99⁹⁵**
- Koss TD60
• Porta Lite, very comfortable **\$199⁹⁵**
- Sony MDR-V4
• Folding headband, closed ear **\$599⁹⁵**
- Sony MDR-V6
• Closed ear, digital ready **\$799⁹⁵**
- Beyerdynamic DT-550
• Semi-open design, wide response **\$999⁹⁵**
- Beyerdynamic DT-990
• Audiophile reference lightweight **\$1899⁹⁵**



ORDER TOLL-FREE 24 HOURS A DAY 7 DAYS A WEEK 1-800-221-8180

J&R Music World, Dept. SR1190, 59-50 Queens-Midtown Expressway, Maspeth, Queens, NY 11378

Outside U.S.A. Call: 1-718-417-3737



MUSIC WORLD

Super Specials!

VHS Video Movies Specials



18⁹⁵ Each TOUCHSTONE HOME VIDEO

- Hot Hits From Touchstone**
- Beaches (Bette Midler) 18.95
 - Cocktail (Tom Cruise) 18.95
 - Pretty Woman (Julia Roberts) 18.95
 - Three Men & A Baby (Tom Selleck) 18.95
- Box Office Hits From MGM/UA**
- A View To A Kill 17.95
 - Lenny 17.95
 - Leviathan 17.95
 - Rainman 17.95
 - Road House 17.95
 - The Year Of Living Dangerously 17.95
 - Thunder Road 17.95
- MCA/Universal Brings You The Hits**
- Do The Right Thing 16.95
 - The Dream Team 16.95
 - Field Of Dreams 16.95
 - Jelsons: The Movie 16.95
 - Parenthood 16.95
 - Slaughter House Five 16.95
 - Uncle Buck 16.95
 - Where The Buffalo Roam 16.95

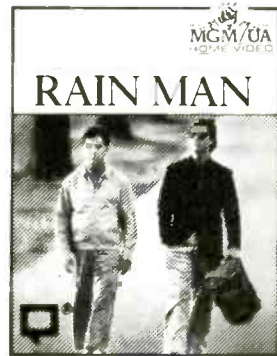

17⁹⁵ Each

Portable CD Players



- Technics SL-XP2**
Portable Compact Disc Player
- 4X oversampling • Dual D/A converters • XBS bass system • 18 track • Includes rechargeable Ni-Cad AA batteries, AC adaptor & lightweight headphones
- Our Low Price **\$189⁹⁵** (TEC SLXP2)
- Sony D-11 • Dual D/A, includes headphones **\$149⁹⁵**
 - Panasonic SL-NP1 • 18 track programming, XBS **\$169⁹⁵**
 - Sony D-66 • 8 X oversampling, with headphones **\$199⁹⁵**
 - Sony DT2 • CD with AM/FM, includes headphones **\$219⁹⁵**
 - Denon DCP-50 • 4 X oversampling, remote **\$249⁹⁵**
 - Sony D25 • 4 X oversampling, with headphones **\$299⁹⁵**

Clock Radios



- Sony ICF-C240**
Dream Machine Clock Radio
- AM/FM tuner • Red LED display • Dream bar • Sleep timer • Easy time-alarm setting • Battery power backup system • Choose beige, gray or white finish
- Our Low Price **\$174⁹⁵** (SON ICF-C240-color)
- Sony ICF-C101GY • AM/FM, cube design, grey finish **\$24⁹⁵**
 - Sony ICF-C900 • Dual alarm, hi/lo brightness **\$39⁹⁵**
 - General Electric 74965 • Stereo AM/FM w/cassette recorder **\$59⁹⁵**
 - Sony ICF-CS970 • Stereo AM/FM, dual alarm **\$59⁹⁵**
 - Panasonic RCX-250 • Stereo AM/FM, dual alarm **\$74⁹⁵**
 - Prolon 320 • High tech, AM/FM, dual alarm **\$99⁹⁵**

Portable Stereo



- Panasonic RX-FS400**
AM/FM Stereo Cassette Recorder
- Compact • AM/FM stereo tuner • Automatic stop • Tone control • Built-in condenser microphone • AC/DC operation • Black finish • Requires 6 X D batteries
- Our Low Price **\$49⁹⁵** (PAN RXFS400)
- Sony CFS-202BK • AM/FM/cassette, stereo, mic **\$69⁹⁵**
 - Sony CFS-1010 • AM/FM/cassette, detachable speakers **\$79⁹⁵**
 - Sony CFS-D30 • AM/FM/cassette, mega-bass, EQ **\$99⁹⁵**
 - JVC PCV-66J • AM/FM/cassette, auto-reverse, 3-piece **\$149⁹⁵**
 - Panasonic RX-DS620 • AM/FM/CD/cassette, 3-piece, EQ **\$259⁹⁵**
 - Sony CFD-760 • AM/FM/CD/dual cassette, 3-piece **\$349⁹⁵**

Microcassette Recorders



- Sony M440V**
Microcassette Recorder
- Two-speed operation • Voice operated recording • Cue & review • Built in condenser mic • Auto recording level • Earphone • Requires 2 X AA batteries
- Our Low Price **\$39⁹⁵** (SON M440V)
- Panasonic RN-105D • 2-speed, cue/review **\$29⁹⁵**
 - Panasonic RN-115 • Voice activated, 2-speed **\$39⁹⁵**
 - Olympus PearlCorder S-914 • Variable voice activation, 2-speed **\$59⁹⁵**
 - Panasonic RN-89 • Voice activated, auto-reverse **\$89⁹⁵**
 - Olympus PearlCorder S-930 • Voice activated, 2-speed, pitch **\$99⁹⁵**
 - Panasonic RN-36 • Ultra compact, 2-speed **\$219⁹⁵**

Worldband Radios



- Sony ICF-7601**
World Band Portable Receiver
- Paperback book sized • 12 wide band spread includes SW 1-10 AM and FM • Electronic feather touch controls • LED tuning indicator • Requires 4 X AA batteries
- Our Low Price **\$119⁹⁵** (SON ICF7601)
- Panasonic RF-810 • AM/FM/6 shortwave bands, local/dx **\$79⁹⁵**
 - Sony ICF-SW20 • AM/FM/7 shortwave bands, clock **\$84⁹⁵**
 - Sangean AT5-800 • AM/FM/SW 20 presets, clock/timer **\$99⁹⁵**
 - Panasonic RF-B20 • AM/FM/LW/SW, dx/local **\$109⁹⁵**
 - Sony ICF-7700W • AM/FM/12-SW bands, quartz tuner **\$179⁹⁵**
 - Panasonic RF-865 • AM/FM/LW/SW, 36 presets **\$229⁹⁵**

Portable Recorders



- Sony TC-S430**
Portable Stereo Recorder
- Compact, hand held design • Records with built-in stereo microphone • Built-in speaker • Lightweight stereo headphones • Requires 2 X AA batteries
- Our Low Price **\$99⁹⁵** (SON TCS430)
- Marantz PMD-201 • Manual, 2-speed, pitch control **\$229⁹⁵**
 - Sony WMD3 • Pro Walkman, stereo, Dolby B **\$239⁹⁵**
 - Marantz PMD-221 • Mono, 3-head, 2-speed, pitch **\$279⁹⁵**
 - Marantz PMD-420 • Stereo, Dolby B, dbx, pitch **\$329⁹⁵**
 - Sony WM-D6C • Pro Walkman, Dolby B/C, stereo, pitch **\$349⁹⁵**
 - Sony TCD-5M • Professional cassette portable, Dolby B **CALL**

Personal Stereo



- Sony WM-AF59 "Sports"**
AM/FM Auto Reverse Walkman
- Rugged water-resistant construction • 2 headphone jacks • Lightweight water-resistant MDR headphones • Includes belt-clip • Requires 2 X AA batteries
- Our Low Price **\$79⁹⁵** (SON WMAF59)
- Panasonic RQ-JA52 • Cassette player, compact **\$19⁹⁵**
 - Sony WM-A12 • Cassette Walkman, auto shut-off **\$27⁹⁵**
 - Panasonic RQ-V151 • AM/FM/cassette, auto reverse **\$49⁹⁵**
 - JVC CXF-35J • AM/FM/Cassette, Dolby B, A/R **\$69⁹⁵**
 - Toshiba KT-4549 • AM/FM/cassette, A/R, Dolby B **\$89⁹⁵**
 - Sony WMA-F604 • AM/FM/cassette, A/R, Dolby B **\$124⁹⁵**

Electronic Keyboards

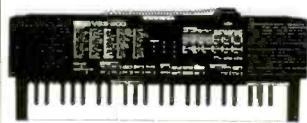

- Yamaha VSS-200**
Digital Voice Sampling Keyboard
- Mid size w/ 49 keys • Voice sampling system w/detachable mic • 100 preset FM voices & sampled voices • Digital synthesizer/voice editor • Requires 6 X C batteries
- Our Low Price **\$79⁹⁵** (YAM VSS200)
- Yamaha PSS-280 • 49-key, 100 preset voices **\$84⁹⁵**
 - Yamaha DD6 • Electronic drum pads **\$99⁹⁵**
 - Casio CA-100 • Tonebank, 49 keys **\$124⁹⁵**
 - Casio CT-615 • 5-octave tonebank, 61-keys **\$189⁹⁵**
 - Yamaha PSS-790 • 61 keys, 28 note polyphonic **\$279⁹⁵**
 - Casio CT-670 • Full-size keyboard, 61-note **\$339⁹⁵**

Car Stereo



- Panasonic CQ-H05**
Digital AM/FM Cassette Car Stereo
- 7.5 watts per channel • Hypertuner with 18 FM & 6-AM presets • Separate bass & treble • Multi-function LCD • Seek/scan • Preamp output • 4-way balance control
- Our Low Price **\$179⁹⁵** (PAN CQH05)
- Pioneer TS-1606 • Speakers, 6.5" coaxial pair **\$59⁹⁵**
 - Clarion 401/A • Amp, 25 X 4 watts/channel **\$69⁹⁵**
 - Sherwood XR-2207 • AM/FM/cassette, mini-chassis **\$99⁹⁵**
 - JVC KSR-400J • In dash AM/FM/cassette **\$149⁹⁵**
 - Clarion 972RT • AM/FM/cassette, Dolby B **\$229⁹⁵**
 - Sony XR-5500 • AM/FM/cassette, Dolby B **\$299⁹⁵**

CIRCLE NO. 39 ON READER SERVICE CARD

TO ORDER BY MAIL: SEND MONEY ORDER, CERTIFIED OR CASHIER'S CHECK, MASTERCARD, VISA, AMERICAN EXPRESS or DISCOVER CARD (include interbank No. expiration date and signature.) TO: J&R MUSIC WORLD DEPT. 31110, 35-59 QUEENS-MIDTOWN EXPRESSWAY, MASPETH, QUEENS, NY 11378. Personal and business checks must clear our Authorization Center before processing. Shipping, Handling & Insurance Charge is 5% of Total Order with a \$4.95 minimum. (Canadian Orders Add 15% Shipping, with a \$9.95 minimum charge.) Payments by air, please double these charges. \$25 MINIMUM ORDER. DO NOT SEND CASH. SORRY, NO C.O.D.'S. NEW YORK RESIDENTS PLEASE ADD SALES TAX. ALL MERCHANDISE SHIPPED BRAND NEW, FACTORY FRESH, AND 100% GUARANTEED. Copyright 1990 J&R Music World



and high school. It is a quietly moving work, eliciting sympathy for each principal character while focusing on the central figure of Laurie. It is not a perfect work. The libretto is sometimes self-consciously "rural," which detracts momentarily from the straightforwardness of the story. Musically, however, it is both masterly and delightful. Copland's familiar blend of seriousness and humor, of rollicking dance and contem-

tentiousness, which, in Copland's case, represents the fine honing of this composer's art."

The new Virgin set, derived from a 1989 Plymouth Music Series production at the Ordway Music Theatre in St. Paul, Minnesota, is the opera's first complete recording. The performances under Philip Brunelle's fluent direction are dedicated and musically effective, particularly Elisabeth Comeaux's warm and pure-

most balanced perspective. The much later and more concise Piano Trio is certainly not without animation or intensity, but its generally more subdued colors and rhythms make it quite a different sort of work and provide a most effective contrast with the more outgoing Op. 15. Neither could ask for more persuasive advocates. The recording, made at the Maltings, Snape, in England, balances warmth and definition in a way that suits this music, and these particular performances, to a T. *R.F.*

IVES: *Symphony No. 2; Central Park in the Dark; The Unanswered Question; other pieces* (see Best of the Month, page 131)

JANÁČEK: *Osud*. Philip Langridge (tenor), Živný; Helen Field (soprano), Míla Valková; Kathryn Harries (mezzo-soprano), Míla's Mother; others. Welsh National Opera Chorus and Orchestra, Charles Mackerras cond. EMI/ANGEL © CDC-49993 (79 min).

Performance: *Gripping*
Recording: *Excellent*

When Charles Mackerras completed his revelatory series of Janáček opera recordings for London a few years ago, we didn't hear many complaints that *Osud* had been overlooked. One of the least known of the composer's works, *Osud* (variously translated as "destiny" or "fate") dates from his best years, the early 1900's, right after *Jenůfa*. But because of problems with its libretto, *Osud* wasn't fully staged until 1958, and the Czech Supraphon label didn't get around to recording it until 1976. *Osud* was a major discovery then, and it is an even more substantial discovery now.

The plot has to do with the creative crisis of a hypersensitive composer brought about by the suicide of his mother-in-law. And while the music is largely typical of Janáček, he never wrote anything else as ecstatic as the opening chorus. Živný, the composer, then has three extended passages of almost uninterrupted singing, the searing emotional intensity of which makes him one of Janáček's most memorable characters. It is also one of the meatiest roles in the tenor repertory.

Even the rather confusing libretto, made even more confusing by the composer's many revisions, doesn't seem all that bothersome in these times of nonlinear theater and resourceful opera directors like David Pountney, whose successful production of *Osud* by the English National Opera in 1984 revived interest in the piece. That production appears to have inspired this recording, too. The opera is performed in a highly singable English translation by Rodney Blumer, which makes the characters seem a little too precious but is more intelligible than the original and only minimally robs the vocal lines of their Czech speech rhythms.

Mackerras works another of his miracles and see that they are all put in the



The Beaux Arts Trio: persuasive Fauré

plative song, of melody flowing as naturally as water from a spring and characterful orchestration heightening each dramatic moment—all this seems to achieve its apotheosis in *The Tender Land*.

It's not often that one has the opportunity of discussing an opera with someone intimately connected with its initial production, in this case the eminent stage designer Oliver Smith, who created the scenery for the first performances of *The Tender Land*, at the New York City Center of Music and Drama in 1954. "The *Tender Land*," Smith told me, "concerns the yearning in each of us for change and development, regardless of the serenity of our environment. I am affected more by the music and less by the libretto, although the text serves the music well; it presents a single action evolving in one place within one day. The music is forthright, instantly identifiable as Copland—in the same way that Puccini and Verdi have their particular tonalities—and at once recognizable as American music. Its nostalgic quality and simplicity bring to mind the work of Robert Frost or Willa Cather, of Thomas Benton or John Steuart Curry. At the same time, Copland's music is highly sophisticated, evocative of the introspective character of the action and commendable for the ready intelligibility it lends the text—an attribute Copland shares with Virgil Thomson. The enduring value of *The Tender Land* lies in its complete unrepre-

voiced Laurie, Dan Dressen's lyrical Martin, Janice Hardy's well characterized Ma Moss, and LeRoy Lehr's sympathetic Grandpa Moss. Altogether, a warmly recommended set. *R.A.*

FAURÉ: *Piano Quartet No. 1, in C Minor, Op. 15; Piano Trio in D Minor, Op. 120*. Kim Kashkashian (viola); Beaux Arts Trio. PHILIPS © 422 350-2 (53 min).

Performance: *Winning*
Recording: *Well-matched*

The two works on this disc are, apart from the violin sonatas, about the only representatives of Fauré's chamber music we get to hear with any frequency. Even these two are far from being overexposed and cannot have had many other performances as winning. Here at last is a presentation of the marvelous scherzo in the First Piano Quartet that can hold its own with the by now legendary recording by Horszowski, Schneider, Katims, and Miller some thirty-five years ago—and the rest certainly doesn't require comparisons of any kind to recommend it.

The quartet is a relatively youthful work, and, along with the animated wit of the scherzo, it shows degrees of restlessness and intensity and an overall emotional range we tend (mistakenly) not to associate with Fauré. The Beaux Arts Trio and Kim Kashkashian catch each of the work's passing moods splendidly and see that they are all put in the

THE FOUR SEASONS

WHAT piece of music started the Great Early Music Revival? Vivaldi's *The Four Seasons*, of course. Back when the LP and stereo were just coming in, Vivaldi concertos constituted a craze all by themselves. The peak of that craze was a recording in the mid-1960's of *Le quattro stagioni* performed by a tiny conductorless Italian ensemble—only twelve string players in the entire orchestra—known simply as the Musicians, or I Musici. They were not actually the first musicians to rediscover the Red Priest of Venice, but their 1965 recording has never been out of print. Now Philips, their original label, has released a modern digital version, not only on CD and cassette but also on videodisc and videotape.

I Musici were not and are not an old-fashioned ensemble of the modern type. They make a full-throated sound, and they go for passion and theatrics, Italian style. Their sound is still as gorgeous as the decoration in a Baroque church or theater. They never play mere notes—they have for years performed this music by heart—but rather long singing or dramatic lines in a grand manner. What is curiously played down in the new performance is the programmatic aspect of the music—probably because the video version has nothing to do with the theme of the seasons but rather with the city of Venice.

The enduring popularity of *The Four Seasons* is illustrated by a plethora of new digital versions. There is a pleasant

one on RCA Victor by Vladimir Spivakov and the Moscow Virtuosi that's quite modern compared with the Romantic Russian string tradition but still rather rich, big in scale, and full-throated, in contrast to the current taste for a light, early-music sound. And a new American entry in this sweepstakes is a version directed by Richard Kapp, with Paul Peabody as soloist, on the ESS.A.Y. label. If the Italians play with Italian theatrics and the Muscovites with Russian soul, then our compatriots take on Vivaldi in a hard-driving American style, even including some improvised ornamentation, somewhere between authentic Baroque and jazz. This is not a purist *Four Seasons* but a lean, latter-day, New World interpretation.

The early-music movement, along with the development of digital and CD technologies, has generated a whole new generation of rerecordings of the classics, and, predictably, *The Four Seasons* is a prime candidate. I didn't think that, in this field, anyone would very soon improve on Nikolaus Harnoncourt's stylish Concentus Musicus version of a few years ago. But, among the current entries, there is one that is comparable—maybe even more striking. This is the colorful and expressive reading by the violinist Monica Huggett, with the Raglan Baroque Players under Nicholas Kraemer, on Virgin Classics. Using period violins, properly strung and bowed, these catchy performances mix a wonderfully plangent string sound with a degree of excitement, flexibility, and

imagination that's extraordinary. All of the new CD's include various works to fill out the playing time, but this Virgin recording (on two CD's) offers Vivaldi's Op. 8, from which *The Four Seasons* is drawn, in its entirety. *Il cimento dell'armonia e dell'invenzione* (*The Contest Between Harmony and Invention*) is the overall title of the complete set of twelve concertos, and Huggett and the Raglan Players take that title very seriously, providing lots of drama, sweet harmony, and imaginative invention. Their renderings of this music fairly leapt from the loudspeakers, as fresh and exciting as the day it was written. In sum, these are very attractive, dynamic, and ear-catching performances.

The other British entry, by Catherine Mackintosh and the King's Consort under Robert King, on Hyperion, is also cast in an eighteenth-century mold, and the performances are perfectly adequate. But they (and the recorded sound itself) are much tamer, without the excitement and dramatic thrust—neatly illustrating the point that not all "authentic" early-music performances are the same, or even very much alike. *Eric Salzman*

VIVALDI: Violin Concertos, Op. 8: Nos. 1-4 ("The Four Seasons"); No. 5 ("Storm at Sea"); No. 6 ("Pleasure"). Federico Agostini (violin); I Musici. PHILIPS © 426 834-4. © 426 847-2 (60 min); VHS videotape 070 235-3. CDV videodisc 070 235-1 (48 min).

VIVALDI: Violin Concertos, Op. 8, Nos. 1-4 ("The Four Seasons"); Violin Concerto in E Minor (RV 278); Violin Concerto in A Minor (RV 357). Vladimir Spivakov (violin); Moscow Virtuosi, Vladimir Spivakov cond. RCA © 60369-4-RC. © 60369-2-RC (68 min).

VIVALDI: Violin Concertos, Op. 8, Nos. 1-4 ("The Four Seasons"); Concerto in A Minor for Two Violins, Op. 3, No. 8. Paul Peabody, Richard Rood (violin); Philharmonia Virtuosi, Richard Kapp cond. ESS.A.Y. © C1001 (50 min).

VIVALDI: Violin Concertos, Op. 8, Nos. 1-12 ("Il cimento dell'armonia e dell'invenzione"); Concerto for Violin, Cello, and Strings (RV 546); Concerto for Two Violins (RV 516). Monica Huggett (violin); Raglan Chamber Players, Nicholas Kraemer cond. VIRGIN VCD 90803-2 two CD's (125 min).

VIVALDI: Violin Concertos, Op. 8, Nos. 1-4 ("The Four Seasons"); Violin Concerto in D Major, Op. 3, No. 9; Violin Concerto in C Minor ("Amato bene"). Catherine Mackintosh (violin); the King's Consort, Robert King cond. HYPERION © CDA66339 (58 min).

I Musici in Venice



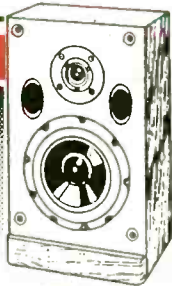

SPEAKERS

PINNACLE PN8+

- TOP-RATED!
- CRITICS' CHOICE
- PORTED 2-WAY
- "SHOCKINGLY GOOD FOR THE MONEY" STEREOPHILE VOL. 13#4

CALL

PRICE PER PAIR			
ADVENT BABY II	156	CELESTION DL-4 SII	326
ADVENT LEGACY II	326	CELESTION DL-12	726
ALLISON AL120	426	D. ACOUSTICS PS-10	316
ALLISON CD6	316	INFINITY RS-3001*	266
ALLISON CD9	886	INFINITY RS-5001*	516
AR TSW-510A	486	KEF C-35*	326
AR TSW-610A	566	KEF C-95*	886
AR TSW-910A	1386	KEF 103.3*	1086
BOSE AM3	399	KEF 104.2*	1686
BOSE SE5	749	KEF 105.3*	2986
BOSE 10.2 S II	896	KEF 107*	3986
BOSE 901 CLASSIC	1399	KLIPSH KG-2	326
B. ACOUSTIC A60SH	216	KLIPSH CORNWALL II	1246
B. ACOUSTIC A70SH	256	NHT	FULL LINE IN STOCK
B. ACOUSTIC T830*	396	OHM 1X0	546
B. ACOUSTIC SUB SAT 6**	466	OHM 5 JR	1486
CELESTION 3	IM	POLK 5 X0+	246
CELESTION 5	STOCK	WARFDALE DIAMOND III	CALL

TAPE DECKS



NAKAMICHI CASSETTE 1*

- 3-HEAD TAPE DECK
- DUAL CAPSTAN
- JUST ARRIVED

\$686

AIWA ADF-800	256	NAKAMICHI CR-3A*	596
AIWA ADF-1000	476	NAKAMICHI DRAGON*	CALL
AIWA ADWX-707	196	ONKYO TA2200*	CALL
AIWA ADWX-777	236	ONKYO TA2800*	486
AIWA ADWX-999	386	ONKYO TARW-490*	486
CARVER TD 1700*	466	PHILIPS TC-60	546
DENON DRP-680*	CALL	PIONEER C1S-707	316
DENON DRM-700*	316	PIONEER C1W-530R	166
DENON DRM-800*	386	PIONEER C1W-830R	316
DENON DRW-850*	426	SONY TC-WR620*	236
H. KARDON TD-262	396	TEAC V-970X	456
JVC TDW-303	166	YAMAHA KXR-730*	396
LUXMAN K112*	396	YAMAHA KXW-900*	526
NAD 6300*	646	YAMAHA KX-630*	376
NAD 6340*	CALL	YAMAHA KX-930*	CALL
NAKAMICHI CASSETTE 2*	266	YAMAHA KX-1200*	556

SEPARATES



ADCOM GFA-555*

- 200 WATT PER CHANNEL
- POWER AMPLIFIER

\$596

ADCOM GFA 565*	616	ONKYO T-9090 MKII*	646
BEHRN	IN STOCK	PROTON AA-1150	246
CARVER CT17*	726	PROTON SD-1000	BEST BUY! 486
CARVER TFM 42*	CALL	YAMAHA AX-630*	356
CARVER TFM 45*	686	YAMAHA DSP-A700*	CALL
DENON TU660*	CALL	YAMAHA DSP-E300*	636
DENON PMA-1060*	466	YAMAHA CX-630*	346
DENON AVC-3000*	CALL	YAMAHA MX-830*	496
NAD 2600A*	596	YAMAHA MX-1000*	896
NAD 1700*	636	YAMAHA TX-540*	CALL

RECEIVERS



SONY STRAV-1020*

- 120 WATT PER CHANNEL
- DOLBY PRO-LOGIC
- PROGRAMMABLE REMOTE

\$436

CARVER HR722*	466	ONKYO TX 844*	266
CARVER HR 752*	546	ONKYO TX-866*	CALL
CARVER HR 772*	CALL	ONKYO TX-SV90 PRO*	896
DENON DRA-335RA*	236	PHILIPS FR-50	296
DENON DRA-435RA*	286	PIONEER VSX-4700S	396
DENON DRA-625RA*	386	PIONEER VSX-5700S	466
JVC RX-703VPK	326	PIONEER VSX-9700S	666
JVC RX-803VPK	396	SONY STR-AV720*	276
LUXMAN R114*	CALL	SONY STR-AV920*	356
LUXMAN R115*	616	SONY STRD2020*	CALL
LUXMAN R117*	946	SONY STR-GX40ES*	286
MARANTZ RS3559	896	SONY STR-GX60ES*	426
NAD 7240PE*	386	YAMAHA RX-330*	196
NAD 7400PE*	796	YAMAHA RX-530*	306
NAD 7600PE*	946	YAMAHA RX-730*	346
NAKAMICHI RECEIVER 3*	256	YAMAHA RX-830*	466
NAKAMICHI RECEIVER 2*	426	YAMAHA RX-930*	646
NAKAMICHI RECEIVER 1*	696	YAMAHA RX-1130*	866

CD PLAYERS



DENON DCD-860*

- 20 BIT 8 X OVERSAMPLING
- DUAL DA CONVERTERS
- LAMBDA CIRCUITRY

\$296

CD-CHANGERS			
ADCOM GDC-575*	446	DENON DCM350*	266
CARVER TL-3300*	466	DENON DCM450*	366
DENON DCD-660*	236	JVC XLM403BK	256
DENON DCD-1560*	486	LUXMAN DC113*	586
DENON DCD-2560*	586	NAD 5170*	546
H. KARDON HD500	176	ONKYO DXC-200*	226
MAGNAVOX CD9-630	276	ONKYO DXC-500*	396
NAKAMICHI CD PLAYER 4*	276	PHILIPS CDC-875	446
NAKAMICHI CD PLAYER 3*	386	PIONEER PDM-530	216
NAKAMICHI CD PLAYER 2*	496	PIONEER PDM-630	286
ONKYO DX-7500*	CALL	PIONEER PDM-730	376
PHILIPS LH5500 Reference Series	266	SONY CDPC-505*	246
SONY CDP-2095S*	286	SONY CDP-705*	286
SONY CDP-900*	336	SONY CDP-C8FS*	396
YAMAHA CDX-530*	216	YAMAHA CDC-805*	366
YAMAHA CDX-930*	456		

TURNTABLES

ARISTON Q-DECK MKII

- BELT DRIVE • SEMI-AUTO
- NAGAOKA MP-11B
- \$96 W/PURCHASE

\$296



CARTRIDGES			
AR ES-1	396	AUDIO TECH S5551LC	146
AR EB-101	296	NAGAOKA MP11	146
B&O RX-2*	176	R&O CARTRIDGES	CALL
B&O TX-2*	286	ORTOFON X1-MC	66
DUAL CS-5000	316	ORTOFON X3-MC	116
DUAL CS-7000	276	ORTOFON X5-MC	166
SONY PS-F17 MKIIB	CALL	ORTOFON CONCORDE	CALL
TECHNICS SL1200 MK II	356	SHURE V15-IV-MR	CALL
THORNS TQ280 MKII	266	SHURE V15-V-MR	CALL
THORNS TQ318 MKII	396	STANTON 500AL	IN STOCK
		STANTON 680 EL	CALL

CALL FOR PRODUCTS NOT LISTED



MAIL ORDER MONDAY THRU SATURDAY

201-48

CAR STEREO



ALPINE 7294*

- PULL-OUT DESIGN
- MUSIC SENSOR
- AUTOREVERSE

\$436

PIONEER CDX-M50

- 16X 40VX SAMPLING
- 6 CD-CHANGER
- SMALLEST

CALL

HEAD UNITS		CD PLAYERS	
ALPINE 7192*	266	ALPINE 5903S*	386
ALPINE 7293*	336	ALPINE 5952S*	476
ALPINE 7288*	376	ALPINE 7903S*	436
ALPINE 7289*	CALL	ALPINE 7904S*	396
ALPINE 7390*	456	DENON DCC-8970*	496
CLARION 9731RT	196	DENON DCC-1570*	446
CLARION 9722RT	216	JVC XL-MK1200	396
DENON DCR5470*	366	KENWOOD KDC-C300*	366
DENON DCR7870*	496	KENWOOD KDC-93R*	396
H. KARDON CR151	446	NAKAMICHI CD760*	686
JVC KS-RGS	286	NAKAMICHI CDC101*	656
KENWOOD KRC-410*	226	PIONEER DEH-750*	396
KENWOOD KRC-510*	276	SONY CDX-A30*	346
NAKAMICHI RD460*	436	SONY CDX7580*	416
NAKAMICHI TD560*	686	-EQ'S / XOVERS	
PIONEER KEH-8100QR	CALL	ADS 642CSI*	186
PIONEER KEH-6100QR	276	ALPINE E321*	206
SONY XR5500*	236	CLARION 711EO	216
SONY XR7500*	456	H. KARDON CQ10	196
SONY XR7070*	316	SONY XE8 MKII*	166
S. STREAM TC303*	316	SONY XE9 MKII*	236
YAMAHA YCR-705*	366	SONY XEC1000*	186

*ADS**BOSTON ACOUSTICS**INFINITY**KEF**POLK**WARF
*PROTON**SONY**YAMAHA**ADCOM**DUAL**B&O**
* THESE PRODUCTS COME WITH A 1 YEAR 6TH AVENUE EL
** 6TH AVE ELECTRONICS IS NOT AN AUTOMERCHANDISE AND THE MANUFACT

NEW JERSEY
RETAIL ONLY

331 Rt. 4 WEST
PARAMUS, NJ

HOURS: 6 DAYS A WEEK MON THRU SAT 10-9

201-489-0666

10-DAY MONEY-BACK
RETURN POLICY

Returns accepted within 10 days (must be called in for prior authorization)
Products must be in original condition. Returns subject to restocking fee,
shipping and handling not refundable

COD ORDERS ACCEPTED
THE SAFEST WAY TO
BUY MAIL-ORDER

GUARANTEED DELIVERY
ON ALL ADVERTISED ITEMS

We do our best to have sufficient inventory on all advertised
products. If demand exceeds supply, rain checks will be issued
on out of stock merchandise.

30-DAY SPEAKER TRIAL

We want you to be acoustically satisfied. If the
speakers you buy don't sound as good as we said they
would, then just send them back for an exchange.

PICTURES ARE FOR ILLUSTRATION ONLY. NOT RESPONSIBLE FOR TYPOGRAPHICAL ERRORS. AD REPRESENTATIVE

WE

CS CITY SINCE 1980

ER CALLS
DAY 10:00 AM TO 7 PM
9-1204

ASK ABOUT
6TH AVENUE'S
EXTENDED WARRANTY
O CENTER

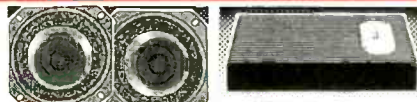

ADS 320 IS*
• 2-WAY DISCRETE SYSTEM
• 5-1/4" WOOFER
• 1" TWEETER
\$386

ADS PQ-10*
• 4 X 40 WATTS
• BRIDGEABLE
• PRICE BREAK!
\$366

SPEAKERS	AMPLIFIERS
ADS 300IS*	ADS PQ-8*
ALPINE 6368*	ADS PQ-20*
ALPINE 6396*	ADS PH-15*
AR GPS400	ALPINE 3552*
B. ACOUSTICS 851**	ALPINE 3542*
B. ACOUSTICS 861**	CARVER M2120*
B. ACOUSTICS 783**	CARVER M4060*
B. ACOUSTICS PRO 4.2**	DENON DCA-3400*
B. ACOUSTICS PRO 5.2**	H. KARDON TC 600
BAZOOKA T82*	HIFONICS
INFINITY CS-1A*	JVC KSA 154
INFINITY RS63K*	KENWOOD KAC-821*
INFINITY RS693K*	NAKAMICHI PA202*
JVC LS-X6936	NAKAMICHI PA304*
MB QUART OM160*	PIONEER GM3000
MB QUART OM215CS*	PROTON CA490*
MB QUART OM328CS*	R. FOSGATE PUNCH 75*
NAKAMICHI SP80*	R. FOSGATE PUNCH 150*
PIONEER TS6995	SHERWOOD
R.FOSGATE SP124*	S. STREAM D1001H*
S. STREAM SS10*	S. STREAM D2001*
ULTIMATE PW1035	S. STREAM MC 140*

ALL* CARVER* DEMON* LUXMAN* NAD* NAKAMICHI* ONKYO
KENWOOD* ALPINE* SOUND STREAM* MB QUART*
ELECTRONICS WARRANTY ONLY NOT THE MANUFACTURER'S
AUTHORIZED DEALER OF BOSTON ACOUSTICS
PRER'S WARRANTY DOES NOT APPLY

CAMCORDERS

SONY CCD-TR7
• HI-FI STEREO
• 5 LUX LOW/LIGHT
• 8:1 ZOOM
• PALM SIZE

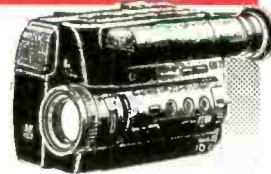

\$946

PANASONIC PV610	736
PANASONIC PV10	746
PANASONIC PVS140	926
SONY CCDTR5	776
SONY CCDTR4	CALL
SONY CCD77	946
SONY CCD755	796
SONY CCDV101	1196
CANON A1MKII	1396
CANON E06	976
MINOLTA V16U	896
OLYMPUS VX-804	CALL
JVC GR-65U	746
PENTAX PVC900A	1286
CHINON CVT-84	996

FULL MANUFACTURERS USA WARRANTY

VCR'S



MITSUBISHI U52
• DJ 4 HEAD HI-FI STEREO
• ON SCREEN PROGRAMABLE
• FULL FUNCTION REMOTE
\$446

JVC HRD-660U	296	PANASONIC PV-4060	346
JVC HRD-850U	456	PANASONIC PVS-4990	1296
JVC HRD-860U	416	PHILIPS VR-6605	546
JVC HRS-5500U	636	PHILIPS VR-6995	1596
JVC HRS-6600U	746	PHILIPS VR-6405	376
JVC HRS-C1000U	846	RCA VR-671HF	446
HITACHI VTF-430	436	RCA VR-740HF	NEW S-VHS 476
MITSUBISHI HS-U32	346	TOSHIBA MHF-845	476
MITSUBISHI HS-U71	866	TOSHIBA SV-F990	1396
PANASONIC PV-2004	236	SONY SLV 575	426
PANASONIC PV-4010	266	SONY SLV 676	496

FULL MANUFACTURERS USA WARRANTY

LASER PLAYERS



PIONEER CLD3080
• 18 BIT 8x OVERSAMPLING
• 5 IN 1 COMBO PLAYER
• JOG SHUTTLE
\$836

DENON LA-2000	IN STOCK	PIONEER CLD2080	CALL
MAGNAVOX CDV 485	596	SONY MDP-510	CALL
PHILIPS CDV487	BEST VALUE	SONY MDP-333	NEW IN STOCK
PHILIPS CDV600	NEW 1 BIT	YAMAHA CDV1100	CALL
PIONEER CLD1080	416	YAMAHA CDV1700	CALL

FULL MANUFACTURERS USA WARRANTY

SPECIAL



DENON DCD-520*
• 16 BIT 4 TIMES OVERSAMPLING
• FULLY PROGRAMMABLE
• FULL FUNCTION REMOTE CONTROL
\$156

TELEVISION

SONY KV27XBR10
• 27" STEREO MTS
• REMOTE CONTROL
• FAMOUS XBR TUBE

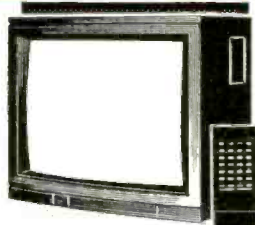

\$786

JVC AV-2080S	396	SONY KV-27TS30	626
JVC AV-2780S	646	SONY KV-27EXR10	696
JVC AV-3180S	1466	SONY KV-27XBR15	CALL
JVC AV-3580S	CALL	SONY KV-27XBR50	996
HITACHI CT-7892	696	SONY KV-32XBR10	1596
MITSUBISHI CS2070R	366	SONY KV-32XBR50	1696
MITSUBISHI CS2722R	626	TOSHIBA CX2779K PIP	746
PHILIPS 13K110	286	TOSHIBA CF3264K PIP	1496
PHILIPS 27K251	796	TOSHIBA CZ3299K PIP	1DTV
PHILIPS 27S272 PIP	1086		
PHILIPS 31S372 PIP	1796		
PROTON VT210	596		
PROTON VT331	1746		
RCA F20700	TOP RATED		
SONY KV-13TR24	256		
SONY KV-19TR20	316		
SONY KV-19TS20	356		
SONY KV-20EXR10	436		

PROJECTION TV'S

HITACHI CU4601	2196
HITACHI CU5001	2376
MISTUBISHI VS-4503	NEW
PHILIPS 46KP30SA	2496
PHILIPS WALL VISION	CALL
PIONEER	NEW LINE IN STOCK
SHARP VISION VX-100	CALL

FULL MANUFACTURERS USA WARRANTY

PORTABLES

DENON DCP-50*
• 4X OVERSAMPLING
• PORTABLE CD PLAYER



\$216

SONY D12	166	SONY WMD3 PRO	226
SONY D25	236	SONY WMD6C PRO	346
SONY D35	286	SONY TCD-5M PRO	546
SONY D66	186	SONY WMAF605	166
SONY D180	226	SONY WMF-2095	136
SONY D555	346	TOSHIBA KT-4868	146
DENON DCP-100*	256	AIWA HSJ880	166
CITIZEN CBM2200KIT	186		
PANASONIC SLP11	196		
PHILIPS AZ6804BK	246		
TOSHIBA XR9459 KIT	316		

SPORTABOUTS

HEADPHONES

SONY MDR-V6	76
SENNHEISER HT-520	126

FULL LINE SENNHEISER
FULL MANUFACTURERS USA WARRANTY

HI-END SYSTEM

PROTON AI3000II \$736
• AM/FM, CASSETTE
CD PLAYER
REMOTE
SYSTEM

PROTON 320	86	DENON DT-400*	296
NAKAMICHI TM*	116	YAMAHA YST-C10*	696
NAKAMICHI CP-1*	316	SONY FH-5CD	796

SUPER SYSTEM

BOSE LIFESTYLE

- MULTIROOM, MULTIZONE INTEGRATED SYSTEM
- AM/FM - CD PLAYER
- ACUUSTIMASS SPEAKER MODULES
- FULL FUNCTION REMOTE
- THIRTY STATION PRESETS



CALL

5-YEAR MANUFACTURERS USA WARRANTY



As good as cash. Low monthly payments that you can afford. Deferred payments and interest. Immediate approval for qualified customers. Details available from any of our salespeople.



WE ARE PLEASED TO ACCEPT THESE MAJOR CREDIT CARDS

MULTI SYSTEM
110/220 PAL/SECAM/NTSC
LARGEST SELECTION AVAILABLE

CUSTOMER SERVICE
201 489-1792

HOURS: MONDAY - FRIDAY 10 AM - 6 PM
PLEASE DO NOT CALL THIS NUMBER FOR PRICES

NEW YORK
RETAIL ONLY

1024 & 1030
6th AVENUE, NY

HOURS: 7 DAYS A WEEK MON-SAT 10-6:30 SUN 11-5

212-391-2777

acles with the score, which is performed with far greater drama and technical security than it was in the Supraphon set, and the singers sound as if their characterizations had been seasoned by stage exposure, compensating for the less-than-ideal casting. For all of Philip Langridge's artistry and the keenness of his portrayal of the composer Živný, the character still sounds undernourished. I could also ask for more musical artistry from Kathryn Harries and Helen Field as mother and daughter, respectively, though both singers are viscerally compelling. The important thing, however, is that the recording as a whole offers a performance of genuine theatrical validity (unlike so many other studio creations) that not only rehabilitates Janáček's *Osud* but makes it one of the most listenable opera recordings of the year. *D.P.S.*

MAHLER: *Symphony No. 1* (see Best of the Month, page 136)

MAHLER: *Symphony No. 2, in C Minor* ("Resurrection"). Felicity Lott (soprano); Julia Hamari (contralto); Latvian State Academic Choir; Oslo Philharmonic Chorus and Orchestra, Mariss



Richard Stoltzman: eloquent Mozart

Jansons cond. CHANDOS © ABDT 2022/3 two cassettes, © CHAN 8838/9 two CD's (84 min).

Performance: *Clear-eyed*
Recording: *Clean, wide-range*

As with its series of Tchaikovsky symphony recordings by Mariss Jansons and the Oslo Philharmonic, Chandos seems to get a better-focused sound here from Oslo Philharmonic Hall than what we have heard over the past year or so from EMI. Mahler's *Resurrection* Symphony emerges from these CD's as athletically energetic in the first movement and with a fine flow in the two intermezzo movements that follow. Clarity and flow are the watchwords here, especially in the third movement (which Mahler marked

"in smoothly flowing motion"). Only when we get to the fourth movement, *Urlicht*, sung with great poise by contralto Julia Hamari, is there something of the mystic aura typical of performances in the Viennese tradition. A striking feature of this performance is that the brass emerges from the background of the orchestra rather than being placed up front in the usual manner. Likewise the vocal soloists in both this movement and the finale—where soprano Felicity Lott is in splendid voice—are treated as integral parts of the total musical texture rather than being spotlighted front-and-center. The approach is all to the good.

Jansons gets a splendid crack of doom in the eruptive opening pages of the finale, and there is a fine sense of space and very wide tonal spectrum for the cosmic music leading into the initial choral entry. The recording of the offstage brass bands at this point is handled to perfection, and the choral contribution is excellent throughout. Most impressive about the whole production, though, is the ferocious attack and precision that Jansons elicits from the Oslo Philharmonic strings, particularly in the first-movement opening and the march episode midway in the finale. Aside from the conductor's remarkable achievement in raising the Oslo Philharmonic to something well beyond provincial status, I would guess that the freshness of the playing as a whole stems from the fact that the big Mahler symphonies have not yet become standard repertory in the Norwegian capital. If you don't insist on the grand Viennese tradition, this reading of the *Resurrection* Symphony has much to offer. *D.H.*

MARTINŮ: *Symphonies Nos. 1 and 2*. Berlin Symphony Orchestra, Claus Peter Flor cond. RCA © 60154-2-RC (62 min).

Performance: *Interesting*
Recording: *Smooth*

It is gratifying, on the centenary of Bohuslav Martinů's birth, to find his music at last coming in for major attention from performing and recording organizations outside his native Czechoslovakia. Young Claus Peter Flor's new recording of the first two symphonies makes a stronger impression than his earlier one of the last two, Nos. 5 and 6, also on RCA. It is vastly enjoyable and could make new friends for this music, but Flor once again, I feel, comes off second-best to Neeme Järvi, whose still more persuasive accounts of these works are on Bis. Järvi's performances of the six Martinů symphonies, with the Bamberg Symphony Orchestra, are perhaps the very finest things he has given us in his somewhat variable traversal of the Complete Works of Everybody, and comparison of his Nos. 1 and 2 with Flor's new recording is a pointed illustration of the difference between "interesting" and "irresistible."

In short, Järvi shows a higher level of

inspiration; he seems to feel and communicate a good deal more fully than Flor the various elements that make up Martinů's personal style. Flor's orchestra, obviously well prepared, plays smoothly and is recorded smoothly—the smoothness taking on a somewhat homogenized character. Järvi's readings, without a single gesture that is in any sense eccentric or tends to divert attention from the music to himself, are anything but homogenized. His basic tempos are virtually the same as Flor's in most cases, but he makes more of Martinů's vibrant coloring and imaginative rhythms, and he responds more sympathetically to the unusual shaping of some of the themes. Bis's recording more than holds its own against the newer RCA sound, too, particularly in respect to percussion and wind textures. *R.F.*

MOZART: *Clarinet Concerto in A Major* (K. 622). **COPLAND: *Clarinet Concerto***. **R. STRAUSS: *Duet-Concertino for Clarinet and Bassoon with String Orchestra and Harp***. Richard Hosford (clarinet); Matthew Wilkie (bassoon); Chamber Orchestra of Europe, Alexander Schneider and Thierry Fischer cond. ASV/HARMONIA MUNDI USA © COE 811 (66 min).

Performance: *Good to excellent*
Recording: *Quite good*

MOZART: *Clarinet Concerto in A Major* (K. 622); **Bassoon Concerto in B-flat Major** (K. 191, trans. Stoltzman). Richard Stoltzman (clarinet); English Chamber Orchestra, Alexander Schneider cond. RCA © 60379-2-RG (51 min).

Performance: *Smooth*
Recording: *Same*

The Chamber Orchestra of Europe, with two of its principal players as soloists and two conductors alternating on the podium, presents an imaginative and varied program of wind concertos on ASV. The handsomely recorded performances do honor to everyone involved—without, perhaps, being all-surpassing in every instance. Like Antony Pay in his recording of the Mozart with Christopher Hogwood and the Academy of Ancient Music, Richard Hosford plays a basset-clarinet, now known to be the instrument for which Mozart actually composed the work. It has a lower range than the "standard" clarinet, adding to the possibilities for color and expressiveness. Hosford does not have a crisp-sounding "original instruments" ensemble, tuned at the lower pitch that was common in the eighteenth century, to partner him, but he does have exceptionally sympathetic and alert partners in Alexander Schneider and the COE. Their association with and responsiveness to one another has made possible the sort of intimate yet enlivening give-and-take we associate with chamber music; it is, of course, every bit as welcome and every bit as effective in a concerted work.

Bassoonist Matthew Wilkie joins Hos-

COMPETITIVE PRICING... CALL NOW FOR YOUR BEST DELIVERED PRICE!

Miniature CAMCORDERS

BY
 CHINON
 OLYMPUS
 YASHICA
 CANON
 and
 MORE



HI-FI STEREO

CAMCORDERS/STILL VIDEO

JVC VIDEO EDITING-PROCESSOR

- 16 W/FES BY COMBINING 5 BASIC PATTERNS
 - COLOR BALANCING w/JOYSTICK CONTROLLER
 - 8 BACKGROUND COLORS, PLUS COLOR BAR CHART
 - VIDEO ENHANCER
 - INDEPENDENT A/V FADERS
 - VIDEO PROCESSOR LOOP
 - HEADPHONE MONITOR
- SALE PRICE: **\$489**
 JXSV55

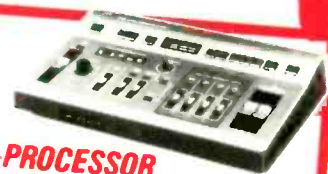

The LATEST MODELS at the BEST VALUE:

- CANON ALMK II
- CHINON CV7124
- KYOCERA KOH150
- OLYMPUS VXH604
- CANON H680
- FISHER FVC720
- JVC GRAX7
- OLYMPUS VC81
- CANON H800
- GE CG911
- JVC GR65
- PANASONIC PV10
- CHINON CBSC98
- KYOCERA KX90
- MINOLTA V20
- PANASONIC PV610

MOST POPULAR FEATURES

- 8mm 3 LHX 8:1 ZOOM **\$999**
- 8mm/8:1 ZOOM FLY ERASE w/COLOR VIEW FINDER **\$995**
- VHS PRO EDIT 8:1 ZOOM FLY ERASE **\$699**
- 8mm HI-BAND/6:1 ZOOM HI-BAND EDIT SEARCH **\$799**
- VHS 6:1 ZOOM **\$499**
- 8mm 6 VHS-C PALM SIZE CAMCORDERS **\$699**

CAR STEREOS



- AM/FM CD in DASH **\$249**
- CAR CD CHANGER, REMOTE **\$329**
- RADAR DETECTORS

SUPER VHS 8mm & BETA



- PANASONIC 4 HD VHS w/FLY ERASE HD **\$399**
- FISHER 4+2 HD Hi-Fi ST MTS **\$299**
- QUASAR 4+2 HD Hi-Fi ST MTS w/FLY ERASE **\$359**
- SUPER VHS Hi-Fi MTS **\$469**
- 4+2 SUPER VHS Hi-Fi MTS SUPER & FLY ERASE **\$569**
- 4+2 SUPER VHS Hi-Fi MTS DIGITAL w/FLY ERASE VIDEO BRAIN - Tiller & Date recording Synchro-Edit Feature - Shuttle Jog Control **\$729**
- SUPER VHS TIGHT PRO-EDITS FOR VIDEO ARTISTS & JOURNALISTS Automatic assemble/insert editing Character generator - Eight scene edit program-Field Accurate editing - Synchro-edit Tape-time remaining indicator **\$799**
- COMBO SVHS & SVHS-C **\$799**
- BETAMAX **\$299**
- 8mm PLAYER **\$299**
- SONY T6120 CV (2 Hour, 8mm) **\$5.99**
- FUJIST120 (SUPER VHS) **\$7.99**

DOLBY PRO-LOGIC HOME THEATER

DIRECT VIEW TV's

30" Mts. **\$799**

35" **\$1599**

REAR PROJECTION TV's

40" **\$1599**

45" **\$1699**

50" **\$1699**

Over 700 Lines



New 32" IDTV by Toshiba



Rear Projections

by
 Toshiba
 Pioneer
 Sony
 JVC
 & more!

CALL FOR BEST PRICES!

DOLBY PRO-LOGIC RECEIVERS & DISCS

- 100 WATT A/V DOLBY SURROUND AMP **\$89**
- LASER DISC w/SPECIAL EFFECTS & OPTICAL OUTPUT **\$780**
- 105 WATT A/V RECEIVER **\$399**



PORTABLE & COMPACT STEREOS

- JVC PCX100 **\$199**
- JVC PCX20C **\$279**
- JVC WX1 **\$599**



DISC PLAYERS

- PORTABLE CD
- WALKMAN **\$129**

START NG AT:

FOR MORE INFO, Call: **WE WILL MATCH OR BEAT ANY LEGITIMATE PRICE**
 1-800-950-4080

Call Toll-Free: **1 (800) 444-6300**
 Orders: **1 (800) 247-4654**

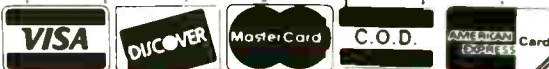

We ship within 24 hours. All prices quoted included manufacturer's standard accessories & U.S. Warranty. All units are factory sealed. Shipping & handling extra.

ford and the COE under Thierry Fischer to produce the most all-round satisfying performance I've heard of Richard Strauss's Duet-Concertino. And if the performance of Copland's Clarinet Concerto is less competitive than the two that frame it, it is still a very good one. It is just that Richard Stoltzman has set a possibly unmatched standard in his RCA Victor recording of it conducted by Lawrence Leighton Smith. Hosford and Fischer come close, but neither seems willing to open up as freely as Stoltzman and Smith do, nor have ASV's engineers opened up the sonic frontiers with anything like the brilliance of RCA's sound. In the Mozart and Strauss, however, the sonics are just about ideal.

The RCA CD is a reissue on the mid-price Gold Seal label of earlier recordings by Stoltzman and Alexander Schneider. The performance of the Clarinet Concerto is eloquent, but in comparison with Hosford and Schneider's on ASV it seems to have some of its corners rounded off. That impression is enhanced by the recording itself, which emphasizes smoothness more than definition. As for Stoltzman's transcription of the Bassoon Concerto, it is effective enough, and no one could find anything but pleasure in his performance of it, but the work is still more strongly appealing when it is played on the instrument Mozart designated. *R.F.*

OFFENBACH: *Les Contes d'Hoffmann*. Plácido Domingo (tenor). Hoffmann: Edita Gruberova (soprano), Olympia/Antonia/Giulietta; Claudia Eder (mezzo-soprano), Nicklausse/La Muse; Andreas

András Schiff: engaging Schubert



Schmidt (bass), Lindorf; Gabriel Bacquier (baritone), Coppélius; James Morris (baritone), Miracle; Justino Diaz (bass-baritone), Dapertutto; Michel Sénéchal (tenor). Frantz; Christa Ludwig (mezzo-soprano), Voice of Antonia's Mother; Richard Van Allan (bass). Schlémil; others. Choeurs de Radio France; Orchestre National de France, Seiji Ozawa cond. DEUTSCHE GRAMMOPHON © 427 682-2 (two CD's (139 min).

Performance: *Spirited*
Recording: *Exceptionally fine*

It's difficult to imagine a *Hoffmann* cast studded, even in the cameo roles, with more illustrious names than this one has. Each of these notable artists brings to his or her assignment unstinting commitment. Seiji Ozawa, too, conducts with verve and a good sense of pace, giving impetus both to the music, which does not sustain a consistent level of quality, and to the action, which is frequently incredible even for what is, essentially, a fairy tale.

Plácido Domingo, despite his articulate characterization of Hoffmann, sounds uncomfortably tight in his top register. His middle voice, though, is beautiful, and his French is exemplary. As Olympia (surely one of the silliest roles in opera), Edita Gruberova acquits herself in first-rate style, tossing off the Doll's Song with ease and becoming simplicity. As Antonia, however, the one "real" woman of Hoffmann's three loves, she lacks sufficient vocal warmth and weight to make her duet with him and the final climactic passages of the act truly stirring. As Giulietta, she uses her middle voice, which is still unusually warm for a light coloratura soprano, to good effect.

In Gabriel Bacquier's sure-footed Coppélius, we have a seasoned artist performing with assurance a role he has sung many times. The vocal velvet of James Morris's Miracle is, for me, the musical high point of the recording, and the Dapertutto of Justino Diaz is almost as effective until the end of the Diamond Aria, which approaches disaster. Why do singers feel compelled to tackle alternate high notes? But there's another, more important, question: Why, if a single soprano is used to portray Hoffmann's three loves, is not one baritone more often assigned to portray the three evil powers (possibly a single evil in three guises)?

In any case, the remaining members of the large cast deserve the highest praise, as do the French Radio Chorus and the Orchestre National under Ozawa's spirited direction. *R.A.*

RAVEL: *Miroirs; Gaspard de la nuit*. Minoru Nojima (piano) REFERENCE RECORDINGS © RR-35CD (49 min).

Performance: *Gorgeous*
Recording: *First-rate*

The booklet with Minoru Nojima's new recording of Ravel's *Miroirs* and *Gaspard*

de la nuit carries a sort of apology for a program "somewhat short by compact disc standards," advising that the pianist "felt strongly that these are the pieces with which he is ready to make recorded statements." While one appreciates the company's solicitude in this respect, we still get CD's with shorter playing times than 49 minutes, and no one who hears this one is likely to feel it offers less than full value in any way that matters. Nojima's only previous recording, an all-surpassing Liszt recital, also for Reference Recordings, created a good deal of excitement and eagerness for more. This long-awaited second release fulfills the highest expectations.

The two works here comprise a total of eight distinctive and wonderful pieces. Nojima's approach to them is not at all traditional. That is not to say it is eccentric, or in any sense unidiomatic, but it is highly personalized. He does not emphasize virtuosity in terms of pyrotechnics. Even in the most scintillating sections of the *Alborada del gracioso* (No. 4 of *Miroirs*), he seems to be spinning out the music from its very core, where it is illumined by a steady flame. And he does not take the kind of steely, cool, reserved, and somewhat brittle approach some consider stylish but lets that flame really warm the music up. Vladimir Horowitz said that *all* music is really Romantic music, and Nojima is not about to say him nay. This is gorgeous playing. I might attempt to catalog the technical features—the subtlety, the color, the detail—but the whole greater than the sum of even those parts is the realization, in full, of the individual character of each of the eight pieces.

The sonic focus is very warm, too, with a "liquid" quality that faithfully conveys the live character of Nojima's playing and the particular sound he cultivates. The documentation is quite exceptional: The labeling itself gives the name of the dedicatee of every one of the eight pieces, there is a splendid essay by Harris Goldsmith, and a brief note by Felix Arahmian introduces the passages from Bertrand that inspired the respective moments of *Gaspard de la nuit*, which are given in full in the original French and in English translations by the playwright Christopher Fry. *R.F.*

SCHUBERT: *Allegretto in C Minor* (D. 915); *Drei Klavierstücke* (D. 946); *Ländler* (D. 790); *Impromptus* (D. 935). Andrés Schiff (piano). LONDON © 425 638-2 (74 min).

Performance: *Excellent*
Recording: *Just right*

The Schubert authority John Reed, in his note with this very appealing release, suggests that the *Allegretto in C Minor* is "a *Moment musical* in everything but name." Here, however, by serving as preface to the *Drei Klavierstücke*, it effectively completes a set of four impromptus, which balances the Op. 142/D. 935 set that concludes Andrés Schiff's hour-

SAVE MONEY, TIME AND FREIGHT ON FAMOUS BRAND STEREO EQUIPMENT

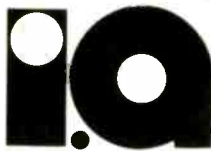

illinois audio

(800) 621-8042 / (312) 664-0020

12 E. DELAWARE PLACE • CHICAGO, IL 60611

LOUDSPEAKERS



TECHNICS SBL-36/40
Powerful
Loudspeaker System

- Linear Phase 2-Way System • Large Diam. 10" Woofer • Anti-resonance cabinet
- Attractive Woodgrain Finish

CALL FOR PRICE

- | | | |
|---|-------------|-----------------------|
| JENSEN 3420
12" 3 way | List 139.95 | SALE \$74.95 |
| E.P.I. CD-55
12" 3 way | List 250.00 | SALE \$99.00 |
| TECHNICS SBS-25
4" 2 way acous. susp. | | CALL FOR PRICE |
| TECHNICS SBL-60
10" 3-way bass reflex | | CALL FOR PRICE |
| DBX SF-5000
3 way monitor | List 399.95 | SALE \$279.95 |

PORTABLES



SONY WM-F2068
AM/FM Stereo Radio
Cassette player

- Dolby B NR • Auto-reverse with direction and mode selectors • Variable Mega Bass • UltraLight MDR headphones

List \$89.95 **SALE \$54.95**

- | | | |
|--|-------------|-----------------------|
| SONY D-11
Discman Port CD Player | List 179.95 | SALE \$129.95 |
| SONY CFD-50
AM/FM/CD/CASS. w/mic mixing | List 199.95 | SALE \$159.95 |
| PANASONIC RX-D520
CD/CASS auto rev. digital tuning | List 279.95 | SALE \$219.95 |
| JVC PCX-200
AM/FM/CD CASS 3-pc | List 399.95 | SALE \$299.95 |
| TECHNICS SLXP-2
Port. CD Player | | CALL FOR PRICE |

AUTO



SHERWOOD XR-1604
Car Stereo with Cassette Deck

- High Power • Removeable din • 19 presets • Dolby • B/C • Auto reverse • Full Logic • CD-Input

List \$409.95 **SALE \$219.00**

- | | | |
|--|-------------|----------------------|
| JENSEN JCX-240
6x9 coax | List 79.95 | SALE \$39.95 |
| SHERWOOD SCP-1002
240 watt 1fl-mode amp | List 279.95 | SALE \$179.95 |
| PANASONIC CGE-850
AM/FM/CD Player Req. Amp | List 700.00 | SALE \$330.00 |

CASSETTE DECKS



TEAC R-616X
Auto Reverse
Cassette Deck

- Dolby B & C • One touch high speed dubbing • Continuous Play • Memory play/search dubbing • Full logic control
- List \$519.00 **SALE \$224.00**

- | | | |
|---|-------------|-----------------------|
| TEAC V285CHX
Dolby: B/C HX Pro | List 145.95 | SALE \$89.95 |
| SCOTT DD-700
Dolby: B/C Dubbing Auto rev #1 | List 179.95 | SALE \$109.95 |
| TECHNICS RSTR-155
Dolby: B Deck #1 auto-rev. | List 189.95 | SALE \$159.95 |
| JVC TDR-431
Dolby: B/C HX-Pro Auto rev | | CALL FOR PRICE |
| SHERWOOD DD-1230
Dolby: B/C Dual auto rev decks | List 289.95 | SALE \$189.95 |
| JVC TDW-903
Dolby: B/C Twin auto rev. dubbing | | CALL FOR PRICE |
| TEAC V-970X
Dolby: HX-Pro 3 HD remote. DBX | List 799.95 | SALE \$469.95 |

AUDIO TAPE

- | | | |
|--|--------|----------------|
| MAXELL XLII 100
High Bias | 10 for | \$22.50 |
| MAXELL R-60DM
Digital Tape | | \$6.95 |
| MAXELL MV-90
Vertex Metal Cassette | | \$14.95 |
| TDK SAX-90
High-Bias | 10 for | \$19.90 |
| SONY SR-90
metal cass | 10 for | \$19.90 |
| TDK T-120
EHG | 10 for | \$34.90 |

HEADPHONES

- | | | |
|--|---------------|----------------------|
| SONY MDR-CD6
Digital Stereo Headphones | List \$119.95 | SALE \$69.95 |
| AKG K-55 | List 50.00 | SALE \$33.00 |
| AZDEN DSR18 | List 69.95 | SALE \$39.95 |
| SENNHEISER HD-450 | List 79.00 | SALE \$59.00 |
| KOSS JCK-200
Wireless headphone system | List 150.00 | SALE \$89.95 |
| SONY MDR 1F5K
Cordless Headphones | List 199.95 | SALE \$134.95 |

RECEIVERS



TECHNICS SA-GX500
Quartz Synthesized
AM/FM Stereo Receiver

- 160 W (80x2) front. 30 W (15x2) rear Amp
- Dolby Surround System • 49 key wireless A/V remote • 24 preset • Parametric Equalizer • Preset EQ curve memory

CALL FOR PRICE

- | | | |
|--|-------------|-----------------------|
| SCOTT RS-30
30 watt ch. digital tuning | List 149.95 | SALE \$89.95 |
| SHERWOOD RV-1340R
100 watt Ch. fr. remote 20 watt Ch. rear. Dolby surround | List 339.95 | SALE \$238.00 |
| ADC 1440
60 watt CH & CD changer, remote control | List 699.95 | SALE \$449.95 |
| TECHNICS SA-GX 100
40 watt/ch. A V remote control | | CALL FOR PRICE |
| JVC RX-703BK
110 Ch. fr. Prog. remote 12 ch rear | | CALL FOR PRICE |
| JVC RX-903VBK
100 watt Ch. learning remote digital delay. Dolby Pro-logic | | CALL FOR PRICE |

VIDEO



PIONEER CLD-1080
Laserdisc™/CD Player

- All Disc talents • High Quality Picture
- High Quality Sound • 8X Oversampling
- 20 bit compact OEC • Remote Control

CALL FOR PRICE

- | | | |
|--|--------------|-----------------------|
| JVC HRD-780
2HD. HiFi. Remote | | CALL FOR PRICE |
| SONY SLV-575
Remote Control VHS HiFi. Videocassette recorder | | CALL FOR PRICE |
| SONY MDP-510
Remote Multi-disc player | | CALL FOR PRICE |
| AZDEN AVS-20
Video switcher w/mic mixing | List 139.95 | SALE \$99.95 |
| AUDIO-SOURCE SS-2
Remote Dolby Surround Sound Amp | | CALL FOR PRICE |
| JVC-HRS5500
S-VHS. HiFi. 4 HD | List 1099.95 | SALE \$649.95 |
| TECHNICS SU-AV55
Remote. A/V AMP. digital Dolby Surround | | CALL FOR PRICE |

CD PLAYERS



TECHNICS SL-P370
Programmable
Compact Disc Player

- A new generation of CD player using the MASH Digital-to-Analog converter
- Linear Motor transport • 10 key direct access on front panel & remote control

CALL FOR PRICE

- | | | |
|--|-------------|-----------------------|
| SHARP DXR-770R
20 track prog. remote | List 219.95 | SALE \$109.95 |
| SHERWOOD CD-1182
8x Oversampling. remote | List 269.95 | SALE \$139.95 |
| TECHNICS SLP-170
1 bit Mash | | CALL FOR PRICE |
| JVC XLZ-431
8x Oversampling. 20bit DAC | | CALL FOR PRICE |
| TECHNICS SLP-S70
Technics best 1-bit remote | | CALL FOR PRICE |
| SHARP DXC-3510
6 Disc CD changer. remote | List 299.95 | SALE \$199.95 |
| SHERWOOD CDM-1260
6-Disc Changer. 4x Oversampling remote | List 349.95 | SALE \$199.95 |
| TECHNICS SL-PC25
1 bit. Mash, rotary changer remote | | CALL FOR PRICE |
| JVC XLM-403
6+1 CD Changer 18 bit DAC | | CALL FOR PRICE |
| PIONEER CLD-980
CD-CLD/CDV Combo player. remote | List 500.00 | SALE \$369.95 |

TURNTABLES



TECHNICS SLD22
Direct Drive
Turntable

- Full gimbal-pivoted tone arm
- Semi-automatic

CALL FOR PRICE

- | | | |
|---|--|-----------------------|
| TECHNICS SLL25
• Fully auto. Linear tracking Turntable
• Remote capable • repeat • front panel operation • Anti-vibration construction | | CALL FOR PRICE |
| DUAL CS 5000
• Belt driven, Semi-Automatic Turntable
• Floating subchassis.
• OPS tonearm | | CALL FOR PRICE |

CARTRIDGES



- | | | |
|--|-------------|----------------------|
| AUDIO TECHNICA AT122LP
P-mount | List 125.00 | SALE \$49.95 |
| STANTON L-680EL
Disco P-mount, extra stylus | List 106.00 | SALE \$49.95 |
| SHURE M-111HE | List 149.95 | SALE \$57.00 |
| AUDIO TECHNICA AT 155LC
Linear contact. Spec buy | List 299.95 | SALE \$119.95 |
| SHURE V15-VMR | List 275.00 | SALE \$129.95 |



18 YEARS OF MEETING THE NATION'S STEREO NEEDS WITH THE ABSOLUTE BEST PRICES ON TOP NAME NATIONAL BRANDS
Call Mon. thru Sat. 10 to 5 (312) 664-0020 • 1 (800) 621-8042



Prices in this ad are for mail-order only. Freight charges not included in prices. All merchandise shipped brand new, factory fresh with full warranty. Not responsible for typographical errors. Prices and availability subject to change.



NOTE: This is just a partial listing of our extensive inventory, please call for quotes on additional items or to request a free price list.

and-a-quarter disc. All eight pieces, and the engaging if somewhat bittersweet dances that separate the two sets, are played with the warmth tempered by elegant restraint and absolute freedom from anything resembling heaviness that we have come to recognize as essential to Schiff's style. It is a style that suits this music particularly well, avoiding starkness as well as both monumentalism and indulgence and simply letting the music sing in the most straightforward way. Tempos, especially in the D. 946 set, tend to be a little brisker than what we regard now as the norm, but the effect is never hurried or breathless—simply uncluttered and unlabored. Every nones-



Composer-conductor Michael Tippett

sential gesture seems to have been eliminated, and the drama, the pathos, the humor all rise out of the music without being coaxed. In sum, a lovely program of performances that go to the heart with unflinching directness. The sonic focus is just right for Schiff's light, crystalline textures. *R.F.*

SCHUBERT: *Fantasia in C Major, Op. 15 (D. 760, "Wanderer"); Piano Sonata in B-flat Major (D. 960).* Alfred Brendel (piano). PHILIPS © 422 062-2 (58 min).

Performance: *Excellent*
Recording: *Rich and warm*

SCHUBERT: *Fantasia in C Major, Op. 15 (D. 760, "Wanderer"); Piano Sonata in G Major, Op. 78 (D. 894).* Elisabeth Leonskaja (piano). TELDEC © 244 189-2 (66 min).

Performance: *Very good*
Recording: *Well-defined*

Both of these discs are so immediately enjoyable, and take one so deep inside the music, that any sort of comparative evaluation must seem at least a little presumptuous. Nonetheless, in the case of the one work common to both, the *Wanderer-Fantasia*, it does come down to Alfred Brendel. He and Elisabeth Leonskaja seem very much in accord in taking an intensely Romantic approach, which of course is just what the music

calls for, though Brendel is marginally more measured in the slow movement, marginally brisker in the last two. But within that similar frame he is quite a bit more adventurous than Leonskaja—pushing portions of the opening movement, for example, up to the border of overemphasis without ever quite crossing it—and I feel in his playing an undercurrent of tension that keeps the music in motion somewhat more successfully in the more reflective, inward sections. The sonic focus of the two discs differs in ways that tend to emphasize these contrasts, the Teldec being sharply etched to the point of brittleness, the Philips somewhat less clearly delineated but agreeably richer and warmer.

Brendel's coupling here is the same as in his earlier Philips recording of the *Wanderer*. He still does not take the big repeat in the opening movement of the great B-flat Major Sonata, but he is surely not alone in feeling that the movement is grand enough without it. This is a more affecting performance overall than his earlier one, particularly in the two inner movements. Leonskaja's way with the so-called Fantasy-Sonata in G Major is especially attractive, but it also comes into comparison with Brendel's. In his remake on Philips (coupled with the unfinished Sonata in C Major, D. 840), Brendel takes the repeat in the opening movement, but he does not spin it out to the length Leonskaja does. She never allows momentum to slacken, though, and in the minuetto some listeners may prefer her straightforward presentation to Brendel's more heavily inflected treatment of the second phrase of the opening theme. But in the final movement, at virtually the same tempo, Brendel manages to impart a sense of vitality without undermining the quizzically reflective mood, while Leonskaja seems to suggest quiet resignation. *R.F.*

SIBELIUS: *Symphony No. 5, in E-flat Major, Op. 82; Symphony No. 7, in C Major, Op. 105.* Vienna Philharmonic Orchestra, Leonard Bernstein cond. DEUTSCHE GRAMMOPHON © 427 647-4, © 427 647-2 (61 min).

Performance: *A disappointment*
Recording: *Vivid, spacious*

Perhaps the strongest entry in Leonard Bernstein's Sixties Sibelius symphony cycle with the New York Philharmonic was the Fifth Symphony. Regrettably, the tautness and muscularity of the earlier version is less in evidence here, and dyed-in-the-wool Sibelians will not care much for Bernstein's sentimentalizing of the slow movement's coda.

While the Fifth may have its slack points, Bernstein's reading of the Seventh is, to my mind, a near disaster, requiring some 25 minutes in playing time as against the standard 22½ minutes. The scherzando episodes suffer particularly from the incessant gear-shifting, and the transition to the big lyrical tune two-thirds of the way

through is ruthlessly squeezed for sentimental effect. The performance as a whole lacks drive and cohesion. Enough said, save that the conductor's groans are at times vividly audible, most clearly in the final pages of the Seventh. For uncritical Bernstein fans only. *D.H.*

TIPPETT: *The Midsummer Marriage: Ritual Dances; Sosostri's Aria. Prælium for Brass, Bells, and Percussion; Suite for the Birthday of Prince Charles (Suite in D).* Alfreda Hodgson (contralto, in aria); Chorus of Opera North; English Northern Philharmonia, Michael Tippett cond. NIMBUS © NI 5217 (61 min).

Performance: *Committed*
Recording: *Voices are lost*

Not long ago Michael Tippett made a recording of his Concerto for Double String Orchestra. *Fantasia concertante* on a Theme of Corelli, and *Songs for David* with the Scottish Chamber Orchestra for Virgin Classics. Now he has begun a new series of recordings of his works for Nimbus, this initial release celebrating his eighty-fifth birthday, which occurred last January. The CD includes one piece that has not been recorded before, the *Prælium* for brass, bells, and percussion composed for the fortieth anniversary of the BBC in 1962. It proves to be a rather more inward, less overtly festive or declamatory piece than one might have expected—the bells are used with great restraint, and the effect of the recurrent trumpet fanfares over the oddly complacent bass line is more ominous than jubilant.

The five-part Suite in D, on the other hand, composed in 1948 for the birthday of Prince Charles, is Tippett at his most ingratiating—and still thought-provoking. Bells again play a part, but the full orchestra is summoned forth in its warmest colors, and there are references to an old hymn, a medieval carol, well-known folk tunes, and other works of Tippett's, among them *The Midsummer Marriage*. While that opera ought surely to be heard, and if possible seen, in full, its musical, dramatic, and spiritual essence may be said to be distilled in the excerpts on this disc. The Ritual Dances make a fine effect on their own as a sort of symphonic poem (with voices in the last of the four dances), and Tippett doesn't slight any details in his fiery, impassioned conducting. His remarkable energy apparently self-renewing, he draws from an orchestra that is perhaps not quite world-class the sort of committed response that tends to sweep all reservations aside.

The orchestra is recorded splendidly but is so favored in Sosostri's Aria that contralto Alfreda Hodgson might as well be singing a vocalise: her tone is steady, the line majestic, but the words are unintelligible, and it is clearly not her fault. The chorus is even dimmer, in both the aria and the last of the Ritual Dances—a curious miscalculation in an otherwise distinguished production. *R.F.*

1-800-356-9514

If you find a better price—CALL US!

- ★ Best Pricing
- ★ Fast Delivery
- ★ 30-Day No Lemon

WISCONSIN DISCOUNT STEREO WDS

- ★ Best Service
- ★ 10-Day Return*
- ★ 1000's of Products



OR
C.O.D.

Hours: Monday-Friday 8-8
Saturday 8-5:30 • Sunday Closed

FEATURING... a small sampling of our in-stock items.

VCR

Quasar HiFi \$277
155 Ch Digital Tuner VHS
31 Day On-Screen Program
Built in Auto Tracking

Panasonic PV4060 \$317
4 Head MTS HiFi VHS
155 Ch, Double Fine Slow
31 Day Timer, OSP

JVC HRSC1000U SPECIAL
Super VHS 4 Head MTS HiFi
Loads SVHS/SVHS-C/VHS/VHS-C
Jog Shuttle, Flying Erase Head

TV

Toshiba CF3060 \$899
32" FST MTS TV
SPECIAL PURCHASE

JVC AV3589S SPECIAL
35" High Performance TV
700 Lines, A/V In/Out
Learning Remote, 180 Ch

Toshiba CF3264 \$1195
32" High Performance TV
700 Lines, A/V In/Out, 181 Ch
Super VHS Input, Channel Block

CAMCORDER

Panasonic PV602 \$624
VHS Camcorder, Switch Hitter
6X Zoom, Self Timer, Time Lapse
Date/Time, Slim Width, 4 lux

RCA VHS Camcorder \$649
6X Zoom, 2 lux, Time Lapse
High Speed Shutter, CCD
2 Page Titler, Brand New

Panasonic PV10 SPECIAL
Palm-corders, 4 lux
6X, Auto Tracking
Date/Time Stamp

MISC AUDIO

Design Acoustics PS-3 SPECIAL
Satelite / Subwoofer System
Dual long-throw woofers
Electronic Protection Circuit

Sony MDRV6 \$67
Professional Headphones
We Carry Wide Assortment
of Small Electronics

REC / INTEGRATED AMP

JVC RX903VBK SPECIAL
100 Wt Audio Video Receiver
Dolby Pro Logic Surround
3 Video, Sequential Commands

Sherwood RV1340R \$238
100 Wt/Ch A/V Receiver
Dolby Surround, Remote
5 Band EQ, 2 Video Inputs

Harmon Kardon PM665 \$399
150 Wt/Ch Integrated Amp
High Current, MM/MC
Pre-out/Main-In, Super Special

CD

Harmon Kardon HD800 \$239
Top of the Line CD
Way Below Cost • Best Buy
Loaded with Features

Pioneer CLD1080 SPECIAL
Combination CD/Laser Player
High Quality Digital Sound
A/V Jacks, Disc Stabilizer

TEAC AD3 \$249
Combination CD/Cassette
Dolby B/C/HX Pro, Remote
16 bit, 4X, 16 Program

PORTABLE

Sony D25 SPECIAL
Portable Discman, 4X
Remote Supplied, Headphones
We Carry Complete Line

JVC PCX200 \$297
Portable with CD Player
Hyper Bass, Digital Tuner
Auto Reverse Cassette, EQ

Sony WMAF605 SPECIAL
Top of the Line Walkman
Digital Tuner, 14 Presets
Wide Assortment of Walkmans

CAR

Clarion 9772RT \$219
Removeable DIN Car Stereo
High Power, 18 Presets, Dolby
Auto Reverse, RCA Out

Alphasonic PMA4050 SPECIAL
50 Watt X 4 Car Stereo Amp
Best Car Amp Line Made
Wide Selection of Car Stereo

Uniden RD9GTL \$108
Radar Detector, Best Buy
BEL, Cobra, and Uniden
Call for Other Specials

MISC VIDEO

RCA VR675 \$317
4 Head MTS HiFi VHS
181 Ch, Auto Head Cleaning
Auto Tracking, 8/365

JVC HRS5500U \$599
Super VHS 4-Head MTS HiFi
LCD remote, Digital Tracking
Advanced Editing Features

Sony Video CALL!
We Won't Be Undersold!
We Carry Most Models
One of Nation's Largest

MISC

JVC AV2080 \$398
20" Top Rated TV, 180 Ch
MTS, Surround Sound, S-VHS
A/V Inputs, Channel Guard

JVC GRS70U \$896
Super VHS-C Camcorder
8X Zoom, Flying Erase Head
4 Page Digital Insert, 2.6 lbs

Recoton Wireless 100's \$149 sys.
Cordless Add-on Speakers
12 Wt/Ch Amp, Extends
your stereo to any room.

Call For Demo Specials.

WDS 2417 W. Badger Road, Madison, WI 53713

*10-Day Return Policy: Return items accepted within 10 days of purchase. (Must get prior authorization.) Original Condition. 10% restocking fee. Shipping and handling not refundable. For return authorization call: 1-608-271-6889.

Some Items Closeouts • Some Limited Quantities.



Knowledgeable,
Friendly Staff



High Volume
Low Pricing



We Stock Most
Major Brands



Best Extended
Warranties

ENCORES

BACK in the Sixties one of the most ubiquitous names in recorded music was that of the conductor Karl Ristenpart. He and his Saarland Radio Chamber Orchestra must have been on a dozen labels at one time or other, mostly—but by no means exclusively—in Baroque music. Their recordings for Erato were issued here by Westminster, Music Guild, the Musical Heritage Society, Epic, Odyssey, and American Decca; those for the Club Français du Disque came out on Nonesuch and Everest. Ristenpart's set of Bach's *Brandenburg* Concertos, issued by Nonesuch in 1966, probably



Karl Ristenpart

made the most dramatic impact: Among the soloists were Rampal in his prime, the oboist Pierre Pierlot, the recorder player Hans-Martin Linde, the orchestra's concertmaster, Georg-Friedrich Händel, and a pair of whiz players of the natural horn, Martin Oheim and Oscar Wunder. From the way the horns punched out those triplets in the opening movement of the first *Brandenburg* you knew this set was going to be a winner, and it was, directing attention to previously issued Ristenpart recordings and creating an eager audience for future releases.

Ristenpart's musicmaking was always enlivening in the best sense, and many of his performances included little touches that made them distinctive the way those triplets did in the *Brandenburgs*. In Bach's Third Suite it was the way he leaned on the appoggiaturas in the gavotte. In Albinoni's best-known concerto, the one for oboe and strings in D Minor, Op. 9, No. 2, it was simply opting to have the accompanying strings play *arco* instead of *pizzicato* in the slow movement. Response to his recordings was such that Nonesuch created a new label, Checkmate, and began recording

him in big-orchestra repertory in Stuttgart (a lovely Schubert First and Second, the Brahms Serenade No. 2 with Wagner's *Siegfried Idyll*, a Beethoven Seventh, and an *Eroica* in which a grand musical vision came through in spite of obvious underrehearsal).

Mahler provided the original impetus for Ristenpart's interest in music when, as a boy of thirteen, he heard the Fifth Symphony conducted by his mother's twenty-two-year-old piano teacher in his Berlin debut; the conductor was Hermann Scherchen, who shortly thereafter became young Karl's stepfather. Later in life he found not only musical stimulation but "moral precepts" in Mahler's scores, but Mahler was *verboten* in the Third Reich, and opportunities for Ristenpart to conduct at all were sealed off by his refusal to join the Nazi party. After the war, Ristenpart first organized a chamber orchestra for RIAS and then, in 1953, created the Saarbrücken ensemble with which he made so many recordings.

All this background is incidental to the happy reappearance of the Ristenpart *Brandenburgs* on a pair of Accord CD's (200382 and 200392, distributed by Harmonia Mundi USA). No "original instruments" here, but the sort of musicmaking that sweeps everything before it. The sound, first-rate on the Nonesuch LP's, is well preserved in the CD transfers.

Another illustrious German conductor, with a bigger reputation than Ristenpart's but less "visibility" in terms of recordings, was Robert Heger, who died in Munich in January 1978, at the age of ninety-one. Heger presided over the famous abridged recording of *Der Rosenkavalier* with Lotte Lehmann and Richard Mayr some six decades ago. He seemed especially happy in music characterized by warmhearted lyricism, such as Goldmark's *Rustic Wedding* Symphony and Otto Nicolai's delicious opera *The*

Robert Heger



Herbert von Karajan

Merry Wives of Windsor. His marvelous 1963 Munich State Opera recording of that opera, with Edith Mathis, Fritz Wunderlich, Gottlob Frick, and other singers whose names may be less recognizable, was represented only by a single disc of "highlights" in Angel's domestic LP catalog but is now available in full on two beautifully mastered CD's in the mid-price Studio series (CDBM 69348). Even people who think they don't care for opera must respond to the sheer enchantment of this lovely performance. The last twenty minutes in particular (from the Elves' Chorus to the end) represent a stunning concentration of wit and warmth and inexhaustible melodic inventiveness.

A far better-known conductor than either of the two mentioned so far, of course, was the late Herbert von Karajan, whose 1950 Viennese recording of *The Magic Flute*, pretty enchanting in its own right, was brought back on CD, in the same Studio series, at the same time as Heger's *Merry Wives*. Without spoken dialogue, the entire performance fits comfortably on two CD's (CDBM 69631), and the sound now is so far superior to what was heard on the old Columbia LP's or the subsequent EMI LP reissue that it is hard to believe it's the same recording. What convinces one that it is, of course, is the peerless performance, not only more appealing than Karajan's digital remake but touched with a fairy-tale ambience and overall warmth of heart unmatched in any other recording of this work known to me. What a cast—Irmgard Seefried (Pamina), Anton Dermota (Tamino), Wilma Lipp (Queen of the Night), Erich Kunz (Papageno), Ludwig Weber (Sarastro), Emmy Loose (Papagena), Sena Jurinac (first of the Three Ladies), George London (the Speaker)—and what magical spontaneity and unselfconscious flexibility from the Karajan of 1950. For my money, this set is among the most remarkable mementos of that remarkable career.

Richard Freed

Sound City

TURNING THE INDUSTRY
UP-SIDE-DOWN

HAFLER SUPER SALE

MADE IN THE U.S.A. CALL FOR OTHER MODELS

DH-500 \$499
• Amplifier

DH-110 \$299
• Pre-Amplifier

DH-330 \$289
• Tuner

PROTON D940

40 w/ch 280 w peak
• Hi-Fi Grand Prix Winner
• Schotz N.R.
ORIGINALLY \$600
NOW ON SALE AT... \$288

NAD MR13 #1 Rated

MTS Stereo/Sap
• 450 Lines - S-VHS & RGB inputs
• #1 Rated - Video Magazine
CALL FOR PRICE

Atelier Components C2/3

20/20 Freq. Resp.
• Dolby B/C & HX Pro a/d/s/
• Search, Scan, E/R Counter
ORIGINALLY \$700
NOW ON SALE AT... \$329

BBE Sound Inc.

BBE 1002 For Home \$179
BBE 3012 For Car \$199

"The most hearable advance in audio technology since HI FIDELITY ITSELF" Laurence Henry, Music Connection

THORENS TD280 MKII

Affordable European quality & craftsmanship
• 5 yr. man. warranty
• Includes Ortolon cart, mounted Free!

NOW ONLY \$699

Also Available TD316 MKII TD320 MKII TD318 MKII TD520 MKII

ALL THORENS ACCESSORIES IN STOCK

dbx

SOUND PROCESSORS

dbx 18XDS \$179
dbx 38XDS CALL
dbx 5NR1 \$179
dbx 120XDS \$189
dbx 228 \$279
dbx 224XDS \$199
dbx 500XR \$389

dbx XI Tuner only \$299
Matches BX1 Amp
dbx SX10 \$50
Audio Video Dynamic Expander
dbx SX20 \$50
Audio Video Impact Restorer
BOTH FOR \$89

dbx BX-1

800W/Power Amp
• 2/3/4 Ch.
Configuration \$1499
• Words Finest
Quad/ Mono Amp ORIGINALLY \$3770

MEADTOWN SHOPPING CENTER
ROUTE 23 SOUTH
KINNELON, NJ 07405
HOURS: MON-FRI 10-9 SAT 10-6
Not Responsible for typographical errors
Pictures for illustration only

201-838-3444

STEREO REVIEW RETAIL MART

Where to buy Polk Speakers AUTHORIZED HOME DEALERS

CANADA Call Evolution Technology, Toronto for nearest dealer 1-416-847-8888

AK Anchorage: Magnum Electronics • Fairbanks: Holt's
AL Birmingham: Audical • Huntsville: Sound Distributors • Mobile: Hi Fi Zone • Montgomery: The Record Shop • Tuscaloosa: Kincaid Stereo & TV
AR Ft. Smith: Stereo One • Little Rock: Leisure Electronics • Searcy: SoftMart
AZ Phoenix/Scottsdale: Hi Fi Sales • Tucson: Audio Emporium • Yuma: Warehouse Stereo
CA Bakersfield: Casa Moore • Campbell: Sound Goods • Canoga Park: Shelley's • Chico: Sounds By Dave • Corona Del Mar: Pacific Coast Audio Video • El Toro: Genesis Audio • Escondido: Sound Company • Eureka: Audio Video • Huntington Beach: Good Guys • Lancaster: California Soundworks • Long Beach: Audio Concepts • Los Angeles: Good Guys • Mountain View: Sound Goods • Napa: Futurvision • Penn-grove: California Stereo • Redondo: Systems Design • Riverside: Speakercraft • Sacramento: Good Guys • San Diego: Sound Company • San Francisco & Suburbs: Good Guys • San Gabriel: Audio Concepts • San Jose: Good Guys • San Luis Obispo: Audio Ecology • Santa Barbara: Creative Stereo • Santa Cruz: Sound Wave • Santa Maria: Creative Stereo • Santa Monica: Shelley's Stereo • Thousand Oaks: Creative Stereo • Tustin: Good Guys • Upland: Audio King • Ventura: Creative Stereo • Visalia: Metro Stereo • Westminster: Videotek Stereo
CO Boulder: Soundtrack • Colorado Springs: Sunshine Audio • Denver & Suburbs: Soundtrack • Glenwood Springs: Stereo Unlimited • Grand Junction: Sound Company • Minturn: Custom Audio Video • Pueblo: Sunshine Audio
CT Danbury: Carlson's • Tweeter Etc. • Fairfield: Audio Design • Greenwich: Al Franklin's • Hartford: Al Franklin's • New Haven: Audio Etc. • Newington: Hi Fi Stereo House • Tweeter Etc. • New London: Robert's • Waterbury: Zimo Music • Waterford: Tweeter Etc.
DE Wilmington: Bryn Mawr Stereo
FL Daytona Beach: Stereotypes • Ft. Lauderdale: Sound Advice • Ft. Pierce: Sound Shack • Gainesville: Electronics World • Jacksonville: Audio Tech • Spectrum Home Theater • Key West: Audio International • Lakeland: Sound Factory • Mary Esther: Palm Audio Video • Merritt Island: Southern Audio • Miami: Sound Advice • Naples: Stereo Garage • Panama City: HiFi Sound Stereo • Pensacola: All Pro Sound • Sunrise: Sound Advice • St. Petersburg: Sound Advice • Tallahassee: Stereo Store • Tampa: Sound Advice • W. Palm Beach: Electronic Connection, Sound Advice
GA Athens: Hi Fi Buys • Atlanta & Suburbs: Hi Fi Buys • Augusta: Stereo City • Brunswick: H&H Service Store • Columbus: Merit TV • Gainesville: Audio Dimensions • Macon: Georgia Music • St. Marys: Premier Sight & Sound • Savannah: Audio Warehouse • Valdosta: Premier Sight & Sound, Stereo Connection
HI Honolulu: Honolulu Audio Video
IA Davenport: Gng's Music • Des Moines: Audio Labs • Dubuque: Reniers • Ft. Dodge: Sound World of Ft. Dodge • Iowa City: Hawkeye Audio • Mason City: Sound World • Sioux City: Audio Visions
ID Boise: Stereo Shoppe • Idaho Falls: Video & Electronics Shoppe • Ketchum: Infinite Audio • Moscow: Stereo Shoppe • Twin Falls: Audio Warehouse
IL Alton: Helibank Stereo • Aurora: Stereo Systems • Carbondale: Southern Stereo • Champaign: Good Vids • Chicago & Suburbs: United Audio • Decatur: Team Electronics • DeKalb: Classic Hi-Fi • Fox Valley/Aurora: United Audio • Highland Park: Columbia • Joliet: Stereo Systems • Lansing: UniTek Electronics • Naperville: Stereo Systems • Niles: United Audio • Normal: Sundown One • Northbrook/Dakbrock: United Audio • Peoria: Team Electronics • Quincy: CarTunes of Quincy • Rockford: Columbia • Schaumburg: United Audio • Springfield: Sundown One • Spring Valley: Audio Labs • Sterling: Sterling Electronics • Vernon Hills: United Audio • Elgin • Bloomington: Campus Audio • Bluffton: Fine TV & Appliances • Evansville: Riskey's • Ft. Wayne: Lehman's • Indianapolis: Ovation • Jas-

per: Riskey's • Lafayette: Good Vibes • Michigan City: Audio Connection • Muncie: Great Sounds • South Bend: Audio & Computer Specialists • Terre Haute: Stereo Crafters • Vincennes: Riskey's
KS Junction City: Audio Junction • Kansas City: Brands Mart • Overland Park: Audio Electronics • Brands Mart • Wichita: Audio Visions • Topeka: Nelson's
KY Bowling Green: Poston's • Lexington: Ovalion Audio • Louisville: Audio Video Buy Design, Ovation • Madisonville: Riskey Electronics • Owensboro, Paducah: Riskey's • Pikeville: Mayo Inc.
LA Alexandria: Simpson Electronics • Lafayette: Sound Electronics • Metairie & New Orleans: All-terrain Audio • Shreveport: Wrights Sound Gallery
MA Boston & Suburbs: Goodtimes • Tweeter Etc. • Fitchburg: Fitchburg Music • N. Dartmouth: Sound I • Pittsfield: H.B.S. Stereo • Seekonk: Tweeter Etc. • Worcester: O'Coins
ME Bangor: Sound Source
MD Baltimore: Soundscape • Gaithersburg: Audio Buys • Hagerstown: Sunrise Electronics
MI Ann Arbor: Hi Fi Buys • Birmingham: Almas Hi Fi • Dearborn: Almas Hi Fi • Farmington Hills: Almas Hi Fi • Flint: Stereo Center • Grand Rapids: Classic Stereo • Iron Mountain: Sound North • Kalamazoo: Classic Stereo • Lansing: Midland • Hi Fi Buys • Petoskey: Kurtz Music • Rochester: Sound Choice • Saginaw: Court St. Listening Room • Traverse City: Kurtz Music
MN Alexandria: Sound Shop • Duluth: Mel's TV & Audio • East Grand Forks: Maunys • Grand Rapids: Audio Files of Grand Rapids • Mankato: Audio King • Minneapolis & Suburbs: Audio King • Rochester: Audio King • St. Paul: Audio King • Winona: Audio Designs
MO Cape Girardeau: Stereo One • Columbia: Johnson Audio • Jefferson City: The Entertainer • Kansas City: Brands Mart • Springfield: Harvey's Stereo • St. Louis: Sound Central
MS Columbus: Hooper's • Gulfport: Hooper's • Hattisburg: McLeland TV • Jackson: Hooper's • Pascagoula: Empress, Hooper's
MT Billings: Video Sat & Sound • Bozeman: Thrifty Ear • Great Falls: Rocky Mountain Hi-Fi • Kallispell: Audio Visions • Missoula: Aspen Sound
NC Boone: Highland Audio • Carrboro: Stereo Sound • Chapel Hill: Stereo Sound • Charlotte: Audio Video Systems • Concord: Tri City • Greensboro: Stereo Sound • Hendersonville: Audio Connections • Kinston: Stereo Concepts • Moorehead City: Anderson Audio • New Bern: Anderson Audio • Raleigh: Audio Buys, Stereo Sound • Rocky Mount: Microwave Audio • Wilmington: Alliantic Audio • Wilson: Modern Stereo
ND Bismarck: Pacific Sound • Fargo: Today Electronics
NE Kearney: Midwest Audio • Lincoln: Stereo West • Norfolk: Mid City Stereo • Omaha: Stereo West • York: Midwest Audio
NH Concord: Audio of New England • Laconia: Greenlawn Music • North Hampton: The New Audiophile • Salem: Cuomo's
NJ East Brunswick: Atlantic Stereo • Maple Shade: Bryn Mawr Stereo • Paramus: Harvey Electronics • Raritan: AC Audio • Ridgewood: Sounding Board • Shrewsbury: Monmouth Stereo • Toms River: Rands Camera • Trenton: Hais Stereo Sound Center • Wall Twp.: Monmouth Stereo • Westfield: Squarts Audio Video
NM Alamogordo: D&K Electronics • Albuquerque: West Coast Sound • Carlsbad: Jeason's • Clovis: Towse Crier • Santa Fe: West Coast Sound
NV Elko: Elko Audio • Las Vegas: Upper Ear • Reno: Good Guys
NY Albany: Clark Music • Amherst: Speaker Shop • Batavia: Unicorn Audio • Beaufort Hills: The Sound Concept • Buffalo: Speaker Shop • Corning: Chemung • Elmira: Chemung • Forest Hills: Continental Sound • Fredonia: Studio One • Glens Falls: Audio Genesis • Goshen: Long-player's Stereo • Harriman: The Sound Concept • Ithaca: Chemung, Sound Image • Jamestown: Studio One • Massena: Hi Fi Shop • Nanuet: The Sound Concept • Newburgh: Audio Expressions • New Hartford: Adronack Music • New York

polkaudio

The Speaker Specialists®

CTy: Electronic Workshop, Harvey Electronics • Plattsburgh: Alpha Stereo • Queensbury: Audio Genesis • Rochester: JB Sound • Syracuse: Clark Music • Vestal: Hart Electronics • Westbury: Harvey Electronics • White Plains: Harvey Electronics
OH Akron: Audio Craft • Canton: Belden Audio • Cleveland & Suburbs: Stereo Lab • Cincinnati: Stereo Lab • Columbus: Stereo Lab • Dayton: Stereo Showcase • Findlay: Audio Craft • Lima: Classic Stereo • Niles: Reunited Electronics • Toledo: Audio Craft • Wooster: Far East Audio
OK Lawton: Hi Fi Shop • Oklahoma City: Audio Dimensions • Shawnee: Rave Sounds • Stillwater: Cartunes • Tulsa: Audio Advice
OR Eugene: University Hi-Fi • Grants Pass: Sheekelis • Medford: Sheekelis • Portland: Magnolia • Salem: Kellys Home Center
PA Allentown: Bryn Mawr Stereo • Blakely: Hart Electronics • Bryn Mawr: Bryn Mawr Stereo • Camp Hill: Bryn Mawr Stereo • Chambersburg: Sunrise Electronics • Erie: Studio One • Harrisburg: Bryn Mawr Stereo • Jeannette: Audio Communications • Johnstown: Gary's Entertainment • Kingston: Hart Electronics • Lancaster: G'n'l Stereo • Long-horne: Bryn Mawr • Montgomeryville: Bryn Mawr Stereo • Natrona Heights: Stereo Land • Philadelphia & Suburbs: Bryn Mawr Stereo • Pittsburgh: Audio Communications, Audio Junction • Duquesnetown: Bryn Mawr Stereo • Reading: G'n'l Stereo • Sellersville: Stereo Shoppe • State College: Paul & Tony's Stereo • Stroudsburg: Main St. Audio Video • Williamsport: Robert M. Sides
PR TO RICO R10 Piedras: Precision Audio
RI Middleton: Flint Audio • N. Providence: East-ern Audio • Warwick: Tweeter Etc.
SC Anderson: Music Machine • Charleston: Audio Warehouse • Columbia: Music Machine, Sound Advice • Greenville: American Audio • Greenville: Stereo Shop • Spartanburg: Stereo Shop
SD Aberdeen: Engel Music • Rapid City: Team Electronics • Sioux Falls: Audio King
TN Chattanooga: B&R TV • Cookeville: Lindsey Ward • Jackson: New Wave Electronics • Kings-port: Audition • Knoxville: Lindsey Ward • Memphis: Modern Music • New Wave Electronics • Nashville: Hi Fi Buys
TX Amarillo: Sound Systems Ltd. • Arlington: Sound Idea • Austin: Marcum Electronics • Beaumont: John Goodyear Audio • College Station: Audio Video • Corpus Christi: Tape Town • Dallas: Americal • Denton: Bell Audio Video • El Paso: Soundquest • Ft. Worth: Sound Idea • Garland: MJM Audio • Houston: Sheffield Audio • Hurst: Sound Idea • Laredo: Metra International • Long-view: Audio Techniques • Lubbock: Electronics Supercenter • McAllen: Metra • San Angelo: Sound-per • San Antonio: Mobile Hi-Fi • San Marcos: Discovery Audio Video • Sherman: Worldwide Stereo • Temple: Audio Tech • Texarkana: Sound Towne • Victoria: Dyer Electronics • Waco: Audio Tech
UT Logan: Consumer Technologies • Salt Lake City: Broadway Music • St. George: Boulevard Home Furnishings
VA Charlottesville: Holdens • Coincidence: Holdens • Falls Church/Mannassas: Audio Buys • Harrisonburg: Ace Music • N. Electronics • Rad-ford: Holdens • Richmond: Gary's Stereo • Roanoke: Holdens • Virginia Beach: Digital Sound
VT Essex Junction: Creative Sound
WA Bellingham: QC Stereo • Seattle: Music Store • Oak Harbor: QC Stereo Center • Shelton/Bell-view: Lynnwood • Magnolia • Spokane: Electracraft (H&S) • Tacoma: Magnolia
WI Appleton: Sound World • Eau Claire: FS Appliance & TV • Fond Du Lac: Audio Plus • Green Bay: Sound World • Lacrosse: Sound World • Madison: Happy Medium • Milwaukee: Audio Emporium • Oshkosh: Audio Plus • Ripon: Audio Plus • Sheboygan: Genes Sound & Camera • Wausau: Sound World
WV Barboursville, Beckley, Charleston: Pied Piper • Clarksburg: Audio Visual Concepts • Hunt-ington: Pied Piper • Parkersburg: Video Ware-house • Plattsfont: Sound Gallery • Wheeling: Look 'N' Listen
WY Cheyenne: Electronics Unlimited • Gillette/Sheridan: Star Video Library

AUDIO DEN Ltd.

Authorized Sales & Service
Auditions by Appointments

2021 Smith Haven Plaza (Route 347)
Lake Grove, NY 11755 ☐ 516-360-1990

Adcom	Optonica
Aragon	Paradigm
Arcam	Philips
B&K	Proton
CAL	Rogers
Celestion	Shure Ultra
Conrad-Johnson	Sonance
CWD	Sonographe
Grado	SOTA
Hafler	Soundstream
Klipsch	Soundwave
Magnepan	Stax
Mirage	Theta Digital
MIT Cable	Velodyne
Monster Cable	VTL
NAD	Well-Tempered
Nakamichi	Yamaha



Sound Advice...

System 2

System 1

• Audio/Video System •
PIONEER VSX-9700
 RECEIVER - DOLBY PRO-
PIONEER PDM-630
 CD-CHANGER
TANNOY J-95
 SPEAKERS - FRONT
GOODMANS M-100
 SPEAKERS - IN THE REAR

Under \$2500.00!

AUTHORIZED DEALER • DCM • COUNTERPOINT • PS AUDIO • YBA • CREEK • MARANTZ
 HARMON KARDON • JBL • HAFNER • CITATION • MISSION CYRUS • ADS • TANNOY
 GOODMAN • ACOUSTAT • MISSION • OHM • ENERGY • ODEON • TARDIS • AKG
 STRAITWIRE • JVC SUPERDIGIN • TERK • ADVENT • DANTAX • GOLDRING • LANTANA
 DUAL • REVOLVER • THORENS • SONANCE • STEREO STONES • LAZARUS and much more

PIONEER VSA-1000

INTERGRATED AMPLIFIER
 DOLBY PROLOGIC
PIONEER CLD-1080
 LASER DISC
ACOUSTAT SPECTRA
 11 SPEAKERS - FRONT
CASTLE 'TRENT'
 SPEAKERS - IN THE REAR

Under \$2500.00!

• Don't get talked out of this system! •

Sound Equipment...

System 3

CREEK 4040
 POWER AMPLIFIER
REVOLVER
 'REBEL' TURNTABLE
 w/ 'GOLDRING'
 CARTRIDGE
TANNOY E-11
 SPEAKERS

Under \$1000.00!

• Financing Available •

212-691-5823/24

HI-FI CITY is the first step in 'Hi-Fidelity Retail'

Sound Deals!

November Special a/d/s

R4 RECEIVER \$649
CD4 CD-PLAYER \$449
C2/3 TAPE-DECK \$299

145 W. 26th St. NYC NY 10001

WE ACCEPT ALL MAJOR CREDIT CARDS!

TAKE THE SOUND APPROACH

AUTHORIZED DEALERS FOR:

- ADS
- ALPHASONIC
- BAZOOKA
- BOSTON ACOUSTICS
- CARVER
- DENON
- HAFNER
- INFINITY
- KENWOOD
- KICKER
- MONSTER CABLE
- ONKYO
- POLK
- YAMAHA

• Some Items In Store Only •

THE SOUND APPROACH

6067 JERICHO TPKE., COMMAK, NY 11725
 516-499-7680

THE DAT STORE

DIGITAL AUDIO TAPE RECORDERS
 MONDAY THRU FRIDAY: 9:00-6:00 WEEKENDS: 1:00-4:00
 OVER 25 MAKES & MODELS--IN STOCK NOW!

PANASONIC SONY JVC AKAI
 CASIO PIONEER NAKAMICHI
 NEC TASCAM SHARP FOSTEX

& Introducing the smallest DAT to date:
THE AIWA HD-X1
 DIRECT DIGITAL RECORDING MASH FILTERS
 DIGITAL IN & OUT RECHARGEABLE BATTERY
 256X OVERSAMPLING SUB-CODE EDITING
 A/D CONVERTER W/WIRED REMOTE & CASE INC.

2624 WILSHIRE BOULEVARD
 SANTA MONICA, CA 90403
 (213) 828-6487 / FAX (213) 470-6176

STEREO REVIEW CLASSIFIED

For More Advertising Information
 Call 1-800-445-6066 9am - 5pm EST

AUTHORIZED

CALL TOLL FREE! 1(800) 826-0520.
 ONKYO * NAD * HARMAN KARDON *
 PROTON * AUDIO CONTROL * CITATION
 * JBL * LEXICON * HAFNER * M&K * STAX
 * CELESTION * KINERGETICS * NITTY
 GRITTY * PROAC * DAHLQUIST * BELLES
 * dbx * FRIED * CWD * MONSTER CABLE *
 DCM * GRADO * NILES * VELODYNE *
 SOUND SELLER, 1706 MAIN ST., MARINETTE,
 WI 54143. FAX # (715) 735-5838, PHONE
 (715) 735-9002.

WE SELL MORE HIGH PERFORMANCE SPEAKER KITS
 than anyone in the U.S. FREE CATALOG: 1 (800) 346-9183.
 AUDIO CONCEPTS Dept. A, 901 S. 4th St., LaCrosse, WI
 54601.

CABLE TV CONVERTERS/DESCRAMBLERS. Guaranteed
 lowest prices in U.S., Jerrold, Hamlin, Zenith—many others!
 Lowest dealer prices! Orders shipped within 24 hours!
 MasterCard—Visa—C.O.D. accepted. Free catalog—Call
 (800) 345-8927 only! Pacific Cable Co., Inc., 7325 1/2 Reseda
 Blvd., 1368, Reseda, CA 91335. All other information, call (818)
 709-9937.

EXPERIENCED, FRIENDLY ADVICE! AUDIRE, PS, CWD,
 STAX, KINERGETICS, THORENS, MIRAGE, AUDIOQUEST,
 FRIED, MONSTER, QUAD, SPICA, STRAIGHTWIRE,
 MORE!! FREE SHIPPING! READ BROTHERS STEREO,
 593-B KING STREET, CHARLESTON, SC 29403. (803)
 723-7276.

LOW PRICES!! NAD, DENON, HK, NA-
 KAMICHI, CARVER, BOSTON ACOUSTICS,
 LUXMAN, HAFNER, ADS, B&K, ONKYO, PRO-
 TON, BOSE, SNELL, JBL, M&K, PS AUDIO &
 OTHERS!! SOUND ADVICE: (414)727-0071.
 OPEN SUNDAYS!!!

"STEREO WORLD" IS YOUR DISCOUNT MAILORDER
 SOURCE WITH SUPER DEALS ON HOME AND CAR STE-
 REO LINES INCLUDING: KENWOOD, TECHNICS, PAN-
 ASONIC, JVC, SONY, PYLE, PIONEER, SHERWOOD, JBL,
 HIFONICS, BLAUPUNKT, AUTOTEK, ADVENT, AND MANY
 OTHERS. CALL OR WRITE FOR FREE CATALOG. FREE
 UPS IN 48 STATES. 10AM-6PM MON-FRI; VISA/MC, COD
 ACCEPTED. OUR 4TH YEAR. P.O. BOX 596, MONROE, NY
 10950. (914) 782-6044.

SAVE 40% ON HIGH-END home speakers,
 subwoofers, amplifiers. FREE CATALOG!
 RTRD, 3021 Sangamon Ave., Springfield, IL
 62702. 1 (800) 283-4644.

The Sound Seller

For the Musical Difference
 Authorized Dealer For:

Acoustat	NAD
Audio Control	Belles
Nitty Gritty	CWD
M&K	dbx
Nakamichi	Fried
Oracle	Harman Kardon
Polk	JBL
PROAC	Onkyo
Proton	Grado
STAX	Lexicon
Thorens	Celestion
Dahlquist	DCM
Hafner	Niles
Monster Cable	Kinergetics
Citation	Duntech
Velodyne	Carver
Pattern	

1706 Main St.
 Marinette, WI 54143
 (715) 735-9002

Sound City

AUTHORIZED DEALER

• ADC	• FISHER	• PCA
• ADS	• GE	• SAE
• ADVENT	• HAFNER	• SANSUI
• ANWA	• HITACHI	• SANYO
• AKG	• JVC	• SONANCE
• ALTEC LANSING	• KENWOOD	• SONY
• AUDIO SOURCE	• KICKER	• SOUND CRAFTSMEN
• BAZOOKA	• LEXICON	• SOUNDSTREAM
• BBE	• MINOLTA	• STAX
• BELLTRONICS	• MITSUBISHI	• STILLWATER
• CAMBER	• MONSTER CABLE	• 'KICKER'
• CARVER	• MISSION	• SUNPACK
• CELESTION	• NILES AUDIO	• TECHNICS
• CERWIN VEGA	• ONKYO	• TOSHIBA
• CITIZEN	• ORION (CAR AMPS)	• TRIAD
• COBRA	• OLYMPUS	• YAMAHA
• COUSTIC	• PANASONIC	• AND MANY MORE
• CWD	• PARADIGM	
• dbx	• PHILIPS	
• DCM	• PINNACLE AUDIO	
• DENON	• PROTON	
• ECLIPSE	• ROYAL	

CALL FOR ANY BRANDS NOT LISTED!

Meadlown Shopping Center
 Rt. 23 South
 Kinnelon NJ. 07405

the only number you'll ever need.
201-838-3444

AUTHORIZED

High-end and hard-to-find audio components. Low, low prices! **AUDIO AMERICA** (Virginia). Call 1-703-745-2223.

CALL US LAST

WE WILL
BEAT ANY PRICE
PRINTED IN THIS MAGAZINE ON
AUDIO & CAR STEREO

The SOUND Approach

6067 Jericho Tpke., Commack, NY 11725
FAST DELIVERY (516) 499-7680
FULL WARRANTY

SAVE UP TO 60% AT
RADAR WORLD
NOBODY TREATS YOU BETTER SINCE 1976

SPECTRUM **REAR \$295** PASSPORT **K40**
B&B Cobra maxon uniden
MEMBER BETTER BUSINESS BUREAU

WE WILL MEET OR BEAT ANY PRICE

- 30 DAY PRICE GUARANTEE
- 30 DAY MONEY BACK GUARANTEE
- ALL MODELS NEW/FULL WARRANTY
- 1 DAY TO 1 WEEK DELIVERY

ALL ORDERS ARE CHECKED FOR FRAUD

FREE Double Warranty UP TO 1 EXTRA YEAR Ask About Our 60 Day & Max Trial
RADAR WORLD 1-800-237-BUYS M-F 9-5 CST CALL NOW!
A DIVISION OF COMP-U-TRONIX 1-800-USA-4566 Sat. Sun. & After 5 pm CST

CALL TO ORDER OR FOR PRICES 24 HOURS EVERYDAY!
RADAR WORLD 210 S. Milwaukee, Wheeling, IL 60090

SERIOUS AUDIOPHILES DESERVE SERIOUS SERVICE.

And that's what you will get at Reference Audio/Video. We offer the best in high-end audio and the best in friendly service by our knowledgeable staff. From the latest CD players to the finest high-power amplifiers, you'll like our surprisingly affordable prices and fast shipping.

Holiday Gift Certificates Available

Reference AUDIO/VIDEO

Call us at (213) 517-1700

18214 Dalton Ave, Dept. S, Gardena, CA 90248
Hours: M-F 9 to 6, Sat. 9 to 1 Pacific Time

COUNTERPOINT · L
REVOX · ACOUSTAT
MOD SQUAD · JSE
DAHLQUIST · BOSE
NEC · DBX · MELOS
HALFER · PROTON
PS AUDIO · ONKYO
CELESTION · PHIL
LEXICON · CREST
VELODYNE · STAX
FOSGATE · PRECIS
VPI · AUDIBLE ILL
DCM · OHM · TEAC
JBL · HARMAN KAR
SUPERPHON · AKG
SONANCE · MERLIN
JAMO · SAE · DUAL
TANNOY · WHARFE
KIMBER'S NITTY

LOUDSPEAKER COMPONENTS—KITS. Eton, Dynaudio, Focal, Eclipse. Catalog \$1. Meticus, 2442 28th St. S.W. Wyoming, MI 49509. (616) 534-9121.

HIGH-END LOUDSPEAKER systems, speaker kits and the widest selection of raw drivers from the world's finest manufacturers. For beginners and audiophiles. Free catalog. A&S SPEAKERS, 3170 23rd St., San Francisco, CA 94110. (415) 641-4573.

SINGERS! REMOVE VOCALS FROM RECORDS AND CDs!

SING WITH THE WORLD'S BEST BANDS!
An Unlimited supply of Backgrounds from standard stereo records! Record with your voice or perform live with the backgrounds. Used in Professional Performance yet connects easily to a home component stereo. This unique product is manufactured and sold Exclusively by LT Sound - Not sold through dealers. Call or write for a Free Brochure and Demo Record.
LT Sound, Dept. SR-5, 7980 LT Parkway Lithonia, GA 30058 (404) 482-4724
Manufactured and Sold Exclusively by LT Sound
24 HOUR PHONE DEMO LINE: (404) 482-2485

CABLE TV DESCRAMBLERS—FREE CATALOG! 1-800-648-7938. Jerrold, Oak, Hamlin, etc. Guaranteed Lowest Dealer and Retail Prices, Warranties, Immediate Delivery. MC/VISA/COD. Republic Cable Products, Inc., 4080 Paradise Road, #15, Dept. 712, Las Vegas, NV 89109.

PHILIPS, AUDAX, PEERLESS, FOCAL, AND DYNAUDIO LOUDSPEAKERS in stock with good prices and competent service. Crossover components also. MADISOUND SPEAKER COMPONENTS. 8608 University Green, Box 4283, Madison, WI 53711. (608) 831-3433.

DIAMOND NEEDLES, PHONO CARTRIDGES & ACCESSORIES. AUDIO-TECHNICA, AUDIOQUEST, BANG & OLUFSEN, DYNAVECTOR, GRACE, LAST, ORTOFON, PICKERING, SHURE, SIGNET, STANTON, SUMIKO, TARGET, TWEAK & ULTRA. TOLL FREE INCLUDING CANADA (800) 221-0906. N.Y. (516) 599-1112. CREDIT CARDS ACCEPTABLE. FOR CATALOG SEND SELF ADDRESSED STAMPED ENVELOPE. LYLE CARTRIDGE, DEPT S2, P.O. BOX 158, VALLEY STREAM, N.Y. 11582.

FOR SALE

THE BEST RECORD RACK IN AMERICA. Stackable, portable, oak units hold LPs, CDs and tapes. Free Mailorder Brochure, (please mention Stereo Review). Per Madsen Design: (415) 928-4509. P.O. Box 330101, San Francisco, CA 94133.

LOW PRICES—HIGH END EQUIPMENT: Carver, Nakamichi, Infinity, Hafler, Luxman, ADS, B&K, Bose, Onkyo, Proton, Philips and much more! (414) 725-4431.

WE SELL SECOND HAND high quality Audio and Video with a money back guarantee. We Modify quality components Too! For a FREE monthly inventory send your name and address to: ROSS' EXCHANGE 3061 Clairemont Dr. San Diego, CA 92117 or call (619) 276-8235.

A.D.S., ADCOM, BANG & OLUFSEN, B&W, CARVER, DENON, HARMON/KARDON, NAKAMICHI, KEF, REVOX AND OTHER QUALITY COMPONENTS. ALL PRODUCTS COVERED BY MANUFACTURER'S U.S.A. WARRANTIES. AMERISOUND SALES INC. 24 HRS, EAST: (904) 262-4000, WEST: (818) 243-1168.

CASH FOR ALL TYPES of used Stereo equipment. We buy by phone. THE STEREO TRADING OUTLET, 320 Old York Rd., Jenkintown, PA 19046. (215) 886-1650.

IN-WALL STEREO SPEAKERS. All major brands IN STOCK. Quantity discounts. Contractors welcome. Fast delivery. **THE SOUND APPROACH, 6067 Jericho Tpke., Commack, NY 11725 (516) 499-7680.**

DENON

AUTHORIZED DEALER

The mark of a true Denon.

This sticker tells you who is an authorized Denon dealer and who isn't.

Some people who offer Denon products are not authorized dealers. That can lead to problems.

First, *only* authorized dealers offer you the protection of a Denon warranty with your purchase: at other dealers, you may have no warranty at all.

Authorized Denon dealers stock only components designed for the U.S., and have the training to help you select the one right for you.

Authorized dealers know Denon technology inside and out and stock factory parts for your Denon to preserve true Denon sound.

So before you buy your Denon, look for this Denon Authorized Dealer Sticker.

It assures you of the authentic Denon technology and support you expect. And nothing less.

To find your nearest AUTHORIZED Denon Dealer call:
1-201-575-7810
(9:00 am-5:00 pm EST) **DENON**

FREE Catalog. Best Prices on DJ Sound & Lighting Equipment. Call SUPERIOR SOUND & LIGHTING 1-(800) 359-9201.

Wholesale Connection

To order-Call: (718) 997-6644

CD PLAYER		HOME SPEAKER	
Technics	SLP370 \$159	Advent	Heritag 489
	SLP550 239		Maestro Call
	SLP645 259		Legacy 339
JVC	XL2611 299		Prodigy Tower 239
	XL2431 269		Baby II 149
	XL4403 259	Bose	102 Series II Call
Pioneer	XL5512 Call		6.2 429
	PDM510 Call		4.2 319
Kenwood	DP7020 299		AM5 Call
	DP5020 249		SE5 Call
	DPMS620 249	JBL	101 159
Yamaha	CDX820 429		LX22 Call
	CDX730 289		LX44 Call
	CDXC10 429		JBL2800 319
	CDC605 249		Pro Performer Call
	CDP790 249		
Sony	CDP690 219		
	CDPC705 Call		
	CDPC905 239		
	CDPC900 Call		
RECEIVERS		TURNTABLE	
Technics	SAG3300 229	Technics	SL1200MKII 359
	SAG5000 299		
	SAG3700 399	CAR STEREO	
JVC	RX903 599	Blaupunkt	Atlanta Call
	RX803 399		New Orleans Call
	RX703 349		Phoenix 229
	RX503 249		Boston 229
	RX1010 Call		Newport 189
Yamaha	RX830 479	JVC	KSRK190 199
	RX730 399		KSRK1010 229
	RX530 319		KSR500 169
	RX330 239		KSRG3 249
Kenwood	KRV9020 569		KSRG5 299
	KRV8020 459		XLG3500 399
	KRV1020 329		CDX6020 349
	KRV6020 269	Sony	CDX7580 Call
Sony	STRAV1020 Call		CDXA30 Call
	STRAV520 349		XR1180 329
	STRAV720 279		XR1417 189
	STRAV320 199	Sound Stream	TC301 259
	STRAV220 159		TC303 329
TAPE DECK			TC306 Call
Technics	RSTR155 149	Kenwood	KDC93R 379
	RSTR265 189		KDC83R Call
	RSTR355 259		KRC777 Call
JVC	TDV1010 Call		KRC610 319
	TDV711 399		KRC510 279
	TDV531 259	Sansul	KRC3004 199
	TDW901 Call		RX100 129
	TDW803 249		RX3100 139
Kenwood	KRW5020 399		
	KRW6020 219		
Yamaha	KXR730 Call		
	KR630 Call		
	KRW602 399		
	KRW202 259		
Sony	TCRX420 179		

CALL FOR PRICES on Models and Brands Not Listed
HRS. Mon-Sat 10 AM-5 PM EST Prices subject to change. Prices exclude shipping & handling. Not responsible for typographical errors. MasterCard, Visa and C.O.D. accepted. Write To
Wholesale Connection 63-48 108th St. Forest Hills, NY 11375

CAR STEREO

"The Quick Connection"

B.J. AUDIO

991 Beechmeadow
Cincinnati, OH 45238
(513) 451-0112

HOME

CARVER • ADC • DESIGN ACOUSTICS • DENON • POLK
CELESTION • ADCOM • NAD • PARADIGM

CAR

ALPINE • BOSTON ACOUSTICS • AUDIO CONTROL • POLK AUDIO • JVC • KENWOOD • CARVER • SOUNDSTREAM • NAKAMICHI • PYRAMID • AUTOTEK • ADS • COUSTIC • BAZOOKA • INFINITY • PRECISION POWER • MB QUART • DENON • SONY • YAMAHA • PYLE • CLARION

M/C. Visa or COD

CAR STEREO'S... LOWEST PRICES GUARANTEED! Alpine, Kenwood, Rockford Fosgate, Kicker, Coustic, MTX, JVC, JBL, ADS, Impact, Pioneer, Sony, Autoteck, Savard, Code Alarm, Whistler. M/C, VISA or COD. CALL STEREO WAREHOUSE NOW! *****1-800-284-5596****

WANTED TO BUY

TOP DOLLAR PAID FOR QUALITY LP & CD COLLECTIONS! ROCK, JAZZ, CLASSICAL (especially Early MERCURY, RCA, LONDON Stereo, LYRITA, British EMI). U.S.A.'s LARGEST USED/COLLECTOR SHOP! PRINCE-TON RECORD EXCHANGE, 20 TULANE STREET, PRINCE-TON, N.J., 08542. (609) 921-0881.

GOVERNMENT SURPLUS

IS IT TRUE Jeeps for \$44 through the U.S. Gov't? Call for facts! (504) 649-5745 ext 59452.

AUDIO/VIDEO STORAGE

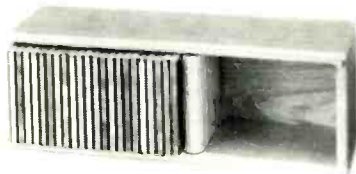

HANDCRAFTED, SLOTLESS, 40 Disc Cabinet. Stackable, hangable, space-efficient design. Solid oak or walnut—no veneers. See Dec. '89 New Products. \$39.95 postpaid & guaranteed. DISC-CONCEPTS, 9861 Copperhill, St. Louis, MO 63124 (314) 768-0103.

ATTENTION CLASSIFIED ADVERTISERS

The CLASSIFIED MAGNET attracts prime prospects for your mail order products and services.

Reach the readers (proven buyers) of this and other DCI Magazine titles through low cost Marketplace Classified advertising.

To place your ads, or for further information (including rates, ad styles, sizes and multi-title discounts), call Lois Price Toll-Free at:

(800) 445-6066

This publication is available in microform from UMI.

U-M-I

800-521-0600 toll-free
313-761-4700 collect from Alaska and Michigan
800-343-5299 toll-free from Canada

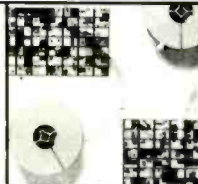

NEW YORK WHOLESALE

DINERS CLUB

- Prices subject to change
- Prices exclude shipping charges
- Not responsible for typographical errors

FOR FASTEST SERVICE CALL **(212) 684-6363** OR FAX **(212) 684-8046**

HOURS: MONDAY-FRIDAY, 9AM-7PM EST • SATURDAY 10AM-5PM

or Write Direct: 2 PARK AVENUE, DEPT. 15, NEW YORK, N.Y. 10016

We sell authorized U.S. branded merchandise and parallel imports. All products covered by manufacturer's warranty or New York Wholesaler's exclusive limited warranty. Manufacturer's rebates may not apply. Ask for full details at the time of purchase.

CO PLAYERS	RECEIVERS	CASSETTE DECKS	CAR STEREO	CAR STEREO
HARMON KARDON	PIONEER	NAKAMICHI	NAKAMICHI	KICKER
HD7300 MK II Call	SX1700 169	CALL FOR LOW PRICES	RD260 269	Kicker 199
HD7400 MK II For	SX2700 229		RD460 489	Super Kicks 249
HD7500 MK II New	VSX3600 309	TDW203 JVC 149	RD540 529	Kicker2 199
HD7600 MK II Prices	VSX4700S 429	TDW303 179	RD560 649	Super2 249
	VSX5700S 489	TDW503 209	CD760 999	
	VSX9700S 699	TDW901 349	CCD101 649	DENON
YAMAHA	VSX01S 899	TW521 279	TD1560 699	DCR4170 159
CCD605 259		TDR431 189	PAQ30 389	DCR5170 199
CCD610 469	NAD	TDX331 169	PAQ31 389	DCR5370 329
CCD705 339		TDV1010 489	PAQ24 249	DCR5470 389
CNC805 429			SP200 209	DCR8970 449
CDX530 239	7000 449		SP10 109	DCC1570 399
CDX730 299	7225 279		SP40 149	DCA3180 159
CDX930 New 449	7240 429	6325 209	SP50 119	DCA3400 259
DCX1030 New 749	7100 629	6340 329	SP55 199	DCA3500 429
	7600 1099	6100 419	SP80 199	DCR2720 299
	7400 899		SP1010 149ea	DCR5270 249
			SP60 139	DCR4270 239
			EC200/EC200H 199ea	DCR7870 449
			PC100 79	
				SOUNDSTREAM
				MC140 349
				D60 II 179
				D100 II 279
				D200 II 399
				TC303 339
				TC306 429
				A40 249
				SS10 299PR
				SS50 249
				SS8 109ea
				SS4.0 79
				MC300 619
				ADS
				6.2 149
				642CSI 199
				200i 229
				PH12 269
				PO10 389
				PO8 189
				PH15 519
				PS5 219
				PO20 589
				S87 299
				S810 369
				300IS 299
				320IS 419
				INFINITY
				RS502 .89
				RS602 .99
				CS4 179
				CS5 199
				RS42K Call
				RS52K 109
				62K 149
				63K 169
				693K 189
				BOSTON
				4.2 Pro 259
				5.2 Pro 279
				757 89
				499 797
				249 763
				149 767
				389 841
				299 851
				239 861
				C700 159
				C793 259
				6.2PRO 299
				SAS-BAZOOKA
				T52 139
				T16 159
				T18 229
				T62 159
				T82 229
				T102 159
				T62A 229
				RADAR DETECTORS
				COBRA Call
				BEL For
				UNIDEN Prices
				FAX
				Sharp Call
				Panasonic For
				Canon Latest
				Toshiba Prices
				Murata Prices
				PORT CD PLAYERS
				SONY D180 219
				SONY D66 199
				SONY D2 169
				SONY D25 279
				SONY D35 299

TIPS FOR MAIL ORDER PURCHASERS

It is impossible for us to verify all of the claims of advertisers. Therefore, the following information is provided for your protection:

1. **Confirm price and merchandise information** with the seller, including brand, model, color or finish, accessories and rebates included in the price.

2. **Understand the seller's return and refund policy**, including the allowable return period and who pays the postage for returned merchandise.

3. **Understand the product's warranty.** Is there a manufacturer's warranty, and if so, is it from a U.S. or foreign manufacturer? Does the seller itself offer a warranty? In either case, what is covered by warranty, how long is the warranty period, where will the product be serviced, what do you have to do, and will the product be repaired or replaced? You may want to receive a copy of the written warranty before placing your order.

4. **Keep a copy of all transactions**, including cancelled checks, receipts and correspondence. For phone orders, make a note of the order including merchandise ordered, price, order date, expected delivery date and salesperson's name.

5. **If the merchandise is not shipped within the promised time** or if no time was promised, 30 days of receipt of the order, you generally have the right to cancel the order and get a refund.

6. **Merchandise substitution** without your express prior consent is not allowed.

7. **If you have a problem with your order or the merchandise**, write a letter to the seller with all the pertinent information and keep a copy.

8. **If you are unable to obtain satisfaction from the seller**, contact the consumer protection agency in the seller's state or your local U.S. Postal Service.

CLOSE-OUT SALE!

Now you can buy copies of *Total Harmonic Distortion*, the hilarious collection of Charles Rodrigues cartoons from *Stereo Review*, at **half price** — only \$4 each, plus postage and handling. The handsome, 128-page trade paperback contains 118 classic cartoons about audio, video, and music, a foreword by William Livingstone, and an illustrated autobiographical sketch by Rodrigues himself. **Makes a great gift!** Orders received before November 15 will be shipped in time for Christmas. Fill out the order form below and mail with your payment today!

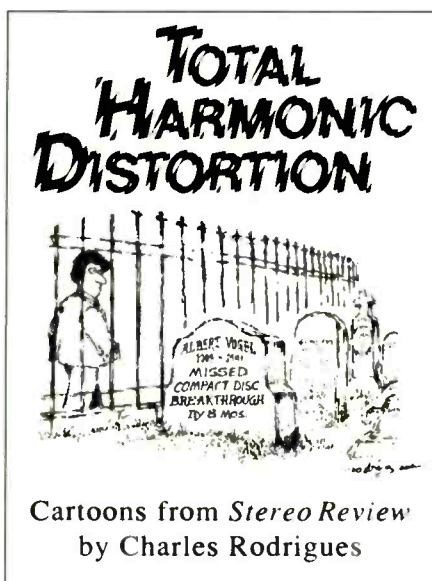

Cartoons from *Stereo Review*
by Charles Rodrigues

YES, please send me 100% of *Total Harmonic Distortion* at 50% of the original \$7.95 price!

No. of copies ordered _____ × \$4 = \$ _____

Enclose a check or money order payable in U.S. funds to **Perfectbound Press** for the amount above **plus \$1.50** for postage and handling (\$2.50 for orders outside the U.S.). New York State residents also add **33¢ per copy** sales tax.

NAME (please print) _____

STREET ADDRESS _____

CITY _____ STATE _____ ZIP _____

Send your order with payment to Perfectbound Press, Suite 4118, 1120 Avenue of the Americas, New York, NY 10036. *Please allow up to six weeks for U.S. delivery, longer outside U.S.*

INDEX TO ADVERTISERS

READER SERVICE NO.	ADVERTISER	PAGE NUMBER
60	Adcom	37-42
50	Allen Products Co.	6
80	Altec Lansing	62-63
58	API-Energy	100
37	Audioquest	69
—	B.I.C. America	6
67	Blaupunkt	148
—	BMG-CD Club	45
—	BMG-Int'l Preview Society	141
24	Bose	56-57, 73, Cover 4
—	Bose Express Music	100
157	Cambridge SoundWorks	150-151
118	Cambridge SoundWorks	32
—	Carver Corporation	152
—	CBS-Columbia House CD Club	33
56	ComponentGuard	34
88	Cooustic	65
68	Cooustic	66-67
—	Crutchfield	8
193	Definitive Technology	72, 143
27	Denon	53
32	Design Acoustics	35
1	Electronic Wholesalers	169
58	Energy	100
165	Geneva	145
—	Illinois Audio	171
100	Image Entertainment	128-129
—	Infinity	4-5
39	J&R Music World	160-163
69	KEF	143
2	Klipsch	Cover 3
52	Luxman	106
29	McIntosh	104-105
194	Memtek	153
22	Mitsubishi	18-19
109	Mobile Fidelity	157
74	Nakamichi	138
47	Onkyo	46
97	Paradigm	147
—	Perfectbound Press	181
—	Phase Linear	12
—	Philip Morris-Buck	97
—	Philip Morris-Marlboro	71
—	Philips	Cover 2, 55
31	Pioneer-Car	31
—	Pioneer-Home	21-28
90	Polk Audio	9-11
—	PolyGram	7, 112
93	Proton	13
94	Pyle	133
—	Radio Shack	109
—	R.J.R.-Magna	59
99	Sansui	2
103	Sherwood	134-135
—	6th Avenue Electronics	166-167
—	Smirnoff	14
59	Sonance	137
—	Sony	49
108	Soundcraftsman	17
—	TDK	50-51
181	Technics	115-122
—	Yamaha	130, 144, 146
—	Wisconsin Discount Stereo	173

NOVEMBER



by *Christie Barter*
& *Maryann Saltser*

THIS year would have seen John Lennon's fiftieth birthday. The anniversary was marked last May by a star-studded tribute concert in Liverpool's Pierhead, and taped footage of the concert will be broadcast in the U.S. in early December (check local listings). The broadcast, to be hosted by the actor and producer Michael Douglas, will also include additional performances of Lennon songs by artists who were unable to be at the Liverpool concert, including U2, David Bowie, Elton John, and Michael Jackson.

The concert started with a rendition of *All You Need Is Love* by the Royal Philharmonic. Cyndi Lauper put her unique stamp on *Working Class Hero* and *Hey Bulldog*. Joe Cocker gave his version of *Come Together*, and Natalie Cole rocked out in *Ticket to Ride*. Dave Edmunds, who also served as the show's musical director, sang *Strawberry Fields Forever*, and New Yorker Lou Reed did his takes on *Mother* and *Jealous Guy*. A countrified *Nowhere Man* came from Randy Travis, Ray Charles put over *Decision*, and the grand finale featured a rousing rendition of *Imagine* with audience participation.

Profits from the concert

Lauper: Lennon tribute



Waters: tearing down the wall

and the broadcast will go to the Spirit Foundation, an environmental charity founded by Lennon and his wife in 1978, as well as the newly established John Lennon Scholarship Fund. □

ALSO slated for U.S. telecast this fall is a tape of what was billed as the most elaborate musical production ever staged, the July 21 performance of Pink Floyd's rock opera *The Wall* at the site of the Berlin Wall. By all accounts, the show was a smashing success. Performing on a huge stage that took a month to build were former Pink Floyd member Roger Waters and an all-star cast that included Sinéad O'Connor, Marianne Faithfull, Joni Mitchell, Thomas Dolby, Van Morrison, and Ute Lemper, accompanied by the East Berlin Radio Symphony Orchestra and Chorus and the marching band of the Combined Soviet Forces in Germany. Fireworks, helicopters, and giant puppets contributed to the festivities. At the end, Waters cried, "Tear down the wall!" and 2,500 white foam bricks came crashing to the stage below.

The show was witnessed by a live audience of more than 300,000 cheering fans and an estimated one billion television viewers worldwide (ex-

cept in the U.S.). It was the first fund-raising event of the Memorial Fund for Disaster Relief, a new international agency. Mercury/PolyGram rush-released a live double album of the show in September. A video is in the works. □

Dmitry Sitkovetsky, who figured in the news recently as the first Russian emigré violinist since World War



Sitkovetsky: busy in London

II to perform in the U.S.S.R. by official invitation, has now settled in as a mainstay of the London-based Virgin Classics label. He's already represented on CD by the two violin concertos of Prokofiev, with the London Symphony under Colin Davis, and an album containing the violin sonatas of Debussy, Janáček, and Richard Strauss. His latest recording, released in Septem-

ber, is a coupling of the two Shostakovich concertos, in which he's accompanied by the BBC Symphony under Andrew Davis.

Upcoming releases from Sitkovetsky include the violin concertos of Bela Bartók, with Libor Pešek and the London Philharmonia, the Beethoven concerto with Neville Marriner and the Academy of St. Martin-in-the-Fields, and a coupling of the Brahms and Mendelssohn concertos with the Leipzig Gewandhaus Orchestra under Kurt Masur. □

WHEN twenty-four top U.S. songwriters went to Moscow a couple of years ago, they went, according to Epic Records, "to join forces with their Soviet counterparts in the creation of exciting new music." Eleven of the songs that came out of the collaboration have now been gathered together in an Epic album titled "Music Speaks Louder Than Words." The performers include Atlantic Starr, Phoebe Snow, and Earth, Wind & Fire as well as Cyndi Lauper, who sings her own contribution, *Cold Sky*, co-written with Franke Previte, Alan Roy Scott, and Igor Nikolajev. A portion of the proceeds from the album is being donated to AFS Intercultural Exchanges, which places exchange students with host families in some seventy countries around the world. □

TEN years ago Charles Dutoit and the Montreal Symphony saw the release of their first recording for London/Decca, an album of works by Ravel including the *Daphnis et Chloé* Suite No. 2. To celebrate the anniversary, the label has released a compilation of some of the best-selling Dutoit/Montreal recordings in a special edition of ten CD's under the title "The Virtuoso Sound."

Having completed his thirteenth season as music director of the Montreal Symphony, Dutoit recently renewed his contract with the orchestra through 1992-1993. □

POLYGRAM recently released a live double album, titled "Knebworth,"

KEVIN MAZUR/LONDON FEATURES

BRIAN ARIS/OUTLINE

VIRGIN CLASSICS





PHOTOS BY FRANK MICELOTTA

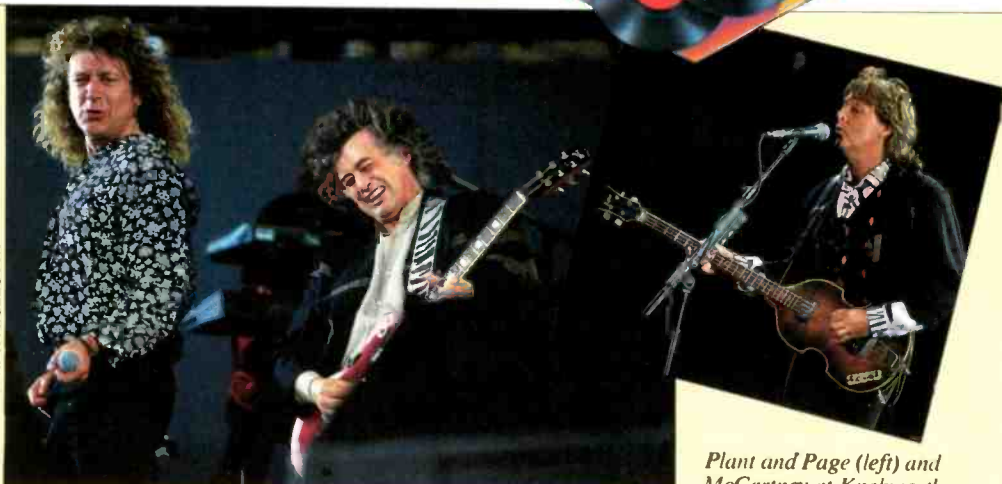

Plant and Page (left) and McCartney at Knebworth

that documents a very special day-long benefit concert in England this past June. It was standing room only for 120,000 fans in Knebworth Park, outside London, when Britain's rock-and-roll elite took the stage to raise money for the British Recording Industry Trust's School for Performing Arts and the Nordoff Robbins Music Therapy Center for autistic children.

Rain failed to dampen spirits as Paul McCartney delivered a medley of Beatles classics including *Help* and *Hey Jude*. Robert Plant, reunited with former bandmate Jimmy Page, played an energetic three-song *Led Zeppelin* set that included *Misty Mountain Hop* and *Rock and Roll*. Mark Knopfler, Eric Clapton, and Elton John got together for a "supergroup" jam, and Pink Floyd brought the concert to a close. Other featured perform-

ers included Tears for Fears, Phil Collins and Genesis, Cliff Richard and the Shadows, and Status Quo. □

MOSCOW-BORN Yuli Turofsky, now a Canadian citizen living in Montreal, is an exclusive Chandos recording artist and one of the label's busiest—on three fronts. He's recorded fifteen Chandos albums as conductor of the chamber orchestra I Musici de Montréal, which he founded in 1983, and twenty as cellist for the Borodin Trio, with pianist Luba Edlina and violinist Rostislav Dubinsky. He is also represented in the Chandos catalog as half of the Turofsky Duo, the other half being his wife, the violinist Eleonora Turovsky.

Just out is conductor Turofsky's latest with I Musici de Montréal, an album of short works by Benjamin Britten.

Turovsky: triple threat



Included is the rarely performed *Young Apollo*, Op. 16, for piano and strings, first performed in Toronto in 1939. □

THE rerelease on compact disc of the *Wizard of Oz* soundtrack by CBS Special Products, honoring the fiftieth anniversary of the film's debut, spearheaded the recent rerelease of nine other MGM soundtrack classics: *Gone with the Wind*, *Gigi*, *Easter Parade*, *Kismet*, *Showboat*, *Singin' in the Rain*, *An American in Paris*, *Brigadoon*, and *Your Cheatin' Heart*, all of which have been remastered and extended to include previously unreleased material. A second batch is just now arriving in soundtrack record bins, including five more musicals—*The Band Wagon*, *Summer Stock*, *Kiss Me Kate*, *Silk Stockings*, and *The Unsinkable Molly Brown*—and two of MGM's most popular instrumental soundtracks, *Doctor Zhivago* and *2001: A Space Odyssey*, all on compact disc for the first time.

Also new from CBS Special Products is a "Rock Goes to the Movies" series of five CD compilations of material derived from a variety of film sources. Featured are a number of rare tracks by Pink Floyd, the Grateful Dead's Jerry Garcia, the Yardbirds, the Hollies, and the Dave Clark Five. □

MOVE over, David Bowie. Some landmark rock-and-roll retrospective boxed sets are being released on CD.

LP (in one case), and cassette this fall.

First out, released in September on PolyGram, is a three-CD or three-cassette box for Eric Clapton fans titled "The Layla Sessions: 20th Anniversary Edition." It includes tracks originally recorded at Miami's Criteria Studios by Clapton with the late Duane Allman and friends from August to October 1970, lengthy jams by Clapton, Derek and the Dominoes, and the Allman Brothers, and outtakes and alternate mixes.

Slated for October is "Tales from the Brothers Gibb, A History in Song 1967-1990," also on PolyGram. The four-CD/cassette set spans the Bee Gees' career, from their very first hit to their most recent album, "One."

Also scheduled for October release, on Atlantic, is a four-CD/cassette, six-LP *Led Zeppelin* boxed set (titled simply "Led Zeppelin") that's guaranteed to surpass all previous Zeppelin CD's in terms of sound quality, partly because Jimmy Page himself is supervising the remastering. □



The Wizard: fiftysomething

COLUMBIA SPECIAL PRODUCTS

by Ralph Hodges



COUCH-POTATO AUDIO

A PRETTY good scrap is shaping up in the neighborhood of television sound, with a number of contestants preparing digital audio systems that they hope to have accompany video improvements predicted for the relatively near future. A parallel contest will occur in the radio district, but the stakes won't be nearly as high.

With the full potential for cable and satellite systems not nearly exploited as yet, television programmers foresee a chance to create entertainment channels for almost everyone's taste, which they believe would make TV the preferred broadcast medium for both viewers and listeners. It's a possibility, to be sure; TV tends to get much more attention and cooperation from the FCC than radio and hence can advance its interests more rapidly. There remains, however, a small problem: audio quality on TV.

The system introduced not long ago in this country for stereo TV—called BTSC (after the Broadcast Television Standards Committee) or, more generically, MTS (for multi-channel television sound)—is by a significant margin the worst delivery

mechanism we have of any presuming to near-hi-fi sound. The problem is the usual one: There is barely enough room for BTSC in the frequency band assigned for TV channels, and the sound can be afflicted by interference from the video.

So BTSC is ripe for some competition, and upcoming high-definition television (HDTV) is in need of an audio partner of superlative quality. Digital audio leaps immediately to mind; it would be fundamentally immune to video interference. The trouble is, video and BTSC stereo (which must be retained for compatibility) would not be immune to interference from *it*. Confining the digital audio to the tiny bands of frequencies left for exploitation in the TV signal presents grave difficulties. Conventional pulse-code modulation (PCM) seems hopeless in this application. A scheme that incorporates data compression is a far more promising choice.

Some time ago I discussed in this column a form of adaptive delta modulation (ADM) in development at Dolby Laboratories. Since then the company has devised a second, more sophisticated system and has made encoders and decoders available for both systems. The first system, now called AC-1, has even acquired a field history, and it's quite likely that many of us have unknowingly heard material processed by it at some point. (A Dolby spokesman suspects that consumers' first direct contact with AC-1 will be through rental boxes for cable TV.) The very new AC-2 system is still feeling its way within a broad range of potential applications, but HDTV for the uncompromising videophile is definitely one of them.

In stereo operation, the AC-1 system entails an audio data rate of typically 400 kilobits per second—far lower than what would be required for any listenable system based on conventional, uncompressed PCM coding. Exhaustively researched complementary filter elements are used for both encoding and decoding in order to keep AC-1 signals out of the way of other information in the video channel. The encode-decode loop is "wrapped" by a digital compander that applies signal-dependent pre-emphasis (en-

coding) and de-emphasis (decoding).

The most novel AC-1 feature is its audio delay, which enables control data to get ahead of the program content and preadjust emphasis and step-size regulators for coming events. The most attractive AC-1 feature may be its decoder price, which has been made quite low by confining most of the system's complexity to the encoder.

AC-2 explores some rather different territory, entering regions where the audiophile might not be conceptually comfortable. To achieve a data rate as phenomenally low as 128 kilobits per second per channel, with CD-like fidelity, the AC-2's ADM scheme processes in critical bands, relying on psychoacoustic masking to keep quantization difficulties and bit errors inaudible.

As has long been known, the ear hears in critical bands, roughly a third of an octave wide at middle frequencies, and its response is highly selective within those bands. Of any sounds occurring within each narrow range of frequencies, only the loudest will be heard; the listener will be oblivious to all the rest. Hence AC-2, processing only within those bands, can permit an outrageous rate of error, because the noise thereby generated will fall within the same bands and be masked by the program.

I know, I know. This sounds more than a little bit like saying that you'll never know what they put in your food unless you can taste it. But Dolby systems have exploited psychoacoustic masking from the beginning, and nobody has yet died from it.

I regret confining these remarks to Dolby Labs developments when others have been working hard as well. I think, however, that Dolby's level of preparedness is higher than that of most others and that its chances of becoming a major player are more promising. Given Ray Dolby's demonstrated ability to get the Far East thinking his way, we have the sort of situation that the Dolby group has traditionally managed very well. And it won't hurt that the new Dolby systems will give Japan a chance to add an international complexion to technologies aimed specifically at U.S. checkbooks. □



The Big Klipsch Sound Is Now Small In Size And Price

You've always expected KLIPSCH to give you a big, dynamic sound. Yet KLIPSCH has never been known for making small speakers.

Well allow us to introduce the new KLIPSCH kg¹®. Here is absolute proof that big performance can come from a very small speaker system. The kg¹ fills your listening room with the presence and dynamics of a live performance. Yet it's so small that it sits comfortably (and inconspicuously) on a bookshelf. Technology is the reason why.

The woofer cone, for example, is carbon graphite filled

to set a new standard for bass quality and authority in a system of this size. The voice coil of this woofer is vented for increased power handling and effortless reproduction of dynamic musical passages.

The tweeter uses a special ferrofluid cooling system to give you increased output, power handling, dynamic range, and reliability.

And the elegantly-styled cabinet of the kg¹ is hand finished in your choice of genuine wood veneers to make this speaker as beautiful as the music it reproduces. In this price range, the

cabinet of virtually every competitive system is wrapped with vinyl which merely *imitates* wood. The kg¹ gives you the real thing.

Yes, though quite small in size and price, the kg¹ is very big in performance and value. Your investment in this system will be a lasting one. Hear and see the new KLIPSCH kg¹ at your nearest KLIPSCH dealer.

To find him, look in the Yellow Pages.
Or call toll free 1-800-395-4676.

 **klipsch**[®]
A LEGEND IN SOUND.[™]
P.O. BOX 688 • HOPE, ARKANSAS USA 71801



**YOU CAN HAVE A MUSIC SYSTEM
WITH CLASSICAL LINES, IF YOU'RE
WILLING TO GIVE UP SPACE.**



**YOU CAN HAVE A MUSIC SYSTEM
WITH PERFORMANCE, IF YOU'RE
WILLING TO GIVE UP SIMPLICITY.**



**YOU CAN HAVE A MUSIC SYSTEM
WITH SIMPLICITY, IF YOU'RE
WILLING TO GIVE UP TECHNOLOGY.**

**BUT NOW YOU CAN HAVE IT ALL.
CALL 1-800-444-BOSE.**

BOSE[®]
BETTER SOUND THROUGH RESEARCH

FOR MORE INFORMATION AND FREE PRODUCT BROCHURE, OR TO FIND YOUR NEAREST BOSE DEALER, CALL 8:30 AM - 9:00 PM EST.

CIRCLE NO. 24 ON READER SERVICE CARD