

HiFi/Stereo Review

AUGUST 1965 • 50 CENTS

● **SPECIAL ISSUE ON LOUDSPEAKERS** ●

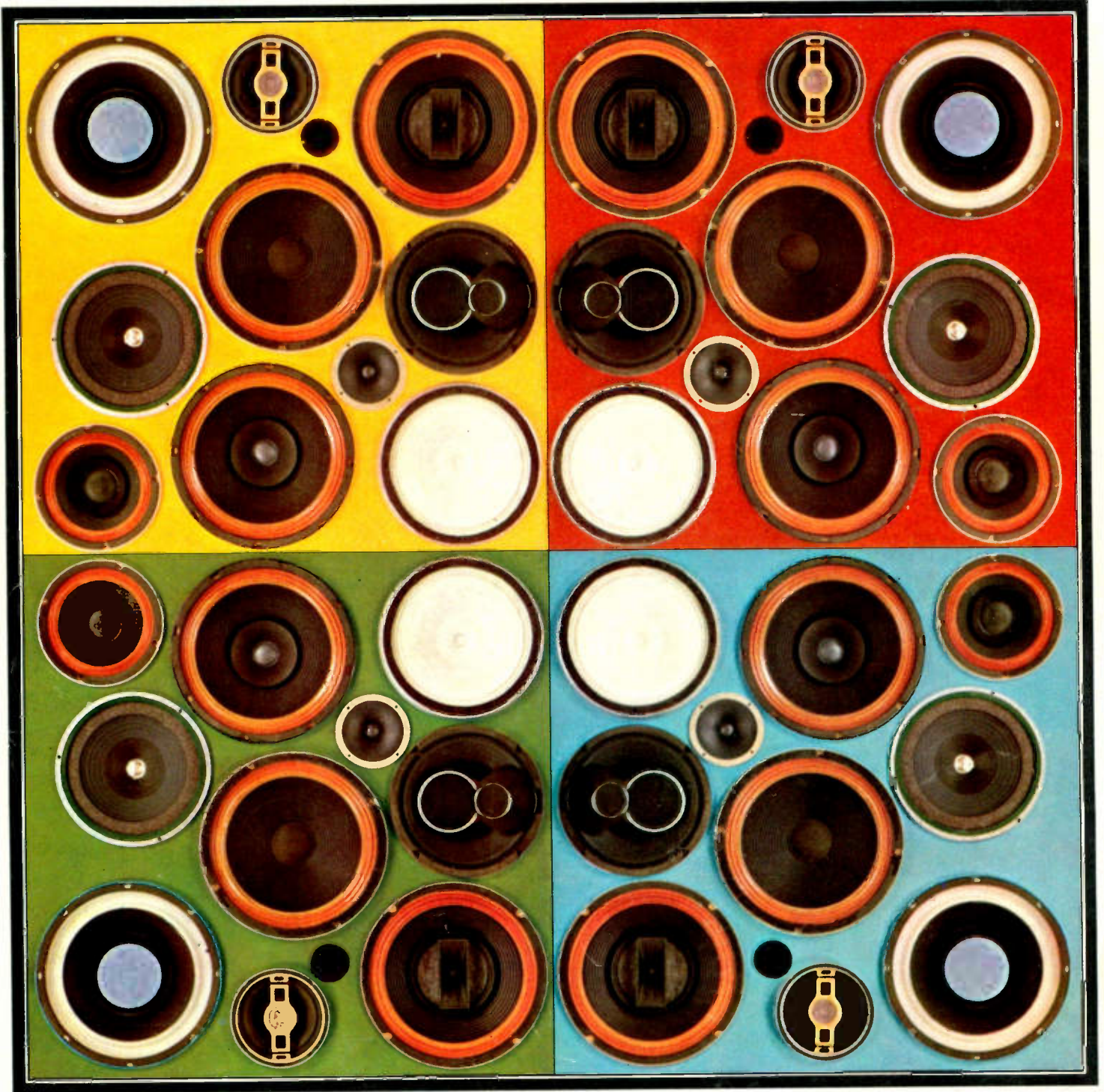

NEWEST CONCEPT IN SPEAKER DESIGN



MAXIMUS

PACKS MORE SOUND IN SMALLER SPACE THAN ANY OTHER SPEAKER SYSTEM!

How big should a fine speaker system be? Some people still believe the bigger the box the better the sound. It's no longer true.

There's a new concept in speaker design that has revolutionized all the old ideas about speaker size. It's a new breakthrough in electromagnetics called Cushioned Air Pneumatic Suspension (CAPS)[®]. For the first time . . . it makes possible superb high fidelity performance in an ultra-compact size.

The MAXIMUS Systems (CAPS)[®] create all the "big speaker sound" you want.

The CAPS[®] principle may be imitated by other speaker companies, but you can only get the true CAPS[®] principle in the MAXIMUS line, by UTC Sound. There's nothing else like it on the market — at any price.

In any side-by-side (A-B) test between

two speakers, loudness alone is not a criterion of quality. In fact, loudness represents efficiency only and has no bearing on the quality of sound. Judge speakers by hearing them at the same sound level, adjusting the amplifier volume control if necessary. Remember, too, that any fine speaker system will sound better in your home than in a store. Try MAXIMUS in your home, and you'll see why it is universally acclaimed.

*How do the experts feel about MAXIMUS? Here are just a few of the comments:***

AUDIO: "We had not imagined that a box that small could produce such musical sound, unaided by special circuits."

HI-FI NEWS: "I just don't believe it. In fact, I still switch it on periodically to see whether I'm dreaming."

ELECTRONICS WORLD: "The sound of the system is decidedly musical, balanced, and free from distortion or coloration. It has an open, airy quality which is difficult to associate with such a small box."

RADIO & TV EXPERIMENTER: "All in all, where space or decor requirements call for midget speakers we feel the MAXIMUS I is the only model (so far) which can deliver Hi-Fi performance."

We invite you to judge for yourself. See the MAXIMUS line at your high fidelity dealer. Compare it at the same sound level with any other speaker — loud, medium or soft — and see how much fuller and richer it sounds. MAXIMUS — first in the new trend to miniature high fidelity speaker systems. The only speaker line with the CAPS[®] principle.

Once you hear it, you'll never settle for less.

For Example: The MAXIMUS I

**sounds so "alive"
you won't believe
your ears...**



**— yet it's so small you can
hide it on a shelf and
hardly know it's there.**

**Complete articles available upon request.

The Only Speaker Systems to feature CAPS® (Cushioned Air Pneumatic Suspension)

ULTRA COMPACT

The MAXIMUS 1

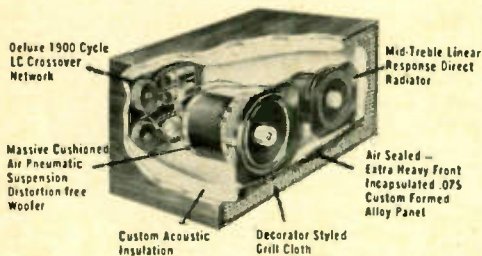

First of a new generation of Speaker Systems designed for modern living. Full, rich, solid performance in a compact enclosure. Delivers depth and brilliance never before possible in a speaker system this size. Designed specifically for the new high powered Solid-State Receivers and Amplifiers as well as present tube components.

Only 10½" x 5½" x 7¼" . . . fits everywhere . . . book shelf . . . end table . . . wall! Takes no more space than a few books, a small lamp, or a modest picture frame. True bass from the specifically designed MAXIMUS woofer. Exceptionally large 3½ lb. magnet structure provides high acoustic efficiency and power capability. Uniquely designed L-C crossover network transfers power at 1900 CPS to a newly developed backloaded mid-range/high frequency unit. Ideal for wide range mono . . . two for stereo. 45-20,000 CPS. Designed for 8 to 16 ohms. Net Price \$59.50



Another UTC-MAXIMUS FIRST!

The MAXIMUS TWIN-PACK . . . a portable take-home carton. Contains all the speaker equipment you need for full, rich stereo sound.

the MAXIMUS 2 — This middle-size brother to the compact MAXIMUS 1 handles twice the power, extends the bass range down to 35 CPS. It measures only 14½" x 11" x 8". MAXIMUS II uses two of the new MAXIMUS woofers, and the unique mid-range/high frequency driver to provide an uncanny audio mirror of life-like projection of mono or stereo sound. 35-20,000 CPS. 8 to 16 ohms. Net Price \$109.00

the MAXIMUS 3 — Biggest brother . . . but still only 18" x 12¾" x 10" . . . the MAXIMUS III employs 4 MAXIMUS I woofers to give extraordinary precise critical damping for perfect transient response. Ideally suited for use with the newest high-powered Transistorized High Fidelity amplifiers. At 1900 cycles a Deluxe LC crossover network transfers the electrical drive from the 4 woofers to 2 MAXIMUS mid-range and high frequency units. 30-20,000 CPS. 8 to 16 ohms impedance. Net Price \$169.00

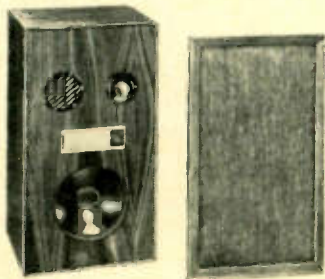

the MAXIMUS 4 — 2-Way Speaker System

The MAXIMUS 4 features the newest 8" version in the family of CAPS woofers. The total inter-modulation distortion from 100 to 20,000 cycles is less than ½%. The distortion at 40 cycles is less than 3%. The pneumatic suspension woofer has an ultra efficient 3½ lb. double duty ring magnet structure with a total flux of 17,000 gauss. At 1800 cycles the audio drive is transferred to a shielded back-loaded mid-treble lens speaker. A continuously variable KONToured ACOUSTIC control is supplied to provide acoustic room tailoring to suit individual taste. The frequency response is virtually flat from 35 to 20,000 cycles. Oiled walnut enclosure finished on 6 sides. Removable grill cloth. 40 watts IHFM. Impedance: 8 to 16 ohms. Size: 21¾" x 11¾" x 11¾". Net Price \$97.50

ULTRA LOW DISTORTION SPACE-SAVERS

Less than ¼% distortion | Less than 3% distortion
 from 50 CPS to 35,000 CPS | at 30 CPS

The MAXIMUS 7 — Bookshelf 3-way Speaker System

The new UTC cushioned air pneumatic suspension design used in the MAXIMUS 7 speaker system brings the hitherto unattainable ideal right to your unbelieving ears. Extended bass response with swings of 3 to 75 watts at a distortion level that is less than three-quarters of one per cent. This has never been attained up to now, even in speaker systems five times the price of the MAXIMUS 7, and all within a cabinet that is one-third to one-fifth the size of comparable fine speaker systems. The array of laboratory checked components comprising this system includes a heavy duty 12" pneumatic suspension woofer with a 9½ lb. ceramic magnet structure; two shielded back-loaded bi-polar mid-treble wide dispersion lens radiators and a dome lens compression type multicellular ultra high treble horn. To complete this deluxe system, 3-way LC crossovers are provided at 1800 and 8000-cycles coupled to continuously variable mid and treble KONToured ACOUSTIC controls to satisfy individual listening require-

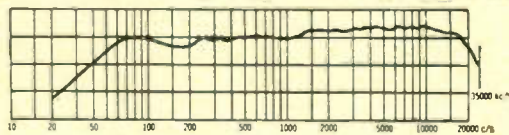

ments. Uniform response from 25 to 35,000 cycles. Total distortion less than ¼% from 50 to 35,000 cycles. Distortion at 30 cycles less than 3%. Impedance: 8 to 16 ohms. Size: 24" x 14" x 12". Finished on all 6 sides, oiled walnut cabinet with air-tight sealed enclosure and custom designed removable decorator style grill. Net Price \$189.00

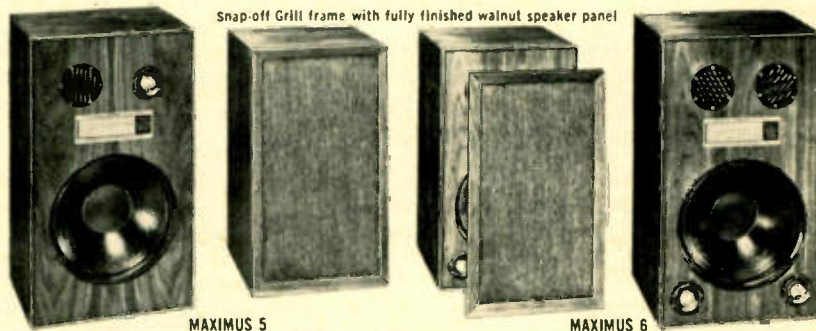

the MAXIMUS 6 — 3-Way Speaker System — The MAXIMUS 6 boasts tremendous, vital, uncanny bass, precise transient control, and virtually flat response from 25 to 22,000 cycles. The CAPS woofer will handle 75 watts of IHFM music power and responds to high power excursions at less than ¼% distortion. The MAXIMUS 6 requires only 3 watts of audio driving power to fill a large listening area with superb sound. The MAXIMUS 6 utilizes a pneumatic suspension woofer having a 9½ lb. double duty ceramic magnet structure, two shielded back-loaded wide dispersion bipolar mid-treble lens speakers, and 3-way LC crossovers at 1800 and 8000 cycles with continuously variable mid-treble KONToured ACOUSTIC controls for individual acoustic listening requirements. Handsome oiled walnut enclosure with removable grill cloth. Impedance: 8 to 16 ohms. Size: 24" x 14" x 12". Net Price \$169.50

the MAXIMUS 5 — 2-Way Speaker System — The MAXIMUS 5 exceeds all extant laboratory standards for a low distortion popular priced space-saving speaker system. It has high power capability, superb transient control, and exceptionally clean bass response in the critical region of 30 to 50 cycles. It will handle 50 watts IHFM of audio music, and requires only 3 watts of input audio drive to fill a large listening area with exciting sound. Features a CAPS woofer with a 5 lb. double duty ceramic magnet structure. The electrical crossover point is at 1800 cycles through an LC continuously variable KONToured ACOUSTIC control to a shielded closedback mid-high frequency lens speaker. Response virtually flat from 30 to 20,000 cycles. Finished on all 6 sides with a removable decorator type front grill. Impedance: 8 to 16 ohms. Size: 24" x 14" x 12". Net Price \$129.00

For complete literature and name of dealer nearest you write Dept. HFS8

UTC SOUND DIVISION

809 Stewart Ave., Garden City, New York



Creative Engineering for the Sound of Tomorrow



How does the *Garrard*[®] LAB 80 transcription turntable...

The value of automatic play can hardly be overstated. The automatic shut-off feature alone adds an entire area of pleasure. But the problem has been to provide this convenience without impairing the distortion-free performance demanded by modern music systems. Today, with a fine tone arm (as exemplified by the dynamically balanced, low geometry arm of the Lab 80), the maximum variation in stylus pressure between one record and a stack is a negligible 0.2 grams (two-tenths of a gram). Therefore, the question of whether it is preferable to play only single records on a turntable, has been obviated.

Now, the same principles which established Garrard as the pre-eminent name in automatics have been designed into the Lab 80 automatic spindle. It is the safest, most positive device of its kind. A stack of 8 records is securely supported on widely extended arms.

**become the
finest automatic
record changing
unit?**



The arms retract and the next disc is gently released. It drops quietly to the turntable, cushioned by air. The tone arm is absolutely free of the automatic mechanism through the entire performance of the record.

But this is only half of the story. At the end of the record—and not before—the tone arm must engage the trip to activate the automatic operation.

Friction or drag must be infinitesimal. In the Lab 80, this problem is brilliantly solved. The trip assembly is molded of Delrin[®], the remarkable new Dupont "slippery" material. The tripping cycle is unique. It works through magnetic repulsion. Mechanical contact has been eliminated!

These principles, ingeniously combined for the first time in an automatic record playing device, are Garrard's answer to the stringent requirements of the latest ultra-sensitive cartridges. Use the cartridge of your choice, no matter how feather light the tracking specifications may be. You will find they are all compatible with the Lab 80.

Just switch spindles!

Both spindles included with the Lab 80—\$99.50—less base and cartridge. The features of all Garrard models are explained in the new 32-page Comparator Guide. For your copy, write Garrard, Dept. GK-15, Westbury, N.Y. 11591.

CANADIAN INQUIRIES TO CHAS. W. PONTON, LTD., 66 RACINE ROAD, REXDALE, ONTARIO. TERRITORIES OTHER THAN U.S.A. AND CANADA TO GARRARD ENGINEERING LIMITED, SWINDON, WILTS., ENGLAND.



FOR STORES "WHERE YOU CAN BUY"—SEE LAST PAGE.

CIRCLE NO. 103 ON READER SERVICE CARD



HiFi/Stereo Review

AUGUST 1965 • VOLUME 15 • NUMBER 2

THE MUSIC

THE BASIC REPERTOIRE

Dvořák's Cello Concerto in B Minor.....MARTIN BOOKSPAN.....**35**

POP POP!

Pop artists take a look at some pop recording stars.....**54**

BEST OF THE MONTH

Reviews of outstanding new record releases.....**61**

CHARLES ALKAN: A PIANISTIC ENIGMA SOLVED

A new disc introduces French Romanticism's most exotic composer.. ROBERT OFFERGELD.....**70**

THE EQUIPMENT

HI-FI Q & A

Answers to your technical questions.....LARRY KLEIN.....**16**

JUST LOOKING

Surveying the latest in hi-fi equipment.....**22**

AUDIO BASICS

The Nature of Sound: Pitch.....HANS H. FANTEL.....**26**

TECHNICAL TALK

A discussion of power bandwidth, plus lab reports on the Fisher TX-300 and the Knight-Kit KG-870 amplifiers.....JULIAN D. HIRSCH.....**29**

BASIC TRAINING FOR SPEAKER SHOPPING

A cram course in showroom aplomb.....JOHN MILDER.....**39**

EXTENSION SPEAKERS AND CENTER-CHANNEL TECHNIQUES

Pointers on matching additional speakers to your present system.....H. B. MORRIS.....**43**

ANSWERS TO SOME COMMON LOUDSPEAKER QUESTIONS

A compilation of some frequently posed questions.....LARRY KLEIN.....**47**

THE MAGNET: HEART OF THE LOUDSPEAKER

An examination of how this vital part functions.....GEORGE L. AUGSPURGER.....**50**

HOW TO TUNE A BASS-REFLEX ENCLOSURE

A step-by-step method for the do-it-yourselfer.....LARRY KLEIN.....**56**

INSTALLATION OF THE MONTH

Stereo Central.....**60**

TAPE HORIZONS

Advice and suggestions for tape-recorder users.....DRUMMOND MCINNIS.....**113**

THE REVIEWS

CLASSICAL.....**67**

ENTERTAINMENT.....**89**

TAPE.....**107**

THE REGULARS

EDITORIALLY SPEAKING.....**4**

LETTERS TO THE EDITOR.....**6**

WHERE TO BUY IT; PRODUCT INDEX.....**116**

COVER PHOTOGRAPH, BRUCE PENDLETON; DESIGN, BORYS PATCHOWSKY

Copyright © 1965 by Ziff-Davis Publishing Company. All rights reserved. HiFi/Stereo Review is published monthly by Ziff-Davis Publishing Company at 307 North Michigan Avenue, Chicago, Illinois 60601. Ziff-Davis Publishing Company also publishes Skiing, Flying, Business/Commercial Aviation, Popular Boating, Car and Driver, Popular Photography, Electronics World, Popular Electronics, Modern Bride and Skiing Trade News. One year subscription rate for U.S., U.S. possessions and Canada, \$5.00; all other foreign \$6.00. (Schedule for payment in foreign currencies may be found elsewhere in this issue.) Second-class postage paid at Chicago, Illinois and at additional mailing offices. Authorized as second-class mail by the Post Office Department, Ottawa, Canada, and for payment of postage in cash.

HiFi/Stereo Review

PUBLISHER
PHILLIP T. HEFFERNAN

EDITOR
WILLIAM ANDERSON

MANAGING EDITOR
WILLIAM LIVINGSTONE

MUSIC EDITOR
ROBERT OFFERGELD

TECHNICAL EDITOR
LARRY KLEIN

ASSOCIATE EDITOR
ROBERT S. CLARK

ART DIRECTOR
BORYS PATCHOWSKY

CONTRIBUTING EDITORS

MARTIN BOOKSPAN
HANS H. FANTEL
WILLIAM FLANAGAN
JOE GOLDBERG
DAVID HALL
NAT HENTOFF
JULIAN D. HIRSCH
GEORGE JELLINEK
IGOR KIPNIS
PAUL KRESH
GENE LEES

ADVERTISING SALES MANAGER
LAWRENCE SPORN

ADVERTISING
SERVICE MANAGER
ARDYS C. MORAN

ZIFF-DAVIS PUBLISHING COMPANY

Editorial and Executive Offices (212 OR 9-7200)
One Park Avenue, New York, New York 10016

William B. Ziff, Chairman of the Board (1946-1953)
William Ziff, President
W. Bradford Briggs, Executive Vice President
Hershel B. Sarbin,
Vice President and General Manager
Philip Sine, Financial Vice President
Walter S. Mills, Jr., Vice President, Circulation
Stanley R. Greenfield, Vice President, Marketing
Phillip T. Heffernan, Vice President
Frank Pomerantz, Vice President, Creative Services
Arthur W. Butzow, Vice President, Production

New York Office (212 OR 9-7200)
One Park Avenue, New York, New York 10016
Eastern Advertising Manager: Jerry Sweeney
Jack Grant

Midwestern Office (312 726-0892)
307 North Michigan Avenue, Chicago, Illinois 60601
Eastern Advertising Manager: Jerry Sweeney

Western Office (213 CR 4-0265)
9025 Wilshire Blvd., Beverly Hills, Calif. 90211
Western Advertising Manager: Bud Dean

Circulation Office
Portland Place
Boulder, Colorado 80311

SUBSCRIPTION SERVICE: All subscription correspondence should be addressed to HiFi/Stereo Review, Circulation Department, Portland Place, Boulder, Colorado 80311. Please allow at least six weeks for change of address. Include your old address, as well as new—enclosing if possible an address label from a recent issue.

EDITORIAL CONTRIBUTIONS must be accompanied by return postage and will be handled with reasonable care; however, publisher assumes no responsibility for return or safety of art work, photographs, or manuscripts.

Member Audit Bureau of Circulations



EDITORIALLY SPEAKING

By William Anderson

WELL, they're at it again. Philharmonic Hall at New York's Lincoln Center for the Performing Arts will be closed from August 1 to September 2 to undergo "Phase III," another round of adjustments, alterations, and major surgery that (it is hoped) will finally cure the hall's catalog of acoustical ailments—too short a reverberation time, bass weakness, over-brilliance in the treble, and uneven distribution of sound. The goal, understandably, is eventually to make *music* rather than *acoustics* the news at the Philharmonic.

This summer's changes, oddly enough, will not concern themselves exclusively with acoustical problems. Certain other considerations having to do with decor (seats will be covered in a warmer-colored fabric and the blue color scheme will disappear) are designed to create what Center spokesmen call a more favorable "psycho-acoustical atmosphere." It is true that the blue color scheme, the rigid angularity, and the general ambiance of Philharmonic Hall have been found by many concert goers to be lacking in both warmth and grace. In this it is remarkably unlike the New York State Theater, which faces it, only one fountain away, across the plaza. There is not, it seems to me, another theater, concert hall, or opera house in the city more gratifying to an audience than this relatively recent addition to the Lincoln Center complex. I have been reminded more than once, while attending performances there, of American critic Richard Grant White's comment about the old Astor Place Opera House in the 1840's: "... admirable in design... well adapted to its musical purpose, beautifully and skillfully contrived for the exhibition of its audiences as well as its artists."

And there, of course, is the key—"contrived for the exhibition of its audiences." A really effective theater, concert hall, or opera house, it seems to me, must be designed in purely human terms, a structure perfectly scaled and shaped to enclose not only the performers, but the audience as well. Just as the stage itself and the proscenium are the frame for the performers, so the public spaces (seating, halls, stairways, lobby, promenade) must be seen as the frame for the audience, a graceful and beautiful background against which its members may also move, converse, and enjoy together the highly civilized exercise of theater-going.

Architect Philip Johnson's New York State Theater does all this perfectly. Its Grand Promenade, which has been called New York's most elegant drawing room, is of awesome proportions, yet has an intimacy many living rooms lack. It will hold the whole of an evening's audience easily—and not elbow to elbow either—but the noise level never seems to rise above the conversational. It seems somehow wrong to settle for anything less than champagne at the easily accessible bar, and if you don't happen to be in evening clothes, you resolve that you will be the next time. The room is presided over, you might say, by two enormous pairs of Elie Nadelman fat ladies, sculptures in white marble polished to porcelain smoothness. They are, I think, the most distinguished municipal sculpture the city can presently boast of. Their very massiveness (I understand they weigh in at twelve tons each), strangely and provocatively coupled as it is with that airy lightness of foot known only to fat ladies, strikes precisely the right notes for this particular temple of the arts: a solemn gravity and a blithe jollity. Is it too much for the concert-going public to hope that some of this spirit will this summer infect the redecorators of Philharmonic Hall across the way?



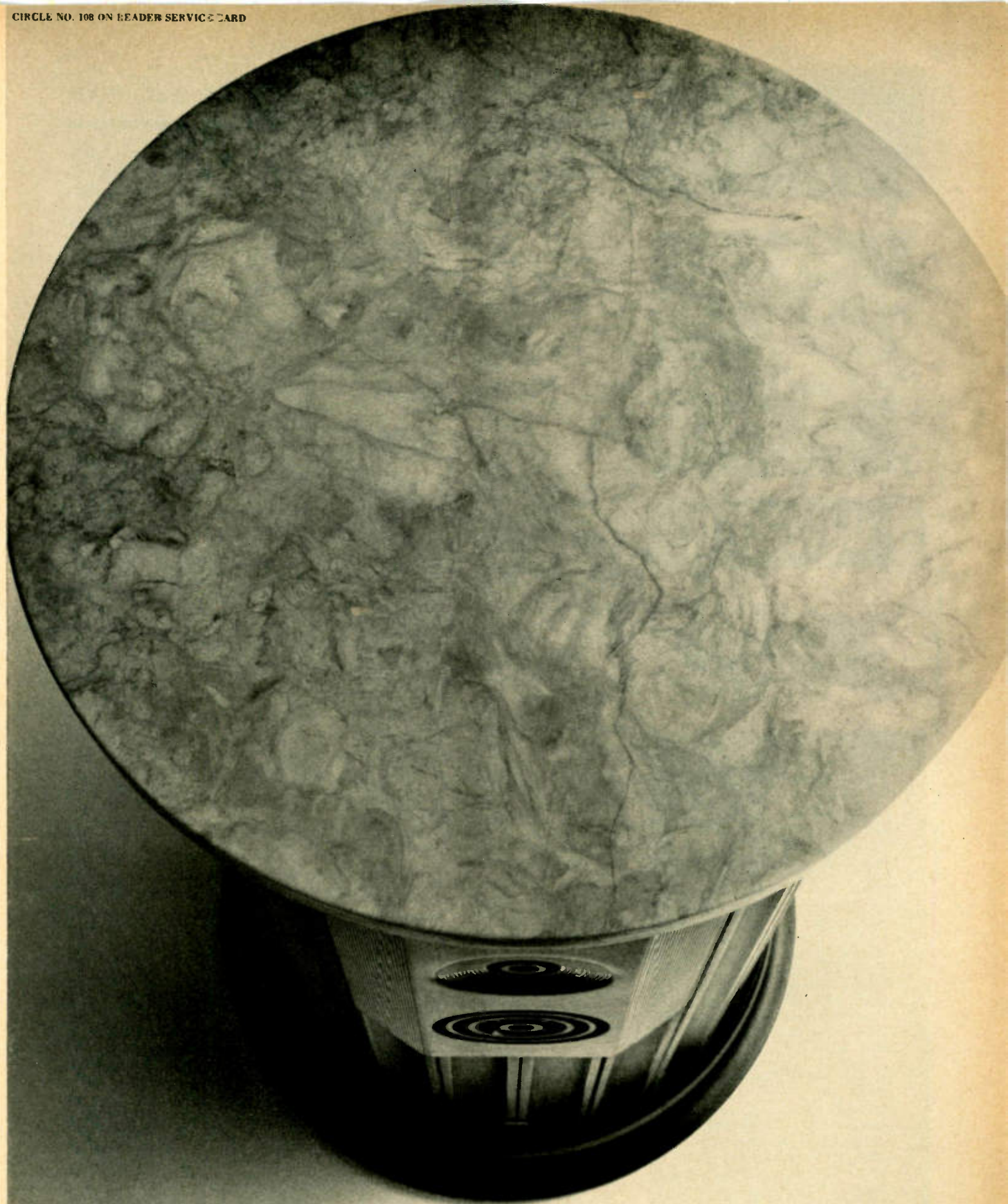

Irresistible from any angle.

The new Empire 8000P Grenadier speaker system is the most significant advance in stereophonic reproduction from no matter where you sit or stand. Empire's new Dynamic reflex stop system allows you to adjust the bass and treble response of your 8000P Grenadier speaker system to suit your individual room acoustics. **EMPIRE**

CREATORS OF THE WORLD'S MOST PERFECT SPEAKER SYSTEM. EMPIRE SCIENTIFIC CORP., 845 STEWART AVE., GARDEN CITY, N.Y.; EXPORT: EMEC, PLAINVIEW, N.Y.; CANADA: EMPIRE SCIENTIFIC CORP. LTD., 1476 EGLINGTON WEST, TORONTO

HOW LONG CAN
WE STAY NEW?



FOREVER!

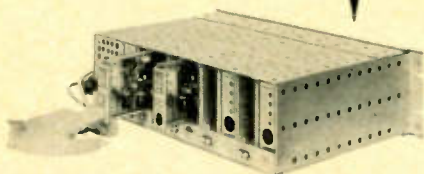

BUY THE NEW 1024

Magnecord

\$648

Plagued with a tape recorder that becomes outdated every year? Looking for a recorder that is built to give you maximum performance FOREVER? Then INVESTigate the NEW 1024! Examine the back. Notice the long life features . . . our unique cards for example. Expandable electronics can accommodate such accessories as a voice operated relay, slide synchronizer, cuer, and other devices, all mounted on electronic cards. These cards fit spaces provided for them in the electronic assembly and are easily removed and inserted. With such superb advancements, Magnecord 1024 remains NEW year after year. You get highest quality at a price that seems ridiculously low.

MAGNECORD SALES DEPARTMENT

MIDWESTERN INSTRUMENTS, INC.
Subsidiary of the TELEX Corporation
P. O. Box 7509 / Tulsa, Okla. 74105

CIRCLE NO. 39 ON READER SERVICE CARD
FOR STORES "WHERE YOU CAN BUY"
SEE LAST PAGE.

LETTERS TO THE EDITOR

Oscar for Mancini?

● The excellent article on Henry Mancini (June) was long overdue, but perhaps it will make up a little for the Academy Award Oscar he should have received this spring. With the one-year embarrassment lag they work on out in Hollywood, however, he should be due for it next year. This year they had to give all the prizes to *Mary Poppins* because Julie Andrews didn't get the part in the movie version of *My Fair Lady*. Next year they'll have to give the music prize to Mancini to cover their embarrassment over not giving it to him this year.

OLIVER M. MILLER
Ann Arbor, Mich.

● Just read Gene Lees' ridiculous piece on Henry Mancini. I can't understand how he can rank the perpetrator of such rubbish as *Dear Heart* and *Baby Elephant Walk* with a composer of the stature of George Gershwin. Yes, I have been enjoying more movie music lately, but it has come from the pens of Alex North, Elmer Bernstein, Jerry Goldsmith, and David Raksin.

OWEN PETERSON
New York, N. Y.

● Mancini has written a couple of good songs, and he's expert at writing glossy, tinselly arrangements for technicolored Hollywood trifles like *The Pink Panther*, but most of his compositions are trite and empty, and he is frequently guilty of self-plagiarism. Gene Lees is wrong in calling him the new master of American popular song—that title should be reserved for Burt Bacharach—and Mancini would have to write another fifty songs as good as *Moon River* before he could be compared with geniuses such as Gershwin and Rodgers.

SKEETER GOLD
New York, N. Y.

Mr. Lees replies: "As for 'guilty of self-plagiarism,' any real composer (Bach and Mozart) knows it can't—and shouldn't—be avoided. I do not recall asking Gershwin and Rodgers to move over."

The Great American Composers

● I have enjoyed HiFi/STEREO REVIEW for several years, but I believe you have made the greatest contribution to music journalism with the initiation of "The Great American Composers" series.

We should all be more fully aware of the notable composers of our own land and time. There are numerous American composers who would be most interesting to read about. I would like to see, for example, articles about Aaron Copland, Samuel Barber, Roy Harris, William

Schuman, Walter Piston, George Gershwin, Roger Sessions, Leonard Bernstein, and—controversial as he may be—John Cage.

WILLIAM E. HAMILTON
Altoona, Pa.

Mr. Hamilton, you peeked!

● May I suggest that one of the future articles in your excellent series on American composers be devoted to Edward "Duke" Ellington, whom I consider, with the possible exception of Charles Ives, the most creative American composer of the twentieth century.

CHARLES B. SULLIVAN
Cambridge, Mass.

Hanslick and Modern Music

● Henry Pleasants' article on Eduard Hanslick (June) was very interesting and informative. I have long suspected that Hanslick was not the buffoon that Wagnerites have made him out to be. However, I was very unhappy to find that Mr. Pleasants had used this article as the vehicle for another of his attacks on modern music. Mr. Pleasants has a perfect right to hate modern music, but I feel he should confine his attacks to articles written about such music.

CARRINGTON DIXON, JR.
Garland, Texas

Mr. Pleasants replies: "If a critic were writing a commentary on Spengler, would Mr. Dixon consider it irrelevant to review his objections to the cultural climate of the first decade of the century against the realities of the present?"

Music in One Theater

● I enjoyed very much the editorial in the June issue, and couldn't agree more. In connection with the editor's plea for more music in the "legit" theater, you may be interested in an incident that took place in Toronto a few years ago.

That city now sports the brilliant new O'Keefe Center, which runs pre-Broadway tryouts of major shows. The sixty-year-old Royal Alexandria, the city's other legitimate house, had been losing its business to its new rival. Things reached the point that the owners were planning to sell the theater to make room for a parking lot. Into the breach stepped Edwin Mirvish, Toronto's discount-store king. Mirvish bought the theater and spent \$250,000 renovating it.

But it seems that the unions in Canada have managed to make it a rule that houses such as the Royal Alex hire a pit orchestra for every production, whether it's a musical or not. The members of the orchestra are accustomed to playing

(Continued on page 8)

COLUMBIA STEREO TAPE CLUB
 NOW OFFERS YOU
ANY 5
 of these exciting pre-recorded 4-track
STEREO TAPES \$2.97 FOR ONLY
 Value up to \$43.75 at regular Club prices
 If you join the Club now and agree to purchase as few as 5 selections from the more than 150 to be offered in the next 12 months

EUGENE ORMANDY CONDUCTS THE PHILADELPHIA ORCHESTRA FIREWORKS RIDE OF THE VALKYRIES SABRE DANCE • 6 more	I WISH YOU LOVE Andra Kesteljanetz Maria Elena Hella, Dolly! Fools Rush In 9 more	DEBUSSY: LA MER RAVEL, DAPHNIS ET CHLOE (Suite No. 2) George Szell • Cleveland Orch.	Miles Davis in Europe
1661. Also: In The Hall of The Mountain King, etc.	1699. Also: I Will Follow Him, Blue Velvet, etc.	1650. "A stunning accomplishment!" — American Rec. Guide	1642. Recorded live at the Antibes Jazz Festival
ROGER WILLIAMS GREATEST HITS Autumn Leaves Near You Tammy 9 More	BERNSTEIN conducts TCHAIKOVSKY 1812 Overture Marche Slave Capriccio Italien NEW YORK PHILHARMONIC	Jazz impressions of Japan the Dave Brubeck quartet	Barbra Streisand People Absent Minded Me Fine And Dandy 10 MORE
1302. Also: The High And The Mighty, I Got Rhythm, etc.	1603. Bernstein "at top of his form." — High Fidelity	1636. Zen Is When, Rising Sun, Osaka Blues, 8 in all	1646. Also: Love Is A Bore, My Lord And Master, Autumn, etc.

FREE - if you join now
 REVOLUTIONARY SELF-THREADING TAKE-UP REEL

Just drop the end of the tape over this reel, start your recorder, and watch it thread itself! Unique Scotch® process automatically threads up tape of any thickness, releases freely on rewind.

WEST SIDE STORY
 Original Soundtrack
 COLUMBIA Recording
 1037. "The most adventurous musical ever made." — Life

VLADIMIR HOROWITZ BEETHOVEN: "Patience" DEBUSSY: Three Preludes CHOPIN: Scherzo No. 1 2 ETUDS	MY FAIR LADY AUDREY HEPBURN REX HARRISON Original Sound Track	MY LOVE FORGIVE ME ROBERT GOULET This Is All I Ask Too Good 10 MORE	BOB BROOKMEYER and friends STAN GETZ • RON CARTER MERLE HANCOCK GARY BURTON • ELVIN JONES
1683. "Virile grace... noble simplicity." — HiFi/Stereo Rev.	1530. Greater than ever... winner of 6 Academy Awards	1735. Also: What Kind of Fool Am I?, Just Say I Love Her, etc.	1713. A lively session abounding in passion and truth
THE VENTURES PLAY TELSTAR THE LONELY BULL	LORD'S PRAYER MORMON TABERNACLE CHOIR BATTLE HYMN OF THE REPUBLIC THE LORD'S PRAYER • 9 MORE	PERCY FAITH Great Folk Themes Greenfields 500 Miles 10 MORE	TCHAIKOVSKY Symphony No. 7 World Premiere Recording ORMANDY PHILADELPHIA ORCH.
1008. Also: Green Onions, Red River Rock, Calcutta, etc.	1090. "This is an extraordinary chorus." — New York Times	1349. Also: Sloop John B., This Train, Darlin' Corey, etc.	1283. "Appealing tunes and lush romanticism." — Life
BOBBY MACKETT plays MANCINI Days of Wine and Roses Moon River • Dreamsville 9 MORE	MONK BIG BAND AND QUARTET IN CONCERT	GROFE: GRAND CANYON SUITE N.Y. Philharmonic	THE MANY MOODS OF FERRANTE & TELCHER Dream of Love • Gigi Bewitched 9 more
1161. Also: Baby Elephant Walk, Peter Gunn, Mr. Lucky, etc.	1637. Epitaphy, Four in One, I Mean You, 7 in all	1645. Delightful performance of Grofe's soaring tone poem	1640. Also: Camelot, Three Coins in the Fountain, Till, etc.
RAY CONNIFF Speak to Me of Love	PETER, PAUL & MARY IN CONCERT	TWIN-PACK Equivalent To Two Selections	GOLDFINGER Original Motion Picture Sound Track
1442. The Sweetest Sounds, You'll Never Walk Alone, 10 more	1673-1674. Twin-Pack (Counts As Two Selections.) Blowin' In The Wind, If I Had A Hammer, Five Hundred Miles, 18 in all	1704. Featuring the title song sung by Shirley Bassey	
Rhapsody in Blue An American in Paris Leonard Bernstein plays Gershwin	TONY BENNETT Who Can I Turn To WRAP YOUR TROUBLES IN DREAMS LISTEN, LITTLE GIRL	ANDRE PREVIN My Fair Lady	LATH THEMES For Young Lovers PERCY FAITH The Girl From Ipanema The Lonely Bull 10 MORE
1098. "Fierce impact and momentum." — N.Y. World-Telegram	1714. Also: Autumn Leaves, I Walk A Little Faster, etc.	1706. A sparkling new jazz treatment of this great score	1772. Also: Spanish Harlem, Manha de Carnaval, etc.
RAY CONNIFF INVISIBLE TEARS Everybody Loves Somebody Honeycomb • 10 MORE	NEW CHRISTY MINSTRELS LAND OF GIANTS John Henry • Casey Jones Joe Magarac • 10 MORE	ANDY WILLIAMS DEAR HEART Red Roses For a Blue Lady Who Can I Turn To 9 MORE	Norman Luboff Choir MOMENTS TO REMEMBER I'll Never Smile Again Paper Doll The Breeze and I plus 9 more
1672. Also: S'posin', Kisses Sweeter Than Wine, etc.	1644. Also: Natural Man, Paul Bunyon, El Camino Real, etc.	1905. Also: I Can't Stop Loving You, Emily, 12 in all	1209. Also: Sleepy Lagoon, Flamingo, Time Was, etc.

IF YOU ARE ONE OF THE FORTUNATE PEOPLE who owns 4-track stereo tape playback equipment, you know the thrill of the near-perfect fidelity, the unsurpassed sound of tape. Now you have an exceptional opportunity to build an outstanding collection of superb stereo tapes at great savings through the most generous offer ever made by the Columbia Stereo Tape Club!

By joining now, you may have ANY FIVE of the magnificently recorded 4-track stereo tapes described here — sold regularly by the Club for up to \$43.75 — for only \$2.97!

TO RECEIVE YOUR 5 PRE-RECORDED STEREO TAPES FOR ONLY \$2.97 — simply fill in and mail the coupon today. Be sure to indicate which Club Division best suits your musical taste: Classical or Popular.

HOW THE CLUB OPERATES: Each month the Club's staff of music experts chooses outstanding selections for both Divisions. These selections are described in the Club Magazine, which you receive free each month.

You may accept the monthly selection for your Division . . . or take any of the wide variety of tapes offered in the Magazine to members of both Divisions . . . or take no tape in any particular month.

Your only membership obligation is to purchase 5 tapes from the more than 150 to be offered in the coming 12 months. Thereafter, you have no further obligation to buy any additional tapes . . . and you may discontinue your membership at any time.

FREE TAPES GIVEN REGULARLY. If you wish to continue as a member after purchasing five tapes, you will receive — FREE — a 4-track stereo tape of your choice for every two additional tapes you buy.

The tapes you want are mailed and billed to you at the regular Club price of \$7.95 (occasional Original Cast recordings somewhat higher), plus a small mailing and handling charge.

IMPORTANT NOTE: All tapes offered by the Club must be played on 4-track stereo playback equipment. If your tape recorder does not play 4-track stereo tapes, you may be able to convert it simply and economically. See your local service dealer for complete details.

COLUMBIA STEREO TAPE CLUB, Terre Haute, Indiana

SEND NO MONEY—mail coupon to receive 5 tapes for \$2.97

COLUMBIA STEREO TAPE CLUB, Dept. 400-2
 Terre Haute, Indiana 47808

I accept your special offer and have written in the boxes at the right the numbers of the 5 tapes I would like to receive for \$2.97, plus a small mailing and handling charge. I will also receive my self-threading reel FREE!

Enroll me in the following Division of the Club:
 CLASSICAL POPULAR

I understand that I may select tapes from either Division. I agree to purchase five selections from the more than 150 to be offered in the coming 12 months, at the regular Club price plus a small mailing and handling charge. Thereafter, if I decide to continue my membership, I am to receive a 4-track, pre-recorded tape of my choice FREE for every two additional selections I accept.

SEND ME THESE FIVE TAPES
 (fill in numbers below)

Print Name.....
 First Name Initial Last Name

Address.....

City.....

State..... Zip Code.....

This offer is available only within the continental limits of the U.S.

ALIVE & VIBRANT

The revolutionary LEAK Mark II Piston-Action Sandwich Speaker System will thrill you with its live, vibrant and exciting sound—only the patented piston-action principle can give you this concert hall realism at any and every dynamic and harmonic level—in any size listening area.

LEAK • MARK II



Piston-Action Sandwich®
Speaker System

NATURAL

The LEAK Mark II gives you natural sound . . . NO artificial resonances, or even the faintest hint of distortion . . . performance proven by laboratory tests and confirmed by recognized music critics.*

LEAK • MARK II



Piston-Action Sandwich®
Speaker System

Beautiful!



Its award winning decorator design . . . its rich, deep-grained choice Scandinavian woods . . . its simplicity and ideal size (26"x15"x12") add a beautiful note to any room decor.

The New LEAK Mark II is a natural at only \$199.

*Insist on hearing the Mark II at any Leak Authorized Specialist and request your free copy of the "Leak Report File" . . . or write:



ERCONA CORP.

432 Park Ave. So., N.Y. 16, N.Y.

God Save the Queen, then dashing out to play at a wedding reception or Bar Mitzvah in the suburbs. Mirvish asked himself why, since he was paying for an orchestra anyway, he couldn't also get an overture and intermission music. When word got back to the union, the hierarchy was thunderstruck. Nobody had ever heard of such a thing: it would take bread out of the mouths of starving violinists, etc., etc. But there was nothing in the contract to prevent Mirvish from getting a full evening of music-making from the musicians once he'd hired them. So now the Royal Alex's patrons, as they are ushered to their seats, get a pleasant medley of Broadway hits to set the mood for the evening's entertainment.

ROBERT ANGUS
Brooklyn, N.Y.

The Bouncing Repertoire

● In your June issue Martin Bookspan recommends Sir Thomas Beecham's performance of Haydn's first series of "Salomon" Symphonies (Capitol DGCR/GCR 7127) "for over-all bounce and 'élan.'" According to a recent issue of the Schwann catalog, this beautiful set has unfortunately been "bounced," but apparently without much "élan." It has been a trusted friend for years.

D. FERGUSON
Memphis, Tenn.

Beecham's versions of Haydn's "Salomon" Symphonies have happily bounced right back into the catalog on the Angel label, in both mono and reprocessed stereo (36242/3/4 and 36254/5/6).

Thomson Heard and Unheard

● I have just received my copy of HiFi/STEREO REVIEW's record of the three Virgil Thomson pieces, and am inspired to attack my typewriter and gush out reams of appreciation. Imposing self-discipline by an effort of will, however, I shall convey my heartfelt thanks in a few words.

Everything about the record and its distribution is so very, very right. The recording itself, although low-priced, is obviously done with the best of modern mastering and pressing techniques. The labelling is tasteful, the liner notes are informative and entertaining, and the packaging is perfect. Most important, however, is that a magazine of criticism took upon itself the task of doing more than criticizing. Such an act goes a long way toward filling the record-catalog gaps other magazines merely complain about.

ROBERT J. BELDEN
New Brunswick, N. J.

● Congratulations on your very fine May issue. It has always been a mystery to me how groups such as the New York City Center can, year after year, fail to program Virgil Thomson's operas. This past spring the City Center again devoted a

month or so to modern works, and while the company programmed works of value, they failed to include *The Mother of Us All*, a work which contains, I think, one of the finest and most moving final scenes ever written for the operatic stage.

Thomson was fortunate in having a collaborator such as Gertrude Stein, and if there is any vogue for Stein today (outside a small circle who understand her contribution to modern literature), it is because of Thomson. It is reported that Thomson is now looking for a libretto—what a joy it would be if he chose Stein's *Doctor Faustus Lights the Lights!*

EDWARD EICHEL
Brooklyn, N. Y.

● I have just received my Virgil Thomson recording, and what a pleasant surprise it was! I consider it my prize record of the year. The *Sonata da chiesa* is wonderful! Now if someone will only record the *Symphony on a Hymn Tune*. Many thanks, and I look forward to your future releases.

PAUL SIMPSON
Charlotte, N. C.

Life of Riley

● "All critics," writes Harold C. Schonberg in his article on Virgil Thomson (May), "get letters from aspiring youngsters who want to join a newspaper critical staff."

The critic, according to legend, lives in his own private editorial world, protected from the irritating problems that plague less fortunate staff members. He writes as he pleases, and his opinions are inviolate. He gets the cream of concerts, operas, recitals—the second-stringers get what's left.

Whatever the requirements—concert coverage, a lead article for the Sunday music page, an occasional book review, or an analysis or critique of some newsworthy development or event in the music world—there is always time to contribute to other publications. There is always time, in fact, to do whatever pleases him most.

With such a utopia to aspire to, it is no wonder youngsters want to join a newspaper critical staff.

RALPH COKAIN
New York, N. Y.

Mr. Schonberg replies: "I agree wholeheartedly with Mr. Cokain. I won't say that I am free to do exactly what I want; even the barons of medieval Germany couldn't. Nor is Mr. Cokain entirely accurate in his assumption that I am free from the irritating problems that plague less fortunate staff members. I have my share. On the whole, though, I must admit he is right. I love my job, luxuriate in it, love my newspaper, and would not trade my lot for any other existence."

(Continued on page 12)

This is a coupon for people who aren't square.

Only a square buys phonograph records at store prices when the Citadel Record Club offers huge discounts on all labels. Mail this coupon for a 3-month trial membership, absolutely FREE!

Now, without paying a cent or obligating yourself in any way, you can join the unique Citadel Record Club for three months as a regular member. See for yourself how much Citadel can save you on all phonograph records (not just a few specials!), as well as on all 4-track recorded tapes.

Here is what Citadel offers to all its members: **Discounts!** Tremendous price reductions on all records and tapes; in certain cases you save as much as 55%.

No obligations! You buy as few or as many records as you wish. No agreements to sign.

All labels! Any record, album or tape that's in print is available at a discount to Citadel members. Your choice is unlimited.

Promptest service! Orders are usually shipped the same day as received, rarely later than the next few days. Citadel is famous for speed.

100% guarantee! Guaranteed factory-fresh, unplayed, defect-free records and tapes; if not, you are entitled to an immediate replacement.

Free Schwann catalog! Every new member gets a free copy of this 300-page guide to all long-playing records in print.

CITADEL RECORD CLUB, 545 Fifth Ave., New York, N. Y. 10017

Please enroll me for three months, without charge, as a member of the Citadel Record Club. I understand that I am entitled to all membership privileges without any obligation to buy anything, ever.

Name _____ 885B

Address _____

City _____ State _____

Zip _____

(If you don't have scissors, remember that only a square hesitates to tear out the whole page.)

CITADEL RECORD CLUB

SOLID STATESMANSHIP

again
Bogen
practices
dollar diplomacy
in your
behalf

BOGEN

COMMUNICATIONS DIV.  LEAR SIEGLER, INC.

Paramus, New Jersey

Solid Statesmanship: the ability to steer the difficult but rewarding course that starts with the design of superb transistorized circuitry, continues through painstaking manufacture, and results in outstanding products at a realistic price. It's the fine art that Bogen inaugurated over ten years ago when we produced the industry's first solid state amplifiers.

And it's what now makes possible the new RT4000.

Here's a receiver that *looks* as though it should cost a lot more. That's because Bogen believes

that design is almost as important on the outside as it is on the inside. And the RT4000 *performs* as though it should cost a whole lot more. Because Bogen didn't stint on the inside either.

Ample power (40 watts IHF) to drive *any* speaker system, FM sensitivity that pulls in — and holds — any station you'll get on any other receiver. Frequency response ± 1 db from 15 to 30,000 cps. Plus all the features you really need: instrument-type tuning meter, Stereo Minder (*automatically switches when a station is broadcasting stereo*), AFC switch, front panel headphone jack, tape monitor. And separate switch positions for FM-mono and FM-stereo (*to eliminate sub-carrier noise*).

Nor do we cut corners on longevity. The RT4000 boasts circuitry of the same reliable breed that has made our RT6000 one of the most dependable performers in hi-fi history. We take great pains with our quality controls to make sure that every unit will deliver years of trouble-free operation. That's what makes for friendly relations with consumers.

And thirty-three years of experience, ten of them in Solid Statesmanship, teach a company pretty nearly all there is to know. Which means (in very *undiplomatic* terms) that we don't have to pass the cost of failures along to you.

Just the savings.

BOGEN'S New RT4000 Solid State 40 watt FM-Stereo RECEIVER

\$279^{95*}



* SLIGHTLY HIGHER IN THE WEST. WALNUT WOOD AND WALNUT VINYL METAL ENCLOSURES OPTIONAL.

small fry

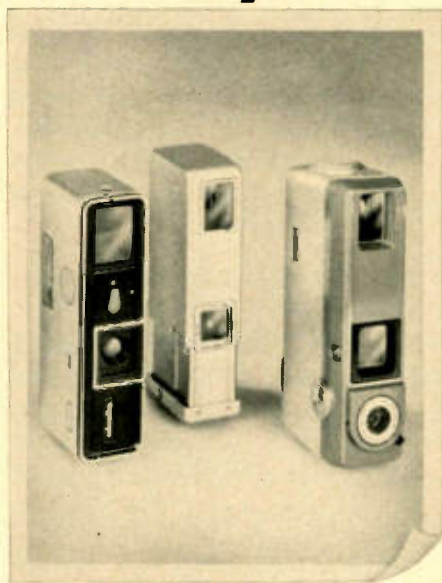

left to right: Minolta 16-Ps, 16-II, 16-CdS

big shots

Minolta puts photography in the palm of your hand with easy-to-operate 16mm subminiature cameras. Each of these Minolta "small fry" gives you wallet size "big shots" in color or black-and-white... plus razor-sharp slides. And each features a superb Rokkor lens.

The fully automatic Minolta 16-CdS combines palm-size convenience with a sensitive CdS electric eye for automatically perfect exposure. Has settings for normal, low light and flash. Other features include bright frame viewfinder, easy zone focusing and rapid film advance. Under \$90 with case. 4½ inches high.

The palm sized Minolta 16-II has exclusive push-pull automatic action that simultaneously advances film, cocks shutter, counts exposures and prevents double exposure. Under \$40 with case. Only 3¼ inches high.

The economical Minolta 16-Ps has a unique "Weather Dial" that automatically sets the lens for perfect exposures in any light. Under \$27 with case. 4½ inches high.

Each Minolta subminiature camera features unique drop-in loading with no-threading, no winding cartridges. A wide variety of film is available everywhere. And there's a complete "system" of special accessories for Minolta 16mm cameras, including a miniature flashgun, slide projector, enlarger and filters.

At your photo dealer or write for illustrated brochures: Minolta Corp., 200 Park Ave. South, New York, N.Y. 10003. Dept. M8.

Minolta subminiature cameras

CIRCLE NO. 42 ON READER SERVICE CARD

Footnote to Little Cotton Dolly

● Mr. George Goldberg, the author of the article on copyright law and the phonograph (June) may be interested in this little footnote:

Adam Geibel (the composer who had his troubles with the Apollo piano-roll company) was a blind organist and composer who was, for a number of years, the organist at the McDowell Memorial Presbyterian Church in Philadelphia. His famous law suit was decided the year my parents were married, and as a small child I knew him and marvelled at his musical ability.

JAMES F. MCMULLAN
Philadelphia, Pa.

For Audio Equipment Standards

● In the May issue Julian D. Hirsch discussed standardization and invited comment, so I avail myself of the opportunity.

I should like to see a standard cartridge shell, one that would enable the audiophile to use a single cartridge in both a manual turntable and an automatic turntable. I like to use the automatic for operas and the manual for single discs, which must be turned over anyway.

Going slightly afield, I have another proposal. Many times a.c. cords make disconnecting a component a bothersome task. I would suggest that all components be fitted with detachable cords, as are many kitchen appliances. Some turntable manufacturers have already adopted this idea with the leads, but not, to my knowledge, with the a.c. cord.

SOREN LAURSEN
Granada Hills, Calif.

Jellinek and Callas

● I was pleased to read the letter (Letters to the Editor, May) from Arnett H. Butler questioning George Jellinek's thinking on the topic of Maria Callas' *Carmen*. I'm afraid I quite agree with Mr. Butler.

A year or so ago I read a book by Mr. Jellinek on Miss Callas. He had me convinced that she was indeed all the wonderful things I had heard she was. But when I played some of her supposedly marvelous recordings, to which Mr. Jellinek referred, I found them not anywhere near as great as he had led me to believe.

Might I suggest a different critic when it comes to the Callas repertoire?

PETER M. SORENSON
New York, N. Y.

● It is clearly evident that Mr. Butler's letter about George Jellinek's review of *Carmen* is predicated on dislike of Maria Callas and an apparent wish to read only such reviews as reflect his own opinions. But it is not Mr. Jellinek's function to write reviews to please his readers. It is his function to express his opinions as he sees fit. And his review of the new Callas *Tosca* (May) answers Mr. Butler's charge

that he is biased in favor of Callas.

While I have not always concurred with Mr. Jellinek's findings, I have always thought him to be fair. Whenever he has taken issue with an artist's interpretation, he has kept his criticism on a constructive level, without finding it necessary to resort to vitriol. Mr. Butler's quite unnecessary reference to Callas' "wobble" isn't criticism, it's just plain rudeness.

ROBERT SANTISO
New York, N. Y.

● I have read and appreciated George Jellinek's recordings reviews for some time, and find them completely honest. Therefore, when I read Mr. Butler's letter calling Mr. Jellinek biased, I couldn't help wondering if Mr. Butler had really listened to Angel's new *Carmen*. If he has heard this completely electrifying performance, how could he say that it has little to distinguish it except Mme. Callas' wobble?

Thanks to Mr. Jellinek for putting down what so many of us feel about Callas' *Carmen*.

RALPH LATIMER
New York, N. Y.

The Pros and the Cons

● As one who makes his living from "pop" music and who has watched Gene Lees' curious career—singer, editor of *Down Beat*, record reviewer, and, lately, author of some of the best lyrics in current popular music, it seems to me that Lees is well qualified to write about all phases of the music industry. If he wants to carp about bad liner notes, warped records, dull record jackets, *et cetera*, in addition to his perceptive record reviews, why not? After all, nobody else seems to be interested enough in this aspect of the recording industry to do the same.

Lees is one of the few critics I'll listen to about my own work, and I am sure there are many other singers and writers who feel the same. His review of *The Umbrellas of Cherbourg* was first rate. His annoyance with the deceptive repackaging of old Morgana King albums was needed by the recording industry and the consumer alike, and his article on Henry Mancini is probably one of the best stories on a composer in recent years.

It's refreshing to find a writer who is talented and blunt, and a magazine where you get the feeling that the reviewers and the advertising department aren't sleeping together.

ROD MCKUEN
Hollywood, Calif.

● For his own sake, Gene Lees should do something about his ears. I would hate to think that he had really heard the *Fiddler on the Roof* and *Golden Boy* tapes when he decided that *Golden Boy* was the better score.

(Continued on page 14)

We aim at the Six

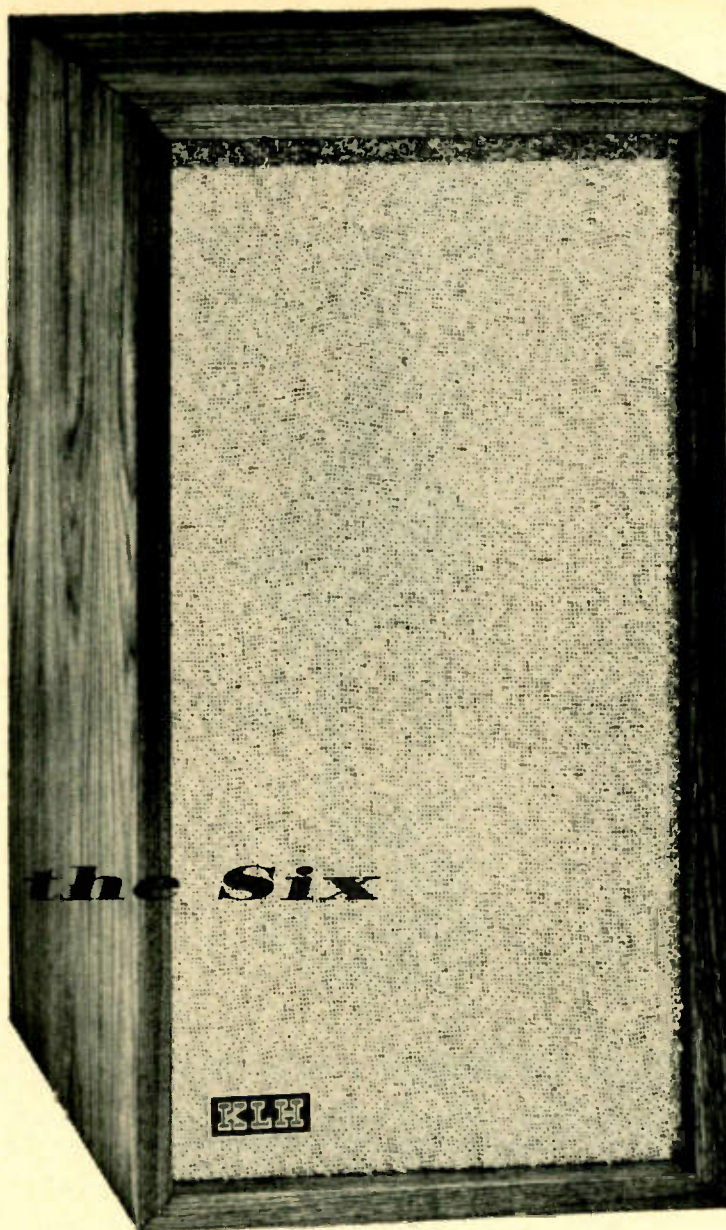

KLH makes speaker systems that sell from \$50 to \$1140. Each of these systems delivers the cleanest, best balanced performance you can buy for the price.

But the one by which we judge every new product we make is the Model Six.

How does such a modestly priced speaker become the standard bearer for an entire line?

It isn't just that the Six is a magnificent speaker. More than any other speaker we have ever made, the Model Six embodies the qualities that the name KLH stands for — an engineering approach that separates the trivial from the important; cuts through the accepted to find the exceptional — a patient, painstaking effort to give you cleaner, finer performance at lower cost.

We aim at the Six because it gives you the highest quality of performance, *per dollar*, of any speaker we make. Or anybody else makes.

That's why we call the Model Six:

the lowest priced speaker
you can be satisfied with
for the rest of your life.



KLH RESEARCH AND DEVELOPMENT CORPORATION
30 CROSS STREET, CAMBRIDGE 39, MASSACHUSETTS



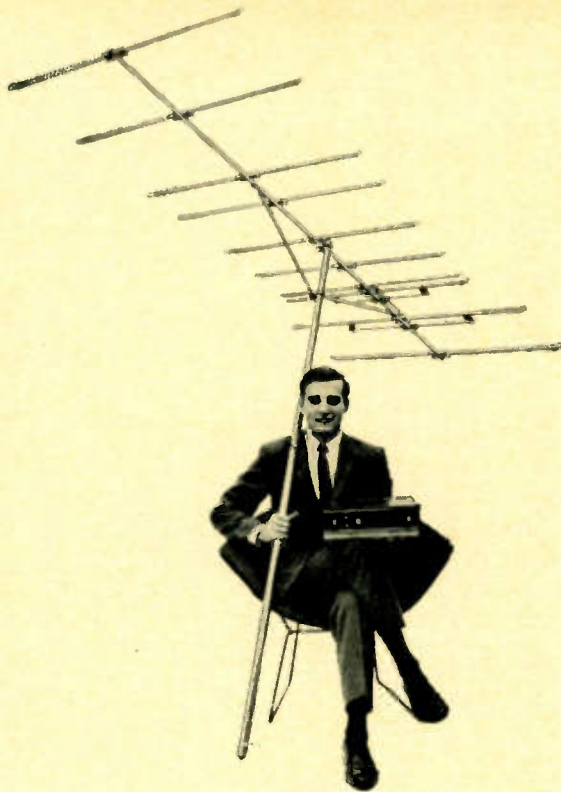

CAN YOU HAVE PERFECT FM SOUND?

TRY THE ALL NEW WINEGARD STEROTRON AND FIND OUT!

You've got an FM tuner. Let's say it's the best that money can buy. But for some reason the sound isn't "just so". Maybe it hisses. Or maybe the pureness of that FM signal is being distorted. This can happen to any FM tuner... even in strong signal areas. The cause—an inadequate FM antenna.





The cure... a Winegard Stereotron FM antenna. Stereotron's two powerful driven elements give it the highest front-to-back ratio of any FM antenna. It reduces multi-path distortion, eliminates hiss and noise.

If you're miles from the nearest FM station and never dreamt of receiving beautiful FM sound, you should know this: Winegard Stereotrons are GUARANTEED to bring in 85% of all FM stations within a 200 mile radius when used with the Stereotron antenna amplifier.

Winegard Stereotron antennas carry a 100% guarantee. If you're not completely satisfied, your money will be refunded. Write today for technical specs, gain charts, polar patterns, VSWR, etc., and get a brochure on FM reception plus an FM station log and map absolutely FREE.

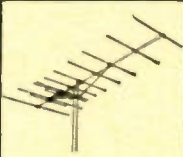
STEREOTRON ANTENNAS

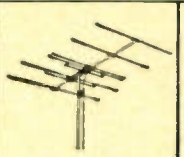
AMPLIFIERS

			
MODEL SF100 32.50	MODEL SF80 24.95	MODEL SF60 19.95	2 MODELS from 39.95

Winegard Co.

3018F Kirkwood • Burlington, Iowa

CIRCLE NO. 62 ON READER SERVICE CARD
FOR STORES "WHERE YOU CAN BUY"—SEE LAST PAGE.



I had barely digested these two reviews (May) when I came upon his incredible statement that Joan Baez is wasting her "abundant gifts on the folk fad." Come, Mr. Lees, you're putting us on!

WARNER SHILKRET
New York, N. Y.

Mr. Lees replies: "Not on, but down."

Editors and Critics

● Re your "Editorially Speaking" column (May) about critics—well, the same is true here! Sometimes I feel it is a thankless job to edit any magazine (except *Playboy*, maybe). Another reason for writing: Roy Allison's "Stereo Stethoscope" (May) was excellent.

HANS KOEBNER, Editor
Das Ton-Magazin
Munich, Germany

● I want to congratulate the editor on his May editorial—it is the finest statement I have read on the function of a music reviewer.

I think you consistently have the best reviews of any magazine I have read, and I particularly enjoy the detail with which your reviewers explain why they like or dislike each recording—an example is one reviewer's explanation that poor and unintelligible French very seriously marred a recording that had many good characteristics. When I read a review, I am looking for an opinion, and it should be obvious that the only opinion a reviewer should give is one based on his own reactions. Too many of those who criticize your reviewers seem to be looking, not for a fresh opinion, but for support of their own. When they vilify the reviewer and call names, it is obvious that they have lost the common sense that respects varying opinions.

EARL B. WORKING
Downey, Calif.

Go Go Goldberg!

● Congratulations to Joe Goldberg for his review (May) of the Mainstream album "Tonight," which features Clark Terry and Bob Brookmeyer. Jazz 1965 needs more capable critics like Joe Goldberg and more excellent recording artists like Clark Terry and Bob Brookmeyer.

DENNIS HENDLEY
Milwaukee, Wisc.

Liner-Note Lapses

● In Gene Lees' review of the "Oh, What a Lovely War" disc (April) he comments on London Records' uninformative and inadequate liner notes. His charge is true, and not just for that release. Recently I purchased London's *Die Zauberflöte* highlights (OS 25046), and find that though the complete cast is listed twice on the jacket and once on the disc itself, there is no indication of who sings what role.

CLYDE M. WATSON
Atlanta, Ga.

The price tag went on last



KLH Model Seventeen

The quality went in first. The kind of quality you can hear. Quality in the Seventeen's smooth, flawless response. Quality that gives the Seventeen the lowest harmonic distortion in the bass of any speaker in its price range. KLH quality in a handsome new oiled walnut enclosure. In the ingenious grillecloth that can be changed in a snap.

And while the quality was going in, the waste was coming out. All the waste that inflates the cost of speakers. The waste of rejects and varying quality in stock components from outside suppliers. (KLH builds, tests, and rigidly controls the quality of every component that affects the musical performance of a speaker.) The waste of obsolete design and engineering. Of inefficient and outdated manufacturing techniques. Of gingerbread 'features'

that add nothing to musical performance.

When we finally had a speaker that was all quality and no waste, we put the price tag on. And you won't find a trace of puff in the price.

This is the Model Seventeen. A speaker that brings a whole new level of sound quality — a new distinction to speakers costing under \$100.

But no description can tell you how the Seventeen sounds. You've got to hear it. Only then will you be able to understand what an unusual achievement the Seventeen is in high performance at low cost. See the Seventeen at your KLH dealer now. Listen to it. *Then* look at the price tag. We think you'll agree that nothing touches the Seventeen for honest sound at an honest price.

**Suggested retail for eastern U.S. Slightly higher in the West.*



KLH RESEARCH AND DEVELOPMENT CORPORATION
30 CROSS STREET, CAMBRIDGE 39, MASSACHUSETTS



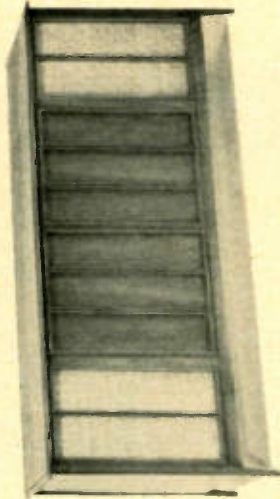

MODEL 606-D
stunning all-in-one stereo component center

Our new collection is now available . . .

equipment cabinets • speaker enclosures • consoles • cabinets galore. Danish and Provincial styles in new decorator finishes.

see your dealer or write for free brochure



audio originals

546 S. Meridian • Indianapolis, Ind.



MODEL 303D
for the "bookshelf speaker" and components

HI-FI

By Larry Klein



Wavy Record Edges

Q. I have noticed that several of my records have wavy edges, and when I play them there is a definite up-and-down motion by the tone arm. When I can, I use a cartridge that tracks at 1 gram, but on some records I have to go to 2 grams to keep the needle from skipping grooves. What causes the wavy edges, and is there anything I can do about it?

WILLIAM L. DAVIS
Denver, Colorado

A. The waviness is due to internal stresses developed in the plastic material of the record during manufacture. I doubt if there is any way you can permanently remove the wave. Your only recourse is to return the record to the manufacturer with a nasty letter—and if enough nasty letters are received, the manufacturer will probably do something about their quality-control procedures. Incidentally, it may be that your 1-gram tracking force is a trifle too low for your cartridge/stone-arm combination. Tracking at 2 grams will not significantly affect either record life or stylus wear and may result in somewhat cleaner sound under normal playing conditions.

Recommended Equipment

Q. What, in your opinion, would be the best amplifier I could buy in the \$200 to \$400 categories? Also, I would like to know what is the best stereo FM tuner priced under \$200.

GEORGE REILLY
Bronx, N. Y.

A. The letter above is typical of many addressed each month either to me or to Julian Hirsch. Although we appreciate the confidence readers show in us by asking for our advice, and as much as we would like to be of assistance, we cannot honestly evaluate or recommend a piece of high-fidelity equipment without extensive lab tests. It would obviously be unfair to rate equipment on hearsay, manufacturer's advertising copy, personal prejudices, or on any basis other than

complete, objective testing. When we undertake a report on a piece of equipment, the results are printed in *HiFi/STEREO REVIEW*. Each December, our annual index lists all equipment reports published during the preceding year; back issues are available from Mailers Fulfillment Company, 589 Broadway, New York, N. Y. 10012, at 65 cents each.

Recorder Decibel Ratings

Q. What is the difference between a tape recorder rated at ± 2 db and one rated at ± 3 db? For example, some are rated 60 to 15,000 cps ± 2 db and others are 30 to 18,000 cps ± 3 db. Would I be able to notice the difference between these machines, and should I insist on one that has a ± 2 db rating?

SANFORD M. LOTTER
Eggettville, N. Y.

A. The \pm (plus-or-minus) decibel ratings refer to how evenly an amplifier will reproduce test tones over a given frequency range. The smaller the decibel deviation, the flatter (and hence better) the response. For example, the specification ± 2 db, 20 to 20,000 cps, would mean that no tone in the range between 20 cps and 20,000 cps is louder or softer than a middle frequency tone by more than 2 db.

In the examples you give in your question, the two specifications might actually describe the same machine, since it is easier to obtain a flat response over a narrower frequency range. Although it is often stated that a deviation of 3 db or less is not generally noticeable on musical material, this is not entirely true. For example, if the range from 50 to 1,000 cycles were increased by 3 db and the range from 1,000 cycles to 20,000 cycles were decreased by 3 db, the overall response would still be ± 3 db from 50 to 20,000 cycles, and this is generally considered a flat response. However, any music reproduced by such an amplifier would sound rather dull and heavy. In other words, frequency-response figures
(Continued on page 20)

SEMINARS IN SOUND

The Institute of High Fidelity invites the participation of readers of *HiFi/STEREO REVIEW* in its new "Seminars in Sound" program. These seminars will be held at hi-fi music shows throughout the country during the next year, including the New York High Fidelity Show, September 29

through October 3. The Institute welcomes suggestions for discussion topics from interested audiophiles. (Topics of wide interest are preferred.) These suggestions should be sent to "Seminars in Sound," Institute of High Fidelity, Inc., 516 Fifth Avenue, New York, N. Y. 10036.

Perfection results from CHOICE...NOT CHANCE

Since no single phono cartridge can be all things to all people, we earnestly recommend that you employ these individual criteria in selecting your personal cartridge from the broad Shure Stereo Dynetic group:

YOUR EAR: First and foremost, listen. There are subtle differences in tonality that beggar description and are quite unrelated to "bare" specifications—yet add immeasurably to your personal listening pleasure.

YOUR EQUIPMENT: Consider first your tone arm's range of

tracking forces. Too, keep in mind that the cartridge ordinarily represents the smallest monetary investment in the system, yet the ultimate sound delivered depends *first* on the signal reproduced by the cartridge . . . "skimping" here downgrades your entire system.

YOUR EXCHEQUER: Shure cartridges cover the entire economic spectrum. And they are ALL Shure in quality, all Shure in performance. Even the least costly has received copious critical acclaim.

BEST SELLER



MODEL M3D

Where cost is the dominant factor, the M3D provides extremely musical and transparent sound at a rock-bottom price. The original, famous Shure Stereo Dynetic Cartridge . . . with almost universal application. Tracks at pressures as low as 3 grams, as high as 6 grams. For any changer. Only \$15.75

MUSICAL BEST-BUY



MODEL M7/N21D

Top-rated cartridge featuring the highly compliant N21D tubular stylus. Because of unusually clean mid-range (where most music really "happens") it is especially recommended if your present system sounds "muddy." For 2-gram optimum tracking (not to be used over 2½ grams). Only \$17.95 (Also, if you own an M3D or M7D, you can upgrade it for higher compliance, if tracking force does not exceed 2½ grams, with the N21D stylus for only \$12.50.)

ALL THE MOST WANTED FEATURES

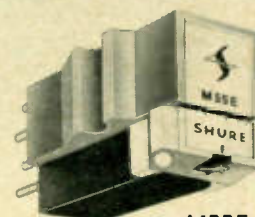

M55E

15° TRACKING, ELLIPTICAL STYLUS
Professional performance at a modest price. Compares favorably to the incomparable Shure V-15, except that it is produced under standard Shure quality control and manufacturing techniques. Remarkable freedom from IM, Harmonic and tracing distortion. Will definitely and audibly improve the sound of monaural as well as stereo records. A special value at \$35.50. Upgrade M44 cartridge (if you can track at 1½ grams or less) with N55E stylus, \$20.00

THE "FLOATING" CARTRIDGE

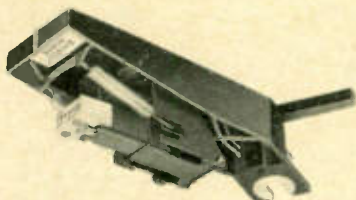

M80E GARD-A-MATIC®
WITH ELLIPTICAL STYLUS

Bounce-proof, scratch-proof performance for Garrard Lab 80 and Model A70 Series automatic turntables. Especially useful for applications where floor vibration is a problem. Spring-mounted in tone arm shell. Unique safety feature retracts stylus and cartridge when force exceeds 1½ grams . . . prevents scratching record and damaging stylus. \$38.00

THE ULTIMATE!

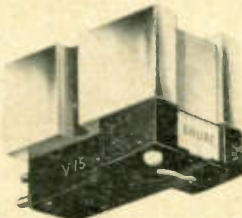

V-15
WITH

BI-RADIAL ELLIPTICAL STYLUS

For the purist who wants the very best, regardless of price. Reduces tracing (pinch effect), IM and Harmonic distortion to unprecedented lows. 15° tracking. Scratch-proof, too. Produced under famed Shure Master Quality Control Program . . . literally hand-made and individually tested. In a class by itself for mono as well as stereo discs. For manual or automatic turntables tracking at ¾ to 1½ grams. \$62.50

"THE BEST PICK-UP ARM IN THE WORLD"



SHURE SME

Provides features and quality unattainable in ANY other tone arm. Made by British craftsmen to singularly close tolerances and standards. Utterly accurate adjustments for every critical factor relating to perfect tracking . . . it realizes the full potential of the cartridge and record. Model 3012 for 16" records \$110.50; Model 3009 for 12" records \$100.50

SHURE

Stereo Dynetic®

High Fidelity Phono Cartridges . . . World Standard Wherever Sound Quality is Paramount
Shure Brothers, Inc., 222 Hartrey Ave., Evanston, Illinois



*One masterpiece
deserves another*

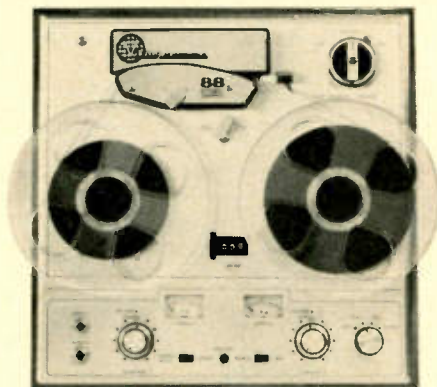

88 Stereo Compact

Enjoy pleasure filled hours in full fidelity with an 88 Stereo Compact — the choice of music connoisseurs.

Play standard tapes or build a library — easily recorded from AM and FM radio or LP's. Concerts, lectures, family or social events — all come to life — ready at your fingertips.

Features exclusive "Edit-Eze" cuing and editing. Superb 30-18,000 cps frequency response for finest mono or stereo recording with three hyperbolic heads. Monitor-off-tape, Sound on Sound, Erase-Protek, automatic shut-off, tapelifters, are but some of the many features to let you thoroughly enjoy high quality tape recording.

Ask your Viking dealer to run an 88 Stereo Compact through its paces. You'll enjoy the practical features and superb quality of this fine tape recorder — truly a masterpiece made by SKILLED AMERICAN CRAFTSMEN

4-track model . . . \$339.95
2-track model . . . \$347.95
Walnut enclosure . \$ 18.95



Viking OF MINNEAPOLIS, INC.

9600 Aldrich Ave. So. Minneapolis, Minn. 55420

do not completely describe the sound of a component; one has to look at the shape of frequency-response curves also. This matter was discussed in detail in Julian D. Hirsch's "Technical Talk" column in the February 1965 issue.

Hi-Fi Timer

Q. I have recently put together an excellent hi-fi system and have spent the last six months in a vain search for a clock timer to complete my setup. What I need is a timer with either a 12- or 24-hour clock face with both an hour hand and a minute hand (I would like a sweep second hand also). The timer must be able to turn my system on and off at pre-set times, and all controls must be front mounted. My intention is to use this clock timer to tape FM programs when I'm not at home. Can you direct me to a manufacturer who can fill my requirements?

JAMES W. BROWN
Westover, Mass.

A. Yale Electronics (2732 Florida Ave., Tampa, Florida 33602) has a 12-hour clock timer with up to 48 automatic time-setting positions (at 15-minute intervals). The walnut-housed unit sells for \$37.50 postpaid and is also available with a built-in buzzer with an individual 5-minute setting for \$5 more.

Blend-Switch Question

Q. In your June Q & A column you showed a blend-switch setup designed to feed a mono signal from a stereo amplifier to a single extension speaker. I have heard that it is not a good idea to connect a stereo amplifier's speaker terminals in parallel because one speaker output acts as a short circuit on the other. Is this true?

DAVID TUCKER
Philadelphia, Pa.

A. It is partly true. The short-circuit problem arises only when there is a stereo signal present at the speaker output terminals. I should have cautioned the reader to switch his amplifier or pre-amplifier to mono when using the extension-speaker switching setup.

High-Temperature Paint

Q. I have tried without success to re-paint the metal cage that covers my amplifier, for the heat from the four output tubes discolors and bakes off the paint in a short time. Can you suggest some paint that can withstand the heat?

ARNOLD KRANTZ
Cambridge, Mass.

A. The automotive parts mail-order house J.C. Whitney and Company (1917-19 Archer Ave., Chicago, Ill. 60616) has very high temperature enamels available in a variety of colors. A 12-ounce aerosol spray can sells for \$3.95 post paid.





“On the basis of these results, the Fisher XP-5 at \$54 would be a ‘best-buy’ selection.” — *How Good Is the New Breed of Compact Speakers?*
Popular Science, March 1965

That's the verdict reached by the experts at Popular Science magazine after sitting in judgment of six new low-cost loudspeakers of 'pygmy' size: the AR-4, the KLH Model 17, the Scott S-5, the Sonotone RM-1, the Goodmans Maximus 1, and the Fisher XP-5.

"Most cheap speakers previously available," the Popular Science report noted, "had glaring faults. Some were screechy or harsh sounding. Others were seriously shy of bass or treble, or had noticeably uneven frequency response. Not one of the speakers we tested suffers from these defects. Some are better than others, but all produce a pleasant, listenable sound.

"... Three speakers were unanimously judged to have an edge over the others. The top-rated models (in order of de-

scending price) were the KLH Model 17, the AR-4, and the Fisher XP-5. The KLH and Fisher sound were astonishingly similar in character. The AR's were somewhat different.

"Some judges liked the KLH-Fisher sound quality best; others preferred the AR. But the difference in quality among these three was judged inconsequential. . . . On the basis of these results, the Fisher XP-5 at \$54 would be a 'best-buy' selection."

The ultracompact XP-5 measures only 20" by 10" by 9" deep. It has an 8" woofer with a magnet structure weighing 2½ pounds, and a 2½" tweeter of the wide-dispersion cone type. The LC network has a crossover frequency of 2000 cps. Price, in oiled walnut, \$54.50. In unfinished birch, \$49.50.

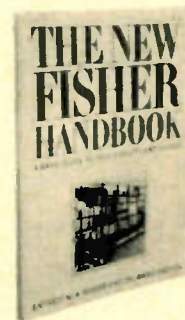

For your free copy of this 76-page book, use coupon on page 27.

FISHER RADIO CORPORATION, 21-40 34TH DRIVE, LONG ISLAND CITY, N.Y. 11101. OVERSEAS RESIDENTS WRITE TO FISHER RADIO INTERNATIONAL, INC., L. I. CITY, N.Y. 11101. CANADIAN RESIDENTS WRITE TO TRI-TEL ASSOCIATES, LTD., WILLOWDALE, ONT.

The Fisher

AUGUST 1965



CIRCLE NO. 26 ON READER SERVICE CARD
FOR STORES "WHERE YOU CAN BUY"—SEE LAST PAGE.

21

KEEPS NEW RECORDS CLEAN... DUST FREE!

The Cecil E. Watts PREENER provides the perfect solution for keeping new records new. This handy record cleaning component protects the mirror-like finish of a fresh pressing, leaving no trace of film or residue to clog the stylus of sensitive cartridges. As the record rotates on the turntable, the specially designed plush pile of the PREENER penetrates each groove, removing dust and grit... cleans entire record so quickly it can be used between record changer cycles.

Acclaimed by Experts as the finest method for the maintenance of new records.

For full information on how to protect your big investment in records, get a copy of "How to Clean, Maintain and Protect Records" by Cecil E. Watts, world's leading authority on record care... only 25c. Write to Dept. 112HS-8...

ELPA MARKETING INDUSTRIES, INC., New Hyde Park, N.Y.

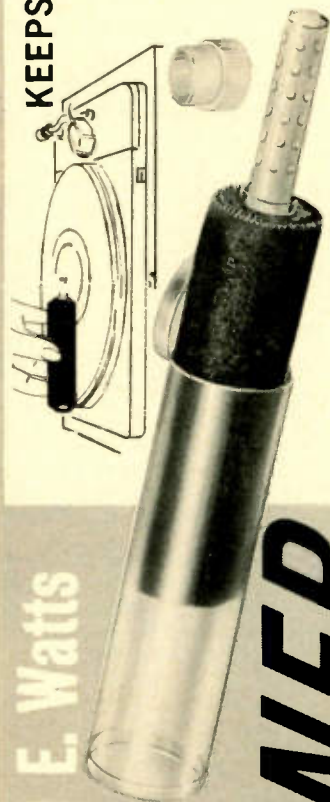

This is the Cecil E. Watts
Record Cleaning

IMPROVED

*PREENER

*PREENER — A Mark of Elpa Marketing Industries, Inc.

CIRCLE NO. 22 ON READER SERVICE CARD FOR STORES "WHERE YOU CAN BUY" SEE LAST PAGE.

JUST LOOKING

... at the best in new hi-fi components



● **Altec Lansing** is producing the 100A Bass Energizer, a device designed to compensate for any low-frequency deficiencies in small speakers. The 100A



provides an increase in the relative level of the very low bass (below 150 cps). The unit requires no electrical power and connects between the amplifier output terminals and speaker terminals. It can be mounted on the back of the speaker enclosure, or installed next to the amplifier. Though designed to operate with efficient speakers, the 100A can be used with low-efficiency speakers if the amplifier's power capability is adequate. Price: \$30.

circle 181 on reader service card

● **Cel Products** is producing a tape or book rack with adjustable ends that will hold over fifteen tape boxes. The

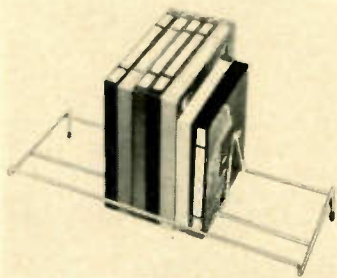

folding rack, which can be placed on a table top or shelf, has a brass-plated finish and non-scratch protective tips on its legs. Price: \$1.49.

circle 182 on reader service card

● **Concord's** R-2000 automatic four-track stereo tape recorder incorporates automatic tape reversal and a diode-controlled wind- and rewind-delay circuit. An operator can quickly search or cue by depressing the forward or rewind push buttons in rapid succession. Four separate solenoids are employed to bring the tape to a complete stop during these operations. All of the transport functions of the machine can be controlled from a remote-control panel at the end of an 18-foot connecting cable. The use of three hysteresis-synchronous motors achieves a timing accuracy of 0.2 per cent or better. A plug-in head assembly permits

quick and precise changing of head configuration to any desired pattern: either half-track or quarter-track record and play. Each plug-in assembly contains erase, record, and two playback heads. The record-head bias adjustment is easily reached. The Concord R-2000 employs dual-movement NAB-standardized VU level indicators. The machine can operate in either vertical or horizontal posi-

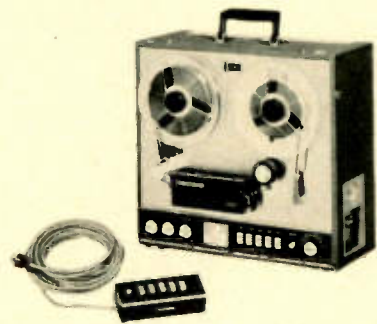

tion and is available with either 3 3/4- or 15-ips speeds in addition to the standard 7 1/2-ips. List price: \$795.

circle 183 on reader service card

● **Electro-Voice's** new Sonocaster I has an 8-inch, component-quality, high-efficiency speaker in a gray portable scuffproof cabinet. Frequency response of the system is 70 to 13,000 cps, program-handling capacity is 30 watts (peak), and impedance is 8 ohms. Price: \$27.50.

The original Sonocaster will retain its beige color, and the improved magnet in the speaker permits the 8-inch dual-cone driver to deliver an additional 2,000 cps



at the high end. The Sonocaster is also rated at 30 watts peak power and 8 ohms impedance. Price: \$39.60.

circle 184 on reader service card

● **Elpa** is distributing the Editall tape-splicing block that is designed to be easily fastened to any tape machine with or without the use of screws. Editab splicing tapes are used in conjunction with the Editall editing block and produce splices that are as flexible, uniform, and sturdy

(Continued on page 24)

A 110-piece orchestra playing Wagner full blast for six hours leaves this Fisher cold.



The Fisher 600-T Transistorized Stereo Receiver, \$459.50*

With or without intermissions, this solid-state Fisher receiver is engineered for cool operation regardless of the volume level or your musical tastes. Let those Wagnerian climaxes rattle the windows—the Fisher 600-T, thanks to its transistorized design, will generate no heat to speak of. (Even with all 110 watts, one for every member of the orchestra, blasting away.) And thanks to the Fisher way of using transistors, it will stay in perfect alignment and optimum operating condition indefinitely. (Transistors don't necessarily mean progress. Fisher solid-state engineering does.)

Even without this advantage, the Fisher 600-T would still be considered an incomparable instrument. On a single chassis it combines the most advanced Fisher FM-multiplex tuner circuitry, the ultimate in Fisher control-preamplifiers and the most remarkable solid-state power amplifier ever developed by Fisher engineers. All the stereo electronics you need, in less than 17 inches of shelf space.

The 600-T features the exclusive Fisher Nuvistor-Golden Synchrode front end, 5 IF stages, 5 limiters and a wide-band ratio detector. FM sensitivity is 1.8 microvolts IHF Standard. The famous Fisher Stereo Beacon[†] automatically switches between FM-mono and FM-stereo and automatically signals when you are receiving a stereo broadcast. The professional-type d'Arsonval tuning meter assures dead-accurate tuning. The transformerless power output stage, with 4 output transistors per channel, provides 110 watts IHF music power.

No other stereo receiver even comes close to the performance of the Fisher 600-T. But is it as good as any combination of separate components? In 999 cases out of 1,000, it's better! *NEW TAX-FREE PRICE (CABINET \$24.95) †PATENT PENDING

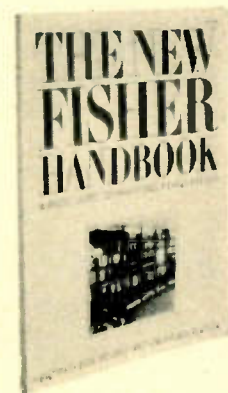

For your free copy of this 76-page book, use coupon on page 27.

FISHER RADIO CORPORATION, 23-40 44TH DRIVE, LONG ISLAND CITY, N.Y. 11101. OVERSEAS RESIDENTS WRITE TO FISHER RADIO INTERNATIONAL, INC., L. I. CITY, N.Y. 11101. CANADIAN RESIDENTS WRITE TO TRI-TEL ASSOCIATES, LTD., WILLOWDALE, ONT.

AUGUST 1965



CIRCLE NO. 26 ON READER SERVICE CARD
FOR STORES "WHERE YOU CAN BUY"—SEE LAST PAGE.

The Fisher

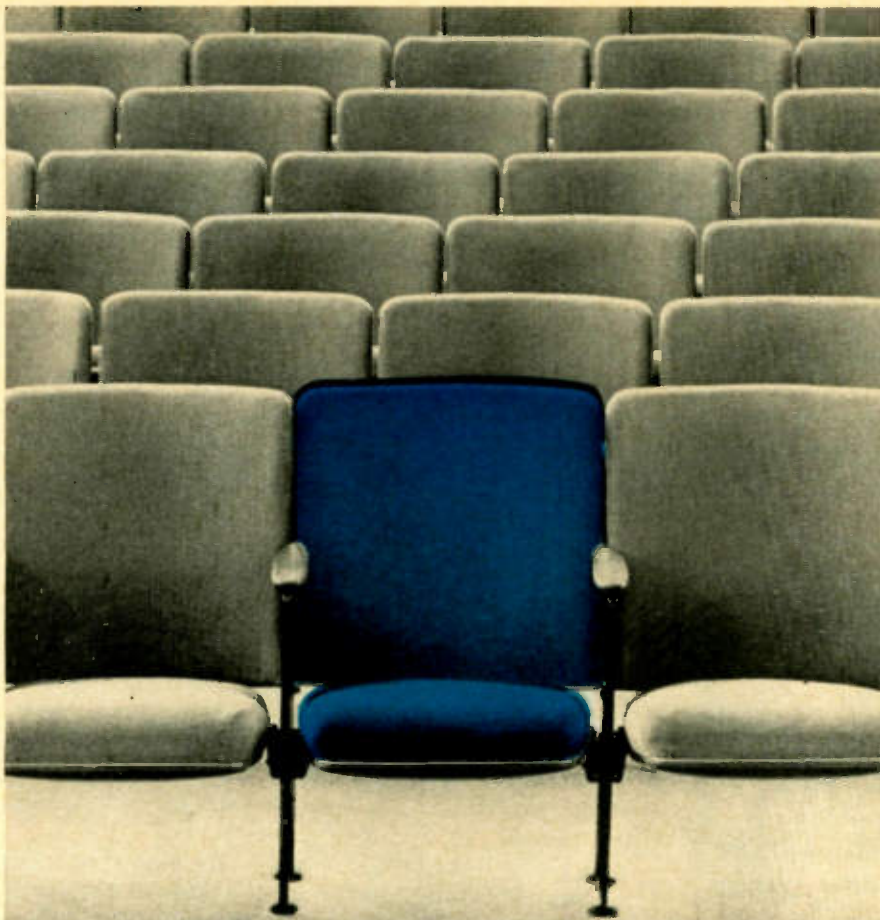

the best seat in the house...

... and it's right in your living room if your FM is equipped with a

FINCO® AWARD WINNING FM ANTENNA

Broadcasting authorities agree that an outdoor antenna is absolutely essential for the reception of full quality monaural and multiplex FM sound.

A *FINCO* FM antenna will deliver a clean undistorted signal and bring in more stations, regardless of location.

Guarantee yourself the best seat in the house for tonight's FM concert... install a fidelity-phased *FINCO* FM antenna.

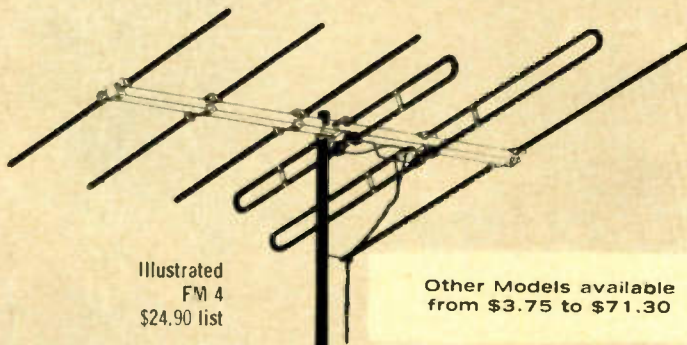

Illustrated
FM 4
\$24.90 list

Other Models available
from \$3.75 to \$71.30

Available at local dealers...
or write for Bulletin #20-213.

THE FINNEY COMPANY

PRODUCERS OF THE WORLD'S FINEST FM AND TV ANTENNAS
Dept. HD 34 West Interstate, Bedford, Ohio

CIRCLE NO. 25 ON READER SERVICE CARD

as the original tape. The Editall KP-2 editing kit contains an Editall splicing block, thirty Editab tape splices, a marking pencil, a specially treated demagnetized razor blade, and complete instructions. Price: \$3.50.

circle 185 on reader service card

● **Empire** introduces the 8000P speaker system that includes the Dynamic Reflex-Stop principle. This technique permits the system's low-frequency response to be adjusted (in 1-db increments) by removing the stops installed in the base of the cabinet. Maximum bass is ob-

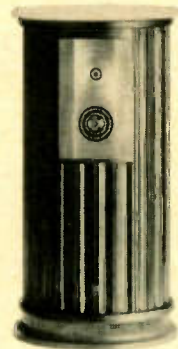

tained with all stops out. A three-position switch that permits adjustment of high-frequency response above or below normal level is located beneath the speaker.

The system incorporates a mass-loaded woofer with floating suspension and 4-inch voice coil. The woofer faces downward and radiates through a front-loaded horn with a circular-aperture throat. The mid-range direct radiator and low-mass domed tweeter employ a die-cast divergent acoustic lens for broad sound propagation. The frequency range is 25 to 20,000 cps, and the power-handling capacity on music is 100 watts. The highly damped walnut cabinet is made of stain-resistant polyester laminate. Dimensions are 16 inches in diameter, 29 inches in height. Price: \$235.

circle 186 on reader service card

● **Rheem Califone** is producing a four-track stereo tape recorder, the Corsaire II, Model 3550. The unit has a VU

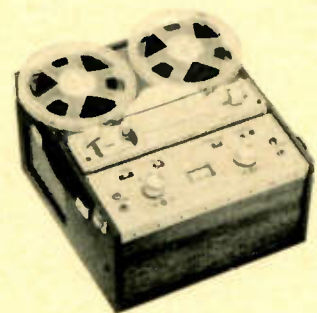

meter, two microphones, two speakers, three tape speeds (1/8, 3/4, and 7 1/2 ips), and individual volume and tone controls for each channel. Wow and flutter are better than 1.5 per cent at 7 1/2 ips. Price: \$169.95.

circle 187 on reader service card

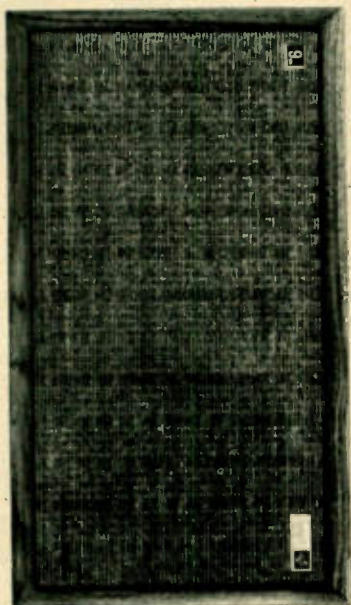

XP-6

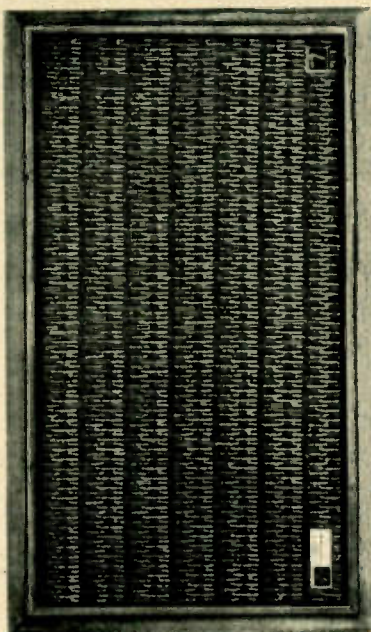

XP-7

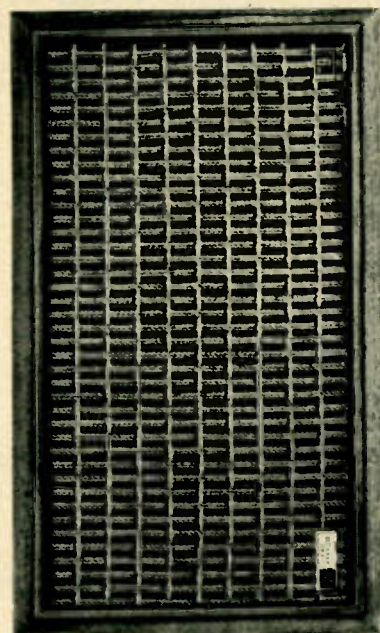

XP-9

There are only a few bookshelf speakers that don't sound like bookshelf speakers. Fisher makes all of them.

Despite their many celebrated virtues, loudspeaker systems between 1½ and 2 cubic feet in volume—today's standard bookshelf speakers—all leave something to be desired if you are looking for completely open, spacious, unstricted sound. All except three, that is. The Fisher XP-6, XP-7 and XP-9.

This new family of three-way bookshelf speakers is based on the design principles of the incomparable Fisher XP-10, a totally original 5-cubic-foot system that ranks with the world's finest. Among these principles is the assignment of more than three octaves of the audible spectrum to the *midrange* channel, with a considerably lower bass-to-midrange crossover than is conventional. This wide-band approach flattens the upper bass and lower midrange response to an unprecedented degree, completely eliminating one of the typical colorations of other bookshelf designs. Three highly specialized 5" drivers carry the midrange in the XP-9, two of the same drivers in the XP-7, one in the XP-6.

Another exclusive feature borrowed from the XP-10 is the Fisher soft-dome tweeter, whose exceptional dispersion characteristics and uniquely smooth, resonance-free response result in the most natural-sounding treble range ever achieved. In the XP-9, this 1½" soft-dome tweeter has an even more powerful magnet than in the other two models.

As for the bass, it is carried by a 10" Fisher free-piston woofer in the XP-6, a 12" woofer of similar design in the XP-7 and a very heavy-duty 12" woofer in the XP-9. In each model, the efficiency is considerably higher than previous experience with bookshelf speakers would make you expect. The end results is state-of-the-art sound in the XP-9 and something very close to it in the other two units.

You owe it to yourself as a high fidelity enthusiast to hear these new speakers at your Fisher dealer. Each has an impedance of 8 ohms and comes in handsome Scandinavian walnut. Prices: XP-6, \$99.50; XP-7, \$139.50; XP-9, \$199.50.



For your free copy of this 76-page book, use coupon on page 27.

The Fisher

FISHER RADIO CORPORATION, 21-40 44TH DRIVE, LONG ISLAND CITY, N.Y. 11101. OVERSEAS RESIDENTS PLEASE WRITE TO FISHER RADIO INTERNATIONAL, INC., LONG ISLAND CITY, N.Y. 11101. CANADIAN RESIDENTS WRITE TO TRI-TEL ASSOCIATES, LTD., WILLOWDALE, ONT.

AUGUST 1965

CIRCLE NO. 26 ON READER SERVICE CARD



FOR STORES "WHERE YOU CAN BUY"—SEE LAST PAGE.

DIAMONDS
ARE
NOT
FOREVER

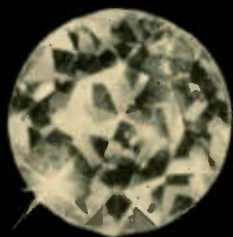

**CHECK YOUR
SHURE STYLUS
PERIODICALLY**

True, it's unfortunate . . . and unfortunately, it's true: the diamond tip of ANY high fidelity stylus eventually wears out. Some sooner, some later. The new ultra-lightweight tracking force cartridges (1 or 2 grams) extend diamond tip life many times. But even they need periodic inspection. Depending upon the degree of wear, a worn stylus will (at the very least) appreciably accelerate *audible* record wear—or it can actually damage a record beyond redemption, in a single playing!

**SHURE PERFORMANCE
DEPENDS ON A GENUINE
SHURE STYLUS**

The superior performance of all Shure cartridges *DEPENDS* upon the Shure Stereo Dynetic Stylus Assembly. An inferior stylus replacement will audibly detract from and significantly reduce the cartridge's performance, and increase record wear. Obviously, if an imitation Shure Stereo Dynetic Stylus is used, we cannot guarantee that the cartridge will perform to published specifications. Accept no substitute. Look for this wording:

"THIS DYNETIC STYLUS IS PRECISION MANUFACTURED BY SHURE BROTHERS, INC."

SHURE

Stereo Dynetic[®]
REPLACEMENT STYLUS

Write: SHURE BROTHERS, INC.
222 Hartrey Ave., Evanston, Illinois

CIRCLE NO. 63 ON READER SERVICE CARD
FOR STORES "WHERE YOU CAN BUY"
SEE LAST PAGE.



**AUDIO
BASICS**
by HANS H. FANTEL

THE NATURE OF SOUND: PITCH

ANY discussion of the principles of sound must include a brief explanation of its two fundamental attributes—pitch and loudness. These, together with harmonic structure (discussed in last month's column), are the elementary physical realities of musical sound, the absolutes against which the performance of a high-fidelity system must be judged.

From one point of view, sound may be considered a purely subjective phenomenon, a sensation experienced principally by the ear, and, to a certain degree, the entire body. But to understand the technical aspects of audio, we need to relate this subjective experience to the corresponding objective physical events that produce it. Sounds are fast-moving areas of high and low air pressure created by the "pumping" action of a sound source such as a plucked string, the vibrating body of an instrument, or the resonant action of an enclosed air mass. The air adjacent to these vibrating elements is driven back and forth, thus forming a series of pressure peaks and nulls that are first sensed by the eardrum and are then perceived as sound by the brain.

Whenever you hear a musical note, it has a pitch—high, medium, or low. The sense of pitch is the brain's way of recognizing, without actually counting, the number of air-pressure pulses impinging on the ears within a given period of time. This number is called the *frequency* of a tone, and each vibration (or pulse) is called a *cycle*. Frequency—which we perceive as pitch—is therefore expressed in *cycles per second*, abbreviated *cps*. The faster the vibrations (the higher the frequency), the higher in pitch the tone will appear.

The lowest sounds audible to the human ear (the roll of distant thunder, for instance) have a frequency of about 16 cps. The lowest musical notes, such as the pedal notes of an organ, are in the vicinity of 30 cps, although it is a rare musical note that falls below 50 cps. A sound system with a bass response extending down to the 40- or 50-cycle range is therefore quite adequate for music reproduction.

The upper limit of human hearing varies with age. As a rule, only the young can hear frequencies above 20,000 cps. The limit for adults usually lies around 16,000 cps, declining with age (in most cases) to 10,000 cycles or less. No musical instrument has a basic pitch higher than about 5,000 cps. But music played on a radio or phonograph that is limited to a top frequency of 5,000 cps sounds stripped of tonal richness—and it is, for the overtones or harmonics (see last month's column) that lend each instrument its characteristic tone color fall mainly in the 8,000- to 15,000-cps frequency range. A frequency response that extends to at least 15,000 cps is therefore essential if the reproduced sound is to bear any relation at all to the original. Audio engineers are still disputing how high an amplifier's frequency response must go in order to reproduce accurately the wave shapes of transients and to preserve the proper time relationships among the harmonics.

Certain sounds do not have a definite pitch—for example, splashing water, rushing air, or wooden rattles. The reason for this is that their vibrations do not have a regular rate of recurrence, but are made up of a random mixture of frequencies that the ear is not equipped to unscramble and perceive as definite and separate pitches.

Next month's column will round out this discussion of the basic attributes of sound with an explanation of loudness and its meaning in terms of the ear and in terms of high-fidelity equipment.

If you can't part with your 1937 Fisher hi-fi system, this may change your tune.



In 1937 the big news in music was made by Arturo Toscanini, Kirsten Flagstad, Koussevitzky and the Boston, Wanda Landowska, and Fisher. When Fisher introduced America's first high-fidelity system that year, it immediately became the connoisseur's way to enjoy the music of the world's greatest artists in the home. Even today, despite the many technological breakthroughs over the years, the original Fisher offers a standard of monophonic performance that many other manufacturers have yet to duplicate.

But, with the advent of stereophonic sound, the remaining barriers between home and concert hall began to crumble. And again music lovers turned to Fisher for leadership.

One result is the new Fisher 500-C stereo receiver, a remarkable synthesis of modern engineering concepts, space-saving ingenuity and simplified operation. Here, on *one* magnificent chassis, are *three* top-rated stereo components. An FM-multiplex stereo

tuner, a stereo control-preamplifier and a 75-watt stereo power amplifier—in only 17½ inches of shelf space! *All* the electronics you need for one of the world's most advanced stereo systems. Yet so functionally designed, even a child can operate it. In 1965, the Fisher 500-C is the logical instrument for serious music listeners. That's why, at \$349.50*, it is the single best-selling high-fidelity component in the world today, bar none.

If you wish to pay \$50 more, you can have the Fisher 800-C, which is identical to the 500-C, with the addition of a superlative AM tuner. Or, for \$70 less, there is the Fisher 400, a stereo receiver with 65 watts of power. And, if you're willing to pay a premium for the last word in space-age electronics, consider the transistorized Fisher 600-T with 110 watts output, at \$459.50* (Cabinets for all models available at \$24.95.)

For complete information, use coupon below.



Even Mr. Fisher himself (right) finally parted with his 1937 Fisher in 1960. Here he presents it to the Secretary of the Smithsonian Institution for their permanent collection.



FREE! \$2.00 VALUE! Mail this coupon for your free copy of *The New Fisher Handbook*. This entirely new, revised and enlarged edition of the famous Fisher high fidelity reference guide is a magnificent 76-page book. Detailed information on all Fisher components is included.

Fisher Radio Corporation
21-40 44th Drive
Long Island City, N. Y. 11101

Name _____

Address _____

City _____ State _____

028

The Fisher

OVERSEAS RESIDENTS PLEASE WRITE TO FISHER RADIO INTERNATIONAL, INC., LONG ISLAND CITY, N. Y. 11101. CANADIAN RESIDENTS WRITE TO TRI-TEL ASSOCIATES, LTD., WILLOWDALE, ONT. *NEW TAX-FREE PRICE



Of the Finest Three Power Amplifiers, Only One Is Solid-State: The Mattes SSP/200

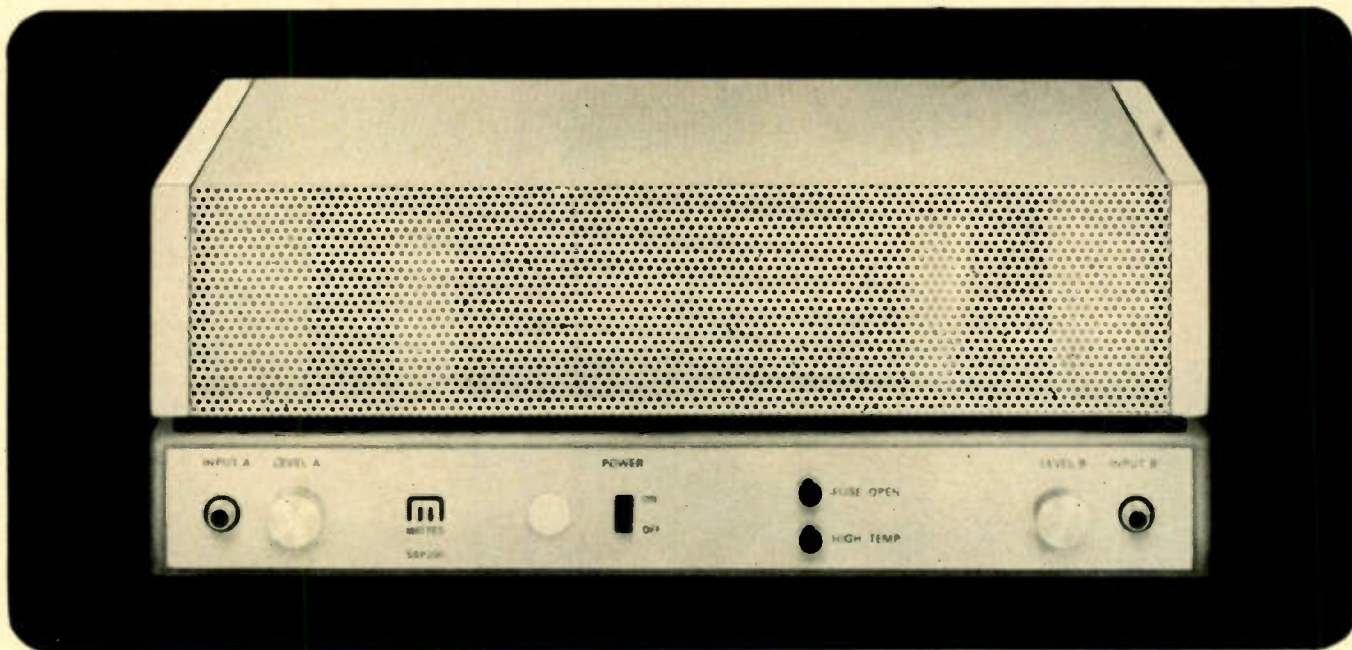

MODEL SSP/200 AS SHOWN, \$375. SLIGHTLY HIGHER IN FLORIDA AND THE WEST. OPTIONAL RACK MOUNTING AVAILABLE.

200 Watts RMS Total Power at 0.1% Distortion

Three high-fidelity power amplifiers are demonstrably superior to all others in design and performance. Of the three, two are vacuum-tube amplifiers; while they are similar, each has its partisans. The third amplifier—the Mattes SSP/200—utilizes a new circuit which transistors alone make possible. Because it is remarkably different in design from earlier solid-state amplifiers, the SSP/200 delivers more power at lower distortion than either of the tube amplifiers in the premium class, yet it costs less than either of them.

Readers familiar with older transistor amplifier circuits will readily recognize that conventional solid-state designs do not approach the level of performance of the SSP/200, even when the costliest silicon transistors are employed. Instead, the radically new Sharma Circuit*, developed at Mattes, is used in the SSP/200; rather than depending upon unusual transistors, the Sharma Circuit applies ordinary transistors in a surprising new way. Reprints of the technical articles describing the Sharma Circuit are available from Mattes Electronics; the salient features of the SSP/200 amplifier are as follows:

Power output is 100 watts per channel (rms) to 8-ohm or 4-ohm loads, delivered at any frequency between 20 and 20,000 cycles within 1 dB and with less than 0.5% total harmonic distortion. For those for whom it is meaningful, the "IHF Music Power" is 160 watts per

channel. Intermodulation distortion is well under 0.1% at full output, whether the test frequencies are the standard 60 and 7,000 cps or 20 and 20,000 cps. Accidental short-circuit of the output terminals does not disable the SSP/200. Its stability is unaffected by open-circuit operation or by playing each channel into a 0.5-microfarad capacitor—it is unexcelled as a signal source for electrostatic loudspeakers. The damping factor is greater than 200.

These unusual characteristics permit the SSP/200 to reproduce musical performances at their original acoustic level, even with inefficient loudspeaker systems. It can do this at extremely high levels with insignificant distortion.

All of this is accomplished in a small ($\frac{1}{3}$ cu. ft.), light (27 lbs.), cool unit incorporating such functional refinements as parallel inputs on front and rear panels, and binding-post output terminals spaced for General Radio plugs. A comprehensive description of the SSP/200 can be obtained by visiting a franchised Mattes dealer in your area, or by writing to Mattes Electronics.

Other Mattes advanced solid-state components are to be released shortly.

*U.S. and foreign patents pending. The Sharma Circuit is described in *Journal of the A.E.S.*, Vol. XIII, No. 3, July, 1965, and, in less detail, in *Electronics World*, Vol. 73, No. 3, March, 1965.



MATTES ELECTRONICS INC. 4937 WEST FULLERTON AVE., CHICAGO, ILLINOIS 60639
MANUFACTURING ENGINEERS/SOLID STATE CIRCUITRY



TECHNICAL TALK

by JULIAN D. HIRSCH



● **POWER BANDWIDTH:** It is evident, from the letters I receive, that many readers are unfamiliar with the exact meanings of some of the technical terms used in audio discussions. The term "power bandwidth," often given as one of an amplifier's specifications, appears to be particularly confusing. Power bandwidth is usually expressed as a frequency range—for example, "20 to 20,000 cps." A more complete statement of this specification, however, would add (for example) "referred to 20 watts at 2 per cent distortion."

To make a power-bandwidth measurement, a 1,000-cps test tone is fed into the amplifier under test, which is driven to its rated power output at a given distortion level, say, 2 per cent. Then the input test-signal's frequency is decreased until the amplifier's output falls to half its original power at the rated distortion level. The low frequency at which this occurs establishes the lower bandwidth frequency. The half-power point at which the same distortion occurs is also determined (in the same manner) for high frequencies. The high-frequency figure together with the low-frequency figure define the power bandwidth. In the example cited above, if a 20-watt amplifier (20 watts rms at 2 per cent distortion) can deliver 10 watts at 20 and 20,000 cps with 2 per cent distortion, the amplifier's power bandwidth is 20 to 20,000 cps.

Obviously, it is desirable to have as wide a power bandwidth as possible in a high-fidelity amplifier, preferably one spanning at least the 20- to 20,000-cps range. Some amplifiers have bandwidths far exceeding this range; others may have power bandwidths of 50 to 10,000 cps or even less. A limited power bandwidth does not necessarily mean that the amplifier cannot deliver useful power ("useful" for a particular speaker system and listening room) at the frequency extremes. If one assumes that, for satisfactory reproduction, 10 watts is required at 20 and 20,000 cps, sufficient power might be obtained from a 10-watt amplifier with a 10- to 40,000-cps bandwidth, a 20-watt amplifier with a 20- to 20,000-cps bandwidth, or a 40-watt amplifier with a 50- to 10,000-cps bandwidth. Although the mid-range power from the three amplifiers varies over a four-to-one range, their power outputs are equal at the frequency extremes.

REVIEWED THIS MONTH

●
Fisher TX-300 Amplifier
Knight-Kit KG-870 Amplifier
●

In the example given, the choice of 2 per cent as the rated distortion level is purely arbitrary. Under the terms of the present IHF standard, a manufacturer is free to rate his amplifier's power at any distortion level he wishes. Some of the best amplifiers are rated at 0.5 per cent distortion or less, and inexpensive amplifiers might be rated at 3 to 5 per cent. I use 2 per cent as a good compromise value. If the manufacturer rates his unit at a lower distortion, I usually check it at both levels. Such an amplifier will generally show little difference in power bandwidth between the two distortion levels. On the other hand, a mediocre amplifier may, in effect, have *no* power bandwidth at 0.5 per cent distortion, simply because it has at least that much distortion at all power levels.

Another—not so technical—term that seems to give difficulty is the much abused "decibel." The decibel is an expression of a power *ratio*. Although it is mathematically equal to $10 \log P_1/P_2$, it is sufficient for our purposes to realize that 3 db corresponds to a 2:1 power ratio, 6 db to a 4:1 ratio, and 10 db to a 10:1 ratio. Most other power ratios can be expressed in decibels by simple addition of these figures. For example, a ratio of 100:1, or 10×10 , is equal to 10 db + 10 db, or 20 db. A 200:1 ratio is twice as great, or an additional 3 db, for a total of 23 db.

Doubling the power output of an amplifier therefore gives a 3 db increase in power. This is true whether the increase is from 0.01 to 0.02 watt, or from 10 watts to 20 watts. This is an important concept, since the human ear is logarithmic in its response, and a change from 0.01 watt of acoustic power to 0.02 watt gives the same subjective impression as an increase from 10 watts to 20 watts. In both cases, we hear an increase of 3 db—which is a barely noticeable change in loudness.

Sometimes decibel figures are presented as though they were absolute levels, rather than power ratios. In all such cases, a reference level is implied, and should be stated clearly. Typical examples are a hum level of -60 db (referred to 10 watts output), or a sound-pressure level of +80 db (referred to a sound pressure of 0.0002 dyne/cm²).

Many measurements are made in terms of voltage instead of power. Power is proportional to the square of the

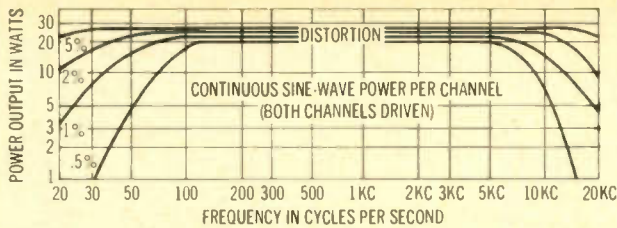

Power response of an amplifier graphed at four different distortion levels. The amplifier at 0.5 per cent distortion delivers 20 watts, and its power bandwidth is about 70 to 9,000 cps. When rated at 2 per cent distortion, the amplifier delivers about 25 watts and has a bandwidth of approximately 25 to 18,000 cps.

voltage, so that doubling the voltage in a system increases the power four times. Thus, a voltage ratio of 2:1 is equivalent to 6 db, one of 10:1 is equivalent to 20 db, and so forth. There is no such thing as a different kind of decibel for voltage and power, although some people have this mistaken idea. The decibel is related to power, and only the scale factor is changed for voltage measurements.

FISHER TX-300 AMPLIFIER



● THE FISHER TX-300 is a fully transistorized, integrated stereo amplifier with an IHF music power rating of 100 watts total, or 36 continuous watts (rms) per channel. Like other Fisher integrated amplifiers, it is extremely flexible, with ample control functions to fulfill the most exacting requirements.

The TX-300 has four sets of inputs (tuner, tape, auxiliary, and low-level), selected by latching push-button switches. A red indicator light glows above the selected input switch. A separate rotary switch connects the low-level input to one of four stereo sources: tape head, either of two magnetic cartridges, or microphone. Other controls include a mode selector (mono, stereo, or stereo reverse), bass and treble tone controls for each channel (mounted concentrically), a balance control, a volume control/power switch, and a speaker selector. The TX-300 has two independent sets of speaker outputs, which can be switched in either simultaneously or individually, or turned off for headphone listening via a front-panel jack. Another front-panel jack provides an output for a tape recorder. A row of rocker-type switches operates the tape-monitor and loudness-contour functions, as well as low- and high-cut filters. Hidden behind the removable Fisher nameplate are controls for the low-level inputs.

The Fisher TX-300 is fairly compact, measuring approximately 15 inches wide, 5 inches high, and 12 inches deep. Like most transistor amplifiers, it runs quite cool in normal operation. Although Fisher recommends thorough ventilation (to the extent of using a fan if the amplifier

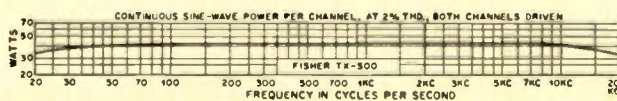

is mounted on edge), I found that the amplifier was no warmer than room temperature after hours of use.

The TX-300 uses four germanium drift-field power transistors in each output stage. Each half of an output stage has two transistors effectively in series, minimizing chances of junction breakdown and distributing the heating over four transistor junctions instead of two. The output transistors are biased to operate somewhere be-

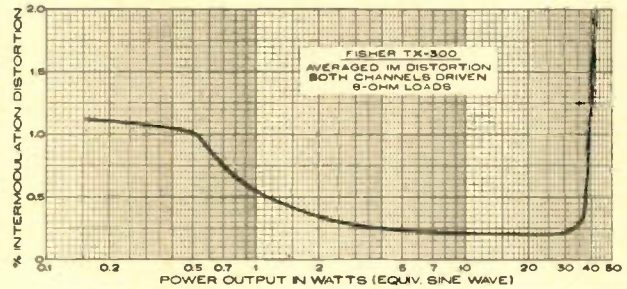

tween class A and class B. Class A operation gives the lowest distortion, but the transistors would have to handle large currents even under no-signal conditions, and this would tend to make the transistors run warm. Class B operation is much more efficient (as well as being easier on the transistors), but it causes "crossover" distortion at very low signal levels. The bias point Fisher has chosen establishes an excellent compromise between the two classes of operation.

I measured the power output of the TX-300 at over 40 watts per channel, both channels driven, through most of the audio range. Even at 20 and 20,000 cps, each channel delivered 33 watts at 2 per cent distortion. The amplifier was absolutely stable with capacitive loads. The IM distortion was only slightly over 1 per cent at power levels of a fraction of a watt, falling to less than 0.5 per

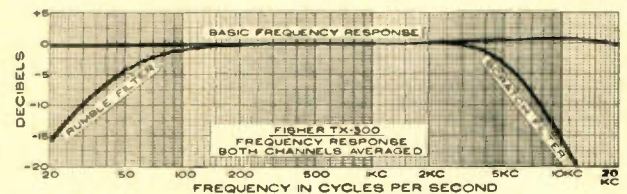

cent between 1 and 37 watts, and to less than 0.25 per cent in the important 5- to 35-watt region. With one channel driven, IM distortion in the under-1-watt region averaged about 0.6 per cent. The amplifier was very quiet, with an inaudible hum level of -60 db on all inputs (referred to 10 watts). At lower volume-control settings the hum was -80 db.

The tone controls had considerable range, with +20 and -17 db variations available at 50 cps and ± 14 db at 10,000 cps. The volume-control sections tracked within ± 0.75 db over a full 35-db range, so that the stereo balance was maintained over the normal range of volume adjustment.

The frequency response, RIAA phono equalization, and NAB tape-playback equalization were all exceptionally flat, falling within ± 1.5 db from 30 to 15,000 cps with the tone controls mechanically centered. The loud-

(Continued on page 32)

HEAR Wharfedale

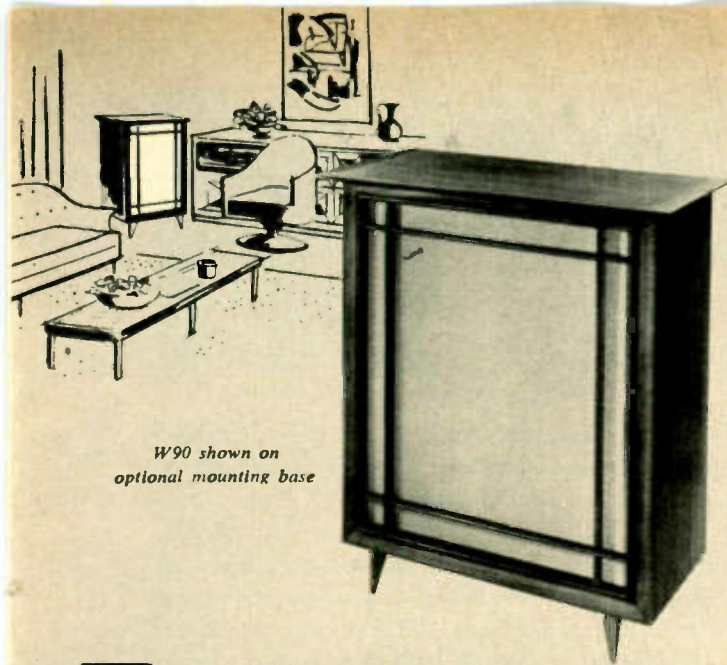

W90 shown on optional mounting base

W90 6-speaker system (two 12½" bass, two 5½" mid-range, two Super 3 treble), superbly matched and integrated with a magnificent sand-filled enclosure.

The impact of the great Wharfedale systems used in G. A. Briggs' notable live vs. recorded demonstrations, now in a new format—neither compact nor large, to sound well and look well in any living room. Maximum performance through advanced acoustical techniques—speakers with polystyrene facing—enclosures with tuned and distributed ports. Now restyled with decorator bouclé fabric grille and handsomely finished table top. Oiled or Polished Walnut, \$272.50; Utility model, \$256.50.

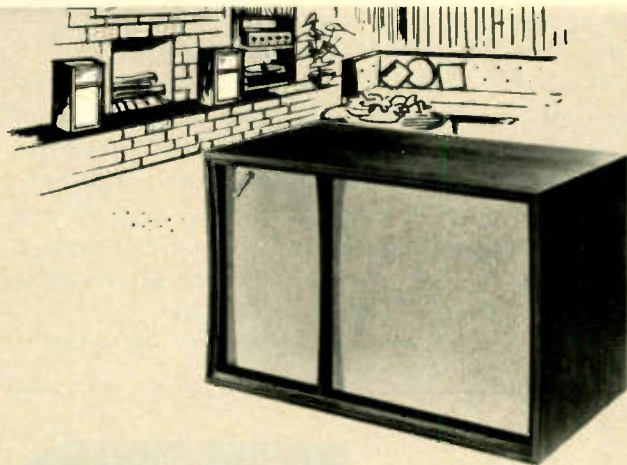

W80 Full-range 2-speaker system (12½" bass; 5" mid-range tweeter) in exclusive sand-filled enclosure.

The original Achromatic system, W60 continues to be the most popular Wharfedale model. Its high standing was established by comparative tests against speaker systems of every calibre. New magnetic materials, a more compliant cone surround, and other developments have now added luster to its recognized acoustical qualities. Fine furniture detailing, including new decorator-selected champagne bouclé grille fabric. Oiled or Polished Walnut, \$122.50; Utility model, \$106.50.

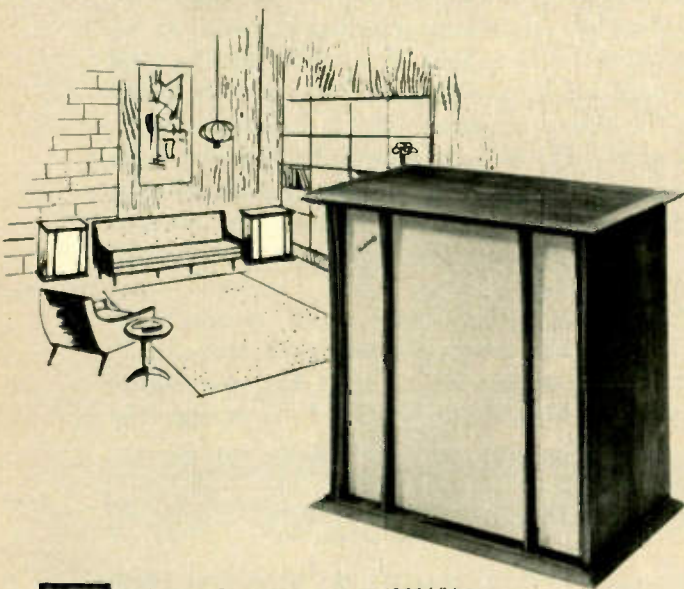

W70 Full-range 3-speaker system (12½" bass; 10¼" mid-range; Super 3 treble) in exclusive sand-filled enclosure.

An unusually versatile system providing excellent bass, transparent highs and the fullness of a superb mid-range. Recent technical advances make it compatible with the latest electronic equipment, including solid state. Now restyled with champagne bouclé grille and decorative table top and base... an attractive addition to any listening room. Oiled or Polished Walnut, \$172.50; Utility model, \$153.50.

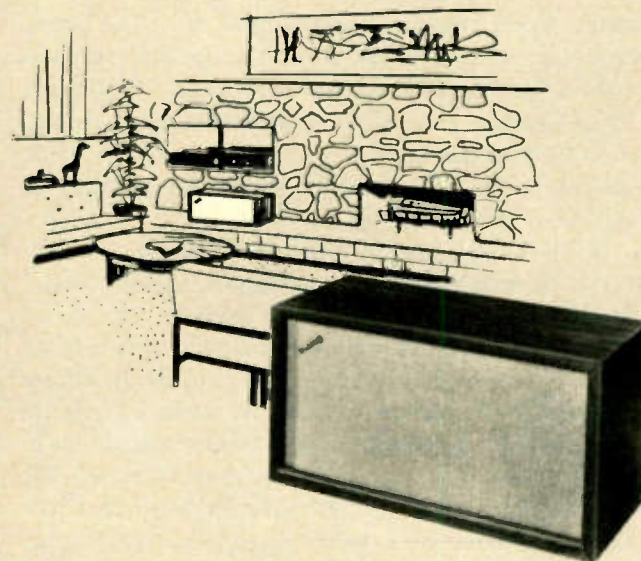

W40 Full-range 2-speaker system (10½" low frequency; 5" mid-range tweeter) in exclusive sand-filled enclosure.

Now, W40 incorporates a highly advanced 10½" bass speaker with extremely high flux density magnet, providing excellent low end. Highs are reproduced without stridency through the same cone-type 5" tweeter as in the W60. Restyled with distinctive champagne bouclé grille and decorative molding, it is admirably suited to any music system where space must be carefully utilized, but quality is required. Oiled or Polished Walnut, \$83.50; Utility model, \$72.50.

WHARFEDALE COMPONENT LOUDSPEAKERS



Full Range 8" Super 8	Full Range 10" Super 10	Full Range 12" Super 12	Woofer W 12/RS	Woofer W 15/RS	Tweeter Super 3
RS/DD	RS/DD	RS/DD	\$52.50	\$89.50	\$26.50
\$26.50	\$47.50	\$89.50			



Mail this coupon to Wharfedale, Dept. WK-125, Div. British Industries Corp., Westbury, New York 11591

Name _____
Address _____
City _____ State _____

ness compensation affected both low and high frequencies, and was pleasing in its effect. The filters were exceptionally good, having little effect on program material. The scratch filter had a 12-db per octave slope above 6,000 cps, which is very nearly ideal for the purpose.

I found the Fisher TX-300 to be a very clean, effortless amplifier in listening tests. It was completely free of switching transients when inputs were changed or controls were being operated. I could not find a single negative point on which to criticize this well-designed unit, either from a listening or operating viewpoint. One could hardly ask for more. The Fisher TX-300 sells for \$280. A walnut cabinet is available for \$22.45.

For more information, circle 188 on reader service card

KNIGHT-KIT KG-870 AMPLIFIER



● THE KNIGHT-KIT KG-870 70-watt transistor amplifier is sold either as a kit or factory-wired by Allied Radio Corporation. It is the firm's most advanced solid-state stereo amplifier and has a number of novel design features.

The amplifier uses 22 transistors and 4 diodes. The output transistors are mounted on the bottom plate of the metal chassis, which serves as a heat sink. The output transistors are coupled directly to the speaker voice coils without blocking capacitors or transformers. This insures a high damping factor down to the lowest audio frequencies. Most of the amplifier's circuits are assembled on printed boards, the main amplifier board being hinged for maximum accessibility.

The KG-870 is rated at 70 watts IHF music-power output, or 28 watts per channel rms with one channel driven. It will drive either 8- or 16-ohm speakers. The use of 4-ohm speakers is not recommended. The amplifier has inputs for tape head, magnetic phono cartridge, tuner, and two high-level auxiliaries. There are separate level and loudness controls, which is an excellent method of obtaining loudness compensation for low-level listening. The level control is uncompensated. The loudness control affects the volume over a limited range (about 30 db), but introduces both bass and treble boost as its level is reduced. The level control is adjusted to give the loudest desired volume with the loudness control at its maximum setting; reducing the loudness setting then provides an excellent tonal balance down to even the softest background listening levels.

Both the bass and the treble tone controls are concentrically mounted. The balance control cuts off either channel without materially affecting the other. A single four-position filter switch has Flat, Rumble, Scratch, and Rumble+Scratch positions. Along the bottom of the front panel is a headphone jack and a row of slide switches for tape-monitor operation with a three-head machine, stereo reversal, stereo/mono selection, speaker-phase reversal, and power.

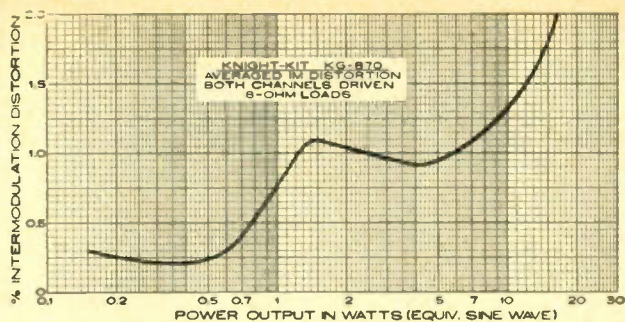

This rather completely equipped amplifier measures 23/4 x 13 x 11 inches and weighs about 20 pounds. It runs very cool and has the well-known solid-state virtues of low current drain and freedom from microphonics. Driving both channels together, with 8-ohm loads, we measured 22.5 watts per channel at mid-frequencies, and more than 20 watts per channel from 50 to 10,000 cps at 2 per cent harmonic distortion. The low-frequency power response was excellent, with 18 watts available at 20 cps at 2 per cent distortion. The high-frequency power output fell off somewhat—to 10 watts at 20,000 cps.

Like a number of other transistor amplifiers, this unit has a moderate amount of IM distortion at low power levels. It averaged about 1 per cent between 1 watt and 10 watts output, falling to 0.25 per cent at outputs of less than 1 watt. The unit's frequency response was flat from a few hundred cycles to 20,000 cps, rising about 2 db below 100 cps. The phono equalization was accurate to within ± 1 db of the RIAA curve from 30 to 15,000 cps. The NAB tape equalization was within ± 2 db from 50 to 15,000 cps. The rumble and scratch filters were rather strong in their action, with the latter removing a good deal of the high-frequency program material. The tone controls had a moderate range—about 8 to 10 db of boost or cut at 50 and 10,000 cps—more than adequate for any normal listening situation.

The amplifier was stable with modern capacitive loads, but oscillated with a 0.65-microfarad load. Such a condition would be encountered only when driving an electrostatic speaker. Hum and noise were -75 db on high-level

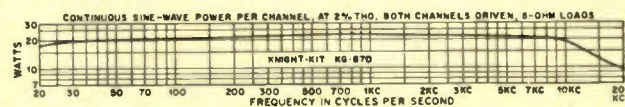

inputs and -50 db on phono inputs (referred to 10 watts output). The noise consisted mostly of hiss and was not audible at normal listening levels.

The Knight-Kit KG-870 provides a prime example of what has come to be known as "transistor" sound. With good, but not exceptional, measured performance, this amplifier nevertheless has a superbly transparent and well-defined listening quality. This may be due in some measure to the direct-coupled output stages, but whatever the reason, this low-priced amplifier has much the same sound quality of some selling for twice its price.

The "Knight-Kit" KG-870 sells for \$99.50 in kit form and \$149.50 factory wired. An oiled walnut case is available for \$12.95 additional.

For more information, circle 189 on reader service card

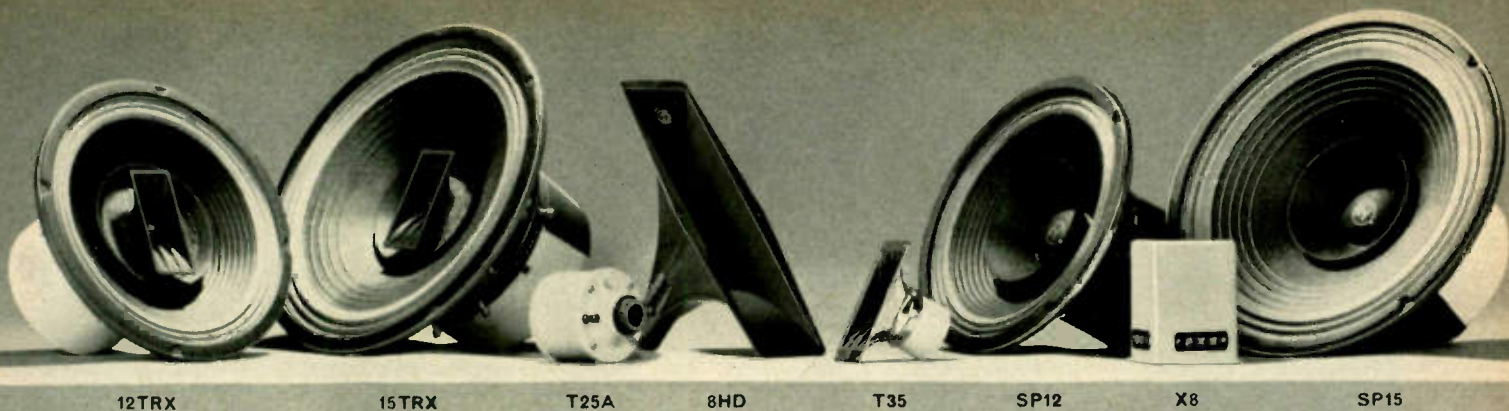

A Return to the Fundamental Concept of High Fidelity: SOUND OF UNCOMPROMISING QUALITY!

Before you make the final choice of speakers for your high fidelity system, take a moment to review your goals. What comes first—size, cost, or performance? If performance is of prime importance, then you owe it to yourself to look at—and listen to—Electro-Voice Deluxe component speakers. Granted, they are not the smallest or the least expensive speakers you can buy, but their design is predicated on the need for quality reproduction above all other considerations.

Your ear is the final arbiter of speaker system quality, but it may help you to know what's behind the unequalled popularity of E-V in the component speaker field. It begins with the finest engineering laboratory in the industry, finest not only in equipment, but also in the size of its staff and in its creative approach to electro-acoustics.

The basic design for E-V Deluxe components was laid down over a decade ago, and, despite numerous detail improvements, this approach is just as valid today. It begins on a firm foundation: the rigid die-cast frame that provides a stable basis on which this precision instrument can be assembled. It is this frame that assures that each E-V Deluxe speaker will forever maintain its high standard of performance by maintaining perfect alignment of all moving parts.

Added to this is a magnetic assembly of generous proportions that provides the "muscle" needed for effortless reproduction of every range at every sound level. In the case of the SP15, for example, four pounds, ten ounces of modern ceramic magnet (mounted in an efficient magnetic assembly weighing even more) provides the force needed for perfect damping of the 15-inch cone.

Within the gap of this magnetic system rides the unique E-V machine-wound

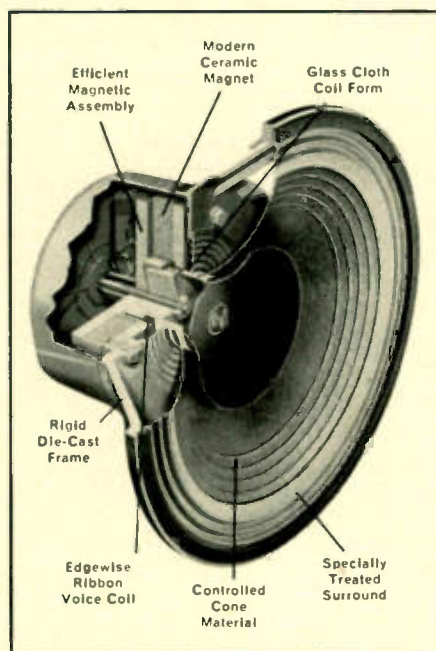

edgewise-ribbon voice coil. This unusual structure adds up to 18% more sensitivity than conventional designs. Production tolerances on this coil and gap are held to $\pm .001$ inch! The voice coil is wound on a form of polyester-impregnated glass cloth, chosen because it will not fatigue like aluminum and will not dry out (or pick up excess moisture) like paper. In addition, the entire voice coil assembly can be made unusually light and rigid for extended high frequency response.

In like manner, the cone material for E-V Deluxe components is chosen carefully, and every specification rigidly maintained with a battery of quality control tests from raw material to finished speaker. A specially-treated "surround" supports the moving system accurately for predictably low resonance, year after year, without danger of eventual fatigue. There's no breaking-in or breaking down!

Now listen—not to the speaker, but to the music—as you put an E-V Deluxe component speaker through its paces. Note that bass notes are neither mushy nor missing. They are heard full strength, yet in proper perspective, because of the optimum damping inherent in the E-V heavy-magnet design.

And whether listening to 12-inch or 15-inch, full-range or three-way models, you'll hear mid-range and high frequency response exactly matched to outstanding bass characteristics. In short, the sound of every E-V Deluxe component speaker is uniquely musical in character.

The full potential of E-V Deluxe component speakers can be realized within remarkably small enclosure dimensions due to their low-resonance design. With ingenuity almost any wall or closet can become a likely spot to mount an E-V Deluxe speaker. Unused space such as a stairwell can be converted to an ideal enclosure. Or you may create custom cabinetry that makes a unique contribution to your decor while housing these remarkable instruments. The point is, the choice is up to you.

With E-V Deluxe component speakers you can fit superlative sound to available space, while still observing reasonable budget limits. For example, a full-range speaker such as the 12-inch SP12 can be the initial investment in a system that eventually includes a T25A/8HD mid-range assembly, and a T35 very-high-frequency driver. Thus the cost can range from \$70.00 up to \$220.00, as you prefer—and every cent goes for pure performance!

Write today for your free Electro-Voice high fidelity catalog and list of the E-V audio specialists nearest you. They will be happy to show you how E-V Deluxe component speakers fulfill the fundamental concept of high fidelity with sound of uncompromising quality!

ELECTRO-VOICE, INC.

Dept. 854F, Buchanan, Michigan

ElectroVoice
SETTING NEW STANDARDS IN SOUND

CIRCLE NO. 65 ON READER SERVICE CARD
FOR STORES "WHERE YOU CAN BUY"—SEE LAST PAGE.



The lyric majesty of Sony sound



The new **Sony 500-A**: A magnificent stereophonic tape system with the amazing new **2.5 micron-gap head** that produces a flat frequency response from 40 to 18,000 cps ± 2 db.* A remarkable engineering achievement; a complete four track stereo tape system with detachable speakers** and two new award winning F-96 dynamic microphones. All the best from Sony for less than \$399.50.

Outstanding operational features distinguish the amazing new Sony Stereorecorder 500-A: ■ Two bookshelf type acoustical suspension speaker systems combine to form carrying case II ■ 4-track stereo/mono recording and playback ■ Vertical or horizontal operation ■ Special effects with mike and line mixing and sound on sound ■ Two V.U. meters ■ Hysteresis-Synchronous drive motor ■ Dynamically balanced capstan fly-wheel ■ Pause control ■ Automatic sentinel switch ■ Multiplex Ready with FM Stereo inputs.



*Rave Review: "The NAB playback characteristic of the 500, as measured at USTC, was among the smoothest and closest to the NAB standard ever measured."—High Fidelity Magazine, April 1964. ■ **Rave Review: "One of the striking features of the TC 500 is the detachable speakers, ...they produce a sound of astonishing quality."—Hi Fi/Stereo Review, April 1964. Available now: A sensational new development in high quality magnetic recording tape, SONY PR-150. Write today for literature and your special introductory bonus coupon book allowing a substantial discount on 12 reels of PR-150. Superscope Inc., Sun Valley, Calif. Dept. 18

SONY

SUPERSCOPE

The Tapeway to Stereo

CIRCLE NO. 57 ON READER SERVICE CARD

HIFI/STEREO REVIEW

Dvořák's cello concerto in B minor

In 1894 a brilliant cello virtuoso performed a concerto of his own at a New York concert attended by Antonin Dvořák. The virtuoso was Victor Herbert, then several years from his subsequent world fame as a composer of light opera. Herbert had been cellist in Vienna with the Eduard Strauss waltz orchestra and had composed numerous works for cello and orchestra. His impressive achievements both as composer and performer in this medium soon set Dvořák to work on a cello concerto of his own. This rare photograph of Herbert as a cellist was taken in the early Nineties, when he was a member of the Metropolitan Opera orchestra.

CULVER PICTURES

AT LEAST three distinguished cellists of the 1890's strongly influenced Antonin Dvořák during the period of the conception and composition of his Cello Concerto in B Minor. The first of these was Victor Herbert, who was later to win renown as the composer of some of the best-loved operettas of the early twentieth century. In the early 1890's, however, Herbert was a cellist—and a highly gifted one—in the orchestra of the Metropolitan Opera in New York. In 1894 he appeared as soloist with the New York Philharmonic Society Orchestra in the premiere of his own Second Cello Concerto. Dvořák, then the Director of the National Conservatory of Music in New York City, attended the Herbert performance and was deeply impressed with the musical potentialities that lay in the combination of cello and orchestra.

Next to enter the picture was Alvin Schroeder, first

cellist of the Boston Symphony Orchestra. When it became known in musical circles that Dvořák was at work on a concerto that promised to be a notable addition to the scant literature for cello and orchestra, Schroeder offered to assist the composer in writing the passagework for the solo instrument. It logically fell to Schroeder to introduce the Concerto to Boston Symphony audiences, and he did so in December, 1896, just a few months after the world premiere performance in London that Dvořák himself had conducted.

The third cellist to be associated with the Concerto, and probably the most influential, was Professor Hanuš Wihan of Prague, a teacher at the Conservatorium there and founder of the Bohemian String Quartet. Indeed, there is strong evidence to support the contention that even before Dvořák heard the Victor Herbert concerto, Wihan had suggested to his countryman that he turn



Among available recordings of Dvořák's Cello Concerto, two, the oldest and the most recent, are supreme—the Casals-Szell collaboration in Angel's Great Recordings of the Century series, and the Rose-Ormandy stereo reading for Columbia. The team of Rostropovich and Talich makes Parliament's budget-priced monophonic disc an excellent alternative.

his attentions to a piece for solo cello and orchestra.

Dvořák began work on the Concerto in November, 1894, in his East Seventeenth Street apartment in New York City. The score was completed in Prague the following summer. Dvořák's correspondence with his publisher, Simrock, indicates the extent of Wihan's cooperation: "The principal part with fingering and bowing indications has been made by Professor Wihan himself," the composer wrote. And there are clear signs that Wihan wanted to have a much more definitive voice in the final form of the score than Dvořák permitted him. In a letter to Simrock dated October 3, 1895, Dvořák forbade further editing of the music by the cellist:

"My friend Wihan and I have differed as to certain things. . . . I give you my work only if you will promise me that no one—not even my friend Wihan—shall make any alterations in it without my knowledge and permission—also no cadenza such as Wihan has made in the last movement—and that its form shall be as I have felt it and thought it out. The cadenza in the last movement is not to exist either in the orchestral or the piano score. . . . The finale closes gradually *diminuendo*—like a breath—with reminiscences of the first and second movements; the solo dies away to a *pianissimo*, then there is a *crescendo*, and the last measures are taken up by the orchestra, ending stormily. That was my idea, and from it I cannot recede."

A measure of the bitterness that seems to have developed between the two friends is the fact that, though Dvořák dutifully dedicated the Concerto to Wihan, the cellist never performed the work in public.

Like much of the music that Dvořák composed or first conceived in the United States, the Cello Concerto has an unmistakable Slavic folk quality. In many of its pages there is a genuine nostalgia which can only be attributed to Dvořák's homesickness for the Bohemian countryside he loved so deeply.

A classic recording of the Concerto is the one made in Prague during the later 1930's by Pablo Casals, with George Szell conducting the Czech Philharmonic Orchestra. This was an occasion when everything conspired to bring about a performance as close to perfection as one is ever likely to hear. The recording sessions found Casals at the zenith of his powers; his playing is by turns hair-

raising in its drama, eloquent in its serenity, and ennobling in its poised and polished lyrical command. Few who hear it will forget the knife-like thrust of the solo cello's first entry in the opening movement as Casals played it on that occasion. When Angel-EMI inaugurated its series of historic reissues, this performance was quickly recognized as one of the "Great Recordings of the Century," and was among the first releases in the project (Angel COLH 30). Considering the fact that nearly thirty years have elapsed since the recording was made, the sound is still amazingly good. Clearly this recording belongs in every music library.

THE Concerto has fared well in more modern recordings, too: there are fine stereo-mono performances by Fournier (Deutsche Grammophon 138755, 18755), Piatigorsky (RCA Victor LSC/LM 2490), Rose (Columbia MS 6714, ML 6114), and Starker (Mercury SR 90303, MG 50303) listed in the current catalog, and a recently withdrawn Rostropovich stereo-mono disc (Capitol SG/G 7109) may still be available in some specialty shops. (In addition, there is an excellent budget-priced Rostropovich mono recording, Parliament 139, in the catalog).

Of the stereo versions currently available, each has its special qualities: Fournier's a grace and supple warmth, Piatigorsky's a grand dignity and nobility, Starker's an impressive power and forward thrust. But my own preference among modern recordings is the most recent of all, that by Leonard Rose, with Eugene Ormandy conducting the Philadelphia Orchestra. Rose's consummate artistry and his supreme mastery of his instrument are heard against an orchestral realization that ranks among the finest of Ormandy's many recorded performances over the years. The disc also offers a matchless account of Tchaikovsky's "Rococo" Variations for Cello and Orchestra.

The Casals-Czech Philharmonic recording of the Dvořák Cello Concerto, then, is the touchstone of all versions of the work, and belongs in every record collection. And the team of Leonard Rose, Eugene Ormandy, and the Philadelphia Orchestra offers, in my opinion, the finest and most deeply felt of the more modern recorded performances of the work.

REPRINTS of the latest review of the complete "Basic Repertoire" are available without charge. Circle number 179 on reader service card.

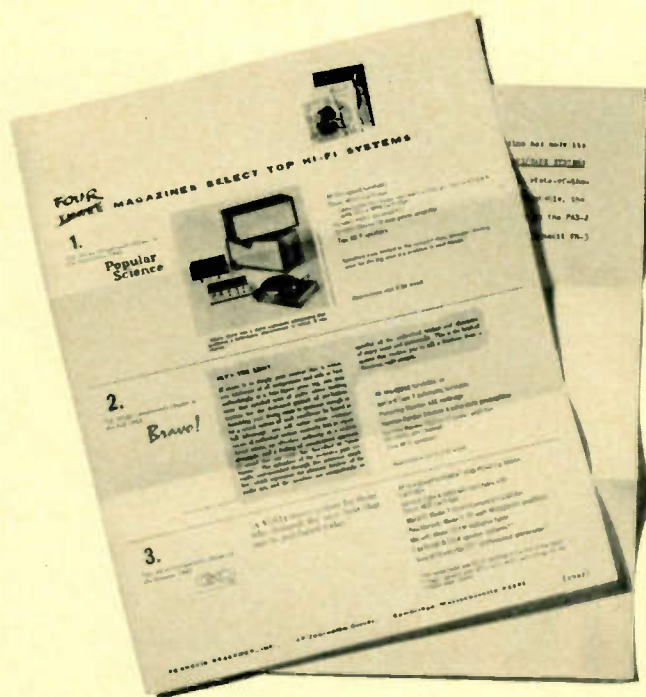

**This is a survey (*available for the asking*)
of the hi-fi equipment recommendations of
four magazines.**

These four lists of equipment choices, from stereo cartridge to speakers, were compiled independently by each of four national magazines — *Gentlemen's Quarterly*, a men's clothing magazine for the carriage trade; *Bravo!*, a concert program "wrapper" with a circulation of almost a million; *Popular Science*, the leading high-circulation science magazine; and *Hi-Fi/Tape Systems*, a hi-fi annual.

**AR-3 speakers were the top choice of three
of the four.**

The fourth magazine, *Gentlemen's Quarterly*, chose speakers costing \$770 each for its most expensive stereo system; AR-3's were relegated to the "middle-range" (\$1,273) system.

**The AR turntable was the top choice of all
four.**

The AR turntable is \$78 including arm, oiled walnut base, and transparent dust cover. The AR-3 is \$203 — \$225, depending on finish (other speaker models from \$51). AR's catalog is available on request.

ACOUSTIC RESEARCH, INC., 24 Thorndike Street, Cambridge, Massachusetts 02141



Compare these Sherwood S-9000 specs! Power output for both channels is 150 watts at 3/4% I.M. distortion. Continuous sine-wave power output (two channels) is 100 watts at 1/4% distortion. Power band width: 12-25,000 cps. at 1% distortion. Hum and noise: Phono—70db, Tuner—80db. Sensitivity: Phono 2.5 mv, Tuner 0.35v. Other Sherwood ALL-SILICON Solid-State amplifiers are the S-9900, [diagram] 90-watts music power (features ctr. channel mono power) @ \$229.50 and the S-9500, [diagram] 50 watts music power @ \$179.50.

0.1% distortion

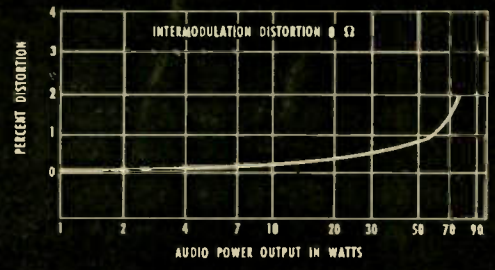

... and All-Silicon too!

Chart reprinted from test lab report, May, 1965, *High Fidelity*.

Are you ready to step up to a Sherwood? You are, if what you seek is the "transparent", "life-like" reproduction resulting from 0.1% distortion previously obtainable only in bulkier, more-expensive basic amplifiers. And, did you know that *only* Sherwood features ALL-SILICON solid-state circuitry in every amplifier to earn the industry's most enviable reliability record? This is why experts confirm again-and-again... *Sherwood is the best!*



Paired in "Gemini" walnut cabinet @ \$39.50 is Sherwood S-9000 Solid-State 150 watt amplifier, \$292.50, and S-30000 FM Stereo tuner, \$165.00.

Sherwood

Sherwood Electronic Laboratories, Inc., 4300 North California Ave., Chicago, Illinois 60618 Write Dept. 8R

CIRCLE NO. 52 ON READER SERVICE CARD FOR STORES "WHERE YOU CAN BUY"—SEE LAST PAGE.

HIFI/STEREO REVIEW

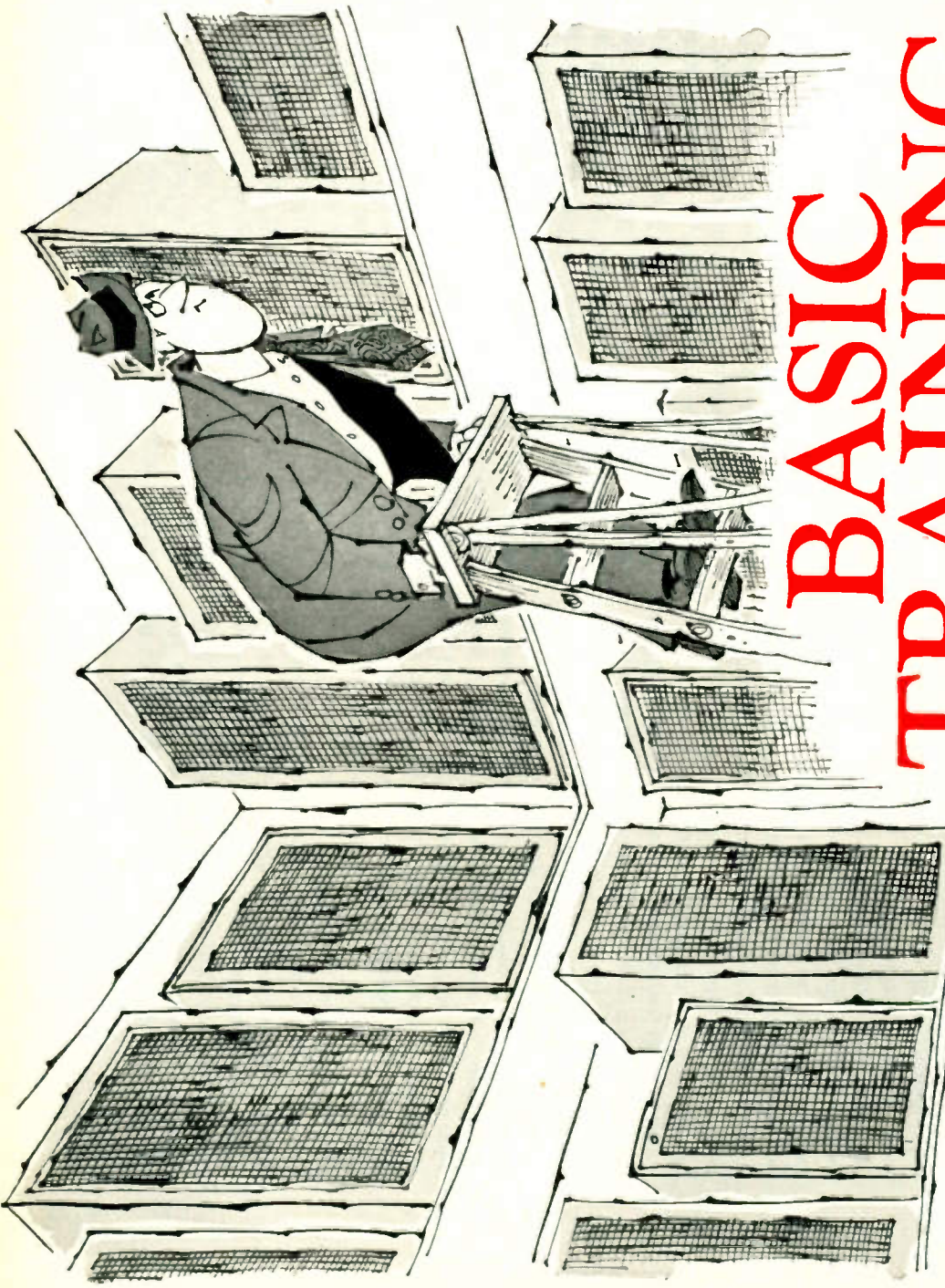

BASIC TRAINING FOR SPEAKER SHOPPING

HOW TO GET IN SHAPE TO MAKE YOUR OWN SELF-CONFIDENT APPRAISAL IN THE SHOWROOM

By JOHN MILDER

LOUDSPEAKER shopping can be a challenge even for the experienced audiophile. One reason is that a speaker system—like a bottle of wine, a beautiful woman, or any number of other good things—is difficult to judge accurately while on public display. Of the three, however, the loudspeaker is by far the most accessible to such judgment, and it is often possible to predict with



considerable accuracy how a speaker is going to sound as part of your system at home.

The fact that so many of the speakers you hear in the showroom sound so *radically* different from one another does not mean that there are no reliable rules for determining quality, or that you will have to rely heavily on that elusive yardstick "taste." With a reasonable amount of practice, you can easily learn to sort out and determine the significance of even the subtlest differences in speaker sound.

It is well, first of all, to start out on your speaker shopping trip with the unshakable conviction that a loudspeaker is an electromechanical device and *not* a musical instrument. Not only is it poor logic to construct an analogy between a musical instrument and a speaker system that is designed only to reproduce the sounds such an instrument might make, but any tendency to confuse the two will probably lead you to prefer the kind of speaker system that asserts its own personality at the expense of the music. If you can manage to keep clearly in mind that a speaker is a contraption whose job it is to *reproduce* rather than to produce music, your critical faculties are certain to remain in better shape during prolonged listening comparisons in an audio showroom.

What makes a good speaker? The basic requirements can be stated fairly concisely. Probably the most familiar is that a speaker must have a wide enough frequency bandwidth to reproduce—in convincing proportions—both the lowest and highest frequencies of musical interest. Equally important, a speaker should not tend to favor one segment of the frequency range over the others. And it should have low distortion, good transient response (the ability to follow exactly the rapidly changing electrical waveforms delivered by the amplifier), and it should radiate all frequencies uniformly throughout the listening area.

All really good speakers, of course, should sound alike—and, to a remarkable extent, they do. But three things make the choice of a speaker a little more than a simple game of yes or no: (1) there are some audible differences among even the best speakers; (2) most buyers have to—or choose to—make compromises for the sake of their budgets; and (3) some speakers, including some very expensive ones, are just plain bad, and it is important to be able to recognize their deficiencies.

Let's take the last matter first. What makes a speaker system sound mediocre or downright awful? There are several fairly uncomplicated reasons. One is the presence of spurious outputs at certain frequencies, usually in the mid-range and low bass. In the mid-range, for instance, excessive output is very often brought on by the use of too "live" a cone material. A badly designed cone is subject to internal standing-wave reflections and resonances that produce, at high volume levels, spurious tones that overwhelm the fundamental musical frequencies. (It may be of inter-

est to note in passing that most radio and television sets rely upon the mid-range resonances of their hard-cone speakers to achieve a loud volume for a very small investment in amplifier power and loudspeaker magnet.) Needless to say, no speaker with any pretension to high-fidelity status can rely on spurious resonances to supply high output or presence effects, for the result must inevitably be a false mid-range coloration.

Spurious output in the bass frequencies is not caused by cone-material problems, nor is it as audibly offensive. In the bass range, the problem is two-fold. First, all cones have a tendency to vibrate most freely at a fundamental resonant frequency which is determined by their particular combination of suspension elasticity and mass. The tendency to vibrate too freely at (and also near) the resonant frequency must be curbed (damped) to prevent false, boomy bass production. If the damping is inadequate, the speaker system loses definition in the bass frequencies.

The second problem in the bass range is harmonic distortion, caused either by a tight cone suspension that does not permit the proper amount of cone excursion for a given input signal, or by a voice coil that is not always under uniform control by the speaker's magnetic assembly. In either case the speaker tends to produce not only the frequency actually fed to it, but a multiple (harmonic) of that frequency. The problem worsens at higher volumes (and longer cone excursions) to the point that the harmonic frequency may completely swamp the fundamental frequency.

There remains one other main source for the false color of a poor speaker: the absence of necessary high frequencies. The high frequencies provide the final measure of audible definition, the sense of "air" surrounding the musical instruments. If the high frequencies are not present in full proportion, a speaker will sound dull or boxy. Sometimes, even though the high frequencies are being adequately reproduced by the speaker, they are not being distributed uniformly enough over the listening area. If this is true, the composite sound that reaches the listener (made up in great part of reflections from the room sur-

A "presence" that seems to make the brass section leap right out of the enclosure may make a speaker impressive on first hearing.



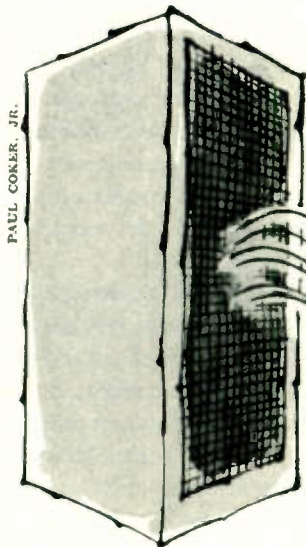

Be alert to the possibility of being seduced by "loudspeaker sound."

faces) will not contain the proper proportion of highs, but instead a predominance of the more easily spread lower frequencies. Inadequate high-frequency dispersion will often make a speaker system sound closed-down and small.

THUS forearmed with as much basic speaker theory as is necessary, you need not concern yourself, when you arrive at an audio showroom, with *how* a manufacturer has solved the various problems discussed above, but can concentrate instead on listening for those qualities of excellence that are to be found within your price range. By far the most important single fact to realize is that your first impression of a good speaker is not likely to be a very persuasive one. A bad speaker, on the other hand, one with a highly exaggerated mid-range output and a "presence" that seems to make the brass section of the orchestra leap right out of the speaker enclosure, may be much more impressive on first hearing. In fact, it may even overwhelm a much better speaker in direct A-B comparison on some musical material—particularly since (unless the showroom's switching arrangements provide for equalizing speaker efficiencies) it almost certainly will sound *louder*.

This does not mean that bad speakers will always sound good in a showroom, and *vice versa*. But if you realize very early that a poor speaker is likely to seize your attention first, you can better prepare yourself to begin sorting out your impressions of speakers as soon as possible during a listening comparison. If you are alert to the possibility of being seduced by "loudspeaker sound," you will have a relatively easy time recognizing it, and can thus dismiss the highly colored speaker from your considerations immediately. It is a good idea to ask for (or bring) a variety of musical material, preferably material you know well, and simply check briefly to see which speakers always seem to assert their own character rather than reflect exactly what is on the recording. If one

speaker, for example, imparts a hollow or nasal quality to *everything* played through it, it is safe to assume that the nasality resides in the speaker and not in the recordings.

Slightly more difficult to evaluate, but equally important, is proper bass response. Both of the factors mentioned previously (underdamped bass and harmonic distortion) tend to produce a rich, juicy mid-bass sound—the juke box at your corner bar has the same quality—that can totally mask the absence of actual *low* bass and, as you might expect, may even sound more impressive than the real thing. And here there is an even further complication: the spurious bass is not nearly as offensive to the ear as exaggerated mid-range response, and it takes a good deal of critical listening to tell the real from the imitation.

It is important to realize also that the good speaker may be suffering in a direct comparison because of its placement in the showroom. The proportion of bass in a speaker's over-all sound can be markedly changed by room placement, with the bass increasing as the speaker is placed closer to intersecting surfaces (such as two walls or the junction of wall and floor) that serve to reinforce non-directional bass frequencies. Many audio dealers place speakers in their showrooms seemingly with no recognition of this important factor. (In some cases, of course, there is only so much premium display space in the store, and all the available speakers cannot occupy it at the same time.) Although the speaker with exaggerated response may bring its artificial richness to just about any location, the good speaker may sound somewhat bass-shy when placed poorly.

What all this means is that you should take your time deciding whether speakers sound rich or thin, full or light in weight. Recordings or broadcasts of male speaking voices will help show up a speaker with an exaggerated mid-bass response. Depending on room position and other factors, one good speaker may easily sound slightly

heavier or lighter in weight than another good speaker, but a speaker with badly exaggerated bass will reveal itself with an unmistakable chesty, boomy, or rain-barrel quality when reproducing the male speaking voice. Once you have eliminated the obvious offenders, you can then listen for real low-frequency response with program material such as organ pedal notes (from a "classic" organ, not the theater type) and wallops on a bass drum (not tympani, which are boomy by nature), both of which should have a good deal of the kind of raw power you can feel as much as hear.

If you are in the market for the "best" speaker regardless of price, you should be prepared to listen for very subtle distinctions. It goes without saying, of course, that if you have long been absent from the concert hall, you should first take a quick refresher course in "live" sound before attempting to judge speaker subtleties. It is very unlikely that a truly good speaker will overwhelm you on first hearing with the feeling that it is the one-and-only, the speaker of your dreams. It should convince you instead over an extended listening period that it has unusual (or just slightly better) clarity, musical definition, and "openness." All three of these adjectives point directly to the speaker that not only has the best-controlled mid-range behavior, but also the most extended high-frequency power and dispersion. A speaker lacking well-dispersed highs may sound either dull or shrill, but a speaker with a good top end should never sound anything but neutral and transparent. A quick and fairly reliable test of dispersion is to listen to the speaker in question while it is playing "white noise" (the noise between FM stations on the radio dial, for example) and you are walking back and forth in front of it. The character of the noise will change on all speakers as you move from a position directly in front of them, but the speakers that produce the least radical (and least abrupt) change in the overall quality of the noise have the best dispersion. Then go back to the speakers that seem to be the best from the dispersion standpoint and listen for the proper reproduction of subtle transients, such as plucked strings in a *pizzicato* string quartet passage. Gradually, but definitely, you will be able to narrow your choice down to the three or four speakers whose differences are minor enough that a final decision becomes a matter of taste.

BUT suppose you simply want a good speaker within your price range, rather than the very best? What sacrifices in quality do you have to make for the sake of price? If you shop wisely, you should have to give up only two things: a slight amount of bandwidth, and some smoothness within the range covered. It is this slight superiority in smoothness and frequency coverage (seldom found, by the way, in speakers claiming "20 to 20,000 cps response") that differentiates the very highest quality speakers from the otherwise excellent ones in the medium-price

range (\$100-150). In return for the sacrifice of frequency extremes, the medium-price speaker usually offers a slight gain in efficiency, which permits the use of slightly less powerful amplifiers. And the uniformity of response of the best medium-price systems can be such as to make them very close in musical quality to the same manufacturers' more expensive systems. This uniformity, producing almost the same kind of "neutrality" heard in the very best systems, is very much worth searching for.

If your budget puts you in the \$50 to \$100 price class, you are just in time to take advantage of a quiet revolution that has made most of the *musical* quality of expensive speakers available also in this lower-price category over the past year or so. Here again, you should expect only a slight (in some cases, an almost incredibly slight) shrinkage in the frequency range. The sacrifice may occur at the high end, low end, or both, but it should be emphasized that the sacrifice is only in comparison to today's *finest* systems. There are speakers in the \$50 to \$75 class now that are unquestionably better-sounding than many \$300 to \$500 systems of five to ten years ago. It is in this price class, however, that you will also find the greatest proportion of blatantly bad speakers. Insist on the "musical neutrality" discussed above, making comparisons meanwhile with the higher-priced speakers of known excellence to keep this quality firmly fixed in your mind's ear. One further factor that deserves attention here is the frequent variation in power-handling capability between good speakers in this class. None of the good systems is likely to be damaged by a momentary peak on musical material, but some are more suited than others for use in large rooms, and provide better handling of very heavy bass material at very high levels. While less marked, there are also differences in efficiency to consider.

Only in the under-\$40 class are you likely to be forced to choose between various types of musical distortion rather than degrees of actual quality. If you need to start at the bottom budget-wise, pick an inoffensive-sounding system that can be used later as an extension speaker.

If you approach your speaker purchase as something less than a mysterious rite, you will find that it is not difficult to choose a totally satisfactory system. Fortunately, Gresham's Law seems to have been enacted in reverse as far as the speaker industry is concerned, with the result that better and better systems at lower and lower prices are driving out the mediocrities and the poor performers. The odds on your making a good choice are therefore continually changing in your favor. All you need do is to bring your best matter-of-fact, show-me attitude along to the showroom and let your ears do the rest.

John Milder, a longtime contributor to these pages, has bought, sold, and listened to loudspeakers for many years, becoming in the process fairly relaxed about the whole subject. He is currently employed by a major manufacturer of audio equipment.

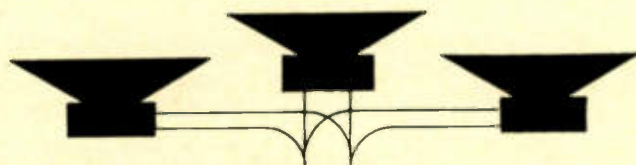

EXTENSION SPEAKERS AND CENTER-CHANNEL TECHNIQUES

THE UNUSED POWER RESERVE GOING TO WASTE IN YOUR AMPLIFIER
IS A LIKELY SOLUTION TO YOUR HOLE-IN-THE-MIDDLE, BACK-FILL,
AND EXTENSION-SPEAKER PROBLEMS



By H. B. MORRIS

A HIGH-FIDELITY amplifier, like the automobile, has enormous reserves of power that are seldom used. In an economic sense this is wasteful if you—or someone else—could be making use of this extra power. And, in the case of your amplifier, chances are very good that you could. Have you been struggling along with a hole-in-the-middle problem that is "just too much trouble" to eliminate? Would your stereo system profit from the sonic rounding-out that a back-fill speaker would give it? Would an extension speaker in the basement, the garage, on the terrace—or in the bath, for that matter—amplify your listening pleasure? All three of these potentialities refer back to one source: the unused power available in your amplifier. The investment in almost all cases involves only an additional speaker, some wire, and a few minor parts, so it can easily be seen that the economics, at the very least, are compelling.

In most cases, however, there is more to be considered than simply acquiring an extra speaker and hooking it up to an amplifier's output terminals. For, in addition to some important but easily overlooked electronic considerations, there are quite a few different hookup possibilities that are worth examining. Let us take up these possibilities in the approximate order of their cost and complexity. Somewhere in the progression there should be an extra-speaker approach that will be directly—or with some minor modifications—suited to your particular listening needs.

First of all, before purchasing additional speakers, check carefully for any precautions that may be noted in your amplifier's instruction manual. Some amplifiers, particularly transistorized units, will not tolerate certain types of connections at their output terminals. Other equipment may have special amplifier-speaker compensation

that should not be disturbed. In most cases, however, supplementary speakers can be installed with but minor disturbance to the main system.

Simple Extensions

To start, let us consider a simple arrangement for connecting an additional speaker to a mono system or to each side of a stereo system. The important consideration here is impedance matching—connecting the speakers so they present the most favorable load to the amplifier. Shown in Figure 1 is the *parallel* hookup. Two 8-ohm speakers wired as shown on a common line present a total impedance of 4 ohms to the amplifier. Both speakers therefore connect to the 4-ohm terminals on the amplifier. Figuring other combinations for more speakers is simple if all the speakers are of the same impedance. Just divide the number of speakers into the impedance value of one of them. If the answer doesn't agree perfectly with the figure on an amplifier tap, use the closest available tap. (For example, for three 8-ohm speakers in parallel: $8 \div 3 = 2.7$ ohms. Use the 4-ohm amplifier tap.)

Next let us take the case where the main speaker is (for example) 16 ohms and it is desired to add a couple of inexpensive speakers for background music (not stereo)

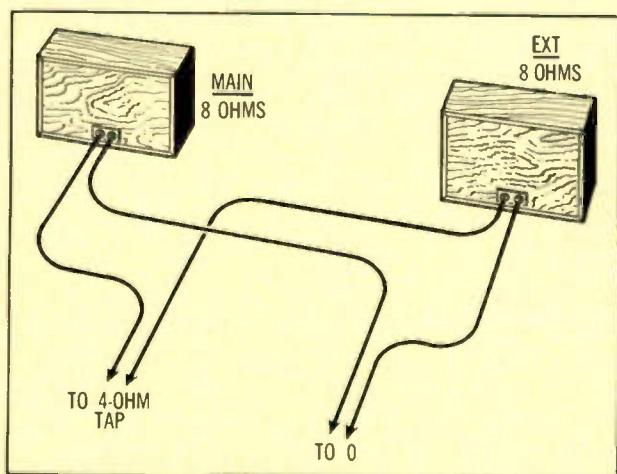

Figure 1. Parallel connection of a main and an extension speaker, both having the same impedance. When connecting two 16-ohm speakers as shown, use the 8-ohm amplifier terminals.

in a recreation room. If these speakers are rated at, say, 8 ohms, a matching problem with the 16-ohm main speaker will be created. The solution is a *series* arrangement for the two extension speakers, as illustrated in Figure 2. When wired in this fashion, the two extension speakers add impedances for a total of 16 ohms. Then, if we consider the new pair of speakers as being a single element in parallel with the main speaker, the net result is 8 ohms, so the 8-ohm amplifier output should be used, with connections as shown in the figure. The same approach is used for 4- and 8-ohm combinations.

Switching

The examples above should take care of all but the most exotic extension-speaker setups. But there is still room for improvement even in these: as the setups are shown, all the speakers are on at the same time, and it is not possible to adjust the volume of individual speakers. The volume-control problem is easily eliminated in one approach if the listener is willing to accept a limitation: only the main *or* the extension speaker plays at one time. If this is acceptable, a selector switch can be installed, as in Figure 3. The switch is a standard toggle or slide type. (In a mono system, use a single-pole, double-throw—SPDT—switch. For stereo extension speakers, use a double-pole, double-throw—DPDT—switch.) Now the main or extension speakers will operate independently, with the volume of either of the two speaker systems still being controlled at the amplifier.

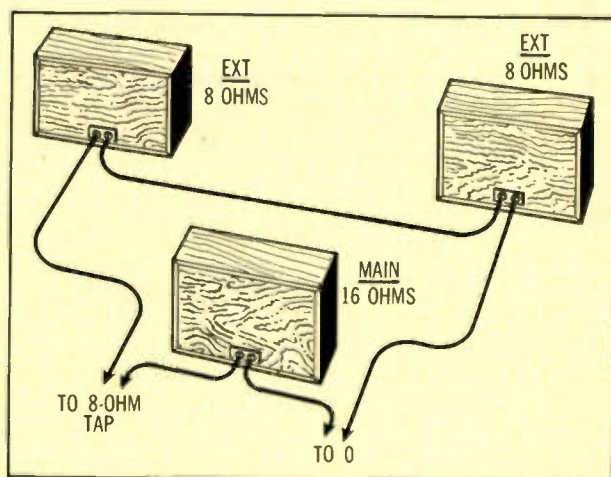

Figure 2. This series-parallel hookup makes it possible to connect a pair of lower-impedance extension speakers (wired in series) across a single main-speaker system of higher impedance.

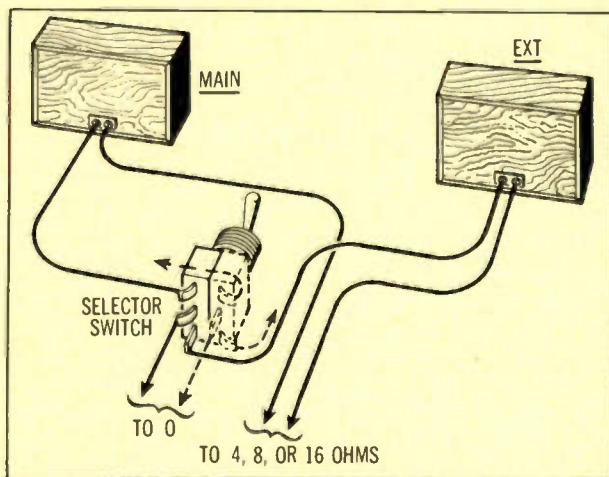

Figure 3. This selector-switch hookup furnishes a choice between main- and extension-speaker operation. The phantom half of the switch shows additional connections for stereo operation.

A better solution is to use one of the accessory switches available at your local dealer or through electronics mail-order houses. Several companies—Vidaire, Audiotex, Switchcraft, Lafayette, and Mosley—market units capable of selecting as many as three pairs of stereo speakers (six speakers per channel) in stereo or mono, maintaining a reasonable impedance match to your amplifier while so doing.

Again, in the interests of simplicity, certain limits must be observed in a switch-selected system. To preserve matching in each switch position, main and remote speakers must have the same impedance. For example, if the main speaker is 8 ohms, the extensions may be one 8-ohm unit or two 4-ohm speakers connected in series (Figure 4). Or the main speaker may be 16 ohms and the extension one of 16 or two of 8 ohms, connected as shown in Figure 2.

Volume Controls

In any of the systems described up to this point, the volume of individual speakers can be adjusted only at the main amplifier. However, local adjustment of volume, for one or more extension speakers, can easily be provided by means of an L-pad control mounted on, in, or near

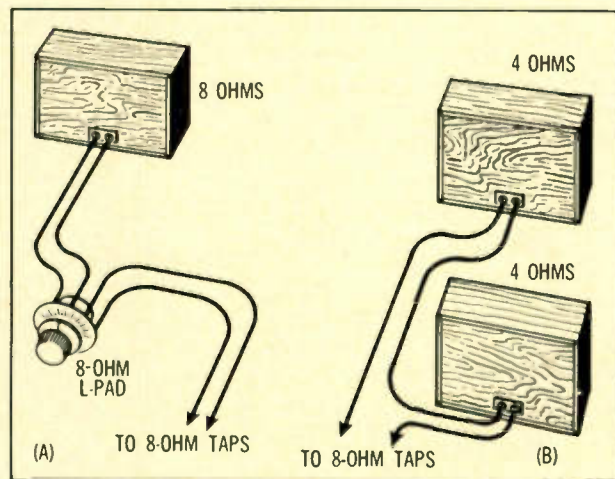

Figure 4. A single 8-ohm extension speaker with L-pad control is shown at (A). Series-connected speakers totalling 8 ohms are shown at (B); four-ohm L-pads could be used at each speaker.

a speaker cabinet. The L-pad used should be rated at the same number of ohms as the line it controls—an 8-ohm speaker, for example, should be controlled by an 8-ohm pad. Note, too, that two 4-ohm speakers in series (totaling 8 ohms) also require an 8-ohm pad. (Wiring instructions are supplied with the pads.) You should be aware that when an L-pad is used to turn down a speaker, audio power is still being consumed—it is converted to heat within the pad. For this reason, it is not desirable to operate your main speaker system while relying on the pads to keep the remote speakers silent for extended periods

of time (weeks or months). This can be avoided by using the switch-selector system in conjunction with the L-pad. When this is done, the pads dissipate power only when extension speakers are actually in use.

The techniques described thus far will solve most speaker-extension problems. Mono or stereo, they make it possible to use the amplifier's output at any point where wiring can be routed in or around the home. The wire used, incidentally, can be rubber- or plastic-insulated lamp cord. If you intend to run speaker wires much over 30 or 40 feet, heavier No. 16 wire will have less power loss and less effect on amplifier damping factor. (See also the suggestions on very long wiring runs given below.)

Stereo plus Mono

One significant limitation of any of the above systems is that it is not possible to listen to stereo in the main listening area and mono at a remote point. This is quite often a desirable option, for it requires just one extension speaker. In many recent-model amplifiers, a powered center-channel speaker output is provided. Although designed for stereo center-channel fill, the center-channel output will also supply a mono signal to an extension speaker, or provide back-fill sound in the main listening area. Where such an output is not available, a mono channel will have to be derived by combining the left- and right-channel speaker outputs into a single signal.

A method developed by one manufacturer (Dynaco) is shown in Figure 5. While it is primarily intended to serve as a center channel to fill the hole-in-the-middle, it can also be used to drive an extension speaker. The main left and right speakers are connected in a somewhat unorthodox fashion—in series with each other. Output for the middle channel is derived between them, with a 100-ohm control providing volume adjustment of the middle speaker. In operation, the combined left- and right-channel signal (mono) appears at the middle speaker. There is, however, one serious limitation to this circuit: the speaker connections cause some cross-feed between the original stereo channels, thus diminishing the stereo effect. (An improved version of the circuit, now under development by Dynaco, will eliminate cross-feed.) It is possible to use this circuit for extension purposes, however, without detriment to normal stereo performance. This is done by adding a switch to permit choosing between the conventional stereo hookup and the center-channel connection. When the switch is in the mono position, the remote extension speaker is energized with a mono signal and the main speakers play stereo—albeit slightly diminished in separation. In the stereo position, the extension speaker is cut off and the original stereo connections are restored. The extension speaker used should be similar to the main speakers, at least to the extent of having the same impedance.

Speaker phasing becomes very important if the setup

of Figure 5 is intended for center-channel use in the same room as the main speakers. Most speaker systems have some sort of polarity coding on their terminals that should be followed. If you are in doubt as to which hookup at the center channel is correct, try it both ways. The connection that provides the best bass response and stereo perspective is the correct one.

At a somewhat higher cost you can obtain a special mixing auto-transformer that can provide a center-channel output without affecting normal stereo operation. The Microtran HM-90, for example (\$6.33), creates mono from stereo and solves the impedance-matching problem at the same time. Instructions are provided with the unit for wiring various combinations and impedances.

If your extra speaker is to be used for either hole-in-the-middle or back-fill purposes, incidentally, volume control is mandatory to avoid the possibility of the new speaker's overshadowing or even destroying the very thing you are trying to improve—the stereo effect. For this purpose, it is best to place the speaker in the position it will eventually occupy and then adjust the volume of the new

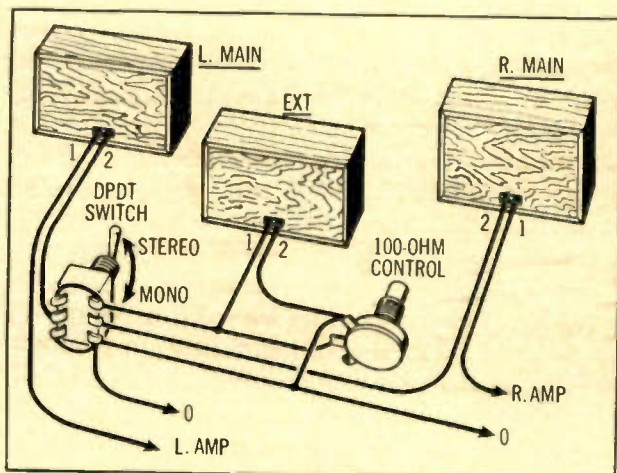

Figure 5. This hookup, suitable for extension-speaker or center-channel use, was designed by Dynaco's David Hafler. In the mono position, the switch disconnects the center-channel speaker.

speaker with the L-pad control for the best effect in your normal listening position.

There are two other techniques for achieving a mono signal at an extension speaker while your main system is playing stereo. Both of these techniques are particularly well suited for use with those transistor amplifiers on which the user is warned not to join the common terminals on the speaker-output connectors. Both approaches have the minor disadvantage that a four-wire speaker line must be used. The connections are the same as shown in Figure 3, except that instead of having two separate extension-speaker systems, two small loudspeakers are housed in one cabinet. Another and more sensible idea is to use one of the special 8-inch Jensen dual-voice-coil speak-

ers in your extension unit. Simply connect the line from one stereo channel to one set of voice-coil terminals and the line from the other stereo channel to the other set of terminals. The Jensen speaker (Stock Number DCA-850) sells for \$8.10 and is available at large hi-fi equipment or electronic-parts dealers. Incidentally, dual L-pads are available that will handle both channels simultaneously.

(The center-channel hookup that requires a separate mono amplifier to handle the mixed mono signal taken from the preamplifier output or speaker lines is omitted from this discussion. It is too cumbersome to be practical.)

Running Long Wires

Finally, let us consider the problem of a really long wiring run to one or more extension speakers. As mentioned earlier, heavy wire helps overcome the losses, but the problem becomes serious when lines are in excess of about 75 feet and also if extension speakers are being connected in at different points along the line. This might occur, for example, if music is desired both on a terrace and near a pool or some other outdoor area. The last speaker on the line may be barely audible, while the first speaker blasts at an intolerably loud level.

The long-lines problem can be overcome by borrowing a trick from professional public-address practice. Public-address systems almost never function at 4, 8, or 16 ohms, but instead have 500-ohm outputs that are almost immune to line losses. This kind of operation may also be approximated with a hi-fi amplifier that must feed extension speakers that are remote from the main system. Several 70.7-volt line-to-voice-coil transformers (such as the Lafayette 33G3709, priced at \$1.98 each) are required. The appropriate leads of the transformer are connected to the amplifier's speaker-output terminals. The higher-impedance side of the transformer establishes a line of approximately 500 ohms. A transformer is used for each additional extension speaker. (Speakers suitable for extension use are sometimes available with built-in transformers.) Approximate level adjustments at each speaker are made by selecting wattage taps on the transformers.

A further refinement of the system is the addition of L-pads at each speaker for convenient volume adjustment. Any number of speakers can be attached to the line at different points—with one important restriction: the total power drawn by all speakers must not exceed the rated power of the amplifier. The amount of power drawn by the speaker is easily determined by adding up the wattages marked on the transformer taps selected for each speaker. If one or more speakers sound distorted, it means that you are probably exceeding the amplifier's maximum power-output rating.

H. B. Morris' broad experience with both public-address and background-music installations equips him to write with authority on the proper use of center-channel and extension speakers.

ANSWERS

to some common loudspeaker

QUESTIONS

By LARRY KLEIN

Speaker Specs

Q *I've been going over speaker specifications trying to decide on the system to use with my new hi-fi rig. I can't understand how a twenty-dollar full-range speaker can have essentially the same specifications as speakers costing four and five times as much. Are the figures lying or are the liars figuring?*

A I assume the specification you are referring to is frequency response, since this is practically the only performance specification given in most speaker advertisements. When manufacturers claim that their speaker has a response from 30 to 15,000 cycles, for example, they usually mean that if you were to drive it with an audio signal having a frequency anywhere between 30 and 15,000 cycles, the speaker would respond. It might twitch inaudibly at the low end and distort wildly on the highs—but it will respond. You will note that there is usually no qualification as to the frequency response in plus or minus so many decibels. Furthermore, there is usually no statement as to the distortion that the speaker will produce. In short, speaker specifications presented by most manufacturers are so inadequate as to be meaningless. This problem will probably continue to exist until the high-fidelity industry settles on some rating standards for speakers, as they have done for other audio equipment.

Parallel Wattage

Q *What is the wattage rating of a speaker system consisting of two identical 8-ohm loudspeakers connected in parallel, each rated at 30 watts?*

A Assuming that the speakers have similar impedance characteristics, the applied power will be divided across them equally. Therefore, if a total of sixty watts is applied, each speaker will receive thirty watts. The above would also apply if the speakers were connected in series.

Power Rating and Fusing

Q *I like the sound of a particular speaker that happens to be rated at 25 watts. My stereo amplifier, however, is a 60-watt-per-channel unit. Can I safely use 25-watt speakers?*

A You are most likely to run into overload difficulties with a speaker when it has a wattage rating of under 15 watts. If the speaker's power-handling capacity is higher than this, a 60-watt amplifier can be used because in the usual listening room the sound would be unbearably loud before damage to the speaker's voice coil or cone suspension would result. But there is an additional problem that should be mentioned. If an input plug to your preamplifier accidentally loosens, the full power of the amplifier at the hum frequency of 60 cps may be applied to your speaker—with catastrophic results. Therefore, if the amount of power your speaker can take is substantially less than the amount your amplifier can deliver, it would be wise to put a fuse in the speaker line.

The circuit on page 48 works very well. A heavy-duty (25 watts or higher) wire-wound resistor equal to the speaker's impedance is wired directly across the speaker line. The fuse is installed between the resistor and the speaker as shown. The connections to the amplifier's speaker-output terminals are now made at the next lowest tap; a 16-ohm speaker shunted by an 16-ohm resistor is connected to the 8-ohm tap, and an 8-ohm speaker shunted by an 8-ohm resistor is connected to the 4-ohm tap. (Four-ohm speakers cannot use this system; if they require fusing, the procedure outlined on page 38 of the August 1963 issue should be followed.)

A type 3AG standard (not slow-blow) fuse should be used. A 5-watt, 16-ohm speaker requires a 1/2-ampere fuse, a 10-watt speaker requires a 3/4-ampere fuse, and a 20-watt speaker requires a 1-ampere fuse. Eight-ohm

speakers with equivalent power ratings take fuses of the next highest value. The fuse ratings specified above are approximate values, and if the fuse blows on normal program material, try using the next highest value.

This system has several advantages: (1) the amount of power reaching the speaker is effectively halved, thereby reducing the chances of overloading the speaker on peaks—and at the cost of only a hardly noticeable

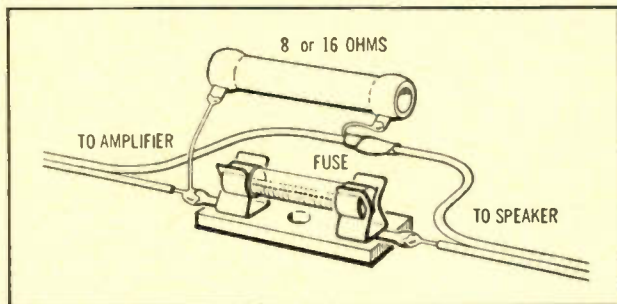

decrease in volume; (2) the resistor tends to smooth out variations in speaker impedance, and thus damps resonant peaks; and (3) if the fuse blows, the amplifier's output will be delivered entirely to the resistor and not partially to the speaker—making it impossible not to notice when the fuse has blown out.

Voice-Coil Impedance

Q I was rather surprised to learn that the rated impedance of a speaker varies considerably from the manufacturer's specified 4, 8, or 16 ohms. What is the reason for this? Does it cause matching problems?

A Speaker manufacturers usually specify a full-range speaker's impedance as it occurs at some mid-range frequency—usually 400 or 1,000 cps. However, since the voice coil of any speaker has inductance, it therefore has a higher impedance at higher frequencies. The impedance starts to rise (due to voice-coil inductance) somewhere around 400 cycles.

There is another sharp rise (perhaps five times nominal impedance) at the speaker's resonant frequency. The reason for this is rather complicated. When a voice coil is driven by an incoming signal it simultaneously generates a "back voltage." This back voltage appears because the voice coil moving in the magnetic gap acts as an electrical generator. Since the back voltage opposes the incoming signal, the electrical effect is identical to that caused by an increase in voice-coil impedance. The speaker cabinet should be designed to minimize the rise in impedance at the resonant frequency.

Stereo Speaker Placement

Q What is the ideal placement of a pair of stereo speakers in a room 15 by 22 feet?

A To some degree, anyone setting up stereo speakers in his listening room must meet head on the same problems faced by designers of a concert hall. The speakers must be placed for maximum dispersion, elimination of dead spots, minimization of standing waves, best sound at the selected seating area, and so forth. Additional domestic factors, such as the type and placement of furniture, drapes and rugs, all make their contribution to the over-all sound.

In general, if your speakers face the long dimension of a relatively narrow room, you are going to get strong bass reinforcement and possible boominess. Your best bet is to place the speakers along the long wall and to sit opposite them. However, if the room is too narrow, standing-wave effects (heavy bass in one area and no bass in the other) may be bothersome. The most advantageous arrangement will very likely be arrived at through a process of trial and error.

For detailed information, see the article by Edgar Villchur ("How to Get the Most from Your Loudspeakers") in the October 1961 issue of *HiFi/STEREO REVIEW*. A reprint is available from Acoustic Research, Inc., 24 Thorndike St., Cambridge, Massachusetts 02141.

Adding a Tweeter

Q I would like to add a tweeter to my full-range single-cone speaker. Are there any rules I should follow and what problems should I watch out for in the installation?

A An important factor to be considered is the relative efficiency of the tweeter and your present full-range speaker. If your present speaker is very efficient, you had best match it with a high-efficiency tweeter, or

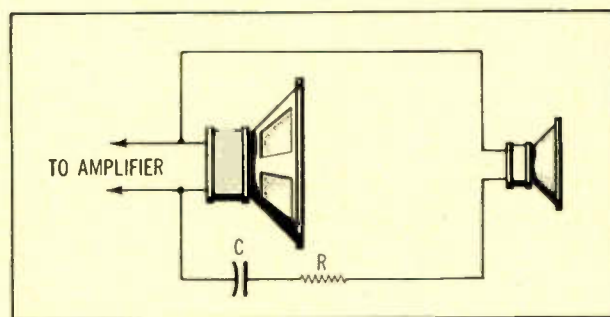

the tweeter's contribution to the overall sound may never be heard. In this regard, it is usually safe to add a tweeter made by the manufacturer of your full-range speaker. If in doubt, use a horn-type tweeter since these usually are more efficient than cone types, and their output can be reduced as desired with a level control.

Also check the impedance of your tweeter. It is best to use a tweeter that has the same or higher impedance than your woofer. If a tweeter's impedance is much

below that of the woofer, the tweeter may draw excessive energy from the amplifier and be overloaded to the point of distortion and possible damage. It is probably safe to use a 4-ohm tweeter with an 8-ohm woofer or an 8-ohm tweeter with a 16-ohm woofer, but never use a 4-ohm tweeter with a 16-ohm woofer. If you already have a 4-ohm tweeter that you want to use with a higher-impedance speaker, you might try placing a 4-ohm or higher value resistor (R) in series with the high-pass filter crossover capacitor (C) as shown in the diagram. If the efficiency of the tweeter is high enough, its output level may still match that of the main speaker.

The value of the crossover capacitor (C) can be determined by referring to the chart below. Use a non-polarized capacitor—available from Lafayette Radio, Olson Electronics, and other electronics-parts dealers. If a resistor (R) is needed, the capacitor value should be selected on the basis of the sum of (R) and the tweeter's impedance. Further factors that must be considered in your choice of crossover, tweeter, and so forth are discussed in the question below.

An excellent small paperback book covering the entire subject is Tremaine's *All About Crossover Networks*

Tweeter Impedance, ohms	Crossover frequency, cps				
	1,000	2,000	3,000	4,000	5,000
4	40 μ f	20 μ f	15 μ f	10 μ f	8 μ f
8	20 μ f	10 μ f	8 μ f	5 μ f	4 μ f
16	10 μ f	5 μ f	4 μ f	2.5 μ f	2 μ f

published by Howard W. Sams & Co., Inc. The book sells for \$1.50 and is available in large technical bookstores or from the publisher in Indianapolis, Indiana.

High-Pass Filters and Crossovers

Q What is the difference between a high-pass filter and a crossover network—or are they the same? And which is preferred with a woofer-tweeter setup?

A A high-pass filter, as its name implies, permits frequencies above a certain point to pass through it unhindered. Frequencies below that point are attenuated a certain number of decibels per octave. The simplest kind of high-pass filter is a nonpolarized capacitor connected in series with the tweeter. The crossover frequency is determined by the impedance of the tweeter and the rating of the capacitor.

The simplest crossover network has, in addition to the capacitor in series with the tweeter, a coil in series with the woofer. This coil prevents the high frequencies from reaching the woofer, just as the capacitor prevents the low frequencies from reaching the tweeter.

As to whether a high-pass filter or a crossover network is preferred, this is determined by the requirements of the specific woofer and tweeter. For example, RCA's excellent studio monitor speaker, the LC1A, which sells for almost \$200 without cabinet, uses no coil—only a single oil-filled capacitor in series with the tweeter. In general, if the woofer will reproduce distorted highs, or if its high-frequency output would interfere (acoustically) with the tweeter output, then it is best to keep all high frequencies away from the woofer. In any case, the lows must be kept out of the tweeter to avoid damaging it.

Speaker Muting/Off Switch

Q How can I install a three-position speaker switch that in addition to its normal setting has a setting that will turn the speakers off when I want to use headphones and a setting that will temporarily lower the speaker volume whenever it is necessary to answer the telephone?

A Use a Lafayette Radio double-pole, double-throw switch with a center-off position (Stock Number 99G6148). These cost 49¢ each. The ohmic value of the resistors (R) should be approximately three to four times the impedance of your speakers, and the wattage rating should be at least half your amplifier's power

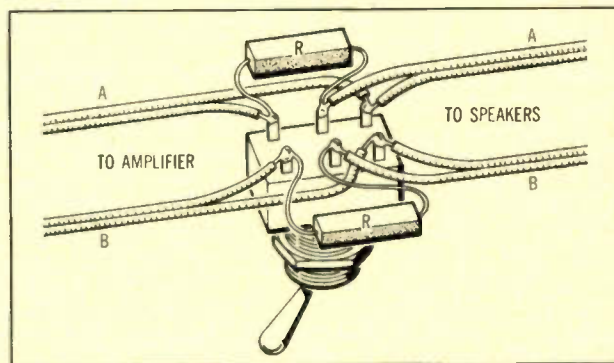

rating. The greater the ohmic value of the resistors, the greater the muting effect will be. When wired as shown in the diagram (you can either use the switch's screw terminals, or else solder the wires directly to the lugs), the resistors will be in series with each speaker and will cause substantial reduction in volume when the toggle switch is set in the center position. When the toggle switch is set in one side position, the resistors will be out of the circuit and the volume will be normal. When the toggle is in the other side position, the speakers will be shut off completely and the amplifier will be loaded by the two resistors. The resistors will not present an accurate impedance match to the amplifier's output terminals, but this is of no importance.

THE MAGNET: HEART OF THE LOUDSPEAKER

WHETHER or not you are a regular reader of loudspeaker specifications, you may have wondered occasionally why manufacturers often specify the weight of the "magnetic assembly" of a given speaker model rather than the weight of the magnet itself. If your speculations have led you to conclude that the main reason for quoting the weight of the complete assembly is to come up with a bigger and more impressive number, you would be quite wrong. In a high-quality loudspeaker, the structure (called the "pot") that surrounds the magnet costs more than the magnet itself.

To appreciate this fact, what it means to loudspeaker designers, and eventually to speaker buyers, let us examine this complex structure in detail. Figure 1 shows the type of magnetic assembly that might be used on an expensive loudspeaker (A), contrasted with the type usually found on a mass-produced speaker designed for use in radio or television receivers (B). Despite their physical differences, the two structures have the same essential parts: a set of concentric pole pieces (formed by the center pole piece and top plate), a magnet, and the additional iron (the pot) needed to carry the magnetism from the magnet to the pole pieces.

The physical size, shape, and arrangement of these various parts will vary, depending upon the overall design of the particular loudspeaker. The magnet may be long and thin or short and squat; it may be a slug, a ring, or even a "W." (Some of the various conformations in common use today are shown in Figure 2.) It is important to remember that the sole purpose of the magnetic assembly is to provide a concentrated magnetic field for the voice coil to operate in. All of the physical parts are selected and assembled to achieve the desired field strength as efficiently as possible.

Some speakers use Alnico magnets, some use ceramic magnets, and some use still other materials. Which is best? As far as the loudspeaker designer is concerned, the choice depends upon a number of complicated and interrelated factors. But as far as the performance of the final design is concerned, the *kind* of magnetic material used has no effect whatever. In setting up his basic design, the design engineer first determines how strong a magnetic field he wants the voice coil to operate in. Whether it takes two pounds of Alnico V or ten pounds of something else to provide this field is of little concern at that point in the design procedure. Perhaps it will help to

IN AN EASY-TO-FOLLOW DISCUSSION
 OF PRINCIPLES AND THEORY,
 AN AUDIO ENGINEER CLARIFIES SOME OF THE MYSTERY
 SURROUNDING THE ELECTROMECHANICAL PROCESSES
 THAT MAKE A SPEAKER SPEAK

by George L. Augspurger

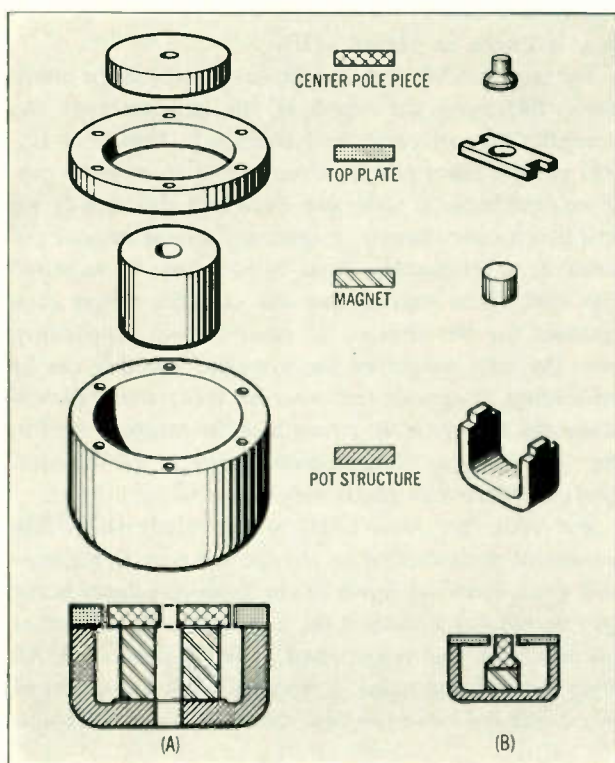

think of the magnet as a bottle that will hold so much magnetic energy. What the bottle is made of, how brittle it is, how much it weighs—these are not directly related to how much it holds. In working out a magnetic circuit, a "bottle" of a certain capacity is needed, and the designer then tries to make use of all the magnetic potential it can supply.

Obviously, if we are to get full use out of everything in the "bottle," there can't be any leaks in the path from the magnet to the voice-coil gap. If the pole pieces, or any other parts of the circuit, are too thin or are made of inferior material, magnetic potential will be lost—usually leaking away in the form of stray fields. For example, if the back of a loudspeaker strongly attracts a screwdriver, this means that a portion of the magnet's potential is not reaching the voice-coil gap. This is one reason why magnet weight alone is no guarantee of speaker performance. The magnet and the surrounding structure must be designed as a unit for best results. *(Continued overleaf)*

Figure 1. The magnet assembly of an expensive speaker (A) and an inexpensive one (B). Both have essentially the same parts. The better speaker, however, uses heavy cast and machined components; the cheaper one uses stamped, light-weight materials.

HOW THE SPEAKER OPERATES

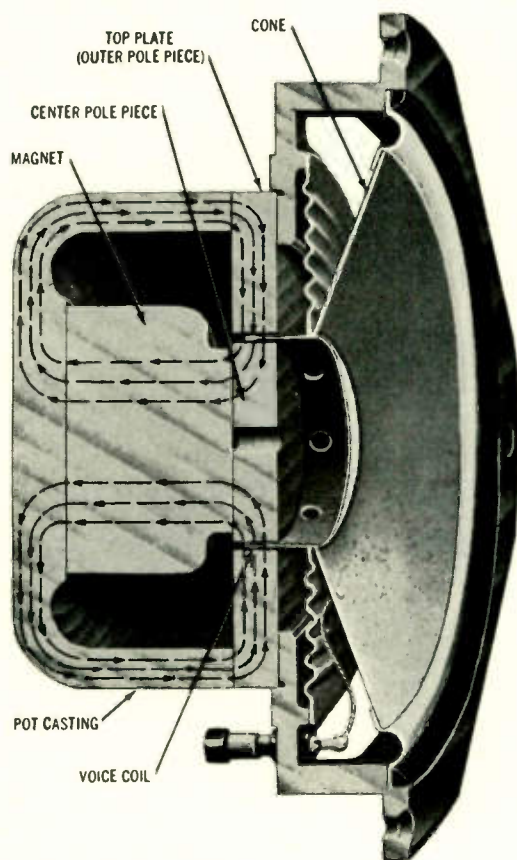

The magnetic field in which the loudspeaker voice coil operates fills the ring-shaped space (the "air gap") between the two pole pieces. The center pole piece is joined directly to one end of the magnet. The magnetic lines of force are carried from the opposite end of the magnet through the heavy pot structure to the outer pole piece. Although the arrows indicate the path of the magnetic lines of force, the magnetic field does not "flow" or fluctuate, but remains constant.

The electrical audio signal from the amplifier is carried to the terminal posts and through the flexible wires to the voice coil, producing a varying current *in* the coil and consequently a varying magnetic field *around* the coil. This varying magnetic field interacts with the fixed field of the magnet, thus causing the entire cone assembly of the speaker to move in and out. Under ideal conditions, the cone movement is an exact replica of the waveform of the electrical signal fed to the voice coil.

The cone assembly can move freely because of its flexible suspension. The voice coil is centered in the air gap by a corrugated "spider," and the outer edge of the cone is joined to the frame by a flexible ring of fabric or rubber. The movement of the cone compresses and rarefies the air next to the cone, thus producing sound.

The most critical element in the design of the magnetic assembly is the voice-coil gap. Magnetic energy finds it very difficult to jump across the gap between the two pole pieces: the wider the gap, the weaker the magnetic field within the gap. Magnetic-field strength is measured in *gauss*. This term can be misleading because it sounds as though it describes the *total amount* of something, but it does not. Rather, it is like saying that there are three dandelions per square foot in my front yard. I don't know the total number of dandelions, but I do know their density. Similarly, gauss is an indication of *flux density*.

Let us assume that we are going to build some loudspeakers and that we have worked out a magnetic assembly which produces 10,000 gauss in the voice-coil gap. A cross-section of the gap is shown in Figure 3(A). It has further been decided that this particular loudspeaker is going to be mass-produced on an assembly line, but for economic reasons we cannot afford to precision-machine the pole pieces for a perfectly concentric gap; nor will it be possible to reject every voice coil that has a slight physical imperfection. However, without close-tolerance components, chances are that most of the speakers we produce this way won't work properly—the voice coils will rub against the pole pieces. The solution is to open up the gap

enough to permit wider manufacturing tolerances. The new cross-section of the speaker, with its wider voice-coil gap, is shown in Figure 3(B).

But what has happened to the flux density in the meantime? Increasing the width of the gap decreases the strength of the magnetic field alarmingly. Instead of 10,000 gauss, we may now have only 3,000 gauss in the gap. If we need both the wider gap *and* a high flux density, we will have to use a heavier magnet and a more massive pot structure to get enough "push" to overcome the increased gap width. The heavier magnetic assembly simply compensates for the changes in other factors. Apparently, even the total weight of the magnetic assembly can be misleading. It appears that what we really want to know about any speaker is the strength of the magnetic field in the voice-coil gap. Ten thousand gauss is ten thousand gauss no matter how much iron it takes to put it there.

But even this doesn't tell us the whole story. The amount of push exerted on the speaker cone in response to a given electrical signal in the voice coil depends not only on the flux density in the gap, but on the amount of voice-coil wire that is immersed in the magnetic field. All other things being equal, a voice coil with a diameter of two inches has twice the total conductor length of a one-

inch coil. Similarly, a very deep gap will accommodate a longer coil than a shallow one will.

If both the flux density and the dimensions of the voice-coil gap are known, the *total* amount of useful flux can be calculated. To return to the dandelion analogy, if I know the number of dandelions per square foot and the area of my yard, I can calculate the total number of dandelions in it. In magnetic circuits, total flux is given in *maxwells*. If a speaker manufacturer quotes both gauss and maxwells, he is giving you the two basic specifications about his loudspeaker-magnet assemblies. Any further discussion of magnet weight or of material is pointless. As you might expect, the design of a magnetic circuit is much more complicated than these few paragraphs suggest. But the point I am trying to make is an essentially simple—and valid—one: a speaker's magnet weight alone is of practical interest only if you can't find out anything else about it.

From what has been discussed so far, you might assume that the higher the flux density and the greater the total flux, the better the loudspeaker. Unfortunately, it isn't quite that simple. In very general terms, the statement is true: a quality loudspeaker *does* have a heavier magnetic assembly, a stronger magnetic field in the gap, and more total flux than a cheap speaker. But among very good loudspeakers, substantial differences in any of these do not necessarily mean that one unit is better than the other. A compression horn driver (such as is used in some mid-range and public-address loudspeakers), for example, needs a magnetic gap only as long as the voice coil, and the clearance between the coil and the pole pieces can be

minute. Such a design can achieve very high flux density without resorting to an enormous magnet. On the other hand, high-power compression drivers designed for greatest possible efficiency *do* have large, heavy magnets. In fact, everything about them is large and heavy.

A woofer intended for use in an infinite-baffle speaker enclosure may not need a very heavy magnetic assembly—too much magnet may result in too little bass in this instance. But a woofer with a very heavy cone and a voice coil designed for long excursions may need a much stronger magnetic field in the gap to insure good transient response.

In short, there are all sorts of corollary factors that the speaker designer has to take into consideration. The fact that he chooses a six-pound magnetic assembly instead of one weighing ten pounds doesn't necessarily mean that he is trying to save money. The six-pound assembly may very well be the best possible choice for a particular loudspeaker in a particular application. So, the next time an audiophile friend asks you how many pounds of magnet are in your favorite woofer, you can be ready for him. You might even practice a condescending half-smile to use on this occasion, the kind of look which clearly indicates that the questioner really doesn't understand the subject at all.

"How many pounds?"

You will placidly reply, "Enough to do the job."

George L. Augspurger, an audio designer who has been active in various phases of high fidelity for over fifteen years, is presently associated with James B. Lansing Sound, Inc., Los Angeles.

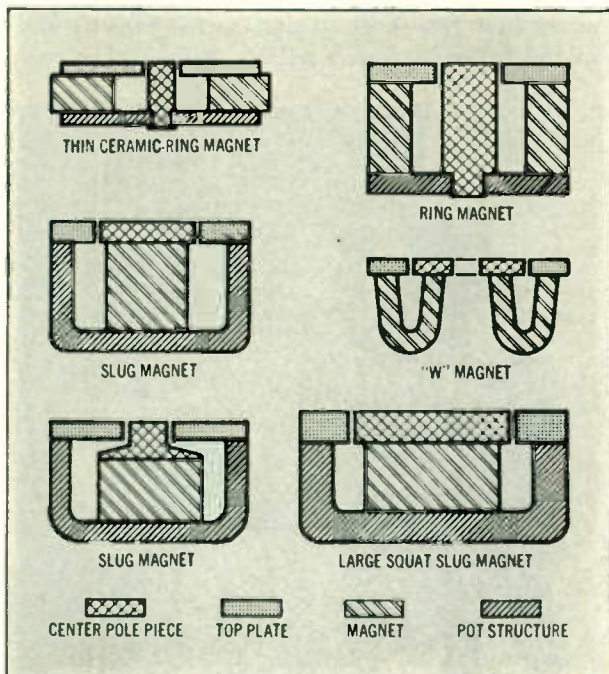

Figure 2. Examples of variations encountered in magnet assemblies. The three basic types are the slug, the ring, and the "W" magnet. The ceramic-ring type is coming into greater use.

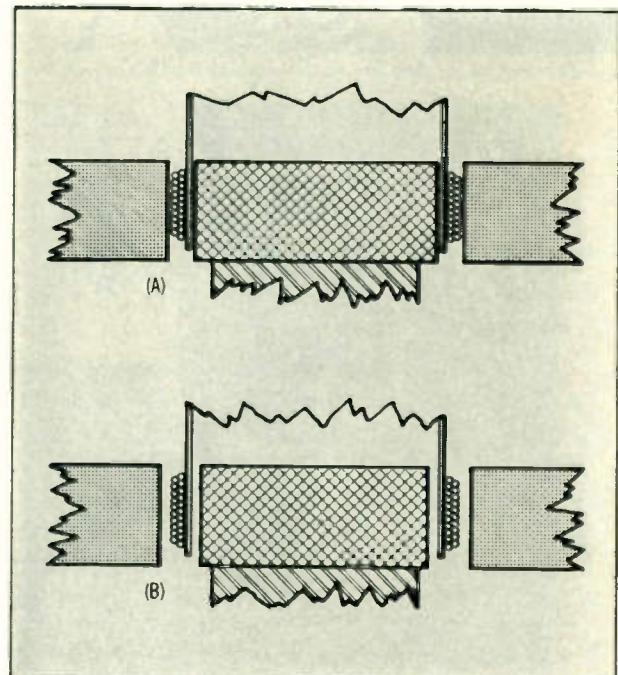

Figure 3. Cross-section of the speaker voice-coil air gap. A close-tolerance gap requiring precision assembly is shown in (A). The wider gap shown at (B) requires less care in its assembly.



The Folksinger: Leo Jensen, Amel Gallery.



The Supremes: Bob Stanley, Bianchini Birillo Gallery.

ALTHOUGH there are those who deny that they are deep, some of the cultural currents running past our doors these days are certainly strong and—even more certainly—fast. In the field of literature we get the darkly comic anti-novel; in painting, banal attacks on banality through pop, op, and ob art; and in music, yeasty and riotous rock-and-roll. Inevitably, some of these rushing torrents had to converge, merge, and comment on each other. Some recent pop art has been heard to sing and to make other, ruder, noises, but we present here a more easily presentable (for us) activity: pop (for the most part) art commenting on popular music. The results, gathered from New York art galleries and private collections, can be seen to have a reckless charm of their own.



KORNBLEE GALLERY

Above, *Chubby Checker: Rosalyn Drexler, from the Joseph H. Hirshhorn Collection.* Right, *The Beatles: Rosalyn Drexler, Kornblee Gallery*



"All the arts have a certain common bond of union, and are connected by blood relationship with one another."—Cicero



Ringo #2: Richard Bernstein, Terrain Gallery.



Beatles Recording: Bob Stanley, Bianchini Birillo Gallery.



Two Rolling Stones: Bob Stanley, Bianchini Birillo Gallery.

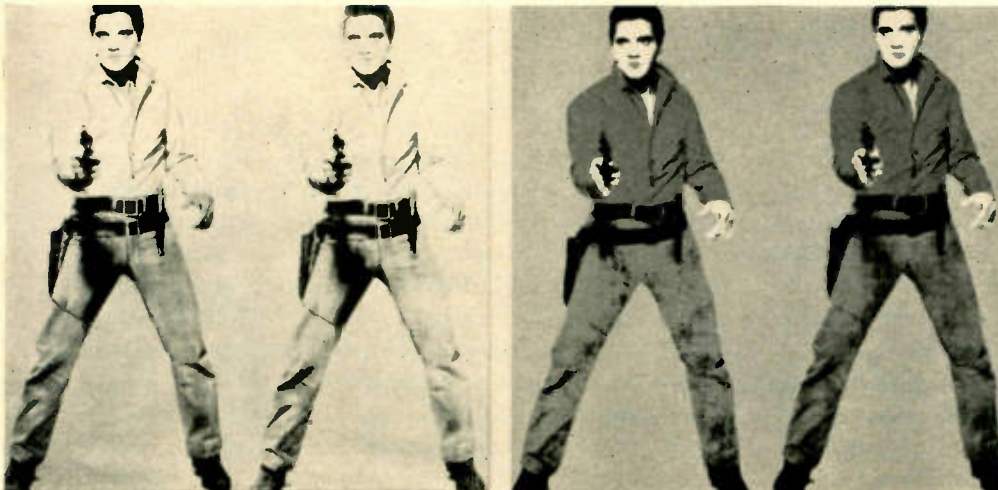

Four X Elvis: Andy Warhol, Castelli Gallery.



The Beatles: David Wynne, David B. Findlay Galleries.

HOW TO TUNE A BASS-REFLEX ENCLOSURE

*A simple step-by-step procedure,
using an audio signal generator and a
standard voltmeter, for securing
the optimum bass response
from your speaker system*

By LARRY KLEIN

THE bass-reflex speaker-system design, also known variously as the tuned-port enclosure, vented enclosure, and acoustic phase inverter, dates back to a patent awarded in 1932 to A. L. Thuras. Since that time, numerous charts have appeared in the audio and electronics publications, each purporting to guide the reader in building a properly tuned bass-reflex speaker enclosure.

These charts, graphs, and nomographs are all based on the assumption that the only information one needs to design a bass-reflex enclosure are (1) the free-air resonant frequency of the speaker, and (2) the enclosed volume of the cabinet. From these two figures, the port or duct size is then determined. Unfortunately, this method seldom results in optimum tuning, and practically never insures proper damping. (Such a formula could be worked out, but it would also have to take into account the relative contributions made by the speaker-cone mass and speaker-

cone compliance in establishing the speaker cone's free-air resonance.) The would-be builder of a speaker system would therefore be better advised to follow the speaker-manufacturer's enclosure recommendations or to construct a non-critical enclosure with heavy acoustic damping, such as was described in the August 1964 issue of *HIFI/STEREO REVIEW*. The best approach of all, however, is to tune the cabinet to your particular speaker using two basic electronic instruments—an audio signal generator and a voltmeter—that can be rented from your local electronic service shop, or perhaps borrowed from an audiophile friend.

But before getting into the actual tuning procedure, it may be of interest to examine briefly just what we are trying to achieve when we install a loudspeaker in a bass-reflex cabinet. In addition to serving as an acoustic barrier between the front and rear of the speaker cone, most speaker housings are also designed to deal with the related

problems of speaker-cone resonance and bass reinforcement. The speaker-cone resonance of an unboxed speaker is determined by the cone's weight (mass) and the stiffness of the suspension supporting it. The resonant frequency is the "natural" frequency at which the speaker cone "prefers" to vibrate, and the voice-coil excursions at resonance therefore far exceed those at any other frequency (for a given level of input signal).

When the speaker is mounted in a bass-reflex enclosure, there are two interacting resonances, because the air inside the box also prefers to resonate at a particular frequency (the same way the air in a bottle resonates when you blow across its mouth). The speaker's resonance is set off by an audio signal at or near the speaker's resonant frequency; the cabinet's acoustical resonance is activated by the speaker. By adjusting the size of its port, or opening, the cabinet's resonant frequency can be tuned so that the two resonances interact, thus converting the speaker's single high resonant peak into two smaller peaks located (in frequency) above and below the original peak. This interaction and partial cancellation of resonances results in decreased voice-coil travel at the speaker's resonant frequency. This, to the ear of the listener, means that bass

muddiness and hangover effects will be considerably reduced. Other benefits include decreased intermodulation and harmonic distortion, increased power-handling capacity, and extension of the low-frequency response.

The tuning setups illustrated in Figure 1 are used to derive the speaker system's impedance characteristics, which in turn serve to indicate the effectiveness of the bass-reflex action. From this, a curve can be drawn to illustrate how the speaker's impedance changes with frequency, and although this curve does not indicate speaker output directly, it does provide important information on the voice-coil behavior of the speaker under different frequency conditions (see Figure 2).

The reason for a loudspeaker's change of impedance with frequency is not hard to discover. When the speaker's voice coil is driven by an incoming signal, like any coil of wire moving in a magnetic field, it generates a voltage. This voltage, known as the "back voltage," opposes the audio signal current flowing in the voice coil. As far as the signal source (the audio generator or amplifier) is concerned, the effect of this back voltage is identical to an increase in voice-coil resistance. Since the amplitude of the back voltage depends on the velocity of the voice coil in

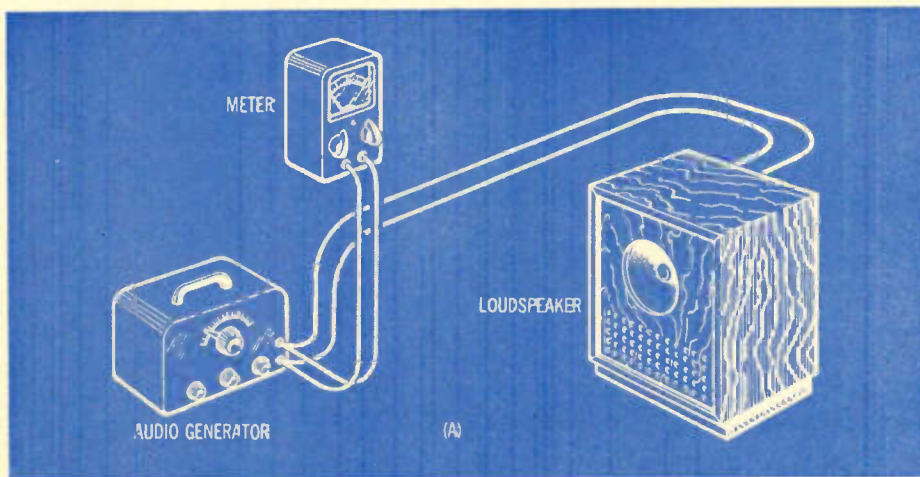
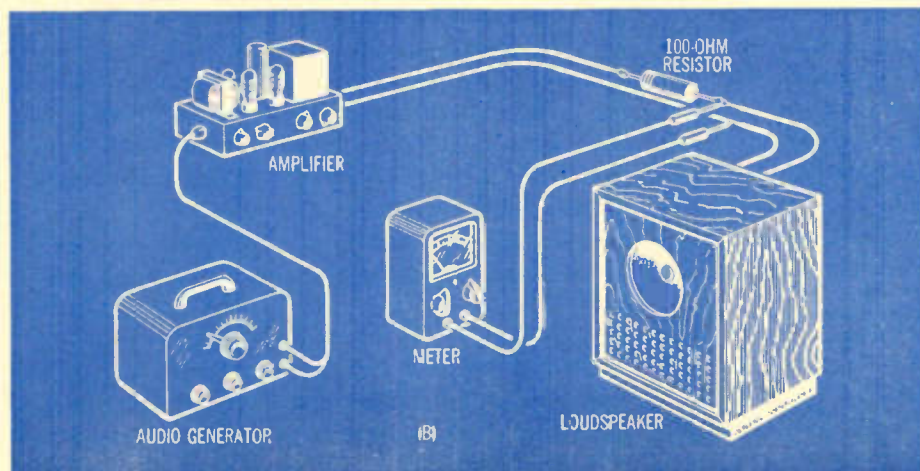
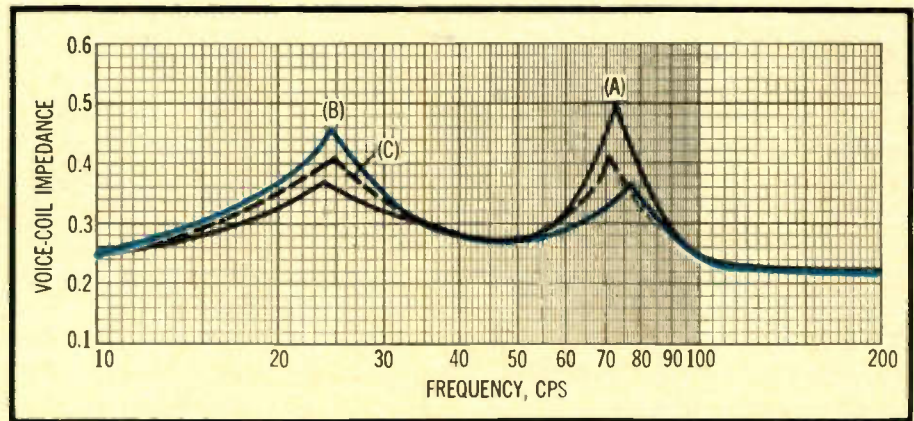

Figure 1. The diagrams at left and below show two ways of deriving the impedance curve of a bass-reflex enclosure. In (A), the speaker is driven directly from the audio generator, the meter being connected directly across the speaker terminals.



The method shown in (B) requires an amplifier and an isolating resistor and is suitable for use with those signal generators that do not have sufficient output to drive a speaker system directly.

Figure 2. Impedance curves of the same bass-reflex enclosure taken with too few holes (curve A), too many holes (curve B), and the proper number of holes (curve C). (Figures indicating voice-coil impedance are readings of test voltage developed across the voice coil.)



the magnetic gap (it is highest at the point of speaker-cone resonance), an impedance peak at a given frequency is a direct reflection of a greater-than-average voice-coil activity at that frequency. Therefore, any measures that will smooth out the low-frequency impedance curve of the speaker will usually be reflected in a smoother over-all bass response.

Two tuning setups are shown. The simplest requires only an audio signal generator that will cover at least a 20- to 200-cps frequency range, and a voltmeter that will read low a.c. voltages over the same frequency range. The equipment is hooked up as shown in Figure 1(A). It is assumed that the audio generator used has sufficient output to drive the speaker system directly and that the output will vary according to the impedance load it "sees." (The generator, in effect, presents a relatively high-impedance constant-current source; hence, changes in speaker impedance as the frequency is varied will in turn be reflected as voltage changes in the generator output, and these will be indicated on the voltmeter.)

The setup shown in Figure 1(B) makes no special demands on the generator other than that it be able to cover the 20- to 200-cps range. The meter shown in both setups can be either a vacuum-tube voltmeter or a standard volt-ohm-milliammeter (VOM) that can cover the required frequency range. The generator is connected to an AUX input on the amplifier and the speaker system to be tuned is connected to the 16-ohm taps on the amplifier. A 100-ohm, 2-watt resistor is wired in series on one side of the speaker line as shown. The purpose of the resistor is to isolate the speaker from the damping effects of the amplifier. (Be sure that the meter is set to its lowest a.c. voltage range and that it is connected across the terminals of the speaker, *not* the amplifier.)

The tuning procedure from this point on is quite simple. If you are starting fresh, any one of the enclosures shown in the August 1963 and August 1964 issues of *HIFI/STEREO REVIEW* would be a good choice. You need not follow the dimensions given, but for proper operation, the

cabinet should have a minimum internal volume of about 2 cubic feet (for a small speaker) and a maximum volume of about 8 cubic feet. Smaller cabinets severely restrict the bass response and larger cabinets do not benefit from bass-reflex operation. If you are adjusting the tuning of an older cabinet, you might try blocking off sections of its existing port as required by the tuning process. With new cabinets, some type of distributed port consisting of small holes ($\frac{1}{2}$ inch in diameter or smaller) or a series of narrow slots is recommended. The location of the holes or slots is not critical—the sides, front, back, or even the bottom of the cabinet (if it is standing on legs) will do equally well.

The size of the holes or slots is also not critical, except that if the speaker used has a resonance above 55 cps (you can check its free-air resonance with the same setup used to check the in-cabinet resonance), it may be necessary to drill a very large number of holes to achieve correct tuning. Drill the original holes with 1-inch spacings, and when their number becomes excessive you can then make them larger as required with a larger drill or reamer. (The speaker-cabinet articles in August 1963 and August 1964 issues of *HIFI/STEREO REVIEW* provide information on the number and size of holes for a good starting point.)

The amount of fiber glass or damping material used in the cabinet is determined mostly by its dimensions. The main purpose of the fiber glass is to reduce or eliminate reflections within the cabinet, for these can cause irregularities in frequency response. The smaller the cabinet, the higher the frequency of the reflections and the more annoying they will be unless suppressed. On the other hand, the larger the cabinet, the lower the frequency of the reflections and the thicker the fiber glass will have to be to have any effect. A 1-inch layer of fiber glass will serve if it is stapled to the inside top panel of the enclosure, spaced 3 or 4 inches away from the rear and side panels, and hanging down to the bottom of the enclosure.

There is one more step that must be taken before the tuning proper starts. If the speaker you intend to mount in the cabinet has already been in use elsewhere, this step may be skipped; but if you are working with a fresh-out-of-the-

carton unit, it is advisable to put it through a break-in period before mounting it. Some—not all—speakers require a break-in because, when fresh off the production line, their cone suspensions are not as loose as they will become after a short period of use. There is obviously no point in critically tuning an enclosure to a speaker resonance that will have changed 48 hours later. To avoid this embarrassment, follow the arrangement shown in Figure 1(B), but omit the resistor and the meter. Set the generator to about 40 cps and for full output. Turn up the amplifier gain to the point that the speaker cone can be seen to move, but not so violently that it rattles. About 3 or 4 hours of this break-in treatment should bring the speaker down to a stable resonant frequency.

And now to the heart of the matter—the tuning. With the speaker and fiber glass installed and the whole enclosure well sealed, drill a preliminary series of holes. Connect the instruments as in Figure 1(A) or (B). Set the generator to about 200 cps and for full output. In (B), turn up the amplifier's volume until the meter needle (set to its lowest a.c. voltage range) goes up to about one-fifth of its full-scale reading. Sweep the generator's frequency dial from about 20 to 200 cps. If there are enough holes in the enclosure, the meter should give a peak reading at two points on the dial: a bottom peak somewhere between 20 and 60 cps, and a top peak between 60 and 150 cps, as shown in Figure 2. It is unlikely that the two peaks will be identical in amplitude (have the same voltage reading on the meter) at this stage, but note down the two readings and the frequencies at which they occur. If the peak at the upper frequency has a higher voltage than the one at the lower frequency (as in curve A, Figure 2), more holes (or larger ones) are needed. If, through excessive zeal, you have already drilled too many holes (as revealed by a higher voltage for the low-frequency peak—curve B), masking tape and wood putty will serve to correct your error. It now should be relatively simple, through cut-

and-try procedures, to adjust the two peaks to the approximately equal amplitudes (the dashed curve C) that indicate proper tuning.

It is at this point that most builders—and some manufacturers—stop. However, contrary to popular belief, correct tuning alone does not insure that a bass-reflex system will be free of bass blur and boom. In the usual bass-reflex system, the upper and lower peaks are both quite high in amplitude, resulting in excessive output, poor transient response, and distortion at these peak frequencies. The valley between the peaks in the usual reflex system is also unpleasantly audible. These problems are somewhat reduced by using small holes for tuning rather than a single large square port, but it is still possible to smooth out the bass response even further.

THE height of the two resonant peaks reflects the amount of over-all damping in the system. The nature of speaker-system damping may be magnetic (determined by the intensity of the magnetic field in the voice-coil gap of the speaker) or acoustic (determined by the design of the enclosure). A speaker with a very efficient magnet mounted in a cabinet with a high degree of damping will lack bass, and a speaker with a small or inefficient magnet mounted in an undamped cabinet will sound boomy. The problem is to achieve a compromise between the two. Since we are not in a position to control the magnetic damping of the speaker, we must adjust the acoustic properties of the cabinet. Additional damping can be obtained, if needed, by wrapping a layer or two of fiber glass around the speaker so that the entire rear of the speaker is covered, then stapling it to the inside front panel. If required by an excessively resonant cabinet, a layer of fiber glass can be stapled over the port area from inside the enclosure. Use only as much damping as is necessary (see box below), or bass loss may result. One last caution: fiber glass should not be handled with bare hands.

A SIMPLE OPTIMAL-DAMPING TESTER

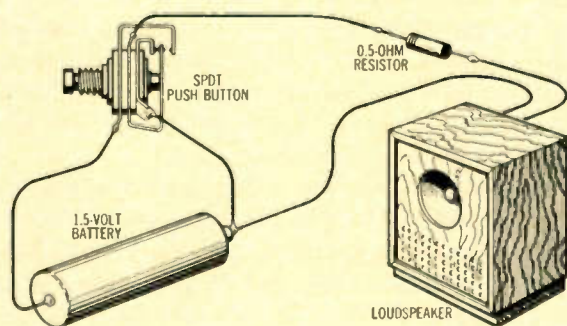

THE simple damping tester shown in the accompanying diagram was suggested by James Novak, design engineer with the Jensen Manufacturing Company. The parts required are a single-pole, double-throw, push-button switch, a 1.5-volt flashlight battery (any type), and a 0.5-ohm, 1/2-watt resistor (value not critical). Connect the apparatus to the speaker terminals, depress the switch and then release it. If your speaker is optimally damped, a click or a tick will be heard from the speaker in each switch position. The chances are good, however, that there will also be a little boomy or thumpy quality to the click, and this indicates the need for further damping.

INSTALLATION OF THE MONTH

STEREO CENTRAL



AFTER deciding that the proper place for his hi-fi installation was the comfortable den overlooking the lagoon in front of his home, Melville Marx, Jr., of Belvedere, California, called in Dan Strohl of San Francisco's Lakeshore HiFi. Nine months were spent designing and installing the complete home-entertainment center shown above. It consists of two Ampex tape recorders, a stereo FM tuner, amplifiers and preamplifiers by McIntosh, a Thorens turntable, KLH speakers, and a color-television set custom-built by Andrea.

The main panel of the novel built-in oiled walnut cabinet is mounted flush with the adjacent walls and is well braced and damped to prevent transmission of vibration. The section bearing the record player and four-track stereo recorder is cantilevered out of the slightly recessed area that houses the tuner and preamplifier units.

Mr. Marx uses his Ampex 354 half-track stereo professional recorder for taping stereo FM at 15 ips and for

dubbing 7 $\frac{1}{2}$ -ips prerecorded tapes on 10 $\frac{1}{2}$ -inch reels. His hobby also embraces documentary recordings of sounds from the lagoon and of boat horns from San Francisco Bay. The Ampex 4450 four-track stereo unit serves for recording backup and also as a playback unit. The McIntosh amplifying equipment consists of an MR65B stereo FM tuner, a C20 preamplifier, two MC30 basic amplifiers (to drive KLH 14B speakers in the bedroom), and a separate MC275 stereo power amplifier providing 75 watts per channel to drive the two-section KLH Model Nine electrostatic speaker.

Other components are: a Thorens TD 124 turntable with an ADC-Pritchard arm and cartridge, two Sennheiser condenser microphones, and two Electro-Voice Sonocaster speakers for outdoor use. Two Channel Master antennas with rotors for TV and FM reception complete the equipment list. Mr. Marx plans to round out the system with Empire Grenadier 8000P speakers in his living room.

HIFI/STEREO REVIEW'S SELECTION OF THE TOP RECORDINGS
BEST OF THE MONTH



CLASSICAL

VLADIMIR HOROWITZ AT CARNEGIE HALL

New Columbia release documents an historic musical event

THE NEW Vladimir Horowitz album from Columbia has many meanings. Entitled "An Historic Return: Horowitz at Carnegie Hall," it is probably the most explicit report of a public concert in existence. It is complete with the bellowed bravos, the coughs, the electric hush of an enthralled audience, and even some of the crackling psychic tension that made the occasion itself so memorable. And Mr. Horowitz's recorded piano tone has never sounded nobler, thanks to the warm ambience of an acoustically ripened concert hall.

More importantly, this recording clearly discovers Mr. Horowitz in the very act of ensorcelling those obedient spirits who metamorphose time and events for him as they did for Prospero. Mr. Horowitz had obviously made up *his* mind, no doubt months ago, as to the character of his indicated task. And in this program he confronts a clamorously historic occasion—one that was bound, unavoidably, to possess highly sensational elements—and turns it serenely into a musical occasion, one in which the music itself makes the subtlest kind of historical comment. His methods of accomplishing this unexpected feat are inevitably a subject of endless fascination to any musician. As revealed in this album, they can serve, and equally well, as a definitive text on those resources of the

twentieth-century piano that in most hands today go unexploited, or as documentation of the proposition that the greatest art does not follow fashion but defies it.

For weeks in advance, what happened on May 9 at New York's Carnegie Hall had been heralded in front page headlines both here and abroad. And on what proved to be an unseasonably hot Sunday afternoon (a fact that caused the pianist a misery of continuous perspiration), the musical world, its booking agent, and its psychiatrist were all feverishly aware that Mr. Horowitz was returning to the concert stage after an enigmatic absence of twelve years. Because of the legendary nature of this artist's reputation, few concerts since the meridional years of Franz Liszt can have aroused such expectation, and the audience included almost every ranking New York professional who was ambulatory.

For a number of other reasons—uncertainty, for example, as to the pianist's nervous state and physical stamina following his long retreat—the public expectation was colored by a perceptible degree of apprehension. In certain quarters, doubts were also entertained as to the wisdom of his reappearance at this particular moment in our musical history—and even as to the intellectual relevance, today, of his kind of con-

COLUMBIA RECORDS



cert. After all, his repertoire is not only nineteenth-century Romantic but grandly unspecialized: he has never settled for the all-Baroque, or all-Beethoven, or all-Chopin, or all-Upper Silesia fashions that gave us the comfortingly infallible keyboard pontiffs of the Forties and Fifties. Today, also—when everybody else knows that the piano is just another percussion instrument—Mr. Horowitz's performance style remains an intensely emotional and sensuous one, concerned with nothing if not with sentiment and song. And if his tremendous sonorities and dazzling bravura are admittedly spectacular, how justifiable is this sort of thing in a musical age given to brainy aleatory doctrines on the one hand and to really serious electronic experiment on the other? All in all, wouldn't Mr. Horowitz be better advised just to rest on his legend?

With a passion, his audience wanted these questions answered, and before its very eyes and ears. With the primitive longing that in all ages demands of royalty a ceremonial public showing, this audience wanted Mr. Horowitz to reassert his sovereignty there and then. And if nobody who has heard his recent recordings doubted that he could do so, neither could anybody, until Mr. Horowitz had actually done it, be certain that he would.

THE press apparently came equipped with synchronized stop-watches, for it was universally noted that Mr. Horowitz, looking slender and elegant in impeccable morning dress, walked on stage at precisely 3:38 P.M. This kind of meticulous space-age annotation presumably classifies the pianist among such important countdown phenomena as Cape Kennedy blastoffs. But it neglects entirely the meaning of his sartorial elegance, which in fact defined certain basic terms of his reappearance before he had played a note. *This* occasion, it served notice, was to be neither a "happening" for beatnik genius nor a doctrinaire piano lesson from an intellectually lofty but sociologically unidentifiable diamond-in-the-rough. In effect, Mr. Horowitz walked out from the 1965 wings as from the Edwardian heyday of the *concert pianist*, an era when by definition the artist, unheralded by recordings or TV, fulfilled his obligations in public and with grace *vis-à-vis* large, sophisticated, and socially distinguished audiences. In that day, his understood obligation was to transport his audience by means of art beyond its quotidian self, and the epoch had a precise term for the platform style in which it preferred him to do this. The term was *princier*, and on May 9 Mr. Horowitz embodied it.

Then—and later, repeatedly, as this recording makes abundantly clear—he was greeted by an appalling roar of approbation, a crashing tidal wave of sound that at one moment visibly jolted the pianist to a wide-eyed standstill in his tracks. When I discussed this phenomenon later with a celebrated conductor, he remarked, "That is a frightening thing. It means that you are President of

the United States. After that you have to be very careful."

Well, careful *how*? The President sat at the piano, the audience held its breath, and the great Bach-Busoni Organ Toccata began with a peremptory flourish of icy sound that shocked like shattering crystal. And in half a minute, drawing audible gasps from the musicians in my vicinity, Mr. Horowitz had performed his first miracle—to be exact, it began in the thirty-fourth measure of the piece, just after the magnificent pedal octaves have concluded their arrestingly disjointed and provocative utterance. "God Almighty," gritted somebody behind me, "the piano just can't *do* that!" What the piano can't do, and what Horowitz nevertheless was calmly doing, was causing us to hear with hair-raising distinctness in a piano solo the vividly contrasted *colors* that you expect only from organ registration.

The Bach-Busoni piece concludes with a fugue of which Mr. Horowitz makes a transfigured Brueghelian country dance, all muscular health and earthy high humor, an irresistible jubilation of whirling figures in ordered motion. And before he had even concluded it, one had begun to suspect the grand plan behind his choice of program. Who else dares play transcriptions today—particularly transcribed Bach? And how long since Busoni has been in fashion?

With the incontestably vocal and, you might say, private lyricism of the Schumann Fantasy, suspicion of Mr. Horowitz's *arrière-pensée* became certainty. Only heroes attempt this interminable, this gorgeously ungrateful piece in concert—and only reprobate angels succeed in making anything of it. Its formal coherence must be discovered emotionally, and unless it is literally *vocalized* with the passion, the energy, and the tenderness that Schumann specifically directs for it, it simply has no shape at all. In Mr. Horowitz's hands it could have gone on, songfully articulate, for another half an hour. As the ravished audience so demonstrably wished it had.

At this point I recalled a remark that Mr. Horowitz, referring to this program in prospect, made some months ago: "I think," he said, all innocence, "that I will just play some things I am comfortable with." Somehow, "comfortable" now seemed a pretty loose term as covering the intentions of an artist who means, in the space of an hour and against the tide of all current practice, to make a piano evoke a pipe organ, various orchestral sounds, and the world's greatest lieder singer incinerated by Schumannesque love.

Anyway, we now knew what Mr. Horowitz was up to. No Liszt Rhapsodies. No Sousa arrangements. No Paganinian *diablerie*. What was he going to do for fireworks?

The fireworks came, of course, in the places and the forms you'd least expect them to: in the sombre, involuted, and widely unplayed Scriabin Sonata; in the concluding Chopin Ballade, so widely overplayed for generations that ordinarily nobody can really hear it any more. But for

these imperial fireworks, Mr. Horowitz sent up great golden rockets filled with jewels, not gunpowder. And the result, happily preserved in this album, is in its way as sumptuous, as mysterious, and as moving as the time-stopping Byzantine mosaics at Ravenna.

Meanwhile, as lightening the shadows of these monumental structures, Mr. Horowitz also gave us, with an ineffable silken flourish, the runaway grace of Chopin's brief F Major Etude and—as an encore—Moszkowski's even briefer Etude in A-flat. Disbelieving shades of Milton Babbitt. Who, since Xavier Scharwenka and Paderewski, plays *Moszkowski*?

At the end, with the audience howling for a blockbuster, Mr. Horowitz crowned the whole unlikely event with a master stroke of arrogant humility. His final encore was Schumann's hushed little *Träumerei*. And it is played with the kind of ultimate simplicity that only comes when years of labor and vigilant inner listening have deciphered the surprisingly childlike recipes of profundity.

After the stage lights were extinguished, much of the audience mobbed the street behind Carnegie Hall to witness the pianist's departure. Passersby might well have thought that the Beatles were about to emerge, and as Mr. Horowitz was taken through the crowd to his car between guards, a young man suddenly thrust his hand aloft as if burned and shouted, "I touched him, I touched him!" It was the sort of thing you might have heard at a medieval coronation, and it is produced by something not very widely credited today: namely, magic. And not even the other recordings by Mr. Horowitz contain quite as much of it as this one.

Robert Ojfergeld

© © VLADIMIR HOROWITZ: *Horowitz at Carnegie Hall. Bach-Busoni: Organ Toccata in C Major. Schumann: Fantasy in C Major; Träumerei. Scriabin: Sonata No. 9 in F Major; Poem in F-sharp Major; Etude in C-sharp Minor. Chopin: Mazurka in C-sharp Minor; Etude in F Major; Ballade in G Minor. Debussy: Serenade for the Doll. Moszkowski: Etude in A-flat Major. Vladimir Horowitz (piano). COLUMBIA M2S 728 two 12-inch discs \$11.98, M2L 328* \$9.98.*

FROM THE RCA ARCHIVES: SERKIN AND TOSCANINI

An electrifying performance of Beethoven's Fourth Piano Concerto from a 1944 radio broadcast

CONSIDERING the number of Toscanini broadcast performances still available to RCA Victor for release, the company has, during the last several years, been somewhat less than generous. Commercial considerations—including the fact that none of these recordings are in

stereo—may be partly responsible: there is no denying the fact that the artist who is no longer alive does not sell as well as the one who is. Therefore, the record-collecting public must share the blame for having failed to buy the already issued older treasures in sufficient quantity to encourage the record companies to release more like them. There is no excuse, for example, for a serious collector's failing to acquire the newly issued historic recording of the Beethoven Fourth Piano Concerto, as broadcast by Rudolf Serkin, Toscanini, and the NBC Symphony on November 26, 1944.



RUDOLF SERKIN
Precise, strong piano execution

Serkin, of course, is very much alive and still playing, but the collaboration of two such distinct and powerful musical personalities is a rare occurrence in our musical life. The release of this disc, which makes it possible to hear this unique interpretation more than twenty years after the original broadcast, is an event of the greatest magnitude, and the fact that it is not in stereo, nor even recorded under ideal studio conditions, is unimportant.

During this period of his life Toscanini's view of Beethoven was a controlled, even tight one. Although lyricism is never sacrificed, there is little leisure in his interpretation here. Serkin's playing matches this approach perfectly. Their combined performance of the Fourth—a genuine partnership—is much closer in spirit to the dy-

namism of the "Emperor" Concerto than to the Mozartean graciousness of Beethoven's earlier works in this form. One is constantly made aware of the music's power, even in the hushed, mysterious passages of the slow movement. It is a grand view, even if it is not the only valid one, and for me, the effect of Serkin's precise, strong piano execution, combined with Toscanini's forceful yet marvelously sensitive handling of the orchestra, is quite electrifying.

If the sound were wretched, I would still recommend this reading. As it happens, however, the reproduction—even considering the dryness of the studio acoustics and the close-up miking of the solo instrument—is remarkably good. There is some distortion, but far less than there is on some of the other Toscanini recordings that have been rescued from the past. Let us hope that RCA will delve further into its archives for other performances as worthy as this one.

Igor Kipnis

© BEETHOVEN: *Piano Concerto No. 4, in G Major, Op. 58*. Rudolf Serkin (piano); NBC Symphony Orchestra, Arturo Toscanini cond. RCA VICTOR LM 2797 \$4.98.

JAZZ

"FATHA" HINES: STILL THE MASTER IMPROVISER

Prodigious technique in one of the best jazz-piano albums of the decade

WITH a few exceptions—Duke Ellington, Count Basie, and Coleman Hawkins among them—the jazzmen now past fifty have been nudged toward the periphery of the current jazz scene. They seldom work the major clubs, and they are not recorded so often as younger musicians. And yet, some of them are still beyond easy categorizing: they have continually deepened their musical language, and they still have a great capacity to entertain—as well as a great deal to teach us. One of these oldsters is Earl Hines, and his new Contact release, "Spontaneous Explorations," must be counted among the more spectacular jazz-piano albums of the decade.

Recorded in New York in 1964, the disc presents Hines and only Hines—so prodigious is his technique, and so secure is his sense of rhythm, that bass and drums are not necessary to sustain his performances. Hines' most immediately recognizable hallmarks are the ringing clarity of his tone and the astonishing structural cohesiveness of his complicated, idea-crammed improvisations. Also in evidence here are his ebullient charm (*Undecided*), the depths-within-depths of his blues (*Fatha's Blues*), and the sweepingly lyrical variations he constructs on the core themes of ballads. He takes the mawkish *Jim*, which even



EARL HINES
His musical language deepens

Billie Holiday couldn't quite raise to believability, and turns it into an unexpectedly poignant short story. *Black Coffee* here is one of the most resourceful improvisations Hines has ever recorded—it reveals how much newly relevant detail a master improviser can find to build on in a familiar song.

In fact, this sense of constant building, of moving to fuller and fuller climaxes, characterizes every Hines performance. While his melodic inventiveness and his rich, pungent harmonies are electric, his rhythmic patterns are every bit as startling. (The pliability of Hines' rhythmic lines here reveals itself as an antecedent of the "free" rhythms of Charles Mingus and the later jazz avant-garde.) His rhythms surge and recede; sometimes there is no audible beat at all, but the inner pulse is as clearly felt as if it were being marked by a gong.

Tying all these musical qualities together are an exuberance and a technical confidence that define the term "orchestral piano": you often have the impression that ten fingers by themselves could not possibly handle the abundance of ideas that cascades from Hines' piano. But there was no dubbing over in making this record: it's all Hines, and, as ever, larger than life.

Nat Hentoff

© EARL HINES: *Spontaneous Explorations*. Earl Hines (piano). *A Sunday Kind of Love; Squeeze Me; Tosca's Dance; Black Coffee*; and five others. CONTACT CS 2 \$5.98, C 2 \$4.98.

Franco Corelli is six feet two. So is every note he sings.

Just listen to
Corelli's towering new
recording of *Il Trovatore*.**
Hear him as Manrico in this "tenor's
tenor's opera" and you'll understand
why *The New York Times* says: "There
is no tenor around with the vocal strength,
endurance, and sheer animal magnetism of
Mr. Corelli."**



**†SCL 3653



†SCL 3615. (Highlights S35666)



SBL 3618



†SBL 3632



†SCL 3645



†S 35918



S 36126



S 36208

© 1964 by The New York Times Company. Reprinted by permission.
† Also available on four-track stereo tape.

LISTEN TO "THE ANGEL WORLD OF OPERA"

ANGEL RECORDS P.O. Box 12-E Hollywood, Calif.
Gentlemen: Enclosed is \$1.00. Please send me your stereo
preview disc of complete selections from nine outstanding
Angel operas — featuring nine international stars.

Name _____
Address _____
City _____ State _____ Zip Code _____
Offer expires 9-30-65.



PHOTO BY FAYER

WE TOOK ALL THE COMPONENTS OF OUR
FAMOUS A-7 "VOICE OF THE THEATRE"[®]
AND DESIGNED THIS WIFE-PLEASINGLY-
BEAUTIFUL ENCLOSURE FOR THEM.

(Now everyone can have a full-size speaker system!)

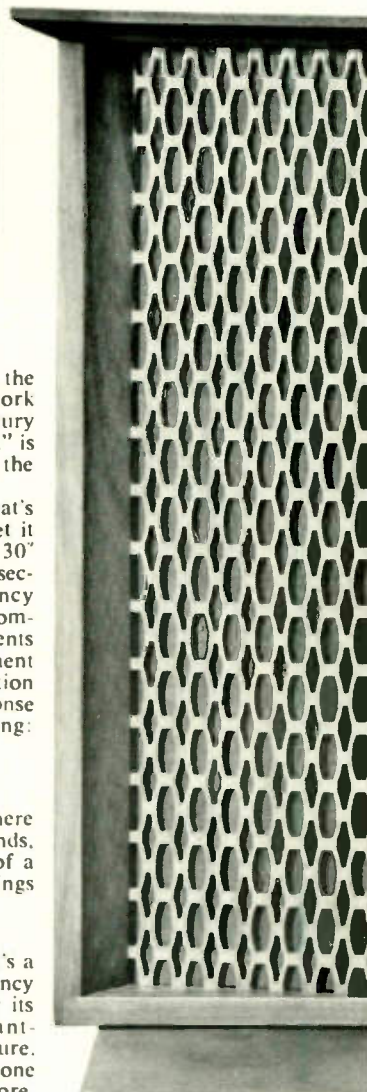
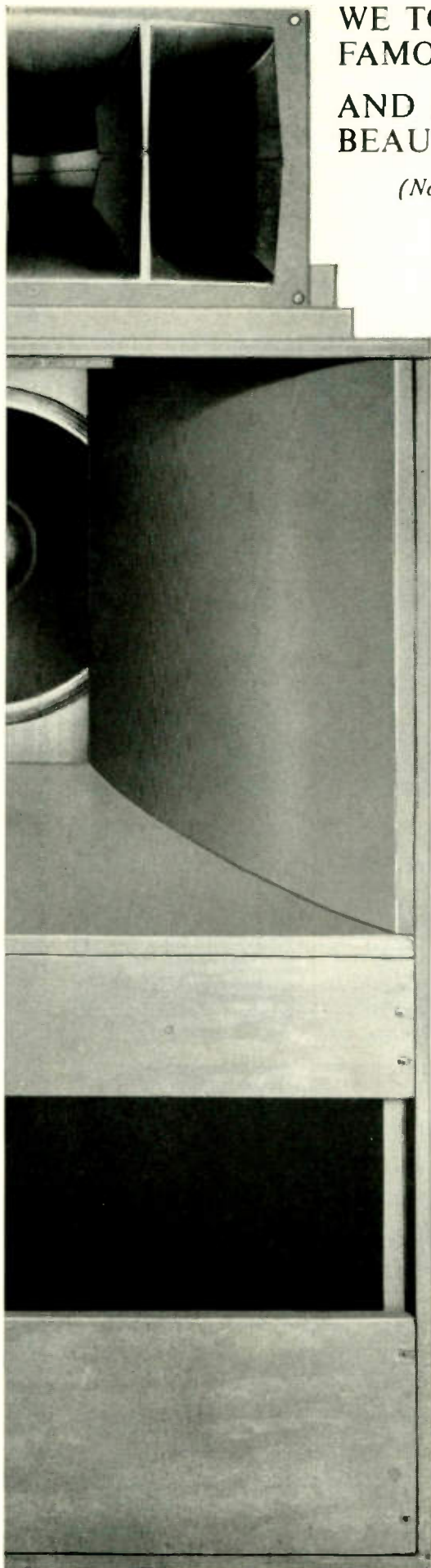

We call our new **PLAYBACK** speaker system the "Valencia." That's because its unique fretwork grille design is adapted from a 16th-Century Spanish palace ornamentation. The "Valencia" is so beautiful your wife will want to rearrange the room to show it off!

We call our new "Valencia" fantastic. That's because it measures 29 $\frac{3}{4}$ " x 27 $\frac{1}{2}$ " x 19"—yet it has all the components of our gigantic, 54" x 30" x 24", A-7! The 15" 416A bass speaker, 811B sectoral horn driven by an 806A high-frequency driver, and 800-cycle dividing network are components of the "Valencia." The same components that have made the huge A-7 standard equipment for broadcast and recording studios and motion picture theatres everywhere. Frequency response of the "Valencia": 30-22,000 cps. Power rating: 30 watts.

COMPARE THE SOUND OF A SPINET PIANO TO THAT OF CONCERT GRAND!

Spinets can be pretty, and they can "fill in" where there's no room for a grand. But the big sounds, the power and majesty, the dynamic range of a Beethoven sonata—these require the long strings and big sounding board of a grand!

THE SAME THING WITH SPEAKERS.

For big sound, you need full-size speakers. It's a matter of physics. The ability of a low-frequency speaker to reproduce low bass is limited by its resonant frequency. When a low-resonant-frequency speaker operates in a small enclosure, the stiffness of the air behind the speaker cone causes a rise in resonance a whole octave or more. Below this resonant point, the response falls off at a rapid rate, 12 db per octave!

WHAT ABOUT ALL THE PUBLISHED 'TESTS' WITH LITTLE SPEAKERS?

Just this—they were all compared with little speakers—*NOT ONE TEST* was matched with a full-size speaker system!!

Reason:—read the full facts from the Great Debate—"Is a Good Big Speaker Better Than a Good Little Speaker?" A copy will be forwarded to you along with information on the new "Valencia."

'VALENCIA' BRINGS YOU SOUND WITHOUT COMPROMISE.

Even if your wife thinks a speaker's beauty is just skin deep! Even if you have just an average-size room! Now you can get the sound that only a full-size speaker system can offer: a meaty, no-distortion sound without compromise!

HEAR THE 'VALENCIA' AT YOUR ALTEC DEALER'S NOW!

Make a real test—A-B it against any other speaker! You won't believe that anything as beautiful as the "Valencia" could sound so impressive! Consumer net, \$333. Write Dept. SR8 for literature.



ALTEC LANSING

A Division of **LSV** Ling Altec, Inc.

ANAHEIM, CALIFORNIA

©1965 AL





HIFI/STEREO REVIEW'S CHOICE OF THE LATEST RECORDINGS

CLASSICAL

Reviewed by WILLIAM FLANAGAN • DAVID HALL • GEORGE JELLINEK • IGOR KIPNIS

RECORDING OF SPECIAL MERIT

© ② J. S. BACH: *Cantata No. 53 "Schlage doch, gewünschte Stunde"; Cantata No. 54 "Widerstehe doch der Sünde"; Cantata No. 169 "Gott soll allein mein Herze haben."* Maureen Forrester (contralto); Anton Heiller (harpichord and organ); Erna Heiller (harpichord); I Solisti di Zagreb. Antonio Janigro cond. VANGUARD BACH GUILD BGS 70670 \$5.95, BG 670 \$4.98.

Performance: Very fine
Recording: Excellent
Stereo Quality: Ideal

These three cantatas were composed during the years 1730-1732, shortly after the completion of the *St. Matthew Passion*. In fact, in majestic feeling and rhythmic outline, one of the arias ("Stirb' in mir") in Cantata No. 169 is strongly reminiscent of the "Erbarme dich" from that monumental Passion.

The three Cantatas differ considerably in design and content. No. 53 consists entirely of a haunting and meditative aria with a delicate accompaniment of strings and continuo, punctuated by bell effects. There are two arias in No. 54, separated by a dramatic recitative. The prevailing mood here is tension, musically emphasized by long passages of biting dissonance. Most elaborate of the three is No. 169, in which Bach reworked material previously used in his Clavier Concerto in E major. Aside from the beautiful "Stirb' in mir," the most striking piece in the work is the opening *Sinfonia*, in which organ and harpsichord are both prominent, and three oboes are added to enrich the orchestral texture.

Maureen Forrester's voice is audible velvet. The vocal writing demands an extensive range, and she responds with warm and full tones in all registers. While the drama in No. 54 is understated, she conveys the text with such clarity and meaning that further emphasis is scarcely needed—this is expressive vocal art of the highest order. Janigro and his associates are excellent in support, and the engineering—particularly in balancing the complex *Sinfonia* in stereo—could hardly be better. G. J.

BEETHOVEN: *Piano Concerto No. 4, in G Major* (see Best of the Month, page 63)

Explanation of symbols:

- ② = stereophonic recording
- ① = monophonic recording
- * = mono or stereo version not received for review

RECORDING OF SPECIAL MERIT

⑤ ② BEETHOVEN: *Symphony No. 6, in F Major, Op. 68 ("Pastoral")*. New York Philharmonic. Leonard Bernstein cond. COLUMBIA MS 6549 \$5.98. ML 5949* \$4.98.

Performance: Warmly poetic
Recording: Spacious and rich
Stereo Quality: Panoramic

As in his recorded performance of the Beethoven Fifth Symphony, Bernstein seems to



LEONARD BERNSTEIN
Fresh insight into the "Pastoral"

have subjected his approach to the "Pastoral" Symphony to a careful recasting of thought and feeling. And as in the recording of the Fifth, there are unexpected interpretive twists here that succeed because they afford fresh insight into a popular and much-abused masterpiece.

The pacing of the "arriving in the country" movement (it is done with repeat) is brisk, but not pushed, and Bernstein's phrasing and dynamics—in the opening pages especially—carry a reflection of that almost physical surge of exultation that one feels upon first breathing clean country air after long confinement to the city.

The problem with the second movement—"Scene by the Brook"—is how to communicate a poetic feeling without putting the audience to sleep on the one hand or violating the allusive, pictorial essence on the other. Bernstein's tempo represents a compromise between languorous flow and the

sparkle of a spring freshet, making subtle but highly effective use of *rubato* to sustain interest. Most importantly, Bernstein's orchestral balance is perfect—exquisite, I am tempted to say—bringing to this movement an aura of shimmer and transparency that almost suggest Debussy.

The "Merry Gathering of Country-Folk" is played in a way that communicates zest and vitality rather than comic loudness. Tempo contrast between the main episodes is plain, but not exaggerated. As for the thunderstorm, Bernstein understates dynamic volume, concentrating on clear attack and rhythmic pulse. He thus gets near the real inner life of this episode, which too often is played merely for "wow" effect—with resultant distortion in the playback.

Bernstein seems to take a slightly different tack than is usual with the final thanksgiving song. He lightens the bass line slightly in order to achieve a more effective sense of melodic flow. A certain amount of tonal richness is lost in the process, but the movement's repetitions are less tiring, and the contrapuntal life of the inner voices becomes clear.

The "Pastoral" Symphony has not lacked distinguished recorded performances in the past, but I would certainly put this disc beside the very best of them. Together with his recent pairing of the Haydn symphonies Nos. 82 and 83, I think this performance represents a genuine fulfillment of Bernstein's own musicality at its best, as well as of Beethoven's musical and poetic intent. D. H.

BEETHOVEN: *Triple Concerto, for Piano, Violin, and Cello* (see BRAHMS)

⑤ ② BELLINI: *La Sonnambula (excerpts)*. Joan Sutherland (soprano), Amina; Nicola Monti (tenor), Elvino; Margreta Elkins (mezzo-soprano), Teresa; Sylvia Stahlman (soprano), Lisa; Fernando Corena (bass), Count Rodolfo. Chorus and Orchestra of the Maggio Musicale Fiorentino, Richard Bonyngue cond. LONDON OS 25887 \$5.98, 5887* \$4.98.

Performance: Sutherland is excellent
Recording: Not London's best
Stereo Quality: Adequate

Few opera lovers would pick *La Sonnambula* as their one desert-island choice—its melodic delights are best enjoyed in moderation. This expertly chosen sequence from the two-year-old London complete set serves that purpose admirably. Plot complications need not deter the listener, for Joan Sutherland's purely vocal achievements will command his attention throughout. And neither Sutherland's

unconvincing character portrayal nor her habitual mannerisms of phrasing and diction are too distracting in this context from her well-controlled, rich-toned, and generally dazzling vocalism.

The soprano's partners operate on a much more modest plane. Laboring against overwhelming vocal odds, Nicola Monti acquits himself creditably and tastefully, while Corena does the best he can in an assignment—calling for a smooth *cantabile* style—for which he lacks the equipment. The orchestral playing provides an appropriate frame for Sutherland's languid conception, but, happily, all concerned come to life for the glittering "Ab, non giunge" which concludes the work. The overall sound is rich, but somewhat diffuse due to excessive echo, and there were several noisy spots in my review copy. G. J.

Next month in
HiFi/Stereo Review

Jean Sibelius
and
Carl Nielsen:

Hundredth Anniversary
Reevaluation by David Hall

The Northern Stars:
A Scandinavian Opera Quiz

Jenny Lind and Ole Bull
in America

PLUS
How to Start an FM Station

Ⓢ Ⓜ BRAHMS: *Double Concerto, in A Minor, for Violin, Cello, and Orchestra, Op. 102; Trio No. 2, in C Major, Op. 87; BEETHOVEN: Triple Concerto, in C Major, for Piano, Violin, Cello, and Orchestra, Op. 56.* Eugene Istomin (piano); Isaac Stern (violin); Leonard Rose (cello); Philadelphia Orchestra, Eugene Ormandy cond. COLUMBIA D2S 720 two 12-inch discs \$11.96, D2L 320 \$9.96.

Performance: Rich and full-blooded
Recording: Big as life
Stereo Quality: High, wide, and handsome

Both the Triple Concerto of Beethoven and the Brahms Double Concerto are currently represented in stereo by previous performances of unusual distinction—the Beethoven by the Serkin-Laredo-Parnas disc from the Marlboro Festival, and the Brahms by Schneiderhahn, Starker, and Fricsay with the Berlin Philharmonic.

For sheer sonority and an almost physical vitality in super-stereo sound, these two discs most surely deserve a place in the sun. The Brahms is given a more massive reading than is usual, though not at the expense of its lyricism (this is particularly true of the first movement). The effect of this approach can

be seen through comparison with the old Stern-Rose-Walter disc, and also with the vintage Thibaud-Casals-Cortot version transferred from 78's. The new recording is a welcome contrast to the rather taut and hard-driven treatment given the concerto on the earlier discs. Stereo directionality is excellent: the soloists are sufficiently prominent, but they never obscure the orchestra.

I am not so sure that the new recording of the Beethoven Triple Concerto represents any notable advance over the Marlboro disc. For some, the mere combination of a virtuoso trio and a virtuoso orchestra will have special attractions, but I have found that the more discreet chamber-ensemble point of view seems to work for the Triple Concerto, where the collective virtuoso idea fails to convince. To be sure, the *sound* of the Marlboro performance—as opposed to interpretive approach—is anything but chamber music: it packs a real wallop. The choice, then, between Marlboro music-making and the virtuoso concept represented in this latest recording is largely a matter of taste. The playing is superb, as is the sound.

Since the last movement of the Brahms and the first movement of the Beethoven share one side of a disc, a fourth side is available for the Brahms C Major Trio, as played by Messrs. Istomin, Stern, and Rose. This is a performance that stands poles apart from the recently released RCA-Victor disc by Gary Graffman, Berl Senofsky, and Shirley Trepel. To begin with, the Istomin-Stern-Rose group is recorded in a considerably more spacious acoustical environment, and the stereo microphoning is worked out so that the instruments not only produce greater sonority *en masse*, but are also properly located individually for stereo speakers. Where Miss Trepel's cello seems unduly reticent in the RCA disc, Rose and Stern are heard on equal terms throughout the entire Columbia recording.

In general, the pacing of the Istomin-Stern-Rose performance is broader, more romantic, and has greater dynamic range. The tempo contrast becomes most striking in the scherzo, which the Columbia artists take at an easier pace than the true *presto* of the RCA ensemble. With this one exception, my preference is for the Columbia disc, largely by virtue of its superior instrumental balance and recorded sound. D. H.

Ⓢ Ⓜ BRUCKNER: *Symphony No. 3, in D Minor.* Amsterdam Concertgebouw Orchestra. Bernard Haitink cond. PHILIPS PHS 900068 \$5.98, PHM 500068* \$4.98.

Performance: Taut
Recording: Too little bass
Stereo Quality: Not very pronounced

Bruckner composed his D Minor Symphony in 1873. Shortly before its completion he showed the score to his idol, Richard Wagner, who was both impressed by the music and pleased by the dedication. During the years 1876 to 1878, Bruckner re-worked the composition, and it was eventually published in this form. Another revision, done ten years later, has been generally dismissed by Bruckner scholars as being too much influenced by the well-meaning brothers Schalk (who would do for Bruckner what Rimsky-Korsakov did for Moussorgsky's *Boris*). It is the second version (1878)

(Continued on page 73)

THE HOROWITZ OF TODAY ON COLUMBIA RECORDS



KL 5771/KS 6371*/MQ 499†



ML 5811/MS 6411*/MQ 519†



ML 5941/MS 6541*/MQ 617†



ML 6058/MS 6658*/MQ 697†

Since 1962 Vladimir Horowitz has recorded four other albums for Columbia Masterworks that have been acclaimed the ultimate in the art of musical interpretation and in the science of recording. These superlative collections are part of a series that sets the standard for the finest piano music on records. All are available now at your record dealer.

*Stereo †Tape

© COLUMBIA MARCAS REG. PRINTED IN U.S.A.

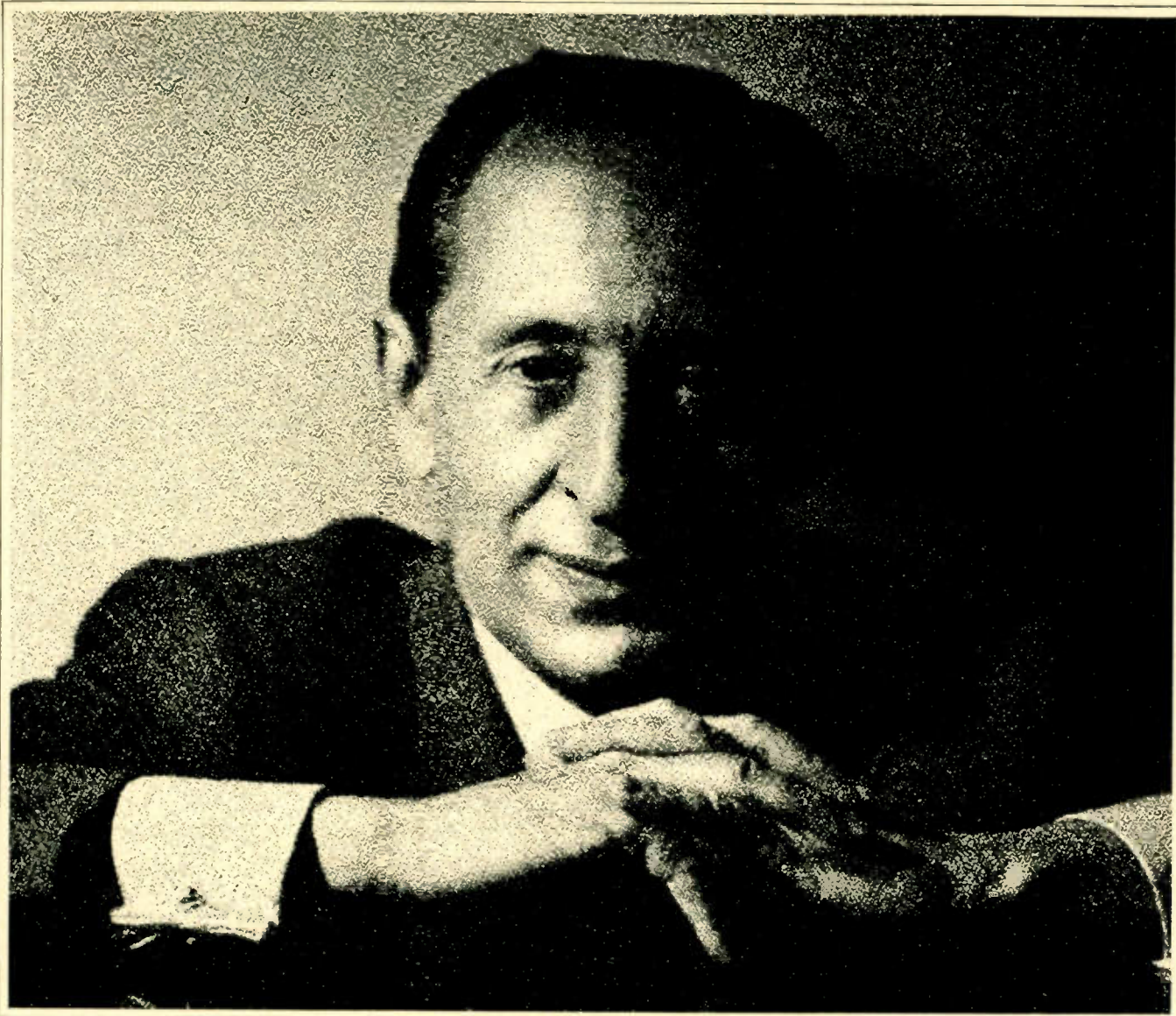

**THE MOST
EAGERLY AWAITED
MUSICAL EVENT
OF THE DECADE
NOW ON
COLUMBIA RECORDS**

May 9, 1965, after an absence of twelve years, Vladimir Horowitz stepped onto the stage of Carnegie Hall and received the greatest ovation in recent musical history. Horowitz the legend had become Horowitz the reality. An audience of almost three thousand people, many of whom had waited in line for tickets

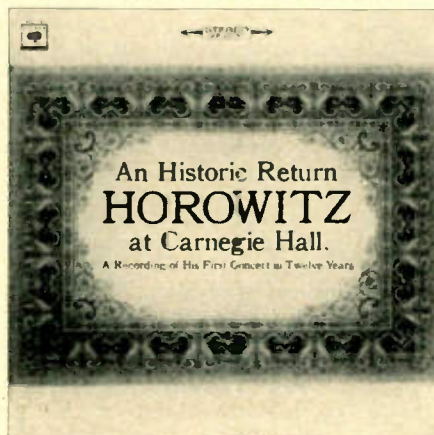

through a rainy windswept night, was profoundly moved as the master pianist played works by Scriabin, Bach-Busoni, Schumann, Chopin, Debussy and Moszkowski. This historic event, recorded live at Carnegie Hall, is now available on Columbia Masterworks in a deluxe two-record set.

M2L 328/M2S 728 Stereo / M2Q 745 Tape

CIRCLE NO. 14 ON READER SERVICE CARD

Charles Alkan: A Pianistic Enigma Solved

THE NEW RCA Victor recording entitled "Piano Music of Alkan" makes several kinds of news at once, offering a program of Charles Alkan's forgotten, ferociously difficult, and very French piano music as performed with awesome competence by an American, Raymond Lewenthal. This release is in every way out of the ordinary, since to begin with, both the composer and the pianist (who on the basis of this recording alone obviously deserve headlines) are virtually unknown to the broad public.

Indeed, Alkan—who died in 1888—is today scarcely a name to any public. And until his recent recitals and broadcasts, Mr. Lewenthal (after an auspicious New York debut in 1948) had since 1951 absented himself entirely from our public musical affairs. Their arrival together in what amounts to a kind of recorded world premiere therefore makes this release a major entry in the Schwann catalog on archival grounds alone. What is equally important, however, is that Mr. Lewenthal's scholarly dedication and pianoblistering virtuosity have at last turned a nineteenth-century musical enigma into a fine dazzle of sound for living ears. And if the balance of these remarks is of necessity devoted largely to the endless strangenesses of *l'affaire Alkan*, I hope also to indicate that Mr. Lewenthal cannot be given too much credit for his king-sized feat.

When Alkan was born (in Paris, on November 30, 1813, in the same year as Wagner and Verdi), Napoleon had four months left as Emperor and Beethoven was still a year from his personal glorification at the Congress of Vienna. When Alkan died (in Paris, on March 29, 1888), Napoleon's remains had received almost five decades of veneration at Les Invalides, the Napoleonic legend had changed French intellectual life beyond recognition, the main aesthetic battles of Romanticism were long since won, a rich European bourgeoisie had been taught that artists were born principally to shock it... and Mahler was twenty-eight, Debussy twenty-six, Richard Strauss twenty, Schoenberg and Charles Ives fourteen, and Stravinsky six.

In other words, Alkan lived long enough to see the post-Romantics in the saddle and to sense that modernism was just around the corner. Meanwhile, he himself had mysteriously left the battlefield—mysteriously, because at mid-century this major pianistic innovator (and brilliant concert pianist) was known to everybody who was anybody: Chopin and Liszt, after all, were Alkan's friends and respectful colleagues. Turning his back on all that, he had become a sombre recluse and Talmudic scholar who eventually died alone—his path odd to the end, since he is the only historic figure I know of who was killed by a toppling bookcase.

No great time after his death, and despite the subsequent attentions of such performers as Busoni and Egon Petri,

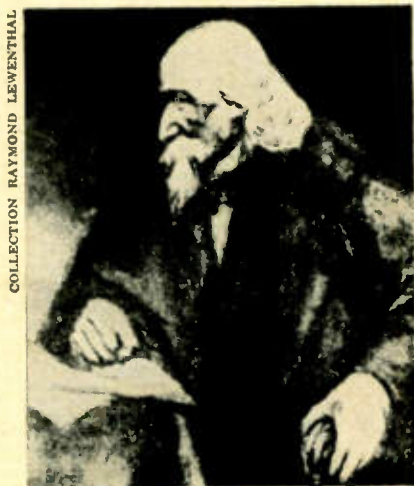

CHARLES ALKAN

Alkan's music disappeared with the century that it reflects so variously and so interestingly. And this is very strange, for what we are most conscious of in Mr. Lewenthal's recording is the vast generic image that Alkan mirrors—the mighty-muscled mid-nineteenth century itself, in all its ornate grandiosity, its obsession with power and *la gloire*, its morbid fascination with the painfully grotesque, its underlying and ineradicable melancholy. In Alkan we hear music that has come to terms with the nostalgic Napoleonic drums, with the loneliness of great cities grown suddenly crowded, with the inhuman speed and violence of the railroad trains that expanded time and diminished space. And it does this without forgetting the Balzacian village legend or neglecting Parisian elegance—for the teeming boulevards of Constantin Guys and Baudelaire's perverse and icy cult of the Dandy are also somehow present. Even the curious titles of Alkan's pieces—*Le Chemin de fer*, *Rythme molosique*, *Festin d'Ésope*, *Super flumina Babylonis*, *Le Tambour bat aux champs*—remind us how deeply the musical Romantics were involved with the intellectual exoticism of the period, its literary and pictorial mystifications. And also, to be perfectly honest, with its chronic confusion of *métier*. I think that if Baudelaire had possessed half an ear for non-Wagnerian music, this father of modern aesthetic criticism would certainly have noted the affinities between Alkan's huge piano pieces and the outsized narrative canvases of, say, Delacroix and Géricault. And it is of the very spirit of the period that the memory of Alkan's music should have survived, not in the concert hall, but in the books of such sophisticated connoisseurs as Bernard van Dieren and Sacheverell Sitwell.

The listener will find it easy enough to note Alkan's family resemblances to Schumann, Chopin, Berlioz, or Liszt. But what is more interesting is the fact that in any given family circumstance, his tone of voice, like his harmonic vocabulary, is

never really quite like theirs. It is in fact precisely at the point that Alkan rejects identification with them that he discovers—largely through a process, one guesses, of strenuous introspection—his own cryptic originality, his peculiarly thought-darkened flavor and color. Establishing his own domain—perhaps a somewhat less accessible one—at the periphery of these sovereign central figures, Alkan enlarges our conception of the concert piano in several ways: by demanding the ultimate in sheer physical power and endurance; by exploiting orchestral concepts of piano sonority (note the fantastic passages in which, anticipating Liszt, he obtains an overwhelming, orchestra-like crescendo through huge chords repeatedly sounded *prestissimo*); and lastly, and above all, by expanding our concept of pianistic architectural *scale*. Mr. Lewenthal devotes one whole side here to a Symphony for solo piano, and in an even vaster solo Piano Concerto as yet unrecorded (its first movement is longer than Beethoven's entire Hammerklavier Sonata), Alkan requires that a solitary pianist be convincing in *solo* and *tutti* passages alternately. The long *Quasi-Faust* section of this recording is but one movement of an enormous *Grande Sonate*, the *Festin d'Ésope* consists of twenty-five variations on a simple folklike tune—and will anyone else ever contrive a "sonatina" that goes on for thirty-five very black pages? Today I can imagine nothing more pertinent than this recording to remind us that we have perhaps lingered overlong in an era of cautious miniaturism, an intimidated generation to whom this kind of audacious grandiosity has long been almost ethically suspect.

Volumes remain to be written on the subject, and it is heartening to know that Mr. Lewenthal will be heard from further in a forthcoming book on Alkan (this in addition to the Lewenthal edition of selected Alkan works just published by G. Schirmer). As for Mr. Lewenthal's performance in this recording, his technical and interpretive resources as demonstrated under extreme stress place him comfortably in the major pianistic leagues. Stylistically, his unflinching drive, his lucidity in long-lined declamation, and his coloristic reserve all recall somewhat the playing of the late Alfred Cortot, who turns out to have been his teacher. Let it be said in conclusion that Mr. Lewenthal has returned from the silences with a magnificent trophy of French Romanticism and has covered himself with distinction by presenting it in the very grandest manner. Robert Offergeld

© © ALKAN: *Piano Music of Alkan*. *Symphonie*, Op. 39: *Allegro*, *Marche Funèbre*, *Minuet*, *Finale*; *Le Festin d'Ésope*, Op. 39, No. 12: *Barcarolle*; *Quasi-Faust*: 3rd movement from *Grande Sonate*, Op. 33. Raymond Lewenthal (piano). RCA VICTOR LSC 2815 \$5.98, LM 2815 \$4.98.

PAY LESS FOR THE BEST IN STEREO HI-FI & TAPE RECORDING

at *ALLIED*

*... where more people buy their stereo hi-fi
than anywhere else in the world*



FREE



send today
for your
money-saving
508-page
ALLIED
1966 catalog

ENJOY THE WORLD'S LARGEST SELECTION CHOOSE FROM THE NEWEST AND FINEST

See the world's largest selection of famous-make components and systems—buy at the lowest prices anywhere. See latest solid-state stereo hi-fi. Get our lowest price on a complete hi-fi system. Build your own KNIGHT-KIT® hi-fi—and save even more. See famous KNIGHT® components, equal to the very best in performance, yet far lower in cost. Enjoy the largest selection of tape recorders, tape decks, pre-amplifiers, and recording tape. Get the most for your money in beautiful hi-fi cabinetry. For everything in Hi-Fi, for everything in Electronics, SEE THE 1966 ALLIED CATALOG—SEND CARD TODAY.

satisfaction guaranteed or your money back!

EASY TERMS: Use the convenient Allied Credit Fund Plan—over 24 months to pay

**SEND CARD
TODAY!**

For your FREE 1966 Allied Catalog, fill in card, detach and mail now. (Please give other card to an interested friend.)

**MAIL
NOW!**



Name _____
PLEASE PRINT
Address _____
City _____
State _____ Zip _____
10-H

send today
for your **FREE**

ALLIED
1966
CATALOG

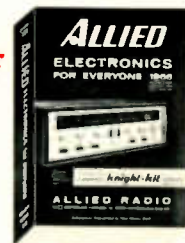

SAVE MORE ON STEREO HI-FI
AND TAPE RECORDING

MAIL CARD TODAY

Name _____
PLEASE PRINT
Address _____
City _____
State _____ Zip _____
10-H

send today
for your **FREE**

ALLIED
1966
CATALOG

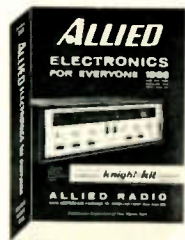

MORE OF EVERYTHING IN HI-FI
FOR EVERYONE

MAIL CARD TODAY



send today for your money-saving

ALLIED

508-PAGE 1966
HI-FI-ELECTRONICS CATALOG

BIGGEST SELECTION, BIGGEST SAVINGS EVER

STEREO HI-FI more of everything



See 56 amplifiers, 32 tuners, 24 receivers, 21 turntables, 176 speakers and enclosures. **All famous makes:** Knight, Knight-Kit, Fisher, Scott, Bogen, Harman-Kardon, Eico, E-V, Sherwood, McIntosh, Dyna, Garrard, Jensen, AR and many more.

knight® STEREO for greater savings



Foremost value name in stereo hi-fi. KNIGHT components and systems are equal to the very best in quality and performance, yet they're far lower in cost, give you most for your money in every way.

send
card
now



knight-kits®

Best in Build-Your-Own Hi-Fi

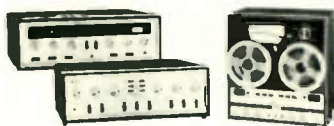

Enjoy large savings. See latest solid-state receivers, amplifiers, tuners. Also many other kits: hobby, CB, Amateur, automotive, test instrument, intercom—all wonderfully easy to build.

TAPE RECORDING
unbeatable values

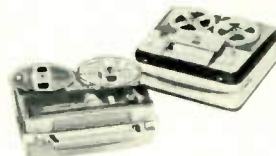

See 40 recorders, 14 tape decks, largest selection of tapes. **All famous makes:** Knight, Knight-Kit, Ampex, Wollensak, Sony, Concord, Tandberg, Viking, RCA, Scotch, Audio-tape and many others.

PLUS EVERYTHING IN ELECTRONICS

- FM-AM & AM Radios
- Phonographs • Portable TV
- Citizens Band Radios
- Amateur & Short Wave Equipment
- TV Tubes & Antennas
- Test & Lab Instruments
- Intercoms & P. A. Systems
- Electronic Parts, Tubes, Transistors

FREE



Send card today for your 1966 Allied Catalog—and give one card to an interested friend.

EASY TERMS: Use the convenient Allied Credit Fund Plan—over 24 months to pay

satisfaction guaranteed or your money back

ALLIED RADIO

100 N. Western Ave., Chicago, Ill. 60680

TO:

ALLIED RADIO

P. O. Box 4398

CHICAGO, ILLINOIS 60680

PLACE
STAMP
HERE

TO:

ALLIED RADIO

P. O. Box 4398

CHICAGO, ILLINOIS 60680

PLACE
STAMP
HERE

of the Bruckner Third Symphony that is recorded here by Bernard Haitink and the Amsterdam Concertgebouw Orchestra.

I have an abiding affection for the Fourth and am deeply moved by the Ninth of Bruckner's symphonies; a truly outstanding performance of the apocalyptic Eighth fills me with awe. But I must confess to an inability to assimilate the Third, despite the fine New York Philharmonic performances done by Joseph Krips this past season and the clearly earnest efforts expended by Haitink in this recorded version.

Save for the Scherzo, which is a pleasingly effective essay in a late Schubertian vein, I find the D Minor Symphony essentially a primitive version of the grandiose rhetoric displayed so much more effectively in the Eighth and Ninth symphonies.

It is just possible, however, that the sound on this disc may also be to blame in part for this reaction. Music of this kind needs the sound of a Philadelphia or Vienna Philharmonic, but what came from my speakers seemed to need bass sonority, while the orchestra as a whole sounded as though microphoned from a vast distance. The string body, in particular, seemed to lack bite, compared with the best of the London, Columbia, DGG, and RCA (Boston) symphonic products.

Perhaps a re-mastering of this disc or a more effective original recording will one day change my mind about this work—but for the moment my personal verdict is "no."

D. H.

RECORDING OF SPECIAL MERIT

Ⓢ Ⓜ CANTELOUBE: *Songs of the Auvergne (L'Antouèno; Pastourelle; L'aïo dè roïso; Buièro; Passo del prat; Malurois qu'o uno femmo; Brezairola)*. VILLA-LOBOS: *Bachianas Brasileiras No. 5*. RACHMANINOFF: *Vocalise*. Anna Moffo (soprano); American Symphony Orchestra, Leopold Stokowski cond. RCA VICTOR LSC 2795 \$5.98, LM 2795* \$4.98.

Performance: Exquisite
Recording: Rich but over-reverberant
Stereo Quality: Excellent

The music of such disparate cultures as those of France, Brazil, and Russia can sometimes be drawn together into a unified experience, and on this disc it is accomplished by that noblest and most expressive of instruments, the human voice. For what these haunting expressions of Canteloube, Villa-Lobos, and Rachmaninoff have in common is a luscious, flowing vocal line that blends with the surrounding orchestra into an essentially instrumental web of sound, colorful and magically evocative. Rachmaninoff's *Vocalise*, entirely wordless, was obviously conceived for such an effect. So was most of the Aria portion of the Villa-Lobos work and, although the remainder was set to a text, I doubt that many listeners have ever paid much attention to its meaning. This is probably also true of the *Songs of the Auvergne*, whose texts are readily available for those who wish to explore them. But the magic of this music is in the singing, and it takes a voice of purity, effortless ease of delivery, and a finespun legato style to communicate it to the listener. Happily, Anna Moffo has that kind of voice and style.

Although violin and orchestral transcriptions abound, this is the only sung version

in the catalog of the *Vocalise*, into which Rachmaninoff poured so much longing for his lost Russia. Miss Moffo handles this music and also the wordless portion of the *Bachianas* with absolute ease and virtually flawless intonation. I only wish that she had managed the ending of the Aria in the manner of Bidú Sayão, taking the octave rise to A on one breath.

Miss Moffo offers only seven of the Canteloube settings, as against the thirty songs available in Netania Davrath's admirable rendition on Vanguard discs 2090 and 2132. Both sopranos are exquisite singers. Davrath shows more temperament, more earthiness and verbal emphasis, while Moffo, singing in a more detached "concert" style, stresses the perfection of her "instrumental" line. This almost disembodied *vocalise* tone quality, however, is at least partially owing to RCA Victor's excessively reverberant sound.

Leopold Stokowski's own jacket annotations confirm the loving regard for these scores that is evident in his interpretation. Indeed, Canteloube's orchestration—with its highly colored sprays of sound and elaborately contrived "simplicity"—has everything a conductor with Stokowski's ear and flair for sound could ask for. The sensuous tone of this young orchestra is captured by the engineers faultlessly and in rich detail in the Canteloube and Rachmaninoff works. In the Villa-Lobos, more prominence for the solo cello and a sharper definition in the contrapuntal voices of the eight cellos would have been desirable.

It is a reassuring thought that all this gorgeous music for the human voice—and for orchestra—was written in the twentieth century!

G. J.

Ⓢ Ⓜ DVORÁK: *Cello Concerto*. TCHAIKOVSKY: *Variations on a Rococo Theme*. Leonard Rose (cello); Philadelphia Orchestra, Eugene Ormandy cond. COLUMBIA MS 6714 \$5.98, ML 6114* \$4.98.

Performance: Solid
Recording: Sonorous
Stereo Quality: Excellent

This rendition of the Dvořák *Cello Concerto*—and for that matter the Tchaikovsky *Variations*, too—is wonderfully gratifying as pure musical sound, pure musicianship, and typically American virtuosic manner. But one wonders. Rose turns on the rich-full-and-luscious cello sound pretty relentlessly, and although his phrase shapes are quite exquisite, it is surely indicated by the score itself that more *variety* of sound might have brought the beauty of Rose's lush tone into bolder relief. Oddly enough, Ormandy has kept his orchestra's rich-full-and-luscious sound to a minimum, has let the orchestral complement serve as accompaniment and almost that alone. In general, the performance is no match for the less spectacular Casals reading (Angel COLH 30) or the Piatigorsky-Munch reading with the Boston Symphony Orchestra (RCA Victor LSC 2490, LM 2490).

When the present forces are given the Tchaikovsky to deal with, however, the tables are turned. Rose seems to understand the essentially neo-Mozartean impulse underlying the work, and plays it lightly, vivaciously, and yet ever so singingly. Here, however, the Philadelphia Orchestra just can't seem to help being the Philadelphia Orchestra, and the accompaniment is weighty,

NEW TREASURES FROM ARCHIVE PRODUCTION

CONTINUING THE MOST WIDELY-
ACCLAIMED AND AUTHORITATIVE
HISTORY OF MUSIC ON RECORDS

5 REMARKABLE ALBUMS:

TELEMANN:

MUSIQUE DE TABLE, Vol. 1

Contents: Overture-Suite for Flutes, Strings and Continuo—Solo for Flute and Continuo in B minor—Conclusion—Quartet for Flute, Oboe, Violin and Continuo in G—Concerto for Flute, Violin, Strings and Continuo in A—Trio for 2 Violins and Continuo in E flat. Soloists and ensemble of the Schola Cantorum Basiliensis/August Wenzinger.

(3234/35 Stereo 73234/35)

Vol. 2 will be available in October, Vol. 3 in January, 1966.

A. SCARLATTI:

IL GIARDINO DI AMORE

(The Garden of Love)

Catherine Gayer as Venus and Brigitte Fassbaender as Adonis, with trumpet, piccolo, lute, violins, cello, bassoon and harpsichord. Munich Chamber Orchestra/Hans Stadlmair.

(3244 Stereo 73244)

HANDEL:

CONCERTI GROSSI, Op. 6

Schola Cantorum Basiliensis/August Wenzinger. (Complete—New Stereo Edition)

(3246-7-8 Stereo 73246-7-8)

THOMAS MORLEY:

9 CANZONETS, MADRIGALS AND BALLETS; 6 PIECES FOR HARPSICHORD

The Ambrosian Singers/Denis Stevens; Valda Aving, Harpsichord.

(3209 Stereo 73209)

MOZART:

FLUTE CONCERTO NO. 1 IN G, K. 313,
OBOE CONCERTO IN C, K. 285d/314—
H. M. Linde, Flute; H. Holliger, Oboe; Munich Chamber Orchestra/H. Stadlmair.

(3242 Stereo 73242)

Direct Import—Factory Sealed.
Available wherever fine classical
records are sold; or write direct.

FREE: New illustrated 1965-1966 DGG/
ARCHIVE catalogues on request.

MGM RECORDS, CLASSICAL DIVISION,
1540 BROADWAY, N.Y., N.Y. 10036

CIRCLE NO. 18 ON READER SERVICE CARD

AUGUST 1965

←CIRCLE NO. 3 ON READER SERVICE CARD

73



did you know...

that any records and tapes reviewed in this issue can be purchased through the HI-FI/STEREO REVIEW Record Service?

To order, simply fill out the coupon below. Orders can be accepted only for recordings reviewed in this issue, and must be received no later than the date indicated at the bottom of the coupon.

HIFI/STEREO REVIEW RECORD SERVICE • DEPT. SC
ONE PARK AVE. • NEW YORK 16, N.Y.

Please send the following records and/or tapes reviewed in this issue.

- Check or Money Order for \$_____ is enclosed.
- C.O.D. Within the Continental Limits of the United States only.

ALL RECORDINGS ARE FULLY GUARANTEED

PAGE NO. OF REVIEW	TITLE	RECORD (TAPE) NUMBER (SEE REVIEW)	MANUFACTURER	PRICE (SEE REVIEW)
(N.Y.C. residents add 4% sales tax)				
Total				

Name (please print)

Address

City.....Zone.....State.....

Orders must be received no later than September 1, 1965

865

a little lacking in the dryness of sound that would suit the work better.

The recorded sound is beautiful, although I cannot ascertain whether the emphasis on the cello role in the Dvořák is the result of a musical or an engineering decision. W. F.

© ® GOUNOD: *Saint Cecilia Mass*. Pilar Lorengar (soprano), Heinz Hoppe (tenor), Franz Crass (bass); Henriette Puig-Roget (organ); Choeurs René Duclos; Orchestre de la Société des Concerts du Conservatoire, Paris. Jean-Claude Hartemann cond. ANGEL S 36214 \$5.98, 36214* \$4.98.

Performance: Very good
Recording: Echo-y, but good
Stereo Quality: Good spread and balance

Completed in 1855, four years before *Faust*, Gounod's *Saint Cecilia Mass* is a religious work of easy tunefulness, with overtones of theatricality. I would not overestimate its significance—its melodies are frequently commonplace, its harmonies are simple, and an aura of comfortable predictability hangs over the entire work. All the same, viewed in the context of the period that produced it, the Mass has an undeniable appeal. Furthermore, it is not without some originality—the concluding section has a rather surprising martial character, injecting a note of patriotism into the devotional atmosphere.

There are few opportunities in the score for showy vocalism, but the writing for the soloists is effective nonetheless. Here all three are well-schooled singers with attractive voices, and the chorus assists them with rich and well-balanced sonorities. The sound is strongly reverberant—the recording originated in the Église St. Roch, Paris—but with ample definition and richness. This is the only currently available recording of the Mass. G. J.

© ® HAYDN: *Piano Sonatas, Vol. 1: No. 18, in B-flat Major; No. 22, in E Major; No. 28, in E-flat Major; No. 46, in A-flat Major*. Artur Balsam (piano). L'OISEAU-LYRE SOL 273 \$5.98, OL 273* \$5.98.

© ® HAYDN: *Piano Sonatas, Vol. 2: No. 6, in G Major; No. 30, in A Major; No. 31, in E Major; No. 38, in E-flat Major*. Artur Balsam (piano); L'OISEAU-LYRE SOL 274 \$5.98, OL 274* \$5.98.

© ® HAYDN: *Piano Sonatas, Vol. 3: No. 20, in C Minor; No. 23, in F Major; No. 40, in G Major; No. 48, in C Major*. Artur Balsam (piano). L'OISEAU-LYRE SOL 275* \$5.98, OL 275 \$5.98.

Performance: Very satisfying
Recording: For the most part excellent
Stereo Quality: Normal for solo piano

This is an excellent selection of twelve sonatas, almost none overly familiar, ranging from fairly early in Haydn's career to his late years. Furthermore, there have not been so many recorded collections of Haydn's piano music that a survey of this type cannot be welcome. The choice of Artur Balsam as the performer is excellent. Although he is basically a pianist in the Romantic tradition—in the manner of Schnabel, say—he is an interpreter of considerable intellect, and he avoids the calculated approach and glassy tone that characterize so many younger artists' performances of Haydn and Mozart.

(Continued on page 76)

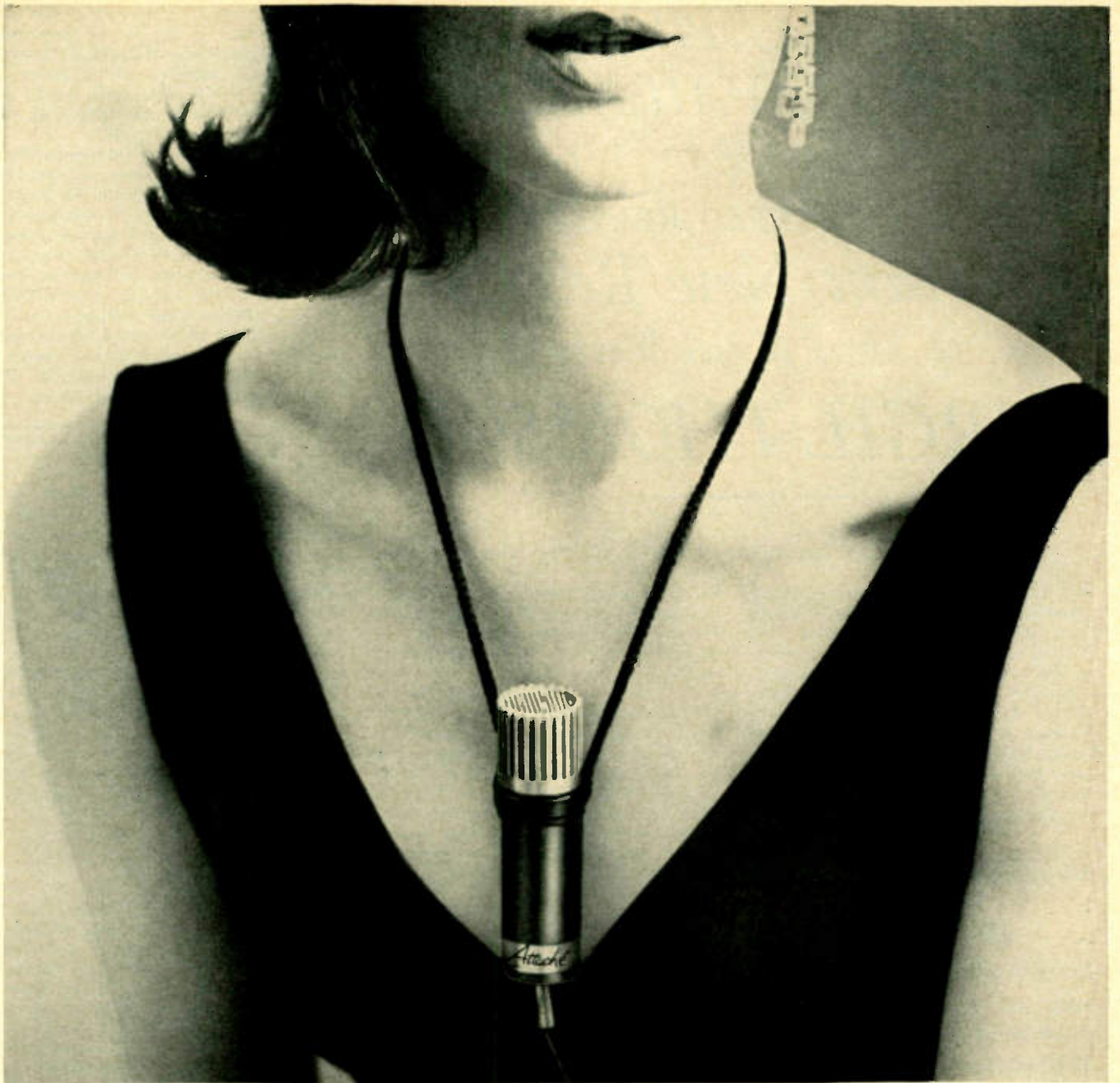

**She's wearing the new revolutionary Attaché
The smallest professional cardioid dynamic microphone
Wear it, hold it, or put it on a stand**

Here's the most versatile, cardioid dynamic microphone ever made. More than two years in development, University engineered the Attaché for the professional and the serious tape recordist. But, it is priced for everyone—only \$66.59 list.

The Attaché is especially suited for "on-the-move" applications, obsoleting the quality compromising omni (all-directional) lavalier. Because it is a cardioid, the Attaché Professional rejects background sounds. It is resistant to feedback—enables you to talk closely without boom, or sibilance. Its low impedance is ideal for modern solid state equipment using cables of 200 feet or more for mobility.

Use the Attaché any way you like—wear it, pin it to your lapel, hide it in your hand or pocket. Or, mount it on a stand, a boom, a gooseneck...even hang it from the ceiling—all in seconds without time-consuming modifications. Supplied with built-in, 15-foot spring-loaded, indestructible cord and handsome carrying case. As with all quality University products, the Attaché carries the exclusive University 5 year warranty! For details, write Desk D-8, LTV/University, 9500 West Reno, Oklahoma City, Okla.

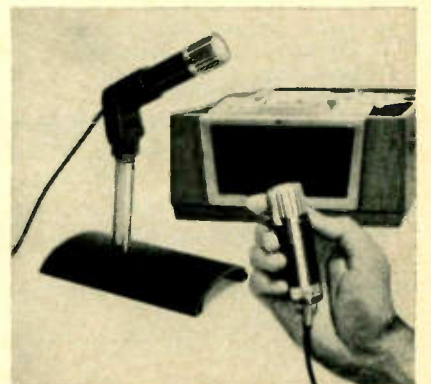

⇨ A FEW COPIES ARE ⇨
STILL AVAILABLE ⇨

of
HiFi/STEREO REVIEW'S
Important New Recording
of Three Major Works by
VIRGIL THOMSON

THE MUSICAL PROGRAM of the recording is as follows:

• I. *Sonata da chiesa*. This challengingly dissonant three-movement work (Chorale, Tango, and Fugue) was composed in Paris in 1926, producing a scandal at its premiere and frequently at performances thereafter. It is recorded here (as performed on the occasion of the 1961 birthday tribute to Mr. Thomson at New York's Town Hall) by Lillian Fuchs, *viola*; Edward Erwin, *trombone*; Paul Ingraham, *French horn*; Peter Simenauer, *clarinet*; and Fred Mills, *trumpet*. The composer conducts.

• II. *Sonata for Violin and Piano*. A large-gestured neo-Romantic work in four move-

ments, this sonata was composed in 1930. It is recorded here as performed by Joseph Fuchs, *violin*, and Artur Balsam, *piano*, on the same Town Hall occasion as the selection above.

• III. *Praises and Prayers*. Composed in 1963, this strong and moving song cycle contains masterly contemporary settings of ancient devotional texts. It is performed here by soprano Betty Allen, accompanied by the composer at the piano. The performance records the occasion of the world premiere of the work at the Grace Rainey Rogers Auditorium of the Metropolitan Museum of Art in New York City.

WE CALL your attention to the fact that this HiFi/STEREO REVIEW Editorial Recording is not being distributed in the ordinary commercial channels. This tribute to one of America's most distinguished composers is specially produced in a *limited quantity* for the readers of HiFi/STEREO REVIEW. You can obtain it only by direct order, using the coupon below. TECHNICAL NOTE: The historic in-performance mono recordings on this disc do not measure up to the highest present-day studio standards, but they are entirely adequate for full musical satisfaction.

TO: VIRGIL THOMSON RECORD
c/o Ziff-Davis Service Division
589 Broadway
New York, N.Y. 10012

8-65

I enclose my check for \$2.50. Please send me a copy of the new mono HiFi/STEREO REVIEW Editorial Recording, THREE WORKS BY VIRGIL THOMSON. I understand that the quantity is limited, and that orders will be processed on a first-come, first-served basis for as long as the supply lasts. (NOTE: New York City residents add 4% city sales tax.)

NAME
ADDRESS
CITY STATE ZIP CODE

There is plenty of feeling—one notices this rich musicality in the slower movements (the gentle beginning of No. 40 is a particularly elegant example). He is almost as persuasive in the faster ones, though on occasion the tempo exceeds the marking and the mood becomes a bit glib.

With only some minor reservations, then, I would consider these among the very best recordings of keyboard Haydn. My reservations concern both the use of a non-definitive text (Balsam omits quite a number of ornaments) and the absence of certain important stylistic practices (such as beginning most trills on the upper auxiliary or the addition of little cadenzas when required, as in the slow movement of No. 6). L'Oiseau-Lyre's reproduction is extremely natural, though I found the second volume rougher in tone than the others. Stereo is unobtrusive. I. K.

RECORDING OF SPECIAL MERIT

© ● MOZART: *The Magic Flute*. Fritz Wunderlich (tenor), Tamino; Franz Crass (bass), Sarastro; Roberta Peters (soprano), Queen of the Night; Evelyn Lear (soprano), Pamina; Dietrich Fischer-Dieskau (baritone), Papageno; Lisa Otto (soprano), Papagena; Hans Hotter (bass), Speaker; Friedrich Lenz (tenor), Monostatos; Hildgard Hillebrecht, Cvetka Ahlin (sopranos), and Sieglinde Wagner (mezzo-soprano), Three Ladies; Rosl Schwaiger, Antonia Fabberg (sopranos), and Raili Kostia (mezzo-soprano), Three Boys; James King (tenor) and Martti Talvela (bass), Two Armed Men. RIAS Chamber Choir and Berlin Philharmonic Orchestra, Karl Böhm cond. DEUTSCHE GRAMMOPHON 138981/82/83 three 12-inch discs \$17.94, 18981/82/83* \$17.94.

Performance: First-rate
Recording: Good
Stereo Quality: Lively

Here is another excellent *Magic Flute*, in some ways even superior to the Klemperer performance issued by Angel earlier this year. Above all, it is complete. However limited in literary merit the spoken passages may be, they provide continuity between various episodes and introduce musical numbers which otherwise would follow one another in a seemingly random fashion. The presence of these spoken portions here results in a completely faithful recording of the opera, and in this respect DGG scores a decided plus over Angel.

The list of credits continues with DGG's Sarastro, Franz Crass, who, though a mite uncomfortable in the *profundo* range, delivers his divine music with solid sonority and a flowing, *cantabile* style that Angel's Gottlob Frick cannot match. As the Tamino of the set, Fritz Wunderlich is just about ideal. He captures both the tender and the manly quality of the character in tones that are effortless at all dynamic levels and are always elegantly phrased. Evelyn Lear's Pamina is also excellent—combining pure vocalism with a warm and sensitive character projection—but not really superior to Angel's Gundula Janowitz.

Roberta Peters, however, is a small-scale and rather unsteady Queen of the Night compared to Angel's spectacular Lucia Popp. And in the important ensemble parts—the Three Ladies, the Armed Men, and the Priests—DGG offers adequacy, which is not
(Continued on page 78)

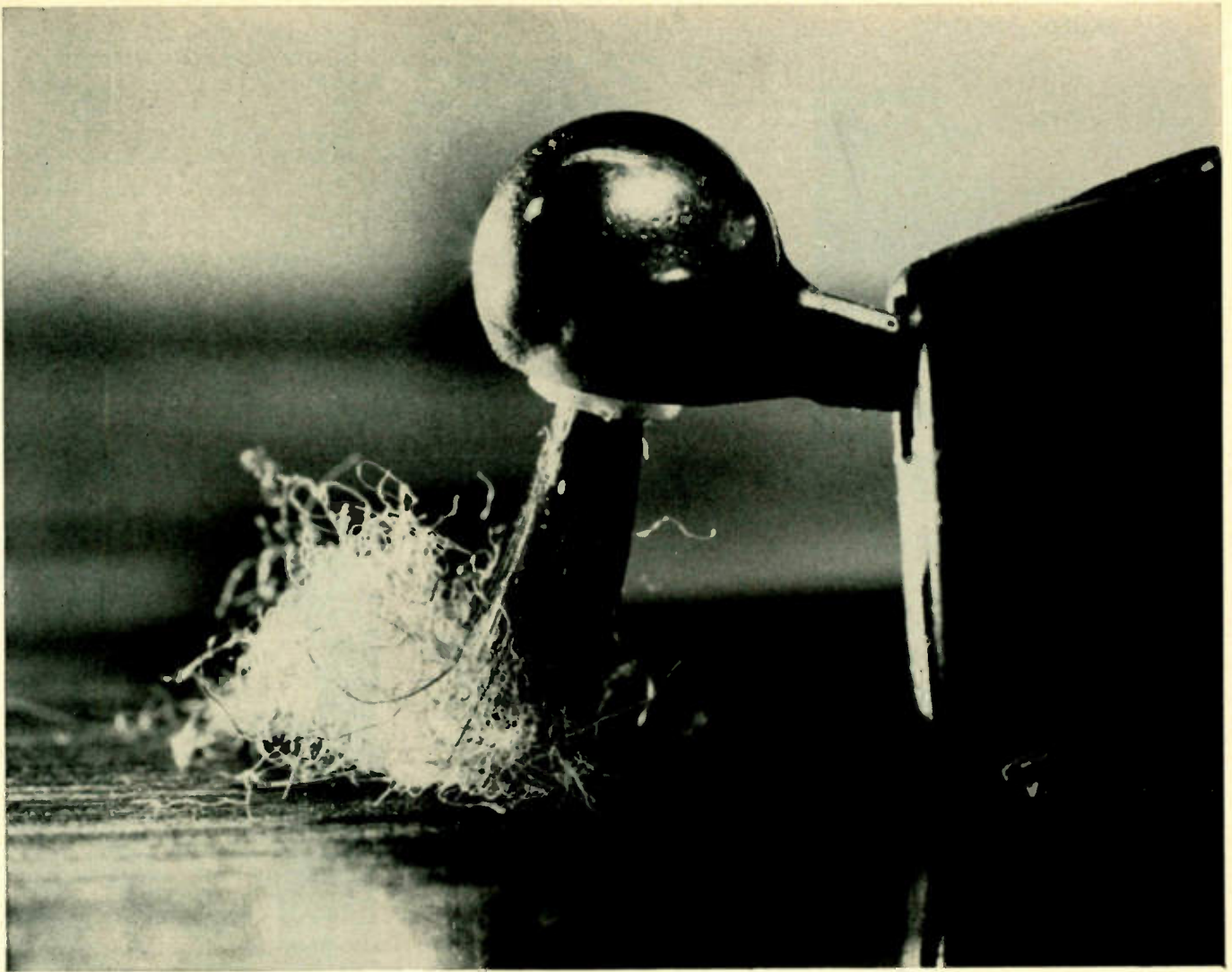

You are looking at the world's only true **longhair** cartridge.

In this unretouched photograph, the long, black hair of the brush built into the new Stanton 581 is shown in action on a rather dusty record. Note that all the loose lint, fuzz and dust are kept out of the groove and away from the stylus. That's why the Longhair is the ideal stereo cartridge for your Gesualdo madrigals and Frescobaldi toccatas. Its protective action is completely automatic, every time you play the record, without extra gadgets or accessories.

The stem of the brush is ingeniously hinged on an off-center pivot, so that, regardless of the stylus force, the bristles never exert a pressure greater than 1 gram and always stay the right number of grooves ahead of the stylus point. The bristles provide just the right amount

of resistance to skating, too.

But even without the brush, the Stanton 581 Longhair is today's most desirable stereo cartridge. Like its predecessors in the Stanton Calibration Standard series, it is built to the uniquely stringent tolerances of Stanton professional audio products. Its amazingly small size and light weight (only 5 grams!) make it possible to take full advantage of the new low-mass tone arms. And its frequency response is factory calibrated within 1 db from 20 to 10,000 cps and within 2 db from 10,000 to 20,000 cps. Available with 0.5-mil diamond (581AA) or elliptical diamond (581EL); price \$49.50.

For free literature, write to Stanton Magnetics, Inc., Plainview, L.I., N.Y.

Stanton



When Summer Calls You

Outdoors



Need You Leave Music Behind?

Summer is a fun season. It's the time when you enjoy all the good things of outdoor living — your pool, your patio, your barbecue, the warm sun and the balmy nights.

But, remember good music reproduction can add as much to your summer outdoor enjoyment as it does to your winter fire-side. For dancing on the terrace, perhaps. Or as background while you laze by the pool. Maybe a dinner concert with your cookout.

We're not talking about the cramped sound of a transistor radio, of course. We mean the same type of rich, full-bodied sound you get from your indoor high fidelity system.

It's easy to achieve. Just a pair of wires, a Bozak Bard (two for stereo) and your present music system, right where it is.

bard



The Bard is a remarkable new type of carefree outdoor speaker made by Bozak. You can stand it on the deck, attach it to a wall, hang it from the rafters. It's completely weatherproof — even an accidental ducking in the pool won't harm it.

We won't promise that the Bard will deliver all the musical realism that has made Bozak the quality leader in speaker systems since high fidelity began. We just say there isn't a finer speaker made for your outdoor use.

It only costs \$83.50. You ought to hear it.

Your Bozak dealer is in the Yellow Pages or write us.

Bozak

DARIEN, CONNECTICUT

CIRCLE NO. 10 ON READER SERVICE CARD
FOR STORES "WHERE YOU CAN BUY"
SEE LAST PAGE.

satisfactory to anyone who has enjoyed the vocal luxury Angel so lavishly secured from Schwarzkopf, Ludwig, & Co.

In the final analysis, I think the choice of conductors will dictate the listener's preference for this opera. Böhm's orchestra plays with a lighter texture, and he is undoubtedly more successful than Klemperer in the comic episodes. Here, of course, one must take into account the contribution of Fischer-Dieskau, whose mercurial and ebullient Papageno eclipses the darker-toned and slightly heavy-handed performance Walter Berry delivers on Angel under Klemperer's less unbending baton. But comedy is merely an undercurrent, though an important one, in this remarkable opera. The work's essence lies in the music allotted to Tamino, Pamina, and Sarastro—and here Klemperer's conception triumphs for me, Beethovenian overtones and all. Böhm chooses tempos that are invariably slower than Klemperer's—which are by no means fast. Furthermore, Böhm's pacing very often lacks a certain dramatic intensity that is so vividly present in Klemperer's handling of the Queen of the Night scenes, the opening trio of the Three Ladies, and the Quintet in Act II (No. 12). This stress on the underlying drama may not please everyone, and Böhm's mellower, more jovial view of this intriguing opera should find many partisans.

Chorus, orchestra, and the individual performers I have not discussed in detail are all above reproach. There is good separation of voices and a lively approximation of a stage layout in the stereo scheme. The sound, however, is rather low-level, and not particularly wide-ranging in dynamics. To recapitulate: this is a first-class performance. For me, however, Klemperer and Lucia Popp for Angel remain powerful attractions. G. J.

© MOZART: *Symphonies: No. 40, in G Minor (K. 550); No. 41, in C Major ("Jupiter," K. 551)*. Philharmonia Orchestra, Otto Klemperer cond. ANGEL S 36183 \$5.98, 36183* \$4.98.

Performance: Broadly classic

Recording: Good

Stereo Quality: Excellent

Since recording these two symphonies in 1957 and 1955, respectively, Klemperer has changed his views somewhat regarding tempos and dynamics, not to speak of the matter of repeats. The older recordings observed repeats of the expositions of both the first movement of the G Minor and the last movement of the "Jupiter," but they were also generally faster in tempos and tauter in phrasing than these new versions. This is more immediately evident in the "Jupiter" (first and minuet movements) than in the G Minor, though in the latter one is struck by the much sharper dynamic contrasts adopted by Klemperer in his 1957 recording.

Regardless of these differences of interpretation, the present performances will stand as a "last will and testament" so far as Klemperer's views on the symphonic Mozart go. While I prefer his somewhat more dramatic earlier approach to the G Minor, I do find the new and broader version of the "Jupiter" an improvement over the rather hectic 1955 treatment. Recorded sound is first-rate all the way. D. H.

© PAGANINI: *Violin Concerto No. 2, in B Minor, Op. 7 ("La Campanella"); SAINT-SAËNS: Violin Concerto No. 1,*

in A Major, Op. 20. Ruggiero Ricci (violin); Cincinnati Symphony Orchestra, Max Rudolf cond. DECCA DL 710106 \$5.98; DL 10106 \$4.98.

Performance: Spirited

Recording: Crystal clear

Stereo Quality: Fine space illusion

This is Ricci's second time around with the Paganini B Minor Concerto, which he recorded some ten years ago for the London label (the performance is still available). I did not have that disc on hand for reference, but let it be said at once that the mettlesome thrust and brilliance of Ricci's technique and musicianship are very much in evidence everywhere in this new Decca disc.

In these days, when we tend to accept as commonplace even the most hair-raising musical acrobatics, it is extremely difficult for a performer to make some of the dazzling pyrotechnical repertoire of the nineteenth



CAPITOL RECORDS

Fritz Wunderlich

Just about ideal as Tamino

century sound fresh and contemporary without at the same time compromising its older musical style. In the case of Paganini, the Italian operatic and folk-popular song style of his time serves as a durable matrix that keeps the music from dating, regardless of the pall of repetition. Ricci seems to have sensed all this in his realization of the B Minor Violin Concerto, both in the older London disc and on this new recording for Decca.

I will be frank to say that the unerring intonation of a Heifetz is not Ricci's, but he is reasonably close to the mark in those areas which Paganini's contemporaries agreed would "faze the Devil himself." What is more important is the sense of belief in the music that Ricci conveys, in an age of essential *unbelief* in such romantic fairytales. He is ably backed by Max Rudolf and his Cincinnati players with the splendidly bright acoustics of that city's Music Hall.

In the Saint-Saëns Violin Concerto No. 1 (also called *Konzertstück*) Ricci has a tougher row to hoe stylistically, for there is none of the folklike spirit of Paganini's Italianate background to fall back on. Saint-Saëns was not yet twenty-five when he composed this Liszt-influenced one-movement

(Continued on page 82)

Scott / The New Technology

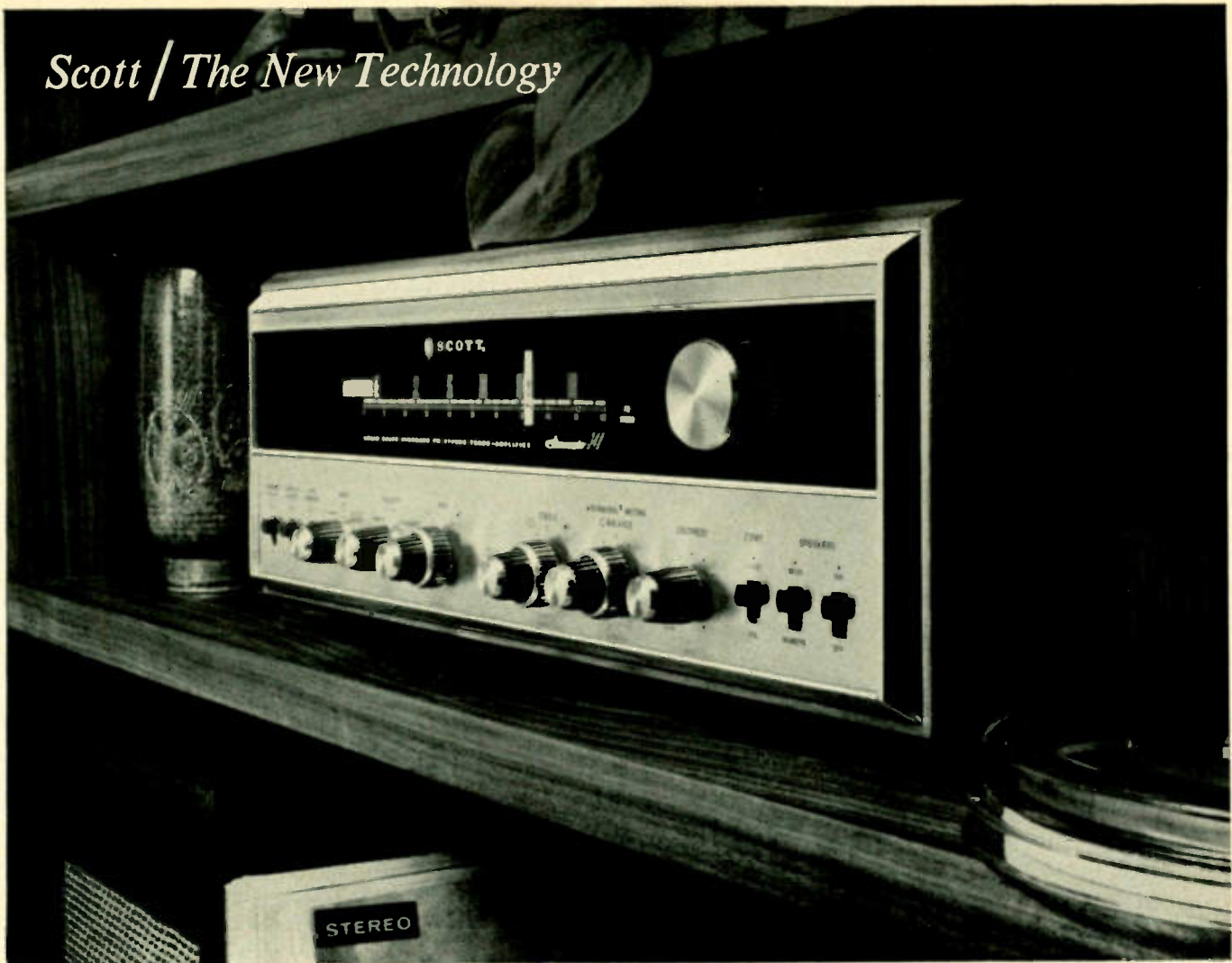

At last! A powerful solid state receiver designed expressly for knowledgeable audiophiles

Scott's new 348 tuner/amplifier is *not* designed for the Mrs. . . . or for the kids. It's *not* a simplified combination unit. This compact receiver is designed expressly for the man who wants a top-end high fidelity tuner, a powerhouse amplifier, and a pre-amp with a really complete set of controls . . . yet still wants all this in one compact unit.

The 348 is a unique piece of high fidelity gear. Scott engineers have loaded it with every feature and control in the book . . . and in hi fi engineering, Scott wrote the book. It packs a powerful 100-watt punch . . . yet it fits in a *standard* 12" bookcase!

You won't find *any* output or driver transformers in the 348. Scott's advanced design has done away with these bulky distortion-inducing power-wasters.

New 348 has everything, even a sink!

The direct-coupled output circuitry of the 348 utilizes silicon transistors mounted on military-type heat sinks . . . more costly, but resulting in dramatically improved tran-

sient response, more instantaneous power for music peaks and cooler, trouble-free operation.

Every control feature you'll ever need is included in the 348: adjustable Dynaural interstation muting control; five-position input switch; seven-position stereo selector switch; dual bass control; dual treble control; balance control; loudness control; compensation switch; main/remote speaker selector; three-level phono sensitivity switch; flywheel tuning control; rumble filter; seratch filter; and tape monitor.

In addition, the 348 gives you a wider range of inputs and outputs than you'll find on most separate units: a switched front panel stereo headphone output; tape head, phono, and extra inputs for both left and right channels, two Tape In jacks; two Tape

Out jacks; and two AC outlets, one of which is switched.

The new Scott 348 is *not* inexpensive. Yet at \$479.95 it represents one of the best high fidelity bargains ever produced. It is superior in performance and features to the most expensive separate preamps, power amplifiers and FM stereo tuners on the market . . . and if you've added prices lately, you know you can't come anywhere near the performance of the 348 unless you spend more than \$800 on separate units.

SPECIFICATIONS: Usable sensitivity (IHF), 1.9 μ V; Harmonic distortion, 0.8%; Capture ratio, 2 db; Selectivity, 45 db; Cross modulation rejection, 80 db; Separation, 40 db; Music power per channel (at 4 ohms load), 50 watts; Steady state power per channel (at 4 ohms), 37.5 watts; Frequency response (1.0 db), 15-30,000; Hum and noise, -80 db.

Dimensions: In accessory case: front panel, 5½" x 17½"; from front foot to back of heat sink, 10½".



SCOTT

H. H. SCOTT, INC., 111 POWDERMILL ROAD, MAYNARD, MASS.

Export: Scott International, Maynard, Mass. Cable HIFI. Prices slightly higher west of Rockies. Price and specifications subject to change without notice.

AUGUST 1965

CIRCLE NO. 100 ON READER SERVICE CARD

FOR STORES "WHERE YOU CAN BUY"—SEE LAST PAGE.

79



To be sure, get brand-name tape

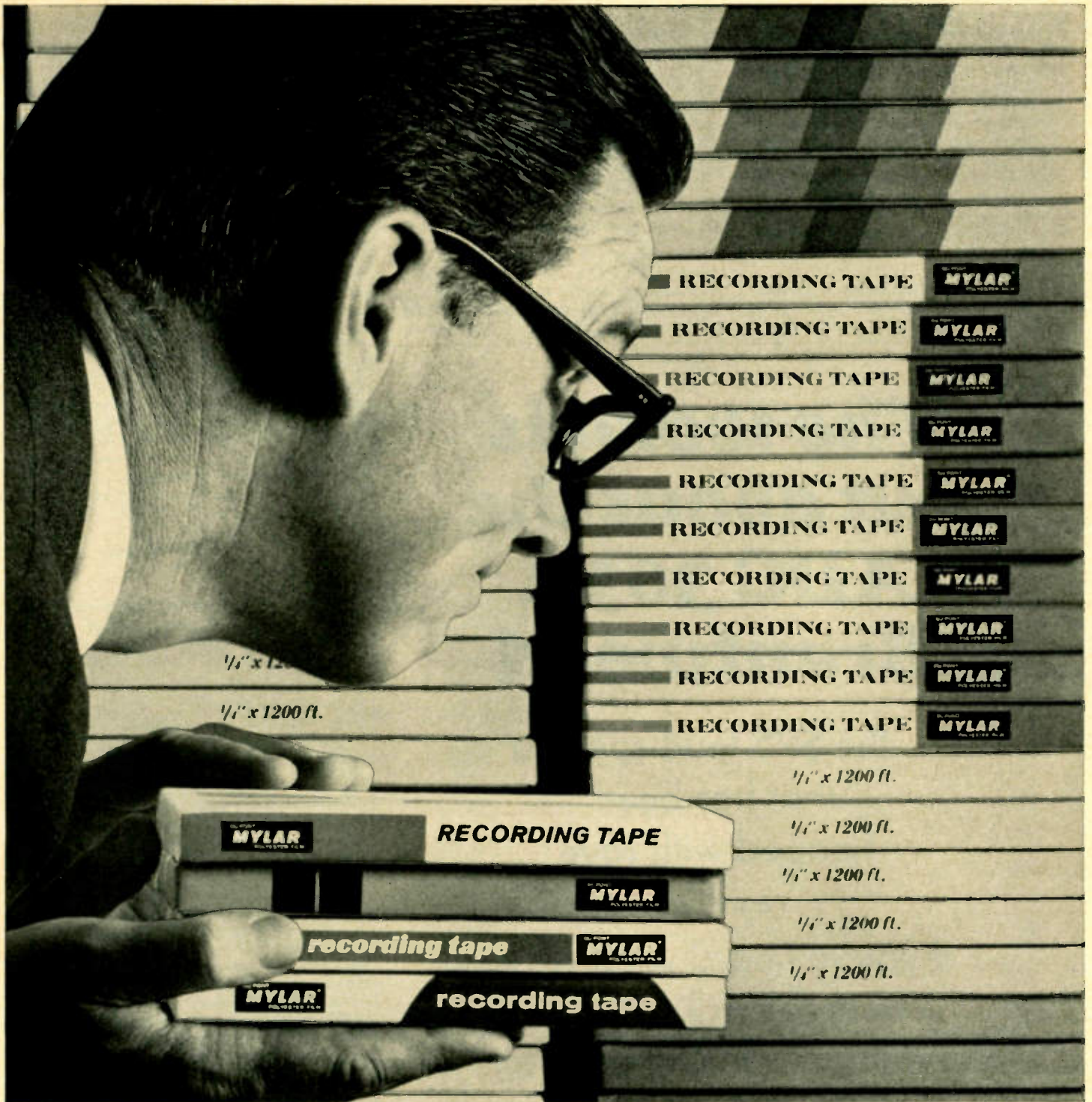

that says MYLAR® on the box...

There's an easy way to be sure that the tape you buy is worth all the time, money and effort you put into recording. Just look for brand-name tapes, and make certain they're on a base of Du Pont MYLAR*.

Less-than-perfect tape is sold unbranded, at a price reflecting its lower quality. But tape that meets the highest standards always displays the manufacturer's trademark. Most of these national brand-name tapes are available on a base of MYLAR.

For good reasons.

Brittleproof MYLAR can't dry out—it's protected

against time, moisture and temperature. It can be stored almost anywhere without fear of deterioration. Year after year. And super-strong MYLAR can't split or stretch under normal use.

So if you care at all about your recordings, look for the tape manufacturer's brand name . . . his guarantee of first-rate quality. And insist on the reliable tape base that will assure your valuable recordings the protection they deserve. Play it safe. Be sure with MYLAR.



*DU PONT'S REGISTERED TRADEMARK FOR ITS POLYESTER FILM.

piece in 1859 (it was first performed a half-dozen years later by Sarasate). He had not yet developed the irony-*cum*-antiquarianism that was to be the hallmark of his mature style. There is plenty of glitter in the ten-minute span of this music; but there is precious little character. It is a kind of anonymous music comparable on the one hand to the innumerable concerti grossi of seventeenth- and eighteenth-century composers whose works are now being resurrected by the dozens to satisfy the current craze for the Baroque—or, on the other, to the hundreds of post-Webern contemporary works being composed and given first-and-last performances everywhere.

The handicap in this instance is the composer's, not the performer's. Ricci gives everything there is to be given to Saint-

Saëns' music; but there is little question that the versatile French master was doing far better as a creative artist a decade and more later. *D. H.*

Ⓢ Ⓜ RACHMANINOFF: *Piano Concertos: No. 1, in F Minor; No. 4, in G Minor*. Leonard Pennario (piano); Royal Philharmonic, André Previn cond. RCA VICTOR LSC 2788 \$5.98, LM 2788 \$4.98.

Performance: *Simpatico*
Recording: *Excellent*
Stereo Quality: *Excellent*

Messrs. Previn and Pennario seem to have a penchant for this music. I have something of a penchant for the Fourth Concerto myself (it isn't fashionable to admit this these days). It flows like so much excessively

smooth liqueur, and its tunes are far more distinguished than they are generally given credit for being—the more schmaltzy and popular Second Concerto seems like the work of a self-indulgent schoolboy by comparison. The First Concerto is, on the other hand, Rachmaninoff breaking free of immediate influences, and it tends to be predictable in structure.

But to revert to the Pennario-Previn performance of the Fourth: these two are clearly not out to chasten the music, but they step it along at a brisk, unsentimental pace—taking, I assume, the sensible attitude that the music will express its luxurious sentiments without extra help from them. The playing is virile, contemporary, wide-eyed, and alive. In fact, the buoyancy of the work here makes comparisons with other recorded versions *de trop*. Though Michelangeli's recording of the Fourth (Angel S 35567) probes more deeply into the music and is generally more mature, it lacks some of the flair and fun we get from Pennario and Previn; on the other hand, from any point of view, Pennario has the souped-up and eccentric reading by Entremont beat by a country mile.

The recorded sound is lavish, and the stereo treatment is nicely managed. *W. F.*

RACHMANINOFF: *Vocalise* (see CANTELOUBE)

Ⓢ Ⓜ ROSSINI-RESPIGHI: *La Boutique fantasque; Rossiniana*. Orchestra of the Vienna Festival, Antonio Janigro cond. VANGUARD VSD 71127 \$5.95, VRS 1127 \$4.98.

Performance: *Balletic*
Recording: *Spacious and detailed*
Stereo Quality: *Excellent*

Hybrids of this sort are either to your taste or not, and I do not intend to lecture on the subject here. *La Boutique fantasque*—Rossini as orchestrated in Respighi's rather trashy but virtuosic twentieth-century manner—is fine enough in the pit at the ballet. Heard for itself, it is pleasant music to converse by.

Rossiniana, according to S. W. Bennett's liner notes, is "a free arrangement taken from the album of piano pieces called 'Les Riens' or 'mere nothings.'" Rossini was right about the pieces, I think, and Respighi's orchestration is contemporary frosting on a somewhat fallen cake. Like *Boutique*, *Rossiniana* is diverting music if one listens with half an ear. But it just might be that there is enough of the real McCoy around to preclude attention to these transcriptions.

The performances are studiously "vivacious"—after the manner called for—but the instrumental virtuosity for its own sake that might set their ears atwitter is not the *métier* of the Orchestra of the Vienna Festival.

The recorded sound is good. *W. F.*

SAINT-SAËNS: *Violin Concerto No. 1, in A Major, Op. 20* (see PAGANINI)

RECORDING OF SPECIAL MERIT

Ⓢ Ⓜ SCHUBERT: *Trio No. 1, in B-flat, Op. 99*. Eugene Istomin (piano), Isaac Stern (violin), Leonard Rose (cello). COLUMBIA MS 6716 \$5.98, ML 6116 \$4.98.

Performance: *Immensely vital*
Recording: *Fine presence*
Stereo Quality: *Lifelike*

The word is out about the ADC 303A Brentwood

...the \$95 loud-speaker that has been heaped with rave reviews.

If you've heard what we've heard, you'll ask your dealer about it right away.



Audio Dynamics Corp.
Pickett District Rd., New Milford, Conn.



Beginning with the legendary Cortot-Thibaud-Casals performance (Angel COLH 12) of the 1920's, there has been hardly a time when the active catalog has not had at least two or three first-rate versions of the Schubert B-flat Trio. Those of Rubinstein-Heifetz-Feuermann and of Istomin-Schneider-Casals come most particularly to mind.

This newest recording of one of the most ingratiating of all chamber-music works can hold its own very well in such company; it offers a delightful combination of youthful bounce and nostalgic sentiment—which is really what this music is all about. For its elegant and vital playing, and first-rate recorded sound I recommend this release to any collector. D. H.

RECORDING OF SPECIAL MERIT

Ⓢ Ⓜ SCHUMANN: *Dichterliebe*, Op. 48; *Kerner Lieder*, Op. 35; *Liederkreis*, Op. 39. Hermann Prey (baritone), Karl Engel (piano). Vox SLDL 5562 two 12-inch discs \$9.96, LDL 562* \$9.96.

Performance: Warm and impassioned
Recording: Excellent
Stereo Quality: Appropriate

The year he married Clara Wieck—1840—was Robert Schumann's "year of song." In a burst of unparalleled activity he created musical settings for more than one hundred poems—a production made even more remarkable by the fact that prior to 1840 he had thought very little of the song as a musical form. No Schumann biography omits mention of the "year of song," but the output of that singular year is seldom given detailed attention. Suddenly, in this Vox album, one is faced with forty of the 1840 songs—less than half of that year's miraculous total and nearly all of them masterpieces—and the mind is staggered by the magnitude of Schumann's achievement and by the wealth of his inspiration.

Dichterliebe, in which Schumann's music is the ideal complement to Heinrich Heine's acid-tinged lyricism, is justifiably the best known of the three cycles. Some of the greatest recitalists—tenors as well as baritones—have recorded it, and Hermann Prey's performance ranks with the best of them. There is a youthful, at times impulsive, air about his approach, but the interpretive range he commands is that of a mature artist. His soft tones are full of warmth and tenderness, but he can achieve a total change by darkening his timbre to strike the quality of weighty solemnity in "*Im Rhein, im heiligen Strome*" or of massive despair in "*Die alten, bösen Lieder*." For me, one of the special highlights of this cycle is "*Ein Jüngling liebt ein Mädchen*," where Prey and his excellent accompanist go all out in their emphasis on the music's mock gaiety to make the impact of the final, heart-breaking line most effective. And "*Ich grölle nicht*," the focal song in the cycle, gets a performance of shattering strength—in the original key of C, with a brilliant high A at its climax.

Prey is an intensely passionate singer, occasionally given to explosive delivery. In his *Dichterliebe*, these instances are infrequent, but there are times in the *Kerner Lieder* when his tone suffers as a result of an emotional overload. Aside from these moments, Prey's singing is consistently expressive and appealing. A sense of sadness and resignation pervades most of the twelve songs Schumann

composed to poems by Justinus Kerner (1786-1862). Of these songs, *Wanderlust*, *Erstes Grün*, and *Frage* are near the level of inspiration Schumann consistently maintained in *Dichterliebe*.

Although *Liederkreis*, Op. 39 (for which poems of Joseph von Eichendorff were the source of inspiration) has had at least six complete microgroove recordings over the years, all seem to have vanished from the domestic catalogs, leaving the field free for this excellent new version. These ardent songs also find admirable expression in Prey's caressing lyricism, his convincingly youthful fervor, and his excellent sense of drama.

Karl Engel is the skilled and responsive accompanist and the recorded sound is warm and spacious, with a fine balance and resonant piano reproduction. Background notes and

full texts and translations complete this significant and praiseworthy presentation. *G. J.*

Ⓢ Ⓜ SCHUMANN: *Symphony No. 2*, in C Major, Op. 61; *Genoëva: Overture*, Op. 81. Berlin Philharmonic Orchestra, Rafael Kubelik cond. DEUTSCHE GRAMMOPHON SLPM 138955 \$5.98, LPM 18955* \$5.98.

Performance: Rather fussy
Recording: Splendid
Stereo Quality: Fine

The heroic and romantic aspects of Schumann's special genius reached their fullest orchestral realization in the C Major Symphony, despite the violent contrasts between the magnificently controlled introductory pages of the first movement and their breath-



VANGUARD EVERYMAN CLASSICS

\$1.98 for both mono and stereo
presents one of the most distinguished series of orchestral recordings at any price, featuring
SIR JOHN BARBIROLI
conducting the Hallé Orchestra
New Releases

DEBUSSY: La Mer
RAVEL: Daphnis et Chloe, Suite No. 2
La Valse SRV-177 & *SRV-177SD
"A winner if ever there was one—at any price, Barbirolli gives a marvellous performance of *La Mer*, the Hallé plays superbly." *The Gramophone, London*
NIELSEN: Symphony No. 4, Op. 29, "The Inextinguishable" SRV-179 & *SRV-179SD
Making available to collectors a modern classic, which joins Barbirolli's now famous Vanguard Everyman recordings of Vaughan Williams and Sibelius symphonies.

Sir John Barbirolli and the Hallé Orchestra on Vanguard Everyman Classics

VAUGHAN WILLIAMS: A London Symphony SRV-134 & *SRV-134SD
"One of the best records of the year... glowing performance." *David Hall, HiFi/Stereo*
SIBELIUS: Symphony No. 5 & Pohjola's Daughter SRV-137 & *SRV-137SD
"Noble, eloquent, beautifully proportioned readings." *Alan Rich, High Fidelity*
SIBELIUS: Symphony No. 1 in E minor SRV-132 & *SRV-132SD
"As handsome a presentation of this popular and frequently misused work as I have ever heard on records." *Jack Dieher, American Record Guide*
BEETHOVEN: Piano Concerto No. 5 in E flat, "Emperor" (with Mindru Katz, piano) SRV-138 & *SRV-138SD
"Here is an *Emperor* to share first place with Rubinstein/Leinsdorf, Fleisner/Szell and Schnabel/Sargent." *H. Goldsmith, High Fidelity*
BEETHOVEN: Symphony No. 1 in C major, Symphony No. 8 in F major SRV-146 & *SRV-146SD
"The more we hear of Sir John Barbirolli, the stronger the advice becomes: Don't hesitate to buy anything under his name." *H. Schaden, Washington Star*
TCHAIKOWSKY: Symphony No. 6 in B minor, "Pathétique" SRV-148 & *SRV-148SD
"A great conception of the score." *David Hall, HiFi/Stereo*
TCHAIKOWSKI: Symphony No. 5 & March Slav SRV-139 & *SRV-139SD
TCHAIKOWSKY: Symphony No. 4 in F minor SRV-135 & *SRV-135SD
DVORAK: Symphony No. 4 in G & Scherzo Capriccioso SRV-133 & *SRV-133SD
BRAHMS: Double Concerto in A minor, Op. 102 (with Campoli, violin; Navarra, cello) SRV-136 & *SRV-136SD
"Barbirolli's interpretations of the Dvorak 4th, Tchaikowsky 4th, Brahms Double Concerto, take precedence over all others... One of the giants among contemporary conductors." *M. Bookspan, HiFi/Stereo*
BARBIROLI CONDUCTS WAGNER SRV-149 & *SRV-149SD
*Stereo



Critics' Accolade for Vanguard Everyman Classics

The Griller Quartet with William Primrose, viola
MOZART: Quintet in C major, K. 515; Quintet in G minor, K. 516

SRV-158 & *SRV-158SD
"The performance of the C major is absolutely first-class from every point of view." *N. Broder, High Fidelity*

"This rendition of the G minor is one of the most moving I have ever heard on records." *I. Kipnis, HiFi Stereo*
Denise Matthews, piano & Hans Swarowsky, conductor

MOZART: Piano Concerto in D minor, K. 466; Piano Concerto in C minor, K. 491

SRV-142 & *SRV-142SD
"Outstanding performances of these favorite pieces by an English pianist whose style combines strength with poetry." *Washington Star*

The Deller Consort
MADRIGALS OF MORLEY AND WILBYE

SRV-157 & *SRV-157SD
"Authoritative performances which should attract many new friends to this wonderful literature." *J. W. Barker, American Record Guide*

The Deller Consort
ALBUM OF BELOVED SONGS

SRV-141 & *SRV-141SD
"Delicacy, refined taste and buoyancy... brings new light to old favorites... The album is a buy at \$1.98." *Howard Klein, N.Y. Times*

Mario Rossi, conductor; Tommaso Boskovsky, violins
VIVALDI: L'Estro Armonico, Op. 3 — complete 3 discs in album

SRV-143/5 & *SRV-143/5SD
"His soloists are excellent and he is given magnificent recording... highly recommended." *N. Broder, High Fidelity*

Mogens Woldike conducts
Haydn's 6 last symphonies
HAYDN: Symphony No. 99 in E flat; Symphony No. 102 in B flat

SRV-129 & *SRV-129SD
HAYDN: Symphony No. 100 in E flat, "Drum Roll"; Symphony No. 104 in D, "London" SRV-166 & *SRV-166SD
HAYDN: Symphony No. 100 in G, "Military"; Symphony No. 101 in D, "Clock"

SRV-109 & *SRV-109SD
"This wonderful disc contains the best performance of each symphony now available on records." *J. F. Indox, High Fidelity*





FM station directory... covers FM stations in U. S. and Canada. Factual equipment test reports. Test reports on tuners, preamps, poweramp/preamps. Find out what the experts think. A complete 36 page catalog tells about tuners, power amplifiers, preamplifiers, preamp/power amp combinations, and tuner preamp.

ALL FREE

JUST WRITE TO:

McIntosh

McIntosh Laboratory Inc.
1 Chambers Street
Binghamton, N. Y. 13903

Yes, I would like your
36 page catalog.

NAME _____
STREET _____
CITY _____
STATE _____ ZIP _____

CIRCLE NO. 38 ON READER SERVICE CARD
84

less sequel. George Szell (Epic) and Paul Paray (on a temporarily unavailable Mercury recording) seem to be among the few who have taken account of this in their interpretations of the work. Since I would have expected no less from Rafael Kubelik, it is a surprise to find his reading of the score surprisingly fussy and lacking the broad line that should inform the work as a whole. Similarly, I miss in his reading of the lovely *Genoveva* Overture the sheer exuberance and unspoiled romanticism that Leonard Bernstein brought to his performance for Columbia (as a filler for the "Spring" Symphony).

The playing of the Berlin Philharmonic is altogether splendid, as is the recorded sound. *D. H.*

© ① SHOSTAKOVICH: *Sonata for Cello and Piano*. STRAUSS: *Sonata for Cello and Piano, in F Major, Op. 6*. Harvey Shapiro (cello), Jascha Zayde (piano). NONESUCH H 71050 \$2.50, H 1050 \$2.50.

Performance: Musicianly
Recording: Vivid and bright
Stereo Quality: Okay

Shostakovich's *Sonata for Cello and Piano, Op. 40*, dates from the middle Forties, the time of the Soviet composer's head-on collision with Stalinism over his opera *Lady Macbeth of the Minsk District*. As sleeve annotator James Lyons points out, the *Sonata* "may be considered the last work that Shostakovich ever composed as a free man—an assumption which, on the face of it, lends a special interest to it."

But "suffused with secrets" though Lyons claims the work to be, I personally find it less provocative than many of the works that followed the composer's musico-political brainwashing. Many of the later chamber works do indeed contain the "secrets" of a man trying to communicate through a veil of authoritarian censorship of creativity. But this Last Free Work seems rife with the shortcomings that we recognize now as characteristic of much of Shostakovich's work: a slack, square rhythmic plan; an all-too-easy flow of pleasant but undistinguished melody; and a tendency to make heavy-handed jokes about music—in no way lightened in this case by Shapiro's and Zayde's laborious way of spelling them out. In general, both musicians, though secure and musical, let the work run its slack course without the pinch of dynamic rhythmic articulation that might get it off the ground.

The Strauss piece is conservatory Schumann and Brahms, worked out with the student skill (he wrote it at eighteen) of the master composer to be. For me, at least, it seems worth about a single, attentive listening. It is nicely and cleanly played.

The recorded sound is rich, but the stereo treatment may be spread a little wide for the instrumental combination. *W. F.*

STRAUSS: *Sonata for Cello and Piano, Op. 6* (see SHOSTAKOVICH)

© ① TCHAIKOVSKY: *Symphony No. 3, in D Major, Op. 29 ("Polish")*. Vienna Philharmonic Orchestra, Lorin Maazel cond. LONDON CS 6428 \$5.98, CM 9428* \$4.98.

Performance: Brilliant
Recording: Good, but has hum
Stereo Quality: Good

There is as sharp a break in style between Tchaikovsky's first three and last three symphonies as between Beethoven's first two and those that followed. The so-called "Polish" Symphony is the most striking case in point—one almost wonders why he did not call it a suite instead of a symphony. Incidentally, the fact that its last movement is in polonaise rhythm accounts for the nickname "Polish."

At any rate, what we have here is a sequence of five brilliantly scored movements, in Tchaikovsky's ballet-music style. It is brilliantly played and powerfully recorded under Maazel's dynamic direction. The recorded sound is most impressive, except for an annoying low-frequency hum. I have noticed this distraction not only on this disc, but in certain of London's Suisse Romande Orchestra recordings. *D. H.*

TCHAIKOVSKY: *Rococo Variations for Cello and Orchestra* (see DVORÁK)



DEUTSCHE GRAMMOPHON

LORIN MAAZEL

Dynamism for Tchaikovsky's Third

© ① TELEMANN: *The Passion of Jesus According to St. Mark*. Agnes Giebel (soprano); Ira Malaniuk (contralto); Heinz Rehfuß (baritone), Evangelist; Horst Günther (baritone), Jesus; Theo Altmeyer (tenor); Leonel Rogg (organ); Leonard Hokanson (harpsichord); Children's Choir of Lausanne; Pro Arte Orchestra of Munich, Kurt Redel cond. PHILIPS PHS 29 30 two 12-inch discs \$11.96, PHM 25 30* \$9.96.

Performance: Very impressive
Recording: Excellent
Stereo Quality: First rate

The obvious comparison of Telemann's treatment of the Passion with Bach's is not likely to leave much room for Telemann. Yet, in terms of period taste, the conclusion is not entirely fair. In contrast to Bach, who relied heavily on the older contrapuntal treatment, Telemann, for his particular time, was being far more up-to-date. His chorales, for example, are more homophonic, his arias more characteristically *galant*; the entire style of writing is simpler and more accessible. Bach's Leipzig congregation would undoubtedly have preferred Telemann, and, taken entirely on its own, away from the shadow of the two great Bach Passions, his Passion is quite an impressive work. The personal spirituality is there in *(Continued on page 86)*

MORE CLASSICAL REVIEWS

★ IN BRIEF ★

DATA

⑤ ⑥ BEETHOVEN: *Symphonies: No. 1, in C Major, Op. 21; No. 8, in F Major, Op. 93*. Suisse Romande Orchestra, Ernest Ansermet cond. LONDON CS 6388 \$5.98, CM 9388* \$4.98.

⑤ ⑥ BERLIOZ: *Symphonie fantastique, Op. 14a*. Philharmonia Orchestra, Otto Klemperer cond. ANGEL S36196 \$5.98, 36196 \$4.98.

⑤ ⑥ CHOPIN: *Scherzos: B Minor, Op. 20; B-flat Minor, Op. 31; C-sharp Minor, Op. 39; E Major, Op. 54*. Tamás Vásáry (piano). DEUTSCHE GRAMMOPHON SLPEM 136451 \$5.98, LPEM 19451* \$5.98.

⑤ ⑥ MONTEVERDI: *Madrigals: Lamento d'Avianna; Lagrime d'Amante al Sepolcro dell'Amata; Ecco Silvio*. Nuovo Madrigaletto Italiano, Emilio Giani cond. NONESUCH H 71021 \$2.50, H 1021* \$2.50.

⑤ ⑥ PONCE: *Sonata Romántica*. CASTELNUOVO-TEDESCO: *Second Series from Platero and I*. Andrés Segovia (guitar). DECCA DL 710093 \$5.98, DL 10093 \$4.98.

⑤ ⑥ WALTON: *Façade—an Entertainment with Poems by Edith Sitwell*. Hermione Gingold (reader), Russell Oberlin (tenor); instrumental group. DECCA DL 710097 \$5.98, DL 10097* \$4.98.

COMMENTARY

In these first-rate performances of two of the most enjoyable Beethoven symphonies, Ansermet favors moderate tempos and firmly etched phrases. A choice between this disc and Monteux's with the Vienna Philharmonic on RCA Victor is all but impossible to make. This is, incidentally, a reissue from Ansermet's complete set of the symphonies recorded for London several years ago. *D. H.*

In general, events proceed at a rather slow pace throughout this recording. Yet Klemperer does achieve a fine effect of monolithic power as the music approaches the final statement of the *Dies irae* motive in the *Witches' Sabbath* movement. The recording is lacking in presence. *D. H.*

As applied to the Chopin scherzos, Vásáry's lyrical refinement and agile fingerwork do not make for truly convincing or stirring performances—save for the predominantly lyrical E Major work. These pieces abound in dynamic and rhythmic contrasts, and Arthur Rubinstein on RCA Victor best mines these riches. Good sound here. *D. H.*

These works are meant to be sung with intense expression, something these performers do not seem to understand. Even more serious is the singers' problem of intonation. Notes and Italian texts. *I. K.*

Ponce's *Sonata Romántica* (1929) bears the subtitle *Hommage à Fr. Schubert qui aimait la guitare*. It is a lovingly and skillfully conceived compendium of Schubertian melodies, moods, and mannerisms. The *Platero and I* selections are brief evocative pieces keyed to the book by Juan Ramón Jiménez. Both works are dedicated to Segovia, who performs with authority. The recorded sound is rich and clear. *G. J.*

This recording of *Façade* seems to be the work of a demented Hollywood casting director. The late Miss Sitwell's poems are read here by Miss Gingold, the wicked witch of the Jack Paar TV show, who seems to regard them as a kind of chic pop-art joke. Russell Oberlin's rock-solid musicianship brings a certain distinction to the work, but his performance is totally lacking in humor. *W. F.*

SELECT THE FINEST IN AUDIO PRODUCTS



for quality recording

D-810 This new microphone excels in clarity and intelligibility for recording both speech and music. It includes a Lavalier accessory which extends its usefulness—while accentuating mid-range frequencies. Also equipped with a stand adaptor, and silent on-off switch to compliment its flexibility in use as a public address microphone.



and listening pleasure

K-50 Here is a top-rated headphone set, providing excellent reproduction of stereo and monaural recordings and broadcasts. This superb headset compares favorably with well designed speaker systems by capturing every nuance and intensity of the original sound source.

Send for information and specification sheets today!

MADE IN VIENNA BY AKG GMBH



NORTH AMERICAN PHILIPS COMPANY, INC.
Professional Products Division, 100 East 42nd St., New York, N. Y. 10017

CIRCLE NO. 45 ON READER SERVICE CARD



New Addition to the Recordings of Rubinstein

Each performance by Artur Rubinstein adds to the legend which has grown up about his name, and the performances recorded in his new album of Beethoven Sonatas are no exception. Here are two "firsts"—his first recording of the Sonata in C and his first stereophonic recording of the "Appassionata." The freshness of interpretation and the over-all quality of this album are characteristic of every Rubinstein performance. The recording, in RCA Victor's Dynagroove sound, is all a perfectionist such as Rubinstein could want. As a result, this new album should take its place beside the prize-winning "French Program" which was released last fall. Add both of these distinguished RCA Victor Red Seal albums to your library of great piano works soon.



RCA Victor
TRADE MARK
 The most trusted name in sound
 CIRCLE NO. 68 ON READER SERVICE CARD

abundance, though it lacks the agonized effects of the Leipzig cantor's harmonic and rhythmic devices. The style is also dramatic, especially as the story unfolds. I felt disappointed at first, but was gradually more and more taken with Telemann's conciseness and his particular way of creating tension and repose. Particularly effective—and again to be considered independently of Bach's treatment—is Telemann's tonal painting, for example in No. 25, an aria in which Jesus is compared to a lamb about to be shorn. Kurt Redel, who resurrected and edited this work (it was composed in 1759 and is one of forty-four Telemann Passions), has done a spectacular job of bringing it to life. The pacing is excellent, and both the orchestral playing and choral singing are splendid. The vocal soloists are all satisfactory; however, Rehfuss (the Evangelist) has more than a bit of trouble reaching his high notes, and Günter suffers in comparison with more mellifluous Christs, such as, say, Fischer-Dieskau. Nevertheless, both singers convey the drama most effectively, and the recording, well spaced for stereo, is quite admirable. Notes, German texts, and English synopses are included.

I. K.

VILLA-LOBOS: *Bachianas Brasileiras No. 5* (see CANTELOUBE)

COLLECTIONS

© MARIO DEL MONACO: *Italian and German Arias*. Leoncavallo: *La Bohème: Testa adorata*. Cilea: *L'Arlesiana: È la solita storia*. Mascagni: *Isabeau: Tu ch'odi lo mio grido; O popolo di vili*. Zandonai: *Frauccesa da Rimini: Inghirlandata di violette*. Puccini: *Gianni Schicchi: Firenze è come un albero fiorito*. Wagner: *Die Walküre: Ein Schwert verbiess mir der Vater; Winterstürme; Siegmund heisst ich. Lobengrin: In fernem Land*. Mario del Monaco (tenor); Lucilla Cipriano (soprano). Orchestra of L'Accademia di Santa Cecilia, Rome, Carlo Franci cond. LONDON OS 25894 \$5.95, 5894* \$4.98.

Performance: Disappointing
 Recording: Erratic
 Stereo Quality: Adequate

The gushing, fan-club-style jacket commentary notwithstanding, this is a regrettable release. Far from presenting the prodigiously gifted tenor "in full flower," it rather suggests either a serious deterioration of his vocal resources or a temporary period of indisposition.

The Italian side of the disc offers several unusual selections from the *verismo* period, in which we can intermittently hear those solid, bronze-like tones and the virile, stirring delivery that characterized the Del Monaco of ten or even five years ago. But there is just too much harshness in his tone production and too little control over his present resources to make his performance consistently enjoyable. The effective but melodically undernourished music of *Isabeau* fails to get the lyric infusion Gigli was able to impart to it in his earlier recordings, and not even in his full flower did Del Monaco possess the mellowness and warmth needed for the Cilea and Puccini excerpts.

Del Monaco's attempts with Wagner are certainly respectable. At this point, there is still the matter of language to consider—words and phrases, which are always mean-

ingly conveyed in his Italian renditions, do not emerge with a natural expression in German. Beyond this obvious handicap, one must note the absence of a real legato line, which automatically disqualifies his Lohengrin. Nevertheless, these efforts are not to be taken lightly. His sound, even on this disc, has a basic rightness not only for Siegmund but also for Siegfried and Tristan. If Del Monaco is willing to make the transformation, he may yet rejuvenate his career in these roles.

But is he really interested? And is the record company with which he is connected willing to assist him in this aim? If so, another program, better prepared, will some day tell a different story. Then, let us hope, the artist will have the assistance of someone like Knappertsbusch on the podium, and someone above the semi-professional level of Miss Cipriano to sing duets with. It goes without saying that such a future recital should also be enhanced with the best sound London is able to produce, not the indistinct, unevenly balanced mélange heard here.

G. J.

VLADIMIR HOROWITZ: *At Carnegie Hall* (see Best of the Month, page 61)

© SHIRLEY VERRETT. Falla: *Seven Popular Spanish Songs*. Nin: *Minué cantado; Paño murciano; Montañesa; Corazón que en prisión*. Granados: *La maja dolorosa; El mirar de la maja*. Obradors: *Del cabello mas sutil; El vito*. Monsalvatge: *Canción de cuna para dormir a un negrito*. Turina: *Farruca*. Shirley Verrett (mezzo-soprano); Charles Wadsworth (piano). RCA VICTOR LSC 2776 \$5.98, LM 2776* \$4.98.

Performance: Impressive
 Recording: Good
 Stereo Quality: Centered

Shirley Verrett will be heard in many recordings this year, according to advance reports, and this upsurge of her career seems amply justified. With youth, voice, looks, and temperament going for her, hers may become the big success story of 1965.

In the present program devoted to Spanish song literature, Miss Verrett shows not only a fine linguistic command but also a true affinity for the style. She commands a wide range of tone and dynamics for interpretive purposes, but wisely avoids the exaggerated emotionalism which many non-Spanish interpreters mistake for ethnic authenticity. Everything, in fact, is rendered here with a high degree of tasteful artistry, and in only one instance (in the haunting *Canción de cuna*) does her performance fall short of a consistently high level of technical polish. Her approach to Falla's *Seven Popular Spanish Songs* is relatively subdued, but the fire and abandon she displays in *El vito* or *Paño murciano* should dispel any lingering doubt about her temperament. The voice itself appears to be placed somewhere between the soprano and the mezzo range. It seems to lack a fully supported, rich contralto register, and there is a definite break between her high and low tones. But none of this causes problems here.

The difficult piano accompaniments are capably done, and balance is well maintained throughout. The overall sound, however, is somewhat lacking in warmth. Texts, translations, and informative notes by Walter Starkie complete the presentation.

G. J.

Once upon a time, there was a new
 kind of stereo amplifier.
 It's name was **IBL** Energizer.
IBL Energizer was very special.
 Goodness, how special.
IBL Energizer never got too warm,
 never made noises or hummed,
 didn't distort a thing and
 wasn't microphonic at all.
 Because **IBL** Energizer was
 all solid state and stayed so cool
 and stayed so quiet, it learned it
 could do what no other stereo
 amplifier could do.

It could hide.
 It could hide right inside a **IBL**
 loudspeaker box.



See the pretty
IBL
 Energizer?

Not if you
 don't want to.



Rear view of Lancer 99 showing Stereo Energizer.

Model SE401 80 Watt Solid State Stereo Energizer
 Replaces conventional stereo power amplifier; sets new standard
 of audio perfection. Unique plug-in equalizer board integrates with
 specific speaker system used. Non-microphonic. Effectively non-
 existent hum, noise or distortion. Factory installed in one loud-
 speaker enclosure. Also available separately or specially integrated
 and installed in your present speaker system.

JAMES B. LANSING SOUND, INC. 3249 Casitas Ave., Los Angeles California 90039 • Tel. 665-4101



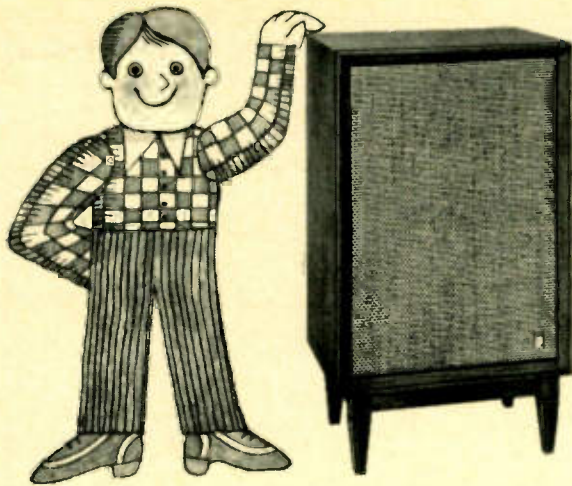

HI-BOY



LOW-BOY

OR SNUG ON A SHELF

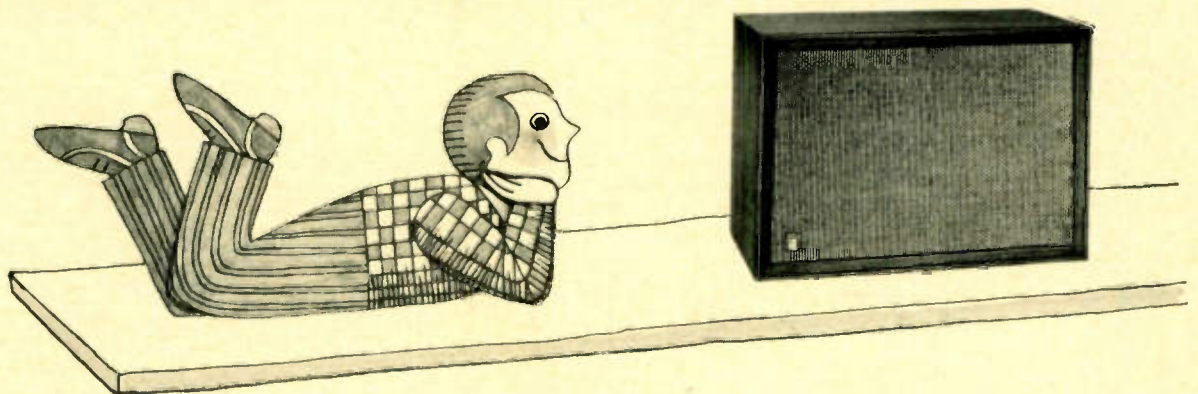

Jensen PR-300 Loudspeaker system combines decorative freedom with the fine, big sound you want from your hi-fi system.

Sophisticated and luxuriously styled, the PR-300, 3-speaker system with 12" woofer is as much at home in the richly urban manner of an in-town apartment or the casual informality of a country home.

The handsome oiled walnut cabinet is accompanied by a Mediterranean styled floor base. This unique accessory permits you to creatively arrange the PR-300 in either the Hi-Boy or Low-Boy positions. Without the floor stand your PR-300 fits snugly on a shelf. 25½" x 18¼" x 14⅞"—that's the size of it. \$225.50 that's the price of it. Jensen PR-300—that's the name of it. 5 year guarantee—that's the best of it. See and hear it at your local Hi-Fi dealer.



JENSEN MANUFACTURING DIVISION / THE MUTER COMPANY / 6601 SOUTH LARAMIE AVENUE, CHICAGO, ILLINOIS 60638
Canada: Radio Speakers of Canada, Ltd., Toronto • Argentina: Ucoa Radio, S.A., Buenos Aires • Mexico: Fapartel, S.A., Naucalpan, Mex.





HIFI/STEREO REVIEW'S CHOICE OF THE LATEST RECORDINGS

ENTERTAINMENT

POPS • JAZZ • FILMS • THEATER • FOLK • SPOKEN WORD

Reviewed by JOE GOLDBERG • NAT HENTOFF • PAUL KRESH • GENE LEES

RECORDING OF SPECIAL MERIT

© © THE BEATLES: *Beatles VI*. John Lennon, Paul McCartney, George Harrison (vocal and guitar), Ringo Starr (vocal and drums). *Eight Days a Week*; *Yes It Is: Bad Boy*; and eight others. CAPITOL ST 2358 \$4.98, T 2358 \$3.98.

Performance: **Happy**
Recording: **Echoed but good**
Stereo Quality: **Excellent**

I used to go with a girl whose face, frankly, was a puzzle. She had not one good feature. Her nose was crooked, her mouth was too big, her eyes were too far apart, the line of her jaw was somehow all wrong. But she was beautiful. Though I'd hardly call them beautiful, the Beatles are a little like that. Taken individually, the features of their performance are not all that good: Ringo's drumming is unskilled, if amiable; the guitar work is loud, ragged, and often whiny; and not one of the four has a voice worthy of the name. Yet, taken all in all, their work is undeniably attractive.

The Beatles' chief and best quality is their comic talent. They make me laugh inside. They're putting the world on so openly and with such high good spirits that there is a special delight to be had from watching this exuberant leg-pull. Perhaps it is because the Beatles unabashedly invite us to join in their laughter that so many adults have responded to them. They have an astonishing popularity within the music profession too. Tony Bennett says that their film, *A Hard Day's Night*, is a genuine art film. And Buddy Rich, who at first had to be dragged to it by friends, went back to see it five more times. I've yet to encounter a singer, musician, producer, or anyone else in the trade—and this includes not only jazz people but classical people—who dislikes them, or who is not charmed by their music.

The Beatles' latest album opens with *Kansas City*, a blues song by Paul McCartney. This track isn't a joke. It expresses an obvious admiration for American blues. I like it for its vigor and its sincerity. How "authentic" it is (not very, really) is a question that has no point in this context. Most of the rest of the album is made up of John Len-

non-Paul McCartney songs. As usual, the melodies are pretty good and the lyrics pretty bad. And there is the paradox: put the two together, and the results are marvelous.

Queen Elizabeth, who recently made the Beatles members of the Most Excellent Order of the British Empire, obviously has more sense than the *London Times*, which criticized her for it. It is all very well for people on this side of the Atlantic to snicker at

ens and Rolls-Royce engines ever could; and they've dispelled forever the image of an Englishman as a stuffy man of middle years with his eyes fixed forever on the past. And it is somehow very satisfying to know that the Beatles won't be taking their M.B.E.'s half as seriously as the *London Times* does. This is the Beatles' sixth record, and if you haven't really listened to them yet, you've been depriving yourself. G.L.

CAPITOL RECORDS



CHIEF BEATLE JOHN LENNON, M.B.E.

knighthoods or at medals reading "Hero of the Soviet Union." But these procedures are both wise and kind: they are devices for giving official national recognition to those who do something significant for their country, and it is an obvious flaw of our system that we have no regular method for expressing public appreciation to anyone but soldiers. We must be good at something besides winning wars!

The Beatles have done more for their country than any bemustached officer whose sole contribution to civilization has been a brief and possibly silly military charge. They have contributed noticeably to the health of the British economy; they have given American young people an awareness of and liking for England that no amount of British wool-

RECORDING OF SPECIAL MERIT

© NAT KING COLE TRIO: *The Easy Listening Favorites*. Nat King Cole (piano and vocals), Oscar Moore, Irving Ashby (guitar), Johnny Miller (bass). *I'll Never Be the Same: I'm Through with Love: Body and Soul*, and eight others. CAPITOL T 2311 \$3.98.

Performance: **Suave**
Recording: **Surprisingly undated**

Cole had a face like a cat, and the grace of one. He was one of the few men I have ever seen who looked right with a cigarette holder. Even his movements—perhaps because he had once been an athlete, and a good one—were feline. He wore clothes beauti-

Explanation of symbols:

- © = stereophonic recording
- © = monophonic recording
- * = mono or stereo version not received for review

fully. On a nightclub floor or in front of a TV camera he looked at home, poised and totally unhurried.

This is the way Nat Cole was, and this is the way he sang. He played the piano this way, too, a fact of which his younger fans were perhaps unaware. This Capitol re-release of various Cole sides, dating from his first record date for Capitol in 1943 (Twenty-two years ago! Can it be possible?) to one held in March of 1949, reminds us how good a pianist he was. Some younger hippies, who think of him as "only" a pop singer, would be surprised if they found out to what extent some current idols among jazz pianists owe debts to Nat Cole.

His playing was essentially simple. But it wasn't the simplicity of ignorance; it was the simplicity of a musician who knows all that he and the instrument can do and who knows what he *wants* to do. Cole had an absolutely exquisite touch. There is a way of striking a note on the piano that I have always found hard to describe: the tone produced is warm and soft, yet there is a hint of a click at the beginning of the note, rather like a glottal stop in speech or singing. You can hear, as it were, the softness of the felt on the hammers but at the same time hear the clean certainty with which they strike the strings. I haven't the slightest idea how this sound is achieved, but Bill Evans has it, Walter Gieseking had it, and so did Nat Cole.

Besides genuine beauty (beauty on the small scale—that's the way he apparently wanted it), Cole had a wonderful quality of bounce and ebullience in his playing, which is particularly evident in *I'll Never Be the Same*, done on a 1947 date.

The sound he got in his playing was in his voice, too. Of course, since these are early Cole vocals, the long lines and masterful control had not yet come to his voice—his breath control was so poor that he sometimes sang in phrases as short as two words. But the lovely, soft, furry quality and clean attack were there from the beginning.

Even those who regretted the loss of his piano-playing when he turned full-time to singing found pleasure in his vocals. He was one of the most musicianly singers of our time; and unlike many singers trained originally as pianists, he never slighted the words of a song. This man knew how to interpret lyrics. And that, too, was there from the beginning.

I hope there will not be an orgy of death-worship now that he is gone—it happens too frequently when a great American entertainer dies. Cole may well escape it: he was too urbane and civilized a man to be a suitable target for this kind of thing. Nonetheless, it is a fact that when an artist dies, his works become more valuable—precisely because there will be no more of them. I hope, therefore, that Capitol will reissue more of Cole's work in tastefully edited collections like this one.

G. L.

© ● AUSTIN CROMER: *Sings for Her*. Austin Cromer (vocals); Hubert Laws (flute, alto flute, guitar), Chick Corea (piano), Richard Davis (bass), Bruno Carr (drums). *This Love of Mine*; *Laura*; *I Wish I Knew*; and five others. ATLANTIC SD 8107 \$4.98, D 8107* \$3.98.

Performance: Able
Recording: Not so good
Stereo Quality: All right

This is the first recording in several years by Austin Cromer, once the vocalist with Dizzy Gillespie's big band. After a long period in obscurity, he was found working on a construction gang. Time and absence from professional music have not damaged his singing, which is in a vein similar to that of Billy Eckstine, Al Hibbler, and Herb Jeffries, without actually sounding like any of them.

It's too bad Cromer was not presented in a more auspicious setting here. The musicians are all very capable, but a singer seeking a comeback needs more substantial backing than a mostly improvised rhythm-section accompaniment filled in by flute lines. What's more, the balances are wrong. Corea's piano has been recorded at too high a level, Cromer's voice at too low a level. Cromer sounds as if he's standing somewhere back of the piano. In *Laura*—which is very well sung—you can hardly hear Cromer or Laws



GALE GARNETT
Irreverence in a warm smoky contralto

at a point where the pretty flute figure is far more important than the chords being laid down by Corea.

Everything about this disc indicates penny-pinching. Its eight tunes may have been done in two dates; with only four musicians employed (the leader receiving double scale), the accompaniment then would cost only about \$600. When someone like Tony Bennett makes a record, he does twelve tunes in three dates, and he is backed by thirty-five musicians. More than \$6,000 is spent on musicians alone, to say nothing of money for copying and for charts by skilled arrangers. Admittedly, no sensible record company will gamble that kind of money on a now-unknown singer like Cromer—Bennett, after all, has an established audience to guarantee return of the investment. Yet Cromer still has to compete in the marketplace with singers like Bennett and Sinatra. He needs the punch of proper accompaniment even more than they do. And a comeback disc needn't cost \$6,000. Sinatra's comeback disc, "Songs for Young Lovers," used only eleven men—and some imaginative writing by Nelson Riddle.

The old 10-inch LP's contained eight tunes, and so does this 12-inch disc. How many people are going to buy it, seeing that

they're being short-changed on quantity? It will be surprising if the record sells a thousand copies. Then, when the sales figures are in, Cromer, a very good singer, will no doubt drop back into obscurity—and it will be a shame.

G. L.

© ● SERGIO FRANCHI: *Live at the Coconut Grove*. Sergio Franchi (vocals); Freddy Martin's Orchestra, Neil Warner cond. *Just Say I Love Her*; *I Wish You Love*; *In the Still of the Night*; and twelve others. RCA VICTOR LSP 3310 \$4.98, LPM 3310 \$3.98.

Performance: Night-clubbish
Recording: Good
Stereo Quality: Good

The theory behind recording in front of audiences ("live," so-called) is that some extra quality of fire and communication is captured—a quality you can't get in the recording studio. For instrumental jazz, this is undoubtedly true. But in the case of vocal performances of whatever kind, I think more is lost than is gained.

Night-club brass sections are one of the drawbacks. They have a sound that is feeble and syrupy. Perhaps we've been spoiled by those stunning New York studio brass sections that include players like Ernie Royal, Doc Severinsen and J. J. Johnson.

Withal, Franchi himself is less bombastic in this set than in some previous recordings he's made. To have a big "legit"-trained tenor belaboring light popular music strikes me as a mismatch of voice and material. Still, Franchi shows a certain discretion here in the use of his vocal equipment. His *Stella by Starlight* is the highlight of the session. G. L.

© ● GALE GARNETT: *The Many Faces of Gale Garnett*. Gale Garnett (vocals); orchestra, Sid Bass cond. *Excuse Me Mister*; *Forget It*; *God Bless the Child*; and nine others. RCA VICTOR LSP 3325 \$4.98, LPM 3325 \$3.98.

Performance: Fresh
Recording: Good
Stereo Quality: Good

The "image" of Gale Garnett has been that of a folk singer. Her third album for RCA Victor shows that her inspiration is not only non-folk—it's non-American. It is in fact French. Miss Garnett writes much of her material, and its inspiration is the long tradition of French songwriter-singers that includes Charles Aznavour, Gilbert Bécaud, and Charles Trenet. Miss Garnett obviously has listened to them, and above all to Edith Piaf.

Not that Miss Garnett is a Piaf imitation. Her vocal quality is quite different—warm, smoky, soft around the edges, a sort of husky contralto that sounds more like an adolescent boy's voice than anything else. Furthermore, she is humorous, whereas Piaf was usually tragic. But there is bite in her material that is assuredly Piaf-like. *Excuse Me Mister*, for example, is an amusing song in which a girl is trying to pick up a man with money; it's an idea Piaf might have used. *Marionette* has ferocity in it. It is a wickedly pointed criticism of one woman by another, who is fiercely jealous of her. Not all the songs are in this vein: *As Much as I Can* is a tender, sensitive, and highly believable sketch of a girl entering hesitantly into love.

(Continued on page 92)

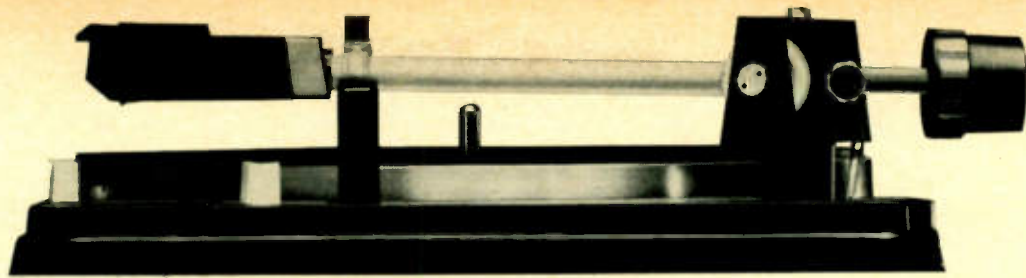

It took **Dual** precision to close the quality gap between the manual and the automatic turntable

FRICION-FREE TONEARM PIVOTS. The tonearm pivots vertically on two microscopically-honed hardened steel points, each supported by miniaturized ball bearings (A). Horizontally, double ball bearings are used (B). Bearing friction is so low . . . less than 0.1 gram . . . that only laboratory instruments as sensitive as Dual's own can actually measure it.

CONTINUOUSLY VARIABLE STYLUS FORCE AT PIVOT. A long, multiple-coil flat mainspring (C) applies stylus force, internally and at the pivot. As only a small fraction of its total length is used, stylus force remains virtually constant . . . from the first to the tenth record in changer operation. Tonearm remains so perfectly balanced in all planes, it can actually track at angles approaching 90°.

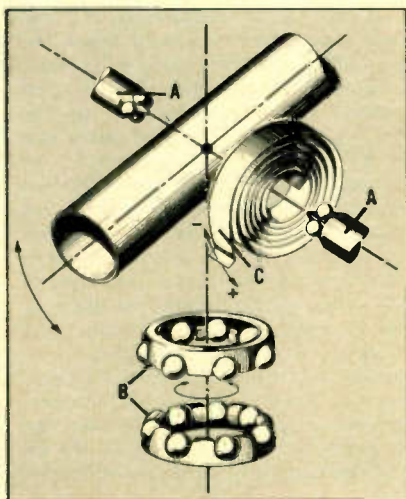

ELASTICALLY DAMPED COUNTERBALANCE WITH CONTINUOUSLY VARIABLE FINE ADJUST. Slips on tonearm via shaft (D) for rapid balance, then adjusts on fine threads. No click stops to limit precision tonearm balance, so essential for ultra lightweight tracking. Nylon-braking (E) on the shaft prevents slippage. Rubber damping (F) between counterbalance and shaft helps reduce tonearm resonance to below 8 cps.

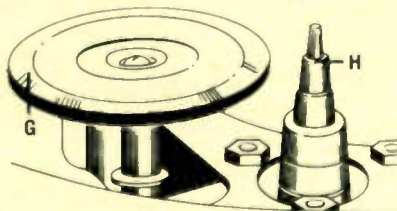
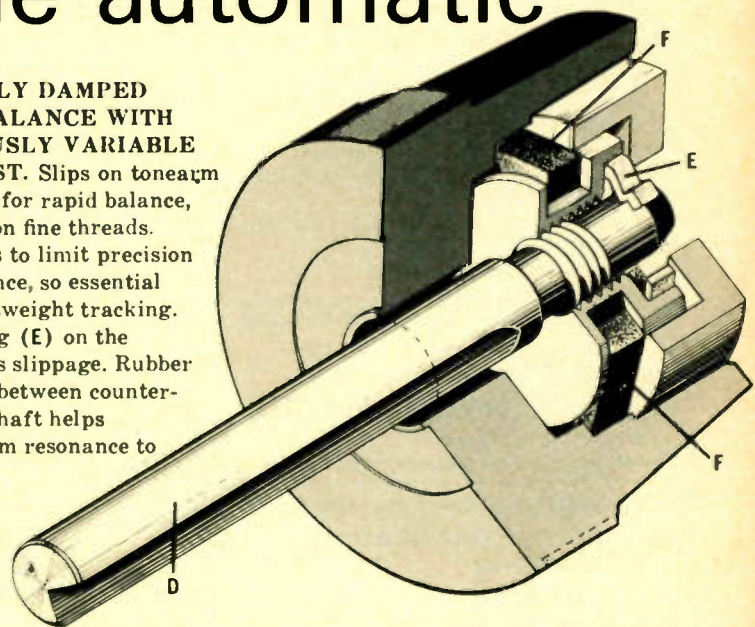

6% VARI-PITCH CONTROL FOR ALL FOUR SPEEDS. Idler wheel (G) rises and lowers along each of the four tapered sections on motor pulley (H), thus varying platter speed without affecting motor speed or power. Speed accuracy is within 0.1% . . . easily verified with strobe disc supplied.

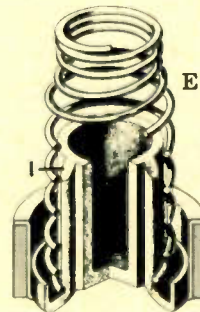

ELASTICALLY DAMPED SOFT-SPRING FOOTINGS. Extremely pliant spring footings are made possible by Dual's feathertouch slide switches. Rubber damping (I) between spring and cup avoids metal-to-metal contact. Another reason why the Dual is so free from resonances and acoustic feedback.

DUAL 1009

Auto/Professional Turntable

As many have long suspected, there's far more to the Dual 1009's matchless performance than could ever meet the eye. For an automatic tonearm to track and trip flawlessly as low as 1/2 gram, every aspect of design and engineering, only a few of which are shown here, must be of an unprecedented high order of precision. A short visit to your franchised United Audio dealer will also show you its many exclusive operating features, such as fully automatic and manual start in both single play and changer mode. Then you'll know exactly why the world-renowned DUAL 1009 Auto/Professional Turntable at \$99.50 is unquestionably your most outstanding value.



12 WEST 18th ST., NEW YORK, N. Y. 10011

DUAL'S THE FINEST . . . THE RECORD PROVES IT SINCE 1900
In Canada: DUAL OF CANADA, 24 Millford Ave., Toronto 15, Ontario



FOR STORES "WHERE YOU CAN BUY"—SEE LAST PAGE.

CIRCLE NO. 58 ON READER SERVICE CARD

NEW RESEARCH-PRECISION TONE ARM FOR HOME USE



The Castagna Professional Tone Arm represents critical engineering innovations that give you reduced distortion, improved sound and minimum record and stylus wear.

Developed for laboratory studies of high quality cartridges, the Castagna brings unique features never before available to the audiophile:

- Anti-bias and distortion characteristics hitherto unavailable in its price class. Unlike other arms, the Castagna plays the last third of the record as cleanly and distortion-free as it plays the first part.
- A jewel bearing, gimballed post suspension with opposing magnets to reduce bearing friction almost to zero.
- Calibrated stylus pressure adjustment (0-5 grams)
- All-plane balance adjustment
- Minimal tracking error for all acceptable cartridges (Adjustable 8° to 28° of angle)

Complete in compartmented case \$125.

For name of nearest supplier write:

SCOPE ELECTRONICS CORPORATION

235 East 42nd St., New York, N.Y. 10017

CIRCLE NO. 51 ON READER SERVICE CARD

**Recommended by leading
consumer publications.**

This is a dangerous loudspeaker



MODEL DLS 529

Caution—it will mercilessly reveal the flaws in any defective or outmoded equipment used with it. The transient-perfect sound reproduction is totally different from all other Bookshelf speakers, regardless of size or price! \$159.00*

EMI

*Higher in South and West.

For further information write

Scope Electronics Corp.

235 East 42nd St., New York, N. Y. 10017

CIRCLE NO. 23 ON READER SERVICE CARD
FOR STORES "WHERE YOU CAN BUY"
SEE LAST PAGE.

Miss Garnett writes attractive melodic lines and intelligent lyrics. But there is a flaw—she has a streak of show-biz hippiness, which leads her to throw in contemporary slang such as "where I'm at" and "put me down." If she listens to herself in *Spring Can Really Hang You Up the Most*, she will see the hazard of using slang in lyrics—it dates a song, and very quickly.

Although she is less effective in songs by other people, she sings five of them in this album. Her interpretation of *St. James Infirmary Blues* is misguided and annoying (it's a man's song, anyway). Malvina Reynolds' *I Wish You Were Here* comes off well—perhaps because it is the only one of the five songs as good as Miss Garnett's own.

Miss Garnett sings flat. There is a long American tradition, probably rooted in the blues, of singing constantly a shade below true pitch. This flatness, which we should perhaps call under-pitch, can be attractive, and it works for Miss Garnett. But she hits some notes *really* flat, and these are a nuisance. She also tends at times to mush-mouthed folkie pronunciations—I played one line of the Malvina Reynolds song seven times and still couldn't understand the last word.

I like Sid Bass's arrangements for this album very much. They're simple but lyrical and tasteful. In *Excuse Me Mister* he underlines Miss Garnett with a softly-punching trombone figure that is most effective. In *As Much as I Can*, he tosses a little falling figure back and forth between piano and flutes on the two speakers. Charming.

Miss Garnett's overall quality is one of egotistical irreverence. Egotism is annoying only when it is unjustified. Miss Garnett has plenty of ability to back it. Dig this chick—she's interesting, and possibly important.

G. L.

© © BENNY GOODMAN: *Memorable Vocal Performances with the Benny Goodman Orchestra*. Buddy Clark, Ella Fitzgerald, Johnny Mercer, Jimmy Rushing, Martha Tilton, Helen Ward (vocals); Benny Goodman Orchestra. *There's a Small Hotel: Goodnight My Love; Cuckoo in the Clock*; and seven others. CAMDEN CAS 872 \$2.49, CA 872 \$1.98.

Performance: Dated
Recording: Dated
Stereo Quality: Useless

These recordings were made between April 4, 1935, and April 7, 1939. Most are in the standard format of the era: a chorus of melody from the band, a chorus of vocals, a "swinging" passage from the band, interspersed with solos, and out. I found almost all of it forgettable.

An oddly surprising performance is that of Ella Fitzgerald, then Chick Webb's singer, who made *Goodnight My Love* and *Did Ja Mean It* on a loan-out arrangement with Goodman. Miss Fitzgerald sounds much younger now than she did then; certainly her voice is clearer and infinitely better today. The Martha Tilton and Helen Ward tracks went by almost without my noticing: they sound like most of the other singers of that era—superficial and rather amateurish.

Jimmy Rushing fares better than most of them, and so does Johnny Mercer. Already established as a lyricist in 1939 when he recorded *I Sent for You Yesterday and Here*

You Come Today and *Cuckoo in the Clock* (which he wrote), Mercer cuts through the fog of the pre-war recorded sound with a vocal quality surprisingly like that he has today. No doubt it is because both Mercer and Rushing were traveling in personal stylistic grooves, rather than conforming to the vocal fashions of the time, that they don't sound dated. Mercer's curiously humorous singing had a swing that lifted it above the lead-footed rhythm of the era.

The stereo reprocessing of these mono records is quite pointless. G. L.

© © LIZA MINNELLI: *It Amazes Me*. Liza Minnelli (vocals); orchestra, Peter Matz cond. *It Amazes Me; Plenty of Time; Lordei*; and eight others. CAPITOL ST 2271 \$4.98, T 2271 \$3.98.

Performance: Exaggerated
Recording: Good
Stereo Quality: Good



LIZA MINNELLI

A singer with something of her own

This is Liza Minnelli's second album. It is clear that she is a gifted young lady, but this disc demonstrates nothing so clearly as a need to find a good voice teacher, and fast. If she's already got one, she'd better find another. Otherwise, she's going to be ruined as a singer by the time she's thirty. She has no control. The held notes often slip and waver as a result of improper breath support. When singers sing improperly, the vibrato gets wider with age until it becomes a hopeless wobble. Since Minnelli's is too wide at 19, what's going to happen to her? She is often out of tune, too, and not even the device of electronic echo can cover it. Finally, since she has listened too much to Barbra Streisand and to her mother, Judy Garland, she overinterprets material.

She has something—she really does—and it's her own. But if her present success shoots her to the top too fast she will be under too much pressure and too busy to do the urgently needed groundwork she has apparently skipped.

G. L.

© © ROBERT SHAW: *The Robert Shaw Chorale and Orchestra on Broadway*. Orchestra and chorus, Robert Shaw cond. *Hello, Dolly!; Lost in the Stars; New York, New York; Seventy-Six Trombones*; and eight

others. RCA VICTOR LSC-2799 \$5.98, LM-2799* \$4.98.

Performance: Dated
Recording: Excellent
Stereo Quality: Excellent

No arranger for Broadway is more highly thought of than Robert Russell Bennett; no choral group of its type is more highly thought of than the Robert Shaw Chorale. So, when Shaw turns his attention to Broadway classics arranged by Bennett, the result should be a superb album, should it not?

This may indeed be a superb album, and taken on its own terms perhaps it is, but I find it old fashioned. Everything is in its place and all proportions are nicely maintained, but a conductor who can give us brilliant recordings of Ives and Schoenberg should be able to come up with an approach a little more contemporary than this recorded approximation of the *Bell Telephone Hour*.

Since the still-effective Bennett was in his prime, Broadway arranging has moved in new directions, in the hands of Hershey Kay and others. Next time out, it would be nice if Shaw turned to one of these men for assistance. As it is, he has made one of the best Broadway albums of the Forties. J. G.

JAZZ

© ® LOUIS ARMSTRONG: *The Best of Louis Armstrong*. Louis Armstrong (trumpet, vocals); various instrumental combinations. *Basin Street Blues; Memories of You; Lazy River; Blueberry Hill*; and twenty others. DECCA DXSB 7183 \$9.95, DXB 183* \$7.95.

Performance: Armstrong excels
Recording: Competent to good
Stereo Quality: Fake

Considering that this two-disc set is billed as comprising "the best" of one of our leading jazz figures, Decca has been remarkably lax in its packaging. No players are given for the various tracks, and only a few recording dates are furnished. So I make an educated guess in saying that most of the performances were recorded in the 1940's and 1950's. In any case, they are hardly the best of Armstrong, and are not even the best of Armstrong in Decca's catalog. Nonetheless, this collection has considerable substance—largely because Armstrong's trumpet-playing and singing are consistently good.

The Armstrong of the past three decades has stripped his style of all excess decoration to produce a classical clarity of line. His singing, while more ornamented, is irresistible—to this listener, at least—because of its enveloping warmth and because of the singer's mastery of swinging time.

The backgrounds, by small combos and orchestras, range from ragged to adequate, although a few solo bursts from Armstrong's colleagues are of some merit. In essence, however, Armstrong carries the weight, and he does it with ebullient zeal.

Decca describes the stereo pressing of these recordings as "enhanced." The processing that this euphemism describes resulted only in shrillness of sound. Stick with the mono version. N. H.

© ® PAUL DESMOND: *Bossa Antigua*. Paul Desmond (alto saxophone), Jim Hall (guitar), Eugene Wright (bass), Connie

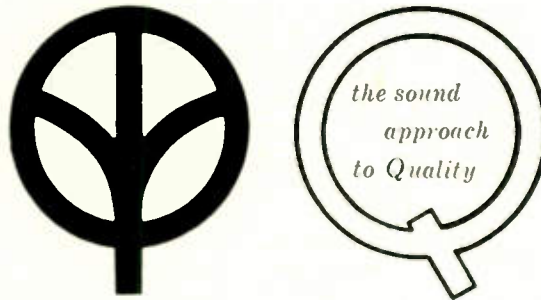

PROVEN RELIABLE

KENWOOD SOLID STATE has proven its superiority to many thousands of audiophiles who have purchased these components during the past years. Those selective stereo fans are enjoying consistent, trouble-free performance — good reason why this symbol  is synonymous with highest quality. Of course, there are other reasons — the automatic transistor protection circuit, handsome chassis, luxury features, original performance sound and amazing dollar-for-dollar value.

Visit your nearest KENWOOD Franchised Dealer* and insist on a demonstration of proven reliable solid state. He has the KT-10 and TK-80, and if you prefer a separate tuner and amplifier, KENWOOD offers the TK-500 Tuner and TK-400 Amplifier.

KT-10

ALL SOLID STATE AM FM
40 WATTS AUTOMATIC
STEREO RECEIVER • \$269.95

- automatic silent switching
- automatic instant stereo/mono indicator
- direct tape monitor
- FM AFC control
- front-panel stereo headset jack



TK-80 SOLID STATE FM 80 WATTS
MULTIPLEX RECEIVER • \$339.95

- silicon power transistors
- unsurpassed wide frequency range
- front-panel switching for 2 stereo speaker sets and earphones
- automatic mono stereo indicator
- inter-station muting

*Write to us for the name of the franchised dealer nearest you.



KENWOOD

Los Angeles Office: 3700 So. Broadway Pl., Los Angeles, Calif. 90007, ADams 2-7217
New York Office: 212 Fifth Ave., New York, N.Y. 10010, MURray Hill 3-1115



Kay (drums). *Bossa Antigua: Alianca: The Girl from East Ninth Street*; and five others. RCA VICTOR LSP 3320 \$4.98, LPM 3320 \$3.98.

Performance: Impeccable
Recording: Improperly balanced
Stereo Quality: Very clear

The surprising thing about Paul Desmond's playing is its year-after-year consistency. Like anyone else, he has off days, but even then his work is at a high level and rewarding. This album was obviously not recorded on an off day.

The personnel is the same as that on an earlier RCA Victor disc called "Take Ten." Here, the group turns to bossa nova—or rather Desmond turns bossa nova to his own uses. His controlled swing and his seemingly inexhaustible capacity for melodic invention are the album's chief attractions. And I've never heard his tone so well captured on records. Too often in the past engineers have made it seem thin. This disc reveals that it is full-bodied and warm.

Except for the recording of Desmond himself, the engineering has shortcomings. Eugene Wright's bass is under-balanced. It sounds light and unassertive, and often you can't hear its pitch properly. Since there's no piano in the group, and since the guitar isn't made to play most chords in root positions, Wright is assigned the job of playing the chord roots—and you can't hear them properly, a fault that makes the group seem to lack underpinning. Wright is a strong and forthright player, and so the recording must be blamed for this flaw. Also, surprisingly, even Connie Kay's drums sound faint at times. Unless you push your volume way up, you can hardly hear him at the beginning of *The Night Has a Thousand Eyes*.

Jim Hall fits himself beautifully to the context, as usual. His solos sustain the mood and flavor first set by Desmond. That mood is soft and ballad-like, lucid and clear.

I nominate Desmond for a Grammy Award for his drily witty liner notes: "It's me, Paul Desmond, rapidly aging sax player with the Brubeck Quartet, sometimes called the John P. Marquand of the alto. . . ." G. L.

© ● DUKE ELLINGTON: *Ellington '66*. Unidentified personnel. *Charade: People: Satin Doll: Moon River: The Good Life*; and seven others. REPRISÉ RS 6154 \$4.98, R6154* \$3.98.

Performance: Mostly brilliant
Recording: Excellent
Stereo Quality: Very good

Last year's "Ellington '65" was a great and unexpected success, and now, a bit in advance, like the new cars, we have "Ellington '66." Like the previous album, it consists of Ellington's view of currently popular songs.

The game is to see how well the pieces become Ellingtonia. There are some marvelous coups here, and some wide misses. *A Beautiful Friendship*, for instance, fits into the mold perfectly, but it takes some straining to make *People* work. The masterpiece of the set, though, is the Lennon-McCartney *I Want To Hold Your Hand*. With the aid of growl trumpets, it comes out in Ellington's style of the Thirties. There is also a remake of *Satin Doll*, and the new title track is a rather slight set-piece for the piano player.

While the personnel is not listed—an unforgivable oversight by the recording company—one hears the unmistakable sounds of Lawrence Brown, Cootie Williams, and Johnny Hodges, all perennials in what is still the best jazz band in the world. J. G.

© ● PETE FOUNTAIN: *Mr. Stick Man*. Pete Fountain (clarinet); orchestra and chorus, Charles "Bud" Dant cond. *Jambalaya: Goodbye: Whipped Cream: Gotta Travel On*; and eight others. CORAL 757473 \$4.98, 57473* \$3.98.

Performance: Cool
Recording: Okay
Stereo Quality: Okay

Together, Pete Fountain and Al Hirt were once the pride of New Orleans, and they now have gone their separate though fairly similar ways. Fountain has not achieved the enormous popularity of his friend, but he seems

BUCKY MILAM FOR LIMELIGHT RECORDS



DIZZY GILLESPIE
Controlled gusto for a Caribbean romp

to be trying for that kind of acclaim: he turns out novelty records with choruses, tricky little rhythms, and even a funky organ.

One is tempted to say he hasn't quite made it simply because he's a better musician than Hirt. Actually, the reason probably lies elsewhere: the clarinet makes a less spectacular impact than the trumpet and Fountain seems concerned with toning down the flashy aspect of his playing. In any case, with his cool tone and spare phrasing, Fountain's style has become something of a virtuoso pop version of the "swamp period" Jimmy Giuffrè.

This is a hard row to hoe, something like a contemporary version of the records alto-player Eddie Calvert used to make, but I find, despite all the needless tricks, that Fountain is one of the most satisfying musicians in this particular sector of the trade. J. G.

RECORDING OF SPECIAL MERIT

© ● DIZZY GILLESPIE: *Jambo Caribe*. Dizzy Gillespie (trumpet, vocals), James Moody (tenor saxophone, flute), Kenny Barron (piano, bass), Chris White (bass, guitar, vocal), Rudy Collins (drums), Kansas Fields (percussion), *Barbados Carnival: Trinidad: Hello: And Then She Stopped: Poor Joe*; and

four others. LIMELIGHT LS 86007 \$5.98, LM 82006* \$4.98.

Performance: Festive
Recording: Very good
Stereo Quality: Superior

One of Dizzy Gillespie's major preoccupations is the diversity of forms and colors which have resulted from various migrations of African music. Previously he has explored jazz adaptations of the Afro-Cuban and North African idioms, among others. This time he is in the Caribbean. The mood of the album is buoyantly ironic, a factor due partly to the mocking nature of the music itself and also to the double view of it held by Gillespie as an American Negro jazzman. The irony, it should be noted, is unfailingly affectionate.

The album also indicates that, for all the wry comic routines of this combo in live appearances, Gillespie has nonetheless shaped it into a disciplined musical unit. He himself plays with the controlled gusto that makes the force of his solos all the more incisive. His colleagues, while not on Gillespie's level of invention, are persuasive, and of particular interest in this set is the flowing, crisply styled piano of Kenny Barron.

The composers represented are Dizzy, members of the band, and West Indian calypso writer Joe Willoughby. The pieces include carnival songs, calypso tunes, and vignettes of street life. (One of the vignettes, *And Then She Stopped*, is Dizzy's evocation of a girl in Harlem spontaneously dancing in the street to a West Indian strain from a record store.) An especially intriguing example of the multiple fusions possible through jazz explorations of Caribbean mixtures is Dizzy's *Jambo*, which blends Caribbean, African, and bop rhythms. The set is packaged and illustrated with a wit and play of colors that mirror the fun inside. N. H.

© ● EARL HINES: *The Grand Terrace Band*. Earl Hines (piano); Walter Fuller, Edward Simms, Milton Fletcher, and Shirley Clay (trumpets); George Dixon (trumpet, alto and baritone saxophones); Edward Burke, John Ewing, and Joe McLewis (trombones); Leroy Harris, Robert Crowder, Budd Johnson, and James Mundy (saxophones); Omer Simeon (clarinet and baritone saxophone); Claude Roberts (guitar); Quinn Wilson (bass); Alvin Burroughs (drums). *Indiana: Number 19: Piano Man: Father Steps In: Riff Medley*; and eleven others. RCA VICTOR LPV 512 \$4.98.

Performance: Period
Recording: Well remastered

I am beginning to believe that nostalgia has a good deal to do with the reputations of "legendary" jazz bands. Not that this band—led by pianist Earl Hines at Chicago's Grand Terrace in 1939-40—wasn't a good jazz band, or even an excellent one. But one of the greatest jazz bands of all time? Of course, the chief arranger was Budd Johnson, who was one of the best of that day, and he is still a considerable saxophonist. And there is Hines himself, with his spare, often-imitated piano style—a sort of cross between Waller and Teddy Wilson. If you are irrevocably hooked on the swing era, you may find this release a complete delight. If not, you may feel you've heard much of it before. J. G.

(Continued on page 96)

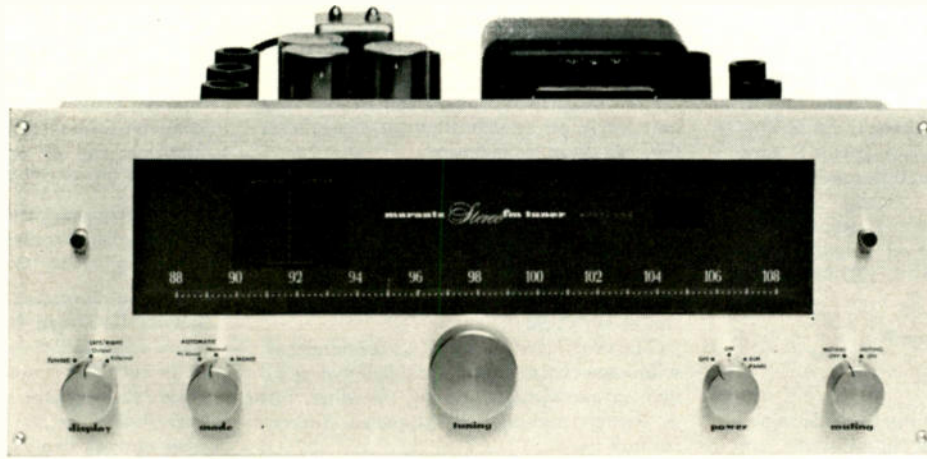

MARANTZ 10-B TUNER: "... rather spectacular results."

Q. Mr. Marantz, your new 10B stereo FM tuner has caused quite a stir in the hi-fi industry. Now that a large number are in the field, what reactions have you received?

Mr. Marantz: The overwhelming reaction has been one of surprise from owners who found our claims were not exaggerated. One user wrote he had "... taken with a grain of salt your statement that reception was as good as playback of the original tape or disc. However, after using the tuner for several days I felt I owed an apology for doubting the statement." This is typical.

Q. What success have users had with fringe area reception?

Mr. Marantz: Letters from owners disclose some rather spectacular results. From the California coast, which is normally a very difficult area, we have had many letters reporting clean reception from stations *never reached before*. An owner in Urbana, Illinois told us he receives Chicago stations 150 air miles away with a simple "rabbit ears" TV antenna. Another in Arlington, Virginia consistently receives fine signals from Lancaster, Pennsylvania, 125 miles away; Philadelphia, 200 miles away, and three stations in Richmond 100 miles over mountains, which he said "come in as good as local stations."

Q. For the benefit of these readers interested in the technical aspects, what

are the reasons for this improved fringe area performance?

Mr. Marantz: Technical people will find it self-evident that the rare four-way combination of high sensitivity—better than $2 \mu\text{V}$, IHF—both phase linearity and ultra-sharp selectivity in our new advanced IF circuit, and a unique ability to reach full quieting with very weak signals—50 db @ $3 \mu\text{V}$, 70 db @ $24 \mu\text{V}$ —virtually spells out the 10B's superior reception capabilities. Engineers will also appreciate the additional fact that our circuitry exhibits very high rejection of "ENSI," or equivalent-noise-sideband-interference.

Q. Considering the 10B's excellent fringe area performance, shouldn't one pick up more stations across the dial?

Mr. Marantz: Yes. The report published in the April edition of Audio Magazine claimed to have logged 53 stations with an ordinary folded dipole used *in the reviewer's apartment*, which was "more than ever before on any tuner!"

Q. I appreciate, Mr. Marantz, that the 10B's built-in oscilloscope tuning and multipath indicator is very valuable in achieving perfect reception. How big a factor is this device in the total cost of the 10B?

Mr. Marantz: Well, first we should note the fact that no manufacturer would offer a quality tuner without tuning and signal strength meters. Therefore, what we should really consider is the difference in price between ordinary tuning meters, and our infinitely more useful and versatile Tuning/Multipath Indicator, which is only about \$30! While our scope tube and a pair of moderately priced d'Arsonval meters costs about the same—slightly under \$25—the \$30 price differential covers the slight additional power supply complexity, plus two more dual triode tubes with scope

adjustments and a switch. The rest of the necessary associated circuitry would be basically similar for both types of indicator. The price of the 10B tuner is easily justified by its sophisticated precision circuitry and extremely high-quality parts.

Q. With the 10B's exceptionally high performance, does it have any commercial or professional application?

Mr. Marantz: Yes, very much so. In fact, a growing number of FM stations are already using 10B's for monitoring their own broadcast quality. One station wrote that they discovered their 10B outperformed their expensive broadcast monitoring equipment, and were now using it for their multiplexing setup adjustments and tests.

Q. Just how good is the general quality of FM stereo broadcast signals?

Mr. Marantz: As I have remarked on previous occasions, the quality of FM broadcasting is far better than most people realize. The Model 10B tuner has proven this. What appeared to be poor broadcast quality was, in most instances, the inability of ordinary FM receiving circuits to do the job properly. The Model 10B, of course, is based on a number of entirely new circuit concepts designed to overcome these faults.

Q. In other words, the man who uses a MARANTZ 10B FM tuner can now have true high fidelity reception?

Mr. Marantz: Yes, very definitely—even under many conditions where reception may not have been possible before. This, of course, opens up a tremendous source of material for the man who wants to tape off the air, and who needs really good fidelity. He can, as many of the 10B owners are now doing, build a superb library of master-quality tapes, especially from live broadcasts.

New price: \$600—no excise tax.



marantz

MARANTZ, INC. SUBSIDIARY OF SUPERSCOPE • INC.
25-14 BROADWAY, LONG ISLAND CITY, NEW YORK

EARL HINES: *Spontaneous Explorations* (see Best of the Month, page 64)

⑤ ⑥ HERBIE MANN: *My Kinda Groove*. Herbie Mann (bass flute, concert flute), Dave Pike (vibraphone), Attila Zoller (guitar), Don Friedman (piano), Jack Six (bass), Willie Bobo and Carlos "Potato" Valdez (percussion), Bobby Thomas (drums), unidentified orch. *Vikki; Spanish Grits; Musbi Musbi; Soul Guajira*; and three others. ATLANTIC S 1433 \$5.98, 1433* \$4.98.

Performance: Mann's usual
Recording: Good
Stereo Quality: Good

Herbie Mann keeps dropping his little sugar-coated placebos down the throat of the jazz

audience, and coming away smiling angelically, just as though he had done something of value. He has surrounded himself with good musicians, notably guitarist Attila Zoller and pianist Don Friedman, but they only rarely get an opportunity to show what they can do in his company.

Part of this issue features Mann's regular group, which is listed above; the rest employs a larger orchestra, playing the arrangements of Oliver Nelson, among others. On these latter, one occasionally hears the fluegelhorn of Clark Terry, who can make music almost anywhere.

The program is primarily Latin-influenced, with some bossa novas included, but it all goes in one speaker and out the other, just as though nothing has happened. Indeed, nothing has. J. G.

⑤ ⑥ SHELLY MANNE: *Manne—That's Gershwin!* Shelly Manne (drums); Conte Candoli (trumpet); Frank Strozier (alto saxophone); Russ Freeman (piano); Monte Budwig (bass); orchestra, Johnny Williams cond. *By Strauss; Mine; Prelude No. 2; Summertime*; and six others. CAPITOL ST 2313 \$4.98, T 2313* \$3.98.

Performance: Varied
Recording: Excellent
Stereo Quality: Good

This jazz album is indeed of Shelley Manne playing Gershwin, but it shows considerably more imagination than its title might imply. It is not "Gershwin's Swinging Hits." *The Man I Love* is here, but so is *The Real American Folk Song (Is a Rag)*. And Manne has also essayed two of the serious pieces, the *Prelude No. 2* and the main theme from the second movement of the *Concerto in F*. Some of the selections are played by Manne's quintet; in others, the quintet is augmented by a large orchestra under the direction of Johnny Williams. The quintet, largely through its trumpeter Conte Candoli, is influenced by Miles Davis, and arranger Williams is influenced by Gil Evans. In *My Man's Gone Now*, which Davis and Evans have recorded together, the resemblance is startling.

Highlights are the work of altoist Frank Strozier, who sounds much like Jackie McLean used to, and bassist Monte Budwig, who is splendid in *The Man I Love*. Williams is best with his light, intricate arrangement of *By Strauss* and the rhythmic treatment he gives the *Prelude*. The one failure is the *Concerto*, where both Williams and pianist Russ Freeman replace Gershwin's apt harmonies with more "modern" ones of their own. The result sounds like a complicated arrangement of *Out of This World*.

The notes call this set "the cross section that puts Gershwin in the best possible focus for a whole new generation of music lovers." It is hardly that, but it is an intelligent, adventurous jazz album. J. G.

⑤ ⑥ SERGIO MENDES: *The Swinger from Rio*. Sergio Mendes (piano), Antonio Carlos Jobim (guitar), Tião Netto (bass), Chico DeSouza (drums), Art Farmer (fluegelhorn), Phil Woods (alto saxophone), Hubert Laws (flute). *Maria Moita; So Danço Samba; The Dreamer; Favela*; and seven others. ATLANTIC SD 1434 \$5.98, 1434* \$4.98.

Performance: Graceful
Recording: Superior
Stereo Quality: Excellent

After the surfeit of bossa nova of the last few years, I had not expected to find another album of this kind beguiling. This collaboration between American and Brazilian musicians, however, should last after most of its predecessors are consigned to limbo. For one thing, the rhythm section is Brazilian, and as one might expect, the various bossa nova rhythms utilized here are authentic and flexible. The challenge of bossa nova is to keep the time springy yet firm, intimate yet pulsive. Led by Mendes, an incisive pianist, this rhythm team meets this challenge admirably.

Turning to the horn complement, Art Farmer on the fluegelhorn is particularly attuned by temperament and style to the bossa nova mood. flutist Hubert Laws plays attractively, but Phil Woods, though his playing is

NEW!—READY FOR ACTION ANYWHERE!

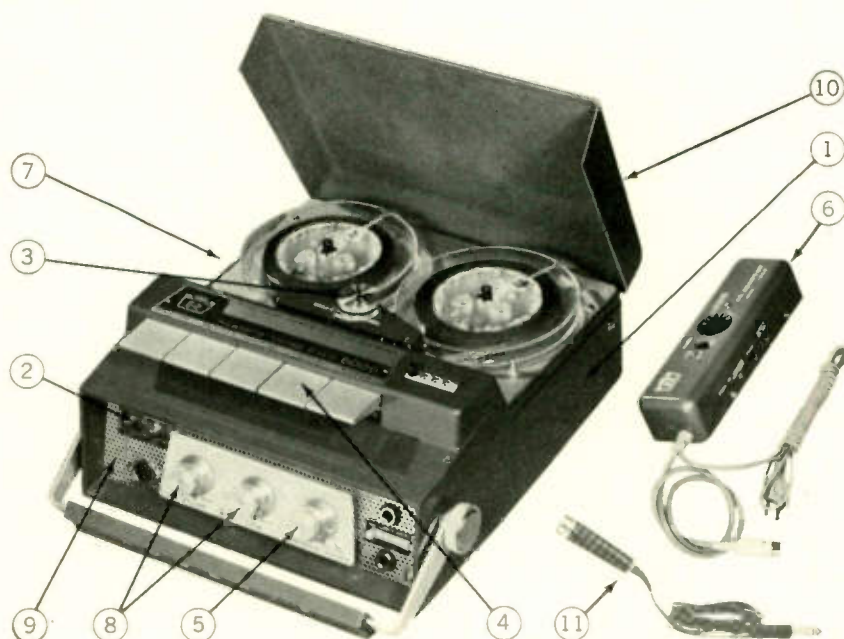

ROBERTS "ROVING REPORTER"

The exclusive Cross  Field sound in a battery portable

- | | |
|----------------------------|----------------------------|
| 1. 33 SOLID STATE ELEMENTS | 6. AC ADAPTER |
| 2. 22,000 CYCLE RESPONSE | 7. BATTERIES INCLUDED |
| 3. CROSS FIELD HEAD | 8. MONO OR STEREO; 4 TRACK |
| 4. PIANO KEY CONTROLS | 9. BROADCAST QUALITY |
| 5. FOUR SPEEDS | 10. A COMPACT 12 POUNDS |
| | 11. MIKE INCLUDED |

In the field your Roberts 6000 is a professional broadcast quality stereo or monaural recorder and playback unit. In the studio, the 6000 is your complete tape recording and playback center, and while the AC Adapter is plugged in, the battery is automatically recharging. Amazing sound quality from the built-in speaker, or plug in two external speakers for bigger sound.

Model 6000M—professional mono (includes mike and batteries)—\$299.95.
Model 6000S—stereo (includes mike, rechargeable battery, stereo amplifier and AC adapter/battery recharger)—\$359.95

 **ROBERTS**

ROBERTS, A DIVISION OF RHEEM MANUFACTURING COMPANY WITH 75 PLANTS AROUND THE WORLD

vibrant and personal, is almost too strong in attack and beat for this context.

Although there is not much depth of emotion or much invention to the proceedings, this set is charming, and an aid to relaxation. All of the songs are gentle and caressing, I found Mendes' *Pau Brazil* and Jobim's *Useless Panorama* particularly intriguing. N. H.

© Ⓜ OLIVER NELSON: *More Blues and the Abstract Truth*. Thad Jones and Daniel Moore (trumpets), Phil Woods (alto saxophone), Phil Bodner (tenor saxophone, English horn), Ben Webster (tenor saxophone), Pepper Adams (baritone saxophone), Roger Kellaway (piano), Richard Davis (bass), Grady Tate (drums): Oliver Nelson cond. *Blues o' Mighty; Midnight Blue; The Critic's Choice; Goin' to Chicago Blues*; and four others. IMPULSE AS 75 \$5.98, A 75* \$4.98.

Performance: Authoritative
Recording: Excellent
Stereo Quality: Very good

Oliver Nelson has chosen the personnel wisely for this collection of his lean, brightly colored scores: the ensemble passages are played with that combination of precision and ease that is so difficult to attain, particularly on pickup recording dates. The slashing alto saxophone of Phil Woods brilliantly complements the witty, cracklingly lyrical trumpet of Thad Jones. On two numbers, the magisterial Ben Webster adds another dimension of depth and sensitivity. Pepper Adams is predictable but competent on baritone saxophone, and though pianist Roger Kellaway's solos tend to be overbusy, the rhythm section as a whole moves with fluidity.

Rudy Van Gelder's engineering has produced superb recorded sound here—exceptionally immediate, yet spacious too. N. H.

© Ⓜ STANLEY TURRENTINE: *Hustlin'*. Stanley Turrentine (tenor saxophone), Shirley Scott (organ), Kenny Burrell (guitar), Bob Cranshaw (bass), Otis Finch (drums). *Trouble (No. 2); Love Letters; The Hustler; Ladyfingers; Something Happens to Me; Goin' Home*. BLUE NOTE ST 84162 \$5.98, 84162* \$4.98.

Performance: Relaxed groove-making
Recording: Very good
Stereo Quality: First-rate

Stanley Turrentine and Shirley Scott are a musically congenial husband-and-wife team who have produced another characteristic album of easeful jazz. Miss Scott has one of the lightest touches of any jazz organ player: both a supple accompanist and a convincing soloist, she disarms rather than overwhelms the listener. Her ideas, however, are not especially provocative, although they are well structured. Turrentine plays with a firm, full sound and a thoroughly assured sense of flowing time, but he too is more a consolidator of others' innovations than a strikingly personal soloist. Within these limits, however, both produce attractive music.

This album contains rolling blues, ambling ballads, a beguiling blues waltz (*Ladyfingers*), and an interpretation of *Goin' Home* that puts more of the Negro musical heritage into that theme than Dvořák was in a position to know when he adapted it for symphonic purposes. Guitarist Kenny Burrell is aptly mellow and pulsating, and bassist Bob Cranshaw and drummer Otis Finch lay down

AUGUST 1965

dust, (dust), n. grime, smut, soot (UNCLEANNES); soil, earth, ground (LAND); powder, sand, grit (POWDERINESS).

NEW DUST COVER FITS ALL MIRACORD TURNTABLES; ALSO OTHER MAKES
Protect your turntable while not in use with this impact-resistant, heavy-gauge, vacuum-formed clear plastic cover. Fits units mounted on base, on board, or in cabinet enclosure. Measures 13½ x 15¾ x 3¾ inches. \$5.95 at most high fidelity dealers. Benjamin Electronic Sound Corporation, 80 Swalm Street, Westbury, New York.



Benjamin DC-2

CIRCLE NO. 8 ON READER SERVICE CARD
FOR STORES "WHERE YOU CAN BUY"—SEE LAST PAGE.



The
sound
is
why



Harman-Kardon Stratophonic is the biggest-selling all-transistor stereo

This incredibly pure, *spacious* sound has captivated discerning ears throughout the nation. And only Harman-Kardon offers a choice of four completely solid-state FM or AM/FM stereo receivers, from 36 to 75 watts, *plus* an all-transistor 36-watt amplifier and an all-transistor AM/FM stereo tuner—all with the performance that has come to be

known as Stratophonic Sound. At your Harman-Kardon dealer's you can learn first-hand that "the sound is why."

harman kardon

A subsidiary of THE JERROLD CORPORATION
15th & Lehigh Ave., Philadelphia, Pa. 19132
In Canada: Charles W. Poynton Ltd., Rexdale, Ontario
Export agency: E.M.E.C., 160 Terminal Ave., Plainview, N.Y. 11803

LEADER IN SOLID-STATE STEREO COMPONENTS

CIRCLE NO. 28 ON READER SERVICE CARD
FOR STORES "WHERE YOU CAN BUY"—SEE LAST PAGE.



DYNACO

STEREODYNE III stereo phono cartridge by B & O

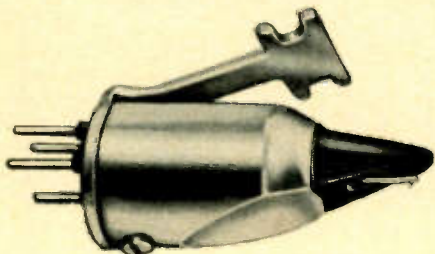

"one of the truly
musical pickups"

With the exception of loudspeakers, no part of your music system affects its quality as much as the choice of a phonograph cartridge.

Specifications and test reports, while helpful, cannot substitute for a thorough listening evaluation in making so crucial a decision.

The Stereodyne III is the latest refinement by E. R. Madsen of Bang and Olufsen, who first recognized the importance of standardizing on a 15° stylus angle. In separate arms, as well as in the better changers, its clearly superior sound will be apparent.

- Wide, smooth response
- Lower distortion
- Less crosstalk
- Lowest hum (by a mile!)
- Replaceable stylus
- 15° vertical angle
- just \$19.95

Be sure you listen to
this cartridge at your
audio specialist's showroom

DYNACO INC.
3912 POWELTON AVENUE
PHILADELPHIA, PA. 19104

CIRCLE NO. 21 ON READER SERVICE CARD
FOR STORES "WHERE YOU CAN BUY"
SEE LAST PAGE.

a resilient four-voice ensemble of this music cuts very deeply, but as unpretentious jazz-as-pleasure, the album can be recommended.

N. H.

© M LARRY YOUNG: *Into Somethin'*. Larry Young (organ), Sam Rivers (tenor saxophone), Grant Green (guitar), Elvin Jones (drums). *Tyrone; Plaza de Toros; Paris Eyes; Backup; Ritba*. BLUE NOTE ST 84187 \$5.98, 4187* \$4.98.

Performance: Crisp and lean
Recording: Good
Stereo Quality: Good

The quartet of organ, tenor sax, guitar, and drums has become such a standardized grouping in the last few years that I hardly expect anything from it any more, and I am a little leery of new examples. A superior organ-tenor combo record, such as this one, comes then as an especially welcome surprise.

Much of the credit goes to the organist-leader, Larry Young. Most organists set everyone else awash in a swamp of electronic sound. Not Young. He is clean and lean, showing concern for matters of balance and coherence within the group. He has, as well, a fine feel for straightforward single-note blues lines, well complementing the talents of guitarist Grant Green. Tenor saxophonist Sam Rivers has some of the Rollins-Coltrane licks that almost everyone does nowadays, but he is a mellower, softer player than either, and this is the key to his individuality. The superb drummer Elvin Jones has cannily modified his style for this context and is a considerable asset to the date. The result is one of the best organ-combo records I have heard in a long time.

J. G.

FOLK

RECORDING OF SPECIAL MERIT

© M DORSEY DIXON: *Babies in the Mill*. Dorsey Dixon (vocals, guitar), Howard Dixon and Nancy Dixon (vocals). *I Saw the Wood; Pin Ball Machine; Burglar Man; Our Johnny*; and fifteen others. TESTAMENT T-3301. \$4.98 postpaid (from Testament Records, P. O. Box 1813, Chicago 60690).

Performance: Authentic, authoritative
Recording: Competent to good

Sixty-seven-year-old Dorsey Dixon has worked in the textile mills of North and South Carolina for most of his life. By avocation, he has been a singer and guitarist specializing in the traditional secular and religious songs of his region as well as in work songs that have come out of the mills of the Southeast. Also a composer, Dixon has contributed valuably to the heritage of American industrial songs. He and his brother Howard recorded for a few years in the 1930's, but they remained in the mills. Howard died at work in 1961, and two years later, Dorsey Dixon returned to the attention of folk collectors through an appearance at the Newport Folk Festival. Since then he has recorded for Piedmont and for the Library of Congress.

This disc contains a full-scale collection of his singing, guitar playing, and compositions taped in 1962. Three of the original Bluebird records by the Dixon Brothers have been added, and Dorsey's sister Nancy, now 72, also sings on two tracks. The Bluebird material includes the durable *Weave Room Blues*, a notably effective use of the white

blues tradition in picking up the pressures of factory life. Of the newer performances, there are comic pieces, mill songs, sacred tunes, railroad ballads, and the persistently popular *Wreck of the Old 97*.

Dixon's voice has a gnarled quality, and through it he animates these life fragments of a Southern mill worker with the authority of a man who has endured and prevailed.

Two solos by Nancy Dixon are especially affecting—*Hard Times in Here* and *Factory Girl*. The latter is a 130-year-old New England broadside; Miss Dixon learned it during her first year of employment (when she was eight years old). As social documents, these and the other tracks are invaluable. As the still vivid record of an indomitable family, the performances make these rough-hewn musical autobiographies immediate.

Archie Green, one of the country's wide-ranging folk music experts and a specialist in industrial songs, has produced and annotated



DORSEY DIXON
Immediacy for songs of mill-town life

this album with the care that a project of this importance merits. The booklet of notes includes a bibliography as well as references to other interpretations of these songs. N. H.

© M MIMI AND RICHARD FARIÑA: *Celebrations for a Grey Day*. Mimi Fariña (vocals, guitar, and autoharp), Richard Fariña (vocals and dulcimer). *Hamish; Tuilevies; Another Country; Dog Blue; The Falcon*; and eight others. VANGUARD VSD 79174 \$5.98, VRS 9174 \$4.98.

Performance: Varies
Recording: Good
Stereo Quality: Good

Richard Fariña is a serious writer, and his wife Mimi is the younger sister of folk singer Joan Baez. This is their first recording as a folk act. Since there is some enjoyable music to be found on their disc, I suggest that you play it immediately without being put off by Mr. Fariña's liner notes, which are probably the most pretentious I have ever read.

Seven of the thirteen tracks are instrumental. Although most of these, especially the title track, are very good, there is only so much that can be done with dulcimer and guitar, and it doesn't take seven tracks to exhaust the possibilities.

century geographical treatise explaining that the world is flat. As music, it leaves me utterly uninterested. G. L.

SPOKEN WORD

© **THE STATE FUNERAL OF SIR WINSTON CHURCHILL.** Richard Dimbleby, commentator. UNITED ARTISTS UAL 3427 \$3.98.

Performance: Lugubrious
Recording: Flot

If you like funerals, especially big, official ones, complete with hymns, dead marches, and speeches, by all means add this one to your collection. The laconic, typically BBC voice of Richard Dimbleby narrates, and the music, consisting of Churchill's favorite hymns, is solemn, noble, and not very well recorded. Sir Robert Menzies declares that "Winston Churchill was not an institution but a man," and then does his best to institutionalize him; no other than Dwight D. Eisenhower recites *Crossing the Bar*; the train departs for the cemetery; Mr. Dimbleby reads a closing poem.

Personally, I find Mr. Churchill's memory better served through any of the several fine albums offering passages from his speeches and memoirs—I prefer to think of him as alive, witty, and the pivot of great events rather than as the passive subject of sad eulogies and sermons. P. K.

© **ROBERT LOWELL: *Benito Cereno.*** Lester Rawlins, Jack Ryland, Roscoe Lee Brown, Frank Langella, Clayton Corbin,



ROBERT LOWELL
His Benito Cereno is dynamic theater

Michael A. Schultz, and others. Jonathan Miller, director. COLUMBIA DOS 719 \$11.94, DOL 319* \$9.94.

Performance: Spooky
Recording: Exceptionally alive
Stereo Quality: Adds to atmosphere

Benito Cereno opens with a visit by a Yankee merchant captain, Amasa Delano, and his stuffy New England mate to a slave ship anchored somewhere off South America early

in the 19th century. They find the ship and its captain, a blue-blooded Spaniard named Cereno, in seedy condition, with slaves roaming the decks. A curious, smilingly unctuous servant named Babu dogs the captain's footsteps.

The action unfolds in a series of hypnotic episodes: the natives enact bizarre rituals before the officers, and Cereno is shaved by Babu, who uses the Spanish flag as an apron. Slowly the full horror is revealed—in a mutiny, Don Aranda, the ship's co-owner, has been murdered, and his skeleton set up as a totem and figurehead. Cereno is a prisoner aboard his own vessel, and Babu is the real power. He forces Delano and his mate to kiss the skeleton and tells Delano he must take the slaves on the pirated ship to Africa. But American sailors arrive and massacre the slaves. Delano tells Babu: "The future is with us—this is your future!" and then shoots him down.

The play is based on a short novel by Herman Melville. In Melville's murky, spine-tingling narrative all is innuendo, and dialogue is sparse. There is some hint of political allegory and perhaps of prophecy, but never an overt preaching. For the American Place Theatre production duplicated here, Robert Lowell has fashioned a brilliant adaptation, filling in the outlines of Delano's character and making dynamic theater out of wispy clues in the story. He has also succumbed, however, to the temptation to supply direct prophecy, and he has drawn gratuitous parallels with contemporary political issues, notably, of course, the struggle for Negro rights. These interpola-

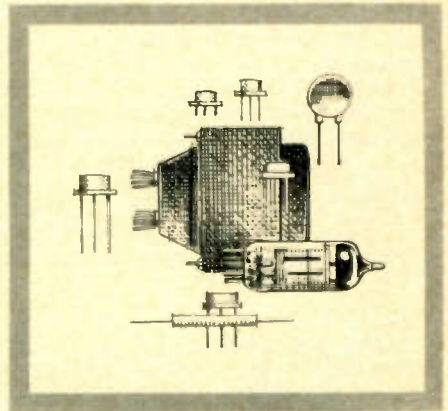
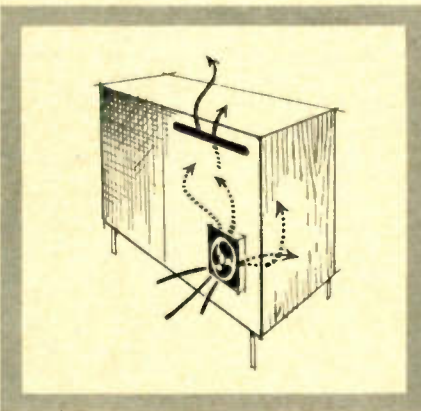
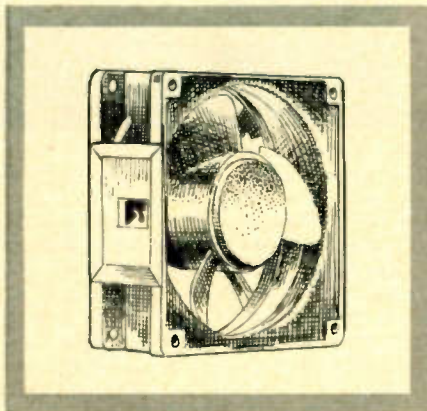

KEEP

IT

COOL

A QUICKLY AND EASILY INSTALLED WHISPER FAN KIT COOLING YOUR HI-FI EQUIPMENT...

BREATHES 65 CUBIC FEET OF COOL AIR PER MINUTE THROUGHOUT THE ENCLOSURE...

THOSE HEAT GENERATING TRANSISTORS, TUBES AND COMPONENTS FOR ADDED LIFE...

Whisper Fan
KIT

The WHISPER FAN beats the heat that wrecks the set. Engineers have found that up to 40% or more life can be added to computer systems when components are properly cooled. And the life of your hi-fi, TV or ham equipment will be shortened unless you provide for the dissipation of the heat generated by transistors, tubes, transformers and other components. In addition, the Whisper Fan improves equipment performance by minimizing component drift due to heat and eliminates hot spots due to eddies.

Measuring only 4 1/16" square and 1 1/2" deep, it can be set in a corner or mounted on the rear panel in just minutes. The Whisper Fan requires only 7 watts, just pennies a week to operate. Whisper Fan Kit comes complete with mounting hardware, plug and cord for electrical connections and installation instructions. Cost only \$14.85 □ Write for descriptive literature and name of nearest dealer.

ROTRON MANUFACTURING COMPANY, INC.
WOODSTOCK, NEW YORK
West Coast: Rotron / Pacific, Glendale, Calif.
Canada: The Hoover Co., Ltd., Hamilton, Ont.

THE MAGNIFICENT NEW MOVIE THEMES

from THE YELLOW ROLLS-ROYCE . . .
ZORBA THE GREEK . . . VON RYAN'S
EXPRESS . . . THE SANDPIPER . . .
MARY POPPINS . . . GOLDFINGER . . .
plus 6 more great ones



ENOCH LIGHT

and the Light Brigade

featuring Doc Severinsen, trumpet; Tony Mottola, guitar; Robert Maxwell, harp; Dick Hyman, harpsichord, and 35 of America's greatest musicians. The fascinating and memorable new style of movie themes has inspired Enoch Light to a new approach to movie theme recording. Light gives each stunning tune a special musical setting specifically designed for its mood, its quality and its content. Each theme, in fact, is as much an exciting and vital production, in a musical sense, as the film for which it was originally written.

THEME FROM ZORBA THE GREEK • "LOVE ME NOW" FROM THE THIRD DAY • "VON RYAN'S MARCH" FROM VON RYAN'S EXPRESS • "FORGET DOMANI" FROM THE YELLOW ROLLS ROYCE • "THE SOUND OF MUSIC" FROM THE SOUND OF MUSIC • "I REMEMBER HER SO WELL" FROM FANNY HILL • GOLDFINGER • SHIP OF FOOLS • THEME FROM THE AMOROUS ADVENTURES OF MOLL FLANDERS • "CHIM CHIM CHER-EE" FROM MARY POPPINS • LOVE THEME FROM THE SANDPIPER (THE SHADOW OF YOUR SMILE) • DEAR HEART

#887 AVAILABLE IN STEREO, MONAURAL AND
4 TRACK TAPE

WRITE FOR FREE FULL COLOR BROCHURE OF ALL
COMMAND RELEASES

WORLD LEADER IN RECORDED SOUND

Command RECORDS

A Subsidiary of ABC-Paramount Records, Inc.
1501 Broadway, New York 36, N. Y.

CIRCLE NO. 15 ON READER SERVICE CARD
102

tions mar an otherwise most arresting play.

The production on records, under Jonathan Miller's direction, moves slowly but grippingly to the horror of the climax, employing sound with great imagination to convey the immediacy of the locale, the chanting of the slaves, and the sense of darkness.

The cast is superb—Lester Rawlins the essence of complacency as Captain Delano; Jack Ryland a perfect Yankee prig; Frank Langella a wan and decadent Don Benito. Most effective of all are the simpering, ironic insinuations of Roscoe Lee Browne's Babu, with hints of half-concealed hysteria. *Benito Cereno* emerges on records as a tighter and even spookier exercise than it was on the stage with the same performers. P. K.

RECORDING OF SPECIAL MERIT

Ⓢ Ⓜ THE BEST OF MIKE NICHOLS
AND ELAINE MAY. MERCURY SR 60997
\$4.98, MG 20997* \$3.98.

Performance: Top of the top
Recording: Excellent
Stereo Quality: Satisfactory

America has gained a clever playwright in Elaine May and a fine director in Mike Nichols, but it lost its worthiest comedy team when these two began to pursue separate careers. This treasury of gems from three of their records—three of the best comedy records ever made in the first place—includes the now classic dialogue with the telephone company ("Oh, no sir. Bell Telephone doesn't need your dime") with Nichols as the frustrated pay station patron and Miss May as practically the entire Bell System. Also included are the analyst who reminds her patient of his mother; the re-enactment of practically all the dialogue from Noel Coward's *Brief Encounter* in a dentist's office with the Rachmaninoff Second Piano Concerto throbbing away in the middle distance; the young executive luring his secretary to his apartment by praising her skill at the mimeograph machine; two pseudo-highbrows expiring over Bach ("There are no absolutes in a relationship"); and others. I regretted only the omission of any samples at all from "An Evening With Elaine May and Mike Nichols," especially the phone conversation between Jewish mother and astronaut. Never mind—the editors must have had a hard enough time choosing from such a wealth of material, as it was. Some of the stereo has been put in electronically but with such skill that it's indistinguishable from the real thing. P. K.

RECORDING OF SPECIAL MERIT

Ⓢ Ⓜ EUGENE O'NEILL: *Hughie*. Jason Robards and Jack Dodson (players). José Quintero, director. COLUMBIA OS 2760
\$5.98, OL 6360* \$4.98.

Performance: Supreme
Recording: True-to-life
Stereo Quality: Accents movement

O'Neill began *Hughie* as part of a series of eight one-act plays he planned to call *By Way of Obit*. He never finished any of the others, but the word "obit" (slang for obituary) is a good description of *Hughie*—it is a factual, shrewd, but humane summation of a life.

The scene is the lobby of a shabby Broad-

way hotel at three in the morning, circa 1928. Enter Erie Smith, a middle-aged "Broadway sport and wise guy," as the playwright describes him, whose "sentimental softness . . . doesn't belong in the hard-boiled picture." He starts talking to a seedy, bored night clerk about his predecessor Hughie, the erstwhile sounding-board for Erie's monologues and a "sap, who cheated on his wife usin' me and my dolls." A dual portrait emerges—of Erie, a Runyan tintype transformed by the playwright into a three-dimensional man, and of Hughie, who was nothing yet everything: gullible and weak, but essentially decent, honest, simple, stable, and human. The plot is a wisp, but as it unfolds, the play's sense of life becomes irresistible.

Robards, whose recording of dramatic readings from other O'Neill works (Columbia OL 5900) is one of the best spoken-word records available, spares none of his formidable talent to elicit from the audience con-



ELAINE MAY AND MIKE NICHOLS
Together again in a treasurable collection

tempt, attention, then identification and compassion for the small-time tout Erie. Quintero's taut direction utilizes everything from traffic sounds to footsteps echoing in the deserted lobby in order to give the restless, garrulous Erie a realistic backdrop. Too short for a full evening at the theater, but the perfect length for home listening, *Hughie* comes across as a powerful tour de force.

P. K.

RECORDING OF SPECIAL MERIT

Ⓢ Ⓜ SHAKESPEARE: *Henry IV, Part II*. Max Adrian, Harry Andrews, Felix Aylmer, Pamela Brown, Dame Edith Evans, Richard Johnson, Miles Malleon, Anthony Quayle, Joyce Redman. Peter Wood, director. CAEDMON SHAKESPEARE RECORDING SOCIETY 218
four 12-inch discs \$23.80 stereo and mono.

Performance: Full-blooded
Recording: Excellent
Stereo Quality: Wraparound

By the end of *Henry IV, Part I*, Hotspur and a number of other conspirators against the king are either dead or defeated. *Part II* is concerned mainly with a plan to trick the remaining rebels into dismissing their forces
(Continued on page 104)

HIFI/STEREO REVIEW

“Until just recently, I have been somewhat skeptical about low priced transistor amplifiers. However, after testing and listening to the Heath AA-22, I feel it is time to revise my opinion. This remarkable amplifier can easily hold its own against any amplifier — tube or transistor — anywhere near its price range.”

JULIAN D. HIRSCH, Hi Fi/Stereo Review, Nov. '64

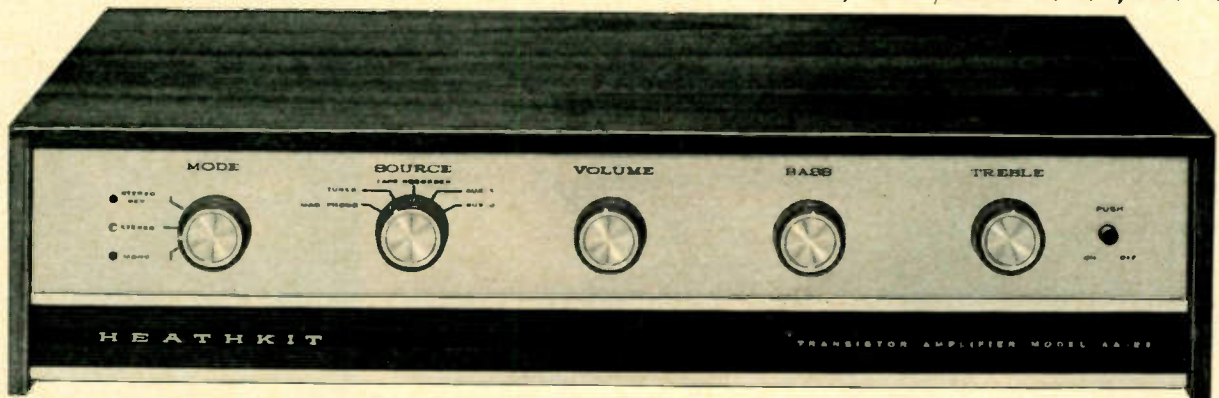

Heathkit® 40-Watt Transistor Stereo Amplifier \$99⁹⁵!

Mr. Hirsch Went On To Say: “It is the embodiment of the so-called ‘transistor sound’ — clean, sharply defined and transparent. It has the unstrained effortless quality that is sometimes found in very powerful tube amplifiers, or in certain expensive transistor amplifiers.” “The AA-22 is almost unique among amplifiers at or near its price, since it delivers more than its rated power over the entire range from 20 to 20,000 cps” . . . “The power response curve of this amplifier is one of the flattest I have ever measured” . . . “Its RIAA phono equalization was one of the most precise I have ever measured” . . . “Intermodulation distortion was about 0.5% up to 10 watts, and only 1% at 38 watts per channel, with both channels driven” . . . “The hum and noise of the amplifier were inaudible” . . . “Hi Fi/Stereo Review’s kit builder reports that the AA-22 kit was above average in ‘buildability’” . . . “In testing the AA-22, I most appreciated not having to handle it with kid

gloves. I operated it at full power for long periods, and frequently overdrove it mercilessly, without damage to the transistors, and with no change in its performance measurements” . . . “One of the best things about the Heath AA-22 is its price, \$99.95 in kit form, complete with cabinet.”

Let’s Look Closer! The AA-22 provides 40 watts continuous, 66 watts IHF music power at ± 1 db from 15 to 30,000 cps. Features 5 stereo inputs to handle mag. phono, stereo-mono tuners, tape recorders, & 2 auxiliary sources. There are 4, 8 & 16 ohm speaker outputs plus tape recorder outputs; a 5-position selector switch; 3 position mode switch; dual-tandem control; bass & treble controls.

Get Full Details Free! Simply use coupon below. Or better yet, order both the AA-22 Amplifier & its matching AJ-33 tuner now! Kit AA-22, Amplifier, 23 lbs. \$99.95

“WILL GET ANY STATION THAT CAN POSSIBLY BE PULLED IN”



Matching AM /FM /FM Stereo Tuner

The above quote comes from July '64 issue of *Radio-Electronics*.

The matching AJ-33 tuner features a built-in stereo demodulator; AGC for steady volume; AFC for drift-free reception; stereo indicator light; stereo phase control for maximum separation, minimum distortion; filtered stereo outputs; tuning meter; flywheel tuning; voltage regulated power supply; illuminated FM “front-end” tuner and AM-FM I.F. circuit board for fast, easy assembly.

Kit AJ-33A, Tuner, 17 lbs. . . Now only \$94.50



FREE 1965 CATALOG!

See these and over 250 other exciting Heathkits available in easy-to-build kit form. Save 50% or more by doing the easy assembly yourself! Send for your free catalog today!

HEATH COMPANY, Dept. 40-B
Benton Harbor, Michigan 49023
In Canada: Daystrom, Ltd., Cooksville, Ontario

Enclosed is \$ _____, plus shipping. Please send Kit(s) _____
 Please send Free 1965 Heathkit Catalog.

Name _____ (Please Print)

Address _____

City _____ State _____ Zip _____

Prices & specifications subject to change without notice.

HF-179



You can now bring home a complete color slide show (24, 40, or 72 perfectly exposed pictures) on just one roll of 35mm color film with the new fully automatic **FUJICA DRIVE** half size 35mm camera



It sets both correct shutter speed and lens opening all by itself. Advances film all by itself. It has a 5 element f/2.8 fast lens. Now at your camera dealer. Less than \$75

Or write for booklet to:

FUJI PHOTO OPTICAL PRODUCTS, INC.
A subsidiary of
Ehrenreich Photo-Optical Industries, Inc.
623 STEWART AVENUE, DEPT. A-19
GARDEN CITY, NEW YORK
New York City Showroom,
111 Fifth Avenue

CIRCLE NO. 27 ON READER SERVICE CARD
104

by promising that their grievances will be redressed. When the bait is taken, Henry's son, Prince John, sees to it that the principal insurgents are arrested for treason and their scattered troops tracked down and slain.

The real heart of the play, of course, lies not in these intrigues but in the personality of Sir John Falstaff, rascally, roistering companion of the king's early days. Shakespeare undoubtedly built up the part in response to popular demand, and the reason is more than clear—the tavern scenes with Falstaff and his cronies are like Brueghel paintings come to life, spiced with high seasonings of wit and drunken merriment. Anthony Quayle elaborates the wonderful portrait of Falstaff he began on the Caedmon recording of *Part I*, and Dame Edith Evans adds new vigor to the role of the tavern hostess Mistress Quickly. Joyce Redman is a rowdy Doll Tearsheet, and Max Adrian a sly cartoon of the country justice Shallow. These episodes are so satisfying that one cares little what happens to Henry. This is an unusually worthwhile release. P. K.

RECORDING OF SPECIAL MERIT

Ⓢ Ⓜ WILLIAM SHAKESPEARE: *King Lear*. Paul Scofield, Rachel Roberts, Pamela Brown, Ronnie Stevens, Cyril Cusack, Robert Stephens, John Stride, Ann Bell. Howard Sackler, director. CAEDMON SHAKESPEARE RECORDING SOCIETY 233 four 12-inch discs stereo and mono \$23.80.

Performance: **Awesome**
Recording: **Perfect**
Stereo Quality: **Excellent**

Howard Sackler's wonderfully imaginative conception of *King Lear* for the phonograph would be difficult to equal on the stage. When, for example, Lear begins to lose his mind amid the pelting of the rain and the roaring of the thunder—when all nature seems in sympathy with the king's disasters—the resources of the recording medium serve to widen the listener's perspectives on the action and its meaning.

In addition, this production is blessed with an astonishingly skillful cast. With the king's opening lines, Paul Scofield arrests attention, his voice seeming to seek the strength to convey anger through a quaver that immediately suggests near-senility. As the play proceeds, Scofield calls upon his apparently limitless reserve of vocal power and subtlety to find for every passage the tone, the pace, and the rhythm it requires. Robert Stephens fills out the role of Edgar with remarkable versatility, John Stride makes a most interesting fellow of the scheming Edmund, and Cyril Cusack is so melodious and winning as Gloucester that he makes the old man almost an operatic figure. Lear's Fool, who chides the king with epigrams and doggerel, is zestfully played by Ronnie Stevens. Pamela Brown's Goneril and Rachel Roberts' Regan are almost caricatures, but their exaggerations are never inappropriate. I was disappointed only by Ann Bell's Cordelia, who seems to be rather more like Snow White than the iron-willed girl the lines of the play make her.

Two other effective recordings of *Lear* are available—the Dublin Gate Theatre's on Spoken Arts (A9), and the Marlowe Society's on London (1414, 4423). But these are left far behind by this soaring new Caedmon album. P. K.

Ⓢ Ⓜ SHAKESPEARE: *Pericles, Prince of Tyre*. William Squire, Prunella Scales, Frank Duncan, Michael Hordern, Peter Orr, Tony Church, Gary Watson, David King, Margaret Rawlings, Janette Richer, Denis McCarthy. George Rylands, director. LONDON OSA 1377 three 12-inch discs \$17.94, A 4377* \$14.94.

Performance: **Colorful**
Recording: **Resourceful**
Stereo Quality: **Fine**

"Some mouldy tale" is what Ben Jonson called *Pericles* back in 1631, and it hasn't grown any less mouldy with the years. The adventures of the Prince of Tyre are utterly preposterous. He tries to win the daughter of Antiochus, King of Antioch, away from her incestuous father and is forced to flee the country to escape the king's assassins. He is later shipwrecked in a storm and cast on the coast of Pentapolis, where he wins

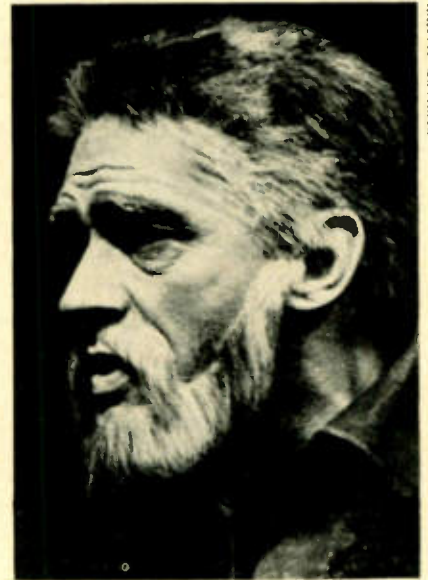

PAUL SCOFIELD AS LEAR
Limitless resources of power and subtlety

another king's daughter as a prize in a tournament. Pericles sets out for home with his new wife, but carelessly loses her in another storm at sea just after she bears him a daughter. A kindly doctor turns up conveniently on the beach to bring the wife around, and gets her in as a priestess in the temple of Diana at Ephesus. The daughter, Marina, is brought up by Pericles' friend Cleon while Dad goes off on further journeys. When Marina grows up, pirates kidnap her and sell her to a brothelkeeper. She is so virtuous, however, that she converts all the customers into pious Christians and emerges from bondage still virginal. Marina is eventually reunited with her father and, finally, at the Temple in Ephesus, with her mother. Have you followed?

In spite of all this nonsense there is much that is lovely in the play's twenty-two scenes, and the present production takes full advantage of the opportunities for evoking a magical atmosphere—the whistling of the wind and feverish tossing of the seas in the storm scenes, the sounds of pageantry at tournament and wedding festivals. William Squire is an ardent Pericles, and Prunella Scales makes Marina a wistful, appealing child caught among ogres in a fairy tale. Peter Woodthorpe as the brothelkeeper, Patrick Wymark

as his servant Boulton, and Patsy Byrne as the "Bawd" stir up much earthy excitement in their respective episodes. And from time to time the authentic Shakespearian lyric speech comes through, making one forgive the foolishness of this yarn. P. K.

Ⓜ **TURKISH FOLKTALES:** *Altin Samdan (The Golden Candlestick)*, Dikmen Gürün (narrator); *Deli Mehmet ve Üç Rabip (Crazy Mehmet and the Three Priests)*, Erdal Birkan (narrator). FOLKWAYS FL 9922 \$5.95.

Performance: Miss Gürün is a delight
Recording: Amateurish

By billing Miss Gürün and Mr. Birkan as "narrators," Folkways implies that this recording of Turkish folk tales captures professional Middle Eastern storytellers at work. It does not. Their intonation and the noisy turning of pages make it clear that both performers are reading their stories. Nevertheless, Miss Gürün quickly creates a long-ago-and-far-away atmosphere. She has the kind of womanly charm and narrative skill with which Sheherazade beguiled King Shahriyar for a thousand and one nights. Sensitive to the beauties of the Turkish language, Miss Gürün seems to take pleasure in speaking it. She renders the dialogue especially well, bringing to life each of the tale's many characters in only a line or two. In the narrative sections suspense never lags as she relates the adventures that lead the merchant's beautiful daughter to the predictable happy ending and marriage to the son of the sultan.

Mr. Birkan is far less successful. His tale of the murder of four priests is dull, and his manner of reading it is duller. There is something mildly irritating about his rather purse-lipped enunciation—it makes his Turkish sound smug.

Technically, the whole undertaking is quite unprofessional. Miss Gürün's reading is marred by heavy distortion (due, I think, to microphone overloading), and Mr. Birkan's side is sonically even worse. He sounds as though he were reading in a diving bell under water. One can also occasionally hear the turns of a squeaky tape reel, and the tape had apparently been inefficiently erased.

The American market for spoken records in a language as exotic as Turkish is, at best, minute. There is no sizeable colony of Turks in the United States, the language is taught at very few universities, and this disc would be beyond the comprehension of beginning students anyway. Presumably, then, this record was made for the benefit of the few linguists, folklorists, and other scholars who might be interested in Turkish material. But the notes tell us nothing about the origins of these particular versions of the two tales and nothing about the readers except that Miss Gürün is from Iskenderun and Mr. Birkan from Ankara. The printed Turkish texts are an inaccurate transcription of what the readers actually say on the disc, and the English translations are undistinguished.

If there is an aching void in your collection for a recording of folk-tales in Turkish, you might as well settle for this one, despite its many shortcomings, because we are not likely to see another one soon. Someone at Folkways apparently thought it was important to make this disc available to the public—I wonder why they didn't think it important to do a better job. *William Livingstone*

WITH A REK-O-KUT R-34, YOU GET "QUIET" YOU CAN HEAR



Rek-O-Kut R-34 owners have come to call our turntables "The Quiet Ones". It's because when you listen to records on the R-34, you can actually "hear" the quiet. Rumble? It's down 60 db below average recorded levels. Flutter? Wow? So little it's undetectable by human ears. Listen for yourself. See if you can't hear the quiet. It's a reflection of Rek-O-Kut quality . . . quality so fine we even provide you with a 5 year warranty.

REK-O-KUT R-34 Turntable \$89.95



also manufacturers of famous Koss Stereophones

KOSS REK-O-KUT

2227 NORTH 31st STREET
MILWAUKEE, WISCONSIN 53208

CIRCLE NO. 35 ON READER SERVICE CARD
FOR STORES "WHERE YOU CAN BUY"—SEE LAST PAGE.

SAVE over 40% on hi-fi

COMPONENTS & TAPE RECORDERS

- Easy-Pay-Plan—Up to 24 mos. to pay
 - 15 day money-back guarantee.
 - Franchised all lines, assuring you up to 5 yr. Mfr. Warranty.
 - Most items shipped promptly from our \$250,000 inventory.
 - Trade-Ins—Highest allowance—Send your list.
 - Shipments double packed & fully insured.
 - Special Consideration—Export & APO inquiries.
 - 21st yr. dependable service—World Wide.
- Write for price, and receive FREE—\$1.00 List—Clip-on-Record Brush or Record Cloth (please specify)

We own the sharpest pencils in the U.S.A.



RECORDING TAPE

The Most Trusted Name in Sound

				3-11	12
10A	3"	225'	Acetate	ea. .39	.35
702C1	7"	1200'	Acetate	ea. 1.59	1.49
708C1	7"	1800'	Mylar	ea. 2.59	2.49
710C1	7"	2400'	Ten.Myl.	ea. 3.49	3.29

Minimum Order \$10.00. All Prices include shipping USA, APO.

Any assortment permitted for best price. Please write for types not listed.

HI-FIDELITY

CENTER

"The House of Low Low Prices"

1797-A 1st Ave.
New York, N. Y. • 10028

CIRCLE NO. 30 ON READER SERVICE CARD

for the critical ear

SHURE

Stereo Dynamic

HIGH FIDELITY PHONO CARTRIDGES

MUSICAL BEST-BUY

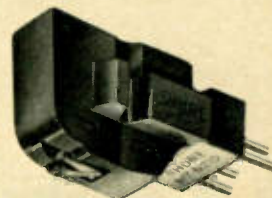

MODEL M7/N21D

Top-rated cartridge featuring the highly compliant N21D tubular stylus. Because of unusually clean mid-range (where most music really "happens") it is especially recommended if your present system sounds "muddy." For 2-gram optimum tracking (not to be used over 2 1/2 grams). Only \$17.95 (Also, if you own an M3D or M7D, you can upgrade it for higher compliance, if tracking force does not exceed 2 1/2 grams, with the N21D stylus for only \$12.50.)

Write for literature:

SHURE BROTHERS, INC.

222 HARTREY AVE., EVANSTON, ILLINOIS

CIRCLE NO. 67 ON READER SERVICE CARD

Silentex

We think new about ceilings

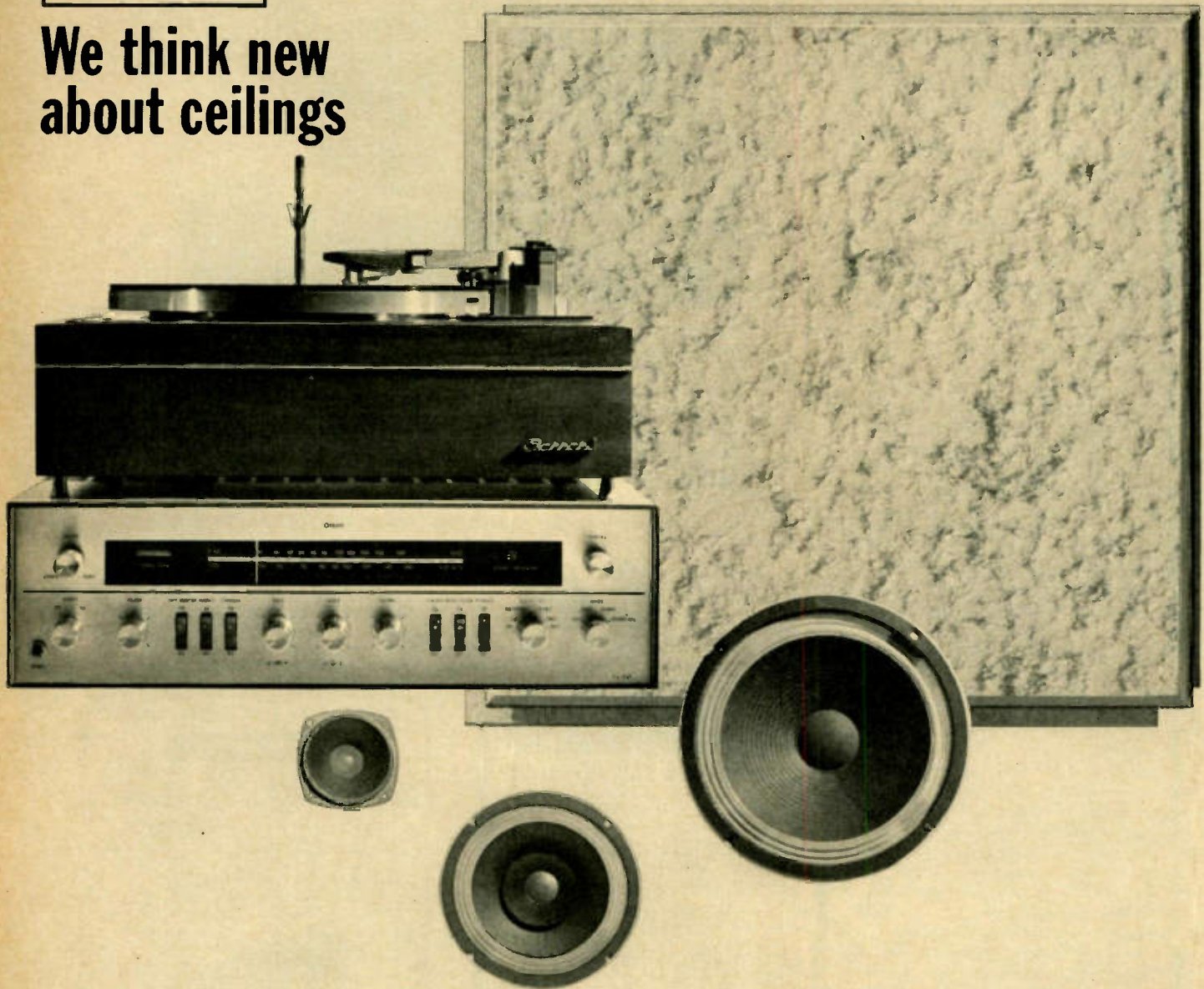

Think of Silentex ceiling tile as one of your hi-fi components.

Most auditoriums, concert halls and recording studios are treated acoustically. If your listening area is too live or over-reverberates, treat it acoustically with low-cost Gold Bond Silentex—the most effective acoustical tile you can buy. It absorbs up to 80% of the noise reaching it, kills reflected out-of-cycle sound to give concert-hall fidelity. You get more realism from your rig. Silentex is beautifully brush-textured, has no unsightly holes. Goes up in a hurry. Your Gold Bond® Building Supply Dealer will show you how. Thinking about listening enjoyment? Think new with Silentex®. National Gypsum Company, Department HF-85, Buffalo, New York 14255.

Gold Bond®
CEILING TILE

One of the many fine products that come from 40 years of thinking new

NGC NATIONAL GYPSUM COMPANY

CIRCLE NO. 44 ON READER SERVICE CARD



FOR STORES "WHERE YOU CAN BUY"—SEE LAST PAGE.



HIFI/STEREO REVIEW'S CHOICE OF THE LATEST RECORDINGS STEREO TAPE

Reviewed by DAVID HALL • IGOR KIPNIS • GENE LEES

RECORDING OF SPECIAL MERIT

© **BRITTEN:** *Albert Herring*. Peter Pears (tenor), Albert Herring; Sylvia Fisher (soprano), Lady Billows; Johanna Peters (contralto), Florence Pike; April Cantelo (soprano), Miss Wordsworth; John Noble (baritone), the Vicar; Edgar Evans (tenor), the Mayor; Owen Brannigan (bass), Superintendent of Police; Joseph Ward (baritone), Sid; Catherine Wilson (mezzo-soprano), Nancy; Sheila Rex (mezzo-soprano), Mrs. Herring; Sheila Amit (soprano), Emmie; Anne Pashley (soprano), Cis; Stephen Terry (treble), Harry. English Chamber Orchestra, Benjamin Britten cond. LONDON LOR 90090 two reels \$21.95.

Performance: Flawless
Recording: A-1
Stereo Quality: Highly effective

Anyone who has ever been exposed to much small-town life, even as a regular summer resident, will find Benjamin Britten's *Albert Herring* a singularly entertaining experience. One of the most striking aspects of Britten's great tragic opera *Peter Grimes* (taped on London LOR 90083) is the unerringly accurate characterization of the various village types living and working in the Borough. *Albert Herring* tells the tale of a mother-bedeveled milquetoast of a lad who is named King of the May (there being no girls in town deemed virtuous enough to be Queen). At the ensuing May Day celebration, Albert's lemonade is spiked with rum, and the village of Loxford is subsequently thrown into an uproar as Albert disappears on an all-night toot. Eventually he does return, somewhat chastened—but also man enough to let his mother know who runs the show from now on.

The opera that Britten has fashioned around this story amounts to a delightful portrait of a country town in action, with all its pomposities and foolishness (Lady Billows), scenes of young love (Sid and Nancy), and moments of pathos (Albert versus his mother). Britten's music is apt and clever, and Eric Crozier's beautifully turned text is eminently singable and understandable.

The situations and types that turn up in the course of the action afford Britten a number of opportunities for delicious musical parody, both as to style (the Victorian tone of the Vicar's "Virtue, says Holy

Writ") and form (the fugue on "Albert the Good" at the climax of the May Day festivities). The spiking of Albert's rum is accompanied by an apposite musical quote from Wagner's *Tristan und Isolde*. The light touch is preserved in the orchestral texture, which is magically spun out by a mere dozen players under Mr. Britten's baton.

It is impossible to single out any one member of this cast as outstanding. Everyone, from Peter Pears in the title role to the boy treble Stephen Terry, treats his work here as a true labor of love. The recorded sound (and there are special sound effects) is altogether masterly. Two-and-a-half hours

treatment of this great score, as opposed to the generally taut and hard-driving approach of the two latter conductors, may find the Ansermet interpretation very much to their taste. For myself, I am still looking for a perfect combination of the two approaches.

The music for Stravinsky's ballet *Le Baiser de la fée*—based on themes from Tchaikovsky, for the most part from his piano music and songs—appears here complete for the first time on tape, and in fact for only the second time in any recording medium. (The 1956 recording with Stravinsky conducting the Cleveland Orchestra is still available on disc: Columbia ML 5102.) After hearing Ansermet's elegant treatment of it, there remains no doubt in my mind that the complete score carries far more impact than the more familiar *Divertimento* fashioned from it. The ballet proves to be as fascinating a listening experience in its way as *Pulcinella*, in which Stravinsky accorded Pergolesi the same treatment (why couldn't we have had these two scores on a single tape?). On one hand, Stravinsky's drypoint orchestration gives the Tchaikovsky originals an extra measure of champagne sparkle, while, on the other, the transformations of the famous *None but the Lonely Heart* at the climax of the ballet communicate a curiously intense poignancy not usually associated with Stravinsky, yet far removed from the lachrymose sentiment of the older Russian master.

Stravinsky's recording emphasizes the finely etched aspect of the score, but Ansermet seeks out the grace and warmth—and not to the detriment of the music. The Suisse Romande players bring precision and ardor to their performance, and the recorded sound is first-rate all the way. D. H.



BERKO

BENJAMIN BRITTEN

His Albert Herring is fine musical parody

may seem long on the face of it for such a lightweight comedy, but once the tape is going, the time goes by as though on wings. D. H.

© **PROKOFIEV:** *Symphony No. 5, in B-flat, Op. 100*. **STRAVINSKY:** *Le Baiser de la fée (complete)*. Suisse Romande Orchestra, Ernest Ansermet cond. LONDON LCK 80156 \$11.95.

Performance: Thoughtful symphony, sparkling *Baiser*
Recording: Good
Stereo Quality: Good spread and depth

Ansermet's tape version of what might be called Prokofiev's "Eroica" must compete with those of Leinsdorf and the Boston Symphony and Szell and the Cleveland Orchestra. Those listeners who favor a broadly lyrical

© **RIMSKY-KORSAKOV:** *Le Coq d'Or—Suite*; **STRAVINSKY:** *The Firebird—Suite (1945)*. Boston Symphony Orchestra, Erich Leinsdorf cond. RCA VICTOR FTC 2168 \$8.95.

Performance: Refined
Recording: Smooth
Stereo Quality: Fine

This tape and its disc counterpart offer the only stereo recording of the extended suite that Stravinsky compiled in 1945 from the *Firebird* score. In addition to the more familiar suite's music, therefore, we get here the *Pas de deux* in which the Firebird is freed by her captor, as well as the pert Scherzo of the princesses and the golden apples. (One would never know this from reading either the program notes or the label copy provided with the tape.) The 1945 Suite represents, in short, all of the best in the *Firebird* score, relieving us of hearing

Explanation of symbols:

- Ⓢ = stereophonic recording
- Ⓜ = monophonic recording

Only OKI

has a complete lightweight solid-state portable stereo tape system under 25 lbs.



Only OKI

has 2 unique detachable two-way speaker systems for true stereo sound.



Only OKI 555 plays so great, weighs so little!

Guaranteed for one full year*

And its price is less than you'd expect to pay. \$349.95*

Oki has a fine choice of other solid state tape recorders, starting at \$129.95*. See and hear them now at your Oki dealer.

*manufacturer's suggested list price
one year parts, 6 months labor

OKI CHANCELLOR

HFSR865

Chancellor Electronics, Inc.
457 Chancellor Ave., Newark, New Jersey

Name _____

Address _____

City _____ State _____ Zip _____

CIRCLE NO. 46 ON READER SERVICE CARD
FOR STORES "WHERE YOU CAN BUY"
SEE LAST PAGE.

the "furniture-moving" music that makes for such dead spots in the complete ballet (available on tape in versions by Stravinsky and the Columbia Symphony, and Ansermet and the Suisse Romande Orchestra). Leinsdorf's reading is precise, refined, and a bit tame. The Szell-Cleveland Orchestra tape of the shorter 1919 Suite, on Epic, still packs the most excitement and sonic brilliance.

Although again neither liner notes nor label tells us so, the *Coq d'Or* Suite recorded by Leinsdorf is (with some modifications) the four-movement sequence arranged by Rimsky-Korsakov's pupils Alexander Glazounov and Maximilian Steinberg. It consists of the Introduction, Slumber Scene, and Cockerel's Warning; the Prelude to Act II and King Dodon at the Battlefield; the Dance of King Dodon and the Queen of Shemakha; and the Prelude to Act III and Bridal Cortege. Though the program notes explain that the Bridal Cortege ends when the enraged cockerel kills the King, these crucial closing musical pages are altogether missing from the Leinsdorf performance: it is cut short at the point of transition to this episode by a rude unison on A-flat. Leinsdorf's refined and sensuous approach and RCA Victor's lush sound are better suited to Rimsky-Korsakov than to Stravinsky, and despite the truncated conclusion, the performance is impressive both musically and sonically. *D. H.*

© R. STRAUSS: *Der Rosenkavalier: Introduction and opening scene; Marschallin's monologue and conclusion (Act I); Presentation of the Rose (Act II); Concluding trio and duet (Act III)*. Régine Crespin (soprano), Marschallin; Elisabeth Söderström (soprano), Octavian; Hilde Gueden (soprano), Sophie; Heinz Holecek (baritone), Faninal; Vienna State Opera Chorus Members; Vienna Philharmonic Orchestra, Silvio Varviso cond. LONDON LOL 90094 \$7.95.

Performance: Fascinating
Recording: Sumptuous
Stereo Quality: A-1

I am not a *Rosenkavalier* buff of the sort represented by some of my friends (most of them from *Mittel-Europa*) who claim to be able to sing all the parts from memory—and who have sometimes attempted to prove it in the course of bibulous social occasions. Strauss' three-hour serving of *Saebertorten* is a bit rich for my taste, and for this reason I have always preferred my *Rosenkavalier* via the Angel Great Recordings of the Century abridged version with Lotte Lehmann, Elisabeth Schumann, Maria Olszewska, and Richard Mayr.

Crespin is a warmly emotional Marschallin, yet very much a woman of the world, in this recording. Söderström's Octavian is an effective foil to Crespin. Hilde Gueden is properly sweet and naïve as Sophie, and Heinz Holecek does well with his brief bit as papa Faninal. If the emotional atmosphere surrounding the Marschallin and Octavian seems overpoweringly hothouse on this tape, it is in part because one hears the Act I scenes without the interruptions of the levée and the intrusion of Baron Ochs. Another contributing factor is that Crespin, in singing for a recording rather than for the opera house, creates an effect of striking, almost uncomfortable, intimacy.

From a purely vocal standpoint, I find the performance virtually flawless, and the gor-

geous playing that Silvio Varviso elicits from the Vienna Philharmonic is a pleasant surprise—I would have expected such results only from the likes of Krauss and Kleiber.

My only real criticism of the recording concerns the rather clumsy opening and closing of the Silver Rose scene: not all of the orchestral prelude is included, and the scene could have been ended on a tonic chord rather than being chopped off just before the subsequent duet. London's sound is glorious from start to finish. *D. H.*

STRAVINSKY: *Le Baiser de la fête—complete* (see PROKOFIEV); *The Firebird—Suite* (see RIMSKY-KORSAKOV)

COLLECTIONS

© RENATA TEBALDI: *Operatic Recital*. Verdi: *Don Carlo: Tu che le vanità; Un Ballo in Maschera: Ecco l'orrido campo...*



RENATA TEBALDI
Singing with thrilling emotional fervor

Ma dall'arido stelo divulsa; Morrò, ma prima in grazia; Giovanna D'Arco: Oh ben s'addice... Sempre all'alba. Puccini: *Turandot: In questa Reggia*. Ponchielli: *La Gioconda: Suicidio*. Puccini: *La Rondine: Sogno di Doretta*. Mascagni: *Cavalleria Rusticana: Voi lo sapete*. Cilea: *L'Arlesiana: Esser madre è un inferno*. Renata Tebaldi (soprano); New Philharmonia Orchestra. Oliviero di Fabritius cond. LONDON LOL 90093 \$7.95.

Performance: Emotionally vivid
Recording: Excellent
Stereo Quality: Average

This fifty-one-minute recital, the equivalent of London OS 25912 in disc form, is an excellent sampling of Tebaldi's art, as well as of the present state of her vocal resources. With the exception of "*Voi lo sapete*," the soprano had not previously recorded any of the arias in this release, and there are a number of roles here—notably Turandot—that she has never done on the stage. Yet she brings to each selection an amazing degree of dramatic projection. The singing from the standpoint of emotional fervor is thrilling, although one cannot deny that the voice is not what it once was. Louder notes in the high register are a giveaway, and the vel-

vety quality is regrettably no longer there in this range; nor does Tebaldi seem to be able to get a true *mezza voce* on her high notes until nearly the conclusion of the recital. What remains, however, is well worth having, and I must say that the quality of her tone is far more comfortable for the ear than one is liable to hear in some of the more recent Callas performances. Tebaldi is very well supported by her conductor, and London's sound, a bit smoother in the treble on tape than on disc, is first-class. Commendably, the tape box includes both texts and translations. I. K.

ENTERTAINMENT

© RAY CHARLES SINGERS: *Songs for Lonesome Lovers*. Chorus, Ray Charles cond. *One More Time; I'll Never Smile Again; Over the Rainbow*; and nine others. COMMAND RS4C 874 \$7.95.

Performance: Bland
Recording: Excellent
Stereo Quality: Excellent

The music of the Ray Charles Singers is best described as antiseptic. It will corrupt no morals, inspire no riots, assist no seductions. It has the qualities of argon gas: it is flavorless, colorless, odorless, and totally inert. There's nothing wrong with the music. It's good clean choral writing, faultlessly sung. But it just lies there, like a clockwork orange, ticking competently but doing no useful work whatever. Nice enough, I guess. But what's this tape good for? G. L.

© SAMMY DAVIS-COUNT BASIE: *Our Shining Hour*. Sammy Davis (vocals); Count Basie orchestra, Quincy Jones cond. *My Shining Hour; Teach Me Tonight; April in Paris*; and nine others. VERVE VSTC 324 \$7.95.

Performance: Bright
Recording: Good
Stereo Quality: Good

The singing voice, if exercised properly, grows stronger. But if it is exercised improperly, or excessively, it can be injured. If Sammy Davis isn't careful, he's going to ruin his. This album was recorded while the previews of *Golden Boy* were running on Broadway, and Davis was working very hard. There is a scratchiness in his vocal sound which, though not unattractive, hints of trouble. By the time of the recording of the *Golden Boy* original-cast album (I imagine it was done later than this disc), the scratchiness had grown more obvious.

Davis' collaboration with the Basie band is in some ways the most successful of the several discs of this kind, made by Frank Sinatra, Tony Bennett, and others. Davis seems to fit himself better to the Basie sound than these other singers. The material is good, especially Cy Coleman and Joseph McCarthy's small masterpiece, *Why Try to Change Me Now?* I can't understand why this tune isn't recorded more often.

One piece of material deserves discussion — *Blues for Mr. Charlie*, by Bobby Sharp, the title of which is taken from the James Baldwin play. The thesis of the song comes from the play, too: i.e., that the white man (Mr. Charlie) is rotting inside because of guilt for his sins against the Negro. This is one of Baldwin's favorite ideas. Its one flaw is that it's wrong. One of the principal fac-

AUGUST 1965

CIRCLE NO. 43 ON READER SERVICE CARD →

IF YOU HAVE TELEVISION HI.FI-STEREO C. B. RADIO

Consider This

TELEVISION

Are you planning to Build? Remodel? Add-A-Room? If so, you will want built-in convenience and versatility, even your TV and FM. Now you can! How? Mosley has a complete line of accessories for completely installing your antenna lead within the wall and terminating in a decor harmonizing wall outlet. Convenient? Versatile? You Bet! With two or more Mosley outlets installed throughout your room or home, even a console becomes portable.



and this

HI FI/STEREO

Hi Fi and Stereo is a great source of family enjoyment and company entertaining. Here too, a versatile and convenient system is needed. Mosley has switch plates, remote speaker outlets, attenuator plates and many more, each expertly designed to harmonize with room decor and give positive performance wherever installed.



and this

COAX TERMINATION OUTLETS FOR NEW RADIO

Here is a NEW, COMPLETE line of coaxial termination accessories that enables your antenna lead-in to be concealed within the wall, and terminated in a decor harmonizing wall outlet. A convenient, low cost way to add a professional touch to your two-way communications.



FILL OUT AND RETURN FOR **FREE** CATALOGS AND LITERATURE

- TELEVISION ACCESSORIES.
- HI FI/STEREO ACCESSORIES.
- COAX TERMINATION OUTLETS.

NAME ADDRESS
CITY STATE

Mosley Electronics Inc.

4610 NORTH LINDBERGH BLVD. - BRIDGETON, MISSOURI, 63044



Go
Ampex
all the
way!

■ Ampex speakers

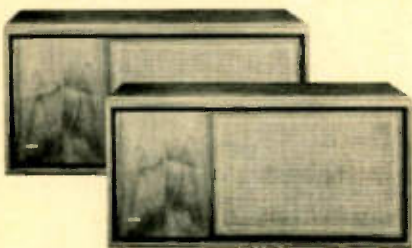

Only speakers of this quality can do justice to AMPEX Tape Sound . . . or any high-fidelity music source! Our 3010 units are 3 way speakers housed in handsome walnut cabinets . . . the richest sound ever in speakers priced at \$149 each. Hear the full line of AMPEX speakers, as low as \$29.95 a pair.

■ Ampex stereotapes



More than 1300 selections . . . the cream of some 23 top labels, including Deutsche Grammophon . . . all available on AMPEX Stereotapes. Write for a complete catalog.

■ Ampex blank tape



Keep your quality high with AMPEX recording tapes for every need . . . including the world's only tape specially formulated to overcome high frequency loss while recording at slow speeds.

recorders/microphones
speakers/tape/headsets
accessories

ask anyone who knows

AMPEX

AMPEX CORPORATION, 2201 LANDMEIER ROAD, ELK GROVE VILLAGE, ILLINOIS 60009

CIRCLE NO. 5 ON READER SERVICE CARD

tors of the racial problem is indeed that most white Americans do *not* feel guilty for, or even fully recognize their share of responsibility in, the mistreatment of the Negro. This white man's-guilt thesis is the wishful thinking of the Negro intellectual. Transferred into song form, in which any statement is of necessity succinct, the idea becomes downright silly. I'm not arguing that most white men *aren't* bastards—along with most black men, brown men, and yellow men. I am arguing that bastards never *believe* they're bastards, no matter how much Baldwin, Bobby Sharp, and Sammy Davis would like to think they do.

A much better statement about discrimination here is *Work Song*, which Davis sings well. Originally a jazz instrumental composition, it was given excellent lyrics by Oscar Brown, Jr. Brown's talent is a sometime thing, but in this song he hits home: his simple demonstration of how frustration leads to violence, and violence to punishment on a chain gang, makes the preaching of *Blues for Mr. Charlie* seem very shallow by comparison.

There's a track at the end of this album in which Davis converses with Basie, saying what a gas it's been to work with him, and all that. This is the second instance I've heard in which Davis has recorded his conversation. Not even Frank Sinatra ever had the gall to think he was so magical that the recordings audience wanted to hear him talking. This sort of thing is ill-advised.

Though the tone of this review may seem negative, I liked the album. I like all Davis albums. His is one of the greatest talents in show business today. But it's a talent marred by curious and surprising aesthetic follies.

G. L.

© BOB DYLAN: *Bringing It All Back Home*. Bob Dylan (vocals, guitar, and harmonica). *Subterranean Homesick Blues*; *Gates of Eden*; *Outlaw Blues*; and nine others. COLUMBIA CQ 729 \$7.98.

Performance: Coarse
Recording: Good
Stereo Quality: All right

America appears to be puzzled that its students have begun to protest against things. It seems to be something new. It is—but only to America. Students have been staging riots, strikes, and protest marches throughout history and all over the world, often with salutary results. It seems to me one of the healthiest developments of contemporary America that its students are at last taking enough interest in the world to protest some of the dumb things that are going on in it. Their very failure to do so in the past has contributed to the world's impression of Americans as political idiots, a bland and uncultivated people interested only in refrigerators, automobiles, and indoor plumbing.

Yet there is something tragic in the protests of the young. What they cannot grasp is that there will be as many sell-outs in their generation as there were in previous ones. In my thirties, I am saddened to see one after another of my generation already selling out—the thirties are either the period of great self-betrayal or great fulfillment. The sell-outs are people I believed in, men I thought would never desert their principles, whatever happened. So many of them have done so that at times I feel alone and a little foolish. I look around and wonder, Where

Why?

DO THOUSANDS OF HI-FI ENTHUSIASTS BUY FROM AUDIO UNLIMITED

It's Obvious!

- LOWEST PRICES
- FAST SERVICE
- FACTORY SEALED UNITS
- FULLY INSURED SHIPMENTS
- UP TO 2 YEAR
- MANUFACTURERS' WARRANTY
- PACKAGE DEALS—SAVE MORE
- FRANCHISED DISTRIBUTORS
- Free parking space for our customers.

Write for FREE Catalog Today

SEND US YOUR LIST
FOR OUR AIR MAIL
QUOTE TODAY

Visit Our Showroom and Warehouse

AUDIO unlimited, inc.
715-S Second Ave., (Nr. 38) New York 16, N. Y.
3 blocks from the U.N.

FOREIGN CURRENCY RATES

for 1-year subscriptions
outside the U. S. A.,
its Possessions & Canada.

(All prices include postage.)

Australian pounds: 2/14
Austrian schillings: 155
Belgian francs: 300
Colombian pesos: 78
Danish kroner: 40
Dutch guilders: 20
English pounds: 2/3
Finnish new markka: 20
French francs: 30
Greek drachmas: 180
Hong Kong dollars: 35
Indian rupees: 29
Irish pounds: 2/3
Israeli pounds: 17
Italian lire: 3,745
Japanese yen: 2,150
Lebanese pounds: 18
Mexican pesos: 75
New Zealand pounds: 2/3
Norwegian kroner: 43
Pakistan rupees: 29
Philippine pesos: 23
Portuguese escudos: 172
South African rands: 4.25
Spanish pesetas: 375
Swedish kronor: 31
Swiss francs: 26
Venezuelan bolivares: 27
West German marks: 24

Mail order with remittance to:
HIFI/STEREO REVIEW

Portland Place/Boulder, Colo., U.S.A. / 80311

did everyone go? And why do I continue to fight for principle? In darker moments I suspect even myself, and wonder whether I continue to fight for principle because I like principle or because I like to fight. The young cannot foresee the subtle shifts of personality that develop as one ages and becomes *involved* in a corrupt world, when one is no longer a student merely looking on. Nor do they understand that their elders are not betraying the young so much as they are betraying themselves. When the young are betrayed—and they will be—it will be by their own. That is why their passionate faith in their own is so touching. After you have learned cynicism (the protective cloak of the broken idealist), you can spot the phonies among the young even when they can't themselves. You have had experience, and they haven't, in spotting the early signs of spiritual decay, the first stirrings of the money-hunger, the power-hunger, the status-hunger. And when you try to point this out, the young fight back because they think you are attacking their ideals rather than the phony betrayers of those ideals still among them.

Bob Dylan, I think, is a phony. From the moment you pick up this album, you can smell it—providing you're not too young. It begins in the liner notes, which Dylan wrote, a precious and affected exercise in e. e. cummings lower case, the ramblings of a flagrant poseur with delusions of surrealism. The songs are worse. There are those who think that what is opaque must be deep. Dylan's lyrics are banal, a fact that is concealed (but only slightly) by the free-association form that passes for profundity among his admirers. But they aren't really good enough to be called lyrics, though some have gone so far as to call them poetry.

Dylan is, of course, fashionably *against* things. But just what it is he's against is rather unspecific. Oh, there are hints. He's against Bad Things. People pushing each other around. Conformity. Dictatorial politicians. Layers of fascism in American life. Who, other than the Birchites, isn't? What is original about such statements? They echo all the fine reckless zeal of Calvin Coolidge, who was against sin.

Musically, Dylan's stuff is dismal. The first track of this album, *Subterranean Home-sick Blues*, is built out of two notes and two chords, and it is almost incredibly monotonous. The composer's defenders, of course, will say that this very monotony is significant, that it "evokes the True Horrible Flavor of Contemporary America" and like that. Dylan's singing is as bad as his music, except on one track—*She Belongs to Me*, in which his voice has a sad, soft, rather haunting quality. Other than that one moment of musicality, the album is pure trash.

But Bob Dylan's albums are not for making music; they're for making money. That's where it's at, and that's where he's at. He has learned, whether consciously or by osmosis, that posing pays off in publicity and sales. His hair is long and shaggy for the same reason that the Beatles' is: it's a good gimmick. But the young who admire him won't see that—they don't dare. For to do so would be to see the first awful evidence of their generation's betrayal. G. L.

© GEORGE SHEARING QUINTET: *Satin Affair; Mood Latin*. George Shearing Quintet, plus strings and Latin percussion. (Continued on next page)

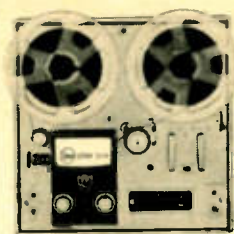

MODEL 3110



MODEL 3170

NEW TAPE DECKS FOR CUSTOM INSTALLATIONS

from the company that manufactures for industry professionals

Califone tape decks are ideally suited for sound perfectionists who already have a hi-fi system. Equalized pre-amp outputs permit you to merely **PLUG THE DECK** into your present system. Complements the sound of America's top rated audio components.

MODEL 3110—Perfect for the critical ear of a budget minded audiophile. 3 speeds, 4 track stereo, automatic shut off, built in monitor amplifier, 40-18,000 CPS, enough plug-in inputs and outputs for quick connection to your present system. **\$189.95**

MODEL 3170—reverse play **AUTOMATICALLY**, repeat play **AUTOMATICALLY**, select play **AUTOMATICALLY**, automatic stop. Push button solenoid controls, remote control (optional), sound-with-sound, sound-on-sound, echo chamber, 3 heads, 3 motors, 2 VU meters, 10½" reel adapters (optional), **\$599.95**



Rheem Califone, Manufacturers of Tape Recorders, Record Players, Language Laboratories and Audio Equipment for Creative Educators. **RS-88**

CIRCLE NO. 49 ON READER SERVICE CARD

Again! NEW DRAWING
ANOTHER CHANCE
WIN A NEW SOLID STATE

Professional Series
FISHER

#600 Transistorized FM-MX Receiver



110 Watts \$499.50 less case
Once again **RABSONS** offers Only the Best. Check these fabulous **FISHER** features • Cool — trouble free operation • Fisher Solid State means Longer Life • 110 Watts Total Power Output • 1.80V FM Sensitivity • Compact Size for Custom Installations only 11½" Deep • Direct Tape Monitor • Exclusive Fisher Nuvistor • Golden Synchron FM Front End AND much more. Write Direct to Rabsons For Complete Free "Specs"

free Nothing to buy — to win a Fisher 600 just write to Rabsons for a "Rock Bottom" quote on any Hi Fi component. This alone makes you eligible. Drawing will be held Sept. 30, 1965.

NOW IN OUR 60th YEAR

• "Sky High" inventory • Quick Personal Service • 60 Years of Reliability • Easy Payment Plan • Up to 3 years to pay • New Factory Sealed Equipment • New — Free Mail Order Hi Fi Clinic Service • Free Double Packing of all Shipments • Franchised Protection — PLUS! — Rabsons own unique guaranty.

FREE RECORD CLOTH (\$1 Value) WITH EVERY QUOTE

RABSONS 57 ST. INC
119 West 57th Street, New York, N. Y. 10019
Tel. Area Code 212-247-0070

This drawing is not open to residents in any locality whose laws prohibit such a drawing.

CIRCLE NO. 48 ON READER SERVICE CARD

**SELLING HI-FI
WORLD WIDE
SINCE 1948**

COMPONENTS • RECORDERS
KITS • SPEAKER SYSTEMS • TAPE

- LOWEST PRICES
- MFRS. GUARANTEES UP TO 5 YEARS
- SAME DAY REPLY TO YOUR INQUIRY
- MFRS. SEALED CARTONS
- DOUBLE BOXED WHEN POSSIBLE
- FAST, INSURED SHIPMENTS
- PACKAGE DEALS SAVE YDU MDRE
- FRANCHISED DISTRIBUTORS FOR OVER 5D MFRS.
- PARKING METERS AT PREMISES

• SPECIAL: STEREO DYNE II DIAMOND STEREO CARTRIDGE — \$7.25 ppd.

Send for FREE "MONTHLY SPECIALS" on other Cartridges, Tapes, and Components.

WRITE FOR MONTHLY SPECIALS VISIT OUR STORE

CARSTON Studios

1686-A Second Ave. (Nr. 87), N.Y. 10028

CIRCLE NO. 12 ON READER SERVICE CARD

PURCHASING A HI-FI SYSTEM?

TRADE-INS O.K. TIME PAYMENTS
Up to 2 years to pay!

Send Us
Your List Of
Components
For A
Package
Quotation

FREE TIME
STEREO
RECORDS
WITH ORDER

All merchandise is
brand new, factory
fresh & guaranteed.

Visit our N.Y. showroom
Free Hi Fi Catalog

AIREX RADIO

CORPORATION
85-MR Cortlandt St. N.Y. 7, WO 4-1820

Altec Lansing
Electrovoice
Jensen • Leak*
University
Acoustic Research
Janszen
Wharfedale
Grenadier Speakers
International Crystals
Hallcrafters
Texas Crystals
Marantz* • Viking
Bell • G.E.
Weathers
Harman—Kardon
Eico • Ampex*
Sherwood*
Superscope
Dual Changer
Bogen • RCA
Dynakit • Fisher
H. H. Scott
KSC Speaker Systems*
ADC Speakers
Finco • ECI
Empire Troubador
Sony • Roberts
Challenger
Hammarlund
Garrard • Norelco
Miracord
General Radio
Rek-O-Kut
Polytronics
Crown Recorders*
Fairchild
ADC Cartridges
Pickering • Sonar
Audio Tape
Magnecord*
Rockford Cabinets
*Fair Traded

CIRCLE NO. 2 ON READER SERVICE CARD

SAVE MONEY on NATIONALLY ADVERTISED BRANDS HI-FI COMPONENTS TAPE RECORDERS



TAPES,
ACCESSORIES
SLEEP LEARN KITS
MERITAPE
Top Quality Recording Tape

- Franchised Distributors
- Factory Sealed Cartons
- Up to 2 yrs. Mfgr. Warranty

Write for our
VERY LOW QUOTATIONS

FREE CATALOG

DRESSNER

1523 Jericho Tpke. New Hyde Park 31, N.Y.

Visit Our Showroom

CIRCLE NO. 19 ON READER SERVICE CARD

Early Autumn; Midnight Sun; My Romance; Blue Moon; and 20 others. CAPITOL Y2T 2265 \$9.95.

Performance: Sleek
Recording: Sleek
Stereo Quality: Clean

It is difficult to realize that George Shearing, now a darling of the Lawrence Welk set, was once considered an innovator and a daring pianist, and that the now-tired sound of piano voiced with guitar and vibes seemed the freshest thing around. *Sic transit* revolution, or something.

Yet, though Shearing now specializes in commercial albums of the Muzak stripe, he is still a first-rate performer. He has great facility, lovely tone, and a phenomenal ear.

In one half of the album the quintet is backed by strings; in the other it is augmented by a Latin rhythm section. The music sounds as if it's made of plastic. G. L.

RECORDING OF SPECIAL MERIT

© CLARK TERRY: *The Happy Horns of Clark Terry*. Clark Terry (trumpet and fluegelhorn), Phil Woods (alto saxophone and clarinet), Ben Webster (tenor saxophone), Roger Kellaway (piano), Milton Hinton (bass), Walter Perkins (drums). *Rockin' in Rhythm; In a Mist; Perdido; and nine others. IMPULSE ITC 312 \$7.98.*

Performance: Very musical
Recording: Good
Stereo Quality: Good

There's a pretty good case for the opinion, fairly widely held, that Clark Terry has become our best all-around trumpeter. Not that versatility is everything, of course, but Terry has attributes of flexibility that have gone unpraised (except among trumpet players) for far too long. Once I was listening to him in a nightclub with a trumpeter friend who at a certain moment said, "Did you hear that little figure he was just playing? That's a flute figure. It's ridiculously difficult on trumpet, and he played it like the horn was built for it."

And when Terry turns to the fluegelhorn, he plays it on its own terms, making the instrument speak in the warm and vital voice that is its unique characteristic. On fluegelhorn or trumpet, he displays uncanny control of tone, subtly and precisely suiting it to the shape of each phrase.

But Terry isn't merely a flashy technician. His always-melodic playing is warm and humorous—sardonic one moment, gently whimsical the next, and perhaps slapstick a few measures later. Sometimes it is quite pretty and unostentatiously sad. And he *swings*.

This album presents Terry in an interesting setting of Ellington-derived material. Though improvised choruses are its attraction, this isn't one of those disorganized and interminable "blowing" dates. Someone has written ensemble frameworks that give each number order and shape; unparadoxically, no arranger credit is given. Terry's colleagues on the horns—Ben Webster and Phil Woods—are powerful swingers themselves. Woods, known for his fiercely hot alto playing, is heard in some lovely, liquid clarinet work. And Roger Kellaway, one of the best of the post-Bill Evans jazz pianists, acquits himself well in this senior company. Given that the rhythm section is good, how could this be anything but a great album? G. L.

WRITE FOR QUOTATION

FACTORY SEALED CARTONS
FRANCHISED DISTRIBUTOR
QUICK SHIPMENT

the
'MOST' IN
DISCOUNTS
ON ANY HI-FI
COMPONENTS

SOUND REPRODUCTION INC.

34 New Street, Newark, N. J. (07102)
(201) Mitchell 2-6816

CIRCLE NO. 55 ON READER SERVICE CARD



SEND HI FI/STEREO REVIEW REGULARLY EACH MONTH, FOR:

- | SUBSCRIPTION
OFFER | SAVING UNDER
SINGLE-COPY PRICE |
|--|-----------------------------------|
| <input type="checkbox"/> 3 Years \$12 | YOU SAVE \$6 |
| <input type="checkbox"/> 2 Years \$9 | YOU SAVE \$3 |
| <input type="checkbox"/> 1 Year \$5 | YOU SAVE \$1 |
| <input type="checkbox"/> New <input type="checkbox"/> Renewal <input type="checkbox"/> Extension | |

name _____ please print

address _____

city _____ state _____ zip code _____

- Bonus!**
- Payment enclosed. (We will add 2 EXTRA ISSUES at no extra cost, for each year of your order!)

Bill me. I'll pass up the bonus. _____ Initial

Additional postage: Add \$1 per year for Pan-Am and all other foreign countries.

Mail to: HI FI/STEREO REVIEW
Dept. 0145 Portland Place, Boulder, Colo. 80311

HI-FI/STEREO REVIEW

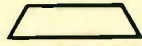

TAPE HORIZONS

By DRUMMOND McINNIS

LAST month's column was concerned with the many uses of masking tape, a versatile material we don't usually think of in connection with tape recording. But there is another kind of tape—still not recording tape—that presents a few handling problems for the neophyte: splicing tape.

Splicing techniques are hardly a science, but proper results do require a certain amount of skill. For instance, you can, in a pinch, cut and splice tape using only a pair of scissors, but holding two overlapping tape ends together while you cut them is awkward at best. And at worst you can end up with slightly different angles on the two cut ends which, when butted together, cause a slight bend at the tape joint and consequent weaving or creasing of the tape edge. Splicing blocks or splicers that hold the two ends of tape in alignment while you cut and splice are cheap—a worthwhile investment that will repay itself many times over.

You should be careful never to cut your tapes with an instrument (scissors, cutter blade, or razor blade) that has become magnetized. This leaves a little blip on the tape where the cutter's magnetism has recorded itself as a pulse. Your bulk tape eraser will serve as an excellent demagnetizer, and it is wise to bring it into action before any big splicing session starts.

Have you ever wondered why tape is usually cut and spliced at an angle of 45 degrees? It's to lengthen the transition from one recorded sound to another so as not to cause an abrupt jump. On a full-track, 7 1/2-ips tape, it takes about 0.05 sec for a 45-degree splice to pass the playback head gap. With quarter-track, it takes about 0.01 sec—and the transition will occur about 0.015 sec sooner in the lower track of a stereo tape than in the upper one. If and when we get around to using quarter-track stereo at 15/16 ips, the time lag between transitions in the two tracks will be about 0.12 sec. Since this is quite perceptible as a sonic jump between channels, we will then have to splice at a 90-degree angle.

That time, I imagine, is not too far in the future, and I suspect that even then, despite all educational efforts to the contrary, there will still be some people making splices with ordinary household-type cellophane tape. And there will therefore still be tapes hopelessly goosed up in this way, for the adhesive in ordinary sticky tapes will "creep" through the splice onto the oxide, onto the heads, and onto the next layer of tape. But I'll do my bit for education anyway: use *only* splicing tape for your splices; its adhesive is specially formulated not to creep.

* * *

A letter that came across my desk this past week concerns a use for tape recorders that I—and perhaps you, too—somehow never thought of. The Student Nonviolent Coordinating Committee (SNCC) informs me that its hardworking volunteers have found tape recorders to be extraordinarily effective in their voter education program. Furthermore, SNCC uses tape recorders to preserve for libraries a running record of these historic times through the activities and the events in the lives of the people they reach. SNCC's funds, unfortunately, lag behind their ambitions for a really adequate record. The Committee would be delighted to hear from you if you have any equipment, tape—or money, for that matter—to donate to the program. Write Jamens Bond, Student Nonviolent Coordinating Committee, 6 Raymond Street, N.W., Atlanta 14, Georgia.

DOES YOUR SPEAKER
SOUND LIKE IT'S
LOCKED IN A TRUNK?

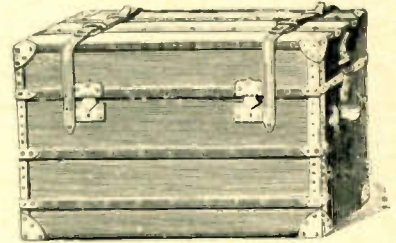

Here's the key to natural sound . . . the Golden Horn. Compare with other speaker systems at any cost and you will choose as others have, the velvet sounds of the Golden Horn. Ask your dealer for a demonstration.

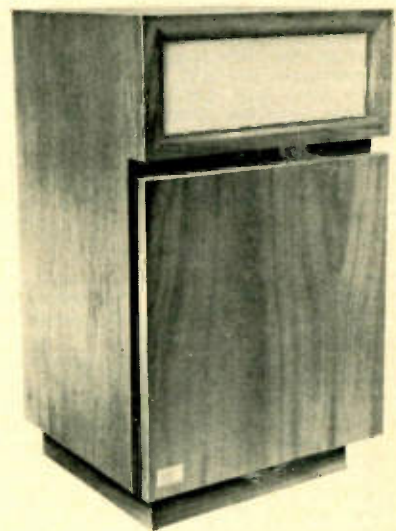

PO BOX 608 ORANGEVALE CALIFORNIA 95667

AVAILABLE IN FLOOR AND SHELF MODELS
CIRCLE NO. 16 ON READER SERVICE CARD

HIFI/STEREO REVIEW CLASSIFIED

COMMERCIAL RATE: For firms or individuals offering commercial products or services. 50¢ per word (including name and address). Minimum order \$5.00. Payment must accompany copy except when ads are placed by accredited advertising agencies. Frequency discount: 5% for 6 months; 10% for 12 months paid in advance.
READER RATE: For individuals with a personal item to buy or sell. 30¢ per word (including name and address). No Minimum! Payment must accompany copy.
GENERAL INFORMATION: First word in all ads set in bold caps at no extra charge. Additional words may be set in bold caps at 10¢ extra per word. All copy subject to publisher's approval. **Closing Date:** 1st of the 2nd preceding month (for example, March issue closes January 1st). Send order and remittance to: Hal Cymes, HIFI/STEREO REVIEW, One Park Avenue, New York, New York 10016.

EQUIPMENT

LOW, Low quotes: all components and recorders. HiFi, Roslyn 9, Penna.

WRITE for quotation on any Hi Fi components: Sound Reproduction Inc., 34 New St., Newark, N.J. Mitchell 2-6816.

BEFORE You Buy Receiving Tubes, Transistors, Diodes, Electronics Components and Accessories... send for your Giant Free Zalytron Current Catalog, featuring Standard Brand Tubes: RCA, GE, Etc.—all Brand New Premium Quality Individually Boxed, One Year Guarantee—all at Biggest Discounts in America! We serve professional servicemen, hobbyists, experimenters, engineers, technicians. Why Pay More? Zalytron Tube Corp., 469-H Jericho Turnpike, Mineola, N.Y.

TAPE recorders. Hi-Fi components. Sleep Learning Equipment, tapes. Unusual values. Free catalog. Dressner, 1523HF Jericho Turnpike, New Hyde Park 9, N.Y.

KIT Experts—Dynaco Specialists—Kits at reasonable prices are our specialty. Also custom wired kits guaranteed to exceed factory standards at substantial savings. Beautiful handcrafted Walnut cases for complete Dynaco line, plus everything in audio. Kitcraft, Dept. HSB-65, 738 Washington Avenue, Brooklyn, N.Y. 11238, MA 2-5230.

HI-FI Components, Tape Recorders, at guaranteed "We Will Not Be Undersold" prices. 15-day money-back guarantee. Two-year warranty. No Catalog. Quotations Free. Hi-Fidelity Center, 1797 (HC) 1st Ave., New York, N.Y. 10028.

COMPONENT quotations—tapes Mylar 1800' \$1.49. Bayla, Box 131r Wantagh, N.Y.

FREE! Send for money saving stereo catalog #H8R and lowest quotations on your individual component, tape recorder or system requirements. Electronic Values, Inc. 200 West 20th St., N.Y., N.Y. 10011.

CANADIANS—Giant Surplus Bargain Packed Catalogs. Electronics, HiFi, Shortwave, Amateur, Citizens Radio. Rush \$1.00 (refunded). ETCO, Dept. Z, Box 741, Montreal, CANADA.

THE Price is Right! Hi-Fi Components. J. Wright Co., 65-B Jensen St., East Brunswick, N.J.

SPEAKER system: Janszen Z300, birch. \$80. Reed, 5533 S. Cornell, Chicago, Ill. 60637.

FREE 148-page electronics catalog. Big 43rd Anniversary edition! Thousands of astounding buys on stereo hi-fi components, shortwave, citizens band, tape recorders, radios, parts, kits, everything you need at "wholesale low" prices. Write: Radio Shack, Box HF-8, 2727 W. 7th, Ft. Worth, Texas.

EXPERIMENTERS. Spatial Stereo Inducers—\$5.00 Cal's. Box 234, Dearborn, Michigan.

FOR SALE

COMPONENTS & Furniture at big discounts. Write for discount catalog. Mendota Furniture Company, Mendota, Minnesota.

JAPAN & Hong Kong Electronics Directory. Products, components, supplies. 50 firms—just \$1.00. Ippano Kaisha Ltd., Box 6266, Spokane, Washington 99207.

ACHTUNG! Das machine is nicht fur Gerfingerpoken und mittengraben. Is easy schnappen der Springenwerk, blowenfusen und poppencorken mit spitzernsparken. Ist nicht fur gerwerken by das Dummkopfen. Das rubbernecken sightseeren keepen hands in das pockets. Relaxen und watch das Blinkenlights. This attractive, brass metal plaque only \$2.00 ea. ppd. Southwest Agents, Dept. H, 8331 Hwy. 80 West, Fort Worth, Texas 76116.

BUILD TV Camera Cheaper Than Ever! Send 10¢ for Details. ATV Research, Box 396, South Sioux City, Nebr. 68776.

TRANSISTORS—Miniature Electronic Parts. Send for Free Catalog. Electronic Control Design Company, P.O. Box 1432N, Plainfield, N.J.

WANTED

QUICKSILVER, Platinum, Silver, Gold. Ores Analyzed. Free Circular. Mercury Terminal, Norwood, Mass.

ARC-27, ARC-34, ARC-38, ARC-44, ARC-52, ARC-55, ARC-73, ARC-84, RT-220c/ARN-21, APN-22, R-540/ARN-14c, ARN-18, ARN-59, 51X-2/17L-7, 17L-4, RT-68/GRC, Test Sets with ARM, UPM, URM, SG, Prefixes. Top Dollar Paid. Slep Electronics, Drawer 178ZDHF, El-lenton, Fla. 33532.

TEBALDI Taped Metropolitan Opera broadcasts wanted. Tosca 1/7/56. Manon Lescaut 1/17/59. Excellent sound only. Sidney Denker, 2215 Cranston Rd., Cleveland, Ohio 44118.

TAPE AND RECORDERS

"MY FAIR LADY," "HELLO, DOLLY," many other stereo and monaural records and tapes at 50% off retail price. 25¢ puts you on mailing list. Topselco, P.O. Box 112, Wilmette, Ill.

RENT Stereo Tapes—over 2,500 different—all major labels—free brochure. Stereo Partl, 1616-G Terrace Way, Santa Rosa, California.

TAPE-MATES MAKES AVAILABLE TO YOU—ALL 4-TRACK STEREO TAPES—ALL LABELS—POSTPAID TO YOUR DOOR—AT TREMENDOUS SAVINGS. FOR FREE BROCHURE WRITE TAPE-MATES CLUB. 5280-H W. PICO BLVD., LOS ANGELES, CALIF. 90019.

RENT 4-TRACK STEREO TAPES—Narrow it down, it has to be TRIMOR—Goodbye to partial satisfaction—Service and Dependability our keynote—ALL LABELS and TITLES—No Deposit—Postpaid both ways. (48 states)—FREE BROCHURE and TAPE CATALOG. TRIMOR Company, P.O. Box 748, Flushing, N.Y. 11352.

BEFORE renting Stereo Tapes try us. Postpaid both ways—no deposit—immediate delivery. Quality—Dependability—Service—Satisfaction—prevail here. If you've been dissatisfied in the past, your initial order will prove this is no idle boast. Free catalog. Gold Coast Tape Library, Box 2262, Palm Village Station, Hialeah, Fla. 33012.

STEREO TAPE. Save up to 60% (no membership fees). We discount recorders, batteries, accessories. We mail prerecorded tape, prepaid, anywhere that United States rates prevail. Free 60 page catalog. Saxitone, 1776 Columbia Road, Washington, D.C. 20009.

TAPE RECORDER SALE. Brand new, latest models, \$10.00 above cost. Arkay Sales, 1028-A Commonwealth Ave., Boston, Mass. 02215.

AMPEX recorders, Ampex and Kodak tape discounted. Collegetown Audio, Box 342, Columbia, Mo. 65202.

SAVE UP TO 38%—Stereo Tapes! Records! All Major Labels—Guaranteed. Free Details. P.O. Box 280, West Des Moines, Iowa 50265.

STEREO tapes from America's foremost outlet at America's lowest prices. No membership fees. Free particulars. Roberts Recordings, 4454 Broadway, Chicago, Ill. 60640.

PHOTOGRAPHS

PHOTOGRAPHS and transparencies wanted, to \$500.00 each. Valuable information free—Write Intraphoto-HF, Box 74607, Hollywood 90004.

PLANS AND KITS

WEBBER Labs. Transistorized converter Kit \$5.00. Two models using car radio 30-50Mc or 100-200Mc, one Mc spread. Easily constructed. Webber, 40 Morris, Lynn, Mass.

PHOTOGRAPHY—FILM EQUIPMENT, SERVICES

SCIENCE Bargains—Request Free Giant Catalog "CJ"—148 pages—Astronomical Telescopes, Microscopes, Lenses, Binoculars, Kits, Parts. War surplus bargains. Edmund Scientific Co., Barrington, New Jersey.

MEDICAL FILM—Adults only—"Childbirth" one reel, 8mm \$7.50; 16mm \$14.95. International H, Greenvale, Long Island, New York.

CLASSIFIED ADVERTISING ORDER FORM

Please refer to heading on first page of this section for complete data concerning terms, frequency discounts, closing dates, etc.

1	2	3	4	5
6	7	8	9	10
11	12	13	14	15
16	17	18	19	20
21	22	23	24	25
26	27	28	29	30
31	32	33	34	35

_____ Words } @ \$.30 Reader Rate } = \$
 _____ } @ .50 Commercial Rate }
 Insert _____ time(s) Total Enclosed \$ _____

NAME _____

ADDRESS _____

CITY _____ ZONE _____ STATE _____

SIGNATURE

WORD COUNT: Include name and address. Name of city (Des Moines) or of state (New York) counts as one word each. Zone or Zip Code numbers not counted. (Publisher reserves right to omit Zip Code if space does not permit.) Count each abbreviation, initial, single figure or group of figures or letters as a word. Symbols such as 35mm, COD, PO, AC, etc., count as one word. Hyphenated words count as two words. HF-865

RECORDS

RARE 78's. State Category. Write Record-Lists, P.O. Box 2122, Riverside, California.

"HARD To Get" records—all speeds. Record Exchange, 812 Seventh Avenue, New York, N.Y.

THE Record Collector Journal—comprehensive, valuable data, varied record mart. Introductory six issues—\$1.50. Record Research, 131 Hart, Brooklyn 6, N.Y.

DISCOUNT Records—All Labels—Free Lists, write Cliff House, Box 42-H, Utica, N.Y.

BRITISH LP's New From \$1.40—All Labels. Complete Catalogue \$1. Vocal 78 Lists Available. "Gramophile," 1017 Argyle St., Glasgow, Britain.

CASH For Unwanted LPs. Reder, 81 Forshay Rd., Monsey, New York.

60% OFF List Like New LPs. Lists 25¢. Records, Box 323, Hillburn, New York.

PROTECT Your LPs. Heavy Poly Sleeves for Jackets 5¢. Light Inner Sleeves 2 1/2¢. Min. Shipment Heavy 50, Light 100. Poly Sleeves, Box 323, Hillburn, N.Y.

POLART Index to Record Reviews—Covers leading 1964 music/audio periodicals including HIFI/STEREO REVIEW. \$1.50. Polart, 20115 Goulburn, Detroit, Mich. 48205.

RARE Record Finders. Write Post Office Box 95007, Los Angeles, Calif. 90045.

NEW LP's—Stereo \$3.50, Monaural \$2.75, 45's—80¢. Varmint Distributing, Silvis, Ill.

RECORDS cut from your tapes. Send for free price list. Keener Recording, 1270 Fifth Ave., New York, N.Y. 10029.

REPAIRS AND SERVICES

ALL Makes of Hi-Fi Speakers Repaired. Amprite, 168 W. 23 St., N.Y.C. 10011. CH 3-4812.

HI-FI Problems solved by "The Hi-Fi Doctor" on the spot. Audio, Acoustic, Radio Engineer, Professional visits, day, evening. New York area. William Bohn, Plaza 7-8569.

TV TUNERS Rebuilt and Aligned per manufacturers specification Only \$9.50. Any Make UHF or VHF. We ship COD Ninety day written guarantee. Ship complete with tubes or write for free mailing kit and dealer brochure. JW Electronics, Box 51F, Bloomington, Ind.

MUSIC

POEMS wanted for songs and records. Send poems. Crown Music, 49-RB West 32, New York 1.

ADD programs of continuous, commercial free music thru your FM tuner with our sub carrier detector plugged into tuner. Hear the famous background music programs now transmitted as hidden programs on FM. Wired unit \$75.00, Kit \$49.50. Music Associated, 65 Glenwood Road, Upper Montclair, N.J. 201-744-3387.

SONG ideas wanted. Write with Professional Songwriters. Share royalties. Songwriters' Associates, 236 West 55th Street, N.Y. 10019-V.

PATENTS

INVENTIONS; Ideas developed for Cash/Royalty sales. Raymond Lee, 1606G Bush Building, New York City 36.

HELP WANTED

YOUR Own Business. Sell Matchbook advertising—part or full-time. No investment. We tell you how. No experience needed. Earn cash commissions plus free gifts. Sales kit furnished. Matchcorp, Dept. MO-85, Chicago 60632.

HYPNOTISM

FREE Hypnotism, Self-Hypnosis, Sleep Learning Catalog! Drawer H400. Ruidoso, New Mexico 88345.

MAGAZINES

FASCINATING New Magazine for Book Collectors! Information Free. TBA, Webster 13, N.Y.

AUGUST 1965

INVENTIONS WANTED

INVENTORS. We will develop, help sell your idea or invention, patented or unpatented. Our national manufacturer clients are urgently seeking new items for outright cash sale or royalties. Financial assistance available. 10 years proven performance. For free information, write Dept. 45, Wall Street Invention Brokerage, 79 Wall Street, New York 5, N.Y.

IMMEDIATE cash, for Patent Applications, free Patent Searches. Write for details, Universal Patents, 184-W, Marion, Ohio.

ANTENNAS

FAMDUS Channel Master antennas now available in kits. Do it yourself and save! Also rotators, UHF Convertennas, indoor TV, FM antennas. Free Catalog "R": Jefferson-King, South Fallsburg, N.Y. 12779.

BOOKS

PLAYER Piano Books. Send for List. Vestal Press, Vestal 30, New York 13850.

AUTHORS' SERVICES

AUTHORS' Learn how to have your book published, promoted, distributed. Free booklet "ZD," Vantage, 120 West 31 St., New York 1.

WANTED WRITERS! Short stories, articles, books, plays, poetry. Will help place, sell your work. Write today, free particulars! Literary Agent Mead, Dept. 37A, 915 Broadway, New York 10, N.Y.

REAL ESTATE

FLORIDA WONDERLAND—Home, cottage, Mobilites. Established area. \$590 full price, \$9.00 a month. Swimming, fishing, boating. Write: Lake Weir, Box KC38, Silver Springs, Fla. AD 6-1070 (F-1)

FREE!—SUMMER CATALOG. Thousands of new properties described, new photos too—Land, farms, homes, businesses,—Recreation, Retirement. 470 offices, 34 states coast to coast. "World's Largest." Mailed **FREE!** **STROUT REALTY**, 50-ZD East 42nd St., New York, N. Y. 10017

INSTRUCTION

REI First Class Radio Telephone License in (5) weeks Guaranteed. Tuition \$295.00. Job placement free. Radio Engineering Institute, 1336 Main Street, Sarasota, Fla.

LEARN Electronic Organ Servicing at home. All makes including transistors. Experimental kit—trouble-shooting. Accredited NHSC, Free Booklet. Niles Bryant School, 3631 Stockton, Dept. A, Sacramento 20, Calif.

HEALTH, Success, Self-culture Courses. Homestudy. Psychology, Metaphysics. Bible, Philosophy. Write, **INSTITUTE OF METAPHYSICS**, 1250 Indiana Street, Birmingham, Alabama 35224.

COINS

"S" MINT Lincolns! 25 different, \$2.00. 30 different, \$3.50. 35 different, \$8.00 postpaid! John Finneran, 22166 North 6th St., Castro Valley, Calif.

KEY Jefferson nickels and Roosevelt dimes. Send stamp for free price list. John Grant, 6509 Cedarbrook, Peoria, Ill. 61614.

CLEARANCE! Cents to Dollars! Tremendous Reductions! Special List 15¢. Fairway, 121-Z, Rye, New York.

MOVIE FILMS

16mm SOUND Projectors, Films, New, Used for Sale, Free Catalog. National Cinema, 71 Dey Street, New York, N.Y.

RECORDED Music Enthusiasts don't limit their special interest activities to this one field. They are movie takers, car drivers, boating sportsmen, too! Inform them of all of your products and services by placing an ad here.

BUSINESS OPPORTUNITIES

INVESTIGATE Accidents—Earn \$750 to \$1,400 monthly. Men urgently needed. Car furnished. Business expenses paid. No selling. No college education necessary. Pick own job location. Investigate full time. Or earn \$6.44 hour spare time. Write for Free Literature. No obligation. Universal, CZ-8, 6801 Hillcrest, Dallas 5, Texas.

SELL CB Equipment—Dealerships available to aggressive people who can sell Citizens Band Radio full or part time. Knox Electronic, Dept. 174, Galesburg, Ill. 61401.

I MADE \$40,000.00 Year by Mailorder! Helped others make money! Start with \$10.00—Free Prof. Torrey, Box 3566-N, Oklahoma City 6, Oklahoma.

FREE BOOK "990 Successful, Little-Known Businesses." Work home! Plymouth-845-H, Brooklyn 18, New York.

PHOTOGRAPH accidents for Insurance Companies. \$10.00 hour spare time. Not a school. Free Information. Underwriters ZDG, 7400 Pershing, St. Louis, Mo. 63130.

EDUCATIONAL OPPORTUNITIES

LEARN While Asleep, hypnotize with your recorder, phonograph. Astonishing details, sensational catalog free! Sleep-Learning Association, Box 24-ZD, Olympia, Washington.

LEARN While Asleep. Remarkable, Scientific, 92% Effective. Details Free, ASR Foundation, Box 7021, Dept. e g., Lexington, Kentucky.

HIGHLY—effective home study review for FCC commercial phone exams. Free literature! **COOK'S SCHOOL OF ELECTRONICS**, Craigmont, Idaho 83523.

FREE EDUCATION! Greater Success! Information Free! Cameo Enterprises, Carrolltown, Pa. 15722.

IBM COMPUTER PROGRAMMING. Home Study. UCI, POB 495, Freehold, N.J.

GOVERNMENT SURPLUS

JEEPS \$64.50 . . . Boats \$6.18 . . . Typewriters \$4.15 . . . Airplanes, Electronic Equipment, 100,000 Bargains Typically Like These Direct From Government in Your Area. For Complete Directory and Surplus Catalog Send Only \$1.00. Surplus Service, Box 820-L, Holland, Michigan.

GOVERNMENT Surplus Receivers, Transmitters, Snopescopes, Radios, Parts, Picture Catalog 20¢. Meshna, Nahant, Mass.

EMPLOYMENT INFORMATION

FOREIGN Employment. Construction, other work projects. Good paying overseas jobs with extras, travel expenses. Write only: Foreign Service Bureau, Dept. D, Bradenton Beach, Fla.

EMPLOYMENT Resumes. Get a better job & earn more! Send only \$2.00 for expert, complete Resume Writing Instructions. J. Ross, 80-34 Kent St., Jamaica 32, N.Y., Dept. HF.

MISCELLANEOUS

WORLDWIDE Export and Buyers Guide \$1.50. Burke Associates, Manchester, Mass.

WELDERS, 150 Amps. \$49.50 110/220. Morris 1070-W Inner, Schenectady, N.Y.

FOREIGN CAR SEAT COVERS. Prices, Samples: 25¢. Box 385, Arvada, Colorado 80002.

ATTENTION! CLASSIFIED ADVERTISERS—Take advantage of the opportunity to reach hundreds of thousands of prospects by placing your advertising in one or all of these forthcoming Ziff-Davis Electronic Annuals:

FALL 1965 ELECTRONIC EXPERIMENTER'S HANDBOOK: 75¢ Word; Closing Date: August 13th; On Sale: September 30th.

1966 ELECTRONICS INSTALLATION AND SERVICING HANDBOOK: 50¢ Word; Closing Date: August 31st; On Sale: Oct. 21st.

1966 TAPE RECORDER ANNUAL: 50¢ Word; Closing Date: September 1st; On Sale: October 21st.

In order to guarantee inclusion Act Now! Send copy and payment to: Hal Cymes, Classified Advertising Manager, Electronics Annuals, One Park Ave., New York, N.Y. 10016.



WHERE TO BUY IT

HI FI/STEREO REVIEW'S EXCLUSIVE SUMMER SERVICE

Is there a product in this issue that interests you? Would you like to see it? . . . hear it? . . . buy it? It's easy! Advertisers cooperating in our special summer service program are indicated with the little telephone symbol at the bottom of their ads, and here's how you can get prompt answers to your questions:

1. Note the page number and the brand name of the merchandise in which you are interested.
2. Dial the HiFi/Stereo Review advertising service office nearest you—see the list of telephone numbers below.
3. Give the operator the page number of the ad and the name of the product, and she will give you the names of the stores in your vicinity that carry it, plus any other pertinent information made available by the manufacturer.

DIAL THE NUMBER IN YOUR AREA

CALIFORNIA		INDIANA		New York City	212 421-6672
Los Angeles	213 653-5172	Indianapolis	317 ME 6-6883	Rochester	716 CH 4-0400
San Francisco	415 GA 1-7191	MASSACHUSETTS		OHIO	
COLORADO		Boston	617 542-8942	Cleveland	216 781-5148
Denver	303 244-3136	MICHIGAN		Columbus	614 221-1993
CONNECTICUT		Detroit	313 961-7116	PENNSYLVANIA	
Hartford	203 247-7229	MINNESOTA		Philadelphia	215 LO 7-1200
DIST. OF COLUMBIA		Minneapolis-St. Paul	612 333-5927	Pittsburgh	412 391-3680
Washington	202 347-8668	MISSOURI		TEXAS	
FLORIDA		St. Louis	314 CH 1-4071	Dallas	214 RI 7-7164
Miami	305 374-1821	NEW JERSEY		Houston	713 CA 7-8589
GEORGIA		Newark	201 642-8380	VIRGINIA	
Atlanta	404 233-0987	NEW YORK		Richmond	703 643-6185
ILLINOIS		Albany	518 434-8886	WASHINGTON	
Chicago	312 372-9251	Buffalo	716 853-2288	Seattle	206 MU 2-1292

HIFI/STEREO REVIEW ADVERTISERS' INDEX

Acoustic Research, Inc.	37	Elpa Marketing Industries, Cecil E. Watts Div.	22	Mosley Electronics, Inc.	109
Airex Radio Corporation	112	EMI (Scope Electronics Corp.)	92	National Gypsum Company	106
Allied Radio	71, 72	Empire Scientific Corp.	5	North American Philips Company, Inc.	85
Altec Lansing Corporation	66	Ercona Corporation	8	OKI—Chancellor Electronics	108
Ampex Corporation	110	Finney Company, The	24	Pickering	3rd COVER
Angel Records	65	Fisher Radio Corporation	21, 23, 25,	RCA Victor	86
Audio Dynamics Corporation	82	Fuji Photo Optical Products, Inc.	104	Rabsons—57th Street, Inc.	111
Audio Originals	16	Harman-Kardon, Inc.	97	Rek-O-Kut	105
Audio Unlimited, Inc.	110	Heath Company	103	Rheem Califone	111
Benjamin Electronic Sound Corp.	97	Hi-Fidelity Center	105	Rheem Roberts	96
Bogen Communications	10, 11	Jensen Manufacturing Center	88	Rotron Manufacturing Company, Inc.	101
Bozak	78	KLH Research and Development Center	13, 15,	Scope Electronics Corp.	92
British Industries—Garrard	2	Kenwood Electronics, Inc.	93	Scott, Inc., H. H.	79
British Industries—Wharfedale	31	Koss/Rek-O-Kut	105	Sherwood Electronic Laboratories, Inc.	38
Carston Studios	111	LTV University	75	Shure Brothers, Inc.	19, 26, 105
Citadel Record Club	9	Lansing Sound, Inc., James B.	87	Sonotone Corporation	100
Columbia Records	68, 69	Leak & Company Ltd., H. J.	8	Sound Reproduction, Inc.	112
Columbia Stereo Tape Club	7	Lear Siegler, Inc.	10, 11	Stanton Magnetics, Inc.	77
Command Records	102	MGM Records, Classical Division	73	Superscope, Inc.	34
Custom Craft	113	McIntosh Laboratory, Inc.	84	UTC Sound Division	2nd COVER, 1
Dressner	112	Magnecord	6	United Audio Products	91
Dual	91	Marantz, Inc.	95	Utah Electronics	99
Du Pont	80, 81	Mattes Electronics, Inc.	28	Vanguard Records	83
Dynaco, Inc.	98	Minolta Corporation	12	Viking of Minneapolis, Inc.	20
Electro-Voice, Inc.	33, 4th COVER			Winegard Co.	14



Nine out of ten musical people prefer the sound of Pickering.

Nearly all musical people prefer *natural* sound. And natural sound begins with Pickering. Right where the stylus meets the groove.

Any of the new Pickering V-15 stereo cartridges will reproduce the groove, the whole groove and nothing but the groove. That's why a Pickering can't help sounding natural if the record and the rest of the reproducing equipment are of equally high quality.

To assure compatibility with *your* stereo equipment, there are four different Pickering V-15 pickups, each designed for a specific application. The V-15AC-1 is for conventional record changers, where high output and heavier tracking forces are

required. The V-15AT-1 is for lighter tracking in the newer automatic turntables. The even more compliant V-15AM-1 is ideal for professional-type manual turntables. And the V-15AME-1 with elliptical stylus is the choice of the technical sophisticate who demands the last word in tracking ability.

No other pickup design is quite like the Pickering V-15. The cartridge weighs next to nothing (5 grams) in order to take full advantage of low-mass tone arm systems. Pickering's exclusive Floating Stylus and patented replaceable V-Guard stylus assembly protect both the record and the diamond.

But the real payoff is in the sound. At least for those who can hear the difference.

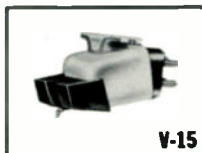

V-15

Pickering

Plainview, L. I., N. Y.

For those who can **hear** the difference.

WIN a \$1000 stereo system or any of 125 other prizes! To become eligible, simply identify the musical people pictured above. See your hi-fi dealer for entry blanks and full details.



CIRCLE NO. 33 ON READER SERVICE CARD

FOR STORES "WHERE YOU CAN BUY"—SEE LAST PAGE.

HiFi/Stereo Review

June, 1964

"...the designers of the E-V TWO were aiming for a smooth, uncolored sound, and they have succeeded very well. Overall the E-V TWO is a very smooth and musical reproducer."

Radio-Electronics

February, 1964

"In brief, the E-V TWO's produce a quite spectacular sound with a big, low-down bass...that is the best, to my ears, that Electro-Voice has yet produced."

POPULAR SCIENCE

June, 1964

"They effortlessly fill my large listening room with clean, well-balanced sound."

© 1964, Popular Science Publishing Co., Inc.

AUDIO

April, 1964

"...the Electro-Voice Model SIX is as close in sound to a Patrician as one can come without being a Patrician. You listen."

high fidelity

April, 1964

But whatever one's personal listening tastes are, it would seem there is an E-V model to suit them."

"Reproducing test tones, the Model SIX was found to have a remarkably smooth, clean and uniform response across the audio range!..."

The American Record Guide

December 1963

"(I) have found them to be smooth and easy-to-listen-to...I found the top end very smooth and silky, not overbright, and also it extended well beyond the 15-kc. claim of the manufacturer."

If Speakers Could Blush, Ours Would!

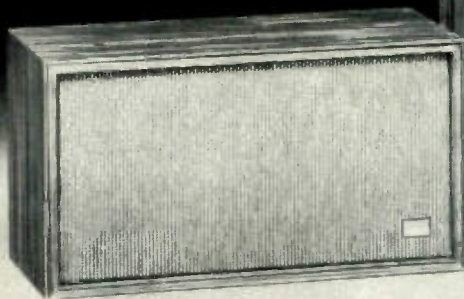

E-V TWO



E-V SIX

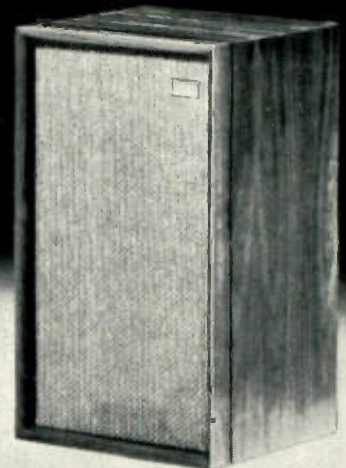

E-V FOUR

Read what the critics say about the new E-V TWO, E-V FOUR and E-V SIX acoustic suspension speaker systems. Then conduct your own impartial listening test. For a complete set of review reprints, plus the name of your nearest franchised E-V hi-fi showroom, write us today.

E-V Two, \$108.00; E-V Six, \$333.00; E-V Four, \$138.00

ELECTRO-VOICE, INC., Dept. 854F, 616 Cecil St., Buchanan, Michigan 49107

CIRCLE NO. 17 ON READER SERVICE CARD



FOR STORES "WHERE YOU CAN BUY"—SEE LAST PAGE.

Electro-Voice

SETTING NEW STANDARDS IN SOUND