

JANUARY/FEBRUARY 1986  
\$2.95



# THE SOUND ENGINEERING MAGAZINE

*serving: recording, broadcast and sound contracting fields*

Featuring: 2 to 8-The Smaller Recording Studio  
Guide: Performance Speakers



AL1201POMD193  
DOUGLAS M POMEROY  
POMEROY AUDIO  
193 BAL TIC ST  
BROOKLYN

01 800 8703

NY 11201

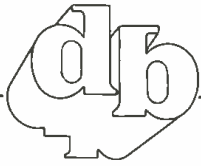

# Letters

## WHERE TO STUDY

I am pursuing a career as a recording engineer and my concern is to find the school which will provide the most extensive training possible. Right now I am in the process of reviewing schools and would appreciate the following advice on what criteria to look for in choosing training for my field:

The names of specific schools whose facilities and curriculum you regard as desirable when looking for an employee.

What accreditation to look for when evaluating possible schools.

I realize the recording industry is highly competitive and a diploma from an institution whose credentials are

well respected would allow me greater discretion in choosing my job while increasing my value to a perspective employer.

I thank you for your time and consideration and appreciate any advice or further contacts.

BILL SMALL

**YOU CONFIGURE  
IT OUT  
FOR YOURSELF!**

You really can! Wireworks Mix & Match Components Group gives you all the products you'll ever need to create your own perfect audio cabling system. And our Audio Cabling Design Kit shows you exactly how to put them all together.

**Call or write today for your free Design Kit.  
With Wireworks you really conduit!**

**wireworks**

Wireworks Corporation 380 Hillside Avenue, Hillside, NJ 07205  
201/686-7400 800/624-0061

Well, Bill, an answer to this question could go on for pages. One of the most comprehensive listings of educational programs is published by the Audio Engineering Society, and can be obtained by either writing to the AES at 60 East 42nd St., New York, NY, 10165 or calling at (212) 661-8528. Good luck in your endeavors!

## RESEARCHING RAMKO

TO THE EDITOR:

I am very interested in the Ramko Research audio mixers that appear on page fifty-two of your November/December, 1983 issue (volume 17, number 10). I would greatly appreciate it if you could provide me with the address of this company.

Thank you.

MICHAEL HESS

Because we've gotten several requests for the same information, here is the address:

*Ramko Research, Inc. 11355 Folsom Blvd. Rancho Cordova, CA 95670.*



## FINISH UP ON TIME WITHOUT SACRIFICING QUALITY.

You want it quick and you want it good. In today's competitive post-production audio/visual scene, the rewards go to those who can produce results that are quick *and* good. That's why TASCAM designed the MS-16 1" 16-track recorder—to bring together top-notch audio quality plus premium features that streamline production and move you ahead of schedule.

Quality reproduction starts with the heads, and TASCAM has three decades of design experience behind the MS-16's new micro-radii heads. They bring "head bumps" under control and ensure flat frequency response. And unlike most tape machines, the MS-16 record/sync and playback heads are identical in performance. Because sync response equals repro response on the MS-16, you can make critical EQ and processing decisions on overdubs or punch-ins without having to go back and listen a second time. You get what you want sooner and with fewer headaches.

The MS-16 cuts down on the time you spend locking up with other audio and video machines as well. A 38-pin standard SMPTE/EBU interface affords speedy, single-cable connection with most popular synchronizers and editing systems. It's the easy, efficient way to get the most out of today's sophisticated synchronization equipment. The MS-16's new Omega Drive transport is tough enough to stand up to long days of constant shuttling... while handling tapes with the kid-glove kindness they deserve.

Record/Function switches for each track allow effortless, one-button punch-ins. Input Enable allows instant talkback during rewinds, fast forwards and cue searches. These features speed you through sessions and let you concentrate on the project at hand... not on your tape machine.

Take a closer look at the MS-16. See your TASCAM dealer for a demo or write us for more information at 7733 Telegraph Road Montebello, CA 90640.

THE TASCAM MS-16 SIXTEEN TRACK

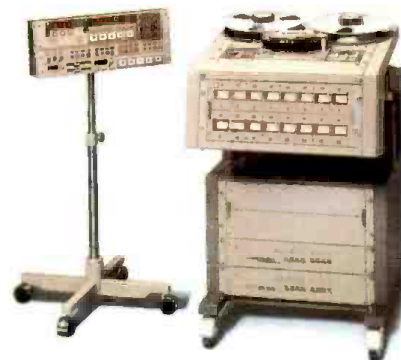

**TASCAM** THE SCIENCE OF BRINGING ART TO LIFE.



## Brain of the Beholder

*The following lends a general explanation of psychoacoustics.*

**F**OR THOSE PEOPLE who are fortunate enough to have unimpaired hearing, there is a rich world of sounds and sensations that constantly color our perception of reality. Our hearing mechanism is quite good at telling us about our physical surroundings though this information usually becomes part of the sum of all of our sensory input and goes unheeded.

For example, think about what is called the Cocktail Party effect. Say you're holding a conversation in a crowded room. It's a simple matter to mentally filter out extraneous noises or other conversations and concentrate on the speech of interest. Another simple luxury of life is the ability to close your eyes and precisely determine the location of a nearby sound source. These feats of signal processing depend on the physical makeup of our hearing apparatus and the way our brain processes auditory infor-

mation. Though we can't compete with a bat or porpoise when it comes to auditory information processing, we can put our ear/brain combination to good use as audio practitioners if we are aware of our limitations. Thus, a general understanding of psychoacoustics can surely come in handy.

In the 1930s, several folks were involved in research that laid the foundation for much of our current understanding of hearing. A good deal of this research was conducted at particular universities and corporate facilities like Bell Laboratories. The questions of how and why people hear the way they do were mostly unanswered questions. These questions fall under the heading of psychoacoustics which is defined as the study of the brain's perception of, and response to, all aspects of sound (Woram). Let's look at some of the aspects of this subject that immediately affect us and see what conclusions can be drawn.

Our brain perceives a certain frequency of sound as a particular pitch sensation. If there are several other frequencies present in some complex harmonic structure,

---

*Oliver Masciarotte is a faculty member of Miami University.*

# It's like holding an isolation booth in your hand!

Compared to older microphone designs, the ATM63 is far better at rejecting sounds from the sides and rear. Even with a stage full of monitors and amplifier stacks. And as you get farther from unwanted sound, the ATM63 advantage sharply increases when compared to the others.

Only the vocal comes through loud and clear, making both monitor and house mixes cleaner and far more controllable. With the punch and clarity that is the very definition of a great vocal microphone.

But the ATM63 works

for more than vocals. Around a drum kit, for instance, the ATM63 provides outstanding bleed-through rejection to greatly reduce troublesome phase cancellation. Both musicians and engineers have more freedom...and more control.

If your "old reliable" microphones have reached their limit, reach for the new ATM63 from Audio-Technica. It's a far better sound value...for just a little more.

Learn all the facts from your nearby Audio-Technica sound specialist today.



# ATM63



**audio-technica**

Audio-Technica U.S., Inc.  
1221 Commerce Dr., Stow, OH 44224  
(216) 686-2600

Circle 16 on Reader Service Card

that will usually alter only the timbre of the sound. The interesting thing to note is that pitch changes with changing intensity (Stevens). Least affected are frequencies around 1,000 Hz. Below approximately 1,000 Hz, perceived pitch goes down as intensity is increased. Predominantly low frequency sounds go flat as they get louder while predominantly high frequency sounds behave in an opposite manner; they seem to go increasingly sharp as they get louder. This is not the kind of stuff my college professors would call "intuitively obvious."

Another interesting aspect of hearing is the fact that the perceived timbre of a sound changes as the sound is made louder or softer. Two researchers, Fletcher and Munson, averaged the responses of a group of test subjects and graphed this phenomenon as a family of curves showing frequency vs. (perceived) "equal loudness" (Fletcher and Munson). What these curves or contours show is that as a sound's intensity approaches the threshold of hearing, as it is made quieter, our sensitivity to high and low frequencies gets progressively worse. Using 1,000 Hz as a reference we find that, at low intensities, frequencies below 800 Hz and above about 4,000 Hz must be of much higher intensity to be perceived as equally loud as 1,000 Hz. Near the threshold of hearing a 40 Hz tone must be more than 50 dB greater in intensity to be perceived as loud as a 1,000 Hz tone. That is 100,000 to one increase in intensity! These equal loudness curves also show that human hearing is most acute between 3,000 and 4,000 Hz. It is no surprise that human speech lies predominantly in the 1,000 to 4,000 Hz range. Our hearing apparatus has become finely tuned for interpersonal communication.



**Pssst!**

**.. There is a better way to sell your equipment — in classified or display advertisements! Call us today for an advertising rate package.**

**(516) 433-6530**

While we're on the subject of frequency response, I'd like to talk about one of the mechanisms that allows us to determine the location of a sound source. Let's try a thought experiment (after Mehrgardt & Mellert) whereby we take a tiny microphone and carefully place it at the entrance to the ear canal of a willing test subject. This should be a calibrated microphone with known frequency response. We then place a wide range loudspeaker driven by a linear amplifier, again with known frequency response, in front of our test subject. The microphone output is sent through a preamp to a spectrum analyzer to provide frequency versus amplitude data, and pink noise is applied to the amplifier/loudspeaker. Now we can determine the frequency response of the subject's head/outer ear combination. With that accomplished, we move the loudspeaker slightly in an arc with the subject's head at the center of the arc. Again we measure the response and continue to move the speaker around the head, graphing as we go. What we come up with is a family of curves that show a strange thing. The ear "sees" a different frequency response depending on the sound source's lateral angle around the head. At 8,000 Hz where the wavelength of the sound is significant relative to the dimensions of someone's head, the variation is + or - 10 dB! Two factors make this experimental result, performed by various researchers in the past, less hideous than it seems. One is the fact that the ear canal itself acts as an acoustical filter with a frequency response that alters the response variations created by the head and outer ear. The other consideration is that we are born with this complex acoustic filter and it has become part of our day to day existence.

I must mention one last quirk of our hearing mechanism that is of interest to the audio professional. At those same frequencies that we observe wide lateral variations in frequency response, from about 3,000 Hz to 8000 Hz, there is also a gradual change in the perceived height or elevation of a fixed source located on a horizontal plane with a listener's head (after Roffler and Butler). As frequency goes up, the source seems to come more and more from above. At frequencies above 8,000 Hz, the perceived elevation rapidly diminishes until it seems to be back on a horizontal plane at 10,000 Hz. Stranger and stranger...

The one word I have repeated several times in this discussion is "perceived"—the key to this subject. The four phenomena I have mentioned: changing pitch with changing intensity, the Equal Loudness curves, changing timbre with different lateral angles and, different perceived elevations at different frequencies all work together to unconsciously inform us of where a sound source is located. We can also use these hearing mechanisms to our advantage to paint a sound picture as real or bizarre as we could imagine. Also by keeping the principles of psychoacoustics in mind we can avoid violating the laws that govern how we hear. Next time we will talk about the more obvious ways that our brain derives location information and discuss how we can manipulate information to create specific effects:

- (1) from Woram, Recording Studio Handbook, Elar, 1982
- (2) from Stevens, Journal Acoustical Soc. of America, Vol. 6, No. 3, 1935
- (3) Fletcher & Munson, J. A. S. of A., Vol. 5, No. 2,
- (4) Mehrgardt & Mellert, J. A. S. of A., Vol. 61, No. 6
- (5) Roffler & Butler, J. A. S. of A., Vol. 43, No. 6. ■

Go ahead and run it.

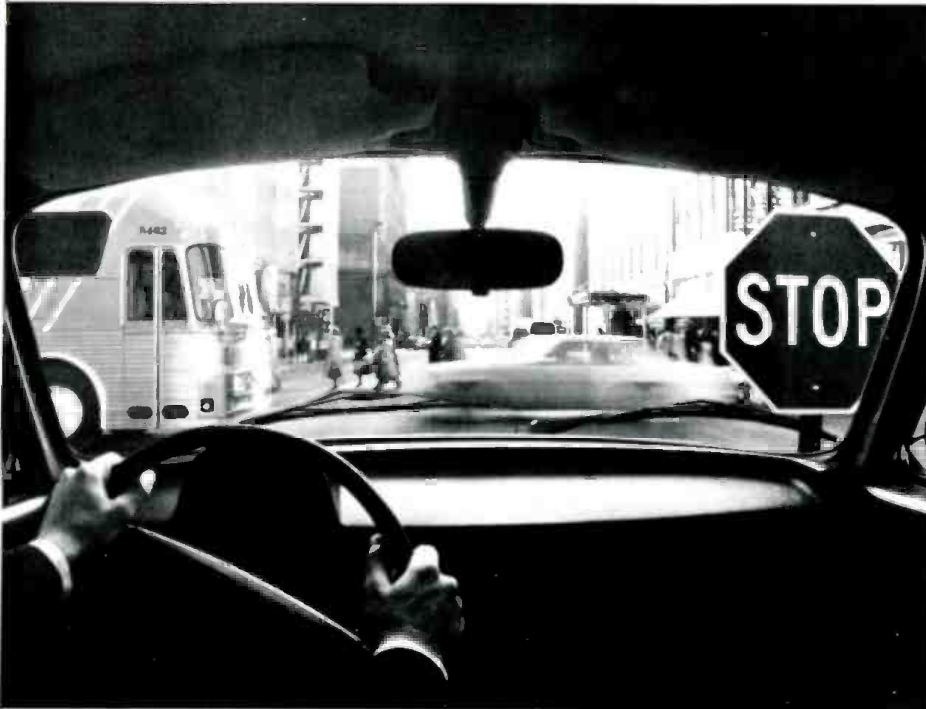

Maybe there's a car coming and maybe there isn't. Fortunately, most people figure the risk isn't worth the chance.

But with a heart attack, it doesn't work that way. Most people ignore the signals. Or chalk it up to indigestion. Or wait to see what happens next.

Every year 350,000 heart attack victims die before they reach the hospital.

If you feel an uncomfortable pressure, fullness, squeezing or pain in the center of your chest that lasts for two minutes or longer, you may be having a heart attack. In some cases, the sensation may spread to the shoulders, neck or arms—and be accompanied by sweating, dizziness, fainting, nausea or shortness of breath.

The important thing is to call your local emergency medical service or ask someone to drive you to a hospital emergency room.

If you ignore the signs of a heart attack, you'll have no one to blame.

Not even yourself.

WE'RE FIGHTING FOR  
YOUR LIFE



American Heart  
Association

NEW!

## The Aphex Aural Exciter® Type C

### The Best Way to Improve Your Sound System Just Got Better.



**And more affordable!** Less than \$300! Like the famous Type B, the new Type C restores natural brightness, presence and detail to live and recorded sound... and does it more quietly and musically! Lyrics will have more intelligibility... guitars more bite... drums more kick. The overall mix will be cleaner, more natural and exciting.

The Type C is the best way to improve any sound system. It adds that *extra edge* that is impossible to add with any other

processor. Live sounds fill the room without all the problems of high frequency EQ. Multitrack tapes made on narrow format machines will sound like they were made on expensive studio recorders. Even cassette dupes will have an unmuffled, professional sound.

Hear the difference *only* a genuine Aural Exciter can make at your dealer today. Or write us for more information and the name of your nearest dealer.



Aphex Systems Limited  
13340 Saticoy St., North Hollywood, CA 91605  
(818) 765-2212 TWX: 910-321-5762

Detachable rack ears included.

Aural Exciter is a registered trademark of Aphex Systems Ltd. © 1985 Aphex Systems Ltd.

Circle 15 on Reader Service Card

www.americanradiohistory.com

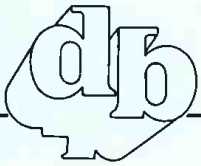

# Welcome New Readers

**W**E WANT TO WELCOME a new group of readers to this issue. These new readers, some 13,000 strong, come to us from a former sister publication which specialized in the small studio market. Its readers are now our readers, and, again, I welcome them.

With this issue, we have created a major new section that, I believe, many seasoned readers of *db Magazine* will find of significant value. It's called *2 to 8 Track—for The Smaller Recording Studio*.

This section will contain articles specifically created for this important and growing segment of the recording industry.

At the same time, a perusal of this issue will assure long-time readers that they have not been abandoned. This issue, has been assembled by our guest editor (and usual columnist) Jesse Kalpholz. I think that Jesse did an incredible job in organizing a series of articles covering the sound-reinforcement and present-day science of acoustics. Jesse found himself so involved with the assigning and editing of these articles that he couldn't get his regular column done, but rest assured, it will reappear in our next issue.

Finally, I again wish to welcome the many new readers to *db Magazine*. They, and you, the loyal long-time reader will find that the new *db Magazine* will be even more than it was in the past.

For the next issue, March/April, we are assembling a special broadcast-audio editorial thrust to coincide with that issue's distribution at the NAB Convention to be held in April in Dallas, Texas. The 2- to 8-track section will have a major article on MIDI, what it is, what it does, and, what it doesn't do.

Larry Zide  
Editor/Publisher



## THE NEXT GENERATION. THE NEXT STEP.

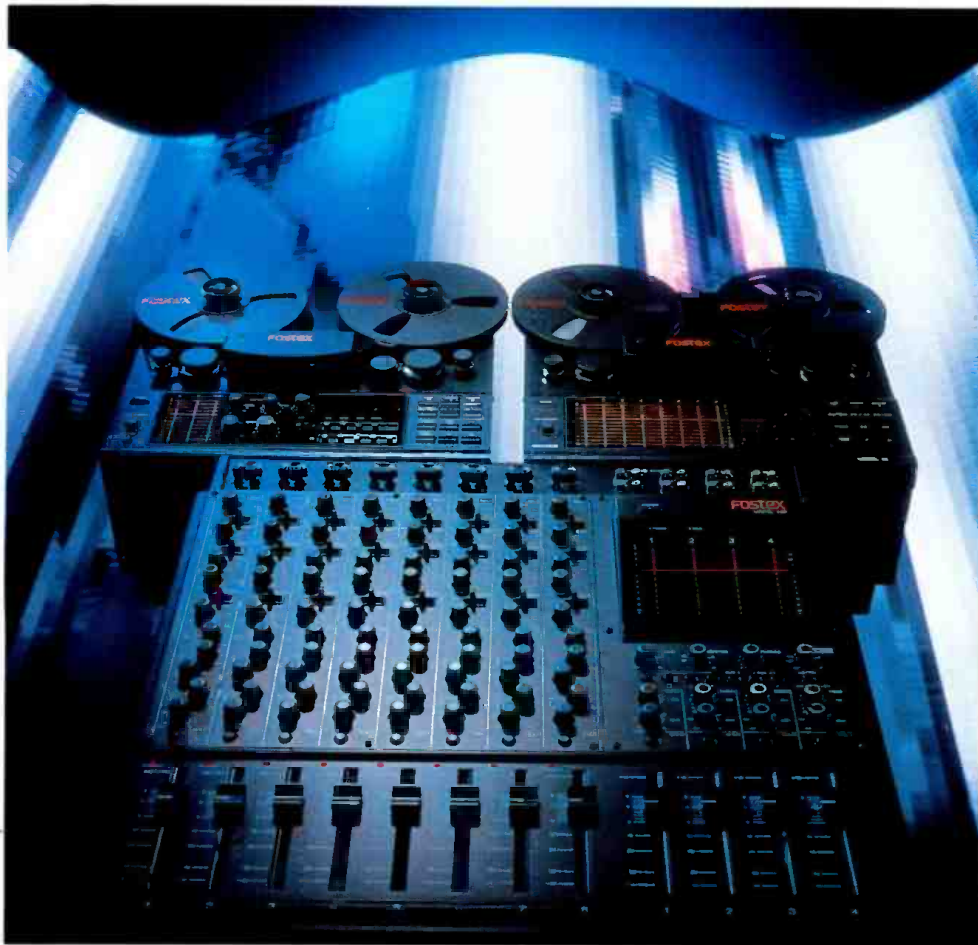

The compact 8-track format worked like a charm from day one. Hard as it was to believe something so small could produce sound so good, people became believers after they heard the reality.

Now the next step. The next generation. Microprocessor controlled transports, and record/play functions. Dolby\* C noise reduction on the Model 80, center channel SMPTE on the Model 20.

8 balanced mic inputs each with phantom powering, solo and in-line monitoring on the Model 450 8 x 4 x 2 mixer.

All available now; high tush processors (left) available soon. Your next step.



4050  
AUTOLOCATOR

This Auto-Locator offers more features for the musician/songwriter than ever before available. Not only minutes and seconds, but also bars and notes can be cued. Additionally, changes in tempo and rhythm can be precisely programmed with reference to real time. There's a SMPTE time code generator/reader, as well as a MIDI synchronizer allowing you to sync MIDI to SMPTE. Setting of cue points and tempo sequences can be stored in the memory or dumped to tape. Finally, this Auto-Locator can communicate with a computer through the serial communication buss. For the artist working on sound tracks, there is nothing that even comes close to the performance of the Fostex 4050.

4030 SYNCHRONIZER



4035  
SYNCHRONIZER/CONTROLLER

Finally. A cost effective synchronizer that sets up fast and operates painlessly. Locks video to audio or audio to audio, rock solid. Resolution to 1/100th of a Frame. In CHASE, the slave will follow the master regardless of tape mode. All displays, status and command functions are clearly marked, so operation is fast and positive. About 1/5 the cost of comparable synchronizers.

**Fostex**  
15431 Blackburn Ave.  
Norwalk, CA 90650  
(213) 921-1112

\*TM Dolby Labs Licensing Corp.

Circle 17 on Reader Service Card

# Editorial

**A**COUSTICS IS A SCIENCE that has been around since the days of the ancient Greeks. Sound systems have been around since 1915. Since then, acousticians and sound system designers have been mixing the two like gasoline and water. Both the sciences of acoustics and electroacoustics have always been evolving (and will continue to) empirically around our culture(s). During the days of Sabine, Knudsen, and Beranek, the public-at-large did not live with "walkmen" glued to their ears, nor did our youth's accoutrements include "boom-boxes." Remember tennis-elbow? I suppose now they'll have box-shoulder! It is with the rapidly escalating integration of "high-technology" with today's culture and newer musics that combining electroacoustic technologies with architectural techniques will become a necessity rather than a nicety.

The AES Convention this past fall, in New York, featured an Electronic Architecture Workshop, organized by Marc L. Beningson of Jaffe Acoustics, Norwalk, CT. The information presented at the workshop was gathered from a wide variety of sources, including phone conversations with various contributors, as well as notes, papers, and numerous diagrams submitted by them. All of this information was then compiled into a presentation for the workshop. The workshop was a survey of existing companies, people, and technologies involved with electronic architecture. The material of all of the participants of the workshop is included in this issue. The following is a list of all the workshop's participants:

## ELECTRONIC ARCHITECTURE WORKSHOP

Chairman: Marc L. Beningson, Jaffe Acoustics, Inc.

Panelists: Wade R. Bray, Jaffe Acoustics, Inc., Peter Barnett, Acoustic Management Systems Ltd.

Contributors: Herbert T. Chaudiere, Towne, Richards & Chaudiere, Inc.; Ing. Peter Swarte, N.V. Philips, Electro-Acoustics Div.; Professor John Ditamore (retired); Roger Happer, Acoustic Investigation Research Organization (AIRO); David L. Klepper, Klepper Marshall King Assoc., Ltd; David Neaderland, Technical Acoustics, Inc. (TAD); Theodore J. Schultz, Theodore J. Schultz Assoc., Inc.; Dr. J. Jacek Figwer, Jacek Figwer Assoc., Inc.

Based on the AES Workshop, the material included goes beyond the scope and limits of the original presentation. This expanded coverage of Electronic Architecture will provide more information, background material, and applications for those involved in live sound, commercial-sound, and/or studio work. With more than a hundred books, and what seems like an infinite amount of articles and papers, we have attempted to cover the topic in general, and have included extensive bibliographies for those who wish to probe the topic further.

The first article in this issue comes from the desk of this month's editor, entitled, "Good Acoustics." Specifications, especially for ones written for something as subjective in performance as acoustics or electroacoustics, i.e., any type of sound system, have become such a detailed objective art that we often forget what the original intent was—to understand the spoken word, or enjoy the music! The essence of this review is to remind us what good acoustics really means, and to provide a base from which to branch out to the science and art of Electronic Architecture.

Marc Beningson presents the information from the

Workshop, covered in greater depth and detail in his article, "Electroacoustics in Architecture." Having the understanding of what electronic architecture is all about, the next three pieces in this issue are about some of its applications. "Electronic Architecture Applications," discusses the implementation of Electronic Reflected Energy Systems (ERES), in some unique problem solving situations in concert halls, and music pavilions.

To conclude this installment of Electronic Architecture, we have a presentation from L. Richard Feld about 'invisible sound', or what Harry F. Olson talked about over twenty-five years ago—"active acoustics." Many of us have worked with a myriad of table mics, micro-processed mixers, logic-controlled loudspeakers, sophisticated signal processing, miles of wire, ad infinitum. What can be accomplished in board/conference rooms with electronic architecture using several ceiling-mounted modules, and a plug-in-card/mainframe system is a real eyebrow raiser—everything is in the ceiling, not a cable on the table!

Harry F. Olson first reported, in the JASA July 1959, of an "Acoustoelectronic Auditorium," in which the design of the room acoustics and sound system were integrated modifying the room's acoustics. Later, in his October 1965 AES paper entitled, "Passive and Active Acoustics in Architectural Enclosures," Olson described the limitations of "passive acoustics" and outlined the revolutionary concept of "active acoustics." Olson concluded, in his completely objective manner:

The main reason for the passing of the acoustically passive architectural enclosure is its limited, antiquated, inadequate, capricious, and atrocious acoustical performance as compared to the acoustically active architectural enclosure. Furthermore, new electronic developments have made the acoustic possibilities and properties of the acoustically active architectural enclosure practically universal and unlimited.

Olson had worked earlier, in the mid-1950s, with John Volkman also of RCA, on "active acoustics" with an "electronic orchestra shell" in Haddon Heights, NJ, and at the Academy of Music in Philadelphia where they used the stairwells as reverb-chambers and coupled them back into the hall, thereby, extending the reverberation time. Thus, it can be said, that electronic architecture was first developed by Olson and Volkman, in the 1950s, when they designed architectural enclosures with "active acoustics" that provided optimum acoustic conditions for speech, voice, and music programs within the same space.

With the direction in which music is headed, catalyzed by synthesizer technology and communication via the MIDI (Musical Instrument Digital Interface) standard, it is clear that Electronic Architecture will become a vital part in the presentation of music. MIDI is rapidly growing in its capabilities; it can control, from note-to-note, signal processing, mixing consoles, lighting consoles, and now acoustics. Just as composers have always used their tools beyond the limits, they will now use acoustics beyond its limits. Those who will remain vociferous through the present evolution of Electronic Architecture techniques, will take their place in history with those die-hard vacuum tube crusaders.

—Jesse Klapholz  
Guest Editor



## Good Acoustics

*What is the meaning of “good acoustics”?*

**G**OOD ACOUSTICS is perhaps the most presupposed and most loosely used term by the musical/architectural world. Everybody from music critics to music listeners use “Good Acoustics” freely in their vocabularies without stopping to think about what it really means. “Good Acoustics” is not as “cut and dry” as it appears on the surface. Its parameters are based upon subjective musical tastes, which are then

*Jesse Klapholz is a contributing editor for db Magazine as well as guest editor for this particular issue.*

translated into the “physical domain,” and are then finally defined scientifically. It is the object of this short review article to give us a perspective of the field of acoustics, including some background information, so that we may better understand and appreciate the term “Good Acoustics.”

### **OUR FOREFATHERS' FOREFATHERS**

It has often been said of acoustics that the basic theory was laid down early, and that all that was needed was its implementation by the necessary analysis and its application to new problems as they arose. The basic

theory of the production, propagation, and reception of sound was postulated by the ancient Greeks in substantially the same form as we accept it today.

While the theory of pitch was conceived by the Greeks, it was not until the time of Galileo Galilei (1564-1642) that acoustics as a science really developed. The great scientists and mathematicians of that period—Mersenne, Hooke, Taylor, Bernoulli, D'Alembert, Euler, Wallis, and Sauveur—were the most prominent to work on the mathematical and physical relationships of vibrating bodies. Perhaps Joseph Sauveur's most recognizable contribution was that he first suggested the name acous-



tics for the science of sound. Acoustics actually comes from the French word "acoustique," which was derived from the Greek word akoustikos, meaning "of or for hearing," which is from the word akouein, "to hear."

### OUR FOREFATHERS

In 1853, a Boston physician, J. B. Upham, wrote several papers concerning the "multiple reflections" of sound from all the surfaces in a room and how they could be treated so the room's reverberation time could be reduced. In 1856, Joseph Henry made a study of auditorium acoustics, although his suggestions were all of a qualitative nature. In 1895, Wallace Clement Sabine, a professor at Harvard University, developed a theory that reverberation could quantitatively be measured as the time it takes a sound in an enclosed space to decay 60 dB, and is directly proportional to the room's volume and inversely proportional to the area of its absorbent surfaces. In 1900, Sabine served as the acoustical consultant for Boston Symphony Hall, making it the first music hall designed according to scientific principles. The only instrumentation available to Sabine at the time was his stop watch and his ears. Ironically, according to many critics it is still one of the best concert halls in the world.

Sabine's work marked a new era in acoustics—an age of reverberation. For the next half century, the theory of reverberation, as first developed by Sabine, was to be the "golden rule" as well as the "buzz-word" of much discussion and conjecture for acousticians. Although during the vaudeville era, rooms were being designed

empirically (Radio City Music Hall in New York City was the last such theatre to be built during this time), the early '20s saw the growth and development of a more scientific approach. Watson's "Acoustics of Building" (1923), was a milestone "single-source" on the subject for architects and engineers. In the '30s, Frederick V. Hunt, using the new electronics of broadcasting to the measurement of reverberation times and sound fields, perfected an apparatus for accurately tracing sound-decay curves. Professor Hunt engaged in continual discussions with his students (among whom were L.L. Beranek and T.J. Schultz) on the meaning of sound diffusion in auditoriums, direct-to-reverberant sound energy, optimum reverberation times for different sizes and purposes of auditoriums, and so on. A source of reverberation criteria still used can be found in Vern O. Knudsen and Cyril M. Harris' book published in 1931, *Acoustical Designing in Architecture, The Hearing of Speech in Auditoriums*, published by Knudsen in volume #1, 1929, of the *Journal of the Acoustical Society of America*. This endures as an important work in which he discusses the causes and effects of percentage of articulation, signal-to-noise ratio, reverberation, and the shape of the auditorium on speech communication in rooms.

### ROOM ACOUSTICS

When a sequence of sounds is produced in a room, the original sound reaches a given listening point, plus a multiplicity of reflected versions that may reinforce and embellish the original or may distort and blur it beyond recognition. Room acoustics is a study of the influence of the room on the end product reaching each listening position. Rather than attempt to analyze such a complex phenomenon in one "view," several different idealized models may be used, which are often categorized under the headings of "geometrical acoustics," "statistical acoustics," and "wave acoustics." Simply stated "geometrical acoustics" is the application of geometrical optic techniques to acoustical investigations. The basic method is a graphical ray-tracing process from a source, through reflections from various surfaces in a hall, to their ultimate arrival at a listening/observation point. The application of geometrical acoustics to design is ingeniously demonstrated by W.C. Sabine's paper, "Theatre Acoustics." It illustrates his very successful use of an optical-acoustical pulse technique for studying the propagation of wave fronts in auditoriums. Variations of Sabine's approach were later developed by A.H. Davis, Takeo Satow, and the team of R. Vermeulen and J. de Boer. As in geometrical optics, there are limitations: for specular reflection a surface must be comparable in size to a wavelength, and smooth compared to a wavelength. Another complication of the acoustical analogy is that the various direct and reflected versions of a brief sound may arrive at a listening point at noticeably different times, with a resultant distortion of the original. The acoustician must therefore consider both the spatial and temporal distributions of sounds. Thus, it can be said that geometrical acoustics provides a way of examining the direct sound plus the first few reflections.

Statistical acoustics deals with the reverberant sound resulting from many reflections from the room boundaries. The multiplicity of reflected sounds is treated

statistically to relate the average level of reverberant sound in the room and the rate at which it decays to the absorption properties of the room surfaces. The first such scientific revelation was Sabine's famous formula  $T = 0.049V/A$ , where  $T$  is the reverberation time in seconds,  $V$  is the room volume in cubic feet, and  $A$  is the room's absorption expressed in sabins. The assumption upon which Sabine's theory is based is that the growth, steady-state, and decay of sound in a room may be treated as continuous processes, with equilibrium at all times between the energy density in the room, the power being added to the room, and the power being lost by transmission or absorption. Implicit in this is the assumption that the sound field is diffuse; i.e., that on the average it looks the same everywhere, with equal probability of waves traveling in all directions. Sabine recognized these limitations, but he found that in many rooms his theory described the reverberation processes with adequate accuracy.

Indeed it still does. Sabine's formula has the defect that it yields a finite reverberation time in the limit when all surfaces are perfectly absorptive. Attempts were subsequently made to eliminate this defect and provide a formula that gives more accurate results. The most successful of these is the formula developed simultaneously by K. Schuster, R.F. Norris, and Carl Eyring. The two more prominent presentations form an interesting contrast: the Norris version is simple and brief, while Eyring's is an exhaustive analysis using image theory. Both lead to the same formula, quite widely used today, which agrees with Sabine's formula when room absorption is low. Of the various reverberation theories, the Sabine theory remains the most satisfactory, when restricted to highly reverberant rooms. The other approaches involve certain assumptions about transit times between successive reflections and the use of ray-tracing concepts that cannot easily be pushed to the statistical limit. These difficulties were examined later in some detail by F.V. Hunt, L. Batchelder, and W.B. Joyce.

However, for the accuracy needed in design, the Sabine formula provides the basis of a method for measuring absorption coefficients of materials; and depending on the parameters, either the Sabine or the Norris/Eyring formula can be used to calculate the reverberation properties of a hall. Wave acoustics is based upon wave theory as developed by Lord Rayleigh, who published wave equations and the expressions for normal modes in rooms and applied them to "room resonance" control methods. In the mid '20s, E.T. Paris, who invented the stationary-wave tube for measuring normal-incidence absorption and impedance of materials, further developed the concept of acoustic impedance and its relation to sound absorption. The application of wave theory to room acoustics really took off in the mid '30s as a result of research by P.M. Morse and his co-workers. It was believed at the time that all the phenomena of room acoustics would soon be explained by wave theory.

As the story unfolds, however, sound fields in most rooms are far too complicated to be described by wave acoustics alone. However, these studies have given us yet another view of the behavior of sound in rooms and of the physics of the absorption process. Although it is beyond the scope of this writing, a comprehensive look at the applications of wave acoustics to rooms may be

found in a review paper by P.M. Morse and R.H. Bolt (*Sound Waves in Rooms, Review of Modern Physics*—#16:69-150, April 1944.)

### SHORT-TERM ROOM CHARACTERISTICS

The techniques of statistical acoustics and reverberation time provides us with room characteristics which may be described as the long-term transient behavior of sounds in rooms. Reverberation, though, is only part of what we experience in listening to sounds being transmitted in rooms; equally important are the short-term transient characteristics of rooms. The sequence of reflected sounds in a hall is universally accepted to have a strong influence on a listener's acoustical assessment of a hall. Early systematic approaches concerning the short-term response of halls were carried out by C.A. Mason and J. Moir, and Erwin Meyer and his associates at Gottingen University in Germany.

While some investigators studied the directional distribution of arriving sounds, others have emphasized the timing and relative magnitudes of successive arrivals. A special objective of the early reflection studies was to investigate the relation between the timing of the various signals reaching the listener and the apparent location of the source. The effect, in how it relates to electronic reinforcement systems, was known at least as early as 1935, when two papers were independently presented by R.D. Fay and W.M. Hall at the fourteenth meeting of the Acoustical Society of America.

In 1951, a more complete study was made by Meyer's student, Helmut Haas—hence, the term "Haas-effect"

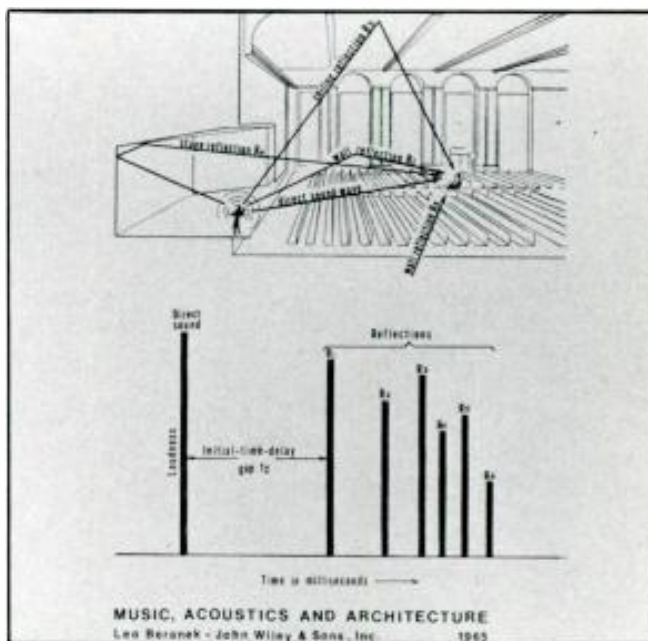

*Architecturally developed early reflections.*

Shortly thereafter, Bolt and Doak proposed a transient response criterion for auditorium design purposes. In the '50s a worldwide study of many of the better known concert halls was undertaken by Leo L. Beranek, including interviews with conductors, musicians, and music critics. This study resulted in his book, *Music, Acoustics, and Architecture*. Two of the most important design

parameters, as described in Beranek's book, were the initial time-delay gap at a listener's position (defined as the difference, usually measured in milliseconds, between the direct sound from the source and the first reflection), and the values and shape of the curve of the reverberation time versus frequency.

Later, researchers at Bolt Beranek and Newman, Inc., (BBN) of Cambridge, Massachusetts, set up an electroacoustical experiment in Philharmonic Hall which simulated the sound field perceived by a main floor listener in terms of three components: direct sound; the reflection from the ceiling panel array; and the reverberant sound. Through being able to electroacoustically alter the above-mentioned sound components, they were able to demonstrate the effects of changing spectral content in the early and late sound fields. At the BBN laboratory, Schultz and his co-workers demonstrated that it is not important that early reflections have a full complement of low-frequency energy. Like telephone circuits, the "musical intimacy" and "definition" functions depend principally on clear "consonants." They further showed, that the perception of "warmth" (or rich bass sound), though apparently independent of the spectrum of the early sound, is lost when the late arriving reverberant sound is deprived of its low-frequency energy. The ear seems to judge spectral-balance in terms of an integration over several hundred milliseconds; it is willing to wait for the reverberant energy before making its evaluation of musical warmth. One of Schultz's conclusions was that the reverberant field can stabilize the overall spectral balance despite low-frequency deficiencies in the early sound.

### CONDITIONS FOR GOOD HEARING

Let's take a moment to review what we have discussed so far. Starting immediately after the initial-time-delay-gap (whose duration establishes the "size" of the hall), we hear a number of individual reflections that perceptually "cue" us for our determination of the hall's characteristics that include articulation, definition, spatial imaging of the source(s), intimacy, presence, and ambience/spaciousness.

Subsequent to the early arrivals, the later reflections' density increases as time squared, so the density of reflections becomes extremely high after a short time. Therefore, for clarity's sake alone, we are primarily concerned with the statistical properties of the late-field and not its detailed structure. The quantity of RT60 is just that, a number—not the definition of what reverberation is. The balance of energy between the early- and late-field is the critical acoustical parameter that determines a hall's liveness, clarity, and warmth of sound. Simplistically, a hall's acoustical parameters are structured in terms of its components in the early- and late-field, and the balance between the two.

A concept that is most overlooked is the coupling of adjacent spaces—in fact, most tables of absorption coefficients include proscenium openings. While a proscenium may be absorbent for one space under consideration, it misleads us in that we overlook the effects of the reverberant energy of one space coupling to another. In most theaters the stagehouse may be larger than the auditorium, with a greater reverberation time which couples to the listening space. This may be used to the designers advantage by "fooling" the space into thinking it's bigger than it actually is. In designing musical performance spaces, one

must satisfy the requirements of the source area, the listening area, and how the two interact with each other. While it is beyond the scope of this article, it must be understood that the acoustical requirements for performance/listening spaces include many aspects not discussed here, including site selection, noise criteria, room shapes, dynamics, ensemble for performers, and freedom from flutters and echos.

Acoustics is a science that constantly evolves around musical technology and musical trends. Musical instruments were developed empirically, and as they became reliable composers and musicians began using them in their works. As musical instruments grow, so do the requirements of room acoustics. It is the job of the acoustician to provide a "translation" system so that the musician may communicate his ideas to the listener. It is, therefore, the priority of the designer to accurately understand the requirements of the space, so that he can implement them into a physical design with good acoustics.

### BIBLIOGRAPHY

- "Acoustics: Historical and Philosophical Development," Bruce R. Lindsay, *Benchmark Papers in Acoustics Series, vol2*, Dowden, Hutchinson & Ross, Inc. (1973).
- "Collected Papers on Acoustics," Wallace C. Sabine, Dover (1964).
- "Collected Papers from The JASA," Vern O. Knudsen (1975).
- "Architectural Acoustics," Vern O. Knudsen, *Scientific American*, Nov 1963.
- Hutchinson & Ross, Inc. (1977).
- "Acoustics of Auditoriums," F.R. Watson, *Journal of the Franklin Inst.*, July 1924.
- "Buildings for Music," Michael Forsyth, MIT Press, (1985).
- "Progress in Architectural Acoustics," Erwin Meyer and Heinrich Kuttruff, in "Technical Aspects of Sound," edited by E.G. Richardson and E. Meyer, Elsevier (1962).
- "Room Acoustics," Heinrich Kuttruff, *Applied Science*, (1973).
- "Architectural Acoustics," Vern O. Knudsen, *Scientific American*, Nov 1963
- "Toward Better Acoustics for Concert Halls," Manfred R. Schroeder, *Physics Today*, 33, #10, October 1980.
- "The Subjective Effects of First Reflections in Concert Halls—the Need for Lateral Reflections," M. Barron, *Journal of Sound & Vibration*, 15, 1971, pp.475-494.
- "Acoustics of the Concert Hall," T.J. Schultz, *IEEE Spectrum*, (1965).
- "Optimum Acoustic Criteria of Concert Halls for the Performance of Classical Music," JASA, Fritz Winkel, 1962, 34, 81-86.
- "Multivariate Analyses of Subjective and Physical Measures of Hall's Acoustics," JASA, 1972, 52, 1271-1279.
- "The Influence of Reflections on Auditorium Acoustics," J.P.A. Lochner and J.F. Burger, *Journal of Sound Vibration*, vol.1, #4:426 (1964).
- "Sound Waves in Rooms," P.H. Morse, & R.H. Bolt, *Review of Modern Physics*, 16:69-150 (April 1944).
- "Spatial Hearing," Jens Blauert, MIT Press, (1983).

# Electro - Acoustics in Architecture

*Electro-acoustic solutions create the correct acoustic environment.*

**T**HE ACOUSTIC CHARACTERISTICS of a space are critical to the correct perception of any performance in that space. Traditionally, physical acoustic solutions have been used to create the correct acoustic environment for a given program. More recently, electro-acoustic solutions have been developed to create required acoustic criteria in situations where innovative architecture, historic preservation, multiple use, or other factors limit or prevent more traditional physical acoustic solutions. In the next few pages, the reader will find a synopsis of what Electronic Architecture is, as developed and practiced by Jaffe Acoustics, and descriptions of seven different electronic systems used for acoustic design problem solving.

## PHYSICAL/ELECTRONIC

Perception of sound in a performing arts facility is dependent upon the relationship of the acoustic environment to the program being presented. Qualities that listeners describe as warmth, intimacy, and fullness are the result of specific acoustic criteria of both source and listening areas of a concert hall or theater. The acoustician can translate these qualitative experiences into quantitative room characteristics relating to the time arrival and intensity of early reflections and the amplitude and duration of reverberation. It is the role of the acoustician to create the correct acoustic environment for the intended program(s) of a performing arts facility, using a variety of design solutions.

Traditionally, acoustic design solutions have been of a physical nature, dealing mainly with the placement and treatment of boundary surfaces. While not in any way a replacement for properly executed physical acoustic designs, electronic solutions can be devised to provide the same acoustic characteristics, especially in situations where physical acoustic solutions are impossible, impractical, or undesirable.

Simply stated, Electronic Architecture is the application of electro-acoustic systems to meet the necessary

acoustic criteria of a space in place of, or in conjunction with, physical architectural surfaces.

## THEORY

It is well known that reverberation time is an important factor in the acoustic design of any performing arts facility. The distribution and intensity of early reflections is at least as important as reverberation time. The sound received by the ear in the first 30 milliseconds following the arrival of the direct sound contains information that is critical to the perception of definition or articulation of speed and music. The ratio of direct to early reflected sound, and the ratio of direct to reverberant sound are key factors in determining the quality of sound in a space.

Our experience indicates that these architectural components can be enhanced or even replaced by electronic components. The use of electronic design solutions is referred to as Electronic Architecture because the system affects sound in a space in exactly the same way as physical architecture.

The direct sound field is not amplified, reinforced, enhanced, or affected in any way. A design solution encompassing electronic architecture cannot be described as a sound reinforcement system. Only the reflective and reverberant fields are controlled through electronic architectural design. Because the system operates at low levels, loudspeakers are never identified as discrete sources, and experienced listeners cannot discern between comparable physical and electronic architectural acoustic environments.

## INNOVATIVE AND UNUSUAL ARCHITECTURE

Throughout the world, there are hundreds of concert halls and theaters. The vast majority of them have configurations that do not vary significantly from one another. Even so, most architects prefer to add a personal statement to their designs. Acoustical requirements place a severe limitation on the architect's creativity if only physical design solutions are considered.

The use of electronic architecture allows the basic hall configuration to deviate from the norm. Architectural surfaces such as the theater walls and ceilings, underbalcony ceilings and soffits, and the proscenium throat-walls can be placed in less than ideal acoustical positions. The volume of the hall can vary, and within limits, the propor-

Marc L. Beningson is an acoustical consultant at Jaffe Acoustics of Norwalk, CT.

tions of the hall can deviate from the usual. Importantly, a more intimate atmosphere can be created without sacrificing acoustical performance. The limitations placed upon an architect's design in order to meet acoustic criteria are reduced, because the criteria can be satisfied electronically. Electronic Architecture offers the architect more freedom to develop creative performing environments.

The Outdoor Music Pavilion is a North American phenomenon which is rapidly spreading. The Pavilion provides an informal, comfortable setting for concerts of all types. Frequently, such facilities are summer homes for major symphony orchestras, but the casual atmosphere and number of seats attract "middle of the road" and rock acts as well. The combination of fixed seating under a shed-roof and an open-lawn area accommodates audiences from four thousand to well over fifteen thousand, without the facility seeming empty or overcrowded.

With wide-fan shaped seating, a high roof, and no side or rear walls, a music pavilion is an unusual piece of architec-

acoustic quantities of a renovated theater are of prime concern to the user, a delicate balance between historical and acoustical requirements must be maintained. With the acceptance of electronics in the concert hall environment, both acoustic and historical requirements are met, thereby giving special historical spaces "a new lease on life."

### ASSISTED RESONANCE (AR) ACOUSTIC— INVESTIGATION RESEARCH ORGANIZATION

Assisted resonance (AR) was developed by P. H. Parkin and K. Morgan of the Building Research Station. The year 1964 saw the start of a four-year research and development program to install a system in the Royal Festival Hall to correct the short-fall in low frequency reverberation. The reverberation time was measured at some 1.5 seconds, a little on the low side for symphonic presentations. The AR system was a practical alternative to radical physical changes to the room.

An AR system consists of a large number of micro-

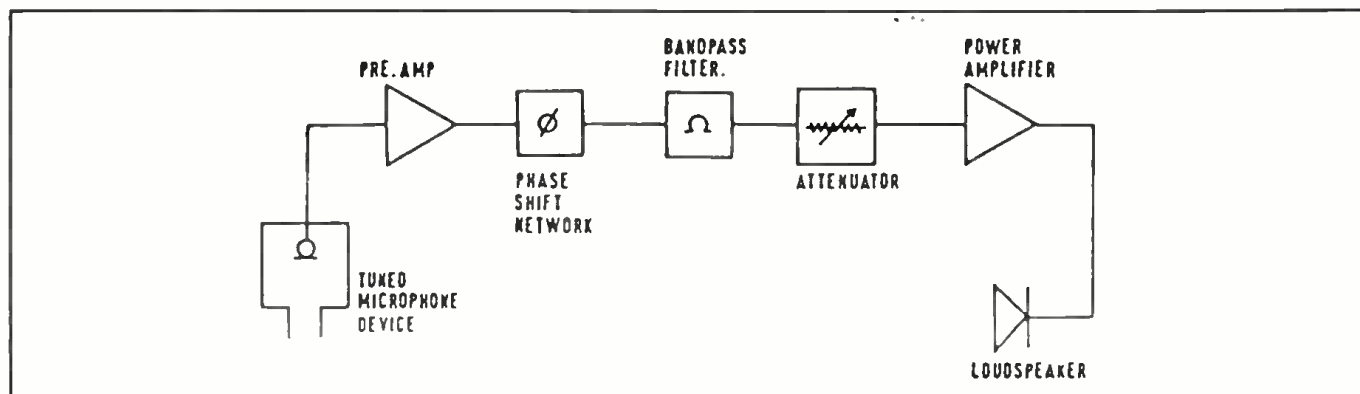

Figure 1. Block diagram of the basic system channel.

ture presenting many difficulties in terms of physical acoustic designs. While concert enclosures and forestage canopies can provide early reflections to seating areas closer to the stage, the size and shape of the seating area does not permit the distribution of natural reflections in sufficient quantity or amplitude to the entire audience. Due to their size, it is difficult for an orchestra to generate enough sound pressure to energize the air volume in a typical pavilion. With electronic architecture, an orchestra can perform without reinforcement to an audience of five thousand people under the shed roof cover. The volume under such a roof might be 1.5 to 2.0 million cubic feet, two to three times that of the Boston Symphony Hall.

### EXISTING STRUCTURES AND HISTORIC RENOVATIONS

Physical modifications to an existing structure to improve the acoustics environment of a space may be impractical or impossible. Lifting a balcony, raising a roof, or moving walls are all extraordinarily expensive undertakings whose budget implications could easily eliminate the feasibility of proceeding with a project. Electronic architecture provides the ability to create the appropriate acoustic environment without the expensive alterations of building structure.

Historical renovations are an important application for electronic architecture because the historic character of the architecture of the theater is the motivating factor for the renovation. This environment would be destroyed through the architectural modifications required by traditional physical acoustic design solutions. Because the

phone-amplifier-loudspeaker channels with each channel being, as far as practically possible, frequency independent of the others. This frequency independence is achieved by the use of high Q acoustic filters (Helmholtz resonators). A block diagram of the basic system channel is illustrated in Figure 1. Each microphone is placed at a frequency-specific pressure anti-node, and its associated loudspeaker is placed at a corresponding frequency-maxima (peak). The two are then joined by an amplifier and phase shift network, and the phase is adjusted so the signal is in a "phase-locked-loop." The system employed in the Royal Festival Hall uses 168 of these channels and achieves an increase in reverberation as shown in the graph of Figure 2. Parkin also recorded an increase in sound pressure level in the reverberent field with the system on and this amounted to some 1.9 dB in the 115 Hz octave band.

The number of channels used is based on work carried out by Schroeder and Kuttruff who demonstrated using a statistical method that the transmission response between any two points in a space had peaks which may be expected to occur, on average, at a frequency interval  $n(f)$  given by:  $n(f) = 3.91/RT$ .

For the Royal Festival hall this implied a frequency spacing of around 3 Hz and hence to cover the frequency range 58 Hz to 700 Hz which would require over 200 channels.

In 1969 the Acoustic Investigation Research Organization (AIRO) was granted a license to exploit the assisted resonance concept and between 1969 and 1983 some ten systems have been installed.

There have been a number of developments in the Assisted



Resonance System since the Royal Festival system. AIRO reduced the number of channels and increased the frequency range over which the system was to operate. A recent typical system employs 90 channels and covers the frequency range 63 to 1300 Hz. The channel spacing is not allocated on the basis of constant frequency, but instead the spacing is typically four percent at low frequencies and two percent at the highest. This is based on the premise that the ear's discrimination is related more closely to a logarithmic rather than linear frequency interval.

Obviously, the technology employed has been updated. AIRO now uses 50 Watt MOSFET power amplifiers instead of the 5 Watt tube amplifiers of the original system, and instead of fixed attenuators they use a microcomputer to change the gain. The microcomputer offers the feature

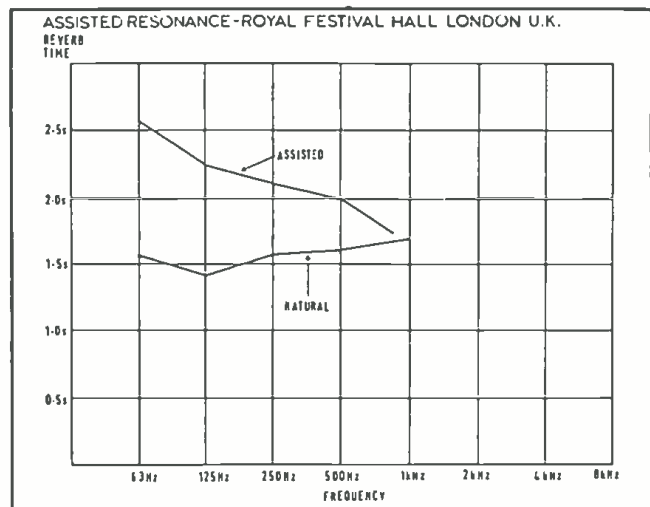

Figure 2. Graph showing increased reverberation in the Royal Festival Hall.

of instantaneous changes of every channel, with, for example, "presets" of opera, symphony, or speech. The latest system installed was in Eugene, Oregon (1981), in accordance with the specifications of our firm. It is a multi-purpose hall that hosts symphony, Broadway shows, and rock concerts. The reverb times for these presentations are obviously conflicting, and Figure 3 shows the AR system's range.

The AR system, as installed at Royal Festival Hall, was the first application of Electronic Architecture. When first installed, no one was told of the intrusion of electronics into the hall. However, it was when musicians and the music critics began favorably commenting on the hall's improved acoustics that, the system was announced and subsequently expanded. It was the immediate success of the AR system that paved the way for the acceptance by musical communities of Electronic Architecture. Multi-Channel Reverberation System (MCR), N. V. Philips, Electro-Acoustics Division.

This system was developed by Professor N. V. Franssen of Philips Electroacoustics Division, Netherlands, in 1968. This system, as its name suggests and in common with Assisted Resonance, consists of a large number of channels (between fifty and 100), the exact number being dependent on the hall and the reverberation lift required. However, the channels are not frequency-selective, and are, therefore, frequency independent. Franssen's original intent was to design a sound reinforcement system that was source/listener-position independent. However, the number of channels required made this approach cost prohibi-

tive. Philips, therefore, applied the system to reverberation enhancement techniques.

Philip's MCR, however, is not to be confused with their Ambiophony system which predates MCR. In the Ambiophony system the sound near the source was picked up by microphones, delayed by a magnetic tape waterfall type delay unit, and then added by means of distributed loudspeakers to the diffuse sound in the auditorium. This system, which used the Philips EL6911 tape delay unit, was installed in many theaters including Studio 4 in the BBC Television Center, and the Teatro alla Scala in Milan, where it is still in use.

The typical MCR channel is shown in Figure 4. Equalization is applied to correct for the random-directive sensitivity of the microphone, loudspeaker, and the transfer function between them. The principle behind this system is simple and compact. In the diffuse field, sound energy density and reverberation time are directly related, so that if the diffuse sound is amplified there will be a corresponding increase in reverberation time. Basically then, the MCR system is a sound reinforcement system that amplifies the diffuse or reverberant field, as opposed to conventional reinforcement systems that amplify the direct field only.

Unlike Assisted Resonance, where the microphones are placed at frequency-specific pressure antinodes, the positions of the MCR microphones and loudspeakers are predetermined statistically and each channel amplifies the entire spectrum. However, each element must be in the reverberant field with respect to any other element. In practice it is found that for each channel about 0.8% is added to the energy of the sound field, but only 0.6% to the reverberation time. Increasing the reverberation time by

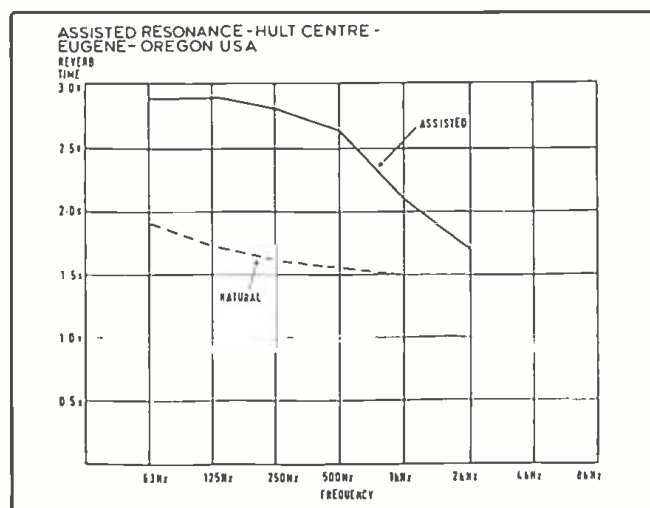

Figure 3. Reverberation times at Hult Center, Eugene, OR.

half, thus, requires over 80 channels. While it is advantageous to be able to precisely define the positions of transducers for very small spaces, it could be difficult or impossible to find sufficient positions that both satisfy the reverberant field criteria and provide the required reverberation lift.

Like Assisted Resonance, the MCR system's reverberation is dependent directly upon system gain. Both systems operate at only -5 dB to -10 dB below feedback, and as such there is only a small margin of error. The theoretical limit for raising the original diffuse-field level is 12 dB. However, coloration sets in just above 5 dB of gain and system instabilities are encountered beyond 6 dB of gain, where

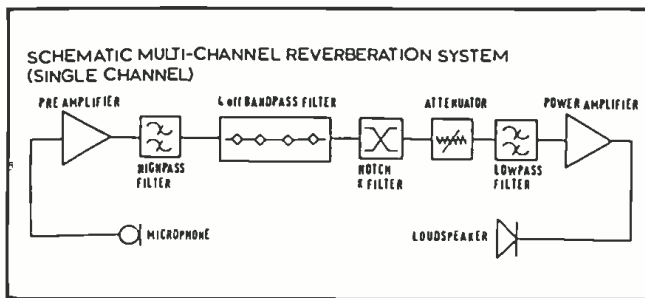

Figure 4. Simplified block diagram of basic reverberation system.

there is a doubling of the reverberation time. The MCR system has a continuous checking system that inspects the electronic gain to detect the onset of problems. It does not, however, check the total loop gain since this would involve continuous acoustic measurements. There are also two detection and measuring microphones which are placed between the sound source and the system microphones. These microphones provide advance warning of levels outside the system's capability (110 dB SPL) such that overload and distortion will not result.

To date, five MCR systems have been installed, the most recent is in Limehouse Studio 1, London, where it is intended to provide an acoustic climate suitable for orchestral presentations in an otherwise acoustically dead space. Similarly, the Hans Rosbud Studio Sudwesfunk broadcasting organization in Baden-Baden (Federal Republic of West Germany) has been provided with a 70-channel MCR system. The first auditorium to be provided with an MCR system was the one in Philips POC Congress Centre, Eindhoven, (1981). The POC system consists of 90 channels, so that the reverberation time can be increased in steps from 1.1 seconds to about 1.7 seconds. An MCR installation has also been fitted at the Claude Debussy Theatre of the Palais des Festivals et des Congres, Cannes (France). The 66 channels can be used to increase the mean reverberation time from 1.45 seconds to 2.0 seconds. The Saalbau, a multi-purpose hall at the Weinstrasse, in Neustadt Netherlands, is the most recent MCR installation. It has 79 channels, and through the mid-range it raises the reverberation time from 1.25 seconds to 2.0 seconds.

### REVERBERATION CHAMBERS AND ACTIVE ACOUSTICS—Bolt, Beranek, & Newman; John W. Ditamore; Paul S. Veneklasen.

Prior to the advent of electronic delay and reverberation devices, external chambers were used as the source of additional reverberation to be added to halls. In a system of this type, microphones fed loudspeakers in an isolated reverberation chamber located elsewhere in the facility. Additional microphones were used to pick up the reverberant sound and feed it to loudspeakers distributed through the facility.

In 1965, David Klepper (now with KMK) and Russell Johnson (now with Artec) worked in conjunction with John Ditamore, an independent theater consultant on the faculty of Purdue University. They designed and specified an electronic reverberation/surround system for the Miller Auditorium, University of Western Michigan, Kalamazoo. The system used conventional microphoning and mixing techniques, with the console feeding a power amplifier driving an Acoustic Research loudspeaker in a reverberation chamber, well isolated from the auditorium.

The reverberation chamber had an adjustable drape to vary the reverberation time from about one to three seconds at mid-frequencies, depending on the extent of the drape exposed from its pocket. The signal in the reverberation chamber, which was completely non-parallel, was picked up by an omnidirectional condenser microphone, fed through a tape-loop delay unit (built from an Ampex 350), and delivered through amplifiers to a number of Altec 604 coaxial loudspeakers above a panel-array ceiling and behind sound-transparent walls. This system worked well for orchestral performance, and is still in use, although some modern digital equipment has been added.

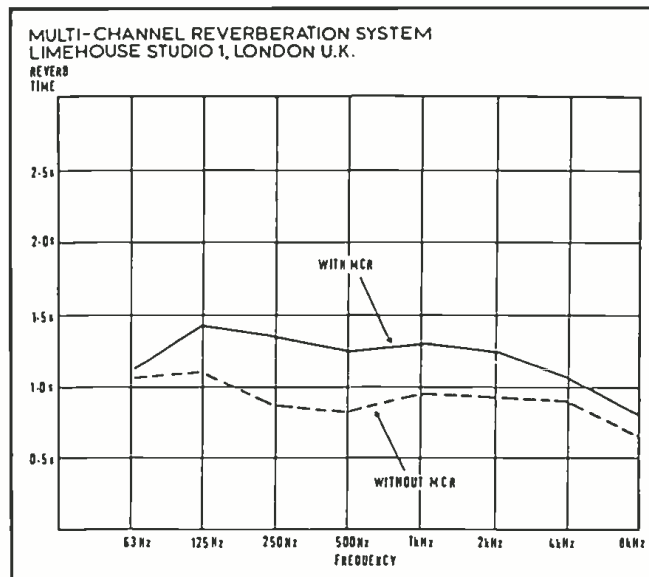

Figure 5. MCR system graph at Limehouse Studio 1 in London.

Paul S. Veneklasen filed for a patent on a "Method for Synthesizing Auditorium Sound" in May of 1967, was granted U.S. Patent Number 3,535,453 in October, 1970, which is shown in Figure 6. This system utilizes a reverberation chamber and a delay tube to provide both the reflection patterns and reverberation of a large auditorium in a smaller room. The system was conceived for use with either a natural or amplified source. The system was described to have a more natural room sound, hence the use of the word 'synthesized,' rather than 'artificial' reverberation provided by tape delay systems. The Veneklasen system was installed at the Classic Beauty Collection, San Sylmar Museum, Sylmar, California, to enhance the acoustics of an auditorium where a large Wurlitzer theater pipe organ is played regularly.

Veneklasen's Auditorium Synthesis method was also used by his firm as a research tool. The progression of direct, envelopmental, and reverberant sound were precisely controllable. One of the most important facts first demonstrated was that, as important as are time delays and directions, the relative levels of the three key components of auditorium sound are most important. They also found that, the preferred levels vary with taste and program material, and in particular, the ratio of reverberant versus direct sound is more important than the reverb time itself and controls the clarity.

In 1974, John Ditamore served as theater consultant to Rudder Auditorium at Texas A & M University in College Station, Texas, and designed a sound reinforcing system

FIG. 1.

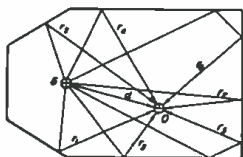
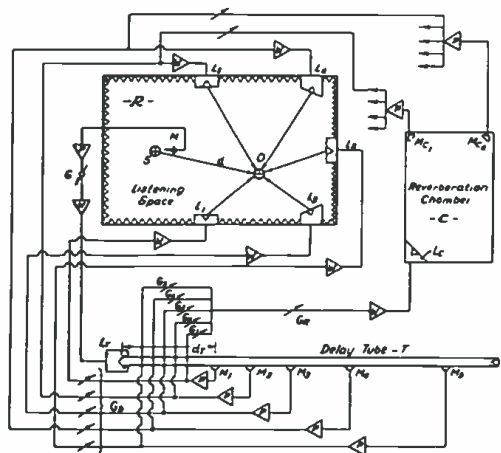

FIG. 2.



INVENTOR.  
**PAUL S. VENEKLASSEN**  
 By *White & Heflinger*  
 ATTORNEYS.

Figure 6. Paul S. Veneklasen's method for synthesizing auditorium sound.

including 'active acoustics.' In a manner similar to the University of Western Michigan system, an external reverberation chamber was used to provide additional reverberant sound through loudspeakers located throughout the ceiling, sidewalls, and balcony soffits. The levels of both the direct sound from proscenium speakers and the reverberant sound were independently adjustable. The basic reverberation time at mid-frequency, without the active acoustics system, was 1.4 seconds. This was increased to 1.8 second with the system in use.

**REVERBERATION ENHANCEMENT WITH ELECTRONIC DEVICES—Bolt, Beranek & Newman; J. Jacek Figwer; Theodore J. Schultz; David L. Klepper; Towne, Richards & Chaudiere, Inc.**

In the late 1960s, Bolt Beranek & Newman served as acoustical consultants on a project to improve the acoustics of Kresge Auditorium, a 1238-seat multi-purpose auditorium on the Massachusetts Institute of Technology campus. In conjunction with a series of suspended plaster sound reflecting panels designed to counteract the undesirable acoustic qualities of the room's dome-shaped ceiling, a number of experiments in electronically assisted reverberation were conducted in 1967-1969. The result was a system designed by Jacek Figwer, using a Kuhl's plate as the reverberation source and two rows of four loudspeakers installed above the reflector panels. The front row speakers point upward and the sound is reflected from the ceiling. The rear speakers point downward. Signal delay is used to provide the correct arrival time of the reverberant sound following the direct sound. The two system microphones are hung from the reflector panels over the orchestra. "In the technical minded community of M. I. T., the intrusion of electronics into the world of music did not seem to create any adverse reactions," according to Dr. Figwer. The block diagram for the system, and the resulting lift in reverberation is shown in Figure 7.

In 1976 to 1977, Figwer designed an underbalcony system in conjunction with Ted Schultz, physical acoustics consultant for Bolt, Beranek, & Newman, Inc., on a project involving the Orpheum Theatre in Vancouver, British Columbia. The concept was to obtain reverberation from the upper portion of the hall itself, which was not lacking in reverberation, and introduce this natural reverberation into the deep, low overhang underbalcony area through loudspeakers in the balcony soffit. No additional delay was required due to the geometry involved. The intent was to keep the installation a secret, but word leaked out, resulting in skepticism on the part of the conductor and musicians. However, Schultz reports that after initial tuning and adjustments, the musical community was delighted with the system's ability to remove the balcony.

In 1984 at Klepper Marshall King Associates, Ltd., David Klepper designed a simple, but comprehensive,

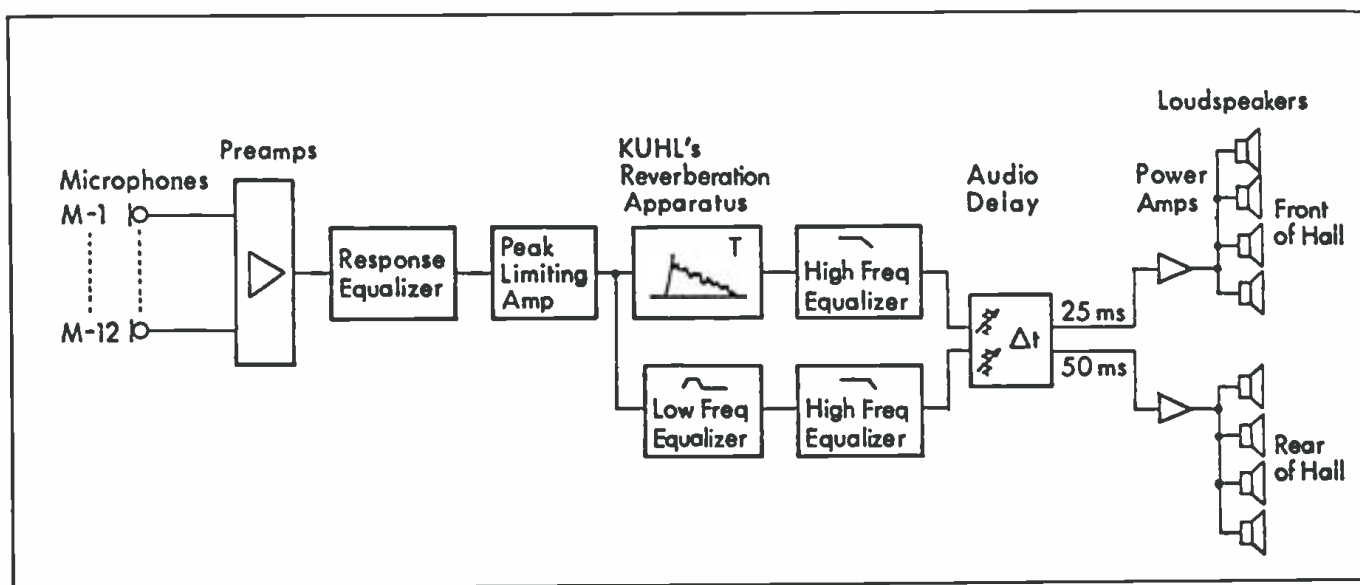

Figure 7. Block diagram for the Kresge Auditorium reverberation system.

db January-February 1986

sound reinforcement system for the University of Hartford's Lincoln Theatre, in West Hartford, Connecticut. The system re-used existing JBL loudspeaker clusters, which can provide reinforcement by themselves, or serve as precedence loudspeakers in conjunction with a distributed system of Electro-Voice PRO-12 loudspeakers, partly on delay. The Music School's Lexicon 224 reverberation unit has been used with the system to add liveness to chamber music performances and will be programmed for orchestral concerts in the future.

Electronic Reflected Energy System (ERES)—Jaffe Acoustics, Inc.; Technical Acoustics, Inc. When an Electronic Forestage Canopy (EFC) was installed at the Oakland Paramount Theatre in Oakland, California, in 1973, the involvement of Jaffe Acoustics in the field of Electronic Architecture began. Historical renovation did not permit the installation of forestage reflector panels, required for providing critical early reflections in the theatre. In conjunction with the natural excitement of physical volumes acoustically coupled with a hall—such as acoustic 'moats,' stagehouses and organ chambers—to extend and enhance reverberation in a hall, Jaffe Acoustics developed a system to electronically energize these coupled volumes—the Reverberant Field Energizer (RFE). This system was first used in 1977 at Laurie Auditorium, San Antonio, Texas, and was granted U.W. Patent #4,061,876 in December, 1977. In the following years, these systems evolved into the Electronic Reflected Energy System, or ERES.

ERES uses loudspeakers distributed throughout a hall to enhance or provide natural reflection patterns for the proper perception of sound in the hall. While other electronic architecture systems deal primarily with reverberation, ERES provides presence, running liveness, reverberation, and warmth in a concert hall, theater, or multi-purpose performing arts facility. Any or all of the four channels may be used individually or simultaneously, depending on the acoustic requirements of the hall itself and particularly the intended program of the space. ERES can be used to correct acoustic deficiencies in an existing hall, however, a number of multi-purpose theaters have been constructed with ERES included as an integral part of the acoustic design of the facility. The four basic channels of ERES are shown in *Figure 8*.

The first two channels are provided through the use of digital delay devices and strategically located distributed groups of two- and four-inch loudspeakers. Delay times are set to provide or augment the envelope of early field reflection patterns for a specific audience area. Each transducer requires 10-20 Watts of amplifier power. The second two channels are provided through the use of a custom, multi-tap digital reverberation device and distributed eight-inch coaxial and twelve-inch loudspeakers. The custom reverberator provides a diffuse package of late arriving reflections, gradually decaying but pseudo-randomly varying in amplitude and time spacing, which combines with the natural reverberation decay of the room. The reverberation time, the level of the reverberant field, or both, may be increased. Each transducer requires 20-50 Watts of amplifier power.

Sound pick-up is in the late field of the sound source, by microphones implanted in overhead reflector panels. Although a number of microphones are provided for different programs (symphony, symphony pops with soloists, chamber, chorus), generally only one microphone is used for a particular function. One or more notch filters are pro-

vided to remove primary feedback frequencies if necessary. Technical Acoustics Inc., a wholly-owned subsidiary of the Bozak Corporation, New Britain, Connecticut, currently manufactures a line of products for Acoustic Field Management Systems using ERES and other technology under license from Jaffe Acoustics for applications in performing arts and religious facilities, as well as corporate boardrooms and conference rooms.

### AMBIENCE ENHANCEMENT BY TOWNE, RICHARDS, AND CHAUDIERE, INC.

Towne, Richards, and Chaudiere's involvement with Electronic Architecture, or as we call it, Ambience Enhancement, has been in the area of broad-band enhancement of reverberation, in conjunction with the facility's sound reinforcement system.

This approach has been the result of typical projects with budget limitations and multi-use program requirements. It is not always possible to have sufficient volume for music programs (hence, inadequate reverberation), and speech-related programs are best with relatively little reverberation. This conflict (speech vs. music) can be resolved for much less money using Ambience Enhancement as compared to adjusting reverberation by architectural means.

Our first experience was at the Capitol Theater restoration in Yakima, Washington. This Pantages theater originally opened in 1920, functioned for a time as a movie theater and was restored as a community multi-purpose performing arts facility in the late 1970s. Our calculations indicated the hall would be on the dry side for classical concert use and since a good house sound reinforcement was needed, we looked into the possibility of adding some reverberation.

The sound system was designed as a combination point source/delayed distributed, primarily since the seating under the deep balcony could not see the cluster centered over the proscenium. A Quad Eight CPR-16 digital reverb unit was fed from one of the outputs of the sound system console and fed to the four delay zones as well as directly to speakers in the domed ceiling of the theater. The reverb unit was operated as a single-channel device.

The opening concert with Jan Peerce and the Yakima Symphony was positively enhanced by judicious use of the system. It was determined that any attempt at "more is better" could be disastrous, particularly in view of the inherent coloration of the CPR-16.

The next two installations used a similar approach, but with the Lexicon 224. These systems, one at the McMinnville, Oregon, Community Center, a multi-purpose facility generated out of an old National Guard Armory building, and the other at South Kitsap High School Auditorium, a 700 seater in Port Orchard, Washington, were a definite improvement over the Capitol Theater system, but were still basically a single channel system.

The next installation, in a multi-purpose room at the new Jewish Community Center on Mercer Island, Washington, incorporated two basic improvements. In all of the previous installations, the distributed speakers were all ceiling mounted and exposed. In the Jewish Community Center, there were both ceiling and side wall speakers, totally concealed, which were wired on alternate circuits to the left and right incoherent outputs of the 224 reverb unit.

In the previous installations, the sound system operator had access to all the reverb unit controls. At the JCC, the 224 control head was preset and put in the equipment rack.

The sound system controls and a single reverb control were mounted on a panel at the back of the hall. The effect was the best yet.

The latest system is presently being installed in a multi-purpose auditorium on Kodiak Island in Alaska. The hall is very similar to the South Kitsap High School Auditorium, but the system will use the Lexicon PCM-60 which is less expensive than the 224, and will have only ceiling distributed speakers, but will be wired on alternate "left/right" circuits.

Characteristic	Frequency Spectrum	Time Arrival
Presence	250 - 6000Hz	0 - 20 msec
Liveness	250 - 2000Hz	300 - 2500 msec
Reverberation	20 - 1500Hz	300 - 3000 msec
Warmth	20 - 250Hz	60 - 300 msec

Figure 8. Four basic channels of ERES.

Two other systems, one at another Pantages Theater restoration and the other for a new State University Theater building, were carried through design but not implemented to date, due to budget constraints. All of the systems can apply the reverb to the reinforcement mix and/or dedicated "ambience" mics. The latter can be PZM's mounted on the orchestra shell overheads. Where "idiot proof" user operation is a requirement, preset parameters with a simple "dry to wet" control can be used effectively.

Our limited experience shows that properly implemented, broad-band ambience enhancement can provide a positive effect that would not be possible without it. We see an increasing potential market in community and institutional multi-purpose performing facilities. Where competent resident operators are available, the wide range of selectable parameters in state-of-the-art reverberation devices can be used to good advantage for special effects, and/or varying program requirements.

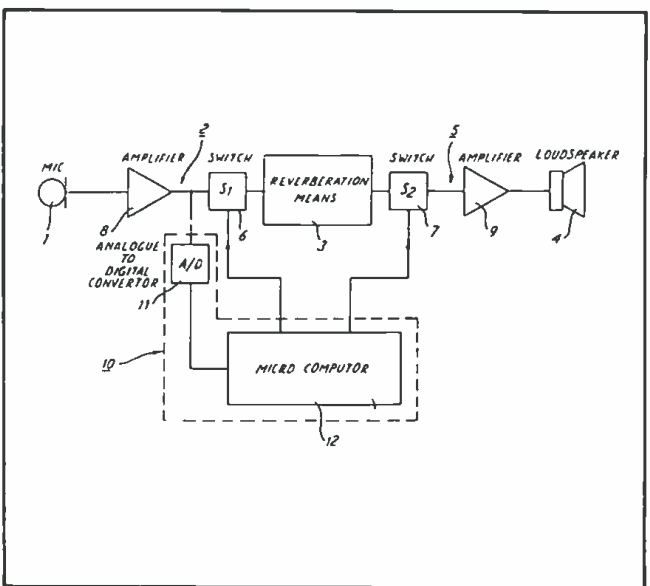

Figure 9. Simplified block diagram of the basic RODS system.

## REVERBERATION ON DEMAND SYSTEM (RODS)—ACOUSTIC MANAGEMENT SYSTEMS, LTD.

RODS is the most recent development in the area of electronic architecture and was developed by Peter Barnett, formerly with AIRO (the developers/suppliers of the AR system). This system is designed to integrate with ERES and provides only the reverberation content. The diagram of Figure 9 shows a simplified block diagram of the basic system. The essence of the system is as follows: Switches S1 and S2 are controlled by a microprocessor. The state of the switches is dependent upon the sound field; when the field is either steady or rising, S1 is closed and S2 is open. When the sound field starts to fall, S1 opens and S2 closes, releasing the stored reverberation into the space. Since S1 and S2 cannot be closed at the same time, the problem of coloration due to recirculation is much reduced. Clearly this is a much simplified account, since S1 and S2 are not, in fact, switches, rather they are digitally-controlled attenuators.

Because the reverberation level in one frequency band could be falling while another is rising, there is a need to increase the number of frequency dependent channels. The expanded block diagram of Figure 10 shows a comprehensive system. The system operates on the same principle as the basic system, but each channel operates independently in a fixed frequency bandwidth. In addition, delay units and input and output transducers have been added to ensure that the reverberation is delivered in a natural fashion.

### EPILOGUE

The viability of electronics in imitation of architectural acoustics has been shown as an adjunct to basic architectural and noise-reduction acoustic design techniques. An outline of the seven basic types of electronic architecture techniques established a perspective on the technology. It was also shown that the use of electronic architecture gives the architect and/or owner unprecedented freedom for expression in architectural statement and flexibility, while providing true multi-purpose spaces with the appropriate good multi-purpose acoustics. Likewise, these techniques allow for complete and precise control of the acoustics by/for the composer/musician enhancing and extending the limits for both performers and listeners alike. The increasing interest in performance-space electroacoustics, and its economic and functional attractiveness, is manifest in applications from small boardrooms to large multi-purpose halls. Perhaps, the next horizon are real home hi-fi ambience systems!

### REFERENCES

- (1) C. Jaffe and W. Lobb, "Reflected Energy Designs for Auditoriums." Presented at 64th A.E.S. Convention, New York, 1979.
- (2) D. E. Gilbeau and C. Jaffe, "Reverberant Field Energizer and Electronic Forestage Canopy." Presented at 51st A.E.S.

### BIBLIOGRAPHY

"Music and Reverberation," P.W. Barnett & W.R. Stevens, presented at the International Association of Auditorium Managers 56th Annual Conference and Trade Show, July, 1981.

"Electronic Architecture—the Application of Electronic Solutions to Physical Acoustic Design Problems," Marc L. Beningson, presented at the National Sound Contrac-

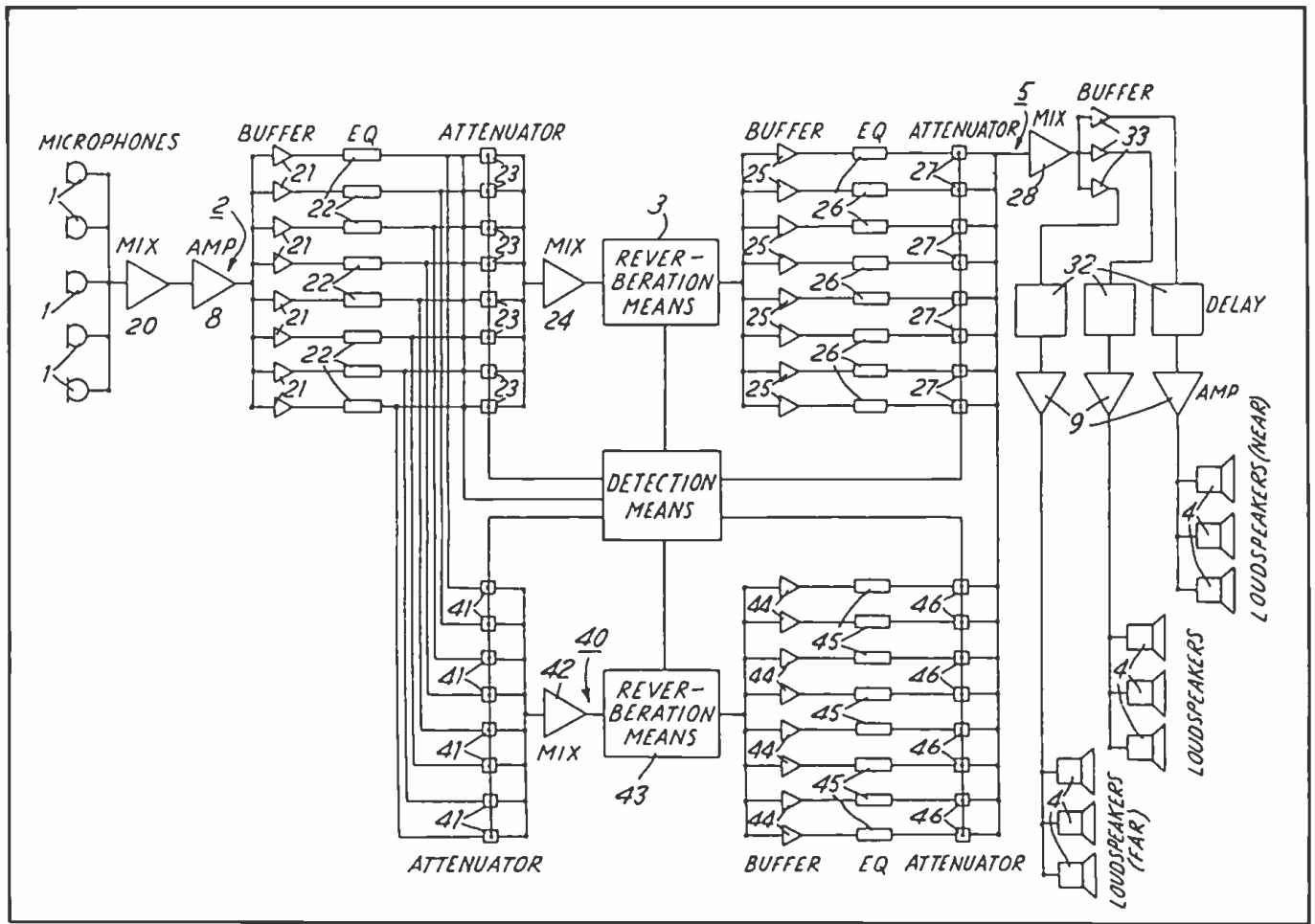

Figure 10. Expanded block diagram showing a comprehensive system.

tors Association Convention, April, 1985.

"Electronic Architecture via Acoustic Field Management Systems," Marc L. Beningson, presented at the West Coast Electronic Sound & Systems Conferences, September, 1985.

"Music, Acoustics and Architecture," Leo L. Beranek, Wiley, 1962.

"Electronic Architecture in the Broadcast Studio," Wade R. Bray, presented at the 5th Annual WOSU Broadcast Engineering Conference, at The Ohio State University, July, 1985.

"Ambiophony: Has its Time Finally Arrived?," Herbert T. Chaudiere, presented at the 63rd Convention of the Audio Engineering Society, May, 1979.

"The Application of Artificial Reverberation to a Large Lecture Theater," Frank Fowweather & B.H.S. Sharp, presented at the 5th Congress International d'Acoustique, Liege, Belgium, September, 1965.

"Reverberant Field Energizer and Electronic Forestage Canopy System," Donald E. Gilbeau & J. Christopher Jaffe, presented at the 51st Convention of the Audio Engineering Society, May, 1975.

"Reverberation Time Control by Direct Feedback," R.W. Guelke & A.D. Broadhurst, *Acustica*, vol.24, 1971.

"Assisted Reverberation in an Outdoor Environment," R.W. Guelke, *Acustica*, vol.38, 1977.

"A Method for Measuring Early- Mid- and High-Frequency Patterns," J. Christopher Jaffe & William Lobb, presented at the Acoustical Society of America 95th Meeting, May, 1978.

"Reflected Energy Designs for Auditoriums," J. Christopher Jaffe & William Lobb, presented at the 64th Convention of the Audio Engineering Society, New York, 1979.

"About this Reverberation Business," James A. Moorer, *Rapports-IRCAM*, vol.17, 1978.

"Acoustics of the Concert Hall," T.J. Schultz, *IEEE Spectrum*, June, 1965.

"Halls for Music Performance—Two Decades of Experience: 1962—1982," R.H. Talaske, E.A. Wetherill, W.J. Cavanaugh, *The Acoustical Society of America*, 1982.

"The Alteration of the Reverberation Times in a Small Theatre and a Concert Hall Using Loudspeaker Equipment," Ernst-Joachim Volker, presented at the 40th Convention of the Audio Engineering Society, April, 1971.

"The MCR System—Multiple Channel Amplification of Reverberation," S.H. de Koning, *Philips Technical Review*, vol.41, #1, 1983/84.

"Amplification of Sound Fields," S.H. de Koning and N.V. Franssen, presented at the 37th Convention of the Audio Engineering Society, October, 1969. preprint #697.

"Multiple Amplification of Reverberation," S.H. Koning & L.C. Keijser, presented at the Convention of the Audio Engineering Society, March, 1977, preprint #1208.

"Design Considerations from the Viewpoint of the Professional Consultant," Paul S. Veneklasen, *Auditorium Acoustics*, Edited by Robin Mackenzie, Applied Science Publishers, 1975.

"The Acoustic Design of Multi-Purpose Halls," Heinrich Kuttruff, *ibid*.

"Assisted Resonance," Peter H. Parkin, *ibid*. ■

# Electronic Architecture Applications

*Learn the ins and outs of architectural acoustics.*

**R**oom acoustics, characteristic of almost any room or hall, can be duplicated in three dimensional space through electronic analogies of surfaces, material types, and physical volumes, as developed and practiced by Jaffe Acoustics, Inc.

## ACOUSTICS

Any sound in three dimensional space has four charac-

walls, enhance volume, timbre, and articulation. They also provide a sense of liquidity, breadth, and immersion. Late reflections, from more distant surfaces and from multiple bounces, are important in maintaining the warmth and impact of bass instruments. This is also true of the reverberant-field, in addition to its prolonging and enriching effect.

Listeners appreciate the enhancement that good acous-

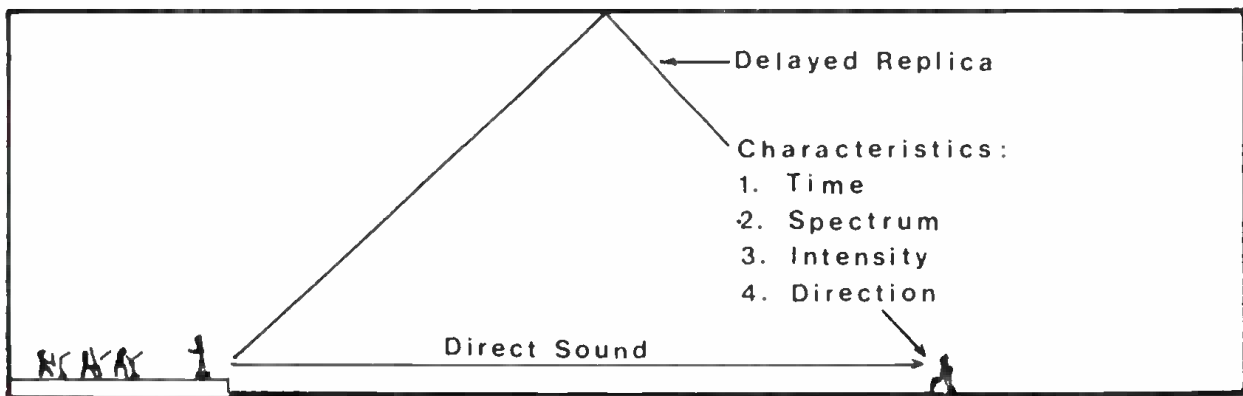

*Events which collectively make up architectural acoustics.*

teristics: direction, intensity, frequency composition, and time of arrival (which can be remembered by the acronym DIFT). Each of the many sonic events which collectively make up architectural acoustics is so characterized.

The direct sound, early reflections, late-field, and reverberant-field all make important contributions to musical sound, not only for the listener but for the musicians as well. Direct sound provides localization and a foundation to be enhanced by acoustic interaction.

Early reflections, normally from a concert shell and side

*Marc L. Beningson is an acoustical consultant of Jaffe Acoustics of Norwalk, CT.*

tics give to a performance. It is less well known that musicians also require good acoustics. They must hear their own sounds and be able to hear each other as an ensemble. The "friendliness" of a responsive space and its acoustic cues bring about an inspired performance. When good acoustical cues are absent limits are put on the performance even before it begins, including the impossibility of presenting certain types of music at all.

## THE ELECTRONIC REFLECTED ENERGY CONCEPT(ERAS)

It is possible to provide all of the components of natural

acoustics through the careful application of audio technology, augmenting deficient natural acoustics or providing the complete ambience in a "dead" space. An electronic analogy of walls, canopies, ceilings, and physical volumes can be created, which responds to a sound source as would physical structures.

A basic ERES channel consists of a microphone, mic-

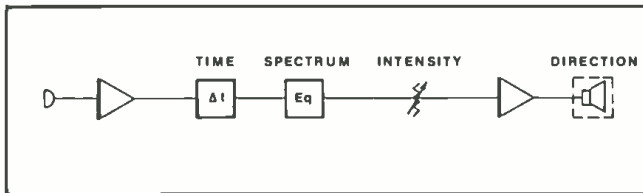

Basic channel for reflected energy system.

rophone preamplifier, frequency shaping network, signal delay, power amplifier, and loudspeaker. The location of the loudspeaker provides the "D" in "DIFT"; the other three characteristics are controlled in the electronic path.

Unlike a recording or sound reinforcement audio chain, which typically condenses a multiple of input transducers into one or two output channels, an ERES begins with very few input transducers (usually a single carefully placed microphone) and expands through independent signal processing channels into a multitude of independently placed and adjusted output transducers, numbering in the hundreds in large installations. Appropriate location and signal processing enables these channels to imitate the behavior of architectural reflections in a concert hall, church, or other desired space. ERES, like the Philips MCR system, does not amplify the direct field, which contains unblended, amplitude-only information; ERES amplifies the diffuse sound which is a true representation of the intensity or total power and is fully blended. This aspect of which sound-field that is being amplified is what differentiates ERES from conventional sound systems.

The effect of a larger physical volume is provided by a special reverberator containing a large digital memory, through which signal passes only once (no electrical recirculation). The reverberator releases a dense string of replicas of the original sound, appropriately tapered and

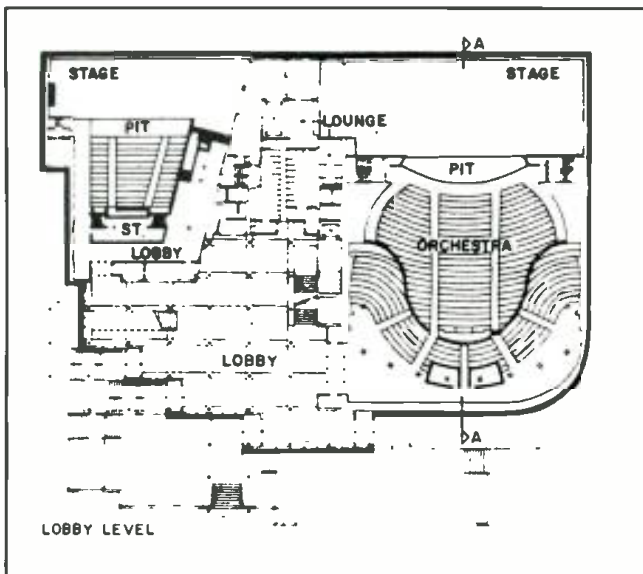
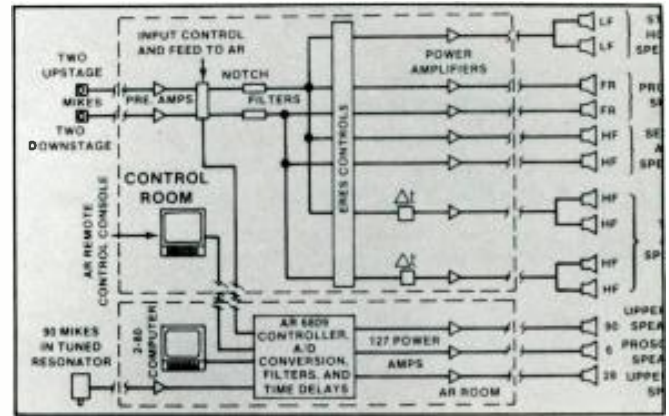

Figure 1. Orchestra level plan of Silva and Soreng Halls.

randomized in amplitude, time and phase, through a number of incoherent output channels. Between releases the room's early and late reflective fields are always developed, giving the decay a uniform character and avoiding coloration. The custom reverberator was designed by our firm and was first used for the NBC television programs "Live from Studio 8H," featuring the New York Philhar-



Block diagram of system at Silva Hall.

monic Orchestra. (Editor's note: this application will be discussed in greater detail in Wade Bray's article which will appear next month).

### ARCHITECTURAL FREEDOM

A classic example of a facility incorporating innovative architecture are the Silva and Soreng Halls in the Eugene, Oregon, Performing Arts Center. Figure 1 shows an orchestra level plan of the two halls, and Figure 2 shows a section of Silva's 2200 seat multi-purpose hall. In order to accommodate a wide variety of loudspeaker systems, the proscenium arch is sound transparent. Reflective panels located behind the transparent proscenium at critical areas and an orchestral shell provide substantial early reflections.

The acoustics of this hall would not be satisfactory for symphonic programs without the use of electronic architecture. In Silva Hall, the natural acoustics are supplemented by ERES, which supplies the early reflection package that is not sufficiently provided by the architecture. In addition, an Assisted Resonance System extends

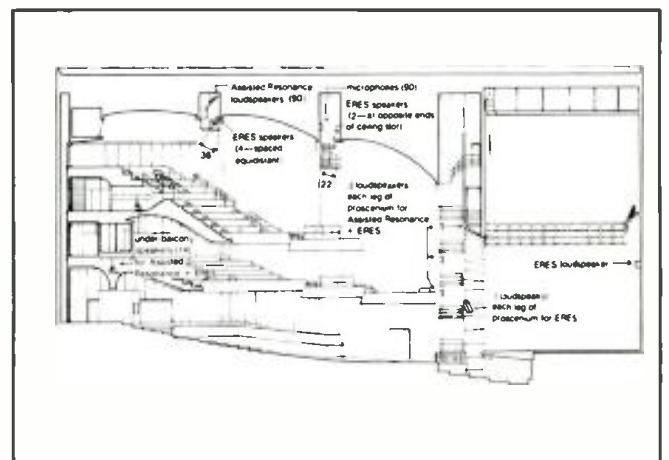

Figure 2. Section of Silva Hall's 200 seat hall.





View from Balcony of Silva Hall.

the reverberation time as required, for unamplified musical programs. Assisted Resonance was originally developed by Peter Parkin, and designed by Jaffe Acoustics as part of the overall plan for Silva Hall. (*Editor's note: The principles of the AR system are covered in detail in "Electro-Acoustics in Architecture" in this issue.*)

By varying the settings of the systems, multi-purpose acoustics becomes a reality. Patched absorption above the acoustically transparent basket-weave ceiling increases diffusion and reduces the natural reverberation times, allowing Silva to handle amplified programs more easily. When ERES and the AR are turned on, there is more presence, warmth and fullness for symphony and other musical programs. Settings between these two extremes allow

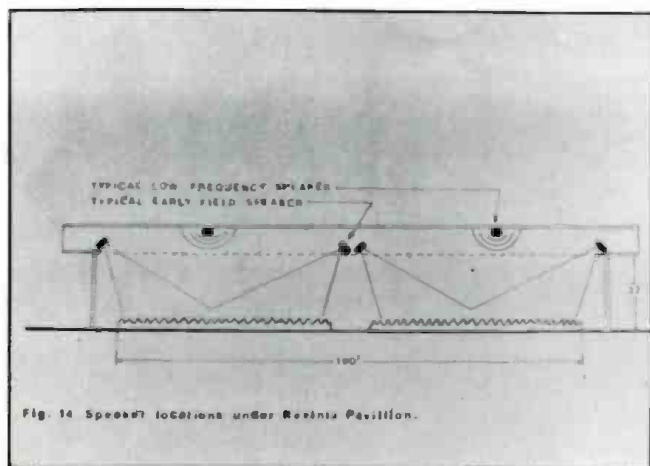

Fig. 14 Speaker locations under Ravinia Pavilion.

Drawing of Ravinia.

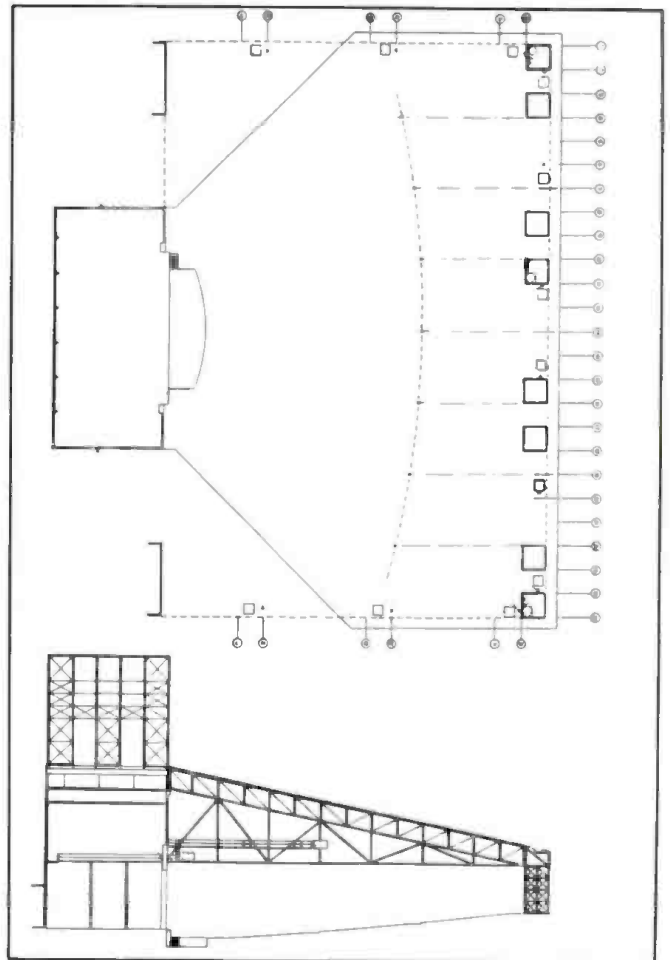

Figure 3. Plan and section of Riverbend.

many other different programs to be accommodated. Here, electronic architecture has provided the architect with the ability to design a hall that makes a particular statement by reducing the need to conform to generally accepted architectural acoustic rules.

### HALLS WITH NO WALLS

Ravinia Festival Park, summer home of the Chicago Symphony Orchestra, and Riverbend Music Pavilion, summer home of the Cincinnati Symphony Orchestra, are two examples of outdoor music pavilions with no side or rear walls. *Figure X* shows a plan and section of River-



Shed at Ravinia.



*Ravinia Shed*

bend. At Riverbend, an audience of over 5,000 is seated in front of a standard proscenium stage. Ravinia seats 3,000 in front of a stage platform which is in the same acoustic space as the audience. Ravinia has a somewhat capped roof, while Riverbend's walls are almost completely open. Both have patched absorption under their shed roofs to increase diffusion and reduce the reverberation for amplified programs, and ERES re-creates and further increases early reflections and reverberation for concerts and symphony pops productions.

The lawn at Ravinia Festival Park, Chicago, Illinois, is an interesting example of unusual architecture—there is none. Here physical acoustics cannot be utilized, because there is no structure of any kind. The direct sound must be reinforced on the lawn. No symphony orchestra could provide enough sound pressure level for ten thousand people spread over ten acres to be heard effectively. But, in addition to the pole-mounted column speakers needed to reinforce the direct field, delayed omni-directional speaker arrays on each pole provide lateral and rear reflections for the lawn audience. Low-frequency speakers on long delays provide a sense of reverberation in what is essentially a free-field environment. The acoustics of a fine concert hall are created by electronic architecture in a situation where there is absolutely no possibility of using a physical acoustic solution.

Laurie Auditorium at Trinity University in San Antonio, Texas, is an example of an existing facility whose



*View from balcony of Laurie Auditorium.*

original design intent did not accommodate the acoustic requirements of a new program. Built as a collegiate lecture hall, Laurie Auditorium has a wide fan-shaped seating area and a low physical volume. The acoustics of the space were appropriate for speech and lecture. But when the San Antonio Symphony began performing in the auditorium, it was immediately apparent that the acoustics were inappropriate for the presentation of orchestral music. A simple ERES was installed and later expanded to a full system. In conjunction with onstage reflectors, ERES provides early reflections which would otherwise arrive too late because of the wide side walls.

The reverberant-field, which was severely lacking in the space due to the low physical volume per unit area of audience seating, is supplied almost completely by ERES. Thus, without altering the structure in any way, the acoustic requirements of a new and different program were effectively and inexpensively met. Additionally, because the structure was not altered, the original program has not been excluded from the space. With ERES off, Laurie Auditorium is the same lecture hall it was before. With ERES on, it becomes a viable concert hall. In this case, a physical solution providing the same flexibility would be complex and cost prohibitive.

The Circle Theatre, which is the new permanent home of the Indianapolis Symphony Orchestra, is currently the flagship of a number of facilities utilizing ERES technology of electronic architecture to meet the correct acoustic criteria for symphonic performance. Originally, a vaudeville house and movie theater, the Circle has a low physical volume per person, and deep but low-ceiling underbalcony



*Stage at Circle Theatre.*

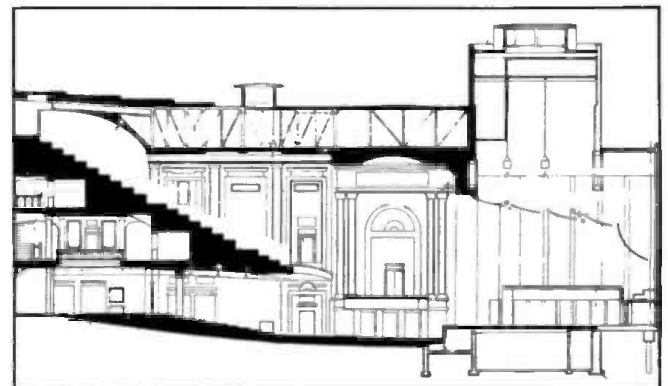

*Section of Circle Theatre.*

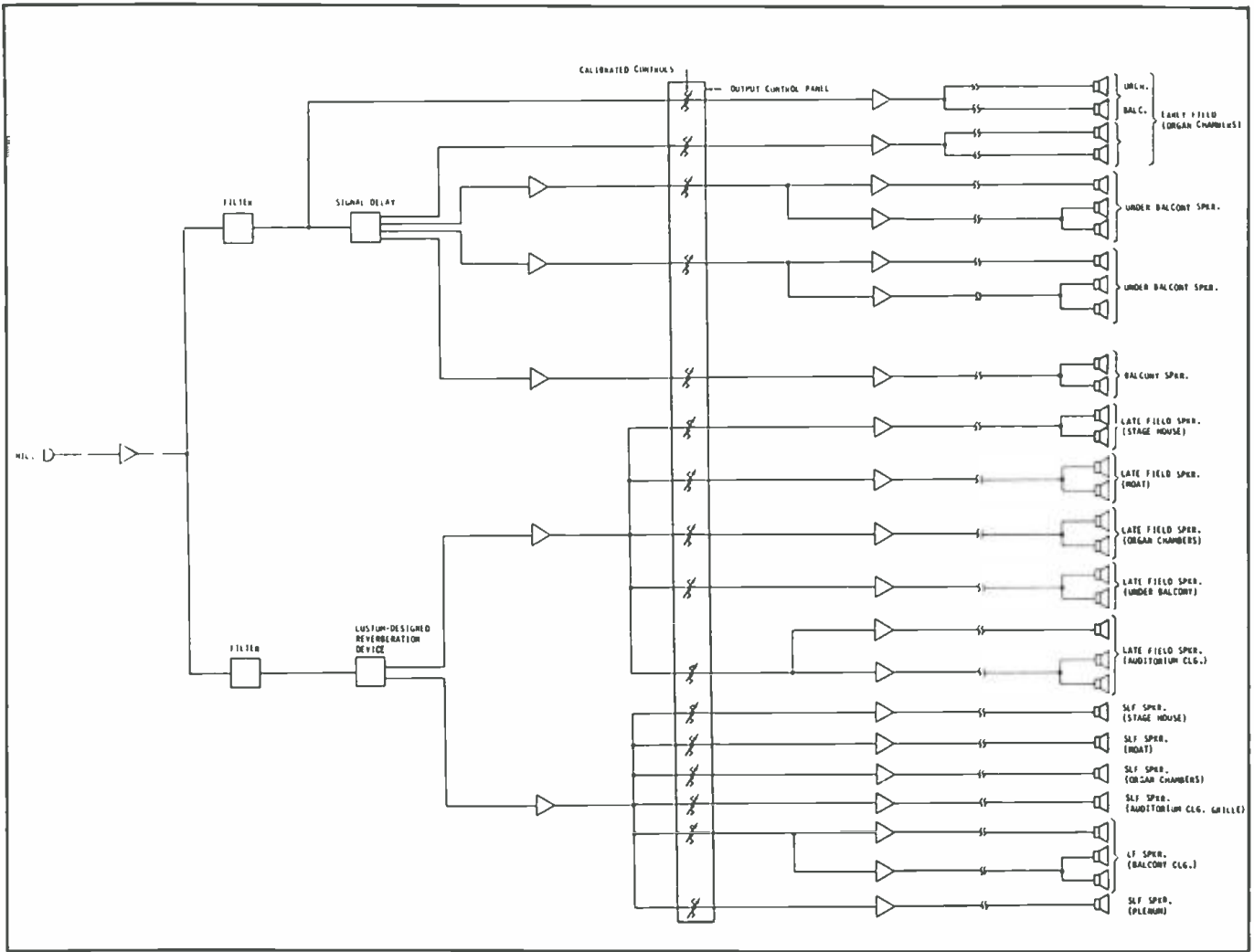

*ERES system at Circle Theatre.*

area typical of this type of theater. With narrow sidewalls and a renovated stagehouse, including a Jaffe Acoustics designed reflector system (concert shell), the natural early-field was excellent; thus, only a minimal early-field system was required to augment presence and running liveness in the underbalcony and low-ceiling upper mezzanine. The late-field system was designed to provide the additional reverberation required for the symphony. A number of coupled physical volumes were energized, including the stagehouse over the reflectors, the organ chambers, and an acoustic-moat constructed from the old orchestra pit. SLF field speakers, located in the same spaces, provided additional warmth for the low-frequency instruments. Several warmth speakers were also located in the underseat return air plenum which coupled to the hall through over one-hundred "mushrooms."

Electronic architecture, in the form of ERES, was able to transform the Circle Theater from a movie palace into a concert hall. The symphony could not have used the space within the guidelines of historic preservation without electronic architecture. With the acceptance of electronics in the concert hall environment, both acoustic and historical requirements were met, thereby, giving a special space such as the Circle Theater a new lease on life.

The ERES installation at the Circle continues to be well received as the Symphony begins its second sold-out

season in its new home. Musicians, concert goers, and critics have been pleased with the Symphony's sound in the theater.

ERES has also been used successfully in other facilities for symphonic production including Whitney Hall, Kentucky Center for the Arts, Louisville, Kentucky; Salle Wilfred Pelletier, Place des Arts, Montreal; NBC Studio 8H, New York City; and Kansas City Music Hall, Kansas City, Missouri; among others. Upcoming projects utilizing ERES include a 2,100-seat, multi-purpose hall at the Anchorage, Alaska Performing Arts Center, designed by architects Hardy Holzman Pfeiffer Associates, the architects of the Eugene facility, and a 1,200-seat, multi-purpose theater in Columbus, Ohio.

### CONCLUSION

Electronic Architecture is not a replacement for physical acoustics. Other aspects of acoustic design such as sound isolation, elimination of echoes, HVAC noise control and the reduction of excessive reverberation, must rely on physical acoustic solutions. At present, electronic architecture is most effective when used in conjunction with good physical acoustic design practice. However, after twelve years of development and application, ERES has proven itself a sophisticated and cost effective tool in the design of all types of performing spaces.

# Electro-Acoustic Techniques In The Boardroom

*Good acoustics prompts efficient communication.*

*Editor's note: This article is based upon "A New Concept in Boardroom Sound" that appeared in the January, 1986, issue of Sound & Communications.*

**G**OOD ACOUSTICS IS NOT WHAT one generally associates with corporate boardrooms. But in today's computerized information age when meetings take place almost robotically, good acoustics affords the possibility of efficient communication within the conference room itself. Good boardroom acoustics also greatly enhances the quality of transmitted audio for teleconferencing. When a sound contractor is called upon to "do something about the sound" in a corporate boardroom, the last thing on their minds is modifying their posh decor or tearing out their solid Brazilian rosewood walls, both of which happen to reduce the reflections necessary for increasing speech intelligibility. A lot of us have been faced with these situations, and unfortunately conventional sound system designs are often marginal at best. When TekCom Corporation was recently called upon to improve the speech intelligibility in one such boardroom, we decided to install an electro-acoustic "enhancement" system. The story begins here with some basics on electro-acoustic techniques in boardroom applications and concludes with some highlights of the installation at the Health Services Center, in Princeton, NJ.

## SOME BASICS

Poor conference room acoustics can degrade the working environment to such a degree that productivity decreases—something with which no company can live with. Human stress can be attributed to several basic common acoustical problems, prevalent in many conference and board rooms today. When one must project their voice loudly, to overcome the distances encountered in long boardroom tables, physical and psychological stress is provoked. Likewise, physical and psychological stress is provoked when one must strain throughout a meeting to hear properly. Also, secondary problems may arise due to individuals who habitually speak at low levels, or even more frequently, for many senior board members who have some degree of hearing difficulty. The studies on speech intelligibility date back to the early days of telephone with much work done in the early 1900s by Cambell, French & Steinberg, Fletcher, and Knudsen. Their work provided us with a wealth of information and has served as a foundation for work in the field of speech intelligibility. Later, Beranek conducted research concerning speech communication and his methods became the "benchmark"

*Richard Feld is the president of TekCom Corporation, a Philadelphia based sound system design, supply, and contracting firm.*



*Ceiling showing installation at Health Services Center in Princeton, NJ.*

for the assessment of the percentage of articulation of consonants used as a basis of a measure of speech intelligibility. Lochner and Burger developed the concept of signal-to-noise-ratio (S/N) discriminating between "early" energy deemed useful and "late" energy which masked the signal.

The intelligibility of speech is easily rated subjectively—either one can understand words spoken in a room or the words result in cacophony. Reliable objective analysis, however, was not possible until the work of Houtgast and Steeneken, who developed the Modulation Transfer Function (MTF). With MTF measurements one can, for the first time, objectively measure the intelligibility in any room or sound system/room(s) and assign a single meaningful MTF number, which corresponds to subjective assessment. Based on the work of Houtgast and Steeneken, Bruel & Kjaer have developed a dedicated system that simplifies the measurement of MTF, their process is called Rapid Speech Transmission Index or, RASTI. With these tools at our disposal, it is now possible to objectively measure, with great accuracy, exactly what degree of intelligibility may be expected, and thus, assign target values to be provided for. Once these values are established, it is the object of the designer to determine methods of providing the necessary articulation, signal-to-noise ratio, and optimum MTF.

## THE HARDWARE

Based on the technologies Jaffe developed for con-

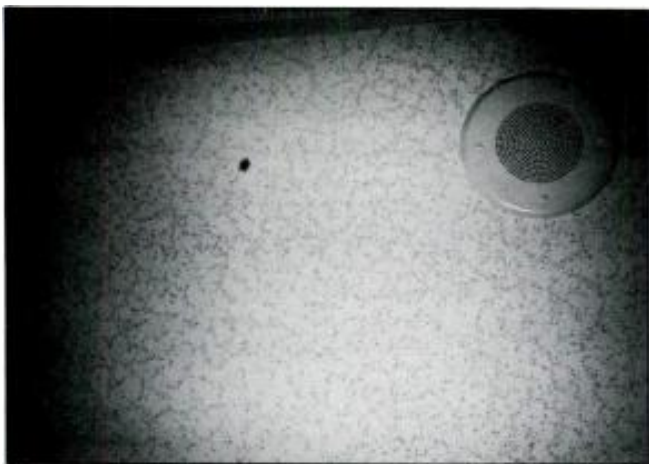

*Speaker and mic on ceiling at Health Services Center.*

cert hall ERES, they developed a "Boardroom Sound Reinforcement System," and were granted patent #3,992,586 in 1976. Jaffe's boardroom system is based upon modules which consist of two loudspeakers operating in anti-phase, such that there is a "cancellation-zone" in between the loudspeakers, where a microphone is then placed. The loudspeakers in a module do not reproduce any sound pickup from its microphone; the loudspeakers only reproduce signals from microphones in the other modules. This technique allows for a stable system since the microphone is not in the direct field of the loudspeakers. Thus, there is a sufficient amount of gain-before-feedback due to the geometrical relationship of the talker/microphone/loudspeaker/listener. Additionally, the reverberation times in these types of rooms is usually on the dry side, especially in the vicinity of the acoustical ceiling. This helps even more by ensuring that there is not much in the way of reverberant energy to be amplified. The only physical requirement is that a maximum noise level of NC25 should be measured in the room. That is what might be called the "physical-alignment" part of the system.

Now, for the electronic side of the story. Everybody knows that when the distance from a source is doubled, its SPL drops by 6 dB—that is, the inverse-square law. So the electronics in the mainframe are set-up to compensate for the 6 dB drop-off by increasing the gain at a rate of 6 dB as the distance from the source is doubled. This is, of course, field-adjustable to compensate for any reverberant energy that may contribute to the level. Signal delay is also incorporated to take advantage of the well known "Haas-effect" or "auditory fusion-zone." This simulates the "early-field" reflections one would normally hear a lot more efficiently (no absorption or diffraction from architectural materials). Because of the incremental delay introduced to the signal the source is never "colored" by the loudspeaker. In addition to the gain afforded by the "cancellation-zone" microphone placement, narrow-band notch-filtering is also employed for extra system stability.

Jaffe's first specified boardroom installation was the General Electric Corporate Headquarters in Fairfield, Connecticut. After the highly successful installation at GE, the boardrooms of prestigious corporations soon followed suit, they included Federated Stores, IBM, Natomas Company, Utah International Corporation,

and Mitsubishi Corporation in New York. Because of the need for this technology to be brought to its full potential in the marketplace, Technical Acoustics Incorporated, a wholly owned subsidiary of Bozak, Inc., was formed. TAI licenses the technology from Jaffe, manufactures "ready-to-install" Boardroom Systems, and directly supports those interested in specifying or installing the "Jaffe Boardroom System" with complete design specifications on a project-by-project basis. TAI currently manufactures a mainframe that houses individual cards that perform the various I/O, mixing/matrixing, filtering, delay, and amplification functions. They also manufacture two different configurations of the ceiling loudspeaker/microphone module. The notch-filter cards that are included with the system feature two sets of four filters each. Each card has dip switches so that the notch-filters may be assigned to any part of the circuit, or disabled if necessary (for example, AV playback). Other options that the mainframe can accommodate include AV inputs, recording outputs, teleconferencing interface, link-ups of multiple spaces, hard-of-hearing loops, and translation system interface. Recently, GE renovated their board room and decided to update the original Jaffe Boardroom System. This time, instead of a custom-wired installation, a TAI mainframe and modules were installed which incorporated teleconferencing features. A true testimonial when a client orders the same system after ten years of use!

### "HOT-CEILING"

A further development of the Boardroom System is

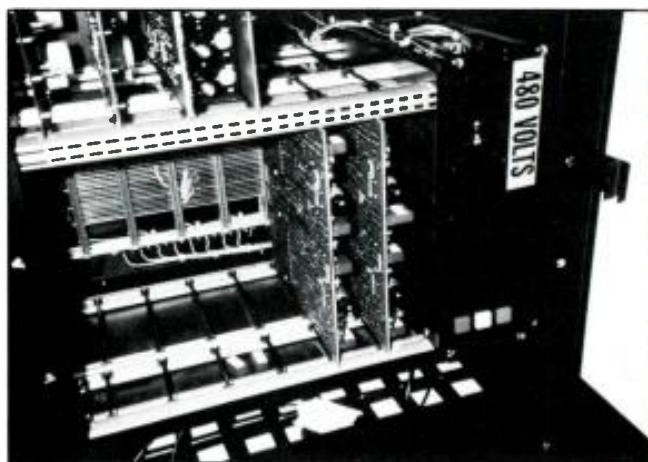

*Box with cover off at Health Services Center.*

### Small Business

The IRS conducts workshops to help small business owners understand their tax rights and responsibilities. Contact the IRS for information.



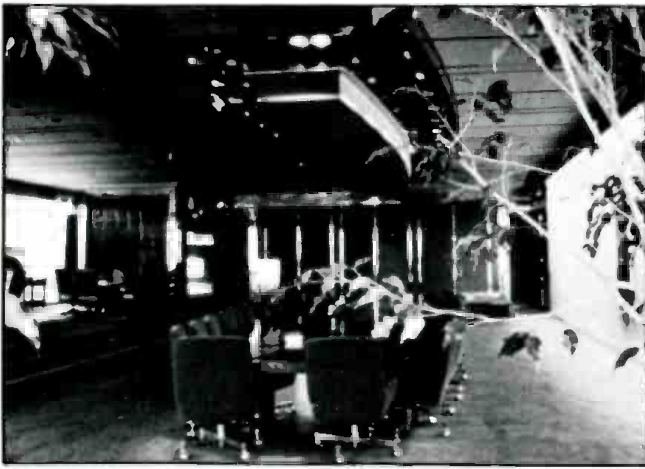

*Boardroom Installation at Federated Stores*



*Boardroom Installation at Natomas Co.*

what TAI calls the "Conference-Ceiling." The Conference-Ceiling evolved around the necessity to provide a system for boardrooms with irregular layouts. For example a large square table. This system differs in that the modules use only one loudspeaker, and are installed such that they are geometrically and electronically balanced in pairs. A Conference-Ceiling system was the type of system installed at the Center for Health Affairs in Princeton, NJ. Their boardroom presented some unique features, starting with the large square-shaped boardroom table with twenty-six seats, and ending with the three rows of "audience" seating that must be capable of two-way communication. For this project the capability was added to mute the audience microphones during formal presentations and then open them for full duplex-communication when desired.

The boardroom's solid-wood walls, concrete floor with thin carpeting, and oversized table presented several problem areas. These hard surfaces in this rectangular shaped room yield several room modes at 200 Hz and 440 Hz. When the system was being designed it was clear that these modes would be both excited and amplified by the system. Therefore, a White 3900 series narrow-band passive equalization was specified. The 3900 system consists of 600 ohm filters that have a Q of 50; i.e., below 500 Hz they are 10 Hz wide. The filter-set covers the frequency range of 50 Hz to 2.5 kHz, with a 5 Hz spacing at the low end changing to a 13 Hz spacing in the upper range. This adds up to 195 filters. The filters are brought to the job site in three flight-cases, weighing in at approximately 175 pounds.

The narrow-band system enabled us to de-energize the system at several predicted room modes, suppress individual sinusoidal feedback frequencies, and eliminate proximity modes. Because of the very high Q bandwidth of the filters, very little information was lost in the equalization process, yielding a high-fidelity, high-intelligibility, sound system. All totalled, fifteen filters were used, and the tuning took several hours. Since the filters are passive the equalization is totally quiet—using active electronics would result in a noise generator.

From an ergonomic point of view, the Jaffe/TAI board room systems offer a unique alternative to the massive array of microphones and the associated hardware of "conventional" systems. The Jaffe/TAI systems offer the consultant or contractor the opportunity

to show a client a system that is totally invisible, not only visually but operationally as well. Jaffe/TAI's Boardroom Systems have proven themselves as an effective approach in providing a "perfect" acoustic environment for corporate executives to work in. Articulation of consonants is maintained at a high level, while eliminating the need and stress/inhibition of talking into a microphone. There are ergonomic advantages for the consultant and contractor as well. A typical corporate person who wishes to "do something about the sound" in his boardroom may have his requirements easily fulfilled by the architecture of one system. The specifier of the project may now design the system from

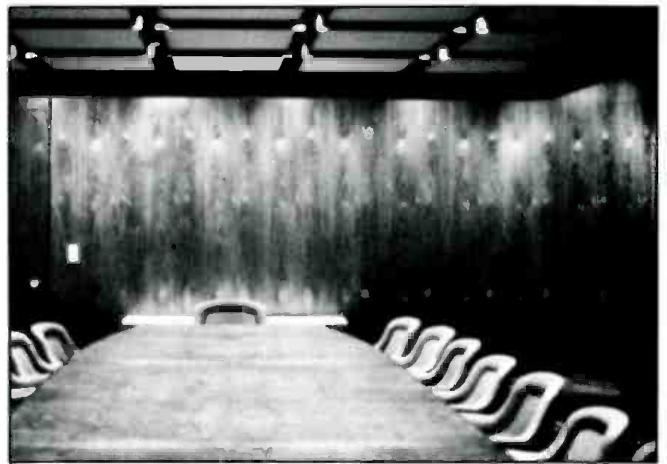

*Boardroom Installation at Utah International Corp.*

various plug-in components within a mainframe system—no more custom engineered relay schemes, etc. The actual installation is also easy as it entails only installing ceiling modules and wiring them to a factory-wired mainframe. There is no pre-installation fabrication of the system required by the installer. Any system may be installed, tweaked, and tuned in a matter of a couple of days.

The bottom line is that in most cases the TAI Board-Room System is a more economical approach than using conventional microphones, signal processing, and amplifiers. In the long-run, it saves the customer money, while at the same time giving him a "slick" installation, and may be your best sales tool. ■

# db Buyer's Guide

## Performance

### Speakers

#### **BOSE**

CLS-2 has an 8-in. long throw woofer and a 3-in. tweeter with a crossover frequency of 1.65 kHz. Finish is walnut grain with vinyl veneer outside and a brown cloth grill. Impedance is 8 ohms and frequency response is 80 Hz-14 kHz, +/-3 dB. Dimensions are 18.25 x 11.5 x 9; weight is 15.7 lbs.  
Price: \$170.00.

102 Professional Sound System is available as flush mount or surface mount system and has a 4.5-in. Bose helical voice coil and four range driver within a ported enclosure. Impedance without transformer is 8 ohms and frequency response is 80 Hz-18 kHz, with a 25 watt power handling capability and a 70 volt transformer available as an option.  
Price: 102 FM-\$96.00; 102 SM-\$120.00; 102 C-\$265.00.

#### **CARVIN**

1330 uses 15-in. E-V/Magna Lab drivers with horn/port loaded design for maximum clarity and efficient use of power. Finish is black Tolex with a black metal grill. Impedance is 8 ohms and the frequency response is 40 Hz-4 kHz. Dimensions are 28 x 24 x 32; weight is 100 lbs.  
Price: 239.00.

R-540E uses a 1-in. E-V horn for 60 x 90 degree dispersion. Finish is black Tolex. Impedance is 16 ohms and the frequency response is 1.2 kHz-17 kHz. Dimensions are 28 x 24 x 12; weight is 50 lbs.  
Price: \$279.00.

980M is a full range system using a 15-in. Magna Lab woofer and a 1-in. E-V radial horn tweeter with a crossover at 1.2 kHz. Finish is black Tolex with a black metal grill. Impedance is 8 ohms and the frequency response is 36 Hz-17 kHz. Dimensions are 24 x 18 x 32; weight is 96 lbs.  
Price: \$379.00.

960M uses a .75-in. Fostex exponential horn and a 15-in. Magna Lab woofer with a crossover at 1.5 kHz. Finish is black Tolex with a black metal grill. Impedance is 8 ohms and the frequency response is 38 Hz-20 kHz. Dimensions are 24 x 15 x 31; weight is 75 lbs.  
Price: \$279.00.

300E uses a 18-in. E-V woofer in a folded horn design and has applications for tri-amping. Finish is Ozite. Impedance is 8 ohms and the frequency response is 35 Hz-500 Hz. Dimensions are 33 x 40 x 24; weight is 135 lbs.  
Price: \$379.00.

#### **EASTERN ACOUSTICS**

FR-102 is a compact system providing 99 dB SPL sensitivity and a coverage of greater than 120 degrees and uses a 10-in. woofer and 1-in. horn tweeter with a crossover at 3.5 kHz. Finish is black poly with a vinyl steel grill. Impedance is 8 ohms and the frequency response is 80 Hz-18 kHz. Dimensions are 19.75 x 11.75 x 9.5.  
Price: \$300.00.

FR-122 provides greater than 130 degrees coverage and uses a 12-in cone woofer and a 52 mm hard dome tweeter with a crossover at 2.5 kHz. Finish is black poly with a vinyl steel grill. Impedance is 8 ohms and the frequency response is 50 Hz-19 kHz, +/-2 dB. Dimensions are 25.6 x 14.75 x 11.75.  
Price: \$450.00.

FR-153 provides wide bandwidth and coverage, 98 dB SPL and long term power handling, and uses 15-in. cone woofer, 6.5-in. poly cone mid-driver and 52 mm hard dome tweeter with a crossover at 350 Hz and 3.5 kHz. Finish is black poly with a vinyl steel grill. Impedance is 8 ohms and the frequency response is 40 Hz-19 kHz, +/-2 dB. Dimensions are 19.75 x 24.6 x 19.75.  
Price: \$670.00.

FR-253 provides 103 dB SPL and long term power handling capability and uses two 15-in. cone woofers, two 6.5-in. poly cone mid-drivers and a 44 mm horn tweeter with a crossover at 350 Hz and 2.5 kHz. Finish is black poly with a vinyl steel grill. Impedance is 4 ohms and the frequency response is 33 Hz-17 kHz, +/-3 dB. Dimensions are 41.2 x 24.6 x 19.75.

Price: \$1,200.00.

JF-500 is a horn loaded system providing 106 dB SPL sensitivity and 90 degree coverage, and uses 15-in. cone woofer, 10-in. horn mid-driver and a 1.75-in. horn tweeter with a crossover at 250 Hz and 2.2 kHz. Finish is black poly with a vinyl steel grill cloth. Impedance is 8 ohms and the frequency response is 60 Hz-17 kHz, +/-3 dB. Dimensions are 50 x 24 x 29; weight is 232 lbs.

Price: \$1750.00.

KF-500 is similar to the JF-500 above and uses 18-in. cone woofer, 12-in. horn mid-driver and 3-in. horn tweeter with a crossover at 250 Hz and 1.5 kHz. Impedance is 8 ohms and the frequency response is 50 Hz-16 kHz, +/-3 dB. Dimensions are 55 x 30 x 25; weight is 260 lbs.

Price: \$2,100.00.

KF-550 is similar to the KF-500 above and uses two 15-in. cone woofers, 12-in. horn mid-driver and a 3-in. horn tweeter with a crossover at 250 Hz and 1.5 kHz. Impedance is 4 ohms and the frequency response is 40 Hz-16 kHz, +/-3 dB. Dimensions are 32 x 53; weight is 320 lbs.

Price: \$2,900.00.

## CETEC GAUSS

5226 is a 300 watt high-efficiency stage monitor capable of 125 dB and uses a 12-in. cone woofer and a 1.5-in. compression high-frequency driver with a crossover at 3.6 kHz. Finish is brown carpet with a brown fabric grill. Impedance is 8 ohms and the frequency response is 80 Hz-20 kHz. Dimensions are 16 x 23.6 x 16; weight is 50 lbs.

Price: \$760.00.

5280 is a 200 watt RMS light weight, high power portable PA system using 18-in. cone woofer and a 2-in. high-frequency compression driver with a crossover at 1.5 kHz. Finish is brown carpet with a brown fabric grill. Impedance is 8 ohms and the frequency response is 40 Hz-18 kHz. Dimensions are 34.75 x 24 x 16.25; weight is 85 lbs.

Price: \$1,145.00.

## ELECTRO-VOICE

FM-1202 provides 300 watts of power and uses a 12-in. cone woofer and 7 x 9 horn tweeter with a crossover at 1.5 kHz. Finish is black carpet with a black metal grill. Impedance is 8 ohms and the frequency response is 75 Hz-20 kHz, +/-3 dB. Dimensions are 19.4 x 19.4 x 24.4; weight is 66 lbs.

Price: \$576.00.

FM-1502 is the same as the FM-1202 above but with a 15-in. woofer. Frequency response is 65 Hz-20 kHz, +/-3 dB. Dimensions are 22 x 22.5 x 27.9; weight is 75 lbs.

Price: \$726.00.

S-1202 is the same as the FM-1202 above, but it is stand mountable or stackable. Dimensions are 24.7 x 19.1 x 11.7; weight is 66 lbs.

Price: \$612.00.

SH-1502 is the same as the S-1202 above, but it has a 15-in. cone woofer and a 9 x 18 horn tweeter. Frequency response is 62 Hz-20 kHz, +/-3 dB. Dimensions are 31 x 21.1 x 14.6; weight is 78 lbs.

Price: \$550.00.

S-1503 is a 200 watt three-way system suitable for stacking and uses a 15-in. cone woofer, 10-in. cone mid-driver, and a 5 x 6 horn tweeter with a crossover at 600 Hz and 4 kHz. Impedance is 8 ohms and the frequency response is 65 Hz-16 kHz, +/-3 dB. Dimensions are 28.7 x 24.4 x 13.8; weight is 105 lbs.

Price: \$948.00.

S-1803 is the same as the S-1503 above, but it has wheels and uses an 18-in. cone woofer and has a frequency response of 50 Hz-16 kHz, +/-3 dB. Dimensions are 35.5 x 28 x 19.4; weight 134 lbs.

Price: \$1,145.00.

S-200 is a 280 watt two-way system with handle and uses 12-in. cone woofer and 7 x 9 horn tweeter with a crossover at 2 kHz. Finish is black carpet with a gray fabric grill. Impedance is 8 ohms and the frequency response is 50 Hz-18 kHz, +/-3 dB. Dimensions are 24 x 15 x 8.5; weight is 36 lbs.

Price: \$607.00.

TL 1225/4025 is a 300 watt stackable system that uses one 15-in. and one 12-in. cone woofer, a 12-in. horn mid-driver and a horn tweeter with a crossover at 125 Hz and 250 Hz. Impedance is 8 ohms and the frequency response is 40 Hz-12 kHz, +/-3 dB. Dimensions are 32.25 x 60 x 34; weight is 278 lbs.

Price: \$1,884.00.



## **FOSTEX**

SP-7 uses one 4-in. cone driver. Finish is flat black with a black metal grill. Impedance is 8 ohms and the frequency response is 120 Hz-20 kHz, +/-3 dB. Dimensions are 4.5 x 7.5 x 4.5; weight is 5.3 lbs.

Price: \$99.95.

SP-11 is a compact PA that can be stacked in multiples. It uses two 5-in. cone drivers. Finish is black plastic with black metal grill. Impedance is 8 ohms and the frequency response is 150 Hz-15 kHz, +/-3 dB. Dimensions are 7 x 13.75 x 8.5; weight is 12.1 lbs.

Price: \$195.00.

SPA-11 has a built-in 100 watt amp with both mic and line inputs and is similar to the SP-11 above. Frequency response is 80 Hz-18 kHz, +/-3 dB. Weight is 16.7 lbs.

Price: \$295.00.

## **JBL**

4691B uses 15-in. cone woofer and has a black finish with a black fabric grill. Impedance is 8 ohms and the frequency response is 40 Hz-20 kHz, -10 dB. Dimensions are 30.2 x 20.1 x 18.8; weight is 109 lbs.

Price: \$795.00.

4695B uses 18-in. cone woofer and has a black finish with a black fabric grill cloth. Impedance is 8 ohms and the frequency response is 30 Hz-20 kHz, -10 dB. Dimensions are 40.2 x 29.6 x 18.2; weight is 142 lbs.

Price: \$795.00.

4602B uses a 12-in. cone woofer and has a black finish with a black fabric grill cloth. Impedance is 8 ohms and the frequency response is 50 Hz-15 kHz, -10 dB. Dimensions are 20 x 16 x 14.7; weight is 57.25 lbs.

Price: \$528.00.

4612B uses two 8-in. cone drivers and has a black finish with a black fabric grill cloth. Impedance is 8 ohms and the frequency response is 60 Hz-22 kHz, -10 dB. Dimensions are 18.5 x 21.5 x 10.25; weight is 51 lbs.

Price: \$495.00.

AFI-VD is similar to the TA-12C above, but it is a three-way system using a 18-in. cone woofer, 12-in. cone mid-driver and 5 x 6 horn tweeter with a crossover at 125 Hz and 3.5 kHz. Impedance is 4 ohms and the frequency response is 40 Hz-19 kHz, +/-3 dB. Dimensions are 42 x 20 x 20; weight is 120 lbs.

Price: \$1030.00.

S-15B is a low frequency unit using either a sealed or vented 15-in. woofer. Impedance is 8 ohms and the frequency response is 40 Hz-2.5 kHz, +/-4 dB. Dimensions are 18 x 27 x 24; weight is 80 lbs.

Price: \$560.00 for brown oiled birch finish; \$380.00 for black texture paint.

S-18B is the same as the S-15B above, but it uses an 18-in. woofer and has a frequency response of 40 Hz-500 Hz, +/-4 dB. Dimensions are 29 x 22 x 20; weight is 40 lbs.

Price: \$680.00 for wood finish; \$480.00 for paint finish.

## **PEAVEY**

Project 1 is a tri-amped three component system providing 110 dB SPL and using Black Widow low and mid frequency sections for high power handling capability. It uses two 15-in. cone woofers, 12-in. mid-driver and a CH-4C horn tweeter with crossovers at 150 Hz and 1.2 kHz. Finish is black texture paint. Impedance is 4/8/8 ohms and the frequency response is 60 Hz-16 kHz, +/- 3 dB.

Price: \$1,723.00.

Project 2 is a tri-amped three component system providing 104 dB SPL and using Black Widow low and mid frequency sections. It uses 15-in. cone woofer, 12-in. mi-driver and MX horn tweeter with a crossover at 250 Hz and 1.2 kHz. Finish is black texture paint. Impedance is 8 ohms and the frequency response is 60 Hz-16 kHz, +/-3 dB.

Price: \$974.00.

Project 5 is an efficient, self-contained three-way system with Black Widow components. It uses 15-in. cone woofer, 12-in. mid-driver and horn tweeter with crossovers at 250 Hz and 2 kHz. Finish is black Tolex with a black mesh grill. Impedance is 8 ohms and the frequency response is 60 Hz-16 kHz, +/-3 dB. Dimensions are 37 x 19 x 20.75; weight is 145 lbs.

Price: \$599.00.

SP-1 uses a 15-in. cone woofer and a horn tweeter with a crossover at 600 Hz. Finish is black texture paint. Impedance is 8 ohms and the frequency response is 60 Hz-16 kHz, +/-3 dB. Dimensions are 39 x 23.7 x 30.2; weight is 159 lbs.

Price: \$599.00.

**TRIFLEX** is a three-way system with two stand mountable satellite enclosures for portability that operates bi-amped or full range. It uses two 12-in. cone woofers, two 8-in. mid-drivers and two 4-in. horn tweeters with crossovers at 250 Hz and 2 kHz. Finish is black Tolex with black steel grill. Impedance is 4 ohms and the frequency response is 60 Hz-14 kHz, +/-3 dB. Dimensions are 17.75 x 18.25 x 31.5; weight is 109 lbs.

Price: \$599.00.

**118 International** is a bi-ampable system using a 18-in. cone woofer and horn tweeter with a crossover at 800 Hz. Finish is black Tolex with a black mesh grill cloth. Impedance is 8 ohms and the frequency response is 60 Hz-16 kHz, +/-3 dB. Dimensions are 30.5 x 18.5 x 24; weight is 114 lbs.

Price: \$499.00.

## **RENKUS-HEINZ**

**BJ2** uses a 15-in. cone woofer and 2-in. horn mid-driver with a crossover at 1.2 Hz. Finish is black carpet with a black steel grill. Impedance is 8 ohms and the frequency response is 40 Hz-17 kHz, +/-3 dB. Dimensions are 30 x 20 x 16; weight is 85 lbs.

Price: \$725.00.

**BJ4** is similar to the BJ2 above, but it uses a 1-in. horn as its mid-driver and has a crossover at 1.6 kHz. Frequency response is 40 Hz-20 kHz, +/-3 dB. Weight is 80 lbs.

Price: \$625.00.

**FRS 1582** uses a 15-in. cone woofer and 2-in. horn mid-driver with a crossover at 1.2 kHz. Finish is black carpet with a black steel grill. Impedance is 8 ohms and the frequency response is 45 Hz-17 kHz, +/-5 dB. Dimensions are 30 x 21 x 19; weight is 87 lbs.

Price: \$570.00.

**SMS 1280** uses a 12-in. cone woofer and 1-in. horn mid-driver with a crossover at 1.6 kHz. Finish is black carpet with a black steel grill. Impedance is 8 ohms and the frequency response is 100 Hz-16 kHz, +/-4 dB. Dimensions are 21 x 18 x 25; weight is 48 lbs.

Price: \$399.00.

**B1** is a long-throw enclosure with optional flying hardware and uses two 15-in. cone woofers and a 2-in. horn mid-driver with a crossover at 1.2 kHz. Finish is black carpet with a black steel grill. Impedance is 8/4 ohms and the frequency response is 40 Hz-17 kHz, +/-3 dB. Dimensions are 51 x 24 x 17; weight is 125 lbs.

Price: \$995.00.

**B2** is a wide coverage version of the B1 above, and it has one 15-in. woofer. Dimensions are 30 x 20 x 16; weight is 85 lbs.

Price: \$725.00.

**B3** is the same as the B1 above, but it is a stage monitor and not available with flying hardware. It uses one 15-in. woofer. Dimensions are 25 x 18 x 28; weight is 87 lbs.

Price: \$555.00.

**L1** is a subwoofer system that can be use with any of the above systems. It uses two 18-in. cone woofers with a crossover at 120 Hz. Impedance is 4 ohms and the frequency response is 33 Hz-300 Hz, +/-3 dB. Dimensions are 24 x 24 x 48; weight is 200 lbs.

Price: \$995.00.

## **TOA**

**380SE** has 360 watt power handling capability, mid and high frequency attenuators, and uses a 15-in. cone woofer, 1-in. horn mid-driver and 1.75-in. horn tweeter, with crossover at 800 Hz and 8 kHz. Finish is gray poly with a black nylon grill cloth. Impedance is 8 ohms and the frequency response is 50 Hz-20 kHz. Dimensions are 30 x 20 x 16; weight is 79 lbs.

Price: \$895.00.

**38SD** is the same as the 380SE above, but it has a 1-in. moving-coil tweeter with crossover at 1 kHz and 10 kHz and is available as a stage monitor. Dimensions are 27 x 20 x 18; weight is 59.5 lbs.

Price: \$589.00.

**30SD** is the same as the 38SD above, but it uses a 12-in. cone woofer. Dimensions are 23 x 17 x 15; weight is 46.3 lbs.

Price: \$529.00.

**SL-22** has 240 watt power handling capability and is designed for touring. It uses one 10-in. and one 12-in. cone woofer, and a horn tweeter. Finish is gray poly with black steel grill. Impedance is 8 ohms and the frequency response is 70 Hz-20 kHz. Dimensions are 33 x 15 x 12; weight is 44 lbs.

Price: \$319.00.

RS-20 is a portable stage system using four 5-in. cone drivers and a horn tweeter. Finish is black vinyl with black nylon grill. Impedance is 8 ohms and the frequency response is 90 Hz-20 kHz. Dimensions are 17.5 x 14 x 10; weight is 29.8 lbs.

Price: \$299.00.

## YAMAHA

S10X is a 75-watt compact system using a 4-in. cone speaker. Finish is black with black mesh grill. Impedance is 6 ohms and frequency response is 65 Hz-20 kHz. Dimensions are 6.2 x 9.5 x 6.5; weight is 6.2 lbs.

Price: \$120.00. S20X is the same as the S10X above, but it has 150-watt power handling capability and uses two 4-in. cone speakers. Dimensions are 7.5 x 11.6 x 7.75; weight is 10 lbs.

Price: \$180.00.

S2112H is a slant, stage monitor using a 2-in. cone woofer and a 3 x 9 horn tweeter with a crossover at 2.5 kHz. Finish is black with black mesh grill. Impedance is 8 ohms and frequency response is 60 Hz-16 kHz, +/-6 dB. Dimensions are 17.75 x 19 x 22.25; weight is 40 lbs.

Price: \$395.00.

S2115H is a 120-watt slant, stage monitor using a 15-in. cone woofer and a 1.7-in. compression tweeter with a crossover at 1.6 kHz. Impedance is 8 ohms and frequency response is 50 Hz-16 kHz. Dimensions are 26.5 x 22.5 x 26.25; weight is 77 lbs.

S3112H is a stand mountable compact stage speaker using a 12-in. cone woofer and a 3 x 9 horn tweeter with a crossover at 2 kHz. Finish is black with black metal grill. Impedance is 8 ohms and frequency response is 65 Hz-16 kHz, +/-6 dB. Dimensions are 23.75 x 17 x 11.5; weight is 41.5 lbs.

Price: \$375.00.

S3115H is the same as the S3112H above, but it uses a 15-in. cone woofer and a 4 x 12 horn tweeter with a crossover at 2 kHz. Frequency response is 65 Hz-14 kHz. Dimensions are 25.9 x 18.6 x 14.6; weight is 65 lbs.

Price: \$495.00.

S3208H is a 250 watt compact system using two 8-in. cone woofers and a 3 x 9 horn tweeter with a crossover at 2.5 kHz. Finish is black paint. Impedance is 8 ohms and frequency response is 65 Hz-17 kHz. Dimensions are 17.5 x 22 x 10.25; weight is 43 lbs.

Price: \$545.00.

**Bose Corp.**  
The Mountain  
Framingham, MA 01701

**Carvin Corp.**  
1155 Industrial Ave.  
Escondido, CA 92025

**Cetec Gauss**  
9130 Glenoaks Blvd.  
Sun Valley, CA 91352

**Eastern Acoustic Works, Inc.**  
PO Box 437  
Jenkintown, PA 19046

**Electro Voice, Inc.**  
600 Cecil St.  
Buchanic, MI 49107

**Fostex Corp.**  
15431 Blackburn Ave.  
Norwalk, CA 90650

**JBL/Urei**  
8500 Balboa Blvd.  
Northridge, CA 90650

**Meyer Sound Laboratories, Inc.**  
2832 San Pablo Ave.  
Berkeley, CA 94702

**Modular Sound Systems, Inc.**  
P.O. Box 488  
Barrington, IL 60010

**TOA Electronics, Inc.**  
PO Box 2047  
South San Francisco, CA 94080

**Peavey Electronics**  
711 A Street  
Meridian, MS 39301

**Renkus-Heinz, Inc.**  
17851-AB Sky Park Circle  
Irvine, CA 92714

**Yamaha International Corp.**  
6600 Orangethorpe Ave.  
Buena Park, CA 90620

*Write directly to these manufacturers  
for further information on products  
in the charts.*

# Sonic Sound Studios

*Urban technology can be found in the suburbs.*



**L**ONG ISLAND IS UNIQUE in that it's a 200 mile long (by twenty mile wide) island, separated from Manhattan Island and "New York City" by only the narrow East River.

Over the past decade, Long Island (which includes two of New York's boroughs—Brooklyn and Queens) saw a rapid proliferation of 24-track recording facilities. This was due in part to the problems associated with Manhattan studios—parking shortages, high costs, traffic jams, crime, etc. However, during the past couple of years, most of these suburban studios have either closed or been turned into rehearsal studios being used by local bands.

One studio *has* endured and is perhaps the most successful on Long Island. It is Sonic Sound Studios in Freeport (featured on this month's cover). Freeport is about twenty-five miles from Manhattan and its legendary studios like the Power Station, the Hit Factory, Sigma Sound and Electric Lady. Unlike its more urban counterparts, Sonic Sound is housed in a modified private home.

*Sammy Caine is the technical editor of db Magazine as well as a freelance recording engineer.*

The atmosphere is, in fact, one of being at home. Pull up in the driveway, unload your instruments from your car, and climb the three stairs to the small porch and ring the bell. It's obviously the atmosphere Long Island musicians are looking for. Studio A is booked about sixty hours a week.

"The atmosphere (at Sonic) is very relaxed, low key and quiet. We have quite a few Manhattan and New Jersey clients that like the low pressure, relaxed atmosphere and being able to come and go without any headaches—no parking problems," co-owner Al Falcon says. "A lot of people really enjoy using the facility and getting away from the hustle and bustle of midtown Manhattan. The product is competitive with what is coming out of Manhattan studios and the rates are very good for the kind of gear and the kind of room we offer," Jerry Comito adds.

Sonic's state-of-the-art facility caters to a large cross-section of the music industry.

"It's a very wide and varied client list. We've done every kind of music, but we're not a major jingle house, and a majority of the stuff is pop music—whether it be rock, dance, r&b, heavy metal. There is a large percentage of heavy metal and dance. We have done some rap and funk stuff,



*Rich wood walls offset the drums tucked into one end of Studio A.*

and even some international music,” says Al.

Gerry and Al became partners about six years ago. They both had done live engineering work and each had his own small 8-track studio. When they opened Sonic Sound in 1980, it too, was an 8-track studio operating with a small Tascam console. The studio experienced initial success and was upgraded to 24 tracks within a year and a half of opening. Then the Tascam was replaced by a modified Soundcraft 400 Series when the room was redesigned.

But Jerry and Al were still not finished. About two and a half years ago they felt it was time for a complete overhaul. They brought in Francis Milano then of Analogique Labs in New York City, to redesign the control room so it would be perfectly balanced.



*The studio also features a grand piano and a rack of synthesizers.*

A lot of time and attention was given to angles and dimensions during the renovations. The designers specified exactly where all the beams should go and what density the carpets and insulation should be.

When the physical renovations were complete, it was time for new equipment. A Trident Series 80B, 32-input console (which is still in use) was installed. With it, a full array of tape machines and outboard gear was put into use. An MCI JH-24 and Ampex ATR-102 was installed as well as a full compliment of delay/reverb systems.

Gerry and Al are constantly updating and adding new equipment to their already extensive list that includes a Lexicon 224X with LARK digital delay, an EMT 140 Tube Plate, and a brand new Studer A-80 Mark IV 24-



*Two views in the main control room showing both an 8-track and 24-track tape unit.*

“The room was actually completely gutted. It was quite a job. We did all the work ourselves. The room was measured and blueprints made up. Francis came in to examine the room. The construction was very, very detailed,” Al recalls. “The renovation was very involved. Since we are in a building that was actually a house, we had to knock out the brick fireplace and chimney. It was four stories of just bricks. It was quite a job.”

The result was a studio that the partners felt could compete with state-of-the-art New York City studios.

“It’s a totally symmetrical room. All the angles were done on a computer and there are bass traps in the ceiling and underneath the studio window. The stereo imaging was also designed to be very good, even though it is a very small control room,” Al explains.

track tape machine. And they remain one of the relatively few studios on Long Island to offer 1/2-inch mixdown facilities.

“We were *the* first studio on Long Island to have 1/2-inch mixdown capabilities. We picked up our Ampex ATR-102 the very month they came out on the market. We’ve had that for over two more years. We have been encouraging all our clients to use the 1/2-inch for mixdown since it provides a much fuller sound—on the low end especially—and it adds a little more headroom and definition,” remarks Al.

The owners feel that digital recording equipment is not in their immediate future because costs are prohibitive at this point. “When the costs come down we will consider digital if our clients request it,” they contend.



*A closeup of the synthesizer rack. See the list of equipment for details.*

"We are very satisfied with the product coming out of our studio.

The mastering we have done has been excellent. There is very little need for tweaking anything that comes out of our room. We don't use any room equalizers. The room is strictly acoustically balanced. In fact, a lot of the independent engineers that have been in here compare the room with the major studios in Manhattan."

**LAYOUT**

Studio A consists of a 25 x 14 studio and 18 x 14 control room with a 22 x 14 lave and "acoustically bright" drum room, which is used for drums or heavy guitars. Since the room is not in the direct line of sight of the control room, the studio utilizes a closed circuit color video system that

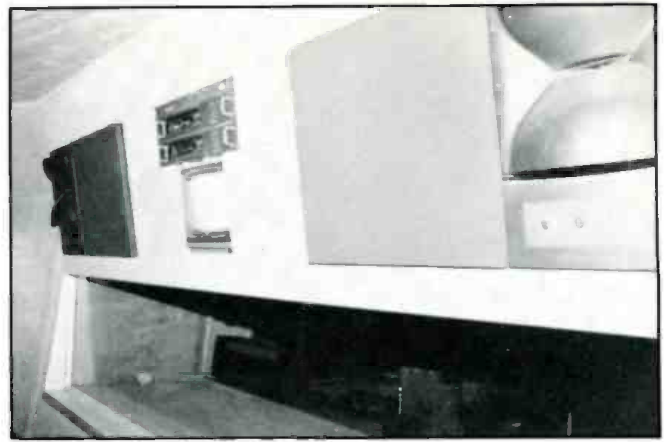

*The monitors are in their traditional position above the window to the studio.*

allows the producer or engineer to have a full view of the room. Both rooms have full talkback systems and there are facilities for three separate headphone mixes.

"The room is very simple to use. The room is self explanatory and we have a large chart in the control room that describes everything that is in the patch bay. Everybody that has worked here has found it very flexible. The Trident board is easy to operate and user friendly," Al states.

The studio also has a full MIDI (Musical Instrument Digital Interface) keyboard system including a Roland MSQ-700 Sequencer, a Dr. Rhythm—that patches their LinnDrum to the sequencer—an Ensoniq Mirage digital sampling keyboard and numerous other keyboards and gear. In fact, the studio's MIDI system can drive up to six-



*The equipment rack are in reach just to the right of the console. Note the Studer 24-track remote box in the foreground.*

# EQUIPMENT LIST

## STUDIO A

*Trident Series 80B 32-input mixing console*  
*Studer A-80 Mark IV 24-track tape machine*  
*Ampex ATR-102 (1/2 & 1/4-in.) 2-track tape machine (2)*  
*Tascam 80-8 8-track tape machine*  
*Technics RS-1500 US 1/4-in. 2-track tape machines*  
*Otari DP 4050 OCF High Speed Duplicator*  
*Alpha 4000 M High speed cassette duplicator*  
*Nakamichi MR-1 3-head cassette deck (2)*

## MONITOR SPEAKERS

*JBL 4430s*  
*Yamaha NS-10Ms*  
*AR 18s*  
*JBL 4301s*  
*Auratones*

## MONITOR AMPLIFIERS

*Carver PM 1.5 (2)*  
*JBL Electronic Crossover*  
*URIE 6500*  
*Crown DC-300*  
*Crown 150*  
*Crown D-75*

## ECHO, REVERB & DELAY SYSTEMS

*Lexicon 224 X with LARK Computer*  
*Lexicon PCM 60*  
*Echo Plates (2)*  
*Loft 440 (4)*  
*Lexicon Prime Time I*  
*Lexicon Prime Time II*  
*Delta Lab DL4*  
*Delta Lab DL1*  
*Roland SDE 300D*  
*Lexicon Model 92*  
*Quad Eight System 5*  
*EMT Tube plate*

## OTHER OUTBOARD EQUIPMENT

*dbx 900 Series comp/limiters (2 racks)*  
*parametric equalizers*  
*Drawmer noise gates*  
*Orban de-essers*  
*flangers*  
*Teltronics LA-2A tube limiters*  
*URIE LA-4 limiters*  
*dbx 165s*  
*MXR pitch transposer*  
*Eventide Harmonizer*  
*White 1/3-octave equalizers (2)*  
*URIE 527 A 27-band equalizers (2)*

## MICROPHONES

*Neumann*  
*AKG*  
*Electro Voice*  
*Sennhieser*  
*Shure*  
*Sony*  
*Audio-Technica*  
*PZM*  
*Sanken*  
*Telefunken*

## INSTRUMENTS AND INSTRUMENT AMPLIFIERS

*Oberheim OB8 (2)*  
*Yamaha DX-7 (2)*  
*Roland Super Jupiter*  
*Moog Source*  
*Esoniq Mirage digital sampling keyboard*  
*Rhodes 88*  
*Roland MSQ-700 Sequencer*  
*Mini DOC*  
*Kawai grand piano*  
*Marshall amps (2)*  
*Mesa Boogie amp*  
*Fender amp*  
*Gallien Kreuger amp*  
*LinnDrum and interchangeable chips*  
*Simmons drums*  
*Ludwig drums*  
*Fender Jazz Bass with EMG pickups*  
*Gibson custom guitar*

teen keyboards simultaneously.

If this all seems too complicated: "All the engineers on staff are familiar with the basic operation and programming of all the keyboards and drum machines. As far as really sophisticated and detailed programming goes, the client will either bring in their own programmer or the keyboard player will do it."

Studio B is 28 x 20 with a 12 x 9 control room and while "the clientele is very much an overlap" it is used primarily for pre-production and 8-track work. "Studio B is also similarly acoustically designed and is comfortable, but

smaller than studio A. It's great for 8-track demos and it's very professionally equipped," they say.

Studio B also houses a very well equipped p.a. which makes it an ideal rehearsal studio.

## STAFF and PROJECTS

Sonic has a staff of six engineers other than Jerry and Al. A few freelance engineers come in with their own products from time to time, and sometimes the studio calls in different independent engineers to work on specific projects. "Some of our staff engineers have been with us from

the start," Al says. Jerry adds, "We try to have a continuity in projects. Some artists work on projects and then come back a second time and we try to see that the same engineer works with them each time. Sometimes the engineer will even follow right through on a project to the final mastering. They will travel with the band wherever the mastering is taking place and lend a little extra continuity to the project, so they can see it through all the way to the test pressing."

### **STUDIO B**

*Sound Workshop Series 30 with super EQ (24-inputs)  
MCI 24-, 16-, 8-track tape machine*

### **MONITOR SPEAKERS**

*Fostex RM 780s  
Yamaha NS-10s  
Auratones*

### **MONITOR AMPLIFIERS**

*McIntosh 2200  
Crown DC-300*

### **ECHO REVERB & DELAY SYSTEMS**

*Master Room Super C  
Loft 440  
Roland SDE-1000  
Mic Mix flanger/chorus  
Eventide Harmonizer  
Lexicon PCM 60  
MXR Pitch transposer*

### **OTHER OUTBOARD EQUIPMENT**

*OmniCraft Noise Gates  
Gemini Easy Rider Comp/limiters  
URIE 27-band graphic equalizers*

### **MICROPHONES**

*Neumann  
Electro Voice  
AKG  
Sennhieser  
Shure*

### **INSTRUMENTS AND INSTRUMENT AMPLIFIERS**

*Oberheim OB8  
Yamaha DX-7  
CP10  
Hammond  
Arp Omni II  
Marshall amp  
Gallien Kreuger amp  
Peavey amp  
Simmons drums  
LinnDrums  
Ludwig Drums  
Mesa Boogie amp*

The studio has many regular clients that continually use it for their own projects as well as to do outside production of other artists.

The co-owners are always willing to lend an extra hand with production or engineering. In addition, both Jerry and Al are musicians and they will make contributions whenever requested. In fact, they have put their production stamp on a large portion of the projects that have come through the studio. "The majority of the projects that we have produced or co-produced are clients that have hired us to do that kind of work. They were independent bands all the way up to bands on national labels with a much larger distribution. We have done work for bands and artists at many of the major labels," Al explains.

They are both competent musicians—Jerry plays keyboard and guitar and Al plays guitar. "If we can help out a client and if the situation calls for it, we will. Some of our engineers are also musicians and they will partake in assisting the clients to shape their project in any direction the client wants—artistically, production-wise, or musically—and if need be they will play on some tracks.

Of course, all of this experienced help does not come free: "Hourly rates include an engineer, but any production service is additional. The price ranges from about \$300 to \$600 a song, depending on what is involved. There are also a number of different ways to book a room—with an engineer, without, with an assistant—and the rates vary, the rate is somewhat flexible," says Al. The approximate hourly rate in studio A ranges from \$35 an hour to \$75 an hour; studio B is from \$15 to \$45 an hour. ■



**"Knowledge is of two kinds.  
We know a subject  
ourselves, or we know  
where we can find  
information upon it."**

*Bowell. Life of Johnson (1775)*

You can find a wealth of information from the Federal Government at Depository Libraries. Contact your local library.



**The Federal Depository  
Library Program**

Office of the Public Printer, Washington, DC 20401  
This program is supported by The Advertising Council and is a public service of this publication.





# 2 to 8 trk



# WHEN YOU MUST BE 100% MUSICIAN

MCR™ 4 Multi-Track with "Overdubber™ pedal remote"

Historically, musicians doing their own multi-track recording had to be half engineer and half musician. When you do it all, it's difficult to work out musical parts, concentrate on your playing in addition to punching buttons, moving faders and watching levels to make multi-track tape recordings.

Most musicians are familiar with foot-switches used by guitar players. They allow the performer to change effects or sounds by simply tapping a foot-switch, with no distract-

tion to their playing. This quickly becomes second nature.

Overdubber™ brings the same concept to multi-track recording. It has only three buttons and is simple to use. Now recording tape tracks can be as simple

as using a guitar footswitch.

## What is the Overdubber™ Pedal Remote?

With the Overdubber™ pedal remote, you can play and rehearse, pause and work out parts,

work on the whole tune, work on any portion of the tune, punch in, punch out, rewind and listen over and over and over again. Most important of all, you can keep your mind on the music, your foot will do all the control as second nature. You can now be 100% musician when you need to be. The MCR™ 4 with Overdubber™ pedal remote is only available from AMR. Try it for yourself at your local AMR dealer or call the factory for the name and location of your nearest AMR dealer.

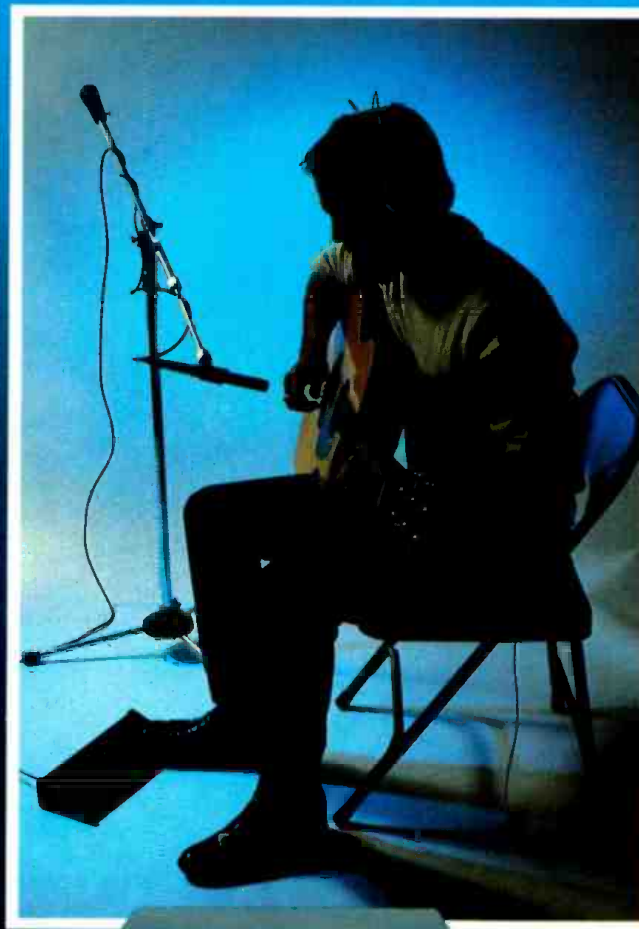

## MCR™ 4 Multi-Track Cassette System for Musicians

- Overdubber™ Pedal Remote
- Solenoid-operated Transport Function Controls
- Dolby B and C\*
- Zero Stop and Zero Play functions
- Electronic Stopwatch



- Peak-type LED Level Indicators
- Headphone Jack

- Headphone Track Selector Switch
- Record/Play Status Buttons with LED Indicators
- Many Additional Features
- Made in the U.S.A.

# AMR™

Built for professionals by professionals in America

Route 2, Highway 5C3  
Decatur, MS 39327 (800) 635-2234

\*Dolby® is a registered trademark of Dolby Laboratories Corporation

2  
to  
8  
trk

# Sonic Studio's

## Other Room



*Figures 1 and 2. Two views of the studio. The wide angle view on the left shows the full bank of installed speaker systems used when the groups want a rehearsal room. To the right, you can see the array of equipment, including a drum set that is available for recording purposes.*



Elsewhere in this issue, there is a major story on Sonic Sound Studios. This fine operation on Long Island has not ignored the needs of the musician/small studio market. A ten minute drive from the Freeport location brings you to Island Park (an island, but not a park) where, in an industrial area, we found a building containing another studio complex.



*Figure 3. The console looks out at the full studio. Note the groups of monitors on the board, flanked on the outboard sides by a pair of Fostex units.*

In this single-room operation, the musician with limited funds is catered to in a fully professional way. The equipment installed allows the room to be used as a rehearsal hall, or as a recording studio. In the typical Sonic Sound way, the studio is equipped to handle 16-track (and more) work, but, when visited, all that was in the control room was an 8-track Tascam that feeds a 2-track Technics 1500. The board, and other equipment in the room does permit 16 track work to be done, if the equipment is brought in from the other location.

It is good to note that Sonic Sound has not forgotten the musician with limited funds. The result is a studio complex that can take artists from their beginnings right through state-of-the-art analog technology. It goes a long way towards explaining why this Long Island operation is virtually fully booked in both locations. ■

# Everyone Says They're Better — We Prove It!



- Time Delay
- Compressor / Limiters
- Reverberation
- Expanders
- Crossovers
- Spectrum Analyzers
- Tape Noise Reduction
- Parametric EQ

Before you purchase another piece of signal processing gear for Studio or Performance use, you would be Wise to listen to our Demo Album. Instead of merely "Saying" we're Better, we Prove it in side by side comparisons with the competition. You really can pay Less and get a Better product through our factory direct sales!

We're out to set new standards for Quality and Performance as well as dollar value. We want you to choose us for our Quality more than our Prices. Our 15 day Satisfaction Guarantee and Two Year Warranty on our Crossovers, Time Delays, Reverberation, Compressor/Limiters, Expanders, Parametric EQ, and Tape Noise Reduction, allow you to purchase with Confidence.

The Demo Album is both fun and Educational. Examples are drawn from the master tapes of Top 40 Hits and show some of the most sophisticated effects ever devised. You will hear our phenomenal MICROPLATE® Reverb with over 18 KHz bandwidth in side by side comparisons with the \$7,000 EMT® Plate on percussion and vocals. No other spring reverb would dare attempt such a comparison! The cost is incredible too, under \$600 mono and \$1,200 in stereo!

Write or call for a free 24 page Brochure and Demo Album.

**LT Sound**, Dept. D-2, P.O. Box 338, Stone Mountain, GA 30086

**TOLL FREE: 1-800-241-3005 - Ext. 1** In Georgia: (404) 493-1258

## **LT Sound**

**We Make A Better Product**

# On Taxes

## Casualty Losses

● Losses are almost inevitable. Fire, theft, vandalism and destruction, regardless of what caused them, inevitably result in a loss. Insurance may pick up a portion of the financial or out-of-pocket loss, but the bottom line is that the recording studio owner is the one who actually suffers the burden of that loss—unless, of course, Uncle Sam picks up part of the tab.

Yes, Uncle Sam, in the form of our tax laws as administered by the Internal Revenue Service, will foot part of the bill for your loss. In fact, the tax deduction for losses also covers many losses where insurance or other reimbursement is non-existent. And, what's more, the worse that loss is, the more relief our tax laws provide—sometimes.

Under our tax rules, losses to property are tax deductible as so-called "casualty losses" if they result from fire, storm, shipwreck or other casualty. Those "other casualties" are defined by the IRS as an unexpected, accidental force exerted on property where the taxpayer is powerless to prevent it. Direct and approximate damages cause a loss similar to that sustained in a fire, storm or shipwreck.

Almost any accidental loss may qualify as a casualty loss so long as it results from some event that is identifiable, damaging to property and sudden, unexpected and unusual in nature. To be "sudden," the event must be one that is swift and precipitous and not gradual or progressive. To be "unexpected," the event must be one that is not ordinarily anticipated and one that occurs without the intent of the one who suffers the loss. To be "unusual," the event must

be one that is both extraordinary and non-recurrent. That is, one that does not commonly occur in the course of the activity in which the studio owner was engaged when the destruction or damages occurred, and one that does not commonly occur in the ordinary course of the day-to-day living of the taxpayer.

According to the tax rules, theft losses, unlike casualty losses that are deductible for the year they occur, are deductible for the year they are discovered. The reason for this rule is that, in many circumstances, a theft may not be discovered for some time after it has occurred. Theft losses include losses resulting from larceny, embezzlement and robbery, not to mention burglary, extortion, kidnapping for ransom, threats or blackmail.

In addition to proving that there was an actual loss of property, a studio owner must also prove that the property was really stolen. The so-called "mysterious disappearance" of any property—i.e., property that was simply lost—does not constitute a loss deduction for theft under our tax rules. Fortunately, whether property will be considered lost or stolen often depends on all of the facts and circumstances surrounding the loss.

One of the toughest problems with the casualty loss tax deduction is actually proving the loss. Under our tax laws, in order to qualify for a casualty or theft loss deduction, a studio owner has the burden of proving not only that a loss really occurred but also in proving that a casualty or theft was actually the cause of the loss. As with any other loss deduction, the

owner must show that he was the owner of the property, or if the property was leased from someone else, that he was legally responsible for the damage.

In order to claim a casualty or theft loss, the studio owner must have evidence that demonstrates the following:

1. The exact nature of the incident constituting the alleged casualty, the date and/or time when the alleged casualty actually occurred, and that the loss occurred as a direct result of the alleged casualty;
2. Evidence must also exist that the recording studio owner is the legal owner of the property damaged;
3. A description of the damaged property and its location;
4. The cost or book value of the property;
5. If the property is depreciable, the depreciation allowed or allowable;
6. The fair market value on non-business property immediately before and after the alleged casualty;
7. Salvage value; and
8. Any insurance or other compensation recovered or recoverable.

When it comes to determining the amount of that loss, the tax rules are quite specific. In general, the amount deductible as a casualty loss is the lesser of: the difference between the fair market value of the property immediately before the casualty or theft reduced by the fair market value of the property immediately after the casualty or theft; or the adjusted basis or book value of the property.

Unfortunately, the tax rules are also specific in limiting the amount of a personal casualty loss which may be deducted by an individual taxpayer. For property not used in a trade or business—or for the production of income—the amount of the loan deduction is reduced by \$100 for each casualty plus ten percent of the studio owner's adjusted gross income. If several items are destroyed in a single event, only one \$100 reduction must be taken.

To illustrate this loss limitation on individual studio owners, consider the situation of one hypothetical recording studio owner. Mike Jones' recording studio was totally destroyed by high winds in a storm in 1985. The fair market value of the building immediately before the loss was \$3,000. Mike's adjusted gross income for the year is \$23,000. His casualty loss is computed like this:

Amount of loss	\$3,000
\$100 floor	(100)
	<hr/>
	\$2,900
Ten percent of adjusted gross income	\$2,300
Deductible loss	\$600

A special rule applies in the case of the complete destruction of business or income-producing property by a casualty. In this case, the full adjusted basis or book value, minus the salvage value (if any) and any insurance or other compensation, is deductible regardless of the fair market value of the property.

Of course, if the insurance is more than the adjusted basis of the business property, a taxable gain results. But, unfortunately, that gain is a capital gain.

A loss to property employed in a business—even for a tax purposes-only business—is a completely different story. In this case the loss, without a floor or income restrictions, may be taken as an ordinary (or not so ordinary) business deduction.

When it comes to determining the amount of any casualty loss, the fair market value of the damaged property immediately before, and its fair market value immediately after, the casualty is generally determined by means of a competent appraisal where the cost of repair method is not used. Naturally, the appraiser must recognize any general market decline in order to limit the deduction to the actual casualty loss.

Remember, however, that under our confused tax rules, the appraisal fees are not taken into account in computing the loss, but they can be deducted as a miscellaneous deduction because they constitute an expense incurred in determining a tax liability. In other words, those appraisal fees are not computed when attempting to surmount the \$100 floor and ten percent of adjusted gross income tests imposed on personal casualty losses.

Unfortunately, a casualty loss is generally not tax deductible if there has been a decline in value without physical damage or destruction to the property for which the casualty loss is claimed. Thus, when a landslide destroyed neighboring homes but did not physically damage the recording studio owner's property, the owner was not entitled to a casualty loss deduction, even though there was an all-too-real decline in the value of his property.

Generally, both the IRS and the courts take the position that any decline in value to undamaged property following a landslide that affected neighboring land is due to temporary buyer resistance, which is insufficient to support a casualty loss deduction.

Where a loss is sustained to property that is used partly for business purposes (including profit-making activities), the \$100 and ten percent attributable to the non-business use.

Finally, we come to those disaster losses, the so-called "throwback election." Any studio owner who sustains a loss attributable to a disaster occurring in an area later determined by the President of the United States to warrant assistance by the federal government under the Disaster Relief Act of 1974 can choose to deduct the loss for the taxable year immediately preceding the taxable year of the disaster. This gives the recording studio owner an opportunity of applying for a refund on a return that has already been filed and paid, thus allowing him an immediate tax benefit to help restore his damaged home or business.

While casualty losses are almost inevitable, our tax laws do provide some relief in the form of a tax deduction. Although the tax laws and rules are frequently confusing and obviously restrictive, they do provide a degree of financial relief from those losses that are not fully covered by insurance. But the time to think about meeting the deductibility requirements is at the time of the loss—or before it if at all possible. ■

Ask for our  
**FREE CATALOG**  
OF PROFESSIONAL  
*Sound* RECORDING  
& DUPLICATING SUPPLIES



**Polysette**  
Blank-Loaded  
AUDIO CASSETTES

**TAPES**  
• CASSETTES  
from MAXELL  
AMPEX • FUJI • 3M  
BASF • AGFA • TDK

**CASSETTE BOXES**  
LABELS • ALBUMS

**ACCESSORIES**  
from NORTRONICS  
3M • BASF • EDITALL

**Polyline** Empty  
REELS & BOXES

Switchcraft Connectors  
Genere Microphone Cable  
Connextronics Cable  
Tapes Cassette Covers  
Signature Prod Music Library

**NAB BROADCAST**  
CARTRIDGES

**Polyline Corp.**  
1233 Rand Rd. • Des Plaines, IL 60016  
**(312) 298-5300**

Circle 19 on Reader Service Card

SUMMER 1986 SESSIONS  
**EASTMAN**  
RECORDING INSTITUTE

Eastman School of Music  
of the University of Rochester

*Analog/Digital Professional  
Facilities*

**Basic Recording Techniques**  
June 30 - August 8

**Advanced Recording Techniques**  
July 21 - August 8

instruction by leading audio engineering professionals in: basic electronics applied to audio digital technology; acoustics; microphones; tape and disc recording; studio, remote, and classical recording; signal processing; maintenance; etc.

Labs, recording sessions, mixdowns.  
*Credit and non-credit.*

Coordinator: Ros Ritchie, director of  
Eastman Recording Services

**For further information and applications write: Summer Session, Dept. N, Eastman School of Music, 26 Gibbs St., Rochester, N.Y. 14604**

Eastman School of Music of the University of Rochester provides equal opportunity.

Circle 21 on Reader Service Card

# Recording Techniques

## AES Workshop On Recording Pop Music On Location

● At the seventy-ninth convention of the Audio Engineering Society last October there were two sessions covering on-location recording of popular music. The first was "On the Repeal of Murphy's Law—Interfacing Problem Solving, Planning, and General Efficiency On Location." The second was "Popular Music Recording Techniques." Participating in the sessions were:

Paul Blakemore of Blakemore Audio, Takoma Park, Maryland; Neil Muncy, Neil Muncy Associates, Toronto, Ontario, Canada; Skip Pizzi, NPR, Washington, DC; Dave Moulton, SUNY, Fredonia, New York; Curt Wittig, Recording Engineer, Washington, DC.

Several topics were covered, including: hum prevention, grounding and power, cables, site survey, pre-production planning, microphone techniques, monitoring, and mixing.

All of the following discussions have been paraphrased.

### HUM PREVENTION

Most audio equipment includes a green wire in the AC power cord that is connected to the chassis, and also to the low side of the power supply. Thus, if you interconnect two pieces of unbalanced equipment where the shield carries signal, you set up a ground loop formed of the shield and the power-ground wiring. This ground loop can cause audible hum. A balanced interconnect solves this problem because the audio signal is not shared with the shield.

Power lines in walls radiate magnetic and electrostatic fields that oscillate at 60 Hz and its harmonics. These fields can couple to audio cables and produce audible hum or buzz. Magnetic fields couple best at low frequencies, and so are heard as a low tone or hum at 60 Hz. Electrostatic fields couple best at high frequencies, and so are heard as a buzz including harmonics of 60 Hz.

In an audio cable, the grounded

shield is the path of least resistance to ground for electrostatically coupled interference. Thus, the shield helps prevent electrostatic hum pickup.

If you break a shield connection in a mic cable, there is no ground path for induced electrostatic charges, so you'll hear a buzz in the audio.

The pair of conductors in a balanced audio cable are twisted together to reduce pickup of magnetic hum. Here's why: according to the inverse square law, a magnetic hum field weakens very quickly with distance. In a twisted pair, both leads are the same average distance from the hum source, so they receive the same average field strength. Thus, equal voltages are induced in each conductor. At the preamp input where the cable is connected, the preamp amplifies only the difference signal between the pair. And since there is little difference in the hum voltage between the two conductors, there is little hum to be amplified.

Audio cables contained shielded,



twisted pairs to reduce hum. The cable connector is susceptible to magnetic hum interference because the leads are separated.

Star Quad cable has two parallel-connected twisted pairs inside for extra hum rejection.

In a snake box, direct box, or splitter, it's a good idea to keep internal wiring twisted up to the connector and to use short lengths.

Mic-cable shields are either spiral wrapped or braided. Spiral wrap costs less but provides less coverage. Braided shield is stronger and provides better coverage, but costs more. Double spiral wrap covers the conductors better than single spiral wrap.

## POWER AND GROUNDING PRACTICE

Here are some suggestions for making AC power connections on location. Check that your AC power source is not shared with lighting dimmers or heavy machinery; these devices can cause noises or buzzes in the audio.

Measure the AC line voltage. Know what your equipment can do under widely varying voltages. You may need to use a Variac. Use a 3-prong tester to check AC outlets for reversed polarity or lack of ground.

If possible, get AC power from the same place as the sound-reinforcement company. Run a long, thick (14 or 16 gauge) extension cord from that point to the control room. Plug AC outlet strips into the extension cord, then plug all your equipment into the outlet strips.

Do not overlook the third-pin safety ground on equipment power cords. If you have to float the ground to prevent ground loops, make a box as follows: put male and female AC power connectors in the box, with the hot and neutral leads wired together. Put a bridge rectifier shorted across its center terminal between the ground lugs. It will conduct only in the event of a ground fault. It will give you a disconnected ground at signal voltages, but will clamp if a fault occurs and the voltage rises above 1.2 volts. You may want to add a 20-amp circuit breaker. Plug this box between each piece of equipment and the AC power outlet.

Turn on all the stage musical-instrument amps and the sound system. Using a neon tester or voltmeter, connect one lead to system ground, and the other lead to the chassis of each

instrument amp. Verify that there is no voltage measured. Also measure between guitar strings and sound-system microphones.

## INTERFACING WITH TELEPHONE LINES

If you're doing a live remote for broadcast, you'll probably send your signal to the transmitter via rented telephone lines.

The telephone company (Telco) rates the noise level of telephone lines in dBm. 0 dBm is the "absolutely quiet" reference. 0 dBm -90 dBm. Thus, if the noise level is 30 dBm, the signal-to-noise ratio is 90 to 30 or 60 dB.

Telco zero level is +8 dBm. You don't necessarily have to feed +8 dBm from your console into a phone line; +4 dBm will give 4 dB more headroom. Telco test level is 0 dBm for tones above 400 Hz.

You may want to ask for lossless lines (with unity gain); otherwise you may be down about 20 dB after transmitting through the phone lines.

You need a 600-ohm source impedance, achieved by putting a 600-ohm resistor in series with the console output connector (300 ohms per leg of the balanced line). Have a terminated transformer on the sending end. To make a receiving line 600 ohms, put a 600 ohm resistor across pins 2 and 3.

For stereo programs, specify phase-matched lines.

In addition to the program lines, rent a non-equalized private line for communications. Order program lines two or three days in advance. Order a standard non-EQ'ed line for communications about a week in advance.

## CABLES

Let's move on to the subject of cables and cable connectors. In a 3-pin connector, if you tie pin 1 to the shell grounding lug, you reduce pickup of electrostatic hum. With this wiring method, however, ground loops are more likely to occur if the shell contacts metallic surfaces onstage.

Furthermore, if pin 1 is grounded to the shell, and you plug the connector into a direct box and push the ground-lift switch, you don't lift ground!

It's probably best *not* to tie pin 1 to the ground lug when you're recording on-location, because ground loops are more likely to occur than electrostatic hum pickup. But in controlled studio situations, it's best to tie pin 1 to the ground lug. In any case, standardize

your connector wiring.

If SCR dimmer noise is a problem, insert an adapter between two mic cables to tie pin 1 to the shell.

Number the cables near their connectors and cover the label with clear heat-shrink tubing. Also label both ends of each cable with the cable length. Loctite the connector screws in place.

Try to use a single mic cable between each mic and its snake-box connector.

Avoid bundling mic cables, line-level cables, and power cables together. If you must cross mic cables and power cables, do so at right angles and space them vertically.

Don't leave a rat's nest of cables near the stage box. Coil the excess cable at each mic stand. That way, you can move the mics and reduce clutter at the stage box. Don't tape the mic cables down until the musicians are settled.

Have an extra microphone and cable off stage ready to use if a mic fails.

## PRE-PRODUCTION MEETING

Have a pre-production meeting with the sound-reinforcement company and the production company putting on the event. Find out the date of the event, location, phone numbers of everyone involved, when the job starts, when you can get into the hall, when the second set starts, etc. Decide who will provide the split, which system will be plugged in first, second, etc. Draw block diagrams for the audio system and communications system.

If you're using a mic splitter, note that the mixer getting the direct side of the split provides phantom power for condenser mics not powered on stage. If the house system has been in use for a long time, give them the direct side of the split.

Overly loud stage monitors can ruin a recording, so work with the sound-reinforcement people toward a workable compromise. Ask them to start with the monitors quiet, because the musicians always want them turned up louder.

Make copies of the meeting notes for all participants. Don't leave things unresolved. Know who is responsible for supplying what equipment.

## SITE SURVEY

Visit the recording site in advance and go through the following checklist:

1. Listen for ambient noises—ice machines, coolers, 400 Hz generators, nearby discos, etc. If the room is noisy, you'll need to mic close. If not, you may want to mic at a distance to include room acoustics.
2. Sketch dimensions of all rooms related to the job. Estimate distances for cable runs.
3. Turn on the sound-reinforcement system to see if it functions okay by itself (no hum, etc.). Turn the lighting on at various levels with the sound system on. Listen for buzzes. Try to correct any problem so that you don't document bad p.a. sound on your tape.
4. Check AC power on stage with a circuit checker. Are grounded outlets actually grounded? Is there low resistance to ground? Are the outlets correct polarity? There should be a substantial voltage between hot and ground, and no voltage between neutral and ground.
5. Determine locations for any audience/ambience mics. Keep them away from air-conditioning ducts and noisy machinery.
6. Plan your cable runs from stage to control room.
7. If you plan to hang mic cables, feel the supports for vibration. You may need microphone shock mounts. If there's a breeze in the room, plan on taking windscreens.
8. Find a source of power for the remote truck that can handle the truck's power requirements. Find out whether you'll need a union electrician to make those connections.
9. Find the circuit breakers for your power source and label them. Stay away from circuits supplying heavy machinery or old-style cash registers. Use an assistant to see if any devices are on your circuit. Ask the custodian not to lock the circuit-breaker box the day of the recording.
10. Make a file on each recording venue including the dimensions and the location of the circuit breakers.
11. Find out where the control room will be. Find out what surrounds it—any noisy machinery?
12. Visit the site when a crowd is there to see where there may be traffic problems.
13. You might want to record the ambient noise with a portable

recorder and play it back at home. This will make the ambient noise much more audible.

14. If the AC power is noisy, you might need a power isolation transformer with an electrostatic shield. Use a line voltage regulator if the AC line voltage varies widely.

After doing the site survey, draw a complete system block diagram including all cables and connectors. Use this to generate an equipment list. Keep a file of system block diagrams for various recording venues.

### MISCELLANEOUS TIPS

Hook up and use new, unfamiliar equipment before going on the road. Don't experiment on the job!

Walkie-talkies are okay for pre-show use, but don't use them during the show because they can cause RF interference.

Allow fifty percent more time for troubleshooting than you think you'll need. Expect failures. Have backup plans if equipment fails. Leave as little to chance as possible.

Bring a tool kit with screwdrivers, pliers, soldering iron, connectors, adapters, cables, 9V batteries, guitar cords, guitar strings, AC-outlet checkers, fuses, a pocket radio to listen for interference, ferrite beads of various sizes for RFI suppression, canned air to shoot out dirt, Q-tips and pipe cleaners, and Cramoline Red from Cague Labs to remove oxide from connectors.

Assistants can relay messages to and from the stage crew while you're mixing.

During short set changes, use a closed-circuit TV system and light table to show what set changes and mic layout changes are coming up next; transmit this information to the monitor mixer and sound-reinforcement mixer.

Don't unplug mics plugged into phantom power because this will make a popping noise in the sound-reinforcement system.

After the gig, note equipment failures and fix broken equipment.

Don't put tapes through airport X-ray machines because the transformer in these machines is not always well shielded.

Hand-carry your mics on airplanes. Arrange to load and unload your own freight containers, rather than trusting them to airline freight loaders.

Get a public-liability insurance policy to protect yourself against suits.

In general, plan everything in advance so you can relax at the gig and have fun!

### MICROPHONE TECHNIQUES

The following are suggested mic'ing techniques for on-location recording. Since they are meant to minimize leakage and feedback, they are not necessarily the same techniques you might use in the studio.

**Upright bass:** Try a direct feed from a pickup to minimize leakage. This method provides clarity and "bite," but has an "electric" sound. Also, wrap a condenser lavalier mic in foam and stuff it in an f-hole. Mix this microphone with the pickup to "round out" the tone. You may need to roll off the bass of the f-hole mic. Try flipping the polarity of the mic and use whatever polarity sounds best.

A mic near the bridge will pick up a more natural tone, but will also pick up more leakage.

**Grand piano:** Mount a coincident pair of cardioids, angle them 120 degrees apart over the middle-C strings, very close to the strings, and near the hammers. This gives a sharp, percussive sound with little low end. There may be excessive hammer noise and pedal noise. Add reverb.

Moving the mics away from the hammers toward the diagonal rail will give a more natural sound with a little more leakage.

An alternative is to use two spaced cardioids aiming down over the bass and treble strings, but this arrangement may cause phase cancellations when heard in mono.

Try two Crown PZMRs taped to the underside of the piano lid, over the bass and treble strings, with the lid closed. Pan them half-left and half-right. This arrangement is not mono-compatible, so you may want to try a single PZM over the middle strings.

PZM pioneer Ken Wahrenbrock has made a prototype stereo PZM for mic'ing pianos: two PZM capsules mounted 1-1/2 inches apart on a single plate.

**Drums:** Place a coincident pair of flat-response cardioid condensers (such as Neumann KM-84s) over the center of the drum kit. Move the mics up if the cymbals are too loud. These overhead mics will pick up very little kick drum because the front-and-rear heads of the kick drum produce out-of-phase

sound waves that cancel at the mic position. So you'll need to add a mic in the kick drum.

These three mics usually are enough for straight-ahead jazz recording. For fusion or rock, you'll probably want to add close-up spot mics, which give a fuller, brighter, closer sound. Spot-mic suggestions are as follows:

**Snare drum:** A mic under the snare drum gives a "zippy" sound; a mic over the snare drum gives a "fuller" sound. Keep the mic out of the drummer's way, near the rim. If you want to pick up the hi hat with the snare mic, aim the snare mic partly toward the hi hat. Caution: Every time the hi hat closes, it produces a puff of air that can "pop" the snaredrum mic. Place the snare drum mic so it is not hit by this air puff.

**Hi hat** To avoid the air puff just mentioned, don't mic the hi hat off its edge. Mic it from above aiming down.

**Tom toms:** Mic'ing the toms from inside gives a full, "jungle" sound with little stick attack. Mic'ing the toms from above picks up a percussive attack with more "click" or "snap." Place mics very close and near the rim. You might want to try a bidirectional mic between two tom-toms.

**Flute:** In the studio, place the mic at the joint where the two pieces of the flute go together. A mic near the mouthpiece picks up a breathy, whistling sound; a mic near the open end picks up an unnatural sound with key noise.

On stage, try taping a miniature omni condenser mic to the handle of the p.a. microphone.

**Woodwind section:** When mic'ing a woodwind section within an orchestra, you need to reject nearby leakage from other instruments. To do that, try aiming a bidirectional mic down over the woodwind section. The side nulls of the mic will minimize leakage.

**Sax** A mic in the bell picks up mainly the upper harmonics, giving a hard, bright sound. A mic off to the side picks up a quiet sound, with poor isolation. Perhaps the best spot is in front pointing at the player's left hand, about one third to one half way down the wind column. Don't mic too close, or else the level will vary when the player moves.

**Brass:** Place the mic in-line with the bell. The sound is brightest on-axis to the bell, duller off-axis.

**Guitar amp:** Place a mic at the center of one speaker. The electric guitar usually is not taken direct. Mic the amplifier if the amp is creating the player's sound.

**Jazz vocals:** Try an omnidirectional mic up close. Compared to a cardioid mic, an omni has smoother off-axis response, less handling noise, and no proximity effect (up close bass boost).

**Vibraphone:** Mic it over the top, never underneath.

**Electric piano:** This often has a stereo output, so be sure to record both channels.

**Reeds (woodwinds):** The reeds' low frequencies and mid-frequencies radiate from the wind column, while the highs above 5 kHz (and the fundamentals of some notes) radiate from

the bell. Consequently, mic'ing the column gives a natural sound; mic'ing the bell gives a thin, nasal sound.

**Strings:** Strings radiate low frequencies omnidirectionally. High frequencies radiate off the top or front face. Consequently, a mic over the top sounds bright and strident. A mic near the side sounds warm. For mic'ing a string section with minimal leakage, try a bidirectional mic over the section aiming down.

**Harp:** Try some C-Ducer tape on the soundboard with some added reverb. Also, try a bidirectional mic oriented vertically along the axis of

## "Gauss. The Best Unknown Speakers in The World"

"Most people don't even know Gauss speakers exist," says Jim Martindale, Engineering Manager of Apex Systems Ltd. "I live with sound at work and at home. At Apex, we specialize in products that make sound better. So, I'm really critical of sound quality and demand dependability. That's why I like and use Gauss speakers."

"With Gauss, you always know you're getting a professional loudspeaker," Martindale continued, "with XXX (the three letter company), you never know whether the speaker was developed for hi-fi or pro use. The quality just varies all over the place. For my money, Gauss speakers are by far the best speakers I can use."

These comments were unsolicited and made by Mr. Martindale who purchased the Gauss speakers he uses in an elaborate sound system which supports Cinemascope movies, VHS Hi-Fi video, compact discs, stereo TV and "normal" stereo.

There's a Gauss loudspeaker to fit every professional need from 10" to an 18" that handles 400 watts and a range of high power compression drivers with response to 20 kHz. For information on the entire Gauss line, see your authorized Gauss dealer or write Cetec Gauss, 9130 Glenoaks Boulevard, Sun Valley, CA 91352, (213) 875-1900, Telex: 194 989 CETEC.

Choice of the Pros  
**gauss**  
by Cetec

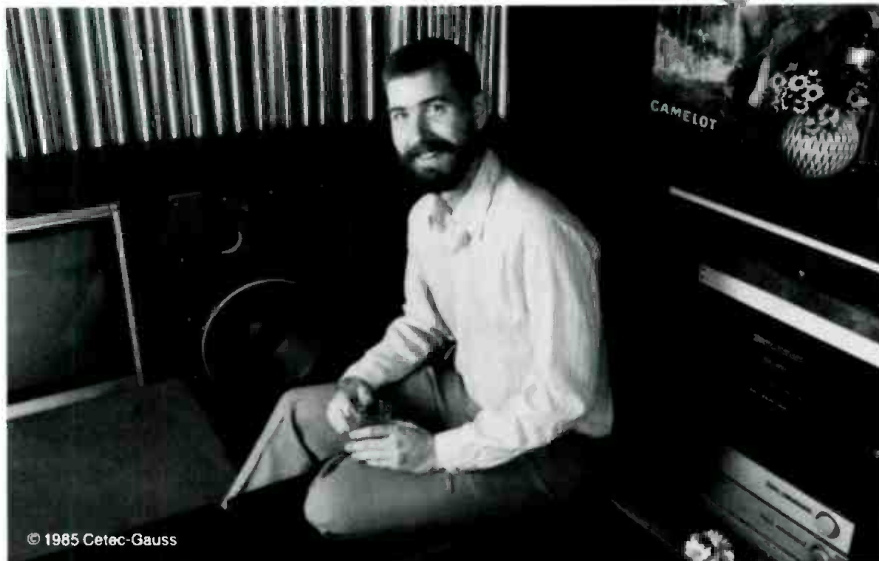

© 1985 Cetec-Gauss

Circle 22 on Reader Service Card



*"Being an 8 piece ensemble we put a monitor system through rigorous demands and the Carvin system performs excellently. I'm impressed by the flexibility and overall layout of the Carvin MX mixers. We use the Carvin system for both rehearsal and live performances."*

— Danny Elfman, Oingo Boingo

## Carvin Tri-Amp Systems

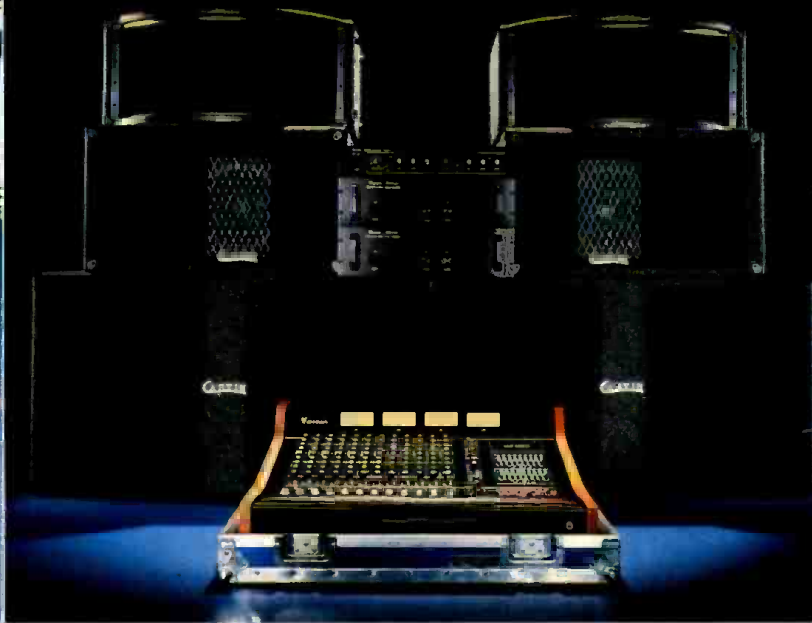

**Tri-Amp System C12-3000E DIRECT \$3999 List \$7995**

The Carvin C12-3000E Tri-amp Concert system produces a wall-of-sound that's earth shaking! Components include: 12 ch MX1222 pro stereo console, 2 single 18" 3000E folded horn Electro-Voice sub-woofers, 2 1200E E.V. midrange enclosures, 2 R540H Carvin/Renkus-Heinz radial horns, 1 DCA800, 1 DCA300 power amp (1100 watts), and 1 XC1000 crossover.

# CARVIN... Made in USA

## Carvin System S12-980

**System S12-980 DIRECT \$1979 List \$3895**

Our best compact stereo 12 ch sound system features high powered speaker components designed for peak over-loads normally found in professional sound reinforcement. The quality of the S12-980 demonstrates its clarity of undistorted audio regardless of price! Components include: the MX1222P stereo powered mixer with 400 watts rms, 2 980M speaker enclosures, and cables.

The 980M speaker enclosure features the Carvin high energy HE15 woofer and Electro-Voice DH1202 radial horn compression driver. **DIRECT \$369 List \$695.**

## Carvin System S8-960

**System S8-960 DIRECT \$1449 List \$2695**

One of our best performance values is the 8 ch S8-960 system featuring the 960M enclosures. The 960's offer Carvin's high energy HE15 woofer in a tuned port enclosure for smooth, deep bass output. Carvin's HE490 compression horn delivers superb highs for clarity. Components include: the MX822P stereo powered mixer with 400 watts rms, 2 960M enclosures, and cables.

The 960M speaker enclosure has a high power capacity of 150 watts, 300 watts peak. An exceptional value at **\$269 ea. DIRECT List \$495.**



## Pro Monitors



Carvin's Pro monitors are incredibly powerful, projecting a clear full-range sound to your ears when everything around you seems deafening. The 12" 750M model sells **DIRECT \$179 List \$295.** The 15" 790M model sells **DIRECT \$219 List \$395.**

## DCA800 Power Amp



The stereo DCA800 amp clearly demonstrates uncompromising performance. Its 800 watts rms (bridged) output drives speakers from sub-audible sounds to explosive levels without distortion. Pro features include balanced inputs and fail-safe protection. **DIRECT \$549 List \$1095.**

Join the Pro's who use Carvin mixers or P.A. systems

- Tony Brock (Rod Stewart)
- Brad Gillis (Night Ranger)
- Danny Gottlieb (John McLaughlin)
- Peter McLan (prod. Men at Work)
- T. Lavitz (The Dregs)
- Musician's Institute
- Missing Persons
- Oingo Boingo
- Starship
- Steve Vai
- Frank Zappa



## MX1688 Recording Mixer

16 x 8 x 2

### Recording Features

- Eight Track Studio Control Center
- Input/Output Channel Organization
- Independent 8 Into 2 Monitor Mixer
- Four Auxiliary Busses w/ Pre/Post
- Three Band Parametric EQ w/ Defeat Switch
- Mute and Solo on all Input and Output Channels
- Two Effects Returns w/ Pan and Solo
- Talkback w/ Built-in Mic and Monitor Dimming
- Peak Warning Indicators w/Peak Stretching
- Patch Points on all Channels
- Microphone Phantom Power
- Cue and Effects Sends from Output Channels
- Alternate Metering of Cue and Two-Track
- Quick Tape Playback Through Monitors
- Independent Mic and Line Preamps
- Studio Feed w/ Source Selection
- Totally Modular Internal Construction
- Input Noise of -128 dBu. THD less than .05%
- Frequency Response: 20 Hz to 20 KHz
- 20 dB headroom at All Stages

**\$2995**

List \$6950

### P.A. Features

- Eight Sub-Groups w/ Solo and Mute
- Channels Assignable to L & R Stereo Output
- Four Independent Monitor Mixes Available
- Headphone Monitoring of Main or Monitor
- 11 Step Gain Controls for Easy Set-up
- Talkback to Monitors



50 page Operation Manual preview of MX mixers. Specify MX22, 44, or 88 series \$10.

# Performance Guaranteed!



**MX1644 16x4x2x1**  
**\$1695** List \$4595  
Four 9 band EQ \$200  
Studio Reverb \$100



**MX1222P w 400w**  
**\$1299** List \$2595

**MX1622 16x2x1**  
**\$1299** List \$2595

**MX2422 24x2x1**  
**\$1799** List \$3695



**MX822P w 400w**  
**\$949** List \$1795

**MX622P w 300w**  
**\$799** List \$1495



**CARVIN PROFESSIONAL MICS**

CM90	Condenser Recording mic	\$139	List \$269
CM67	Studio Instrument mic	\$99	List \$199
CM68	Professional Vocal mic	\$99	List \$199

Don't let Carvin's low prices fool you. We are the company that has been making and selling pro audio gear DIRECT since 1946! Enjoy big savings because we eliminate "Retail Store Profits", not quality.

All "MX" consoles offer the professional features and performance you've grown to expect from Carvin! Computer grade components, heavy-duty regulated power supplies, modular circuits and low noise signal path designs optimize the "MX" boards for professional recording and sound reinforcement. Before you buy another PA board, discover the transparent, low noise performance of the Carvin "MX" consoles. We guarantee it or your money back after trying for 10 days! Carvin products are proudly made in the U.S.A. and warrantied for 1 year. Send for your FREE 84 page color catalog. To rush 1st class mail, enclose \$1, \$5 for foreign. Master Card and Visa accepted. For more information, call TOLL-FREE 800-834-2235 (Calif. 800-542-6070).

CARVIN'S New Hollywood store is conveniently located at 5900 Santa Monica Blvd., Hollywood, CA. (ph 213-461-2700) offering the same low Direct prices.

# CARVIN

Dept. DB69, 1155 Industrial Ave.  
Escondido, CA 92025

Circle 20 on Reader Service Card

## Free Catalog

FREE CARVIN CATALOG	
<input type="checkbox"/> Free Catalog	<input type="checkbox"/> \$1 for Rush 1st Class Mail
Name _____	
Address _____	
City _____	
State _____	Zip _____ DB69

# The Modus Operandi of David Kurtz

## Part I

● History has come full circle. When I was five, history was last week. In junior high school, it retreated to a distance located millenniums in the past, perhaps before the ice ages, or somewhere in the black holes of outer space. But with the advent of the transistor a few decades ago, history began to move toward us again, for that became demarcation for reckoning, anything *before* the transistor was ancient, everything after was *today*. But now, thanks to the chip and the computer, history is once again only a week behind us, or perhaps only an hour in the past, for that's when our brand new equipment becomes obsolete.

I had to laugh, hearing composer David Kurtz talk about the original synthesizers of the 1960s as being in "the olden days." But he's right, for musical technology is changing so fast that the trend toward obsolescence is inescapable: anything invented at breakfast is history by lunchtime.

This is more serious than it sounds, for how does the updated musician handle this without going broke before dinner?

This is just one of the problems David Kurtz met head-on when he tackled the Hollywood film industry as a young composer moving out from the east coast without a lot of money. Not that he wasn't prepared. Having attended both Yale and Stanford, having studied as an award student with two music giants, Jacob Druckman and Krzysztof Penderecki, and having been composer-in-residence with the prestigious American Dance Festival with seven premiers to his credit, he did not come without portfolio. But, having impressive credentials is one thing and coming in off the street to earn a coveted role as composer for film and television is quite another. Yet, in just a few years his credits speak for themselves; a list of shows he has worked on includes: *Annie* and *The Big Chill* for Columbia Pictures,

and *The Young And The Restless* and *Blade In Hong Kong* for CBS television. Today David can speak freely of hurdles facing a newcomer to the film capitol, but before he got into that we had a special question.

**db Magazine:** Today you compose mainly with the use of a computer, and your music is punctuated with new electronic sounds, yet your training is in the classics. Where and when did this transition of interest take place?

**David Kurtz:** While I was at Yale. For years I'd been doing traditional scoring with instrumentalists, but my interests began to encompass electronic music. I guess I really got into it, because before I graduated in 1980 I found myself teaching a course in electronic music. It was purely a synthesizer studio, but I loved it.

At that time the synthesizer was modular, which allowed you a flexibility that's unbelievable. Today's synthesizers are based around *pre-*



David Kurtz working at home among a myriad of electronic instruments, all controlled through MIDI connections from his Fairlight CMI.

sets, and the variations of the pre-sets. Ninety-nine percent of the people today go out and get a Prophet or an Oberheim or a Roland to start with, using the pre-sets that are there as their point of departure. However, in the modular days you didn't have that; you had to start from a very fresh standpoint. All you had were oscillators, VCAs VCFs and so forth. No pre-sets. You couldn't just turn it on and get a sound. There's something about the process of taking a wire (a patchcord) and connecting it from one point to another, that made you think about what you're doing. In a sense, I'm really grateful that I grew up from that school of endeavor, from the modular synthesizer...the early Moogs, the Arps, the Buchla systems.

**db:** But this is not where your training started. Your beginnings were with piano and guitar, followed by conducting and composing. What led you from that into synthesizers?

**DK:** Again, at Yale they were interested in getting into computers, so in the late 70s they sent me to the Artificial Intelligence Lab at Stanford

University which may be the foremost center for computer music in this country. They were time-sharing on this enormous computer that's really not designed for music; it's designed for artificial intelligence, and specifically for robotics...sound recognition they called it... They soon concluded, Hey, if it can make sounds it can probably make music.

**db:** How computer-wise were you when you went out to Stanford?

**DK:** Not at all. It really is a very different world, the computer world. The people at Stanford were very different types than what I was used to. Even so, it was a musical environment to the extent that others there were groping through new ground in music, too. I came from music, I'm not a technician, but I make it a point to always understand what goes on *in front* of the machines; in the back I wouldn't know what to touch first. Actually I prefer to work that way; for me, that's better. It keeps music as my main concern; electronics in itself is not my domain.

**db:** How long were you at Stanford?

**DK:** For one long summer. At the end of that period I decided to take a holiday and visit friends in Los Angeles, and while down here I got a slight feel for the motion picture industry. So when I went back to Yale for a year, I took a course in film criticism. I had never thought of film in terms of the whole flow of the history of art. But in this course at Yale I started getting into the Busby Berkely films, the Charlie Chaplin films, Ingmar Bergman, Fellini, Spielberg and others. And suddenly I realized what some people before me already knew, that this is not only a legitimate art form but that it's *the* art form of our times...the Michelangelos, the Beethovens...are probably working in film.

After my graduation I found myself out here with no money, and I did the typical survival trip of selling sandwiches on the street, doing a few odd jobs, and eventually became a copyist. During those lean times, when I could look around and see what was being done all around me in the music

business, I began to appreciate the kind of training I had to go through with Druckman and Penderecki. We used to have to do things like take sixteen bars of music and orchestrate it in the style of Hayden, Brahms, Ravel, Vivaldi, or Stravinski. It was excellent discipline, where you have to think of sounds in your head first. You also had to do that with modular synthesizers, because when you turn on an oscillator you get a sine wave or a pure saw-tooth, which is not much to go on. So your thinking always has to come from your head first. When you orchestrate that's all you're doing; you're sitting there imagining what all this will sound like being played by a brass section in combination with two flutes, being supported with sixteen cellos underneath.

When I came out here I had no money and no machines, and the time wasn't really right for that anyway. So when I finally got a foot in the door I used synthesizers merely to augment the traditional instruments that I was using.

**db:** You said, "When I finally got a foot in the door"... How does a young up-and-coming musician go about doing that?

**DK:** I don't really know what to say about that. There isn't any one particular way. For me, every show has been different. What I know for a fact is that it's very hard to get in people's doors and have them listen. I know this is a cliché, but there's a lot of competition out there and there's no denying that luck has a part in it, just as personalities sometimes mesh and sometimes don't. I think the big thing is to stay on the scene and do anything that's involved in music, no matter how trivial it may seem at first. I mentioned that I was a copyist for about a year, which gave me a sound financial basis and kept me visible in the music world. *Visibility* is an absolute must. You have to get out; if you stay in your room you'll just get lost, because nobody's looking for you. Nobody. They've got a hundred other people who can do what you can do, and even if you can do it better, it doesn't count if you don't circulate. You can lose out to someone who's not nearly as good. It's a hard sell.

Now one of the first things I wanted to do when I came out here, (and it didn't happen right away), was to get an agent. Agents are important in that they give you respectability. For some reason, before I had an agent, my early interviews would end with, "Your

music's fine, now who's your agent?" It's part of the process. There's a process out here that people go through, an unspoken protocol that makes things work. When my answer was, "I don't have an agent," I could sense an imperceptible pause that slowed things down.

Something that I'm still learning, still trying to understand, is *where* the priorities are. It has to do with those "evolved processes" I just mentioned. Take budget, for instance. You learn very quickly that music, in the grand scheme of doing a production, is not the foremost priority in itself. It's often the last consideration when the producers are putting together a show, and by the time they get around to talking music, the budget is nearly depleted. After the actors and their salaries have been selected, after the sets have been agreed upon, and perhaps even after the food catering has been nailed down, that part of the budget left over for music may have shrunk to something quite small. There's no animosity here working against music; it's just a process that has evolved.

So, one reason for my having quite a bit of work so far is that I learned how to produce music within the strictest budget requirements early on. In a way you might think this puts severe limits on what you can do, but looked at in another light, it teaches you to do more with less...and quite often that can lead to a uniqueness that puts your work in demand. Also, when you're coming in from the sidewalk your lifestyle is somewhat on the thin side, and you can afford to get involved in projects that they can't consider asking the more celebrated composers to do. We're talking about a fine line here, for you can't do anything for free. That's the kiss of death. But with nothing to lose you can certainly give 101 percent for the agreed-upon dollar.

**db:** It looks like the composer new to the industry has a lot to keep his eyes on...

**DK:** True, and when it comes to getting a foot in the door, that *visibility* I spoke of is the important thing. If this means finding a way to sneak onto a set, so be it. I found ways to hang around scoring stages, where I'd come in very quietly and watch and listen and not open my mouth. I knew that musicians take breaks at least once an hour, and for me it was another chance to mingle, it was a continuing learning process.

Also, your time is just as important to you as a beginner as when you're established. Maybe even more so, for you're coming from a sense of urgency, if not desperation, so you've got to use it well. If you're really counting the hours available for accomplishment, you must learn who to sell yourself to and who to minimize. This is not to soft-pedal friends and acquaintances; rather, it's to *not* waste your life with insignificant dallying when you're trying to get a foothold. You may make new friends, yes; commiserate, yes; be of assistance to your fellows, yes; but you don't waste time selling yourself to other composers or instrumentalists or editors, for they don't buy. The only people that you're going to be selling to are producers, for they are the ones who buy. That's all that counts.

All this is said on the assumption that you've done your homework, and much of that homework comes *after* you've finished school, during the time spent on the street when you do more listening than talking. For example, in Yale I took a very thorough film music course. Then I came out here and could hardly wait to score a film or TV series. Thank God no one hired me. I wasn't ready. There was a lot I had to learn, particularly about procedure, about that protocol I touched on earlier, not to mention the specifics, the manual technicalities that go with the genre. In some ways this is a small town, and when you bite off more than you can handle, it's common knowledge overnight, and you might as well wear a sandwich board that reads I blew it."

**db:** What are some of these established procedures that you must follow?

**DK:** I'm sure that specifics will come up as we talk, but let me say that in every category of this business there are accepted avenues through which things get done, and if you try to take too many detours around this unwritten system you may as well enjoy the water, for you're just swimming upstream. For example, there are certain ways you approach the editors (who may be beneath you in authority) as well as the producers who hire you, stances which should neither sacrifice your own convictions nor allow you to elbow your way into oblivion. Again, you do a lot of listening and assessing, while at the same time protecting your identity with reasonable assertions.

If this sounds like I'm describing







NO POSTAGE  
NECESSARY  
IF MAILED  
IN THE  
UNITED STATES

### BUSINESS REPLY CARD

FIRST CLASS PERMIT NO. 47, DEER PARK, NY

Postage will be paid by addressee



Mail to:  
**The Sound Engineering Magazine**  
Sagamore Publishing Co.  
1120 Old Country Road  
Plainview, New York 11803



# Free Information Service

To receive manufacturer's information about products advertised or editorially mentioned in this issue.....Circle the numbers on the card to correspond with the key numbers at the bottom of the advertisement or editorial mention that interests you.

- |    |    |    |    |    |    |    |    |    |     |
|----|----|----|----|----|----|----|----|----|-----|
| 1  | 2  | 3  | 4  | 5  | 6  | 7  | 8  | 9  | 10  |
| 11 | 12 | 13 | 14 | 15 | 16 | 17 | 18 | 19 | 20  |
| 21 | 22 | 23 | 24 | 25 | 26 | 27 | 28 | 29 | 30  |
| 31 | 32 | 33 | 34 | 35 | 36 | 37 | 38 | 39 | 40  |
| 41 | 42 | 43 | 44 | 45 | 46 | 47 | 48 | 49 | 50  |
| 51 | 52 | 53 | 54 | 55 | 56 | 57 | 58 | 59 | 60  |
| 61 | 62 | 63 | 64 | 65 | 66 | 67 | 68 | 69 | 70  |
| 71 | 72 | 73 | 74 | 75 | 76 | 77 | 78 | 79 | 80  |
| 81 | 82 | 83 | 84 | 85 | 86 | 87 | 88 | 89 | 90  |
| 91 | 92 | 93 | 94 | 95 | 96 | 97 | 98 | 99 | 100 |

January / February

Please type or print Card expires four months after cover date of issue.

Name \_\_\_\_\_

Address \_\_\_\_\_

City \_\_\_\_\_ State \_\_\_\_\_ Zip \_\_\_\_\_

# Free Information Service

To receive manufacturer's information about products advertised or editorially mentioned in this issue.....Circle the numbers on the card to correspond with the key numbers at the bottom of the advertisement or editorial mention that interests you.

- |    |    |    |    |    |    |    |    |    |     |
|----|----|----|----|----|----|----|----|----|-----|
| 1  | 2  | 3  | 4  | 5  | 6  | 7  | 8  | 9  | 10  |
| 11 | 12 | 13 | 14 | 15 | 16 | 17 | 18 | 19 | 20  |
| 21 | 22 | 23 | 24 | 25 | 26 | 27 | 28 | 29 | 30  |
| 31 | 32 | 33 | 34 | 35 | 36 | 37 | 38 | 39 | 40  |
| 41 | 42 | 43 | 44 | 45 | 46 | 47 | 48 | 49 | 50  |
| 51 | 52 | 53 | 54 | 55 | 56 | 57 | 58 | 59 | 60  |
| 61 | 62 | 63 | 64 | 65 | 66 | 67 | 68 | 69 | 70  |
| 71 | 72 | 73 | 74 | 75 | 76 | 77 | 78 | 79 | 80  |
| 81 | 82 | 83 | 84 | 85 | 86 | 87 | 88 | 89 | 90  |
| 91 | 92 | 93 | 94 | 95 | 96 | 97 | 98 | 99 | 100 |

January / February

Please type or print Card expires four months after cover date of issue.

Name \_\_\_\_\_

Address \_\_\_\_\_

City \_\_\_\_\_ State \_\_\_\_\_ Zip \_\_\_\_\_



NO POSTAGE  
NECESSARY  
IF MAILED  
IN THE  
UNITED STATES

### BUSINESS REPLY CARD

FIRST CLASS PERMIT NO. 47, DEER PARK, NY



Mail to:  
**The Sound Engineering Magazine**  
Sagamore Publishing Co.  
1120 Old Country Road  
Plainview, New York 11803



the pecking order to be found in any Madison Avenue ad agency, so be it. The truth is, the creative artist must be a businessman, and if he ignores the mechanics of what makes businesses work, he may as well take his creativity to a desert island where it can't get in the way of reality. It would be a foolish omission not to say right here that politics exists in this business as it

these things happen, where a lot of money is involved...we're talking ten million dollars or more per picture...you realize that there must be something very correct about the structure. So when they hand a film or a series over to you as a composer you have an enormous responsibility, even though that budget may have shrunk to a shadow of its former self by the

this trend. It gets a hold of innovations first. As soon as manufacturers come out with equipment, they seem to be here before they're anywhere else, except perhaps Japan itself. Before it gets to all the art centers, let's say New York even, they're here, and they're being used, tested and critiqued. Out here you really do feel that you're in the center of something active, something innovative and exciting.



David Kurtz at work

does everywhere else. There are definite hierarchies, and you can't rationalize this or you'll just frustrate yourself. You must learn what these patterns are, recognize the structure, and deal with it. When I first came out here I had trouble handling all this, of accepting it conceptually, but the good thing about it all is that *it works*. It's a system of conventions that allows things to get done, and allows determined people to rise.

When you're lucky enough to get the opportunity, and you've let the politics work for you instead of against you, and everything works out, that's when you have to make music. I don't want to give anybody the impression that music is secondary, for it's not. But there's a lot you have to do to scramble until you get to the point where you're given the opportunity to deliver, but when you get there it's only the music that counts. That's why I appreciate the way the system works, where you have to respect the various hierarchies through which your work must pass.

When you think of the top names over the years who have been making

time you are brought in. Still, part of your talent is to take what you're given and make it work.

"Trying to make it work" is partly what led me into using electronic music in my scoring, even before I had my own studio. Because of budget restrictions, I was supplementing my sound with synthesizers just to round it out, to give it fatness. I never planned to use synthesizers necessarily for their own distinctive electronic sound, but rather to augment the several traditional instruments which the budget would allow. However, I was led, through a fascination with these sounds, into the use of synthesizers as the sole source for the entire score, providing it fit in with all the other elements: the time period of the script, the mood of the dialogue, the intended tensions, and so forth.

**db:** There's a difference between the synthesizers you were first combined with and the computerized music you're doing now. How did you bridge this gap?

**DK:** There wasn't much bridging to do. Since I had moved to the west coast I couldn't help but be aware of

**db:** Let's follow an assignment from beginning to end. What happens?

**DK:** Your first task after being hired is to "sit down and spot" the picture with the film editor and the producer (or whoever he has delegated to represent him here, perhaps the director). This is a meeting whereby it is determined when and where in the film music will be used. They may give you a script to read beforehand, but I don't like to do that. I prefer to see a picture fresh if I can. I find that it doesn't matter how the script reads anyway, because the music should not only *represent* the story, but it should *fit in* with the style of the movie. *Romeo and Juliet* set in Shakespeare's time probably should have authentic instruments of that time, but if you're doing a modern-day version you might want to have a rock score.

So it depends on the film's intended style as to how you'll handle the music, and I get that from seeing the film, not reading the script. That's particularly true today when so much is influenced by MTV. But sometimes a producer says to you, "Read the script and give me your impression," so that's exactly what you do.

**db:** Well, what is that?

**DK:** When you get the assignment you go to a screening room and begin your spotting session, which can last from an hour to a few days, depending on several things—how important the music is to the picture, how much the producer is willing to leave to the composer, and so on. By the time you get to the spotting session you should be involved only in music; most of the sweat and tears and political tightrope walking used in getting to this position should be behind you. Here we screen the picture, and the producer, who has been living with this now-edited film for weeks or months, will tell you where he has envisioned the music to be. When a producer says to you, "I want the music to begin here and end there," you'd be well-advised to agree as much as possible if you are new to

the genre, *particularly* if he says "I 'I want." Now, if he says "I think," that's another matter, you should feel free to jump in with your own input.

As you become more well-known in town and build up your credits you can become more adventurous, but I would strongly recommend to someone who's new at the game to be ready to lay back and do a lot of intelligent listening during these first spotting sessions. Don't worry, if a producer's open to your input right at the onset, you'll know it by the way he responds to you. That's when you come out with your ideas and opinions. It's been my observation that many producers want you to speak up, at least to some extent, for he's hired you for your musical expertise, out of respect for what you know. Secondly, as already stated, by the time of the spotting session he may be too close to the picture to see it with a fresh eye. If it's a feature, he may have been on this thing for two years...he knows every frame, he knows everyone's contract by heart, he even knows what the flowers cost in the first scene. So, by the spotting session, he may show that he does indeed welcome your ideas. You just *feel* this as you go along; it's part of the protocol I mentioned earlier.

A television series, in contrast to a feature film, has its own way of doing things, its own *protocol*, if I may say that once more. If you're lucky enough to be involved in the pilot (that first episode which the producers use to show the networks and the networks use to feel out the viewers), the musical style is set at that time by the person who composes the theme.

Now, if you aren't involved in the pilot but if you come in later to do the background music for subsequent episodes, by and large, you are expected to stay within that musical attitude. So when you go into a spotting session for a TV series it goes very quickly, for there's a certain amount of routine to it. If you listen to a lot of TV underscores you find that much of it is based around the theme, a practice that's worked well for years, although even that seems to be changing.

**db:** In the spotting session there's you, the producer, and the editor. What does the editor do?

**DK:** The editor works with the composer very carefully to ensure that his intentions reach the screen. Although he's hired by the producer, sometimes the producer will ask who you want as editor. Except in general

terms, the producer doesn't deal with the film editor, the composer does that. The editor is your right hand. Or to put it more bluntly, he can save your neck so be nice to him. If you don't hit it off with the editor, your life can become very difficult.

**db:** But if you, as composer, are instrumental in selecting the editor, I'd think there's no way he's going to make life miserable for you.

**DK:** To some extent this is true, but this arrow points in both directions no matter whose authority prevails. The handling of your music, the way it's inserted into the film, is such a delicate procedure, so involved with technical know-how and value judgements, that a rapport with your editor is crucial. Avoiding communication problems with this person is not only part of that unspoken protocol I mentioned, but it's excellent insurance that your project will not go astray. In your own head you may be very clear on your musical idea, but you have to make sure that the editor can pull it off, and he *can* if you never lose that meeting of the minds.

The music editor's first function is to note the footage at the points where music is to be inserted, and break down" the film into segments (of so many feet, or so many seconds) where action to be scored is taking place. Take, for example, a car chase, a car skids around a corner...where does that happen? Okay, it happens at 23.7 seconds into the picture. A guy jumps out of the car and is shot...where in the film does that happen? If these are things that you want to emphasize musically, you've got to know where in the film it is and how long it lasts. The editor takes care of this, he figures out footages and timings to those spots where you decided that music will come in or go out. He gives you these notes, and you then go to work writing your music.

You decide such things as, what tempo you are going to use in these cues. Then you compose within the limits of the medium, to make your sounds "hit" at the right spot. You're always working within the confines of the picture; you're not just writing music for the purpose of hearing music. You're subservient to what has already been done with the product; you're not making phonograph records here.

**db:** Once the music is composed and copied, are you now ready to conduct the orchestra on the scoring stage?

**DK:** Not yet. Before I can conduct

the orchestra while watching the movie roll by on a giant screen in the back of the room, I have to go back to the editor and tell him what I need in order to do this. As the editor puts the film back together in the proper order, he takes my notes and adds certain visual cues to the film which will alert me to those points where music should come in or go out. These lines will move across the screen as I conduct and are called streamers; of course they are never seen in the final product. Also, since I am wearing earphones as I conduct, the editor puts "clicks" onto the soundtrack at certain spots that will appear in my earphones, which are carefully timed tempos that I have worked out from his earlier notes. Thus, I know that I am starting at exactly the right place, that I'm conducting in exactly the right tempo, and that all musical parameters will match the action. After all this music has been recorded on sprocketed tape called mag-stripe. The editor takes this tape and physically cuts it into the picture alongside other mag-stripe tapes containing dialogue and sound effects.

**db:** Is the editor a musician, as a rule?

**DK:** The best ones are, although it's not an absolute must. Many have a natural feel for the work without musical training. One of my big breaks came from working on an important musical where the editor who started the film did not read music. The film was quite complicated musically and they needed someone to assist him with certain matters, for the composer/conductor Ralph Burns was busy elsewhere. Since I was working for Burns (and Columbia Pictures) as a copyist at the time, they assigned me to assist the editor in any way I could. This is what I meant earlier by being on the scene; you take whatever job you can get just to be there when an opportunity pops up.

Before being a copyist I was a proof-reader, where my job was to check for any errors the copyist may have made; before that I was a scoring stage assistant where I would run copies back and forth from the copyist to the stage, make clean copies when coffee was spilled, and generally be useful. The point is, you want to be on the scene. I believe it's far better to have the lowest job in your chosen field, even if it's just cleaning coffee cups for starvation wages, than to have a better-paying job, however temporary, in some other field as you wait for the big break.

# Live With The Dead



• Dan Healy has been the Grateful Dead's sound engineer since the band's inception nearly twenty years ago. Over the years he has become known as an innovator in the field.

Working with Don Pierson of Ultrasound, Dan has come up with a multitude of new techniques and innovations. They have also put together what has been called the "largest touring system" to ever be used which includes Meyer Sound Labs cabinets set up in an array that is designed

by computer.

Another new technique being employed by Dan is the use of a Bruel & Kjaer FFT analyzer in conjunction with MSL parametric equalizers and a computer. This new system is still in the R&D stages, but Ultrasound and the Grateful Dead held a press conference late last year to demonstrate it in action.

Before the Grateful Dead's concert performance at the Meadowlands/Brendan Byrne Arena, Dan and Don demonstrated how the system oper-

ates. It provides virtually flat frequency response in just about any room because it actually reads the room.

During the concert, it was apparent that all of Dan's work is well worth the effort. The sound was nothing short of amazing. It was extremely loud and clear which is quite an unusual occurrence at a rock concert. The system seemed to only be running at fifty or sixty percent capacity, yet my pant leg shook with each beat of the kick drum. A quick walk around the arena proved this to be the case everywhere. The system was extremely flat and even, and the clear, powerful sound travelled to the rear of the arena without much degradation.

Watching Dan mix was also amazing. He did not stand still for one mo-

*Our resident live sound mixer, Ed Learned, spoke to Dan Healy at the end of the Grateful Dead's 1985 tour. The intro. for this article was written by db's technical editor, Sammy Caine*

ment. He has been called the seventh band member, and watching him in action is proof of the claim. He interacts with the band from the mix position, and even throws in some sound effects when he feels the time is right. Dan is also in constant communication with the band members on stage.

When meeting him, it's apparent that Dan is both happy with his work and willing to share his developments and techniques with other sound engineers. In fact, when his computerized equalization system is complete, he hopes to see other sound engineers use it.

**db:** Tell us a bit about Ultrasound, which was your p.a. company for this past tour.

**DH:** Ultrasound is owned by Don Pierson and Howard Dancheck. They are long-time San Francisco audio guys, kind of in the same "school" that I'm in. There was kind of a consortium—John Meyer, Don, Howard, John Curl, and myself—that spent the last twenty years comparing notes on audio, and at various times we've all worked on projects together in different groups. Ultrasound is basically a p.a. company that is a holding company for some modified Meyer stuff that the Grateful Dead and I use when we tour.

**db:** Does Ultrasound service other accounts besides the Dead?

**DH:** The gear is available for use when we're not on the road, but essentially it's pretty much the Grateful Dead sound system. We've modified the Meyer stuff quite a bit for Grateful Dead applications, and have top priority on its use. Ultrasound couldn't do, say, a Starship tour in its entirety because of eventual overlapping dates with the Dead. So, aside from casual gigs, that system only gets used for us.

**db:** Much has been written about Meyer loudspeakers, electronics and enclosures. What do you feel are their biggest advantages over conventional designs?

**DH:** The Meyer system is really the only system that is kind of servo controlled. Essentially, you've got your speaker cabinets and the power amps that drive them. Before the power amps is a box called the processor. This processor contains the crossover, and also incorporates time and phase correction for the crossover. If you add up all the crossover outputs, it will reproduce square waves and stuff. It's

very accurate with respect to time and phase. Another advantage is resonant damping. You take a sample off the speaker or the output of the amplifier, and feed it back into a side port on the processor. This allows the processor to sense for resonant nodes in the speaker cabinets, and provide damping and amplitude adjustments to correct for these cabinet resonances. As the cabinet goes through resonant modes, the processor senses the rise in impedance and voltage and causes an averaging of the levels, so you don't get resonances.

**db:** Do you see any "trickle-down" of these ideas into the rest of the sound industry?

**DH:** Not really. I have noticed that some of the current guys are into time correction of the crossovers—that is, time alignment. But nobody is doing phase correction of the crossovers, and nobody is doing damping of the resonances of the cabinet. That stuff is quite different, and really stands by itself in the industry. There's a lot of pros and cons to these ideas; all I can tell you is that I've been doing this stuff for twenty-two years, and I've gone through a lot of different systems. This is the most accurate yet. I'm sure that you and some of your reading audience are familiar with some of the past trips that the Grateful Dead sound system has gone through. The '74 to '76 system, the huge breadboard system euphemistically called the "Wall of Sound," was sort of the forerunner of what Meyer is doing now.

**db:** How did that evolution take place?

**DH:** In 1976, the economy sort of bottomed out on us, with the gas crisis and all. It became prohibitively expensive for the Grateful Dead to personally continue the research we were doing on sound systems from '68 up until that point. It got so we were playing eleven months a year, broke all the time, and we were slaves to the sound system—it wasn't fun to play anymore so we decided to get out of the p.a. business and just concentrate on playing music.

At that point, John Meyer got various investors and backers, and continued on with our research. It's where we were headed all along, and now we're seeing its results.

**db:** Can you comment on some of Meyer's elaborations to the Dead's basic research?

**DH:** One of the problems Meyer ran into was inconsistency in speaker

manufacturing. If you buy 200 12' speakers from JBL, put them in a test jig and sweep them out, you'll find that they're not the same. The gap would vary tremendous amounts, the glue and paper densities would vary. He believed that if speakers were all off in the same way, than a single correction for one would work for all, sort of a quantum correction theory. However, Meyer found the speakers so different that a single correction wouldn't work. Then he went to JBL to see if they could build speakers to his specifications, and they said forget it. They were selling speakers faster than they could make them, and didn't care, which unfortunately is kind of the American attitude. So he went to Switzerland and found a speaker manufacturer that was willing to build speakers to immensely tight specifications, so that 200 12' speakers would be identical, allowing the quantumized correction theory to work.

This went for the 15' and 18' speakers and the mid-range horn drivers as well. Also, this same concern for consistency is extended to the construction of the speaker cabinets themselves.

**db:** The Meyer speaker system, without its processor, doesn't have the greatest sound. Does this mean that the speakers themselves require electronic compensation to sound good?

**DH:** Not at all. You can just go buy them and stick them in a guitar amp, like a Twin Reverb. If you don't want to, you don't have to use them with a processor. Due to the manufacturing tolerances, what you basically end up with is a better speaker. (Bob) Weir plays his guitar through them without a processor. Phil (Lesh), however does use a processor on the Meyer 15s and 18s that he uses for his bass rig. It linearizes the speaker system, particularly down in the lower frequencies. Phil tends to like a real clean sound, and I must say it really is (clean). Weir likes a more raspy sound, so he doesn't bother to smooth it out. In the case where Bobby uses the speakers, it would be no different than the way you'd use a JBL or some other speaker.

**db:** You used quite a large number of Meyer cabinets on this past tour. What exactly did you take with you, and how was it divided between flying and ground support, if at all?

**DH:** I carried 112 MSL-3 cabinets and thirty-two 650 subwoofers as a total speaker complement. I hung everything—I didn't split it up. I know

there are guys who fly some and leave some on the ground. I don't do that because it creates point-source distortion and phase problems.

**db:** I agree with you. My biggest complaint about splitting the p.a. up and down is that it's very difficult to align flying and stage support stacks to maintain time alignment.

**DH:** You can't really successfully do it. It might look good on paper, and it might be easier to set up that way, but when you measure it you find that it just doesn't work well. In big halls I fly everything; if I do stack the p.a., then I stack everything. I don't mix it up, because timewise, it's impossible to correct it out and stuff—no matter where you are in the house there are deficits.

**db:** Yeah, not to mention the combing you hear when you move from place to place.

**DH:** What I do instead is hang clusters of them. In the case of the average hockey hall I use usually about twelve cabinets wide by three cabinets high. Sometimes I might have a row of six or eight wide for lower rows. I usually get an architectural drawing from the house, or if one isn't available I generate it myself. We then plot the sound system coverage, because we know the vertical and horizontal dispersion of each cabinet, and we also know the collective effect from arraying them. With that knowledge and an architectural diagram, we literally plot the sound system in the room so that it covers every seat in the room with as close to even frequency amplitude as you can get. That's what everybody does when they hang their system, but I don't know how many companies take the time to generate a scale drawing and really adjust the arrays so it applies itself specifically to that room. Our setup can change radically from show to show if the room changes. We don't have a general hanging package that we hang wherever we go.

**db:** ...which we both know happens all the time!

**DH:** Yeah, but that's a little too loose for us. If you're going through all the trouble of servoing the equipment, going through all the changes we're going through to really clean it up, and you turn around and arbitrarily throw it up in a room, well, you've sort of defeated yourself, right?

**db:** Absolutely.

**DH:** The thing is, once you've launched yourself onto the trip of extreme attention to detail and quality, you find you can't let down anywhere

along the line. If you drop the ball anywhere, you lose everything you've put out in the other areas. You have to do it right from the design of the equipment clear on down to how you set it up in the room and use it. That's reality; anyone who is interested in doing superior sound work will have to come to grips with that sooner or later.

**db:** How do you adjust your flying speaker arrays for the plotted coverage when they're in the air?

**DH:** We use multiple points in the hall, with independent chain motors attached not only to the top of the flying arrays, but to the sides and bottoms as well. By using the chain motors in proper sequence, we pull the bottoms up and the sides in, the physically pull the arrays into the shapes that we want.

**db:** How do you handle center-fill requirements without the use of ground-support p.a.?

**DH:** When I fly, I attach MSLs to the bottom of the arrays that are pointed straight down and slightly in. The near-center area is covered directly from the main arrays by these speakers, insuring consistency in point-source. If it's ground-support in a big outdoor place, where the stage is real wide and the p.a. is really far apart, I might use a cluster of UPAs for center-fill. I build a small riser between the stage and the barricade, and place this in the middle. I use four to six UPAs, stacked on this riser with the tops of the cabinets even with the stage.

**db:** So your speaker complement also includes some UPAs?

**DH:** I always carry about a dozen with me on tour. I use them for lobbies, delay systems, even rearfill when we play hockey halls where seats are sold behind the stage.

**db:** Your speaker complement of 112 MSL-3s and thirty-two 650 subwoofers creates a ratio of 3.5 MSLs per subwoofer. What do you feel is a standard ratio for matching MSLs to 650s?

**DH:** As a rule of thumb, one subwoofer for every five MSLs is sufficient. Let me go into detail on this a bit. If you're only using five MSLs I wouldn't say that, but if you're using more than twenty MSLs I would say that. When you stack up the subwoofers, you begin to appreciate the mutual coupling of them all, you begin to gain efficiency and low-end response as your array gets taller and taller. I usually use sixteen 650s in the average hockey hall, but for Brendon

Byrne I used all of them. I had the full thirty-two in there, which is twice as many cabinets as I normally used, but I had four times as much low end. I had to run the bass 6 dB below the MSLs, where I normally run them at unity.

**db:** When you looked at it on the analyzer before system EQ and level changes, what was the dB difference?

**DH:** Forty Hz was 14 to 16 dB above 1 kHz. I had a lot of low end between 80 and 100 Hz. I have separate drive capability for my sub-bass cabinets. What I do is first turn everything on at unity and then look at it. In the case of the 32 subwoofers, I had a horrendous amount of low end, more than I needed. So, I just turned it down until it was sort of in the ballpark, and then I set out equalizing it.

**db:** What sort of console were you using?

**DH:** I used a Gamble console, which was custom built for me. Ultra-sound owns it; we also used a Gamble monitor console on stage. I worked with Jim Gamble on the design of it; it's built specifically for p.a. production mixing. It has eight effects sends, 3-band parametric EQ on each input, and all the typical stuff. It has real clean specifications; a lot of it is direct-coupled, so we've eliminated a lot of capacitors from the audio path. It's really clean, quiet board with low distortion and crosstalk. On the output side it has eight stereo sub-masters into a stereo master output.

**db:** After the console comes the equalizer. What type of EQ were you using?

**DH:** We came out of the board, in stereo, and went into two 25-band equalizers. These were special parametric equalizers that we designed and Meyer built. Now he manufactures them and anybody can buy one. I prefer a parametric for equalization, because one of the flaws in 1/3-octave equalization is that you're stuck with the frequency. Quite frankly, most of the time the center of peaks and stuff doesn't coincide with the fixed frequencies of 1/3-octave EQ. They're really sort of obsolete: it's a fixed frequency and a fixed width, and that's kind of useless when you're trying to pin down resonances and stuff. Our parametrics will go down to one tenth of an octave wide, and we usually use them in that narrow mode. It turns out, particularly with servoed speaker systems, that resonances tend to be real steep and narrow. We actually

pull these tall, narrow peaks out of the system, and because the EQ is parametric you can center it right on the frequency of the peak. These equalizers are also time and phase corrected: they self-correct via networks that deal with the time. That's another bummer with 1/3-octave equalizers. By the time you get all the equalization in it, you've reached diminishing returns due to all the phase distortion in the equalizer itself.

**db:** What's after the EQ?

**DH:** I go into a splitting network that feeds a series of line drivers. These are API modules: a balanced-input discreet opamp that swings 24 volts, so you can get +30 out of them. They make ideal line drivers. A pair of these feed the left and right MSL stacks, with another pair feeding only the left and right subwoofers.

**db:** How hot do you run the line drivers?

**DH:** I usually run them around +6, although that changes with size. At Brendon Byrne I found, due to the vertical array, that I had way too much signal. I wound up running around -4, and the low end was REALLY laid back; the whole system wasn't anywhere near clipping. I had a good 15 dB of headroom at any time during that show. I'm into headroom—I'm down on running a system full out. I usually use more gear than most people would at the same venue for that reason.

**db:** I couldn't agree more. Bring more, use it less.

**DH:** That's another one of my styles. The extra gear isn't because I run it louder, but because I run it cleaner. You tend to come up with a massive sound if you use more stuff; I don't mean in terms of overall volume, but in perception. It's like a feeling of clout or something—it fills the hall. One cabinet causing 100 dB at the booth versus twenty cabinets causing 100 dB at the booth; it's the same 100dB but the sound is considerably different as you can well imagine.

**db:** I think that it's just a case of more cone area moving more air.

**DH:** Right. I think that's what it is; it makes a room more alive. It also makes it easier to overcome the acoustical properties of the room: the echoes and other weirdness. The more you have, the more you can overpower problems. You literally have to brute-force the room, not necessarily in terms of volume, but in overall mass. I used my entire complement of speakers at Brendon Byrne Area. It was the first

time I'd used that many, and to the best of my knowledge it was the largest sound system ever used there in terms of power. Boy, I'll tell you, it gave that room a feeling of absolute ease of operation. The sound just poured out of the system. It was magnificent to hear, man; it'd blow you away to listen to that. You would really have gotten a kick out of it. But I'll do that again there. I laid for Brendon Byrne for two reasons: I never really felt that I'd nailed that building good, and second, I wanted to do something special in New York, where there's a large conglomerate of people like yourself who are colleagues in sound. I kind of wanted to set the record straight in New York; I was really happy with the results of what went down there. For what it's worth, we'll be playing some stadiums this coming summer, so I'm planning on taking an even larger system.

**db:** I think your success at Brendon Byrne was proof of your attention to detail. Speaking of which, you mentioned an interesting point concerning speaker arrays. I'm sure most companies are aware of the dispersion characteristics of their cabinets. However, some have no idea of the dispersion and frequency response changes that occur when these cabinets are combined in different arrays. No one seems to have thought about that.

**DH:** That's true. Actually, the majority of professional sound companies are much looser than you think; you don't really get a great sound. For instance, I used Claire's system between '76 and '79 before the MSLs came together. I actually had them send a group of S-4s out here to the coast to the Grateful Dead's shop. I set them up and did a serious study on what their gear actually did, not what they said it did. That testing suggested that I re'array their stuff, because they hadn't paid close attention to what happens when you combine cabinets in arrays. I had them build me special hanging gear, with bumpers and stuff, that enabled me to put the right tilts and angles between the various cabinets. This allowed me to minimize the combing effects and serious build-ups due to array problems. While I was never able to get it as tight as the Meyer stuff, I was able to improve on it a bit.

**db:** Were they concerned about your findings?

**DH:** Even changing the hanging arrays was like pulling teeth; they didn't

want to know about it. I don't think they wanted me to stir up a lot of controversy and look too closely at their gear. They wanted their gear to be considered good and left alone. I looked closely at it because my allegiance is to myself and good sound. After I made these changes, they began using them and, in fact, still use the designs of hanging and arraying that I developed from my testing. The Claire guys are good guys, and they try damn hard. I'm not trying to put anybody down or be judgemental; I look at myself as a scientist who is trying to get the best results I can.

**db:** Naturally, your allegiance should be to yourself and your client. My clients expect a certain standard of quality from me, and I'm always trying to ensure that they get it, no matter what it takes. I've got my subjective opinions about what's good, and so do you. We might differ, but I think that at the very least these different opinions ought to be heard.

**DH:** That's right. I think the more we can get together and talk about it, the more the industry and sound in general will gain from it. I'm not into hiding from each other and bum-rapping each other. I think everybody should pitch in—onward and upward for all of us is what I want to see.

**DH:** I think that's a healthy philosophy, no matter what business you're in.

**DH:** In the future, I think you'll see more readiness to embrace the new ideas. Claire's S-4 has been around for a long time, and they supposedly are looking at new designs right now. They've borrowed some ideas from Meyer, they're kicking around the idea of using processors and stuff. It's also true that Claire bought a bunch of speakers from Meyer for evaluation. They've recognized that you can get a lot closer to good sound with these ideas than without them. I feel that eventually the entire industry will lean in this direction, and that's good. I think that all these ideas should be spread around for everyone to use. It grieves me sometimes to see people being secretive and not sharing information, because I'm not that way.

**db:** Let me put it this way. I know from having done this a while myself that the secretive attitude you're describing was far more prevalent in the old days, when the people who were doing sound wouldn't tell you anything about what they did. Through sound magazines like *db* and *Modern Recording & Music*, the basic techni-



ques of sound reinforcement are much more in the public domain now than they ever were.

**DH:** It was a big clouded mystery thing. There was a lot of that hot-dog engineer stuff for a lot of years, where guys had their own secret formulas for things. I think that's bull. I've always shared every bit of knowledge that I've unearthed, and have tried to encourage sharing information. One of the things I am happy about is that guys like you and the magazines are making great efforts to go into detail about what guys like me are doing. When I was starting out, there weren't any magazines, so getting information was really hard. Remember what that was like? How long have you been doing this?

**db:** Counting my college days, this is the end of my fourteenth year.

**DH:** So you know what it was like. There never used to be all of this stuff. I think it's marvelous that there are magazines that are able to spread around new knowledge. There are a lot of young sound guys around now that have an advantage we never had. I think it's great, and I will always divulge anything that I've ever discovered to you guys for the purpose of sharing information.

**db:** Well, we'll take you up on that offer right now. You're currently involved with developing computer software that deals with room equalization. Tell us a bit about it, starting with gathering the data.

**DH:** We use one of those B+K fast fourier analyzers, which performs all sorts of transfer functions and mathematical functions. It really is an industrial piece of equipment; it's used to search for oil, or to test resonant structures like bridges and assess possible damage from wind, etc.. We've adapted it for use in the audio world, which it basically had the programs for, but for which we had to write different frequency parameters. It has two input ports; one of the inputs is fed from the console output, in real time. Into the other port we fed a calibrated mic that's located in the room. The analyzer does a comparison between these two, and gives you the mathematical differences, displayed in fourier forms or straight amplitude forms. As opposed to a real-time analyzer, it has a time domain which can be set for so many samples per second or samples per minute, and it will perform the mathematical transfer functions. This gives us a much more sophisticated set of data than a real-

time analyzer, which is where we were before.

**db:** Okay, you've now got the data from the analyzer. What are you going to do with it?

**DH:** We're going to take the data from this analyzer/computer, and we're going to feed it to another computer, probably an Apple Mac. We're working on a program for the Mac right now that will take the assessed data from the analyzer and convert it into decision-making capabilities. These "decisions" will then be fed to our Meyer equalizers, which will ultimately be voltage-controllable. The object of all this is to allow you to walk into a room, turn on the sound system, put some noise into it, enable the program, and the system will sweep itself out for you.

**db:** So basically what we're talking about here is a program that will allow you, through automation, to have the house equalization controlled for the optimum response, whatever that happens to be. I take it this can be continually done, even during the show?

**DH:** You've got the right idea. It will be able to noise out the system, but also be able to compensate and update in real time during a show. It will also be surprisingly accurate. It takes into consideration barometric pressure, humidity, and temperature. It's a very complicated program: there are a lot of things involved in it. It's also applicable to the monitors, by the way.

**db:** How far along on the R+D are you?

**DH:** This program idea was the gist of what that press conference in New York was all about. We had one channel of it working on a breadboard temporary basis, just to show that it worked. That was only a basic test to prove the theory. Now what we're doing is going back and actually writing the program. This is a Grateful Dead project; we have three professional programmers working on it. It's really quite complicated; there are quite a large number of variables to consider. But we're on the case and headed for it although it could take as much as a year to get it up and running. There aren't too many other people doing this. Do you know of White equalizers?

**db:** Sure.

**DH:** They're now deriving a set of filters that are voltage controllable. So far, though, their equalizers are not time-corrected, so while they would be suitable for us, they don't have the

distortion characteristics that are as fine as we're looking for. We're trying to do all of this without losing the time and phase correction that we've acquired along the way.

**db:** As far as the software is concerned, what do you feel is the major parameter that the program will look at?

**DH:** The crux of the matter is going to be its ability to take the amplitude response data from the B+K analyzer and be able to make quantitative decisions. The hard part is teaching it how to respond when it "hears" a certain frequency at a certain amplitude; how far will it take that frequency down? Because most of that is voicing—just plain old flat isn't necessarily good enough. You have to taper it to the room. The problem isn't getting the equalizer voltage-controllable or getting data from the analyzer; it's getting the computer to make wise decisions.

**db:** Where do you feel the optimum measuring point for your microphone will be, or will you use a series of mics and go for an average sample?

**DH:** I am multiplexing mics, using a multiplexing device that I built that basically samples and switches back and forth between three different calibrated microphones, which are B+K calibration mics with 1/2 inch capsules. They're at the mix point, about three feet apart. The analyzer has its own delay built into it that is user adjustable. Through pulse and time response, I delay the mics in the room so they only "see" the equivalent time frame of what's put into the console. The analyzer is able to ignore anything that's before or after that, and is able to reject a whole lot of useless information. You adjust it to a time window.

**db:** That makes the location of your mix point critical.

**DH:** I go to extreme lengths to get that, too; it's measured off and all that stuff. I'm incredibly picky about that. I mix in the center, 85 feet from the stage indoors and 125 feet from the stage outdoors. If you mix from the center one day and the side the next, then you'd have another set of dual information to deal with. You try and eliminate any differences from show to show that you can, in hopes of winding up with the most consistent set of information each time. ■

# People, Places...

- **David Bowman** has been selected to fill the newly created position of director of professional dealer products at **Studer ReVox America, Inc.**. At his new post, Bowman will assume primary responsibility for the marketing of all Studer ReVox professional audio products sold through the company's pro-dealer networks. Bowman will also be responsible for coordinating government sales. Bowman comes to Studer ReVox after seven years of service at Electro Sound of Sunnyvale, CA.

- **Kelly Quan**, former software engineering manager of **OTARI Corporation**, has left OTARI to start his own company—**Kelly Quan Research**. **KQR** is a micro-computer consulting service for the professional audio, video, and broadcast industries. It also includes Kelly Quan Recording, a world-class 24-track recording facility for use as a test facility for the company's work.

- **Eastern Acoustic Works, Inc.**, manufacturer of professional loudspeaker products, has announced the appointment of three new independent field sales representatives. According to Frank Loyko, EAW's vice president of marketing, "This is the first step in our expansion program to broaden EAW's market base. Throughout the first quarter of 1986 we will be moving very strongly into some of the more geographically distant markets." **Pro Tech Marketing** has been appointed to represent EAW in the southwest market. Pro Tech's principals are Bob Prideux and Hector Martinez, and will cover the California, Arizona and Nevada states. **Fleetwood Marketing** has been appointed to represent EAW in the midwest market. Fleetwood's principal is Rick Parent and will cover Michigan, Illinois, Wisconsin, Iowa, and Minnesota. **World Wide Electronics** has been appointed to represent EAW in Florida. World Wide's principal is Bob Gale.

- **Charlie Winkler**, former marketing director of the **Audio Technica** professional products division, has resigned to form a professional sound products sales representative firm, **Charlie Winkler & Associates**. He will work from Uniontown, Ohio, with dealers and distributors in Ohio, Pennsylvania, and West Virginia.

- **COMSAT General Corporation**, a subsidiary of COMSAT, has established a new public and media relations office under the direction of **Judy D. Blake**.

- **Conrac Division**, a leading manufacturer of video display monitors for the computer, broadcast, and medical imaging industries, has appointed **Ralph Semyck** to the post of midwest regional sales manager. A sales engineer with Sony Broadcast Corporation for the past five years, Semyck also brings four years related sales and technical experience to his new position.

## & Happenings

---

### Compact Disc Plant A Capitol Idea

- **Capitol Industries, EMI, Inc.**, and **EMI Music Worldwide**, announced that Capitol will set up a compact disc manufacturing facility in Jacksonville, IL. Production is due to begin in the fall of 1986 with an initial annual capacity of seven million compact discs. The CD operation will be situated alongside the company's manufacturing and distribution activities at that location. Capitol is the first major US record company to announce plans for commissioning a CD plant independently.

- **TekCom**, one of Philadelphia's professional audio dealers, has recently completed two audio installations including an upgrade of the house sound system in the world-renowned Academy of Music and a sound reinforcement system for the new cabaret in the

Trump Castle in Atlantic City, NJ. Both systems are based on EAW loudspeaker products.

- Classical music label **Telarc** recently completed an extensive sound system upgrade utilizing **Monster Cable** professional cables and acoustic controls in both its in-house and mobile studios. As a classical label, Telarc does its recording on location and then edits the tapes at its main Cleveland, Ohio-based facility. The current retrofit enables the company to fulfill all the requirements of sound production and post-production. Pro-link Series 1 super high-resolution cable and Interlink Reference interconnect cable link all of Telarc's equipment—from the microphone lines, to the master recorder, to the editing machines.

- **Studioline Cable Stereo**, a nationwide supplier of premium music pro-

grams to cable systems, has purchased a total of forty-eight Studer A810 audio recorders for use in the company's main production/origination facility in Reston, Virginia. The Studer recorders will be used for production of program master tapes as well as for playback direct into the system.

### Tandberg Is Reorganized

- **Tandberg of America, Inc.**, the US distributor of Norway's Tandberg electronics and tape recorders, has been reorganized as **Tandberg Audio**. This reorganization brings American management and marketing skills together with the European company's highly regarded engineering and production capabilities. One of the initial benefits of the reorganization will be an expansion of the existing line of high fidelity products, while maintaining Tandberg's position in the industry.

## TWELVE INPUT CHANNELS UREI BROADCAST CONSOLE

• Radio and television stations can handle up to twelve simultaneous program sources with the UREI 1690 Broadcast Console Series, which includes three different models that offer a choice of mixer controls. The model 1691 is available with rotary conductive plastic attenuators; the 1692 is available with Shallco precision stepped rotary attenuators; and the model 1693 features Penny & Giles straight-line attenuators. The signal-to-noise ratio of the microphone channel, from input to console output, is more than 74 dB with -50 dBm input and +4 dBm output, or more than 90 dB referenced to maximum output. At the full output level of +24 dBm into 600 ohms, the THD of both Program and Audition channels is less than 0.25% over the range of 30 Hz to 15 Hz. Each mixer position has two inputs selectable with a rocker switch. In addition, three banks of four push-button switches may be connected to any mixer input for use with additional sources such as remote or network feeds. An overload indicator LED is located between the VU meters and its threshold can be internally adjusted to alert the operator

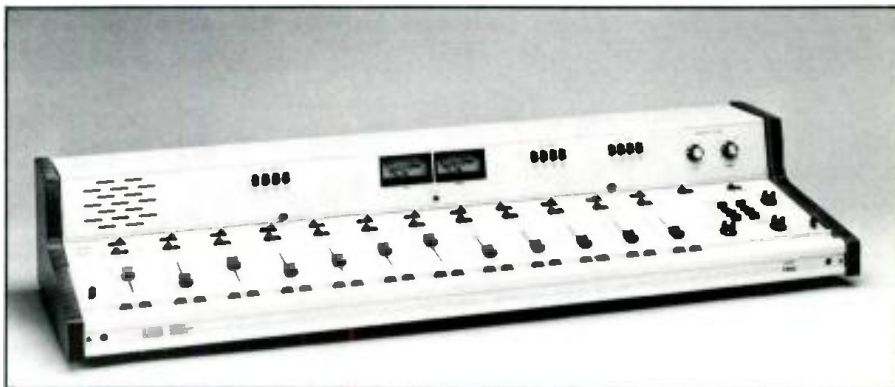

that a downstream device, such as an STL, may be clipping. All channel On/Off switching is performed by FET switches activated by illuminated push-buttons. These push-buttons have extra switch contacts which may be used for activating cartridge machines, turntables or similar equipment. The 1690 Series Consoles are supplied with one monaural transformer isolated microphone input preamplifier and eleven stereo line input preamplifiers. A four-position push-button selector connects Program, Audition, Air or an external input to an internal 8 W stereo power amplifier. Another four position selector sends Program, Audition, Air, or Cue to an internal 1 W amplifier and two

stereo phone jacks, one on either end of the console front edge, so that operator preferences can be accommodated. A cue loudspeaker with its own 1 W amplifier is built in and is automatically muted whenever Mute Bus 1 is activated. For those broadcast stations that require mono monitoring for internal or external use, an optional mono sum output card is available that will allow a mono sum output from any of 1650, 1680 or 1690 Series stereo consoles. *Mfr: UREI/JBL Professional*  
*Prices: 1691: \$6,496.00;*  
*1692: \$6,776.00;*  
*1693: \$6,996.00.*

Circle 40 on Reader Service Card

## ASHLY NOISE GATE

● The Ashly SG-33 Stereo Noise Gate is a versatile two channel noise reduction system, requiring a single rack space. Designed to control leakage and background noise in recording and sound reinforcement applications, and acting like a level-sensitive "switch," it automatically attenuates audio signals which fall below a user selected threshold. The SG-33 features extremely fast attack time, and a 60 dB threshold range. Inputs and outputs may be used as balanced or unbalanced, and a stereo patch is provided for accurate track-

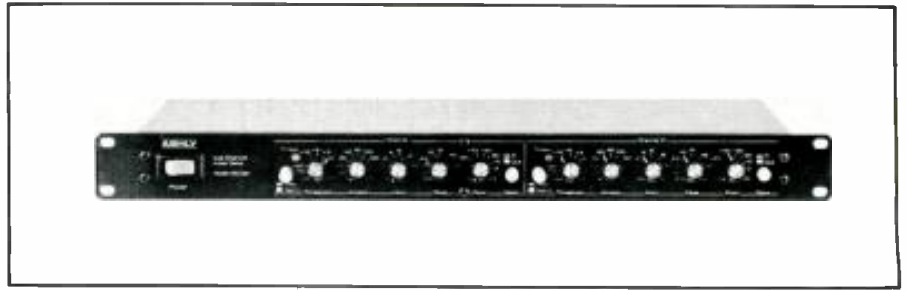

ing of two or more gates. In/out bypass switching for each channel is provided on the front panel, along with the widest range of adjustments available on any gate, including: thres-

hold, attack time, hold time, fade time and floor.

*Mfr: Ashly Audio, Inc.*

*Circle 41 on Reader Service Card*

## SONY DASH RECORDERS

● The Sony Professional Audio Division's PCM-3000 series DASH 1/4-inch format digital audio recorders include the PCM-3102 and PCM-3202 2-track recorders. Both use the Digital Audio Stationary Head standard agreed upon by Sony, Matsushita Electric Industrial Co. Ltd. and Willi Studer AG. The format provides for 16-bit linear quantization and switchable 44.1 and 48 kHz sampling frequency, for a dynamic range of over 90 dB with frequency response within +0.5 and -1.0 dB from 20 to 20,000 Hz. In addition, both machines shared advanced features that bring the sonic attributes of today's digital systems to a familiar, easy-to-use open reel format. Each employs a multiple channel system that provides time-aligned analog audio track for razor blade editing, and a track for time-code from an on-board SMPTE/EBU generator/reader. An automatic chase/lock synchronizer is also included. Tape transport functions are controlled by a 16-bit microprocessor and include MVC, auto-locate, repeat, +/- 12.5 % vari-speed, and a variable spooling safeguard that protects the master while the machine is in FAST FORWARD or REWIND. Extensive interface capabilities are also built into the PCM-3000 series. Outputs are provided for AES/EBU and PCM-1610 digital standards, and both recorders contain serial and parallel machine control ports, providing for upward compatibility with a future unified studio bus. The PCM-3102, designed primarily for long playing applications, runs at 7 1/2 ips, providing three hours of con-



secutive RECORD and PLAYBACK with 12-1/2-inch reels. The PCM-3102 provides for playback to the DAE-1100 electronic editor. The PCM-3202 operates at 15 ips and also provides for playback to the DAE-1100. It offers up to 1-1/2 inch reels. The PCM-3102 and PCM-3202 can be supplied by Sony

in configurations for rack, console or table top mounting.

*Mfr: Sony Professional Audio Division*

*Prices: PCM-3102 \$17,000.00  
PCM-3202 \$20,000.00.*

*Circle 42 on Reader Service Card*

## AUDIO TECHNICA MICROPHONE

• A phantom-powered unidirectional condenser microphone, the ATM33R, is a Lo-Z (150 ohms) model recommended for recording uses. It is also useful, as well, in broadcast and sound reinforcement applications. The response of the ATM33R, which covers a frequency range of 30-20,000 Hz, is described by the microphone's designers as being smooth overall, with a moderately rising high end. Designed for inconspicuous hand or stand use, the microphone is a compact handful, measuring only 7 inches long, with a head diameter of 1-1/64 inches and a handle diameter of only 13/16 inches. It weighs 4.75 ounces.



The ATM33R accepts standard 3-pin receptacles.

*Mfr: Audio-Technica*

*Price: \$250.00.*

*Circle 43 on Reader Service Card*

## STUDER COMPACT CONSOLES

• Studer's line of compact mixing consoles, the 961/962 Series, is designed for a wide range of applications in video editing, remote video production, radio production, and remote recording. Modular construction allows each 961/962 console to be easily configured to meet specific customer needs. A 961 frame accepts up to fourteen 30 mm modules, while a 962 holds up to twenty modules. The 961/962 mixers offer stereo line/level input modules, either with or without a 3-band equalizer section. The equalizer is standard in the mono microphone/line input module, which also includes a new proprietary microphone input combining the advantages of both active differential and transformer balanced designs. The master input modules feature a built-in compressor limiter which operates on PDM (pulse duration modulation) principle. Additional module options feature a selection of monitor, auxiliary, talkback, and communication functions. The 961/962 Series circuits were developed and refined from similar circuits in the Studer 900 Series of studio pro-



duction consoles, resulting in similar digital-compatible performance specifications. Other features presented in the 961/962 Series include new faders with improved glide characteristics, click-free electronic muting, FET switching, LED peak indicators on each input, elec-

tronically balanced insert points, and a Littlite socket.

*Mfr: Studer ReVox America, Inc.*

*Prices: 961 begins at \$10,500.00.*

*962 begins at \$16,250.00.*

*Circle 44 on Reader Service Card*

## AUDIO LOGIC STEREO COMPRESSOR-LIMITER

• The Audio Logic MT 66 Stereo Compressor-Limiter provides dynamic range compression from 1:1 or infinity:1, and is simultaneously accompanied by its own noise gate to ensure quiet operation of the MT 66 when no signal is present. Features included on the front panel are: "link" switch to join both compressors for stereo tracking, a five LED bar graph to indicate gain reduction, gate, threshold, ratio, attack and release controls, plus input and output controls and "compress" to activate the compressor. At the rear of the Audio Logic MT 66 Stereo Compressor-Limiter are both balanced and unbalanced inputs and out-

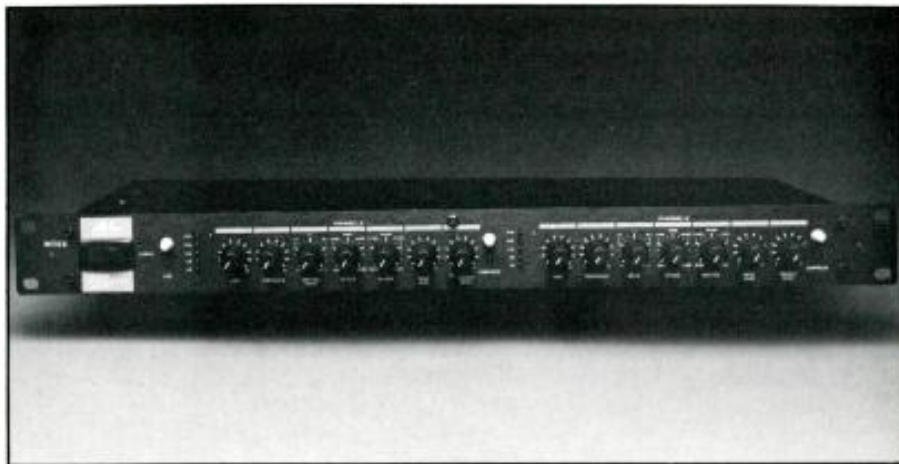

puts along with side chain inputs and outputs that can be utilized in changing the compression characteristic, or as a de-esser.

*Mfr: Audio Logic  
Price: \$299.95.*

*Circle 45 on Reader Service Card*

## NEW JBL EQUALIZERS

• Providing improved headroom and lower noise than conventional integrated-circuit gyrator designs, the new JBL 5547 Graphic Equalizer and 5549 Room Equalizer use a new solid-state hybrid to synthesize the inductor in the LC circuit. The equalizers are designed for professional studio and sound reinforcement applications. They provide minimum phase shift consistent with amplitude response, and smooth minimum-ripple combining action over the entire control range. The 5547/5549 systems feature ease of operation. Front panel input and output level controls let the user easily adjust the signal level through the equalizer, allowing system response to achieve optimal headroom and signal/noise ratio. An LED display presents signal levels for determination of precise control settings. The 5547 Active Graphic Equalizer has thirty 1/3-octave bands centered between 25 Hz to 20 kHz, with 12 dB boost or cut available at each center frequency. The 5549 provides corrective room equalization and a 0-15 dB cut-only range. Both models incorporate high- and low-frequency end-cut filters. The 12 dB/octave low-frequency cutoff filter has a -3 dB point that can be set from 20 to 250 Hz. The high-frequency cutoff filter can be switch-selected

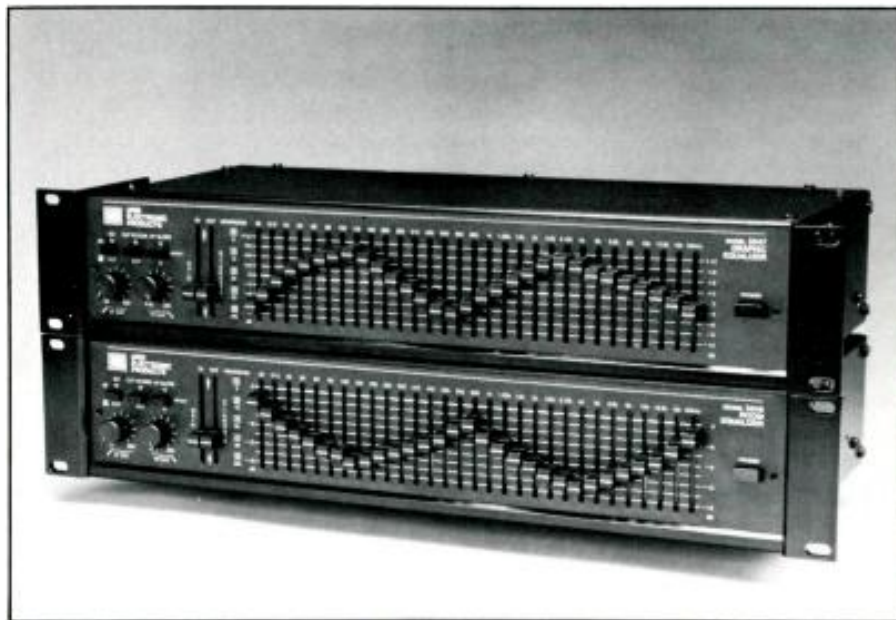

for 6 dB or 12 dB/octave attenuation slopes, by means of a front panel push button. Its -3 dB point can be set within a 3.5 to 20 kHz range. The end-cut bypass switch eliminates these filters from the circuit when they are not needed. Additional features include 45 mm (1.77 inch) throw slide posts, with center detent on the 5547; and EQ bypass switch that facilitates before-and-after comparisons; a hardware bypass with power-off; and a delayed turn-on that precludes power-on-thump. Ground loop isolation is provided

by means of a chassis-ground to audio-ground barrier strip jumper. A durable polycarbonate overlay protects the front panel graphics. The rugged, all-steel housing has heavy-gauge extruded aluminum rack ears that can move forward for flush mounting of the optional security cover.

*Mfr: JBL Professional  
Prices: 5547: \$798.00;  
5549: \$849.00.*

*Circle 46 on Reader Service Card*

# Louis R. Burroughs

*July 23rd, 1903—January 13, 1986*

**L**OU BURROUGHS needed no introduction to the readers of *db*. His name was a byword among professionals. After a lengthy illness, Lou Burroughs died on Monday, January 13, 1986, in Lake Havasu City, Arizona. Lou was associated with Electro-Voice, Inc., since its inception in 1927. At his retirement in 1974 he held the position of Vice President, Professional Products. He, at that time, had been active in microphone engineering at E-V for nearly fifty years.

During World War II, Lou developed the first noise-cancelling (differential) microphone. Used by the Army Signal Corps, the T45 lip mic proved to be a significant contribution to the war effort, effectively raising the intelligibility of radio communications from a previous eighteen percent to eighty-five percent and was cited by the Secretary of War for this contribution.

Lou also created Acoustalloy, E-V's copyrighted name for a non-metallic sheet from which dynamic microphone diaphragms are molded. The use of this material significantly enhanced the ability of the dynamic to provide wide-range flat response. All told, Lou held twenty-seven patents on electro-acoustic products, many of which won industry awards and kept E-V in a leadership position among broadcast and recording engineers.

But Lou will be remembered for much more than these accomplishments. For years Lou travelled the country, offering sound advice on microphone usage to all who would listen. At the same time, he gained valuable insights into the kind of products the industry needed. His regular visits to broadcast, movie, and recording studios or stages all over the country made him a familiar face and personal friend to several generations of artists and production people alike, earning him the nickname "Mr. Microphone."

Friend and fellow engineer and former *db* Magazine editor John Woram once wrote, "Some refer to his lectures as 'Doctor Burroughs' Medicine Show,' while wishing they thought of it first, or could do it half as well." (Who else could prove the durability of a microphone by using it to hammer nails into boards, and show that the mic still performed perfectly? LZ)

Woram continued, "Lou offers no stock rules-of-the-road for the microphone user. He does offer a lot of common sense though, and usually gets his listeners to start thinking about the way they put their microphones to use. And, at the conclusion of any one of his lectures, someone always asks, 'Why don't you write a book?'"

Which is, of course, what Lou did, and we were pleased to be its publisher. In addition, he was a charter member of the SBE and a Fellow of the AES, and authored many articles, some of which appeared in our pages.

It is difficult to assess the impact that Lou Burroughs has made on Electro-Voice, the audio industry, or, with our long personal relationship, on us. One thing is certain, he leaves for all a legacy of commitment. Perhaps what



expressed this all best is a plaque that has hung at E-V since Burrough's retirement:

**WITH DEEPEST APPRECIATION TO  
LOU BURROUGHS  
FOR YOUR CONSTANT INSPIRATION  
TO ALL AROUND YOU,  
AND FOR YOUR INCESSANT  
STRIVING TO PERFECT BETTER  
METHODS AND PRODUCTS  
FOR HUMAN COMMUNICATION  
AND ENTERTAINMENT, THROUGH  
RECOGNIZING AND SOLVING OUR  
CUSTOMER'S PROBLEMS.  
FROM YOUR FRIENDS AT  
ELECTRO-VOICE**

*Louis R. Burroughs, once our friend and mentor, and certainly an inventor and consummate educator, is survived by his wife, Marguerite.*

*I would like to thank E-V's Mary Ellen Long for much of the background information herein contained.  
Larry Zide, Editor/Publisher.*

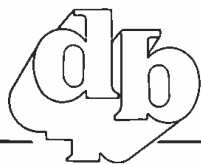

# 1985 db INDEX

## INDEX BY TITLE

**Audio Engineering Special!: The History of Audio Recording.** Peter Hammar. Sept./Oct., 1985, p. 25.  
**Bagels And Then Some—Profile of Howard Schwartz Studio.** James Corona. July/Aug., 1985, p. 37.  
**The Birth of the German Magnetophon Tape Recorder. 1928-1945.** Peter Hammar and Don Ososke. Sept./Oct., 1985, p. 28.  
**The Boom Operator—The Unsung Hero of Television Audio.** Marshall King. May/June, 1985, p. 20.  
**Breakfast With Bear Witme.** Bear Witme. Nov./Dec., 1985, p. 21.  
**Broadcast Applications For Voice-Activated Microphones.** Michael Petersen. July/Aug., 1985, p. 18.  
**Profile: Cherokee Recording Studio.** Sammy Caine. May/June, 1985, p. 35.  
**db Test: Tandberg TDC910 Master Cassette Recorder.** Len Feldman. Nov./Dec., 1985, p. 33.  
**Dynamic Compression In Studio Monitor Loudspeakers.** John Earle.

March/April, 1985, p. 41.  
**The First Digital Broadcast Via Satellite! Stevie Wonder Comes Home.** Lon Neumann. Jan./Feb., 1985, p. 20.  
**How To Deal With Room Acoustics.** Steve Carter. May/June, 1985, p. 26.  
**LED Bar Graph Meter Project.** Jon Gaines. Nov./Dec., 1985, p. 44.  
**Long View Farm Recording Studio.** Steve White. March/April, 1985, p. 44.  
**Master Sound at Movie Studio—Profile: Master Sound Astoria Recording Studio.** Sammy Caine. Sept. Oct., 1985, p. 41.  
**Mixing For Television.** Joe Moore. May/June, 1985, p. 30.  
**Piano From A Trash Can.** Channa Idor. July/Aug., 1985, p. 40.  
**Profile: Cherokee Recording Studio.** Sammy Caine. May/June, 1985, p. 35.  
**Profile of a Part-time Roadie.** Jim Norman. Nov./Dec., 1985, p. 41.  
**Polymer Film For Transducers.**

Jesse Klapholz. Nov./Dec., 1985, p. 27.  
**Ramsa At The Olympics.** Kimio Takei. Jan./Feb., 1985, p. 25.  
**The Reflection Phase Grating Acoustical Diffuser.** Peter D'Antonio. Sept./Oct., 1985, p. 46.  
**Reflections of an Audio Man.** Joel Tall. May/June, 1985, p. 25.  
**Renovations At Montreal Sound.** Robert Brewster. Jan./Feb., 1985, p. 31.  
**Scoring One For The Gipper.** March/April, 1985, p. 47.  
**Sound In The Holy Land.** Ronald Altman. March/April, 1985, p. 34.  
**Sound Reinforcement in Asia.** Ed Learned. Jan./Feb., 1985, p. 37.  
**Sound Reinforcement in Europe.** Ed Learned. July/Aug., 1985, p. 23.  
**Sound Reinforcement in Southeast Asia.** Ed Learned. March/April, 1985, p. 24.  
**Technical Postcards.** Sammy Caine. May/June, 1985, p. 32.  
**Universal Recording Studios.** Murray.



R. Allen. Sept./Oct., 1985, p. 36.  
**WGBH: Host To a First.** W. Spurlin  
& J. Voci. Nov./Dec., 1985, p. 12.

## INDEX BY COLUMNIST

**BARRY BLESSER** (Digital Audio)  
**More Words.** Jan./Feb., 1985, p. 4.  
**Analog and Digital Degradations.**  
March/April, 1985, p. 20.  
**RFI and Audio.** May/June, 1985,  
p. 17.  
**Economics.** July/Aug., 1985, p. 5.  
**Living with Standards.** Sept./Oct.,  
1985, p. 19.  
**Audio Engineering Standards.** Nov./  
Dec., 1985, p. 4.

**JOHN BORWICK** (Scenes From  
Europe)  
**The World's First All-Digital Studio.**  
March/April, 1985, p. 10.  
**A Soundcraft Celebration.** May/June,  
1985, p. 12.  
**AES Hamburg Report.** July/Aug.,  
1985, p. 12.

**JOHN EARGLE** (Sound Reinforce-  
ment)  
**Speech Privacy and Noise Masking  
Systems.** Jan./Feb., 1985, p. 12.  
**Line Arrays and Sound Columns,  
Part 1.** May/June, 1985, p. 6.  
**Line Arrays and Sound Columns,  
Part 2.** July/Aug., 1985, p. 10.  
**Overview of Sound Reinforcement  
in the Theater.** Sept./Oct., 1985, p.  
4.

**JESSE KLAPHOLZ** (Computer  
Audio)  
**Computers: The Paradoxical Infan-  
cy.** Jan./Feb., 1985, p. 16.  
**Speaker Design Software.** Sept./  
Oct., 1985, p. 12.  
**The Role of Audio Today.** Nov./  
Dec., 1985, p. 8.

## INDEX BY AUTHOR

**Allen, Murray R.** Universal Record-  
ing Studios. Sept./Oct., 1985, p. 38.  
**Altman, Ronald.** Sound In The Holy  
Land. March/April, 1985, p. 34.  
**Brewster, Robert.** Renovations At  
Montreal Sound. Jan./Feb., 1985,  
p. 31.  
**Caine, Sammy.** Profile: Cherokee  
Recording Studio. May/June, 1985,  
p. 35.  
**Caine, Sammy.** Master Sound at  
Movie Studio—Profile: Master Sound  
Astoria Recording Studio. Sept./Oct.,  
1985, p. 41.  
**Caine, Sammy.** Technical Postcards.  
May/June, 1985, p. 32.

**Carter, Steve.** How To Deal With  
Room Acoustics. May/June, 1985,  
p. 26.

**Corona, James.** Bagels And Then  
Some—Profile of Howard Schwartz  
Studio. July/Aug., 1985, p. 37.

**D'Antonio, Peter.** The Reflection  
Phase Grating Acoustical Diffuser.  
Sept./Oct., 1985, p. 46.

**Eargle, John.** Dynamic Compres-  
sion In Studio Monitor Loudspeakers.  
March/April, 1985, p. 41.

**Feldman, Len.** db Test: Tandberg  
TDC 910 Master Cassette Recorder.  
Nov./Dec., 1985, p. 33.

**Gaines, Jon.** LED Bar Graph Meter  
Project. Nov./Dec., 1985, p. 44.

**Hammar, Peter.** Audio Engineering  
Special: The History of Audio Record-  
ing. Sept./Oct., 1985, p. 25.

**Hammar, Peter and Ososke, Don.**  
The Birth of the German Magnetophon  
Tape Recorder. 1928-1945. Sept./  
Oct., 1985, p. 28.

**Idor, Channa.** Piano From A Trash  
Can. July/Aug., 1985, p. 40.

**King, Marshall.** The Boom Operator—  
The Unsung Hero of Television Audio.  
May/June, 1985, p. 20.

**Klapholz, Jesse.** Polymer Film For  
Transducers. Nov./Dec., 1985, p. 27.

**Learned, Ed.** Sound Reinforcement  
in Asia. Jan./Feb., 1985, p. 37.

**Learned, Ed.** Sound Reinforcement  
in Europe. July/Aug., 1985, p. 23.

**Learned, Ed.** Sound Reinforcement  
in Southeast Asia. March/April, 1985,  
p. 24.

**Moore, Joe.** Mixing For Television.  
May/June, 1985, p. 30.

**Neumann, Lon.** The First Digital  
Broadcast Via Satellite! Stevie Won-  
der Comes Home. Jan./Feb., 1985,  
p. 20.

**Norman, Jim.** Profile of a Part-time  
Roadie. Nov./Dec., 1985, p. 41.

**Ososke, Don and Hammar, Peter.**  
The Birth of the German Magnetophon  
Tape Recorder. 1928-1945. Sept./  
Oct., 1985, p. 28.

**Petersen, Michael.** Broadcast Appli-  
cations For Voice-Activated Mic-  
rophones. July/Aug., 1985, p. 18.

**Spurlin, W. & Voci, J.** WGBH: Host  
to a First. Nov./Dec., 1985, p. 12.

**Takei, Kimio.** Ramsa At The Olym-  
pics. Jan./Feb., 1985, p. 25.

**Tall, Joel.** Reflections of an Audio  
Man. May/June, 1985, p. 25.

**Voci, J. & Spurlin, W.** WGBH: Host  
to a First. Nov./Dec., 1985, p. 12.

**White, Steve.** Long View Farm Re-  
cording Studio. March/April, 1985,  
p. 44.

**Witme, Bear.** Breakfast With Bear  
Witme. Nov./Dec., 1985, p. 21. ■



Have you mis-  
placed your db  
again? Our  
high quality,  
royal blue vinyl  
binders keep  
12 copies of  
db neat and  
handy for  
ready  
reference.  
Just \$9.95,  
available in  
North America  
only. (Payable  
in U.S. currency  
drawn on U.S.  
banks.) ORDER  
YOURS NOW!!

**Sagamore Publishing Co., Inc.**  
1120 Old Country Road  
Plainview, NY 11803

**YES!** Please send \_\_\_\_\_ db binders  
@ \$9.95 each, plus applicable sales tax.  
Total amount enclosed \$ \_\_\_\_\_

Name \_\_\_\_\_  
Company \_\_\_\_\_  
Address \_\_\_\_\_  
City \_\_\_\_\_  
State/Zip \_\_\_\_\_

# Classified

---

## FOR SALE

---

**1/3 Octave  
Real Time Analyzer**



**Real Affordable...\$495<sup>00</sup> Model 728  
\$595<sup>00</sup> Model 728M with Memory**

**Banner** (704) 487-7012  
PO DRAWER 1803 • SHELBY, N.C. 28150

ERS PRO AUDIO. Revox PR99-\$1350. Tangent 24-TR console with patch bay and pedestal-\$8900. ART 01A digital reverb-\$849. (412) 221-2737.

FOR SALE: WESTREX 3DIH. 4,400; Haeco SC-2, \$6,000; Haeco SC-1, \$1,700; Grampian D, \$323; Westrex 28, \$400. Haeco cutterheads new, other cutterheads rebuilt and within specifications. New solid state amplifiers available. International Cutterhead, 194 Kings Court, Teaneck, NJ, 07666. (201) 833-4421.

ERS PRO AUDIO. Klark-Teknik DN780s, Revox PR99s and B77s, Seck mixers, Audio-Technica RMX64s. (412) 221-2737.

**MUSIC CONTACTS:** List of heavy weights Record co's, publishers, managers, investors, much more. Addresses and phone numbers. Send \$6.00 to **CONTACTS PO BOX 1158, DEPT. Q, WOODSTOCK, NY, 12498.**

MCI 24-TRACK JH114, 12 DOLBY361, 3M M64 2-TRACK, 3M M79 2/4-TRACK, SCULLY 280 2-TRACK, EVENTIDE H910 HARMONIZER. ALL EQUIPMENT PROFESSIONALLY MAINTAINED AND IN SERVICE IN MAJOR STUDIO. BROKER PARTICIPATION WELCOME. CONTACT PAT SCHOLLES AT (901) 725-0855. ARDENT STUDIOS, 2000 MADISON AVE., MEMPHIS, TN. 38104.

BEAUTIFUL NEW SOUNDS for your Korg DW-8000, Memorymoog, Jupiter 8, Prophet 5 and Oberheim Matrix 12/Expander. All programmed by expert programmer, Walt Whitney. Only \$15 each except Matrix 12/Expander, \$25 ea. to Walt Whitney, P.O. Box 2411, Overland, MO 63114.

PROFESSIONAL Audio Equipment (used), Mics, Synthesizers, Vocoder, Tape Rec., etc. Call (212) 595-7822. Weekdays 3-7 pm.

**FREE 32pg Catalog & 50 Audio/Video Appl.**



Stereo/Mono Pwr Ampl. PWR SUPP. EQ. PHONO, MIC, TRANS, ACH. TAPE, VIDEO, LINE, OSC.

Video & Audio Dist. Ampls. 8-in/2-out, 12-in/4-out, 16-in/4-out TV Audio & Recd Prod Consoles

**OPAMP LABS INC (213) 934-3566**  
1033 N Sycamore Av LOS ANGELES CA, 90036

CROWN, MICROTECH, Nakamichi, Electro-Voice, professional services, BEST PRICES. Ameri-Sound Sales, Inc., East Coast: (904) 262-4000; West Coast: (818) 243-1168.

AMPEX MM-1000 MINT CONDITION 15IPS-30IPS MANUALS SPARES—\$8,750. AMPEX 440-48 TRACK IN AMPEX CONSOLE MINT VERY LITTLE USE MANUALS—\$3,800. AMPEX 440-28 2 TRACK IN AMPEX CONSOLE MINT HEADS NEW 7 1/2-15-30 IPS MANUALS—\$2,850. PACKAGE PRICE: \$14,000. CALL (203) 264-3666.

---

## SERVICES

---

CUTTERHEAD REPAIR SERVICE for Westrex, Haeco and Grampian. Convert your old Westrex to model 3DIH. New and rebuilt cutterheads available. International Cutterhead, 194 Kings Court, Teaneck, NJ 07666. (201) 833-4421.

Closing date is the first of the second month preceding the date of issue.

Rates are \$1.00 per word with \$25.00 minimum. Boxed ads are \$40.00 per column inch. db Box Numbers are \$8.50 for wording "Dept. xx" plus \$1.50 for postage and handling.

Discounts 3x—15%  
6x—30%.

**ALL CLASSIFIEDS  
MUST BE PREPAID.**

Send copies to:  
db The Sound  
Engineering Magazine  
1120 Old Country Rd.  
Plainview, NY 11803  
att: Classified Dept

## Experience a tape transport ready for the balance of this millenium.

After spending a few minutes with the A820 you'll know you're in touch with tomorrow. Here is everything you've ever dreamed of in a production/mastering ATR. And then some.

For openers, note these features: Four tape speeds. Reel sizes up to 14". Real time counter accurate to *tenths* of a second. Advanced phase compensation in all audio circuits. And, of course, the massive chassis, rugged construction and precision Swiss manufacturing you'd naturally expect from Studer.

And now for the unexpected. Inside the A820 you'll find the most comprehensive microprocessor control systems ever put in an ATR – by anybody. Multiple microprocessors govern all tape motion parameters, switching functions, and audio alignment settings. These innovations not only provide unprecedented operating flexibility, but also explain the A820's uncannily smooth tape shuttling and remarkable editing efficiency. When the

production pressure is on, the A820 becomes a joy and a lifesaver.

The A820 also ushers in a new era of user programmability. In a matter of minutes, by selecting from a menu of more than a dozen operating features, you can tailor an A820 to meet any application. All primary and secondary top panel buttons can be assigned to any desired function. You can practically "redesign" your machine on a day-to-day basis!

The A820 line has been augmented by the addition of 1/2" two-track and center-track time code versions. Also, interfaces for control by external computers or video editing systems are now available.

Call or write today for more information on the new Studer A820. It can transport your facility into the future.

Studer Revox America, 1425 Elm Hill Pike, Nashville, TN 37210 / (615) 254-5651 / New York (212) 255-4462 / Los Angeles (818) 780-4234 / Chicago (312) 526-1660 / Dallas (214) 943-2239 / San Francisco (415) 930-9866

# STUDER REVOX



Circle 11 on Reader Service Card

www.americanradiohistory.com



## Rev into stereo— With the remarkable new FP32 ENG Mixer.

### Introducing the stereo version of our legendary FP31.

Stereo adds incredible dimension and realism to sports and news coverage. And Shure's new compact FP32 Stereo Mixer makes ENG and EFP applications easy and economical.

### Consider these advantages:

- Three transformer-coupled XLR isolated inputs and stereo outputs, all switchable to low-impedance mic or line level.
- Dual mini and 1/4" stereo headphone jacks.
- Built-in slate mic and slate tone.
- Battery, phantom, and A/B power (no special power supplies needed).

### Plus new stereo advantages:

- Full stereo capability with separate, detented stereo pan pots and monitoring capability.

- Full 48 volt phantom capability.

Size? Only 2<sup>5</sup>/<sub>16</sub>" x 7<sup>1</sup>/<sub>4</sub>" x 6", comparable to our FP31. Weight? Just 2<sup>1</sup>/<sub>2</sub> pounds. Price? Hundreds less than you would expect. Stereo is here to stay. So is the FP32. For complete information about our full line of field production gear, write or call: Shure Brothers Inc., 222 Hartrey Avenue, Evanston, IL 60202-3696. (312) 866-2553



The new FP42 Stereo Production Mixer—the stereo counterpart to our M267. Four channels with independent center detented pan pots and cuing. Headphone amplifier. Adjustable limiters.



# SHURE

## Breaking Sound Barrier™

Circle 12 on Reader Service Card

www.americanradiohistory.com