

# db



AKUWA325COMIL JD DB JAN79  
KUOW RADIO  
D S SU UNIV OF WASH  
325 COMMUNICATIONS BLDG  
SEATTLE WA 98195



# Test and Save.

A simple philosophy? Yes. But, one that can save you and your clients many dollars.

Consider this:

You're recording an exciting, new spot for a new client. The musicians and vocalists are set. You're getting noise on the tape and you can't find it anywhere. Testing with a TM 500 audio test set before recording could have saved time and money.

Or: does this sound familiar?

You're midway through an important broadcast. You've sold every commercial minute allowable, when your audio fuzzes out. During a commercial minute a make good is in order. A quick check through your basic frequency/response levels with a TM 500 Oscillator/dB reading meter combination could have saved that minute.

Try this:

You're engineering a big theatre production. It's opening night with a full house attending. The curtain goes up while your audio stays down. Troubleshooting with a TM 500 test set before the show could have found the problem.

In this world of sound, time is money. TM 500 is a collection of modular test and measurement instruments from Tektronix that can save you plenty of both.

The heart of our TM 500 Audio Travel Lab is our 600  $\Omega$  low distortion audio oscillator, which generates square or low distortion sine waves from 5 Hz to 500 kHz (0.035% THD 20 Hz to 50 kHz).

For general troubleshooting combine this compact oscillator with a full function TM 500 Multimeter with ac, dc, current, temperature and resistance readings as well as dB capabilities. Add one of our TM 500 Counters (measuring capability to 1 GHz) with a TM 500 Oscilloscope (5 MHz, 15 MHz and 80 MHz varieties), you've got a complete, portable TM 500 audio test set.

Or if you're in need of a signal source, try our 40 MHz function generator capable of tone bursts, 20 Hz to 20 kHz log or linear sweep, and amplitude modulation.

TM 500 even has a tunable bandpass filter which selects narrow bands for selective frequency tests and a hi-gain differential amplifier with hi or lo filter capabilities.

These versatile plug-ins can be mixed, matched and packed in any one of 6 portable, benchtop, or rackmount TM 500 Mainframes to make a test set that suits your measurement needs.

**The Traveler Mainframe is on the move with you.**

When you're in and out of a lot of studios our TM 515 Traveler Mainframe is your number. The TM 515 carries up to five TM 500 plug-ins, looks like and acts like

carry-on-flight luggage. A rear interface circuit board in the TM 515 Traveler Mainframe lets you interconnect the plug-in instruments to make gain, loss or response measurements — at the touch of a pushbutton.



## TM 500 Designed for Configurability

For additional information on TM 500 Audio Labs, call Tektronix' automatic answering service (toll free) at 1-800-547-1512. Oregon residents call collect on 644-9051. For even faster service, call your local Tektronix Field Office.

In Europe write: Tektronix Limited, P.O. Box 36, St. Peter Port, Guernsey, Channel Islands.

**Tektronix**  
COMMITTED TO EXCELLENCE

Circle 10 on Reader Service Card

www.americanradiohistory.com

## Coming Next Month

• The subject for this next issue is Digital Electronics.

There will be a story from Ampex on digital recording standards—a subject that gets more important to discuss with each passing day.

John Woram is assembling a story based on visits to a new automated recording studio in San Francisco aptly named the Automatt.

Digitally operated automatic location of a tape will be another subject. A number of present day systems will be detailed.

A sophisticated digital synchronizer from BTX is the subject of another article. Learn all about the SMPTE time code and what it can do for you.

The world's first digital tape recorder directory will appear in this issue.

And there will be articles on micro-processors now available that can do almost everything in your studio and yet cost almost little more than a good typewriter.

All this digitally coming in November in *db*, *The Sound Engineering Magazine*.



THE SOUND ENGINEERING MAGAZINE

OCTOBER 1978 VOLUME 12, NUMBER 10

|  |    |
|--|----|
| EDITORIAL                              | 40 |
| BASIC GROOVE GEOMETRY                  | 42 |
| Irwin J. Diehl                         |    |
| FROM CYBERSONICS:                      | 46 |
| A NEW DISC-MASTERING LATHE             |    |
| Suzette Fiveash                        |    |
| CBS DISCOMPUTER                        | 50 |
| C. P. Repka                            |    |
| THE GRAMOPHONE                         | 54 |
| db TEST REPORT—                        | 58 |
| KEITH MONKS RECORD CLEANING MACHINE    |    |
| THE LOGISTICS OF DIRECT-DISC RECORDING | 61 |
| Bert Whyte                             |    |
| BRING YOUR OWN LATHE                   | 64 |
| Suzette Fiveash                        |    |
| A LOOK AT THE RECORD-PLATING PROCESS   | 66 |
| James P. Shelton                       |    |
| LETTERS                                | 2  |
| CALENDAR                               | 8  |
| BROADCAST SOUND                        | 10 |
| Patrick S. Finnegan                    |    |
| SOUND WITH IMAGES                      | 20 |
| Martin Dickstein                       |    |
| THEORY AND PRACTICE                    | 26 |
| Norman H. Crowhurst                    |    |
| NEW PRODUCTS AND SERVICES              | 32 |
| CLASSIFIED                             | 69 |
| PEOPLE, PLACES, HAPPENINGS             | 72 |



is listed in **Current Contents: Engineering and Technology**

**Larry Zide**  
PUBLISHER

**Bob Laurie**  
ART DIRECTOR

**Eloise Beach**  
CIRCULATION MANAGER

**Ann Russell**  
ADVERTISING PRODUCTION

**Crescent Art Service**

**John M. Woram**  
EDITOR

**Hazel Krantz**  
COPY EDITOR

**Lydia Anderson**  
BOOK SALES

**Suzette Fiveash**  
ASSOCIATE EDITOR

**GRAPHICS AND LAYOUT**

## About The Cover

• This month's cover shows what one of the first direct-to-disc sessions looked like. The illustration is taken from an early issue of *Scientific American*. For a look at the complete cover see pages 56/57. And don't forget to read our reprint of their cover story, simply titled *The Gramophone* and appearing on pages 54/55.

db, the Sound Engineering Magazine is published monthly by Sagamore Publishing Company, Inc. Entire contents copyright © 1978 by Sagamore Publishing Co., Inc., 1120 Old Country Road, Plainview, L.I., N.Y. 11803. Telephone (516) 433 6530. db is published for those individuals and firms in professional audio-recording, broadcast, audio-visual, sound reinforcement, consultants, video recording, film sound, etc. Application should be made on the subscription form in the rear of each issue. Subscriptions are \$7.00 per year (\$14.00 per year outside U.S. Possessions, Canada and Mexico) in U.S. funds. Single copies are \$1.00 each. Controlled circulation paid at Brattleboro, VT 05301. Editorial, Publishing, and Sales Offices: 1120 Old Country Road, Plainview, New York 11803. Postmaster: Form 3579 should be sent to above address.

## Amid the confusion . . .

So much is stated, contradicted and re-stated, but in the end it is not a matter of opinion.

Other things being equal, 'goodness' can be expressed in simple terms.

A pick-up arm should have the lowest possible effective mass, coupled with the highest possible rigidity.

A cartridge should have the lowest possible effective tip mass, coupled with a correctly related compliance and tare (cartridge weight).

These are the rules of physics and engineering. They can be denied for various reasons but the penalty is then paid each time you play a record.

Immediately available. In case of difficulty write to Dept 1850, SME Limited, Steyning, Sussex, BN4 3GY, England  
*Exclusive distributors for the U.S.:* Shure Brothers Incorporated, 222 Hartrey Avenue, Evanston, Illinois 60204  
*and in Canada:* A. C. Simmonds and Sons Ltd, 975 Dillingham Road, Pickering, Ontario, L1W 3B2

The Series III precision pick-up arm and Shure V15 Type IV cartridge. Designed and built by the rules for faithful, uncoloured musical reproduction.



# SME

Design Council  
Award 1978

"Stereo Sound is Japan's principal hi-fi magazine. The Summer '78 issue carries an article compiled by seven leading critics. Of forty-three arms they recommend the SME Series III as the best and the Series II Improved as good".

# db Letters

## index of advertisers

|                                   |         |
|-----------------------------------|---------|
| Accurate Sound . . . . .          | 8       |
| ADC . . . . .                     | 39      |
| AES . . . . .                     | 26      |
| AKG . . . . .                     | 16      |
| Altec Corporation . . . . .       | Cover 4 |
| Ampex . . . . .                   | 36-37   |
| Ashly Audio . . . . .             | 53      |
| Audio Design Recording . . . . .  | 28      |
| Audio-Technica U.S. . . . .       | 7       |
| Auditronics . . . . .             | 5       |
| Bogen . . . . .                   | 27      |
| BTX . . . . .                     | 55      |
| Clear-Com . . . . .               | 30      |
| Community Light & Sound . . . . . | 13      |
| Crown International . . . . .     | 3       |
| dbx, Inc. . . . .                 | 19      |
| Dolby . . . . .                   | 33      |
| Duncan Electronics . . . . .      | 31      |
| Garner Industries . . . . .       | 14      |
| Hammond Industries . . . . .      | 4       |
| Inovonics . . . . .               | 9       |
| J & R Music World . . . . .       | 32      |
| JBL . . . . .                     | 25      |
| Leader Instruments . . . . .      | 24      |
| Lexicon Inc. . . . .              | 12      |
| Neptune . . . . .                 | 29      |
| Neutrik . . . . .                 | 18      |
| Northwest Sound . . . . .         | 20      |
| Orban Associates . . . . .        | 22      |
| Otari . . . . .                   | 21      |
| Philips Audio . . . . .           | 16, 18  |
| Pioneer . . . . .                 | 11      |
| Pro-Audio Specialties . . . . .   | 34      |
| Recording Supply . . . . .        | 38      |
| Shure Brothers . . . . .          | 41      |
| SME Ltd. . . . .                  | 2       |
| Sound Technology . . . . .        | 17      |
| Sound Workshop . . . . .          | 65, 67  |
| Standard Tape Lab . . . . .       | 10      |
| Stanton Magnetics . . . . .       | 23      |
| Studer-Revox . . . . .            | 15      |
| Tandberg of America . . . . .     | 48-49   |
| TDK Electronics . . . . .         | 35      |
| TEAC Corp. of America . . . . .   | Cover 3 |
| Techniques by Panasonic . . . . . | 44-45   |
| Tektronix . . . . .               | Cover 2 |
| Telex Communications . . . . .    | 60      |
| Tentel . . . . .                  | 63      |
| UREI . . . . .                    | 6       |
| Waters Manufacturing . . . . .    | 16      |
| White Instruments . . . . .       | 14      |

### THE EDITOR:

Herewith a few thoughts prompted by Marshall King's two-part article, *The Technician and His Union*. He mentions the decline of the big old movie studios and the rise of the independents. Popular opinion has it that unions were in part responsible for this, and that unions do not promote excellence; that seniority lists eliminate competition between engineers and shelter incompetents.

As we all know, the recording field has undergone meteoric growth over the past ten years. Along with this, the role of recording engineer has also evolved. Whereas new equipment has kept the maintenance engineer on his toes, his work has remained essentially the same. But the recording engineer has had to become increasingly involved, creatively, in the use of multi-track techniques, and of the studio itself as a giant musical instrument. In general, the unions have resisted this trend, or responded in purely reactionary fashion.

To the extent that it is democratic, the union is bound to speak for the majority, that which all workers have in common rather than the attributes which make each man unique. Not all workers are equally good at all tasks, and this fact must be reconciled with the democratic principle of equal pay for equal work. The controversy surrounding "job classification" is implicit recognition of the problem, but the paradox remains, within any category there will always be important differences between individuals, with regard to both ability and motivation.

The unions are also seen, especially by artists and producers, as being opposed to all new technological development, resisting with featherbedding and sabotage. Once a shop gets a reputation for such activities, it may suffer loss of jobs or even extinction. Thus, while acting to support the idea of fair treatment for workers, the union may, ironically, sacrifice the very jobs it intends to protect.

Additionally, there is a growing feeling that bigness is itself an enemy. As they have gotten bigger, the unions have begun to resemble the giant corporations they are supposed to

(continued)

# The Crown D-75 is all new.



Except the shape.  
(And we invented that.)

If the new D-75 professional power amplifier looks familiar, it's because the shape, which we created years ago, is truly functional. But, until now, you have never seen any amplifier of this size, including Crown, that performs like the D-75.

The Crown D-75 is a powerful amplifier. 35 watts continuous average power per channel into 8 ohms, 20Hz to 20KHz @ .05% THD. 45 watts into 4 ohms. In mono, the D-75 provides 95 watts continuous average power into 8 ohms.

The D-75 is virtually distortion-free. Frequency response  $\pm 0.1$ dB, 20Hz to 20KHz @ 1 watt into 8 ohms;  $\pm 1.2$ dB, 5Hz to 100KHz. Hum and noise 106dB below rated output. THD less than .001% from 20Hz to 400Hz, increasing linearly to .05% at 20KHz. IMD less than .01% from .25 to 36 watts (less than .05% from .01 to .25 watts).

The D-75 is professionally convenient. Signal-presence LED's indicate peak output greater than  $\frac{1}{8}$  watt into 8 ohms. Active balanced XLR connectors, as well as unbalanced  $\frac{1}{4}$ " phone plugs, are standard on the rear panel, plus an external dual/mono switch. Gain controls are lockable.

The D-75 now includes the Crown Input-Output Comparator (IOC) which reports non-linear behavior in the amp: overload, TIM or protection circuit activation. In addition, separate signal and chassis grounds are provided to minimize ground loops.

The D-75 is a Crown amplifier, so you can expect it to be rugged and reliable. Compare it with any competitive amplifier. The Crown D-75 is truly an exceptional value. For more information, please write or call Crown or consult your Crown dealer.



1718 W. Mishawaka Road, Elkhart, Indiana 46514

*American innovation and technology...since 1951.*

# At Last, an Equalizer that Comes Clean...

Up until now, whether you tried to equalize your control room or contour your sound system for a concert hall, the end result was an increase in distortion.

That was yesterday.

Klark-Teknik equalizers are built for today, for tomorrow.

Uncompromised.

Unequaled.

If your livelihood depends on good clean sound, depend on us.

After all, if you're using yesterday's equipment, will you be ready for tomorrow?

Write to Hammond

Industries Inc., 155 Michael Drive, Syosset, New York 11791 or call (516) 364-1900.

## MODELS:

DN27: 1/3 octave mono, with bypass switch & gain control. **\$765**

DN22: 11 band, stereo, with high & low pass filters, separate gain controls & bypass switches. **\$815**

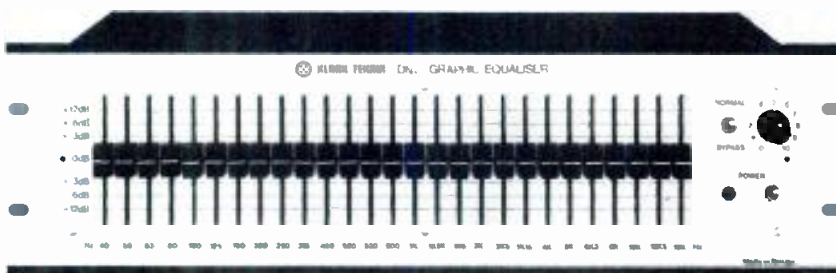

## SPECIFICATIONS:

INPUT IMPEDANCE: Unbalanced, 10K ohms nominal. OUTPUT IMPEDANCE: Unbalanced, less than 10 ohms, short circuit protected. OPERATING LEVEL: -20 dBm to +24 dBm; input protection 60V RMS. CENTER FREQUENCY ACCURACY:  $\pm 2\%$ . CALIBRATION ACCURACY:  $\pm 0.5$  dB. FREQUENCY RESPONSE (CONTROLS FLAT):  $\pm 0.5$  dB : 20Hz to 20kHz. OUTPUT CLIPPING POINT: +22 dBm into 600 ohms load. DISTORTION: Less than 0.01% ... 1kHz at +4 dBm into a 600 ohms load; less than 0.05% ... 20Hz to 20kHz at +18 dBm into a 600 ohm load. EQUIVALENT INPUT NOISE: Less than -90 dBm unweighted, 20Hz to 20kHz.



# KLARK-TEKNIK

A Member of the Hammond Industries Group

## The Sound of Today.

counterpose—unresponsive to local needs, and resistant to change of any kind (bureaucracy breeds more bureaucracy). And, like big business, some unions are seen as having become immoral, dealing, when expedient, with elements of organized crime.

Finally, there are those (admittedly, very few) who have deep concern about the Constitutional question posed by compulsory union representation of all workers in a closed shop. (A recent Supreme Court ruling on this matter affirms freedom of the individual.)

Educated people know of the great good done by the unions in this country, over the years. Whatever problems the unions have today, the solutions can come only from the members themselves. Mr. King is right in saying those who criticize a union should also be actively trying to do something about it.

DOUG POMEROY  
Brooklyn, NY

## THE EDITOR:

I really find it quite disappointing, and a little hard to believe, that the error in Patrick Finnegan's March, 1978 piece was claimed as the absolute truth in the June issue. In Mr. Finnegan's answer, he does refer to peak bias at 1 kHz as the common guideline it is. In the original article, however, he stated correctly that the level at 10 kHz is much more sensitive to the exact bias setting. He erred, and Gordon Carter, in his letter, picked him up on this, when he stated that the bias is set for the "peak audio output" with the high frequency signal.

The range of 10 kHz drop with correct bias is at least as wide as given by Mr. Carter. I have seen the best performance obtained with drops anywhere from 2 to 12 dB at 10 kHz. Within that great spread for 10 kHz levels, the great majority of tapes were very close to peak bias for 400 to 1,000 Hz. In the last two years of using a 1/3-octave rta (real-time analyzer) with a pink noise source for tape and tape recorder testing, I have become convinced of the essentiality of such a display if the goal is widest and flattest response.

The levels of the highest frequencies and the shape of the curve change so rapidly with small changes in bias that it is close to impossible to match the possible performance using such a scheme, if just 1,000 Hz peak bias is used. Anyone who has not seen the

(continued)

Circle 31 on Reader Service Card



## **“Since I bought my first Auditronics board...**

... five years ago. I've done all of Shaun Cassidy and Leif Garrett on it, most of Donny and Marie, plus Al Martino, Sammy Davis, Debby Boone, the Supremes and others.”

“After 20 singles and 12 albums on this console, 25 of them gold and platinum, I guess you could say my Auditronics 501 (serial number 0002) is a real money-maker. It does what I want as well as when it was new, and I'm still cutting on it today.”

Independent producer Michael Lloyd is one of over 300 satisfied Auditronics console users. If you'd like to learn some of what they know about Auditronics console quality and reliability, circle reader service number or write to

3750 Old Gerwell Road, Memphis, Tennessee 38118 (901) 362-1350



**auditronics, inc.**

*Circle 42 on Reader Service Card*

# Model 927 DDL

## What Took You So Long, UREI?

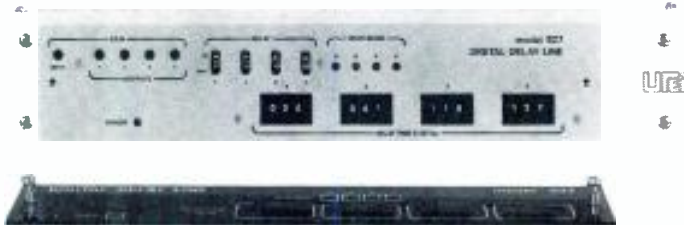

Well, frankly, we didn't think much of the marginal performance of the digital delay lines we'd seen to date. We vowed we wouldn't get into the DDL ballgame until we could field an entry we'd be really proud to see in a UREI uniform.

But now, our time has come! The UREI Model 927 Digital Delay Line! The proud result of over two years of intensive research and development, now available at a very competitive price to set new standards of performance and reliability.

Are you tired of gain pumping and transient overload that is typical of companding A/D converters? Tired of whistles at the high end? Tired of pre-emphasis/de-emphasis filters taking 12dB of high end headroom just to meet the 90 dB spec? And are you tired of not being able to believe what you read about digital delay line specs? Well, you should be! The technology is here to eliminate that nonsense in digital audio systems.

Our Model 927 uses a unique A/D system we call "instantaneous floating point conversion" to take care of those problems *without* any of the annoying side effects inherent in other floating point and delta modulation systems, and *without* resorting to companding and/or high end pre-emphasis to achieve >90 dB dynamic range. Ultra-sharp 8-pole, 6 zero Cauer filters put an end to the whistles and beats. The result? A clean 92 dB dynamic range with *full-power bandwidth* to 12kHz at all delay settings (distortion typically 0.07% at full rated output).

As a bonus, you get FOUR separate, isolated outputs, each thumbwheel switch-adjustable to 127 milliseconds in 1mS steps.

So — write us or ask your UREI dealer for a Model 927 data sheet. You can *believe* the honest and complete specs it lists. Get one for your next delay job and prove to yourself that — "our time has come!"



8460 Sun Fernando Road, Sun Valley, California 91352 (213) 767-1000

Exclusive export agent: Gotham Export Corporation, New York

Circle 54 on Reader Service Card

1/3-octave rta being used to set up a recorder is urged to do so. If nothing else, you will find it very instructive on the interrelationships of relative frequency, bias, eq., tape type, and head alignment. Finally, and perhaps not so incidentally, the pink-noise/rta approach is very fast: 30 seconds is the *most* time needed to see what the record/playback response is.

HOWARD A. ROBERSON  
Pittsfield, Ma.

### THE EDITOR:

I have read with great interest Marshall King's recent articles in *db*. I have found them to be a very factual and informative description of the current status in the film and video tape industry.

I would, however, like to point out two things which need further clarification. First, the freelance sound mixer can put together, with extreme confidence, a total audio package for a producer by contacting one of the several rental houses who specialize in this area. The freelance mixer has the freedom that the staff mixer does not have, to call upon one of these audio one-stops, thereby providing the producer with a state-of-the-art audio package which is maintained to high standards, dictated by the fact that these companies make their profit by providing this equipment on an ongoing basis.

Secondly, the area of rf microphones has given the audio mixer greater flexibility when they are properly applied, thereby giving the *mixer* new found freedom along with the cameraman, lighting directors, etc.

I appreciate the opportunity Mr. King has given everyone to have a greater understanding of the union situation in our industry.

ROBERT N. ESTRIN  
President, Filmways  
North Hollywood, Ca.

## Copies of db

Copies of all issues of *db*—The Sound Engineering Magazine starting with the November 1967 issue are now available on 35 mm. microfilm. For further information or to place your order please write directly to:

University Microfilm, Inc.  
300 North Zeeb Road  
Ann Arbor, Michigan 48106



# Audio-Technica announces a creative new start toward better sound.

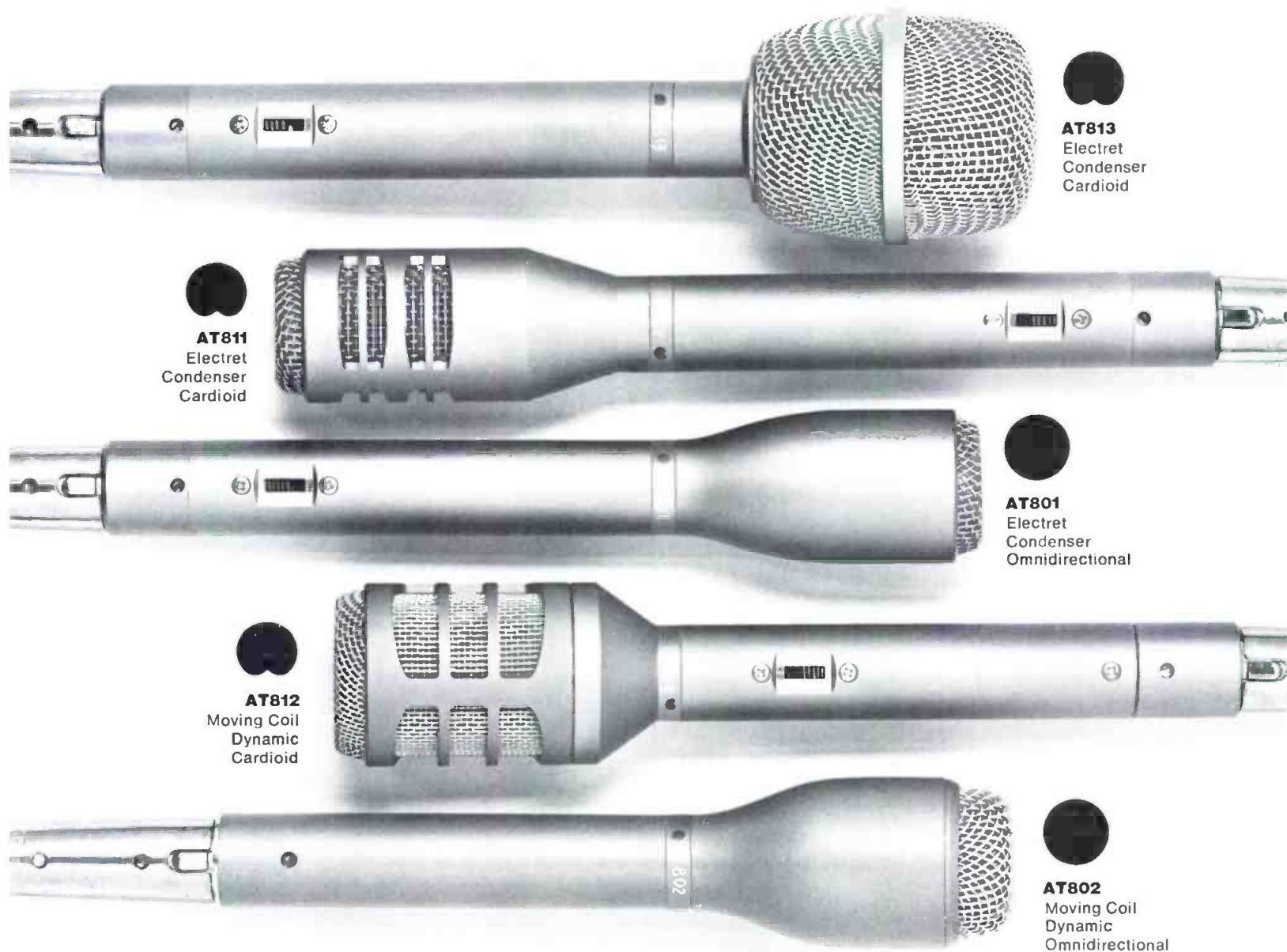

Every "live" recording has an excitement all its own. You must capture sound that will never be heard exactly the same again. And in some cases the recording is literally a once-in-a-lifetime chance. With no opportunity to remake the tape or disc.

Your creativity, your knowledge and experience are on the line. Now is when you appreciate the precision of Audio-Technica microphones. Performance is consistent. With results that help you extend your personal standards.

Audio-Technica gives you a choice of superb new electret condenser or moving coil dynamic microphones. A choice of omnidirectional or cardioid (unidirectional) pickup patterns. With smooth, extended response that complements the finest recorders. Audio-Technica microphones look, sound, and act very, very professional.

Add more than a little creative excitement in your life, with Audio-Technica microphones, today.

 **audio-technica**. *Great sound. right from the start!*

AUDIO-TECHNICA U.S., INC., Dept. 108BD, 33 Shiwasssee Avenue, Fairlawn, Ohio 44313 • In Canada: Superlor Electronics, Inc.

Circle 43 on Reader Service Card

[www.americanradiohistory.com](http://www.americanradiohistory.com)



# The Bottom Line Problem-Solver

## The Bottom Line

We're Audio Consultants. We solve problems; and there is no greater problem than that of high quality at low cost. In our industry, that's the "bottom line".

When a client needs a certain sound, we respond with more than just equipment. We respond with a system that's a problem-solver. And, our equipment must do the same.

That's why everything we produce functions within an area greater than its own . . . within the total system, the total solution to the problem.

Like our systems, our equipment must solve problems at the bottom line, delivering excellence at low cost.

## The Problem-Solver

One of our problem-solvers is the Starbird Microphone Boom.

The standard of quality for the industry, the Starbird reduces costly set-up time dramatically and assures maximum safety for studio personnel.

Its design permits quick and precise "spotting", with maximum extension and height flexibility. The swivel clevis provides 360-degree facing, while the adapters accommodate any microphone you select. The counterweight balances the microphone properly; and ball bearing, rubber-tired casters assure easy and noiseless movement.

The Starbird is simply the best. Ask the countless studios where it is solving problems every day . . . at the bottom line. Or, ask us. We'd like to tell you more.



**Accurate Sound Corporation**

114 Fifth Avenue / Redwood City, California 94063 / (415) 365-2843 / TELEX: ASCO 34-8327

**"Because Sound Comes From A System"**

### OCTOBER

- 24-26 **Society of Broadcast Engineers State of the Art Convention**, Kentucky Chapter. Ramada Inn Bluegrass Convention Center, Hurstbourne, La.. Louisville, Ky. Contact: R. J. Klein KY ETV, 600 Cooper Dr., Lexington. Ky. 40502. (606) 233-0666.
- 24-25 **Institute of High Fidelity Top Management Seminar**. Doral Inn. New York, N.Y. Contact: Gertrude Murphy. IHF, 489 Fifth Ave., New York. N.Y. 10017. (212) 682-5131.
- 29-11/2 **Society of Motion Picture & Television Engineers Conference**, New York City, Americana Hotel. Contact: SMPTE Conference, 862 Scarsdale Ave., Scarsdale, N.Y. 10583. (914) 472-6606.
- 10/31-11/2 **World Energy Engineering Congress**. Atlanta, Ga., Dunfey Atlanta. Contact: Assoc. of Energy Engineers, 464 Armour Circle, N.E., Atlanta. Ga. 30324. (404) 874-8188.

### NOVEMBER

- 3-6 **Audio Engineering Society Convention**, New York City, Waldorf-Astoria. Contact: Almon H. Clegg, Panasonic Corp.. 1 Panasonic Way, Secaucus. N.J. 07094. (201) 348-7768.
- 1-3 **Effective Communication for Engineers**. NYU. Los Angeles. Ca.
- 8-10 **Management of New Technology Projects**. NYU. Atlanta. Ga.
- 6-8 **MIDCON '79 Electronic Show & Convention**. O'Hare Exposition Center, Chicago, Ill. Contact: Midcon/79, Suite 410. 999 Ca. 90245. (213) 772-2965 or N. Sepulveda Blvd., El Segundo. Ca. 90245. (800) 421-6816.
- 7-10 **SCI COM '78**. Chicago Museum of Science and Industry. Films, videotapes for science subjects. Contact: American Science Film Association. 3624 Science Center, Philadelphia. Pa. 19104. (215) 387-2255.

### DECEMBER

- 12-14 **MIDCON Electronic Show & Convention**. Dallas Convention Center, Dallas, Texas. Contact: Electronic Conventions, Inc., 999 N. Sepulveda Blvd., El Segundo, Ca. 90245. (213) 777-2965 or (800) 421-6816.

# Part of every great performance

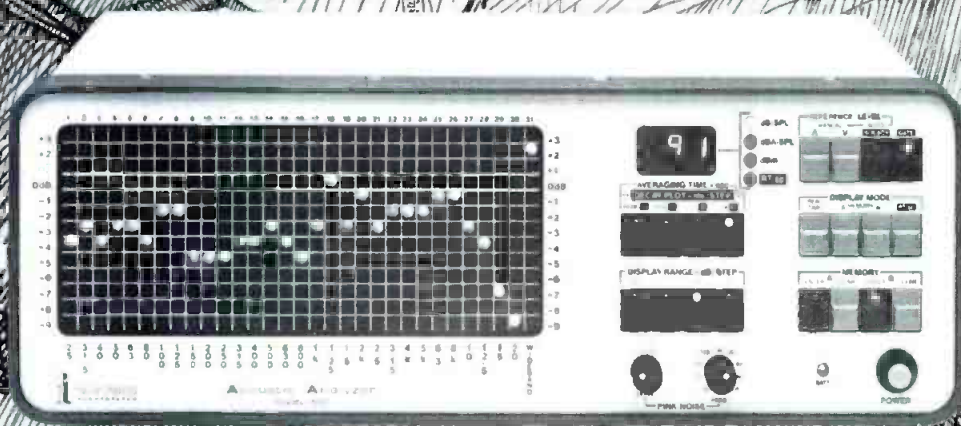

## Inovonics Model 500 Acoustic Analyzer

Here's everything you need for one-third-octave sound-level and reverberation-time analysis in one easy-to-use package... Inovonics' Model 500 Acoustic Analyzer.

In the real-time mode, Model 500 shows you wideband or weighted SPL readings in each one-third-octave band from 25 Hz to 20 kHz. You set the reference level you

want, or Model 500 will seek the proper level automatically over a 100 dB range in 1 dB steps. The built-in pink-noise generator supplies you with wideband or octave-band test signals.

Then, touch a button for the RT<sub>60</sub> mode. The digital display shows reverberation time up to 10 seconds with 10 ms resolution, while the LED matrix plots the decay characteristic.

Rear-panel connectors provide an external oscilloscope output, an auxiliary test signal input, and digital I/O interface. The Inovonics 500 is ready for peripherals.

This rugged, lightweight, precision instrument goes wherever you go. From the freeway interchange to the auditorium, concert hall,

and laboratory. The Model 500 is completely self-contained, and comes to you with an internally charged battery.

For accurate, dependable level response and reverberation analysis, the sound choice is Inovonics' Model 500 Acoustic Analyzer. It's part of every sound design. Call or write us today for all the details. Model 500-\$2750.

### Inovonics Inc.

503-B Vandell Way  
Campbell, CA 95008

Telephone  
(408) 374-8300



Exclusive export distribution through  
**Gotham Export Corporation**  
New York  
Telephone (212) 741-7411  
Telex 12-9269

## Transmission Distortions

● Broadcasting is an aural medium: its end product is audio at the receiving set. The program audio is created in the studios and then delivered to the listening audience by an rf transmission system. The rf system has shortcomings that place limitations upon the audio it can carry. Aside from these limitations, faulty components and operation can put back into the recovered audio many of the distortions we worked so hard to eliminate from the original audio signal. This month I will touch upon some of the ways the transmission can degrade the audio signal.

### SOME BASICS

The audio signal is placed on the rf carrier by a modulation process. Once on the carrier, it is no longer audio per se; it is rf. Although now an rf signal, it must still retain its internal relationships as well as those to the rf carrier.

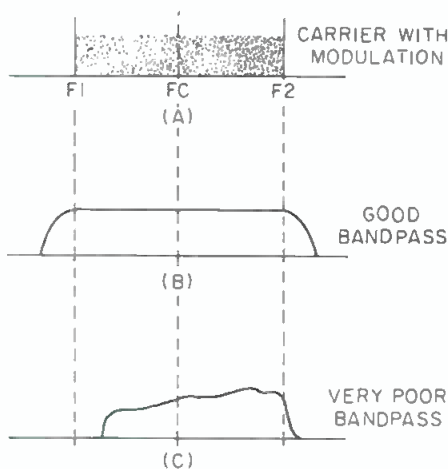

Figure 1. (A) Modulation creates bandwidth to the wave. All circuits which follow must have an adequate bandpass. (B) shows the circuit with a good bandpass for a typical wideband signal, while (C) is a very poor bandpass for that signal.

Should any of these relationships be altered, the recovered audio will be affected in some manner. Once impressed on the carrier, the entire entity becomes a modulated wave. A modulated wave requires far more spectrum space than an unmodulated carrier—how much space depends upon the type of modulation and the characteristics of the wave. The f.m. wave requires considerably more space than the a.m. wave. In a.m., there are two equal sidebands spaced from the carrier according to the frequency of the audio signal. In f.m., the amplitude of the audio directly modulates the master oscillator and causes the carrier to deviate above and below its normal resting space in the spectrum. At the same time, many sidebands are created. The space taken up in the spectrum by the modulated wave is the wave's bandwidth.

Since the audio, through the modulation process, creates the widening of the spectrum space, it becomes an integral part of that wave. Every circuit through which this modulated wave must pass on its way to the detector in the receiver must have a flat response curve across a bandpass at least equal to the bandwidth of the wave. Faulty components, mistuning, or anything else which can restrict or distort the system bandpass, will limit and degrade the modulated wave—and the recovered audio in some manner.

## PRESENTING a new and valuable DATA BOOK

The Standard Tape Manual is not a text book, but rather a practical and much-needed source for sophisticated users of magnetic recording equipment. Robert K. Morrison, international authority in the field and founder of Standard Tape Laboratory, recognized the need for compilation of material used in standardization efforts and compiled this practical tool. It is available as a limited edition.

The price of this book is \$45.00 prepaid. STL can serve all your needs with tapes in 2", 1", 1/2", 1/4" and 150 mil cassette sizes giving you the most accurate reference possible in the widest range of formats.

*Most catalog items can be shipped from our inventory the same day we receive your order.*

*Write or phone for fast delivery. Write for free catalog.*

**STL** STANDARD TAPE LABORATORY, Inc.  
26120 Eden Landing Road / #5 / Hayward, CA 94545  
(415) 786-3546

### INTERFACE

We can have a perfect audio system in the studio and a perfect rf transmission system, yet end up with degraded audio from the receiver. This can happen if there is a mismatch between the rf and the audio systems. Transmitter inputs are designed around standard impedance values: for audio only, 600 ohms balanced. For stereo composite and SCA, these are high impedance, unbalanced circuits.

Mismatch at this junction is purely an audio problem, even though one side of the circuit is the transmitter. And the same audio problems can ensue—poor response curve, phase shifts, poor signal level transfer. Matching is not ordinarily an operational factor, but one of set-up or test procedures. Making measurements and feeding the audio generator directly into the transmitter can result in erroneous indications and adjustments if the generator is not properly matched to the transmitter. Mismatching could occur if the limiting amplifier or unit which normally drives the transmitter has failed and the substitute unit used as a replacement has been set up differently, in another application, in the station.

(continued)

# THE NEW TAD\* DRIVER, IT GIVES YOU MORE BY GIVING YOU LESS.

The new one-inch TAD driver is truly unique. There is nothing else like it. Use it with your favorite horn and you'll get a frequency response from 800 to 22,000 Hz. So one speaker does the same job it used to take both a tweeter and super-tweeter to do. Saves weight. And money.

The secret is the TAD driver's beryllium diaphragm.

The diaphragm is the heart of a driver. It must be both light yet rigid. We used beryllium to achieve a standard of performance never before known to the professional. Every single tone — no matter how subtle or how complex — is captured and reproduced just the way it is played or recorded. The resulting sound is a revelation.

The quality of both parts and workmanship, plus the same care in assembly given a fine watch, makes the TAD driver a new standard for the entire industry. It allows the driver to reproduce frequencies up to 22,000 Hz without any major drop-off in response and permits it to withstand high input power.

If your job involves professional sound reproduction — on stage, in concert halls, in clubs or studios — you have an obligation to yourself to hear this remarkable driver.

With the arrival of the TAD driver the state of the art just took a quantum leap.

**TAD Technical Audio Devices**  
A Division of U.S. Pioneer Electronics Corp.  
142 Redneck Avenue, Moonachie, New Jersey 07074  
Telephone: (201) 440-8234



TO: Technical Audio Devices db  
142 Redneck Avenue  
Moonachie, New Jersey 07074

Please send technical data for the TAD product line. (Dealer inquiries also invited.)

NAME \_\_\_\_\_ (Please Print)

TITLE \_\_\_\_\_

COMPANY \_\_\_\_\_

DIVISION \_\_\_\_\_

ADDRESS \_\_\_\_\_

CITY \_\_\_\_\_

STATE \_\_\_\_\_ ZIP \_\_\_\_\_

PHONE (\_\_\_\_\_) \_\_\_\_\_ EXT. \_\_\_\_\_  
Area Code

TAD is an abbreviation for Technical Audio Devices, the professional products of U.S. Pioneer Electronics Corp.

See us in Room 12L at the AES Convention.

Circle 19 on Reader Service Card

Lexicon Digital Delays

# THE CLEANEST SOUND MADE

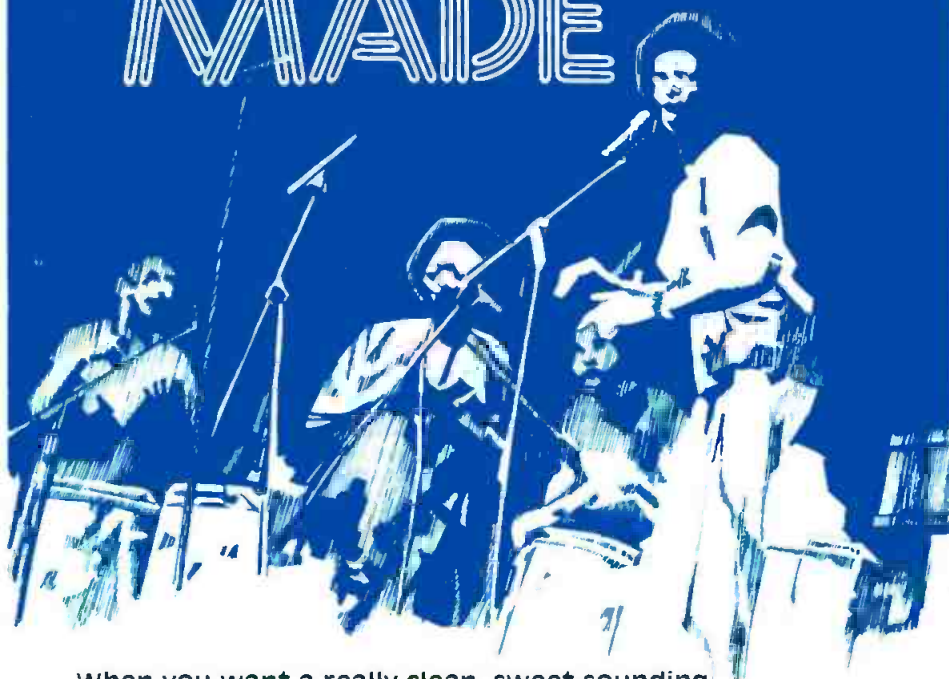

When you want a really clean, sweet-sounding delay for your lead vocals and instrumentals... and professional quality equipment that works *reliably* month after month and gig after gig...

Lexicon has the answer.

Our stereo 102-S is both versatile and exciting to use. It's the industry's only delay system with two independent delay lines in a single chassis. Couple them with our VCO module and you get special effects like you never had before. Our top of the line unit for major studio use.



Our new single-channel, two-output "Prime Time" Model 93 provides delay, mixing and special effects with audio just as clean as the 102-S. Its low cost, reliability and portability make it ideal both for studios and entertainers.

Write on your letterhead for AN-3, our free 24-page application note and demo record on a wide array of audio effects achievable by delay processing.

## Lexicon

Lexicon, Inc., 60 Turner Street  
Waltham, MA 02154 (617) 891-6790

Export: Gotham Export Corporation, New York, New York

Circle 32 on Reader Service Card

www.americanradiohistory.com

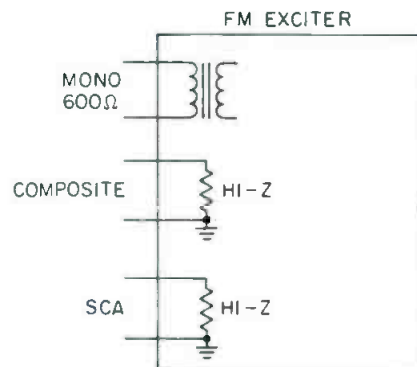

Figure 2. Audio inputs of the exciter are designed for standard audio impedance. Others are high impedance.

### SIGNAL LEVELS

Perhaps the most common cause of transmission distortions result from overmodulation of the carrier. The modulator requires a given level of input audio to produce the 100 per cent FCC limit on modulation. This is the design objective, and if the audio input exceeds this amount, distortions can be created right here at the modulator as well as down along the rf transmission system. Besides standard input impedances, the transmitter is designed around a standard input signal level.

The transmitter does not have operational input controls. Those which are provided are intended for set-up, and trimming controls. The operational control of the input audio levels must be done by external audio limiters or similar devices.

### A.M. MODULATION

The modulator in the a.m. transmitter requires considerably more audio signal level for full modulation than does the f.m. modulator. There will be several audio amplifier stages within the a.m. transmitter besides the modulator itself, which is an audio power amplifier. High input signal levels to the transmitter can overload these audio stages. The most common results of overload are peak clipping and intermodulation distortion.

The audio stages may be able to handle the high input audio level without distortion, but it will be applied to the rf modulated stage. With more than enough audio to fully modulate the carrier on negative going peaks, the carrier will be cut off during the peak portion of that signal. Cutting the carrier with high level audio peaks in this manner creates clipped audio negative peaks and other distortions in the recovered audio at the receiver, the severity depending upon the amount of overmodulation.

(continued)

# COMMUNITY

**The best sound equipment there is.  
Because from conception to completion  
we make no compromises.**

**We start with a job, not a market.**

Every Community horn, every cabinet was designed because there was a need for it, a particular professional application that no other product could fill. So that whether you are considering rock and roll for the masses or one voice speaking to one ear, Community has you covered.

**We engineer the physical design that precisely fills that requirement and construct it exactly as laws of physics dictate it must be built.**

If we can't do it correctly the first time around we work until we find a way. We won't bend it, we won't shorten it, because we found out a long time ago that you can't cheat physics. We don't use inferior materials because the result is always an inferior product. No gingerbread, no inadequacy. Just simple, straight-forward designs with the built-in toughness and strength that have become the hallmark of every Community product.

**We give our products the best warranty in professional sound.**

**We provide the most accurate, usable technical data available on horn-loudspeaker performance in the industry.**

No tricks, no inconsistencies, just factual information on what you can expect from us.

**We distribute through the most knowledgeable, reliable professional retailers in the country.**

Not every big city can boast a Community dealer, but a lot of small towns can, because we go where the talent is.

**In other words, we give our best so that you can give your best. We take pride in what we do and we sincerely believe that what we do is build superior pro sound equipment.**

**Try us. Our business is professional sound.**

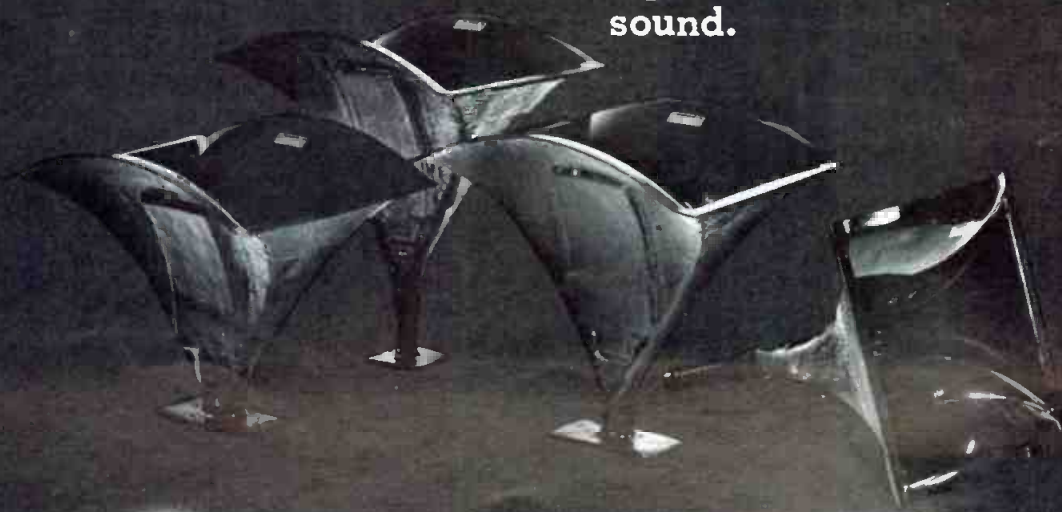

# Community

COMMUNITY LIGHT & SOUND, INC., 5701 Grays Avenue, Philadelphia, PA 19143 • (215) 727-0900

Circle 41 on Reader Service Card

Perfection in duplicating.



### The Garner 1056 High Speed Professional Tape Duplicator.

You'll get perfect dubs time after time with Garner's common capstan drive. It drives the master and 5 slaves at consistently the same speed. And Garner uses only glass bonded ferrite recording heads—which outwear ordinary metal heads 10 to 15 times. In addition to quality and accuracy, the 1056 is fast—2 minute tape loading and 60 ips duplicating speed. The 1056 has a 3-year mechanical and a 1-year electronic warranty. Garner is the choice of professionals. You'll see why.



Look to Garner for quality electronic audio and video products. For more information write or call:

**GARNER INDUSTRIES**

4200 N. 48th St., Lincoln, NE 68504  
Phone 402-464-5911

Circle 55 on Reader Service Card

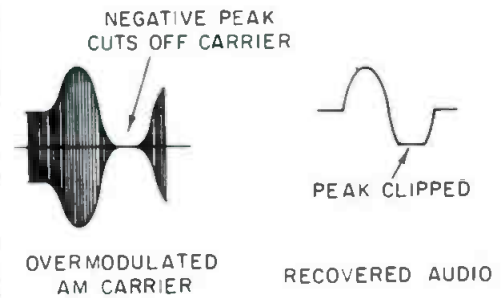

Figure 3. Overmodulation of the a.m. carrier on the negative peaks will cause the audio peak in recovered audio to be clipped.

### MEASUREMENT ADJUSTMENTS

During a maintenance period when measurements are being made on the a.m. transmitter, higher than usual distortion figures may be indicated, in spite of the fact that the modulation and input levels are correct. The modulators and the modulated stage can age so that they become somewhat non-linear, a condition which creates distortion. Balancing the modulators for minimum distortion ordinarily requires adjustment of the bias on each of these stages. Changing the bias can increase the gain of the modulator so less input level to the transmitter is now required. If the input, for example, now requires 1/2 dB less than previously for 100 per cent modulation, the limiter or other driving amplifier at the input of the transmitter must also be reduced by the same amount. If this is not done, that increased 1/2 dB can cause 5 per cent overmodulation during programming. Consequently, the peak will be clipped and distortion result, perhaps far more distortion than was removed by the adjustment in the first place.

### POWER REDUCTION

Many a.m. stations are required by FCC Rules to cut back transmitter output power at sunset every day. This reduction can be considerable, for example 5 kW day to 1 kW night. It requires a correspondingly smaller amount of audio to fully modulate the lower rf power level. This is usually accomplished within the transmitter by switching in an audio pad, or a trimming potentiometer for accurate balance. Any fault in this circuit could cause severe overmodulation at the lower power level. Components will age after a time, so it is necessary to check for correct balance and then trim the audio when necessary to accomplish this.

### FM OVERMODULATION

Most f.m. transmitters use direct modulation. A pair of solid state.

(continued)



SERIES 4300 ACTIVE EQUALIZERS

### A new standard in equalizers!

- 28 ONE-SIXTH octave bands from 40 Hz through 894 Hz on and between I.S.O. one-third octave centers
- 13 one-third octave bands from 1000 Hz through 16 kHz on I.S.O. centers.
- 10 dB boost or cut on continuous, calibrated, Mil-Spec controls
- Equal Q in both boost and cut conditions
- Precision inductors in magnetically shielded enclosures for maximum hum rejection
- Noise guaranteed — 90 dBv or better
- Accessory socket to permit insertion of 12 dB/octave or 18 dB/octave low-level crossover networks for bi-amping or tri-amping
- Mid and high frequency output trimmers accessible from front panel
- Input attenuation control variable to 20 dB of attenuation accessible from front panel
- Variable high-pass filter 20 Hz through 160 Hz, 12 dB/octave
- Security cover

ONE SIXTH OCTAVE REAL TIME ANALYZERS AVAILABLE.



**instruments incorporated**  
P.O. BOX 698 AUSTIN, TEXAS 78767  
512/892-0752

Circle 53 on Reader Service Card





## when cost is more important than price

Value conscious recording engineers specify the Studer B67 because it outperforms its competitors on the criteria that matter most to the discriminating recordist:

- Studer state-of-the-art performance
- Long service life with low failure rate
- Speed and ease of user maintenance

If you've ever had to scrub a session because of a faulty recorder, you'll understand why we talk about total cost rather than price. Write to us for complete information on the superiority of the Studer B67 recorder. We'll show you why it's your wisest tape recorder investment.



Circle 44 on Reader Service Card

# STUDER

Studer Revox America, Inc., 1819 Broadway, Nashville, Tenn. 37203 / (615) 329-9576 • In Canada: Studer Revox Canada, Ltd.

[www.americanradiohistory.com](http://www.americanradiohistory.com)

# Meet AKG's "New Professionals"

AKG is a research, development and manufacturing organization specializing in electro-acoustic technology. Our designs have been awarded over 600 transducer related patents, and our products have earned the highest degree of user respect for quality and dependability.

The AKG line of various microphone models is considered to be the most sophisticated available for applications ranging through the spectrum of professional uses. From studio, to in-concert recording and reinforcement, to location film sound...our products can be called on to solve the most difficult situations you may encounter. AKG has developed a broad range of products to meet your varying creative requirements and, as new audio frontiers evolve, our engineers will lead the technological pioneering.

We set our goals rather high

and turn every stone to live up to, and improve upon, self-imposed challenges. We constantly strive to advance beyond state-of-the-art developments. Some of these advancements you see illustrated below. Loaded with practical, innovative features, AKG's "New Professional" microphones are intended to further build upon the remarkable results achievable with the other AKG "Professionals." Ask your dealer or write:



**PHILIPS AUDIO VIDEO SYSTEMS CORP.**  
A NORTH AMERICAN PHILIPS COMPANY  
91 McKee Drive, Mahwah, N.J. 07430 • (201) 529-3800

The Mark of Professional Quality...  
in microphones, headphones,  
phonocartridges, reverb units.

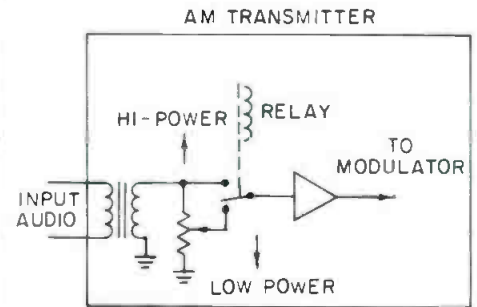

Figure 4. Typical arrangement to reduce the audio when the rf power is cut back in a.m.

voltage variable capacitor diodes are placed across the frequency-determining tuned circuit of the transmitter's master oscillator. Any change in capacity in this circuit will directly change the carrier's frequency. This amplitude of the audio input signal is applied across these diodes; this will change their capacity a corresponding amount. Changing the capacity, in turn, changes the carrier frequency a corresponding amount. The FCC specifies 75 kHz on each side of the carrier resting position as 100 per cent modulation. The modulator is designed for linear operation on standard input levels within this range.

When the audio input levels are too high, the modulator can be driven into non-linear regions and distortion results in the recovered audio. Should the diodes become non-linear in the normal range, distortion will result with normal input levels and modulation. More than one input can modulate the carrier at the same time. If the modulation was set for 100 per cent with the composite only, for example, when the SCA channel comes on, the transmitter will be overmodulated by 10 per cent. Another factor is the 75 microsecond pre-emphasis in the audio input. If the audio has considerable high frequency energy, the boost by this pre-emphasis can severely overmodulate the transmitter or move into non-linear regions of the modulator. Aside from distortion in the modulator, a restricted band-pass along the system is a common cause of distortion. The fully modulated f.m. carrier is a very wideband wave. The system should have a band-pass of at least 200 kHz or better.

## MONITORS

Besides accurately adjusting the audio and rf system for correct modulation levels, program modulation must be continuously monitored so the operator knows the station is within FCC limits in addition to listening to

(continued)

## Waters MM faders mean more mixing in less space

With Waters 3/4-inch thin-line conductive plastic faders you can cram 24 channels into an 18-inch mix bay for high density recording studio applications, sound reinforcement and location mixers, and lighting control consoles.

Waters MM faders retain all the superior quality of our accepted LM series including choice of 2 3/4-inch or 4-inch travel; 600 ohm or 10 k impedance; linear, audio or true log characteristic; and our famed trouble-free long service life. For more mixing in less space circle reader service number or call Don Russell at 617-358-2777 for more information about thin-line faders.



**WATERS MANUFACTURING, INC.**

LONGFELLOW CENTER, WAYLAND, MA. 01778 • (617) 358-2777

Circle 30 on Reader Service Card



## From now on your store or plant needs these three switches

### Changes in distortion standards

Expect some new types of questions from your customers soon about distortion measurements.

Because you will find that the Institute of High Fidelity recently introduced a change in the type of measuring circuit to be used in distortion measurements on amplifiers.

For example, current IHF standards require an **rms-responding** meter circuit for measuring amplifier distortion, but an **average responding** meter for measuring receiver distortion.

What's more, when making total harmonic distortion measurements with either type of circuit, it can be important to know what the distortion **peaks** measure. Because peaks can be large even though rms or average values are small.

### Your choice of three responses

So in the new Sound Tech 1701A Distortion Measurement System, we now give you **three metering circuit responses**.

You can measure with an **average**, **rms** or **peak** circuit. Just push the desired button.

### Measure lower distortion, too

Sound Tech distortion analyzers have become the industry standards. When they were introduced four years ago, they gave nearly a 10-times improvement in distortion range and a 100-times increase in ease of use.

Now our new 1701A improves the distortion range even more — to .001% from 10 Hz to 10 kHz. Overall distortion measuring capability continues superior over the full 10 Hz to 110 kHz range.

There's lots of more features, too, including our automatic set level and intermodulation distortion options, balanced input circuit for measuring bridged amplifiers, and lower distortion tracked signal source.

### Demos and clinics

The 1701A is just what's needed to demo receivers, amplifiers, and other audio equipment to your customers. For clinics, too.

It will give your store the prestige of technical leadership in your area.

And in receiver/tuner production, it's the only such instrument that will give the various types of distortion information you need.

### Call for data

Be prepared for customer questions. Get the details now on the 1701A by calling Mike Hogue or Larry Maguire. Or send in the coupon. Now.

### SEND FOR FREE INFORMATION

To:  
**SOUND TECHNOLOGY**  
1400 Dell Ave.  
Campbell, Ca. 95008

Name \_\_\_\_\_

Firm \_\_\_\_\_

Street \_\_\_\_\_

City, State \_\_\_\_\_

Zip \_\_\_\_\_

Phone \_\_\_\_\_

**ST**<sup>®</sup>

**SOUND TECHNOLOGY**

1400 DELL AVENUE  
CAMPBELL, CALIFORNIA 95008  
(408) 378-6540

In Don Mills, Ont., Canada: The Pringle Group

Circle 23 on Reader Service Card

www.americanradiohistory.com

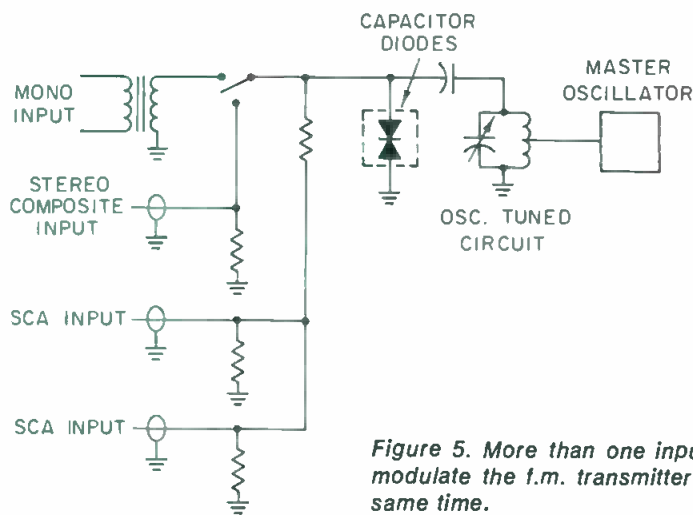

Figure 5. More than one input can modulate the f.m. transmitter at the same time.

what is on the air. Set-up adjustments and operations require some accurate standard of measurement. The monitor can do this, but it must be calibrated properly if it is to indicate accurately.

An oscilloscope and tone modulation can be used to calibrate the a.m. monitor. Set the peak flasher adjustments and the meter adjustments for accurate 100 per cent negative modulation. During programming, however, use the peak flasher as the more accurate indication of overmodulation. The meter circuit will not provide true peak indications on program material.

The f.m. monitor can be calibrated with a spectrum analyzer if one is available, or the method as old as f.m. can be used: tone modulation of the carrier, a communications receiver and the Bessel Zeroes, or nulls. With 100 per cent tone modulation of the carrier, operate the positive and negative switches to note if both peaks are equal. If they are not, there can be some non-linearity of the signal in the rf system.

#### THE RECEIVER

The equipment at the receiving end of the transmission system can do much to degrade the recovered audio, but we can do nothing about it. Poor receiver design, limited and distorted bandpass, poor design in the audio stages, the speakers, plus faulty components, mistuning, multi-path reception, antenna and so forth can all have a definite bearing on what the listener hears. Yet another factor in the design of the receiver is the lack of filtering to sort out the various signals into their own channels. This enters the picture when the f.m. station is in stereo, or mono, and in SCA in either mode. Unless there is actual cross-talk among these various channels occurring at the transmitter, they can show up here as birdies, 10 kHz whistle, etc. without proper filtering in the receiver.

#### RECAP

The rf transmission system can distort the recovered audio signal. We have touched on only a few of the areas in the rf system where distortions can arise. There are many other possibilities. From the operational view, overmodulation and improperly calibrated monitors can be a common area of distortions. Modulated carriers have greater bandwidth and require a comparable bandpass of all circuits through which they must pass. At the end of the system, a cheap receiver can undo just about everything we have tried to accomplish with the audio. ■

**The 3201**

**NEUTRIK Audiotracer**

This high quality, Swiss-crafted instrument represents an outstanding advancement in electro-acoustic measuring. Compact, portable, and completely self-contained, the 3201 covers a wide range of acoustic and electronic parameters from transducer frequency responses to complete audio system measurement. And the 3201 is designed as the first unit of a full tracing system currently in development. Write or call for all the details today:

**NEUTRIK PRODUCTS**

PHILIPS AUDIO VIDEO SYSTEMS CORP.  
A NORTH AMERICAN PHILIPS COMPANY  
91 McKee Drive Mahwah, N.J. 07430 • (201) 529-3800

Circle 15 on Reader Service Card

# Soundmixers enjoys noise-free recording with 84 channels of dbx tape noise reduction.



Harry Hirsch, President  
Soundmixers, New York City.

**dbx**

dbx, Incorporated  
71 Chapel Street  
Newton, MA 02195  
(617) 964-3210

**UNLOCK YOUR EARS**

*Circle 20 on Reader Service Card*

[www.americanradiohistory.com](http://www.americanradiohistory.com)

# Boilermaker

PRESENTS THE  
**\$100**  
MICROPHONE  
STAND



Sure, they come cheaper. But only Boilermaker gives you all these top quality features: 6061 aluminum alloy, machined steel base . . . a choice of five show-stopping colors to choose from.

If you can tolerate only the best in your act, act now and call us for all the details.

# Boilermaker

BY NORTHWEST SOUND

3497 N.W. Yeon Avenue  
P. O. Box 3556  
Portland, Oregon 97205  
(503) 223-1924

MARTIN DICKSTEIN  
**db Sound With Images**

## The Space Camera and Related Subjects

• Can you recall how far back the first space camera was used in a space vehicle? We're not going to tell you. You can do your own research. What is interesting, though, is that a new camera is being developed by RCA under contract to the NASA Johnson Space Center. It will be similar to the ones used in the Apollo lunar surface adventure. Those were also developed by RCA.

This camera system contract will be up around \$10.5 million and will transmit live color and black and white t.v. pictures during the manned orbital Space Shuttle flights. The Space Shuttle is a recoverable launch vehicle that can be reused to place multiple payloads into orbit. It is launched like a rocket, orbits the earth as a satellite, and returns to the ground as an unpowered aircraft. That portion of the Shuttle which flies into space is called the Orbiter.

The closed circuit system will be installed on the Space Shuttle for earth orbital missions starting in 1979 and subsequent flights scheduled for 1980. RCA will provide up to fifty cameras for approximately 500 shuttle flights planned over the next ten years. Each Space Shuttle Orbiter can carry up to six t.v. cameras as part of the closed circuit system. The camera system is intended to assist the crew of the Shuttle in performing the complex tasks of deploying, retrieving and servicing spacecraft in orbit.

The system on each flight will consist of several t.v. cameras, a video control unit, pan and tilt mechanisms, and monitors. The system will use the standard 525 lines of the US NTSC broadcast system. Cameras will be installed in the crew compartment, in the cargo bay, and on a remote manipulator arm. Within the cargo bay, camera positions will be located at the forward and aft bulkheads and in the

*A space shuttle closed circuit t.v. system.*

### Space Shuttle Closed Circuit TV System

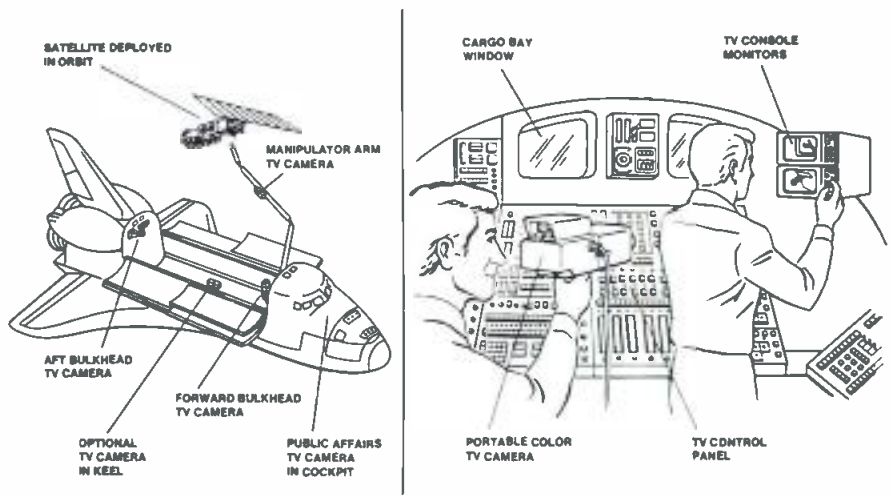

RCA ILLUSTRATION

# Birth of the two-track masterpiece. Otari MX5050-B.

The new Otari two-track machine is designed for discriminating recordists. Built with inside-out improvements over our long succession of compact professional recorders. With built-in operation ease and better serviceability. With fidelity, reliability and professional functions indispensable for every critical application you have in mind.

DC-servo direct drive for minimum wow/flutter and speed deviation. With  $\pm 7\%$  pitch control and foolproof IC motion-sensing control logic. Optional remote control for all transport and mode functions. Maximum 30dBm input and 600 ohm +4dBm or -10dBm switch-over output with XLR connectors. Front-panel edit and cue, test oscillator, stepless bias and NAB or IEC equalization. Full professional four heads with extra quarter-track playback. And it's designed for both vertical and horizontal operation.

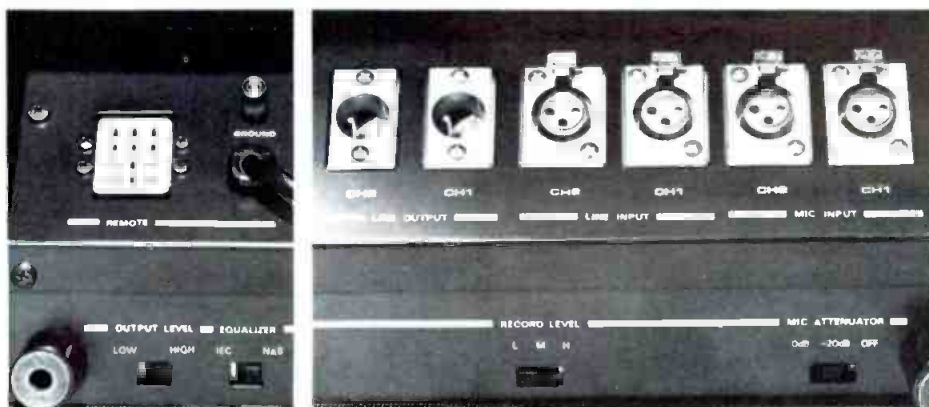

Resultant performance: smooth punch-in/punch-out mastering at 63dB S/N, 55dB crosstalk and 70dB erase with 30Hz - 20kHz ( $\pm 2$ dB) response. It's the latest and wisest choice for your quality 15/7-1/2 or 7-1/2/3-3/4 ips masters. For the full story about the new generation recorder/reproducer, contact your nearest Otari dealer and see why we call it the masterpiece.

## OTARI

U.S.A.: Otari Corporation,  
981 Industrial Road, San Carlos, California 94070.  
Phone (415) 593-1648

Japan: Otari Electric Co., Ltd.  
4-29-18 Minami Ogikubo, Suginami-ku, Tokyo 167.  
Phone (03) 333-9631

Circle 40 on Reader Service Card

www.americanradiohistory.com

# A Really Good De-Esser Shouldn't Do Anything Else.

The Orban 516EC Dynamic Sibilance Controller is the de-essing *specialist*. It inaudibly removes excessive sibilance from voice while retaining brilliance and crispness. Sibilants are reduced to levels that sound natural and that transfer to disc, optical film or cassette without distortion.

Your Orban dealer can show you how the 516EC de-esses quickly and effectively. See your dealer or write us for his name and a brochure with the complete 516EC story.

## orban

**Orban Associates Inc.**

**645 Bryant Street, San Francisco, CA 94107 (415) 957-1067**



keel. The camera in the crew compartment will be portable and capable of beaming "live" telecasts in color to earth monitoring stations. This portable unit could also be used by an astronaut in any extra-vehicular activity (EVA). The astronaut could leave the crew compartment with the hand-held unit and investigate areas of the vehicle that are not adequately covered by the mounted cameras.

### PORTABLE CAMERA

The portable camera will be equipped with its own viewfinder to enable the astronaut to focus accurately on an object in space, such as the moon or a free-flying satellite, or on any part of the vehicle. The fixed cameras will be black and white units with full pan and tilt movement. These cameras can be controlled remotely by either the crew or by the ground control personnel at NASA's Johnson Space Center. These units will be supplied with multiple focal length zoom lenses. The cameras will weigh about 14 pounds and measure 15½ inches long by 5 inches high by 5½ inches wide. They will contain a silicon-intensified-target (SIT) vidicon tube. This tube is relatively immune from damage by high brightness and provides high sensitivity to low light level conditions. The cameras will have interchangeable lens assemblies for color and black and white pictures.

### S.M.P.T.E. CONFERENCE

Speaking of space video equipment and delivery systems reminds me that the S.M.P.T.E. will be holding its 120th Technical Conference in New York from October 29 to November 2. One of the subjects that will be covered in the sessions relates to the space shuttle, including discussions of *Future Developments in Satellite Communications, Transmission of Four Simultaneous Television Programs via a Single Satellite Channel, Remote Control of Earth Systems*, and more.

Other subjects to be covered at the conference are *Digital Television, Sound Technology* in two separate sessions, *Video Production*, and topics related to film production, film-to-tape and tape-to-film transfers, and video-disc special effects, editing, and applications.

In addition to the technical sessions, the conference will have an exhibition of professional motion picture and television equipment. More than 100 companies have signed up and there will be more than 200 booths. Among the exhibitors planning to be there will be Belden, Bell & Howell, Robert Bosch Corp., Chyron Telesystems, CMX Systems, Convergence Corp., Marconi, Rangertone, Sennheiser, Tek-

Circle 52 on Reader Service Card



# PROFESSIONAL

**Nashville, the Center of Country Music,  
is Stanton Country, too!**



*Kitty Puckett checks out 45 rpm stamper, while auditioning one at 33 1/3 rpm.*

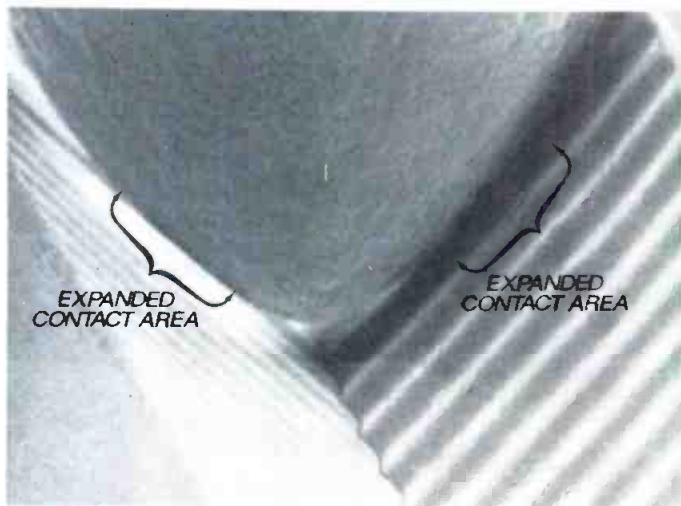

*Scanning Electron Beam Microscope photo of Stereohedron® stylus, 2000 times magnification; brackets point out wider contact area.*

© STANTON 1978



# STANTON!

Circle 45 on Reader Service Card

Nashville Record Production, Inc., uses Stanton exclusively throughout its Disc Cutting Studios. Naturally, they are mostly involved with Country Music, but they also get into Pop and Rock.

John Eberle states that they use the Stanton Calibrated 681A "for cutting system calibration, including level and frequency response"...and they use the Calibrated 681 Triple-E in their Disc Cutting operation...with plans to soon move up to the new Professional Calibration Standard, Stanton's 881S.\*

Each Stanton 681 series and 881S cartridge, is guaranteed to meet its specifications within exacting limits, and each one boasts the most meaningful warranty...an individually calibrated test result is packed with each unit.

Whether your usage involves recording, broadcasting, or home entertainment, your choice should be the choice of the Professionals...the Stanton Calibrated Cartridge.

*For further information write to: Stanton Magnetics, Terminal Drive, Plainview, N.Y. 11803.*

tronix, TeleMation, Thomson-CSF, and more than a half dozen companies from England.

Last year more than 6,000 people attended. This year expectations are for even more. Make it if you can.

### VIDEO EXPO

Speaking of conventions and conferences. Knowledge Industry Publications of White Plains, N.Y. is again running its Video Expo. In May, they had the conference in Chicago. The next meeting will take place in New York at Madison Square Garden from October 15-17th. In December, from

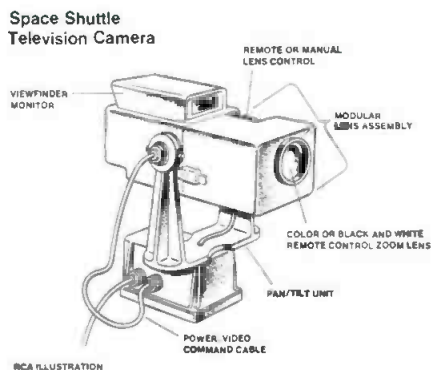

The space shuttle television camera.

the 5th to the 7th, the VideoWorkshops and exhibits will move, for the first time, to the Southwest. The Hyatt Regency Houston in Texas will be the conference site. Then, the whole affair moves to the West Coast. From February 20th to the 22nd, all the exhibitors and video experts will get together at the Jack Tar Hotel in San Francisco.

Each of these Expo locations will give those involved or interested in the video field to get the latest information on what's happening in hardware and software. The workshops and seminars will provide experts in all phases of the industry to instruct and direct hands-on sessions. In the New York meeting, over 110 exhibitors have signed up for space. The others will also have the best in exhibit equipment and software, as well as related services.

First, there will be a seminar on the *Introduction to Electronic Editing*, intended to be a review of where we are and where we're going in vtr/vcr editing. Then, there will be a seminar on *Audio Methods and Techniques*. This will include discussions on practical approaches to choosing, using, and expanding your audio system with emphasis on microphone selection, placement, set-ups, and other techniques for studio and location productions. (This session is intended for those in video who want to improve the audio of their video productions. Old hat to you guys, right?)

Then, there'll be a session on *Basic Lighting Skills*, another on *Learning to Read Video* (video meter, waveform monitor, vectorscope, and other specialized devices to read and interpret a video signal). Other topics will include *Advanced Electronic Editing*, *Interactive Television Methods and Techniques*, *Media Center Set-Up and Management*, *Hardware / Technology State-of-the-Art Report*, *Color VTR / VCR Problem Analysis and Diagnosis*, *Portable Video Production Techniques and Guidelines*, *Evaluating Color Cameras and VCRs*, and more.

In the exhibit area (which you can attend without going to even one seminar), you'll be able to discover what's new and coming in cameras, tape recorders, video projectors, tape equipment, cassettes, editing systems, accessories, etc. Among the exhibitors, there will be Adwar Video, Arvin/Echo Science Corp., BJA Systems, Devlin Productions, Dynasciences, Hitachi, Ikegami, Image Transform, Sharp, Sony, Tele Vue Optics, Video Components, and many, many more.

No kidding. This is one show you really should go to. East Coast, West Coast, or South West . . . no excuses.

## NEW FROM LEADER FREQUENCY RESPONSE ANALYZER SYSTEM.

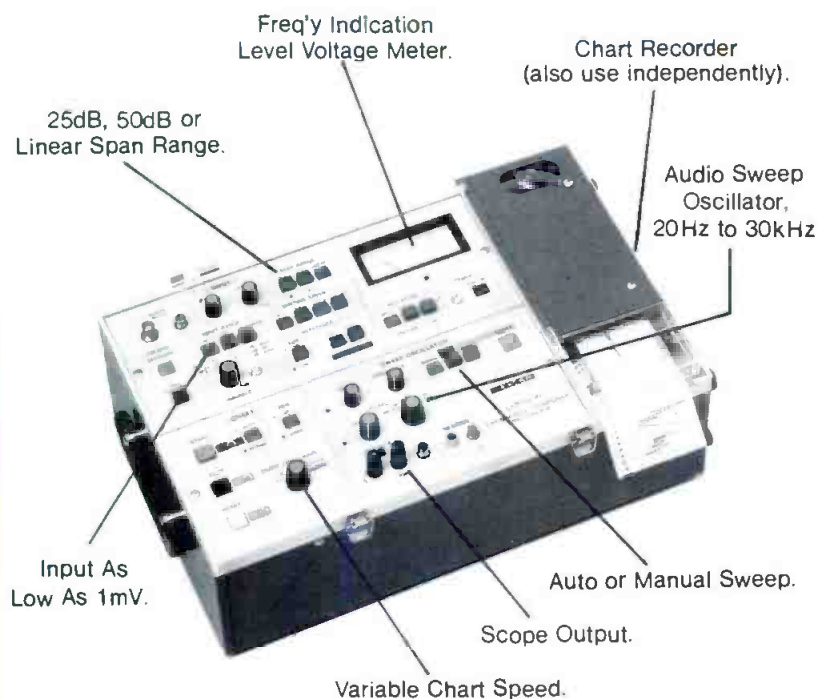

### Now, Hard Copy Readouts Of Audio System Performance . . .

- Tape recorder frequency response.
- Audio amplifier and receiver frequency response and signal-to-noise ratio.
- Cartridge frequency response.
- Wow & Flutter and drift.
- Filter design.
- Speaker design & evaluation.

**Model LFR-5600 . . . \$3195.**  
See your distributor or write for details.

151 Dupont Street, Plainview, N.Y. 11803  
(516) 822-9300  
Regional Offices, Chicago & Los Angeles

When Quality Counts . . .  
**LEADER**  
Instruments Corp.

Circle 29 on Reader Service Card

# A JBL MONITOR KNOWS ITS PLACE.

A studio monitor is only a tool. It is not supposed to enhance, add to, subtract from, or in any way modify sound.

That's your job.

What a studio monitor is supposed to do is tell you precisely what's on tape. Because you have to know everything that's there. And everything that isn't. Before it's too late.

That's why JBL monitors are in thousands

of recording and broadcast studios around the world. In fact, according to a national survey by Billboard Magazine, JBL's are in more recording studios than any other brand.

A JBL monitor plays what it's told. Nothing more. Nothing less. If that sounds good to you, contact your nearest JBL Professional Products Studio Equipment Supplier.

And put a JBL monitor in your place.

**The 4301:** Our newest 2-way monitor. Compact and efficient, for small broadcast control rooms and home studios. \$168.

**The 4311:** The most popular monitor going. A compact, full-range 3-way. \$333.

**The 4315:** An ultra-shallow 4-way, for maximum sound in minimum space. \$783.

JBL studio monitors come in three other models, too. All fully compatible for accurate cross referencing.



GET IT ALL.



James B. Lansing Sound, Inc. / Professional Division, 8500 Balboa Boulevard, Northridge, California

Be sure  
to attend...

THE  
AUDIO  
ENGINEERING  
SOCIETY'S

61st  
Technical  
Meeting and  
Exhibition of  
Professional  
Equipment  
at the  
Waldorf-  
Astoria  
November 3-6

For details,  
write or phone:

AUDIO  
ENGINEERING  
SOCIETY

60 East 42nd Street  
New York, N.Y. 10017  
[212] 661-8528  
and 661-2355

## Loudness and Things

● As might be expected, my column on matching, damping factor and such, in the July issue, brought some responses. Most of them concerned theory in much the same way as the question had come up—a more or less “overall” thing. But one of them introduced the question of load lines, and how things have changed since the days of tubes, when load lines were critical, to now, when switching devices, such as transistors, with lots of feedback, are the order of the day.

Of course, a lot has changed. But basic principles have not. Perhaps negative feedback was a bigger new thing than transistors or other solid state devices were. And for that reason, perhaps it is still less understood. Load lines are just as relevant, if less often used, with switching devices, as they were with tubes; maybe they're not as critical, but even that may be a matter of viewpoint.

The first tubes used for amplification—whether just with voltage amplification to provide gain or with power amplification to provide power—were triodes. Choosing an operating point, by laying a load line on these characteristics, enabled the right resistance load and supply circuit to be provided to get maximum output, whether voltage or power.

Because with a triode the slope of the characteristics represented a lower resistance value than the load into which the voltage or power was fed, triodes had what later became known as damping factor, greater than 1—or an internal resistance smaller than their load resistance.

### TETRODE AND PENTODE

Advent of the tetrode and later, the

pentode, produced a quite different family of plate characteristics. The slope of these characteristics is quite different from that of the triode and represents a high internal resistance, compared to any load that is used with them. The choice of the load line was more critical to getting maximum voltage or power.

The spacing between the characteristic lines was also less linear for the pentode than for the triode so that, until the advent of feedback, pentode outputs, while far more efficient, enabling bigger output from smaller power supplies, produced more distortion than triodes. In view of today's low distortion figures, we should put some figures in here.

Typical distortion, at maximum output level, for a triode was 5 per cent, mostly second harmonic. Typical distortion for a pentode at maximum output was 10 per cent, consisting of second, third, and even higher orders of harmonic. That was not all, these were measured into their ideal resistance load. As anyone knows, loudspeaker impedances spend a lot of their time being reactive, which makes an elliptical load line, increasing the contrast several fold.

### FEEDBACK

Then came feedback, to “straighten things up.” Unfortunately, it was more difficult to apply lots of feedback to a circuit using pentodes than to one using triodes because of their more complicated supply circuits; you had to decouple the screen voltage, and all that.

This led our old friend, Dave Hafler, to come up with something that seemed

# Crazy Like a Fox

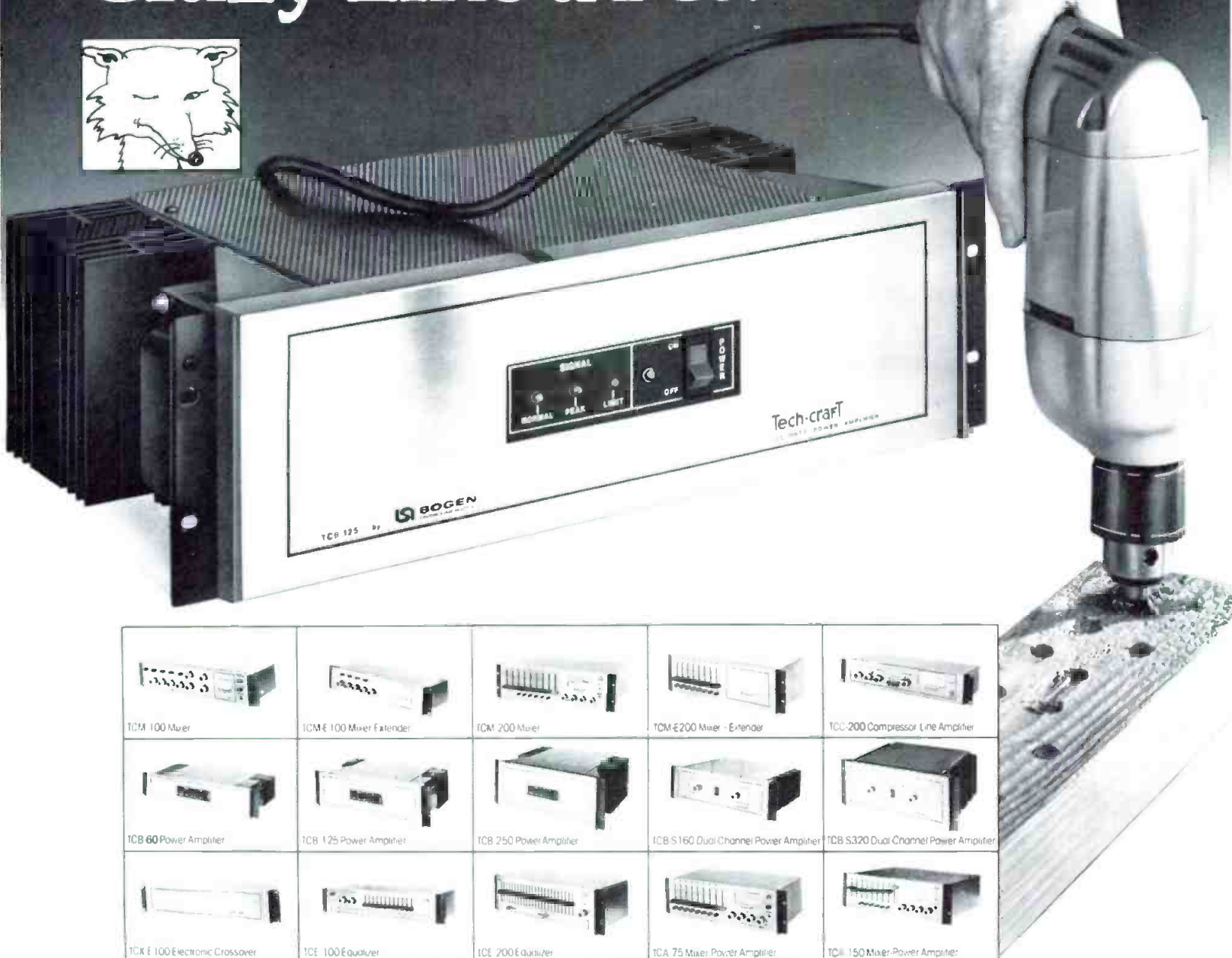
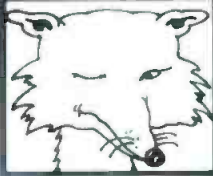

Drive a drill with a 125-watt audio amplifier? Of course you wouldn't. But we did... to prove a point. Our Tech-craft TCB-125 professional amplifier drove the drill for a solid week, continuously, even though we repeatedly clamped the chuck to overload it. Feeding an induction motor like that is one of the toughest torture tests you can give an amplifier, yet it drove the drill through a 2x4 again and again... thanks to our current limiting circuit which protected it from harm even under adverse overload. Crazy? Not if this unusual test convinces you that at Bogen, RELIABILITY is NUMBER ONE.

If it can handle a drill, you can be positive that a Tech-craft amplifier can handle any speaker load under virtually any conditions... beautifully. The performance specs include frequency response within  $\pm 1$  db from 20 to 20,000 Hz at rated output power... and total harmonic distortion less than 1% from 25 to 22,000 Hz, also at rated power.

What does it take to produce a line like Tech-craft? A company like Bogen.

The Tech-craft Professional Series incorporates all the knowledge and skill we've acquired during 45 years in sound. Yet it isn't encumbered by any earlier design concepts. We developed the entire series at the same time, using the latest state-of-the-art technology. It includes active mixers and mixer-extenders, single and

dual channel power amplifiers, mixer-power amplifiers, graphic equalizers, a compressor/line amplifier, and a wide range of accessories.

They are designed with unsurpassed features and specifications for today's sophisticated requirements, highest reliability and total system compatibility. We believe they offer the finest values in professional sound equipment.

Availability? Who but Bogen delivers a line like this from stock?

One last point. The drill we drove was made by another LSI division, National Twist Drill and Tool. They're tops in their field, too, and we mention it to emphasize the vast technological resources that stand behind us as part of a \$1 billion corporation.

ALL BOGEN PRODUCTS ARE G.S.A. - LISTED.

For more information, please write or phone us.

**Tech-craft**  
PROFESSIONAL SOUND by  
**BOGEN**  
A DIVISION OF LEAR SIEGLER, INC.  
P.O. Box 500, Paramus, NJ 07652  
(201) 343-5700

Circle 16 on Reader Service Card

to get the best of both worlds: using a special kind of output transformer, he made a pentode tube work as something in between a triode and pentode, an effect known as *ultra linear*. To explain this—any pentode can be run as a triode by strapping its electrodes together so the screen voltage moves with the plate voltage.

That produced an operation that was no more efficient than a triode, since in effect it was a triode; connecting it as a pentode got much more power, but with much bigger distortion too. The ultra linear connection got much more power—almost as much as pentode connection—with much less distortion. It also made the application of larger lumps of feedback easier than it was with pentode connection.

### TRANSISTORS

Finally came transistors. The first thing that engineers noticed was that the collector current-voltage characteristics, working grounded emitter, are very like the pentode characteristics of a tube. But the circuit is much simpler than that in a tube because the transistor is a triode, not a pentode. Its load impedance, if not its internal impedance, is much lower than that

of a pentode, which make larger amounts of feedback possible too.

Further, it can be operated as a grounded collector, instead of as a grounded emitter, which makes it like the cathode follower used during tube days. When complementary pairs are employed they do not even need an output transformer to get push-pull coupling. So the transistor eliminates a whole lot of problems that came with the pentode tube, in spite of their similarities.

When the transistor is used as a grounded collector, it functions more like a tube than in any other mode. In the more conventional grounded emitter mode—which is the mode in which characteristics are usually taken—the characteristic lines represent increments in input base current, where the lines for a pentode tube represent increments in input grid voltage.

But when you change to a grounded collector operation, which merely means that the collector, instead of the emitter, stays at a constant voltage, what the base needs more than a current swing is a voltage swing, just like its tube counterpart, the cathode follower. It's true there is a current swing input which the tube cathode follower does not have, but in other respects the operation is identical.

In fact, the grounded collector transistor amplifier makes a more perfect impedance multiplier or divider (according to which way you view it) than the tube ever did. The voltage at the base and emitter, just like the voltage at the grid and cathode in the case of a tube, are close to identical (much closer than for the tube) while available current—creating the output—is multiplied at the emitter, as compared with the base, by the current gain of the transistor.

But getting back to transistor characteristics and their similarity to the pentode tube characteristics: load lines are determined in essentially the same way. Both a tube and a transistor have a maximum dissipation line, in the form of a hyperbola (shown dashed in the figures). Both have a maximum voltage which, when operated in Class B so the unit is cut off when it gets its maximum voltage, is close to double the operating voltage.

This means that the operating voltage needs to be about half the maximum voltage in each case. For maximum current, the limitations are little different but, operationally, their effect is similar. For the tube, maximum current depends on the point where the grid voltage crosses from negative to zero, because at that point the grid

# The ADR Compex-Limiter... ... one of my favourite things says Lee De Carlo\*

*"I've been using ADR's Compex-Limiter for well over a year — always with the same gratifying results.*

*It's capacity for effects seems endless while its reliability in its performance as a Compressor; Peak Limiter and Expander/Gate is only surpassed by its flexibility in these same modes.*

*I use it constantly — it is one of my Favourite Things.*

*P.S. If there is a fire in the studio and a Compex-Limiter is destroyed, it is probably better to buy a new one."*



\* Lee De Carlo is Chief Engineer for 'Record Plant Studios' working with such artists as Aerosmith, Aretha Franklin, The Rolling Stones, Angel, and Frankie Miller.



**F 760X-RS COMPEX-LIMITER features:-**

- \* Separate Peak Level Limiting with
- \* Multi-Ratio Variable Threshold Compressor and
- \* Noise-Reducing Expander with Gate option
- \* 19" Rack Mount with integral Power Supply
- \* EXCELLENT TECHNICAL SPECIFICATION

**audio & design recording inc.**

Gregg Dixon, PO Box 23047, Honolulu, Hawaii 96822 Tel: (808) 845 7226

Nigel Branwell, PO Box 902, Marina, Calif. 93933 Tel: (408) 372 9036

Circle 34 on Reader Service Card

www.americanradiohistory.com



**MODEL 2710 ONE-THIRD OCTAVE  
SUPERGRAPHIC EQUALIZER:**

Fine Adjustment Covering the Audio Spectrum  
Gives Professional Sound Man More Control  
Balanced Input and Output  
Highly Portable in Studio or on Tour

**MODEL 2709 ONE-THIRD OCTAVE  
REAL TIME ANALYZER:**

Nine Amplitude Display Steps Per Band  
Internal Pink Noise Generator  
Display Sensitivity Control  
Switchable Range  
Line-in, Line-out Jacks on Rear Panel

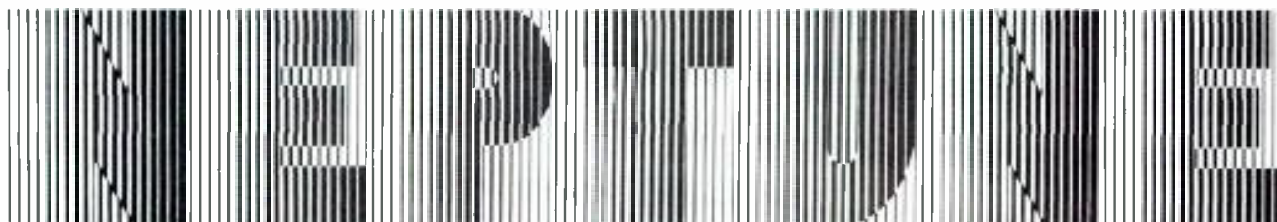

**belongs in your next system**

Just the duo you need for ultimate sound control.  
Gives super fine adjustment and up-front display  
capability over 27 one-third octave bands. Professional  
quality and reliability at surprisingly affordable cost.  
A demo from your favorite pro sound dealer will be  
the convincer. Or write for our promo sheets.

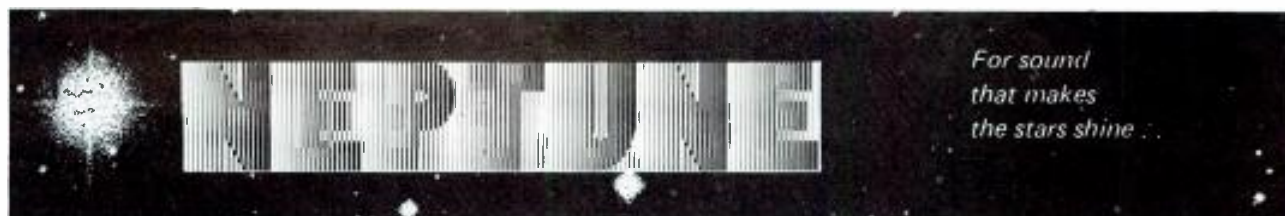

Neptune Electronics Incorporated • 934 N.E. 25th Avenue • Portland, Oregon 97232

(503) 232-4445

Circle 39 on Reader Service Card

www.americanradiohistory.com

current starts, complicating things. For the transistor, the current rating of the transistor sets the limit.

Inherently, the linearity of transistors and pentode tubes is not very different. The advantage of the transistor is that it is easily possible to lay on enormous amounts of feedback, so its effective linearity is much better than that of the tube. Also, since it is a triode, it is possible to reduce the number of reactive coupling elements which, as well as allowing much more feedback, also makes it much more stable, against being thrown off its operating point, when the maximum level is accidentally exceeded.

#### OPERATING POINT SHIFT

Every transformer or coupling capacitor in a feedback loop introduces the possibility of the operating point shifting as the instant maximum level is reached, after which it takes the amplifier a time to return to normal, depending on the time constant of that circuit. This may happen in the case of a tube because the grid starts to conduct, upsetting the operating grid voltage. In the case of a transistor, when the base-emitter junction ceases to conduct, a similar thing can happen because base-emitter voltage is normally small and nearly constant,

where when it ceases to conduct, it suddenly rises in the opposite direction.

So, while the superficialities may seem different, transistors and pentodes have more similarities than most people realize. With both, the effect of large amounts of voltage-derived feedback is to make the output voltage almost independent of the load value connected, which represents a high damping factor.

#### McINTOSH AMPLIFIER

The McIntosh amplifier, with its *unity coupling* — a cathode swung equally and opposite to the plate—was the first to apply large amounts of feedback. But the tubes were operating as pentodes, because the screens were kept at a constant voltage difference from the cathodes. In Dave Hafler's ultra linear circuit, the cathodes stayed at constant voltage and the screens swung at a specified fraction of the plate voltage swing, so the tubes operated in a condition between that of triode and pentode.

Transistors are triodes, but have characteristics more like pentode tubes, bringing to bear the best potential for high output—or high efficiency output—with low distortion, yet. The basic principles, or theory, do not change. The practical ramifications do. ■



sales offices

#### THE SOUND ENGINEERING MAGAZINE

**New York**  
1120 Old Country Rd.  
Plainview, N.Y. 11803 516-433-6530

**Roy McDonald Associates, Inc.**  
**Dallas**  
Stemmons Tower West, Sulte 714  
Dallas, Texas 75207 214-637-2444

**Denver**  
3540 South Poplar St.  
Denver, Colo. 80237 303-758-3325

**Houston**  
3130 Southwest Freeway  
Houston, Tex. 77006 713-529-6711

**Los Angeles**  
500 S. Virgll, Suite 360  
Los Angeles, Cal. 90020 213-381-6106

**Portland**  
2035 S. W. 58th Ave.  
Portland, Ore. 97221 503-292-8521

**San Francisco**  
Suite 265, 5801 Christle Ave.  
Emeryville, Cal. 94608 415-653-2122

# YOUR PRODUCTION DEPENDS ON OUR PERFORMANCE

## VERSATILITY

We have achieved a degree of excellence recognized World Wide in the field of intercom systems.

Exceptional sound quality is achieved with our contoured frequency response (200 Hz to 12,000 Hz) and new audiometric type Series II headsets. Noise cancelling microphones and high output (112 dB) noise attenuating headphones insure communications under the most demanding conditions. Our Stainless Steel Belt Pack with, State of the Art encapsulated electronics assures long life and reliability. Our belt pack will withstand a 60 foot drop to concrete.

## QUALITY

- 1, 2 & 8-channel stage manager control stations.
- Over 200 remote station capability with 8-channel switchboard.
- Visual signaling between stations.
- Interconnects with standard 2-conductor shielded microphone cable and adaptable to other communication systems including telco lines.
- Catalogue with complete specifications available upon request.



759 Harrison St., SF, CA 94107 (415) 989-1130

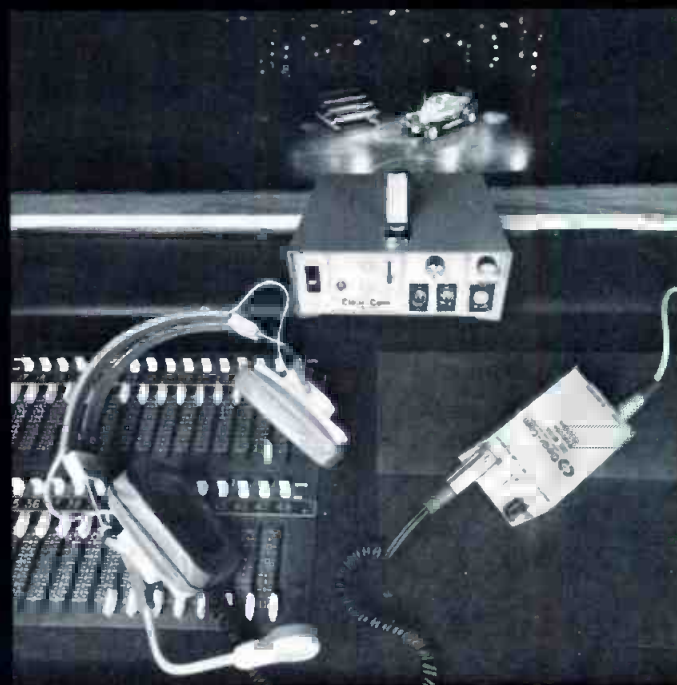

College of Marin Fine Arts Theatre, Larkspur, Calif.



# OUT OF THE WEST COMES THE TOUGHEST AND THE ONLY 5/8" WIDE FADER.

Duncan's new Series 400 Slideline® Fader is the narrowest you can buy. It's also the best. Interchangeable with other professional models, more Series 400 Faders can be positioned in a smaller space because of their slim 5/8" width. That makes them ideal for portable equipment.

Designed for high performance, the Resolon® conductive plastic element is remarkably durable, has low-noise characteristics and enjoys an eight-year, failure-free record in audio/broadcast use.

Other unique features include extremely low profile, linear and audio outputs, single or dual channel in the same size package. Internal

switches with goldplated contacts are also available, with no increase in package size. Series 400 high-impact cases are solvent-resistant plastic with built-in moisture and dust seal. Terminals accept quick-connect receptacles. Temperature range: -55°C to +125°C.

Offered as a complete drop-in module with knob and escutcheon, they are also available in separate components and two stroke lengths with 2 3/4" and 4 1/4" travel.

Custom knobs include our new low-profile, round and square designs in your choice of six colors.

*So give it your best shot. Write or call today for complete information.*



**DUNCAN ELECTRONICS**  
SUBSIDIARY

**SYSTRON**  **DONNER**

2865 FAIRVIEW ROAD • COSTA MESA, CALIFORNIA 92626  
PHONE: (714) 545-8261 TWX 910-595-1128

# db New Products & Services

## HEADPHONE AMPLIFIER



• Designed for driving headphones, Model AP-10 amplifier's rear mounted toggle switch selects mono or stereo outputs. Four watts rms on each side of four stereo channels go into four ohms. Claimed flat frequency response is 20 to 20,000 Hz. The unit includes individual and master gain controls.  
 Mfr: Edcor  
 Price: \$149.50.  
 Circle 81 on Reader Service Card

## LIVE MIXER

• Complexities usually found only in studio mixers are present in Series 1S portable stereo sound mixer. The unit can be had with either an aluminum flight case for on the road or in walnut for permanent installation. It comes in 12-, 16- and 20-channel formats. A switch-in high pass filter combines with a variable gain microphone amplifier to attenuate high level low frequencies and to avoid distortion through the input channels. A four-band active equalizer on each input channel permits a sweepable frequency of the two mid-bands between 130 Hz and 2.5 kHz, and 750 Hz and 15 kHz; four independent equalizer amplifiers avoid interaction between bands. The stereo mix can be overridden on monitor headphones by an auto-solo pushbutton on any input or output channel, which also switches two-volume unit meters to read the solo level. Three auxiliary mics are provided, two for prefade monitor and one for post-fade echo and other effects.



Mfr: Soundcraft North America  
 Circle 82 on Reader Service Card

## BROADCAST DELAY LINE

• A maximum delay of up to 6.4 seconds is possible with BD955 broadcast delay line, used to blip objectional material from live broadcasts. When an announcer hears the obnoxiousity or other unsavory noises, he presses the DUMP button. The program continues immediately in real time while the BD955 extends the safety delay margin to maximum. Delays ranging from 6.5 milliseconds to maximum can also be used to fake "doubling," create echo effects, and provide delay for echo chamber feed. In t.v. applications, landline transmission of audio can be delayed to match satellite video signals. The device is rack mountable, has a frequency response of either 15 or 7.5 kHz; the lower frequency is suitable for "talk only" use while the 15 kHz response model can handle any program material.



Mfr: Eventide Clockworks, Inc.  
 Circle 83 on Reader Service Card

**J&R BLANK TAPES & ACCESSORIES AT WHOLESALE PRICES!**

**BLANK TAPES CASSETTE TAPES**

|                                  |               |                             |         |
|----------------------------------|---------------|-----------------------------|---------|
| Ampeg Grand Master I C-60        | \$2.14        | TDK D C-60                  | \$1.25  |
| Ampeg Grand Master I C-90        | \$2.79        | TDK D C-90                  | \$1.60  |
| BASF Studio C-90                 | \$2.69        | TDK D C-120                 | \$2.15  |
| BASF Professional II or III C-90 | \$2.99        | TDK D C-180                 | \$2.99  |
| Maxell UD C-60                   | \$1.93        | TDK AD C-90                 | \$2.52  |
| Maxell UD C-90                   | \$2.84        | TDK SA C-60                 | \$2.22  |
| Maxell UDXL I or II C-60         | \$2.47        | TDK SA C-90                 | \$3.18  |
| Maxell UDXL I or II C-90         | \$3.47        | Maxell UD 35-90 1800 ft.    | \$5.49  |
| Scotch low noise C-90 / 3 pk.    | \$4.99 (or 3) | Maxell UDXL 35-90B 1200 ft. | \$6.62  |
| Scotch Master I C-90             | \$2.84        | Maxell UD 35-180 3600 ft.   | \$14.70 |
| Scotch Master II or III C-90     | \$3.29        | Scotch 212 1800 ft.         | \$4.35  |
| Sony Ferrichrome C-90            | \$3.58        | Scotch 207 1800 ft.         | \$5.19  |
|                                  |               | TDK L 1800 1800 ft.         | \$5.22  |

Minimum Order 12 Tapes - 100% Guaranteed

**CARTRIDGES audio-technica**

|                           |          |                   |         |
|---------------------------|----------|-------------------|---------|
| AT-20 SLA                 | \$119.00 | <b>SHURE</b>      |         |
| AT-15 SA                  | \$82.50  | V15 TYPE IV       | \$89.00 |
| AT-14 SA                  | \$48.00  | V15 TYPE III      | \$63.50 |
| AT-12 SA                  | \$24.00  | M5E2              | \$28.50 |
| AT-10                     | \$12.00  | M91ED             | \$21.00 |
| <b>STANTON</b>            |          | M24M (QUAD)       | \$36.50 |
| 881E                      | \$22.50  | M70               | \$9.90  |
| 681EE S                   | \$6.00   | <b>PICKERING</b>  |         |
| 681EE                     | \$2.50   | XUV/45000 (QUAD)  | \$88.00 |
| 680E                      | \$20.80  | XSV/3000          | \$45.00 |
| 500EE                     | \$4.40   | XV15/750E         | \$30.00 |
| <b>EMPIRE</b>             |          | XV15/625E         | \$20.00 |
| 2000Z                     | \$59.90  | XV15/400E         | \$7.00  |
| 2000T                     | \$31.50  | <b>KOSS</b>       |         |
| 2000EIII                  | \$19.50  | PRO 4 AA          | \$37.00 |
| 4000DI                    | \$29.90  | HV/1              | \$26.97 |
| <b>HEADPHONES PIONEER</b> |          | HV/1LC            | \$32.97 |
| SE-306                    | \$19.95  | PHASE/2+2         | \$83.00 |
| SE-325                    | \$46.70  | TECHNICIAN/VFR    | \$14.97 |
| SE-330                    | \$33.50  | <b>PICKERING</b>  |         |
| SE-340                    | \$39.95  | DA-7              | \$41.90 |
| SE-700                    | \$59.95  | <b>SENNHEISER</b> |         |
| HD-400                    | \$24.99  | HD-400            | \$24.99 |
| HD-414                    | \$36.97  | HD-414            | \$36.97 |
| HD-424                    | \$59.95  | HD-424            | \$59.95 |

**HOW TO ORDER:** For shipment within 48 hours, send money order or certified check. Two weeks delay on personal checks. Please add \$3.50 per order for shipping & handling. (\$5.50 for orders outside U.S.). N.Y.S. residents add tax. No C.O.D.'s. All merchandise 100% guaranteed, brand new & factory fresh.

**J&R MUSIC WORLD**  
 33 Park Row, New York City, 10038 (212) 732-8600  
 WRITE FOR FREE CATALOG

Circle 28 on Reader Service Card

# Good FM sound is good FM business.



Dolby Laboratories Model 334 FM Broadcast Unit is the only station equipment needed for Dolby FM

More and more FM listeners these days are sensitive to good sound. If you have any doubts, just take a look at the sales of quality home and automotive stereo equipment. For these listeners, *signal quality* could well be a significant factor in distinguishing your station from the run of the mill.

Signal quality is what Dolby FM is all about. The Dolby FM process incorporates a reduction of pre-emphasis from 75 to 25  $\mu$ s, along with B-type Dolby encoding. That gives you about 8 dB more headroom at 10 kHz — just the thing for today's program sources that are rich in high frequencies. Limiting can go back to doing what it was originally designed for — handling the occasional difficult peak — rather than filtering out the highs most of the time.

Listeners with receivers equipped for Dolby FM reception\* have the opportunity, for the first time, to recover your signal in virtually the same form it left the studio. Your FM signal can sound as good as the high quality records and tapes your listeners play at home. At the same time, listeners with conventional receivers aren't penalized, because 75  $\mu$ s de-emphasis subjectively complements the Dolby encoded 25  $\mu$ s signal for compatibility.

Attracting new listeners to your FM station is one thing; keeping today's sound sensitive listeners happily tuned in is another. That's where signal quality — and Dolby FM — come in. If you would like to find out more about how the good sound of Dolby FM can be good for your business, please contact us at the address below.

\*There are now more than 80 consumer product models equipped for Dolby FM reception including several new car stereo systems



'Dolby' and the double-D symbol are trademarks of Dolby Laboratories

## Dolby Laboratories

731 Sansome Street  
San Francisco CA 94111  
Telephone (415) 392-0300  
Telex 34409  
Cable Dolbylabs

346 Clapham Road  
London SW9  
Telephone 01-720 1111  
Telex 919109  
Cable Dolbylabs London

Circle 25 on Reader Service Card

## STORAGE UNIT



● Sharp contemporary design, all black plexiglass and brushed matte finish aluminum, make the Audiofile Lowboy a showoff piece. The unit has a plexiglass top and heavy casters, can handle in excess of 400 lbs. of equipment with a rack mount capability. Optional shelving is available. Dimensions are 42 $\frac{1}{2}$  x 26 $\frac{1}{4}$  x 18 $\frac{1}{2}$  inches. *Mfr: Hammond Industries.*  
*Price: \$399.00.*  
*Circle 84 on Reader Service Card*

## MODULAR CONSOLE

● Conveniently situated barrier strip connections, on the rear of the console, simplify wiring and patching from SP610 10-in 10/8-out stereo console. Input modules include a 4 $\frac{1}{2}$  in. conductive plastic slide fader, 6-knob 3-band parametric equalization, 8 TK assignment buttons, post echo sends, monitor send control, 2 cue sends, solo button which allows stereo panning when engaged, a mic/line switch, program/sync switch, and an attenuation switch of -10 or -20 dB. Output includes cue 1 and cue 2 level controls, each of which can be soloed, and 2 echo returns. Mic input impedance is 150 ohms balanced, line input impedance 10k ohms, s/n -72 dB, output level +4 dBm above zero vu, output level +20 dBm.

*Mfr: Speck Electronic*

*Price: \$4,120.00.*

*Circle 85 on Reader Service Card*

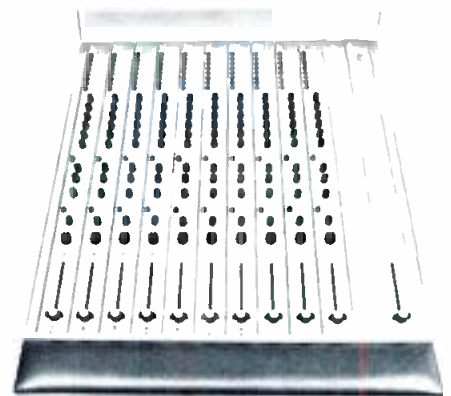

## REAL-TIME SPECTRUM ANALYZER

● Covering the frequency range from 20 millihertz to 25.6 kHz, Model 3582A spectrum analyzer is useful for electrical and physical measurements which have significant spectral information in the audio and sub-audio range. Amplitude and phase are displayed alphanumerically on a large crt display. Two independent measurements (amplitude, phase, or both, as well as coherence) can be displayed simultaneously or digitally stored and recalled later for visual comparisons. The unit has a zoom feature (band selectable analysis) which makes it possible to locate frequency spans of 25 kHz down to 5 Hz anywhere within the frequency range of the instrument. A microprocessor executes the Fast Fourier Transform to measure signals that have long measurement times. An exponential form of power averaging is used for measurements where the spectral information is not stable but varies slowly, continually reducing older spectra importance to prevent old data from obscuring new data. Because of its built-in noise source, the unit can be used to provide a drive signal, which functions like a tracking generator, or low-frequency network analyzer with real-time measurement speed.

*Mfr: Hewlett-Packard*

*Price: \$10,000.00.*

*Circle 86 on Reader Service Card*



**SWITCHCRAFT**  
**AUDIO CONNECTORS**  
**JACKS/PLUGS/PATCH CORDS**

*Shipped from STOCK!*

*Ask for Our Catalog*

**PRO-AUDIO SPECIALTIES CO.**  
1291 RAND ROAD  
DES PLAINES, ILLINOIS 60016  
PHONE (312) 827-8388

*Circle 17 on Reader Service Card*

# Introducing the new TDK testing machines.

At TDK, we know that your test cassette is a vital element of your laboratory or service procedure. So when we created a series of test tapes, we approached them as integral components, with both tape and housing engineered as precisely as your test instruments. You'd expect that from the makers of TDK SA, the high bias reference standard for many manufacturers' cassette decks.

TDK test cassettes don't jam and they're dropout-free. They're built to last under unceasing use. If you're a store service manager, assembly line quality control inspector, or highly discerning audiophile, you need that kind of precision and reliability. To make absolutely sure you get it,

we custom quality-control each and every one. No matter what data you need, TDK has a test cassette to help you find it out: bias/EQ alignment; playback level calibration; Dolby calibration; head azimuth alignment; wow and flutter and tape speed and 11, five and three-point frequency characteristics checks.

Check out the complete line of TDK test cassettes by writing, or calling (516) 746-0880. When you do, find out about our bulk duplication cassettes, bulk duplication pancake tape, audio visual, leaderless, data and endless cassettes, too.

You'll find that the same TDK quality and reliability that goes into our test tapes applies all the way down the line.



**TDK**

World leader in recording tape technology.

TDK Electronics Corp., 755 Eastgate Blvd., Garden City, NY 11530  
2906 W. Peterson Ave., Chicago, IL 60645; 2041 Rosecrans Ave., Suite 365, El Segundo, CA 90245.

Circle 21 on Reader Service Card



# SIONAL

## ATR-700

This is the portable audio recorder designed for commercial service—the Ampex ATR-700. A reel-to-reel tape recorder in a compact package, tough enough for the continuous demands of full-time broadcasting, or the bruising insults of location work.

Use the ATR-700 for full or half-track monaural, or full-range stereo, and you'll get a response that's virtually flat from 40 Hz to 18 kHz. And every switch and control is clearly marked on the compact front panel for easy identification. The back-lit meters show you the situation even when the room lights dim, and switchable equalization means instant setup for most situations.

ATR-700 durability runs deep. All switches and connectors are heavy duty, professional types, and the transport itself is a rigid, massive casting that keeps all moving parts aligned even after hundreds of trips back and forth between the studio and the field.

Now there's no excuse for less than professional audio in the programs, commercials and productions you turn out. Ampex has the finest, most up-to-date reel-to-reel portable on the market, and it's available at Ampex audio distributors in every major city.

# AMPEX MAKES IT EXCITING.

Ampex Corporation, 401 Broadway, Redwood City, California 94063, 415/367-2011

## MICROPHONE SPLITTER



● 19-inch rack mountable Model 1003 10 x 3 microphone splitter is constructed for sound reinforcement as well as recording and broadcasting. Working from ten female XLR connectors for the microphone inputs, you can go three ways from each input—direct output for phantom powering from the main console for condenser microphones or splitter outputs consisting of two bridged outputs with ground lift switches on each. The transformers are dual Faraday shielded, to eliminate hum and buzz.

*Mfr: Uni-Sync Inc.*

*Price: \$840.00.*

*Circle 87 on Reader Service Card*

## OPEN REEL DECK



● Three-head, three-motor, two-speed (15 and 7½ in/sec.) Model A-3440 four channel open reel deck with Simul-Sync accepts 10-inch reels, can be monitored through monophonic headphones, each channel switch-selectable. Features include professional micro-switch, manual cue level, four vu level meters, mic/line input selectors, four front-panel mic jacks and independent output level controls for each channel. Remote control is available. Specifications include 0.04 per cent wow and flutter, 65 dB s/n ratio, and 35 to 22,000 Hz frequency response at 15 in/sec. In the same series, the manufacturer is also offering two new reversing decks taking a seven-inch reel, and another 10-inch reel model. *Mfr: TEAC Corporation*  
*Price: \$1,500.00.*

*Circle 88 on Reader Service Card*

## CASSETTE WINDER



● Lightweight (10 lbs.) CW-3 cassette winder will rewind three c-60 cassettes in 55 seconds. Individual cassettes can be loaded or removed without affecting the operation of the other stations. Precision set torque evenly winds the cassettes. *Mfr: Pentagon Industries*  
*Price: \$165.00.*

*Circle 89 on Reader Service Card*

## db New Literature

### VOCORDER

"By its nature, the Vocorder is absolutely multi-para-poly-phonic" is a quote from a fascinating booklet on the Vocorder Sound Effects device, which, among other sounds, is able to replicate human speech. Source: Sennheiser Electronic Corp., 10 W. 37th St., New York, N.Y. 10018.

### AMPLIFIERS

The Son of Ampzilla and his entire family tree of amplifiers are described in a sort of amp *Roots*, an 8-page brochure. Source: The Great American Sound Co., 20940 Lassen St., Chatsworth, Ca. 91311.

### OSCILLOSCOPES

Dual and single trace oscilloscopes are the subject of a full-color catalog from Leader Instruments. Source: Leader Instruments Corp., 151 Dupont St., Plainview, N.Y. 11803.

### WORLD VIDEO STANDARDS

A laminated 4 x 9 in. trifold card lists 150 countries alphabetically, along with their standard plus scan frequencies and their line voltage and frequency rates. Source: Devlin Productions, Inc., 150 W. 55th St., New York, N.Y. 10019.

### ELECTRONIC COMPONENTS

A 20-page catalog lists capacitors, resistors, switches, cable assemblies, accessories, etc. Source: World Business Corp., 1669 E. Del Amo Blvd., Carson, Ca. 90746.

### POTENTIOMETERS

Miniature 12 and 16 mm 300 degree potentiometers for consumer and commercial applications are covered in a data sheet. Source: Murata Corporation of America, 1148 Franklin Rd., S.E., Marietta, Ga. 30067.

## Audio Tape for professionals

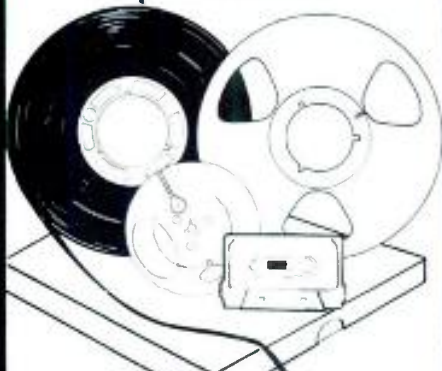

### REEL TO REEL TAPE

Ampex, 3M. All grades.  
On reels or hubs.

### CASSETTES, C-10—C-90,

With Agfa, Ampex, 3M tape.

### LEADER & SPLICING TAPE

### EMPTY REELS & BOXES

All widths, sizes.

— COMPETITIVE • FROM STOCK —

For your catalog, call or write: **Vito Cappi**

312/297-0955



**Recording Supply Co.**

Div of  
Polyline Corp.

1233 Rand Road  
Des Plaines, IL 60016

*Circle 51 on Reader Service Card*





# OUR ORIGINAL BUSINESS WAS MAKING SOUND CONNECTIONS

**We're still at it.** We started in 1935 as the Audio Development Company producing jacks and jack panels for the broadcast and telephone industries. Since then, ADC has produced such innovations as Bantam Jacks, printed circuit board jacks and Wrapid terminal blocks. What are we doing for you today?



We are introducing our new line of low impedance audio connectors. We have six models now in production. They're reliable, compatible and competitively priced. Most important, they're available sooner. Ask about making a sound connection with ADC. Call or write today.



## ADC Products

A DIVISION OF MAGNETIC CONTROLS

ADC Products, 4900 W 78th St., Minneapolis, MN 55435 / Telephone: (612) 835-6800 TWX 910-576-2832 Telex 29-0321

Sales offices in: Atlanta, GA (404) 766-9595 • Dallas, TX (214) 241-6783 • Denver, CO (303) 761-4061 • Fairfield, CT (203) 255-0644  
• Lafayette, IN (317) 474-0814 • Melbourne, FL (305) 724-8874 • Menlo Park, CA (415) 323-1386 • Minneapolis, MN (612) 835-6800  
• Washington, DC (202) 452-1043 • Montreal, Quebec (514) 677-2869

Circle 47 on Reader Service Card

[www.americanradiohistory.com](http://www.americanradiohistory.com)

# Editorial

**I**S THE TAPE-TO-DISC transfer session the last step in record production, or the first step in record manufacturing? It depends on whom you ask. Some disc mastering facilities (notably abroad) are located at the pressing plant, far, far away from the influence of anxiety-ridden producers who—if given half a chance—will spend hours trying to “fix it *after* the mix.”

Other facilities are found right at the recording studio, where the recording engineer and producer can directly supervise (or interfere with) the transfer from tape to disc. Still others are found at “halfway houses,” specializing just in disc mastering, and usually not affiliated with a particular record company or studio.

So, perhaps we should view disc mastering as a little bit of both the production and the manufacturing process. And maybe we should also spend a little more time learning something about it. After all, how many people hear your priceless master *tapes*?

Irv Diehl helps us get started, with a look at **Basic Groove Geometry**. On tape, the recorded level has no influence whatever on playing time. Not so on disc, where every extra dB means a bit less playing time. On tape, a 10½ in. reel will record for about thirty minutes (at 15 in./sec). How long is a 12 in. LP record? Well, it depends. Depends on what? Check with Irv for the answers.

When was the last time you saw a new disc cutting lathe? We saw one at the recent Audio Engineering Society convention, and sent Suzette Fiveash (our new Associate Editor, no less) out to find out something more about it, and report back. She did, as you'll read in her story, **From Cybersonics: A New Disc Mastering Lathe**.

Given the time vs. level constraints of disc recording, wouldn't it be nice to figure out a way to squeeze a few more dB onto your next record? The folks at the CBS

Technology Center thought so too, and have spent the past five years developing a way to do just that. Charlie Repka reports on their progress in his feature on the **CBS DISComputer Mastering System**.

Direct-to-disc recording has been attracting a lot of notice these days. And, whenever (or wherever) the conversation turns to “d-d,” you're sure to hear the name of Bert Whyte mentioned. Bert has been very active in this challenging area, and in between sessions, we asked him to tell us a little something about **The Logistics of Direct-to-Disc Recording**.

Never one to take the easy way out, Bert does most of his d-d work on location. And that means he's got to beg, borrow or steal a few cutting lathes for every session. And *that* means talking a few disc mastering engineers into coming along, and not just for the ride. Well, since Ms. Fiveash made the mistake of sending her Cybersonics story in early, we sent her out again—this time to talk to Stan Ricker at the JVC Cutting Center, about what it's like to **Bring Your Own Lathe: The Logistics of Cutting Direct-to-Disc—on Location!**

This issue of *db* was really inspired by a letter from James Shelton, president of Europadisk Plating Company. Mr. Shelton took us gently to task for not saying much about the lesser-known aspects of audio—such as the record plating process. We cheerfully admit to ignoring record plating for years. And for good reason: we don't know much about it at all. And that placed the ball back in Mr. Shelton's court, where he quickly obliged by serving us **A Look At the Record Plating Process**.

And that brings us to the end of this issue. We know a little more about disc cutting now, and promise never to take it for granted again. What about you?

J.M.W.



# fact: you can choose your microphone to enhance your sound system.

Shure makes microphones for every imaginable use. Like musical instruments, each different type of Shure microphone has a distinctive "sound," or physical characteristic that optimizes it for particular applications, voices, or effects. Take, for example, the Shure SM58 and SM59 microphones:



## SM59

**Mellow, smooth,  
silent...**

The SM59 is a relatively new, dynamic cardioid microphone. Yet it is already widely accepted as a standard for distinguished studio productions. In fact, you'll often see it on TV . . . especially on musical shows where perfection of sound quality is a major consideration. This revolutionary cardioid microphone has an exceptionally flat frequency response and neutral sound that reproduces exactly what it hears. It's designed to give good bass response when miking at a distance. Remarkably rugged — it's built to shrug off rough handling. And, it is superb in rejecting mechanical stand noise such as floor and desk vibrations because of a unique, patented built-in shock mount. It also features a special hum-bucking coil for superior noise reduction!

**Some like it essentially flat...**

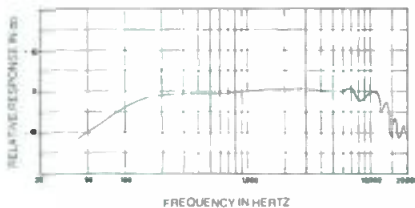

## SM58

**Crisp, bright  
"abuse proof"**

Probably the most widely used on-stage, hand-held cardioid dynamic microphone. The SM58 dynamic microphone is preferred for its punch in live vocal applications . . . especially where close-up miking is important. It is THE world-standard professional stage microphone with the distinctive Shure upper mid-range presence peak for an intelligible, lively sound. World-renowned for its ability to withstand the kind of abuse that would destroy many other microphones. Designed to minimize the boominess you'd expect from close miking. Rugged, efficient spherical windscreens eliminates pops. Lightweight (15 ounces!) hand-sized. The first choice among rock, pop, R & B, country, gospel, and jazz vocalists.

**...some like a "presence" peak.**

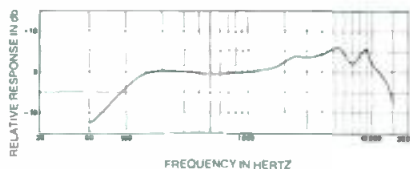

**professional microphones...by**



Shure Brothers Inc., 222 Hartrey Ave., Evanston, IL 60204, In Canada: A. C. Simmonds & Son Limited  
Manufacturers of high fidelity components, microphones, sound systems and related circuitry.

Circle 26 on Reader Service Card

# Basic Groove Geometry

*The mathematics governing the spiral trip from the perimeter to the center of a recording disc.*

**D**ESPITE ALL THE RECENT ADVANCES in all audio technology, the recorded disc remains the favorite mass-market medium for music recordings. Yet, at times disc recording appears to be a sort of step-child to the recording industry. Often misunderstood, the disc recording art is considered by some to be a "mystery technology."

Of course, there have been impressive advances in disc recording technology too, but, the basic principles employed in cutting discs have remained unchanged for decades.

Simply stated, the disc record comprises a spiral groove, engraved or embossed on the surface of the disc. Conventionally, the groove is engraved from the outside to the center of the disc, while the signal to be recorded modulates the groove. Other than for the sake of standardization, there is no reason why the process could not be reversed with the record beginning near the label and then spiralling its way outwards, towards the record's outer diameter.

## RECORDING PITCH

One first principle that may be obtained from this simple description is the relationship between the time it takes the groove to spiral from the outside to the center of the disc, and the duration of the program to be recorded. The spiral rate, or *pitch*, depends upon the dimensions of the disc (7", 10," 12"), and determines how many lines there will be from the start of the recording to the end. The number of lines will therefore be related to the dimensions of the disc and the program length. This relationship is expressed by the formula:

$$P = \frac{(T) (V_r)}{R}$$

- P = Pitch, measured in lines-per-inch (LPI).
- T = Program time.
- $V_r$  = Rotational velocity of the disc.
- R = Dimension available for recording.

Typically, a twenty minute program, to be recorded on a 12 in. LP record at 33.3 rpm, will begin at an outer diameter of 11.5 inches, and should end at an inner diameter of about 5.5 inches. The outer diameter conforms to the Record Industry Association of America (RIAA) standard for the Outermost Groove at Recording Pitch. The standard also specifies a Minimum Inside Diameter of Recording, which is 4¾ inches. However, if the program length is not excessive, most disc mastering engineers prefer to end the recording well before this minimum dimension in order to minimize inner-groove distortion.

The dimension over which the program is recorded is equal to the outer diameter minus the inner diameter, divided by two.  $(11.5 - 5.5)/2 = 3$  inches). This is the radial distance across which the groove spirals while the program is recorded onto the disc. Using the above formula, we find the required pitch to be:

$$P = \frac{(20 \text{ min.}) (33.3 \text{ rpm})}{3 \text{ inches}} = 222 \text{ LPI}$$

Once the recording pitch has been determined, other parameters can be ascertained. For example, the spacing between the lines is the reciprocal of pitch. (For our purposes, we are assuming the groove is spiralling inwards at a constant rate.) If the pitch is 222 lines-per-inch, then the line spacing is 1/222, or 0.0045 inches-per-line.

Typically, this dimension is expressed in mils (thousandths of an inch), which in this case would be 4.5 mils.

This space between lines must be apportioned between the width of the groove, the modulation displacement, and any headroom that may be required. The basic groove width is generally equal to, or greater than, 2 mils. The space remaining after subtracting the width of the groove is that available for modulation.

### DISPLACEMENT AND VELOCITY

When we inspect the modulated groove under a microscope, one parameter observed directly is the **amplitude of displacement**. However, there is no direct relationship between the applied electrical signal level and the resulting mechanical displacement. The quantity that is directly proportional to the applied electrical signal is **stylus velocity**. As the applied signal voltage is increased to twice its original value, stylus velocity increases by the same proportion. Displacement of the groove, on the other hand—though dependent on the magnitude of the applied signal—is inversely proportional to the frequency of the applied signal. As the recorded frequency decreases, displacement increases, and *vice-versa*. Due to the direct relationship between the applied electrical signal and the stylus velocity, the RIAA pre-emphasis and de-emphasis characteristics are tabulated in terms of velocity, as are recording levels. (These RIAA characteristics are analogous to the NAB pre- and post-emphasis found in tape recorders. Ed.) The relationship between stylus velocity and groove displacement is expressed as:

$$A_p = \frac{V_p}{2\pi F}$$

$A_p$  = Amplitude of displacement.  
 $V_p$  = Peak stylus velocity.  
 $2\pi F$  = Angular frequency.

Given a line-to-line spacing of 4.5 mils, and assuming a groove width of 2 mils, 2.5 mils of space remains to accommodate modulation. A common record velocity reference level used in disc recording is 7 cm./second (peak) at 1 kHz. Note that this reference is a *peak*, or maximum, velocity, thus implying that other velocities are involved as well. Unlike an automobile travelling at a fixed speed along a winding road, on an LP record it is the "road" (that is, the groove) that is doing the travelling, while the "car" (the stylus) is pushed from side-to-side by the undulations of the groove. If the groove is a sine wave, at each of its amplitude peaks the stylus comes to a halt and then reverses direction, pretty much like a pendulum. It then picks up speed, until it reaches its peak velocity (at the zero crossing point) and then it begins slowing down again as it approaches the next amplitude peak in the sine wave.

Our 7 cm./second reference level represents the maximum velocity at which the stylus travels, as it traces (or engraves) the groove. The displacement that would result if 1 kHz was recorded at a reference velocity of 7 cm./second is calculated below:

$$A_p = \frac{V_p}{2\pi F} = \frac{7 \text{ cm./second}}{6.28(1000)} \\ = 0.00111 \text{ cm.} = 0.439 \text{ mils peak displacement}$$

Doubling this value gives us a peak-to-peak displacement of 0.878 mils. Since the next adjacent inner and outer lines (grooves) are also modulated, the total space required between adjacent lines is equal to the peak-to-peak displacement ( $A_{p-p}$ ). In our example, more than ample space is available for signal modulation at 1 kHz.

On the other hand, if a frequency of 100 Hz was recorded at the same velocity, we would find that our groove

displacement is excessive, and the adjacent grooves will run into each other, causing overcut. In this example, we have included a conversion factor,  $10^3/2.54$ , to provide an answer directly in mils.

$$A_p = \frac{7}{6.28(100)} \times \frac{10^3}{2.54} = 4.39 \text{ mils} \\ A_{p-p} = 8.78 \text{ mils.}$$

### VELOCITY AND RIAA PRE-EMPHASIS

Since groove displacement is inversely proportional to the frequency of the modulation signal, the standard RIAA Recording Characteristic provides for a low frequency attenuation to conserve disc space (some -13 dB at 100 Hz), as well as a high frequency boost. When referenced to 7 cm./second peak velocity at 1 kHz, the peak velocity and resultant displacement at some other frequency (after RIAA pre-emphasis) will be:

$$V = (10^{dB/20}) 7 \text{ cm./second}$$

$V$  = Peak velocity as some specified frequency.

dB = Amount of pre-emphasis at the specified frequency (taken from the RIAA standards).

7 cm./second = Reference velocity at 1 kHz.

For a frequency of 100 Hz, we find that the peak velocity is  $(10^{-13/20}) 7 = (0.2239) 7 = 1.57 \text{ cm./second}$ . Therefore, since earlier we found that  $A_p = V_p/2\pi F$  (or, to simplify matters,  $A_{p-p} = V_p/\pi F$ ), we can now calculate the displacement of a 100 Hz input signal, with our system calibrated to a 7 cm./second reference at 1 kHz. Once again, we include the conversion factor for mils:

$$A_{p-p} = \frac{V_p}{\pi F} \times \frac{10^3}{2.54} = \frac{1.57}{6.28(100)} \times \frac{10^3}{2.54} \\ = 1.864 \text{ mils, peak-to-peak displacement.}$$

It is evident from the last example that if the applied electrical signal at the input to the disc recording system was constant at all frequencies, the resulting groove displacement would not be constant, but would increase as frequency decreases, even with the compensation provided by the RIAA standard.

We have looked at just one point in the low frequency range, namely 100 Hz. What of the displacement at say, 50 or 70 Hz? Why not try these yourself, to get some insight into disc level constraints at low frequencies?

### RIAA RECORDING CHARACTERISTICS

| Frequency | Pre-emphasis | Frequency | Pre-emphasis |
|-----------|--------------|-----------|--------------|
| 15,000 Hz | +17.17 dB    | 4,000 Hz  | + 6.64 dB    |
| 14,000    | 16.64        | 3,000     | 4.76         |
| 13,000    | 15.95        | 2,000     | + 2.61       |
| 12,000    | 15.28        | 1,000     | 0.0          |
| 11,000    | 14.55        | 700       | - 1.23       |
| 10,000    | 13.75        | 400       | 3.81         |
| 9,000     | 12.88        | 300       | 5.53         |
| 8,000     | 11.91        | 200       | 8.22         |
| 7,000     | 10.85        | 100       | 13.11        |
| 6,000     | 9.62         | 70        | 15.31        |
| 5,000     | + 8.23       | 50        | 16.96        |
|           |              | 30        | -18.61       |

### AN ADDENDUM ON VARIABLE PITCH

Note that most modern disc cutting systems provide a variable pitch function. This automatically adjusts the pitch, as the disc is being cut, to provide the optimum spacing between grooves. Typically, during a quiet passage, when not much space is required between lines, the pitch will be tightened. Before a very loud signal, the pitch will "open up," to provide ample space for the increased groove displacement. ■

# If this is what you are looking for.

If you demand nothing less than true hi-fi performance, you'll understand the advantages and flexibility that resulted when Technics separated the basic amplifier/control/tuner functions into the five units we call the Flat Series: The automatically switchable dual IF band ST-9030 FM tuner. The SU-9070 DC preamplifier. The SH-9010 stereo parametric/graphic frequency equalizer. The SH-9020 peak/peak-hold/average metering system. And the SE-9060 stereo/mono DC power amplifier.

You'll also understand why the Flat Series challenges the performance of the most expensive professional equipment in the world. And very often surpasses it.

Look at the graphs. The reproduced waveform is virtually true to the original. All types of distortion—some measurable, some not—are negligible. And the linear frequency response is extremely wide.

We're confident that the truly discriminating critic will recognize the magnitude of our achievement. Especially when that achievement is offered at prices that are unprecedented for equipment of this caliber. And with the flexibility to incorporate one or more, or all five units into your system. Depending on your needs or budget.

To see how Technics achieved the incredible performance shown in the graphs, you have to see and compare the incredible specifications that are typical of the Technics Flat Series on the facing page.

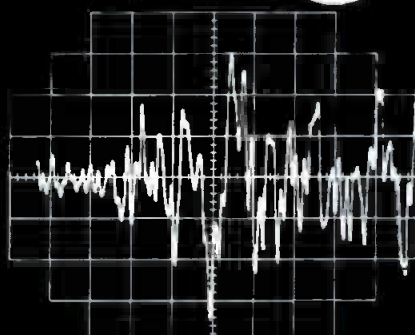

Input Waveform to ST-9030 FM Tuner.

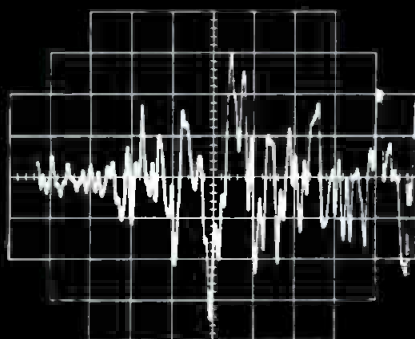

Output Waveform from Technics Flat Series.

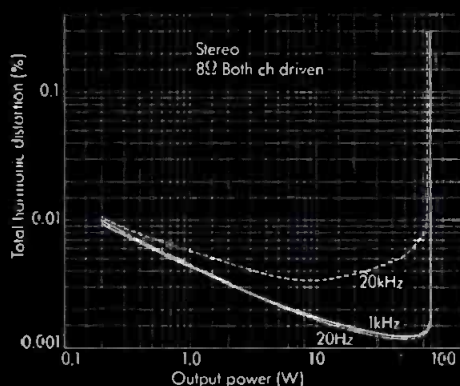

THD vs. Output Power in Stereo SE-9060.

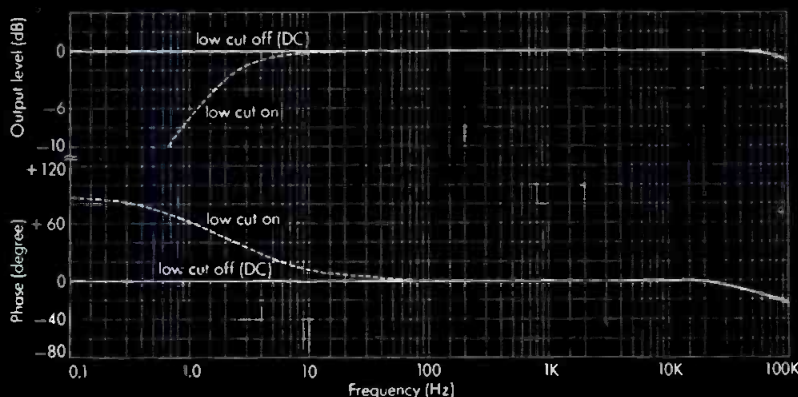

Gain, Phase vs. Frequency Response, SE-9060 Amp.

**TECHNICS ST-9030 THD (stereo):** Wide—0.08% (1 kHz). Narrow—0.3% (1 kHz). **S/N (stereo):** 73 dB. **FREQ. RESPONSE:** 20 Hz—18 kHz +0.1, -0.5 dB. **SELECTIVITY:** Wide—25 dB. Narrow—90 dB. **CAPTURE RATIO:** Wide—0.8 dB. Narrow—2.0 dB. **IMAGE and IF REJECTION, SPURIOUS RESPONSE (98 MHz):** 135 dB. **AM SUPPRESSION (wide):** 58 dB. **STEREO SEPARATION (1 kHz):** Wide—50 dB. Narrow—40 dB. (10 kHz): Wide—40dB. Narrow—30dB. **CARRIER LEAK:** Variable terminal—65 dB (19 kHz). Fixed—70 dB (19 kHz, 38 kHz).

**TECHNICS SE-9060 POWER OUTPUT:** 70 watts per channel (stereo), 180 watts (mono) min. RMS into 8 ohms from 20 Hz to 20 kHz with no more than 0.02% THD. **INTERMODULATION DISTORTION (60 Hz: 7 kHz, 4:1):** 0.02%. **FREQ. RESPONSE:** DC~100 kHz, +0dB, -1 dB. **POWER BANDWIDTH:** 5 Hz -50 kHz, -3 dB. **S/N:** 120 dB (IHF A). **RESIDUAL HUM & NOISE:** 100  $\mu$ V. **INPUT SENSITIVITY & IMPEDANCE:** 1V/47k $\Omega$ .

All the specifications of Technics Flat Series are too numerous and complex to list here. But their performance is too good to miss. So don't. Technics Flat Series is now available for demonstration at selected audio dealers. For very selective ears. And for very selective eyes there's Technics SH-999. A movable 19" custom rack with rosewood veneer side panels.

Technics Flat Series. A rare combination of audio technology. A new standard of audio excellence.

**Technics** Professional Series  
by Panasonic

Circle 36 on Reader Service Card

This is what you  
should listen to.

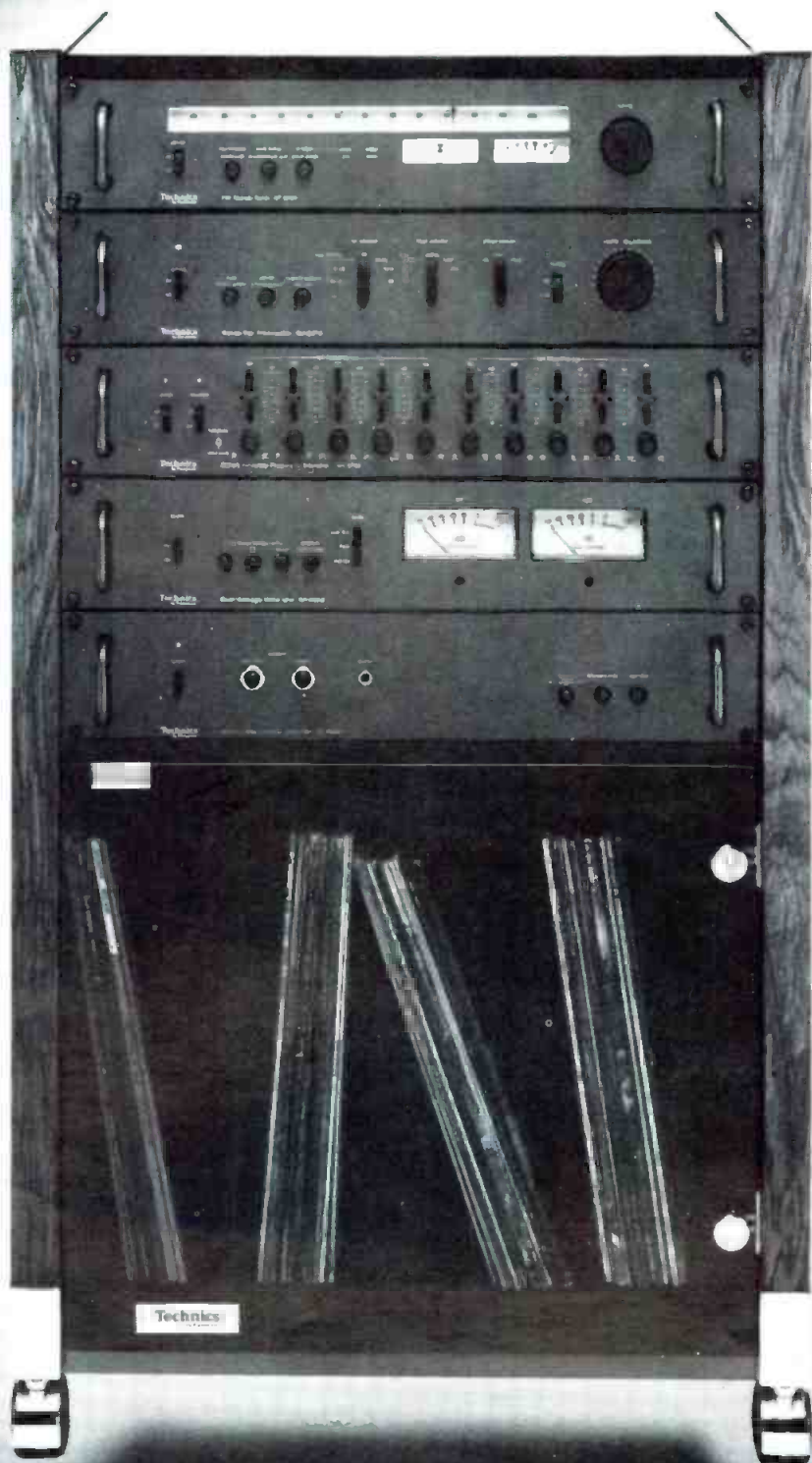

# From Cybersonics: A New Disc- Mastering Lathe

*Smaller size and cost-trimming simplicity might bring this lathe into the more modest studio operation.*

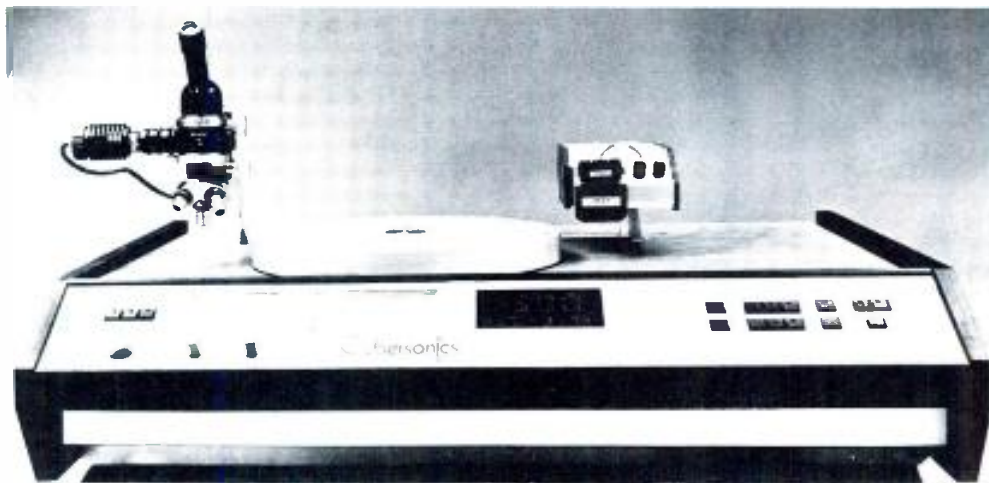

*The Cybersonics DM 2002 Disc Mastering Lathe.*

**D**EVELOPMENT of the Cybersonics DM 2002 Disc Mastering Lathe began about five years ago. At the time, there were all sorts of new ideas and products around. Consoles were becoming automated, digital delays had made their appearance; there were parametric equalizers, new expanders and compressors, noise reduction systems—the list goes on and on.

Most of these newly-developed devices were brought about through the application of an ever-expanding variety of digital and analog integrated circuits, many using the new computer technology, which was fast becoming accessible to audio design engineers. Designers had a seemingly endless number of options from which to choose in developing newer, smaller, more compact devices. It seemed as though everyone was improving everything.

Yet, disc mastering remained more-or-less invisible. Improvements in this area were known only to those few with an intimate knowledge of the medium. It occurred

to Cybersonics president Tom Lippel that here was an area of professional audio that could also benefit from some of the new technology. He noted that a very small percentage of recording studios were directly involved in disc mastering. Possibly, the complexity and expense were a deterrent, limiting the field to a comparatively few specialists.

Thus, the newly-formed Cybersonics, Inc. directed its R&D towards coming up with a mastering system that would be far less formidable than those presently available. In doing so, they hoped to make disc mastering more attractive to the small studio, by keeping the price tag down and offering a lathe that would be simple to operate and maintain. In fact, simplicity became the primary goal, not only because it would allow a precision machine to be manufactured at a reasonable cost, but it would also permit the non-specialist user to easily gain competence in disc cutting.

## EARLY RESEARCH

Cybersonics is located in Southern California, which is not only a focal point in the recording industry, but also supports the bulk of the aerospace design companies in





*The head mount assembly.*

the USA. The accessibility of technical information from both industries was a great asset in the development of the lathe.

After reviewing the various technologies, and researching several methods of generating controlled linear motion, digital positioning systems, and other electro-mechanical systems, it appeared that it would be possible to design a complete mechanical system—in modular form—without using any belts, pulleys, gears, or hydraulic devices.

#### **FIVE YEARS LATER**

What emerged after five years of development was a self-contained disc mastering lathe bearing little resemblance to its predecessors. When first encountering the Cybersonics DM 2002 Disc Mastering Lathe, one notes its compactness of design. In fact, it could almost be mistaken for a large record playing device of some ultra-modern design. Not only is it compact, but its designers seem to have paid some attention to aesthetic detail as well. In other words, it doesn't exactly look like a traditional lathe. This may distract some, who are accustomed to the behemoths seen in the modern tape-to-disc transfer facility, but there is certainly some rhyme and reason behind the DM 2002's diminutive size. 35½-inches wide, 27½-inches deep and 16-inches high (including microscope). It weighs in at about 250 pounds, and this should make it especially attractive for those remote direct-to-disc sessions, where a lathe must be transported to an often-hostile environment, and set up very quickly.

#### **THE MECHANICS**

Mechanically, the concept is: simple, direct, small. The lead screw carriage, microscope drive system and turntable assembly are all mounted on a single platen, which is ¾-inch thick, 33-inches wide and 24-inches deep. The platen is constructed of special-grade aluminum, ground and finished to a flatness within a 1 mil tolerance. The platen's weight—in excess of 150 pounds—offers extreme damping, stability, and linearity to all moving mechanical functions.

The actual lead screw and head-mount carriage assembly consists of two end blocks—also precision-ground, and pinned to the underside of the platen. Between the end blocks are two stainless steel parallel rods, on which the carriage assembly glides, and these are mounted on super-precision low-friction linear bearings. The head-mount carriage itself is driven by a lead screw, captured by a half-nut follower made from a special "oil-homogenized" plastic material.

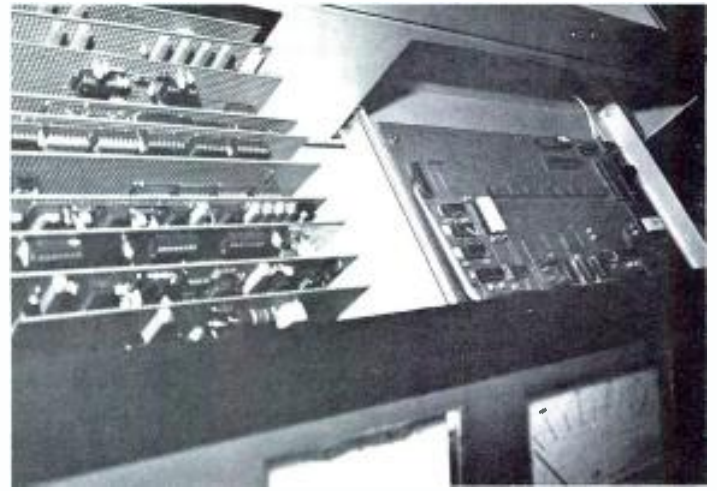

*Prototypes of electronics cards, accessed by sliding the front panel out on drawer slides.*

The microscope drive system is a smaller replica of the carriage assembly, and is also fitted to the platen, as is the turntable drive system.

#### **D.C. TORQUE MOTORS**

A good measure of design simplicity was made possible by a new d.c. torque motor, one of many components "borrowed" from the aerospace industry. It is a permanent-magnet d.c. servo motor, with enough commutator segments to virtually eliminate any "cogging." The motor's speed/torque relationship is linear, and it satisfies Cybersonics' precision-design requirements for all mechanical sub-assemblies. For its size, the motor has extremely high torque, very low inertia, and is easily controlled with relatively simple electronics. Consequently, Mr. Lippel feels that its speed control is considerably superior to that of other types of motors.

Four of these torque motors are used in the DM 2002. The motors directly drive the lead screw, the turntable, the cutter suspension, and the microscope.

In the lead screw carriage sub-system, the motor controls the linear speed (lines-per-inch, or LPI) of the carriage. It is able to follow a complex velocity profile quite accurately, thus assuring precise control of the groove spacing on the disc's surface. Since the motor is direct-coupled to the lead screw, all complicated systems (such as clutches, gears, belts and pulleys) are eliminated, along with their associated problems. The motor's slow speed reduces the possibility of mechanical vibration transmission, and its design simplicity reduces the necessity of many routine adjustments.

In the turntable sub-system the torque motor is used as a constant-speed device. It has sufficient torque to accelerate the ten pound platter to 45 rpm in about one quarter of a revolution. Once up to speed, it is held constant by a crystal-controlled phase lock loop. Long term speed stability is as good as the crystal, 0.001 per cent. Wow and flutter are negligible because the motor's torque is always in control. The lathe also has an automatic disc hold-down vacuum system, which utilizes a hollow drive shaft through the motor housing to the underside of the platter. (No more forgotten vacuum chucks!)

In the microscope-drive sub-system, slow speed and easy control are the requirements, so the motor is pulse-width driven. Speed and direction are controlled from a single knob on the operator's panel. This allows the engineer to inspect the disc being cut comfortably, and therefore do a more thorough job inspecting the lacquer for groove imperfections.

*(continued)*

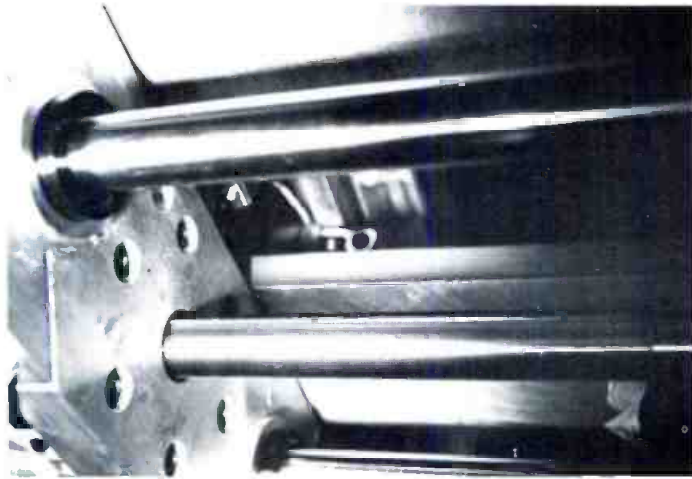

*The precision ground lead screw and carriage ways viewed from below.*

The fourth torque motor is for cutter-suspension control. It is only rotated through a few degrees in total; while the disc is being cut, it moves through seconds of an arc. Its primary function is to control cutting stylus pressure and thereby the depth and width of the groove.

Electronic damping—using a feedback circuit in conjunction with the cutter head suspension—eliminates levers, strings, knobs, cams, and hydraulic dampers. Again, there's not much to adjust or change; therefore, not much margin for error.

The motor is also used to raise and to lower the cutter head, at the start and finish of the transfer.

## FRONT PANEL CONTROLS

Deliberately, the front panel has been kept simple, for ease of operation. Microscope control knobs and switches are at the extreme left. Next, two large analog meters indicate pitch and depth information. At the center of the panel, a rectangular l.e.d. display reads out the precise diameter at which the stylus is cutting. This is accomplished by means of a shaft encoder coupled to the lead screw. The encoder also eliminates the need for mechanical switching relating to automatic mode functions, such as head drop, lead-in spiral, automatic tape-start, lock-out concentric groove diameter, head lift, and automatic retract-to-rest position.

Within the l.e.d. display area, two additional readouts indicate stylus heater current and turntable speed. The speed indication is actually a digital strobe, and reads the precise speed at which the platter is rotating.

Motion and mode control buttons are located to the right of the front panel. Below the front panel, there is a sub-panel with pre-set controls for heater current, band-time switch, half-speed selector, etc.

## THE ELECTRONICS

Contemporary electronic devices are used within the DM 2002: random access memories, twelve-bit analog-to-digital and digital-to-analog converters with an accuracy of one part in 4,096 ( $2^{12}$ ), or  $\pm 0.025$  per cent, precision sample-and-hold circuits with f.e.t. op-amps and low power Schottky logic. These circuits control the pitch/depth computer as well as the basic lathe functions, such as turntable speed, mode control, etc. Additional logic circuits provide safety against an accidental head-drop when the lathe is functioning in a mode that would be dangerous. For ex-

# The New TCD 340 A With The Exclusive ACTILINEAR Recording System

Tape recorders can no longer be looked upon as independent units in today's extremely sophisticated sound systems, but rather as components within a total system with performance capability as advanced as all other components of that system.

Drawing upon its unequalled 30 year tradition in magnetic recording technology, Tandberg has met this challenge by developing a completely new concept known as ACTILINEAR Recording (Patent pending).

In conventional recording systems, the summation of record & bias currents in the recording head is done through passive components, leading to inherent compromise solutions. The new ACTILINEAR System is free of these compromises, as the passive components have been replaced with an active Transconductance amplifier developed by Tandberg. Just a couple of its benefits are: up to 20 dB more headroom over any recording system currently available, and the ability to handle the new high coercivity tapes.

In fact, Tandberg's new ACTILINEAR Recording System, when used in conjunction with the soon-to-be-available metal particle tapes now under intense development in the U.S., Japan and Ger-

many, offers performance parameters approaching those of experimental Pulse Code Modulation (PCM) technology, yet is fully compatible for playback on all existing tape recorders. It is literally a recording system for the future, with no obsolescence factor, as it can be used with any tape, available now or in years to come.

Tandberg engineers have mated this advanced recording system with the finest cassette deck transport available today, making their new TCD 340 A a worthy successor to the world-famous TCD 330 cassette deck. When used with the better brands of recording tape currently available, the TCD 340 A's ACTILINEAR Recording System permits an extremely linear frequency response, a significant increase in headroom, as well as a reduction of high frequency IM distortion and the cancellation of Slew Rate limitations.

And when metal particle cassette tapes become available, the TCD 340 A can be adjusted to take full advantage of their increased signal capacity. At that time, Tandberg will also offer the ultimate cassette deck—the remarkable TCD 340 AM, complete with front panel switching for the new metal particle tape.

Both these remarkable cassette decks

excel in more than just their circuitry. Like their famous predecessor, the TCD 340 series offers three separate heads (not a "2-in-1 sandwich" head compromise) for professional recording & monitoring, as well as Tandberg's renowned three-motor, dual capstan closed loop transport, coupled with complete logic-controlled solenoid operation. Plus exclusive features such as adjustable azimuth & built-in 10 kHz tone generator, allowing the user to select the perfect alignment for each cassette, as well as to spot dropouts and inferior quality tape. And the TCD 340 A boasts a 70 dB signal-to-noise ratio, plus very low 0.12% WRM wow & flutter!

And there's more: Automatic take-up of tape loops when the cassette is inserted. Frequency-equalized, peak-reading meters. Servo-controlled high speed winding. Plus vertical or horizontal operation, optional remote control & rack mounting.

Tandberg's TCD 330 was the deck that delivered cassette performance exceeded only by the finest reel-to-reel machines. Now, the 340 series with ACTILINEAR Recording narrows the gap even more.

For your nearest dealer, write: Tandberg of America, Inc., Labriola Court, Armonk, N.Y. 10504. Available in Canada.

# TANDBERG

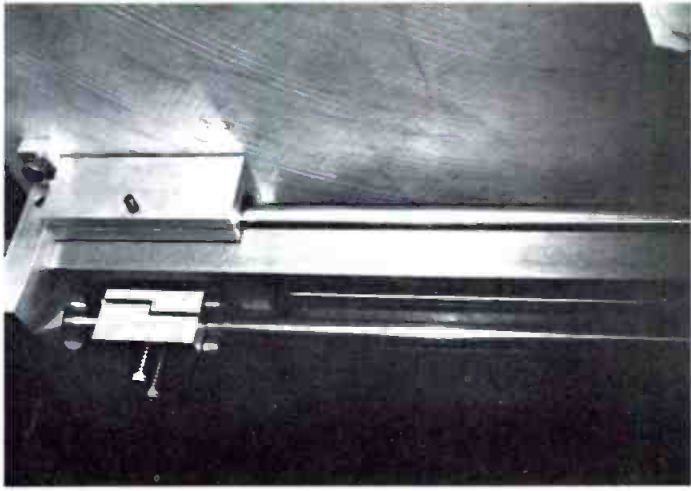

*The microscope carriage viewed from below.*

ample. automatic head lift is initiated if the operator stops or changes turntable speed, or moves the carriage in the fast-out mode while cutting.

When the front panel is pulled out, all electronics are exposed, for easy trouble-shooting. I.c.'s are mounted in computer-grade sockets to allow quick replacement if and when the need should arise.

#### COMPUTER PITCH CONTROL

All control signals are taken from the standard preview head on the tape playback system to allow the circuits to anticipate what is going to happen to the groove when it is cut. The preview signal is also stored for one revolution

in the computer, where a comparison is made between what the previous groove looked like and what the uncoming groove will look like. This information is converted into pitch and depth control signals.

The computer receives new information constantly and is capable of up-dating pitch and depth information from two to eighteen times per turntable revolution. A programmable delay time in the computer's logic compensates for preview head-to-playback head distances, disc speed, and tape speed, thereby eliminating the need for complicated tape paths on the master tape machine.

All control signals are formed into eight-bit words, in order to facilitate automated disc recording, in conjunction with presently available computer mixdown systems, or with future microprocessor-based systems. The feature also makes it possible to link several lathes together electronically, for high production or direct-to-disc recording.

#### CONCLUSION

Because of its small size and ease of operation, there is no doubt that the Cybersonics lathe could open the door to versatility in disc mastering a bit wider. Two or three lathes might be placed in the amount of space formerly required for just one. Since the lathe is not much bigger than a typical tape recorder, it is conceivable that it could be placed in the recording studio control room. This would allow the engineer to cut a reference lacquer in the same environment in which the multi-track recording and mixdown were done.

And more important perhaps, if the Cybersonics DM 2002 Disc Mastering Lathe lives up to its promise of reducing the cost and complexity of disc mastering, it should make this important aspect of recording services more accessible to the small and medium-size studio operation. ■

## Tandberg Presents the Next Generation

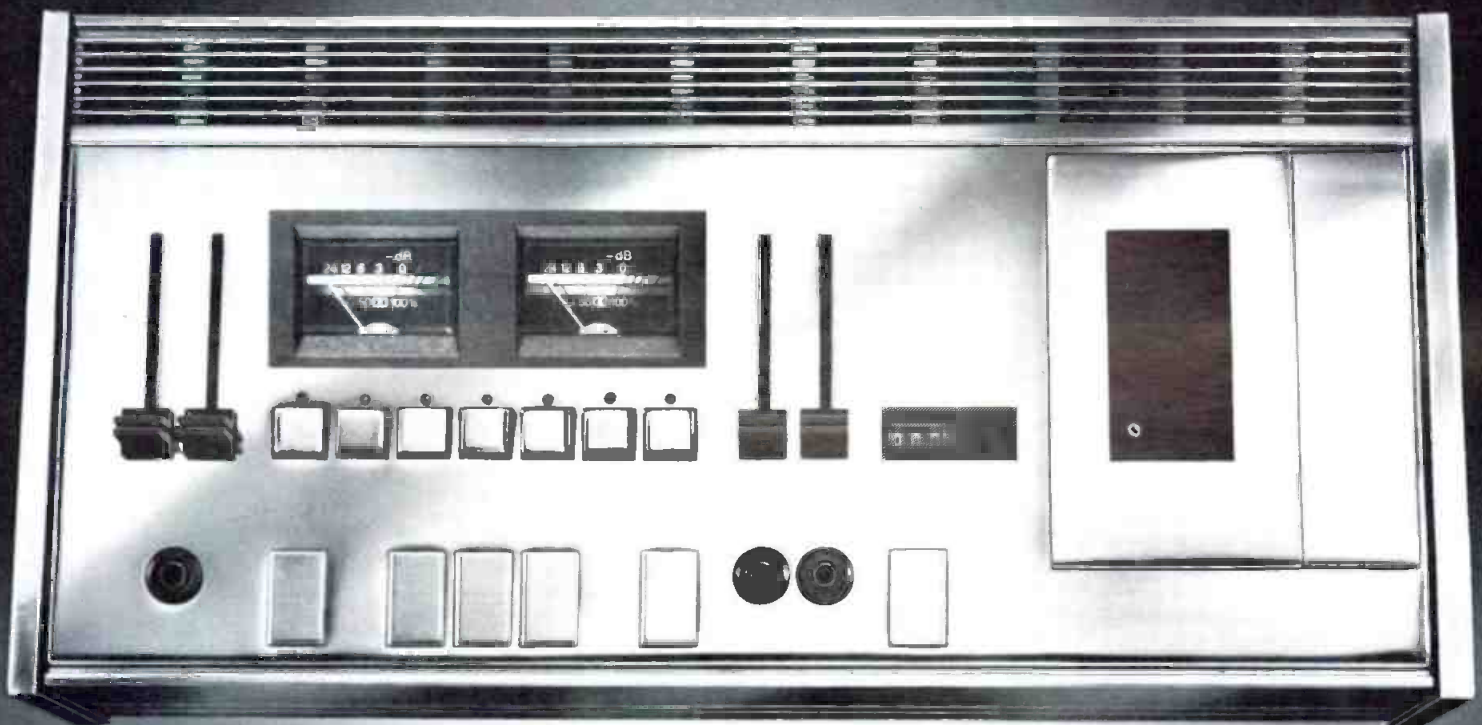

Circle 27 on Reader Service Card

[www.americanradiohistory.com](http://www.americanradiohistory.com)

# CBS' DISComputer

*A micro-processor based unit controls consistent production in disc-cutting operations at CBS' farflung installations.*

**C**ONSIDER the following problem. You are a major record company producing records on a world wide basis and you have to manufacture enough records to meet the demand for your latest hit album, along with all your normal production demands. Solution?? Design and build a state-of-the-art variable pitch and depth computer and install it in all your cutting lathes around the world. Now if these first two sentences don't seem related to each other, perhaps a few more facts will clear things up a bit.

The production of a million or copies of the same record requires that a large number of *identical* metal stampers also be produced. And this in turn requires that a large number of identical lacquer masters be made. In a large company like CBS, with its large staff of cutting engineers and variety of mastering equipment, the chances of the same engineer, using the same equipment, cutting all the necessary lacquers for that million dollar seller is very small indeed. At the same time, there is an excellent chance that a tape mastered by engineer A, using a Neumann cutting system (for example) cannot be duplicated by engineer B using a Scully/Westrex system, or vice versa. In addition, if you consider that some records (usually classical) will remain in production for many years and that CBS has divisions all over the world producing what are theoretically identical discs, you can see that what appeared to be a relatively simple problem is in reality a very complex one.

The awareness of this problem led CBS Records to ask CBS Laboratories (now known as the CBS Technology Center) to find a way to improve lacquer mastering standards. The research team began by investigating every cutting system existing at the time with the hope that one system could be chosen as a standard. This idea was quickly rejected when it was discovered that all the cutting systems were either inadequate with respect to repeatability or were too conservative in design to meet the demands of modern studio recording technique (as well as that ever lurking nemesis, the modern record producer!). It would also have been prohibitively expensive for CBS to throw away all of its existing lathes and replace them with any one manufacturer's system.

It was then decided that the best approach would be to design a variable pitch and depth computer that could be interfaced with any lathe used by any division of CBS Records. The result, after five years of research and development, was the CBS DISComputer.

## MICROPROCESSOR

The start of the DISComputer is a microprocessor unit which allows the very complex pitch and depth command

*A close-up of the recording lathe.*



*Charles Repka is a freelance recording engineer based in Oakland, N.J.*

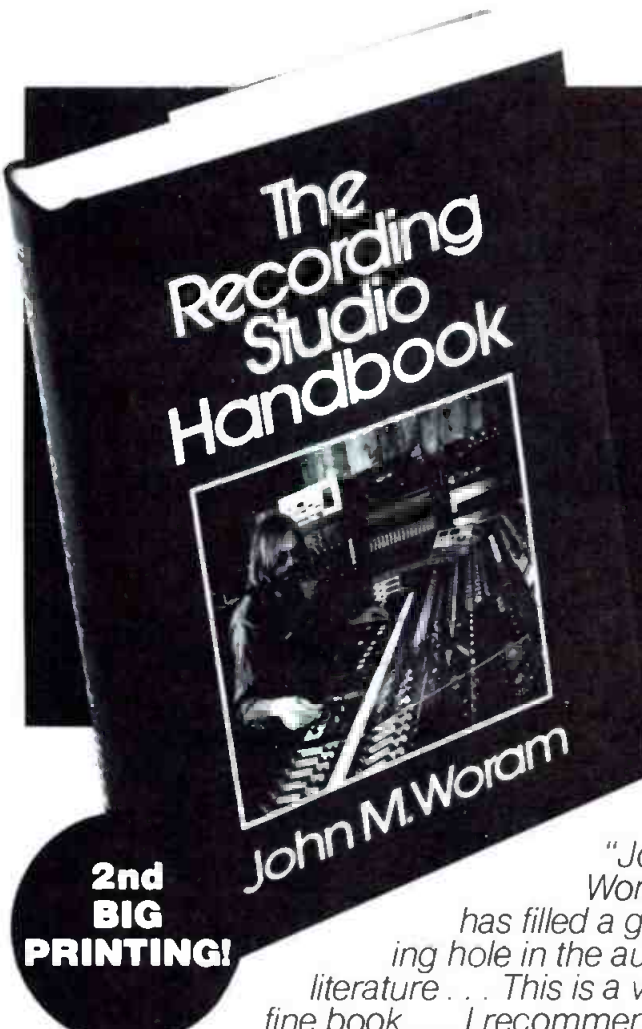

From the publishers of **db**

An in-depth manual covering every important aspect of recording technology!

# The Recording Studio Handbook

by John Woram

*"John Woram has filled a gaping hole in the audio literature . . . This is a very fine book . . . I recommend it very highly . . ." — High Fidelity.*

*And the Journal of the Audio Engineering Society said: ". . . a very useful guide for anyone seriously concerned with the magnetic recording of sound."*

The technique of creative sound recording has never been more complex than it is today. The proliferation of new devices and techniques require the recording engineer to operate on a level of creativity somewhere between that of a technical superman and a virtuoso knob-twirler. This is a difficult and challenging road. But John Woram's book charts the way.

*The Recording Studio Handbook* is an indispensable guide. It is the audio industry's first complete handbook that deals with every important aspect of recording technology.

Here are the eighteen chapters:

- The Decibel
- Sound
- Microphone Design
- Microphone Technique
- Loudspeakers
- Echo and Reverberation
- Equalizers
- Compressors, Limiters and Expanders
- Flanging and Phasing
- Tape and Tape Recorder Fundamentals
- Magnetic Recording Tape
- The Tape Recorder
- Tape Recorder Alignment
- Noise and Noise Reduction Principles
- Studio Noise Reduction Systems
- The Modern Recording Studio Console
- The Recording Session
- The Mixdown Session

This hard cover text has been selected by several universities for their audio training programs. With 496 pages and hundreds of illustrations, photographs and drawings, it is an absolutely indispensable tool for anyone interested in the current state of the recording art.

Use the coupon at the right to order your copy of *The Recording Studio Handbook*. The price is only \$35.00, and there's a 15-day money-back guarantee.

**SAGAMORE PUBLISHING COMPANY, INC.**  
1120 Old Country Road, Plainview, N.Y. 11803

Yes! Please send \_\_\_\_\_ copies of THE RECORDING STUDIO HANDBOOK at \$35.00 each. On 15-day approval.

Name \_\_\_\_\_

Address \_\_\_\_\_

City/State/Zip \_\_\_\_\_

Total payment enclosed \$ \_\_\_\_\_  
(In N.Y.S. add appropriate sales tax)

Please charge my  Master Charge  
 BankAmericard/Visa

Account # \_\_\_\_\_ Exp. date \_\_\_\_\_

Signature \_\_\_\_\_  
(charges not valid unless signed)

Outside U.S.A. add \$2.00 for postage

October 1978 db 51



*The entire disc-mastering system.*

signals, needed during the cutting of an LP side, to be repeatable to a high degree of accuracy. The analog signals from the preview head are continuously examined for maximum waveform levels. The maximum level is sampled 200 times on each disc revolution, converted to digital, and then stored in the computer. Next, the computer uses the previous revolution's stored signal and the present signal to generate proper pitch and depth control signals that not only meet the demands of the program material, but also the constraints (level, pitch and groove width) required by the cutting engineer as well as several pre-programmed constraints. (The circuit details regarding the manner in which the command signals are generated within the computer are considered proprietary by CBS and cannot be discussed until proper patent protection has been secured.)

The high sample rate (about 25 times higher than used in previous systems) allows a more efficient use of the available recording space. The computer can expand the pitch for a loud signal and then close the pitch again very quickly, while remembering to avoid those groove excursions on the next revolution. Since more "decisions" are made in each revolution, the net result is a 20 to 40 per cent improvement in space utilization. This means the engineer can either cut a record using 25-40 per cent less space than before (sometimes desirable due to distortion considerations) or use the same space and put a 2-3 dB higher level on the disc.

The built-in constraints control the rate at which the pitch and depth can change to keep the control signals well below the point of audibility, yet make efficient use of record space. Studies by CBS Technology Center revealed that these changes should be smoothed to yield a well defined path of cutter head motion, which has virtually all of its energy concentrated at frequencies below the tone arm resonance of the playback system. This ensures maximum utilization of record "real estate" with no disturbance to

the listener. The computer also has a built-in non-linear function (again based on extensive studies in the lab which corrects for pre- and post-echo that can take place during cutting and plating).

The use of a microprocessor has resulted in several unique features not usually found in professional audio equipment. The computer has a self-test function that operates each time the unit is turned on. 800 test points are checked and, if a malfunction is found, the problem area is indicated on the front panel. The test function can also be initiated at any time by the operator.

#### **FAIL-SAFE**

The computer will not permit the cutting engineer to make a "dumb" mistake. Say the engineer tells the computer to cut at 800 lines per inch with a 4 mil groove width. The computer will ignore the LPI command and will instead set itself to 250 LPI (the maximum allowable at a 4 mil width) and indicate the proper LPI on the readout display.

The computer can also be used by the engineer to determine the optimum level for any given program material. When cutting a tape for the first time, the engineer looks at the running time and the nature of the program material and makes an educated guess as to the proper pitch and level settings. The lacquer is then cut and at the end of the side, the computer displays the amount of level (in dB) that should be added or subtracted (assuming no change in the basic pitch setting) to give an optimum cut utilizing all the available space. Or, more simply put, if the chosen pitch and level has not used up all the available space, the computer tells the engineer how many dB he can raise the level, using the same pitch setting, to fill the disc.

If, on the other hand, the engineer had guessed wrong and run out of space, the display would show how many dB the level must be lowered to fit the program onto the

disc. This process can also take place without ever cutting a lacquer by simply playing through the computer and observing the display at the end of the tape. Of course, the engineer always has the option of trying a different pitch setting and going through the process again.

As part of the research for this article, I went to the CBS mastering facility in NYC to observe the DISComputer in operation. I brought with me a tape that I had cut on another system (no names please, but it was the best money could buy, about one year ago) with which I had experienced some difficulty. The tape was of a symphony orchestra recorded in a large reverberant hall, contained no unusual levels or dynamics and was only 23 minutes long. However, the recording had been made using spaced omni microphones and, as a result, contained a great deal of out-of-phase low frequency information that cause the system to overexpand and run out of space on the initial cut. The DISComputer cut the same tape at the same level, with room to spare, and told us at the end of the tape that an additional 1½ dB of level could have been used. A second cut was then made at the higher level with no problems. During both cuts, mastering engineer Stew Romain used a much coarser pitch (300 LPI at 2.6 mils groove width) than I had used (400 LPI at 2 mils). Using my pitch settings, several additional dB of level could have been obtained. To achieve a satisfactory cut with the other system, I had to resort to a 150 Hz mono combine network as well as a slight reduction in level.

Installation of the DISComputer involved the removal of the existing pitch and depth computer as well as the lead screw drive mechanism and replacing them with the CBS-designed units. Typical installations with a modern Neumann lathe and an older Scully system are shown in

the accompanying photographs. Units are currently in service in CBS cutting facilities in New York City, Nashville and Canada, and modifications are taking place at CBS divisions in Australia, Mexico, Holland, Germany, and Japan. Since installation has been completed in the U.S., CBS has experienced a significant reduction of lacquer-master related quality control problems in its plating and pressing plants. This means there are fewer rejections due to overcuts, lifts (too narrow a groove), and fewer recuts due to mastering related problems in the plating process.

#### EVALUATION

In summation, the new CBS DISComputer has brought the following improvements to the recordmakers' art:

Increased the average level of a typical disc by 2-3 dB.

Made possible longer sides with no sacrifice in level.

Improved repeatability for lacquer recuts.

Improved product uniformity in all CBS divisions.

Reduced costs by reducing the number of recuts caused by cutting errors.

Improved disc quality achieved by improved s/n ratio and reduced pre- and post-echo.

That's quite an impressive list and before any of you accuse me of being paid off by the CBS Publicity department, you may be surprised to discover that CBS has no plans whatsoever to market the DISComputer; only enough computers will be made to equip the various CBS record divisions. CBS is not and does not want to be in the disc computer manufacturing business.

The DISComputer will pay for itself at CBS by means of reduced manufacturing costs and hopefully, through increased sales as a result of improved product quality.

I find that to be a refreshing thought! ■



# ASHLY

**PARAMETRIC EQUALIZERS** capable of true narrow-band equalization

**PEAK LIMITER-COMPRESSORS** with ultra-low noise and distortion

**ELECTRONIC CROSSOVERS** with continuous frequency and rolloff adjustment

**INSTRUMENT PREAMPS** with 3 band tunable eq. and built-in direct outputs

If you need more control of your sound, chances are ASHLY can help. Write or call for our free brochure or, better yet, check us out at your pro-audio dealer.

**ASHLY AUDIO Inc. 1099 JAY STREET  
ROCHESTER, N.Y. 14611 (716) 328-9560**

**EXCLUSIVE DISTRIBUTION IN CANADA:**

Gerr Electro-Acoustics  
365 Adelaide Street East  
Toronto, Ontario, Canada M5B 4R9  
# 416-868-0528

Circle 49 on Reader Service Card

# The Gramophone

*If a machine talks, we are apt to regard it as almost human; if it sings, we look upon it as being artistic.*

**M**AKING EITHER permanent or transient records of sounds, as exemplified by Scott's phonograph or Koenig's monometric flames, is no longer a novelty, but recording and reproducing musical sounds and speech are recent. Sound reproducing machines are no less wonderful than sound transmitting apparatus, and although the talking machine may not find as wide a field of application as the telephone, it is perhaps more interesting and instructive, and has the additional peculiar charm possessed by anything mechanical that faithfully reproduces any of life's actions. If a machine talks, we are apt to regard it as almost human; if it sings, we look upon it as being artistic.

The versatility of the gramophone enables it to embrace almost any sound; military bands, instrumental solos, piano, cornet, clarinet, banjo, etc., songs, recitations, whistling, imitations. Educational features of the instrument are lessons in elocution, lessons on the correct pronunciation of different languages and the memorizing of verses, songs, and music.

Some years ago we gave an account of the earlier work of the inventor, Mr. Emile Berliner, in this direction, and our present first page engraving illustrates the gramophone in its latest form. It is presented as a popular instrument for the use of everybody. It affords amusement to people of all ages and also presents a means of preserving records of various kinds.

In FIGURE 1 is shown a gramophone provided with the reproducing apparatus only, it being designed for use in connection with records made by the Gramophone Company or the dealers. The instrument is provided with a turntable mounted on a pivot, as shown in FIGURE 8, which is revolved by frictional contact with a rubber wheel on the shaft of the fly wheel. The latter is provided with a pulley and is driven by a belt extending around

the larger pulley on the crank shaft. On the turntable is placed the rubber disk bearing the record. The sound box is mounted on a swinging arm, which also supports the conical tube or resonator.

FIGURE 2 represents the recording instrument operated by a simple electric motor.

The essential parts of the recording instrument are the turntable, the worm screw which guides the carriage holding the recording diaphragm, and the recording diaphragm. The action of the mechanism is to so guide the recording diaphragm, while recording the sound, as to make it trace a continuous spiral line from the outer edge of the table to the center.

The method of making a sound record is to place upon the turntable a highly polished disk of zinc, previously prepared with a film of fat, exceedingly delicate to the touch of a lightly bearing stylus, but dense enough to resist an etching bath.

As the machine is set in motion, a delicately pointed finger or stylus pivoted at its center transfers the wave vibrations from the diaphragm to the zinc surface. The finger moves laterally, and literally writes the sound through the thin film which covers the zinc disk. During the operation the plate is kept soaked with alcohol from the glass reservoir seen in the cut. The object of this is to soften the film and to prevent the particles of film or dust from collecting around the point of the stylus or finger: by this method a true and exact sound wave is recorded.

The record made, the zinc disk is taken from the turntable and the alcohol is rinsed off; the disk is then placed in an etching bath of chromic acid. The length of time consumed in the etching depends solely upon the amplitude of the wave vibrations. Recorded waves of small amplitude receive short etching and those of large amplitude long etching. When taken from the etching bath the disk is cleaned and ready for the first reproduction.

Since the first reproduction consists mainly in cleaning out the groove, the sound is at first slightly harsh and grating. Two or three reproductions make the record smooth and quick.

*This is a reprint of an article which appeared in the May 16, 1896 issue of Scientific American.*



The record is now ready to go through the duplicating process. A copper matrix is first made by a method of careful electrotyping. From the matrix hard rubber duplicates are pressed in the manner in which castings are made.

The rubber duplicates are superior to the zinc records in several ways. They will bear rough handling and an indefinite number of reproductions, whereas the zinc would burnish and soon wear away. They are louder and smoother than the zinc. The rubber records will stand over 1,000 reproductions, the zinc from 50 to 300, according to their delicacy. A first class matrix can press out 1,000 perfect duplicates.

A peculiarity of the gramophone record is that it has almost the penetration of the original sound, although not the broadness of tone, so that if 1,000 gramophones could be worked simultaneously, it would be possible for an orator to fill a hall 1,000 times larger than his voice ordinarily would fill. Gramophone recording agencies have been established in Philadelphia and Washington, New York and Boston, and similar ones will be established in every city of importance, where the voices of those dear to us may be permanently recorded.

In FIGURE 4 is shown the arrangement for producing the record of a cornet solo. The reproducing sound box, which is shown in FIGURE 5, is provided with a diaphragm connected with a spring arm fixed to one side of the diaphragm cell and carrying a point like an ordinary darning needle point. This point, when the instrument is arranged as shown in FIGURE 1, rests in the groove in the record plate and follows the groove as the turntable is revolved. The engagement of the needle point with the groove in the record disk causes the spring arm to vibrate and produce vibrations in the diaphragm, which are the same

as those of the recording instrument; as a consequence, the original sounds are reproduced in the resonator of the gramophone with a loudness and clearness which are surprising. The reproducing sound box is provided with a curved damping spring for reducing the vibration of the spring arm when it is desired to connect the sound box with ear tubes to be held in the ear. A cross section of the reproducing sound box is shown in FIGURE 6. The manner of holding the sound box in the position of use is shown in FIGURE 7. In FIGURE 9 is given a much enlarged view of a section of a record, showing the sinuous nature of the grooves. An electric motor has been applied to the gramophone, as shown in FIGURE 10, by means of which the table is rotated at a uniform speed, and in FIGURE 11 is shown the adaptation of spring clockwork to rotate the turntable.

The type of reproducing machine which seems to find most favor is turned by hand, and as the groove in the record itself guides the sound box, thereby eliminating the necessity of a costly worm screw and intricate gearing, it moves so easily that with five minutes' practice a child can operate it so as to reproduce a band selection or a song in perfect tune. Those who object to manipulating the crank can have a simple motor gramophone that will reproduce the selections by merely turning a switch.

The modest plant first started by the Berliner Gramophone Company, 1032 to 1036 Filbert Street, Philadelphia, has been increased to four times its original size. Duplicates are pressed out by the thousands, showing the rapid growth of this fascinating little machine. ■

Overleaf, the reproduced Scientific American cover that illustrates this article. →

## btx presents the 30-track audio recorder

The btx 4500 SMPTE interlocking system lets you operate any two multi-track recorders in tandem for 14, 22, 30 or 46-track capability. Using standard SMPTE time code written on one track of each machine, any two recorders may be synchronized, including video to audio. You can even mix makes, formats, speeds, and numbers of tracks, with or without servo controlled capstan drive. The btx 4500 is a micro-processor-based system capable of tracking within 50 microseconds of an actual mechanical lock. It's an economical direct plug-in system that's easy to use and ultra-reliable.

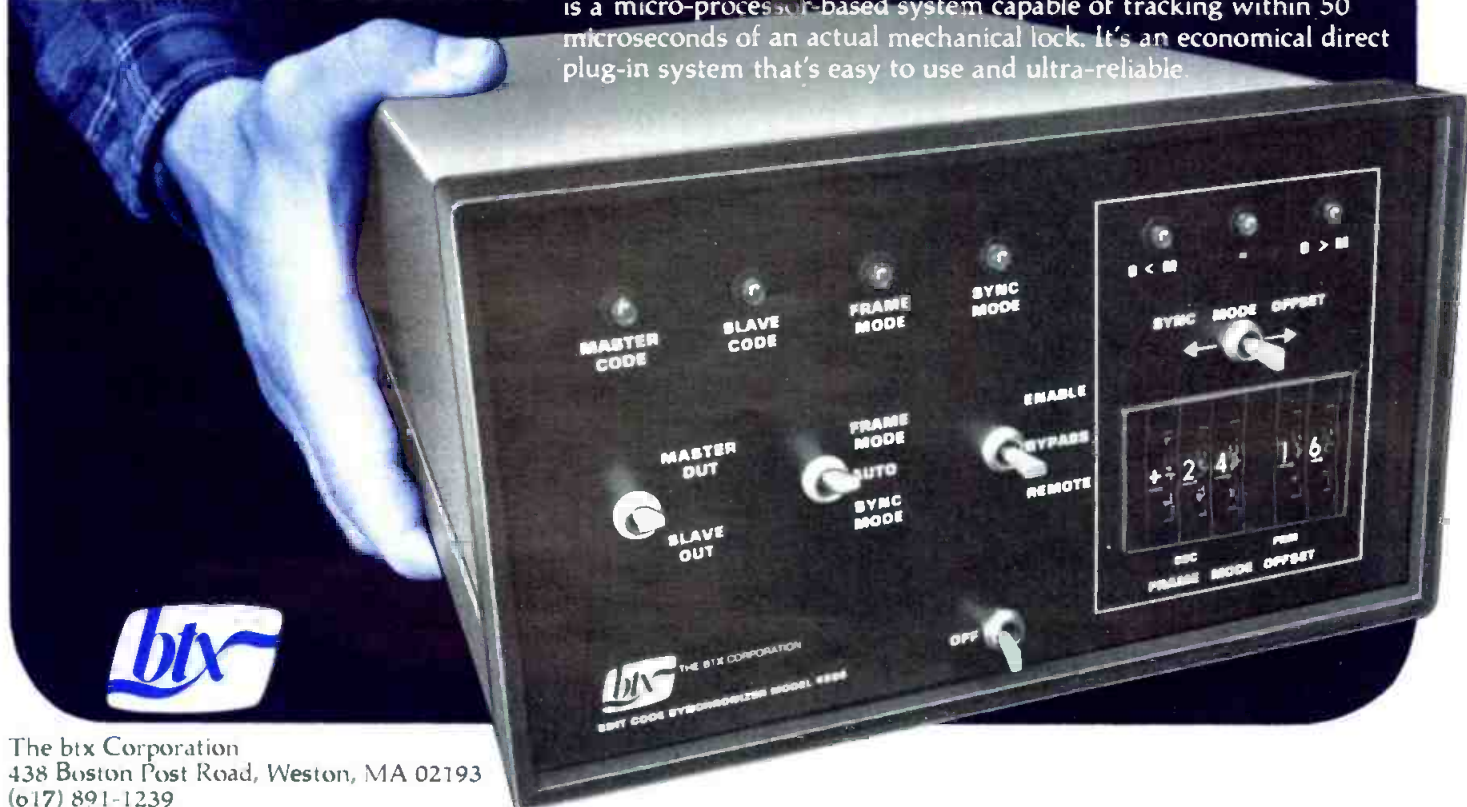

The btx Corporation  
438 Boston Post Road, Weston, MA 02193  
(617) 891-1239

Circle 48 on Reader Service Card

www.americanradiohistory.com

# SCIENTIFIC AMERICAN

Entered at the Post Office of New York, N. Y., as Second Class matter. Copyright, 1896, by Munn & Co.

A WEEKLY JOURNAL OF PRACTICAL INFORMATION, ART, SCIENCE, MECHANICS, CHEMISTRY, AND MANUFACTURES.

Vol. LXXIV, No. 20,  
ESTABLISHED 1845.

NEW YORK, MAY 16, 1896

[ \$3.00 A YEAR,  
WEEKLY.

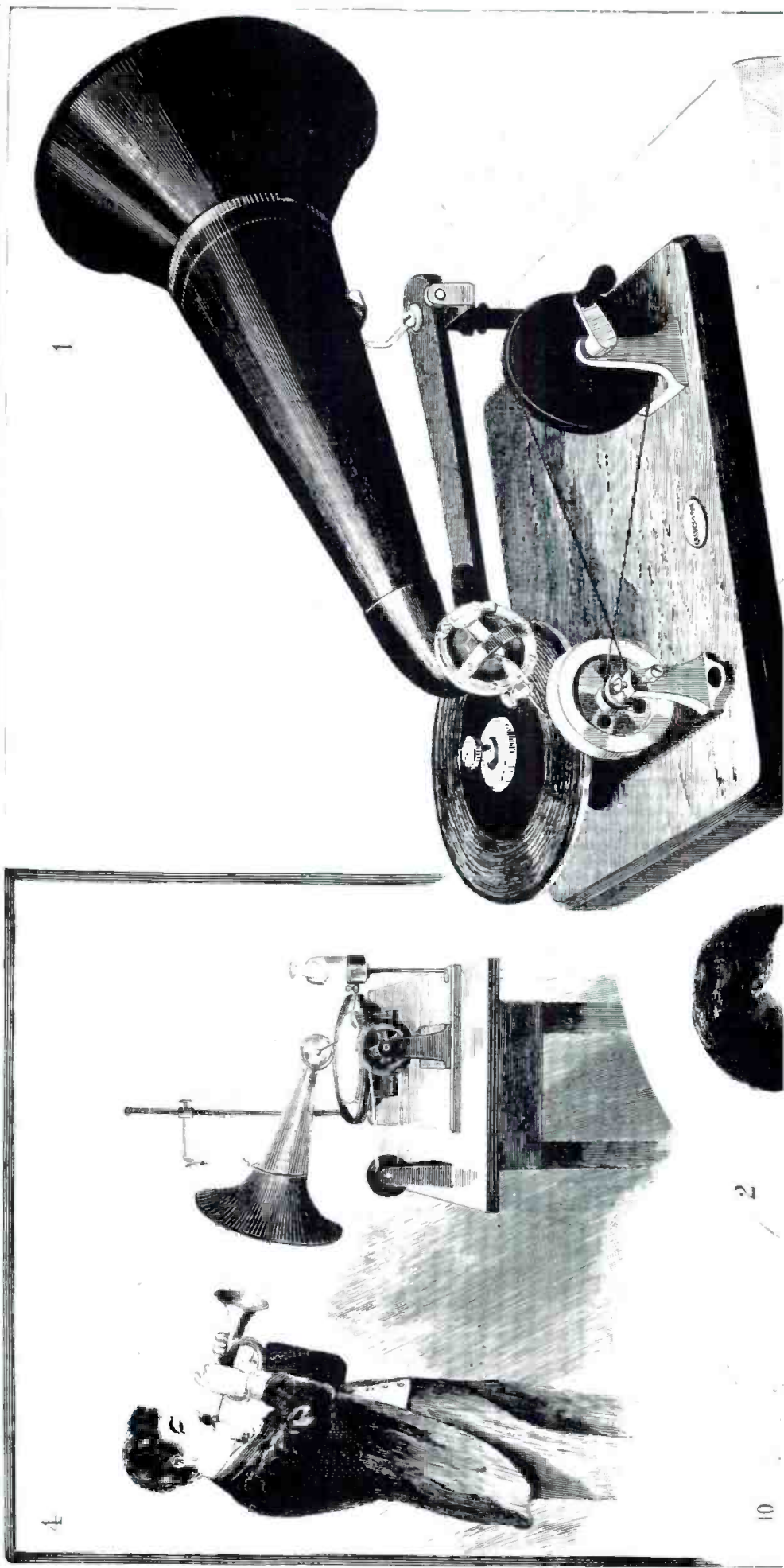

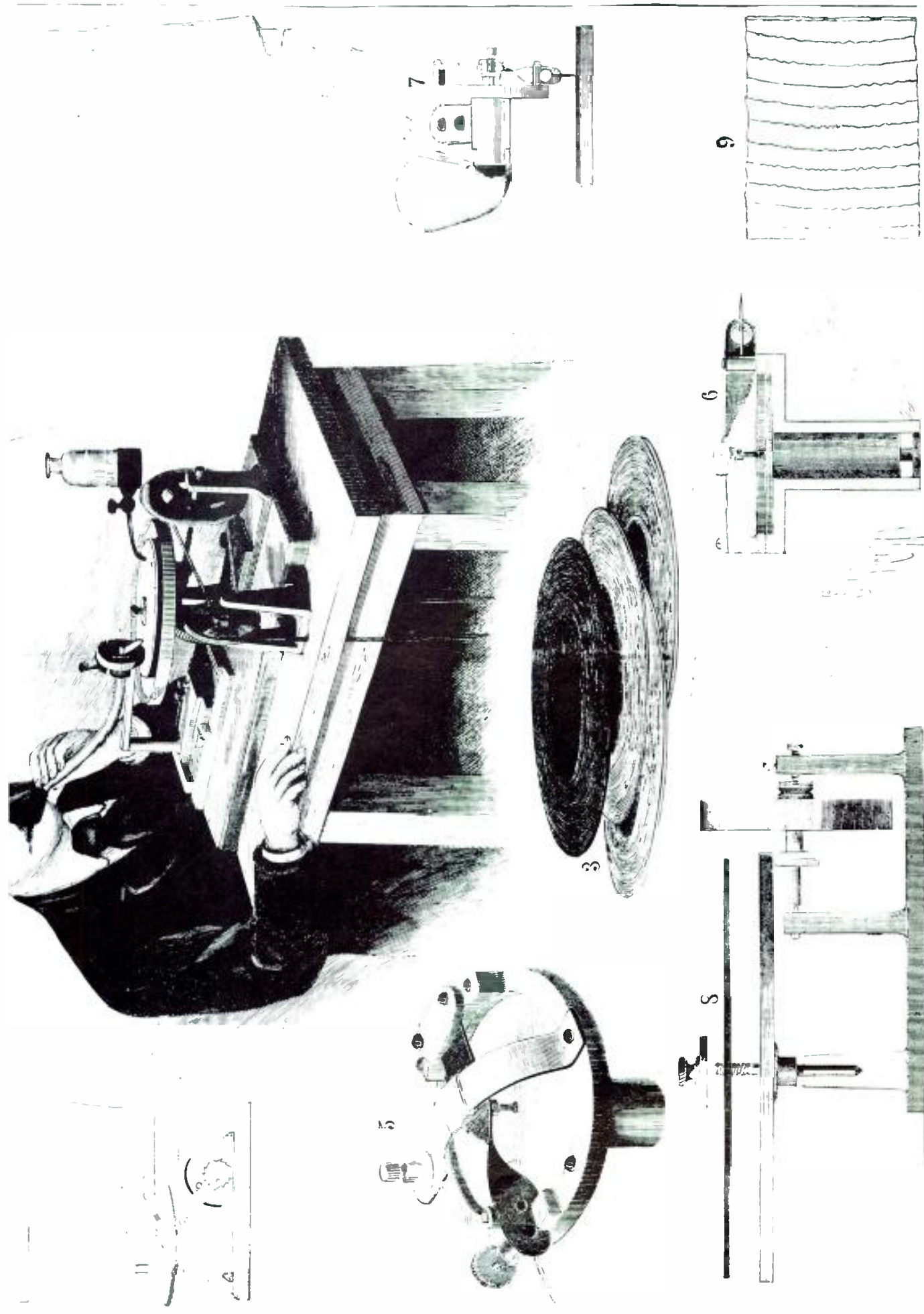

1. Reproducing gramophone. 2. Recording instrument. 3. Record disks. 4. Recording instrument. 5. Reproducing gramophone. 6. Cross section of sound box. 7. Sound box in position for use. 8. Details of mechanism. 9. Part of a record. 10 and 11. Motor driven gramophone.

**THE GRAMOPHONE—THE NEW TALKING MACHINE.**

# Keith Monks' Record Cleaning Machine



*The Keith Monks Record Cleaning Machine.*

**I**F YOU have seen one of these units at a distance, you may be believing that it is the invention of the late Rube Goldberg. As it comes out of its carton it is a turntable system that clearly will not play records. What it is, however, is a turntable that will superbly clean records.

It may seem, based on the following description, that this machine is a kind of cleaning overkill. It probably is, if you have but a few records to clean on occasion. But if you maintain a record station library, retail shop, etc., where discs flow through regularly, this unit will prove extremely effective and efficient to use.

To begin, then. The Record Cleaning Machine is a turntable that revolves at high speed (80-100 r.p.m.), washes down the grooves of the disc to be cleaned via a brush

that is swung over the disc, and then proceeds to remove the wash water and dirt by use of another arm that vacuums up the material.

Underneath the deck, there are three bottles. One is filled with a cleaning liquid of 50 per cent distilled water and 50 per cent industrial methylated spirits. A second bottle is not to be filled; it contains merely air. A third bottle is where the vacuumed-up glop is deposited.

All three bottles are connected to a vacuum pump/motor system which serves all the action.

To use, the disc to be cleaned is placed on the platter, and an electric switch moved to *WET*. The brush (adjustable) is placed across the grooves and a front panel plunger depressed. This releases a controlled amount of cleaning fluid through the brush onto the grooves and, after a few revolutions the disc has been thoroughly cleaned, but is

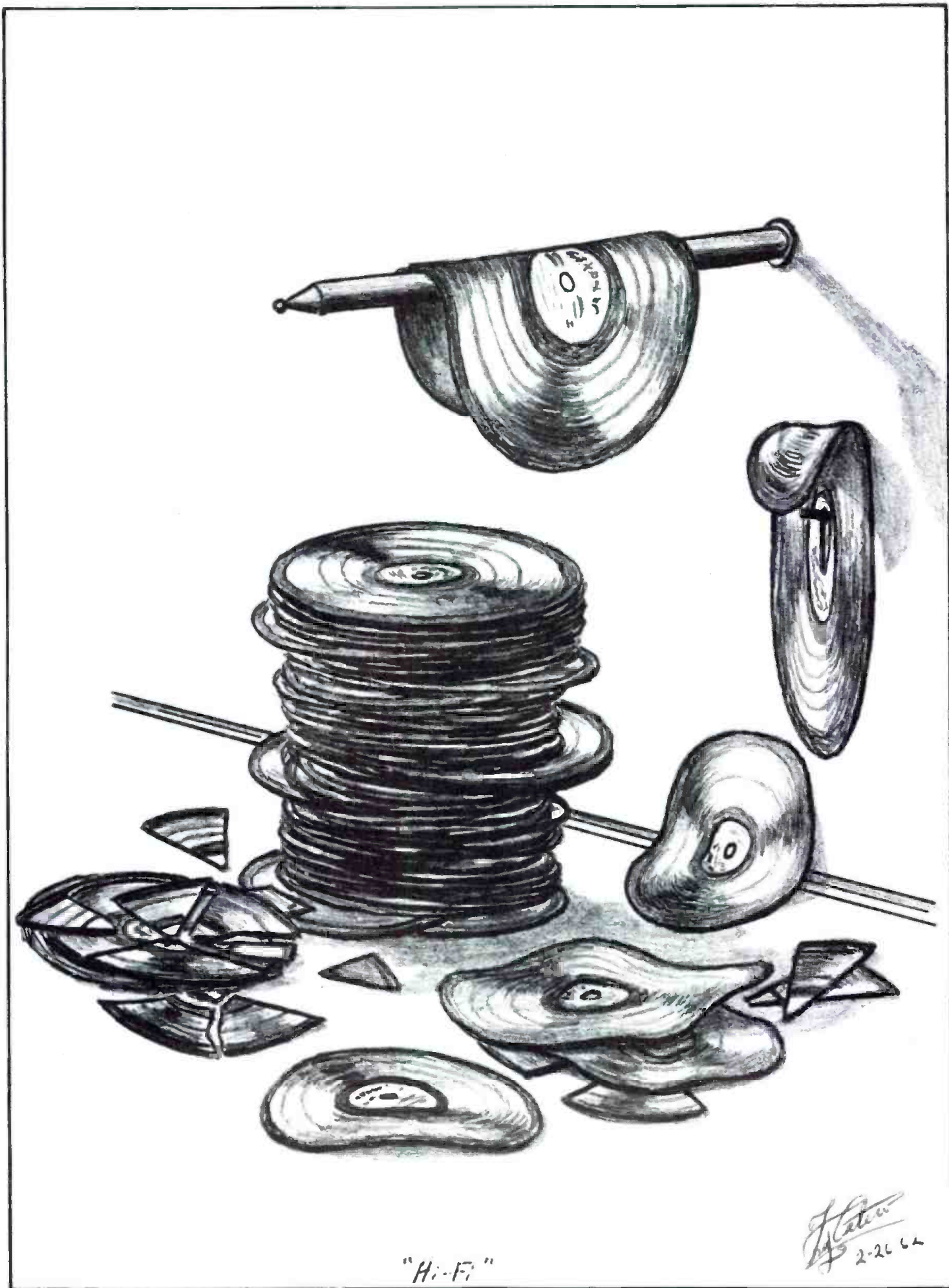

"Hi-Fi"

Fred Catero  
2-26-64

The cleaning machine will not help these discs. We thank Fred Catero for his art. Fred is chief recording engineer at the Automatt in San Francisco.



The vacuum head. A nylon thread acts as a buffer between the disc and the head. It is slowly sucked off a below-deck reel into the bottle with the dirty fluid.

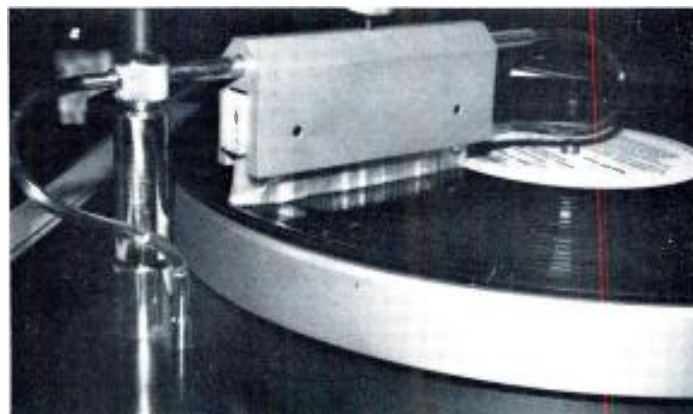

The cleaning brush is fully adjustable.



A close view of the front panel.

also thoroughly wet. Now you swing the brush off the disc and throw the aforementioned front panel switch to *DRY*. This starts the vacuum action. Then if you place the vacuum arm at the center of the disc, it will slowly move outward, slurping up the liquid and dirt into its innards, to be deposited in the appropriate bottle.

Does it really work? I took some new CBS-100 test records, measured their response, then cleaned them several times through the cycles of the machine, and measured them again. No change. But were they quieter sounding!

Even a new disc can be further cleaned (and thus noise reduced) by a pass through this system. It's quite effective and, once mastered, easy to use. A cleaning machine sells for \$1,492.50. It will prove a valuable investment. L.Z.

# Our Logger is a Turtle!

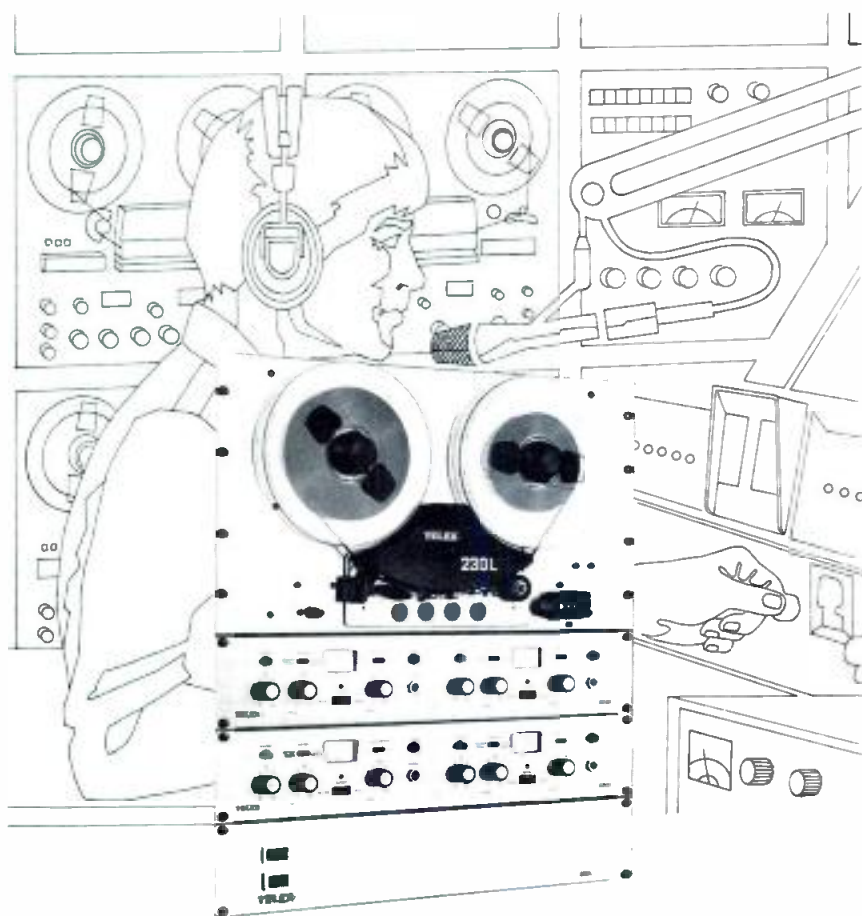

It's slow, slow moving but it wins the race when it comes to recording information. All kinds of information; broadcast logging, telephone messages, fire or police dispatcher record, surveillance, medical emergency room or analog recording in surgery, court reporting and transcription or space and military analog recording.

Our 230L logger records a lot of information; over twelve and one half hours on 3600 feet of tape at 15/16 ips; over six hours at 1-7/8 ips. And it's available in one, two or four channel configuration with professional solid state record/reproduce preamplifiers. So now you can win almost every race with a Telex 230L logger.

It's a turtle.



PRODUCTS OF SOUND RESEARCH  
**TELEX**  
 COMMUNICATIONS, INC.

9600 ALDRICH AVE SO • MINNEAPOLIS, MINN 55420 U S A  
 Europe: 22, rue de la Legion-d'Honneur, 93200 St Denis, France  
 Canada: Telak Electronics, Ltd., Scarborough, Ontario

Circle 37 on Reader Service Card

www.americanradiohistory.com

# The Logistics of Direct-to-Disc Recording

*The search for direct-to-disc pristine sound winds through a labyrinth of frightening possibilities.*

**I**T HAS BEEN SAID that making a direct-to-disc-recording is an exquisitely refined form of masochism. Certainly it is an exhausting, tension-filled experience for artists and engineers alike. The direct-to-disc recording process is unquestionably the most demanding and unforgiving of all present recording techniques.

In spite of this, more and more d-d recordings are being made; it is claimed that more than 60 companies are producing them. Needless to say, the quality of a d-d recording can vary as much as it does in conventional recordings. The mere fact that a recording has been made with the d-d process does not automatically confer on it some extraordinary degree of fidelity to the original sound. In point of fact, the number of d-d recordings that fully exploit the capabilities of this medium is comparatively limited. In consideration of the difficulties in working with the d-d medium, the obvious question is, "Why all the activity in this field?" The answer, of course, is that if the stringent requirements of the d-d process are scrupulously observed, this system is the highest quality, most accurate recording medium in use today.

## WIDE RANGE ACCURACY

Few engineers, or the audiophiles who are the principal buyers of d-d recordings, are aware of the degree of sophistication or the technical capabilities of modern disc cutting systems such as those made by Neumann or Ortofon. The Neumann SX74 and Ortofon 732 are moving-coil cutterheads, employing motional feedback. They differ in a number of important respects, but their overall specifications are similar. As I happen to have the Neumann specs at hand, I'll describe this system. The SX74 is a remarkable device, an exceptionally linear, very low distortion transducer. Its frequency response surpasses that of the very best tape recorders, being a rather astonishing 7 Hz to 25 kHz, plus or minus 3 dB. Even more impressive is that in the critical range from 15 Hz to 16 kHz, the deviation from flatness is a miniscule plus or minus a half dB! In a Virgil Fox organ recording I engineered for Crystal Clear

Records, the particular SX74 cutterhead in the system we used was down only 3 dB at 4 Hz! Obviously, the 16 cycle fundamental of the 32 foot pedal stops could be recorded with a cutter with such an extended low frequency response. The harmonic and intermodulation distortion of the cutterhead is less than one percent. Unlike tape recorders, there is no modulation noise in this Neumann disc cutting system, wow and flutter are exceptionally low, and the dynamic range/signal-to-noise ratio is about 80 dB, without the use of any noise reduction systems. This truly is "state-of-the-art," and permits recording of the highest known quality.

People not familiar with the d-d recording process have commented adversely on the comparatively restricted playback time per side. In normal tape-to-disc transfer, an advance head on the tape playback machine is positioned a certain distance before the standard playback head on the machine. The output of this advance head feeds into a special computer on the lathe and controls a number of automated functions. Principal among these is automatic control of the pitch and depth of the record groove that is being cut. The actual pitch (lines-per-inch) cut on the lacquer disc is continuously variable, as a function of the amplitude and dynamics of the program material. In low level passages of music, the automatic variable pitch mechanism makes the groove width narrower, and spaces the grooves closer together. In loud passages, the combination of variable pitch and variable depth control makes the grooves wider, deeper and spaced further apart. With this variable cutting technique, space on the record can be saved (as compared to cutting at a fixed pitch), and therefore more recording time per side is possible.

When we record direct-to-disc, there is no tape and obviously no advance head, and therefore no possibility of automated control of groove pitch and depth. Now we must depend on a really savvy cutting engineer (preferably one who can read scores, and thus to a certain degree anticipate the dynamics of the music) who must manually control the pitch and depth mechanisms. Even the most skilled cutting engineer simply cannot compete with the speed of the computer as used in the normal tape-to-disc transfer. With the limitations of manual control, and depending on the dynamics of the program material, the playback time per side on a d-d recording can rarely exceed 18-19 minutes, at 33 $\frac{1}{3}$  rpm, and about 12-13 minutes per side at 45 rpm.

As if the restrictions of manual cutting control were not enough of a handicap in d-d recording, the really conscientious d-d companies who strive for maximum quality make

---

*Bert Whyte's career as a recording engineer is almost as legendary as some of the conductors he has worked with. He supervised and engineered the great Stokowski interpretations, as well as many others, while with the original Everest Records, and earlier made some of the first stereo or binaural orchestral recordings while with Magnecord.*



Author Bert Whyte with conductor Arthur Fiedler and the equipment used for the recently released Boston Pops album (Crystal Clear Records).

life for the cutting engineer still more difficult by eschewing the use of any kind of limiters or compressors in the recording chain. Some do not even use the stylus acceleration limiter in the Neumann electronics.

### MERCILESSLY REVEALING

As mentioned earlier, the use of the d-d process is no guarantee of high quality. It is a mercilessly revealing medium, which will expose the bad just as easily as the good. The "prime directive" of computer technology—"garbage in—garbage out"—is equally applicable to d-d recording. Thus, the signal fed into the cutting head electronics must be as sonically pure as possible, if the high quality of the d-d process is to be fully realized. In the Virgil Fox and Boston Pops recordings I have engineered for the Crystal Clear Records people, I had the advantage of using highly refined custom-built recording equipment, especially designed to interface with the d-d cutting electronics. Thus special attention was directed to the suppression of transient intermodulation distortion in the microphone pre-amplifiers. Similarly, in the recording console, all input transformers were eliminated, and sophisticated discrete circuitry employed for ultra-fast transient response, lowest noise and minimum tid. The amplifiers in the gain stages and all other active devices are characterized by ultra-fast rise-times and high slew rates, resulting in little or no time-delay distortion or tid. The console is extremely simple and straightforward—there are no echo send or return facilities, and no equalization is available, nor is any used throughout the entire recording chain. You might be amused by the fact that the engineers who made simultaneous digital recordings along with the d-d recording on the Virgil Fox and Boston Pops sessions wanted to make sure that the signal coming out of this fancy console was "clean enough" for their digital recorder. They were a bit nonplussed when they used the highly accurate Sound

Technology distortion analyzer and couldn't get a reading because the console distortion was below the residual level of the instrument!

### BLANK LACQUER DISC

In d-d recording, it goes without saying that the lacquer recording blank disc is a vitally important part of the process. There are only four manufacturers of lacquer recording discs in the western world, and naturally, every cutting engineer is partial to a particular brand. The lacquer disc is, in every respect, a precision product, which must be made under the most carefully controlled conditions. The aluminum base discs must be ground and polished to near-optical flatness. The lacquer coating is a mixture of cellulose nitrate in a very volatile solvent, plus plasticizers, lubricants, dyes, and various other ingredients.

Lacquer disc manufacturers have special proprietary methods of coating or "flowing" the lacquer onto the aluminum bases to ensure as flat and uniform a coating as possible. After coating, the discs are passed through "curing" tunnels, where the solvent is driven off at a controlled rate to insure minimum deformation of the coating. In spite of this care in fabrication, the discs have minute deviations and undulations on their surfaces. The cutter-heads cope with this by being mounted in a special suspension with a controlled amount of flexure. A top quality lacquer recording disc has a dynamic range/signal-to-noise ratio of about 80 dB, which is better than that of tape, even with Dolby A noise reduction.

Even though the lacquers have been "cured" in the manufacturing process, many cutting engineers like to maintain a stock of lacquers which are "aged" by allowing them to "out-gas" for five or six weeks. This is felt to be of particular importance in d-d recording. Cutting engineers also seem to be in general agreement that, ideally, when a lacquer has been cut, it should be put into the electroplating tank at once. (But, see Stan Ricker's opinion, in Suzette Fiveash's companion article, Ed.) Which is why in August of 1977, you would have found Ed Wodenjak, president of Crystal Clear Records, on the freeway at 4 a.m., rushing lacquers of the Virgil Fox d-d sessions from Garden Grove, 60 miles North to the AFM plating plant in Los Angeles.

### RECORDING ON LOCATION

If a d-d recording session in a studio is fraught with peril (and it is), the problems of d-d recording "on location," can be positively nightmarish. First thing is the matter of the lathe itself. Whether it is a Neumann or a Scully, it is at one and the same time, delicate, big, ungainly, and very, very heavy! Among other things, it should be placed on a solid foundation, with as little vibration as possible. Needless to say, finding such a location at the recording site can be a frustrating experience. There is also the matter of the recording console, monitor speakers, perhaps an analog or digital back-up tape machine, and other paraphernalia fitting into the same location as the lathe.

Now it is obvious that a recording lathe can cut but one lacquer disc at a time. If you want to "generate" enough lacquers so as to ensure a specific number of pressings, you can have the artists repeat their performance as many times as their stamina and union recording rules will permit. Or you can record on more than one lathe. Or, you can do both. If you opt for more-than-one-lathe, you compound the misery of handling these beasts.

At the Virgil Fox sessions two lathes were used, and on the Boston Pops recording, there were three lathes, heaven help us! Of course, we recorded multiple performances as well. The organ used for the Virgil Fox recordings was a magnificent Rufatti instrument from Italy, ensconced in



the Garden Grove Community Church, in Garden Grove, California, some sixty miles south of Los Angeles. The church is a modern structure, far removed from traditional concepts of religious architecture, and by its nature, not suitable for housing assorted recording equipment. Thus we wound up in the immediately adjacent administration building, using a second floor room normally used as a choir dressing room. I won't go into the harrowing details of set-up and communications this entailed.

The sessions began at 10 o'clock in the evening, so as not to interfere with church functions—and because Virgil Fox is a "night person." Four nights produced two recordings which have been very well received, but oh, the problems! As you can readily understand, when you are making a d-d recording, once the recording begins, the artist must perform the particular work completely, for a duration of some 16 to 18 minutes. If he makes an obvious mistake early in the recording, we must stop, put on a fresh lacquer blank, and start all over again. If the mistake is made only a few seconds before the end of the recording, it's still back to "square one" again, with another lacquer. By the same token, if the performance is note-perfect, but there is a technical problem, again it's back to the beginning.

Among things we had to contend with on the Fox sessions was the police breaking in during a fine take because some people 600 feet away complained we were making too much noise. (How's that for an appreciation of music from the great unwashed?) Another take was ruined by a low-flying helicopter. And at the conclusion of a bravura performance of the Widor *Toccata*, some kids outside broke into loud and lusty cheers before the reverb had fully decayed.

## BOSTON POPS

The Boston Pops sessions had their own share of problems. First off, when my wife and I arrived at McArthur Airport on Long Island to fly up to Boston on the Friday before the sessions on Monday, we were blithely informed that the flight was cancelled. Now, out in the boonies, that is that . . . there is only one flight per day. So it was either grind back into New York, or do what we did—which was to drive to Orient Point at the tip of Long Island, and take a World War Two, "Landing Craft, Tank," which they now call a ferry, to New London, Conn. and thence wend our way to Boston.

Our logistics engineer, Frank Dickinson, was already in Boston desperately trying, late on a Friday afternoon, to find tanks of helium and nitrogen for cooling the cutter-heads and blowing off lacquers, respectively. In Boston we used three lathes. Symphony Hall is a magnificent room, but it wasn't designed with direct-to-disc recordings in mind. The only place we could set up the lathes was in the Ancient Instrument Room, which—you guessed it—was to the front, and the left of the second balcony. If it hadn't been for the wonderful help and co-operation of the great Boston stagehands, the recording would have been a disaster. The ancient instrument room is not large, and true to its name, contains glass-fronted cases of ancient musical instruments, many of them three or four hundred years old. Fascinating yes, but the reflections from the cases would make our monitoring just awful. So there was Frank, out getting Fibreglas 703, and covering the front of every case.

In this room was crammed two Neumanns and one Scully lathe, the recording console, two of the big new UREI "time aligned" monitor speakers, an Ampex ATR 102 and ATR 104, and, spilling over into the adjacent lavatory, was Dr. Tom Stockham and his Soundstream digital recording equipment. Actually, once set up, we didn't have too many problems, and a minimum of "blown"

lacquers. Maestro Fiedler was delighted with what he heard from test lacquers and digital tape playback, and joined us in a champagne toast at the conclusion of the sessions.

## MICROPHONE STRATEGY

Whether it be an organ recording with Virgil Fox in a church, or the Pops with Fiedler, the choice of microphones depends on the philosophies of the engineer, as does their placement. There is essentially but one difference in mic placement between a normal tape-to-disc recording session, and a direct-to-disc session. While one tries to exercise his judgment to ensure the best possible balances under any recording circumstances, it is still partially true in the normal tape-to-disc context . . . "fix it in the mix," but obviously this is not possible in the d-d process.

It can be seen that many things can go wrong on a direct-to-disc recording session, but even assuming that everything goes like clockwork, and you have made some superb lacquers—you are not "home free" just yet. For yet more perils are lurking in the electroplating baths. For all their generally careful work, the plating companies can, and do, lose lacquers to a number of technical gremlins. In most cases, this means a reduction in the number of pressings that can be produced. In an extreme case, it would be possible for all the lacquers to be ruined, and the entire recording effort a total loss.

So, direct-to-disc recording is not for the faint of heart. The obvious question, is it worth the effort, depends on the commitment of the recording company to the production of really high quality recordings. When they are done properly, I think the direct disc recordings are the truest reflections of the original sound. ■

## YOUR "FISH SCALE" WAS DESIGNED TO WEIGH FISH!



The Tentel tape tension gage is designed to diagnose problems in your magnetic tape equipment. Throw away your fish scales (or put them in your tackle box where they belong). The TENTELOMETER will measure tape tension while your transport is in operation, so you can "see" how your transport is handling your tape . . . smooth, proper tension for quality recording? or oscillating high or low tensions causing pitch problems, wow and flutter?

"See" what your heads "See" and HEAR the difference.

**Tentel**  
50 Curtner Avenue

**(408) 377-6588**  
Campbell CA 95008

Circle 38 on Reader Service Card

# Bring Your Own Lathe

**S**EDENTARY RECORDING engineers, who feel that remote recording sessions are just more trouble than they're worth, will find little cause to envy the disc mastering engineer who is rash enough to go "on location" with his lathe. Consider the adventures of Stan Ricker and Richard Simpson. As two of the west coast's finest disc cutting engineers, one would think that by now they had picked up enough smarts not to venture out of doors with their lathes. But not only have they done just that—they have transported their lathes across the country to work with Bert Whyte (and others) on remote direct-to-disc sessions.

As Stan Ricker described it to me, it's not quite the same thing as wheeling a tape recorder down the hall to Studio B.

## FIRST STOP—THE INSURANCE COMPANY

Still back home in Los Angeles, as the cutting system comes apart for shipping, so does the insurance policy. For once outside the cutting room door, all bets are off. So, Step #1 is to get a marine insurance policy, one that will cover about \$100,000 worth of very fancy hardware. If you can convince the insurance company that you're really sane, it's safe to begin the disassembly and packing.

The lathe must be (carefully!) broken down into its many component parts, and these must be packed with great care. If an electronic component runs afoul of the shipping company, usually a little solder will take care of things. But there's not much that can be done for a lathe carriage assembly that arrives on-site with a dent in it.

At Bert Whyte's Virgil Fox session, two Neumann lathes were used. Stan Ricker brought along a VMS 70 system, and Richard Simpson supplied his AM 32B. Both are quite heavy, so Stan and Richard become an assembly team, once the equipment arrives on location.

## LATHE PLACEMENT

Unlike a tape recorder—which can probably be placed just about anywhere—choosing the wrong spot for a lathe can be a disaster. Generally, Stan looks for a likely spot about a foot or so away from a wall, since the wall adds some rigidity to the floor in that area and this helps to minimize building vibration. Hopefully, it's not an outside wall with a super-highway on the other side, but even that's better than a railroad. Subways under the building are also a lot of fun. Even if you can't hear the roar, the lathe may feel the vibrations transmitted through the building structure, and an otherwise-perfect lacquer master may be destroyed.

Once the lathes are re-assembled, the alignment procedure begins, using an NAB test record. When the playback electronics are properly aligned, the test record is replaced with a blank lacquer, and a test cut is made. With a reference tone applied to the cutter head amplifier, the drive level is adjusted while monitoring the playback of the test cut. In general principle, it's about the same procedure as aligning a tape recorder. However, since the playback stylus is located about three-quarters of a revolution

beyond the cutting stylus, there is a lag time of more than one second until the record level adjustments show up at the playback electronics.

As with test tapes, test records come with a variety of reference levels available. For example, test records from the Victor Company of Japan use a reference level of 3.54 cm./second, while the NAB standard is 7 cm./second. (For more on this subject, see Irwin Diehl's article on Groove Geometry in this issue—Ed.)

## DON'T FORGET THE REFRIGERATOR

Temperature plays a very important role in getting a quality master disc plated and pressed. Ten minutes of direct sunlight or prolonged exposure to warm temperatures can virtually destroy a lacquer. Therefore, it must be stored in a cool place. Stan keeps his in a refrigerator, to insure their quality. After cutting, a common problem is getting the lacquers quickly packaged to keep them from being exposed to heat on the way to the plating plant. Stan packages his finished lacquers in styrofoam cartons, lined with Saran wrap. Aluminum is then wrapped around the styrofoam, and the cartons are placed in a crate filled with those "plastic peanuts" that we all know and love.

## BEWARE OF THE OOZE

The lacquer that is used to cut discs has a melting point of 130 degrees Fahrenheit, but, since it is vinyl, it isn't a very well-defined type of melting. It oozes. When this happens, high frequencies deteriorate. Transients suffer first, creating a loss of crispness on the final product.

On one direct-to-disc session, several masters were cut. These were sent to plating plants in California, New York, Canada, Germany and Japan. All were carefully packaged, but later, one set of test pressings betrayed a tell-tale loss of highs. The only conclusion that Stan and the pressing plant engineers could make was that somehow the lacquers had been exposed to heat in transit. The exposure must have been long enough to cause the damage.

On playback, the effect of heat exposure sounds somewhat like a medium-thin blanket draped over the speakers. It doesn't cut the highs completely, but rather, subdues them.

A general conception in the plating business is that a lacquer must be put in a plating bath within the first fifteen minutes after completion of cutting. Stan feels this isn't really necessary, so long as the lacquer itself is protected against the elements. Back in Los Angeles, his cutting room is kept quite cool, and the lacquers cut beautifully, and may be stored for quite some time without degradation. Under such controlled conditions, the disc might be preserved indefinitely, but of course Murphy's Law clearly states that "On a remote session, the optimum location for a lathe will also be the hottest spot in the house, once the session gets under way."

## MICROPHONES AND DISC CUTTING

Although the microphone choice and placement is left up to the recording engineer, the disc mastering engineer should check for possible phase problems with an X/Y oscilloscope to make sure the input signal going to the disc will present no problems later on. Ideally, the ratio of lateral-to-vertical modulation should be about 2:1. The

playback stylus doesn't really care too much for vertical modulation and—as Stan neatly puts it—there may be “. . . a lot of nasty problems associated with it.”

With lateral modulation, the playback stylus is driven to the left and right by the groove walls. With vertical modulation, the stylus is driven up the groove wall by a positive-going waveform, but literally falls back down through natural gravitational forces and the vertical compliance of the cartridge/stylus design. Nothing else is there to drive the stylus back down, so if the groove falls away faster than the stylus can drop, the stylus loses contact with the groove—an acute symptom on loud vertical modulation. Although it's no problem to cut such heavy vertical modulation, the difficulties will show up later on, during playback of the test pressings. And the test pressings don't show up until long after the session is over. So it's best to keep a close watch on the 'scope at all times!

#### **HARMON MUTES AND CIRCUIT BREAKERS**

On any direct-to-disc session, the fine art of gain riding can make or break the disc, particularly on brass or percussion instruments. One example might be that of a trumpet soloist using a Harmon mute. Although the trumpet may not seem to be very loud, the upper harmonic structure is quite intense. When this type of signal is sent to the disc, the circuit breakers may trip to prevent the cutter head from burning up, although the head is also cooled with helium to help keep the heat away from the drive coils. But, because of that fine line between the head doing its work well and “going up in smoke,” this protective circuitry is still required. It also means that an overly-enthusiastic musician may wind up blowing more than his own horn!

Or, one nice transient peak from the kick drum—

although it may not pop the breakers—can easily overcut the previous groove and then become overcut itself with the following groove, because of the unexpected displacement. (Remember, there are no preview heads around on direct-to-disc sessions to prevent such little surprises.) This type of overcut may not be easily seen while the record is being cut, so it can get awfully sweaty if the disc mastering engineer guesses wrong and stops the session needlessly. But it's just as bad to discover the trouble later on, after the recording is over. Either way, you lose.

To keep the disaster rate within reason, and ulcers at a minimum, there must be much pre-session planning. The recording engineer, producer, musicians and disc mastering engineer must review any musical passages that may have phase or level problems, and work together to correct them without violating the musical value of the piece itself. In fact, the most important word on any direct-to-disc session is *organization*. And on a remote session, the word is spelled with a capital “O.”

There's a whole series of finely-tuned decisions—and then actions—required to create a successful direct-to-disc recording. The end result depends heavily upon coordination between musicians and engineers. The cutting equipment must be in first class shape. The disc mastering engineer should be able to follow the score, and act as his own “preview head,” anticipating fortissimos and pianissimos, in order to properly adjust pitch and depth controls. The musicians must be up to the pressure of playing a complete side without interruption. There must be no airplanes, subways, door slams, chair squeaks, wrong notes, missed cues, and so on.

Aside from that, there's nothing to it! Just ask Stan Ricker or Richard Simpson. But don't tell them I sent you. ■

---

## **Sound Workshop will introduce the Audio Machinery Shared Access Memory System at the A.E.S. Convention in New York City on November 3rd, 4th, 5th, and 6th.**

**It will change all your present concepts  
about digital delay, pitch shifting, and  
digital reverberation.**

**Sound Workshop**  
PROFESSIONAL AUDIO PRODUCTS

**bringing the technology within everyone's reach.**

**Sound Workshop Professional Audio Products, Inc.**  
1324 Motor Parkway, Hauppauge, NY 11787 (516) 582-6210

# A Look at the Record-Plating Process

*The need for controlled conditions and expertise could trigger a whole new industry.*

**A** FEW YEARS AGO, the introduction of tape cassettes and 8-track cartridges once again prompted predictions of the imminent demise of phonograph records. Such predictions have been made numerous times in the past, yet the record industry has prospered. Even now, some say the video disc is again ringing the death knell for records.

However, no other medium for sound reproduction has such wide tolerance in all phases of its manufacturing and playback technology. The records themselves cover a range from floppy Evatone discs cheap enough for mass direct mail promotions, to the latest direct-to-disc releases costing upwards of \$12. Record player quality spans the spectrum from a \$20 children's machine to elaborate systems costing thousands of dollars.

The remarkable simplicity and wide tolerance of the record medium is likely to stand it in good stead before such potential competitors as the video disc, which is a comparatively critical, high technology medium. For the foreseeable future, it appears that records will continue to be the preferred medium for the reproduction of music.

The continuing popularity of records seems to be as much a surprise to some industry leaders as to anyone else. How else does one account for the serious lag in the development of improved technology for record plating in this country? Significant improvements have been made in master tape and disc master technology, especially with regard to dynamic range and signal-to-noise ratios. Yet the

U.S. record industry has made virtually no efforts to improve what is now the weakest link in the record making process—American plating is still largely being done with the same primitive methods and equipment employed for the past twenty years.

There is another and equally destructive problem here and that is the notion that there is some close relationship between the plating and pressing operations. The molding of vinyl under high temperature and pressure is definitely heavy industry, involving equipment such as steam boilers and hydraulic presses, the same technique used to make a vast array of plastic products from toys to plumbing pipe.

## **A DELICATE PROCESS**

Record plating could hardly be further removed in terms of equipment, environmental and operational considerations. The electroforming of record production parts is a highly complex process, demanding extremely tight control of all operational parameters as well as the maintenance of a contaminant-free environment. Such high standards of cleanliness, control, and handling do not lend themselves to an industrial environment, but are better suited to a laboratory. The operational considerations for operating a record press are quite different from those required to oversee a complex electro-chemical operation consisting of a number of completely different processes, each requiring constant monitoring and adjustment. There is, in fact, no more correlation between plating and pressing operations than between the disc mastering and pressing operations. Electroforming is an entirely unique part of the record making process and, as such, should be a separate industry as distant from the pressing plant as is the recording studio.

More and more these days, one reads record reviews and hears talk among record collectors of the superior quality of European pressings. When questioned closely, most people mention surface noise as the most obvious quality difference between American and European press-

*James P. Shelton is the president of the Europadisk Plating Company, of New York City.*

ings—those pops, ticks, swishes, ocean roars, crackles, tearing, and ripping sounds. Perhaps the most annoying noise of all is the pre- and post-echo sound, or “ghosting.”

Undoubtedly, some of this noise can be traced to problems in the pressing plant, such as contamination of the vinyl material or perhaps non-fill of the record stamper due to incorrect temperature, pressure, or timing in the press cycle. However, it is the conviction of many people in cutting, plating, and pressing operations that the great majority of noise and echo problems are generated in the plate making process. The basis for this conviction is that this process is tolerant of a surprisingly wide range of errors while still producing a part which is deemed “useable.”

#### **IGNORANCE THE CULPRIT**

Most U.S. plating is mired in mediocrity more through ignorance than conspiracy. “We’ve always done it this way,” is the answer one receives most often when questioning practices that invite unnecessary noise and other problems. The nickel sulfamate plating process used to produce parts will tolerate a considerable latitude of such parameters as boric acid concentration, plating bath temperature, Ph levels, and nickel concentration. But experience in state-of-the-art operations indicate that all these parameters have significant effects and the more closely they are kept to their optimum levels, the better and more consistent are the results. One can tell by a glance at a typical matrix that things aren’t right in the plating plant; the part is wavy and looks as if it wants to curl up. This curly look is the result of plating bath contamination with metals other than nickel which causes stress to be “built into” the

part as it is formed and results in early failure of the part by cracking or splitting. A grainy, rough finish on the back of the matrix instead of a smooth, grainless surface is further indication of a poorly controlled plating process.

The obvious consideration of cleanliness to exclude potential contaminants from the plant environment gets short shrift in most operations. All it takes is a single mote of dust in the right place at the right time to produce an audible pop or tick on the finished pressing. Yet most plants are veritable pig stys, with accumulations of dirt, spilled chemicals, dust, etc. on the floor, equipment and work surfaces. Most make no attempt to control the cleanliness of the air; dust laden outside air flows freely over all operations. Metal part polishing stations that produce metal dust are not sufficiently separated from critical silvering and plating areas.

Rough handling is another major problem in an industrial environment. There is no time at which the record making process is more vulnerable than when the lacquer master is first unpacked in the plating plant. Handling at this point and during the silvering and pre-plating require delicacy and precision, hardly the qualities one would expect from the industrial workers found in a pressing plant. Even the metal parts, though tougher than lacquer masters, are highly subject to damage from rough or careless handling. Coming in contact with a hard surface can permanently imbed a particle into the groove or collapse a groove wall.

The U.S. record market is presently dominated by rock music and this has served to encourage mediocre plating. Since much rock music has a limited dynamic range, the essentially steady state level of the program will cover virtually all noise and echo problems. As a result, the atti-

---

**Talking about automation is one thing.  
Showing a working system is another.**

**Sound Workshop will demonstrate the  
Series 1600 Recording Console with  
ARMS automation at the A.E.S. Show  
in New York.**

**We suggest you check it out.**

**Sound Workshop**  
PROFESSIONAL AUDIO PRODUCTS

**bringing the technology within everyone’s reach.**

**Sound Workshop Professional Audio Products, Inc.**  
1324 Motor Parkway, Hauppauge, NY 11787 (516) 582-6210

tudes of many plating plants has been to allow these low quality requirements to become the standard of their work.

## WIDE DYNAMIC RANGE

More mature levels of rock music, as opposed to so-called "bubble gum" rock, as well as all classical music, are characterized by a wide dynamic range. This type of program will expose any surface noise during low level passages and echo problems become painfully obvious when percussive attacks are either preceded or followed by silence. Echo is often heard on piano solo records because of the percussive nature of the instrument. These problems are typical of poor plating.

There is already a shortage of plating facilities good enough to do this critical work, and as the demand for quality plating grows, the shortage will become acute. The premise for this growth is based on the fact that the median age of the record buying public is increasing along with that of the population in general. This increase in maturity translates into a growing market for classical and other serious music with a wide dynamic range.

The trend is already in evidence and there is a growing demand for records of the highest technical quality as exemplified by the recent interest in direct-to-disc records, which exploit the wide dynamic range capabilities of lacquer masters. With good plating and pressing, these efforts represent the highest state of the art in the record medium. There are actually record producers, some of the direct-to-disc people among them, taking their business to Germany because they cannot get adequate plating and pressing quality in the U.S.! Such evidence cannot be taken lightly, since it means that the producer is willing to pay roughly double the U.S. cost and is still able to find a market for the result. Of course, most producers cannot afford to double their pressing costs by going to Europe and simply have to take their lumps (pops and ticks) and live with their frustrations.

Superior playback equipment is also contributing to demand for better records. Even a moderately priced stereo system costing \$500 to \$600 boasts a good magnetic cartridge and speakers capable of reproducing all the noise, just as clearly as they do the program. The proliferation of really expensive equipment is a further indication of the interest in achieving the highest quality in sound reproduction. Such systems have the capability of reproducing quality far beyond that offered by commercial tape formats. Only state-of-the-art records can provide a program source consistent with such superior equipment and there are precious few domestic records in that category.

## MATRIX CLEANING

One of the most important factors in preventing the introduction of surface noise in the plating process is matrix cleaning. When two matrices are separated at the completion of a plating step, some particles from the matrix being plated are transferred to the surface of the new plate. Any such particles must be completely cleaned off before the next plating step, or they will be reproduced on the following matrix. This also applies to any contamination, such as airborne particles, reaching the surface of the new matrix after separation.

In order to remove the so-called horns which have been transferred from the lacquer master to the mother matrix, the mother matrix is polished, which contaminates the surface with polishing compound. This contamination must also be completely removed before the final plating step to produce the stamper.

These two cleaning steps are extremely critical in that they must be thorough and yet not damage the matrix surface. At Europadisk, we are using a new technique devel-

oped at Teldec which, so far as we know, is not in use elsewhere in the U.S. The process is electrolytic in nature and is the most thorough and safe technology yet developed for this critical application. In most U.S. plants, this cleaning is accomplished by using a stiff brush and solvents.

Perhaps even more important than equipment and technique is the basic approach, the philosophy if you will, of the plant owner/operator. This consists principally of a firm commitment to achieving the highest quality obtainable in every aspect of the plating operation. In any such endeavor there are constant temptations to compromise in the interest of expediency or cost. By making a commitment to quality above all at the outset, the pitfalls of mediocrity that are endemic in the U.S. plating industry may be avoided. It must also be realized that to make such high standards practical will require operating personnel of the highest caliber and this will make personnel as well as equipment costs higher, relative to other U.S. plating operations.

## CAREFUL PLANT LAYOUT

The layout of a high quality plating plant is such that different types of operations are physically separated to minimize contamination from one to the other. Packing/unpacking is done in a room separate from silvering and plating operations to keep cardboard and paper particles out of these critical areas. The stamper back-polishing and mother face-polishing, which generate metal dust are in their own room. Special consideration must be given to surfaces such as floors and walls to help minimize airborne particles. Special air treatment, including both mechanical and electronic filtration is also required.

Because of higher equipment and personnel costs, rates will be higher than at most other plating plants. However, when this higher cost is amortized per pressing over average press runs, the increase is negligible: typically, less than one cent per pressing. Certainly this small premium will not present an obstacle to quality-conscious producers since plating costs are a very small part of overall production costs.

One important goal is to make record producers more aware of the importance of good plating and to encourage them to specify the plating plant to be used for their work. As it is, some producers are not familiar with the vital role plating plays in the quality of the finished pressing. This can best be accomplished in cooperation with a reliable disc-mastering studio. In a quality operation, producers generally have a close association with the engineer who cuts their masters and a healthy respect for his opinion. The majority of these engineers are already aware that many defects in the finished pressing are caused in the plating process and, because of that professionalism, the task is simplified. Of course it is in the interest of the cutting studios to have their lacquer masters receive the best plating possible, since that will mean fewer problems as well as better results for their clients.

As quality plating work becomes better known in the industry, we hope that new interest in its role will be generated. This awareness can stimulate the growth of a new industry. The series of events that has led to the birth of disc mastering as a separate industry may prove to be a parallel for the same sort of phenomenon in plating. Only a few years ago, mastering was exclusively associated with pressing plants, recording studios, or were the in-house operations of major record companies. With the introduction of new European cutting technology and a philosophy of excellence, a whole new industry came into being. We hope to generate a similar transformation in the plating industry and, at the same time, make a commercial success of our own Europadisk Plating Company. ■

# db Classified

Closing date is the fifteenth of the second month preceding the date of issue.  
Send copies to: Classified Ad Dept.  
db THE SOUND ENGINEERING MAGAZINE  
1120 Old Country Road, Plainview, New York 11803

Minimum order accepted \$10.00.  
Rates: 50¢ a word.  
Boxed Ads: \$25.00 per column inch.  
db Box Number: \$1.00 per issue.

Frequency Discounts: 3 times, 10%; 6 times, 20%; 12 times, 33%.

**ALL CLASSIFIED ADS MUST BE PREPAID.  
FREQUENCY DISCOUNT ADVERTISEMENTS ARE TO BE  
PREPAID IN ADVANCE.**

---

## FOR SALE

---

THE RESONATOR is more than a reverb. Designed for use with any console, including Tascam. \$359.00. Dyma, Box 1697, Taos, N.M. 87571.

MINI-STUDIO package systems from \$2,599, using pro-recording equipment from Revox, Otari, Lamb Labs, Trident, Beyer. Write for full details of offers to Entertainment Sound Services, Inc., 78 N. Franklin Ave., Hempstead, N.Y. 11550. (516) 538-2220.

TEST RECORD for equalizing stereo systems. Helps you sell equalizers and installation services. Pink noise in 1/3 octave bands, type QR-2011-1 @ \$20. Used with precision sound level meter or B&K 2219S. B&K Instruments, Inc., 5111 W. 164th St., Cleveland, Ohio 44142.

AMPEX, SCULLY, OTARI, all major professional audio lines. Top dollar trade-ins. 15 minutes George Washington Bridge. Professional Audio Video Corporation, 342 Main St., Paterson, N.J. 07505. (201) 523-3333.

USED RECORDING equipment for sale. Professional mics, speakers, miscellaneous gear. Dan (415) 232-7933.

NEW PROFESSIONAL LINE of pre-assembled mic and patch cables in seven colors, two thicknesses; not a me-too copy of existing cables. Further info, Sound Applications, 342 Lexington Ave., Mt. Kisco, N.Y. 10549. (914) 241-0034.

FOR SALE, large Moog synthesizer. All components, 2 keyboards, ribbon controller, 2 sequential controllers. Excellent condition. Scott-Textor Productions, 220 E. 54th St., New York, N.Y. 10022. (212) 688-4330.

IVIE SOUND ANALYZERS, all models in stock. Theatre Technology, 37 W. 20th St., New York City 10011. (212) 929-5380.

**FREE CATALOG & AUDIO APPLICATIONS**



CONSOLES  
KITS & WIRED  
AMPLIFIERS  
MIC, EQ, ACN LINE,  
TAPE, DISC, POWER  
OSCILLATORS  
AUDIO, TAPE BIAS  
POWER SUPPLIES

**OPAMP  
LABS INC**

1033 N. SYCAMORE AVE.  
LOS ANGELES, CA. 90038  
(213) 934-3566

CANADIANS!  
SEMI-PRO MULTITRACK RECORDING HEADQUARTERS FOR: TEAC/TASCAM, Soundcraft, Sennheiser, BGW, Altec, Lexicon, dbx, Bi Amp, Beyer, R.S.D., Tapco, and more.



Richard's Music Shop Inc.  
6078 Sherbrooke W.  
Montreal, Canada H4A 1Y1  
(514) 487-9911

**AUDIO and VIDEO  
On a Professional Level**

Lebow Labs specializes in equipment sales, systems engineering, and installation—full service and demonstration facilities in-house. We represent over 200 manufacturers of professional and semi-professional equipment for recording, broadcast, sound reinforcement, and for commercial sound. Call or write for information and pricing.

**LEBOW LABS, INC.**  
424 Cambridge St.  
Allston (Boston) Mass. 02134  
(617) 782-0600

## FOR SALE

SCULLY 8-TRACK w/Sync Master, mint condition; Accurate 8 x 8 mixing console; best offer over \$6,000.00 takes both. **Le Mans Sound. (201) 359-5520.**

HAECO CSG-2 compatible stereo generator, new condition, \$1,700. Used Westrex 1574D cutter amps, \$400 each. Pultec MH-4 mixer, \$125. HAECO LX-1 crossover, \$600. Fairchild 670 stereo limiter, \$650. Frankford/Wayne Recording, 134 N. 12th St., Philadelphia, Pa. 19107. (215) 561-1794.

CUTTERHEAD REPAIR SERVICE for all models Westrex, HAECO, Grampian. Modifications done on Westrex. Avoid costly down time; 3-day turnaround upon receipt. Send for free brochure: **International Cutterhead Repair, 194 Kings Ct., Teaneck, N.J. 07666. (201) 837-1289.**

STAGE / STUDIO / BROADCAST audio systems: AKG, Allison Research, Amber, Amco., A.P.I., Audiotronics, Beyer, Cannon, dbx, E-V, Eventide Clockworks, Ivie, JBL, Lexicon, MicMix, MRL, MXR, Nagra, Neotek, Neumann, Nortronics, Orban/Parasound, Orange County, Otari, Pultec, Robins, Russco, Scully, Sennheiser, Sescom, Shure, Sony, Soundcraft, Speck, Switchcraft, Spectra Sonics, 3M, Tascam, Technics, White, UREI plus many more. For further information on these and other specialty items from our factory operations contact: **Midwest Sound Co., 4346 W. 63rd St., Chicago, Ill. 60629. (312) 767-7272.**

DISCOUNT PRICES on fresh name-brand tape. Check our prices in bulk, reels, boxes, carts, and cassettes. **P.B.P., 4100 West Kennedy Blvd., Tampa, Fla. 33609. (813) 877-7125.**

REELS AND BOXES 5" and 7" large and small hubs; heavy duty white boxes. **W-M Sales, 1118 Dula Circle, Duncanville, Texas 75116. (214) 296-2773.**

GOING OUT OF BUSINESS. Ampex MM1100 16-track; Scully 280-2; Audiotronics 501 console, 18-in/16-out, wired 24 w/patch and producer's desk; dbx 158; dbx 157; Eventide harmonizer, H-910; much more outboard equipment—mics, amps, etc., all in perfect running order; most under one year old. (516) 295-0371.

### NAGY SHEAR-TYPE TAPE SPLICERS



- FOR CASSETTE ¼ & ½ IN. TAPES
- HAND-CRAFTED
- FIELD PROVEN
- FAST, ACCURATE
- SELF-SHARPENING

NRPD Box 289 McLean, Va. 22101

NAB ALUMINUM FLANGES. We manufacture 8", 10½", and 14". Also large flanges and special reels to order. Stock delivery of assembly screws & nuts & most aluminum audio, video, & computer reels. For pricing, call or write **Records Reserve Corp., 56 Harvester Ave., Batavia, N.Y. 14020. (716) 343-2600.**

REK-O-KUT drive belts. Specify model. \$9.95 delivered. **QRK Electronic Products, 1568 N. Sierra Vista, Fresno, Ca. 93703.**

TASCAM Model 10, 12-in/4-out, accessories; Sony TC8-54 4-channel; associated equipment. **Steve Kurtz, 2421 Mapleview, Kalamazoo, Mi. 49002. (616) 323-9410.**

AMPEX SPARE PARTS; technical support; updating kits, for *discontinued* professional audio models; available from **VIF International, Box 1555, Mountain View, Ca. 94042. (408) 739-9740.**

MODERN RECORDING TECHNIQUE, by Robert E. Runstein. The only book covering all aspects of multi-track pop music recording from microphones through disc cutting. For engineers, producers, and musicians. \$10.50 prepaid. **Robert E. Runstein, 1105 Massachusetts Ave., #4E, Cambridge, Mass. 02138.**

FOR SALE: Westrex 3DIH, \$3,495.00; Haeco SC-2, \$4,800.00; Haeco SC-1, \$1,495.00; Grampian D, \$385.00; Grampian BI/D, \$325.00; Westrex 2B, \$525.00; all Haeco cutterheads new, other cutterheads reconditioned and in specs. **International Cutterhead Repair, 194 Kings Ct., Teaneck, N.J. 07666. (201) 837-1289.**

RANSTEELE custom heavy duty wall/ceiling speaker mounting brackets for JBL, Altec, Big Reds, etc., \$160 pair. Ransteele 200W/ch stereo cutter drive amplifiers; used Westrex and Haeco cutterheads; complete line of custom disc mastering room audio equipment not available anywhere else! Reconditioned Scully lathes; complete turnkey mastering rooms. **Ransteele Audio, Inc. 1697 Broadway, New York, N.Y. 10019. (212) 265-5563.**

THE LIBRARY . . . Sound effects recorded in STEREO using Dolby throughout. Over 350 effects on ten discs. \$100.00. Write **The Library, P.O. Box 18145, Denver, Colo. 80218.**

### New Subsonic Filter



FREE CATALOG

is required for optimum bass response in your system. **ACE AUDIO CO., 532 5th St., East N'thp't, NY 11731**

REVOX MODIFICATION, variable pitch for A-77; in/sync for A-77 or A-700; programmer for A-77; rack mounts, slow speed 1⅞; full track; auto rewind; high speed 15 i.p.s. for A-77; Slidematic for A-77. Machines available with or without mods at low cost (A-77 from \$695). All mods professionally performed by Revox trained technicians. **Entertainment Sound Services, Inc., 78 N. Franklin St., Hempstead, N.Y. 11550. (516) 538-2220.**

ROADSHOW EQUIPMENT. Clearing wide range new & used items including mixers (from \$350 to \$3,500), bass & treble bins (w & w/o speakers, \$125 up), lenses, horns, etc.; limited quantity; be first. (516) 538-2220. **Entertainment Sound Services, 78 N. Franklin St., Hempstead, N.Y. 11550.**

FOR SALE: Ampex MM1200 24-track with 16-track heads, search to cue, VSO Excellent condition. Take over lease or best offer. Also, Ampex 440 mono, 440 2-track, two TEAC ¼-track 3300's. **Larabee Sound, 8811 Santa Monica Blvd., Los Angeles, Ca. 90069. (213) 657-6750.**

TAPCO and Electro-Voice: mixers, equalizers, amps, mics, and raw loudspeakers. Write or call for low mail order prices. **Sonix Co., P.O. Box 58, Indian Head, Md. 20640. (301) 753-6432.**

UPDATED OUR EQUIPMENT. Used mics by Neumann; Sennheiser; Beyer; etc. for sale. (415) 232-7818.

ONE-THIRD octave real time analyzer, Hewlett-Packard Model 8050A with travelling case, cords, and Altec pink noise generator. Perfect condition. \$2,400.00. (212) 675-1166.

SCULLY 16-TRACK—Model 100 complete with 8-track stack and guides, spare elect./remote sync master; both stacks like new; \$10,500. 16x16 APSI console with patch bay plus spare 1/0 module, 4-band eq. (4 para), bi-f.e.t. elect. Very flexible board \$5,000. We're going 24. **Normandy Sound 401-247-0218.**

### CASSETTE LABELS

13 Colors/2 Whites Pressure sensitive; 12 upon an 11¼" x 7¼" sheet; packed 100 sheets (1200 labels) per pkg; die cut and ready to print or type.



**Audico, Ltd., Div. Michael Book Co. 219 Crossen Elk Grove, Ill. 60007 (312) 640-1030**



TEST GEAR Amber 4400 retrofit and factory recal, perfect. Philips PM3232 dual beam scope, two probe sets, cables, Polaroid Scope Camera. All for \$3,100. **Richard Jennings, 2247 Clement, San Francisco, Ca. 94121. (415) 752-6209.**

24 CHANNEL sound reinforcement mixer 100 foot snake, balanced input, 3 band eq, 3 submixers, monitor, echo, solo . . . includes UREI model 527A graphic equalizer. Must sell! Asking price \$2,950.00. **B. C. & G. Enterprises, P.O. Box 708, Arvada, Colorado 80001. (303) 751-5991 or (303) 424-6151.**

CUSTOM DE MEDIO console, 24 x 16 (to 24 with patching), 24 x 4 monitor, e.q., 4 echo sends, 2 cue sends, many other features. Available with 24 API 550 e.q.'s. (550 not sold separately.) **Gray, (415) 771-5780.**

FOR SALE: Mavis 15/4 road boards in road cases with snakes. **SPR Systems. (616) 392-2379.**

AMPEX, OTARI & SCULLY recorders in stock for immediate delivery; new and rebuilt. **RCI, 7912 Georgia Ave., Silver Spring, Md. 20910.** Write for product list.

SPECTRA SONICS 1024-24 recording console; 24-in/out. Producer's desk. 18 months old, excellent condition, \$25,000. **(805) 966-6630, 966-1271.**

FOUR 3M-64 2-track record/reproduce tape machines; all machines in excellent condition. \$16,000. **O'Day Broadcasting, Don Winget, 1305 Third Ave., Suite 400, Seattle, Wa. 98101. (206) 682-2828.**

FREE PROFESSIONAL CASSETTE w/ specs. **Larksong, Box 468M, Point Arena, Ca. 95468.**

AUDIO DESIGNS 16x8 board, separate stereo & mono mixdown. Now in service. Mint condition. \$17,500. **Fred Arthur Productions. (303) 832-2664.**

TWO ALTEC A7 speakers, \$300 ea; 2 Phase Linear 700B power amps, \$500 ea; 2 Yamaha B3 V-FET power amps, \$800 ea; 1 Westrex 3DII cutter head with amps, \$3,000; 1 Neumann complete disc cutting system with SX-68 head and JG66 amps, console, tape deck, eq., etc., \$20,000; 1 Bushnell 24 x 12 console, \$15,000; 1 Dukane 30-50 generator, \$200; 1 3M56 8-track recorder, \$6,000. All prices FOB Hollywood, Ca. **United Recording, 6000 Sunset Blvd., Hollywood, Ca. 90028. (213) 469-3983.**

## Copies of db

Copies of all issues of **db—The Sound Engineering Magazine** starting with the November 1967 issue are now available on 35 mm. microfilm. For further information or to place your order please write directly to:

**University Microfilm, Inc.  
300 North Zeeb Road  
Ann Arbor, Michigan 48106**

REVOX A-77 RECORDERS at low, low price \$695. Brand new batch just received in manufacturer's sealed cartons, manufacturer's warranty. It's a steal. Other models available including A-700's at \$1,350. Write for full listing or make checks or money order (\$695 & \$15 freight & handling A-77. N.Y. residents add appropriate sales tax) payable to **Entertainment Sound Services, Inc., 78 N. Franklin Ave., Hempstead, N.Y. 11550. (516) 538-2220.**

PROFESSIONAL AUDIO COMPONENTS: AKG mics; Badap 1; Crown; dbx; Delta Lab; Eventide; Frazier; Gauss; GLI; Ivie; Malatchi; MasterRoom; Nagra; Neumann mics; Orban; Otari; Pentagon; RTR; Sennheiser mics; Switchcraft; Tascam; Uni-Sync; and UREI. These products are on demo in our showroom and in stock for immediate delivery. Our shipping is insured and prepaid. **Barclay Recording & Electronics, 233 E. Lancaster Ave., Wynnewood, Pa. 19096. (215) 667-3048 or 649-2965.**

CURRENT MCI console, JH528; stereo quad; 28-in/24-out; operated only a few weeks; latest factory mods. **Cherokee Recording Studios. (213) 653-3412.**

AMPEX SERVICE COMPANY: Complete factory service for Ampex equipment; professional audio; one-inch helical scan video; video closed circuit cameras; video systems; instrumentation; consumer audio; professional audio motor and head assembly rebuilding. Service available at **2201 Lunt Ave., Elk Grove Village, Ill. 60007; 500 Rodier Dr., Glendale, Ca. 91201; 75 Commerce Way, Hackensack, N.J. 07601.**

## SERVICES

IMPRESS your manager. Save money on: Technics, Ampex, Scully, Nortronics, Stanton, Inovonics, UREI, Electro-Voice, Belar, Orban, etc. **Val-tronics, Inc. Call collect, (717) 655-5937.**

## BUSINESS OPPORTUNITIES

WEST COAST engineers/producers: Bay Area sixteen-track; fully equipped with tube Neumanns, Schoeps, etc., EMT; DDL's (2); acoustic chamber; Dolby A; Spectrosonics; Scully; Ampex. Free flight for out-of-towners. **Tewksbury. (415) 232-7933.**

## WANTED

WANTED: Karlson model 8-U enclosures. State condition and price. **B. Sherrard, FSI/P-Mountain, APO New York 09023.**

WANTED: Recording equipment of all ages and variety; Neumann mics, EMT, etc. **Dan Alexander, 6026 Bernhard, Richmond, Ca. 94805. (415) 232-7933.**

## EMPLOYMENT

MAINTENANCE/CUTTING ENGINEER. Large independent East Coast disc mastering facility seeks an experienced maintenance/chief engineer who is looking for a bright future and who is completely familiar and is able to maintain Neumann, Scully, Westrex, and Capps cutting room equipment. Other duties will include occasional cutting, R&D projects, and construction. Applicant must be able to work with little or no supervision and be of high calibre. Excellent company benefit programs. Salary commensurate with qualifications. Reply with resume to **Dept. 81, db Magazine, 1120 Old Country Rd., Plainview, N.Y. 11803.**

DISC MASTERING ENGINEERS. The East Coast's largest independent disc mastering house is in need of two experienced cutters, preferably with a good technical background and customer following. Excellent salary and benefits. Apply with resume to: **Dept. 82, db Magazine, 1120 Old Country Rd., Plainview, N.Y. 11803.**

WANTED: Engineer (local) to design audio equipment. Partnership agreement possible. **Ace Audio Co., 532 5th St., East Northport, N.Y. 11731.**

WANTED: Apprentice engineering position. Experienced in sound and video studios; will relocate, self starter, hard worker, and dedicated. References. Contact: **Michael Ciesinski, 5611 South Merrill Ave., Cudahy, Wisconsin 53110.**

LARGE 24-TRACK recording studio, NYC seeking experienced maintenance engineer, preferably familiar w/Neve, Studer, 3M. Salary requirements, references. **Dept. 101, db Magazine, 1120 Old Country Rd., Plainview, N.Y. 11803.**

# db People/Places/Happenings

● Festivities for a Centennial of Light, celebrating Thomas Edison's invention of the electric light, which culminated on October 21, 1879, are being planned by the **Thomas Alva Edison Foundation**, (P.O. Box 1310, Greenwich, Conn. 06830.) Focus of activities will be at Edison shrines, such as Menlo Park, N.J. and Ft. Myers, Fla. Because of the close connection between **Henry Ford** and Edison, the Museums at Dearborn, Mich. will also participate. Educational materials for science fairs and exhibits will be provided by the Foundation.

● The post of semi-professional products sales manager at **dbx, Inc.** of Newton, Mass. has been filled by **Emil Handke**. Mr. Handke's appointment is part of an executive expansion program. Mr. Handke's extensive experience in recording and sales was mainly acquired in Nashville, Tenn.

● **Lawrence G. Jaffe** has assumed the position of vice-president in charge of marketing at **Uni-Sync Inc.** of Westlake Village, Ca. Mr. Jaffe joined Uni-Sync at the time of its purchase by BSR last year, as marketing manager.

● The newly-formed **Creative Audio and Music Electronics Organization—CAMEO**, is a combination of electronic manufacturers and distributors who serve musicians and production people engaged in creative and original sound. Charter members include: **AKG, Altec, ARP, BGW, dbx, Fender-Rogers-Rhodes of CBS Musical Instruments, ITX-Aphex, JBL, KM Records, MXR, Oberheim, Phase Linear, RolandCorp US, SAE, Sirius Music, Soundcraftsman, Tangent, Tapco, and TEAC Tascam.** Headquarters are Suite 3501, LaSalle Plaza, 180 N. LaSalle St., Chicago, Ill., 60601 (312) 332-7400. **David Schulman** is the executive director.

● The promotion of **Almon Clegg** to the position of assistant general manager, product engineering division at **Panasonic**, of Secaucus, N.J. has been announced. Mr. Clegg, who has been with Panasonic since 1974, has also been associated with **General Electric** and has been a professor at **Illinois Central College.**

● New manager for antenna engineering at **RCA's** Gibbstown, N.J. facility is **Bruno F. Melchionni**. Mr. Melchionni has been with RCA since 1941 except for a period of Air Force service during World War II. Also at RCA, **Edward B. Campbell** has been appointed manager of industrial electronic services marketing at the **RCA Service Company**, concentrating on the company's industrial electronic services operation.

● The Meadow Lands, Pa. facility of **RCA** has acquired the services of **Richard L. Rocamora** as manager of broadcast transmitter equipment engineering and product management. Mr. Rocamora has been with RCA since 1952 as an electrical engineer.

● Several managerial level appointments have been made at **Shure Bros. Inc.**, Evanston, Ill. **Patrick J. Dalton** has been named domestic distributor sales manager and **Ken Reichel** will head the technical markets and product management department. Working with Mr. Reichel will be **John F. Phelan**, professional sound products; **Al Groh**, high fidelity products; **Jerry Quest**, manager of communications and government products. **Lee Habich** has been appointed as manager of advertising and sales promotion. Assisting Mr. Habich are three section managers, **Ruth Delke, Jim Paton, and Shelly Brown.**

● Here's an opportunity to win some "esoteric" audio equipment. Just think up a brand name for the **Carver** audio line. Further details may be obtained from **Mr. Bob Carver**, P.O. Box 604, Woodinville, Wa. 98072. The contest, open to residents of the continental U.S., closes November 30, 1978.

● **Howard Harman** has been appointed to the post of western regional sales manager of **Audio-Technica**, of Fairlawn, Ohio. Mr. Harman had been previously covering the northern California district for **Harman International.**

● Research and development programs at **Kustom Electronics, Inc.**, of Kansas City, Mo. are now in the hands of **William Goodson**. Mr. Goodson has been with the firm since 1973, in the capacities of design engineer and project engineer.

● **The Society of Motion Picture and Television Engineers** has organized a committee, "Working Group for Interface of Television Broadcast Studio Equipment." The intent is to create an optional control interface—a digital communications scheme—for video tape recorders, film chains, character generators, still stores, audio tape decks, audio consoles, video switchers, frame synchronizers, etc. The committee is under the direction of **Robert W. McAll, Vital Industries, Inc.**, 34 Autumn Lane, Hicksville, N.Y. 11801.

● The importance of telecommunications has gotten the nod at **Switchcraft**, of Chicago, Ill. with the appointment of their first telecommunications marketing manager, **Fred Fitzpatrick**. Mr. Fitzpatrick, who comes from **Amphenol**, will focus on new programs to market electromechanical components to telecommunications customers through authorized telephone distributors. Another personnel item at Switchcraft is the appointment of **Gerald F. Olsen** as vice president in charge of finance. Mr. Olsen had previously been with the **Raytheon Company.**

● Sales in Europe, Africa, and the Middle East will be the special responsibility of **Milo L. Cermak**, recently appointed vice president, international marketing at **Information Terminals Corp.** of Sunnyvale, CA. Mr. Cermak has served as an international advisor for a number of companies, including **RCA** and **AMF**. Also at Information Terminals, **Paul Olmstead** has assumed the job of corporate controller.

● After a number of months of familiarization with the executive workings of the company, **Thomas R. Shepherd** has assumed the post of president of **GTE Consumer Electric Company**, the television marketing organization of **General Telephone & Electronics Corporation** of Stamford, Conn. Mr. Shepherd's activities, since 1956, have been mainly with the **Sylvania** portion of the company.

● **Lex Rodgers** has been appointed president in charge of engineering at **Fisher-Burke Professional Audio**, of Phoenix, Arizona. Fisher-Burke specializes in broadcast consulting.

**The 90-16.  
\$1000<sup>00</sup> per track.\***



**Now you can make money  
while you save money.**

Let's face it. What you really want to do is sell your album. And the new affordable TASCAM Series 90-16 can help do just that. But at the same time, you can pick up cash to help you pay for it by recording other musicians' songs for them.

And here's how you save. You don't pay studio time. You don't pay for 2" equipment. And you don't pay the heavy hit of "outboard" DBX which usually cost about \$300 per channel. Our suggested retail price of just \$16,000\* includes integral DBX interface.

If you're an engineer, the 90-16 Function

Select panel will make a lot of sense to you. One button operation simultaneously switches three interrelated functions: tape/source, playback/record, and DBX decode/encode thus eliminating the need for three arms. If you're a musician, this human engineering factor means you won't have to wait for the engineer and lose the spontaneity of your music in the process.

All of which means that if you need 16 tracks, you only have one choice: the new TASCAM Series 90-16. You'll find it exclusively at these TASCAM dealers.

**DEALERS**

Audio Concepts  
7138 Santa Monica Blvd.  
Hollywood, Ca. 90046  
(213) 851-7172

The Express Sound  
Co., Inc.  
1833 Newport Blvd.  
Costa Mesa, Ca. 92627  
(714) 645-8501

Sound Genesis  
2001 Bryant St.  
San Francisco, Ca. 94110  
(415) 285-8900

Nashville Studio Systems  
16 Music Circle South  
Nashville, Tenn. 32703  
(615) 255-1650

Audio By Zimet, Inc.  
1038 Northern Blvd.  
Roslyn, New York 11576  
(516) 621-0138

Lebow Labs  
424 Cambridge St.  
Boston, Mass. 02134  
(617) 782-0600

A.M.I., Inc.,  
680 Indiana St.  
Golden, Colo. 80401  
(303) 279-2500

AVC Systems  
1517 East Lake St.  
Minneapolis, Minn. 55407  
(612) 729-8305

Electronic Music Box  
2320 6th Ave.  
Seattle, Wash. 98121  
(206) 622-6984

Arnold & Morgan  
510 South Garland Rd.  
Garland, Tex. 75040  
(214) 494-1378

PA Palace  
2631 Buford Hwy.  
Atlanta, Ga. 30324  
(404) 636-3044

Ford Audio & Acoustics Inc  
1815 Classen Blvd.  
Oklahoma City, Ok. 73106  
(405) 525-3343

**TASCAM SERIES BY TEAC**

A new generation of recording instruments  
for a new generation of recording artists.

\*Prices subject to dealer preparation charges where applicable.

# A Sound System Without Feedback?



Photography courtesy City of Huntington Beach

## Your ears won't believe what they're not hearing!

Feedback has plagued sound systems since the day they were invented. It's something city councils, church choirs and boardrooms have had to cope with... something most sound system manufacturers have learned to live with—or ignore. Not Altec. Altec never gave up their search to find a better way of controlling nagging feedback.

It wasn't an easy task, but it was the kind of challenge that Altec has been meeting for over 40 years... applying advanced research techniques to perfecting sound system technology. That's why they're the leader.

**To Altec, being a leader also means being an innovator: introducing the 1628A Automatic Microphone Mixer.**

Several microphones can be used simultaneously with this newly-patented device that automatically divides the system's volume among the in-use microphones, compensating for the number of persons speaking into them—without affecting intelligibility or the overall volume of the system. Each person will still be heard loud and clear all the way to the back of the room. If only one microphone is in use, it receives the maximum system attention while the others are automatically silenced.

The 1628A also automatically turns the various microphones up or down as persons speak or stop speaking into them. And, up to five 1628A's can be linked together to accommodate up to 40 microphones. That's an innovation!

### **The difference with automatic microphone mixing...**

In conventional systems, multiple microphones used simultaneously have had to rely on manual techniques, or, in some cases, a less-than-adequate "voice gating" system. Neither has been successful.

The sophisticated 1628A operates on the principle of adaptive threshold audio gating (unique to Altec), which means that its activation point is automatically adjusted, allowing the system to discriminate between various noise levels and the voice signal that activates the microphone.

Let a professional Altec sound contractor demonstrate the 1628A to you. Your ears won't believe what they're not hearing. Write today for further information.

1515 So. Manchester Ave., Anaheim, Calif. 92803 • 714/774-2900

ALTEC CORPORATION

Circle 12 on Reader Service Card

[www.americanradiohistory.com](http://www.americanradiohistory.com)

**ALTEC**  
the sound of experience.