

db

THE SOUND ENGINEERING MAGAZINE

JUNE 1971 \$1.00

192

**FOUR
CHANNEL
ISSUE**

INTERNATIONAL ELEC ING
64 UNIVERSITY PL
NEW YORK N Y 10003

MORE

Versatile!

MODEL 550A EQUALIZER

- Shelving or peaking curves independently selectable for upper and lower ranges.
- Transformer coupled output to +28 dBm.
- Low noise and distortion.
- Panel mounting 1½" x 5¼".
- Utilizes Automated's 2520 Op Amps.

NEW COPY



The Automated Processes Model 550A Equalizer embodies improvements and changes to the well known Model 550, further increasing its versatility, performance and reliability. The Model 550A provides reciprocal equalization at fifteen points in five steps of boost or attenuation to a maximum of 12 dB at each point. These points are divided into three ranges, with the upper and lower ranges individually selectable as either peaking or shelving. Ten controls are provided to accomplish the various functions. Three dual concentric rotary switches perform frequency selection and degree of equalization for the three ranges; the inner knob selects the desired frequency while the outer knob sets the degree of boost or cut from a mid position (reciprocal equalization) in steps of 2, 4, 6, 9 and 12 dB.

Noise has been reduced 5 dB, and the In-Out indicator lamp has been changed to a light emitting diode reducing current requirements and providing almost unlimited indicator life.

Two push buttons select either the bell-shaped peaking curves or shelving curves for the upper and lower frequency ranges. The five center frequencies in the mid-range are reciprocal bell-shaped peaking families. A band-pass filter (50 Hz to 15 kHz) is switch selected independent of all equalization settings, and a push-button In or Out switch with tally light inserts or removes equalization without clicks or program interruption.

The virtually limitless range of repeatable curve shaping combinations provided by the Model 550A makes it ideally suited for all types of music or voice enhancement and effects equalization.

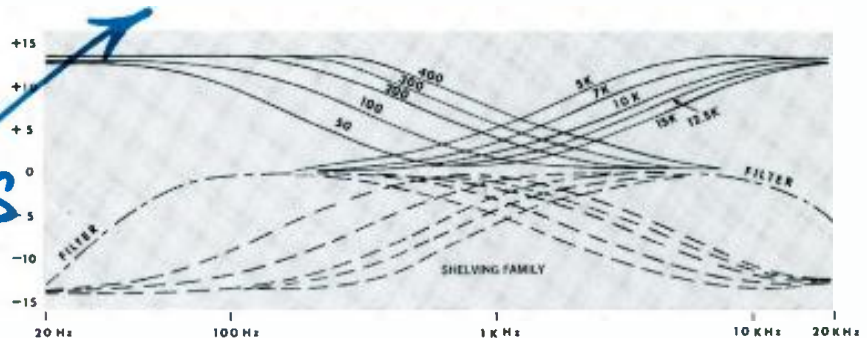
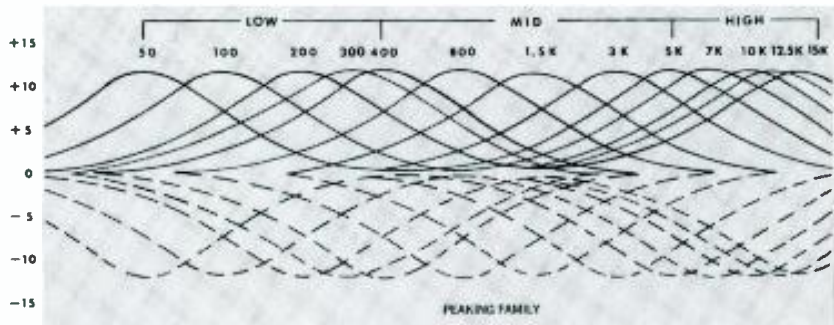

NEW PHOTO

NEW GRAPHS



AUTOMATED PROCESSES, INC.
 80 MARCUS DRIVE, MELVILLE, NEW YORK 11746 • 516-694-9212

Circle 10 on Reader Service Card

COMING NEXT MONTH

● Norman H. Crowhurst has prepared a special report on a very interesting and growing segment of the audio industry. His survey tells the full story of **HIGH POWER AMPLIFIERS—Why? How Much Power? What is available?** You won't want to miss this high-powered article (pun intended).

ASSEMBLING A DIFFERENTIAL NOISE-CANCELING MICROPHONE is the title of the first of a series of microphone articles by Lou Burroughs. This article and others to come will eventually make up a forthcoming definitive book on the subject of microphones—something the industry has long needed.

BUILD A SIX-CHANNEL IN, TWO OUT MIXER KIT. Here's a build-it-yourself kit designed specifically for the audio professional. It's easy to build the Gately ProKit mixer. After reading the text and seeing the pictures of how we did it, you may decide to build one too.

And, as an extra: a **PICTURE GALLERY** of the products our peripatetic camera saw in sunny southern California's AES Convention. Lots of goodies!

And there will be our regular columnists: George Alexandrovich, Norman H. Crowhurst, Martin Dickstein, and John Woram. Coming in **db**, The Sound Engineering Magazine.

ABOUT THE COVER

● We told our art director, Bob Laurie, that this is a special four-channel stereo issue. The cover is the result.

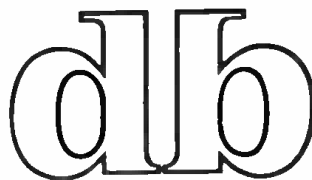

THE SOUND ENGINEERING MAGAZINE

JUNE 1972 VOLUME 6, NUMBER 6

- 24 A FOUR-CHANNEL 'SCOPE DISPLAY
Donald L. Patten
- 28 THE MIDWEST ACOUSTICS CONFERENCE—
FOUR CHANNELS
John Woram
- 31 RECORDING IN FOUR CHANNELS
Stephen H. Lampen
- 2 LETTERS
- 8 THE AUDIO ENGINEER'S HANDBOOK
George Alexandrovich
- 14 THE SYNC TRACK
John Woram
- 16 THEORY AND PRACTICE
Norman H. Crowhurst
- 18 NEW PRODUCTS AND SERVICES
- 34 SOUND WITH IMAGES
Martin Dickstein
- 36 BOOKCASE
- 37 CLASSIFIED
- 38 PEOPLE, PLACES, HAPPENINGS

db is listed in **Current Contents: Engineering and Technology**,

Robert Bach PUBLISHER	Larry Zide EDITOR
Bob Laurie ART DIRECTOR	John Woram ASSOCIATE EDITOR
A. F. Gordon CIRCULATION MANAGER	Marilyn Gold COPY EDITOR
Eloise Beach ASST. CIRCULATION MGR.	Richard L. Lerner ASSISTANT EDITOR
GRAPHICS Crescent Art Service	

db, the Sound Engineering Magazine is published monthly by Sagamore Publishing Company, Inc. Entire contents copyright © 1972 by Sagamore Publishing Co., Inc., 980 Old Country Road, Plainview, L.I., N.Y. 11803. Telephone (516) 433 6530. db is published for those individuals and firms in professional audio-recording, broadcast, audio-visual, sound reinforcement, consultants, video recording, film sound, etc. Application should be made on the subscription form in the rear of each issue. Subscriptions are \$6.00 per year (\$7.00 per year outside U. S. Possessions, Canada, and Mexico) in U. S. funds. Single copies are \$1.00 each. Controlled Circulation postage paid at Harrisburg, Pa. 17105. Editorial, Publishing, and Sales Offices: 980 Old Country Road, Plainview, New York 11803. Postmaster: Form 3579 should be sent to above address.

One of a series of brief discussions
by Electro-Voice engineers

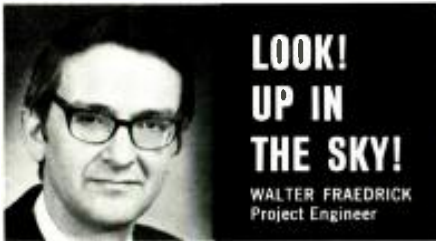

Skylab is NASA's most ambitious project to date, with a program of 3 separate crews planning to spend tours of from 28 to 56 days in the orbiting space laboratory. And the special microphones and speakers required have been one of the more interesting E-V projects of late.

Several limitations proved challenging. One is the need to perform despite wide variation in atmospheric pressure. In addition, flammable and out-gassing materials were prohibited, and lightness and extreme reliability were obvious design goals. In addition the transducers had to be unaffected by extended exposure to vacuum.

Both design and production testing was rigorous and extensive, with X-ray techniques employed for all castings, and E-V's altitude chamber used to duplicate the near-vacuum conditions specified.

While the microphone design finally selected bears many similarities to military models supplied regularly by Electro-Voice, the speaker required extensive development. Traditional cone materials were all ruled out by the rigors of the ambient conditions. The solution was found in a new plastic not presently used for this purpose.

To make the 4" speaker cone, dust dome, and supporting spider required development of new molding techniques involving unusual temperature and pressure to convert the sheet plastic into the desired parts. The result is a cone assembly that is unusually strong, chemically inert, and unaffected by the atmospheric environment or by abrupt pressure variations from 15 p.s.i. down to a virtual vacuum.

A total of 9 sets of microphones and speakers are located in communications stations at each of the work positions and section of the Skylab, providing instant communications to all three astronauts. In addition other similar speakers are used as an electronic Klaxon to warn of changes in the life support system. The system was produced for McDonnell Aircraft, the prime contractor, and continues the Electro-Voice participation in the space program that began with the early Mercury and later Gemini flights.

For reprints of other discussions in this series,
or technical data on any E-V product, write:
ELECTRO-VOICE, INC., Dept. 623BD
686 Cecil St., Buchanan, Michigan 49107



Circle 15 on Reader Service Card

letters

The Editor:

Without trying to use your worthy publication as a battle ground, I feel compelled to reply to the rather inaccurate and weak rebuttal given by Eric Small with regard to my CSG.

First of all, I don't believe I ever stated in my first letter that I explained to Mr. Small how CSG, quadrature, or any degree of phase shift worked. At the time we first met he was working for MGM Records and obviously the system mechanics were not described to everyone. I merely stated it was at that time he was first made aware of the problems of stereo/mono compatibility which CSG helped to

advertisers index

AKG	5
Altec	3
Auditronics	23
Automated Processes	Cover 2
Electro-Voice	2
Fairchild Sound	19, 20
Gately Electronics	22
Gothan Audio	14, 15
KMK	12
Koss	facing Cover 2
Philips Broadcast	Cover 4
Quad-Eight	30
Sansui	10, 11
Sony Corp.	7
Soundcraftsmen	6
Spectra-Sonics	9
Stanton Magnetics	4
Thurmond	16
Timekeeper	17
UREI	12
Westrex	23



THE SOUND ENGINEERING MAGAZINE

SALES OFFICES

New York
980 Old Country Road
Plainview, N.Y. 11803
516-433-6530

Dallas
Roy McDonald Associates, Inc.
Semmons Tower West
Suite 714
Dallas, Texas 75207
214-637-2444

Denver
Roy McDonald Associates, Inc.
846 Lincoln Street
Denver, Colorado 80203
303-825-3325

Houston
Roy McDonald Associates, Inc.
3130 Southwest Freeway
Houston, Texas 77006
713-529-6711

Los Angeles
Roy McDonald Associates, Inc.
1313 West 8th Street
Los Angeles, California 90018
213-483-1304

Portland
Roy McDonald Associates, Inc.
2305 S. W. 58th Avenue
Portland, Oregon 97221
503-292-8521

San Francisco
Roy McDonald Associates, Inc.
625 Market Street
San Francisco, California 94105
415-397-5377

New Tools for Professional Monitoring



THE 8050A REAL TIME ANALYZER provides continuous audio spectrum scanning every 30 ms, 40 Hz to 16 kHz on ISO center frequencies. Has *fast* RMS response for visual program monitoring and *slow* RMS response for room equalization. Cost is about 1/3 of competitive models.

THE 9860A ACTIVE EQUALIZER has phase and amplitude transfer characteristics identical with those of the Altec passive equalizer. Permits detailed equalization from 40 Hz to 12.5 kHz. High and low-pass functions, 18 dB/octave, permit more precise finishing of frequency extremes. Cost is about 1/2 of comparable passive devices.

THE 8080A PINK NOISE GENERATOR plugs into standard Altec mixers. An ideal flat and stable noise source for room/speaker equalization with 24V power supply or battery. Cost is about 1/5 of standard noise generators.

THE 771B BIAMPLIFIER has a switchable 12 dB/octave crossover at 500, 800, and 1500 Hz. Can be adapted to most studio monitoring systems and coaxial speakers. Acoustical balances can be exactly controlled by separate HF and LF gain controls. The LF section delivers 60 Watts and the HF section 30 Watts continuous sine wave power.

For more detailed data and specs write Altec, Professional Studio Products, 1515 S. Manchester Ave., Anaheim, Calif. 92803.

ALTEC

Circle 23 on Reader Service Card

www.americanradiohistory.com

The Pick-Up Pros.



WOR-FM, the country's leading FM/Stereo rock station, has been using Stanton cartridges since its inception.

Program Director Sebastian Stone likes the smooth, clean sound the Stanton delivers; the way it is able to pick up everything on the record so that the station can assure high quality transmission of every recording.

Eric Small, Chief Engineer for WOR-FM, likes the way that Stanton cartridges stand up under the wear and tear of continuous use. "We standardized on Stanton a couple of years back," Small said, "and we haven't had a cartridge failure since." Studio Supervisor Artie Altro concurs.

Whether you're a professional or simply a sincere music lover, the integrity of a Stanton 681 Series cartridge delivers the quality of performance you want.

It affords excellent frequency response, channel separation, compliance and low mass and tracking pressure. And every Stanton cartridge is fitted with the exclusive "longhair" brush to keep grooves clean and protect the stylus.

For complete information and specifications on Stanton cartridges, write Stanton Magnetics, Inc., Terminal Drive, Plainview, L.I., N.Y. 11803.



All Stanton cartridges are designed for use with all two and four-channel matrix derived compatible systems.

cure. While no explanation was given as to how CSG worked, he was certainly aware of the fact that CSG did indeed solve the compatibility problem as he wrote about in his *db* article. If there are any doubts to this statement, perhaps Mr. Val Valentine (his past supervisor), chief engineer for MGM Records, could be queried.

It is indeed true that the CSG's placed at MGM, Atlantic, Contemporary, Warner Bros. and A & M Records were "magic black boxes" with red-lacquered seals on them. I am really dedicated to the advancement of the audio industry but I do have a wife, two children, three dogs, two cats and one hell of a big airplane to support! No one has condemned RCA for their secrecy in patent matters, nor CBS for theirs. Has anyone ever tried to enter the Mattel or Ideal toy manufacturing facilities? Their security measures parallel those of the F.B.I. Perhaps in the future, should Mr. Small have the ingenuity to invent a very useful and commercial tool, he will change his tune a little.

As to an admission of the principle of how CSG works, as stated by Mr. Small in his reply, I can only re-affirm that he either has a very short memory or is trying to spread mis-truths.¹ A review of the May 1969 panel discussions (AES New York Chapter) will reveal that the principles and design concepts of CSG were discussed in rather vivid detail, with John Eargle, Floyd Harvey, Sidney Feldman, and myself. I was invited to participate at that meeting solely because of my CSG device and its principles of operation were widely discussed. At that meeting it was Mr. Small who directed various questions to me, and at the time vainly tried to discredit the advantages of using quadrature for the purpose of having an esthetically equal stereo and mono signal, no matter where the stereo was finally combined. It was clearly pointed out at that meeting that one of the prime uses to which the CSG could be put to use was the creation of a perfect mono from a stereo tape or disc without center-channel build-up. He certainly ought to remember, he cut a few masters, both mono and stereo, processed through the CSG when he worked at MGM Records. Perhaps a copy of the recording made of that May 1969 AES meeting would refresh Mr. Small's memory.

Referring to Mr. Small's first knowledgeable encounter with quadrature, he states that he was first made aware of the system by John Eargle's paper given in *October* of 1968. With deep humility for the excellent capabilities of Mr. Eargle, I must say that the

principles of CSG were disclosed in confidence to many important "in" people at all of the major recording companies in an effort to get acceptance of the system. John Eargle knew how the system worked when it was first displayed and demonstrated at the May 1968 AES convention in Los Angeles. He knew how it worked because I disclosed to him, in confidence, how it worked. I think John spent half of his time in my booth, intrigued by the idea and the device. Again, if there are any doubts, perhaps some affidavits made by some very reliable people in our industry (present at that AES meeting) should be published also. It's always easy once you know what it does and how it works. Obviously, Mr. Small didn't know this when he wrote his article in *db*.

Speaking of how it works, Mr. Small may not have known how until John Eargle enlightened him, but it is beyond me how he can forget the demonstrations that were given to him at MGM wherein we cut mono discs or dubbed mono tapes from stereo tapes — which is exactly what he speaks about in his *db* article on COMPATIBLE STEREO BROADCASTING. Atlantic Records has taken full page ads in *Billboard* and other recording industry magazines extolling the fact that they have released hundreds of mono discs which were cut from stereo tapes with absolute esthetic quality. Our original brochures, which I am certain Mr. Small has seen at one time or another, make this statement very clear. CSG is not limited only to the use of making a stereo record or stereo tape compatible.

If Mr. Small thinks that I have made an issue out of the fact that he did not include me in his bibliography, I want to apologize. John Eargle didn't throw any bouquets my way in his October 1968 paper, and I have successfully lived through that one. My reason for the original letter to *db*, referring to Mr. Small's writings, was more in amazement at the fact that we had discussed together the very essence of his article and he certainly could not forget these conversations or that a device such as CSG existed.

It is true that I have never written a manuscript, nor published any of the twelve technical presentations I have given over the many years that I have been active with the AES. I intend to give many more (God willing) and I doubt if I will ever publish those either; I seldom have enough time. Nevertheless, most of the ideas and innovations I have offered have found their way into usefulness, and I am indeed humbly proud of the Fellowship the Society awarded me for

AKG C-412

A New F.E.T. Condenser Microphone... with nothing to hide!

Here are X-ray pictures . . . "inside views" of the one-inch capsule and associated electronics found in the new **AKG** F.E.T. condenser microphone C-412. This microphone, with its twin-diaphragm system, is equipped with two switches—one providing a choice of polar pattern selections of either omni-directional, cardioid or figure eight. The other, an output attenuator switch offers a selection of 0 or -20 dB. Response is absolutely smooth between 20 and 20,000 Hz., with a minimum of deviation in all three pickup characteristics.

This new microphone can be used as an addi-

tional interchangeable component in the famous **AKG** C-451E system. The C-412 may be phantom powered by the d.c. supply in most input equipment (console, tape recorder, etc.), or either the **AKG** N-46E a.c. power supply or the **AKG** B-46E battery power supply units. The C-412 F.E.T. circuitry includes a d.c. converter providing the polarization voltage for the twin-diaphragm.

This new C-412 microphone is a further example of the broadness of **AKG** choices in providing you with the ultimate in product design, application and excellence in performance.



MICROPHONES • HEADPHONES

DISTRIBUTED BY
NORTH AMERICAN PHILIPS CORPORATION
100 EAST 42nd STREET, NEW YORK, NEW YORK 10017

AKG-23

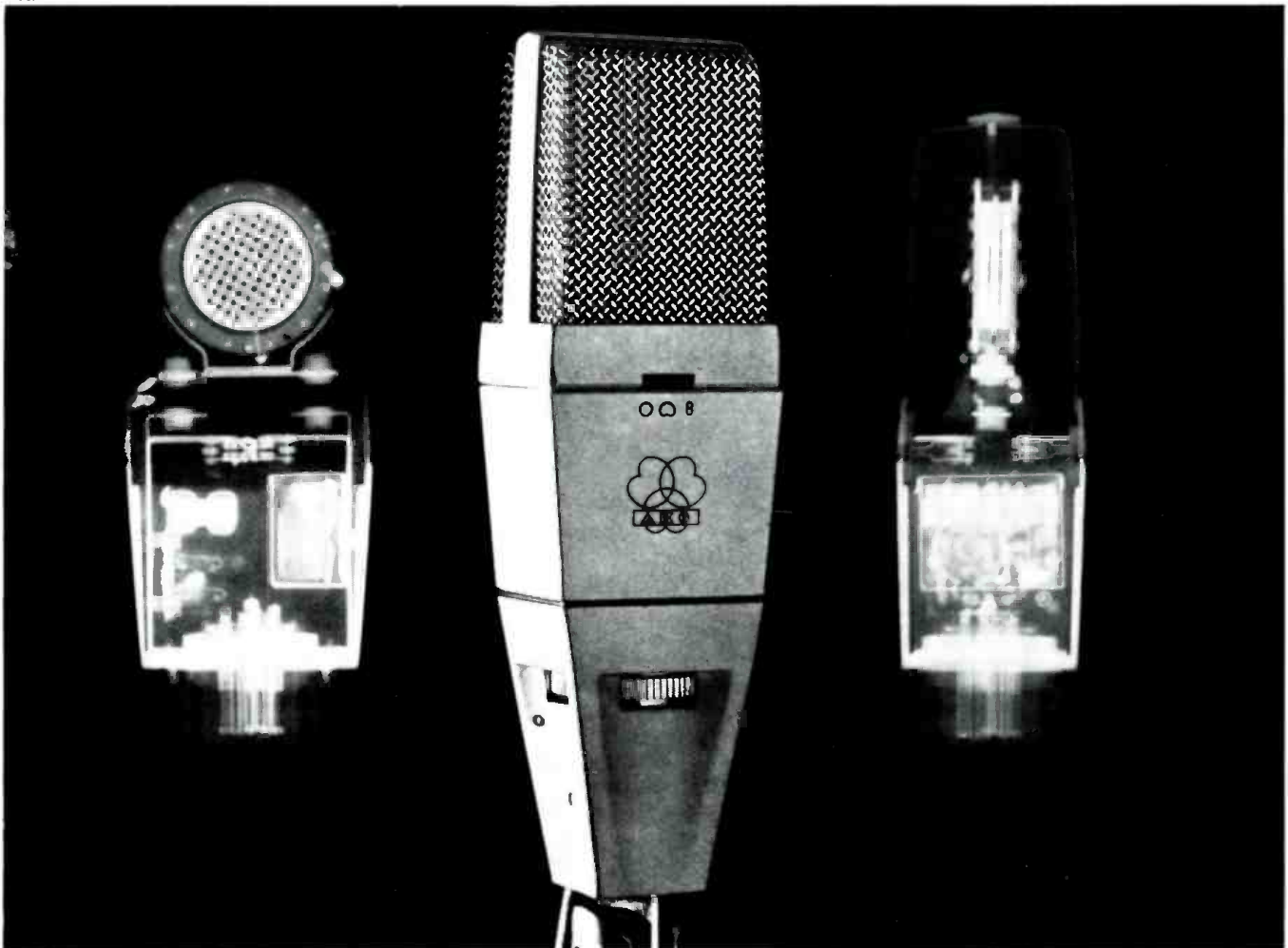

Circle 17 on Reader Service Card

www.americanradiohistory.com

these ideas, even though they will not go down in the archives of published technical papers.

I really think that Mr. Small and I must speak different languages, or semantics becomes a real exercise. I would have to reiterate emphatically that I was the first to use wide-band phase shifting for the purpose of compatibility, regardless of what Mr. Small may try to propagate. I, as well as my patent people, have read all of the references given by Mr. Small, and we (including the U.S. Patent Offices) have not found any instance where there is prior art disclosed with reference to compatibility. As a matter of fact, Ben Bauer had a rather negative attitude about phase shifting as to image projection, and seemingly touted the industry away from it. Further, when demonstrations were given and sample discs were cut for CSB Records in 1969, I was told that "you cannot phase shift and add or subtract successfully." It's surprising how today CBS, Sansui, and other companies are doing just exactly that in their quadriphonic format. Interestingly enough, the entire bag of compatibility with quad to stereo, or mono, lies in the fact that all of those systems use some form of wide band phase-shift to keep from losing, adding, or chang-

ing the esthetic value of the recorded material. Of utmost interest is the fact that CSG has been awarded a U.S. Patent, No. 3646574 which covers the entire subject of compatibility by use of quadrature or wide-band phase shift methods. The situation of who was first and who holds the "aces" will certainly be "most interesting" but I do know this: the CSG Patent was applied for in January of 1968. Ben Bauer's Stereo Recording Systems with Quadrature phase relation was applied for in February 1968, shortly after I made my announcement to the Industry and held a press conference, disclosing the capabilities only, at Atlantic Records' studios in New York City. No one can deny that Ben Bauer is one of the brilliant "heavys" of our Industry.

I sincerely believe and hope that this communication will clear up some of the confusion that may have been created by Mr. Small in his original article, and in his reply to my original letter which was nothing more than a curiosity to enlighten me as to why Mr. Small chose to disavow any knowledge of my pioneering a field which he now writes upon as an "expert."

Howard S. Holzer
Van Nuys, Ca.

you write it

Many readers do not realize that they can also be writers for *db*. We are always seeking good, meaningful articles of any length. The subject matter can cover almost anything of interest and value to audio professionals.

Are you doing something original or unusual in your work? Your fellow audio pros might want to know about it. (It's easy to tell your story in *db*.)

You don't have to be an experienced writer to be published. But you do need the ability to express your idea fully, with adequate detail and information. Our editors will polish the story for you. We suggest you first submit an outline so that we can work with you in the development of the article.

You also don't have to be an artist, we'll re-do all drawings. This means we do need sufficient detail in your rough drawing or schematic so that our artists will understand what you want.

It can be prestigious to be published and it can be profitable too. All articles accepted for publication are purchased. You won't retire on our scale, but it can make a nice extra sum for that special occasion.

Soundcraftsmen presents the new **RP10-12**
PROFESSIONAL EQUALIZER for RECORDING and PLAYBACK
PERFECT tailoring of octave-wide bands... Infinitely variable adjustment flexibility
... Special Effects programming ... Instant re-setting
via Computone-Charts

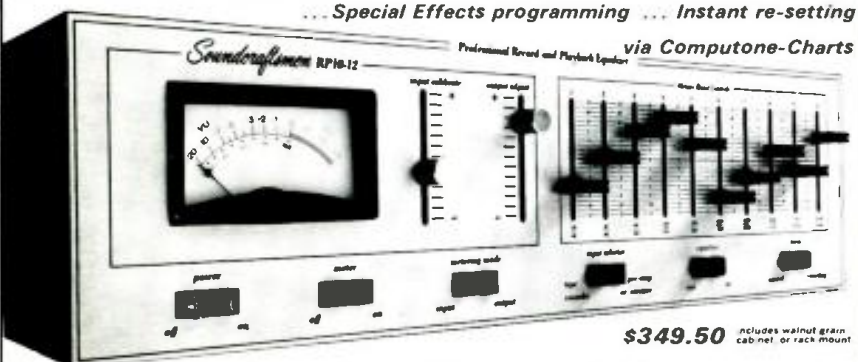

\$349.50 includes walnut grain cabinet or rack mount

Recording Studios • Audiophiles • Night Clubs • Performers • Theatres
Churches • Gyms • Auditoriums • Hi-Speed Duplicating • Musical Groups

SPECIFICATIONS
FREQUENCY RESPONSE: ± 1 dB from 20 to 480 Hz, 1 dB down @ 10KHz
 $\pm 1/2$ dB down @ 100 KHz
HARMONIC DISTORTION: Less than .08% @ 2V, .05% @ 1V, Typ. 0.1% @ 1V
IM DISTORTION: Less than .08% @ 2V, .05% @ 1V, Typ. 0.1% @ 1V
SIGNAL TO NOISE RATIO: Better than 90 dB below 2V output, Typ. 95 dB
INPUT IMPEDANCE: 100K ohms - Operable from any source up to 100K ohms, any Mixer, Hi-Fi Preamp, Receiver or Tape Recorder
OUTPUT IMPEDANCE: 600 ohms - Operable into any Mixer, Hi-Fi Amp, Receiver or Tape Recorder
INSERTION LOSS: Zero (slide controls centered, and "OUTPUT ADJUST" control set so that "input" equals "output")
MAXIMUM OUTPUT: 2V in to 600 ohms impedance, 3.5 V into 600 ohms - (13 dBm)

SPECIAL FEATURES
VU METER: Precision $\pm .5\%$ meter movement provides an accurate scale display to enable exact unity gain input/output matching
INDUCTORS: Toroidal and Shielded ferrite core
CIRCUIT BOARDS: Military grade G 10 glass epoxy
RESISTORS: Low noise selected carbon film throughout
SWITCH CONTACTS: Gold plated to assure low noise and reliability
DEFEAT SWITCH: Electrically removes the Equalizer from the circuit
OUTPUT ADJUST: Controls a continuously variable 18 dB range from -12 dB to +12 dB to match output to input
RANGE: 12 dB boost and 12 dB cut, each octave centered at 30, 60, 120, 240, 480, 960, 1920, 3840, 7680 and 15,360 Hz
SIZE: Walnut grained wood case 5" x 18" x 18" Rack panel 5" x 19"

NEW 1972 STEREO 20-12 \$299.50
MASTER OUTPUT LEVEL: "Frequency spectrum level" controls for left and right channels continuously variable 18 dB range, for unity gain
HARMONIC DISTORTION: Less than .1% TD @ 2V, Typ. .05% @ 1V
IM DISTORTION: Less than .1% @ 2V, Typ. .05% @ 1V
SIGNAL TO NOISE RATIO: Better than 90 dB below 2V output
INPUT IMPEDANCE: Operable from any source 100K ohms or less (any Hi-Fi Pre amp, Receiver or Tape Recorder)
OUTPUT IMPEDANCE: Operable into 30 ohms or greater (any Hi-Fi Amp, Receiver or Tape Recorder)
SIZE: Walnut grained wood case 5" x 18" x 18" or rack mount

ALSO AVAILABLE the **20-12-600 .. \$349.50**
SAME AS 20-12 ABOVE, EXCEPT HAS 600 OHM OUTPUT

Soundcraftsmen 1310 E. Washburn Ave. Santa Ana, Cal. 92705 Ph. 714 836 8375

db binders

only \$4.95 postpaid

Heavy-weight binders are now available to hold the thirteen issues of Volumes 1 and 2. Rich brown leather-grained virgin vinyl, with our name printed in black on the spine and front cover, is electronically sealed over rigid board to give your volumes of *db* lasting protection. Keep your copies preserved in perfect condition, protected from dust and damage.

Please send me _____ copies of the *db* Magazine binder. My check for \$ _____ is enclosed (sorry, no c.o.d.).
Name _____
Address _____
number and street

city _____ state _____ zip _____
(New York State residents please add 6% sales tax).

Mail to: *db* the Sound Engineering Magazine, 980 Old Country Road, Plainview, N.Y. 11803.

We compared our new deluxe preamp to a 10¢ piece of wire.

First we ran a signal through a 10¢ length of shielded cable. What came out the other end was, of course, audibly identical to what went in. Then we ran the same signal through our new TA-2000F preamplifier, and ran an A-B comparison between its output and the wire's. Both were audibly identical. As we'd expected.

This is not to say that sufficiently precise instruments could not detect inaudible differences between our preamp's signal transmission and a wire's. Whereas a straight wire has no distortion whatsoever, we must admit to having some—three hundredths of one per cent harmonic, and five hundredths of one per cent intermodulation, maximum, at rated output. And whereas a wire theoretically does generate some noise, its signal-to-noise ratio is still somewhat better than the 73dB obtained through the TA-2000F's phono inputs, or even the 90dB obtained through our Aux. Tape and Tuner inputs.

But, as you'd expect, the big difference in price between our deluxe preamp and two feet of cable, buys a great deal more than just a pure, clean signal. As our preamp's 58 levers, switches, meters, knobs and jacks would indicate.

NEARLY 2,000 RESPONSE SETTINGS

Six of those controls are devoted to precise adjustment of frequency response. The calibrated, 2dB-per-step, bass and treble controls have switches that adjust their turnover frequencies, so you can choose how deeply the tone controls will affect—or not affect the midrange. Still another switch cuts the tone controls out of the circuit altogether. And a single knob controls the sharply-cutting, 12dB-per-octave, 50Hz and 9kHz filters. Together, these six controls give you a choice of 1,935 *precisely repeatable* response settings including flat (10Hz-100kHz, +0, -2dB) response.

The facilities for tape recording are exceptional and unique; you can record on two tape decks at once, monitoring either (or your program source) at the flick of a switch. You can dub from one machine directly to the other, without external patching or connections. For straight microphone recordings, there's a mic input position on the function

selector knob; for voice-over-music, there's a separate mic level control that diminishes all other input signals as it increases the microphone level.

And, of course, the two, front-panel VU meters, are as useful for testing as they are for monitoring record levels.

TOTAL INPUT AND OUTPUT FLEXIBILITY

The TA-2000F can feed two stereo amplifiers (and an additional monophonic or center-channel amp) at one time, at either a 1 volt or 300mV level. The second amplifier output could also be used for still another tape recorder, should you wish to use the ultra-versatile tone controls and filters in recording. The front-panel output jack feeds both high- and low-impedance headphones, or can be used as a tape output, by suitable adjustment of its independent level control; the same knob also controls the center-channel output.

Five of the 8 rear-panel stereo inputs have rear-panel level adjustments. A sixth—the Phono 1 input—has a switch that selects three separate input impedances at the normal 1.2mV sensitivity setting, and two more impedances at the 0.06mV setting that lets you use even the lowest-output cartridges.

96 TRANSISTORS VERSUS A SINGLE WIRE

But all these features merely make our TA-2000F more versatile than any wire. They don't explain how we can come so close to the wire's pure, unadulterated performance. That explanation will rest with our circuit designers, and with the 96 *high voltage*, and Field Effect transistors they used

THE TA-3200F: AN AMPLIFIER TO TRULY COMPLEMENT OUR PREAMP
A preamplifier like the TA-2000F deserves, of course, its complement in a

power amplifier. Not too surprisingly, we make one: the Sony TA-3200F. Its fully direct-coupled circuitry produces 200 watts continuous (RMS) at 8 ohms, with power bandwidth from 5 to 35,000Hz. IHF Dynamic Power is rated at 320 watts into 8 ohms (and fully 500 watts into a 4 ohm load). Its distortion, at a listening level of one half watt, matches the preamplifier's at 0.03%; at full rated output, it is still a mere 0.1%. And the signal-to-noise ratio is 110dB.

Our amplifier's facilities nearly match our preamp's. The 3200F has controls you've rarely, if ever, seen on power amps before: switch-selected stereo input pairs; a speaker selector switch; a power limiter (which holds output down to 25 or 50 watts, should you so desire), and a rear-panel switch that lets you limit bass response below 30Hz., instead of letting it extend to 10Hz.

For further information, see your Sony dealer, or write us. Or wire. Sony Corporation of America, 47-47 Van Dam Street, Long Island City, N.Y. 11101.



SONY[®]

THE AUDIO ENGINEER'S HANDBOOK

Matching and loss pads-continued

● Last month we took a look at the practical way of figuring resistance values for different pads. At one point in the equation the letter K was used but no explanation given. Some of you may have wondered what K stood for. It stands in other equations we are about to look into this month, for current or voltage ratio, expressed empirically for each amount of attenuation expressed in dB.

Factor K has its lowest value of 1, for zero dB and rises into infinity as the voltage ratio goes up. Here is a table of most commonly used values of K. If you plot these points on periodic log paper by linear divisions and assign dB scale to the linear axis and ratios to the log you will get a straight line. From this line you can interpolate all needed values of K for any amount of attenuation.

dB	K
0	1
5	1.778
10	3.162
15	5.62
20	10.00
25	17.783
30	31.623
40	100.0
50	316.23
60	1000.00
70	3162.3
80	10000.0

Loss in dB	R1	R2	R3
0.5	18	10,000	8.2
1	36	5,100	18
2	68	2,700	36
3	100	1,800	51
4	130	1,200	68
5	160	1,000	82
6	200	820	100
7	220	680	110
8	270	560	130
9	300	470	150
10	300	430	160
11	330	360	160
12	360	330	180
13	390	270	200
14	390	240	200
15	430	220	200
16	430	200	220
17	470	180	220
18	470	150	240
19	470	130	240
20	510	120	240
22	510	100	270
24	510	75	270
26	560	62	270
28	560	47	270
30	560	39	270
32	560	30	300
34	560	24	300
36	560	18	300
38	560	15	300
40	560	12	300

multiply the table values by $\frac{Z}{600}$, Z being the desired impedance. We shouldn't forget that pads are constructed only with resistors. There are pads made of reactive components which are frequency discriminating but also isolate d.c. And there are transformers which can be used not only for attenuation of signals but also for boosting it. One distinguishing quality of the transformer is that it is almost 100 per cent efficient, yet it is a passive device in contrast to the resistive pads where power loss is proportional to the amount of attenuation.

Transformers usually are designed to perform several functions in the circuit. They isolate, change signal levels or voltages, and invert phase, restrict frequency response of the extremes of the audio spectrum, and change impedance. Let us consider a transformer designed for 600 ohms with four identical windings. When two sets of series-connected windings are fed a signal (as shown in FIGURE 2) transformation ratio or turns ratio is 1:1. One set of windings (the primary) is identical to other (secondary) set.

If only one half of the secondary is used, then voltage appearing across it will be one half of the primary. Two to one ratio is 6 dB therefore voltage loss is 6 dB. If the source impedance is 600 ohms then the impedance of the half of the secondary is 150 ohms. This is derived from the power relationship equation of the two windings. We can consider that there is no power lost in the transformer therefore power in the primary winding is equal to the power in the secondary:

$$\frac{V_p^2}{R_p} = \frac{V_s^2}{R_s}$$

From the table it becomes obvious that if higher than 40 dB attenuation is desired changing the value of the shunt resistor R2 will achieve the required attenuation

If the pad has to be designed for 150 ohms then divide resistor values in the tables by 4. Consequently if desired impedance is higher than 600,

We have already had a formula for calculating H pad and T pad values but knowing that most of you wouldn't have time to calculate them, I have decided to do this for you.

In the T pad if we call series resistors R1 and the shunt R2 and for the H pad series resistors R3 (see FIGURE 1) then the values using standard value resistors for 600-ohm symmetrical pad (input and output impedances are the same) are:

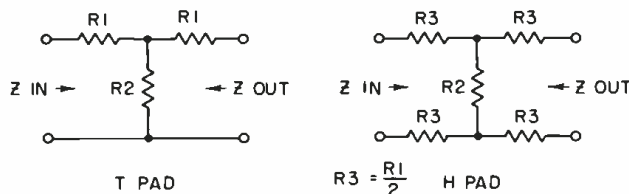
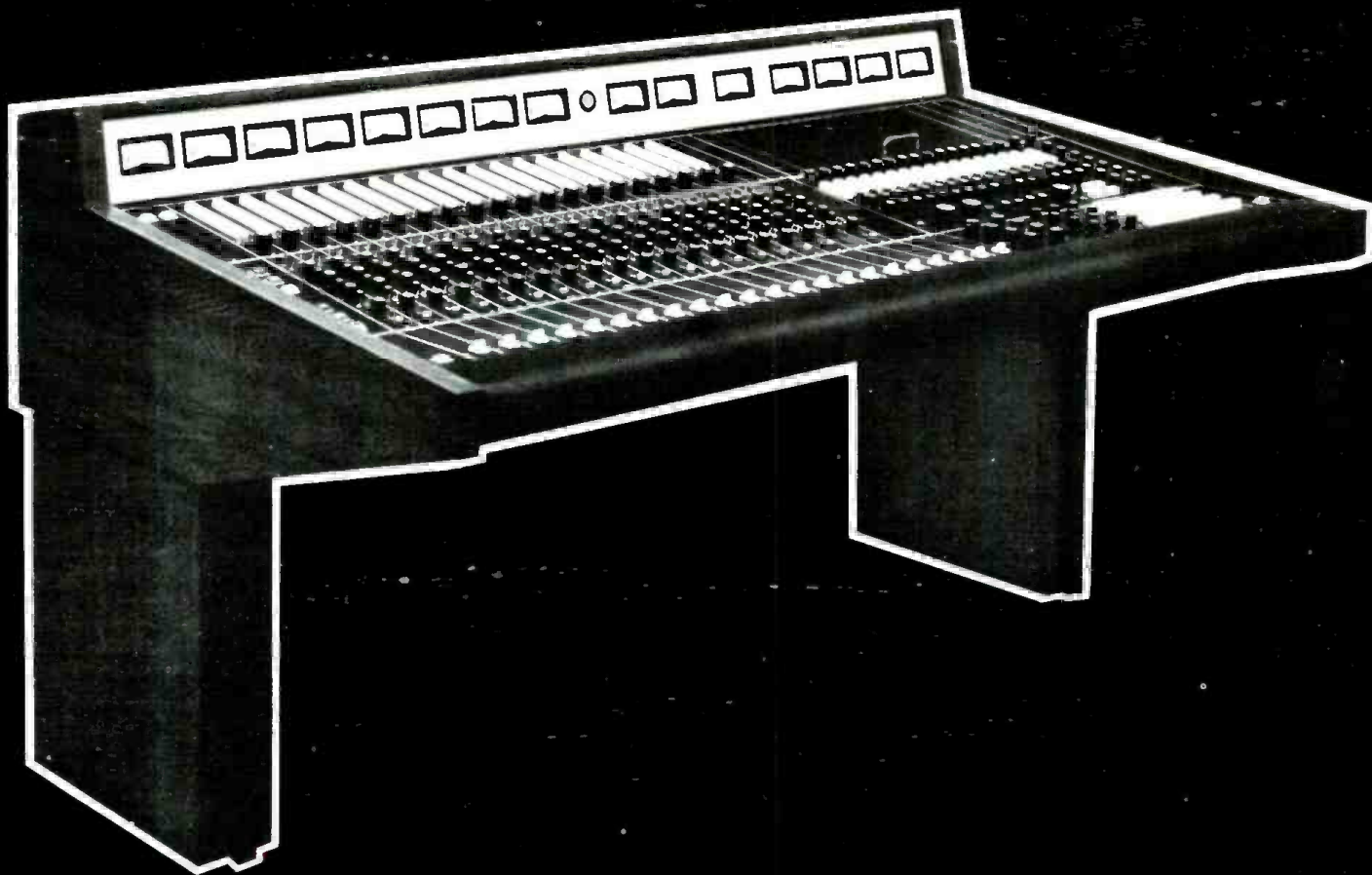

Figure 1.

$$R3 = \frac{R1}{2} \quad \text{H PAD}$$



SPECTRA SONICS Model 1020-8/16 Audio Control Console, the ultimate standard to which all others are compared — — —

SPECTRA SONICS has, and will, continue to lead the audio industry in all specifications of; noise, frequency response, distortion, square wave response, and peak overload.

The versatility of this modular constructed console allows for the needs of today, but provides for future expansion, up to 20 inputs. The 16 input matrix and monitor system is pre-wired. There is no added construction cost required later.

A lease/finance plan is available from SPECTRA SONICS to assist with needed expansion, whether it is one item, or complete studio facilities. For further details on lease plan, or information on consoles Beyond The State Of The Art contact SPECTRA SONICS at:

**770 Wall Avenue
Ogden, Utah 84404
(801) 392-7531**

**6430 Sunset Blvd., Suite 1117
Hollywood, California 90028
(213) 461-4321**

SPECTRA SONICS

LEADER IN ADVANCED TECHNOLOGY



Circle 21 on Reader Service Card

the first step toward standards

Two industry bodies of international standing have finally undertaken, after deliberate study, to lead the way out of the quadraphonic matrixing jungle. Without dictating a fully developed system to anyone, the Record Industry Association of Japan and the Electronic Industries Association of Japan have promulgated a set of basic standards and ground rules. The effect of these standards is twofold: First, they attempt to establish satisfactory compatibility among different systems while still permitting freedom for further development and ultimate refinement. Second, by establishing relationships between the direction for sound sources and corresponding vector directions of modulation, they attempt to point out the correct path to be followed in development while avoiding pitfalls that may lock serious anomalies into the system.

Most current matrix encoding systems but not all—as far as they go—fall within the standards prescribed for “regular matrix system disc recordings.” (The one conspicuous exception is pinpointed in the standards reproduced here, in the form promulgated by the RIAJ.) But only one of the acceptable regular-matrix systems now in actual use offers total realization of the defined capabilities.

It is our proud claim that the Sansui QS coding system faithfully reproduces every modulation condition set forth in the master diagram of the standards. Where other systems fall short in some directions, Sansui QS can accept and accurately reproduce all sounds in every direction of the sound field and at any point within the field, including sounds at the center. It is free of dropouts, cancellations, discrimination, shifts in position, false localization or directional ambiguity. It is the only fully developed system now in use with the same symmetrical, omnidirectional capability of a discrete tape system, and for which compatible decoding equipment is widely available.

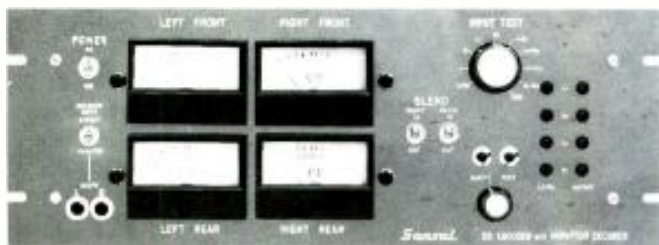

Standard of the Engineering

REGULAR MATRIX SYSTEM DISC RECORDING

Promulgated on March 23, 1972 by the Engineering Committee of the RIAJ.

1. SCOPE OF APPLICABILITY

This standard shall apply to commercially marketed regular matrix system disc recordings. JIS regulations set forth under S. 8502 (Disc Recording) shall apply to all aspects of such recordings not covered by this standard.

2. RECORDING SYSTEM

The sound groove of the regular matrix system disc recording shall be modulated by two signals, left and right, in two directions at 90° to each other and at 45° to the record surface. These two signals shall be converted from multiple original signals in accordance with the regulations given under sub-section 2.1. The left signal shall be recorded in the wall of the groove which is closer to the center axis of the record, and the right signal in the opposite wall.

If the two signals are in phase with each other and identical in quantity, they shall be recorded in such a manner that they can be reproduced by the movement of a reproducing stylus tip in directions parallel to the record surface and lateral to the sound groove.

2.1. Conversion of Signals

The two signals that modulate the sound groove shall consist of one left signal and one right signal converted from multiple original signals. The conversion of original signals into these two signals shall basically be achieved in the manner described below.

2.1.1. Front and Back Signals

A signal originated at the front center shall be converted into a left signal and a right signal which are mutually in phase and of identical quantity. A signal originated at the back center shall be converted into a left signal and a right signal which are out of phase with each other by 180° but of identical quantity.

2.1.2. Left and Right Signals

A signal originated on the left-hand (right-hand) side of the front and back centers shall be converted so that the left (right) signal is of greater quantity than the right (left) signal.

2.1.3. Center Signal

A signal originated at the center of the original sound field shall be converted so that the left and right signals are of identical quantity but so that the former has a phase lead of 90° relative to the latter.

Isn't the Sansui QS encoding system the one you should be evaluating right now?

Put it to the test yourself. Compare it with any other.

For a demonstration or literature, call or write us directly at any of the locations listed here.



for four-channel matrixing

Committee, Record Industry Association of Japan

2.2. Relationship of Direction of Sound Groove Modulation to Sound Source Direction

The relationship of the direction of the modulation of the sound groove to the direction of the corresponding sound source in the original sound field shall, in principle, be such that the angular direction of the former is half the angular direction of the latter (See Figures 1 and 2).

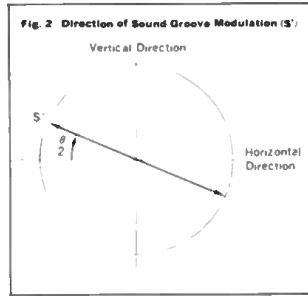
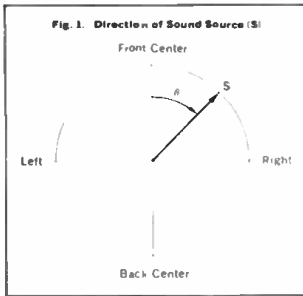

3. RELATIONSHIP OF DIRECTION OF SOUND GROOVE MODULATION TO SOUND SOURCE DIRECTION

The relationship of the direction of a sound source in the original sound field to the direction of the modulation of the sound groove on the regular matrix system disc recording is set forth in Figure 3.

The term "the direction of a sound source in the original sound field" is used to describe the direction of a sound source intended at the time of recording, while the term "the direction of the modulation of the sound groove" is used to describe the locus of the vibration of a cutting stylus tip.

To reproduce the regular matrix system disc recording in more than two channels, it is thus possible to place three or more loudspeakers freely, depending upon the matrixing parameter of the decoder used (including a speaker matrix type).

4. ABBREVIATION

When there is a need to abbreviate the regular matrix system disc recording, it is recommended that "RM" be utilized.

ELABORATION

FOREWORD

The Engineering Committee of the Record Industry Association of Japan has compared and examined the various matrix system disc recordings being marketed by various manufacturers to date. Results of such studies have ascertained that all of them, with the exception of the SQ matrix system, are based fundamentally on one and the same system, that they are encoded similarly, and that they possess satisfactory compatibility with one another. Hence the same committee hereby standardizes them as "regular matrix system disc recordings."

1. SCOPE OF APPLICABILITY

This standard governs only those aspects which are peculiar to the regular matrix system disc recording. All other aspects, such as its physical dimensions and quality, shall be regulated by JIS. S. 8502 (Disc Recording).

The regular matrix system disc recording which this standard regulates encompasses all matrix system disc recordings that are cut by converting the information of sound source directions into linear modulations of a spiral sound groove.

2. RECORDING SYSTEM

So as to ensure compatibility with two-channel stereo playback, this standard is formulated in compliance with the stereophonic recording system stipulated under JIS. S. 8502.

Thus the regular matrix system disc recording manufactured to this standard, when and if reproduced by regular two-channel stereo playback equipment, does not impair the relative sound image and sound volume balance between the left and right channels.

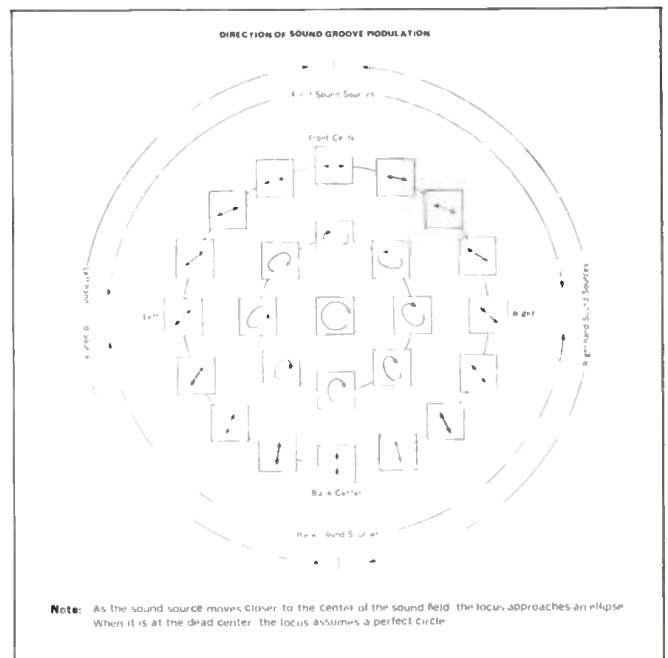

For full details,
contact your nearest Sansui office now.

SANSUI ELECTRONICS CORP.

Sansui Electronics Corp.

New York

32-17, 61st Street, Woodside, N.Y. 11377. Tel.: (212) 721-4408. Cable: SANSUIEC NEW YORK. Telex: 422633 SEC UI.

Sansui Electric Co., Ltd.

Los Angeles
Tokyo

333 West Alondra Blvd. Gardena, Calif 90247 Tel (213) 532-7670
14-1, 2-chome, Izumi Suginami-ku, Tokyo 168, Japan. Tel (03) 323-1111. Cable: SANSUIELEC. Telex 232-2076.

Sansui Audio Europe S.A.

Belgium

Diacem Building Vestingstraat 53-55 2000 Antwerp Tel.: 315663-5. Cable: SANSUIEURO ANTWERP. Telex: ANTWERP 33538

Vernitron Ltd.

Germany, W.
U.K.

6 Frankfurt am Main, Reuterweg 93 Tel 33538
Thornhill Southampton SO9 5OF Southampton 44811. Cable VERNITRON SOTON. Telex: 47138.

Circle 20 on Reader Service Card

our "little dipper"
**cleans up
 sound
 pollution**
 for less than \$500!

The Universal Audio Model 565 "Little Dipper" Filter Set cleans up problem tracks made under adverse conditions: Whistles, heterodynes, hum, camera noise, and general background noise.

- Also, the versatile 565 can be used for:
- "Phasing" and other unique effects
 - Sharp enhancement of any audio frequency
 - Simultaneous elimination of any two audio frequencies
 - Harmonic distortion filtering
 - Wave analysis
- FEATURES** • Two variable width notch/pass filters, lo-pass filter, hi-pass filter, all continuously tunable
 • Zero insertion loss or 20 dB gain • Extremely low noise and distortion

See your dealer or write for complete specifications.



11922 Valerio Street, No Hollywood, Calif. 91605
 (213) 764-1500

Circle 22 on Reader Service Card

CONSULTANTS IN ARCHITECTURAL ACOUSTICS

specializing in

Room Acoustics
 Sound Isolation
 Sound System Design
 HVAC Noise and Vibration Control

Auditoriums/Theatres/Sports Stadiums
 Coliseums/Churches/Synagogues
 Conference Rooms/Board Rooms
 Concert and Recital Halls
 Music Buildings

Service available with
 collaborating consultants in

Audio Visuals
 Theatre Technology

**Klepper Marshall King
 Associates, Ltd.**
 333 Old Tarrytown Road
 White Plains, N.Y. 10603
 (914) 761-8595

Circle 19 on Reader Service Card

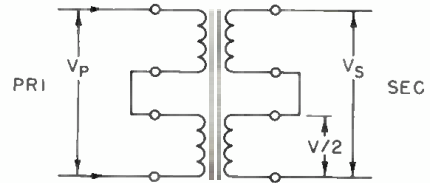

Figure 2.

If we substitute values for voltage, let us say 2 volts for V_p and half of this value or 1 volt for the secondary, it becomes obvious that the impedance ratio is 4 to 1. Therefore, if the primary is 600 ohms, then the secondary is $1/4$ th or 150 ohms.

In order to use transformer winding ratios to attenuate signal, the above relationship can be used to determine (from the impedances) voltage ratios and consequently voltage loss or gain in decibels. By the same token, one can find impedances from the winding or turns ratios which are proportional to the voltage ratios.

The same transformer which is designated as 600:600 can be also called 150:150 providing that source and the load impedances are 150 ohms. The same transformer could also be used with higher impedances but be aware of few pitfalls. Interwinding capacitances, wire resistance, permeability of the core and other factors may play tricks with phase, frequency response, and impedances. Be sure to test performance of the transformer very thoroughly if it is used differently than designed.

Quite often it becomes necessary to use a combination of resistive pad with a transformer. At times it may be advantageous to use a smaller transformer in the input (with the pad in front of it) to reduce the signal level. This technique has been practiced for a long time in recording systems where condenser microphones overload the inputs of mic preamplifiers. A pad in this case consists of two identical resistors in series with the input wires of the transformer's primary winding. If transformer loading depends on the impedance of the source, then an additional shunt resistor across the primary should be added. Again, caution should be exercised to prevent transformer resonances and degradation of the signal-to-noise by abusing this method.

Every time we use a transformer or design a circuit using one we should not be too lazy to run the frequency response just a little further in frequency above 20 kHz and look for peaks. An improperly loaded transformer can have resonance peaks as high as 30-50 kHz increasing the noise content of the signal, or high-fre-

quency crosstalk, or affect the response of the upper part of the audio spectrum. The ability to resonate the transformer may also be used as a handy tool to correct a deficiency of the circuit or of the particular transformer. But this carries with the cure the danger of shifting phase.

I have started talking about transformer circuits used for performing functions of the resistive pads and ended up discussing frequency response and phase. I better get back on the track. Well, in essence, a transformer can do more than the resistive pad, but at higher cost; it does this not only in money but also in adding distortion, frequency discrimination, and weight. It is cheaper today to use two operational amplifiers for obtaining balanced output than to use a single transformer. Just realize that you can buy 400 transistors in the form of twenty complete operational amplifiers for the cost of one medium-level high-grade transformer. No wonder everyone loves resistive pads. If we could only learn to design and properly operate patchbays without transformers we could slash prices of systems by a substantial margin, and improve their performance. The age of integrated circuits has come, resistive elements playing a vital role in it. With the help of i.c. production techniques and modern op amp circuits almost every reactive element can be simulated by a chip hardly seeable by an unaided eye. It is hard to design simple things—for instance a circuit which would perform the function of a simple choke—it is simpler to build a choke. But once the design is accomplished, for the price of one choke you can build ten ic equivalent circuits taking only $1/100$ th of space. I admire simplicity and straight forward approaches. As much as I was against i.c. circuits a year or two ago when reliability and cost were unacceptable, I today admit that this new technology has reached the point of universal acceptance with all of the promised benefits realized.

Well, here I am again off the track, it seems inevitable somehow, all I can promise is to be here next month with a discussion of another fascinating moment in this colorful world of electronics. ■

The Quietest Revox

One of the most compelling reasons for buying a Revox is the sounds it doesn't make.

No spurious pops or clicks. No wavering, fluttering tones. No distracting hum. And best of all, virtually noise-free electronics.

Take our new A77 Mk III for example. We manufacture it to such close tolerances and with such exacting attention to detail, that it is generally regarded as one of the quietest tape recorders ever made.

Unfortunately, no matter how quiet our electronics are, there is still the inherent problem of tape hiss.

And that's where our new Revox A77/Dolby B recorder comes in.

By now, the virtues of the Dolby Noise Reduction system are too well known to require any elaboration on our part.

Suffice it to say, for all practical

purposes the last major stumbling block to quality, noise-free recording has finally been eliminated.

Listening to tapes on the new Revox/Dolby B is a revelatory experience. Tape hiss is virtually non-existent. The music seems to emerge from a background of velvety silence. And at 3-3/4 i.p.s. the absence of extraneous noise is truly startling.

But no mere description of the Revox/Dolby B can adequately convey the experience awaiting you the first time you listen to a tape made on this remarkable machine.

Your nearest Revox dealer will be delighted to audition the Quietest Revox

for you. Once you've heard it, you'll understand why we say...

Revox delivers what all the rest only promise.



THE SYNC TRACK

● The equipment exhibit at the recent Audio Engineering Society Convention in Los Angeles was—to this visitor at least—an outstanding success. It's always a pleasure to get away from Fun City for a while, and I'm told that Californians like to visit us too (during daylight hours, of course), so I suppose some of my enthusiasm can be chalked up to "splitting for the coast"—nevertheless, it was a great show, and I hope we New Yorkers can do as good a job this coming fall.

New multi-track tape recorders seemed popular this year. I've never been wildly enthusiastic about any of the machines I've encountered in day to day studio operations and, what with my caustic humor, I'm always a little surprised when I'm not thrown

bodily out of some exhibitors' areas. However, at the exhibit, I found myself continually drifting back to look at 3M's latest machine. I recall liking it when I saw a prototype last fall, and since then it seems that further improvements have been made. Now, it's available (or will be shortly) in a standard 16-track configuration that can be easily upped to 24 by plugging cards into already existing slots, adding an additional meter assembly if you like, plus a new head stack. It really looked impressive. Of course, if you can't manage with a mere 24 tracks, the Stevens people have a 40-track machine. Interestingly enough, this little beastie has no capstan motor or pressure rollers. For \$38,000, it's yours. And if you run out of tracks

before you run out of loot, they say that additional machines can easily be synchronized.

ITI Audio Products again showed their parametric equalizer. An interesting feature is that frequency selection is continuously variable over the audio spectrum. As an added bonus, a sort-of phasing effect can be achieved by sweeping the frequency selector and re-combining this signal out-of-phase with the original program unequalized.

The Tascam Corporation jolted a lot of people with their 8 in and 4 out console for less than \$2,000. According to a Tascam representative, they should be available in a few months.

Perhaps the most revolutionary development occurred at the Allison Research booth. Defying tradition, they served apple cider from a closed loop system. No doubt the people who travelled thousands of miles for a cup of their long-established Kool-Aid were outraged, but science marches on. Also Allison herself has a new hairdo, which may mean that all those emblems on Kepexes everywhere will have to go back for retro-fitting. On a more mundane note, they've added an equalizer to their product line.

Taber Manufacturing and Engineering Company showed a bulk eraser that will handle two-inch tape. The first production units should be available shortly.

Electro-Voice has a new speaker, the Sentry III, which is somewhat smaller than the well known Sentry IV, yet a better low-end response is claimed. By the way, a tip of the hat to Alan Watson of E-V for his interesting paper, *Acoustical Research Employing Time Average Holography*. Likewise to Thomas Lininger, also of E-V for *Microphone Transient Response Measurement*. A few more papers like these and we may be able to eventually equate personal preferences with laboratory measurements of microphone parameters.

UREI showed the Cooper Time Cube—an acoustical delay system with two inputs and two outputs, one 14, the other 16 milliseconds.

As most db readers know, Crown International's factory was destroyed late last year by fire. They showed some photos of the damage—which was just about total—at their booth, along with an over-cooked tape transport that had been pulled out of the wreckage. Anyway, they're now back in business. The D-40 amp has been succeeded by the D-60, and the popular D-150 and DC-300 are again available.

Once again, Cerwin-Vega Associates conducted life tests on the hotel structure with their line of speakers. One of these days, I'll get up enough cour-

How long should it take to time a 30-minute tape?

Just about a minute.



If you use the new Lyrec Precision High Speed Tape Timer, that is.

This unique time-saver makes stopwatch timing a thing of the past. Simply apply the unit to your Ampex or Scully professional tape machine, and run it at high forward speed. The Tape Timer gives you a direct reading in minutes and seconds for all tapes recorded at 15 IPS. For a half-hour tape, it's accurate to within three seconds. And you can convert readings for other tape speeds quickly and easily. You'll wonder how you ever got along without it.

The Lyrec Precision High Speed Tape

Timer is available in two models: TIM-4a accommodates 1/4" and 1/2" tape, and TIM-4b accommodates 1/2" and 1" tape.

For detailed information, write today.
Don't waste 29 minutes.

GOTHAM
AUDIO CORPORATION
2 West 46th Street, New York, N.Y. 10036 (212) CO 5 4111
1710 N. LaBrea Ave., Hollywood, Ca 90046 (213) 874 4444

Circle 18 on Reader Service Card

age to actually step into their demo room. Being a cowardly type, I'm convinced my liver, or some other critical organ, would disintegrate if I were actually in the room when they played the 2001 opening theme.

By a twist of fate, Burwen Laboratories were located just next door to the Vega room. I believe they worked out some sort of time sharing system so that the Burwen people could demonstrate their impressive Noise Eliminator.

Moog Music, Inc. demonstrated their improved frequency shifter, which was described in the A.E.S. preprint. *A High-Accuracy Frequency Shifter for Professional Audio Applications*, (pre-print # 865). Especially for studios not equipped with a complete electronic music facility, this device should prove valuable for creating special electronic effects.

It would take many more pages to list each of the exhibits individually. They all had something interesting to show, and as usual, Jacqueline Harvey and her crew did a splendid job of stage managing. Although a lot of people passed through the area, one rarely had the feeling of being crowded. The next convention will be held in New York City, September 12-15th at the Waldorf-Astoria, (of all places). Plan now to attend—it should be a great show. The society has issued a call for papers, and interested parties should contact the appropriate session chairman without delay. A list of the sessions, and chairmen, is given.

ADDITIONAL NOTE

In the February Sync Track I mentioned the courses offered by the Institute of Audio Research, but managed to forget to list their address! Here it is; 64 University Place, New York, N.Y. 10003. ■

moving

Have you sent us a change-of-address notice? It takes time for us to change your plate so let us know well in advance of your move. Be sure to send us the complete new address as well as your old address. Include both zip numbers. Keep db coming without interruption!

SUBJECTS AND CHAIRMEN OF TECHNICAL SESSIONS

AUDIO INSTRUMENTATION
Erwin Gross (617-369-4400)
General Radio Company
22 Baker Avenue
West Concord, Mass. 01781

AUDIO AND MEDICINE
Philip K. Kantrowitz
(212 TY 2-6968)
2435 Frisby Avenue
Bronx, N. Y. 10461

BROADCAST ENGINEERING
Eric Small (212 LO 4-8000)
WOR FM Radio Station
1440 Broadway
New York, N. Y. 10018

CASSETTE DUPLICATION SEMINAR
Ray M. Doby (720-1111 or 352-0800)
Dolby Laboratories, Inc.
346 Clapham Road
London, S. W. 9, England
New York Contact:
Morley Kahn (212-489-6652)
Dolby Laboratories, Inc.
1133 Avenue of the Americas
New York, N. Y. 10036

DISC RECORDING AND REPRODUCTION
John J. Bubbers (516-681-0200)
Pickering & Co., Inc.
Plainview, New York 11803

TRANSDUCERS
Mahon D. Burkhard
(312-439-3600)
Industrial Research Products, Inc.
321 Bond Street
Elk Grove Village, Ill. 60007

ELECTRONIC MUSIC AND MUSICAL INSTRUMENTS
Daniel W. Martin (513-621-4300)
D. H. Baldwin Company
1801 Gilbert Avenue
Cincinnati, Ohio 45202
Co-Chairman: M. V. Mathews
Bell Telephone Laboratories, Inc.

MAGNETIC RECORDING AND REPRODUCTION
Arthur E. Gruber (516 LY 3-4806)
AEG Associates
12 Murdock Road
East Rockaway, N. Y. 11518

QUADRASONICS
John M. Woram (212-255-7732)
Vanguard Recording Society, Inc.
71 West 23rd Street
New York, N. Y. 10010

SIGNAL PROCESSING
Albert B. Grundy (212-677-7580)
The Institute of Audio Research
64 University Place
New York, N. Y. 10003

SOUND REINFORCEMENT AND ARCHITECTURAL ACOUSTICS
David L. Klepper (914-761-8595)
KMK Associates
333 Old Tarrytown Road
White Plains, New York 10603

THE PERFECT MIX

Quick delivery. A most attractive price tag. And Studer quality.

That's the unbeatable combination you'll get with Studer's new 189 Mixing Console — now available in the U.S. for the first time.

This precision, Swiss-made instrument has 16 inputs on its 8-track board, and 18 on the 4-track version pictured, with EQ, cut-off filters, pan-pot, phase reversing switch, gain vernier

and linear attenuator.

Plus: 2 echo channels, one cue channel, 4 PDM limiter/compressors(!), monitor and talk-back amplifiers, Weston VU meters, and Phantom[®] powering.

The price? Just \$27,500 for the 8-track model; \$27,000 for the 4-track model. Take your pick. We can have the Studer 189 making perfect mixes in your studio next week.



Circle 30 on Reader Service Card

We're Growing— Why not grow with us?

Automated Processes is expanding rapidly and needs competent people to work in all areas of the console building art. If you are a talented console builder, engineer, technician, designer, etc.—there may be a rare growth opportunity for you at Automated.

Send resume or contact:

Al Parisi
Automated Processes
80 Marcus Drive
Melville, N.Y. 11746
Phone: 516-694-9212



Sound Systems
Design and Equalization
Custom Equalizers Built to Specification
Room Acoustics
Noise Control

G. R. Thurmond and Associates
4709 Shoalwood
Austin, Texas 78756
(512) 453-4173

Norman H. Crowhurst

THEORY AND PRACTICE

● This column has now been running for more than 4 years. A little over 2 years ago, your editor told me that I did not have to stay strictly with technical theory and practice items. Most of the time I have done so, mainly because so many of them keep rolling in. And that is how it should be, because this is **db**, The Sound Engineering Magazine!

The second time I departed from the purely technical, in March 1970, I briefly mentioned the theory and practice of income tax, which is something that involved me far more than I liked, because I would rather leave politics to politicians, and offered to send any reader who wanted it a copy of the 10-page statement that I filed with that year's return, for \$2 to cover the cost of xeroxing.

So many readers responded at the time that I had it printed instead, and all except a few have long since gone. Then just before filing time this year I got a stray request from a reader who is sick of being sucked dry at that time of year, remembered seeing my piece and wrote for it. It is nice to know I have such loyal readers, who have been following what I write for that long!

In case someone else gets an idea from that, I am not having my statements to the IRS copied any more, mainly because they are too specific to my own case. But for those who are interested in the way I came to the impasse that led me to do that, and the sequence that led up to it, I have put together another printed book, which costs \$2, and makes somewhat more interesting reading.

When that letter arrived, I wondered what occasioned it, having forgotten the "rush" of two years ago. Another letter arrived, with a technical problem that made me dig a little further back in my memory. In fact there were two such letters — the other one asked me if I knew the tube compliment for a Columbia model 360 amplifier; he had written to Columbia and they had no record of such an amplifier!

The other letter related to some problems a reader is having, connecting together a tube power amplifier and preamplifier. He has a preamp

and two power amplifiers, a 10-watt and a 60-watt job. Does anyone remember those days? Apparently people still use those things!

His problem is that, when he uses the preamp with the 10-watt amplifier, it builds up a "hoot"! He says further down that he puts his amplifier in the back of his loudspeaker enclosure, as the only convenient place to house it. So I'm thinking, *microphony*. But he's ahead of me—he already thought of that, he's already tried tapping all the tubes with the rubber thingy on the end of his pencil, and none of them has the slightest inclination to emit any sound.

There's more. This amplifier uses an ultralinear output transformer, which gets hot after the amplifier has been on awhile, and the hoot does not start up until the output transformer gets pretty warm. It behaves as good as gold while the amplifier is cold. This 10-watt amplifier has a gain control in it, and one way to stop the hoot is to turn the gain control all the way up, only then he cannot play his tape recorder through it, because it overloads. And turning the control all the way down only makes the hoot louder.

Another thing he tells me: the line voltage around his house is about 10 per cent high. He has run the amplifier in his lab, where he has a Variac and can adjust the line voltage to what it ought to be. Then, no hoot!

I wondered about that overheating output transformer—I never knew the output transformer of a 10-watt amplifier to get hot. But I kept reading. Apparently the output transformer gets hot because the way he has the amplifier mounted, to get it into the cabinet, the tubes are immediately below the output transformer.

Quite a problem, eh? It set me to thinking back several years. I remembered that I have had some real puzzlers, some of which were something like that. But scratch my brains as I would, I had real difficulty remembering what I eventually found. It seems reasonably obvious that it is a temperature effect.

Oh, one more piece I almost forgot. The hooting stops when he shuts off the preamp. When he switches it back on again, the hoot builds up. In describing the hoot a little further, he

says it has a deep tone. Could be hum, maybe?

I remembered an amplifier I had once that would hum intermittently. The hum would gradually build up to a fairly intense pitch, and then there would be a little click, like a capacitor discharging or something, and the hum was gone. After a while, the hum would be gradually building up again until eventually there was another little click, and it was gone.

As far as I can remember—as I say, it's difficult to remember, so long ago—that proved to be something not properly grounded, that ought to be. As I seem to remember, there was a slight leakage or something difficult to measure with the crude instruments of those days, whereby the d.c. potential on the ungrounded section drifted slowly. As it drifted, the hum built up, until somewhere a breakdown effect returned the growing potential to zero, and it started all over again.

That's all I can remember. It could have been the heater wiring that was floating, but I'm not at all sure of that. I do remember that grounding whatever it was stopped the growing hum effect. If that was it, the only thing I can imagine is that changing the d.c. potential of the heaters modified the heater-to-cathode leakage of an early stage, and thus allowed hum to be injected at that cathode.

But if that was it, why would temperature, or time on, have any effect? And why does it seem to be sensitive to the supply voltage, and whether the preamp is on or not, when the gain control at the input is turned all the way off?

Asking myself these questions seemed to ring a bell—so vaguely that I could not recall what it really was. But I do remember sitting and puzzling out peculiar phenomena something like that, which seemed utterly baffling at the time.

Another possibility my mind went into was that heating the transformer could change its characteristics in some way. What would change? If that was a factor, then it might be some kind of feedback, through the feedback network, where the parameters changed. I remember a case where the feedback resistor dropped in value when the amplifier got hot, causing oscillation at either high or low frequency, I forget which.

What if the inductance of the output transformer changed as it got hot? That could change the stability margin at the low frequency end, and it might start to oscillate. But I dismissed that as unlikely, for one thing, how could switching off the preamp change that? I can see that the position of the volume control might. And instability at the low end, with a feedback ampli-

fier, is usually sub-audio, and takes the form we used to call "motor-boating." That recalls a kind of motorboat I have not seen in years, too!

There's one more possibility that I can think of at the moment. When the tubes get too hot, they become unstable. It could be one of those squegging things where the frequency of oscillation is ultrasonic, but it is not continuous—comes and goes in bursts, and the burst rate is at the low end, audible as a hoot.

Somewhat, that does not seem likely. All the squegging oscillations I ever encountered, as far as I can remember, performed their squegging trick because they were too tightly coupled, and thus oscillated hard enough to kill themselves by overbiasing or something, when they stopped until the bias again approached normal, when they would start all over again. That usually came out a succession of ticks, a tick being made each time the oscillation quit. It could go faster, so the ticks merged together to make a note, or hoot.

The odd thing, as I remember, that made such things hard to nail down, is that whatever it was that happened, it was a borderline condition—it only just happened. This meant that things apparently unconnected with the location of the trouble could in some way affect it. Like switching the preamp off when the volume control at the main amp input is all the way down! The fact that this man's 10 per cent high house voltage causes it, when a controlled voltage doesn't, would suggest it comes in this category.

But that still doesn't help me to solve the man's problem. I get letters from readers, every so often, asking this kind of question. It's kind of frustrating to be asked a question like this. What I usually do is to think of all the possibilities I can and try to put them in some sort of probability order, so I can write to the reader with a "try this; if that doesn't work, try this;" type treatment—and hope I have covered something that will help him.

What usually happens is that I will not hear from that reader for two or three years. Then I get a letter that says—long after I've forgotten about it—"you may remember me. You were very kind in helping me solve such and such a problem. Now I have this. . . ."

Here we go again, I think to myself. But then, if I didn't get letters from readers like that, what would I have to write this column about, month after month? My mind is not fertile enough to invent all these problems. Most of them I can explain, or relate, or something. So keep those letters and cards coming, folks! ■

stop watches

These are Switzerland's finest quality stopwatches manufactured by Heuer-Leonidas S.A. Heuer has been the leading manufacturer of quality stopwatches for over 100 years. Their reliability and design leadership are well known throughout the world.

All are fully guaranteed for one year with service available in 90 countries. Isn't it time you had one of these new models?

If you are seeking a stopwatch for a special application please let us know. Heuer stopwatches are available for sports, aircraft, automotive, industrial, scientific and many other uses.



Model
502.401

1/5 second recorder, central 0-60 minute register. 2 crown functions with time-out and locked return. 7 jewels, shock-protected. \$58.00



Model
501.201

1/5 second recorder, central 0-60 minute register. 1 crown function with side-slide. 7 jewels, shock-protected. \$50.00



Model
508.422

FILM-MASTER. 60 second recorder, central 0-60 minute register. Records on outside scale consumed 35 mm film from 1-90 feet, on intermediate scale consumed 16 mm film from 1-36 feet. Framespeed 24 pictures/second. 2 crown functions with time-out and fly-back return. 7 jewels, shockprotected. \$61.00



Model
502.050

WRIST TIMER for program directors in radio, TV and film. 1/5 second recorder, central 0-60 minute register. Dial reading indicates elapsed time; remaining time can be read on 60 minute turning bezel. 2 crown functions with time-out and locked return button with safety bolt. 7 jewels, shockprotected. \$74.00

GUARANTEE

100% absolute satisfaction or your money returned within 10 days without question. To order send check directly to:

TIMEKEEPER

P.O. Box 835, Great Neck, N.Y. 11021
N. Y. State residents add 7% sales tax

NEW PRODUCTS AND SERVICES

DISC CUTTING AMPLIFIER

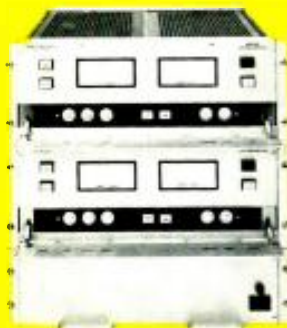

● Stereo disc cutting is done at 500 watts power with full power available at the highest frequencies. Frequency response is 10 Hz to 30 kHz. Automatic cutter protection is provided. Adjustment during operation are simplified. The problems of raising impedance in the cutting head drive coil with frequency are counteracted by the insertion of compensating negative inductance between the output stage and the drive coil. Thermal protection against overheating of the cutter is provided. In addition a special meter indicates constant coil temperature. Two identical amplifiers powered from a twin power supply are employed in the stereo setup. A high-quality monitor amplifier is also included.

Mfr: Ortofon (Gately Electronics)
Circle 67 on Reader Service Card.

PA AMPLIFIERS



● High flexibility is claimed for this new line of amplifiers designated series TA-900. Boosters and mixer preamps are also in the series. The amplifiers are available in outputs of 10, 30, 60, and 100 watt models, as well as 50 and 100 watt boosters. Important specs for all units are: less than 2 per cent thd over the frequency range of 50-15,000 Hz; frequency response of 20-20,000 Hz ± 1 dB. Noise is 60 dB below rated output with the mic pre-amplifiers.

Mfr: TOA Electric Co., Ltd.
Circle 51 on Reader Service Card.

NOISE ELIMINATOR

● The model 2000 noise eliminator is a record/play signal processor which can extend the dynamic range of a studio tape machine or transmission link to as much as 110 dB. A combination of high and low frequency pre-emphasis together with extreme compression reduce the input dynamic range to 55 dB at the tape. Upon playback through the unit the original signal levels are restored with a typical accuracy of 0.5 dB. Three different record characteristics are optimised for 15, 7½, and slow speed in/sec. Noise reduction for tape mastering is 50 dB. One to four channel models are available.

Mfr: Burwen Laboratories
Price: \$2450 (one channel)
Circle 70 on Reader Service Card.



FLUTTER METER

● Neither discriminator nor set level adjustments are required on this new flutter measuring meter. The input range is wide—10 mV to 10 V. Full scale flutter ranges of 0.1, 0.3, 1.0, and 3.0 per cent are selectable. A wide range of carrier frequencies (2 to 4 kHz) are automatically tracked. A built-in oscillator is at 3150 Hz. Flutter measurements are made according to IEEE standard 193-1971, and indications are subjective peak flutter. Drift measurements can also be made ± 3 per cent.

Mfr: BHK Electronics
Price: \$395
Circle 50 on Reader Service Card.



CARDIOID CONDENSER

● The U-47 fet is the newest mic with this famous number. It is a cardioid condenser microphone that uses the same head enclosure as its 25-year old predecessor. But, everything else is new. It uses op amps, its capsule is specially isolated to prevent mechanical disturbances and its dynamic range is 136 dB—50 dB better than the previous model. There is a —10 dB overload protection switchable between the capsule and its internal amp, a —6 dB switchable output pad to prevent console preamp overload on high levels, and a low-frequency proximity compensation switch.

Mfr: Neumann (Gotham Audio)
Circle 68 on Reader Service Card.



HOW TO SELECT FAIRCHILD/ROBINS MODULES IN DESIGNING AN AUDIO CONSOLE

The accompanying chart is a guide for audio designers to help in the selection of components and functions for packaging a complete audio console or system. The block diagram is a graphic representation of all standard units manufactured by Fairchild/Robins. Each column contains units performing similar functions. Numbers represent our part numbers. Signal flow is from left to right.

STEP ONE — Call your knowledgeable Fairchild/Robins representative, distributor or engineering department who will gladly and without obligation advise you and work with you on your console requirements. **HOWEVER, IF YOU LIKE TO GO-IT-ALONE.**

STEP TWO — After determining that a run-of-the-mill console will not fully meet your requirements, or . . . after a rough comparison of costs shows that an individualized console costs little more than a mass-produced job . . . or that operating requirements make a custom console a more valuable long-term investment, **THEN.**

STEP THREE — Make an outline (a block diagram will be helpful) of the functions you require, the number and kinds of inputs, outputs, levels, gain, equalization, limiting, monitoring, switching, reverb requirements, delegation, cue circuits, automatic ducking or cross suppression, etc.

STEP FOUR — “Try on for size” the complete channel modules shown on the lower part of the accompanying chart (referring of course to the appropriate Fairchild/Robins catalog sheets for these items). The FICM series is designed for recording use and the ICBM series for broadcasting. If these modular approaches “fit”, your search is ended and you have found an excellent economical solution to your console requirements. If, however, your requirements are unusual either in that they are very simple and cost saving is the prime consideration, or if they are extremely complex or unique, then proceed to step five, the building block approach. An example of a very simple console might be one which contains only input amplifiers, gain controls and a mixing network. More complex requirements which would indicate the need for the building block approach would be remote control which isolates audio from control signals, rack or special mounting, four channel capability, etc., etc.

STEP FIVE — Using the accompanying chart (which resembles a menu in a Chinese restaurant from which the patron selects one from column A and two from column B), select the functional modules which fit your specific requirements, taking into account power supply compatibility as well as individual preference. For example, the 692 series uses discrete transistors, while the 725 series, which is also produced on printed circuit boards, employs op-amp integrated circuits.

STEP SIX — Select the power supply, console shell, and mounting hardware and auxiliary sound-shaping processing equipment such as reverbs, oscillators, communications circuits, etc., shown at the bottom of the chart to complete your system requirements.

STEP SEVEN — Of course, an easier way to do the above is just to send (or phone) a description of your needs to George Alexandrovich, V. P. of Fairchild/Robins, and he will rapidly send you a recommendation and cost estimate.

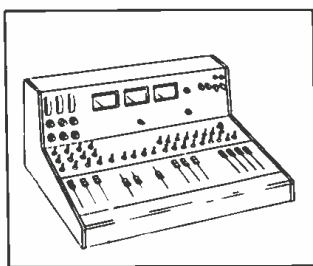

Channel Modular Design



Remote Control Design

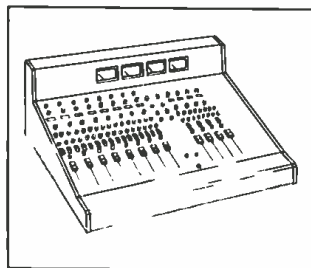

Building Block Design

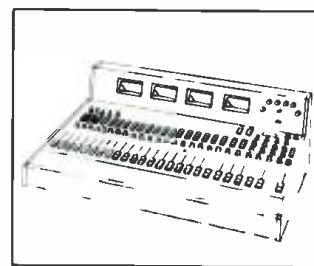

Combined System

FAIRCHILD/ROBINS THE AUDIO SPECIALISTS

FAIRCHILD
SOUND EQUIPMENT CORP.

ROBINS INDUSTRIES CORP. SUBSIDIARY
15-58 127th ST. FLUSHING, NEW YORK 11356 212 445-7200



FOUR-CHANNEL TAPE DECK



● On quarter-inch tape, this model 3340 machine will lay down four tracks, each with a simul-sync capability. Reels up to 10½ inch size are accommodated. Tape speed is 15 and 7½ in/sec. Three-head, three-motor operation, using a hysteresis synchronous capstan motor combined with low-noise electronics feature individually adjustable inputs on each channel for mic and line inputs. Important specifications include: s/n of 60 dB, track isolation 50 dB, flutter is 0.06 at 7½ and 0.04 at 15 in/sec., frequency response at the slower speed is 30-18,000 Hz, ±3 dB, harmonic distortion is 1 per cent at 1 kHz at normal operating level.

Mfr: Teac

Price: \$849

Circle 52 on Reader Service Card.

POWER AMPLIFIER



● Model 1000 is a dual 400 watt continuous power amplifier. Features include Thyristor "crow bar" circuitry activated within microseconds to prevent damage to speakers and protect amplifier output stages. A three-position current limiter controls power output. Forced air cooling of the massive heat sink assembly is thermostatically controlled. Output is 400 watts per channel into 4Ω loads, 200 watts into 8Ω, and 100 watts into 16Ω. Rise time is 3.5 μseconds. Harmonic distortion is less than 0.2 per cent 20 to 20,000 Hz. Full output is achieved with 1.25 volts into the 47 kHz input.

Mfr: BGW Systems

Price: \$1200

Circle 69 on Reader Service Card.

MONITOR SPEAKER



● The Array 12 loudspeaker system is stated to have smooth response from below 23 Hz to beyond 20,000 Hz with a ± 2.5 dB variation between 40 and 20,000 Hz. There is less than 1 dB variation between 200 and 2500 Hz. Each system contains eleven 4½-inch drivers and a high frequency polycarbonate dome. A ducted enclosure loads the drivers and eliminates audible bass resonance. The units are stated to be efficient and have maximum power rating of 300 watts each. Cabinets are East Indian rosewood veneered birch, with other finishes available.

Mfr: Array Company

Price: \$720 pair

Circle 55 on Reader Service Card.

SPECTRUM ANALYZER



● Compactness and economy are claims made for this model 99A600 instrument. Four audio test functions are combined in the analyzer: internal white noise generator, pink noise generator, level averager, and reference meter. The pink noise generator provides outputs in ⅓-octave increments from 40 Hz to 16 kHz. The analyzer is equipped with three 150-ohm mic inputs, but program sources with higher impedances and levels can be used with appropriate padding. Used in combination with a ⅓-octave filter set, complete auditorium and control room analysis and correction can be made.

Mfr: DuKane Corp.

Circle 62 on Reader Service Card.

SYNTHESIZER



● The Performer is a one-piece package with keyboard, controls, speakers, amps and self-mounting legs. Patch cords and matrix pins are eliminated by a total of 101 color-coded switches. Four oscillators are used providing a range of 0.015 to 20 kHz. Sine, ramp, saw tooth, square, triangle, and half wave shaping dials are provided. A white noise generator, a reverb, filter, envelope, trapezoid generator and ring modulator constitute the hardware. The envelope has four controls; the filter is low pass. A manual trigger button indicates the envelope cycle start and completion. Two slide pots can be used to control the X and Y axis of the various features manually.

Mfr: Ionic

Price: \$975

Circle 61 on Reader Service Card.

GO-EUROPEAN

ORTOFON 500 WATT DISC-CUTTING SYSTEM



Now, Ortofon offers the first disc cutting system with sufficient power (500 watts rms) to cut those difficult high frequencies. Write for demo tape and record. Circle inquiry number for literature.

SCHOEPS HYPERCARDIOID



Only Schoeps offers a single diaphragm condenser microphone with a hypercardioid pattern for those difficult sessions where noise and leakage are a problem. Write or call about our 30 day no obligation trial plan.

GATELY ELECTRONICS



57 WEST HILLCREST AVENUE
HAVERTOWN, PENNA. 19083
AREA CODE 215 • HI 6-1415
...have you checked Gately lately?

Circle 24 on Reader Service Card

CAPSTAN MOTOR CONTROL



● Model 214 is a variable speed oscillator power supply designed to accurately control the speed of a capstan motor, etc. by varying its supply frequency. The selector switch has a bypass position feeding 117 V directly to the output, a sync position that permits frequency to be controlled by an external source (maximum input to be + 8 dBm), auto position is frequency controlled by a source (output switches to sync with power line frequency if external signal drops below 0 dBm), line position unit operates in sync with power line frequency, internal oscillator position permits frequency drive between 40 and 80 Hz. Can also be controlled by external d.c. voltage.

Mfr: Stephens Electronics, Inc.

Price: \$685

Circle 56 on Reader Service Card.

TAPE FILM ACCESSORY



● A new accessory for the MM-1000 results in better sound quality and flexibility in recording film sound tracks than present methods. The film lock system permits film makers to record up to fifteen channels of sound, add special effects, dub down to one or two channels, and playback the final sound track in perfect synchronization with the pictures. The MM-1000 when equipped with the system will start, stop, and reverse in perfect synchronization with sprocketed equipment and will return to sync from a stop.

Mfr: Ampex Corp.

Price: \$7500

Circle 63 on Reader Service Card.

MULTIGENERATOR



● A new multi-purpose waveform generator called Lin-Log Multigenerator model 125, features dual output amplifiers each with individual function selection—80 dB attenuation, two generators, 1000:1 internal or external voltage controlled frequency, and a frequency range from 0.1 Hz to 5 MHz on the primary generator (to 1 MHz on the second generator). The unit has the capability to produce normal sine, square, or triangle waveforms; plus and minus sine, plus and minus square, plus and minus pulse, haversine, and several waveforms created by feeding the output of the second generator into the first internally.

Mfr: Exact Electronics

Circle 53 on Reader Service Card.

You can afford all this if you cut just one stereo side per day.

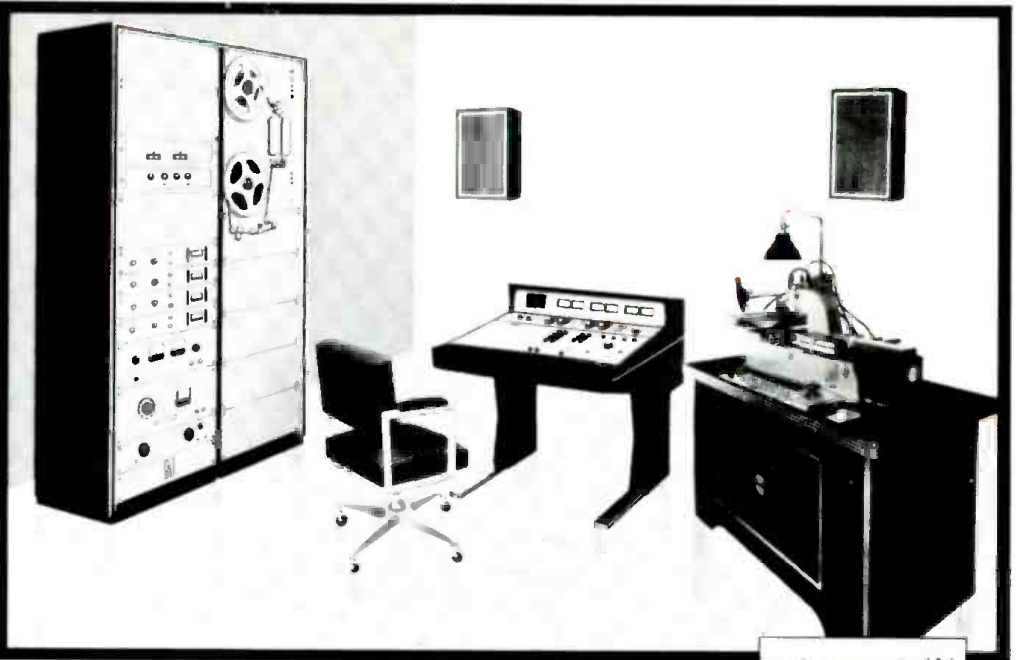

Lease the new Westrex DiskMaster system for less than \$1,500 per month. Cutting just one stereo side per day pays for all of it...the Westrex 3DII StereoDisk recorder, new Westrex solid state drive system, automated Scully lathe, advanced Westrex mastering console, Scully T/M tape reproducer, and complete monitor system.

Attract creative, discriminating customers with the superior, truly exciting performance of the new Westrex 3DII/solid state system. Select the complete DiskMaster system, a modernizing system designed around your present equipment, a supplementary basic system, or any unit. Purchase or 5-year lease.



New Westrex 3DII Recorder

Westrex Stereo Disk Recorders: the first in use, still the first in quality.
WESTREX, 390 N. Alpine Dr., Beverly Hills, Cal. 90213 • (213) 274-9303



Circle 27 on Reader Service Card

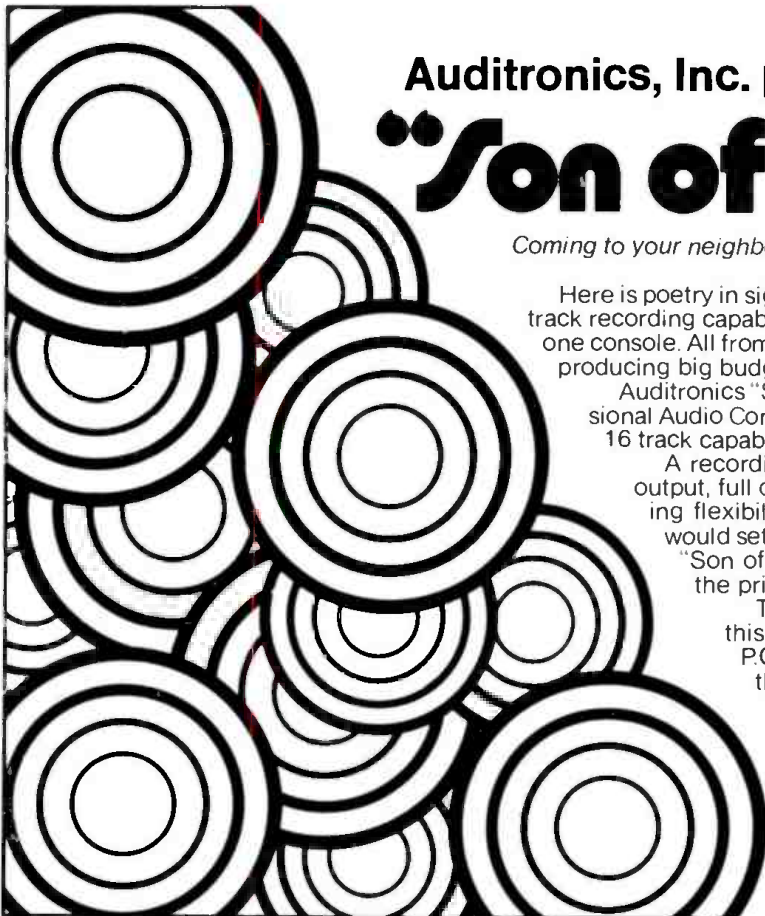

Auditronics, Inc. presents a sneak preview "Son of 36 Grand"

Coming to your neighborhood studio soon (Rated R)

Here is poetry in sight and sound for recording studios that want 16 track recording capability, with real life performance and economy in one console. All from a manufacturer with over five years experience producing big budget recording systems and consoles.

Auditronics "Son of 36 Grand" is a second generation Professional Audio Control Console, five years in the making, that puts 16 track capability within the economic range of every studio.

A recording console that provides 16 in, 8/16 channel output, full quadrasonic capability, and complete monitoring flexibility for both recording and mixdown, normally would set you back about \$36,000. But the action packed "Son of 36 Grand" gives you all this at less than half the price!

To get your pass for a backstage peek at specs on this rising new star, just drop a line to Auditronics, P.O. Box 12637, Memphis, Tennessee 38112... the people who brought you "36 Grand" and many other stupendous extravaganzas.



auditronics, inc.
MEMPHIS TENNESSEE

Circle 29 on Reader Service Card

You're invited to use a brand new communications medium to build on the ideas in this article with a group of people as involved in the subject as you. By means of a new "electronic meeting place" called **db TeleSessions**, you'll be able to dial into a group telephone conference with other **db** readers across the country. You can reserve your spot in the discussion now by turning to the inside back cover for details and information on how to participate.

A Four-Channel 'Scope Display

As four-channel quadriphonic recording becomes more popular, new tools are being developed to make superior recordings possible. This is clearly one such device.

THE PROBLEMS encountered in making quadriphonic recordings or matrix encoded records are considerable in contrast to those found in stereo recording. There is a half a chance that the channel phasing will be correct during a stereo recording session, but the odds in favor of proper phasing become one in eight for quadriphonic recording.

The oscilloscope is widely used in recording studios as an aid in analyzing various problems in stereo recordings. If properly adapted, an oscilloscope can also be used to monitor quadriphonic recordings. This article describes a technique by which an oscilloscope, connected to the power amplifier outputs, can be used to display the audio pattern created by the four audio channels. The 'scope displays can be used to check phasing, separation, spread, channel balance, and over-all directionality.

This article contains photographs of oscilloscope displays obtained by me, as well as construction information that will enable the reader to build a simple "black box."

FIGURE 1 is an oscillograph of a typical quad display. This is a top view of the audio pattern, which represents the listening room with the speakers at the four corners of the oscilloscope display. The top edge of the figure represents the front of the listening room.

The center of the display represents the center of the room, the ideal listening position. The audio level is noted by the distance the trace moves away from the center, and the direction represents the apparent sound source. The display is divided into four quadrants (front, back, left, right). Each of the channel outputs (left-front, right-front, left-back, right-back) forms a vector that becomes a dividing line between the quadrants. These lines are noted by the X pattern in the display.

FIGURE 2 is the display created by a left-back (LB) signal only. With the same signal applied to both the front channels (LF and RF) and no signals on the back channels (LB and RB), the result is a front oriented mono sound (see FIGURE 3). Figure 4 is the same except that the phase is reversed on one front channel. Note the V

pattern, indicating a lack of center signal. The acoustic result is a diffused sound that is difficult to locate.

FIGURES 2, 3 and 4 illustrate the displays for a single input with either a test tone or program material, fed to one or two channels in and out of phase. These displays are easy to analyze, but with quad program material, the phasing results are far more subtle.

FIGURE 5 displays a recording with some front center information, primarily vocals and bass. Note the front center-fill. FIGURE 6 is the same passage but with the left-front channel out of phase. Note the lack of center-fill, a V shaped front quadrant.

FIGURE 7 was taken from a decoded 4-2-4-matrixed record. The V shaped empty back quadrant indicates that the back channels contain almost identical signals which are out of phase, producing a diffused rear sound. The other quadrants show a good spread of sound around the room. This is typical of the audio pattern produced by this matrix system.

FIGURE 8 displays an audio pattern with a predominant left-back signal, and a lower-level front-center signal.

FIGURE 9 is the audio pattern produced by a solo French horn in a concert hall. It is noted that the front and back quadrants show good spread but they are also out of phase. The phasing condition was due to the combination of the microphone spacing, room acoustics, and the note being played. Other notes showed good side spread and some showed a left-to-right out-of-phase condition.

To be able to produce displays like these requires a black box connected to the quad speaker leads and to an oscilloscope. The heart of the black box is a diode-matrix network that steers, or gates, the input signals to the proper "corners" of the 'scope display. FIGURES 10 and 11 show the schematic, and a Vectorboard layout of the network. The only important requirement in this network is to have all resistors matched; otherwise the X in the display will not have perpendicular legs. It is usually the case that when resistors with a 10 per cent tolerance are measured, they tend to fall into two or three groups, and within a group they will be within 1 per cent of each other. It is suggested that a batch of 10 per cent resistors be measured and a matched set selected. The exact value of the resistors is not too important, but it is necessary that they all have the same value.

FIGURES 12 and 13 show a dual-differential amplifier and power supply, which may not be needed depending

Donald L. Patten is a Senior Development Engineer with Shure Brothers, Inc.

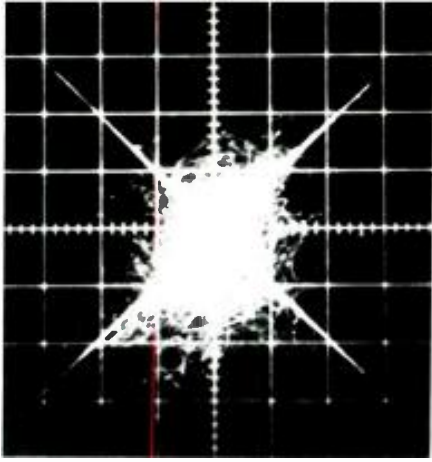

Figure 1: A typical quadriphonic audio pattern oscillograph.

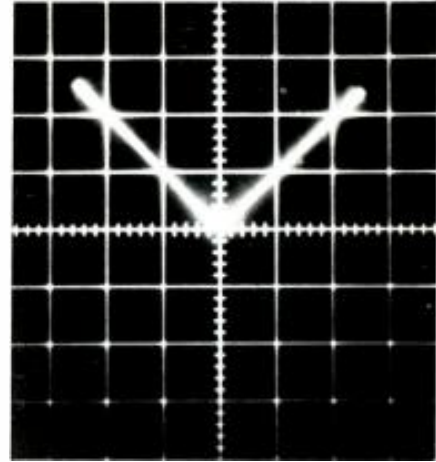

Figure 4: Mono out of phase front (LF and RF) signals only.

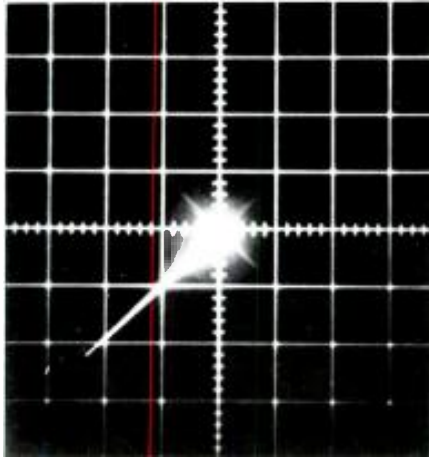

Figure 2: A left rear channel signal only.

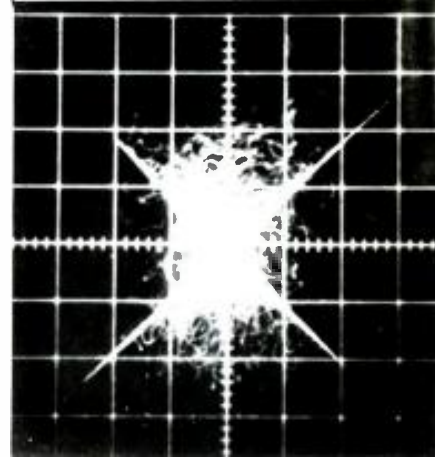

Figure 5: A quadriphonic display with mono front information.

Figure 3: Mono in phase front (LF and RF) signal only.

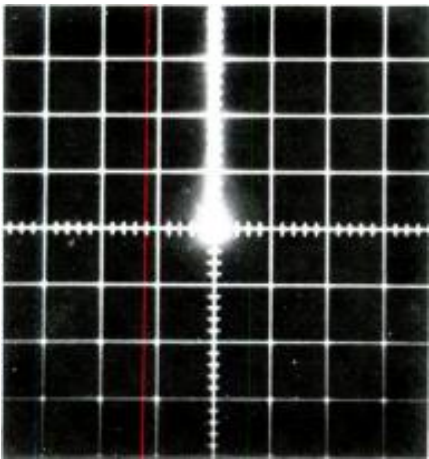
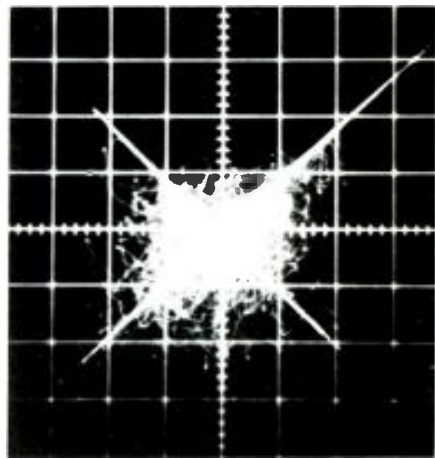

Figure 6: The same as Figure 5 but with the LF channel out of phase.



on the oscilloscope available. It is recommended that the resistors for the amplifiers also be matched to keep the display amplitude (audio gain) equal for all directions.

The modest power requirements for the amplifiers are a plus-and-minus voltage between 9 and 15 volts at 4 milliamperes. Power supply regulation and ripple are not a problem due to the design of the i.e., op-amplifier.

Vectorboard was used for mounting the parts because of the ease of construction. The boards are cut to approximately 2½ x 1¾ inches each, though their size will

depend on the size of the resistors and capacitors used.

The wire leads of the components are pushed through the holes in the board and are used on the back side of the board to connect the parts.

The oscilloscope used must have response down to d.c. on both the vertical and horizontal inputs to keep the display centered and in the proper quadrants. If a 'scope with only a.c. coupled inputs is used, the trace will not stay centered, but the display will still be usable.

For the very fortunate few who possess a Tektronix

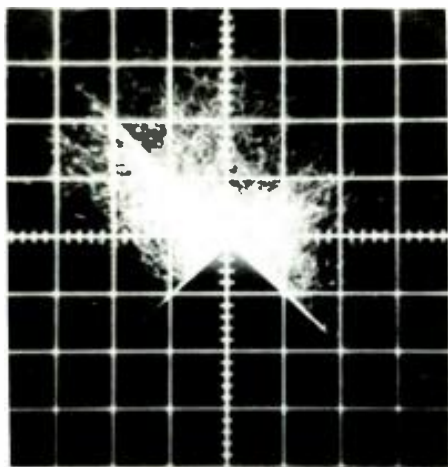

Figure 7: A decoded matrixed record.

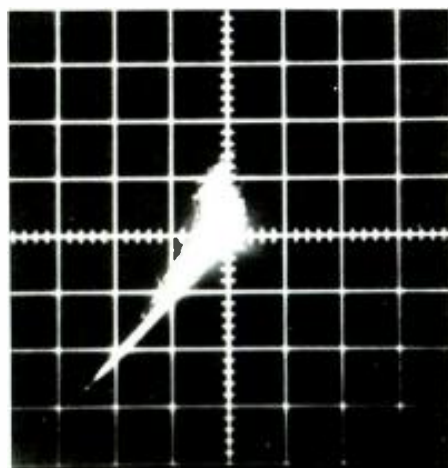
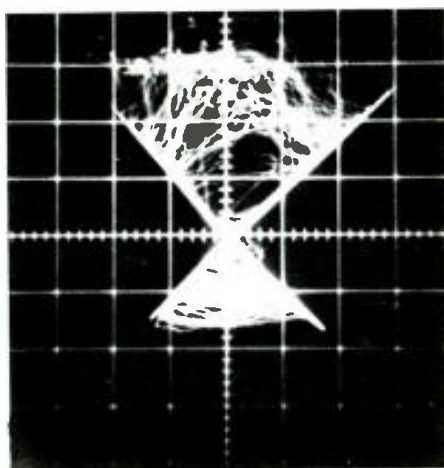

Figure 8: A strong LB signal with some front information also.

Figure 9: A solo French horn in a concert hall.



Type 503 or similar 'scope with differential inputs, only the diode-matrix network is required, and the amplifiers and power supply may be omitted. Connect the four outputs (+V, -V, +H, -H) and ground from the diode-matrix network to the 'scope inputs.

On 'scopes with the conventional single-ended inputs the dual-differential amplifier (and power supply) is connected between the diode-matrix network outputs and the 'scope inputs.

An ideal low-cost scope for this project is the Heathkit 10-10.⁶ This 'scope has identical vertical and horizontal amplifiers with single-ended inputs. Note that the identical

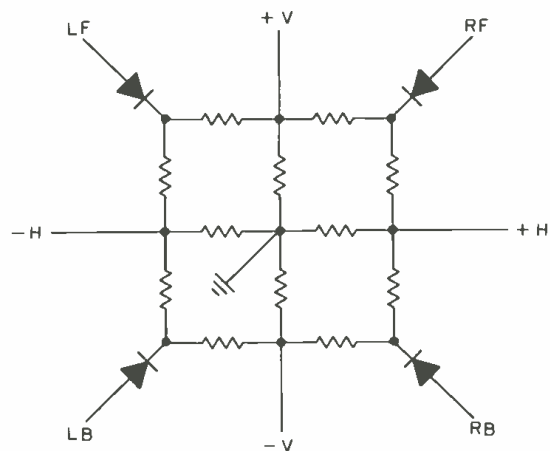

Figure 10: Schematic of the diode-matrix network.

input amplifiers are not required but are very handy when changing ranges to compensate for different levels.

The 'scope position controls should be adjusted for a spot in the center of the screen. The display system can be checked out with a 600-ohm 1 kHz oscillator connected to the diode-matrix network. With the oscillator connected to each input (and ground), one at a time, the 'scope trace should point from the center of the screen to each of its four-corners, respectively. Adjust the sensitivity controls to position the trace toward the corners. If it is noted that the left and right sides of the 'scope screen are reversed, simply relabel the inputs, or interchange the +H and -H leads at the output of the diode-matrix network. This reversal is due to the 'scope manufacturer's convention as to whether a positive horizontal input signal moves the trace left or right. After the inputs have been checked one at a time, they should then be checked in pairs.

Connect the front inputs (LF and RF) to the oscillator, and the trace should point up. Similarly check the other pairs: Back (LB and RB), Left (LF and LB), and Right (RF and RB). Note that if all four inputs are connected to the oscillator, the trace will be only a spot in the center. This is because the sound is in the center of the room (four-channed mono?).

The diode-matrix network may now be connected to a quad system. The network inputs are unbalanced and require a common ground source: if this is not available use 1:1 input transformers. The preferred point of connection to a quad system is to the speaker leads since it allows a complete check of the system. An alternate approach would be to connect to the 600-ohm line outputs of the console. The impedance of the diode-matrix network is high and can be considered a bridging input. At this point it would be wise to connect the oscillator to the console inputs and check the entire system. If, when checking the input pairs (front, etc.) a V shape trace is noted, this pair of channels is out of phase.

Note that the console channel levels can be matched in pairs by adjusting the channel gains until the trace is exactly centered between the two channels.

Now try some program material. As one recording engineer put it: "With the display you can see things your ears do not detect." As a last comment, it should be noted that this display is also helpful in analyzing two-channel systems.

**(A sad footnote is that Heathkit has discontinued this model, though a few may still be around.) An export version is available.*

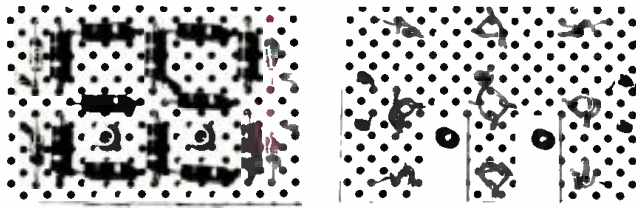
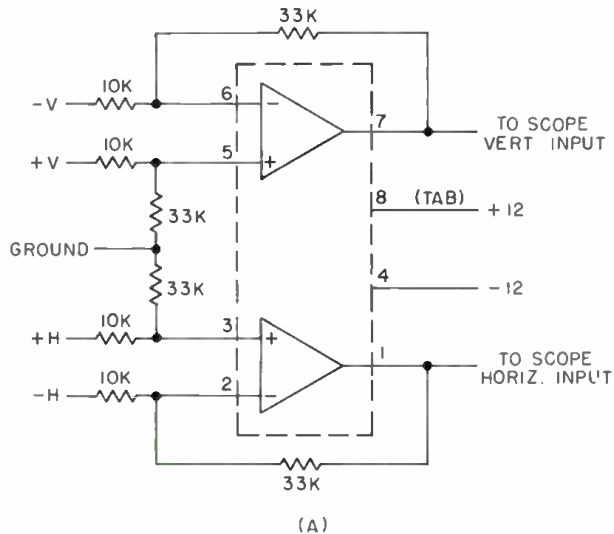
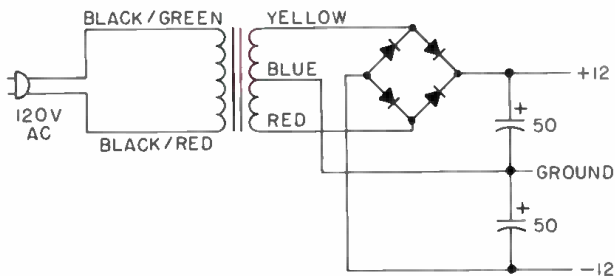

Figure 11: Front (A) and back (B) views of the diode-matrix network.



(A)



(B)

Figure 12: Schematic of the dual-differential amplifier (A) and power supply (B).

Parts List

DIODE—MATRIX NETWORK

12 Resistors: 5.6k, ½ w, ± 10%—Allen-Bradley (matched to within ±1% see text), or 5.6k, ½ w, ± 1%—Texas Instrument or Dale.

4 Diodes: Germanium, IN34A, IN48, or IN60—RCA, or Sylvania.

DIFFERENTIAL AMPLIFIERS

4 Resistors: 10k, ¼ or ½ w, ± 10%—Allen-Bradley (matched to within ± 1% see text), or ± 1%—Texas Instrument or Dale.

4 Resistors: 33K, ¼ or ½ w, ± 10%—Allen-Bradley (matched to within ± 1% see text), or ± 1%—Texas Instrument or Dale.

1 Dual op-amp integrated circuit: MC1458G—Motorola or two MC1741—Motorola or two µa 741.

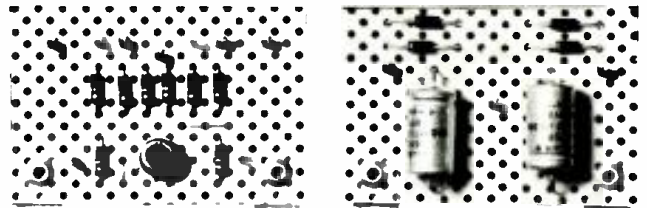

Figure 13: Front and back views of the dual-differential amplifier (A) and power supply (B).

POWER SUPPLY

4 Diodes: ½ A, 50V, IN4001—Motorola, or Texas Instrument.

2 Capacitors: 50 mFd., 25V—Sprague (type TE) or Mallory (type MTA).

1 Transformer: 16VCT, 10 mA d.c.—Triad (type F-94X, F-90X, or F-91X) or Stancore (type TP-2 or TP-3).

MISCELLANEOUS

Terminal Board—Vectorboard 85G24EP.

Push-in terminals—Vector T28.

“Minibox” 5¼” x 3” x 2½”—Bud CU-2106A (use only with Triad F-94X transformer. This is the smallest one; the others may require a larger box).

Input Connectors: suggest stereo phonejacks—Switchcraft 12B, or Barrier Terminal Block—Cinch type 141-Y.

Output Connectors: suggest banana jacks—H. H. Smith type 1508 or Six-Way Binding post—E. F. Johnson type 111.

Neon Pilot Lamp—Leecraft type 36.

A.c. power cord, grommet, miscellaneous hardware.

COST ESTIMATE

The approximate combined cost of the network, amplifier, and power supply, less the oscilloscope is \$25.00. This assumes the use of 10% resistors throughout. If 1% resistors are used, the cost will almost double.

Figure 14: The complete black box containing the parts shown in Figures 10 through 13.



Adventures in Four-Channel Land—The Midwest Acoustics Conference

Four-channel sound seems to be the subject of discussion everywhere. The Midwest Acoustics Conference devoted a full day to the subject. The west coast AES Convention devoted papers and demonstration. And the adventures go on.

Protagoras asserted that there were two sides to every question, exactly opposite to each other.

Diogenes Laertius (c. 200 AD)

Great God, grant that twice two be not four.

Turgeniev 1818-1883

IT'S UNFORTUNATE that neither of the above authorities has had anything further to say about quad sound. Also unfortunate is the fact that just about everyone else has. And, if the Midwest Acoustics Conference was any sort of indication, Protagoras has somewhat underestimated the number of sides to at least one question, "what is the definitive quad system?" but more about that later.

On April 15th, the sixth annual Midwest Acoustics Conference was held in Evanston, Illinois. This year's subject of discussion was *Four Channel Sound Reproduction—Creation and Recreation of a Sound Field*.

Dan Queen got the session under way with a few observations on the earliest references to four-channel reproduction. He noted that four-channel sound has been available at least as long as magnetic recording techniques have been known, and that in fact a patent was issued for a multi-channel Edison cylinder. "Perhaps even DaVinci's notebooks would yield a reference to four-channel sound if one looked hard enough."

Mr. Queen brought up the thorny question of who shall review the technical competence of these who would take advantage of the market potential of quad sound. If things get bad enough, ultimately the Federal Trade Commission may intervene, but it would be better, he pointed out, for us to ". . . show the salesmen of our industry that the specifications of four-channel equipment must be done by the engineering professionals." He continued, "we . . . must realize that we are dealing not merely with the addition of two loudspeakers, and two amplifiers to a stereo system.

"Fraud, by whatever euphenism, is today a great danger in the marketplace of quadriphonic sound. We must see to it that it does not occur by way of our ignorance. There

are many approaches to true four-channel sound. But the public should be able to know when they are getting true four-channel sound, and when they are getting a compromise. It is time that we, from the inside, become the Ralph Naders of our industry."

The first session after Mr. Queen's opening remarks was *The Physical Nature of Ambiance*, with speakers Marvin Camras and John Volkmann. Mr. Camras opened the session with a discussion of ambiance, both real and artificially created. He reminded us that at times even a mono program can be enhanced by reverberating it and feeding it to a rear speaker. At the other extreme, he described some of his experiments with a twelve-channel system!

Following Mr. Camras, John Volkmann continued the discussion of ambiance with a description of the tri-wave concept of acoustics, in which a total sound field is separated into direct sound, early reflections, and the later, more diffuse, reverberant sounds. This concept is of particular interest to the engineer on a classical session, who must create—or re-create—a concert-hall type of sound. Mr. Volkmann felt that at times it might be worthwhile to consider recording a program on three stereo pairs of tracks; one pair for the direct sound, another for the early reflections, and the third for the reverberant information. On the other hand, it might be more practical, and economical, to simulate the second- and third-wave information later on with time delay devices and artificial reverb.

The second session of the conference was devoted to *Reproduction in Rooms: Physical and Psychoacoustical Considerations*. George Augspurger noted the undue attention being given to creating the concert-hall sound in the living room. He felt that living room listening need not become a carbon-copy of the concert hall, anymore than



Dan Queen delivered the opening talk on the evolution of four-channel reproduction and the responsibilities of professional audio.



Bill Putnam, president of UREI, makes an emphatic point as he discusses methods of recording four-channel sound.

a motion picture attempts to simulate the actual experience of being present at the filming. Besides, he pointed out, the perception of a re-created *reality* will differ from one listener to another. As an example, he noted that there were discrepancies of up to 8 dB between various listeners in testing the Haas Effect. In referring to Mr. Volkmann's talk, he noted that early reflections in a small listening room will certainly differ from those in a large concert hall.

Next, Roy Allison spoke about four-channel loudspeaker requirements. He pointed out that since phase information is such an important part of the various matrix systems, it is important that all speakers in a quad system be at least similar in phase relationship and time delay distortion.

In the concluding talk, Bruno Staffen noted that although the placement of loudspeakers in each of the four corners of the listening room seems to be the most frequently encountered arrangement, and the one that many producers were employing, it is often worthwhile to experiment with other placements, and that generally the listener will note a significant improvement over two-channel sound, regardless of where the additional speakers are placed. The afternoon sessions began with *Recording for Ambiance and Effect*. Bill Putnam opened the session with a look at *Live Recording for Quad*, in which he described a live recording session of the Stan Kenton Orchestra. Mr. Putnam noted that more often than not, recordings are no longer made in one sitting, and urged the research and development community to "... become aware of the needs of the commercial record industry."

Relating this to the development of quad sound, he observed that often a lot of creative effort is wasted due to a lack of communication with operating personnel. He stressed the need for theoretical work that would be relevant to the day-to-day needs of the recording studio.

Following Mr. Putnam, John Eargle reviewed some of the techniques that he has used to reprocess old two and three track recordings for quad reproduction. Interested readers are referred to Mr. Eargle's AES paper, *On The Processing of Two and Three-Channel Program Material for Four-Channel Playback*, (AES Preprint #733).

The final paper in this session, *Signal Processing and Console Requirements for Four-Channel Recording*, was given by Jim Cunningham and Ed Rehm. Mr. Cunningham outlined some of his experiences with mic placement, panning, and artificial reverberation in preparing four-channel masters. Later, Mr. Rehm reviewed the extra requirements imposed on a console that is to be used for quad work. The most obvious departure from a standard multi-track board is a more flexible monitoring system. Of particular importance is a practical method of compar-

ing discrete with matrixed outputs, and of monitoring an encoded program in either its encoded (stereo) or decoded (quad) format. The final session of the afternoon was *Recorded Media-Disc Reproduction, Multichannel*. Here, there seemed to be as many viewpoints as there are loudspeakers in a quad system. In fact, "loudspeakers in a quad system" neatly—if somewhat irreverently, describes at least part of this session. Some of the technical descriptions of the contending systems were liberally spiced with pungent comments about the shortcomings of all other systems, and with inquiries into the sanity of producers who would seek to locate sound sources in locations uncomfortable to the favorite matrix. Fortunately, the combatants maintained their good humor despite the occasional brickbats hurled back and forth. Some of the audience would have liked a little more candor from time to time and some questions had a way of not getting answered in eloquent responses such as one usually expects only from people who are running for public office.

On a more serious note, Sidney Silver, representing Sansui, suggested that "... at all costs, the consumer should be spared the expense and confusion arising out of the theoretical and political battles among the proponents of various systems."

A commendable sentiment, although it seems that a certain amount of confusion has already settled in, and time alone will probably lessen the uncertainty in the mind of the record buyer.

Fortunately, no matter what matrix eventually becomes the industry standard, most of the decoders now on the market do wonders to the listeners' library of regular stereo product. As a case in point, I recently installed a Sansui receiver in my home listening room. Up until now, I had no idea what a marvelous four-channel recording engineer I have been all these years. But, the built-in decoding unit does a splendid job of creating a quad program from tapes and discs made long before anyone was seriously thinking about quad sound. This is not an equipment review—just an indication that when—and if—the *matrix* is ever defined, people who have bought other matrix systems need not feel cheated. Any matrix now available will do wonders to most two-channel programs, in addition to whatever it does to quad product produced for it. So, when (and again, if) the industry sets some quad standards, the consumer can probably update his existing matrix, hopefully at a reasonable cost. And even if the discrete disc becomes popular, remember again that a matrix system is well worth its cost, if only to enhance two-channel product.

I seem to be drifting away from the conference and into the consumer market, and as this is a journal for the pro-

professionai, the pros had better keep the consumer well in mind, lest he rebel against this new expense due to mis-handling by the "experts".

Getting back now to the conference, at the afternoon session various methods of presenting a four-channel program were offered by Messrs. Ben Bauer (Columbia), Howard Durbin (Electro-Voice), Sidney Silver (Sansui) Rex Isom, (RCA) and Duane Cooper (University of Illinois). I'm not going to attempt an explanation of what was said—once people start talking about directionality in terms of the cosine of theta, I start thinking about going into some other line of work. Suffice it to say that it was proven that each system is demonstrably better than every other system and that although further improvement is impossible, further improvements will be announced shortly.

Running concurrently with the technical sessions were demonstrations of various quad system in rooms near the auditorium. Demonstrating their systems were; CBS Labs, Dynaco, Electro-Voice, JVC, Nippon-Columbia, RCA Sansui, Sony, and Lafayette Radio. The conference sponsors had prepared a four-channel demo tape and each participating demonstrator was invited to process the tape through his system and play it back in his demo room. Interested listeners could then go from room to room and make their own comparisons of the contending systems. In addition each exhibitor had a good supply of other material for demonstration.

To summarize—The conference offered no clear cut direction in which it would appear that quad sound was to move. Matrix systems continue to improve, yet the strengths of this approach are considerably lessened by the bickering between some of their supporters. We would

all benefit by more constructive collaboration. The "discrete" disc certainly shows promise, and there is every reason to suppose that in time it will become a serious contender. There is even talk of a discrete matrix disc, containing both styles of processing in one groove! This will certainly demand more cooperation between companies than we have seen so far, but may very well be an ideal solution to the problem of deciding which system to buy.

AES CONVENTION

A few weeks later, the Audio Engineering Society held its 42nd convention. Of course, there were a series of papers on four-channel sound. One of the most interesting was, *A Quadraphonic Oscilloscope Display Technique*, by Donald Patten. Some time ago, Mr. Patten sent me a prototype of his device and it has proven an invaluable aid both in setting up our quad mixdown facility, and in visually monitoring four-channel tapes. For a complete description, see Mr. Patten's article elsewhere in this issue.

The other papers were for the most part a further treatment of the various quad systems. The good humor that prevailed during the Midwest Acoustics Conference became a little strained out in sunny California, as the discrete fans called matrixes a "rip-off" totally inadequate for broadcasting, and the matrix people hurled insults at the discrete system and each other. Hopefully, by the next convention, the learned scientists will be able to come up with something a little more constructive, and we shall all be spared another round of name calling. Four-channel sound deserves the best efforts of all the many talented people working in the field. ■

DO YOUR THING ON OUR THING

Our boards are made so that creative engineers and producers can get behind them and work behind them. We feel we're an important part of your artistry. Good sounds, flexibility, reliability and human engineering are what you expect from a professional recording system.

We make some of the best (and most sophisticated) systems and signal-processing devices one would find in any good studio. Like our 2082 mixing console* (it can be automated) or the RV-10 reverb device. The RV-10 is a good room sound squeezed into 19" of rack space. Next session, get behind us. After all, we do our thing for your thing.

*2082 console from the Village Recorders, Los Angeles, Calif.



**quad/eight
electronics**

11929 Vose Street □ North Hollywood, California 91605 □ 213/764-1516

Circle 25 on Reader Service Card

STEPHEN H. LAMPEN

Recording Stereo in Four Channels

Recording quad presents enough problems in studio work. The difficulties are increased when the equipment must go into the field-as in these case studies.

IT WAS ONE OF A SERIES of rainy weekends in San Francisco as 3P Recording and Hansonic, both of San Francisco, loaded up their equipment in preparation for a busy weekend of recording. Hansonic provided the mixers, mics and monitoring while 3P Recording provided the recorder, a Vega 800-4. Five mixers were used with a gaggle of microphones, amps and speakers.

Our first date was the Champagne Gala of the Lamp-lighters, a Gilbert-and-Sullivan light opera group. This involved miking the stage for both singing and speech and miking the house for audience, ambiance, and orchestra. This promised to be an exciting performance as was evident in the fact that the theater had been sold out a month or so in advance.

Those who have miked stages for p.a. systems will appreciate the difficulty of miking moving sources. Many factors have had to have been taken into account. Most obviously, singing and talking vary widely in volume due to individual "output," position on the stage and position in relation to the mics. Relatively "heavy" miking was in order although we usually prefer to "light-mic" a stage to allow each mic to pick up a wider area.¹

Eight mics were used on the stage.(FIGURE 1) Four mics covered a semicircle at the front of the stage. These mics were all placed on MS-25 stands and reached about six inches above the level of the stage. They consisted of two Sony C-37P condenser mics in the center and two Electro-Voice RE-20 dynamics at either end. Due to the proximity of the orchestra, (in some cases right next to the mics) the Sonys were switched to cardioid; the RE-20s already have a cardioid pattern. Two RCA 44 ribbon mics were hung from the first riser to pick up action from center stage. Finally, two AKG D-202 dynamics were

hung on the last riser to pick up the back of the stage. Since most of the action occurs at front-center, little of the action (except during entrances and exists) occurs near the back of the stage. As it turned out, we only used these mics once during the performance.

These eight mics were mixed down in two Shure M67 mixers and fed to channels one and two of the recorder. Two other mics were placed on the balcony to pick up the orchestra and the audience. As this was acoustically a good theater, any ambiance that was picked up was also welcome. These two mics were Sony C-77 shotgun condensers. They were aimed toward the orchestra to limit applause to a controllable amount. These two mics were placed on the upper portion of a small floor stand. These extension tubes were screwed to two large c-clamps which had been fitted with the correct thread and the whole assembly screwed to the railing on each side of the balcony. (FIGURE 2) In this way these mics, being the only ones in the audience, did not interfere with the view from the

Figure 1, A total of eight mics were used on the stage, with two more ambiance mics on the balcony.

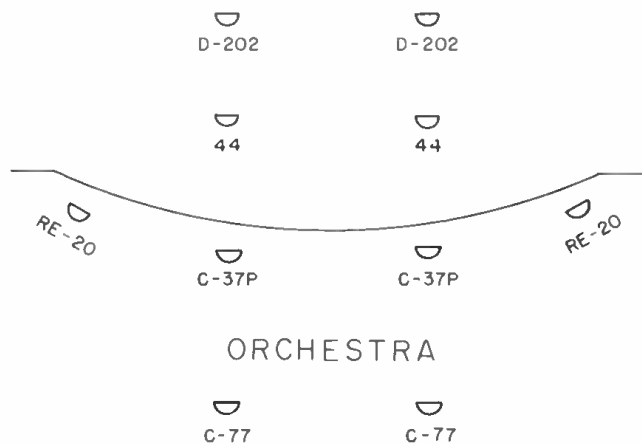

Stephen H Lampen is the owner of 3P Recording of San Francisco. The photos used to illustrate this article are by Edison Fong, an engineer with 3P.



Figure 2. Balcony mounting of the shotgun mics.

balcony or the seating. Stands and loose cables left in aisles, especially in theaters, invite accidents and lawsuits. Thus, our solution removed most of the worry of placing mics in the audience. These two balcony mics were fed into two more Shure mixers and constituted channels three and four. Once the level was set on these back mics, it was found to be so satisfactory that it was rarely changed during the performance and most of the mixing was done with the stage mics.

The Shure M67 mixers have a few advantages over complete consoles not the least of which is their cost. They have built-in 1000 Hz. oscillators with which their vu meters, and the ones on the recorder, can be calibrated. They can be stacked as shown or separated in sets. In fact, two people can do the mixing with each one controlling a pair of channels. Of course, these mixers do not share the super-low noise or overload specs of larger recording consoles but, for good quality and superior portability, they are hard to beat. These mixers also have a high-pass filter on each channel to remove rumble or proximity effects of close miking. They also feature low-z mic level outputs, 600-ohm balanced line (which we use) or a headphone jack which is also useful when someone wants to stick their home recorder into the system for a partial feed. They can also be paralleled for feeding more than four mics into each channel.

The entire recording was made in a classroom behind the theater. (FIGURE 3.) The house mic lines were utilized to feed the stage mics up to us. Due to a good knowledge of the theater, we knew these lines were well kept and we were not taking the same risk as we might by using strange mic lines. The rear shotgun mics were fed to the room through a hundred feet of cable on each mic. All the cable used for the mics was Belden 8412 and 8428.

Five mixers were employed in case either one of them failed or more than four mics were to be fed to each channel. The fifth mixer was not used. A Concord t.v. monitor and camera furnished visual monitoring of the

Figure 3. The recording setup described by the author.

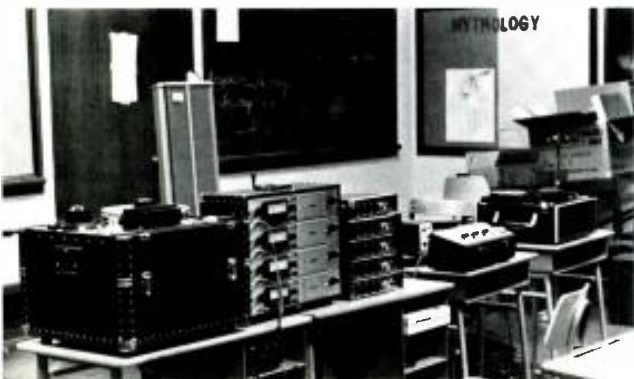

production. Aural monitoring was accomplished by feeding the four headphone jacks from the recorder into two Sansui BA-60 power amplifiers which, in turn, fed four University CSO-4 sound columns. These may seem an odd choice for monitor speakers but they offer advantages over other speakers. First, they are designed for high power applications and can easily handle 75 watts although we rarely use this much for monitoring even in very large rooms. Secondly, they have a surprisingly flat frequency response up to 17 kHz. They are built to be portable and can withstand more bumps and scratches than the ordinary pine-boxed monitors. These speakers were placed around the engineer in a rough square close enough that room acoustics were not a problem but far enough away that the acoustic effect of the quad recording could be heard.

The end result in a remix was very good. The use of the odd columns was advantageous as they, like most columns, tend to be a little "bright" and thus emphasize the higher frequencies where tape noise and other stage and theater noises can be easily heard and compensated for (if possible) even when monitoring in an extremely reverberant room which tends to mask the higher frequencies.

From there it was smooth sailing—almost. The recording went perfectly, no mics failed, no tape run-out. However, at the conclusion of the performance, the champagne was brought out and, as we were packing the gear away, one of the theater staff brought us two bottles of bubbly. At one point, the engineer (also the author) tried to hand his empty champagne glass to someone and dropped it. The glass managed to meet the floor before being caught and my hand came in a close second. Rushed to a nearby emergency hospital, a couple of stitches and a half-hour later, I was back again taking down the equipment. No one will ever believe I only had two glasses of champagne.

Nevertheless, one-handed as I may have been, the show must go on—and this included a scheduled recording the next day in Oakland. After a token sleep, we were all up bright and early for our jaunt across the bay. This second theater set-up was, as we were to find out, radically different from the previous night. One of remote recording's golden rules is to find out *exactly* what one is in for. Unfortunately, all the information we were provided with was a name, an address and a rehearsal time. This was, it turned out, a high-school auditorium rented for a jazz performance of Handel's Messiah. It included orchestra, full chorus, a jazz trio and soloists. Our saving grace was the fact that we arrived more than two hours before the first rehearsal, and we had time to set up some mics to get an idea of what was to happen. The four mics we placed for the rehearsal (FIGURE 4) were two Electro-Voice RE-20's placed almost as a coincident pair about fifteen feet above the conductor and pointing down at a forty-five degree angle into the orchestra on each side. The only other mics we placed were two Sony C-37P switched to omni directional and placed on the first riser to pick up the chorus which was split into two groups on either side of the stage. These four mics were so satisfactory that they were left the way they had been placed for the actual performance. The RE-20's also produced excellent audience pickup. These were the hack two channels. All other mics, including the Sonys, would be mixed to channels one and two. The Sonys, due in part to their omni pattern, picked up virtually everything on stage. In fact, the piano had such beautiful balance through these mics that nothing else was used on the piano at all. However, the drums lacked sharpness. Two Shure 546 dynamics were added to "sweeten" the drum sound. One was placed on a boom over the whole drum set about a foot above the crash cymbal and the other was placed very close to the snare to pick up some of the delicate brush effects which the drummer used. This snare mic was placed on the same

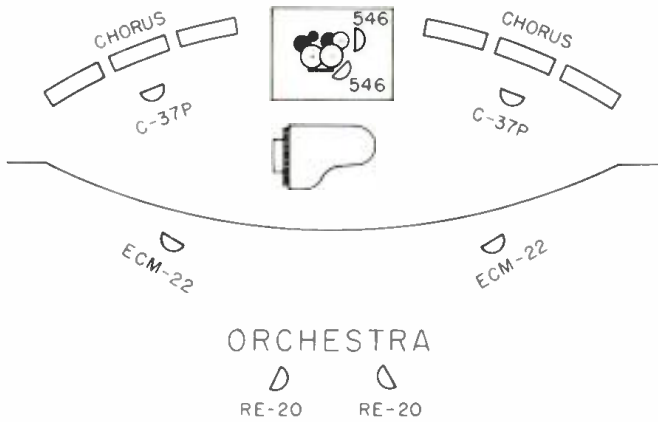

Figure 4. The RE-20s in the foreground were suspended and served for both stage pickup and rear-channel ambiance.

stand by using a small c-clamp with $\frac{5}{8}$ -27 thread. Thus, two mics could be used on one stand. (FIGURE 5.)

Two soloists appeared on the program and we were advised that there were two solo positions, each of which was marked on the stage. In situations where soloists may or may not know that a recording is taking place, it is risky to put a mic on a normal floor stand on the stage. In many cases, the soloists think that these mics are for the p.a. system and approach them with the idea that they are going to hear themselves through the non-existent system. When they fail to hear anything, they back off from the mic. This creates, as one can imagine, rather rapid changes in volume for the engineer to deal with. Because of this we opted for placing the solo mics on regular floor stands placed in the orchestra. With the stands fully extended, the mics (two Sony ECM-22s) were about three



Figure 5. Two mics on drums—both sharing the same stand.

feet above the stage floor. At this level, the soloists could not sing into them and yet these microphones were close enough to allow us to acoustically separate (and control) the soloists from the chorus and other musical instruments on stage. As it turned out, the bass player stood directly in front of one of the solo mics and an extra mic was not even needed for him.

Perhaps the best idea we had was to take along some old half-inch tape and virtually let the recorder run during the rehearsal. In that way we were able to play it back and get a pretty good idea of the levels to expect and judge any mic placement which needed adjusting. The final recording turned out to be one of the best that 3P Recording and Hansonic had done and the whole crew returned to San Francisco tired but happy, ready for whatever will come up in the future. ■



Whenever there is a need.

This is the Olive "motto." We live up to it in our constant attempts to push back the accepted frontiers of audio technology. In fact, Olive products represent a whole new concept in audio engineering excellence. Take a close look at our Series 2100 Equalizer for example. Notice the 4 sections. All capable of independent action. There are two mid ranges and a total of 48 frequencies to choose from. Just wait until you experience the speed of set up and feel the smoothness of lever actuated switching. There's no need

to compromise when the natural frequency range of any instrument can be located and brought out where you can really get at it. Quickly. Using only 1 section you can create 300 separate effects. Imagine how many effects you can get with all 4. Designed to answer any need, the 2100 Equalizer is available as you see it here or as a very important part of the Olive Console. Before you are sold on just any equalizer try the Olive 2100. We'll let the product sell itself. Specifications are available on request.

olive
WHENEVER THERE IS A NEED

Olive Electro Dynamics Inc
2670 Paulus
Montréal 386, Québec
Canada
(514) 332-0331
Cable Olive1, Montreal

Westlake Audio Inc
6311 Wilshire Blvd
Los Angeles, California
90048
(213) 655-0303

Harvey Radio Company
444 Madison Avenue
New York, N.Y.
10022
(212) 582-1500

Studio-Technique
4 avenue Claude
Vellefaux
Paris (10e) France
206-15-60/ 208-(0)-99

SOUND WITH IMAGES

Meetings and Conventions

● Primarily, I try to keep you up to date on the latest information on equipment and developments in the audio/video field, but I also like to bring you anything that might be of interest to anyone in the audio and audio/visual fields for enlightenment and improvement in service to customers and clients.

On occasion, I try to report on happenings at conventions in the hope that some of you will learn of the organizations involved in the sponsorship and perhaps find use for their services. Recently, I learned of some more associations which run meetings and conventions and which some of you might not know about.

In the order of dates of their conventions, let's start with a meeting which travelled across the country trying to reach as many interested people as possible. The group that organized this convention is the International Tape Association, Inc., with offices in New York City. The meetings were held in N.Y. on February 6th and 7th, in Chicago on Feb. 8th and 9th, and in Los Angeles on Feb. 13th and 14th.

The Association has as some of its goals the protection of consumers, the upgrading of the industry in general, the establishment of world-wide standards, and the desire to provide the members with services which are not now available elsewhere. The ITA is solely in the tape industry and is not involved in other areas of the electronics business. The Association does not compete with other groups in the same field but will assist and cooperate with them. The ITA is the only organization of this kind with world-wide scope.

ITA has regular memberships available to manufacturers of tape and

cassettes, duplicating equipment, recording studios, producers and video software manufacturers. Sustaining membership is available to those firms not eligible for regular membership but interested in the tape or information-storage industry. Well over a hundred of the national and international concerns involved in tape or associated industries are members.

At its recent meetings, leaders of the world's tape industry and experts in associated fields such as education, industry, and publishing got together to listen to important papers, discuss and ask questions on a variety of subjects associated with the tape field. Subjects included tape distribution and marketing, applications in the medical and educational fields, legal problems in the tape industry, technological progress, and cassettes for audio and video. This non-profit organization is well worth looking out for the next time they have a seminar.

In April of 1971, the First International Cartridge TV, Video-Cassette & Video Disc Conference took place in Cannes, France. For the first time, an opportunity was extended to communications experts from all over the world to get together and discuss the latest information available in the newest of the communications media. Government agencies, interested industry, educational institutions, publishers, manufacturers of hardware and software, producers, religious organizations, scientists, and the military met for four days to listen to discussions and opinions by the experts, and to see equipment still in the development stages prior to introduction on the market. Cartridge or cassette tv attendees heard talks on standardization, government attitudes, legal problems and international copyrights in-

involved in the production of programs for home and industrial users, and the latest in technical details or progress in the systems soon to be available. Sony talked of its 3/4-inch video cassette system, Matsushita along with Victor of Japan talked of joining the swing to 3/4-inch and standardization of the systems, London Records discussed the advances of the video disc, and others talked of evr and catv and their applications. Over 1,000 participants (paying visitors, that is) attended the sessions which represented over 31 countries and more than 600 organizations.

This year, the second conference took place from March 5-10, also in Cannes. Evr was again demonstrated; Philips showed its latest in its Video-cassette equipment and set up a studio for immediate transfer of anyone's 16-mm film to video tape; Teldec introduced its color video disc; Sony, Matsushita and Novico had their latest video players on display; Avco's Cartivision and Vidicord (British firm) were on hand, the former with a complete 1/2-inch cartridge system and the latter with a super-8mm cineplayer. The study sessions considered the relationship between the cassette systems and the various international coding systems for tv transmission of color signals, legal and copyright problems, distribution dilemmas, applications in industry and education, and the criteria for standardization.

An added feature of this year's VIDCA convention was the concurrent running of the MICAB Conference. This program of the First International Cable TV Convention brought together top executives in the various industries associated with the catv systems, both technical and non-technical. Discussions took place on the

present state of cable systems and the future of broadband communications, the applications of video cassettes and local programming for wide and local distribution, the latest in cable and equipment technology with introduction of specifications for hardware and systems with an eye to eventual standardization, and the extension of local systems into wide distribution networks and the related copyright and legal problems.

From March 20-23, the IEEE held its 1972 International Convention and Exposition at both the New York Coliseum and New York Hilton Hotel. At the technical sessions, almost 300 papers were given on subjects ranging from interconnection of giant power stations to cable television for the home and the latest in 3d displays, applications of electronics to modern transportation both present and future, use of electronics in the courtrooms and medicine, developments of computers and mini-components, and the trends of the future in society and ecology.

Along with the 250 exhibitors representing 400 companies and a total of more than 75 technical and application sessions, there was also a science/technology center in which about a dozen exhibitors showed their contributions to space technology and environmental studies. Among these were NASA, the Army, the Bureau of Standards, the Patent Office, Naval Ordinance, and several of the largest corporations involved in space and ecology research. A technical film center was also provided for presentation of more than twenty movies devoted to space, technological advances, research, nuclear power, ecology and the future of communications. Additionally, in conjunction with the convention, a separate special program was presented at the Americana Hotel on medical engineering with emphasis on the latest in medical electronics and the inter-relation of the engineer with the medical and legal people as well as the patient. The whole subject of "New Horizons for Engineering," the theme of the convention, was covered from all angles.

Of special interest to audio/video specialists, was the introduction by Sony of their latest item in their expanding line of industrial and home video products. In addition to a display of the ¾-inch video cassette player and recorder units (the former now on the market with the latter one to follow in about a month), they showed a color video projection system which would become available in the very near future. Three different types were being developed and only one was shown at this time. The unit presented was a small unit, with

a tuner, for use in front projection. The 50-inch diagonal screen, a special high-reflection type, is part of the system and comes with a small self-standing base. The projection unit uses a specially developed Trinitron tube for projection application with an internal mirror and projection lens. Projection brightness is more than 250 ftL and the image brightness is approximately 6 ftL. Video bandwidth is up to 4 MHz, scanning is at 525 lines with 2/1 interlace and the video input, from either a self-contained tuner or a video cassette or tape player, is in accordance with the NTSC color standard. The sound, with the speaker in the projection unit, is radiated toward the screen and is reflected toward the viewer from the screen, creating the illusion that the sound is actually emanating from the screen itself.

One of the two units to be made available soon is a high-power reflection type, similar to the smaller one, but for use with a 100-inch diagonal screen for larger display areas. In this system, the screen unit, also specially made for high reflectivity, will contain the speaker unit in the base and will project the sound directly toward the audience. The second model coming soon is for rear-projection applications and will include a complete system in one unit working from a base on which would be mounted the mirror/screen/speaker combination. The screen would be made up of 660,000 microlens apertures in an XY matrix on a "black-eye" screen. Source brightness is rated at more than 2500 ftL with a picture brightness of 15 fL. Contrast ratio in a bright room is given at 30 dB. The audience area for optimum viewing should be from 10 to 50 feet from the screen and approximately 40 degrees to each side of center.

Other video manufacturers were also in attendance with displays of their latest wares. Panasonic will have on the market soon a ½-inch video cartridge system and the color recorder/player was on display. The system uses a single-reel cartridge with either blank or pre-recorded tape compatible with any of the player-recorder units conforming to present EIAJ Type 1 black and white and recommended color standards. The recorder has a rotary 2-head helical scan system with tape speed at 7½ in/sec. Horizontal resolution for b and w is given as more than 300 lines with color rated at more than 240 lines. Tape cartridges contain 20 or 30 minutes of tape and rewind the 20-minute tape in less than 80 seconds. In line with their new cartridge system, Panasonic also showed a high-speed video tape duplicating system

for printing tapes at ten times the normal program time. The total system also includes a 2-vidicon studio camera with a built-in crt view finder, 550-line resolution, operation in a minimum of 50-foot candle illumination, and automatic control circuitry.

Other conventions of great importance to audio-visual specialists which took place recently are the 50th Annual National Association of Broadcasters Conference which ran from April 9th to 12th in Chicago, the National Industrial TV Association conference from April 12-14 also in Chicago, the SMPTE session from April 30-May 5 at the N.Y. Hilton Hotel, and the International Music Industry Conference-IV which coincided in time with the SMPTE conference but took place in Acapulco, Mexico.

In addition to the many exhibits of broadcast audio and video equipment at the NAB, there were also displays of equipment applicable to closed circuit and catv by such manufacturers as the Bell System which had a multi-screen show on its equipment and facilities for distribution, Ball Bros. which showed various sizes of color and b and w monitors, Conrac with its line of video monitors, Fairchild Sound Equipment Co. with custom consoles and various special items, Shibaden with cctv recorders and cameras and monitors, Shure with a full complement of broadcast quality microphones, Spindler-Sauppe with various film chain projectors, and World Video with several sizes of 1-gun color monitors.

At the 111th Technical Conference and Equipment Exhibit of the SMPTE, there were exhibits by approximately 50 companies, papers on television and motion picture systems, and discussions on developments in video cassettes, cartridges and catv. The IMIC-IV, sponsored by the Billboard Group of publications, was for leaders in the International music scene to discuss the present and the future markets and developments in quadriphonics, cartridge video, and audio tapes as well as international distribution and legal problems. New equipment was also on display by manufacturers including Sony, Motorola, STM Electronics, and Sansui.

One convention still coming up which will be of value to mark on the calendar is the National Audio-Visual Association conference which will take place on July 15-18 in Kansas City, Mo.

We hope to be able to keep you up to date on some or all of these meetings, but in the meantime, we suggest that you write to the organizations mentioned for any details and information which might be of interest to you. ■



As a service to our readers we are pleased to offer books from prominent technical publishers. All prices listed are the publishers' net. Shipping charges are included.

To order use the coupon at the bottom of the page. Indicate quantity on the special instructions line

If more than one copy of a title is wanted. Full payment must accompany your order. We cannot ship c.o.d. Checks or money orders should be made payable to Sagamore Publishing Company, Inc. Because of the time required to process orders, allow several weeks for the receipt of books.

BOOKCASE

20. The Audio Cyclopedia (2nd ed.). Dr. Howard M. Tremaine. New and updated, here is the complete audio reference library in a single volume. It provides the most comprehensive information on every aspect of the audio art. This new edition includes the latest audio developments including the most recent solid-state systems and integrated circuits. It covers all subjects in the fields of acoustics, recording, and reproduction with more than 3400 related topics. Each topic can be instantly located by a unique index and reference system. More than 1600 illustrations and schematics help make complicated topics masterpieces of clarity. 1760 pages; 6½ x 9½ hardbound. **\$29.95**

1. The Technique of the Sound Studio. Alec Nisbett. This is a handbook on radio and recording techniques, but the principles described are equally applicable to film and television sound. 264 pages; 60 diagrams; glossary; indexed; 5½ x 8½; clothbound. **\$14.50**

7. Acoustical Tests and Measurements. Don Davis. Provides solid understanding of the entire subject of acoustical measurements; based on actual field test work, using commercial equipment. 192 pages; 5½ x 8½; hardbound. **\$6.95**

8. Handbook of Electronic Tables & Formulas, (3rd edition). A one-stop source for all charts, tables, formulas, laws, symbols, and standards used in electronics. Includes an 8-page, full-color fold-out chart showing latest FCC allocations for the entire frequency spectrum. 232 pages; 5½ x 8½; hardbound. **\$5.50**

24. Basic Electronic Instrument Handbook. Edited by Clyde F. Coombs, Jr. Hewlett-Packard Co. A basic reference background for all instruments. Offers saving in time and effort by having complete information in one volume on how to get the most benefit from available devices, how to buy the best instrument for specific needs. Reduces chances of costly errors. Ideal reference book, it is an excellent source for the beginner, technician, the non-electrical engineering man, or general non-engineering scientific and technical personnel. 800 pages. Hardbound. **\$19.50**

25. Operational Amplifiers-Design and Applications. Burr-Brown Research Corp. A comprehensive new work devoted entirely to every aspect of selection, use, and design of op amps—from basic theory to specific applications. Circuit design techniques including i.c. op amps. Applications cover linear and non-linear circuits, A/D conversion techniques, active filters, signal generation, modulation and demodulation. Complete test circuits and methods. 474 pages. **\$15.00**

26. The Design of Digital Systems. John B. Peatman. Textbook for students desiring to develop a creative approach design capability through digital systems approach. Answers these question: Under what circumstances it is desirable to implement a system digitally? What are some of the components available for implementing the system? How do we go about designing it? 448 pages. **\$15.50**

31. Solid-State Electronics. Hibberd. A Basic Course for Engineers and Technicians. An extremely practical reference book for anyone who wants to acquire a good but general understanding of semiconductor principles. Features questions and answers, problems to solve. 1968. 169 pp. **\$9.95**

32. Circuit Design for Audio, AM/FM, and TV. Texas Instruments. Texas Instruments Electronics Series. Discusses the latest advances in design and application which represent the results of several years research and development by TI communications applications engineers. Emphasizes time- and cost-saving procedures. 1967. 352 pp. **\$14.50**

35. An Alphabetical Guide to Motion Picture, Television, and Videotape Productions. Levitan. This all-inclusive, authoritative, and profusely illustrated encyclopedia is a practical source of information about techniques of all kinds used for making and processing film and TV presentations. Gives full technical information on materials and equipment, processes and techniques, lighting, color balance, special effects, animation procedures, lenses and filters, high-speed photography, etc. 1970. 480 pp. **\$24.50**

40. Radio Transmitters. Gray and Graham. Provides, in a logical, easy-to-understand manner, a working knowledge of radio transmitters for quick solution of problems in operation and maintenance. 1961. 462 pp. **\$16.00**

23. Wide Screen Cinema & Stereophonic Sound. M.Z. Wystozky. First published in USSR in 1965 this excellent English translation covers wide gauge films, panoramic films, circular panoramic cinematography; technical fundamentals of stereo sound recording for film, as well as details of the Soviet systems now in use. 284 pages. **\$15.00**

33. Noise Reduction. Beranek. Designed for the engineer with no special training in acoustics, this practical text on noise control treats the nature of sound and its measurement, fundamentals of noise control, criteria, and case histories. Covers advanced topics in the field. 1960. 752 pp. **\$19.50**

27. Noise & Vibration Control. Edit. by Leo L. Beranek. Practical design and regulatory information; formulas, choice of materials and structures, city codes and hearing protection; indispensable for design engineers, public officials who prepare regulations for noise control, safety and environmental engineers involved in noise and vibration controls. Covers data analysis, transmission of sound, psychophysiological design criteria, hearing damage risk, etc. Wealth of detail, comprehensive index and concise appendices. 650 pages. **\$29.50**

28. Environmental Acoustics. Leslie L. Doelle. Applied acoustics for those in environmental noise control who lack specialized acoustical training. Basic information in comprehensible and practical form for solving straightforward problems. Explains fundamental concepts; pure theory minimized. Practical applications stressed, acoustical properties of materials and construction listed, actual installations with photos and drawings. Appendixes illustrate details of 53 wall types and 32 floor plans and other useful data. 246 pgs. **\$18.50**

21. Acoustics—Room Design and Noise Control. Michael Rettinger. 1968. The enormous problems and hazards presented by noise are dealt within an orderly and practical manner. With many charts, graphs, and practical examples, the text covers the physics of sound, room acoustics, and design, noise and noise reduction. 392 pages. **\$17.50**

22. Acoustics of Studios and Auditoria. V.S. Mankovskiy. Basic theory plus a mass of design data covers the field with special reference to studios and places of public performance. For acoustical designers and specialists in sound transmission in cinema and broadcasting. Features exhaustive treatment of studio acoustics by the statistical, geometric and wave methods in parallel. 416 pgs. **\$15.00**

Sagamore Publishing Company, Inc.
980 Old Country Road,
Plainview, N.Y. 11803

Please send me the books I have circled below. My full remittance in the amount of \$_____ is enclosed. N.Y. State residents add 7% sales tax.

1	2	3	4	5	6	7	8	9	10	11
12	13	14	15	16	17	18	19	20		
21	22	23	24	25	26	27	28	29		
30	31	32	33	34	35	36	37	38		
39	40									

Name _____

Address _____

City _____

State _____ Zip _____

Special Instructions _____

Canada and foreign: Add \$1.00 per book

CLASSIFIED

Closing date is the tenth of the second month preceding the date of issue.

Send copy to: Classified Ad Dept.

db, The Sound Engineering Magazine
980 Old Country Road, Plainview, N.Y. 11803

Rates are payable in advance and are 50¢ a word for commercial advertisements. Non-commercial and employment offered or wanted placements are 25¢ a word. The count should include addresses and telephone numbers. These rates apply only to standard style and type size classifieds.

FOR SALE

SOLID-STATE AUDIO PLUG-IN OCTAL (1" Dia x 2" H) modules. Mic preamps, disc & tape preamp-equalizers, tape bias osc. & record ampl., power amps & power supplies. Send for free catalog and audio applications. **Opamp Labs., 172 So. Alta Vista Blvd., Los Angeles, California 90036.**

NEW YORK'S LEADING supplier of professional recording equipment and hi-fi stereo components. All major brands in stock. Call for quote—sales—service—leasing—trade-ins. **Martin Audio, 320 West 46th Street, New York, N.Y. 10036. Telephone: (212) 265-6470.**

AMERICA'S LARGEST SELECTION of new and used broadcast and recording equipment! Latest bulletins available. **The Maze Corporation, P.O. Box 6636, Birmingham, Ala. 35210.**

WHATEVER YOUR EQUIPMENT NEEDS—new or used—check us first. Trade your used equipment for new. Write for our complete listings. **Broadcast Equipment & Supply Co., Box 3141, Bristol, Tenn. 37620.**

SOLID-STATE AUDIO MODULES. Console kits, power amplifier kits, power supplies. Octal plug-ins—mic, eq, line, disc, tape play, tape record, amplifiers. Audio and tape bias oscillators. Over 50 audio products, send for free catalog and applications. **Opamp Labs. Inc., 172 So. Alta Vista Blvd., Los Angeles, Ca. 90036. (213) 934-3556.**

PAPER AND PLASTIC LEADER TAPE. One quarter to two inches. Splicing tape two inches to one quarter. All materials for recording and duplicating firms. Free Catalog. **Tapemaker, 2255 Broadway, New York, N.Y. 10024. (212) 874-0800.**

HAECO announces complete repair service and overhaul for all Westrex cutterheads. Conversions of 3D-II and older models to higher performance standards and reliability. Helium cooling systems and hi-temp oils can protect your investment. Repair insurance program available. Rapid service. Lower cost. **HAECO, 14110 Aetna, Van Nuys, California 91401.**

SCOTCH 150, AMPEX 600 SERIES, REEVES SOUNDCRAFT. One mil Mylar 3600 feet in 10½ inch Fiberglas reel; no boxes, bulk packed 30 reels to a carton; slightly used in Government application but in excellent condition. Original ¼-inch width, not reslit: \$2.50 per reel. Quantity price breaks on request. Will wind to 3-, 5-, 7-inch reels. **Accurate Sound Corporation, Box 2159, Garland, Texas 75041.**

ONE STOP FOR ALL your professional audio requirements. Bottom line oriented. **F.T.C. Brewer Company, P.O. Box 8057, Pensacola, Florida 32505.**

STELLAVOX PORTABLE TAPE RECORDER. 1½ years old, hardly used, completely reworked at factory November 1971. Has 7.5 in/sec stereo head assembly, synchrotone equipped with built-in crystal. Accessories include 10½ inch reel adaptor, power supply/charger, nicads, cables, leather carrying case. Sacrifice: \$1850.00. Call **(212) 533-4012 days.**

FOR SALE: USED AUDIO EQUIPMENT. We are cleaning our studios of many usable items. Write for the list. **Master-tone Recording Studios, 130 West 42 Street, New York, N.Y. 10036.**

SCULLY TAPE RECORDERS—one to twenty-four track and model 270 auto players, many models in stock for immediate delivery. SCULLY LATHES—Previously owned and rebuilt. Variable or automatic pitch. Complete cutting systems with Westrex heads. MIXING CONSOLES—Custom designed using Weigand Audio Lab modules. From \$7,000.00. **Weigand Audio Laboratories, R.D. 3, Middleburg, Pa. 17842. Phone (717) 837-1444.**

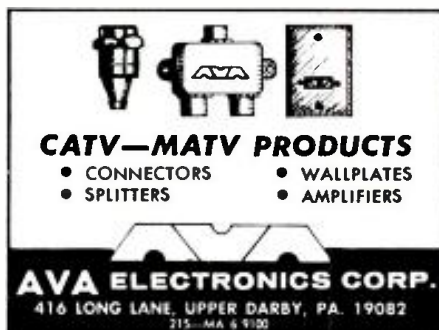

CATV—MATV PRODUCTS

- CONNECTORS
- WALLPLATES
- SPLITTERS
- AMPLIFIERS

AVA ELECTRONICS CORP.
416 LONG LANE, UPPER DARBY, PA. 19082
215-464-6100

AMPEX PARTS AND HEAD REPLACEMENTS. Complete inventory of replacement parts for Ampex 300 and AG 440 equipment. New and used recording equipment. Write for catalog. **Accurate Sound Corporation, Box 2159, Garland, Texas 75041.**

SCHOEPS CMT-56 MICROPHONES. Demonstrators. Three pattern type, cardioid, bi-directional, omnidirectional. +48 volt powering: \$275 (cost new \$377). **Gately Electronics. (215) 446-1415.**

EQUIPMENT FOR COMPLETE EIGHT TRACK STUDIO. Quad-8 console, 3M eight track, JBL 4320 monitors, EMT reverb, UREI limiters. Marantz amps, Neumann mics, etc., etc. Equipment is approximately eighteen months old. Has had long loving maintenance and is in excellent condition. For complete information write or call (collect) **David Freese, Watermark, Inc., 931 N. La Cienega, Los Angeles 90069. (213) 659-3834.**

FOR SALE: SCULLY 288-16, full 16-track 3 head recorder, excellent condition with many extras and spare parts, including 2 syncmaster controls, spare capstan motor. Fully guaranteed, cost new over \$27,000. Will accept best offer. **Sigma Sound Studios, 212 North 12th Street, Philadelphia, Pa. 19107. Phone (215) 561-4488.**

EMPLOYMENT

POSITION OPEN: Chief location film sound recordist with some mixing and studio recording responsibilities. Must have professional experience. **Maryland Center For Public Broadcasting, Bonita Avenue, Owings Mills, Md. 21117. Phone (301) 356-5600, extension 264 or 386.**

EXPERIENCED ENGINEER in 8 and 16 track recording and mixing. Limited electronic and maintenance experience seeking employment in small studio anywhere in California. **Box 704, Mill Valley, Ca. 94941.**

REPRESENTATIVES WANTED: Broadline manufacturer of radio broadcast equipment needs established representatives to call on radio stations, schools, and audio sound. May work on commission basis or act as distributor. Most areas open. **Box 6A, dB Magazine, 980 Old Country Road, Plainview, N.Y. 11803.**

PEOPLE, PLACES, HAPPENINGS



● **William L. Cara** has joined **JBL** as national sales manager for the musical products division. He will be responsible for all JBL musical products marketing programs, dealer and rep relations, seminars and sales meetings. Prior to joining JBL, he was director of marketing for **Samuels Engineering**, and before that was vice president and general manager of **Gauss Electro-physics**.

● A renovated barn is the housing for **Bruce Patch Productions** of Framingham, Mass. Located on eight acres of land, all of the original barnboards were used in the construction. Inside it is all modernity. It is a sixteen-track studio fully equipped with **3M** machines and featuring the latest **Automated Processes** consoles with quadraphonic mixdown capability, and **dbx** noise-reduction systems. The actual location of the new studio is Fayville, about 25 minutes west of downtown Boston.

● Separate announcements from **Altec**: First, the parent corporate name has been changed from **LTV Ling Altec** to **Altec Corporation**. This action was approved by the stockholders. Altec Corporation is no longer a subsidiary of **Ling-Temco-Vought**. Altec Corporation is traded on the **AST** under the symbol **ALE**.

The second announcement tells of the fact that two Altec men, **Don Davis** and **Bart N. Locanthi** of the Altec Division of Altec Corporation, were awarded Fellowships of the **Audio Engineering Society** at the recent convention held in Los Angeles. Both men have been long active in the **AES**. Don Davis was formerly western vice president.

● Changes in the **RCA broadcast division** make **J. Edgar Hill** the new division vice president. Mr. Hill was formerly manager of international sales for the **RCA communications system division**. He is succeeding **Edwin C. Tracy** who has become division vice president, western broadcast region, a new post. The new post is in Hollywood, California; Mr. Hill remains at Camden, N.J.

● **KORJ FM** in Orange, California reports the naming of **Norris "Ace" Simpson** to the position of chief engineer. He comes to the station from similar positions at other stations in the southern California area. The report tells us that Mr. Simpson speaks fluent "non technical". Those within the organization not conversant with ohms, capacitors, and the like will delight in an ability to carry on two-way conversations with Ace.

● An announcement from **TEAC Corporation** tells of the continued growth of the company and its diversification. Of particular interest to audio pros is the formation of **Tascam Corporation** in this country. Tascam is a derivative of **Teac Audio Systems Corporation**, a Japanese subsidiary that has been in full operation since February of this year. Located just outside Tokyo, the facility is devoted to the manufacture of special audio products that will not be mass produced, and are aimed at the professional audio market. The plant produces such items as broadcast consoles, studio mixing consoles, and 1/4-inch and 1/2-inch tape machines.

● **Bill Wilson** has announced his resignation from the **Mincom division of 3M** to form **B.W. Associates**; a professional audio consulting, sales, and service organization in Chicago, Ill. Mr. Wilson was Mincom's East Coast field engineer for the past three years, and had last represented them this past fall at the **AES Convention's Workshop** on Studio Tape Recorders.



● **Thomas R. Humphrey** has been elected to the position of vice president at **McMartin Industries, Inc.**, in charge of engineering. Prior to joining **McMartin** in 1969, he had been director of product engineering at **Visual Electronics Corp.** He is the developer of a remote control system for transmitters, and was chosen to work in the laboratory of the late **Major Edward Armstrong**. In addition to twenty years in broadcast station operation, he was, at one time, with **RCA International, Gates Radio, and Trylon, Inc.**, all in marketing positions.

● An announcement from **Acoustic Research** indicates that **Victor Amador** has been named president of **Acoustic Research** according to **C. Gus Grant** vice president and consumer group executive of the parent **Teledyne, Inc.** Mr. Amador replaces **Abraham J. Hoffman** who has been appointed chairman of the board at **AR**. Mr. Amador comes to **AR** from the **McDonald division of BSR (USA) Ltd.**, where he had been for the past six years.

● **Robins Industries Corp.**, parent of **Fairchild Sound** has acquired a 50,000-square-foot plant in Commack, Long Island, N.Y. in the Commack Industrial Park. In the announcement by **Herman D. Post**, president of **Robins**, it was stated that the company is presently in the process of relocation. He said that major considerations in the acquisition were its efficient layout and space for expansion, with high-ceilinged, one-story configuration. Parking facility, loading docks, and access to major highways were also a factor.



A
unique
and
innovative
service

TeleSessions

exclusively for **db** readers

How many times have you read an unusually stimulating article in **db** and wished you could trade ideas with others involved in that area? (People who share your problems and speak your language, who are full of surprising insights and new ideas.)

Although group discussions like this happen at conferences, and at chance meetings, our readers have been telling us they want it to happen more often and more conveniently.

THE ELECTRONIC MEETING

Now, without leaving your desk, you can have this kind of valuable, informal discussion. Without the time and expense of travel, either. Group telephone conferences are held in connection with selected **db** articles—and we keep each group *small*. For articles that generate tremendous TeleSession* interest, we'll schedule as many separate small group sessions as required.

So readers most interested in each article can dial into an hour-long, freewheeling discussion and build on each other's ideas. TeleSession Company provides the unique telephone conference system that repeals geography. Our editors pick the topics and invite authors or guest experts—whenever appropriate.

A SURPRISING EXPERIENCE

You'll find this specially engineered conference system and the group dynamics different from any "conference call" you may have experienced. You dial in over ordinary phone lines from *anywhere* in the country you happen to be at session time. You're greeted by a session host who introduces everyone and gets things started. Everyone on the line can ask questions, explore ideas (it's amazing how one new idea leads to another), or just listen.

You'll find, even in your first few minutes, that **db** TeleSessions are more interactive and informal than face-to-face discussions. You always know who's talking, because participants say their first names. You drop formalities and simply chime in whenever you have a comment. Yet there are surprisingly few interruptions.

The result is a stimulating and orderly discussion. We've discovered that the participants are willing to reveal the best of their knowledge and ask questions when they don't know something. So what you get is a chain reaction of ideas. One person's knowledge complements everyone else's—though each person forms his own conclusions. Complete strangers end up talking as though they've known each other for years—and wanting to call on each other's expertise again.

So far, there've been over 700 TeleSessions.

HOW TO RESERVE YOUR TELESESSION "SEAT"

Whenever you find a **db** article especially intriguing that is marked for TeleSession discussion, we hope you will accept our invitation to participate with others who feel the same way. Simply fill out the reservation card and mention the topic for which you wish to reserve a "seat". We'll promptly reserve a line for you and advise you of your group's scheduled date and time. (If the time we send you conflicts with your schedule you may call 212/725-2525 and we'll immediately give you an alternate.)

Be sure to mark the scheduled meeting hour we send you in your appointment book; then when your session time arrives simply place a station-to-station call from wherever you are that day to 212/725-2525. Your session host will greet you and then after a few informal introductions you'll find yourself in one of the most productive meetings you've ever experienced.

Wherever you are that day, you can fit the Tele Session hour into whatever you're doing. There's no time lost, no travel or lodging expense.

THE COST

We think the fresh viewpoints you share in the first session will prove this to be the most cost-effective form of consulting you ever experienced. It's just thirty dollars for each TeleSession, plus the cost of your simple station-to-station phone call. You may cancel up to five days before the session or have someone else take your "seat." If for any reason your **db** TeleSession isn't everything we've said it is, merely state the reason for your disappointment on the invoice, return it and owe nothing.

A MAGAZINE WITH AN INTERACTIVE FEEDBACK SYSTEM

A provocative article. A small interdisciplinary group of professionals like you. A uniquely stimulating and convenient meeting environment. You owe it to yourself to give it a try. We look forward to welcoming you. Pick one of the articles marked for TeleSession and send in the attached card.

Announcing the recorder with 10 times normal head life.



**How the Norelco Pro 36
Studio Recorder keeps its
heads when all about
are losing theirs.
(And their sound quality too.)**

Conventional recording and playback heads wear out within a couple of thousand hours of use. But long before then, their electrical characteristics change . . . so your sound changes too. With the Pro 36 studio tape recorder, these problems are non-existent.

Reason: Norelco's exclusive glass-bonded Ferroxcube heads. Made of material almost diamond-hard, they take 10 times the wear of conventional heads. But that's not all. The unique glass-bonded construction maintains precise gap width and electrical characteristics in spite of wear. Amplifier adjustments are virtually never needed. And precision head mounting also makes azimuth adjustment a thing of the past.

The rest of the Pro 36 lives up to the heads. It's the only professional tape recorder with 3 speeds. You get 15, 7½ and 3¾ IPS. Electronically switchable.

Then there's the new ultra-stable Servo tape transport control. A photocell counts capstan revolutions, compares them to line frequency, (or external 1 volt reference source) and provides instantaneous speed-correction signals. To this, Norelco adds constant capstan loading. Plus automatic tape tension control. All together, they hold wow and flutter down to 0.04% maximum.

Other features: total remote control, push-button semiconductor switching, NAB and CCIR equalization, provision for fourth head, controlled tape lifters, horizontal or vertical operation, and much more.

Every broadcast studio, production studio, and sound studio deserves the tape recorder that keeps its head... so you won't lose yours. The Pro 36! Contact Norelco for all the technical data now.

PERFORMANCE SPECIFICATIONS

Wow and Flutter:

weighted peak value at 15 in/s: max. 0.04%

Overall Frequency Response (NAB Specs):

at 15 in/s: 30 . . . 15,000 Hz +2 dB

at 7½ in/s: 30 . . . 15,000 Hz ±2 dB

at 3¾ in/s: 50 . . . 10,000 Hz +2 dB

Signal-to-Noise Ratio: NAB unweighted (reference standard operating level)

62 dB at 15 in/s

60 dB at 7½ in/s

56 dB at 3¾ in/s



Glass-bonded Ferroxcube heads make possible an incredibly precise gap width and hold that precision throughout a wear life 10 times longer than conventional heads. The Pro 36 is the only studio tape recorder that has them.

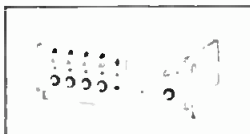
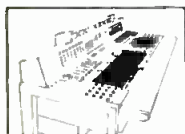

One Philips Parkway, Montvale, N.J. 07645 (201) 391-1000

Circle 12 on Reader Service Card