

# Review of Stereo Techniques

ICD

# audiocraft

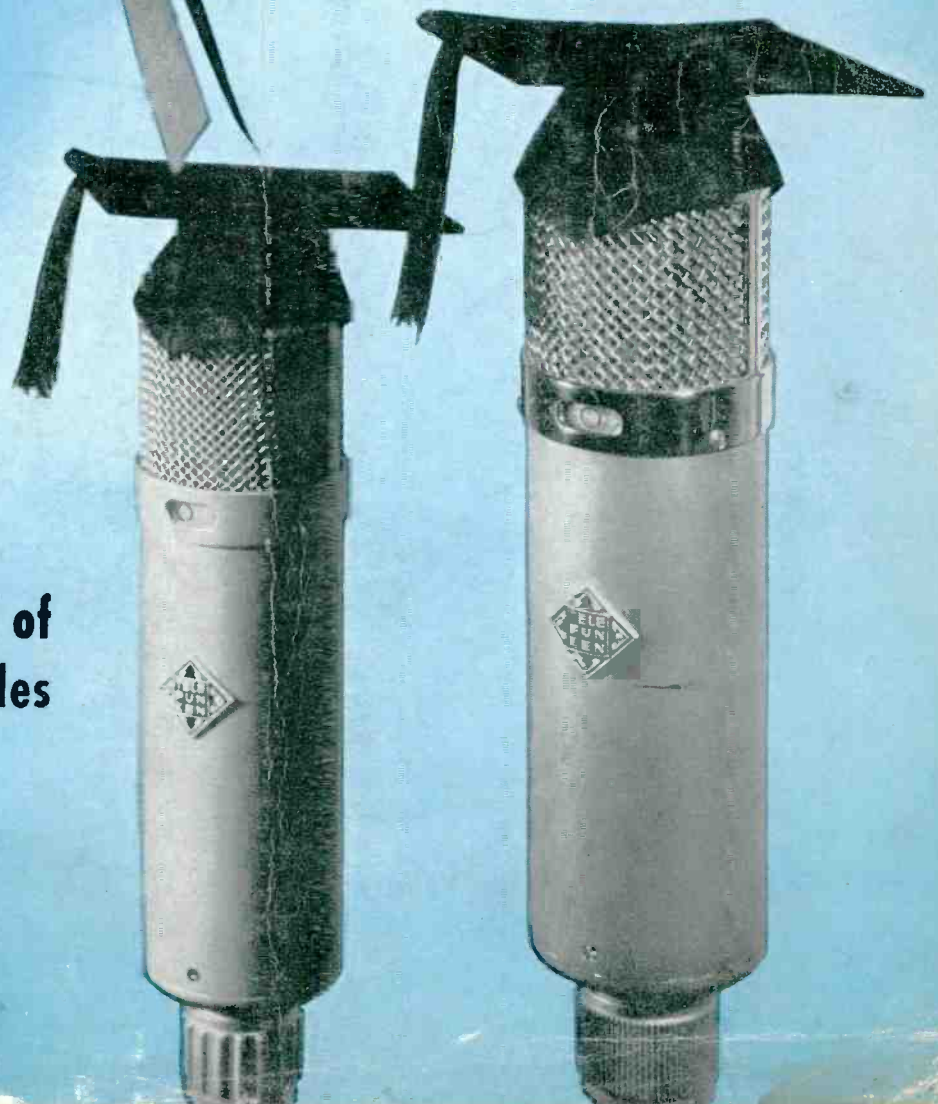
for the **HI-FI** hobbyist

JUNE 1958 • 35 CENTS

**Audiolab Test Reports:**  
ESL C-60, Thorens TD-124

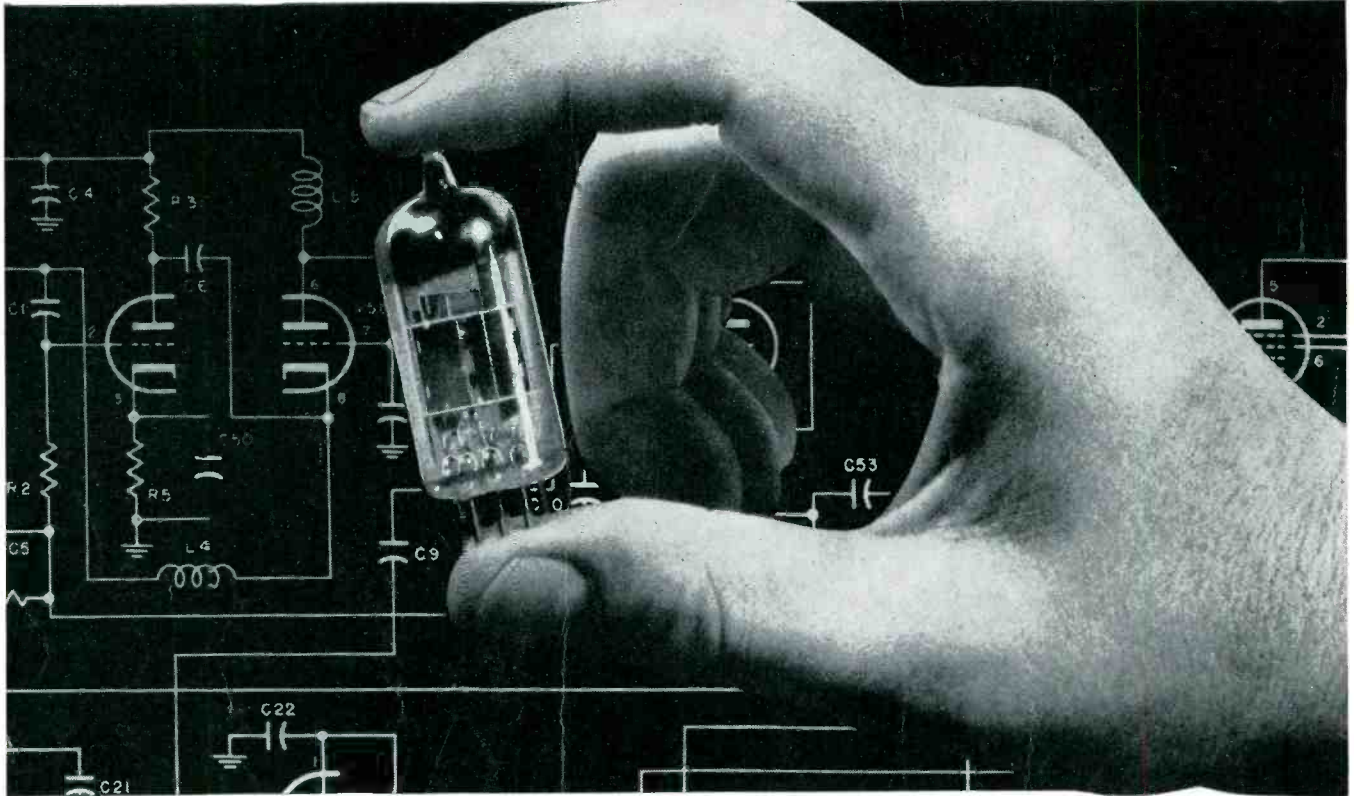
**How to get rid of  
hum, hiss, crackles**

**Building the Bozak  
E-300 enclosure kit**





# WHY DOES THE FISHER



# USE A GOLD CASCODE?



THE FISHER FM-90X

### Everybody Knows...

that only Gold Cascode RF amplification brings FM sensitivity to the theoretical limit, allowing reception at tremendous distances.

**Only FISHER has it!**

### Everybody Knows...

that four IF Amplifier stages are necessary for maximum bandwidth coupled with maximum selectivity, plus a vast increase in gain.

**Only FISHER has it!**

### Everybody Knows...

that Zero-Time-Constant, Dual-Dynamic Limiters operate instantaneously, eliminating any possibility of impulse and random noise.

**Only FISHER has it!**

### Everybody Knows...

that two tuning meters permit micro-accurate tuning plus orientation of the antenna for highest possible signal strength.

**Only FISHER has it!**

**Everybody Knows...** that only a GOLD CASCODE FM tuner CAN be *the* best! And the world's *only* FM tuners using the costly GOLD CASCODE are those made by FISHER. No amount of wild claims by envious competitors can change that simple fact! The costly GOLD CASCODE achieves the *highest possible gain* with the *lowest possible noise*, accounting for its amazing sensitivity. Its inherent gain is *twice* that of the RF tubes used in other FM tuners. On this type of tube, with its gold-plated grid—and *ONLY* this type of tube—is it possible to have the *microscopically small gap* between grid and cathode necessary to achieve absolute-maximum sensitivity.

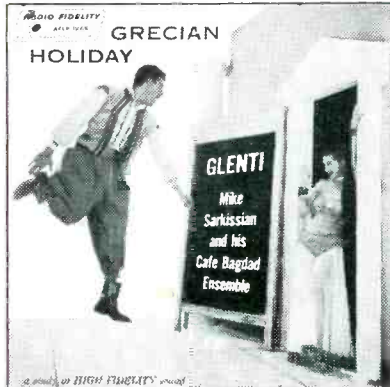
You can *spend* more, but you cannot *buy* a finer instrument than a FISHER GOLD CASCODE tuner. The superior claims made for FISHER tuners are based on actual production units *exactly like the one you can buy*, not on a hand-tailored 'laboratory-pet' sample. Listed at the left are *other* important features, found *ONLY* in THE FISHER. If you have any doubt about the superiority of FISHER tuners, ask your dealer to permit a home trial, under identical conditions, alongside *any other make of tuner, regardless of price*. YOU be the judge!

WRITE TODAY FOR COMPLETE SPECIFICATIONS

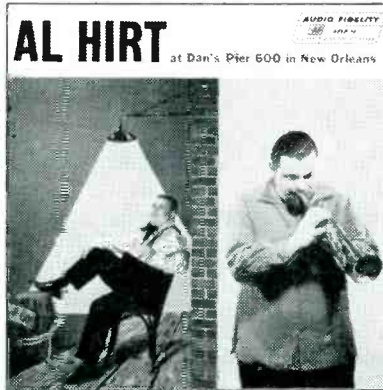
**FISHER RADIO CORPORATION**  
21-31 44th Drive • Long Island City 1, N. Y.



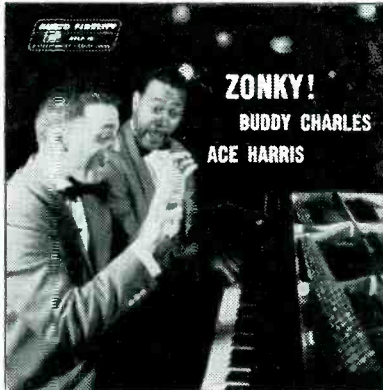
AFLP 1859



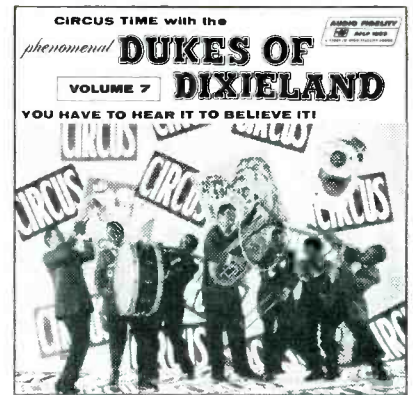
AFLP 1866



AFLP 1877



AFLP 1876



AFLP 1863



AFLP 1873



AFLP 1867

each 12 inch LP — \$5.95



*music  
for your  
every mood!*

# AUDIO FIDELITY®

*total frequency range recordings*

Hot music . . . sweet music . . . music of foreign lands —

all yours to enjoy in brilliant hi-fi on AUDIO FIDELITY records.

- CIRCUS TIME with the DUKES OF DIXIELAND Kids from 6 to 60 will be "under the Big Top" with the Dukes latest album of traditional circus marches. Volume 7 AFLP 1863
- SUTTON PLACE SOUTH Moonlight, champagne and lush strings! Mood music for a penthouse romance. AFLP 1873
- TURKISH DELIGHT Tempestuous, bewitching, alluring music of the exotic Middle East. Featuring Mike Sarkissian. AFLP 1867
- AL HIRT at Dan's Pier 600 New Orleans top performer in true Swinging Dixie in the finest New Orleans tradition! AFLP 1877
- "ZONKY" Ace Harris and Buddy Charles really rock that piano with solid interpretations of old time standards. AFLP 1876
- JOHNNY PULEO and His HARMONICA GANG A terrific new follow-up album of easy-swinging favorites. Volume 2 AFLP 1859
- GRECIAN HOLIDAY Fascinating, rhythmic traditional Greek melodies Featuring Mike Sarkissian & the Ensemble. AFLP 1866

WRITE FOR FREE CATALOG • AUDIO FIDELITY, INC • 770 Eleventh Avenue • New York 19, New York



Save yourself time and trouble  
by ordering your books directly from us.  
Just fill in the coupon below.



# audiophile's bookshelf

## RECORDS IN REVIEW — 1957

Edited by Joan Griffiths. This, the third HIGH FIDELITY Annual, contains over 900 reviews of classical and semi-classical music, and the spoken word, that have appeared in HIGH FIDELITY Magazine from July 1956 through June 1957. It includes both LPs and tapes. \$4.95 **257**

## THE McPROUD HIGH FIDELITY HANDBOOK

Edited by C. G. McProud, Publisher of AUDIO. A volume of well-chosen articles written by hi-fi experts in almost every phase of the field. Here is a wealth of ideas, how-tos, what-tos, and when-tos, that the nontechnical hi-fi enthusiast can appreciate. The articles run from a light dissertation on the theory of Hi-Fi-Manship to serious thoughts about cabinet dimensions and soldering cables and connectors. Paper, \$2.50 **268**

## MAINTAINING HI-FI EQUIPMENT

By Joseph Marshall. A much needed book on the specialized approach necessary to service high-fidelity equipment. The author discusses not only electronic faults, but the mechanical and acoustical defects which cause a hi-fi system to function less than perfectly. The book is clearly written and well indexed. Hard cover, \$5.00 **232**  
Soft cover, \$2.90 **233**

## UNDERSTANDING HI-FI CIRCUITS

By Norman Crowhurst. Here the audiophile will find the answers to questions often confusing. The chapters are: special output stages, feedback, damping, inverter and driver stages, input stages, matching, equalization, speaker distribution and crossovers, loudness and volume controls, tone controls. Hard cover, \$5.00 **254** Soft cover, \$2.90 **255**

## HIGH FIDELITY: A PRACTICAL GUIDE

By Charles Fowler. Here is *the* book for the beginner — one that neither under- nor overrates his knowledge or ability to understand high fidelity. With unusual clarity and in just the right amount of detail it explains the principles involved and their application. Thus the reader is able to exercise an informed and reasoned judgment as to what would best suit his own taste, his available space, and his purse — in building, in buying, or in adding to his high-fidelity system. In short — a complete, intelligible, and literate exposition for the novice high fidelitarian. \$4.95 **234**

### Just Published

## RECORDED JAZZ: A CRITICAL GUIDE

By Rex Harris and Brian Rust

Paper cover, 85¢ **269**

*A quick and easy way to find  
the reference you want exactly  
when you want it —*

## HIGH FIDELITY:

## A Bibliography of Sound Reproduction

Compiled by K. J. Spencer

Foreword by G. A. Briggs

This new book, imported in a limited quantity from England and available in this country only through the publishers of AUDIOCRAFT Magazine, is a volume whose value to everyone seriously interested in high fidelity need not be outlined.

It contains approximately 2,600 entries that represent the whole field of published information and research on high quality sound reproduction, from the subject's very early days up to and including June 1957. The world literature on sound reproduction, which happens to be mainly English and American, is here cited with the result that a specialized work of reference is now available for all who wish to be able to consult, quickly and easily, what has been published on every aspect of the subject from Definitions to Maintenance. Supplements are planned to be published from time to time. \$6.00 **271**

### Audiocraft's Annual

#### FM STATIONS UP-TO-DATE

Here, in convenient booklet form, is a complete geographical listing of FM stations in the United States and Canada, accurate to January 2, 1958. The list was compiled directly from FCC records, and originally appeared in AUDIOCRAFT Magazine.

Only a limited number of copies of *FM Stations Up-to-Date* are available, so, to be sure of getting one, place your order soon. The price is only 50¢. **270**

Book Department

AUDIOCRAFT Magazine  
Great Barrington, Mass.

I enclose \$..... for which please send me, postpaid, the books indicated by circled numbers below. (No C. O. D.'s or charge orders, please.) Foreign orders sent at buyer's risk. Add 55¢ per book for postage on foreign orders except Canadian.

Binder 1 (holds 14 issues)	<b>223</b>	\$3.50	
Binder 2 (holds 12 issues)	<b>245</b>	\$3.00	<b>255</b>
Unmarked binders	<b>265</b>	\$2.75 ea.	<b>223 257</b> <b>232 265</b> <b>233 268</b> <b>234 269</b> <b>245 270</b> <b>254 271</b>
NAME .....			
ADDRESS .....			

THIS MONTH'S COVER: To honor the graduation of stereo into your home and mine, we confer upon this blossoming enterprise our highly coveted BS (Bachelor of Sound) degree.  
Cover by Phil Geraci

<b>Roy F. Allison</b> Editor	<b>Charles Fowler</b> Publisher
<b>Eleanore B. Wright</b> Assistant to the Editor	<b>Warren B. Syer</b> Associate Publisher
<b>Philip C. Geraci</b> Associate Editor	<b>Claire Eddings</b> Advertising Sales Manager
<b>Eleanor Gilchrist</b> Art Assistant	<b>Andrew J. Csida</b> Marketing and Merchandising Manager
<b>R. D. Darrell</b> <b>J. Gordon Holt</b> <b>Joseph Marshall</b> Contributing Editors	<b>Lee Zhitto</b> Western Manager



THE MAGAZINE FOR THE HI-FI HOBBYIST

**JUNE 1958**

Volume 3 Number 6

<b>The Grounded Ear</b> <i>What's new in sound reproduction</i>	<b>4</b>	<i>Joseph Marshall</i>
<b>Book Reviews</b>	<b>6</b>	<i>Richard D. Keller</i>
<b>Audionews</b>	<b>12</b>	
<b>Readers' Forum</b>	<b>14</b>	
<b>Editorial</b> <i>Tape should be compatible, too</i>	<b>15</b>	
<b>Stereo System Techniques</b> <i>The outlook for stereo on tape, disc, radio, and TV</i>	<b>16</b>	<i>Joel Ebrlich</i>
<b>Kill That Noise</b> <i>How to rid your system of bothersome hum and hiss</i>	<b>18</b>	<i>Harold Reed</i>
<b>The Bozak E-300 Enclosure Kit</b> <i>An AUDIOCRAFT kit report</i>	<b>22</b>	
<b>Audiolab Test Reports</b> <i>This month: ESL C-60 cartridge, ESL Dust Bug, Thorens TD-124 turntable</i>	<b>26</b>	<i>Hirsch-Houck Laboratories</i>
<b>How to use a Magnetic Cartridge</b> <i>Guides to achieving maximum performance</i>	<b>29</b>	<i>Herman Burstein</i>
<b>Transistors in Audio Circuits</b> <i>Part Xb: output stages</i>	<b>30</b>	<i>Paul Penfield, Jr.</i>
<b>Tape News and Views</b> <i>Why bias is important</i>	<b>32</b>	<i>J. Gordon Holt</i>
<b>Puzzlements</b> <i>How do you pick a dividing network?</i>	<b>34</b>	<i>Norman H. Crowhurst</i>
<b>Sound-Fanciers' Guide</b> <i>Reviews of exceptional tape and disc records</i>	<b>36</b>	<i>R. D. Darrell</i>
<b>Audio Aids</b> <i>Short cuts for the experimenter</i>	<b>38</b>	
<b>Electronic Firsts</b> <i>Early impedance matching</i>	<b>40</b>	<i>Monroe Upton</i>
<b>Traders' Marketplace</b>	<b>45</b>	
<b>Professional Directory</b>	<b>46</b>	
<b>Advertising Index</b>	<b>48</b>	

**ADVERTISING**

**Main Office** — Claire Eddings, The Publishing House, Great Barrington, Mass. Telephone: Great Barrington 1300.

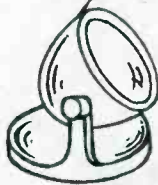
**New York** — 1564 Broadway, New York 36. Telephone: Plaza 7-2800.

**Chicago** — John R. Rutherford & Associates, Inc., 230 East Ohio St., Chicago 11, Ill. Telephone: Whitehall 4-6715.

**Los Angeles** — 1520 North Gower, Hollywood 28. Telephone: Hollywood 9-6239.

**Audiocraft** Magazine is published monthly by Audiocom, Inc., in Great Barrington, Mass. Telephone: Great Barrington 1300. Editorial, publication, and circulation offices at: The Publishing House, Great Barrington, Mass. Subscriptions: \$4.00 per year in the United States and Canada. Single copies: 35 cents each. Editorial contributions will be welcomed by the editor. Payment for articles accepted will be arranged prior to publication. Unsolicited manuscripts should be accompanied by return postage. Entered as second-class matter October 1, 1955, at the post office, Great Barrington, Mass., under the act of March 3, 1879. Additional entry at the post office, Pittsfield, Mass. Printed in the U. S. A. by the Ben Franklin Press, Pittsfield, Mass. Copyright 1958 by Audiocom, Inc. The cover design and contents of Audiocraft Magazine are fully protected by copyrights and must not be reproduced in any manner.

# The Grounded Ear



by Joseph Marshall

## Distortion and Loudspeakers

High fidelity began to come of age ten years ago with the acceptance of what is still the fundamental law: that low distortion is the first and most important requirement. Distortion conditions and affects all other qualities, including both the real and apparent frequency response of a system. High distortion may make a wide frequency response intolerable, or, on the other hand, it may so confuse the real frequency response that it appears to the ear to be narrower or broader than it really is.

This is particularly true of loudspeaker systems, as I was dramatically reminded recently. Yet, although no one who knows anything at all about high fidelity would buy an amplifier without inquiring about its distortion characteristics, few people—even the experts—consciously stop to consider the distortion characteristics of loudspeaker systems. And, while every manufacturer of repute gives distortion figures for amplifiers, distortion figures for speaker systems are almost unavailable.

There are some good reasons for this, among them the fact that it is difficult to measure speaker distortion and even more difficult to design and produce speakers with low distortion. Furthermore, in comparison with the fraction-of-1% distortion of amplifiers, the 5% distortion of a fine loudspeaker system seems scarcely worth boasting about.

These reflections were stimulated by a seeming paradox which developed when I was testing several types of compact speaker systems for stereo use. Among them was a pair of AR-2 speakers, which are slightly smaller and much cheaper than the remarkable AR-1. The frequency response of the AR-2 is not particularly remarkable, unless you consider its size. The resonant point is 58 cps and the response is firm down to

about 40 cps; there is response down to 30 cps, but it is audible only at high input levels, and for normal listening the response really stops somewhere between 35 and 40 cps. There are many systems, both large and small, whose claimed or casually measured curves will match that of the AR-2 within a db or two. The paradox is that in comparison with most of these the AR-2, on musical material, seems to have response about an octave lower.

Drums, for example, sound considerably deeper on the AR-2 and less tautly stretched. The AR-2, like most other systems, has practically no response to the fundamental of the lowest octave of the organ pedal—below 30 cps. Yet, when program material containing such notes is fed into it, the AR-2 sounds as though it were responding and, in any event, is much closer to the sound of the very few systems that do have any respectable response below 30.

Similarly, the bass viols seem to be playing one octave lower when they are at the bottom of their range. This especially doesn't make sense at first, because the range of the double bass is well above 40 cps and consequently would seem to be equally well covered by any speaker which has response above that frequency. What kind of acoustic necromancy does the AR-2 practice?

The answer is obvious if we sweep the speaker systems at a moderate level with a sine-wave generator. On the AR-2 there is no sound whatever when the generator is swept below about 37 cps, although there is still considerable movement of the cone. On most others the system continues to emit considerable sound even when the generator is below 30 cps. The comparison systems are doubling and tripling; what is audible is very largely the second, third, and higher-order harmonic distortion which, indeed, in some cases may run in excess of 50%. On the other hand, the ear does not hear very much actual sound

*What's new for your*

*future in sound*

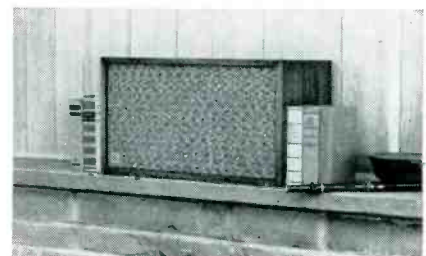
*reproduction?*

below 40 cps except at very high levels, even if the speakers are responding; the relative absence of audible response must be an indication of very low distortion.

A little reflection will show why the low distortion seems to add another octave to the AR-2 or, if you prefer, why distortion takes an octave away from speakers with seemingly similar response curves. Let us take the case of a big bass drum emitting a 45-cps note. That fundamental is accompanied by a lot of harmonics: 90-cps second, 135-cps third, etc. A speaker with little or no distortion maintains the original relationship between the fundamental and the harmonics and thus reproduces the original tone which is dependent on this relationship. A speaker with a lot of distortion increases the apparent amplitude of the harmonics; it may raise the second harmonic to complete dominance. This will make the sound seem higher in pitch. Although both speakers seem to have the same measurable response, high distortion in effect robs one speaker of an entire octave of audible response.

The AR-1 and AR-2 are not, evidently, the only speakers which profit in this way from low distortion. If other speaker systems of highest reputation among the most critical listeners were measured, I suspect it would be found that they, too, are far more notable for their low distortion than for their response in the final bass octave or two. Therefore, it would seem that people who want a speaker system with that "real low-down bass" would do better to inquire into distortion characteristics rather than—or in addition to—frequency response.

*Acoustic Research AR-2 speaker system.*





the experts say... in High Fidelity the best buys

are **EICO**®

**EICO**  
KITS and WIRED

**BETTER ENGINEERING** Since 1945 EICO has pioneered the concept of test instruments in easy-to-build kit form — has become world-famous for laboratory-precision instruments at low cost. Now EICO is applying its vast experience to the creative engineering of *high fidelity*. Result: high praise from such authorities as Canby of AUDIO, Marshall of AUDIOCRAFT, Holt of HIGH FIDELITY, Fantel of POPULAR ELECTRONICS, Stocklin of RADIO TV NEWS, etc. — as well as from the critical professional engineers in the field.†

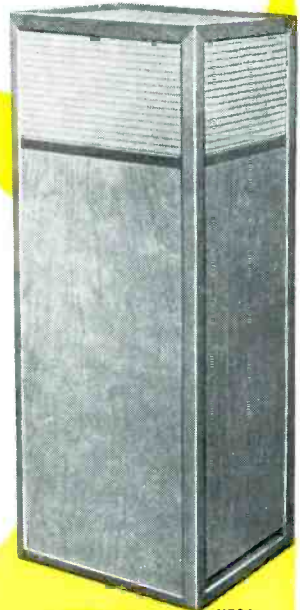
**SAVE 50%** Mass purchasing, and a price policy deliberately aimed to encourage mass sales, make this possible.

**EASY INSTRUCTIONS** You need no previous technical or assembly experience to build any EICO kit — the instructions are simple, step-by-step, "beginner-tested."

**DOUBLE 5-WAY GUARANTEE** Both EICO, and your neighborhood distributor, guarantee the parts, instructions, performance... as well as *lifetime* service and calibration at nominal cost... for any EICO kit or wired unit.

**BEFORE YOU BUY, COMPARE** At any of 1200 neighborhood EICO distributors coast to coast, you may examine and listen to any EICO component. Compare *critically* with equipment several times the EICO cost — then *you* judge. You'll see why the experts recommend EICO, kit or wired, as best buy.

† Thousands of unsolicited testimonials on file.



HFS2 Speaker System



HFT90 FM Tuner with "eye-tronic" tuning



HF61 Preamplifier



HF60, HF50 Power Amplifiers



**HFS2 Speaker System:** Uniform loading & natural bass 30-200 cps achieved via slot-loaded split conical bass horn of 12-ft path. Middles & lower highs from front side of 8½" cone, edge-damped & stiffened for smooth uncolored response. Suspensionless, distortionless spike-shaped super-tweeter radiates *omni-directionally*. Flat 45-20,000 cps, useful to 30 cps. 16 ohms. HWD: 36", 15¼", 11½". "... rates as excellent... unusually musical... really non-directional" — Canby, AUDIO. "Very impressive" — Marshall (AUDIOCRAFT). Walnut or Mahogany, \$139.95. Blonde, \$144.95.

**HFT90 FM Tuner** equals or surpasses wired tuners up to 3X its cost. New, pre-wired, pre-aligned, temperature-compensated "front end" — drift-free. Sensitivity, 1.5 uv for 20 db quieting, is 6X that of other kit tuners. DM-70 traveling tuning eye. Response 20-20,000 cps±1 db. Cathode follower & multiplex outputs. Kit \$39.95\*. Wired \$65.95\*. Cover \$3.95. \*Less cover, excise tax incl.

**HF61A Preamplifier**, providing the most complete control & switching facilities, and the finest design, offered in a kit preamplifier, "... rivals the most expensive preamps..." is an example of high engineering skill which achieves fine performance with simple means and low cost." — Joseph Marshall, AUDIOCRAFT. HF61A Kit \$24.95, Wired \$37.95, HF61 (with Power Supply) Kit \$29.95, Wired \$44.95.

**HF60 60-Watt Ultra Linear Power Amplifier**, with Acro T0-330 Output Transformer, provides wide bandwidth, virtually absolute stability and flawless transient response. "... is one of the best-performing amplifiers extant; it is obviously an excellent buy." —AUDIOCRAFT Kit Report. Kit \$72.95. Wired \$99.95. Matching Cover E-2 \$4.50.

**HF50 50-Watt Ultra-Linear Power Amplifier** with extremely high quality Chicago Standard Output Transformer. Identical in every other respect to HF60 and same specifications up to 50 watts. Kit \$57.95. Wired \$87.95. Matching Cover E-2 \$4.50.

**HF30 30-Watt Power Amplifier** employs 4-EL84 high power sensitivity output tubes in push-pull parallel, permits Williamson circuit with large feedback & high stability. 2-EZ81 full-wave rectifiers for highly reliable power supply. Unmatched value in medium-power professional amplifiers. Kit \$39.95. Wired \$62.95. Matching Cover E-3 \$3.95.

**HF-32 30-Watt Integrated Amplifier Kit** \$57.95. Wired \$89.95.

**HF52 50-Watt Integrated Amplifier** with complete "front end" facilities and Chicago Standard Output Transformer. Ultra-Linear power amplifier essentially identical to HF50. The least expensive means to the highest audio quality resulting from distortion-free high power, virtually absolute stability, flawless transient response and "front end" versatility. Kit \$69.95. Wired \$109.95. Matching Cover E-1 \$4.50.

**HF20 20-Watt Integrated Amplifier**, complete with finest preamp-control facilities, excellent output transformer that handles 34 watts peak power, plus a full Ultra-Linear Williamson power amplifier circuit. Highly praised by purchasers, it is established as the outstanding value in amplifiers of this class. Kit \$49.95. Wired \$79.95. Matching Cover E-1 \$4.50.

Prices 5% higher in the West

**HF12 12-Watt Integrated Amplifier**, absolutely free of "gimmicks", provides complete "front end" facilities & true fidelity performance of such excellence that we can recommend it for any medium-power high fidelity application. Two HF12's are excellent for stereo, each connecting directly to a tape head with no other electronic equipment required. Kit \$34.95. Wired \$57.95.

**HFS1 Two-Way Speaker System**, complete with factory-built cabinet. Jensen 8" woofer, matching Jensen compression-driver exponential horn tweeter. Smooth clean bass; crisp extended highs. 70-12,000 cps ± 6 db. Capacity 25 w. Impedance 8 ohms. HWD: 11" x 23" x 9". Wiring time 15 min. Price \$39.95.

**MAIL COUPON FOR CATALOG**

EICO® 33-00 Northern Blvd., L.I.C. 1, N.Y.  
Show me how to SAVE 50% on professional Test Instruments and High Fidelity.  
Send me free catalog and name of neighborhood distributor.

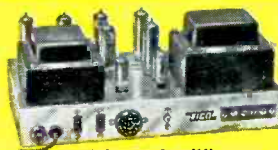
Name .....  
Address .....  
City ..... Zone ..... State ..... AC-6



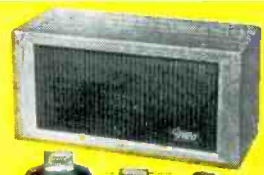
HF52, HF20 Integrated Amplifiers



HF12 Integrated Amplifier



HF30 Power Amplifier



HFS1 Speaker System



33-00 Northern Boulevard, L. I. C. 1, N. Y.  
Over 1 Million EICO instruments in use the world over.

© 1958

by RICHARD D. KELLER



# book reviews

## High Fidelity Sound Reproduction

Ed. by E. Molloy; pub. by George Newness Ltd., London; distributed in the United States by Transatlantic Arts, Inc., Hollywood-by-the-Sea, Florida; 200 pages; \$5.00.

This book brings together contributions from a number of high fidelity experts in England—ten of them altogether—with an introduction by H. J. Leak.

As a general treatise on the subject of high fidelity, it certainly doesn't come up to many of the excellent books already out on that topic. However, any new book should have some contribution to make to the literature in order to justify its existence, and one chapter on electrostatic loudspeakers written by Ralph L. West is one of the best discussions on the subject now available. It is understandable, of course, that a brand new book from England, where considerable effort has been put into the development of electrostatic speakers, would contain much of interest on this subject.

The other chapters cover standard loudspeakers and enclosures, amplifiers and preamps, acoustics, record reproduction, tape recording, and radio reproduction, with a number of schematics of current British radios and amplifiers.

## Television Interference Handbook

Philip S. Rand; pub. by the Nelson Publishing Co., Redding Ridge, Conn.; 56 pages; \$1.75, paper-bound.

This manual should be a boon to radio hams, and to TV engineers, repairmen, and set owners who are plagued with man-made TV-interference problems.

It is packed with good, solid, useful information on the subject and is extremely well illustrated and documented. The author has lectured extensively on the subject and has written numerous articles on TVI in various trade journals during the past ten years.

The manual is the first I know of to bring together so concisely and completely every aspect of this sometimes exasperating problem. Typical chapter headings are: "Sources and Types of TVI," "Locating TVI," "The TV Receiver," "The Radio Transmitter," "Shielding," "High-Pass Filters," "Low-Pass Filters," "Special VHF Problems," and "Medical and Public Utility TVI."

The author, a registered Professional Electrical Engineer, presents both theory and practical solutions, along with photographs of actual TV interference patterns and diagrams of suggested circuits and cures.

The appendix is exceptionally good, with a rundown of FCC regulations on interference, a list of TVI committees throughout the nation, harmonic-frequency tables for all the possible interfering ham bands, and tabulations of picture, sound, and local oscillator frequencies and image bands for the various TV channels; altogether, it is an extremely handy compilation of information for tracking down unwanted signals. Also included in the appendix are several interesting tables on the characteristics of various TV systems now used.

## Electron Tubes and Semiconductors

Joseph J. DeFrance; pub. by Prentice-Hall, Inc., Englewood Cliffs, N. J.; 288 pages; \$9.00.

This book is slanted to technical and trade-school students, and is primarily descriptive and nonmathematical. The author stays strictly on the subject of tube and semiconductor characteristics *per se*, without going into the circuits or applications thereof. Descriptions are lucid, and the book is fully illustrated with graphs, charts, and pictures.

Published in 1958, it is more up-to-date than most on semiconductors and transistors, although here again, of course, the information given is on basic device characteristics and descriptions, not on circuits and applications.

The book is divided into eleven chap-

ters with review questions and problems given after each chapter. The appendix contains electrical data on a number of tubes, transistors, and diodes. For its intended use as an introduction to the basic tools of electronics, the book is nicely executed but rather expensive.

## Introduction to Transistor Circuits

E. H. Cooke-Yarborough; pub. by Interscience Publishers, Inc., New York; 154 pages; \$2.75.

This book has a slightly different emphasis from most elementary or intermediate texts on transistors.

It begins with the basic material on semiconductor and transistor theory, and chapters on equivalent circuits, common-base and common-emitter configurations, DC operating conditions, etc.; the entire second half of the book is devoted to pulse and nonlinear operation of point-contact and junction transistors (for which the author introduces an unusual new symbol).

As such, it is one of the better texts on transistor computer applications and the like. There are only a handful of practical circuits with actual component values given; the author concentrates more on the theoretical, and gives most of the mathematics and explanations necessary to make computations for practical circuit actions.

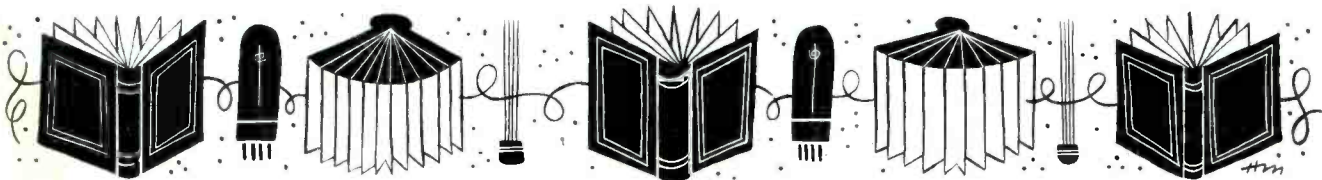
## Theme and Variations or All About FM Antennae and their Installation

L. F. B. Carimi; pub. by Apparatus Development Co., Wethersfield 9, Conn.; 24 pages; 25¢, paper-bound.

The sensitive antennas necessary to receive VHF signals from distant FM stations are not often understood by the average layman.

This small booklet takes most of the mystery out of such terms as Yagi, dipoles, front-to-back ratios, transmission lines, insertion losses, and impedance

Continued on page 46



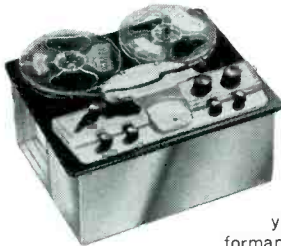


You've  
been  
asking for

  
**HEATHKIT**



**stereo sound equipment . . . and here it is!**



### stereo tape deck kit

HEATHKIT  
MODEL TR-1D **\$143<sup>95</sup>**

Enjoy the wonder of Stereophonic sound in your own home! Precision engineered for fine performance, this tape deck provides monaural-record/playback and stereo playback. Tape mechanism is supplied complete. You build only the preamplifier. Features include two printed circuit boards—low noise EF-86 tubes in input stages—mic and hi-level inputs—push-pull bias-erase oscillator for lowest noise level—two cathode follower outputs, one for each stereo channel—output switch for instantaneous monitoring from tape while recording. VU meter and pause control for editing. Tape speeds 3 $\frac{3}{4}$  and 7 $\frac{1}{2}$  IPS. Frequency response  $\pm 2$  db 40-12,000 CPS at 7 $\frac{1}{2}$  IPS. Wow and flutter less than .3%. Signal-to-noise 55 db at less than 1% total harmonic distortion. NARTB playback equalization. Make your own high quality recordings for many pleasant listening hours.

### stereo equipment cabinet kit

HEATHKIT MODEL SE-1  
(Price to be announced soon)

Beautifully designed, this stereo equipment cabinet has ample room provided for an AM-FM tuner—tape deck—preamplifier—amplifiers—record changer—record storage and speakers. Constructed of  $\frac{3}{4}$ " solid-core Philippine mahogany or select birch plywood, beautifully grained. Top has shaped edge and sliding doors for front access. Mounting panels are supplied cut to fit Heathkit units with extra blank panels for mounting your own equipment. Easy-to-assemble, all parts are precut and predrilled. Includes all hardware, glue, legs, etc. and detailed instruction manual. Speaker wings and center unit can be purchased separately if desired. Overall dimensions with wings 82" W. x 37" H. x 20" D. Send for free details.



### DELUXE AM-FM TUNER KIT

HEATHKIT  
MODEL PT-1 **\$89<sup>95</sup>**

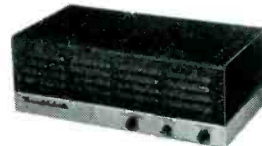
Here is a deluxe combination AM-FM tuner with all the advanced design features required by the critical listener. Ideal for stereo applications since AM and FM circuits are separate and individually tuned. The 16-tube tuner uses three circuit boards for easy assembly. Prewired and prealigned FM front end. AFC with on/off switch—flywheel tuning and tuning meter.



### STEREO PRE- AMPLIFIER KIT

HEATHKIT MODEL SP-1  
(Price to be announced soon)

This unique two-channel control center provides all controls necessary in stereo applications. Building block design lets you buy basic single channel now and add second snap-in channel later for stereo without rewiring. 12 inputs each with level control—NARTB tape equalization—6 dual concentric controls including loudness controls—built-in power supply.



### 55 WATT HI-FI AMPLIFIER KIT

HEATHKIT  
MODEL W-7M **\$54<sup>95</sup>**

First time ever offered—a 55-watt basic hi-fi amplifier for \$1 per watt. Features EL-34 push-pull output tubes. Frequency response 20 CPS to 20 KC with less than 2% harmonic distortion at full output throughout this range. Input level control and "on-off" switch provided on front panel. Unity or maximum damping factors for all 4, 8 or 16 ohm speakers.



### 12 WATT HI-FI AMPLIFIER KIT

HEATHKIT  
MODEL UA-1 **\$21<sup>95</sup>**

Ideal for stereo applications, this 12-watt power package represents an outstanding dollar value. Uses 6BQ5/EL84 push-pull output tubes. Less than 2% total harmonic distortion throughout the entire audio range (20 to 20,000 CPS) at full 12-watt output. Designed for use with preamplifier models WA-P2 or SP-1. Taps for 4, 8 and 16 ohm speakers.

**For complete information on above kits—Send for FREE FLYER.**

**HEATH COMPANY** • a subsidiary of  **Daystrom, Inc.** • **Benton Harbor 18, Mich.**

easy-to-build

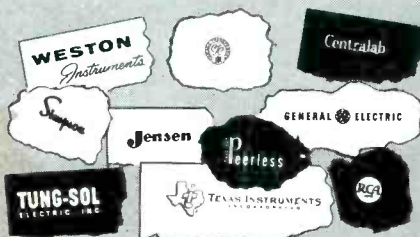
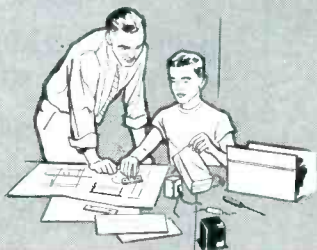
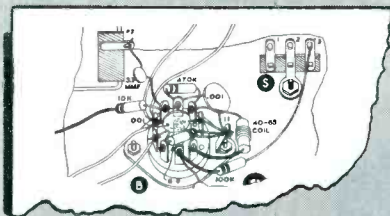
high quality

# HEATHKITS®

**Look** . . . how simply you can assemble your very own high fidelity system! Fun-filled hours of shared pleasure, and an everlasting sense of personal accomplishment are just a few of the rewards. Heathkits cost you only HALF as much as ordinary equipment and the quality is unexcelled. Let us show you how easy it really is! . . .



- (✓) Install a .001  $\mu$ fd disc condenser from socket B7 (NS) to ground lug B11 (NS). Cut the leads so that they are just long enough to reach and dress the condenser close to chassis, over the wires already present.
- ( ) Connect a 470 K $\Omega$  resistor (yellow-violet-yellow) from socket B7 (S) (2) to B8 (NS). Mount as close to the socket as possible.



### Step-by-Step Assembly Instructions . . .

Read the step . . . perform the operation . . . and check it off—it's just that simple! These plainly-worded, easy-to-follow steps cover every assembly operation.

### Easy-to-follow Pictorial Diagrams . . .

Detailed pictorial diagrams in your Heathkit construction manual show where each and every wire and part is to be placed.

### Learn-by-doing Experience For All Ages . . .

Kit construction is not only fun—but it is educational too! You learn about radio, electronic parts and circuits as you build your own equipment.

### Top Quality Name-Brand Components Used in All Kits . . .

Electronic components used in Heathkits come from well-known manufacturers with established reputations. Your assurance of long life and trouble-free service.



HEATHKIT

## bookshelf 12-watt amplifier kit

# NEW

MODEL EA-2

**\$27<sup>95</sup>**

There are many reasons why this attractive amplifier is a tremendous dollar value. You get many extras not expected at this price level. Rich, full range, high fidelity sound reproduction with low distortion and noise . . . plus "modern" styling, making it suitable for use in the open, on a bookcase, or end table. Look at the features offered by the model EA-2: full range frequency response (20—20,000 CPS  $\pm$  1 db) with less than 1% distortion over this range at full 12 watt output—its own built-in preamplifier with provision for three separate inputs, mag phono, crystal phono, and tuner—RIAA equalization—separate bass and treble tone controls—special hum control—and it's easy-to-build. Complete instructions and pictorial diagrams show where every part goes. Cabinet shell has smooth leather texture in black with inlaid gold design. Front panel features brushed gold trim and buff knobs with gold inserts. For a real sound thrill the EA-2 will more than meet your expectations. Shpg. Wt. 15 lbs.

**TIME PAYMENTS AVAILABLE  
ON ALL HEATHKITS  
WRITE FOR FULL DETAILS**





## chairside enclosure kit

# NEW

This beautiful equipment enclosure will make your hi-fi system as attractive as any factory-built professionally-finished unit. Smartly designed for maximum flexibility and compactness consistent with attractive appearance, this enclosure is intended to house the AM and FM tuners (BC-1A and FM-3A) and the WA-P2 preamplifier, along with the majority of record changers, which will fit in the space provided. Adequate space is also provided for any of the Heathkit amplifiers designed to operate with the WA-P2. During construction the tilt-out shelf and lift-top lid can be installed on either right or left side as desired. Cabinet is constructed of sturdy, veneer-surfaced furniture-grade plywood  $\frac{1}{2}$ " and  $\frac{3}{4}$ " thick. All parts are pre-cut and pre-drilled for easy assembly. Contemporary available in birch or mahogany, traditional in mahogany only. Beautiful hardware supplied to match each style. Dimensions are 18" W x 24" H x 35 $\frac{1}{2}$ " D. Shpg. Wt. 46 lbs.

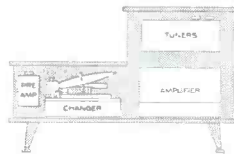


CE-1C Mahogany  
CE-1CB Birch



CE-1T Mahogany

**CONTEMPORARY**



**TRADITIONAL**

Be sure to specify model you prefer

**\$43<sup>95</sup>** each



**HEATHKIT**

### high fidelity FM tuner kit

For noise and static free sound reception, this FM tuner is your least expensive source of high fidelity material. Efficient circuit design features stabilized oscillator circuit to eliminate drift after warm-up and broadband IF circuits assure full fidelity with high sensitivity. All tunable components are prealigned so it is ready for operation as soon as construction is completed. The edge-illuminated slide rule dial is clearly numbered for easy tuning. Covers complete FM band from 88 to 108 mc. Shpg. Wt. 8 lbs.

**MODEL FM-3A \$25.95 (with cabinet)**



**HEATHKIT**

### broadband AM tuner kit

This tuner differs from an ordinary AM radio in that it has been designed especially for high fidelity. A special detector is incorporated and the IF circuits are "broadbanded" for low signal distortion. Sensitivity and selectivity are excellent and quiet performance is assured by a high signal-to-noise ratio. All tunable components are prealigned before shipment. Incorporates automatic volume control, two outputs, and two antenna inputs. An edge-lighted glass slide rule dial allows easy tuning. Your "best buy" in an AM tuner. Shpg. Wt. 9 lbs.

**MODEL BC-1A \$25.95 (with cabinet)**



**HEATHKIT**

### master control preamplifier kit

Designed as the "master control" for use with any of the Heathkit Williamson-type amplifiers, the WA-P2 provides the necessary compensation, tone, and volume controls to properly amplify and condition a signal before sending it to the amplifier. Extended frequency response of  $\pm 1\frac{1}{2}$  db from 15 to 35,000 CPS will do full justice to the finest program material. Features equalization for LP, RIAA, AES, and early 78 records. Five switch-selected inputs with separate level controls. Separate bass and treble controls, and volume control on front panel. Very attractively styled, and an exceptional dollar value. Shpg. Wt. 7 lbs.

**MODEL WA-P2 \$19.75 (with cabinet)**

pioneer in  
"do-it-yourself"  
electronics



a subsidiary of Daystrom, Inc.

**HEATH**

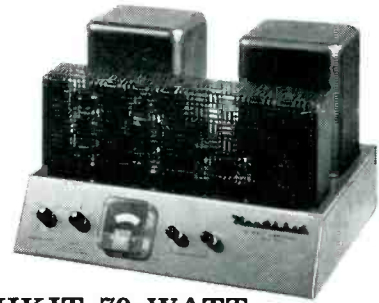
**COMPANY • BENTON HARBOR 18, MICHIGAN**



**HEATHKIT 25-WATT**

MODEL W-5M

**\$59<sup>75</sup>**



**HEATHKIT 70-WATT**

MODEL W-6M

**\$109<sup>95</sup>**

**high fidelity amplifier kits**

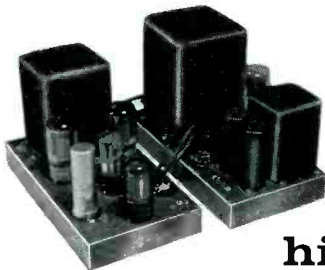
To provide you with an amplifier of top-flight performance, yet at the lowest possible cost, Heath has combined the latest design techniques with the highest quality materials to bring you the W-5M. As a critical listener you will thrill to the near-distortionless reproduction from one of the most outstanding high fidelity amplifiers available today. The high peak-power handling capabilities of the W-5M guarantee you faithful reproduction with any high fidelity system. The W-5M is a must if you desire quality plus economy! Note: Heathkit WA-P2 preamplifier recommended. Shpg. Wt. 31 lbs.

For an amplifier of increased power to keep pace with the growing capacities of your high fidelity system, Heath provides you with the Heathkit W-6M. Recognizing that as loud speaker systems improve and versatility in recordings approach a dynamic range close to the concert hall itself, Heath brings to you an amplifier capable of supplying plenty of reserve power without distortion. If you are looking for a high powered amplifier of outstanding quality, yet at a price well within your reach, the W-6M is for you! Note: Heathkit model WA-P2 preamplifier recommended. Shpg. Wt. 52 lbs.

**HEATHKIT DUAL-CHASSIS**

MODEL W3-AM

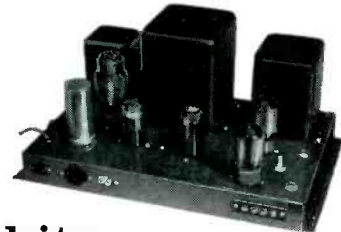
**\$49<sup>75</sup>**



**HEATHKIT SINGLE-CHASSIS**

MODEL W4-AM

**\$39<sup>75</sup>**



**high fidelity amplifier kits**

One of the greatest developments in modern hi-fi reproduction was the advent of the Williamson amplifier circuit. Now Heath offers you a 20-watt amplifier incorporating all of the advantages of Williamson circuit simplicity with a quality of performance considered by many to surpass the original Williamson. Affording you flexibility in custom installations, the W3-AM power supply and amplifier stages are on separate chassis allowing them to be mounted side by side or one above the other as you desire. Here is a low cost amplifier of ideal versatility. Shpg. Wt. 29 lbs.

In his search for the "perfect" amplifier, Williamson brought to the world a now-famous circuit which, after eight years, still accounts for by far the largest percentage of power amplifiers in use today. Heath brings to you in the W4-AM a 20-watt amplifier incorporating all the improvements resulting from this unequalled background. Thousands of satisfied users of the Heathkit Williamson-type amplifiers are amazed by its outstanding performance. For many pleasure-filled hours of listening enjoyment this Heathkit is hard to beat. Shpg. Wt. 28 lbs.

**HEATHKIT**

**high fidelity amplifier kit**

MODEL A-9C **\$35<sup>50</sup>**



For maximum performance and versatility at the lowest possible cost the Heathkit model A-9C 20-watt audio amplifier offers you a tremendous hi-fi value. Whether for your home installation or public address requirements this power-packed kit answers every need and contains many features unusual in instruments of this price range. The preamplifier, main amplifier and power supply are all on one chassis providing a very compact and economical package. A very inexpensive way to start you on the road to true hi-fi enjoyment. Shpg. Wt. 23 lbs.

**HEATHKIT**

**electronic crossover kit**

MODEL XO-1 **\$18<sup>95</sup>**



One of the most exciting improvements you can make in your hi-fi system is the addition of this Heathkit Crossover model XO-1. This unique kit separates high and low frequencies and feeds them through two amplifiers into separate speakers. Because of its location ahead of the main amplifiers, IM distortion and matching problems are virtually eliminated. Crossover frequencies for each channel are 100, 200, 400, 700, 1200, 2000 and 3500 CPS. Amazing versatility at a moderate cost. Note: Not for use with Heathkit Legato Speaker System. Shpg. Wt. 6 lbs.





## high fidelity speaker system kit

Wrap yourself in a blanket of high fidelity music in its true form. Thrill to sparkling treble tones, rich, resonant bass chords or the spine-tingling clash of percussion instruments in this masterpiece of sound reproduction. In the creation of the Legato no stone has been left unturned to bring you near-perfection in performance and sheer beauty of style. The secret of the Legato's phenomenal success is its unique balance of sound. The careful phasing of high and low frequency drivers takes you on a melodic toboggan ride from the heights of 20,000 CPS into the low 20's without the slightest bump or fade along the way. The elegant simplicity of style will complement your furnishings in any part of the home. No electronic know-how, no woodworking experience required for construction. Just follow clearly illustrated step-by-step instructions. We are proud to present the Legato—we know you will be proud to own it! Shpg. Wt. 195 lbs.



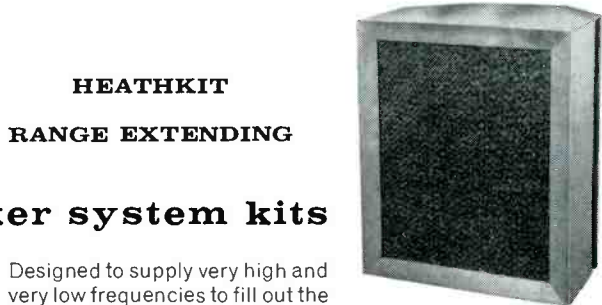
MODEL HH-1-C  
(imported white birch)  
MODEL HH-1-CM  
(African mahogany)  
**\$325<sup>00</sup>** each



**HEATHKIT**  
**BASIC RANGE**

MODEL SS-1 **\$39<sup>95</sup>**

A truly outstanding performer for its size, the Heathkit model SS-1 provides you with an excellent basic high fidelity speaker system. The use of an 8" mid-range woofer and a high frequency speaker with flared horn enclosed in an especially designed cabinet allows you to enjoy a quality instrument at a very low cost. Can be used with the Heathkit "range extending" (SS-1B) speaker system. Easily assembled cabinet is made of veneer-surfaced furniture-grade 1/2" plywood. Impedance 16 ohms. Shpg. Wt. 25 lbs.



**HEATHKIT**  
**RANGE EXTENDING**

MODEL SS-1B **\$99<sup>95</sup>**

Designed to supply very high and very low frequencies to fill out the response of the basic (SS-1) speaker, this speaker system extends the range of your listening pleasure to practically the entire range of the audio scale. Giving the appearance of a single piece of furniture the two speakers together provide a superbly integrated four speaker system. Impedance 16 ohms. Shpg. Wt. 80 lbs.

## high fidelity speaker system kits

## Free Catalog!

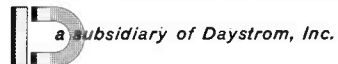
Don't deprive yourself of the thrill of high fidelity or the pleasure of building your own equipment any longer. Our free catalog lists our entire line of kits with complete schematics and specifications. Send for it today!



### HEATH

*pioneer in  
"do-it-yourself"  
electronics*

### COMPANY • BENTON HARBOR 18, MICHIGAN



- Please send the Free HEATHKIT catalog.
- Enclosed is 25c for the New HI-FI book.

name \_\_\_\_\_

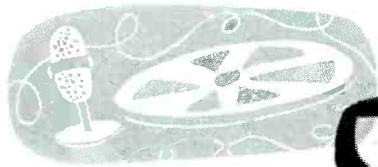
address \_\_\_\_\_

city & state \_\_\_\_\_

#### ALSO SEND THE FOLLOWING KITS:

QUANTITY	ITEM	MODEL NO.	PRICE

Enclosed find \$..... Please enclose postage for parcel post—express orders are shipped delivery charges collect. All prices F.O.B. Benton Harbor, Mich. NOTE: Prices subject to change without notice.



# Audionews

## REK-O-KUT CONTEST

Simply go to any high-fidelity dealer between June 1 and July 30, have him demonstrate any high-fidelity equipment to you, and fill out a three-line application blank with your name and address. Result: you might win the *First Annual Rek-O-Kut Window-of-the-World Contest*. First prize: two tickets to the Brussels World's Fair via Sabena Airlines. There are 100 other prizes consisting of Rek-O-Kut equipment.

## SHURE STEREO CARTRIDGE

Employing the same moving-magnet principle as the Shure Studio Dynetic and Professional Dynetic cartridges, the new *Stereo Dynetic* cartridge is designed for playback of 45-45 stereo-disc records. It can be used on conventional records.

The Stereo Dynetic operates in standard tone arms at a tracking force of 3 to 4 grams, and response of 20 to 20,000 cps is claimed. Selling price is \$45.

## ROYCE STEREO-RAMA

The Royce *Stereo-rama* is a speaker-amplifier combination that can be added to any sound system in any price range, and is said to give a new dimension to sound reproduction. This is done by shifting phase with frequency, producing a sound from its speaker that is always out of phase with the source speaker; radiating sound in a vertical plane which, along

*Stereo-rama speaker uses phase shift.*



with the phase shift, alters room-resonance characteristics; and accentuating transient sounds. It is housed in a small cabinet of hardwood measuring 26 in. high, by 12 deep, by 16 wide.

## STEREO AUDIO CONTROL AND PREAMP

Fisher Radio Corporation has recently announced the 400, a self-contained, self-powered stereophonic master audio control and preamplifier. Stereo facilities



*Fisher's stereo control preamplifier.*

ties provide for the use of tapes, discs, FM-FM, FM-AM, FM-multiplex, and microphones. Monaural applications extend to tapes, discs, dynamic mikes, and AM, FM, TV, and SW sources. There are monitoring facilities for recording. The unit may also be used as an electronic crossover network.

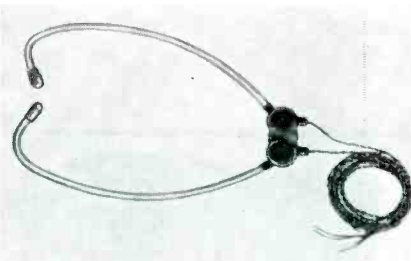
The four output jacks on the rear apron are provided with individual level controls. Sixteen input jacks are arranged in pairs for any combination of stereo and monaural inputs. Nine front-panel controls include electrically separate audio controls for each channel, mechanically ganged for convenience: EQUALIZATION, and Baxendall-type BASS and TREBLE controls; others include a one-knob CHANNEL BALANCE control, three-position LOUDNESS control, and a six-position OUTPUT SELECTOR. The 400 measures 15 3/4 in. wide by 9 1/16 in. deep by 5 7/8 in. high, is priced at \$169.50, and is available with blond, mahogany, or walnut cabinet priced at \$17.95 (prices slightly higher in the far West).

## LAFAYETTE FM TUNER, STEREO HEADPHONES

Two new products have been announced by Lafayette Radio. The *Model LT-70* is a budget-priced FM tuner with a rated sensitivity of 4  $\mu$ v for 20 db of quieting, response from 20 to 20,000 cps  $\pm$  1 db, and less than 1% distortion. The tuner

is said to have an Armstrong FM circuit with limiter, defeatable AFC, hum level 60 db below 100% modulation output, a built-in line cord antenna, multiplex and tape-recorder outputs, a switched AC outlet, and the newest type of tuning eye. Its price, \$47.50, includes a black metal cabinet with gold-finished front panel.

A line of stethoscope-type headphones of lightweight plastic construction has response ratings from 40 to 16,000 cps.



*Lafayette tuner (above) and headphones.*

Stereo models are the MS-431 (6 ohms, magnetic) at \$2.65; the MS-432 (5,000 ohms, magnetic) at \$2.95; and the MS-433 (100,000 ohms, crystal) at \$2.25. Similar nonstereo models are available at even lower prices.

## NEW AUDIO TUBE

CBS-Hytron's CBS 7025 twin-triode tube with folded-coil heaters is electrically interchangeable with any 12AX7 tube. It was designed for original equip-

*CBS low-noise tube will replace 12AX7's.*





ment and replacement use in high-fidelity amplifiers where it is said to minimize hum and noise generation. Low microphonism due to precise grid and mica tolerances is claimed. Twin 150-ma heaters of the nine-pin miniature may be connected in series or parallel for operation at 12.6 or 6.3 v.

#### OLD COLONY CATALOGUE

A *Catalogue* has been announced by Old Colony Sound Labs which describes their line of record-indexing kits. It is free on request. Also available is a sample kit for 10¢.

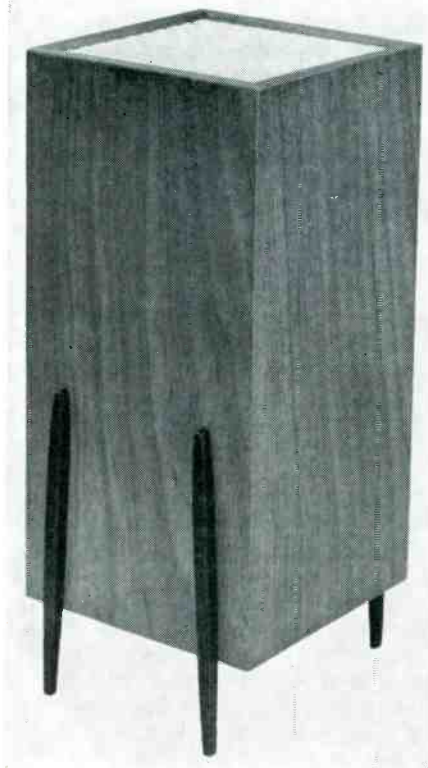
#### GROMMES STEREO PREAMP

*Model 208* is a new stereo preamp-control unit just announced by Grommes, a division of Precision Electronics, Inc. This control center accommodates dual inputs from any stereo or monophonic source — FM-AM tuners, FM multiplex, tape (from tape preamps or directly from tape head), phono, and (when available) TV. Ganged controls are furnished for input selection, phono and tape equalization, volume, bass, and treble. Presence, channel balance, rumble filter, and loudness on-off controls are supplied also, with switching so that an input to one channel can drive both channel outputs. Feedback circuits are used throughout.

#### RUXTON SPEAKER SYSTEM

Of unusual design is the *Ruxton Debutante* speaker system. Making use of an 8½-inch dual-cone driver which faces upward, the acoustically matched enclosure

*Ruxton Debutante speakers face upward.*



sure is said to provide extended bass response and nondirectional high-frequency radiation. Manufacturer's specifications include response from 40 to 19,000 cps, and a power rating of 15 w peak. Dimensions are 29 in. high by 12 by 14; impedance is 8 ohms. The enclosure is finished on all four sides, so that it can be used in any position. Prices are \$89.95 in honey-nut or traditional mahogany, \$94.95 in silver beige.

#### AMPLIFIER — KIT OR WIRED

The EICO *HF-32* 30-watt amplifier is available completely wired for \$89.95 or in kit form for \$57.95. The unit is basically the HF-30 amplifier with a preamp section added. Features include three low-level and three high-level inputs, concentric LOUDNESS and LEVEL controls, Williamson-type power amplifier with four EL84 tubes in push-pull parallel, and low-silhouette construction.

The power output is stated as 30 watts continuous with 47 watts on peaks; IM



*Eico HF-32: combined amplifier-preamp.*

is said to be 2% at 30 watts, 1% at 20 watts, and 0.5% at 10 watts (60 cps and 7 Kc at 4:1); total harmonic distortion claimed is below 1% from 20 cps to 20 Kc within 1 db of 30 watts. According to the manufacturer, frequency response is  $\pm 0.5$  db from 10 cps to 100 Kc at 1 watt, and  $\pm 0.5$  db from 15 cps to 50 Kc and  $\pm 1.5$  db from 15 cps to 100 Kc at 30 watts. Speaker connections are for 4, 8, and 16 ohms.

#### PACO V-O-M KIT

More extended ranges than are typically found in volt-ohm-milliammeters are a main feature of the *Model M-40*, a new kit from the PACO Division of Precision Apparatus Company, Inc.

*For more information about any of the products mentioned in Audio-news, we suggest that you make use of the Product Information Cards bound in at the back of the magazine. Simply fill out the card, giving the name of the product in which you're interested, the manufacturer's name, and the page reference. Be sure to put down your name and address too. Send the cards to us and we'll send them along to the manufacturers. Make use of this special service; save postage and the trouble of making individual inquiries to a number of different addresses.*



*V-O-M features extended voltage ranges.*

A 50- $\mu$ a meter movement with a full-bridge rectifier is claimed to have an accuracy of 2%. Seven DC ranges, from 1.5 to 6,000 v, are supplied; the seven AC ranges extend from 3 to 12,000 v full-scale. Three ohms ranges have 8.5, 850, and 85,000-ohm center-scale readings. Six DC current ranges, from 60  $\mu$ a to 15 amps full-scale, are also provided.

Price of the M-40 is \$31.50. An accessory high-voltage probe, the *AM-1*, costs \$5.95 prewired.

#### TAPE STROBE

A new product from Scott Instrument Labs is the *Tape Strobe*, a stroboscopic device for checking speed accuracy on all tape recorders and tape players. It is a precision-mounted wheel housed in a machined aluminum yoke so that the user may apply it directly to moving tape. Under a 60-cps light source, reference marks appear to stand still when the tape is moving past the capstan at correct speeds of 7½, 15, and 30 ips. Diameter accuracy is said to be  $\pm 0.0005$  in. The *Tape Strobe*, complete with sturdy instrument case sells for \$22.50, post paid.

*Strobe indicates proper recorder speed.*



# AR-1

three reports on

## SPEAKER DISTORTION

We believe that Acoustic Research speaker systems, by virtue of their patented **acoustic suspension** design, establish new industry standards in low distortion. This is a technical characteristic that can be directly interpreted in terms of musically natural reproduction.

Our opinion on the matter is shared by others:

**A** recent Master's thesis written at a leading engineering university (by George D. Ramig) involved distortion measurements on fifteen 12-in. and 15-in. loudspeakers,\* including the AR-1. Here are some of the results:

PERCENT HARMONIC DISTORTION

	AR-1	Spkr 2	Spkr 3	Spkr 4	Spkr 5	Spkr 6	Spkr 7	Spkr 8	Spkr 9	Spkr 10	Spkr 11	Spkr 12	Spkr 13	Spkr 14	Spkr 15
50 cps (lowest used)	2.1	4.4	8.8	10.0	11.2	12.8	15.0	17.8	18.5	18.5	over-loads	23.2	31.0	31.0	43.0
55 cps	2.1	1.8	5.6	7.4	8.8	13.0	11.8	7.6	8.7	8.7	7.3	18.3	12.8	17.5	11.0
70 cps	1.9	1.9	2.7	4.4	5.3	5.9	7.1	2.2	5.4	5.4	9.6	7.2	3.0	4.4	6.3
80 cps	1.0	2.1	2.1	3.4	3.9	3.2	3.9	2.6	3.8	3.8	6.6	4.0	2.1	2.3	3.1

Measurements taken at 3 ft., 102 db on-axis signal level. Amplifier damping factor control "off", giving DF of 30. Data published with Mr. Ramig's permission.

\*All speakers were directly baffled, a less than optimum mounting for some.

Joseph S. Whiteford, president of the Aeolian-Skinner Organ Co., has written us:

"No other system I have heard does justice to the intent of our recordings. Your speaker, with its even bass line and lack of distortion, has so closely approached the 'truth' that it validates itself immediately to those who are concerned with musical values."

The Audio League Report, in adopting the AR-1W as its bass reference standard, wrote:

"At 30 cycles, only 5% total harmonic distortion was measured, as compared to values of 30% to 100% of other speaker systems we have tested. . . we do not specifically know of any other speaker system which is truly comparable to it from the standpoint of extended low frequency response, flatness of response, and most of all, low distortion."

AR-1 and AR-2 speaker systems, complete with cabinets, are priced from \$89 to \$194. Literature is available on request.

ACOUSTIC RESEARCH, INC. 24 Thorndike St., Cambridge 41, Mass.



Gentlemen:

I disagree with pricing idea stipulated in the article, "Stereo Discs Up-to-Date" [by Joel Ehrlich; see Apr. issue, p. 18]. The main idea of double pricing, as I was led to believe by manufacturers, was to dissuade people with inexpensive cartridges (monaural) from buying the stereo discs. Mr. Frey [Audio Fidelity] has originally stated that when he issued a disc in stereo at \$5.95 he would discontinue monaural versions, but has since changed his mind due to RCA findings that discs aren't compatible on all machines.

Malcolm Jay Gottesman  
Rockaway Park, N.Y.

Author's Reply:

"Two-way compatibility" is the subject of considerable controversy at this moment, and I doubt that any camp is revealing the full story. Each particular group has some secrets they are not yet shedding full light on.

In basis, however, the following can be safely assumed by anyone giving the matter a bit of study. The Westrex stereo disc is not *fully* compatible. It is, on the other hand, *practically* compatible, once the conditions of use are taken into account.

When a stereo disc is played by a cartridge not having much vertical compliance, most of the vertical modulation (and stereo effect as a consequence) is destroyed. However, most people playing stereo discs with such cartridges will probably not be converting to stereo during the useful life of the disc in any case. Thus they wreck the stereo effect and have a reasonable (but not perfect) monophonic disc which can be played many times monophonically.

Most of the systems on which these discs will be played are of such low quality that the difference between a conventional record and the stereo disc played monophonically is not detectable. The small vertical modulation remaining is a source of some vertical stylus motion and consequent distortion. This, however, is far below the mean distortion level of the equipment and is not significant.

From this standpoint, the average consumer has lost nothing. The record is compatible, and the situation is even brighter than is assumed above. Better than 85% of the phonographs now in use were built within the past five years. We are concerned only with these because they are the only ones to play



all three speeds. *Within the past five years, even the lowest-quality "hi-fi's" have had good cartridges in them!* With Ronette, GE, Shure, Astatic, Webster, E-V, and all the others, compliance has become important. Study these units; they are better than we give them credit for!

This is so important a problem that I am now working on a series of tests of the wear on stereo discs by contemporary cartridges of all types. The tests will later be expanded to cover wear on stereo cartridges when used on conventional records. This test report will appear sometime this fall, after all companies have released their cartridges.

Results of my tests so far have made me quite convinced that, for all practical purposes, the Westrex stereo disc is compatible.

Joel Ehrlich  
Brooklyn, N.Y.

Gentlemen:

Your April 1958 issue carried a letter from one Mr. John Steiner of Infidelity Associates of Chicago. I enclose my check for \$1,000 and instruct you to send this amount to Mr. Steiner as my contribution to his campaign. Since I wish this donation to be anonymous, my name does not appear on the check.

Although your suggestion that a variable speed control be adapted to all turntables has some merit, it does not solve the basic problem. It seems to me a far better idea would be to conduct a campaign to have the power line frequency changed from 60 down to 16 cps. This would seem to answer satisfactorily Mr. Steiner's complaint since 16 cps is below audibility, and would cause practically no trouble at all except to make the speaker breathe in and out heavily.

In conclusion, I wish to make a suggestion regarding the title of Mr. Steiner's theme song: it should be "The Filter is All Schottisches Up."

E. D. Nunn, President  
Audiophile Records, Inc.  
Saukville, Wis.

Gentlemen:

As another "charter" subscriber, may I add my "amen" to Mr. Burt Zimmer's belief (January 1958 issue) that you have made a serious mistake in dropping the "Tips for the Woodcrafter" series.

In addition to the purely practical needs noted by Mr. Zimmer, let me note the pressing social necessity of keeping peace in the Audiocrafter's vicinity. Any of your married readers can tell you that the way the system looks is—to one member of the family at least—as important as how it sounds. No reader who has had to cope with the havoc wreaked when a six-year old decides to demonstrate Dad's hi-fi system to the

*Continued on page 46*

## Tape Should Be Compatible Too

WITH all the exaggerated fuss about stereo-record compatibility or incompatibility,\* the average consumer (understandably confused at this point) must have thrown up his hands in utter frustration on hearing of the proposed four-channel tape system. This involves, basically, nothing more than dividing the width of standard ¼-inch tape into four "quarter tracks" rather than the two "half tracks" in common use now. It provides room for two sets of stereo tracks on the tape, or four monophonic tracks; for equivalent tape speeds, the playing time of the tape is doubled.

Shure Brothers, Incorporated, has announced a stacked two-channel head for this four-track system. The head can be used for both recording and playback. If the tape channels are numbered from one to four, the pole pieces on this head coincide with tracks one and three: when the tape is turned over and played in the other direction, they cover tracks two and four. Our present tape machines, however, will *not* be able to play either monophonic or stereo tapes recorded for the new system unless the heads are replaced.

RCA Victor has developed an entirely new tape player based on a similar type of quarter-track head. The two sets of pole pieces are positioned to cover tracks one and three, or two and four, but the machine is intended for use with tape cartridges rather than standard reels. The operating speed is 3¾ ips, not 7½ ips. Presumably, RCA (and eventually others) will initiate a line of recorded tapes to play on these machines. The appeal is aimed at a much broader market than now exists for tape units.

We believe that recorded tapes must be reduced in cost substantially if they are to become really competitive with discs, and that four-track recording is a big step in that direction which is technically feasible now. Reducing the speed to 3¾ ips is another logical step—one that, with four-track operation, might well make it possible to sell recorded tapes for less than disc records, on a cents-per-minute basis. Finally, tape cartridges (if properly designed) are desirable simply because they will eliminate the chore of tape threading, and thereby make the tape medium more palatable

to people who now shy away from it because it is "too technical."

It may seem strange, but we take a dim view of the way things are going. We have good reasons for doing so.

Neither the Shure head nor the RCA tape player has been marketed at the time this is written. For the little information we have been able to gather, however, it seems that the RCA player will not be able to handle present recorded tapes on reels. Moreover, the RCA head is reputed to have gap lengths of .043 in. These gaps are so disposed that the upper section of the lower one would fall into the unrecorded central section of a two-track stereo tape made according to RCA's own specifications. Thus, even if the present tapes were put into cartridges, there would be a volume difference between the two channels. If the tape had the slightest tendency to ride up and down on the heads, there would be severe amplitude variations on the lower channel. It appears that the RCA system is needlessly incompatible with present tapes and tape equipment.

The Shure head was designed with gaps short enough that the lower one would be completely covered by the bottom track, on a tape made according to the unofficial two-track stereo standard. In checking samples of actual stereo tapes, unfortunately, Shure has found wide differences in actual track widths.

One other detail that worries us is RCA's new 3¾-ips tape speed. We doubt that the quality long associated with tape reproduction can be retained, at the present state of technology, if both track width *and* tape speed are halved.

Perhaps the new system was introduced as an effort to minimize the threat to the recorded-tape industry presented by stereo discs. We don't believe that such a threat exists, for reasons explained previously in this magazine. To the contrary, heavy promotion of a new and incompatible tape system at this time could destroy a home-tape industry that is now growing healthily.

Shure is pressing for rigid standardization of track widths, so that compatible playback-head gap lengths can be established. We hope this can be done, and that manufacturers will reach agreement on all aspects of tape compatibility before going ahead with a new system. It is too soon yet.

—R.A.

\*See "Readers' Forum" at the left; also "Stereo System Techniques," p. 16.

*No passing fad, stereo will soon be a part of our daily lives. Here are the many ways*

# Stereo

*you'll be able to hear this latest advance in high-fidelity sound.*

# System

by JOEL EHRLICH

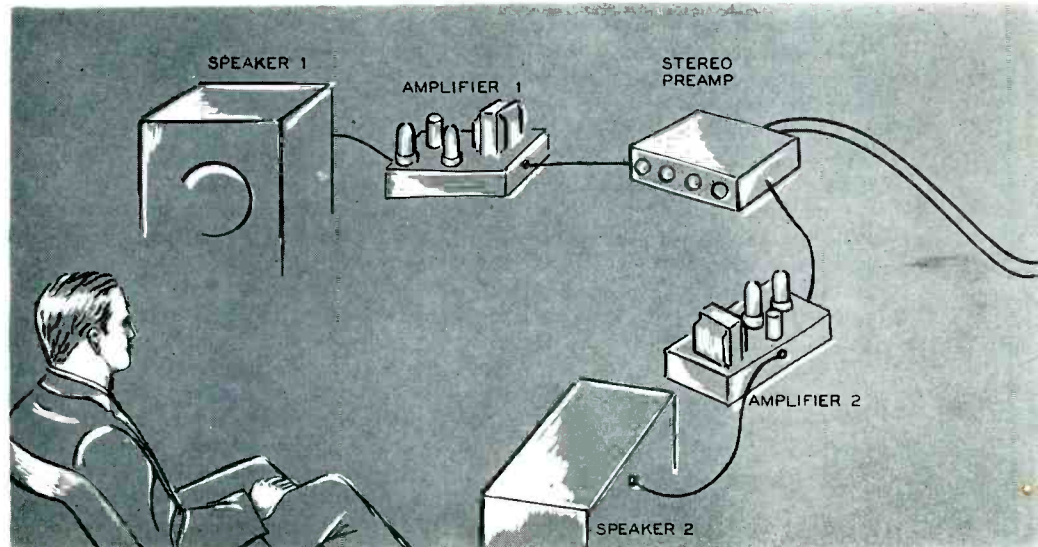
**M**UCH more public attention and thought has been given stereo systems in general since stereo discs crashed into the limelight.

The new stereo interest is reflected in the action of some of the national networks in setting up FM transmitters to complement existing AM transmitters in areas away from the major metropolitan centers. It is further evidenced by the rash of interested parties who have applied for, and have been awarded experimental FM multiplexing licenses. In several major areas there will be FM multiplex broadcasting for the public, much of it in stereo, as this article is read. In many other areas, simulcasting will be tried for the first time. (Simulcasting is stereo broadcasting in which one channel is fed to the AM transmitter and the other to the FM transmitter.) Other stations are experimenting with single-sideband and single-sideband suppressed-carrier AM transmission, multiplexed television-sound transmission, and other technological advances that can be adapted for stereophonic transmission of sound for home use.

Actual trials of experimental stereo discs with the many new stereo cartridges, both magnetic and crystal or ceramic, have brought about their own revolutions in thinking. This applies to the manufacturers of components as well as the manufacturers of packaged hi-fi units and, needless to say, consumers. It can safely be stated that there will be stereo record changers and players on the market by this winter. There are more than a few phonograph manufacturers making such units, with dual speakers and amplifiers, using high-grade record changers and stereo cartridges, in pilot production. There are already a number of stereo discs on the market, and many more to come shortly.

## Equipment Changes

Stereo discs have presented the home listener with some new problems already, as well as emphasizing some old problems. The new records, with vertical modulation as well as lateral, require the use of a cartridge having re-



sponse to vertical motion of the record. Such a cartridge must, therefore, be sensitive also to vertical motion of the turntable. In order to avoid trouble from rumble and vertical IM distortion, low-priced turntables and record changers will have to be improved. Pickup arms will have to be much better, vertical bearings will be more critical than they used to be, and tracking error must be minimized. As for record-changer arms, there will be severe problems indeed to be overcome.

The FM-AM tuners in many homes will be replaced or modified so that simulcast stereo programs can be re-

ceived. Most of these units do not provide for separate tuning of the AM and FM sections, which is necessary in most cases to receive the two channels simultaneously. Many FM tuners will be modified to handle the multiplex FM stereo. In addition, a multiplex decoder will become a part of many home systems.

There will be other changes in home high-fidelity systems. The simple expedient of using two preamplifiers for stereo, one atop the other, will prove to be so inconvenient that most listeners will get a true stereo preamplifier, such as those that Fairchild, Pilot, Fisher,



### For stereo, your basic equipment must include:

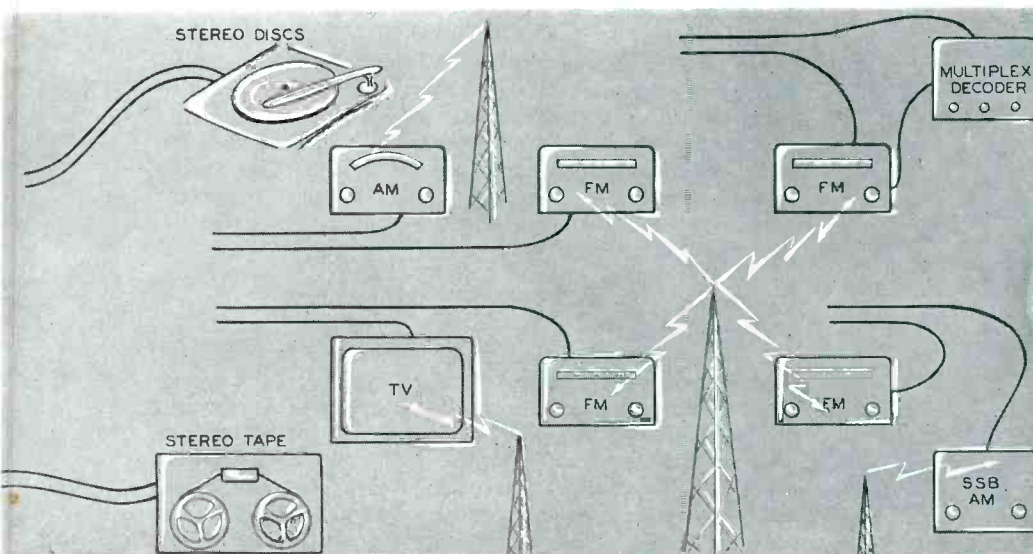
1. Two speaker systems, preferably identical
2. Two power amplifiers
3. Two preamps, or a stereo preamp

#### PLUS

- A. A stereo tape recorder or tape player  
OR  
B. A stereo cartridge for playing stereo discs  
OR  
C. AM and FM radio tuners (or a combined FM-AM stereo tuner)  
OR  
D. An FM tuner and a multiplex decoder  
OR  
E. A TV receiver and an FM (or AM) tuner

(C, D, and E are applicable only if broadcast stations in your vicinity are transmitting stereophonically.)

# Techniques



Grommes, Madison Fielding, Heath, and Arkay have announced. For those who do not have tape-stereo facilities yet, a second amplifier will be needed as well as the new control setup.

Some housewives will be made unhappy again too, because furniture will be moved around in many a home so that the living room can accommodate two speakers instead of one. Basements and garages will become noisy again as do-it-yourselfers get to work on new cabinets and enclosures. So that this confusion will not be aimless, let's look more closely at what we can expect from stereo.

### Playback Problems

When the first stereo recordings were made, the microphones were usually placed 10 or 12 ft. apart. It was felt, and rightly so, that this would enhance the separation of the two channels and allow us to distinguish between right and left more easily. This produced dramatic but tasteless early recordings of ping-pong games, tennis games, and other similar moving sounds that gave an exaggerated sense of side-to-side motion. This was all well and good when one wanted to have a train run through his living room or a B-47 take off down

his hallway, but it became a bit hard to listen to music when the sides were so far apart. In fact, it was most disconcerting to have an operatic diva walk slowly from stage left toward center, fall into a large hole, and reappear at a point two thirds of the way from the center on the other side of the stage.

This was commonly called stereo with a "hole in the middle." More recently, in an effort to bring realism to stereo, multiple-mike setups have been used. With these there is adequate coverage of the center of the stage. More often, however, a third channel is used, either for the soloist or in the middle of a group, and this is later blended into the two final channels as needed to eliminate the hole. Use of a third channel also permits the engineer to obtain optimum placing of the orchestra (when it is used to back up a singer) and still put today's small-voiced singer in such a position that the orchestra doesn't overpower the voice. Finally, although the singer may stand still while on mike, the engineer can move him around a bit later by adjustment of the third-channel mixing. This permits great flexibility.

Perhaps we should devote a little time to the question of speaker placement in the home. Some time ago it was discovered that, when playing back a recording made with the two microphones spread relatively far apart, best results were obtained by placing the two speakers close together and facing them outward. On the other hand, it was found that a stereo recording made with the microphones close together sounded best when the playback speakers were farther apart and facing inward. For that reason, the usual advice to those who have become involved with stereo of late has been to place the speakers about 7 ft. apart and facing into the room.

There seems also to be a general impression that two adjacent corners are needed for stereo speakers. This is far from true. Two corners simply make the use of two corner speakers that much easier; a flat wall, on the other hand, makes the use of rectangular enclosures that much simpler. The speakers should probably face into the room in most cases, but in a small room, such as most people use, this is not essential. The point is that there are no reliable rules for speaker placement. Each user will have to make his own compromise between practicability and optimum stereo effect; and there isn't any way he can determine, before trying the speakers in his room, where that will be.

### Tape and Tape Facilities

As I implied in an earlier article, the tape player is on the way out. Replacing it will be the tape recorder/player. Since this will be finding its way into many

*Continued on page 44*

# Kill

*No audio system is entirely free of unwanted noise. But good design can minimize it. Here are tried and true procedures.*

## that

by HAROLD REED

## noise

OF THE FOUR most troublesome conditions encountered in audio amplifier circuits — noise, distortion, poor frequency response, and instability — perhaps noise can be listed as the most worrisome of all. This applies not only to design and construction of the new equipment, but is equally true in connection with audio systems already in use which may not have been plagued with noise originally. Noise can be caused by aging and deterioration of certain component parts in the circuit. It is good practice, therefore, to use the best parts that can be obtained, both for new construction and for replacements.

### Types of Noise

The word *noise* is used broadly to describe any unwanted audio signal. It may be of the type often spoken of as "hits," "breaking up" or "crackling" sound, caused by a poor connection in some section of the system. These noises may appear in the form of intermittents; that is, they come and go with no regular pattern. The type of noise called "hissing," "rushing," or "white noise" results partly from thermal agitation in resistors and partly from the unsteady electron flow

or random fluctuations of electrons in tubes. Then there is the noise called "buzz," which may originate from line "spikes" in the power transformer getting into the amplifying circuits. The term "microphonics" is used to describe noise caused by slight movement of elements in a tube when it is subjected to mechanical vibration. Mentioned last in this discussion, but by no means least in annoyance value, is hum. This usually appears in one or both of two forms; that is, 60 cps (the power-line frequency) and a 120-cps ripple, twice the power-line frequency.

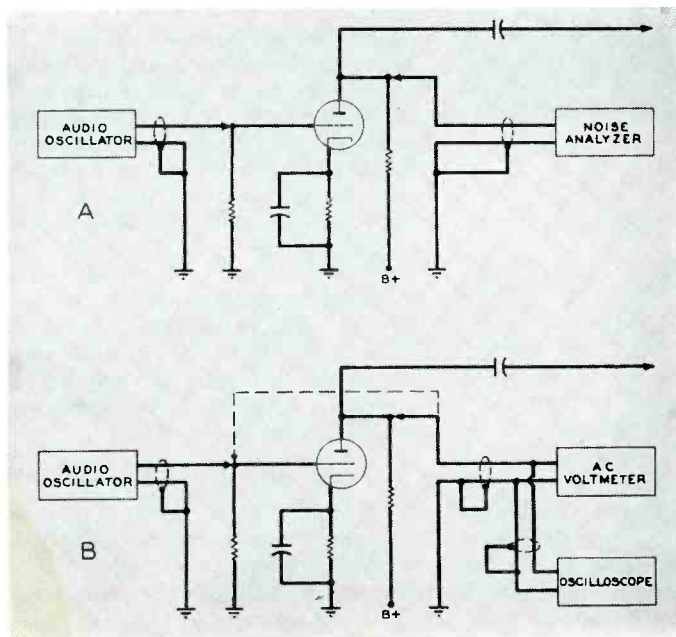
### Test Methods

An arrangement for measuring noise and hum in an input stage is shown in Fig. 1A. This same setup may also be used to make measurements of the complete audio system; then, of course, the noise analyzer is placed across the output of the whole system rather than at the output of the first stage. A signal of suitable level is fed to the input from the oscillator. The analyzer is adjusted for reference indication, after which the oscillator is disconnected from the input. The analyzer is then switched down in range to indicate noise level. This will give the noise level in decibels below the signal output of the stage or system.

Another method, which is to be preferred, is given in Fig. 1B. Several important characteristics can be learned with this setup. Before connecting the oscilloscope to the circuit, adjust the sweep controls to obtain a two-cycle wave pattern on the screen, as shown in Fig. 2. There is usually sufficient AC field in the vicinity of the scope to obtain this pattern simply by touching the high side of the vertical input terminals. A sine-wave signal from the oscillator is then fed to the input. This input voltage should be measured with the AC vacuum-tube voltmeter. Output of the stage is also measured with the voltmeter, and both of these readings recorded. The input signal is then removed and the AC voltmeter sensitivity increased to obtain a reading. The scope sensitivity is likewise adjusted to obtain a wave pattern of the circuit noise.

Of the three types of noise — random, 60-cps, and 120-cps — one will usually be more prominent on the screen. If two cycles appear, as in Fig. 2, then the greatest percentage of the total noise voltage is due to 60-cps hum. Should four

Fig. 1. Two methods of measuring noise in input circuits.





cycles be observed on the screen (see Fig. 3), 120-cps ripple is predominant. Random noise from resistors and the tube would appear as shown in Fig. 4. A photo showing line spikes is reproduced in Fig. 5. These spikes ride on the audio signal and can be seen before removing the oscillator input.

The test equipment used is now available in kit form and is relatively inexpensive. All noise signals on the scope screen, as shown in the photographs, were amplified for purposes of analysis. You should make a special effort to become well acquainted with these various types of noise, for once the noise is identified, half the battle is won.

The oscilloscope informs us of the character of the predominant noise and indicates its relative magnitude. To learn its numerical value we return to the input and output voltages of the oscillator signal as previously read on the AC meter. The third reading recorded—that is, with the oscillator signal removed—is the total noise voltage of the circuit. This noise in db below the output signal can be found from a Decibel-Voltage Ratio table, many of which have been published. You can also use the formula  $S/N = 20 \log E_s/E_n$ , where  $E_s$  is the output-signal voltage and  $E_n$  the noise voltage read on the meter.

A more important bit of information can be obtained from the AC meter readings; you can ascertain the noise level referred to the grid. This is done as follows. Find the gain of the stage by dividing the input-signal voltage into the output voltage (with the oscillator connected, of course). Since this voltage gain applies to noise voltages as well as to signal voltages, obviously the noise at the grid is less than the noise at the output of the stage by the gain factor. As an example, suppose the input voltage to be .01 v (10 mv), and the output 1 v. The voltage gain is then 1 divided by .01, or 100. Consider the noise voltage as read at the tube output to be .01 v. The noise at the grid is then  $1/100 \times .01$ , or  $100 \mu\text{v}$ . This is a fairly high noise level. A good low-noise circuit would have a noise level, referred to the grid, of  $10 \mu\text{v}$  or less. Noise of .01 v at the tube output is only 40 db below the signal at this point. Sixty db below the signal would indicate a noise level at the grid of  $10 \mu\text{v}$ .

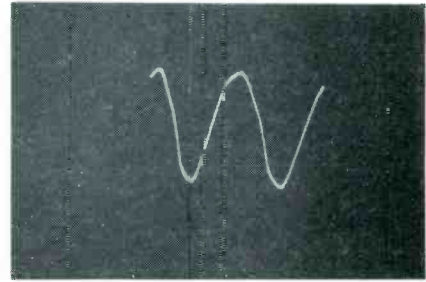
With test equipment at the output, alterations can be made on the circuit and improvements noted on the meter and scope. When approaching the lower noise levels the test equipment may not be sufficiently sensitive to indicate these levels immediately after the input stage. The test equipment can then be moved to the output of the next stage of the amplifier, and tests and measurements continued. Let us now consider these different noise problems and the methods used to eliminate them, or to keep them at minimum levels with respect to the desired audio signals.

There is no need for a lengthy discussion about the first type of noise mentioned. Usual trouble-shooting procedures should be applied to locate and eliminate any loose or poorly soldered connections and poor contacts in switches, tube sockets, or other component parts. Since the rest of the noise types are of concern principally in the first stage, or front end of an audio system, attention will be focused here on input circuits and component parts.

### Thermal Agitation and Tube Noise

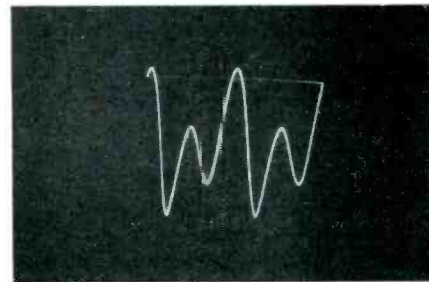
Thermal-agitation noise in resistors and shot-effect tube noise are both results of random electron fluctuations, and include all frequencies the ear can hear. They are often referred to as white noise; the term is analogous to white light, which includes all colors the eye can see. Tubes having low reverse-grid current and designed especially for low-level input stages should be used. Two good pentodes are the 5879 and 1620. Three good triodes are the 12AY7, 12AD7, and ECC83/12AX7. When comparing ordinary 12AX7 tubes to Telefunken's ECC83/12AX7, I have found the ECC83's to be consistently better, particularly in respect to hum. Several ordinary 12AX7's had hum levels as much as 10 db higher

Fig. 2



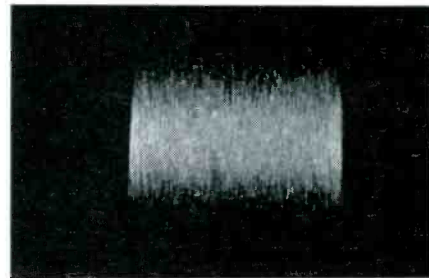
Initial reference trace on oscilloscope is obtained by touching high side of the vertical input terminals with fingers, setting sweep for 2 cycle wave pattern.

Fig. 3



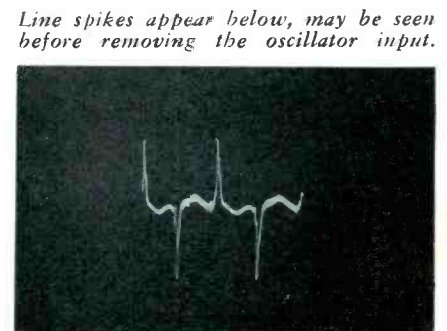
Four-cycle trace indicates the presence of 120-cps ripple in device under test.

Fig. 4

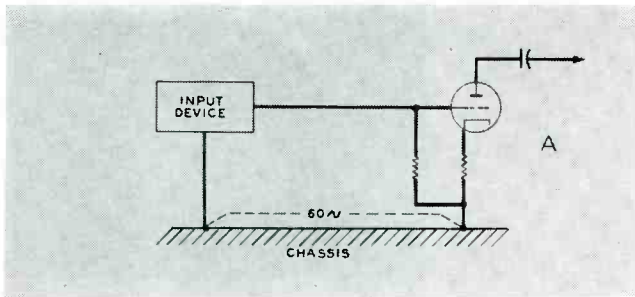


Random noise from tubes and resistors produces this picture on scope screen.

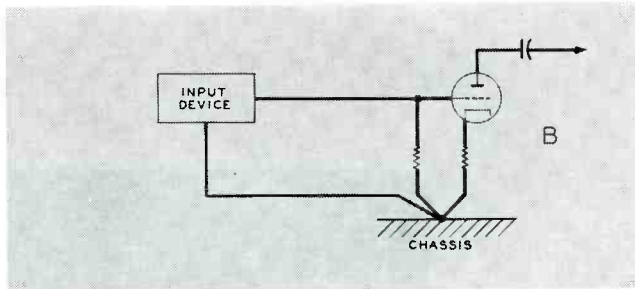
Fig. 5



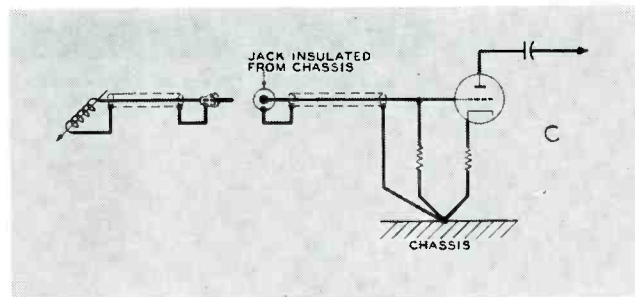
Line spikes appear below, may be seen before removing the oscillator input.



One method of grounding likely to result in a ground loop.



Better method grounds input stage at single point on chassis.



Insulating input jack from chassis eliminates ground loops.

Fig. 6. Three methods of grounding the input stage. Hum due to ground loops may be caused when chassis becomes a path for audio signal. See text for a detailed discussion.

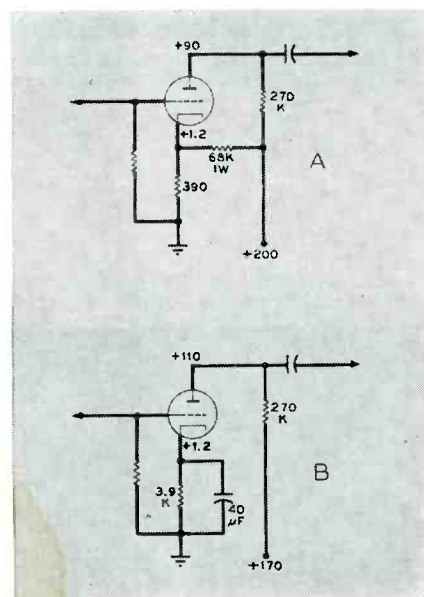


Fig. 7. Two ways of keeping cathode close to ground potential. Both will reduce hum, but feedback of A also helps to reduce distortion.

than the ECC83's. A third acceptable pentode is the 6AU6, if carefully selected. I have had especially good results with the 12AY7 and 5879. Selection of a good input tube, then, is the first step in the fight against noise. The cost of these tubes is higher, but they are worth the difference.

### Input-Stage Resistors

Having given careful consideration to the input tube, the resistors wired into its circuit must be chosen with equal care. Ordinary carbon resistors should be avoided, at least in the grid and plate circuits of the first stage. Considerable variation has been noted in the noise energy of ordinary carbon types. In the grid circuit alone, some of these resistors produce noise levels up to 12 db higher than that measured when a deposited-carbon resistor is used at this point. This represents about a 4 to 1 increase in noise voltage.

Considerable differences are noted also with plate-load resistors. Cathode resistors are not so critical in this respect, since the thermal-agitation voltage is decreased by the cathode-bypass capacitor. Deposited-carbon resistors are to be preferred in the input stage. These will cost approximately four times as much as ordinary types, but even if used in all three points of the first stage, the increased cost of the amplifier will be only about 90 cents.

If these more expensive types of resistors are not selected, it is recommended that carbon types manufactured under JAN or MIL specifications be used. It is found, generally, that the military types are less noisy than the ordinary carbons, and they are not very expensive.

Since heating agitates the random electron motion, it follows that resistors of higher wattage rating may prove beneficial in some applications. The use of one-watt ordinary carbons in place of the usual 1/2-watt size is desirable. Wire-wound resistors, too, have been used to reduce noise voltages.

### Line Spikes

Line spikes, as mentioned previously, result in a moderately high-pitched buzzing sound in the amplifier output and are picked up from the AC power source. These spikes may be introduced through the power transformer, so a transformer should be selected that has an electrostatic shield. The shield is built into the transformer, situated between the primary and secondary windings, and is grounded to the metallic framework of the transformer. Line spikes have also been caused by failure to use a bypass capacitor when applying a positive bias to the heater circuit. See the circuit in Fig. 8A.

### Microphonics

Elimination or reduction of microphonic components is mostly a matter of selecting good tubes for the front end. Tubes designed for low hum and noise, such as the ones specified previously, also prove to be less microphonic. For instance, tests made with ECC83/12AX7 tubes showed them to be considerably less microphonic than ordinary 12AX7's. In some cases, when the amplifier is subjected to considerable vibration, it will be helpful to shock-mount the first stage by floating it on rubber mounts.

### Hum

Of all the noise problems, hum can cause some of the worst headaches. The two hum frequencies usually encountered are, of course, in the band of audio frequencies that must be amplified. Therefore, they cannot be attenuated in the audio-signal circuits without attenuating the audio signal. Again, care should be given to input tube selection. Only tubes with low heater-to-cathode leakage should be used to keep 60-cps hum to a minimum. The tubes listed previously have low leakage.

Care in placement of parts, wiring dress, and grounding points is extremely important. The input stage should be located as far as possible from the magnetic fields of power transformers and motors. This is especially important in



circuits employing an input transformer. It has been suggested that the preamplifier be built on a separate chassis, but with careful planning and wiring this usually isn't necessary. Generally, less difficulty has been experienced with aluminum chassis. Large circulating currents induced by magnetic fields of power transformers have been noted in steel chassis which contribute to higher hum level. It is desirable that the input tube be equipped with a shield. Heater to grid resistive leakage in cheap tube sockets can contribute to 60-cps hum at the grid; it is advisable to use ceramic or mica-filled sockets.

All wire leads to the input stage should be as short and direct as possible, kept away from and not run parallel to AC wiring. This is particularly critical for input grid leads. Heater leads should be twisted together and kept close to the chassis and, on long runs, preferably laid up in the bend formed by the chassis top and sides.

Many builders do not realize how extremely important is the ground point of various circuits. Although the suggestions to follow may not prove to be the best in every case, they have repeatedly been found to result in lowest hum levels by many audio workers.

Ground loops may develop with certain grounding procedures. An example of one such case is shown in Fig. 6A. Here, the input device and cathode and grid resistors are grounded at different points on the chassis. Sixty-cps circulating current induced in the chassis by the power transformer can be fed to the grid in series with the audio input signal. A preferred grounding method is given in Fig. 6B. All grounding is done at one point for this stage, thus eliminating the ground loop provided by the chassis path. If a phono or microphone jack is mounted on the chassis, it may be best to isolate it from the chassis with insulating washers and run a ground lead directly to the input-tube chassis ground; see Fig. 6C. I have seen the hum level drop 10 db simply by insulating this jack.

The ground side of a phono cartridge should never be grounded directly to the metallic construction of a record player. An arrangement which has consistently given good results is to run all ground leads of each stage to one point at the tube socket of the individual stage but not ground them to the chassis at these points. Then carry a separate lead from each stage to one common ground at the center of the chassis. The important thing is to avoid using any section of the chassis as a path for the audio-signal currents.

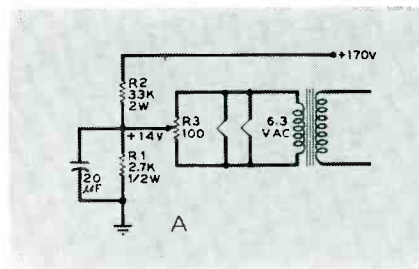
In order to obtain low 60-cps hum level, the cathode should be as close to AC ground as possible. A large cathode-bypass capacitor will take care of this. It should be at least 25  $\mu$ fd, preferably 40 to 50  $\mu$ fd. This effectively shorts the 60-cps hum frequency to ground. Since electrolytic capacitors will deteriorate and become gradually less effective as a bypass, they should be suspected if hum begins to rise in an amplifier.

A circuit that will eliminate the need for a front-end bypass capacitor is shown in Fig. 7A. A low-value resistor is used in the cathode circuit to keep the cathode near ground. The proper bias is then obtained by introducing a positive potential by means of a resistor connected between the cathode and B+ supply. The circuits of Figs. 7A and 7B have about the same DC bias and have the cathode near AC ground potential, but Fig. 7A does not include a capacitor.

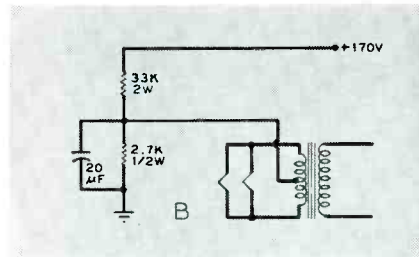
There are several methods to reduce 60-cps hum introduced by a heater circuit. The simplest, but least effective method, is to ground one side of the heater supply. A better way is to use a center-tapped heater winding with the center tap connected to ground. The AC potentials between each side of the heater circuit and center tap are then approximately 180° out of phase, and provide some cancellation of the hum frequency. However, since stray impedances between each heater lead and grid are not equal, further hum reduction can often be attained by employing a hum potentiometer of 50 to 200 ohms across the heater leads with the variable arm connected to ground. The potentiometer is adjusted for maximum can-

*Continued on page 42*

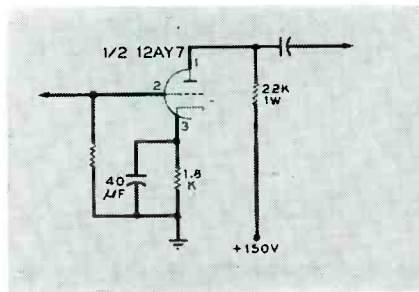
*Fig. 8A. Hum due to heater-cathode leakage may be lessened by adding a pot across the heater supply, and biasing to B+.*



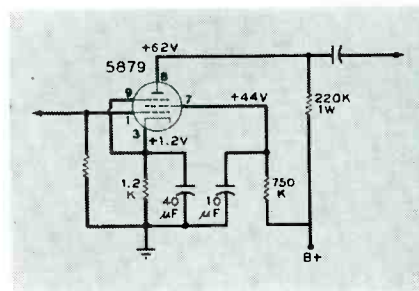
*Fig. 8B. Here the bias is retained, but the balancing potentiometer is not used.*



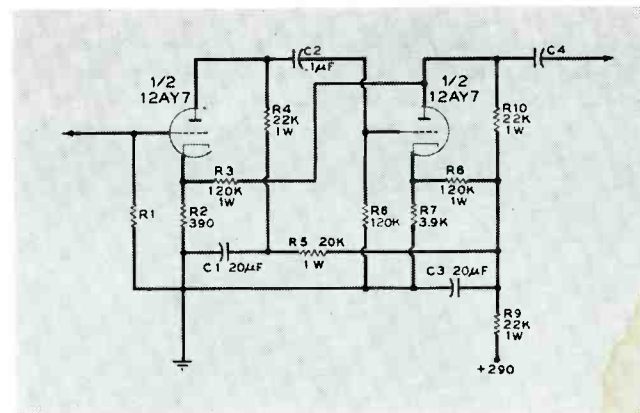
*Fig. 9. A low-noise input stage using one-half of a 12AY7. Parts value depends upon B+ supply.*

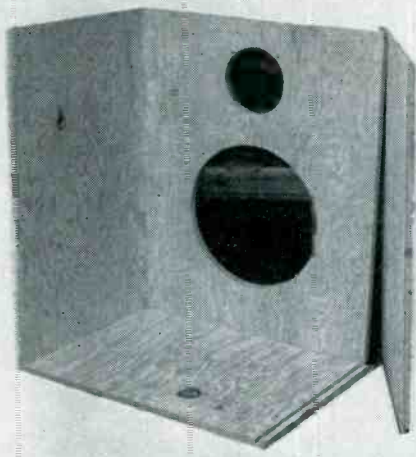


*Fig. 10. A 5879 will provide higher gain than circuit shown in Fig. 9.*

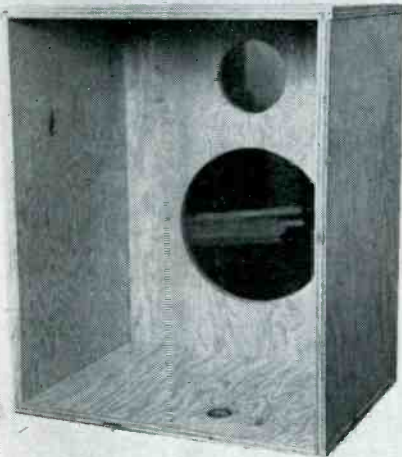


*Fig. 11. A two-stage, low-gain circuit using a 12AY7. Lack of cathode bypass capacitors reduces distortion, while the correct bias is maintained by resistors R3 and R4. R3 also provides an additional 8 db of feedback over the first stage.*

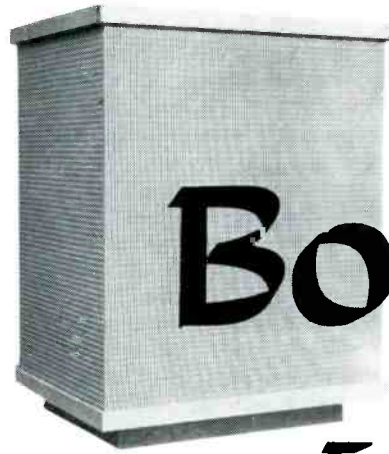




*Exploded view of side, front, and bottom panels show simplicity of E-300 kit.*



*Enclosure is assembled as shown, with glue on all adjoining surfaces. Weights are piled on top, and glue is allowed to dry. Back panel may be inserted (but not glued) to insure good fit later when glue is dry.*



# The Bozak Enclosure

*What do you look for in an enclosure kit?*

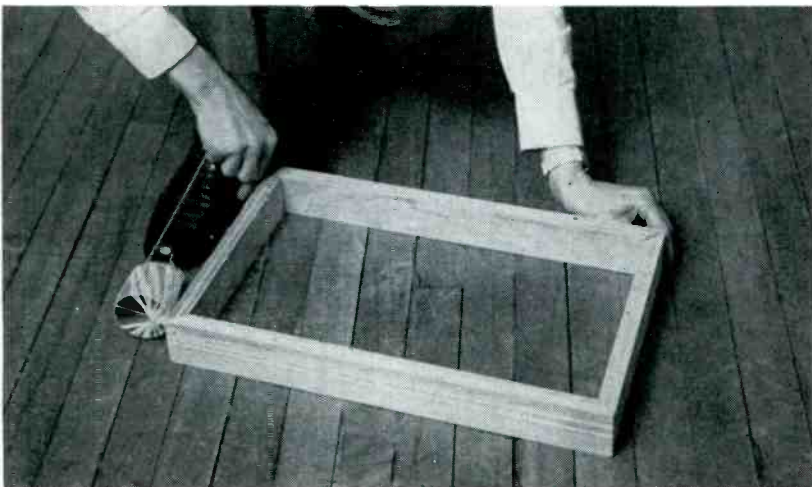
*Easy construction? Beauty?*

*Top performance? Then try the E-300.*

SINCE THE DAYS when high-fidelity sound was the hobby of a few closely knit groups of engineers and tinkerers, Bozak speakers and speaker systems have appealed to perfectionists with ears for music reproduced naturally. Through the years that reputation has grown steadily. Today, built with the same design philosophy as at the beginning, and with virtually the same external appearances, Bozak speakers are recognized everywhere with a respect that is continually becoming more nearly universal. They have been flattered in the most sincere of all ways: superficial imitation. Perhaps this is because the Bozak Company has championed consistently one extreme of loudspeaker design, and their products have become identified with this approach.

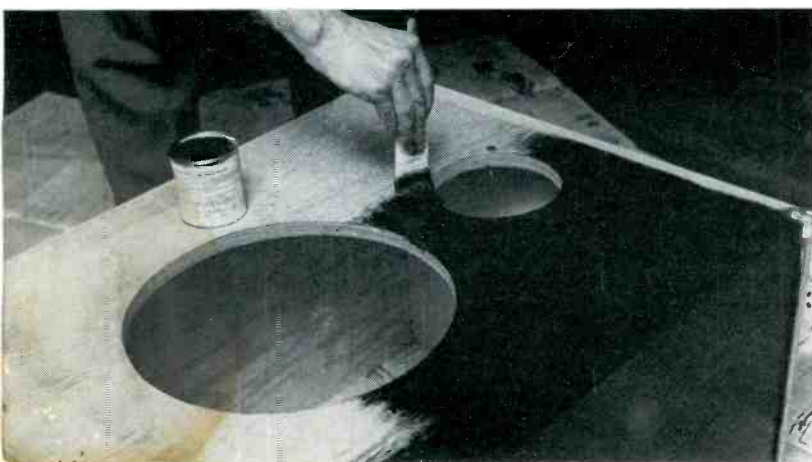
From the point of view of an interested observer, the primary objectives seem to be natural balance and timbre, and low distortion. To avoid phasing difficulties around crossover frequencies, and to achieve uniform timbre, Bozak woofers, middle-range units, and tweeters are all paper-cone types that can be mounted in coplanar fashion. To maintain loading on the woofer below the audible range, and thereby reduce harmonic distortion, the enclosures are infinite-baffle types. To obtain smooth extended bass response in an infinite baffle, the natural resonant frequencies of the woofers are made extremely low and the linear voice-coil travel is greater than normal. These measures all require a sacrifice in upper-bass efficiency. Then, in order to equalize output over the entire range — without accentuated response to emphasize presence or brilliance — the efficiencies of the middle-range and tweeter units are reduced to match that of the woofer. By so doing an added advantage is gained, in that excess efficiency can be traded for smoothness.

This all works out in practice as well as in theory, but it has had disadvantages. A Bozak system requires more amplifier power by far to produce middle-range sound than does a



*Base is "clamped" while drying with string wound tightly around it. Be sure assembly is square all around while drying.*

*After glue which holds basic enclosure has dried, paint surfaces (except top and bottom) black. Also paint one side of middle range hole cover plate if you do not plan to use B-209 speaker.*





An **audiocraft** kit report

# E-300

## Kit

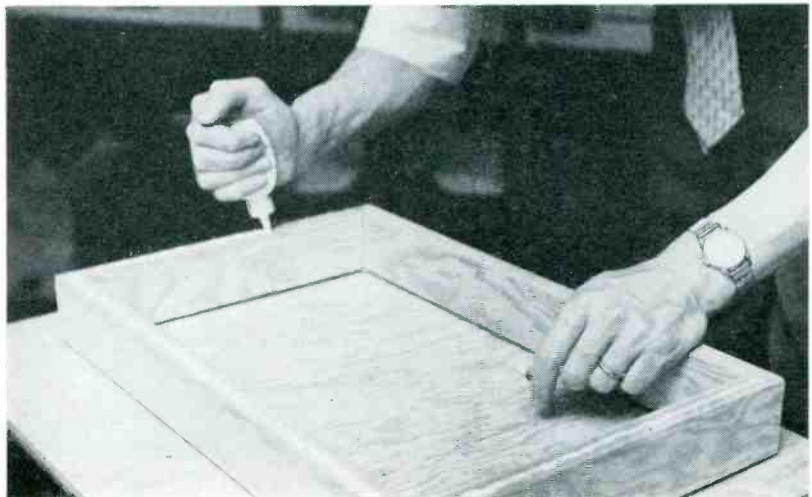
highly efficient horn system, or even a conventional high-resonance speaker in a bass-reflex enclosure. That used to be a problem, but with today's reasonably priced high-power amplifiers, the problem is no longer troublesome for home applications. It is still true, however, that in side-by-side comparisons with systems having more middle-range and treble output, the Bozak systems aren't nearly so impressive to listeners in showrooms. It is equally true that many listeners prefer more brilliance or more accentuated middle-bass response, for long-range listening, than Bozak systems provide.

The real point of this discussion is to make clear to readers that the E-300 kit — which, when built according to directions, is identical in size and acoustical properties to the standard factory-built E-300 — is in no sense a "universal" enclosure. It is a totally enclosed type giving no bass reinforcement to speakers having normal resonant frequencies, which need it; by the same token, it maintains its loading on the cone at subaudio frequencies, while enclosures that provide reinforcement by utilization of the back wave do not. As an infinite-baffle enclosure it is quite small (only 5 cu. ft.) and, therefore, will raise the resonant frequency of a speaker appreciably. Front-panel cutouts are for the Bozak B-209 6-inch middle-range speaker and the B-207A coaxial speaker, with its special cast-aluminum mounting ring. The large hole is too big for a standard 12-inch speaker and not big enough for a 15-inch unit, although the latter could be used. A cover plate is supplied for the smaller hole. In short, the E-300 is designed specifically for the B-207A speaker alone, or the B-207A and B-209 combination. The only other speakers that will sound good in it are very-low-resonance types, preferably intended for infinite-baffle applications. They might well sound superb.

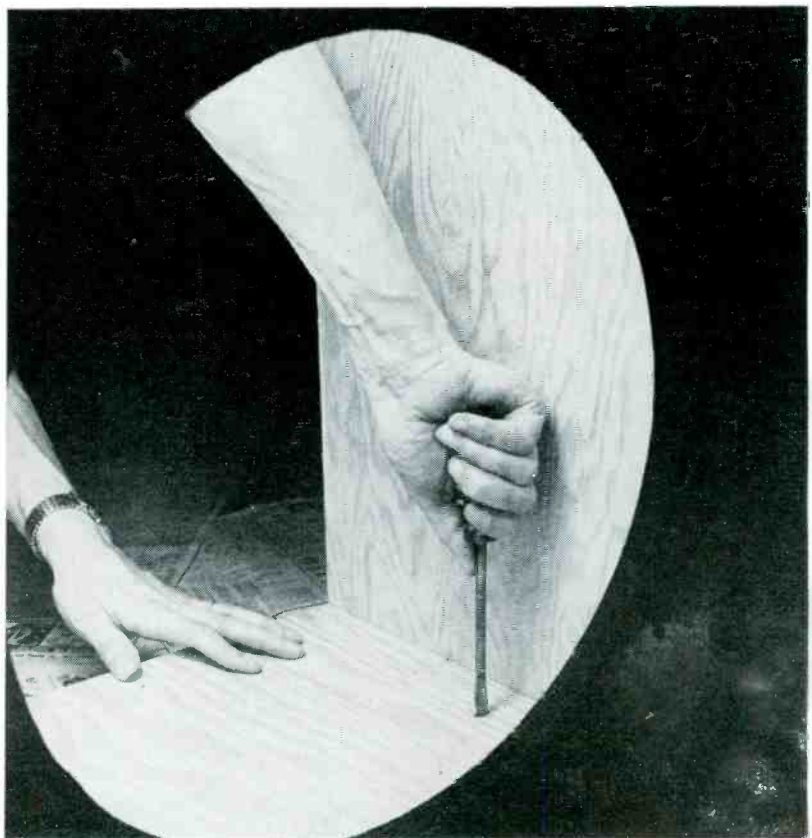
Dimensions of the E-300 are 24 in. wide by 30½ high by 17 deep. Price of the kit is \$42.50; that of the finished factory-built model is \$75.00. Furnished with the kit are all wood parts cut precisely to size, with tongues and grooves made and screw holes drilled and countersunk; grille cloth; wood screws, speaker mounting bolts and nuts, and speaker-lead terminals; Kimsul for acoustic lining; a tube of glue; and



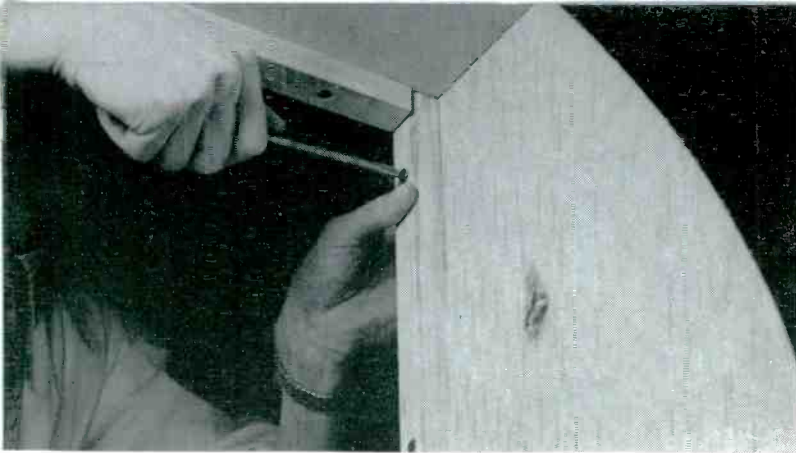
*Furniture glides (which are not supplied with the kit) are most conveniently attached to base before it is screwed to enclosure.*



*Base is positioned on bottom panel and measured to fit squarely in center. Its position is pencil marked for reference when it is finally attached. Glue is applied to the edges (as shown above). Then the base is laid on the bottom panel, accurately positioned, and held in place with screws which are started while the enclosure is still inverted. Finally, the enclosure is uprighted on the base, and the screws driven home (below).*



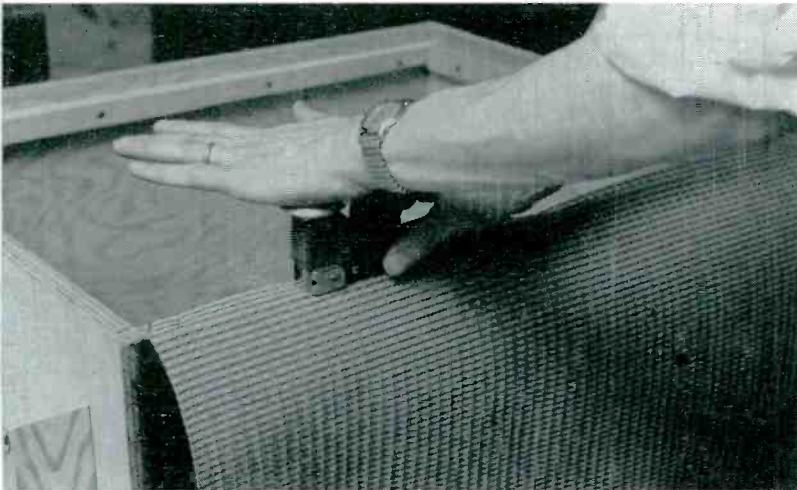




*Cleats for back panel screws are attached with screws and glue.*

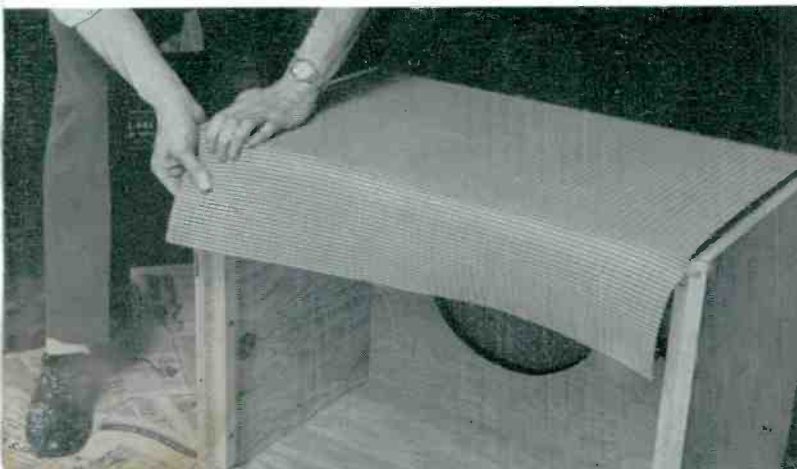


*Grille cloth is measured to fit, and excess trimmed from edges.*



*Grille cloth is attached first along one edge, with stapler.*

*With one edge secured, cloth is stretched (firmly, but not too tightly) around enclosure. Be especially careful to keep fabric lines straight.*



a complete, well-illustrated instruction book. Not furnished are tacks or staples, furniture glides for the base, hookup wire for the speaker, or finishing materials.

### Construction Notes

Assembling the E-300 is a simple enough process, as the accompanying pictures show, and presents no severe difficulties. The instructions are quite clear and we found only one error, which would be spotted by any builder on his toes. It occurs in instruction 15; the four cleats should, obviously, be attached to the rear edges of the side, top, and bottom panels, not to the side and front panels. For that matter, it would be easier to attach these cleats before assembly of the panels—but if you do, be sure to center the cleats lengthwise so that they will not interfere with one another when the panels are assembled.

We endorse heartily the recommendation to make a trial assembly, without glue, before you undertake the real one. The glue supplied sets quickly; and if you should make a mistake, or if it becomes necessary for any other reason to disassemble the panels, after you've applied the glue, you may find yourself in an extremely awkward situation. It's better to spend a few minutes extra, in order to be certain of a successful assembly.

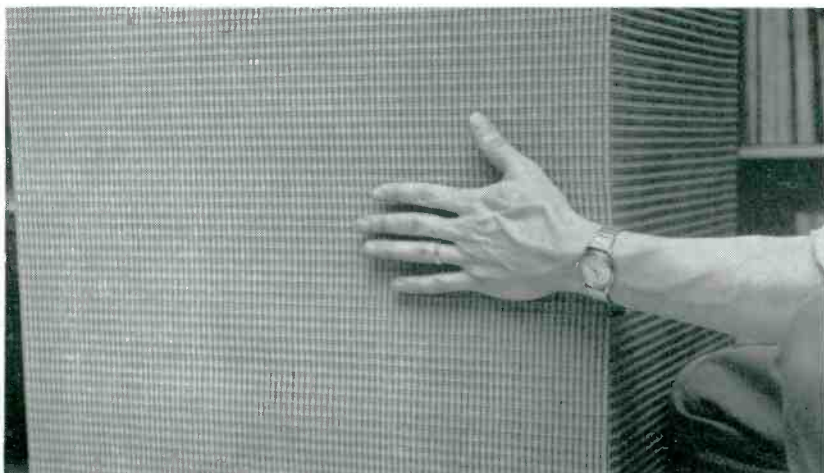
When you are ready to begin the final assembly you'll find that the E-300 goes together far more easily than most enclosure kits. The tongue-and-groove construction of the top, bottom, side, and front panels makes it possible to assemble the basic box entirely without screws. We didn't raise a single blister on this job! These five major panels require only conscientious glue spreading along the joints, which interlock in assembly nicely. Then you hammer four temporary finishing nails half-way in, put some weight on the top panel, and that's all. Let this and the base assembly dry overnight.

When the time comes to attach the base, you'll find that there are four holes drilled through the bottom panel for that purpose. To make certain that the base was aligned accurately with these holes, we turned the box upside-down, adjusted the base properly, and made pencil lines around it on the panel. Then we put glue on the base, repositioned it between the pencil lines, and started screws up into it through the holes while holding it in position. Once the screws were started we turned the box over on its base and seated the screws firmly.

Installing the grille cloth is not an easy task, but, if the instructions are followed faithfully, it is a simple one. A word of advice: have someone available to help you during the stretching procedure. Four hands—or, even better, six—are not too many for this operation.

The instructions mean what they say about the need for a stapling gun to install the Kimsul acoustic lining, too. A

*Lines are smoothed into proper perspective as the opposite end of grille cloth is stapled in place. Proceed slowly and carefully, since external appearance is largely influenced by grille cloth.*





home paper stapler is quite inadequate. If you simply cannot get a heavy-duty stapler, try carpet tacks.

When attaching the molding strips around the top and bottom panels, we didn't have woodworking clamps big enough to hold them in place while the glue dried, and were too lazy to improvise. We tacked the molding in place with small finishing nails, used a nail set to sink them in, and filled the holes with natural-colored wood dough. When sanded smooth the marks of our deviation from the instructions had disappeared.

Total construction time except for finishing the exposed wood surfaces: five hours. If you allot another two hours total for finishing (there isn't much surface area to be done), you can pay yourself \$4 per hour with the saving you've made buying the kit rather than the factory-built E-300. Perhaps more important is that you'll have the real satisfaction of a job well done, on a project worthy of your best effort.

### AUDIOCRAFT Test Results

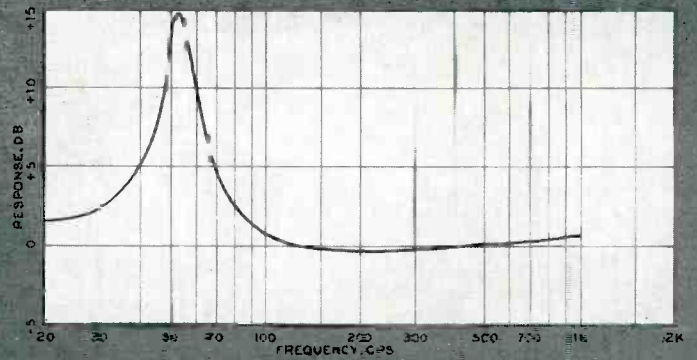
We installed a Bozak B-199A woofer in the E-300. This woofer is identical with the low-frequency cone of the B-207A coaxial unit. Its measured free-air resonant frequency was 38 cps.

The stiffness of the air enclosed within the E-300 raised the resonant point of the system to 53 cps, as the impedance curve shows. Note that the curve is smoothly shaped, without secondary peaks or dips, and that its amplitude shows a considerable amount of damping. This was reflected in very smooth response, audibly even down to about 45 cps. Below that we found a moderately slow dropoff, with useful output to 35 cps; there was still some fundamental output at 25 cps. One of the best features of this combination's performance, however, is the fact that harmonic output was practically nil at any reasonable power levels. Most amplifiers will overload at very low frequencies before distortion from the speaker becomes distressing.

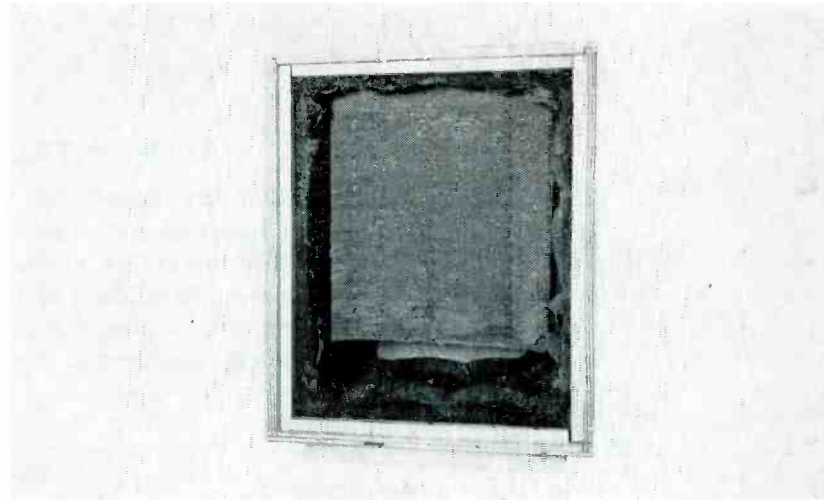
On musical material the bass performance was pleasantly full, yet tight and well controlled. Bass pitch differentiation was excellent. The result was truly musical sound, accurate and free of strain. Balance changed slightly when the enclosure position was changed from a corner to a wall area, but this could be easily and completely compensated for by adjustment of the bass tone control. The important matter is that the entire bass range did *not* drop out when the system was moved away from the corner, as it does with corner horns.

In sum, the E-300 kit is recommended to the attention of anyone who has or plans to get a speaker that will work in a fairly small, well-built, and good-looking infinite-baffle enclosure.

*When the ends of the cloth are secure, top and bottom edges are fastened with staples placed about one inch apart. Be sure to keep staples close to grille-cloth edges, so molding will hide them.*



*Impedance curve of Bozak B-199A woofer in E-300 enclosure.*



*A "curtain" of Kimsul hangs from the top panel behind speaker.*



*Kimsul is also fastened to the center section of the back panel.*

*A stapling gun is more effective than the ordinary stapler when securing Kimsul to the inner surfaces. The Kimsul is spongy and somewhat thick. If a stapling gun isn't handy, use carpet tacks.*



# AUDIOLAB

## Test Reports

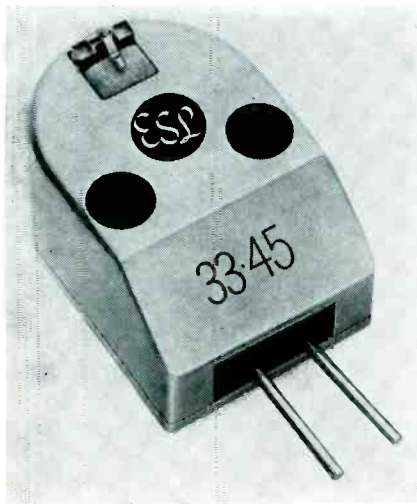
*An objective analysis  
of high-fidelity components*

### AUDIOLAB TEST REPORT POLICY

These reports are prepared by an organization whose staff was responsible for the original Audio League Reports, and which has no connection directly or indirectly with any manufacturer or publisher in the high-fidelity field. The reports are published exactly as they are received from Hirsch-Houck Laboratories. Neither we nor manufacturers of the equipment tested are permitted to delete information from or add to the reports, to amend them in any way, or to withhold them from publication; manufacturers may add a short comment at the end of a report, however, if they wish to do so.

#### ESL C-60 SERIES CARTRIDGE AND DUST BUG

The Electro-Sonic cartridge has become familiar to everyone who keeps abreast of high-fidelity developments in the three or four years since its introduction. It is a magnetic cartridge, of the moving-coil type. The coil resembles a miniature D'Arsonval meter movement, pivoted at top and bottom in a rubberlike material. The stylus, at the end of a cantilever



ESL C-60 cartridge.

arm, rotates the coil about its vertical axis when it traces the record-groove modulation. The coil is positioned between the poles of a powerful magnet, and a current is induced in it as it is rotated.

Two of the outstanding characteristics of the ESL design have been its unusually low impedance (1.5 ohms in the original Concert and Professional Series,

hereafter referred to as the C-1 and P-1) and a correspondingly low output of about 1 mv. The low impedance made the cartridge completely insensitive to the terminating resistance (which has a profound effect on the frequency response of many cartridges) and to cable capacitance. Almost any length of shielded cable may be used to connect the ESL C-1 to the preamplifier input, and in fact unshielded wire may be used for short runs without hum pickup.

The low output made it impractical to use this cartridge with many preamplifiers whose gain was inadequate. A step-up transformer could have been used, but this introduced problems with frequency response and hum pickup, and the system was no longer entirely independent of the terminating resistance.

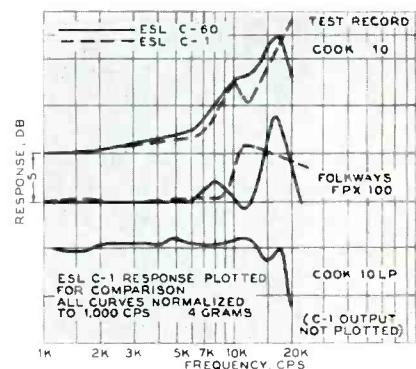
The listening qualities which attracted many users to the ESL C-1 were due to its greatly extended high-frequency response, low moving mass (which was a direct cause of this response), high lateral compliance (which allowed it to track at very low forces), and use of a minimum of damping.

The new C-60 Series cartridge (and the corresponding P-60 for the ESL Professional arm) represents an effort to overcome the weaknesses of the C-1 without sacrificing performance. It is constructed in exactly the same manner, except that the coil has more turns and consequently a higher voltage. A metal cover has been added, enclosing the plastic cartridge body which is similar to that of the C-1. The long, stiff wire leads have been shortened to about 1/2 in. As with the C-1, the distance from stylus to the line between the mounting holes is nonstandard (about 1/8 in.

greater than most other good cartridges). This means that an arm correctly positioned for a cartridge of standard dimensions will have an increased tracking error with an ESL cartridge in it, unless the cartridge mounting position is altered to compensate for the dimensional difference.

#### Performance Tests

The only practical way to measure the performance of a phono cartridge is to play test records. Unfortunately, it is



Response of ESL C-60 and C-1 to Cook 10, Cook 10 LP, and Folkways FPX 100.

difficult if not impossible to make a test record which will give a true picture of the frequency response of a cartridge. At any rate, we know of no such record at this time.

The curves we have plotted from playing three popular test records illustrate the difficulty we faced in trying to draw a final conclusion as to the frequency response of this (or any other) cartridge. The Cook Series 10 and Folkways FPX-100 are 78-rpm test records. Most cartridges exhibit a promi-



nent high-frequency peak when playing these records, and the C-60 was no exception. Note the considerable differences existing between the response to the two records.

As a comparison, we played the same records with an ESL C-1, using the same arm (Fairchild 281) and tracking force (4 grams). These data are plotted with a dashed line. The peak in the upper highs is less prominent, but no clear difference can be seen.

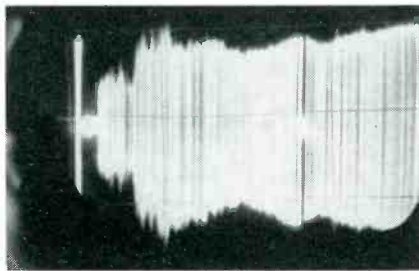
The C-60 was also played on a Cook Series 10-LP, which plays at  $33\frac{1}{3}$  rpm. We have always felt that a cartridge which is intended to play LP records must be tested at  $33\frac{1}{3}$  rpm, since the record speed has a profound effect on the high-frequency response. The response to the Cook 10-LP is so strikingly different from the response to the two 78-rpm records that one would not suspect that the same cartridge was used in both tests. Unfortunately, the C-1 had such a low output when playing the 10-LP that a preamplifier was needed, and we did not wish to introduce the possible response errors of a preamplifier into our curves. Therefore, the C-1 response is not shown on the curve. It was nearly identical to the C-60, however.

A much more informative test involves playing a sweep-frequency test record, which covers a continuous range without gaps. In this way, there is little chance of overlooking any sharp resonances. We use the Elektra 35 record, which sweeps slowly (about three minutes) from 20,000 cps to below 20 cps, with pauses at 2 Kc and 200 cps. We used an oscilloscope with a very slow horizontal sweep and a scope camera to record the response of the cartridges. They were played through a Marantz preamplifier with RIAA low-frequency equalization and flat highs.

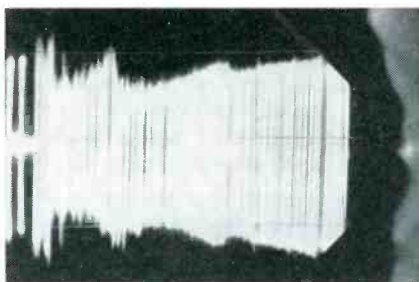
The photos confirm what appeared to be the case in the point-by-point measurements—that the response at 20 Kc and above is down a little in the C-60, compared to the C-1. The C-60 also has a broad rise of about 3 db in the 10- to 12-Kc region, where the C-1 response seems slightly depressed. By and large, however, the two are very similar, and both offer remarkably smooth, extended highs to at least 20 Kc.

The effect of tracking force on high-frequency response can be seen in the first photo, taken with the C-60 at 8 grams instead of the 4 grams used in the others. Instead of a broad peak in the high end, the response is nearly flat to the 10- to 12-Kc point, at which it falls abruptly about 6 db. It is evident that a difference of a few grams in stylus force can make a far greater difference in the response of a cartridge than any intrinsic differences between the C-60 and the older C-1.

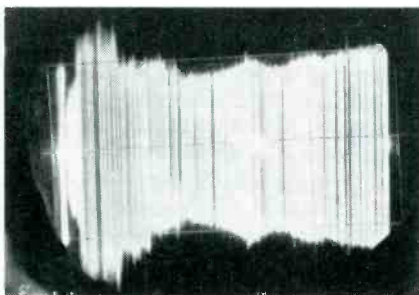
Another sweep record, the Components 1109, covers the range of 100 to



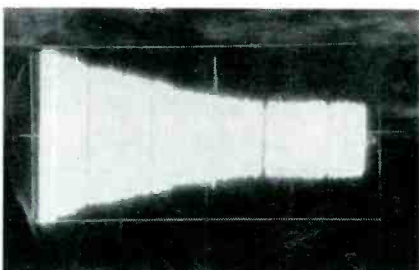
*Elektra 35 sweep record, 20 Kc (left) to 200 cps. ESL C-60 in Fairchild 281 arm. Tracking force for above test: 8 grams.*



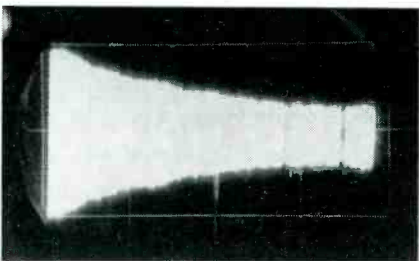
*As above, but ESL C-1. 4 grams force.*



*As above, but ESL C-60. 4 grams force.*



*Components 1109 sweep record, 100 cps (left) to 10 cps. ESL C-60. 4 grams.*



*As above, but ESL C-1. 4 grams force.*

10 cps. It is used primarily for detecting arm resonances, but can also give a rough indication of the relative lateral compliances of different cartridges. The cartridge with the greater compliance will have a resonance at a lower frequency. The compliance of both ESL cartridges is so high that the resonance is in the vicinity of 10 cps or below,

preventing any clear distinction between these units in this respect. The photo taken with the C-1 has a bare suggestion of a rise at 10 cps, but it is hard to tell whether this is due to less compliance than the C-60 or to the latter having a broader resonance.

One of the most severe tracking tests we know of is playing the Fletcher-Munson compensated side of the Cook Series 60 Chromatic Scale test record. At 31 cps, there are some 38 db of boost relative to the middle-range level, with a resultant recorded amplitude that is impossible for most cartridges, even the finest, to track. The ESL C-60 handled it cleanly at 4 grams (it was only the second cartridge we have seen do this).

### Summary

The ESL C-60 sounds almost exactly like the C-1, despite the measurable differences in the upper frequency response. It is clean, smooth, and has very low needle talk. The higher output of the C-60 (6 to 7 mv, or about four to five times as much as the C-1) is sufficient to drive practically any preamplifier without the need for a transformer or transistor preamplifier. It is well worth the slight increase in cost over the C-1. The identical features are available in the P-60, which fits the ESL 310 arm.

For the benefit of those who have not heard any ESL cartridges, they are characterized by great ease and smoothness. Since the high-frequency stylus resonance has been moved up to an inaudible frequency, there is no tendency for peaky response, with its inevitable stridency and high hiss level, to occur. ESL highs have a clear, unstrained sound, with a great deal of definition. The high lateral compliance of these cartridges also moves the low-frequency arm resonance to the subsonic region, with a beneficial effect on tracking of high-level low-frequency passages and over-all cleanness of sound.

To sum it up, anyone who liked the earlier ESL cartridges will like the C-60, only more so. It overcomes the major objection to the early design, with no sacrifice of performance. In fact, we found it superior in tracking ability to our C-1, which was a couple of years old and may have lost a little of its compliance. Our only criticism of the C-60 is the nonstandard stylus-mounting-hole distance. Surely it would be possible to make this conform to the dimensions of practically all other fine cartridges without degrading the performance of the unit.

**Manufacturer's Comment:** We agree that a pick-up equipped with an LP stylus should be tested with an LP record. The minor differences shown in these tests between the C-60 Series and the Concert Series could easily be a result of tolerance variations in the stylus dimensions.

### ESL Dust Bug

The ESL Dust Bug is one of the newest devices dedicated to keeping record sur-

faces dust-free and without static charges. We have been using one for several weeks and are now quite attached to it.

There are a variety of sprays, wipe-on solutions, treated cloths, radioactive devices, and brushes on the market, all of which are supposed to aid in keeping a record clean and free from the crackles caused by dust and static charges built up while playing them. We have not used many of these, so cannot comment on them specifically. Being a trifle lazy, we have never bothered with using solutions, damp cloths, etc. A fixed record brush riding on the surface swept up considerable quantities of lint and grit, but built up a crackling charge in the process. Better than nothing, but not good.

The Dust Bug resembles a miniature

plastic pickup arm with a nylon brush on the end and a pivoted cloth roller just behind it. The brush and roller are moistened with a special liquid in an applicator bottle supplied with the system, and the Dust Bug then tracks the record grooves just as the arm does. The cloth roller moistens the record slightly with the destaticizing solution, and gathers up most of the dust on the surface. The bristles on the end of the Bug get into the grooves and track the little arm, as well as cleaning out some of the dirt in the grooves.

We have found the Dust Bug to be most effective in performing its assigned task. The record surface retains the shiny black appearance of a new disc, and the crackling which used to accompany the removal of the record from the turntable

is conspicuous by its absence. During playing, the background is noticeably quieter than it used to be with the old brush, or with nothing at all.

The price one pays for these benefits (aside from the \$5.75 price of the Dust Bug itself) is the inconvenience of having to remove the Bug after each playing, clean off the lint, remoisten the roller and brush, and replace the Bug after the new record is on the turntable. It makes for a certain amount of fussiness in playing records, without a doubt.

In spite of this, we wouldn't be without it. We have come to appreciate the velvety silence that most of our records have acquired, and until something better comes along, we are quite willing to put up with the slight inconvenience attached to using the Dust Bug.

## Your AUDIOLAB TEST REPORTS on high-fidelity components

### THORENS MODEL TD-124 TURNTABLE

Most of the Thorens line of turntables and record players have an adjustable-speed gear-drive system. Their newest turntable, the TD-124, is basically an idler-drive design, with a fairly long belt to isolate the motor from the stepped speed-change pulley and idler. It appears that the Swiss designers of this turntable decided to develop a unit that would do just about anything that any user could ever demand of a turntable, and do it well, at a reasonable cost. Although it offers no startling basic design improvements over other turntables, the TD-124 gives evidence of extreme ingenuity and fine craftsmanship in its design and construction.

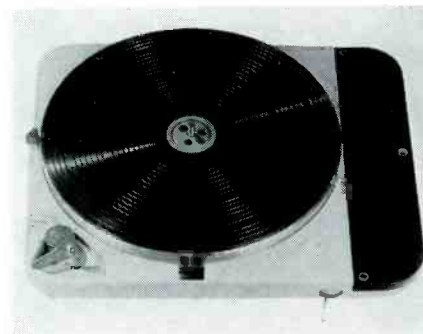
It uses a relatively small, light four-pole motor, with a single stage of vibration isolation from the rugged cast-aluminum base plate. A soft rubber belt drives a stepped pulley some 4 in. from the motor. This pulley turns at half the motor speed, so the stepped portions are twice the diameter of those on directly driven stepped pulleys. This makes a better contact with the rubber idler wheel and minimizes slippage and local deformation of the idler. The pulley, incidentally, is mounted on a precision bearing and resembles a miniature turntable in itself.

An eddy-current braking system is applied to this pulley rather than to the motor shaft. By means of a knob mounted concentrically with the speed-change knob, a 3% variation about each of the four speeds (162½-rpm included) is possible.

A 3⅛-inch-diameter rubber idler wheel with a thin, soft edge is moved up and down to the appropriate step on the drive pulley by the speed-change knob through a flexible steel belt. It

drives the inner rim of an 11½-pound cast-iron turntable. The ½-inch-diameter shaft turns in a nylon sleeve bearing with a ball thrust bearing revolving with the turntable in a nylon seat. The idler is retracted from the turntable when the speed selector is in one of its OFF positions (between each pair of adjacent speed settings). The motor switch is connected to the speed-change knob, so that it goes on when the idler is engaged.

Stroboscope markings on the underside of the cast-iron turntable can be viewed through a lucite window on the front of the base plate via a mirror system. They are illuminated by a neon bulb which goes on when the motor is operating. The turntable can thus be



Thorens TD-124 turntable.

set to exact speed and monitored while a record is being played.

A unique feature of the TD-124 is the clutch system for operating the upper aluminum turntable. This is a light, machined platter with a ribbed rubber mat and retractable 45-rpm hub, which slips over the center spindle. The latter revolves with the heavy turntable. The aluminum turntable rests on six ½-inch-diameter rubber discs fastened to the cast-iron turntable and turns with it. When a clutch knob on the left side of the base plate is moved, the aluminum

turntable is lifted clear of the cast-iron turntable and stops instantly while the main turntable continues its rotation.

This system has obvious advantages in cueing the pickup to a particular portion of the record, or in stopping the playing, and returning to the exact point where it was stopped. Another advantage is that the motor may be operated continuously during a playing session, and so become stabilized in temperature and thus in speed. The change in speed when the upper turntable is engaged is momentary, and the average value remains constant.

The double turntable allows the designers to take advantage of the greater mass of an iron turntable, while the aluminum turntable keeps the cartridge far enough from the iron turntable so that no appreciable magnetic attraction can take place even with some of the older cartridges which were subject to this difficulty.

A rigid extension of the cast-aluminum base plate is provided for mounting a wooden strip holding the arm. A strip of proper dimensions for 12-inch arms is provided, and a larger one is available for 16-inch arms. Since the arm is mechanically a part of the base plate and vibrates with it, there is virtually no relative motion between the two and consequently very little rumble. A template is provided with the turntable which makes it easy to locate the arm in the proper position on the wooden arm plate.

A bubble level is an integral part of the base plate, and leveling knobs are provided on the four mounting screws so that the base plate can be accurately and easily leveled. Soft rubber mounts fit over the mounting screws so that the entire assembly is shock-mounted on the motor board. The motor board

*Continued on page 41*



# How to use a Magnetic Cartridge

*How to  
obtain flattest response*

by HERMAN BURSTEIN

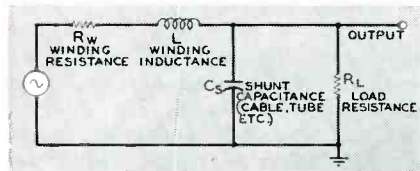
THE resistive and capacitive loads into which a magnetic cartridge works have an appreciable effect upon its frequency response—particularly when the cartridge is of the variable-reluctance type, which customarily has an inductance of several hundred millihenries.

Fig. 1 shows the equivalent circuit, viewing the pickup as a zero-impedance signal generator.  $R_w$  is the winding resistance,  $L$  is the winding inductance,  $R_L$  is the load resistance, and  $C_s$  is the sum of various shunt capacitances—interwinding capacitance of the cartridge, capacitance of the connecting cable, and input capacitance of the tube into which the signal is fed. Ordinarily, load capacitance  $C_s$  is principally that of the cable, because interwinding capacitance is only a few  $\mu\mu\text{fd}$ , and the tube's effective input capacitance is usually quite small at high frequencies.

$L$  and  $C_s$  constitute a series resonant circuit, with maximum signal voltage produced across  $C_s$  (and across  $L$ ) in the region of resonance. If  $L$  and/or  $C_s$  is large enough, the resonant peak can occur within the audio spectrum or close enough to it so as to cause an undesirable rise in treble response. The reference here is to electrical resonance, not to the high-frequency resonance determined by stylus mass and the nature of the disc material.

Assume that  $L$  is 520 mh, as in the case of a GE cartridge, and  $C_s$  is 400  $\mu\mu\text{fd}$ , which could easily be true with several feet of high-capacitance cable. The resonant peak would then occur at about 11,000 cps.

Fig. 1. Equivalent circuit for magnetic cartridge with factors to be considered.



To minimize the resonant peak it is necessary to provide a damping resistor, shown as  $R_L$  in Fig. 1. This may be wired directly across the cartridge terminals or it may be located in the preamplifier; many preamplifiers already contain a load resistor suitable for the GE and cartridges like it. Others may have a calibrated load potentiometer, which can be set for the cartridge that is used. In the case of a GE, the recommended value is 47 K; for a Pickering, 27 K. Although it is true that the smaller the resistor is, the greater the damping effect, too small a resistor causes a loss in high-frequency response, as illustrated in Fig. 2. Cartridge inductance and load resistance form a low-pass filter, with response approximately 3 db down at the frequency for which the reactance of  $L$  equals the resistance of  $R_L$ . In the case of a 520-mh inductance and a 47-K load, this frequency would be about 14,000 cps.

In some audio systems a small load resistor of suitable value is deliberately employed in order to obtain the treble cut required when playing modern discs with a variable-reluctance pickup; consequently, the preamplifier must supply only bass boost. To compensate for the treble portion of the RIAA recording characteristic, which requires attenuation beginning at 2,122 cps, (3 db down), a load resistance of about 6,900 ohms is required for a GE cartridge. Since the cartridge winding has a resistance of roughly 300 ohms, a load resistor of only 6,600 ohms is needed. The nearest standard value is 6,800 ohms, which affords accurate enough treble equalization.

Although the resonance of a variable-reluctance cartridge may be well damped, it is desirable to keep the resonant frequency high, because response falls 12 db per octave beyond this frequency. To maintain resonance well up in the audio range or preferably outside it, shunt capacitance should be low. One way in which this can be done is to use a connecting cable from record player to preamplifier that is of low capacitance (25  $\mu\mu\text{fd}$  per foot is readily available) and no longer than strictly necessary.

*How to  
provide proper loading*

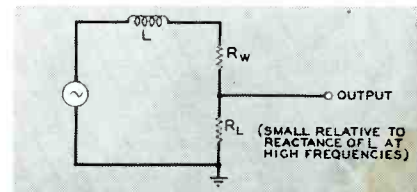
Thus, if total cable capacitance were kept to 100  $\mu\mu\text{fd}$ , and all other forms of shunt capacitance totaled 50  $\mu\mu\text{fd}$  (making 150  $\mu\mu\text{fd}$  in all), then the resonant frequency for a GE would occur at about 18,000 cps, which is satisfactory.

The problems of minimizing shunt capacitance and optimizing load resistance ordinarily do not exist for magnetic pickups of moving-coil design, which characteristically have an inductance of only a few millihenries. An extraordinary amount of shunt capacitance would be needed to bring electrical resonance anywhere near the audio range. Therefore, damping is not needed, and the moving-coil cartridge can work satisfactorily into loads ranging from a few hundred ohms up to typical high-impedance values such as 250 K or 500 K.

The moving-coil cartridge is a relatively low-output device, and is, therefore, used often with a step-up transformer in order to obtain sufficient signal to drive a preamplifier and/or to improve the signal-to-noise ratio. In this case it does become important to load the transformer secondary with the resistance (relatively small) recommended by the manufacturer, because a high-impedance load will result in loss at the bass end. On the other hand, for those who are willing to tolerate a loss of something like 6 db at the very low end, over-all output from the transformer can be substantially increased by connecting the secondary to a high-impedance load.

Other types of magnetic cartridges (such as moving-magnet units) may or may not require resistive loading. It is best to follow the manufacturer's recommendation in each case.

Fig. 2. Effect of load resistor on high-frequency response. See text for details.



# TRANSISTORS

by PAUL PENFIELD, Jr.

in audio circuits

## PART Xb: Transistor output stages

THE advantages and disadvantages of each class of operation and each type of circuit, discussed in detail in the April issue, are summarized in the table on p. 31.

### Output Transducers

Just as input stages were designed to get the most out of the various types of transducers, so output stages must be coupled with the load in the right way.

The factors that determine the "right" way, however, are somewhat different. With input stages we wanted the correct frequency response and low noise. With output coupling we want maximum power transfer at least distortion, with best frequency response. Here are some methods of coupling to common output transducers.

**Loudspeakers.** Most loudspeakers have nominal impedances in the range from

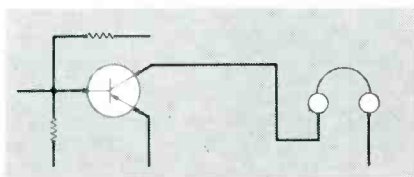


Fig. 7. Low-power stage drives phones.

4 to 16 ohms, with some models as high as 600 ohms. Typical load impedances of high-power transistor stages for maximum power output\* are in the range from 10 to 200 ohms, so with single-ended output stages it is not unreasonable to use a loudspeaker directly as a load, without a transformer. Some speakers will not handle any DC current without distorting the AC signal, but even these can be used with the single-ended push-pull outputs, which have no quiescent DC output.

Transformers are necessary in cou-

\*This is not at all the same as the output impedance of the transistor stage. It is merely the resistance for getting maximum power output within limits of power dissipation, maximum collector voltage, etc. The value depends on the bias point chosen.

pling from double-ended circuits, to add the two collector currents together in the right way. They may be used also in coupling from single-ended stages. Often, transformer coupling is the simplest and the easiest.

Eventually, speakers with center-tapped voice coils will be used with double-ended conventional push-pull stages, but until these speakers are available transformers will be necessary.

If an output transformer is used, standard crossover networks, electrostatic or magnetic tweeters, and woofers can be employed with a transistor amplifier as well as with a vacuum-tube amplifier. But if a transformer is not used, be sure that the DC bias on the last stage will not interfere with the operation of any of these components.

The damping factor can be adjusted on a transistor amplifier the same way it is on a vacuum-tube amplifier.

**Earphones.** For driving earphones a power stage is not really necessary. The phones draw so little power that ordinary low-power stages will drive them sufficiently. Magnetic earphones can be connected as the entire load of a low-power stage, as shown in Fig. 7. The DC bias as well as the AC signal passes through the phones.

Crystal earphones will not pass the DC bias; consequently, some capacitive

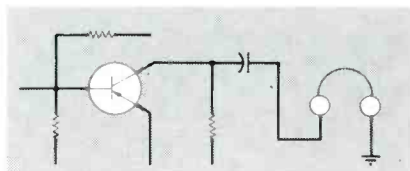


Fig. 8. Crystal phones need capacitor.

coupling arrangement such as Fig. 8 is necessary.

**Magnetic Tape Heads.** Rather small currents are normally required to drive a tape head, in the neighborhood of .02 to 1 ma. For a high-impedance head, or

if an equalizer is used, this current may have to be at a moderately high voltage: 10 v or more. Often it is possible to drive a tape head from a single-transistor stage by capacitor coupling, as in Fig. 9. The DC bias current must be kept out of the tape head, so direct coupling is not advised. Other times, a transformer may be necessary to get the correct ratio of current to voltage.

**Low-Impedance Lines.** Usually transformer coupling is the simplest and best. Treat the secondary of the transformer just as you would the output from a vacuum-tube amplifier.

**Cutting Heads.** For magnetic cutting heads, a transformer coupling is best,

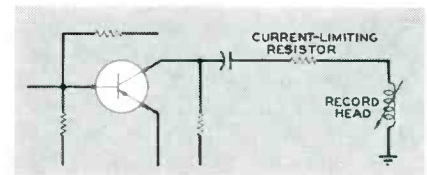


Fig. 9. How a tape head is connected.

since it is necessary to isolate the DC bias from the head anyway. Ordinary impedance-matching principles can be used for best efficiency.

A crystal cutting head also can be transformer-coupled, but from a single-ended output stage it can also be capacitively coupled, just as the crystal earphone can.

**Modulators.** A transformer is usually used in modulating a transmitter, and the amplifier that precedes the transformer can be transistor-operated as well as run by vacuum tubes. The same principles apply: coupling should be done by means of a transformer, as before.

**Others.** For light-beam communication, neon lights are often used, modulated at audio frequency. Different schemes are available, but they all require high voltage so a transformer is necessary in running such a light from a transistor amplifier.

A meter may be used to indicate audio level. Normally, no meter is insensitive enough to require power transistors. Low-level stages can do quite well, and capacitive coupling is adequate. Fig. 10 shows a typical circuit for



driving a DC milliammeter; other rectifying schemes are available also. An AC meter doesn't even need the external rectifier.

If a VU meter is used, capacitor coupling is adequate, but be sure the source impedance is 3,900 ohms, or else the ballistic properties of the meter won't be right.

Power transistors can be used to advantage in operating servo-mechanisms and other types of motors. They can power relays and other control devices. Their rectified output can be used to power still other devices; there are a great many nonaudio applications for power transistors.

### Summary

The coupling circuits for output transducers described are really of only two types: 1) coupling by transformer, using the transformer to isolate the bias voltages, transform the current-voltage ratios, and add the currents from each half of conventional push-pull stages in the proper phase; and 2) capacitor

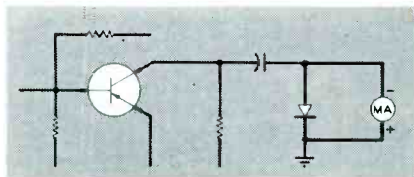


Fig. 10. Typical circuit for DC meter.

or direct coupling for use only with single-ended output stages, when the current-voltage ratios are approximately right.

### Further Reading

#### Vacuum-Tube Power Amplifiers

Allison, R. F. "Basic Electronics," *AUDIOCRAFT*, II (Nov. 1957), pp. 30, 48-52.

Crowhurst, N. H. "Designing Your Own Amplifier." *AUDIOCRAFT*, I (Apr. 1956), pp. 25-27, 41-42; I (Jul. 1956), pp. 19, 33-34; I (Sept. 1956), pp. 28-29, 37-38.

Crowhurst, N. H. *Understanding Hi-Fi Circuits*. New York: Gernsback Library, 1957, pp. 13-32.

Lo, A. W., Endres, R. O., Zawels, J.,

Waldhauer, F. D., and Cheng, C.-C. *Transistor Electronics*. Englewood Cliffs N.J.: Prentice-Hall, 1955, pp. 197-224.

Marshall, J., and Mogen, D. "Transistor Audio Power-Output Stages." *Journal of the Audio Engineering Society*, IV (Apr. 1956), pp. 60-64.

Penfield, P., Jr. "Power Transistors." *Radio & Television News*, LV (Feb. 1956), pp. 37-40, 110, 112.

Shea, R. F. *Transistor Audio Amplifiers*. New York: John Wiley, 1955, pp. 145-188.

Shea, R. F. *Transistor Circuit Engineering*. New York: John Wiley, 1957, pp. 105-125.

Ghandhi, S. K. "Design of Transistor Power Amplifiers." *Electronics*, XXVII (Mar. 1954), pp. 146-149.

Hunter, L. P. *Handbook of Semiconductor Electronics*. New York: McGraw-Hill, 1956, pp. 11-28—11-43.

Lin, H. C. "Quasi-Complementary Transistor Amplifier." *Electronics*, XXIX (Sept. 1956), pp. 173-175.

Table I

	Class A	Class B	Class AB
Single Transistor	Soft distortion Easiest to design Single-ended input Single-ended output Any coupling method possible Power output less than $P/2$ Maximum collector efficiency of 50% Large standby power	Not practical	Not practical
Conventional Push-Pull	Lowest Distortion Biasing not difficult May be driven by any phase inverter Power output less than $P$ Double-ended input Double-ended output Matched pair necessary Maximum collector efficiency of 50% Large standby power	Low standby power Maximum collector efficiency of 78% Biasing not difficult Power output less than $2P$ Double-ended input Double-ended output Matched pair necessary Cannot use capacitor coupling Bad crossover distortion unless eliminated	Moderate standby power Biasing not difficult Double-ended input Double-ended output Matched pair necessary Cannot use capacitor coupling Fairly bad distortion
Single-Ended Push-Pull	Lowest distortion Single-ended output Power output less than $P$ Two batteries usually needed Special transformer or direct coupling required on input Maximum collector efficiency of 50% Large standby power	Low standby power Maximum collector efficiency of 78% Single-ended output Power output less than $2P$ Two batteries usually needed Special transformer or direct coupling required on the input Bad crossover distortion unless eliminated	Single-ended output Moderate standby power Two batteries usually needed Special transformer or direct coupling required on the input Fairly bad distortion
Complementary Push-Pull	Low distortion Single-ended input Single-ended output Power output less than $P$ Two batteries usually needed Matched $p-n-p$ , $n-p-n$ pair necessary Somewhat difficult to bias Maximum collector efficiency of 50% Large standby power	Low standby power Maximum collector efficiency of 78% Single-ended input Single-ended output Power output less than $2P$ Two batteries usually needed Matched $p-n-p$ , $n-p-n$ pair necessary Cannot use capacitor coupling Difficult to bias Bad crossover distortion unless eliminated	Single-ended input Single-ended output Moderate standby power Matched $p-n-p$ , $n-p-n$ pair necessary Two batteries usually needed Cannot use capacitor coupling Fairly bad distortion Difficult to bias

# TAPE NEWS AND VIEWS

by J. GORDON HOLT

## Bias: root of many evils

EVERY bright, alert tape recordist knows (or should know, if he doesn't) that good tape should be used with his recorder, because poor tape can dirty the heads (obliging him to clean them more than twice every year) and can make the recorder's performance much inferior to what it should be. But how to explain the case of the two neighbors who both purchased the same make and model of tape recorder, plus several reels each of professional-quality tape, and then began exchanging reports

recorder had rather poor high-frequency response and heavy bass, but by golly it was as clean as he could wish.

Instead of coming to blows over this, A came over to B's house and brought his recorder along. They ran off simultaneous duplicates of a reasonably new Westlab record, and then compared playbacks. The machines sounded identical, and both had poor high-frequency response, excessive bass, and sound that was as clean as either of them could wish.

Puzzlement?\*

Well, they took both machines back to A's house, and committed a second copyright violation, this time with a Capitol. Now both recorders had excessive highs and muddy bass. They swapped machines, and reported exactly the same results in their respective homes as they had had originally.

This weirdly baffling mystery might never have been solved at all had recordists A and B not remembered one night to bring along their *own* tapes for a comparison session. When they did this, they were able to duplicate their home results at each other's houses. They found that they could use one brand of tape on either machine and get too little treble and clean sound, or they could use the other brand of tape and get excessive treble and thick muddy bass.

The point of this whole epic narrative is that neither of the tapes in question was a "bad" brand; both were top-grade professional brands and types, but they had different ultrasonic-biasing require-

\*Sorry, Mr. Crowhurst, but I just couldn't resist it.

ments. A's original tape required fairly high bias, B's tape required a lower bias than usual. The recorder was set up for a tape that required an average bias current, so neither A's nor B's brand was ideal for that recorder, as it was delivered from the factory. Either the right tape, or readjustment of the recorder's bias current would have (and did) clear up the troubles.

It is no secret that the amount of ultrasonic bias current flowing through a record head affects the distortion, frequency response, and noise of a recording, but it is not usually realized how critical this bias current actually is.

One thing that professional recordists have on their side is the fact that they don't have to concern themselves overly

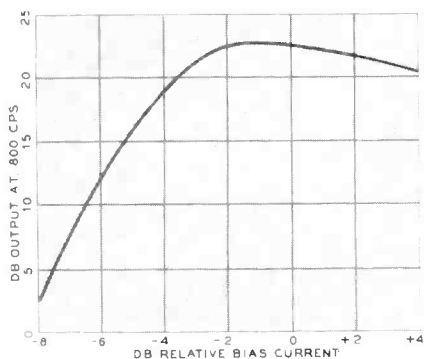


Fig. 1. Variations in tape output due to changes in bias current, at 800 cps.

about the respective performances of their recorders?

Recordist A, who shall remain nameless (to protect him from undeserved ridicule), claimed that his recorder had excessive high-frequency response and muddy bass. Recordist B, (who deserves to be just as anonymous as A) said that Recordist A must doubtless be endowed with a set of rusty tin ears, because it was *his* (B's) observation that said tape

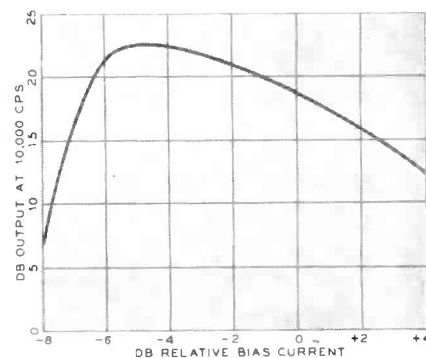


Fig. 2. Variations in tape output due to changes in bias current: 10,000 cps.

about the economics of taping. They can feel free to run off at 15 or 30 ips enough tape in a week to reach from the moon to Boston Common and back, and since high speed is conducive to excellent frequency response, about the only thing they have to do is to adjust bias for minimum distortion and maximum signal-to-noise ratio. The home recordist's "standard" speed, however, is 7½ ips, and this is where the trouble starts.



The high-frequency response limit of a tape playback head is established by the effective width of the gap between its pole pieces, and at frequencies above that for which the gap width is equal to half of the recorded wave length, the output from the head will diminish rapidly. But *most* of the high-frequency losses from tape take place while recording, as a direct result of the ultrasonic bias tone that accompanies the signal *through* the head. Tape is an inherently nonlinear recording medium, which is to say that if we were to try recording a simple sine wave on tape we would get a dreadfully distorted signal on playback, as well as very low output and very high noise level. Superimposing the desired audible signal on an ultrasonic carrier or bias tone of between 30,000 and 100,000 cps largely overcomes the tape's inherent nonlinearity, reducing distortion, increasing output, and minimizing noise. Fig. 1 shows rather graphically how tape output at 800 cps from one brand of professional-grade tape varies with changes in the bias current. As the bias current is increased toward its optimum value, the recorded signal going onto the tape increases markedly in intensity and then

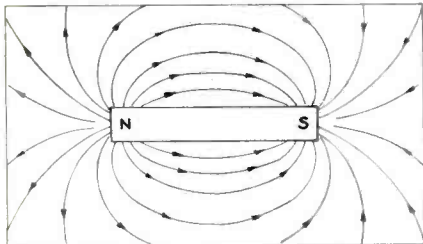


Fig. 3. Recorded tape has force lines like those around a typical bar magnet.

levels out. Beyond this maximum-output point there is a gradual diminution in the signal going onto the tape. It also happens (conveniently) that the bias value which gives maximum output also gives close to minimum distortion, and that the lowest distortion actually occurs when bias has been increased "beyond peak" to the point at which the output has dropped back again by 1 or 2 db.

The other side of the picture, however, is shown in Fig. 2, which represents the same type of variations as are shown in Fig. 1, except that this one shows the output at 10,000 cps. The difference exists because at high frequencies, the bias signal starts to behave like an erase signal, and wipes off some of the audio signal as soon as it is on the tape. It is obvious that if we set bias to produce maximum output from the tape we are going to have to add quite a bit of treble boost in order to maintain flat response to 10,000 cps, let alone to 15,000, but it is not at all difficult to do this as needed. The real stumbling

*Continued on page 47*

## Some facts on the measure of the

# JansZen\* loudspeaker

One very important measure of a loudspeaker's capability as a true high fidelity component lies in its ability to reproduce music with the same emphasis at all volume levels. As the volume control is turned from maximum to minimum, each instrument of an orchestra should remain in the same perspective . . . the effect being of walking farther and farther away from a live orchestra as it is playing.

When a response curve is taken on a JansZen speaker from the lowest listening level up to a full 50 watts of power, the resultant curves are absolutely identical.

This is a true measure of smooth response, which in turn is a measure of the similarity between what goes into a recording microphone compared with what comes out of your speaker at home. Hence, it is a measure of whether a high fidelity speaker is in fact what it is supposed to be.

A response curve is taken on every JansZen speaker before it leaves the factory. Only in that way can it be assured that each speaker is right. Only in that way can it be assured that all speakers are exactly the same. That's why most knowledgeable listeners consider JansZen as The Speaker.

\*DESIGNED BY ARTHUR A. JANSZEN

*Write for literature and the name of your nearest dealer*

Product of **NESHAMINY ELECTRONIC CORP.**, Neshaminy, Pa.

Export Division: 25 Warren Street, N.Y.C. 7, Cable Simonrice, N.Y.



## NEW SUPER-CARDIOID ...and super value!

Difficult acoustic conditions are child's play for this sensational new super-cardioid microphone. Background noise, undesirable echo, and other unwanted sounds disappear when the ESL-SC403 is used for high fidelity broadcasting or recording of music and speech.

Excellent performance, inconspicuous size, and inexpensive price make this advanced moving coil microphone additionally suitable for lecture halls, churches, and conventions. A high impedance model is designated the ESL-SC403H. Write for details on other new ESL microphones.

	ESL-SC403	ESL-SC403H
FREQUENCY RESPONSE:	50 to 12,000 cps $\pm 3$ db	
DIRECTIONAL CHARACTERISTIC:	super cardioid	
INTERNAL IMPEDANCE:	200 ohms	45,000 ohms
OUTPUT LEVEL:	-50 db	2.2 mv/ $\mu$ bat
REFERENCE LEVEL:	1 mw/10 dynes/cm <sup>2</sup>	
DIMENSIONS:	2" x 1 1/2" x 3 3/4"	
NET PRICE:	\$25.50	\$28



FOR LISTENING AT ITS BEST

**Electro-Sonic Laboratories, Inc.**

Dept. C • 35-54 Thirty-sixth Street • Long Island City 6, N.Y.

# What are the best ways to match multiple speakers?

by NORMAN H. CROWHURST



**Q**UESTIONS about crossovers seem to cause more puzzlements than any other subject in high fidelity: "How do you choose a crossover frequency?" "It is worth using an electronic divider with separate amplifiers?" and so on. Different and apparently conflicting opinions may lead to the puzzlement, although sometimes it is just a perusal of loudspeaker manufacturers' catalogues.

For example, one will use a crossover frequency of 1,500 cps, while another chooses 4,000 cps. Then the question becomes, "Which is better?" The puzzlement often gets compounded by impedance complications. A man likes this woofer and that tweeter, but the woofer is 16 ohms and the tweeter is 8 ohms, so how does he go about using them together?

Choice of crossover frequency is governed by the types of loudspeakers used. If each unit is a cone radiator (as, for example, in the Bozak and Wharfedale systems), there is usually considerable latitude in the choice of crossover frequency. Any particular cone unit does not abruptly begin to function at a specific frequency, and cease again at some higher frequency.

At lower frequencies, the excursion needed to give adequate acoustic radiation is large, and begins to cause various kinds of distortion, particularly IM. At

higher frequencies, the cone begins to vibrate in various complicated modes, rather than moving just as a piston, causing erratic frequency response and sometimes distortion as well. But at neither end do these things begin to happen suddenly. So the range for which each unit may be used is somewhat in-

definite, and the choice of crossover frequency the unit just drops dead, and a tweeter must be ready to take over. The ideal crossover frequency, then, is governed by the types of units used. In general, the frequency is chosen so that each unit does not produce distortion from being driven too hard at the low end of its range (except the woofer, of course) and so that it does not get into the region where it responds erratically at the high end (except the tweeter).

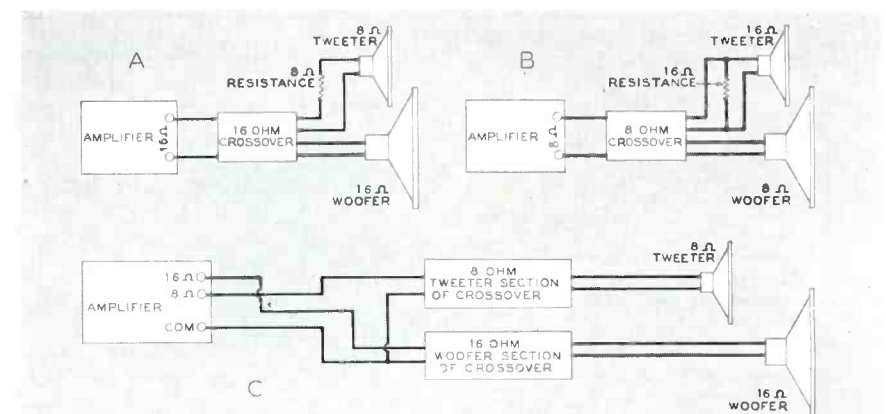


Fig. 2. Methods of combining speakers of different impedance. A: tweeter lower than woofer B: tweeter higher. C: matching to different output taps on the amplifier.

definite, and the choice of crossover frequency is not at all critical.

With horn-type radiators, the story is different. A horn has a very definite low-frequency cutoff. Below this critical frequency the horn no longer radiates sound properly at all. The diaphragm can move without the air loading the

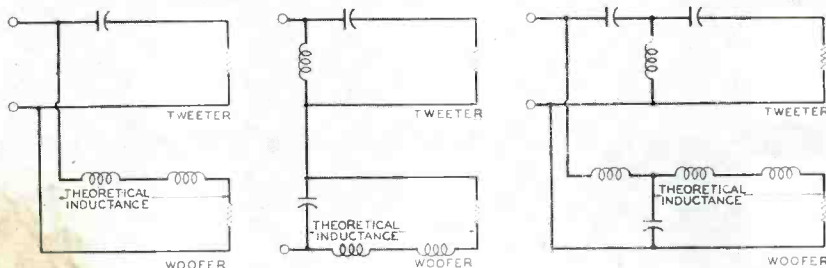
frequency the unit just drops dead, and a tweeter must be ready to take over.

The ideal crossover frequency, then, is governed by the types of units used. In general, the frequency is chosen so that each unit does not produce distortion from being driven too hard at the low end of its range (except the woofer, of course) and so that it does not get into the region where it responds erratically at the high end (except the tweeter).

Having resolved these fundamentals about crossovers in general, the next puzzlement is whether to use a regular dividing network or an electronic one? In short, what does the use of an electronic divider produce in benefits?

Recently a friend called up about a problem with his amplifier, which was of well-known make, enjoying a good reputation. Apparently it behaved very

Fig. 1. Inductance of woofer voice coil must be considered in divider calculations.





well when he had it driving a single 8-inch speaker. But when he connected it to an elaborate three-way system the amplifier oscillated somewhere around 10,000 cps. This sort of experience is not uncommon; using an electronic divider, with separate power amplifiers for each frequency range, would help to eliminate it.

But this reason for using an electronic divider seems to me rather like burning one's house down to get rid of mice. No well-designed amplifier should take exception to working with the reactive elements introduced to it by a three-way dividing network. Avoiding the network may avoid the oscillation, but the amplifier will still be in the borderline region of stability. It will probably produce some undesirable peaks or bad transient effects. The best thing to do for this is to get a better amplifier, or rework the one you have.\*

Other reasons given for using electronic dividers are avoidance of termination problems, which arise because loudspeakers do not have pure resistive impedances; and avoidance of IM in the amplifiers. [Still other reasons: improved amplifier damping for low-frequency speakers; conversion to higher total amplifier power while retaining use of original low-power amplifier; easy compensation for loudspeakers of differing efficiency. — Ed.]

Of course, all amplifiers cause a certain amount of intermodulation. But if an amplifier produces enough to be noticeable in comparison with the IM from the average speaker unit, it is not a good amplifier, either for the whole frequency range or for just one part of it. If the amplifier has an average modern specification in IM distortion — *and really conforms to it under operating conditions* — there is no need to use an

\*Norman Crowhurst, "Optimize Your Amplifier for \$1," *AUDIOCRAFT*, 11 (Apr. 1957).

electronic filter to avoid its IM distortion.

Making sure the loudspeaker units provide correct termination for a conventional dividing network is a more real problem, but not an impossible one. The woofer voice coil has inductance as well as resistance, and this inductance can be allowed for in the network design (Fig. 1). Middle-range and tweeter units are usually sufficiently close to a resistive impedance at crossover frequencies that no such step is needed.

Sometimes the transition provided by a dividing network of normal design does not yield adequate response in the region of crossover. To overcome this, an overlap in the ranges delivered to the two units can help. The woofer may go up to 4,000 cps, for example, while the tweeter starts in at 2,500 cps. With a standard network this modification is quite possible, but will result in incorrect loading for the amplifier in the overlap region. Using an electronic divider involves no problem of this type, and the levels can be set independently.

For a case in which the loudspeaker units have different impedances, the simplest solution also may be the electronic divider, but a little thought will usually save this expense. The woofer generally needs most power, so it is advisable to use a dividing network designed for the woofer's impedance. The other units can be "padded" to match. If the woofer is 16 ohms and the tweeter 8 ohms, an 8-ohm resistance in series with the tweeter will do the trick. The network is then designed for 16 ohms (Fig. 2A).

If, on the other hand, the woofer is 8 ohms and the tweeter 16 ohms, the tweeter can use a parallel resistor of 16 ohms, so that both look like 8 ohms. The network is then designed for 8 ohms, Fig. 2B. Of course, it is simpler

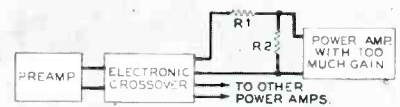


Fig. 3. Attenuator pad before high-gain amplifier helps achieve proper balance.

to use the electronic divider and then match correctly to each unit by using the different output taps on their respective amplifiers.

Another alternative is shown in Fig. 2C. The individual filter sections of the dividing network are designed for their respective speakers' impedances, and the inputs are connected to the corresponding amplifier taps.

Inquiries about electronic dividers often lead into two more questions:

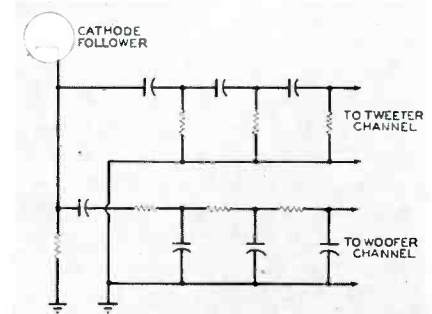


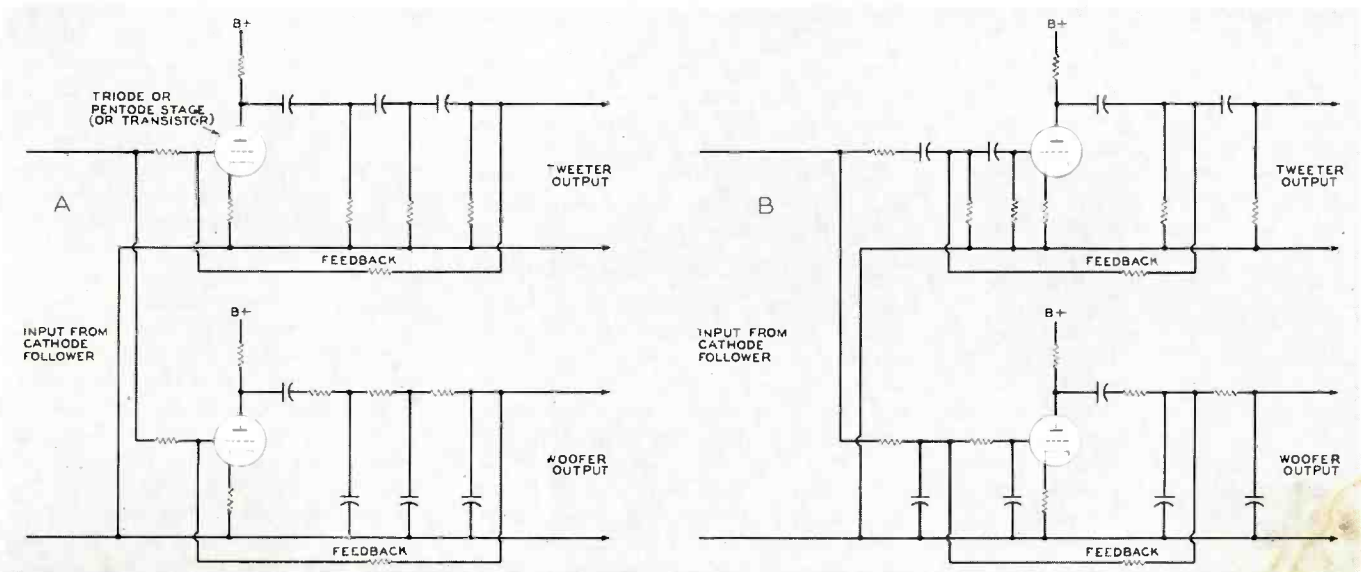
Fig. 4. Basic frequency-discriminating networks of electronic-divider circuits.

should the power amplifiers all have the same power rating, and should they be capable of full-frequency-range operation?

For most program material, the greatest proportion of power is in the lower and middle frequencies. The frequencies handled by the tweeter contain very little power. The woofer and middle-range units require amplifiers capable of a little more than half the power (each) that would be used for full range, while the tweeter amplifier can be considerably

*Continued on page 43*

Fig. 5. Frequency control components in plate circuit (A) or distributed between plate and grid circuits (B) help tailor response.



# Sound-Fanciers' Guide

by R. D. Darrell

## Columbia SLP Compatibility

Tuesday, the 25th of March, 1958, was an exciting day at the IRE Convention. In a previously unscheduled paper, we heard the first news of a completely compatible stereo record developed by Columbia engineers. As Dr. Peter Goldmark was describing his, Ben Bauer's, and Bill Bachman's novel system of elliptical modulation of stereo-disc grooves, I remembered the 18th of June, 1948, when microgroove LP's were first announced and demonstrated.

The actual demonstrations themselves were relatively meaningless in either case (except of course as indexes to the engineers' confidence in the practicability of their new inventions), since under such circumstances it's impossible to make any accurate estimates of sonic quality—and, in any case, I for one never believe a thing I hear in public demonstrations, refusing even to attempt tentative evaluations until I can hear records and/or reproducers at home under known acoustical conditions and with ample time for repetition, comparison, and reflection. Yet from the technical specifications alone it is obvious that Goldmark, Bauer, and Bachman have come up with an exceedingly ingenious solution to the problems of compatibility, both between stereo and single-channel reproductions of the same discs, and between the vertical/lateral and 45/45 stereo-disc systems.

How good Columbia's first SLP's (for "Stereo LP's") will actually sound in home reproduction remains to be seen—and heard, as does also their comparative merit vis-à-vis the more "conventional" 45/45 stereo discs (of which the first four commercial releases are already available from the incredible Sidney Frey of Audio Fidelity—with another from Esoteric hot on their heels—and many more from RCA Victor, Capitol, and probably others expected momentarily). But before my next SFG copy is due, I shall be set up for first-hand home-playback reports—and I confidently expect that stereo-disc reviews will be a prominent feature of this column from then on. For the IRE sessions (which also included papers by



Westrex, RCA Victor, and V-M Corporation, as well as Columbia, engineers) proved more convincingly than any previous publicity, rumors, demonstrations, and experimental releases that the stereo disc is really *here*, sooner and bigger and more importunate than most of us ever dreamed possible. In short: hold your hats, kids—here we go again!

[Just before this issue was printed, we learned that Columbia had decided *not* to release its "compatible" stereo discs. It will issue a line of true 45/45 stereo records, as well as its present monophonic line.—ED.]

## But Don't Sell Tape Short

Just the same, I earnestly beg all audiophiles, including myself, to keep their heads and senses—and remember the early history of LP's. The imposing promotion of stereo discs now getting under way by giants like Columbia, RCA Victor, Capitol, et al., means above all that the immediate emphasis will be on the speedy building up of a mass market with consequent stress on comparatively low-priced playback equipment. Even if

the inevitable first bugs in both recordings and pickups are eliminated more quickly than they were in the original microgroove revolution, it's still going to take time before quality standards are achieved which are at all comparable with those currently existing in single-channel LP's and their reproducers, or in stereo tapes and tape players. Experiment if you must, and can (and few of us will be able to resist that temptation), but don't naively count on really top-quality stereo-disc reproduction within the very near future.

Stereo discs are off to a flying start, all right, but I'll wait to salute their coming of age until they can give me as satisfactory, not to say electrifying, aural experiences as those I've relished lately in listening to such both technically and musically superb tapes as Erich Leinsdorf's Debussy's *La Mer* and Ravel's *Daphnis et Chloé* Suite No. 2 (Capitol ZF 25, in many ways the most impressive of all symphonic stereo tapings to date), the delectable Buxtehude programs by the Cantata Singers under Alfred Mann (Urania UST 902 and 1210), the dynamically stimulating *Bartered Bride* and *Schwanda* selections conducted by Hollreiser (Phonotapes S 713), Reiner's ingratiating coupling of Johann Strauss' Waltzes (RCA Victor ACS 63), and John Ranck's lusciously recorded piano recital which features Ravel's *Sonatine* with a group of impressionistic miniatures by Debussy, Mompou, and Ponce (Zodiac ZST 1005). All these are available in LP editions as well, but good as they may sound in single-channel reproduction, there's just no comparison—sonically or aesthetically—with the stereo versions.

Of less musical substance but still enormous sonic fascination are Richard Schory's *Re-Percussion* and José Bethancourt's *Marimba Tropicale* (Concertapes 25-1 and 506), Felix Slatkin's version of Britten's *Young Person's Guide* and Dohnányi's *Variations on a Nursery Air* with Victor Aller as piano soloist (Capitol ZF 23), the "Original" *Trinidad Steel Band* (Dyna-Tapes DY 3002) and the on-location steel band and calypso



*Jump-Up Carnival* documentary (Cook 1072 ST), and — if you aren't bothered by the super-Stokowskian overfancy arrangements — Carmen Dragon's *Russkaya!* program (Capitol ZF 24).

Still sticking only to outstanding tapes I've enjoyed just recently and haven't yet had a chance to cite in this column, there are such light-music delights as George Feyer's Kern and Porter programs (Phonotapes S 901 and 906) and two infectiously zestful novelty programs, *In My Merry Stereoldsmobile* by the Gerry Wiggins Trio (Stereotape ST 16) and *Jazz'n Razz Ma Tazz* in which George Wright happily abandons his theater organ to lead a Varsity Five from a ricky-tic piano (HiFiTape R 805).

And when it comes to jazz, I haven't even space for adjectives when I begin to list just the best of my current reel-music favorites: Lizzie Miles's *Clambake on Bourbon St.*, Vol. 2 (Cook 1182 ST), Vol. 2 of the incomparable *Jazz at Stereoville* with Cootie Williams et al. vs. Rex Stewart et al. (Concert Hall EX 50), *Mad Thad* with a whole bevy of Jones's sidemen (Period PST 4), the Dave MacKay and Pee Wee Russell programs (Stere-o-Craft TN 104 and 105), Johnny Guarneri's *All That Jazz* (Manhattan MRC 102 — of particular interest to multiple-mike devotees for its effective exploitation of no less than eight channels in the original master), and the debut releases of some striking new Floridians in Lon Norman's *Gold Coast Jazz*, Vols. 1 and 2, on the first Criteriatapes (CRT 1 and 3) to come my way.

When one or two months' stereo-disc releases can come even close to approaching — to say nothing of matching or excelling — a cornucopia of attractions like these, I'll concede that they've achieved maturity. That day will come, I have no doubt whatever; but I surely won't try to hold my breath until then! Sufficient unto the day is the good sound thereof — and my practice as well as my preachment is to enjoy it *now* rather than hold timidly back waiting for that distant, however inevitable, day when hi-fi pie in the sky at last gets down to earth — and our home turntables.

### More Demos and Tools

With few exceptions, the latest sampler and test releases demand no more than passing mention. The only LP "demo" I've received lately is Vanguard's SRV 106 (\$1.98) of the Beethoven Fifth and Schubert *Unfinished* Symphonies conducted by Prohaska (the former is also available in stereo, VRD 1, at \$6.95), and although it's a bargain at the price, all right, neither performance is particularly distinctive, and even tech-

nologically the disc is less impressive than previous Vanguard "demonstrators."

The latest three LP samplers are a mixed bag indeed. Tradition's Folk Sampler (TRS 1, \$2.00) is nicely if not exceptionally recorded, and although it includes a few embarrassingly amateurish performances, it ranges widely through mostly delightful American and foreign repertoires, and at its best (as in Mrs. Etta Baker's backwoods guitar playing, Oscar Brand's rollicking balladeering, and Hillel's and Aviva's piping, drumming, and singing) combines genuine authenticity with distinctive interpretative personality. The renascent Haydn Society's Sampler (SR 1, \$1.98) is more uneven technically, since it includes some fairly old as well as quite recent recordings, yet for sheer musical substance and satisfaction it offers more than any previous recording of its kind: no less than ten complete works by as many truly great composers (from Schütz to Schubert), topped by Marc-Antoine Charpentier's magnificently reverberant *Air de Trompette* and Torelli's joyous Trumpet Concerto.

Most brilliant technically is *The Best of Golden Crest* (CRS 12, \$1.98), but too often its glitter is stridently razor-edged, its acoustics painfully dry, and its levels earsplittingly high. Several of the twelve selections (especially those by tubaist Bill Bell, Phil Kraus's percussion



ensemble, and Don Redman's Band) are very exciting, but only two (by the New York Philharmonic Woodwind and Brass Ensembles) are of much musical consequence, and I take violent exception to the subtitle for the whole disc, "High Fidelity in Good Taste." It is said that there's no disputing tastes, but I do here, for at best this strikes me as overvehement and extremely loud hi fi; at worst, as in Mark Laub's *Lowrey-Organ Song of the Islands*, the sonics, however cleanly recorded, are as aesthetically

repulsive as any even my toughened ears have ever endured!

Of the stereo demos, there is a short seven-minute Livingstonette sampler (temporarily available only by mail and for only 50¢, I believe), which serves as an effective introduction to Livingston's uniquely packaged new low-price tape series; a *Stereo for Dancing* sampler from Omegatape (STD 11, \$5.95), which illustrates the west-coast firm's current pops tapes (and, made by the same company, a special promotional sampler for distribution only via the Stereophonic Music Society); and a *Demo No. 2* from another west-coast firm, Stereotape (ST 20, \$2.95), which also is confined to pop selections except for a part of a Lajtha (contemporary Hungarian) quartet played by the Amati String Quartet. All of these, especially the last, are very well recorded, but all of them are dwarfed in substance by Capitol's *The Stars in Stereo* (ZD 21), which commands a full price (\$12.95), but which gives corresponding value for its cost: nine complete selections by as many noted pop singers and dance bands, topped (much to my surprise) by Frank Sinatra in the former group, and (less surprisingly) by Les Baxter's and Stan Kenton's orchestras in the latter.

The other outstanding release here is Livingston's first test tape (LX 1E, \$9.95), a full-track recording useful for both single- and dual-channel systems. It includes the usual 5-Kc and 10-Kc test tones for head alignment; frequency-response and equalization checking materials (10 constant frequencies from 50 cps to 12 Kc); a 3-Kc flutter-and-wow test tone; and a standard-level 250-cps tone followed by unmodulated tape for signal-to-noise checking purposes. But following this approximately six-minute run of tone tests comes the real novelty: some 40 seconds of stroboscopically printed paper leader tape for accurate speed checking. About time, too! For years I've been inquiring everywhere for stroboscopic tape, only to be told that it was too difficult or impossible to prepare properly. But apparently Livingston has licked the problem at last — and now that it has, I hope it soon will be able to make such printed strobe leader available separately and in quantity, for it would make an invaluable addition to splice onto every test or special demonstration tape, stereo or single-channel, in one's collection. Meanwhile, of course, this feature alone makes this tape indispensable for every technically minded tapeophile.

### Modern Masters

For those who found the going too hard (or would, if they dared try it)

*Continued on page 42*



## Sheet-Aluminum Chassis Cages

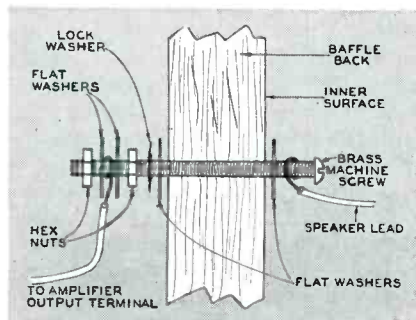
Most amplifiers and tuners more than one or two years old did not come equipped with cage-type covers. An attractive cage-type cover can easily be made from the perforated aluminum sheets now available in most hardware and variety stores. The sheets can be cut easily with shears and straight bends made with the aid of a board. The covers are attractive and the perforations allow enough ventilation for even the largest amplifiers.

John T. Wainwright  
Houston, Tex.

## Airtight Speaker Terminals

Speaker enclosures of the infinite-baffle and bass-reflex types require an airtight back and hence pose something of a problem in getting speaker leads through them. There is also the added necessity for a set of terminals of some sort, even when the wires are fed through a successfully sealed hole.

A simple and effective alternative is the use of two brass machine screws, two hex nuts, four flat washers, and two lock washers. The length of the screws should



be  $\frac{3}{4}$  in. longer than the thickness of the back of the cabinet; holes should be made with a drill that is slightly smaller than the thread circumference.

Drill the necessary holes in the back of the cabinet at a convenient place, about  $\frac{3}{4}$  in. apart. After putting a flat washer on each of the screws, drive them (from the inside of the panel) almost down to the head with a screw driver. Attach the wires from the speaker between the heads of the screws and the flat washers and screw them down tight, being careful to leave enough length of wire to remove the back conveniently.

On the outside of the back put a flat washer, a lock washer, and a nut on the ends of the screws and tighten them down firmly. All that remains is to add two flat washers and a nut to each screw and the leads from the output taps of the amplifier may be attached between the washers. It is a good idea to mark the terminals for correct phasing and impedance before the back is screwed on.

Edward T. Dell, Jr.  
Millis, Mass.

## Determining Unknown Capacitance and Inductance

Although a simple resistance check of a capacitor with a VTVM will readily identify a shorted capacitor, specific measurement is sometimes desirable to identify an unmarked one, or one of suspected value.

Capacitance of small values may be determined easily in the absence of a capacity tester by using an audio generator (sine wave) and a VTVM. A known resistor is merely hooked up in series with the capacitor to be checked, across the output of the generator, using alligator clips. A signal of a few volts is used, the ground side of the VTVM is connected between the resistor and capacitor, and the voltage across first the resistor and then the capacitor is measured at, say, 10 Kc. If the voltage across the capacitor is lower than that across the resistor, reduce the frequency setting (or vice versa) until equal voltage readings are obtained.

Then the unknown capacity may be calculated in microfarads using the following formula:

$$C = \frac{159,200}{fR}$$

Here are two examples:

Voltage used	4.6	4.6
Resistor value	250 ohms	10 K
Frequency required to get equal voltage	68,000	83,000
Calculated capacitance	.0093	.00019
(Marked value of capacitor)	.01 $\mu$ fd	200 $\mu$ fd

A similar principle will enable the owner of a VTVM and an audio generator to measure inductive reactance and thus evaluate inductances (provided the

value is 150 mh or higher). Couple the choke in series with a resistor, across the generator output. The resistor should have a value of 100 ohms or more because of the low current output of such generators. Adjust the frequency until voltage readings across the resistor and the inductance are identical.

Then substitute the observed values in the formula:

$$\text{Inductance in mh} = \frac{159.2R}{f}$$

For example, a frequency of 16,000 cps is required to obtain equal voltages across 130 ohms with an unknown inductance in series:

$$X_L = \frac{159.2(130)}{16,000}$$

$$X_L = \frac{20,696}{16,000}$$

$$X_L = 1.29 \text{ mh}$$

Such inductance measurements may have particular value to the experimenter because schematic diagrams with accompanying parts identification lists seldom stipulate the value of inductances.

Donald D. Bradley  
Williamsville, N.Y.

## Panel Material

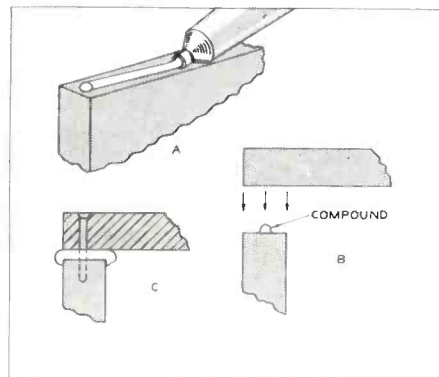
Panels that are both decorative and functional can be made for hi-fi equipment from Formica or Textolite laminated plastic—the kind used to cover counter tops, tables, etc. A wide variety of colors, including wood grains, is available. The material is about the same thickness as metal panel material, it saws easily, and the hard surface accepts Technilabel decals very well. The chances are that your local cabinetmaker will have a selection of scraps which he will either give to you or sell very reasonably.

L. E. Johnston  
Madison, Wis.

## Airtight Joints

I find that the soft puttylike material sold in tubes for calking spaces around window frames and appropriately called "Calking Compound" is a cheap and highly satisfactory material for forming airtight gaskets.

Apply a continuous strip of compound to the screwing surface; then, put the cover in place and screw down. The





compound will squash and cover both surfaces; it will not dry out or act as a glue. To remove the cover, a single rap with a hammer after removing all screws will suffice.

Alan M. Palmer  
Brooklyn, N.Y.

### Resistor Substitute

I have done a few experiments with low-voltage DC power supplies for tube filaments, and have sometimes found myself without the proper size of low-value, high-wattage resistor—or without the cash to buy a slide resistor. Not long ago, I purchased a hot-plate element and the happy thought struck me that these spiral-coiled resistance elements would serve as a substitute, and, indeed, this proved to be correct.

They can be purchased in various sizes: the one I usually buy is rated at 660 w, 110 v, and costs 34¢. The cold resistance for a 6-inch length is about 18 ohms. A piece estimated to be a little larger than required, can be cut off and inserted in the circuit. Should it prove to be too long, the lead to one of the resistors may be inserted between two adjacent turns shorting out a part of the length and so on, until the correct point is found. Then the resistance can be measured with an ohmmeter and an appropriate resistor in a 5- or 10-watt size may be purchased (although I seldom bother).

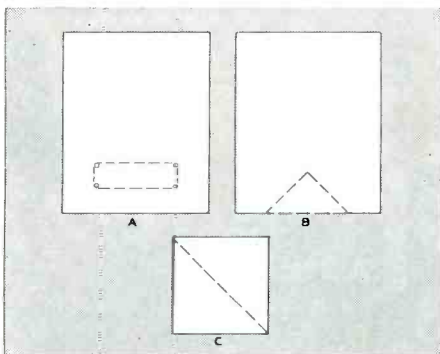
As the current is less than one amp in the usual supply, the cold resistance can be used for estimating the size. After the supply has warmed up, a quick check with an ohmmeter will establish the value more accurately, if the purchase of a more elegant resistor is contemplated.

H. C. Palmer  
Grimsby, Ont.

### Short Cut for Port Cutting

Cutting out a port opening in a speaker enclosure can be a tiresome and time-consuming process. Unless you have the proper power tools, it usually means drilling a hole at each of the four corners of the opening and cutting it out with a coping or keyhole saw (see A).

A much simpler approach is to figure the number of square inches required to make a triangular port, make two cuts



from the bottom of the panel to the apex of the triangle, and your port is finished (see B).

An easy way to find the size of the triangle is to draw a square on a piece of paper twice the area of the port and then cut it in half diagonally (see C). You then have a template the exact shape and size of the port.

Ronald S. Stewart  
Detroit, Mich.

### Finding Flat Settings

The serious audiophile, designer, or repairman will sometimes wish to measure the frequency response of equipment which employs tone controls. Finding the flat position of these controls using an oscillator and meter can be a tedious task, especially if the ranges of the controls overlap. I have found the following method to be very simple and quite accurate.

Apply a 1-Kc square wave of appropriate amplitude to the input of the tone-control circuit. Terminate the output as required, and view the wave form on an oscilloscope. Rounding off or peaking of the leading edge of the wave form indicates high-frequency cut and boost respectively; an upward or downward rounding of the wave-form top indicates low-frequency boost or cut respectively. Manipulation of the controls to produce the best square wave will quickly find the flat position which should be marked for future reference. A frequency-response check will now indicate the performance of the equipment rather than a mis-setting of the tone controls.

This method works well on both the lossier- and feedback-type of controls, and can also be used to check frequency-discriminant volume controls, loudness-contour effects, and the like. It is a simple expedient that can save time in many ways.

Alan Hefflon  
Jamaica, Vt.

### Air-Cooled Amplifier

A 6-inch electric fan placed as close as possible to a power amplifier and connected so that it will turn on and off with the amplifier makes an effective cooling device. On my Dynakit II, this simple arrangement reduced the air temperature between the two power tubes from 155° to 80°. It is a well-known fact that reducing the operating temperature will prolong the life of tubes and other components.

The fan should be oiled once a month.  
L. M. Garrett, M.D.  
Corpus Christi, Tex.

### Protect that Finish

Kit audio equipment is becoming more stylish all the time. Front panels are now things of real beauty, and a scratch can mar the pleasing effect. To prevent damaging the outside, visible parts of

### AUDIO AIDS WANTED

*That's right—we'll pay \$5.00 or more for any short cut, suggestion, or new idea that may make life easier for other AUDIOCRAFT readers, and which gets published in our Audio Aids department. Entries should be at least 75 words in length, and addressed to the Audio Aids editor. No limit on the number you can submit.*

the kit during construction, protect them with paper.

If the panel comes wrapped in paper, leave it on during construction. Use cellophane tape to hold it in place, and punch holes through it to mount controls.

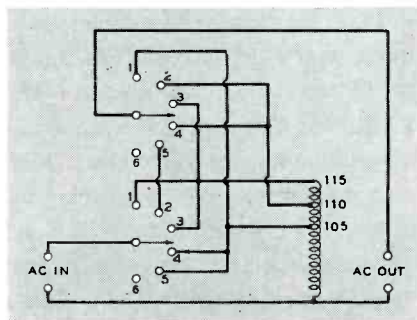
An accidental slip need not spell disaster in the form of a permanent scratch, if the panel is protected in this way during construction.

Paul Penfield, Jr.  
Cambridge, Mass.

### Voltage Checker

There are many times when it would be helpful to have a variable AC source to check equipment at higher or lower voltages than are present at a particular location. Of course, powerstats and variacs are commercially available, but the cash may have other priority.

A heavy antique power transformer, with a primary labeled 105-110-115 v, seemed to me to have possibilities. Experimenting with clips and a 100-watt lamp for a load, it was evident that considerable voltage variation was possible using it as a step-up or step-down autotransformer. The next problem was to make it into a convenient package for bench use. All leads except the primary were cut and taped; the wiring is



diagrammed. The finished product was screwed to a wooden base and provided with a standard AC outlet for plugging in any desired equipment. With a 100-watt load, and an input of 112 v, my transformer provides the following outputs:

Position 1	92 volts
Position 2	100 volts
Position 3	112 volts (direct)
Position 4	125 volts
Position 5	138 volts
Position 6	OFF

Raymond Wyman  
Amherst, Mass.

win a  
dream  
trip  
for  
two



to  
the  
**BRUSSELS  
WORLD'S FAIR!**

win other exciting prizes...  
in the big, new Rek-O-Kut contest!

Rek-O-Kut's exciting, new contest is a music-lover's delight! You can win a trip for two to the Brussels World's Fair via Sabena Belgian World Airlines... magnificent Rondine turntables... and turntable arms... just by listening to a Rek-O-Kut demonstration. Simply stop in at your high fidelity dealer, ask him to demonstrate high fidelity reproduction on a Rondine turntable, and fill out an entry blank. There are no puzzles to solve—no jingles to write—no coupons to clip—nothing to buy! You'll be eligible for one of the big contest prizes... and you'll have enjoyed music reproduction at its finest—on a Rondine! Prices from \$59.95.

Selected for display at the American Pavilion, Brussels World's Fair!

For the high fidelity dealer nearest you, write:  
**REK-O-KUT COMPANY, INC.**  
38-19 108th Street, Corona 68, New York

**Electronic  
Firsts**



by **MONROE UPTON**  
Author of  
"Electronics for Everyone"

**N**O ARCHAEOLOGIST has, as yet, carefully removed from the 4,000-year-old level of his diggings a little mound of copper and glass which, as a result of patient and ingenious restoration, has emerged a pentagrid converter. Still, given any electronic principle, or piece of gear, it will usually be older than you think. Take, for example, the principle of *impedance match*, so vital to the hi-fi amplifier. It was discovered during the dawn of electromagnetism, over a century ago, by Joseph Henry.

While a professor at Albany Academy, Henry pioneered in the winding of coils. Unaware of Ohm's experiments, he nevertheless developed a good idea of electricity's behavior on his own. He kept in mind its "projectile force" (voltage) and "quantity" (current flow), though of course there were no units of these quantities available to him. But with these concepts in mind he worked out the most efficient methods for powering his coils with wet batteries, based upon the proper use of series and parallel connections.

Implicit in Henry's discoveries was the fact that when the load's resistance, in this case a coil, was equal to the internal resistance of the battery, the power in the coil was at a maximum. You can prove this by fitting as many examples as you like into Ohm's law.

Alternating current doesn't change the situation, except that impedance (resistance and reactance combined) replaces resistance. Take for example the output tubes of an audio amplifier. The plate-cathode circuit is analogous to the battery as the power source. The load is the primary coil of the output transformer. For maximum output (dissipation ratings aside) the plate impedance of the tube should equal the impedance of the transformer's primary coil. However, in a hi-fi amplifier, the object is to get a maximum power with minimum distortion, while staying within the output tubes' ratings. In order to achieve this the transformer's primary impedance must be matched fairly carefully to the value established as optimum for the particular output tubes and output circuit. The primary load is determined by the turns ratio and the load on the secondary winding. That's why it is important to match the speaker impedance to the proper secondary taps.

for  
**LOWEST**

hum... noise...  
microphonics...  
in a low- $\mu$   
dual triode...



the  
**Amperex**

**ECC82** A PLUG-IN  
REPLACEMENT FOR THE 12AU7

**MICROPHONICS:**

Negligible in amplifiers requiring an input voltage of at least 100 mv for an output of 5 watts. No special precautions against microphonics necessary even though the tube is mounted in the near vicinity of a loud-speaker with 5% acoustical efficiency.

**HUM AND NOISE LEVEL:**

Better than -60 db relative to 100 mv when the grid circuit impedance is no greater than 0.3 megohms (at 60 cps), the center tap of the heater is grounded and the cathode resistor is by-passed by a capacitor of at least 100 mfd.

**OTHER Amperex TUBES FOR HIGH-FIDELITY AUDIO APPLICATIONS:**

- EL84/6BQ5** 9-pin power pentode; 17 W PP
- 6CA7/EL34** High-power pentode; 100 W PP
- EF86/6267** Low-noise high- $\mu$  pentode
- ECC81/12AT7** Low-noise medium- $\mu$  dual triode
- ECC83/12AX7** Low-noise high- $\mu$  dual triode
- GZ34** Cathode-type rectifier; 250 ma.
- EZ80/6V4** 9-pin rectifier; cathode; 90 ma.
- EZ81/6CA4** 9-pin rectifier; cathode; 150 ma.

At All Leading Electronic  
Parts Distributors

**Amperex  
ELECTRONIC CORP.**  
230 Duffy Ave., Hicksville, Long Island, N.Y.





## AUDIOLAB REPORTS

Continued from page 28

therefore can be rigidly fastened to its surroundings, and the rumble level becomes independent of the motor-board mounting. With most turntables, the mechanical strength and mounting of the motor board have a profound affect on the rumble level.

The turntable is equipped with a 5-foot line cord. A simple adjustment permits its operation on voltages of 100 to 120, 125 to 150, and 200 to 250 v AC. The motor pulley, which drives the belt, is a double pulley. It is supplied for 60-cps operation, but by merely taking it off and reversing it on the motor shaft, the turntable may be operated on 50-cps power.

### Test Results

Rumble was measured with the silent grooves on the Popular Science and Components 1108 records. A Fairchild 225A cartridge mounted in a Fairchild 281 arm was used. Equalization was by a Marantz preamplifier set for the RIAA characteristic.

The rumble measured -43 db relative to a velocity of 7 cm/sec at 1,000 cps. The same value was measured with the clutch disengaged so that the upper turntable was not revolving. It was predominantly 30 cps, with some 60 cps as well. It was quite inaudible in our listening tests.

Wow and flutter were measured with the Components 1106 record. The wow was .05% (including components from 0.5 to 10 cps) and the flutter (10 to 300 cps) was 0.1%.

The TD-124 turntable is unusually silent in operation. Not only can no sound be heard from the motor or idler, but absolutely no vibration can be felt by hand on any part of the unit. With the upper turntable stationary, we found it quite impossible to tell if the unit was turned on, without looking at the illuminated stroboscope markings.

### Summary

The Thorens TD-124 seems to have incorporated with great success practically every desirable operating feature one could desire. It is the equal of the finest turntables we know of in respect to wow and flutter. Its rumble level, while possibly not so low as some others, meets professional standards and is certainly negligible in practical use. It offers four-speed operation, with adjustable speeds and unusual ease of measuring speed. It is virtually universal in its operating voltages and frequencies. It is, in all respects, a pleasure to use. While styling must ultimately be a purely personal consideration, we think it is as clean and functional as any turntable

we have seen. An additional feature is the depth requirement of only 3 in. below the mounting board, which is considerably less than most competitive turntables. This, combined with its width of 15½ in. and depth of 12¾ in., makes it suitable for many installations which could not accommodate a larger turntable.

We studied the TD-124 carefully to find any points on which it could be validly criticized. The only one we came up with was the fact that the center spindle revolved with the lower turntable. If the record had a slightly under-size center hole, as some do, it might continue to revolve when the upper turntable was stopped. There is also a small possibility of wear on the center hole if a record were left on the stationary upper turntable for some time.

**Manufacturer's Comment:** We, of Thorens, wish to congratulate both AUDIOCRAFT and the Hirsch-Houck Laboratories for the much-needed service they are providing to the high-fidelity consumer. It is our opinion that Hirsch-Houck Laboratories have done an excellent job in presenting factual data concerning the units they have tested to date.

It cannot be pointed out too strongly that the test data contained in these reports cannot be compared to advertising data prepared by many manufacturers. We feel very strongly that the only way to compare competitive units properly is to have them tested on the same equipment, by the same men. We believe that by following the AUDIOCRAFT reports, such a comparison can be made.

The unit under test should, of course, be picked at random from the stock of the manufacturer. This was done with the TD-124 reported upon in this issue.

AR<sup>INC.</sup>

Quotation from

**PLAYBOY**

from "THE COMPLETE FIDELITARIAN"  
by John M. Conly

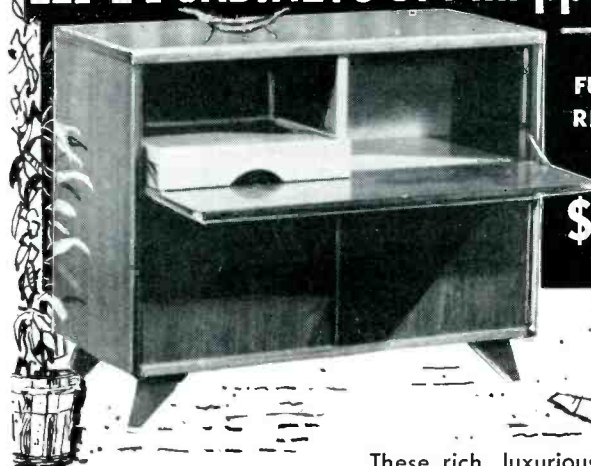
"One exception to this rule: [of selecting a single-cone unit from among low-cost speaker systems] the Acoustic Research AR-2, at just under \$100, is a two-way speaker, (tweeter and special air-supported woofer) of extraordinary smoothness. It is definitely a bargain."



Prices for Acoustic Research speaker systems, complete with cabinets, (AR-1 and AR-2) are \$89.00 to \$194.00. Size is "bookshelf." Literature is available from your local sound equipment dealer, or on request from:

**ACOUSTIC RESEARCH, INC.**  
24 Thorndike St., Cambridge 41, Mass.

## HI-FI CABINETS of Philippine Mahogany



FULLY ASSEMBLED,  
READY TO FINISH

ONLY

**\$3988**

### Fits ALL Hi-Fi Components

2 Top compartments with drop doors, each 17" deep 19" across 11½" high	2 Lower compartments with sliding doors, each 17" deep 19" across 14" high
--	--

**ALL PRICES F.O.B. FACTORY CHICAGO, ILL.**

**ORDER NOW FROM**

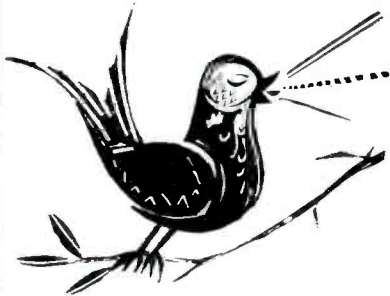
**ALFRAN DISTRIBUTORS**

Suite 900, 22 W. Madison St.  
CHICAGO 2, ILL.

WITH  
**Sonotone**<sup>®</sup>

HI-FI SPEAKERS

you can  
hear the  
difference



Even the price will be  
music to your ears . . .  
Model CA-12 only \$19<sup>50</sup>

(Slightly higher in the West.)

Lowest prices on **HARDWOOD**

**PLYWOOD**

A-3 GRADE (one side perfect)

VENEERS AVAILABLE	4' x 6'		4' x 8'	
	1 1/2"	3/4"	1 1/2"	3/4"
Oak - Birch - Mahg.	18.60	15.00	26.00	21.15
Walnut	20.40	16.80	29.20	24.40
Maple	19.50	15.90	28.00	23.20

FREE with order if requested:

- ★ Speaker enclosure designs
- ★ Equipment cabinet designs
- ★ Wood finishing hints

**GOODMANS LOUDSPEAKERS**

ENGLANDS FINEST 8" to 18"  
Full Range - Woofers - Tweeters  
Mid-Range Horn - Cross Overs  
8" full range \$23.20 Net wt. 3 1/4 lb.  
18" woofer \$118.80 Net wt. 29 1/2 lb.

BOGEN — DYNA-KIT — REK-O-KUT  
GLASER-STEERS — ESL — VIKING

**AUDIO EQUIPMENT CO.**  
Albert Lea, Minnesota

**SOUND FANCIER**

Continued from page 37

in the Roger Sessions *Idyl of Theocritus* (Louisville subscription series, reviewed here last March), it's a pleasure now to be able to recommend a more immediately approachable work by the same American composer: his earlier, more colorfully scored, and more overtly dramatic *Black Maskers Suite* as magnificently performed by the Eastman-Rochester Symphony under Howard Hanson. But if at all possible, do your best to hear the stereo taping (Mercury MS 5-16) rather than the LP version (MG 50106), since it is only in stereo that the full dynamic range and sinister atmospheric magic of this electrifying music achieves its full effectiveness.

Even my personal *bête-noir* among contemporary composers, Hindemith, displays more fervor than usual in his First and Third Piano Sonatas, engagingly played by Paul Badura-Skoda, whose bright, light piano tone is caught to perfection here (Westminster XWN 18200). To be sure, I'm frozen off again by the "German humor" and cold energy

of his Symphony in B-flat for concert band. But the disc (MG 50143) on which this appears (one that has perhaps the finest performances and widest-range recordings we have yet had from Frederick Fennell's Eastman Wind Ensemble) more valuably reveals new insights into Schoenberg through a surprisingly festive (and tuneful!) Theme and Variations, Op. 43a, written especially for school-band use; and, best of all, does full justice to one of the too-seldom-heard abstract masterpieces of Stravinsky — the sardonic, pungently colored *Symphonies for Wind Instruments* of 1920.

The ideal introduction to Hindemith himself, however, will always remain the early—and infectiously saucy—*Kleine Kammermusik*, Op. 24, No. 2, and although there have been several excellent LP versions, I have no hesitancy at all in giving the medal to the first stereo taping (Concertapes 24-4). Quite regardless of where the New York Woodwind Quintet's performance is to be ranked on its own merits, the new life both it and the music assume in stereo makes this an irresistible choice.

**NOISE**

Continued from page 21

cellation and, therefore, minimum hum, as indicated on the scope screen or AC voltmeter.

Usually, there is a best way to connect the power plug to the 115-v AC supply line. With the plug inserted one way the hum control should be adjusted for minimum hum. After turning the plug over, the hum control should again be adjusted for hum minimum. The connection that gives the best results should, of course, be used.

Another method which has proven to be extremely beneficial in many cases is to bias the heaters above ground by 10 to 20 v. This is shown in Fig. 8A, where the variable arm of the hum potentiometer is connected to the junction of a voltage-divider network consisting of  $R_1$  and  $R_2$  in series across the B+ supply. The resistance value of  $R_1$  and  $R_2$  should be chosen so that 10 to 20 v appears between their junction and ground. Values indicated in Fig. 8A have actually been used in some circuits, but these values will vary according to the B+ supply. With this arrangement the hum control should be adjusted as explained previously. Increasing the DC potential at the junction of the resistors above 20 v usually results in little further improvement. The bypass capacitor is important, for without it line spikes have been noted in some amplifiers. In some cases it may be sufficient to connect the resistor junction to a filament-supply center tap without using the hum pot, as shown in Fig. 8B. By applying one or

more of the arrangements and methods just discussed, hum can be reduced in many circuits from 5 to 25 db.

120-cps hum is caused by inadequate filtering of the power-supply rectifier output. In addition to using a well-filtered power supply, the input stage of the amplifier should have additional filtering in its plate-supply circuit. An example of this can be seen in the circuit of Fig. 11, wherein  $C_1$  and  $R_3$  take care of this. This RC network also provides decoupling of the first stage, thereby contributing to amplifier stability.

Hum from 120-cps ripple may be present also because of poor wiring dress. In one case it was produced in a circuit by a common path to the chassis ground terminal for the center tap of the high-voltage winding of the power transformer and an audio-signal ground return. Grounding suggestions outlined earlier will prevent such an occurrence.

**Low-Noise Input Circuits**

As I said before, a good input stage should have a noise level of 10  $\mu$ v or less at the grid. Shot-effect noise may be in the order of 5  $\mu$ v and grid-resistor noise, about 4  $\mu$ v. It can be seen, then, that hum has to be practically eliminated in order to approach the 10  $\mu$ v figure. With feedback around the input stage, even lower noise figures can be attained. Using care in parts selection, parts placement, and wiring, these low-noise values can be obtained with the circuits shown in Figs. 9, 10, and 11.

Fig. 9 shows a triode stage consisting of one-half a 12AY7 as the input tube. The other half may, of course, be used



for the second stage of the amplifier. This is a simple circuit, but it does a good job. Deposited-carbon or 1-watt military resistors are recommended.

A pentode-connected 5879 is diagrammed in Fig. 10. Large bypass capacitors are used across both the cathode and screen resistors. This circuit provides higher gain than the one given in Fig. 9.

Extremely low noise figures can be obtained by using a two-stage, low-gain circuit with a 12AY7. This is shown in Fig. 11. It will be noted that no cathode-bypass capacitors are used. Negative feedback of 8 db around the circuit is provided by resistor  $R_6$ . This resistor also supplies a positive DC voltage to the cathode of the first stage to establish

correct bias. The resistance value of the grid resistor in this and the other circuits will of course, depend on the input device to be used.

In conclusion, a few words of advice that may prove beneficial to the readers of this article. The information given is based on good design and engineering practice. When building a new audio system it is recommended that the suggestions presented be followed. If you have an audio system already, the advice is not to tear into your equipment and haphazardly try everything just discussed. Although the hum and noise problems outlined are those most often encountered, it would be difficult to cover every condition that could produce such problems.

## PUZZLEMENTS

Continued from page 35

smaller. This is based on units of about the same efficiency. Usually tweeters are a little more efficient, which exaggerates the difference in power requirement.

Theoretically, some economy could be effected by using amplifiers designed specifically for each frequency range. An output transformer designed for a woofer amplifier would not require the fancy mixing necessary for full-range operation and so could, in theory, be a few cents cheaper. In practice the saving is probably not available, because the unit would be special and this would make it cost more than you should save.

A bigger saving is possible for the middle-range and tweeter units. Coupling capacitors, as well as output transformer, could be smaller and cheaper. But again, such components are not readily available so the cost might not be as much lower as one would think, because each unit becomes a "special."

Use of electronic dividers requires care. Matching may not be a problem any more, but other features need attention. The levels between the preamplifier, the electronic divider, and power amplifiers must be right. Too low a level will result in either hum or excessive noise. Too high a level causes distortion.

Even though the electronic divider gets about the right level from the pre-amplifier there may be troubles, as some letters from readers have shown. If the power amplifier feeding the woofer has more gain than necessary, hum may become evident, even though the woofer control is turned well down. The solution is a fixed-resistance attenuator pad on the input to the woofer amplifier (Fig. 3).

If the tweeter amplifier has too much gain, hiss may be excessive, in which case the remedy should be applied to the

tweeter-amplifier connections in the same way.

One final point on electronic dividers, and this has puzzled many: what does it buy for you (over the regular type) in frequency response? Many think that the crossover slope is fixed by the number of capacitors used in each filter; one capacitor giving 6 db per octave, two giving 12, three 18, and so on. But this is far from universally true. Examine the schematic carefully. If it uses a cascade of RC circuits of similar value (Fig. 4) in each channel, *but no feedback*, it definitely cannot give the kind of response usually visualized. The circuit values can be adjusted in a variety of ways.


One way is to arrange it so that the response is correct at crossover—half power to each unit. Then the maximum slope is 3 db per octave, becoming about 6 db per octave at an octave beyond crossover. Otherwise stated, it is not better than a single RC section, *however many are used*.

Another extreme is to use values so that the slope is what one would expect. But then there will be a big "hole" in the response in the region of crossover frequency. The only way the ideal sharpened response can be achieved is to use a number of elements in cascade, either directly, or divided between plate and grid circuits, and then use feedback on each channel (Fig. 5).

A common misconception that still prevails is that RC circuits must avoid ringing or transient distortion, for which LC circuits get blamed. This is often an argument put forward for using electronic dividers. But when the filter is correctly aligned to give the same response, its effect in causing ringing or distorting transients is exactly the same, be it LC type or electronic.

I am not against the use of electronic crossovers. They work very well, properly used. But the reason for using them, as well as the manner of using them, is often incorrectly understood.

Easy-to-Use  
= STEREO



by **arkay**  
LEADERS IN  
AUDIO, TV & HI-FI  
EQUIPMENT  
120 CEDAR STREET  
NEW YORK 6, N. Y.  
**FREE!**  
At your dealer or write for complete literature on the Arkay Stereo System. Prices 5% higher west of Mississippi

**Arkay SA 25**

Attached to your present power amp and pre-amp you've got the finest stereo system. Controls: 25-20,000 cycles; 100 db @ 20 watts; 20-20,000 cycles; 100 db phone -4mv for 20 watts; tuner aux -3mv for 25 watts; Controls: volume, bass treble, lo and hi filters; equal for all labels plus MARTB tape head. Channel 2—same sensitivity. **SAVE! Easy-to-build kit \$89.95**

**Arkay Stereo Dual Channel Control Center SP-8K**

The first and only unit of its kind. Precision engineered for all stereo needs—present and future. A complete, rugged, ready to build kit of choice. **\$129.95** w/o cable **\$139.95**

**Arkay Stereo AM-FM Tuner ST-11**

With an exceptional self-powered AC operated stereo-binaural tuner of unsurpassed sensitivity and flexibility of operation. May be used as either a stereo or as a dual channel monaural amplifier. It consists of same chassis as the ST-21's with two 500 ohm resistors. **\$64.95**

**Arkay Stereo Dual Channel 55 Watt Amp SP-9.95**

This is a completely new unit. It may be used as either a stereo or as a dual channel monaural amplifier. It consists of same chassis as the ST-21's with two 500 ohm resistors. **\$64.95**

**OTHER MATCHING ARKAY STEREO UNITS...**

...Your Present System

ONE Logical, Inexpensive Step to STEREO...

## Want a box at the opera?



## BUILD YOUR OWN!

A Bozak E-300 Kit—with Bozak Speakers, worthy associated equipment, and fine program material—is your lifetime pass to all the world's great music, at surprisingly low cost!

The Kit includes every needed part, assembles in a few hours. As an infinite baffle, the E-300 requires the very finest speakers: for a wide-range 2-way system, the Bozak B-207A; add a Bozak B-209 Mid-Range and N-10102 Crossover Network for finest one-woofer 3-way performance.

Going stereo? A duplicate "300" will transform your livingroom into a living stage—your easy chair into the best seat in the world of music!

Hear the Bozaks at a Franchised Bozak Dealer. Write for literature.



The Assembled E-300 Kit



B-207A



B-209

N-10102



**The R. T. BOZAK Sales Co.**  
Darien, Connecticut

## STEREO TECHNIQUES

*Continued from page 17*

other homes, we can safely assume that, besides off-the-air recording and disc-conservation recording, there will be more interest in live recording. This means a whole new field of endeavor for the audiophile. He will have to learn about mike placement, mixing, echo, reverb, splicing, and editing, as well as the more commonplace problems of interconnection of the recorder to the system. Thus, there will be the need for study and practice. The person newly concerned with recording will find it difficult even to adjust level properly to get a good off-the-air recording. His first efforts at splicing tape will be miserable failures. In time, of course, he'll get the hang of it and will acquire the tools of the recordist: the splicing block or patented splicing device, the head degausser, the bulk eraser, and all the many other gadgets that make life easier for him. He will gain a measure of confidence in the use of his machine and, with that, will do even more live recording. As a result, the manufacturers of raw tape will be happy; the professional will be using tape (as he has since the late 1940's), the duplicator will be using and selling tape—and, for the first time, the public will be using large amounts of tape.

Stereo on recorded tape is in for some changes eventually, too. Shure has announced a tape head which will accommodate four tracks across a 1/4-inch tape, with which the same total playing time can be obtained for stereo recordings as for present half-track monophonic recordings. RCA has gone even further with a new cartridge-loaded stereo-tape system. This is notable as the first serious commercial experiment with tape cartridges by any major record manufacturer. It is a four-track system, similar to that of Shure, and tape speed is 3 3/4 ips, giving a playing time of 1 hour per 600-foot cartridge. The obvious disadvantage of this system is the inevitable reduction of quality from halving the playing speed and halving the track width. If RCA can overcome this obstacle, it will have done the engineering feat of the decade.

At this time, there are only a few tape-cartridge ideas that have any real chance of success. Tape cartridges have been used for message-repeating in supermarkets, restaurants, drive-in theatres, and the like. Quite a bit is known about them and their characteristics. The Cousino Company has been working on cartridges for some time and, happily, now sees them in use in a variety of places. Some of the many manufacturers experimenting with tape in cartridges are Pen-tron, Ampex, Viking, and Mohawk.

With the sudden appearance of stereo

discs, we tend to lose sight of the fact that tape is a flexible medium inherently capable of many more things than are disc records, once proper techniques are worked out. The cartridge is a reflection of this. Visualize a home tape changer, a tape juke box, tape in an automobile—the list is almost endless. Cartridges can make all this possible.

### Other Stereo Developments

Convinced that true 45/45 stereo discs are generally incompatible with existing monophonic playback cartridges, and unwilling to release dual lines of records, Columbia has come up with the Columbia Compatible Stereophonic Record. Analysis of a 45/45 record shows that inphase components of the signals picked up by the two stereo mikes produce lateral groove modulation, and that the differences between the two signals produce vertical motion of the groove. It is the vertical components that provide stereo information, since the differences of the two signals are responsible for stereo effects. According to CBS labora-

### COMING NEXT MONTH

#### Assembling Your Stereo System

by Joel Ehrlich

#### Using Test Instruments

Signal Generators, Part II

by Joseph Marshall

#### A Pictorial Diagram

of the Perfectionist's Power Amplifier  
in response to many requests

#### The Lafayette KT-500 Stereo Tuner

An AUDIOCRAFT Kit Report

ories, limiting the maximum vertical modulation electronically in the recording channel, to about  $\pm 0.2$  mil, retains all the important stereo information while providing complete compatibility.

Columbia has expressed its intention to use this system for all its stereo discs. Some other companies have commented that it isn't real stereo and won't sound as effective as the real thing. When both are available to the public, it will decide the controversy soon enough. [Apparently the question has been decided already. On April 11 Columbia announced that, in order to avert an industry war, it would abandon the CCSR system and produce true 45/45 stereo discs.—ED.]

So far as stereo broadcasting is concerned, the hottest developments are in single-sideband-AM and multicarrier-FM multiplexing. The former is the first major improvement in commercial AM broadcasting in a good many years. Without getting too technical, single-sideband (SSB) is a method of transmitting a signal on AM, eliminating one of the two sidebands and using the newly created space to extend the frequency



band width of the transmitted signal.\* The ABC network has begun experiments in eliminating one of the sidebands and broadcasting frequencies up to 10 Kc. In essence, all they are doing is using the space of one of the sidebands for the frequency extension. There are, however, other benefits from SSB. With SSB/SC (single-sideband/suppressed-carrier) transmission, there is almost no static effect and little signal fading. Noise is much lower and the range of the transmitted signal seems to be greater. The over-all results are comparable with FM transmission save for the very high audio-frequency range. Thus, SSB/SC makes simulcasting of stereo much more practical.

It should be noted that, while the experiments being carried on just now are compatible (the SSB/SC signal can be handled by a conventional AM receiver), sets designed especially for SSB/SC reception would make for results worthy of comparison with FM sets.

Of course, AM cannot be multiplexed, so that one could never broadcast stereo compatibly with SSB. The only manner in which to transmit compatible stereo would be via FM, multiplexing by the Crosby system. This produces a conventional FM signal which can be picked up on any FM set, and which will provide normal monophonic sound from it. Yet, with a simple decoding device, it yields two stereo channels. All other proposed systems do not have this compatibility; that is, anyone listening to a stereo broadcast, though it be multiplexed, would hear only one of the two stereo channels, much as though he had tuned into one side of a simulcast broadcast.

For many years background music for restaurants has been transmitted by multiplex on the carrier of a regular FM station which was transmitting something else for the listener at home. Of course, the restaurant pays a rental on the decoder unit necessary to hear the special program. But it is only recently that anyone has gone before the FCC to obtain an experimental license permitting the transmission of dual channels for home stereo use. This has been done in a number of regions and the results should be coming in by the end of the year. Probably, some time in the next three years, the FCC will take a stand on multiplexing and which method of multiplex transmission is to be used for the home.

For something more than a year now, many of the large makers of radios and radio-phonographs have been promoting stereo units. These are mostly phonographs and tape recorders in two cabinets, each with a speaker and amplifier, interconnected for the dual channel.

\*For a more detailed discussion of SSB, see "New Hope for AM Listeners", an Editorial, AUDIOCRAFT, III (Feb. 1958), p. 15.

Only the tape gives stereo results; the records are strictly monophonic. This year, we can anticipate having new models of these same units for disc and tape stereo and others having FM-AM tuners for stereo. Magnavox, for example, already has demonstrated new disc-stereo instruments and conversion packages for equipping old reproducers to handle stereo discs. Somehow, the high-fidelity-components manufacturers seem to have lost the edge they habitually used to retain in the use of any new ideas. The only component-stereo units on the market are of very recent vintage, and there are only a few. It is somewhat surprising to see how our industry has been caught. We claim to be more advanced than the makers of packaged goods — yet they have overtaken us in this matter. In truth, they have stolen our thunder. Perhaps now that the sudden shock of stereo discs has worn off, our engineers will awaken to the danger and make up for lost time.

This article has been an attempt to present the general problems facing the person who plans to go into stereo. In future articles, stereo will be covered in greater detail, one topic at a time. To guide me in this I should like to have readers send any questions on stereo to me, in care of this magazine. They will be taken up in the articles, and a full reply will also be given by mail.

#### TRADERS' MARKETPLACE

Here's the place to buy, swap, or sell audio equipment. Rates are only 20¢ a word (excluding name and address) and your advertisement will reach 20,000 to 35,000 readers. Remittance must accompany copy and insertion instructions.

**ENJOY PLEASANT SURPRISES?** If so, write us before you buy any hi-fi. You'll be glad you did. Key Electronics Co., 120 Liberty St., New York 6, N. Y. EVERgreen 4-6071.

**TAPE RECORDERS, hi-fi components, tapes.** Unusual values. Free catalog. Dressner, 69-02D 174 St., Flushing 65, N.Y.

**HI-FI HAVEN,** New Jersey's newest and finest sound center. Write for information on unique mail order plan that offers professional advice and low prices. 28 Easton Ave., New Brunswick, N.J.

**ANY ELECTRONIC KIT** constructed and aligned with professional equipment. Reasonable. Dudley Borowick, 3334 Costa Drive, Hayward, Calif.

**FOR SALE:** Fairchild 225A cartridge and 280A transcription arm: \$55.00; Viking monaural tape recorder: \$145.00; Electro-Voice 635 low impedance microphone and matching transformer: \$35.00; Wharfedale Super 5 tweeter and crossover: \$30.00. AUDIOCRAFT Magazine, Box CG, Great Barrington, Mass.

**TAPE RECORDERS:** hi-fi components, tapes at wholesale prices! Free catalogue. Carston, 215-V, E. 88 St., N. Y. C. 28.

**FOR SALE — One Pickering Fluxvalve Unipoise pick-up-arm combination, LP stylus (1 mil), new condition, \$40. Write Box BW, AUDIOCRAFT Magazine, Great Barrington, Mass.**

## DYNAKIT Amplifier Kits

A great amplifier circuit of superb listening quality in money-saving kit form!



**MARK III** 60 watts **7995\***  
net

The new Mark III includes all the sensational attributes of the popular Mark II plus these outstanding deluxe features

- ★ 60 watts at less than 1% distortion. Instantaneous peak power of 140 watts. IM less than .05 at average listening levels.
- ★ Choke filtering and low noise circuitry reduce hum and noise to 96 db below 60 watts.
- ★ New rugged KT-88 tubes and other heavy duty parts used conservatively.

**MARK II** 50 watts **6975\***  
net

The Mark II is the best buy in high power high fidelity kits

- ★ Ease of assembly due to uniquely simple circuitry and printed circuit construction with factory-mounted parts.
- ★ Highest stability using patented stabilizing networks with minimum number of phase shifting stages. Suitable for all loudspeaker systems including electrostatic.
- ★ Dyna Biaser (patent pending) for simplified adjustment and complete freedom from effects of unbalanced components. No balancing adjustments required to meet published specifications.
- ★ Dynaco Super-Fidelity output transformer with patented para-coupled windings. This is the finest available transformer of its type for the most critical audio uses.

Available from leading Hi-Fi dealers everywhere  
Descriptive brochure available on request.

\*Slightly higher in West

The Dynaco Amplifier has been selected for display at the Brussels Worlds Fair as representative of highest quality American High Fidelity equipment!

### DYNACO INC.

617 N. 41st Street, Philadelphia, Pa.

Export Division: 25 Warren St. New York 7, N.Y.

AR<sup>INC.</sup>

Quotation from  
**AUDIO ETC.**  
*Edward Tittel-Curry*

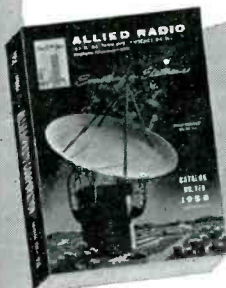
"... I find the AR-2 remarkably like the AR-1 in over-all sound coloration. Its cone tweeter is not the same, but there isn't much difference in sound. (It costs less, but that doesn't prove much.) On direct comparison, given a signal with plenty of bass component in the very bottom, you can tell the difference between the two in bass response. Most of the time, in ordinary listening, I am not aware of it at all.

"... I find AR-2, as with AR-1, remarkably clean and unobtrusive in its sound, easy on the ears for long-period listening, easy also to ignore in favor of the music itself. Either speaker has a way of simply fading into the surroundings (the size helps) leaving the music unattached and disembodied in the room. Excellent illusion!..."

Prices for Acoustic Research speaker systems, complete with cabinets, (AR-1 and AR-2) are \$89.00 to \$194.00. Size is "bookshelf." Literature is available from your local sound equipment dealer, or on request from:

**ACOUSTIC RESEARCH, INC.**  
24 Thorndike St., Cambridge 41, Mass.

for everything in **hi-fi**  
GET THE MONEY-SAVING 1958  
**ALLIED CATALOG**



featuring the world's largest stocks of systems & components

**free!**  
SEND FOR IT

Here's your complete money-saving guide to Hi-Fi. Own a fine custom quality Hi-Fi music system at no more than the cost of an ordinary phonograph. See dozens of ALLIED-Recommended complete Hi-Fi systems, plus the world's largest selection of components (amplifiers, tuners, changers, speakers, enclosures and accessories). Want to build-your-own?—see our exclusive Hi-Fi KNIGHT-KITS. For everything in Hi-Fi—for everything in Electronics, get the FREE 1958 ALLIED Catalog.

**ALLIED RADIO** AMERICA'S HI-FI CENTER

ALLIED RADIO CORP. Dept. 89-F8  
100 N. Western Ave., Chicago 80, Ill.

Send FREE 1958 ALLIED Catalog

Name \_\_\_\_\_

Address \_\_\_\_\_

City \_\_\_\_\_ Zone \_\_\_\_\_ State \_\_\_\_\_

**READERS' FORUM**

*Continued from page 15*

Gang could ever say "Tips for the Woodcrafter" has no place in AUDIOCRAFT. And what does one say to his neighbors when their darling little daughter rushes home screaming with the brand name of an EL34 etched in angry welts on her inquisitive fingers?

From my point of view, "Tips for the Woodcrafter" was the most interesting and helpful single feature in AUDIOCRAFT. Not every reader wants to, or dares to, build an amplifier; but every reader needs something to put his amplifier in, or on, or under, after he gets it. There should be room enough in AUDIOCRAFT for those readers who must consider not only sound, but sight as well. Give those who want watts the articles on electronics, but please give those of us who must keep peace "Tips for the Woodcrafter."

C. L. Patterson  
Durham, N.C.

*Thank you very much for your comments, Mr. Patterson. We are sorry to say, however, that it doesn't appear likely that this series will be restored. Of all the letters we have concerning the series, only three were in favor of continuing it. You will agree, we are sure, that this is not sufficient to warrant using some of our limited space for it.*

—ED.

**BOOK REVIEWS**

*Continued from page 6*

matching. It tells the whole story simply and effectively, with numerous illustrations. After reading it, you should know just what to look for when trying to set up an antenna system for maximum FM sensitivity.

Also quite handy is a full directory of all American FM stations listed by state and city giving the frequency, channel number, and effective radiated power of each. By itself it is worth the nominal cost of the entire booklet. (This booklet is available directly from the publisher.)

**Elements of Magnetic Tape Recording**

N. M. Haynes: pub. by Prentice-Hall, Inc., Englewood Cliffs, N.J.; 392 pages; \$7.95.

I know of no more thorough coverage of tape recorders and their underlying principles than this large reference work by a man who has been associated with magnetic recording for over 20 years.

The first section, on magnetic and electroacoustic fundamentals and nomenclature, is outstanding in its completeness and clarity. Instead of a textbookish discussion of magnetism, it is a clear

**PROFESSIONAL DIRECTORY**

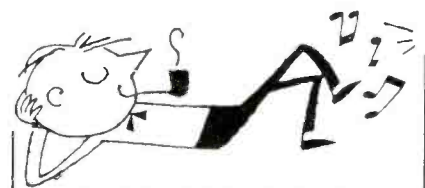


Get more FM stations with the world's most powerful FM Yagi Antenna systems.



Send 25¢ for booklet "Theme And Variations" containing FM Station Directory.

**APPARATUS DEVELOPMENT CO.**  
Wethersfield 9, Connecticut



**TAPE RECORDERS**  
EXCEPTIONAL VALUES  
**HI-FI COMPONENTS**  
NATIONAL BRANDS  
WRITE FOR FREE CATALOGUE  
**CARSTON** 215 VV E. 88 ST.  
NEW YORK 28, N.Y.

World Renowned **HARTLEY** Speakers  
Now Available to DEALERS, SERVICE-MEN, CUSTOM-INSTALLERS  
Lowest Franchise Requirements in the Hi-Fi Industry

WRITE - WIRE - PHONE  
**HARTLEY PRODUCTS CO.**  
521 East 162nd Street, New York 51, N. Y.  
LUdlow 5-4239

SIX BRANDENBURG CONCERTOS  
**BACH'S** greatest works in distinctive performances conducted by HERMANN SCHERCHEN exclusively on tape  
**Omegatape**

**YOU'LL BE SLIGHTLY AMAZED . . .**  
when you receive our reply. Write us your hi-fi requirements now—you'll be glad you did.  
**KEY ELECTRONICS CO.**  
120 Liberty St.  
N.Y. 6, N.Y.  
EVERgreen 4-6071



...the ultimate goal  
of the  
critical listener

**★ marantz**

*Audio Console*  
preamplifier, complete \$171\*

*Power Amplifier*  
\$198\*

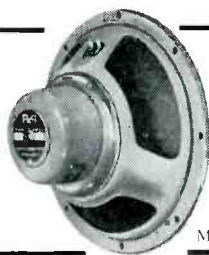
*Electronic Crossover*  
\$90\*

\*slightly higher west of  
the Mississippi

write for literature

**marantz company**  
25-14 Broadway Long Island City 6, N. Y.

*we are ashamed*



Made in England

*to mention the price!*

New **RA** Coaxial 700 Series Mark III

Some manufacturers are ashamed to mention the price because it is so high... we hesitate because it is so low! We know that most Audiophiles feel they have to make a big investment to get a quality speaker. They spend hours reading claims that look impressive on paper but fall down severely when translated into actual performance. All we ask is that you close your eyes and listen to the majesty of sound that floats out of the R & A coaxial phenomenon. Compare it with others... or your present speaker. Your eyes will pop when your dealer whispers the price to you — less than the cost of 2 good seats at the Met!

8", 10" and 12" Models — all with Alcomax III Anisotropic Magnet systems of 12,000 Gauss Flux Densities.

Buy it... try it... we back claims with a money back guarantee. At all hi-fi dealers.

**ERCONA CORPORATION**  
(Electronic Div.)

551 Fifth Ave., Dept. 64, New York, N. Y.  
In Canada: Astral Electric Co. Ltd.  
44 Danforth Road, Toronto 13

description of the natural forces of attraction and repulsion and the manner in which these forces have been put to work for storage of the sights and sounds of the world around us.

The principles of the recording and playback processes, the apparatus used, and typical circuits fill out the remainder of the book with plenty of factual information for the engineer and recording specialist.

The author has not included recording and microphone-placement techniques; he has devoted his efforts instead to background theory and practical circuits, apparatus, operation, and maintenance. In these subjects his score is very high.

### TAPE NEWS

*Continued from page 33*

block, however, is a characteristic of the medium itself.

Anyone who recalls his high-school general-science classes will remember the classic diagram of a bar magnet surrounded by its lines of magnetic force (the classic diagram is reproduced in Fig. 3). Now, suppose we move this magnet lengthwise across a scanning gap of a given width. If the magnet is long compared to the gap there will be little difference in the magnetic field at the two sides of the gap, at any given instant. But as the magnet is made shorter and shorter, the fields at the two sides of the gap become increasingly different until, when the magnet is entirely within the scanning range of the gap, the average field is zero.

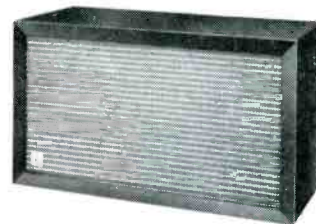
This is exactly what happens with recorded tones of very high frequency. Each magnetic domain on a length of tape consists of what appears (to the playback head) to be an individual bar magnet. The higher the frequency of the recorded tone, the shorter is each individual domain (or bar) until, at very high frequencies, the bars are so close together that their poles tend to negate each other within the playback head gap. This is the major reason why the higher the tape speed, the more extended the high-frequency response. At higher tape speeds, the recorded wave lengths are longer, and hence farther apart. This does not mean that it is impossible to get good high-frequency response at lower speeds; many 7½-ips recorders will reproduce sound above 12,000 cps with negligible loss, but because of the slower speeds and the shorter wave lengths involved, adjustment of bias current is very much more critical at 7½ and 3¾ ips than it is at 15 or 30 ips. High-frequency response sets the upper limit of the bias current, but we can see from Fig. 1 that distortion sets the lower limit. We'll leave that aspect of biasing for next month, however.

AR<sup>INC.</sup>

## Quote from THE Atlantic

(Conly's "They Shall Have Music")

"Heart of this Acoustic Research's AR-1 speaker system] is a conventional moving-coil cone speaker, but with its mechanical stiffness done away with. Instead, the cone is brought back into neutral position, after each impulse, by the elasticity of the air enclosed behind it in a hermetically sealed box, enormously firm and fortunately very small. The AR-1W woofer gives the cleanest bass response I ever have heard."



AR's patented air-suspension speakers, complete with cabinets (models AR-1 and AR-2) are priced from \$89 to \$194. Size is necessarily "book-shelf." Literature is available on request from:

**ACOUSTIC RESEARCH, INC.**  
24 Thorndike St., Cambridge 41, Mass.



TS4A-DLX

## GIBSON GIRL®... TAPE SPLICERS

Six Models from 1.75 to 55.00

● ROBINS GIBSON GIRL tape splicers assure you of PROFESSIONAL SPLICES IN SECONDS! They are the accepted standard of the professional and industrial users of recording tape because of their ease and reliability of operation and high standards of workmanship. The only splicers which cut and trim the splicing tape and tape edges with an indented trim cut, making THE SPLICE WITH THE GIBSON GIRL SHAPE.

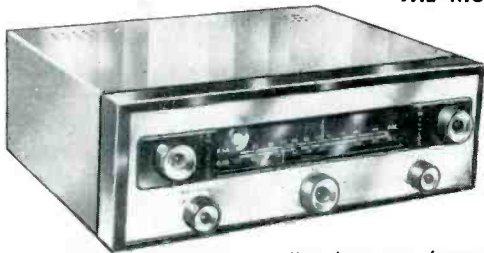
AT DEALERS EVERYWHERE  
Write for FREE Catalog of ROBINS' Phono and Tape Accessories!

**ROBINS**  
INDUSTRIES CORP.  
FLUSHING 54 · NEW YORK

# New! Years Ahead!

## LAFAYETTE STEREO TUNER KIT

### THE MOST FLEXIBLE TUNER EVER DESIGNED



Use it as a  
**Binaural-  
Stereophonic  
FM-AM tuner**

Use it as a **Dual-  
Monaural  
FM-AM tuner**

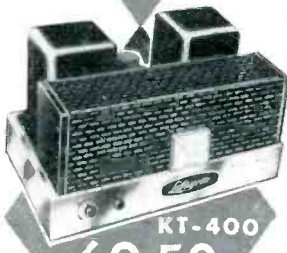
Use it as a  
**straight  
Monaural  
FM or AM  
tuner**



**KT-500 IN KIT FORM**  
**74.50**  
ONLY 7.45 DOWN  
7.00 MONTHLY



**KT-300**  
**39.50**  
IN KIT FORM



**KT-400**  
**69.50**  
IN KIT FORM

ONLY 6.95 DOWN  
7.00 MONTHLY

- Multiflex Output for New Stereo FM
- 11 Tubes (including 4 dual-purpose) + Tuning Eye + Selenium rectifier Provide 17 Tube Performance
- 10KC Whistle Filter • Pre-aligned IF's
- Tuned Cascade FM • 12 Tuned Circuits
- Dual Cathode Follower Output
- Separately Tuned FM and AM Sections
- Armstrong Circuit with FM/AFC and AFC Defeat
- Dual Double-Tuned Transformer Coupled Limiters.

More than a year of research, planning and engineering went into the making of the Lafayette Stereo Tuner. Its unique flexibility permits the reception of binaural broadcasting (simultaneous transmission on both FM and AM), the independent operation of both the FM and AM sections at the same time, and the ordinary reception of either FM or AM. The AM and FM sections are separately tuned, each with a separate 3-gang tuning condenser, separate flywheel tuning and separate volume control for proper balancing when used for binaural programs. Simplified accurate knife-edge tuning is provided by magic eye which operates independently on FM and AM. Automatic frequency control "locks in" FM signal permanently. Aside from its unique flexibility, this is, above all else, a quality high-fidelity tuner incorporating features found exclusively in the highest priced tuners.

FM specifications include grounded-grid triode low noise front end with triode mixer, double-tuned dual limiters with Foster-Seeley discriminator, less than 1% harmonic distortion, frequency response 20-20,000 cps  $\pm$  1/2 db, full 200 kc bandwidth and sensitivity of 2 microvolts for 30 db quieting with full limiting at one microvolt. AM specifications include 3 stages of AVC, 10 kc whistle filter, built-in ferrite loop antenna, less than 1% harmonic distortion, sensitivity of 5 microvolts, 8 kc bandwidth and frequency response 20-5000 cps  $\pm$  3 db.

The 5 controls of the KT-500 are FM Volume, AM Volume, FM Tuning, AM Tuning and 5-position Function Selector Switch. Tastefully styled with gold-brass escutcheon having dark maroon background plus matching maroon knobs with gold inserts. The Lafayette Stereo Tuner was designed with the builder in mind. Two separate printed circuit boards make construction and wiring simple, even for such a complex unit. Complete kit includes all parts and metal cover, a step-by-step instruction manual, schematic and pictorial diagrams. Size is 13 3/4" W x 10 1/8" D x 4 1/2" H. Shpg. wt., 18 lbs.

The new Lafayette Model KT-500 Stereo FM-AM Tuner is a companion piece to the Models KT-300 Audio Control Center Kit and KT-400 70-watt Basic Amplifier Kit and the "Triumvirate" of these 3 units form the heart of a top quality stereo hi-fi system.

**KT-500**.....Net **74.50**

### LAFAYETTE MASTER AUDIO CONTROL CENTER with BINAURAL CHANNEL AND DUAL VOLUME CONTROL

- Self-Powered • DC On All Filaments • 24 Positions of Equalization
- Tape Head Input, High Impedance
- Dual Cathode Follower Output Stages

This is not only the finest hi-fi preamp characterized by unmatched features, but it has been functionally designed to keep pace with the conversion of your present hi-fi system to binaural (Stereophonic) sound. Incorporates an extra channel and dual volume control for binaural reproduction. Features include DC on all tube filaments, negative feedback in every stage, dual cathode follower output stages and latest printed circuit construction. Less than 0.09% 1M distortion and less than 0.07 harmonic distortion at 1V. Hum and noise level better than 80 db below 3V. Uniformly flat frequency response over entire audible spectrum. 7 inputs for every type of phono, tuner or tape. Tasteful styling, brilliantly executed. Size 12 3/4 x 9 1/8 x 3 3/4". Shpg. wt., 10 1/2 lbs.

**KT-300**—Lafayette Master Audio Control Kit Complete with cage and detailed assembly instructions.....Net **39.50**

**LT-30**—Same as above completely wired and tested with cage and instruction manual.....Net **59.50**

### DELUXE 70 WATT BASIC AMPLIFIER

- Conservatively Rated At 70 Watts • Inverse Feedback
- Variable Damping • Metered Balance And Bias Adjust Controls
- Available In Kit and Wired Form

Here's ultra-stability in a 70 watt basic power amplifier employing highest quality components conservatively rated to insure performance and long life. Features matched pair KT 88's and wire range linear Chicago output transformer, variable damping control, meter for bias and balance and gold finish chassis. Frequency response 10-100,000 cps  $\pm$  1 db. Hum and noise 90 db below full output. 1M distortion less than 1 1/2% at 70 watts, less than 0.3% below 30 watts. Harmonic distortion less than 2% at 70 watts from 20 to 20,000 cps  $\pm$  1 db. Output impedance 4, 8 and 16 ohms. Handsome decorative cage perforated for proper ventilation. Size 14 1/2 x 10 x 7 3/8" including cage and knobs. Shpg. wt., 40 lbs.

**KT-400**—Lafayette 70 watt Deluxe Basic Amplifier Kit complete with cage and detailed assembly instructions.....Net **69.50**

**LA-70**—Same as above completely wired and tested with cage and instruction manual.....Net **94.50**

**Lafayette Radio**

165-08 LIBERTY AVE.  
JAMAICA 33, N. Y.

DEPT  
AC-F

Send FREE LAFAYETTE Catalog 305

Name .....

Address .....

City..... Zone.... State.....

CUT OUT  
AND MAIL  
TODAY



## ADVERTISING INDEX

Key No.	Advertiser	Page
1	Acoustic Research, Inc.	14, 41, 46, 47
2	Alfran Distributors	41
3	Allied Radio Corp.	46
4	Amperex Electronic Corp.	40
5	Apparatus Development Co.	46
6	Arkay Radio Kits, Inc.	43
7	Audio Equipment Co.	42
8	Audio Fidelity Records	1, Back Cover
9	Audiophile's Bookshelf	2
10	Bozak, R. T., Sales Co.	44
11	Carston Studios	46
12	Dynaco Inc.	45
13	EICO	5
14	Electro-Sonic Laboratories	33
15	Ercona Corp.	47
16	Fisher Radio Corp.	Inside Front Cover
17	Hartley Products Co.	46
18	Heath Co.	7-11
19	International Pacific Recording Corp.	46
20	JansZen speakers	33
21	Key Electronics Co.	46
22	Lafayette Radio	48
23	Lansing, James B., Sound, Inc.	Inside Back Cover
24	Marantz Co.	47
20	Neshaminy Electric Co.	33
19	Omegatape	46
	Professional Directory	46
15	R & A speaker	47
25	Rek-O-Kut Co.	40
26	Robins Industries Corp.	47
27	Sonotone Corp.	42
	Traders' Marketplace	45



# Information service for audiocraft readers



We've made it easier than ever for you to secure prompt additional information about products advertised or mentioned editorially in this issue.

### HERE'S ALL YOU DO:

1. Tear out one of the two lower cards along its perforated edges.
2. Fill in your name and address in the space provided at the top of the card. Please type, or print in ink, if at all possible.
3. To get additional information about products advertised in this issue, look up the advertiser's name in the index on the page facing this one. In the column at the left will be found the advertiser's current key number. Simply circle this number in the central section of your card. Do this for each advertiser in whose products you are interested.
4. If you want more information about products described in our Audionews department, or mentioned in other editorial sections, print the product names and the numbers of the pages on which they appear in the spaces provided in the lower section of the card.
5. Drop the card in the nearest mail box. We'll do the rest.

Note that two cards are supplied. You can keep one as a spare, for possible later use, or let a friend use the extra card.

Use this service—everything, even the postage, is free. A special service to Audiocraft readers.

THESE CARDS  
FOR THIS ISSUE ONLY

*Use this service*



**BUSINESS REPLY CARD**  
FIRST CLASS PERMIT NO. 62, SEC. 34.9, P. L. & R., GREAT BARRINGTON, MASS.

**audiocraft**

POST OFFICE BOX 600  
GREAT BARRINGTON, MASS.

N 6-8



**AUDIOCRAFT  
READERS'  
SERVICE**

● PLEASE TYPE OR PRINT ●

NAME .....  
STREET & NO. ....  
CITY ..... ZONE ..... STATE .....

ADVERTISED PRODUCTS	1	2	3	4	5	6	7	8	9	10	11	12	13	14	15
	16	17	18	19	20	21	22	23	24	25	26	27	28	29	30
(See Key Nos. in index on page at left)	31	32	33	34	35	36	37	38	39	40	41	42	43	44	45
	46	47	48	49	50	51	52	53	54	55	56	57	58	59	60

PRODUCTS MENTIONED EDITORIALY (Including AUDIONEWS)	PRODUCT .....	PAGE .....
	PRODUCT .....	PAGE .....
	PRODUCT .....	PAGE .....
	PRODUCT .....	PAGE .....
	PRODUCT .....	PAGE .....

**AUDIOCRAFT  
READERS'  
SERVICE**

● PLEASE TYPE OR PRINT ●

NAME .....  
STREET & NO. ....  
CITY ..... ZONE ..... STATE .....

ADVERTISED PRODUCTS	1	2	3	4	5	6	7	8	9	10	11	12	13	14	15
	16	17	18	19	20	21	22	23	24	25	26	27	28	29	30
(See Key Nos. in index on page at left)	31	32	33	34	35	36	37	38	39	40	41	42	43	44	45
	46	47	48	49	50	51	52	53	54	55	56	57	58	59	60

PRODUCTS MENTIONED EDITORIALY (Including AUDIONEWS)	PRODUCT .....	PAGE .....
	PRODUCT .....	PAGE .....
	PRODUCT .....	PAGE .....
	PRODUCT .....	PAGE .....
	PRODUCT .....	PAGE .....









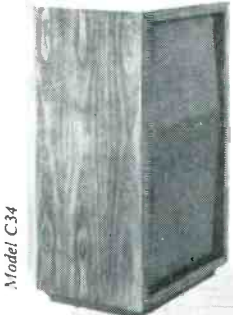
**BUILD  
YOUR  
OWN JBL  
ACOUSTICAL  
ENCLOSURE  
FROM  
DETAILED  
PRODUCTION  
PRINTS**

*get the greatest thrill*

*high fidelity can give you...*



THE HARKNESS Model C40



Model C34

full range, rich, clean sound from precision JBL Signature loudspeakers mounted in an acoustical enclosure you make with your own hands. Reward your painstaking craftsmanship with speakers designed for the perfectionist. JBL Signature units, such as the Model D130, are acknowledged by foremost authorities to be the finest made. The D130 is the only 15" extended range speaker made with a 4" voice coil. It is unsurpassed in efficiency and transient-handling ability. The JBL Model 175DLH gives you smooth, crisp reproduction of frequencies above 1200 cps. The 175DLH is equipped with an acoustical lens, an exclusive JBL development, for even distribution of highs over a 90° solid angle. Any speaker, if it is to give you accurate bass reproduction, must be mounted in a properly engineered acoustical enclosure.

**BUILD A JBL BACK-LOADED FOLDED HORN**

Designed specifically for the JBL D130, the JBL back-loaded folded horn is probably the most widely-used enclosure of its type ever manufactured. The cabinet is relatively small—less than 40" in its greatest dimension—and yet, ingeniously folded within, is an exponentially tapered horn path with an effective length of six feet. The horn adds an octave of accurate, clean, deep down bass. There are two versions of the horn: Model C34 stands vertically and may be placed in a corner, although corner placement is not required. Model C40, the Harkness, is a low-boy folded horn that is independent of wall or corner for proper functioning. Prints are designed for direct, simple, clear instruction, and time-saving construction. Cost is three dollars per set.

**USE THIS FORM TO ORDER YOUR PLANS**

Now you can build this most popular JBL enclosure from detailed production prints which include a complete list of materials, all dimensions, and instructions for assembly.

**JAMES B. LANSING SOUND, INC.**  
3249 Casitas Avenue, Los Angeles 39, California  
Gentlemen:

Enclosed find \$ \_\_\_\_\_ for  
 \_\_\_\_\_ Model C34 Production Prints @ \$3.00 per set.  
 \_\_\_\_\_ Model C40 Production Prints @ \$3.00 per set.

Please print clearly or type your name and complete address:  
 Name \_\_\_\_\_  
 Address \_\_\_\_\_



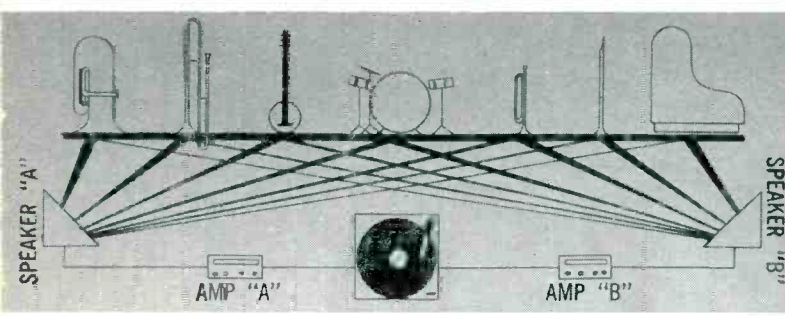
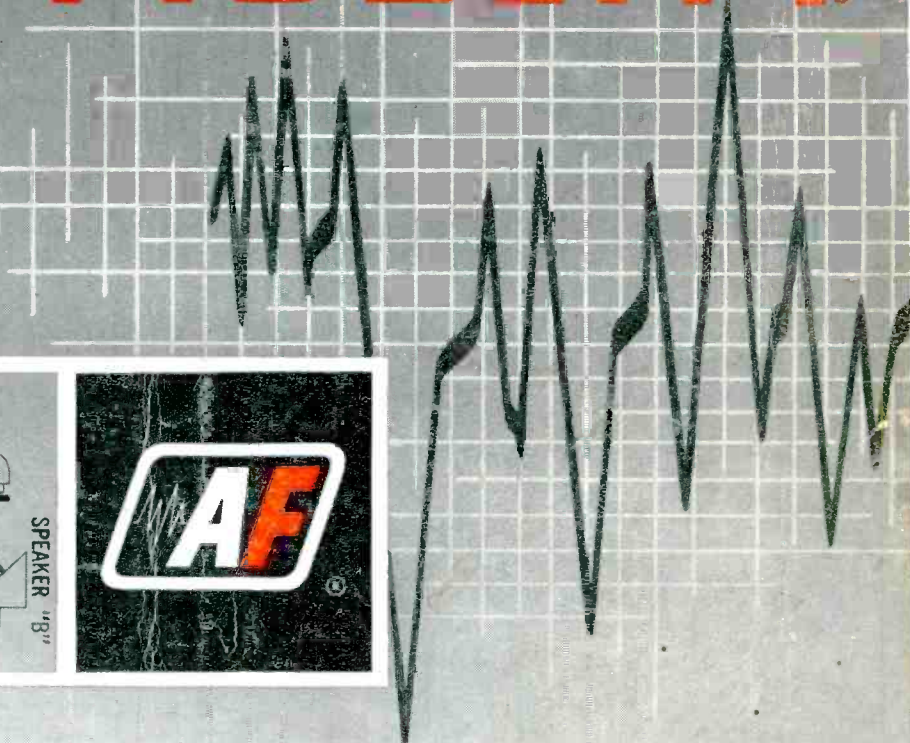


# STEREODISC\*

a new dimension in  
recorded sound by...

# AUDIO FIDELITY.

*the world's first  
compatible stereophonic  
long-play record...*



REPRODUCTION OF STEREO RECORDING FROM STEREODISC\*  
\*NOTE PERFECT REPRODUCTION OF INSTRUMENT PLACEMENT

Truly a pioneer in the recording industry — AUDIO FIDELITY now brings a new dimension in recorded sound right into your listening room on a record... the AUDIO FIDELITY STEREODISC\*!

Hear for the very first time on a record unsurpassed stereophonic reproduction of the total recordable frequency spectrum with guaranteed distortion-free reproduction, perfect balance, maximum dynamics, maximum signal, purest definition, highest brilliance, and startling realism plus exciting entertainment!

WRITE FOR FREE CATALOG • Dept. AC6 • AUDIO FIDELITY, INC. • 770 Eleventh Avenue, New York 19, New York

\*REG. APP. FC